

# სამრეწველო საკუთრების ოფიციალური ბიულეტენი

გამოგონებები

სასარგებლო მოდელები

დიზაინები

სასაქონლო ნიშნები



საქართველოს ინტელექტუალური  
საკუთრების ეროვნული ცენტრი

**საკპატიენტი**

**SAKPATENTI**

NATIONAL INTELLECTUAL PROPERTY  
CENTER OF GEORGIA

[www.sakpatenti.gov.ge](http://www.sakpatenti.gov.ge)

გამოქვეყნების თარიღი – 2021 02 25

**3(559)**

# საერთაშორისო კოდეზი გიზლიობრაფიული მონაცემების იდენტიფიკაციისათვის

## გამოგონებადი, სასარგებლო მოდელები

- (10) - ექსპერტიზაგაელოლი განაცხადის გამოქვეყნების ნომერი
- (11) - პატენტის ნომერი და სახეობის კოდი
- (21) - განაცხადის სარეგისტრაციო ნომერი
- (22) - განაცხადის შეტანის თარიღი
- (23) - საგამოფენო პრიორიტეტის თარიღი ან აღრიხდელი პრიორიტეტის მქონე განაცხადის შეტანის თარიღი და, თუ შესაძლებელია, განაცხადის ომერი
- (24) - თარიღი, რომლიდანაც იწყება პატენტის მოქმედება
- (31) - საპრიორიტეტო განაცხადის ნომერი
- (32) - საპრიორიტეტო განაცხადის შეტანის თარიღი
- (33) - კოდი ქვეყნისა ან რეგიონული ორგანიზაციისა, რომლის უწყებამაც მიანიჭა ნომერი საპრიორიტეტო განაცხადს
- (44) - დამცავი საბუთის ჯერ ამქონე, მაგრამ ექსპერტიზაგაელოლი განაცხადის გამოქვეყნების თარიღი და ბიულეტენის ნომერი
- (45) - რეგისტრაცია გავლოლი საპატენტო საბუთის გამოქვეყნების თარიღი
- (51) - საერთაშორისო საპატენტო კლასიფიკაციის ინდექსი
- (54) - გამოგონების დასახელება
- (57) - რეფერატის ტექსტი
- (60) - სრულ ექსპერტიზაგაელოლი გამოგონებაზე უცხოური საპატენტო უწყების მიერ გაცემული დამცავი საბუთის ნომერი, თარიღი, რომლიდანაც იწყება ამ დამცავი საბუთის მოქმედება, და კოდი ქვეყნისა ან რეგიონული ორგანიზაციისა, რომლის უწყებამაც გასცა ეს დამცავი საბუთი
- (62) - უფრო აღრიხდელი განაცხადის ნომერი და, თუ შესაძლებელია, ნარდგენის თარიღი გამოცემული განაცხადის შემთხვევაში
- (71) - განმცხადებლის სახელი, გვარი (ქვეყნის კოდი)
- (72) - გამომგონებლის სახელი, გვარი (ქვეყნის კოდი)
- (73) - პატენტმფლობელის სახელი, გვარი (ქვეყნის კოდი), მისამართი
- (74) - ნარმომადგენლის ან პატენტრწმუნებულის სახელი, გვარი
- (85) - საერთაშორისო განაცხადის ეროვნული ფაზის დანების თარიღი
- (86) - საერთაშორისო განაცხადის ნომერი და შეტანის თარიღი
- (87) - საერთაშორისო განაცხადის გამოქვეყნების ნომერი და თარიღი
- (94) - დაცვის დამატებითი მონობით გაგრძელებული პატენტის მოქმედების ვადის ამონურვის თარიღი

## ლიზინები

- (10) - განაცხადის გამოქვეყნების ნომერი
- (11) - პატენტის ნომერი და სახეობის კოდი ან რეგისტრაციის ნომერი
- (15) - რეგისტრაციის თარიღი/პატენტის გაგრძელების თარიღი
- (18) - პატენტის ან რეგისტრაციის მოქმედების ვადის გასვლის სავარაუდო თარიღი
- (21) - განაცხადის ნომერი
- (22) - განაცხადის შეტანის თარიღი
- (23) - საგამოფენო პრიორიტეტის თარიღი ან აღრიხდელი პრიორიტეტის მქონე განაცხადის შეტანის თარიღი და, თუ შესაძლებელია, განაცხადის ნომერი
- (24) - თარიღი, რომლიდანაც იწყება პატენტის მოქმედება
- (28) - ღიზინების რაოდენობა განაცხადში
- (30) - საპრიორიტეტო მონაცემები (განაცხადის ნომერი, განაცხადის შეტანის თარიღი და ორასოიანი კოდი იმ ორგანიზაციის იდენტიფიკაციისათვის, სადაც იყო ნარდგენილი საპრიორიტეტო განაცხადი)
- (31) - საპრიორიტეტო განაცხადის ნომერი
- (32) - საპრიორიტეტო განაცხადის შეტანის თარიღი
- (33) - კოდი ქვეყნისა ან რეგიონული ორგანიზაციისა, რომლის უწყებამაც მიანიჭა ნომერი საპრიორიტეტო განაცხადს
- (34) - ისმო-ს სტანდარტის (მთ.3) შესაბამის ორასოიანი კოდი იმ ორგანიზაციის იდენტიფიკაციისათვის, სადაც იყო ნარდგენილი საპრიორიტეტო განაცხადი
- (44) - ღიზინის გამოქვეყნების თარიღი და ბიულეტენის ნომერი (პირველი პუბლიკაცია)
- (45) - საერთაშორისო ბიუროს მიერ დარეგისტრირებული ღიზინის გამოქვეყნების თარიღი და ბიულეტენის ნომერი
- (51) - ღიზინების საერთაშორისო კლასიფიკაცია (ლოკარნოს კლასიფიკაციის კლასი და ქვეკლასი)
- (54) - ღიზინის დასახელება
- (55) - ღიზინის გამოსახულება
- (57) - ღიზინის არსებითი ნიშნების აღწერა, ფერის ჩათვლით
- (58) - ყველა სახის ცვლილებების შესახებ რეგისტრში ჩანანერის შეტანის თარიღი
- (62) - აღრიხდელი განაცხადის, რეგისტრაციის ან საბუთის ნომერი და, თუ შესაძლებელია, ნარდგენის თარიღი, გამოცალკეებული განაცხადის შემთხვევაში
- (71) - განმცხადებლის სახელი, გვარი (ქვეყნის კოდი), მისამართი
- (72) - ავტორის სახელი, გვარი ან დასახელება (ქვეყნის კოდი)
- (73) - პატენტმფლობელის სახელი, გვარი (ქვეყნის კოდი), მისამართი
- (74) - ნარმომადგენლის სახელი, გვარი და მისამართი
- (81) - შესაბამისი მონაწილე მხარეები:
  - II. მონაწილე მხარეები, აღნიშნული 1960 წლის აქტის თანახმად
  - III. მონაწილე მხარეები, აღნიშნული 1999 წლის აქტის თანახმად
- (85) - მფლობელის მუდმივი საცხოვრებელი ადგილი
- (86) - მფლობელის მოქალაქეობა
- (87) - მფლობელის საცხოვრებელი ადგილი
- (88) - ქვეყანა, სადაც მფლობელს აქვს ნამდვილი და მოქმედი სამრეწველო ან საეკონომიკური საწარმო

## სასაქონლო ნიშნები

- (111) - რეგისტრაციის ნომერი
- (151) - რეგისტრაციის თარიღი
- (156) - რეგისტრაციის ვადის გაგრძელების თარიღი
- (181) - რეგისტრაციის ვადის გასვლის სავარაუდო თარიღი
- (186) - ვადის გაგრძელების ვადის სავარაუდო თარიღი
- (141) - რეგისტრაციის მოქმედების ვადის გაუქმების თარიღი
- (210) - განაცხადის ნომერი
- (220) - განაცხადის შეტანის თარიღი
- (230) - საგამოფენო მონაცემები
- (260) - ნომერი განაცხადისა, რომელზედაც გამოტანილია ექსპერტიზის დადებითი გადაწყვეტილება რეგისტრაციის შესახებ (გამოქვეყნების ნომერი)
- (310) - პირველი განაცხადის ნომერი
- (320) - პირველი განაცხადის შეტანის თარიღი
- (330) - პირველი განაცხადის მიმღები ეროვნული ან რეგიონული უწყების ან ორგანიზაციის საიდენტიფიკაციო კოდი
- (511) - საქონლისა და მომსახურების საერთაშორისო კლასიფიკაცია სასაქონლო ნიშნის რეგისტრაციისათვის და/ან კლასიფიკირებული საქონლისა და/ან მომსახურების ჩამონათვალი
- (526) - დისკლამაცია
- (531) - სასაქონლო ნიშნის გამოსახულებითი ელემენტების აღწერა სასაქონლო ნიშნების გამოსახულებითი ელემენტების საერთაშორისო კლასიფიკაციის (ვენის კლასიფიკაცია) მიხედვით
- (540) - ნიშნის გამოსახულება
- (550) - სასაქონლო ნიშნის ტიპი ან სახეობა
- (551) - მითითება, რომ ნიშანი არის კოლექტიური, სასერტიფიკაციო ან საგარანტიო
- (554) - სამგანზომილებიანი (მოცულობითი) ნიშანი
- (580) - განაცხადსა და ნიშნის რეგისტრაციისთან დაკავშირებული ყველა სახის ცვლილებაზე ჩანანერის შეტანის თარიღი
- (591) - ინფორმაცია განცხადებულ ფერებზე
- (731) - განმცხადებლის სახელი და მისამართი
- (732) - მფლობელის სახელი და მისამართი
- (740) - ნარმომადგენლის სახელი და მისამართი
- (750) - მიმონერის მისამართი
- (770) - ცვლილებამდე განმცხადებლის ან მფლობელის სახელი და მისამართი უფლების გადაცემის შემთხვევაში
- (771) - ცვლილებამდე განმცხადებლის ან მფლობელის სახელი და მისამართი უფლების გადაცემის გარეშე
- (791) - ლიცენზიატის სახელი და მისამართი
- (793) - ლიცენზიის პირობები და/ან შეზღუდვაზე მინიშნება (ლიცენზიის სახე, სალიცენზიო ხელშეკრულების ნომერი, სალიცენზიო ხელშეკრულების თარიღი, სალიცენზიო ხელშეკრულების მოქმედების ვადა)
- (800) - სასაქონლო ნიშნის რეგისტრაციის მონაცემები ნიშნების საერთაშორისო რეგისტრაციის მადრიდის ხელშეკრულებასთან დაკავშირებული პროტოკოლის მიხედვით (საერთაშორისო რეგისტრაციის ნომერი)
- (852) - ნაწილობრივ გაუქმებული საქონლის/მომსახურების ჩამონათვალი
- (891) - შემდგომი გარეცემების თარიღი

	გამოგონებადისა და სასარგებლო მოდელების საერთაშორისო კლასიფიკაციის ინდექსები
(21) AP 0000 000000	გამოგონებაზე განაცხადის ნომერი
(10) AP 0000 0000 A	გამოგონებაზე განაცხადის გამოქვეყნების ნომერი (პირველი პუბლიკაცია)
(11) P 0000 0000 B	გამოგონების პატენტის ნომერი (მეორე პუბლიკაცია)
(21) API 0000 000000	შემოტანილი პატენტზე განაცხადის ნომერი
(11) PI 0000 0000 A	შემოტანილი პატენტის ნომერი (პირველი პუბლიკაცია)
(21) AU 0000 000000	სასარგებლო მოდელებზე განაცხადის ნომერი
(10) AU 0000 000 U	სასარგებლო მოდელებზე განაცხადის გამოქვეყნების ნომერი (პირველი პუბლიკაცია)
(11) U 0000 000 Y	სასარგებლო მოდელების პატენტის ნომერი (მეორე პუბლიკაცია)
(21) AD 0000 000000	ღიზინზე განაცხადის ნომერი
(10) AD 0000 000 S	ღიზინზე განაცხადის გამოქვეყნების ნომერი (პირველი პუბლიკაცია)
(11) D 0000 000 S	რეგისტრირებული ღიზინი
M	სასაქონლო ნიშანი
(210) AM 0000 000000	განაცხადის ნომერი
(260) AAM 0000 00000 A	განაცხადის გამოქვეყნების ნომერი
(111) M 0000 0000 R	რეგისტრაციის ნომერი
MMM0000 0000 Rn	მომდენო ვადით რეგისტრაციის ნომერი, სადაც n=1, 2, 3...
M 0000 0000 R(P)	რეგისტრაციის ნომერი ნიშანზე უფლების ნაწილობრივ გადაცემისას
*	საქპატენტის სააპელაციო პალატის გადაწყვეტილების შემდეგ გამოქვეყნებული განაცხადის ნომერი
**	სასამართლოს გადაწყვეტილების შემდეგ გამოქვეყნებული განაცხადის ნომერი

# სამრეწველო საკუთრების ოფიციალური ბიულეტენი

გამოგონებები

სასარგებლო მოდელები

დიზაინები

სასაქონლო ნიშნები

# შ ი ნ ა ა რ ს ი

<b>გამოქვეყნებული ობიექტები</b> .....	3
<b>გამოგონებები</b>	
• განაცხადები, რომლებზეც გამოტანილია გადაწყვეტილება პატენტის გაცემის შესახებ .....	4
• გამოგონების პატენტები .....	7
<b>სასარგებლო მოდელები</b>	
• განაცხადები, რომლებზეც გამოტანილია გადაწყვეტილება პატენტის გაცემის შესახებ .....	9
• სასარგებლო მოდელის პატენტები .....	13
<b>დიზაინები</b>	
• რეგისტრირებული დიზაინები .....	14
• დიზაინები, რომლებიც რეგისტრირებულია საერთაშორისო ბიუროში საქართველოს ტერიტორიაზე უფლებათა გავრცელების მოთხოვნით .....	15
<b>სასაქონლო ნიშნები</b>	
• ეროვნული პროცედურით შემოტანილი განაცხადები, რომლებზეც გამოტანილია გადაწყვეტილება რეგისტრაციის შესახებ .....	31
• რეგისტრირებული სასაქონლო ნიშნები .....	46
• დაჩქარებული პროცედურით რეგისტრირებული სასაქონლო ნიშნები .....	52
• საერთაშორისო სასაქონლო ნიშნები, რომლებზეც გამოტანილია გადაწყვეტილება დაცვის მინიჭების შესახებ .....	58
• საერთაშორისო სასაქონლო ნიშნები, რომლებსაც მიენიჭათ დაცვა საქართველოში .....	233
<b>ოფიციალური შეტყობინებები</b>	
<b>გამოგონებები</b>	
• პატენტების მოქმედების აღდგენა .....	243
• პატენტების გაუქმება აღდგენის უფლებით .....	243
• პატენტების მოქმედების აღდგენის ვადის ამოწურვა .....	244
• პატენტების მოქმედების ვადის ამოწურვა .....	245
<b>სასარგებლო მოდელები</b>	
• პატენტების მოქმედების აღდგენა .....	245
• პატენტების გაუქმება აღდგენის უფლებით .....	246
• პატენტის მოქმედების აღდგენის ვადის ამოწურვა .....	246
• უფლების გადაცემა .....	247
<b>დიზაინები</b>	
• დიზაინის რეგისტრაციის გაუქმება .....	248
• საერთაშორისო დიზაინების რეგისტრაციის მოქმედების გაუქმება .....	248
<b>სასაქონლო ნიშნები</b>	
• რეგისტრაციის მოქმედების ვადის გაგრძელება .....	249
• უფლებების სრული გადაცემა .....	253
• მფლობელის სახელის და/ან მისამართის ცვლილება .....	255
• სასაქონლო ნიშნების რეგისტრაციის გაუქმება .....	259
<b>სისტემური საძიებლები</b>	
გამოგონებები .....	260
სასარგებლო მოდელები .....	261
დიზაინები .....	263
სასაქონლო ნიშნები .....	264

# ბამოქვეყნებული ობიექტები

## ბამოგონებები

- ბანაცხადები, რომლებზეც ბამოტანილია გადაწყვეტილება პატენტის გაცემის შესახებ: 15110; 15344; 15272; 13922; 15001
- პატენტები: 7225-7228

## სასარგებლო მოდელები

- ბანაცხადები, რომლებზეც ბამოტანილია გადაწყვეტილება პატენტის გაცემის შესახებ: 15285-15289; 15331; 15217
- პატენტები: 270, 271

## ღიზანებები

- რეგისტრირებული ღიზანებები: 878-881
- ღიზანები, რომლებიც რეგისტრირებულია სავაჭრო ბიუროში საქართველოს ტერიტორიაზე უფლებათა გავრცელების მოთხოვნით 211740; 211615; 211783; 209213; 209111; 209204

## სასაქონლო ნიშნები

- ეროვნული პროცედურით შემოტანილი ბანაცხადები, რომლებზეც ბამოტანილია გადაწყვეტილება რეგისტრაციის შესახებ: 102358\*; 104328; 105234\*; 105661, 105662; 108514; 108953, 108954; 108960; 108962; 108964, 108965; 109009; 109013-109018; 109021-109023; 109025; 109027; 109034, 109035; 109041; 109046; 109052; 109054; 109115; 109120; 109123; 109208; 109210, 109211; 109227; 109293-109295; 109300; 109381, 109382
- რეგისტრირებული სასაქონლო ნიშნები: 33669-33698; 33708-33726
- დამატებული პროცედურით რეგისტრირებული სასაქონლო ნიშნები: 33658-33668; 33699-33707
- სავაჭრო ბიუროს სასაქონლო ნიშნები, რომლებზეც ბამოტანილია გადაწყვეტილება დაცვის მიზნების შესახებ: 105478; 105589; 106487\*; 107739; 107970; 108001; 108003-108008; 108010, 108011; 108013-108017; 108028; 108035-108038; 108043; 108074-108104; 108106; 108136-108139; 108145-108149; 108155, 108156; 108160; 108162-108174; 108186-108189; 108191-108197; 108199, 108200; 108202-108205; 108244-108265; 108267-108274; 108278; 108288; 108341, 108342; 108346-108349; 108361-108365; 108373; 108375-108379; 108381-108383; 108436; 108444; 108454-108457; 108460-108462; 108464; 108466; 108474; 108476; 108541-108543; 108545, 108546; 108550, 108551; 108557-108563; 108565-108569; 108644-108646; 108699; 108723, 108724; 108726; 108728, 108729; 108731-108733; 108790-108794; 108832; 108836; 108925-108928; 108990-108993; 109055, 109056; 109083-109086; 109145, 109146; 109150; 109182; 109184-109187; 109265-109269
- სავაჭრო ბიუროს სასაქონლო ნიშნები, რომლებსაც მიენიჭათ დაცვა საქართველოში: 94618; 99145; 102867; 102982; 105389; 106476; 106488-106490, 106533, 106534; 106547, 106548; 106561; 106563; 106569-106571; 106573-106576; 106579; 106619-106621; 106623-106626; 106637; 106685-106695; 106697-106701; 106705-106707; 106709, 106710; 106738-106740; 106744, 106745; 106835-106841; 106843-106847; 106849; 106860-106869; 106888, 106889; 106906; 106986; 106999; 107006, 107007; 107026-107028; 107069-107075; 107089, 107090; 107146; 107186; 107188-107191; 107193-107195; 107324, 107325; 107327; 107419; 107421; 107423; 107427-107429; 107431; 107542-107547; 107592; 107603; 107635; 107640; 107642; 107735-107738; 107740-107742; 107744

# ბამოგონებები

## ბანაცხადები, რომლებზეც ბამოტანილია გადაწყვეტილება პატენტის გაცემის შესახებ

გადაწყვეტილების გასაჩივრება შესაძლებელია საქპატენტის სააპელაციო პალატაში გამოქვეყნებულიდან 3 თვის ვადაში ან მცხეთის რაიონული სასამართლოს ადმინისტრაციულ საქმეთა კოლეგიაში 1 თვის ვადაში (მის.: ქ. მცხეთა, სამხედროს ქ. №17).

### ბანყოფილება A

#### A 61

- (10) AP 2021 15110 A (51) Int. Cl. (2006)  
A 61 K 31/4427  
A 61 K 31/497  
A 61 P 3/00  
C 07 D 401/14  
C 07 D 405/14  
C 07 D 413/14  
C 07 D 471/04  
C 07 D 487/04

(21) AP 2017 15110 (22) 2017 12 01

(31) 62/435,533

(32) 2016 12 16

(33) US

(71) პფაიზერ ინკ. (US)

235 ისტ 42ნდ სტრიტ, ნიუ-იორკი,  
ნიუ-იორკი 10017, აშშ (US)

(72) სკოტ ვ. ბაგლი (US);

მეთიუ ს. დოულინგ (US);

მარკ ე. ფლანაგან (US);

კენტარო ფუტატსუგი (US);

დევიდ ა. გრიფით (US);

კიმ ჰარდ (US);

გაჯენდრა ინგლე (US);

ვენჩუა ჯიაო (US);

კრის ლიმბერაკის (US);

დევიდ ვ. პოტროვსკი (US);

როჯერ ბ. რუგერი (US);

ჯონ მ. კურტო (US);

დევიდ ჯეიმს ედმონდს (US);

გარი ერიკ ასპნეს (US);

ალან მ. მათიოვეტუ (US)

(74) შალვა გვარამაძე

(85) 2019 06 14

(86) PCT/IB2017/057577, 2017 12 01

(54) GLP-1 რეცეპტორის ანტიagonისტები  
და მათი ბამოქნება

(57) ბამოგონება უზრუნველყოფს ბენზიმიდაზოლების და 4-აზა, 5-აზა, 7-აზა და 4,7-დიაზა-ბენზიმიდაზოლების 6-კარბონმქავეებს ფორმულით (I)

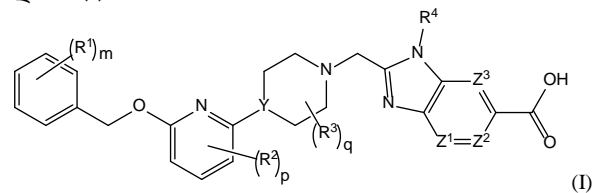

როგორც GLP-1R აგონისტებს, აღნიშნული ნაერთების მიღების ხერხებს და ამ ნაერთების გამოყენებას დაავადებების ან დარღვევების სამკურნალოდ, მათ შორის, დისლიპიდემიის, სიმსუქნის, პრე-დიაბეტის, ფიბროზის.

მუხლები: 3 დამოუკიდებელი

22 დამოკიდებული

(10) AP 2021 15344 A (51) Int. Cl. (2006)

A 61 K 39/12

A 61 P 31/14

(21) AP 2020 15344 (22) 2020 05 22

(71) გიორგი გოგბაძე (GE)

გრიბოედოვის ქ. 21, 0108, თბილისი,  
საქართველო (GE)

(72) გიორგი გოგბაძე (GE)

(54) კორონავირუსული დაავადების 2019

(COVID-19) საპროფილაქტიკო

საშუალება

(57) პოლიომიელიტის საწინააღმდეგო ვაქცინას იყენებენ კორონავირუსული დაავადების 2019 (COVID-19) საპროფილაქტიკოდ.

მუხლები: 1 დამოუკიდებელი

4 დამოკიდებული







## ბამოგონების პატენტები

### ბანყოფილება A

#### A 01

- (11) P 2021 7225 B (51) Int. Cl. (2006)  
A 01 G 17/00
- (10) AP 2020 15155 A (44) 18(550)/2020
- (21) AP 2019 15155
- (22) 2019 07 26
- (24) 2019 07 26
- (73) ალექსანდრე ხარიბეგაშვილი (GE)  
კომუნალურის ქ. 2, 2200, თელავი,  
საქართველო (GE);  
ვლადიმერ მირუაშვილი (GE)  
ვ. დოლიძის ქ. 132, 0115, თბილისი,  
საქართველო (GE);  
მანანა კველიშვილი (GE)  
ალაზნის გამზ. 18, 2200, თელავი,  
საქართველო (GE);  
ლევან შავაძე (GE)  
ქ. 9/37, სოფ. შალაური, 2200, თელავი,  
საქართველო (GE);  
მზია ღაღოლიშვილი (GE)  
დუმბაძის ქ. 20/8, 2200, თელავი,  
საქართველო (GE);  
თელავის სახელმწიფო უნივერსიტეტი (GE)  
ქართული უნივერსიტეტის ქ. 1, 2200,  
თელავი, საქართველო (GE)
- (72) ალექსანდრე ხარიბეგაშვილი (GE);  
ვლადიმერ მირუაშვილი (GE);  
მანანა კველიშვილი (GE);  
ლევან შავაძე (GE);  
მზია ღაღოლიშვილი (GE)
- (54) ვაზის შაპალი

#### A 61

- (11) P 2021 7227 B (51) Int. Cl. (2006)  
A 61 K 31/4168  
A 61 P 3/10  
A 61 P 9/00  
A 61 P 3/04  
C 07 D 233/91
- (10) AP 2020 15132 A (44) 21(553)/2020
- (21) AP 2018 15132
- (22) 2018 01 05

- (24) 2018 01 05
- (31) 62/443,244; 62/581,355; 62/585,326
- (32) 2017 01 06; 2017 11 03; 2017 11 13
- (33) US; US; US
- (86) PCT/US2018/012491, 2018 01 05
- (73) რიუს ფარმასეუტიკალს ინკ. (US)  
706ზ ფორესტ სტრიტ, შარლოტსვილ,  
ვირჯინია 22903, აშშ (US)
- (72) შაჰარიარ მ. ხან (US)
- (74) შალვა გვარამაძე
- (54) ფენილის ახალი წარმოებულები

### ბანყოფილება E

#### E 04

- (11) P 2021 7228 B (51) Int. Cl. (2006)  
E 04 H 6/04
- (10) AP 2020 14905 A (44) 15(547)/2020
- (21) AP 2018 14905
- (22) 2018 10 16
- (24) 2018 10 16
- (73) სერგო ჯორბენაძე (GE)  
თაბუკაშვილის ქ. 46, 0160, თბილისი,  
საქართველო (GE);  
მალხაზ ცისკარიშვილი (GE)  
ნუცუბიდის ქ. 17, ბ. 30, 0177, თბილისი,  
საქართველო (GE)
- (72) სერგო ჯორბენაძე (GE);  
მალხაზ ცისკარიშვილი (GE)
- (54) მქანნიშვილი ელემენტორული  
ავტოფარმისი ვერტიკალურ და  
ჰორიზონტალურ სიბრტყეებში  
მოძრაობი საკიდელები



# სასარბელო მოდელები

## ბანაცხადები, რომლებიც გამოტანილია გადაწყვეტილება კატენის ბაცემის შესახებ

გადაწყვეტილების გასაჩივრება შესაძლებელია საქპატენტის სააპელაციო პალატაში გამოქვეყნებიდან 3 თვის ვადაში ან მცხეთის რაიონული სასამართლოს ადმინისტრაციულ საქმეთა კოლეგიაში 1 თვის ვადაში (მის.: ქ. მცხეთა, სამხედროს ქ. №17).

### ბანყოფილება A

#### A 47

(10) AU 2021 15285 U (51) Int. Cl. (2006)  
A 47 G 19/14  
A 47 J 27/21  
A 47 J 36/06

(21) AU 2020 15285 (22) 2020 02 19

(31) 2019131380

(32) 2019 10 04

(33) RU

(71) ობშესტვო ს ოგრანიჩენიოი

ოტვეტსტვენოსტიუ „პოლარის

ინტერნეიშნლ ლიმიტედ“(RU)

ულ. ელექტროდნაია, დ. 8, სტრ. 2,

მოსკოვი, 111524, რუსეთის

ფედერაცია (RU)

(72) ვიქტორ იგორევიჩ რიჟოვ (RU)

(74) შალვა გვარამაძე

(54) ჩაიღნის თავსახური

(57) ჩაიღნის თავსახური შეიცავს კორპუსს 1, რომელშიც შესრულებულია წყლის ჩასასხმელი ღიობი, ღიობის საფარს 2, რომელიც შესრულებულია ამწევი ზამბარის 3 მქონე, კორპუსის ფუძეზე 4 დამაგრებულ ვერტიკალურ ღერძზე 5 განთავსებული ჩამკეტი სარქელის 6 სახით. ღიობის საფარს, წყლის ჩასასხმელ ღიობზე წყლის წონის ზემოქმედებით აქვს ზამბარის შეკუმშვის შედეგად ქვევით გადაადგილების, ხოლო წყლის მიწოდების შეწყვეტის შემდეგ, ზამბარის დრეკადობის ძალის გავლენით, საწყის მდგომარეობაში დაბრუნების შესაძლებლობა.

მუხლები: 1 დამოუკიდებელი

3 დამოკიდებული

ფიგურა: 2

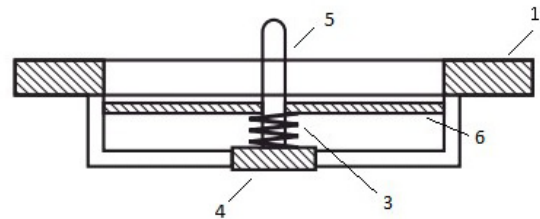

ფიგ. 2

(10) AU 2021 15286 U (51) Int. Cl. (2006)  
A 47 G 19/14  
A 47 J 27/21  
A 47 J 36/06

(21) AU 2020 15286 (22) 2020 02 19

(31) 2019131382

(32) 2019 10 04

(33) RU

(71) ობშესტვო ს ოგრანიჩენიოი

ოტვეტსტვენოსტიუ „პოლარის

ინტერნეიშნლ ლიმიტედ“(RU)

ულ. ელექტროდნაია, დ. 8, სტრ. 2,

მოსკოვი, 111524, რუსეთის

ფედერაცია (RU)

(72) ვიქტორ იგორევიჩ რიჟოვ (RU)

(74) შალვა გვარამაძე

(54) ჩაიღნის თავსახური

(57) ჩაიღნის თავსახური შეიცავს კორპუსს 1 და მასში შესრულებულ წყლის ჩასასხმელ ღიობს, ღიობის საფარს 2, რომელიც შესრულებულია ელასტიკური მასალის, ნაწილებიანი ყელის მქონე, ძაბრისებრი ფორმის სარქელის 3 სახით, რომლის ყელის ნაწილები საწყის მდგომარეობაში მიბჯენილია ერთმანეთზე ღიობის ჩასაკეტად. სარქელის ნაწილებს აქვს წყლის ჩასასხმელ ღიობზე წყლის წონის ზემოქმედებით ერთმანეთისაგან დაშორების, ხოლო წყლის მიწოდების შეწყვეტის შემდეგ, დრეკადობის ძალის გავლენით, საწყის მდგომარეობაში დაბრუნების შესაძლებლობა.

მუხლები: 1 დამოუკიდებელი  
3 დამოკიდებული  
ფიგურა: 4

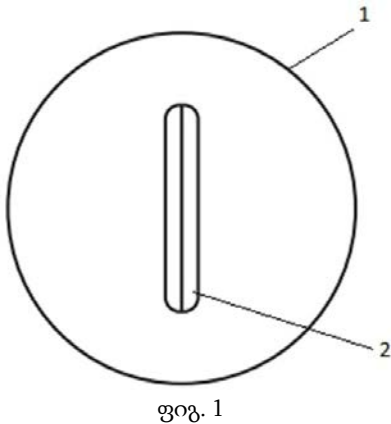

ფიგ. 1

(10) AU 2021 15287 U (51) Int. Cl. (2006)  
A 47 G 19/14  
A 47 J 36/06  
A 47 J 27/21

(21) AU 2020 15287 (22) 2020 02 19

(31) 2019131385

(32) 2019 10 04

(33) RU

(71) ობშესტვო ს ოგრანიჩენიოი

ოტვეტსტვენოსტიუ „პოლარის

ინტერნეიშნლ ლიმიტედ“(RU)

ულ. ელექტროდნაია, დ. 8, სტრ. 2,

მოსკოვი, 111524, რუსეთის

ფედერაცია (RU)

(72) ვიქტორ იგორევიჩ რიჟოვ (RU)

(74) შალვა გვარამაძე

(54) ჩაიღნის თაჰსახჰში

(57) ჩაიდნის თავსახური შეიცავს კორპუსს 1 და მასში შესრულებულ წყლის ჩასასხმელ ლიობს, ლიობის საფარს 2, უკუქცევითი ზამბარის სახით შესრულებულ ჩამკეტ მექანიზმს 3, რომელსაც აქვს საფარზე დრეკადი ამძრავი ძალით ზემოქმედების შესაძლებლობა საფარის საწყის მდგომარეობაში დასაბრუნებლად და წყლის ჩასასხმელი ლიობის საფარით ჩასაკეტად. კორპუსი, ასევე, შეიცავს წყლის ჩასასხმელი ლიობის ფარგლებში განლაგებულ ურთიერთპერპენდიკულარულ თამასებს 4. აღნიშნული საფარი შესრულებულია ცალკეული n-სექციების სახით, რომლებიდანაც თითოეულს აღნიშნული ურთიერთპერპენდიკულარული თამასებიდან ერთზე აქვს ინდივიდუალური სამაგრი.

მუხლები: 1 დამოუკიდებელი

3 დამოკიდებული

ფიგურა: 2

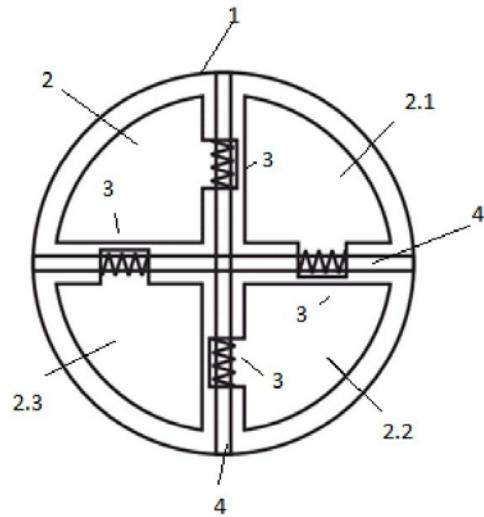

ფიგ. 1

(10) AU 2021 15288 U (51) Int. Cl. (2006)  
A 47 G 19/14  
A 47 J 27/21  
A 47 J 36/06

(21) AU 2020 15288 (22) 2020 02 19

(31) 2019131387

(32) 2019 10 04

(33) RU

(71) ობშესტვო ს ოგრანიჩენიოი

ოტვეტსტვენოსტიუ „პოლარის

ინტერნეიშნლ ლიმიტედ“(RU)

ულ. ელექტროდნაია, დ. 8, სტრ. 2,

მოსკოვი, 111524, რუსეთის

ფედერაცია (RU)

(72) ვიქტორ იგორევიჩ რიჟოვ (RU)

(74) შალვა გვარამაძე

(54) ჩაიღნის თაჰსახჰში

(57) ჩაიდნის თავსახური შეიცავს კორპუსს 1 და მასში შესრულებულ წყლის ჩასასხმელ ლიობს, ლიობის საფარს 2, უკუქცევითი ზამბარის სახით შესრულებულ ჩამკეტ მექანიზმს და წყლის ჩასასხმელი ლიობის ფარგლებში, ჰორიზონტალურად განლაგებულ, სულ მცირე, ერთ თამასას 4. აღნიშნული საფარი შესრულებულია ცალკეული სექციების (2.1,2.2...2.n) სახით, რომლებიდანაც თითოეულს აქვს ინდივიდუალური სამაგრი აღნიშნულ თამასაზე.

მუხლები: 1 დამოუკიდებელი

3 დამოკიდებული

ფიგურა: 4

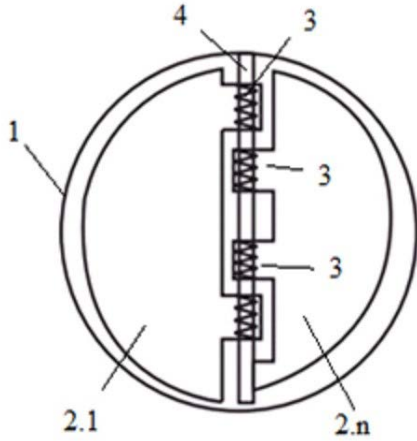

ფიგ. 1

ფიგურა: 3

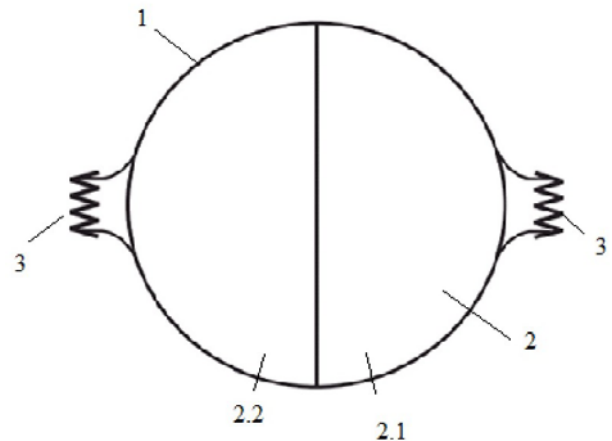

ფიგ. 1

(10) AU 2021 15289 U (51) Int. Cl. (2006)  
A 47 G 19/14  
A 47 J 36/06  
A 47 J 27/21

(21) AU 2020 15289 (22) 2020 02 19  
(31) 2019131389  
(32) 2019 10 04  
(33) RU

(71) ობშესტვო ს ოგრანიჩენიოი  
ოტვეტსტვენოსტიუ „პოლარის  
ინტერნეიშნლ ლიმიტედ“(RU)  
ულ. ელექტროდნაია, დ. 8, სტრ. 2,  
მოსკოვი, 111524, რუსეთის  
ფედერაცია (RU)

(72) ვიქტორ იგორევიჩ რიჟოვ (RU)

(74) შალვა გვარამაძე

(54) ჩაიღნის თავესახეშორი

(57) ჩაიდნის თავსახური შეიცავს კორპუსს 1 და მასში შესრულებულ წყლის ჩასასხმელ ლიობს, ლიობის საფარს 2, უკუქცევითი ზამბარის სახით შესრულებულ ჩამკეტ მექანიზმს 3, რომელსაც აქვს საფარზე დრეკადი ამძრავი ძალით მოქმედების შესაძლებლობა საფარის გადასადგილებლად და წყლის ჩასასხმელი ლიობის საფარით ჩასაკეტად. აღნიშნული საფარი შესრულებულია ცალკეული n-სექციების სახით, რომლებიდანაც თითოეულს აქვს ჩაიდნის თავსახურის კორპუსთან ინდივიდუალური სამაგრი.

მუხლები: 1 დამოუკიდებელი  
5 დამოკიდებული

## განყოფილება F

### F 16

(10) AU 2021 15331 U (51) Int. Cl. (2006)  
F 16 D 65/06  
F 65 D 69/00

(21) AU 2018 15331 (22) 2018 05 28

(31) 2017137561

(32) 2017 10 26

(33) RU

(71) საჯარო სააქციო საზოგადოება  
„ურალის ავტო-ტექსტილის ნაკეთობების  
ქარხანა“(RU)  
პლენხანოვის ქ. 64, ასბესტი,  
სვერდლოვსკის რეგიონი, 624269,  
რუსეთის ფედერაცია (RU)

(72) ვიტალი ვალერის ძე რომანენკო (RU);  
ანდრეი გერმანის ძე კუზმინი (RU)

(74) ლარისა ამირხანიანი

(85) 2020 05 08

(86) PCT/RU2018/000340, 2018 05 28

(54) სარკინიგზო სატრანსპორტო  
საშუალების სამუხრუჭე ხუნდი

(57) სამუხრუჭე ხუნდი შეიცავს კომპოზიციურ ფრიქციულ ელემენტს, ლითონის კარკასს და თუჯის სადგმელს, სადაც სადგმელის მასა შეადგენს ხუნდის მასის 18%-30%-ს.

მუხლები: 1 დამოუკიდებელი

## ბანყოფილება G

### G 01

(10) AU 2021 15217 U (51) Int. Cl. (2006)

G 01 J 3/28

(21) AU 2019 15217 (22) 2019 11 12

(71) სსიპ „მიკრო და ნანოელექტრონიკის  
ინსტიტუტი“ (GE)

ი. ჭავჭავაძის გამზ. ქ. 13, 0179, თბილისი,  
საქართველო (GE)

(72) ზურაბ ჯიბუტი (GE);

რევაზ მელქაძე (GE);

ამირან ბიბილაშვილი (GE);

ლადო ჯიბუტი (GE)

(74) ზურაბ ჯიბუტი

(54) ოპტიკური მოწყობილობა

პოლიმრომატორი

(57) წარმოდგენილია მოწყობილობა, რომელიც შეიცავს კორპუსში მოთავსებულ ნათურებს, ქულერს, საკვლევი ნიმუშების სამაგრს, ნათურების სამაგრებს შესრულებულს ნათურებსა და საკვლევ ნიმუშს შორის მანძილის ცვლილების შესაძლებლობით, ოპტიკური ფილტრების ნაკრებსა და ოპტიკური ფილტრების სამაგრს.

მუხლები: 1 დამოუკიდებელი

3 დამოკიდებული

ფიგურა: 2

---

## სასარბებლო მოდელების კატეგორიები

## ბანყოფილება A

## A 61

- (11) U 2021 2071 Y (51) Int. Cl. (2006)  
A 61 N 5/00
- (10) AU 2020 14972 U (44) 19(551)/2020
- (21) AU 2018 14972
- (22) 2018 12 21
- (24) 2018 12 21
- (73) ვახტანგ ლუაშვილი (GE)  
ლ. ასათიანის ქ. 40, 0160, თბილისი,  
საქართველო (GE);  
მზია ლუაშვილი (GE)  
უშანგი ჩხეიძის ქ. 6, ბ. 5, 0160, თბილისი,  
საქართველო (GE)
- (72) ვახტანგ ლუაშვილი (GE);  
მზია ლუაშვილი (GE)
- (74) შალვა გვარამაძე
- (54) მოწყობილობა კანის დაავადებების  
სამკურნალოდ

- მარინე ავალიანი (GE)  
დ. ჭონქაძის ქ. 10ა, ბ. 13-14, 0108, თბილისი,  
საქართველო (GE);  
თამარ პეტრიაშვილი (GE)  
სოფ. ზემო ნიქოზი, 1417, გორი,  
საქართველო (GE);  
ივანე ჯავახიშვილის სახელობის თბილი-  
სის სახელმწიფო უნივერსიტეტი (GE)  
ი. ჭავჭავაძის გამზ. 1, 0179, თბილისი,  
საქართველო (GE);  
შოთა რუსთაველის ეროვნული სამეცნიე-  
რო ფონდი (GE)  
მ. ალექსიძის ქ. 1, 0193, თბილისი,  
საქართველო (GE)
- (72) ელენა შაფაქიძე (GE);  
მარინე ნადირაშვილი (GE);  
ვერა მაისურაძე (GE);  
იოსებ გეჯაძე (GE);  
მარინე ავალიანი (GE);  
თამარ პეტრიაშვილი (GE)
- (54) ბიოკოლიმერული მზიის მასალის  
შემადგენლობა

## ბანყოფილება C

## C 04

- (11) U 2021 2070 Y (51) Int. Cl. (2006)  
C 04 B 7/00
- (10) AU 2020 15116 U (44) 20(552)/2020
- (21) AU 2019 15116
- (22) 2019 06 18
- (24) 2019 06 18
- (73) ელენა შაფაქიძე (GE)  
ი. ჭავჭავაძის I შეს., კორპ. 6, ბ. 7, 0179,  
თბილისი, საქართველო (GE);  
მარინე ნადირაშვილი (GE)  
ხეთაგუროვის ქ. 6, 0102, თბილისი,  
საქართველო (GE);  
ვერა მაისურაძე (GE)  
ასათიანის ქ. 10ა, ბ. 36, 0186, თბილისი,  
საქართველო (GE);  
იოსებ გეჯაძე (GE)  
ი. ჭავჭავაძის გამზ. I შეს. 6, ბ. 7, თბილისი,  
საქართველო (GE);

# დიზაინები

## რეგისტრირებული დიზაინები

(11) D 2021 879 S	(51) 09-03	მოსკოვის ოლქი, 140126, რუსეთის ფედერაცია (RU)
(10) AD 2020 1156 S	(44) 2020 11 10 №21	(72) მაქსიმ სერგეევიჩ პონომარიოვი (RU)
(21) AD 2020 1156		(74) ალექსანდრე გეგეჟკორი (GE)
(22) 2020 05 08		(54) ეტიკეტი
(24) 2020 05 08		
(28) 4		
(18) 2025 05 08		
(73) გოდივა ბელჯიუმ ბ.ვ.ბ.ა./ს.პ.რ.ლ. (BE) ვეარსენსტრატი 42 D, 1070, ანდერლეჰტი, ბელგია (BE)		(11) D 2021 881 S (51) 19-08
(72) ალი ულკერი (BE)		(10) AD 2020 1154 S (44) 2020 11 10 №21
(74) თამაზ შილაკაძე (GE)		(21) AD 2020 1154
(54) შოკოლადის კოლოფი		(22) 2020 05 06
		(24) 2020 05 06
		(28) 7
		(18) 2025 05 06
		(31) 2019504993; 2019504993; 2019504993; 2019504993; 2019504993; 2019504993; 2019504993
(11) D 2021 878 S (51) 09-05		(32) 2019 11 08; 2019 11 08; 2019 11 08; 2019 11 08; 2019 11 08; 2019 11 08; 2019 11 08
(10) AD 2020 1155 S (44) 2020 11 10 №21		(33) RU; RU; RU; RU; RU; RU; RU
(21) AD 2020 1155		(73) შეზღუდული პასუხისმგებლობის საზოგადოება „ერმან“ (RU) რამენსკის რაიონი, დასახლ. რაოს 15, მოსკოვის ოლქი, 140126, რუსეთის ფედერაცია (RU)
(22) 2020 05 08		(72) მაქსიმ სერგეევიჩ პონომარიოვი (RU)
(24) 2020 05 08		(74) ალექსანდრე გეგეჟკორი (GE)
(28) 4		(54) ეტიკეტი
(18) 2025 05 08		
(73) გოდივა ბელჯიუმ ბ.ვ.ბ.ა./ს.პ.რ.ლ. (BE) ვეარსენსტრატი 42 D, 1070, ანდერლეჰტი, ბელგია (BE)		
(72) ალი ულკერი (BE)		
(74) თამაზ შილაკაძე (GE)		
(54) შოკოლადის საფუთავი		
(11) D 2021 880 S (51) 19-08		
(10) AD 2020 1153 S (44) 2020 11 10 №21		
(21) AD 2020 1153		
(22) 2020 05 06		
(24) 2020 05 06		
(28) 5		
(18) 2025 05 06		
(31) 2019504994; 2019504994; 2019504994; 2019504994; 2019504994		
(32) 2019 11 08; 2019 11 08; 2019 11 08; 2019 11 08; 2019 11 08		
(33) RU; RU; RU; RU; RU		
(73) შეზღუდული პასუხისმგებლობის საზოგადოება „ერმან“ (RU) რამენსკის რაიონი, დასახლ. რაოს 15,		



**ლიზანიები, რომლებიც რეგისტრირებულია საქართველოს  
ბიუროში საქართველოს ტერიტორიაზე უფლებათა გავრცელების  
მოთხოვნით**

გადაწყვეტილების გასაჩივრება შესაძლებელია საქპატენტის სააპელაციო პალატაში გამოქვეყნებიდან 3 თვის ვადაში ან მცხეთის რაიონული სასამართლოს ადმინისტრაციულ საქმეთა კოლეგიაში 1 თვის ვადაში (მის.: ქ. მცხეთა, სამხედროს ქ. №17).

- (11) DM/211 740                   (51) 10-02
- (15) 2020 12 11                 (44) 52/2020 (2020 12 25)
- (22) 2020 12 11
- (28) 5
- (30) No1: 15.06.2020; 008005334; EM; No2: 15.06.2020; 008005334; EM; No3: 15.06.2020; 008005334; EM; No4: 15.06.2020; 008005334; EM; No5: 15.06.2020; 008005334; EM
- (73) Daniel Wellington AB  
Vasa Gatan 12, 111 20 Stockholm (SE)
- (85) –
- (86) EM
- (87) –
- (88) EM
- (89) EM
- (81) III. AM, IS, VN, MD, TJ, BW, MN, ST, GH, SR, TR, KH, TN, KR, JP, KP, CH, IL, UA, BN, AL, MX, TM, AZ, ME, BZ, MC, SG, NA, OA, NO, RS, BA, OM, GE, US, MK, CA, LI, KG, WS, SM, SY, RW, RU, EG
- (72) Filip Tysander  
Vasagatan 12, 111 20, Stockholm (SE)
- (74) AWA Sweden AB  
Box 45086, 104 30 Stockholm (SE)
- (54) 1.-5. Wrist watch
- (55)

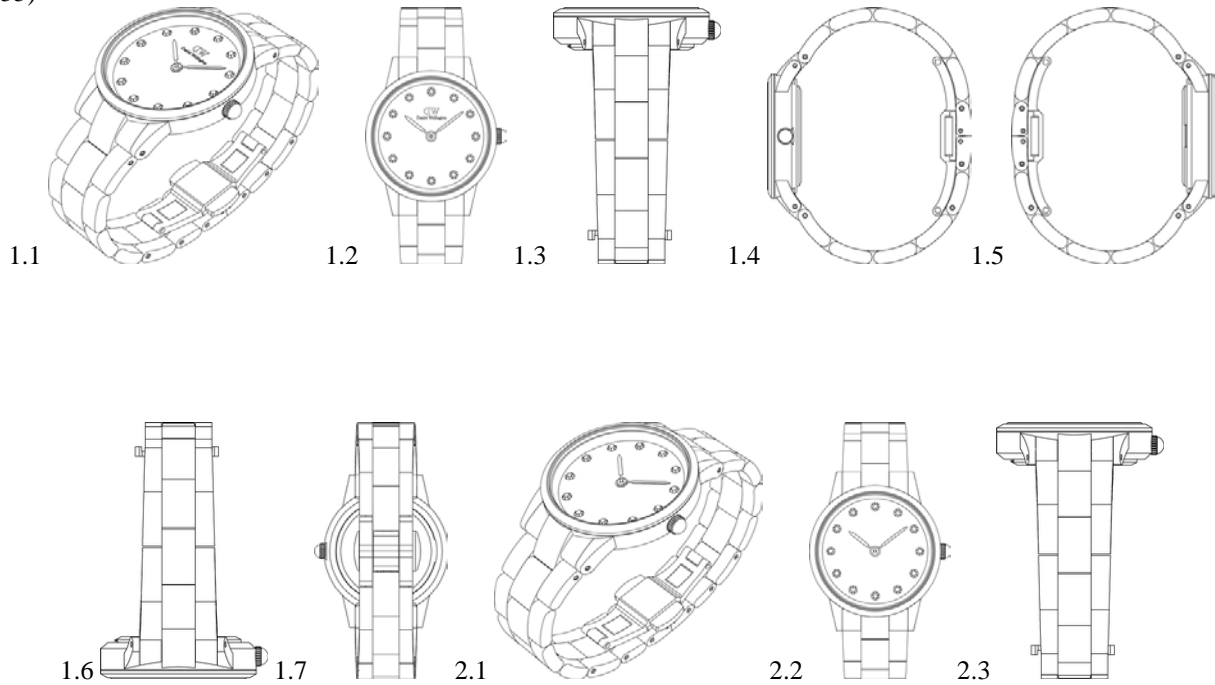

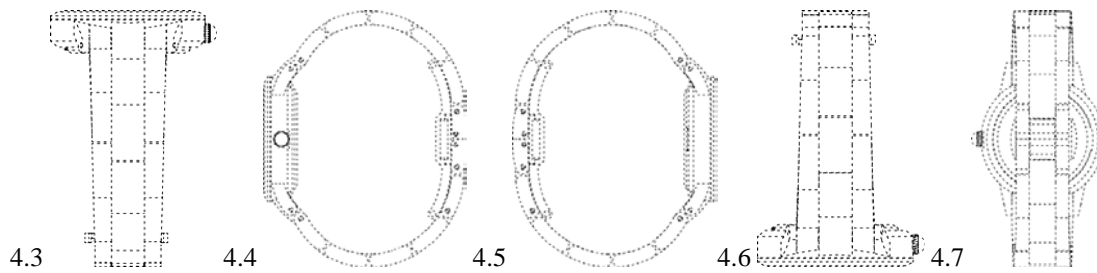
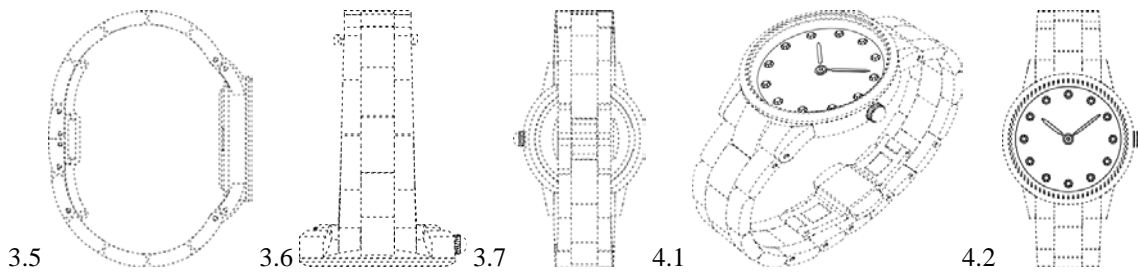
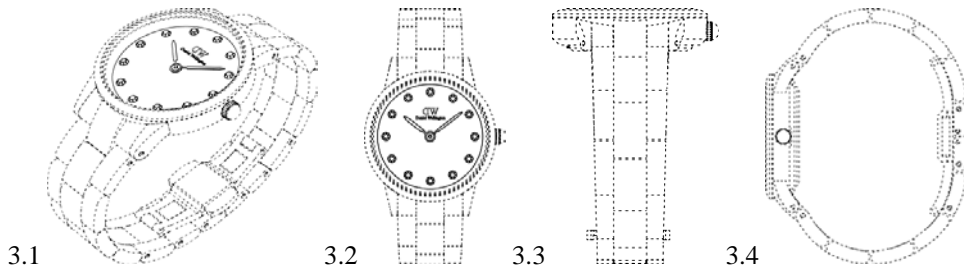
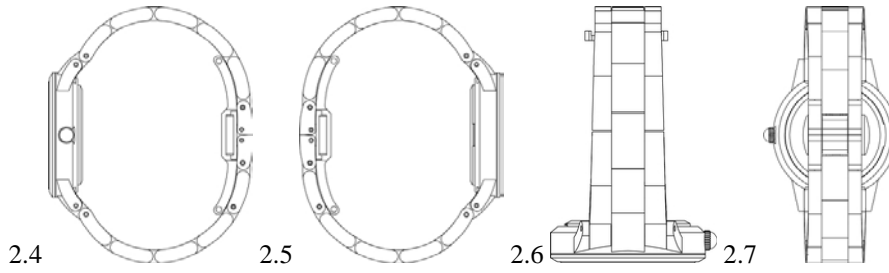







- (11) DM/211 783
- (15) 2020 11 19
- (22) 2020 11 19
- (28) 1
- (30) No1: 26.06.2020; 008024780; EM
- (73) Adp Gauselmann GmbH  
Mercur-Allee 1 - 15, 32339 Espelkamp (DE)
- (85) DE
- (86) DE
- (87) DE
- (88) DE
- (89) DE
- (81) III. BA, GE, MK, MX, GB, SM, CH, RU
- (72) Jens Uwe Themann  
Geistwall 37, 32312, Lübbecke (DE)
- (54) 1. Housing for gaming machine
- (55)

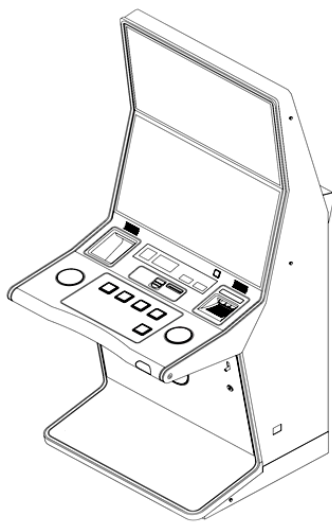

1.1

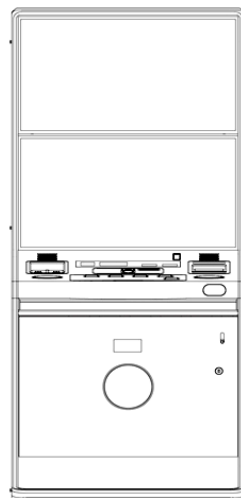

1.2

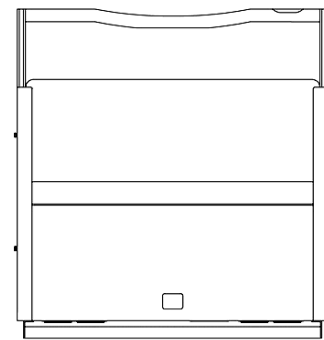

1.3

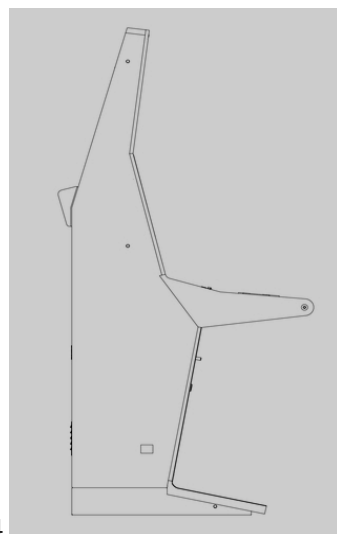

1.4

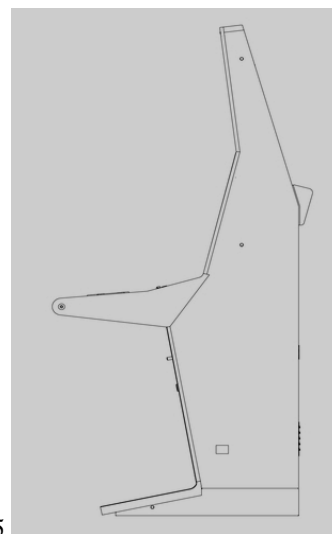

1.5

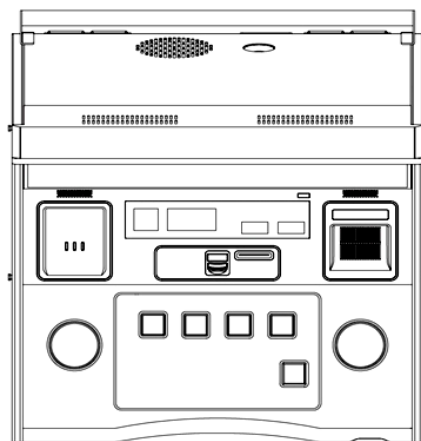

1.6

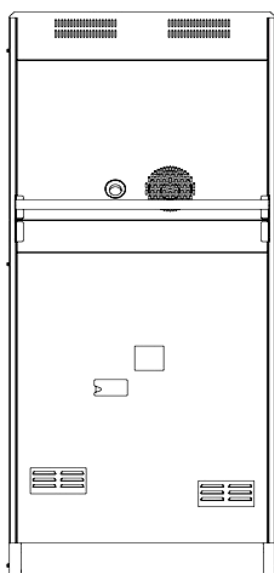

1.7

- (11) DM/209 213 (51) 09-01  
 (15) 2020 07 06 (44) 01/2021 (2021 01 08)  
 (22) 2020 07 06  
 (28) 1  
 (73) Ganten (Shenzhen) Food And Beverage Group Co., Ltd.  
 Via Dei Bossi 4, 20121 Milano (IT)  
 (85) –  
 (86) IT  
 (87) –  
 (88) EM, IT  
 (89) EM  
 (81) IL, GR, GA, MA, SN, SR, IT, BJ, NE, CI, ML III, ES, HU, IS, MN, PL, GB, LT, KR, JP, FR, BN, AL,  
 MX, HR, LV, TM, BZ, MC, SG, NA, DE, BA, MK, US, LI, KG, WS, RU, FI, EG, AM, VN, MD, TJ, BW,  
 GH, ST, TR, KH, TN, CH, KP, IL, UA, AZ, ME, SI, BX, OA, NO, RS, EE, OM, GE, CA, RO, SM, EM, DK,  
 SY, BG, RW  
 (72) Jing Liang Zhou  
 2-3 Floor, No. 3 Factory, High Science And Technology Park, Longzhu Industrial, North Ring Road, Nansh,  
 518055, Shenzhen (CN)  
 (74) SHENZHEN STANDARD PATENT & TRADEMARK AGENT LTD.  
 Room 810-815, Sunshine Golf Building, No. 7008 Shennan Boulevard Futian District, 518040 Shenzhen (CN)  
 (54) 1. Beverage bottle  
 (55)

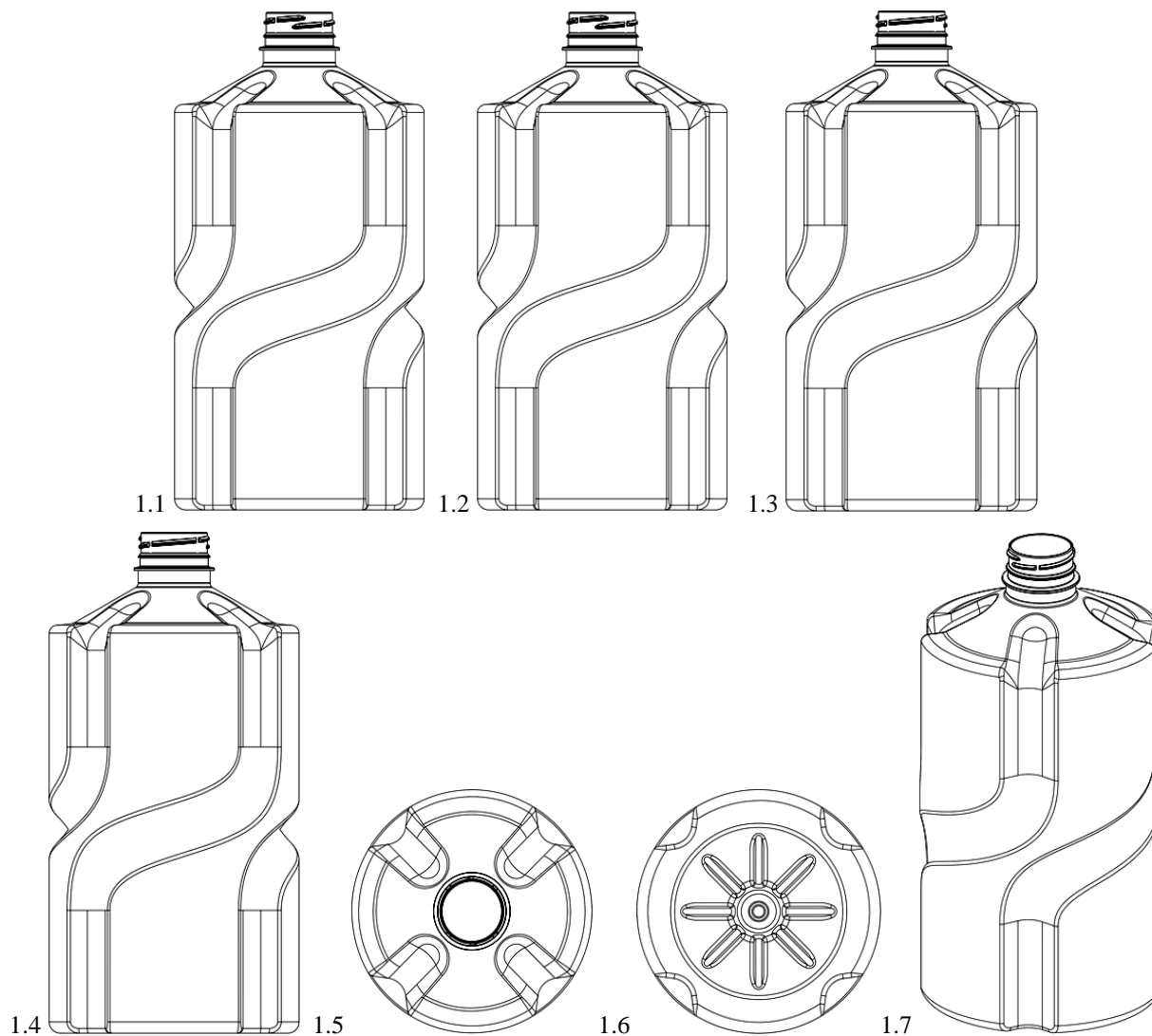



- (11) DM/209 111 (51) 11-01  
 (15) 2020 07 02 (44) 01/2021 (2021 01 08)  
 (22) 2020 07 02  
 (28) 9  
 (73) HARRY WINSTON SA  
 Chemin Du Tourbillon 8, 1228 Plan-les-Ouates (CH)  
 (85) CH  
 (86) CH  
 (87) CH  
 (88) CH  
 (89) CH  
 (81) II. MA III. UA, AM, AL, AZ, ME, BZ, MD, MC, SG, NO, MN, BA, GE, TR, MK, OM, CA, LI, KG, GB, TN, EM, CH  
 (72) 1-2 Dominique RIVIERE  
 C/o Harry Winston Inc., 718 Fifth Avenue, 10019, New York, NY (US);  
 3;6 Delphine ABDOURAHIM  
 C/o Harry Winston Inc., 718 Fifth Avenue, 10019, New York, NY (US);  
 4-5; 7 Rie YATSUGI-KANG  
 C/o Harry Winston Inc., 718 Fifth Avenue, 10019, New York, NY (US);  
 8-9 Charee KWON  
 C/o Harry Winston Inc., 718 Fifth Avenue, 10019, New York, NY (US)  
 (74) The Swatch Group AG (The Swatch Group SA) (The Swatch Group Ltd.)  
 Faubourg Du Lac 6, 2501 Biel/Bienne (CH)  
 (54) 1. Finger ring, 2. Finger ring, 3. Finger ring, 4. Pair of earrings, 5. Pair of earrings, 6. Necklace,  
 7. Finger ring, 8. Necklace, 9. Bracelet  
 (55)





2.2



2.3



2.4



2.5



2.6



2.7



2.8



3.1



3.2



3.3



3.4



3.5



3.6



3.7



3.8



4.1



4.2





4.3



4.4



4.5



4.6



4.7



4.8



5.1



5.2



5.3



5.4



5.5



5.6



5.7



5.8





6.1



6.2



6.3



6.4



6.5



6.6



6.7



6.8

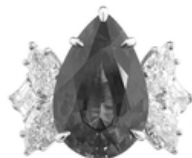

7.1



7.2



7.3



7.4



7.5



7.6



7.7



7.8



8.1



8.2



8.3



8.4



8.5



8.6



8.7



8.8



9.1



9.2



9.3



9.4



9.5



9.6



9.7



9.8

- (11) DM/209 204 (51) 11-01  
 (15) 2020 07 09 (44) 02/2021 (2021 01 15)  
 (22) 2020 07 09  
 (28) 2  
 (73) HARRY WINSTON SA  
 Chemin Du Tourbillon 8, 1228 Plan-les-Ouates (CH)  
 (85) CH  
 (86) CH  
 (87) CH  
 (88) CH  
 (89) CH  
 (81) II. MA III. UA, AM, AL, AZ, BZ, ME, MD, MC, SG, NO, MN, BA, MK, OM, CA, GE, TR, LI, KG,  
 GB, TN, EM, CH  
 (72) 1 Delphine ABDOURAHIM  
 C/o Harry Winston Inc., 718 Fifth Avenue, 10019, New York, NY (US);  
 2 Dominique RIVIERE  
 C/o Harry Winston Inc., 718 Fifth Avenue, 10019, New York, NY (US)  
 (74) The Swatch Group AG (The Swatch Group SA) (The Swatch Group Ltd.)  
 Faubourg Du Lac 6, 2501 Biel/Bienne (CH)  
 (54) 1. Bracelet, 2. Finger ring  
 (55)



1.1



1.2



1.3



1.4



1.5

1.6



1.7



1.8



2.1



2.2



2.3



2.4



2.5



2.6



2.7



2.8

---



# სასაქონლო ნიშნები

## ეროვნული პროცედურით შემოტანილი განაცხადები, რომლებზეც გამოტანილია გადაწყვეტილება რეგისტრაციის შესახებ

გადაწყვეტილების გასაჩივრება შესაძლებელია საქპატენტის სააპელაციო პალატაში გამოქვეყნებიდან 3 თვის ვადაში ან მცხეთის რაიონული სასამართლოს ადმინისტრაციულ საქმეთა კოლეგიაში 1 თვის ვადაში (მის.: ქ. მცხეთა, სამხედროს ქ. №17).

(260) AM 2021 102358 A\*

(210) AM 102358

(220) 2019 03 22

(731) შპს „ლუგელა“

სოფ. ჯგალი, წალენჯიხის რ-ნი,  
საქართველო

(740) გიორგი თაქთაქიშვილი

(540)



(591) ნაცრისფერი, თეთრი, ცისფერი

(531) 25.07.15; 25.07.20; 25.07.21; 26.04.18;

27.05.01; 27.05.10; 27.05.22; 28.05; 29.01.13

(511)

32 – წყაროს წყალი, მინერალური წყალი.

(260) AM 2021 104328 A

(210) AM 104328

(220) 2020 08 11

(731) სს „ელიტ ელექტრონიქსი“

ყაზბეგის გამზ. 24, 0160, თბილისი,  
საქართველო

(740) შოთა მინდელი

(540)



(591) წითელი, თეთრი, ნაცრისფერი,

ყავისფერი, იასამნისფერი

(531) 26.13.25; 27.05.11; 27.05.22; 29.01.15

(511)

35 – რეკლამა; მართვა საქმიან სფეროში; ადმინისტრირება საქმიან სფეროში; საოფისე სამსახური.

(260) AM 2021 105234 A\*

(210) AM 105234

(220) 2019 10 09

(731) ნოელ მაკდონალდი

6 ლაუერ კინგს როუდი, კინგსტონ-აფონ-  
თემზ, KT2 6PH, გაერთიანებული სამეფო

(740) თამაზ შილაკაძე

(540)



(591) შავ-თეთრი

(531) 05.07.13; 05.07.17; 05.07.18; 05.07.24;

05.09.15; 05.09.17; 05.09.24; 26.01.15;

27.05.01

(526) ORGANIC არ ექვემდებარება დამოუკიდებელ სამართლებრივ დაცვას

(511)

29 – საკვები ზეთები და ცხიმები; ქოქოსის ზეთი და ცხიმი; რძეზე დამზადებული სასმელები; ქოქოსის სასმელები გამოყენებული როგორც რძის შემცვლელი; რძის ნაწარმი; დაკონსერვებული პარკოსნები; დაკონსერვებული ხილი; დაკონსერვებული ბოსტნეული; დაკონსერვებული პომიდორი; კარაქი, მარგარინი და სპრედები; რძის ნაწარმზე დამზადებული სპრედები; ხილზე დამზადებული სპრედები; პამტეტები და სპრედები; თხილეულის კარაქი; არაქისის კარაქი; არაქისის პასტა; არაქისის სპრედი; თხილის სპრედი; ჰიუმუსი (თურქული მუხუდოს ცომი); ბოსტნეულის პიკული; ზეთისხილი; ტოფუ (სოიას ხაჭო); ტაპენადები; ქოქოსის ნაღები; დამუშავებული ქოქოსი; პომიდვრის კონცენტრატი; ნახარშები; მზა წვნიანები; ტაპი-

ნი (ქუნჯუთის თესლის ცომისებრი მასა); ვეგეტარიანული ძეხვეული და ბურგერები; ვეგეტარიანული ბურგერ-ღვეხელები; კარტოფილის ჩიფსები; კარტოფილის ჩიფსები; იოგურტები; საუზმეულის ფილები; ორგანული თხილის და თესლეულის ბაზაზე დამზადებული საუზმეულის ფილები; ცილაზე დაფუძნებული მკვებავი ბატონები; ცხარე საუზმეული; ქოქოსის რძე; საკვები თესლი (მარცვალი); დამუშავებული საკვები თესლი (მარცვალი); პარკოსანთა მარცვალი; ხილი ქილებში; ბოსტნეული ქილებში; ყველი; ბალახის შემცველი ყველი; გამხმარი ხილი; დამუშავებული ხილი; ყველა ზემოთ აღნიშნული საქონელი განკუთვნილია მხოლოდ ადამიანებისთვის; ყველა ზემოთ აღნიშნული საქონელი არის ორგანული.

30 – ბრინჯი; ფქვილი და მარცვლოვანი პროდუქტი; პურ-ფუნთუშეული, საკონდიტრო ნაწარმი; ბისკვიტები; დესერტები; პუდინგები; გამომცხვარი დესერტები; ნამცხვრები; მარცვლეულისაგან დამზადებული ნამცხვრები; გალეტები; ტორტები; თაფლი; საფუარი; მდოგვი; ძმარი; საკაზმები; კარის ცხრე საკაზმები; ჩილის სუნელები; საკაზმები, კერძოდ, წიწკის საკაზმები; სალათის საკაზმები; მზა პირშუშა; მაიონეზი; კეტჩუპი; მარინადები; სუნელები; ჩატნი (მოტკბო-მომჟავო საწებელი ხორცისთვის); გამხმარი ბალახეული; ბალახის მარილი; სეზამის (ქუნჯუთის) მარცვლებთან შერეული სუფრის მარილი; შოკოლადიანი ბატონები; მარცვლეულის საკვები ფილები (ბრიკეტები); მარცვლეულზე დამზადებული საკვები საუზმეული; ხრაშუნა პურები; კვერები, ოლადები; მაკარონის ნაწარმი; პიცის ფუძეები; პიცის ქერქები; პიცის ცომები; კრენდელები; ბრინჯის კვერები; მაკარონის ნაწარმის სოუსები; მარციპანი; პესტო (საწებელი); მარცვლეულის საუზმეული; მიუსლი; მიუსლის ბრიკეტები; საუზმისთვის განკუთვნილი ბურღულეული (ფაფები); გაფუებული ბრინჯი; ვაფლი; შაქარი; საკაზმები, სოუსები; ყველა ზემოთ აღნიშნული საქონელი განკუთვნილია მხოლოდ ადამიანებისთვის; ყველა ზემოთ აღნიშნული საქონელი არის ორგანული.

(260) AM 2021 105661 A

(210) AM 105661

(220) 2020 08 14

(731) შპს „აჭარა ჯგუფი“

კოსტავას ქ. 14, 0108, თბილისი,

საქართველო

(740) გიორგი თაქთაქიშვილი

(540)



(591) შავ-თეთრი

(531) 26.01.01; 26.01.18; 28.19

(526) აჭარა

(511)

16 – ქაღალდი და მუყაო; ნაბეჭდი პროდუქცია; მასალა საამკინძაო სამუშაოებისათვის; ფოტოსურათები; საკანცელარიო და საოფისე ნივთები, ავეჯის გარდა; საკანცელარიო ან საყოფაცხოვრებო დანიშნულების მწებავი ნივთიერებები; მხატვართა და გრაფიკოსთა საკუთნო; სახატავი ფუნჯები; სასწავლო მასალა და თვალსაჩინოება; პლასტმასის ფურცლები, ფოტოფირები; გასახვევი და შესაფუთი მასალა; შრიფტი; ტიპოგრაფიული კლიშე; მათ შორის, გაზეთები, ჟურნალები, ალბომები, აფიშები, პლაკატები, ბლოკნოტები, ბროშურები, ბილეთები, ტალონები, ბარათები, წიგნაკები, საქაღალდეები, საწერი საშუალებები, კონვერტები, ბლანკები, ღია ბარათები, ფლაერები.

29 – ხორცი, თევზი, ფრინველი და ნანადირევი; ხორცის ექსტრაქტები; დაკონსერვებული, გამხმარი და თბურად დამუშავებული ბოსტნეული და ხილი; ქელები, ხილფაფები, კომპოტები; კვერცხი; რძე, ყველი, კარაქი, იოგურტი და რძის სხვა პროდუქტები; საკვები ზეთები და საკვები ცხიმები.

30 – ყავა, ჩაი, კაკაო და ხელოვნური ყავა; ბრინჯი, მაკარონი და ატრია; ტაპიოკა და საგო; ფქვილი და მარცვლოვანი პროდუქტი; პურ-ფუნთუშეული, მაკარონი და საკონდიტრო ნაწარმი; შოკოლადი; ნაყინი, შარბათი და სხვა საკვები ყინული; შაქარი, თაფლი, ბადაგი; საფუარი, საცხობი ფხვნილები; მარილი, სანელებლები, საკაზმები, დაკონსერვებული მწვანილი; ძმარი, საწებლები და სხვა საკაზმი; ყინული (გაყინული წყალი).

32 – ლუდი; უალკოჰოლო სასმელები; მინერალური და გაზიანი წყალი; ხილის სასმელები და ხილის წვენები; სიროფები და სასმელების დასამზადებელი სხვა შედგენილობები.

33 – ალკოჰოლიანი სასმელები (ლუდის გარდა); ალკოჰოლური შედგენილობები სასმელების დასამზადებლად; მათ შორის, სუფრის ღვინო,

ცქრიალა ღვინო, შემაგრებული ღვინო, დესერტის ღვინო, ლიქიორი, ბრენდი, არაყი, რომი, ვისკი, ჯინი, კოკტეილები, აპერიტივები, დიჯესტივები, ალკოჰოლიანი ნაყენები.

35 – რეკლამა; ბიზნეს მენეჯმენტი; ბიზნესის ადმინისტრირება; საოფისე სამსახური; ასევე, საცალო და საბითუმო ვაჭრობა.

41 – განათლება; სასწავლო პროცესის უზრუნველყოფა; გართობა; სპორტული და კულტურული აქტივობები; მათ შორის, საგანმანათლებლო საქმიანობა, საშუალო, უმაღლესი და პროფესიული განათლება, დაუსწრებელი სწავლება, საგანმანათლებლო სკოლა-ინტერნატები, გამოცდების ჩატარება, პროფესიული ორიენტირება [რჩევები განათლებისა და სწავლების სფეროში], სასწავლო ან გასართობი კონკურსების ორგანიზება, საგანმანათლებლო-აღმზრდელობითი მომსახურება, პერსონალური საგანმანათლებლო ფორუმების ორგანიზება და ჩატარება, წიგნების გამოცემა, კულტურულ-საგანმანათლებლო და გასართობი კლუბები, კოლოკვიუმების ორგანიზება და ჩატარება, კონფერენციების ორგანიზება და ჩატარება, კონგრესების ორგანიზება და ჩატარება, სიმპოზიუმების ორგანიზება და ჩატარება, სემინარების ორგანიზება და ჩატარება, აღზრდასა და განათლებასთან დაკავშირებული ინფორმაცია, მუზეუმებით უზრუნველყოფა [პრეზენტაციები, გამოფენები].

43 – საკვებით და სასმელებით უზრუნველყოფა; დროებითი საცხოვრებლით უზრუნველყოფა, მათ შორის, დროებითი საცხოვრებლით უზრუნველყოფის ბიუროები [სასტუმროები, პანსიონები]; სასტუმროები; მოტელები; ადგილების დაჯავშნა სასტუმროში; შეხვედრების ჩასატარებელი ოთახების გაქირავება; დროებითი საცხოვრებლის გაქირავება; დროებითი საცხოვრებლის დაჯავშნა; ადგილების დაჯავშნა პანსიონებში; პანსიონები; დასასვენებელი ბანაკები [საცხოვრებლით უზრუნველყოფა]; კემპინგებით უზრუნველყოფა; ტურბაზები; კარვების გაქირავება; მიღების მომსახურება დროებითი საცხოვრებლით უზრუნველყოფისას [დახვედრისა და გაცილების მართვა]; რესტორნები; თვითმომსახურების რესტორნები; ბარების მომსახურება; კაფეები; კაფეტერიები; სასაუზმეები; დაწესებულებების სასადილოები; პირადი შეფ-მზარეულის მომსახურება; საკვების შეკვეთით დამზადება და შინ მიტანა; ავეჯის, მაგიდის თეთრეულისა და ჭურჭლის გაქირავება.

(260) AM 2021 105662 A

(210) AM 105662

(220) 2020 08 14

(731) შპს „აქარა ჯგუფი“

კოსტავას ქ. 14, 0108, თბილისი, საქართველო

(740) გიორგი თაქთაქიშვილი

(540)



(591) შავ-თეთრი

(531) 26.01.01; 26.01.18; 27.05.01

(526) ADJARA

(511)

16 – ქაღალდი და მუყაო; ნაბეჭდი პროდუქცია; მასალა საამკინძაო სამუშაოებისათვის; ფოტოსურათები; საკანცელარიო და საოფისე ნივთები, ავეჯის გარდა; საკანცელარიო ან საყოფაცხოვრებო დანიშნულების მწებავი ნივთიერებები; მხატვართა და გრაფიკოსთა საკუთნო; სახატავი ფუნჯები; სასწავლო მასალა და თვალსაჩინოება; პლასტმასის ფურცლები, ფოტოფირები; გასახვევი და შესაფუთი მასალა; შრიფტი; ტიპოგრაფიული კლიშე; მათ შორის, გაზეთები, ჟურნალები, ალბომები, აფიშები, პლაკატები, ბლოკნოტები, ბროშურები, ბილეთები, ტალონები, ბარათები, წიგნაკები, საქაღალდეები, საწერი საშუალებები, კონვერტები, ბლანკები, ღია ბარათები, ფლაერები.

29 – ხორცი, თევზი, ფრინველი და ნანადირევი; ხორცის ექსტრაქტები; დაკონსერვებული, გამმარი და თბურად დამუშავებული ბოსტნეული და ხილი; ყელეები, ხილფაფები, კომპოტები; კვერცხი; რძე, ყველი, კარაქი, იოგურტი და რძის სხვა პროდუქტები; საკვები ზეთები და საკვები ცხიმები.

30 – ყავა, ჩაი, კაკაო და ხელოვნური ყავა; ბრინჯი, მაკარონი და ატრია; ტაპიოკა და საგო; ფქვილი და მარცვლოვანი პროდუქტი; პურფუნთუშეული, მაკარონი და საკონდიტრო ნაწარმი; შოკოლადი; ნაყინი, შარბათი და სხვა საკვები ყინული; შაქარი, თაფლი, ბადაგი; საფუარი, საცხობი ფხვნილები; მარილი, სანელებლები, საკაზმები, დაკონსერვებული მწვანელი; ძმარი, საწებლები და სხვა საკაზმი; ყინული (გაყინული წყალი).

32 – ლუდი; უალკოჰოლო სასმელები; მინერალური და გაზიანი წყალი; ხილის სასმელები და ხილის წვენი; სიროფები და სასმელების დასამზადებელი სხვა შედგენილობები.

33 – ალკოჰოლიანი სასმელები (ლუდის გარდა); ალკოჰოლური შედგენილობები სასმელების დასამზადებლად; მათ შორის, სუფრის ღვინო, ცქრიალა ღვინო, შემაგრებული ღვინო, დესერტის ღვინო, ლიქიორი, ბრენდი, არაყი, რომი, ვისკი, ჯინი, კოკტეილები, აპერიტივები, დიჯესტივები, ალკოჰოლიანი ნაყენები.

35 – რეკლამა; ბიზნეს მენეჯმენტი; ბიზნესის ადმინისტრირება; საოფისე სამსახური; ასევე, საცალო და საბითუმო ვაჭრობა.

41 – განათლება; სასწავლო პროცესის უზრუნველყოფა; გართობა; სპორტული და კულტურული აქტივობები; მათ შორის, საგანმანათლებლო საქმიანობა, საშუალო, უმაღლესი და პროფესიული განათლება, დაუსწრებელი სწავლება, საგანმანათლებლო სკოლა-ინტერნატები, გამოცდების ჩატარება, პროფესიული ორიენტირება (რჩევები განათლებისა და სწავლების სფეროში), სასწავლო ან გასართობი კონკურსების ორგანიზება, საგანმანათლებლო-აღმზრდელობითი მომსახურება, პერსონალური საგანმანათლებლო ფორუმების ორგანიზება და ჩატარება, წიგნების გამოცემა, კულტურულ-საგანმანათლებლო და გასართობი კლუბები, კოლოკვიუმების ორგანიზება და ჩატარება, კონფერენციების ორგანიზება და ჩატარება, კონგრესების ორგანიზება და ჩატარება, სიმპოზიუმების ორგანიზება და ჩატარება, სემინარების ორგანიზება და ჩატარება, აღზრდასა და განათლებასთან დაკავშირებული ინფორმაცია, მუზეუმებით უზრუნველყოფა (პრეზენტაციები, გამოფენები).

43 – საკვებით და სასმელებით უზრუნველყოფა; დროებითი საცხოვრებლით უზრუნველყოფა, მათ შორის, დროებითი საცხოვრებლით უზრუნველყოფის ბიუროები (სასტუმროები, პანსიონები); სასტუმროები; მოტელები; ადგილების დაჯავშნა სასტუმროში; შეხვედრების ჩასატარებელი ოთახების გაქირავება; დროებითი საცხოვრებლის გაქირავება; დროებითი საცხოვრებლის დაჯავშნა; ადგილების დაჯავშნა პანსიონებში; პანსიონები; დასასვენებელი ბანაკები (საცხოვრებლით უზრუნველყოფა); კემპინგებით უზრუნველყოფა; ტურბაზები; კარვების გაქირავება; მიღების მომსახურება დროებითი საცხოვრებლით უზრუნველყოფისას (დახვედრისა და გაცილების მართვა); რესტორნები;

თვითმომსახურების რესტორნები; ბარების მომსახურება; კაფეები; კაფეტერიები; სასაუზმეები; დაწესებულებების სასადილოები; პირადი შეფ-მზარეულის მომსახურება; საკვების შეკვეთით დამზადება და შინ მიტანა; ავეჯის, მაგიდის თეთრეულისა და ჭურჭლის გაქირავება.

(260) AM 2021 108514 A  
 (210) AM 108514  
 (220) 2020 06 03  
 (731) გიორგი ისაკაძე  
 სოფ. კრიხი, 0402, ამბროლაური,  
 საქართველო  
 (540)



(591) მწვანე, თეთრი  
 (531) 07.01.24; 07.01.25; 07.01.26; 26.03.04;  
 27.05.11; 29.01.03  
 (526) GEORGIA  
 (511)  
 35 – სასტუმროების ბიზნესის მართვა.

43 – დროებითი საცხოვრებლით უზრუნველყოფის მომსახურება (სასტუმროები, პანსიონები); სასტუმროებით მომსახურება.

(260) AM 2021 108953 A  
 (210) AM 108953  
 (220) 2020 07 08  
 (731) გიორგი მელუა  
 კოსტავას ქ. 60, ლანჩხუთი, საქართველო  
 (540)



(591) მუქი მწვანე, თეთრი, ღია მწვანე  
(531) 05.03.16; 26.01.04; 26.01.19; 26.01.21;  
27.01.12; 27.07.01; 29.01.12

(511)

29 – დაკონსერვებული გამხმარი და თბურად დამუშავებული დაფნა.

31 – ნედლი და დაუმუშავებელი დაფნა.

(260) AM 2021 108954 A

(210) AM 108954

(220) 2020 07 08

(731) შპს „საქართველოს დისტრიბუცია და ლოგისტიკა“  
მარშალ გელოვანის გამზ. 2, საბურთალოს რაიონი, 0159, თბილისი, საქართველო

(540)

## სალტო Salto

(591) შავ-თეთრი

(511)

29 – ხორცი, თევზი, ფრინველი და ნანადირევი; ხორცის ექსტრაქტები; დაკონსერვებული, გაყინული, გამხმარი და მომზადებული ხილი და ბოსტნეული (ხილისა და ბოსტნეულის კერძები); ყელეები, ხილფაფები, კომპოტები; კვერცხი; რძე, ყველი, კარაქი, იუგურტი და რძის სხვა პროდუქტები; საკვები ზეთები და ცხიმები.

30 – ყავა, ჩაი, კაკაო და ყავის შემცველები; ბრინჯი, მკარონი და ატრია; ტაპიოკა და საგო; ფქვილი და მარცვლეულის პროდუქტი; პურ-ფუნთუშეული, მკარონი და საკონდიტრო ნაწარმი; შოკოლადი; ნაყინი, შარბათი, და სხვა საკვები ყინული; შაქარი, თაფლი, ბადაგი; საფუარი, საცხობი ფხვნილები; მარილი, სანელებლები, საკაზმები, დაკონსერვებული მწვანილი; ძმარი, საწებლები და სხვა საკაზმი; ყინული (გაყინული წყალი).

(260) AM 2021 108960 A

(210) AM 108960

(220) 2020 07 08

(731) ანი კაჭკაჭაშვილი  
სააკაძის ქ. 4, ბ. 47, 3700, რუსთავი,  
საქართველო

(540)

## მზევინო

(591) შავ-თეთრი

(511)

33 – ალკოჰოლიანი სასმელები (ლუდის გარდა); ალკოჰოლური შედგენილობები სასმელების დასამზადებლად.

(260) AM 2021 108962 A

(210) AM 108962

(220) 2020 07 09

(731) აბდი იბრაჰიმ ილაჩ სანაი ვე თიჯარეთ ანონიმ შირქეთი  
რეშითფაშა მაჰალესი ესქი ბიუიუქდერე  
ჯადესი No:4 34467 მასლაქი სარიერი  
სტამბოლი, თურქეთი

(740) თამაზ შილაკაძე

(540)

## რივოქსარი

(591) შავ-თეთრი

(511)

5 – ფარმაცევტული პრეპარატები, კერძოდ, ანტიკოაგულანტები, რომლებიც გამოიყენება სისხლის შედედების სამკურნალოდ და პროფილაქტიკისთვის.

(260) AM 2021 108964 A

(210) AM 108964

(220) 2020 07 09

(731) აბდი იბრაჰიმ ილაჩ სანაი ვე თიჯარეთ ანონიმ შირქეთი  
რეშითფაშა მაჰალესი ესქი ბიუიუქდერე  
ჯადესი No:4 34467 მასლაქი სარიერი  
სტამბოლი, თურქეთი

(740) თამაზ შილაკაძე

(540)

## RIVOKSAR

(591) შავ-თეთრი

(511)

5 – ფარმაცევტული პრეპარატები, კერძოდ, ანტიკოაგულანტები, რომლებიც გამოიყენება სისხლის შედედების სამკურნალოდ და პროფილაქტიკისთვის.

(260) AM 2021 108965 A

(210) AM 108965

(220) 2020 07 09

(731) შპს „მემარნე“

ალექსანდრე ყაზბეგის გამზ. 8, ბ. 21,  
საბურთალოს რაიონი, თბილისი,  
საქართველო

(540)



**მმმარნე**  
**MEMARNE**

(591) თეთრი, შავი, ბორდოსფერი  
(531) 02.01.01; 05.07.10; 24.01.08; 27.05.01; 28.19;  
29.01.13

(511)  
33 – ალკოჰოლური სასმელები, ლუდის გარდა;  
ალკოჰოლური შედგენილობები სასმელების  
დასამზადებლად.

(260) AM 2021 109009 A

(210) AM 109009

(220) 2020 07 10

(731) შპს „სოლომონე“  
კედრის I-ლი გასასვლელი 9, 0162,  
თბილისი, საქართველო

(540)



(591) შავი, წითელი, თეთრი  
(531) 27.01.12; 27.05.13; 27.05.19; 29.01.12

(526) IMERETI

(511)

33 – ალკოჰოლური სასმელები, ლუდის გარდა;  
ალკოჰოლური შედგენილობები სასმელების  
დასამზადებლად.

43 – საკვებით და სასმელით უზრუნველყოფა;  
დროებითი საცხოვრებელი უზრუნველყოფა.

(260) AM 2021 109013 A

(210) AM 109013

(220) 2020 07 10

(731) პედიატრიკა სპეციალისტ ს.რ.ლ.  
ვია ნიკოლოდი 28/ A, 57121 ლივორნო  
(LI), იტალია

(740) გიორგი თაქთაქიშვილი

(540)



(591) ნაცრისფერი, შავი, თეთრი  
(531) 02.09.15; 05.05.20; 05.05.23; 26.01.15;  
26.04.02; 26.04.04; 26.04.15; 26.04.22;  
27.05.01

(511)  
5 – საკვები დანამატები; სამედიცინო დანიშნუ-  
ლების დიეტური ნივთიერებები.

(260) AM 2021 109014 A

(210) AM 109014

(220) 2020 07 10

(731) პედიატრიკა სპეციალისტ ს.რ.ლ.  
ვია ნიკოლოდი 28/ A, 57121 ლივორნო  
(LI), იტალია

(740) გიორგი თაქთაქიშვილი  
(540)

**FOLIPED**

(591) შავ-თეთრი

(511)

5 – საკვები დანამატები; სამედიცინო დანიშნუ-  
ლების დიეტური ნივთიერებები.

(260) AM 2021 109015 A

(210) AM 109015

(220) 2020 07 10

(731) პედიატრიკა სპეციალისტ ს.რ.ლ.  
ვია ნიკოლოდი 28/ A, 57121 ლივორნო  
(LI), იტალია

(740) გიორგი თაქთაქიშვილი  
(540)

**PEDIAFLUOR**

(591) შავ-თეთრი

(511)

5 – საკვები დანამატები; სამედიცინო დანიშნუ-  
ლების დიეტური ნივთიერებები.

(260) AM 2021 109016 A  
 (210) AM 109016  
 (220) 2020 07 10  
 (731) პედიატრიკა სპეციალისტ ს.რ.ლ.  
 ვია ნიკოლოდი 28/ A, 57121 ლივორნო  
 (LI), იტალია  
 (740) გიორგი თავთაქიშვილი  
 (540)

**PediaKappa Plus**



(591) ნაცრისფერი, შავი, თეთრი  
 (531) 02.09.15; 04.05.01; 04.05.02; 04.05.05;  
 27.05.21  
 (511)  
 5 – საკვები დანამატები; სამედიცინო დანიშნუ-  
 ლების დიეტური ნივთიერებები.

(260) AM 2021 109017 A  
 (210) AM 109017  
 (220) 2020 07 10  
 (731) პედიატრიკა სპეციალისტ ს.რ.ლ.  
 ვია ნიკოლოდი 28/ A, 57121 ლივორნო  
 (LI), იტალია  
 (740) გიორგი თავთაქიშვილი  
 (540)

**PediaKD Plus**



(591) ნაცრისფერი, შავი, თეთრი  
 (531) 02.05.06; 02.05.18  
 (511)  
 5 – საკვები დანამატები; სამედიცინო დანიშნუ-  
 ლების დიეტური ნივთიერებები.

(260) AM 2021 109018 A  
 (210) AM 109018  
 (220) 2020 07 10  
 (731) პედიატრიკა სპეციალისტ ს.რ.ლ.  
 ვია ნიკოლოდი 28/ A, 57121 ლივორნო  
 (LI), იტალია  
 (740) გიორგი თავთაქიშვილი  
 (540)

**PEDIALUT**

(591) შავ-თეთრი  
 (511)  
 5 – საკვები დანამატები; სამედიცინო დანიშნუ-  
 ლების დიეტური ნივთიერებები.

(260) AM 2021 109021 A  
 (210) AM 109021  
 (220) 2020 07 10  
 (731) პედიატრიკა სპეციალისტ ს.რ.ლ.  
 ვია ნიკოლოდი 28/ A, 57121 ლივორნო  
 (LI), იტალია  
 (740) გიორგი თავთაქიშვილი  
 (540)



(591) ნაცრისფერი, შავი, თეთრი  
 (531) 01.15.13; 01.15.15; 02.09.15; 04.05.02;  
 04.05.05; 26.04.02; 26.04.04; 26.04.05;  
 26.04.22  
 (511)  
 5 – საკვები დანამატები; სამედიცინო დანიშნუ-  
 ლების დიეტური ნივთიერებები.

(260) AM 2021 109022 A  
 (210) AM 109022  
 (220) 2020 07 10  
 (731) პედიატრიკა სპეციალისტ ს.რ.ლ.  
 ვია ნიკოლოდი 28/ A, 57121 ლივორნო  
 (LI), იტალია

(740) გიორგი თავთაქიშვილი  
(540)

## PediaTre



(591) ნაცრისფერი, შავი, თეთრი  
(531) 01.13.01; 01.13.02; 01.13.05; 02.09.15;  
04.05.02; 04.05.05; 04.05.21; 26.05.18

(511)  
5 – საკვები დანამატები; სამედიცინო დანიშნულების დიეტური ნივთიერებები.

(260) AM 2021 109023 A  
(210) AM 109023  
(220) 2020 07 10  
(731) პედიატრიკა სპეციალისტ ს.რ.ლ.  
ვია ნიკოლოდი 28/ A, 57121 ლივორნო  
(LI), იტალია  
(740) გიორგი თავთაქიშვილი  
(540)

## PediaTre Fluor



(591) ნაცრისფერი, შავი, თეთრი  
(531) 01.13.01; 01.13.02; 01.13.05; 01.15.07;  
02.09.15; 04.05.02; 04.05.05; 04.05.11

(511)  
5 – საკვები დანამატები; სამედიცინო დანიშნულების დიეტური ნივთიერებები.

(260) AM 2021 109025 A  
(210) AM 109025  
(220) 2020 07 13  
(731) შპს „ქართული ღვინის სახლი“  
სოფ. ზეგაანი, 1500, გურჯაანი,  
საქართველო  
(740) სოფიო ვაჩეიშვილი  
(540)



(591) შავ-თეთრი  
(531) 26.04.18; 26.04.24; 27.05.24  
(511)  
33 – ალკოჰოლური სასმელები, ლუდის გარდა; ალკოჰოლური შედგენილობები სასმელების დასამზადებლად.

43 – საკვებით და სასმელით უზრუნველყოფა; დროებითი საცხოვრებლით უზრუნველყოფა.

(260) AM 2021 109027 A  
(210) AM 109027  
(220) 2020 07 13  
(731) შპს „ჩვენი ფერმერი“  
მ. ქავთარაძის ქ. 11, 0180, თბილისი,  
საქართველო  
(740) მელანო გოგისვანიძე  
(540)



(591) ლურჯი, თეთრი  
(531) 08.01.08; 08.01.18; 28.19; 29.01.12  
(511)  
30 – ყავა, ჩაი, კაკაო და ყავის შემცველები; ბრინჯი, მაკარონი და ატრია; ტაპიოკა და საგო; ფქვილი და მარცვლეულის პროდუქტი; პურ-ფუნთუშეული, მაკარონი და საკონდიტრო ნაწარმი; შოკოლადი; ნაყინი, შარბათი, და სხვა საკვები ყინული; შაქარი, თაფლი, ბადაგი; საფუარი, საცხობი ფხვნილები; მარილი, სანელებ-



ლები, საკაზმები, დაკონსერვებული მწვანილი; ძმარი, საწებლები და სხვა საკაზმი; ყინული (გაყინული წყალი).

(260) AM 2021 109034 A

(210) AM 109034

(220) 2020 07 13

(731) შპს „ალმენდინგერი“

სულხან-საბას ქ. 41, 1100, ბოლნისი, საქართველო

(540)

## შპს ალმენდინგერი LLC ALLMENDINGER

(591) შავ-თეთრი

(511)

43 – საკვებით და სასმელით უზრუნველყოფა; დროებითი საცხოვრებელი უზრუნველყოფა.

(260) AM 2021 109035 A

(210) AM 109035

(220) 2020 07 13

(731) შპს „ქიემსი ვაინსი“

დიდმის მას. მე-3 კვარ. კორპ 31, ბ. 57, თბილისი, საქართველო

(540)

## შედანი Шедан Shedan

(591) შავ-თეთრი

(511)

33 – ალკოჰოლური სასმელები, ლუდის გარდა; ალკოჰოლური შედგენილობები სასმელების დასამზადებლად.

(260) AM 2021 109041 A

(210) AM 109041

(220) 2020 07 14

(731) შპს „თერა მოტორსი“

ივანე მესხის ქ. 2, 6000, ბათუმი, საქართველო

(740) ნიკოლოზ ნადიბაიძე

(540)



(591) წითელი, ლურჯი, ყვითელი

(531) 18.01.21; 27.05.01; 27.05.15; 28.19; 29.01.13

(511)

35 – სავაჭრო საქმიანობა, ახალი და მეორადი საბურავების იმპორტი და საცალო და საბითუმო გაყიდვები.

(260) AM 2021 109046 A

(210) AM 109046

(220) 2020 07 15

(731) გალაჰერ ლიმიტიდ

მემბერს ჰილი ბრუკლენდზ როუდი, უეიბრიჯი, სარი, KT13 0QU, გაერთიანებული სამეფო

(740) შალვა გვარამაძე

(540)

## 5G TASTE

(591) შავ-თეთრი

(511)

34 – დამუშავებული ან დაუმუშავებელი თამბაქო; მოსაწევი თამბაქო, ჩიბუხის თამბაქო, ხელით გასახვევი თამბაქო, საღეჭი თამბაქო, თამბაქო „სუნუსი“; სიგარეტები, პაპიროსები, ელექტრონული სიგარეტები, სიგარები, სიგარილეები; ბურუნუთი; მწველთა საკუთვნოები შემავალი 34-ე კლასში; სიგარეტის და პაპიროსის ქაღალდები, სიგარეტისა და პაპიროსის მილაკები და ასანთი.

(260) AM 2021 109052 A

(210) AM 109052

(220) 2020 07 16

(310) 88/785,897

(320) 2020 02 05

(330) US

(731) ამგენ ინკ.

უან ამგენ სენტერ დრაივ, ტაუზანდ-ოკს, კალიფორნია 91320-1799, აშშ

(740) მერაბ კვიციანი

(540)

## TEZVAYO

(591) შავ-თეთრი

(531) 27.05.01

(511)

5 – ფარმაცევტული პრეპარატები; ფარმაცევტული პრეპარატები რესპირატორული დაავადებების და დარღვევების, პულმონალური დაავადებების და დარღვევების, კარდიოვასკულარული

დაავადებების და დარღვევების, ანთების, ანთებითი დაავადებების და დარღვევების, აუტო-იმუნური დაავადებების და დარღვევების, კიბოს, ონკოლოგიური დაავადებების და დარღვევების, ჰემატოლოგიური დაავადებების და დარღვევების, სიმსივნური დაავადებების, ნევროლოგიური დაავადებების და დარღვევების და მეტაბოლური დაავადებების და დარღვევების სამკურნალოდ.

(260) AM 2021 109054 A

(210) AM 109054

(220) 2020 07 16

(731) შპს „ალკოჰოლური სასმელების ქარხანა“  
სოფ. მარტყოფი, ვაზიანის დასახ. 1320,  
გარდაბანი, საქართველო

(540)

**მარნაველი**  
**Marnavalley**  
**Марнавели**

(591) შავ-თეთრი

(511)

32 – ლუდი; არაალკოჰოლური სასმელები; მინერალური და გაზიანი წყლები; ხილის სასმელები და წვენები; სიროფები და სხვა არაალკოჰოლური შედგენილობები სასმელების დასამზადებლად.

33 – ალკოჰოლური სასმელები, ლუდის გარდა; ალკოჰოლური შედგენილობები სასმელების დასამზადებლად.

(260) AM 2021 109115 A

(210) AM 109115

(220) 2020 07 17

(731) ჯოიე ინტერნეიშნელ კო., ლიმიტედ  
31/F, ტაურ თუ, ტაიმს სკვერ, 1 მატესონ  
სტრიტ, კოზვეი ბეი, ჰონგ-კონგი

(740) თამარ კოჭლამაზაშვილი

(540)

**Joie**

(591) შავ-თეთრი

(531) 27.05.01

(511)

12 – თავმისაღებები სატრანსპორტო საშუალებების დასაჯდომებისთვის; ბავშვის უსაფრთხო

დასაჯდომები სატრანსპორტო საშუალებებისათვის; სატრანსპორტო საშუალებების დასაჯდომების შალითები; ეტლები ახალშობილებისთვის; დასაკეცი ეტლები ახალშობილებისთვის; მსუბუქი ეტლები ახალშობილებისთვის; ჩარდახები საბავშვო ეტლებისთვის; დასაკეცი ჩარდახები საბავშვო ეტლებისთვის; მსუბუქი ჩარდახები საბავშვო ეტლებისთვის; გადასახსნელი სახურავი საბავშვო ეტლებისთვის; გადასახსნელი სახურავი დასაკეცი საბავშვო ეტლებისთვის; საბავშვო ეტლები, დასაკეცი საბავშვო სკამები, მსუბუქი საბავშვო ეტლები; მოწყობილობები ბავშვების და ჩვილების გადაყვანისათვის, კერძოდ, საბავშვო ეტლების, სატრანსპორტო საშუალებებისათვის განკუთვნილი დასაჯდომების, სატრანსპორტო საშუალებების დასაჯდომების საყრდენების კომბინაციები; საბავშვო ეტლების საკუთნო და მოწყობილობები ბავშვების გადაყვანისათვის, კერძოდ, ბალიშები დასაჯდომებისთვის, კისრის და თავის საყრდენები, შენახვისთვის განკუთვნილი განყოფილებები, კოლოფები, ხონჩები (ქვეშები) და საჭერები, დამცავი ეკრანები და შალითები; ბავშვების უსაფრთხოების ღვედები და დამჭერი მოწყობილობები დასაჯდომებისთვის და სატრანსპორტო საშუალებებისათვის.

18 – ბავშვის სატარებელი ჩანთები; ბავშვის სატარებელი ზურგჩანთები; ტანზე გასაკეთებელი ბავშვის სატარებელი საკუთნო; ბები-სლინგები; ბავშვის სატარებელი სამხარილლიები; ჩანთები ბავშვის პამპერსებისთვის; ჩანთები-ორგანიზერები ბავშვის საკუთნოსთვის; ბავშვისთვის მიმართულების მიმცემი სადავეები; ქოლგები ბავშვებისათვის; ზურგჩანთები; სალამქრო ზურგჩანთები; წიგნების ზურგჩანთები, ჩანთები, ჩემოდნები და სამგზავრო ჩანთები, ყველა ზემოთ ჩამოთვლილი განკუთვნილია ჩვილების და ბავშვების მოვლისათვის; ბავშვების და ჩვილების გადასაყვანი ღვედები; ჩვილების გადასაყვანი ჩანთები.

20 – ავეჯი; სკამები (დასაჯდომები); საწოლები; სარწევლა-სავარძელი; ბავშვის სარწევლა საწოლები; აკვნები; ხის საწოლები; მაღალი სკამები ჩვილებისთვის; საბავშვო ჭოჭინები; არალითონის კალათები, ბავშვებისთვის და ჩვილებისთვის განკუთვნილი ლეიბები; დივანის ბალიშები; ბალიშები; ბალიშები ბავშვების სათამაშო მოედნების შემოზღუდვისთვის; ბალიშებიანი სკამები; აქსესუარები მაღალი სკამებისათვის, კერძოდ, დასაჯდომების ბალიშები, ულტობი ბალიშები და მაღალ სკამებზე მისა-

მაგრებელი სათამაშოების პანელები; ბავშვის საკვები სკამი-მაგიდები; ბავშვის საწოლი (მალა-ლი გვერდებით); დაწული საწოლი ახალშობილისთვის; საბავშვო მანქები; საწოლები ბავშვებისთვის და ჩვილებისთვის; სარწველა შეზღოვნები ჩვილებისთვის და ბავშვებისთვის; ყველა ზემოთ ჩამოთვლილი განკუთვნილია ჩვილების და ბავშვების მოვლისათვის; ბავშვის შესახვევი მაგიდები.

(260) AM 2021 109120 A

(210) AM 109120

(220) 2020 07 20

(731) იუნგ პუნგ კო., ლტდ.

64, სონსოგონტანბუკ-რო, ტალსო-გუ, ტეგუ, კორეის რესპუბლიკა

(740) მერაბ კვიციანი

(540)



(591) შავ-თეთრი

(531) 26.04.02; 26.04.04; 26.11.13; 26.13.25; 28.03

(511)

30 – მარცვლეულის ფხვნილი; დამუშავებული მარცვლეული; გაუწყლოებული მაკარონის ნაწარმი; გაუწყლოებული მომზადებული ბრინჯი; მარცვლეულზე დამზადებული დამუშავებული პროდუქტები; ფანტელები (მარცვლეულის ნაწარმი); მარცვლეულის წვნიანები; მარცვლეულის საუზმეული; მარცვლეულის ნაწარმი; მარცვლეულის ფხვნილით დამზადებული საკვები; ატრია; კორეული წიწიბურას ატრია (ნენმიონი); დაფასებული მოხარშული ბრინჯი; გრანულირებული ატრია; კორეული სტილის ცომის გუფთები (მანდუ); ცომისგან დამზადებული გარსები გუფთებისთვის; მაკარონი; აზიური ლობიოს ბლინები (ბინდეტოკი); სენდვიჩები; სპაგეტი; მაკარონის ნაწარმი; სიმინდის ფანტელები; ჰოტდოგები (სოსისები ფუნთუშაში); ფრიტიურში შემწვარი ბრინჯის ტკბილი კვერები (განგიონგი); ორცხობილები; პუდინგები; პური; პური დანამატების გარეშე; ხორბლის ფქვილისა, ზეთისა და თაფლისაგან დამზადებული ტრადიციული კორეული ნამცხვრები (იაკვა); წითელი ლობიოს ტკბილი ყელე; ვაფლი; შოკოლადი; ნამცხვრები; კრეკერები; ღვეზლები; ბლინები; ჩინური ბლინები შაქრის შიგთავსით (ხოტოკი); ბრინჯის კვერები;

ბრინჯის დაჭრილი კვერები; დაკეპილი ატრია (კალგუკსუ); ატრია შავი სოიოს სოუსით (იაიან-გმიონი); მომზადებული კერძი, რომელიც ძირითადად შედგება ცომის ფანტელებისგან და ბულიონისგან (სუჯები); მინისებური ატრია (იამი); ფუნთუშები კრემიანი შიგთავსით; სოიოს სოუსი; ფერმენტირებული ცხარე წიწაკის პასტა (კოხუიანი); დონიანგი; ია-იანგი (შავი ლობიოს პასტა, რომელიც გამოიყენება, როგორც სოუსი ატრიისთვის); ფერმენტირებული სოიოს პასტა (ხონგიანგი); ჩინური სოიოს პასტა (ხუნიანგი); საწებლები; ცხარე სოუსის პასტა; დამრგვალებული ბრინჯის კვერის ჩხირები (გარაეტოკი); მომზადებული კერძი, რომელიც ძირითადად შედგება შემწვარი ბრინჯის კვერებისგან ფერმენტირებული ცხარე წიწაკის პასტით (ტოპოკი); მწვანე ხახვის ბლინები (პაიონი); ოქროსფერი ლობიოს ბლინები; კიმჩის (ფერმენტირებული ბოსტნეული) ბლინები; კარტოფილის ბლინები; ბრინჯის ფაფა ბოსტნეულით; გოგრის ტკბილი ფაფა; კედრის კაკლის ფაფა (ჯატჯუკი); ქუნჯუთის ფაფა; დაფქული ქუნჯუთისგან დამზადებული თხელი ფაფა; ბოსტნეულის ბლინები; შემწვარი ბრინჯის კვერები რამენის ატრიასთან (რაბოკი); რიზოტო; ბეკსოლგი (კორეული თეთრი ბრინჯის კვერები მარწყვით).

(260) AM 2021 109123 A

(210) AM 109123

(220) 2020 07 20

(731) ბეიჯინგ ქსიაოქსიანგ ტექნილოჯი დეველოპმენტ კო., ლტდ.

1-27, ჰუოქსინგ 3რდ სტ., საუთ ეარია, ტონგჟოუ ეკონომიკ & ტექნოლოჯიკალ დეველოპმენტ ზონი, პეკინი, ჩინეთის სახალხო რესპუბლიკა

(740) გიორგი ქართველიშვილი

(540)



(591) FFFFFFF თეთრი, 000000 შავი

(531) 02.01.16; 02.01.23; 26.03.01; 26.03.14; 28.03

(511)

10 – მასაჟის ხელსაწყოები; ფეხის მასაჟის ხელსაწყოები; ელექტრული მასაჟის საგარძლები სამედიცინო მიზნებისთვის; ელექტრული მასაჟის ხელსაწყოები საყოფაცხოვრებო დანიშნულებით; ელექტრული მასაჟის ხელსაწყოები პირადი სარგებლობისთვის; ორთოპედიული ხელ-

საწყობი დეფორმირებული ფეხისთვის; ბრტყელტერფიანობისას გამოსაყენებელი საყრდენები; სამედიცინო ხელსაწყობი და ინსტრუმენტები.

11 – ფეხის სათბურები, ელექტრული და არა-ელექტრული; ელექტრული ფეხის სათბურები; ელექტრული აბაზანები ფეხისთვის; ჰიდრომასაჟის სააბაზანო მოწყობილობები; სანათები; ჯიბის სათბურები; წინდები, ელექტროგათბობით; ჩექმები, ელექტროგათბობით; ჩაიდნები, ელექტრული.

25 – ტანსაცმელი; ფეხსაცმელი; ტრიკოტაჟის ნაწარმი; საბანაო ჩუსტები; კეპები [თავსაბურავები]; მანტოები; შარვლები; მოკლესახელოიანი მაისურები; აბრეშუმის ყელსახვევები; ხელთათმანები [ტანსაცმელი].

26 – ზონრები (ფეხსაცმლის); ფეხსაცმლის შესაკრავები; მოსართავები (ფეხსაცმლის); კაუჭები (ფეხსაცმლის); რგოლები (ფეხსაცმლის თასმის გასაყრელი); ბალთები (ფეხსაცმლის); ნემსები (ხარაზის); ტანსაცმლის შესაკრავები; ელვა-შესაკრავები.

35 – საქონლის გასადებაში ხელშეწყობა მესამე პირთათვის; იმპორტ-ექსპორტის სააგენტოები; ადმინისტრირება მესამე პირთათვის (საქონლისა და მომსახურების ლიცენზირების კომერციული); მარკეტინგი; ონლაინ რეკლამირება კომპიუტერულ ქსელში; საქონლის პრეზენტაცია მასობრივი ინფორმაციის საშუალებებით საცალო ვაჭრობისათვის.

39 – სატრანსპორტო მომსახურება ღირსშესანიშნაობათა ტურებისთვის; ავტობუსების გაქირავება; მოგზაურობის ორგანიზება; მოგზაურების თანხლება; საკურიერო მომსახურება (კორესპონდენცია ან საქონლის ადგილზე მიტანა); ტანსაცმლის შენახვა; მოგზაურობის ინფორმაციის უზრუნველყოფა; დაჯავშნა (სამოგზაურო მარშრუტების); სამოგზაურო მარშრუტების დაგეგმვა; ცალკეული პირების და ჯგუფების მოგზაურობის ორგანიზაციის კოორდინაცია.

40 – ინდივიდუალური სამკერვალო მომსახურება (შეკვეთით); ფეხსაცმლის ღებვა; მონტაჟი და აწყობა შეკვეთით, მესამე პირთათვის; ქსოვილის დამუშავება ჭმუჭნის საწინააღმდეგო თვისების მისანიჭებლად; ქსოვილის კალანდერა; აპრეტურა (ქსოვილის); ქსოვილის დამუშავება წყალგაუმტარი თვისების მისანიჭებლად; ტანსაცმლის კერვა.

(260) AM 2021 109208 A  
 (210) AM 109208  
 (220) 2020 07 24  
 (731) შპს „G&A GROUP“  
 დემეტრე თავდადებულის ქ. 29,  
 თბილისი, საქართველო  
 (740) ნინო მაისურაძე  
 (540)

## ხინდა khinda

(591) შავ-თეთრი  
 (511)  
 29 – ხორცი, თევზი, ფრინველი და ნანადირევი; ხორცის ექსტრაქტები; დაკონსერვებული, გაყინული, გამხმარი და მომზადებული ხილი და ბოსტნეული (ხილისა და ბოსტნეულის კერძები); ჟელეები, ხილფაფები, კომპოტები; კვრცხი; რძე, ყველი, კარაქი, იუგურტი და რძის სხვა პროდუქტები; საკვები ზეთები და ცხიმები.

(260) AM 2021 109210 A  
 (210) AM 109210  
 (220) 2020 07 24  
 (731) შპს „ბიზნესისა და ტექნოლოგიების უნივერსიტეტი“  
 ილია ჭავჭავაძის გამზ. 82, თბილისი,  
 საქართველო  
 (740) შოთა ღვედაძე  
 (540)



(591) შავი, წითელი, მწვანე, ლურჯი, იასამნისფერი  
 (531) 01.13.01; 27.05.01; 27.05.15; 28.19; 29.01.15  
 (526) თბილისი, TBILISI  
 (511)

41 – განათლება; სასწავლო პროცესის უზრუნველყოფა; გართობა; სპორტული და კულტურული აქტივობები (ღონისძიებები).

42 – სამეცნიერო და ტექნოლოგიური მომსახურება და შესაბამისი სამეცნიერო კვლევები და გაფორმება; სამრეწველო ანალიზი, სამრეწველო კვლევა და სამრეწველო დიზაინი; ხარისხის კონტროლისა და ავტენტურობის დადგენის

სამსახური; კომპიუტერებისა და კომპიუტერული პროგრამების შექმნა და დამუშავება.

(260) AM 2021 109211 A

(210) AM 109211

(220) 2020 07 24

(731) შპს „ბიზნესისა და ტექნოლოგიების უნივერსიტეტი“  
ილია ჭავჭავაძის გამზ. 82, თბილისი, საქართველო

(740) შოთა ღვედაძე

(540)



(591) წითელი, ლურჯი

(531) 26.11.03; 26.11.05; 26.11.07; 26.11.11;  
27.05.01; 27.05.15; 27.05.23; 28.19; 29.01.12

(511)

41 – განათლება; სასწავლო პროცესის უზრუნველყოფა; გართობა; სპორტული და კულტურული აქტივობები (დონისძიებები).

42 – სამეცნიერო და ტექნოლოგიური მომსახურება და შესაბამისი სამეცნიერო კვლევები და გაფორმება; სამრეწველო ანალიზი, სამრეწველო კვლევა და სამრეწველო დიზაინი; ხარისხის კონტროლისა და ავთენტურობის დადგენის სამსახური; კომპიუტერებისა და კომპიუტერული პროგრამების შექმნა და დამუშავება.

(260) AM 2021 109227 A

(210) AM 109227

(220) 2020 07 30

(731) გეტც ფარმა ინტერნეშნლ ფზ ელელსი ოფის No. 1307, 13 ფლორ, ალ-ტურაია ტაუერ 1, დუბაი მედია სიტი, დუბაი, არაბთა გაერთიანებული საამიროები

(740) მერაბ კვიციანი

(540)

**STARCOX**

(591) შავ-თეთრი

(531) 27.05.01

(511)

5 – ფარმაცევტული პრეპარატები.

(260) AM 2021 109293 A

(210) AM 109293

(220) 2020 08 04

(731) შპს „ფარმაკაბი“

პ. ქავთარაძის ქ. 20დ, ბ. 33, 0186, თბილისი, საქართველო

(740) გიორგი თაქთაქიშვილი

(540)

**MEXIVEN МЕКСИВЕН**

(591) შავ-თეთრი

(511)

5 – სამკურნალო პრეპარატები.

(260) AM 2021 109294 A

(210) AM 109294

(220) 2020 08 04

(731) შპს „ფარმაკაბი“

პ. ქავთარაძის ქ. 20დ, ბ. 33, 0186, თბილისი, საქართველო

(740) გიორგი თაქთაქიშვილი

(540)

**DUALGIN ДУАЛГИН**

(591) შავ-თეთრი

(511)

5 – სამკურნალო პრეპარატები.

(260) AM 2021 109295 A

(210) AM 109295

(220) 2020 08 04

(731) დავით აბაიაძე

გამსახურდიას ქ., II კვარტ., კორპ. 6ბ, ბ. 18, თბილისი, საქართველო

(540)

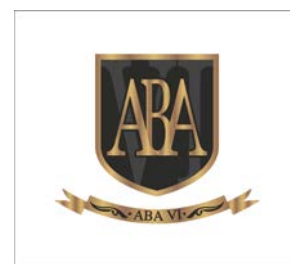

(591) შავი, ოქროსფერი, ნაცრისფერი

(531) 24.01.15; 25.01.05; 25.01.06; 27.05.01;  
27.05.23; 29.01.12

(511)

33 – ალკოჰოლური სასმელები, ლუდის გარდა; ალკოჰოლური შედგენილობები სასმელების დასამზადებლად.

(260) AM 2021 109300 A  
 (210) AM 109300  
 (220) 2020 08 05  
 (731) შპს „ჩემო კარგო“

ცოტნე დადიანის ქ. 108/კავთისხევის ქ. 22,  
 გლდან-ნაძალადევის რაიონი, თბილისი,  
 საქართველო

(540)



(591) C6E6DB ღია ცისფერი, F7EFAE ღია  
 ყვითელი, FBD13B ყვითელი, 2A69B2  
 ცისფერი, 0D0C2E მუქი ლურჯი, 754A37  
 მუქი ყავისფერი, B69166 ღია ყავისფერი,  
 17468A ლურჯი, 483870 იისფერი, 572E85  
 იასამნისფერი, DF708E ღია ვარდისფერი,  
 D4DADC ღია ნაცრისფერი, 231F20 შავი

(531) 03.01.08; 24.09.03; 24.09.07; 27.05.01;  
 27.05.09; 28.19; 29.01.15

(511)

32 – ლუდი, მინერალური და გაზიანი წყალი  
 და სხვა უალკოჰოლო სასმელები; ხილის სასმე-  
 ლები და ხილის წვენები; ვაჟინები და სასმელები  
 დასამზადებელი სხვა შედგენილობები.

(260) AM 2021 109381 A  
 (210) AM 109381  
 (220) 2020 08 12

(731) ფილიპ მორის პროდაქტს ს.ა.  
 კე ჟანრენო 3, 2000 ნევშატელი,  
 შვეიცარია

(740) პავლე მეიფარიანი  
 (540)

## TOGETHER. FORWARD.

(591) შავ-თეთრი

(511)

34 – სადენიანი გამოსაორთქლებლები („ვაპო-  
 რაიზერები“ ან „ვეიპორაიზერები“) ელექტრო-  
 ნული სიგარეტებისათვის და მოწვევისათვის  
 განკუთვნილი ელექტრონული მოწყობილობე-  
 ბისათვის; დაუმუშავებელი ან დამუშავებული  
 თამბაქო; თამბაქოს ნაწარმი სიგარეტის, სიგარე-  
 ტების, სიგარილოების, თვითგახვეული (თვით-  
 ნაკეთი) სიგარეტებისათვის განკუთვნილი თამ-  
 ბაქოს, ჩიბუხის თამბაქოს, საღეჭი თამბაქოს, სა-

ბურნუთე თამბაქოსა და კრეტეკის ჩათვლით;  
 თამბაქო „სნუსი“; თამბაქოს შემცველები (არა-  
 სამედიცინო დანიშნულების); მწვევლთა სა-  
 კუთნო, სიგარეტის ქალაღისა და მილაკების  
 (ჰილზების), სიგარეტის ფილტრების, თამბაქო-  
 სათვის განკუთვნილი ქილების, სიგარეტის კო-  
 ლოფების (პორტსიგარეტის), საფერფლებების,  
 ჩიბუხების, სიგარეტის გასახვევად განკუთვნი-  
 ლი ჯიბის მოწყობილობებისა და სანთებლების  
 ჩათვლით; ასანთი; თამბაქოს ჩხირები (თამ-  
 ბაქოს „სტიკები“), თამბაქოს ნაწარმი მათი შემ-  
 დგომი გახურების მიზნით, ელექტრონული  
 მოწყობილობები და მათი ნაწილები სიგარეტე-  
 ბის ან თამბაქოს გასახურებლად ნიკოტინის შე-  
 მცველი აეროზოლის გამოყოფისათვის შესუნ-  
 თქვის მიზნით; თხევადი ნიკოტინის ხსნარები  
 ელექტრონულ სიგარეტებში გამოსაყენებლად;  
 მოწვევისათვის განკუთვნილი ელექტრონული  
 მოწყობილობები; ელექტრონული სიგარეტები;  
 ელექტრონული სიგარეტები, როგორც ტრადი-  
 ციული სიგარეტების შემცველები; ელექტრო-  
 ნული მოწყობილობები ნიკოტინის შემცველი  
 აეროზოლის შესუნთქვისათვის; ორალური და-  
 ნიშნულების გამოსაორთქლებელი მოწყობი-  
 ლობები მწვევლთათვის, თამბაქოს პროდუქცია  
 და თამბაქოს შემცველები; მწვევლთა საკუთ-  
 ნო ელექტრონული სიგარეტებისათვის; ნაწი-  
 ლები და ფიტინგები 34-ე კლასში შემავალი ზე-  
 მოთ ჩამოთვლილი ნაწარმისათვის; მოწყობი-  
 ლობები გახურებული სიგარეტების, სიგარეტის  
 და, ასევე, გახურებული თამბაქოს ჩხირების ჩა-  
 საქრობად; პორტსიგარეტი (კოლოფები) ელექ-  
 ტრონული მრავალჯერადად დასატენი სიგარე-  
 ტებისათვის.

(260) AM 2021 109382 A

(210) AM 109382

(220) 2020 08 13

(310) 35047

(320) 2020 06 16

(330) AD

(731) ფილიპ მორის პროდაქტს ს.ა.

კე ჟანრენო 3, 2000 ნევშატელი,  
 შვეიცარია

(740) პავლე მეიფარიანი

(540)



(591) შავ-თეთრი  
(531) 26.01.01; 26.01.03; 26.03.01; 26.03.07;  
26.03.10

(511)

34 – დამცავი პორტსიგარები (კოლოფები), დეკორატიული შალითები და გადასატანი ბუდეები ელექტრონული სიგარეტებისათვის, თამბაქოს გასახურებლად განკუთვნილი მოწყობილობებისათვის და მოწვევისათვის განკუთვნილი ელექტრონული მოწყობილობებისათვის; ქვესადგამები და დამჭერები ელექტრონული სიგარეტებისათვის, თამბაქოს გასახურებლად განკუთვნილი მოწყობილობებისათვის და მოწვევისათვის განკუთვნილი ელექტრონული მოწყობილობებისათვის ავტომობილებში გამოსაყენებლად; სათავსოები გამოყენებული თამბაქოს ჩხირების ჩასაგდებად; სამარჯვეები, პრეპარატები, საკუთნო და ჯაგრისები ელექტრონული სიგარეტების, თამბაქოს გასახურებლად განკუთვნილი მოწყობილობების და მოწვევისათვის განკუთვნილი ელექტრონული მოწყობილობების გასაწმენდად.

34 – სადენიანი გამოსაორთქლებლები („ვაპორაიზერები“ ან „ვეიპორაიზერები“) ელექტრონული სიგარეტებისათვის და მოწვევისათვის განკუთვნილი ელექტრონული მოწყობილობებისათვის; დაუმუშავებელი ან დამუშავებული თამბაქო; თამბაქოს ნაწარმი სიგარეტის, სიგარეტების, სიგარილოების, თვითგახვეული (თვითნაკეთი) სიგარეტებისათვის განკუთვნილი თამბაქოს, ჩიბუხის თამბაქოს, სადეჭი თამბაქოს, საბურნუთე თამბაქოსა და კრეტეკის ჩათვლით; თამბაქო „სნუსი“; თამბაქოს შემცვლელები (არსამედიცინო დანიშნულების); მწვევლთა საკუთნო, სიგარეტის ქალაღისა და მილაკების (ჰილზების), სიგარეტის ფილტრების, თამბაქოსათვის განკუთვნილი ქილების, სიგარეტის კოლოფების (პორტსიგარების), საფერფლეების, ჩიბუხების, სიგარეტის გასახვევად განკუთვნილი ჯიბის მოწყობილობებისა და სანთებლების ჩათვლით; ასანთი; თამბაქოს ჩხირები (თამბაქოს „სტიკები“), თამბაქოს ნაწარმი მათი შემდგომი გახურების მიზნით, ელექტრონული მოწყობილობები და მათი ნაწილები სიგარეტების ან თამბაქოს გასახურებლად ნიკოტინის შემცველი აეროზოლის გამოყოფისათვის შესუნთქვის მიზნით; თხევადი ნიკოტინის ხსნარები ელექტრონულ სიგარეტებში გამოსაყენებლად; მოწვევისათვის განკუთვნილი ელექტრონული მოწყობილობები; ელექტრონული სიგარეტები; ელექტრონული სიგარეტები, როგორც ტრადი-

ციული სიგარეტების შემცვლელები; ელექტრონული მოწყობილობები ნიკოტინის შემცველი აეროზოლის შესუნთქვისათვის; ორალური დანიშნულების გამოსაორთქლებელი მოწყობილობები მწვევლთათვის, თამბაქოს პროდუქცია და თამბაქოს შემცვლელები; მწვევლთა საკუთნო ელექტრონული სიგარეტებისათვის; ნაწილები და ფიტინგები 34-ე კლასში შემავალი ზემოთ ჩამოთვლილი ნაწარმისათვის; მოწყობილობები გახურებული სიგარეტების, სიგარეტის და ასევე გახურებული თამბაქოს ჩხირების ჩასაქრობად; პორტსიგარები (კოლოფები) ელექტრონული მრავალჯერადად დასატენი სიგარეტებისათვის.

## რეგისტრირებული სასაქონლო ნიშნები

(111) M 2021 33669 R  
(151) 2021 02 14  
(181) 2031 02 14  
(260) AM 2020 103187 A  
(220) 2020 03 06

(732) გვანცა მიქუჭაძე  
ქავთარაძის ქ. 1, 0186, თბილისი,  
საქართველო

(111) M 2021 33670 R  
(151) 2021 02 14  
(181) 2031 02 14  
(260) AM 2020 104202 A  
(220) 2020 02 17

(732) შპს „დემასი“  
მარჯვენა სანაპირო 9 მარტის სახელობის  
ბაღის მიმდებარე ტერიტორია, თბილისი,  
საქართველო

(111) M 2021 33671 R  
(151) 2021 02 14  
(181) 2031 02 14  
(260) AM 2020 104203 A  
(220) 2020 02 17

(732) შპს „დემასი“  
მარჯვენა სანაპირო 9 მარტის სახელობის  
ბაღის მიმდებარე ტერიტორია, თბილისი,  
საქართველო

(111) M 2021 33672 R  
(151) 2021 02 14  
(181) 2031 02 14  
(260) AM 2020 104204 A  
(220) 2020 02 17

(732) შპს „დემასი“  
მარჯვენა სანაპირო 9 მარტის სახელობის  
ბაღის მიმდებარე ტერიტორია, თბილისი,  
საქართველო

(111) M 2021 33673 R  
(151) 2021 02 14  
(181) 2031 02 14  
(260) AM 2020 106509 A  
(220) 2020 01 06

(732) ტექსოლ ლუბრიტექ ფზკ  
პ.ო. ბოქს. 50802, პლოტ 2B - 12, ჰამრია  
ფრი ზოუნ, ფეიზ 1, შარჯა, არაბთა  
გაერთიანებული საამიროები

(111) M 2021 33674 R  
(151) 2021 02 14  
(181) 2031 02 14  
(260) AM 2020 106517 A  
(220) 2020 01 08

(732) კოულ ჰან ლლკ  
150 იუმენ როუდი, გრინლენდი,  
ნიუ-ჰემპშირი 03840, აშშ

(111) M 2021 33675 R  
(151) 2021 02 14  
(181) 2031 02 14  
(260) AM 2020 106518 A  
(220) 2020 01 08

(732) კოულ ჰან ლლკ  
150 იუმენ როუდი, გრინლენდი,  
ნიუ-ჰემპშირი 03840, აშშ

(111) M 2021 33676 R  
(151) 2021 02 14  
(181) 2031 02 14  
(260) AM 2020 106592 A  
(220) 2020 01 10

(732) იივუ ჰაირონგ ი-კომერს კო., ლტდ.  
No. 1, ბილდინგ 11, სირდ ერეა, ქსიავან  
ვილიჯ, ჯიანგდონგ სტრიტ, იივუ,  
ჟეჯიანგი, ჩინეთის სახალხო რესპუბლიკა

(111) M 2021 33677 R  
(151) 2021 02 14  
(181) 2031 02 14  
(260) AM 2020 106600 A  
(220) 2020 01 14

(732) შპს „ემ ემ მოტორს“  
პაატა ჯანელიძის ქ. 23, თბილისი,  
საქართველო



(111) M 2021 33678 R  
 (151) 2021 02 14  
 (181) 2031 02 14  
 (260) AM 2020 106645 A  
 (220) 2020 01 17  
 (732) შპს „ასფარმა საქართველო  
 ფარმაცევტული კომპანია“  
 მცხეთის ქ. 8, თბილისი, საქართველო

(111) M 2021 33679 R  
 (151) 2021 02 14  
 (181) 2031 02 14  
 (260) AM 2020 106657 A  
 (220) 2020 01 21  
 (732) ჯიარი გრანდ რივერ ენტერპრაიზის  
 დოილანდ გმბჰ  
 რიტცერ ბერგ 28, 14797 კლოსტერ-  
 ლენინ/ოტ რიც, გერმანია

(111) M 2021 33680 R  
 (151) 2021 02 14  
 (181) 2031 02 14  
 (260) AM 2020 106671 A  
 (220) 2020 01 23  
 (732) გეტც ფარმა ინტერნეშნლ ფზ ელელსი  
 ოფის No. 1307, 13 ფლორ, ალ-ტურაია  
 ტაუერ 1, დუბაი მედია სიტი, დუბაი,  
 არაბთა გაერთიანებული საამიროები

(111) M 2021 33681 R  
 (151) 2021 02 14  
 (181) 2031 02 14  
 (260) AM 2020 106751 A  
 (220) 2020 01 24  
 (732) იპ ჰოლდინგს უნლტდ ლლკ  
 1450 ბროდვეი, 3 ფლორი, ნიუ-იორკი,  
 ნიუ-იორკი 10018, აშშ

(111) M 2021 33682 R  
 (151) 2021 02 14  
 (181) 2031 02 14  
 (260) AM 2020 106752 A  
 (220) 2020 01 24  
 (732) იპ ჰოლდინგს უნლტდ ლლკ  
 1450 ბროდვეი, 3 ფლორი, ნიუ-იორკი,  
 ნიუ-იორკი 10018, აშშ

(111) M 2021 33683 R  
 (151) 2021 02 14  
 (181) 2031 02 14  
 (260) AM 2020 106799 A  
 (220) 2020 01 30  
 (732) შპს „მინისო ჯორჯია“  
 ანა კალანდაძის ქ. 4, სად. 1, საოფისე  
 ფართი ა5, ვაკე-საბურთალოს რაიონი,  
 თბილისი, საქართველო

(111) M 2021 33684 R  
 (151) 2021 02 14  
 (181) 2031 02 14  
 (260) AM 2020 106800 A  
 (220) 2020 01 30  
 (732) შპს „მინისო ჯორჯია“  
 ანა კალანდაძის ქ. 4, სად. 1, საოფისე  
 ფართი ა5, ვაკე-საბურთალოს რაიონი,  
 თბილისი, საქართველო

(111) M 2021 33685 R  
 (151) 2021 02 14  
 (181) 2031 02 14  
 (260) AM 2020 106826 A  
 (220) 2020 01 31  
 (732) პაუტეკ ინტერნეიშენელ ჰოლდინგს  
 ლიმიტედ  
 23 ჰელთ როუდ, ნემენელ ჰელთ  
 ტექნოლოჯი პარკ, ტორჩ დეველოპმენტ  
 ზოუნ, ჩჟუნშანი, გუანდუნის პროვინცია,  
 528400, ჩინეთის სახალხო რესპუბლიკა

(111) M 2021 33686 R  
 (151) 2021 02 14  
 (181) 2031 02 14  
 (260) AM 2020 106827 A  
 (220) 2020 01 31  
 (732) პაუტეკ ინტერნეიშენელ ჰოლდინგს  
 ლიმიტედ  
 23 ჰელთ როუდ, ნემენელ ჰელთ  
 ტექნოლოჯი პარკ, ტორჩ დეველოპმენტ  
 ზოუნ, ჩჟუნშანი, გუანდუნის პროვინცია,  
 528400, ჩინეთის სახალხო რესპუბლიკა

(111) M 2021 33687 R  
 (151) 2021 02 14  
 (181) 2031 02 14  
 (260) AM 2020 106828 A  
 (220) 2020 02 01  
 (732) შპს „აიპისი“  
 კორნელი კეკელიძის ქ. 14, სართულისა და  
 მანსარდის დაშენება 14ბ, ძველი  
 თბილისის რაიონი, თბილისი,  
 საქართველო

ახალგაზრდობის გამზ. 5/7, 4600,  
 ქუთაისი, საქართველო

(111) M 2021 33688 R  
 (151) 2021 02 14  
 (181) 2031 02 14  
 (260) AM 2020 106830 A  
 (220) 2020 02 01  
 (732) შპს „აიპისი“  
 კორნელი კეკელიძის ქ. 14, სართულისა და  
 მანსარდის დაშენება 14ბ, ძველი  
 თბილისის რაიონი, თბილისი,  
 საქართველო

(111) M 2021 33692 R  
 (151) 2021 02 14  
 (181) 2031 02 14  
 (260) AM 2020 107307 A  
 (220) 2020 02 27  
 (732) ფრეიზერ რისერჩ ლეზ. ინკ.  
 25 შეპპარდ ავენიუ ვესტ, სვიტ 300,  
 ტორონტო, ონტარიო, M2N 6S6, კანადა

(111) M 2021 33689 R  
 (151) 2021 02 14  
 (181) 2031 02 14  
 (260) AM 2020 106831 A  
 (220) 2020 02 01  
 (732) შპს „აიპისი“  
 კორნელი კეკელიძის ქ. 14, სართულისა და  
 მანსარდის დაშენება 14ბ, ძველი  
 თბილისის რაიონი, თბილისი,  
 საქართველო

(111) M 2021 33693 R  
 (151) 2021 02 14  
 (181) 2031 02 14  
 (260) AM 2020 107311 A  
 (220) 2020 02 27  
 (732) შპს „ვაინმენ შპს“  
 გუდიაშვილის ქ. 11, 0105, თბილისი,  
 საქართველო

(111) M 2021 33690 R  
 (151) 2021 02 14  
 (181) 2031 02 14  
 (260) AM 2020 106952 A  
 (220) 2020 02 05  
 (732) შპს „ინგლიზ ბუქ ედუქეიშენ“  
 ზაქარია ფალიაშვილის ქ. 116, 0162,  
 თბილისი, საქართველო

(111) M 2021 33694 R  
 (151) 2021 02 14  
 (181) 2031 02 14  
 (260) AM 2020 107391 A  
 (220) 2020 03 02  
 (732) ბრანდტ კონსოლიდეტიდ, ინკ.  
 2935 ს. კუკ მილ როუდ, სპრინგფილდი,  
 შტატი ილინოისი 62711 , აშშ

(111) M 2021 33691 R  
 (151) 2021 02 14  
 (181) 2031 02 14  
 (260) AM 2020 107294 A  
 (220) 2020 02 25  
 (732) სსიპ „ქუთაისის საერთაშორისო  
 უნივერსიტეტი“

(111) M 2021 33695 R  
 (151) 2021 02 14  
 (181) 2031 02 14  
 (260) AM 2020 107490 A  
 (220) 2020 03 12  
 (732) დეიზ ინს ვორლდვაიდ, ინკ.  
 22 სილვან ვეი, პარსიპანი, ნიუ-ჯერზი  
 07054, აშშ

(111) M 2021 33696 R  
 (151) 2021 02 14  
 (181) 2031 02 14  
 (260) AM 2020 107491 A  
 (220) 2020 03 12  
 (732) დეიზ ინს ვორლდვაიდ, ინკ.  
 22 სილვან ვეი, პარსიპანი, ნიუ-ჯერზი  
 07054, აშშ

(111) M 2021 33697 R  
 (151) 2021 02 14  
 (181) 2031 02 14  
 (260) AM 2020 107552 A  
 (220) 2020 03 13  
 (732) ბევრიჯ პარტნერს ინტერნეშნლ (ქრავტ) ლტდ.  
 იუნიტ 12, კილკენი რითეილ პარკ, სმით ლენდს საუთ, კილკენი, ირლანდია

(111) M 2021 33698 R  
 (151) 2021 02 14  
 (181) 2031 02 14  
 (260) AM 2020 107814 A  
 (220) 2020 04 08  
 (732) ქრისტი თოფურია  
 დილომი, VI კვარტ., კორპ. 18, თბილისი, საქართველო

(111) M 2021 33708 R  
 (151) 2021 02 19  
 (181) 2031 02 19  
 (260) AM 2019 105671 A  
 (220) 2019 11 07  
 (732) გაბა ინტერნაციონალ ჰოლდინგ გმბჰ  
 გრაბეტსმათევეგ, თერვილი, 4106, შვეიცარია

(111) M 2021 33709 R  
 (151) 2021 02 19  
 (181) 2031 02 19  
 (260) AM 2019 105672 A  
 (220) 2019 11 07  
 (732) გაბა ინტერნაციონალ ჰოლდინგ გმბჰ  
 გრაბეტსმათევეგ, თერვილი, 4106, შვეიცარია

(111) M 2021 33710 R  
 (151) 2021 02 19  
 (181) 2031 02 19  
 (260) AM 2020 106520 A  
 (220) 2020 01 08  
 (732) იაგო ბიტარიშვილი  
 სოფ. ჩარდახი, მცხეთის რ-ნი, საქართველო

(111) M 2021 33711 R  
 (151) 2021 02 19  
 (181) 2031 02 19  
 (260) AM 2020 106603 A  
 (220) 2020 01 15  
 (732) შპს „ჯორჯიან ალიანსი“  
 გიორგი ნადარეიშვილის ქ. 9, 0120, თბილისი, საქართველო

(111) M 2021 33712 R  
 (151) 2021 02 19  
 (181) 2031 02 19  
 (260) AM 2020 106606 A  
 (220) 2020 01 15  
 (732) იაგო ბიტარიშვილი  
 სოფ. ჩარდახი, მცხეთის რაიონი, საქართველო

(111) M 2021 33713 R  
 (151) 2021 02 19  
 (181) 2031 02 19  
 (260) AM 2020 106755 A  
 (220) 2020 01 24  
 (732) ნს სტუდიო  
 ხ. სავანელის ქ. 18, 0105, თბილისი, საქართველო

(111) M 2021 33714 R  
 (151) 2021 02 19  
 (181) 2031 02 19  
 (260) AM 2020 106819 A  
 (220) 2020 01 31  
 (732) გეტე ფარმა ინტერნეშნლ ფზ ელელსი  
 ოფის No. 1307, 13 ფლორ, ალ-ტურაია ტაუერ 1, დუბაი მედია სიტი, დუბაი, არაბთა გაერთიანებული საამიროები

(111) M 2021 33715 R  
 (151) 2021 02 19  
 (181) 2031 02 19  
 (260) AM 2020 106820 A  
 (220) 2020 01 31  
 (732) გეტე ფარმა ინტერნეშნლ ფზ ელელსი  
 ოფის No. 1307, 13 ფლორ, ალ-ტურაია ტაუერ 1, დუბაი მედია სიტი, დუბაი, არაბთა გაერთიანებული საამიროები

(111) M 2021 33716 R  
 (151) 2021 02 19  
 (181) 2031 02 19  
 (260) AM 2020 106931 A  
 (220) 2020 02 03  
 (732) შპს „ენკენი ფილმსი“  
 კოტე აფხაზის ქ. 55, 0105, თბილისი,  
 საქართველო

(111) M 2021 33721 R  
 (151) 2021 02 19  
 (181) 2031 02 19  
 (260) AM 2020 107175 A  
 (220) 2020 02 20  
 (732) ზუფა ლღკ  
 6650 საუთ ტორი პაინზ დრაივი,  
 ლას-ვეგასი, ნევადა 89118, აშშ

(111) M 2021 33717 R  
 (151) 2021 02 19  
 (181) 2031 02 19  
 (260) AM 2020 106934 A  
 (220) 2020 02 04  
 (732) ამირან მეზურიშვილი  
 კოტე აფხაზის ქ. 55, 0105, თბილისი,  
 საქართველო

(111) M 2021 33722 R  
 (151) 2021 02 19  
 (181) 2031 02 19  
 (260) AM 2020 107185 A  
 (220) 2020 02 21  
 (732) შპს „თურმანიძე პლიუსი“  
 კოსტავას ქ. 75, ბ. 81, 0171, თბილისი,  
 საქართველო

(111) M 2021 33718 R  
 (151) 2021 02 19  
 (181) 2031 02 19  
 (260) AM 2020 107047 A  
 (220) 2020 02 10  
 (732) ა(ა)იპ საქართველოს ფერმერთა ასოციაცია  
 აკ. ხორავას ქ. 4, 0179, თბილისი,  
 საქართველო

(111) M 2021 33723 R  
 (151) 2021 02 19  
 (181) 2031 02 19  
 (260) AM 2020 107309 A  
 (220) 2020 02 27  
 (732) ზუფა, ლღკ  
 6650 საუთ ტორი პაინზ დრაივი,  
 ლას-ვეგასი, ნევადა 89118, აშშ

(111) M 2021 33719 R  
 (151) 2021 02 19  
 (181) 2031 02 19  
 (260) AM 2020 107060 A  
 (220) 2020 02 11  
 (732) ელდარი მღებრიშვილი  
 მოსკოვის გამზ., V კვარტ., კორპ. 3, ბ. 43,  
 0137, თბილისი, საქართველო

(111) M 2021 33724 R  
 (151) 2021 02 19  
 (181) 2031 02 19  
 (260) AM 2020 107310 A  
 (220) 2020 02 27  
 (732) ზუფა, ლღკ  
 6650 საუთ ტორი პაინზ დრაივი,  
 ლას-ვეგასი, ნევადა 89118, აშშ

(111) M 2021 33720 R  
 (151) 2021 02 19  
 (181) 2031 02 19  
 (260) AM 2020 107174 A  
 (220) 2020 02 20  
 (732) ზუფა, ლღკ  
 6650 საუთ ტორი პაინზ დრაივი,  
 ლას-ვეგასი, ნევადა 89118, აშშ

(111) M 2021 33725 R  
 (151) 2021 02 19  
 (181) 2031 02 19  
 (260) AM 2020 107392 A  
 (220) 2020 03 02  
 (732) ბრანდტ კონსოლიდეიტიდ ინკ.  
 2935 ს. კუკ მილ როუდ, სპრინგფილდი,  
 შტატი ილინოისი 62711, აშშ

(111) M 2021 33726 R

(151) 2021 02 19

(181) 2031 02 19

(260) AM 2020 107921 A

(220) 2020 04 14

(732) საქართველოში INPHA LLP-ის  
წარმომადგენლობითი ოფისი  
ბესიკის ქ. 4-ის მიმდებარედ, ნაკვეთი  
46/10, 0108, თბილისი, საქართველო

---

## დაჩქარებული პროცედურით რეგისტრირებული სასაქონლო ნიშნები

რეგისტრაციის გაუქმების მოთხოვნით საჩივრის შეტანა შესაძლებელია საქპატენტის სააპელაციო პალატაში გამოქვეყნებიდან 3 თვის ვადაში.

(111) M 2021 33658 R

(151) 2021 02 06

(181) 2031 02 06

(210) AM 111433

(220) 2021 01 27

(732) შპს „კარმენ“

აღმაშენებლის ქ. 34ა, 6000, ბათუმი,  
საქართველო

(540)



(591) B2A2A2 ნაცრისფერი, FFFFFFF თეთრი,

F40404 წითელი, მუქი ნაცრისფერი

(531) 11.03.04; 11.03.14; 19.03.24; 27.05.01;

27.05.24; 29.01.13

(511)

30 – ყავა, ჩაი, კაკაო და ყავის შემცველები; ბრინჯი, მაკარონი და ატრია; ტაპიოკა და საგო; ფქვილი და მარცვლეულის პროდუქტი; პურ-ფუნთუშეული, მაკარონი და საკონდიტრო ნაწარმი; შოკოლადი; ნაყინი, შარბათი და სხვა საკვები ყინული; შაქარი, თაფლი, ბადაგი; საფუარი, საცხობი ფხვნილები; მარილი, საწებლები, საკაზმები, დაკონსერვებული მწვანე ხაჭაპური, საწებლები და სხვა საკაზმი; ყინული (გაყინული წყალი).

(111) M 2021 33659 R

(151) 2021 02 08

(181) 2031 02 08

(210) AM 111442

(220) 2021 01 28

(732) სს „მეგობრების მარანი“

სოფ. შილდა, ყვარლის რაიონი,  
საქართველო

(540)

### მოსილი მამული

(591) შავ-თეთრი

(511)

33 – ალკოჰოლური სასმელები, ლუდის გარდა; ალკოჰოლური შედგენილობები სასმელების დასამზადებლად.

43 – საკვებით და სასმელით უზრუნველყოფა; დროებითი საცხოვრებელი უზრუნველყოფა.

(111) M 2021 33660 R

(151) 2021 02 08

(181) 2031 02 08

(210) AM 111444

(220) 2021 01 28

(732) სს „მეგობრების მარანი“

სოფ. შილდა, ყვარლის რაიონი,  
საქართველო

(540)

### შატროვანი მამული

(591) შავ-თეთრი

(511)

33 – ალკოჰოლური სასმელები, ლუდის გარდა; ალკოჰოლური შედგენილობები სასმელების დასამზადებლად.

43 – საკვებით და სასმელით უზრუნველყოფა; დროებითი საცხოვრებელი უზრუნველყოფა.

(111) M 2021 33661 R

(151) 2021 02 08

(181) 2031 02 08

(210) AM 111445

(220) 2021 01 28

(732) სს „მეგობრების მარანი“

სოფ. შილდა, ყვარლის რაიონი,  
საქართველო

(540)

### ნეტარეული მამული

(591) შავ-თეთრი

(511)

33 – ალკოჰოლური სასმელები, ლუდის გარდა; ალკოჰოლური შედგენილობები სასმელების დასამზადებლად.

43 – საკვებით და სასმელით უზრუნველყოფა; დროებითი საცხოვრებელით უზრუნველყოფა.

(111) M 2021 33662 R

(151) 2021 02 08

(181) 2031 02 08

(210) AM 111510

(220) 2021 02 01

(732) შპს „ინექს გრუპი“

მეტრო სადგურ „ახმეტელის თეატრი“-ს მიმდებარე ტერიტორია, ნაგებობა №1, სართ. 1, თბილისი, საქართველო

(540)



ინექს  
INEX  
ИНЭК  
INEE

(591) შავი, წითელი

(531) 27.05.01; 27.05.22; 28.05; 28.19; 29.01.12

(511)

35 – რეკლამა; ბიზნესის მართვა; ბიზნესის ადმინისტრირება; საოფისე მომსახურება.

36 – დაზღვევა; ფინანსური საქმიანობა; ფულად-საკრედიტო საქმიანობა; უძრავ ქონებასთან დაკავშირებული საქმიანობა.

37 – სამშენებლო მომსახურება; სამონტაჟე და სარემონტო მომსახურება; სამთო მოპოვება, ნავთობისა და გაზის ჭაბურღილები.

38 – სატელეკომუნიკაციო მომსახურება.

39 – ტრანსპორტირება; საქონლის შეფუთვა და დასაწყობება; მოგზაურობის ორგანიზება.

42 – სამეცნიერო და ტექნოლოგიური მომსახურება და შესაბამისი სამეცნიერო კვლევები და გაფორმება; სამრეწველო ანალიზი, სამრეწველო კვლევა და სამრეწველო დიზაინი; ხარისხის კონტროლი

ნტროლისა და ავტენტურობის დადგენის სამსახური; კომპიუტერებისა და კომპიუტერული პროგრამების შექმნა და დამუშავება.

(111) M 2021 33663 R

(151) 2021 02 10

(181) 2031 02 10

(210) AM 111266

(220) 2021 01 08

(732) მაქსიმუსი

მე-6 ქ. 1ა, სოფ. სალიბაური, 6000, ხელვაჩაური, ბათუმი, საქართველო

(540)



(591) 004DFF ლურჯი, FFE600 ყვითელი, თეთრი

(531) 08.07.01; 11.03.03; 11.03.07; 26.01.16; 27.05.01; 28.19; 29.01.13

(511)

35 – რეკლამა; ბიზნესის მართვა; ბიზნესის ადმინისტრირება; საოფისე მომსახურება.

(111) M 2021 33664 R

(151) 2021 02 10

(181) 2031 02 10

(210) AM 111443

(220) 2021 01 28

(732) სს „მეგობრების მარანი“

სოფ. შილდა, ყვარლის რაიონი, საქართველო

(540)

## ტაროსი მამული

(591) შავ-თეთრი

(511)

43 – საკვებით და სასმელით უზრუნველყოფა; დროებითი საცხოვრებელით უზრუნველყოფა.

(111) M 2021 33665 R

(151) 2021 02 10

(181) 2031 02 10

(210) AM 111515

(220) 2021 02 02

(732) შპს „ჯოლიო“

ი. ჭავჭავაძის გამზ. 83, ბ. 49, თბილისი, საქართველო

(540)

# შეფი

(591) შავ-თეთრი

(511)

29 – ხორცი, თევზი, ფრინველი და ნანადირევები; ხორცის ექსტრაქტები; დაკონსერვებული, გაყინული, გამხმარი და მოხარშული ან შემწვარი ხილი და ბოსტნეული; ყელეები, ხილფაფები, კომპოტები; კვერცხი; რძე, ყველი, კარაქი, იოგურტი და რძის სხვა პროდუქტები; საკვები ზეთები და ცხიმები.

(111) M 2021 33666 R

(151) 2021 02 11

(181) 2031 02 11

(210) AM 111581

(220) 2021 02 05

(732) შპს „ინთერნემნალ ბეიკერ ჰაუს“  
ლილო, ლოჭინის ხევი, (ნაკვ. 05/001),  
სამგორის რაიონი, თბილისი,  
საქართველო

(740) ირაკლი გვილია

(540)



(591) წითელი, თეთრი

(531) 08.01.01; 08.01.04; 26.02.07; 26.02.08;  
26.02.09; 29.01.12

(511)

30 – ყავა, ჩაი, კაკაო და ხელოვნური ყავა; ბრინჯი, მაკარონი და ატრია; ტაპიოკა და საგო; ფქვილი და მარცვლოვანი პროდუქტი; პურ-ფუნთუშეული, მაკარონი და საკონდიტრო ნაწარმი; შოკოლადი; ნაყინი, შარბათი და სხვა საკვები ყინული; შაქარი, თაფლი, ბადაგი; საფუარი, საცხობი ფხვნილები; მარილი, სანელებლები, საკაზმები, დაკონსერვებული მწვანილი; ძმარი, საწებლები და სხვა საკაზმი; ყინული (გაყინული წყალი).

35 – რეკლამა; ბიზნეს მენეჯმენტი; ბიზნესის ადმინისტრირება; საოფისე სამსახური; საცალო და საბითუმო ვაჭრობა; პურ-ფუნთუშეულით ვაჭრობა; გამოფენების და ბაზრობების ორგანიზება; ონლაინ საბითუმო და საცალო ვაჭრობა.

(111) M 2021 33667 R

(151) 2021 02 11

(181) 2031 02 11

(210) AM 111582

(220) 2021 02 05

(732) შპს „ინთერნემნალ ბეიკერ ჰაუს“  
ლილო, ლოჭინის ხევი, (ნაკვ. 05/001),  
სამგორის რაიონი, თბილისი,  
საქართველო

(740) ირაკლი გვილია

(540)



(591) წითელი, თეთრი

(531) 08.01.04; 29.01.01

(511)

30 – ყავა, ჩაი, კაკაო და ხელოვნური ყავა; ბრინჯი, მაკარონი და ატრია; ტაპიოკა და საგო; ფქვილი და მარცვლოვანი პროდუქტი; პურ-ფუნთუშეული, მაკარონი და საკონდიტრო ნაწარმი; შოკოლადი; ნაყინი, შარბათი და სხვა საკვები ყინული; შაქარი, თაფლი, ბადაგი; საფუარი, საცხობი ფხვნილები; მარილი, სანელებლები, საკაზმები, დაკონსერვებული მწვანილი; ძმარი, საწებლები და სხვა საკაზმი; ყინული (გაყინული წყალი).

35 – რეკლამა; ბიზნეს მენეჯმენტი; ბიზნესის ადმინისტრირება; საოფისე სამსახური; საცალო და საბითუმო ვაჭრობა; პურ-ფუნთუშეულით ვაჭრობა; გამოფენების და ბაზრობების ორგანიზება; ონლაინ საბითუმო და საცალო ვაჭრობა.

(111) M 2021 33668 R

(151) 2021 02 14

(181) 2031 02 14

(210) AM 111527

(220) 2021 02 03

(732) ვუვ.ჯი  
დოლაბაურის ქ. 1, 58, თბილისი,  
საქართველო

(540)





(591) ნარინჯისფერი, თეთრი, ყვითელი,  
მწვანე, ცისფერი  
(531) 10.03.10; 10.03.11; 20.05.15; 27.05.01;  
27.05.19; 29.01.15

(511)  
25 – ტანსაცმელი, ფეხსაცმელი, თავსაბურავი.

35 – რეკლამა; ბიზნესის მართვა; ბიზნესის ად-  
მინისტრირება; საოფისე მომსახურება.

(111) M 2021 33699 R

(151) 2021 02 15

(181) 2031 02 15

(210) AM 111596

(220) 2021 02 09

(732) შპს „საბი“

რუსთაველის ქ. 89, ზუგდიდი,  
საქართველო

(740) გიორგი თაქთაქიშვილი

(540)



**ZUGDIDI MALL**

(591) ლურჯი, თეთრი, შავი  
(531) 27.01.02; 27.01.03; 27.05.01; 27.05.22;  
29.01.12

(526) ZUGDIDI

(511)

35 – რეკლამა; ბიზნეს მენეჯმენტი; ბიზნესის  
ადმინისტრირება; საოფისე სამსახური; მომარ-  
გების მომსახურება მესამე პირთათვის [საქონ-  
ლისა და მომსახურების შესყიდვა სხვა მეწარ-  
მეებისათვის]; საქონლის გასაღებაში ხელშეწყო-  
ბა მესამე პირთათვის; საცალო და საბითუმო  
ვაჭრობის მომსახურება.

(111) M 2021 33700 R

(151) 2021 02 15

(181) 2031 02 15

(210) AM 111540

(220) 2021 02 05

(732) შპს „ქართული ვაზისა და ღვინის  
კომპანია“

დავით აღმაშენებლის გამზ. 179ა, ბ. 25,  
0112, თბილისი, საქართველო

(540)

**KAKABADZE SHILDA WINERY**  
**კაკაბაძე შილდა ვაინერი**

**КАКАБАДЗЕ ШИЛДА**  
**ВАЙНЕРИ**

(591) შავ-თეთრი

(526) SHILDA შილდა ШИЛДА

(511)

33 – ალკოჰოლური სასმელები, ლუდის გარდა;  
ალკოჰოლური შედგენილობები სასმელების  
დასამზადებლად.

(111) M 2021 33701 R

(151) 2021 02 17

(181) 2031 02 17

(210) AM 111597

(220) 2021 02 09

(732) შპს „სუფთა სახლი“

ქსნის ქ. 36, 0141, თბილისი, საქართველო

(540)



(591) 93C540 მწვანე, 1862B0 ლურჯი  
(531) 07.01.09; 07.03.02; 20.01.09; 25.01.05; 28.19;  
29.01.12

(511)

35 – რეკლამა; ბიზნეს მენეჯმენტი; ბიზნესის  
ადმინისტრირება; საოფისე სამსახური; სარეკ-  
ლამო მასალის გავრცელება. საქონლის დემონ-  
სტრირება. საქონლის პრეზენტაცია მასობრივი  
ინფორმაციის საშუალებებით საცალო ვაჭრობი-  
სათვის. მარკეტინგი. საცალო ან საბითუმო ვაჭ-  
რობის მომსახურება ფარმაცევტული, ვეტერი-  
ნარული და ჰიგიენური პრეპარატებისთვის და  
სამედიცინო უზრუნველყოფა. საქონლისა და  
მომსახურების მყიდველების და გამყიდველე-  
ბის ონ-ლაინ ბაზრით უზრუნველყოფა.

37 – მშენებლობა; რემონტი; დანადგარების და-  
ყენება. ავეჯის მოვლა. გასუფთავება (შენობე-  
ბის, ინტერიერის). თეთრეულის რეცხვა. რეცხ-  
ვა. გასუფთავება (შენობების, გარე ზედაპირე-  
ბის).

(111) M 2021 33702 R  
(151) 2021 02 17  
(181) 2031 02 17  
(210) AM 111598  
(220) 2021 02 09  
(732) შპს „სუფთა სახლი“  
ქსნის ქ. 36, 0141, თბილისი, საქართველო  
(540)



(591) 93C540 მწვანე; 1862B0 ლურჯი  
(531) 01.01.05; 01.01.09; 07.01.09; 07.03.02; 28.19;  
29.01.12

(511)  
35 – რეკლამა; ბიზნეს მენეჯმენტი; ბიზნესის ადმინისტრირება; საოფისე სამსახური; სარეკლამო მასალის გავრცელება. საქონლის დემონსტრირება. საქონლის პრეზენტაცია მასობრივი ინფორმაციის საშუალებებით საცალო ვაჭრობისათვის. მარკეტინგი. საცალო ან საბითუმო ვაჭრობის მომსახურება ფარმაცევტული, ვეტერინარული და ჰიგიენური პრეპარატებისთვის და სამედიცინო უზრუნველყოფისთვის. საქონლისა და მომსახურების მყიდველების და გამყიდველების ონ-ლაინ ბაზრით უზრუნველყოფა.

37 – მშენებლობა; რემონტი; დანადგარების დაყენება; ავეჯის მოვლა. გასუფთავება (შენობების, ინტერიერის). თეთრეულის რეცხვა. რეცხვა. გასუფთავება (შენობების, გარე ზედაპირების).

(111) M 2021 33703 R  
(151) 2021 02 17  
(181) 2031 02 17  
(210) AM 111599  
(220) 2021 02 09  
(732) შპს „სუფთა სახლი“  
ქსნის ქ. 36, 0141, თბილისი, საქართველო  
(540)



(591) 93C540 მწვანე, 1862B0 ლურჯი

(531) 07.01.09; 26.11.12; 28.19; 29.01.12  
(511)  
35 – რეკლამა; ბიზნეს მენეჯმენტი; ბიზნესის ადმინისტრირება; საოფისე სამსახური; სარეკლამო მასალის გავრცელება. საქონლის დემონსტრირება. საქონლის პრეზენტაცია მასობრივი ინფორმაციის საშუალებებით საცალო ვაჭრობისათვის. მარკეტინგი. საცალო ან საბითუმო ვაჭრობის მომსახურება ფარმაცევტული, ვეტერინარული და ჰიგიენური პრეპარატებისთვის და სამედიცინო უზრუნველყოფისთვის. საქონლისა და მომსახურების მყიდველების და გამყიდველების ონ-ლაინ ბაზრით უზრუნველყოფა.

37 – მშენებლობა; რემონტი; დანადგარების დაყენება; ავეჯის მოვლა; გასუფთავება (შენობების, ინტერიერის). თეთრეულის რეცხვა. რეცხვა. გასუფთავება (შენობების, გარე ზედაპირების).

(111) M 2021 33704 R  
(151) 2021 02 17  
(181) 2031 02 17  
(210) AM 111609  
(220) 2021 02 10  
(732) შპს „სუფთა სახლი“  
ქსნის ქ. 36, 0141, თბილისი, საქართველო  
(540)



(591) 93C540 მწვანე, 1862B0 ლურჯი  
(531) 01.15.15; 05.03.13; 05.03.15; 28.19; 29.01.12  
(511)

35 – რეკლამა; ბიზნეს მენეჯმენტი; ბიზნესის ადმინისტრირება; საოფისე სამსახური; სარეკლამო მასალის გავრცელება. საქონლის დემონსტრირება. საქონლის პრეზენტაცია მასობრივი ინფორმაციის საშუალებებით საცალო ვაჭრობისათვის. მარკეტინგი. საცალო ან საბითუმო ვაჭრობის მომსახურება ფარმაცევტული, ვეტერინარული და ჰიგიენური პრეპარატებისთვის და სამედიცინო უზრუნველყოფისთვის. საქონლისა და მომსახურების მყიდველების და გამყიდველების ონ-ლაინ ბაზრით უზრუნველყოფა.

37 – მშენებლობა; რემონტი; დანადგარების დაყენება; ავეჯის მოვლა; გასუფთავება (შენობების, ინტერიერის); თეთრეულის რეცხვა; რეცხ-

ვა; გასუფთავება (შენობების, გარე ზედაპირების).

(540)

(111) M 2021 33705 R

(151) 2021 02 17

(181) 2031 02 17

(210) AM 111603

(220) 2021 02 09

(732) ნოვარტის აგ

4002 ბაზელი, შვეიცარია

(740) შალვა გვარამაძე

(540)

# Энерзейр

(591) შავ-თეთრი

(531) 28.05

(511)

5 – ფარმაცევტული პრეპარატები.

(111) M 2021 33706 R

(151) 2021 02 19

(181) 2031 02 19

(210) AM 111589

(220) 2021 02 08

(732) შპს „ჯეო-კოპ“

ა. თვალჭრელიძის ქ. 5, 0182, ისანი-სამგორის რ-ნი, თბილისი, საქართველო

(540)



(591) მწვანე, წითელი, ლურჯი, ყვითელი, თეთრი

(531) 26.04.02; 26.04.09; 26.04.22; 26.04.24; 27.05.01; 27.05.24; 29.01.15

(511)

35 – რეკლამა; ბიზნესის მართვა; ბიზნესის ადმინისტრირება; საოფისე მომსახურება.

(111) M 2021 33707 R

(151) 2021 02 19

(181) 2031 02 19

(210) AM 111690

(220) 2021 02 12

(732) შპს „სამაუწყებლო კომპანია რუსთავი 2“

ზ. ანჯაფარიძის ქ. 5ა, თბილისი, საქართველო



(591) თეთრი, ნარინჯისფერი

(531) 26.03.01; 26.04.01; 26.04.05; 26.04.09; 26.04.12; 26.11.09; 26.11.11; 27.07.01; 27.07.11; 27.07.21; 29.01.01; 29.01.02

(526) რუსთავი

(511)

9 – სამეცნიერო, საკვლევი, სანავიგაციო, გეოდეზიური, ფოტოგრაფიული, კინემატოგრაფიული, აუდიოვიზუალური, ოპტიკური, აწონვის, გაზომვის, სიგნალიზაციის, გამოსავლენი, ტესტირების, სამაშველო და სასწავლო აპარატურა და ინსტრუმენტები; აპარატურა და ინსტრუმენტები ელექტროობის გადაცემის, გადართვების, გარდაქმნის, დაგროვების, განაწილების ან გამოყენების რეგულირების ან მართვისთვის; აპარატურა და ინსტრუმენტები ხმის ან გამოსახულების ჩაწერის, გადაცემის, აღწარმოების ან დამუშავებისთვის; მონაცემების მაგნიტური მატარებლები, ჩასაწერი დისკები, ციფრული ან ანალოგიური ჩამწერი ან დამმხსოვრებლები; მონეტებზე მომუშავე აპარატების მექანიზმები, სალარო აპარატები, მთვლელი მოწყობილობები; კომპიუტერები და კომპიუტერის პერიფერიული მოწყობილობები; მყვინთავის სამოსი, მყვინთავის ნიღბები, მყვინთავის ყურსაცობები, ცხვირის სამაგრები მყვინთავებისა და მოცურავეებისთვის, მყვინთავის ხელთათმანები, სასუნთქი აპარატურა წყალქვეშა ცურვისთვის; ცეცხლმქრობი მოწყობილობები.

35 – რეკლამა; ბიზნესის მართვა; ბიზნესის ადმინისტრირება; საოფისე მომსახურება.

38 – სატელეკომუნიკაციო მომსახურება.

41 – განათლება; სასწავლო პროცესის უზრუნველყოფა; გართობა; სპორტული და კულტურული ღონისძიებები.

## საერთაშორისო სასაქონლო ნიშნები, რომლებზეც გამოტანილია ბადაყვივები ღაცვის მინიჭების შესახებ

გადაწყვეტილების გასაჩივრება შესაძლებელია საქპატენტის სააპელაციო პალატაში გამოქვეყნებიდან 3 თვის ვადაში ან მცხეთის რაიონული სასამართლოს ადმინისტრაციულ საქმეთა კოლეგიაში 1 თვის ვადაში (მის.: ქალაქი მცხეთა, სამხედროს ქ. №17).

(260) AM 2021 105478 A

(800) 1493775

(151) 2019 02 26

(891) 2019 02 26

(731) ŠKODA INVESTMENT a.s.

Emila Škody 2922/1, Jižní Předměstí,

CZ-301 00 Plzeň, Czech Republic

(540)

# ŠKODA

(591) Black and white

(531) 27.05.17

(511)

1 – Chemicals used in industry, science, photography, horticulture and forestry; unprocessed artificial resins, unprocessed plastics; manures; tempering and soldering preparations; chemical substances for preserving foodstuffs; tanning substances; adhesives and adhesive materials for industrial purposes, other than for cars or lorries; glues for metal and plastics; carpet glue; hot-melt adhesives; spray adhesives; structural adhesives, mastic compounds, glue sticks, all for industrial purposes; adhesive preparations for surgical bandages; adhesives for billposting; adhesives for floor, ceiling and wall tiles, adhesives for paperhanging; cement in the form of adhesives for repairing broken articles; epoxy resins, unprocessed; gums in the form of adhesives and gum solvents; ungluing preparations; refrigerants; chemicals in the form of foams for use in industry; foaming agents; foaming agents in the form of sprays; chemical compositions for use in grout, and for ceramic tiles, and ceramic, porcelain and vitreous china glazings repairs; chemicals for general manufacture use in cleaning electronic components and medical devices; surfactants, surface active agents, chemical compositions for modifying the surface characteristics of liquids, coatings and inks; fluids for use in heat transfer, refrigeration, metal working and drilling, film cleaning, latent fingerprint development, medical device manufacturing, wet cleaning of dry etcher parts, cleaning of liquid oxygen and gaseous oxygen lines, pharmaceutical and chemical processing; chemical cleaning and drying agents for electronic parts, components, subassemblies, assemblies, precision parts, optics, optoelectronics, aerospace components, aircraft engines and aircraft; sterilization indicators, colorimetric indicators, chemically treated

paper, chemically treated paper indicators, chemical composition for application to fabric and apparel to release stains, substances for the impregnation and finish of any material, chemical compositions for cleaning carpet, fabrics and upholstery; chemical compositions for application to fabric, upholstery, carpet and other flooring materials to repel stains and liquids; chemicals to ensure the efficacy of water and oil-repellent materials, chemical products, including chemical mixes for application to various surfaces, materials for repelling greases and oils and stains, liquid polymer coating mixes for application to printed surfaces to improve the adhesion of the aforesaid printing to the aforesaid surfaces; fluorinated products for repelling water and stains, that can be used on woven fabrics, leather and carpets of nylon and polypropylene, microbeads of glass fixed to a substrate of plastic, which, when affixed to the aforesaid fabrics, endow those fabrics with retroreflective properties, enhancing the night-time visibility of clothing made from those fabrics; form release agents for use in the concrete industry; mould-release preparations; roofing adhesives; weatherproofing coating kit consisting primarily of a polymer adhesive and a sealer coating for roof installation; high temperature silicone compound used for forming gaskets; emulsifiers for use in the manufacture of polymers; surfactants for use in the manufacture of polymers and emulsifier for the emulsion polymerization of monomers to create fluoropolymers for use in the manufacture of plastic articles; chemicals, namely filtration agents, filter media, and molecular separation media for general industrial use, including the pharmaceutical, chemical and paint industries; filter media incorporating silica absorbents for the removal of impurities from fluids and other filtrable substances, for use in the pharmaceutical, food and beverage, chemical, paint and electronics industries; unprocessed plastics in the nature of filtering materials for the removal of impurities from fluids and other filtrable substances, for use in the pharmaceutical, food and beverage, chemical, paint and electronics industries; fluoropolymers, fluoroplastics, fluoroelastomers, polytetrafluoroethylene, fluorinated thermoplastic elastomers, perfluorinated elastomers and perfluorinated plastics, including suspensions, solutions, emulsions, dispersions, powders, pellets, granules, gums and extrudates of the same; chemical compositions containing fluoropolymers, compositions containing fluoropolymers and/or non-fluo-

rinated polymers and/or other chemical additives; vulcanizable fluororubber compositions, filled fluoropolymer compositions, electrically conductive fluororubbers and fluoroplastics, and polytetrafluoroethylene compounds; chemical additives for plastics (including engineering plastics) polyolefin processing additives, antiblocking agents, nucleating agents, clarifying agents, chemical based lubricating agents, release agents and flame retardant additives; fluoropolymer bonding agents, rubber processing additives, rubber curatives, internal and external mold release agents for rubbers and plastics, chemical additives that promote or improve the vulcanization of fluoroelastomers and chemical additives that improve or modify the post-vulcanization properties of fluoroelastomers, chemicals used in the manufacture of fluoropolymers, chemicals used in the manufacture of fluoroelastomers, chemicals used in the manufacture of fluoroplastics, fluorinated monomers, tetrafluoroethylene, hexafluoropropylene, vinylidene fluoride, fluorinated ether-containing monomers, halogenated and nitrile cure-site monomers; catalysts; benzene; benzol; fissionable material for nuclear energy.

2 – Paints and washes, coatings, lacquers, other than for cars or lorries; preservatives against rust, other than for cars or lorries, and against deterioration of wood; paints, dyes; inks for printing, marking and engraving; raw natural resins; metals in foil and powder form for painters, decorators, printers and artists; mordants; metals in foil and powder form for painters, decorators, printers and artists; protective coatings and sealer coatings for grout, ceramic tiles, wood floors, concrete floors and surfaces, bath tubs, showers, toilets, sinks; interior and exterior house and building paints; coating compositions in the nature of paint; protective coatings for electronic components, other than for cars or lorries, chemicals for use in stripping wood to repair the surfaces of furniture and for other purposes, chemical compositions for application to substrates of wood to provide a protective stain, solvent and abrasion-resistant coating thereto; light-reflective materials, not in sheets, reflective paints, protective coating compositions [paints], reflective coating compositions for ophthalmic lenses, lenses for photographic apparatus and other optical lenses, epoxy resin coatings, protective coatings for metals [paints], coating for industrial use designed for application to welded pipe joints and fittings and other metal, wood, concrete, and similar materials to protect them from rust, corrosion and deterioration, both above and below ground, clear protective coatings for vehicles; enamels; undersealing for vehicle chassis, other than for cars or lorries; paint thinners, undercoatings for surfaces to be painted; hardeners for paints, primers, coatings, thinners and glazes, other than for passenger vehicles or lorries; coatings for the repair of surfaces of glass fibres and plastics; rubberized non-

skid compound in the nature of a paint for application to walkways in and around marine vehicles; unprocessed resins and coloring agents therefor for application to marine surfaces to prevent corrosion and deterioration thereof.

3 – Non-medicated cosmetics and toiletry preparations; non-medicated dentifrices; perfumery, essential oils; bleaching preparations and other substances for laundry use; cleaning, polishing, scouring and abrasive preparations; soaps; perfumery, essential oils, cosmetics, hair lotions; dentifrices; scouring solutions; make-up removing preparations; astringents for cosmetic purposes; shaving stones [astringents]; aloe vera preparations for cosmetic purposes; amber [perfume]; antistatic preparations for household purposes; antiperspirants (toilettries); aromatics [essential oils]; flavourings for beverages [essential oils]; breath freshening strips; breath freshening sprays; ethereal essences; essential oils; cedarwood (essential oils of -); eyebrow cosmetics; cosmetic pencils; soap for brightening textile; cake flavorings [essential oils]; bath salts, not for medical purposes; baths (cosmetic preparations for -); balms, other than for medical purposes; beard dyes; moustache wax; bergamot oil; pumice stone; skin whitening creams; bleaching preparations [decolorants] for cosmetic purposes; laundry bleach; bleaching salts; bleaching soda; extracts of flowers [perfumes]; polish for furniture and flooring; floor wax; deodorants for pets; deodorants for human beings or for animals; deodorant soap; detergents other than for use in manufacturing operations and for medical purposes; diamantine [abrasive]; canned pressurized air for cleaning and dusting purposes; scented wood; sachets for perfuming linen; perfume water; javelle water; depilatory preparations; wax (depilatory -); descaling preparations for household purposes; color- [colour-] brightening chemicals for household purposes [laundry]; laundry blue; colorants for toilet purposes; color-removing preparations; paint stripping preparations, cosmetic dyes; greases for cosmetic purposes; degreasers other than for use in manufacturing processes; varnish-removing preparations; stain removers; gaultheria oil; geraniol; shining preparations [polish]; laundry glaze; starch glaze for laundry purposes; glass cloth [abrasive cloth]; smoothing preparations [starching]; smoothing stones; flower perfumes (bases for -); hair dye; hair spray; hair tonic; cosmetic creams; cosmetic preparations for skin care; heliotropine; ionone [perfumery]; jasmine oil; adhesives for affixing false hair; adhesives for cosmetic purposes; eyelashes (adhesives for affixing false -); cologne; corundum [abrasive]; cosmetics; cosmetic kits; cosmetic pencils; cleaning chalk; false nails; false eyelashes; varnish-removing preparations; lavender oil; lavender water; leather bleaching preparations; creams for leather; preservatives for leather [polishes]; lip gloss; lipstick; floor wax removers [scouring preparations]; lotions for cosmetic purposes; air frag-

rancing preparations; almond milk for cosmetic purposes; almond oil; almond soap; massage gels, other than for medical purposes; carbides of metal [abrasives]; cloths impregnated with a detergent for cleaning; preparations for unblocking drain pipes; plants (preparations to make shiny the leaves of -); douching preparations for personal sanitary or deodorant purposes [toiletries]; musk [perfumery]; mouth washes, not for medical purposes; nail art stickers; nail polish; nail care preparations; washing soda, for cleaning; soda lye; neutralizers for permanent waving; oils for toilet purposes; oils for cosmetic purposes; oils for cleaning purposes; hair waving preparations; oils for perfumes and scents; perfumery; perfume; pastes for razor strops; mint for perfumery; mint essence [essential oil]; polishing creams; polishing preparations; denture polishes; polishing paper; jewellers' rouge; polishing stones; polishing wax; pomades for cosmetic purposes; potpourris [fragrances]; dry-cleaning preparations; refurbishing preparations; quillaia bark for washing; shaving preparations; shaving soap; after-shave preparations; fumigation preparations [perfumes]; joss sticks; windscreen cleaning liquids, other than for cars or lorries; cleansing milk for toilet purposes; cleaning preparations; preparations for cleaning dentures; rose oil; rust removers; non-slipping liquids for floors; non-slipping wax for floors; safrol; ammonia [volatile alkali] [detergent]; sandpaper; whiting; cosmetic preparations for slimming purposes; grinding preparations; abrasive paper; grinding preparations; make-up preparations; make-up preparations; make-up powder; emery; emery cloth; sandcloth; tailors' wax; beauty masks; boot cream; shoe wax; cobblers' wax; shoemakers' wax; antiperspirant soap; soap for foot perspiration; shampoo; silicon carbide [abrasive]; tanning preparations; sun-tanning preparations [cosmetics]; laundry starch; badian essence; talcum powder, for toilet use; wallpaper cleaning preparations; terpenes [essential oils]; turpentine, for degreasing; oil of turpentine for degreasing; cosmetics for animals; shampoos for pets [non-medicated grooming preparations]; toiletries; cakes of soap; toilet water; tripoli stone for polishing; dry shampoos; drying agents for dishwashing machines; tissues impregnated with cosmetic lotions; petroleum jelly for cosmetic purposes; volcanic ash for cleaning; laundry wax; bluing for laundry; laundry soaking preparations; laundry preparations; hydrogen peroxide for cosmetic purposes; cotton wool for cosmetic purposes; cotton sticks for cosmetic purposes; fabric softener for laundry; incense; cosmetic preparations for eyelashes; mascara; dental bleaching gels; decorative transfers for cosmetic purposes; essential oils of lemon.

4 – Industrial oils, other than for cars or lorries, and greases; lubricants, other than for cars or lorries, and greases; dust absorbing, wetting and binding compositions; lighting fuel; candles and wicks for lighting; oils for paints; anthracite; moistening oil; beeswax;

firewood; fuel oil; vaporized fuel mixtures; fuel in the form of briquettes; Christmas tree candles; tallow; wicks for candles; perfumed candles; coal briquettes; oils for releasing form work [building]; electrical energy; dust removing preparations; illuminating grease; fish oil, not edible; lubricating graphite; wood briquettes; coal; wood spills for lighting; carnauba wax; kerosene; candles for lighting; bone oil for industrial purposes; lignite; firelighters; coke; oil for the preservation of masonry; lamp wicks; wool grease; grease for leather; greases for the preservation of leather; gas for lighting; motor oil; nightlights [candles]; naphtha; non-chemical fuel additives; industrial lubricants; textile oil; oleine; oil-gas; ozocerite [ozokerite]; paper spills for lighting; paraffin; petroleum ether; grease for belts; non-slipping preparations for belts; belting wax; castor oil for technical purposes; rape oil for industrial purposes; lubricating grease; cutting fluids; grease for footwear; producer gas; soya bean oil preparations for non-stick treatment of cooking utensils; sunflower oil for industrial purposes; dust controlling compositions; dust binding compositions for sweeping; stearine; coal naphtha; coal tar oil; peat [fuel]; peat (blocks of -) [fuel]; carburants; petroleum jelly for industrial purposes; illuminating wax; industrial wax; wax [raw material]; arms [weapons] (grease for -); ceresine; tinder; wax for skis.

5 – Pharmaceutical and veterinary preparations; sanitary preparations for medical purposes; dietetic food and substances adapted for medical or veterinary use, food for babies; dietary supplements for humans and animals; plasters, materials for dressings; material for stopping teeth, dental wax; disinfectants; preparations for destroying vermin; fungicides, herbicides; dental impression materials; laxatives; medical preparation for slimming purposes; slimming pills; adjuvants for medical purposes; acaricides; aconitine; aldehydes for pharmaceutical purposes; algicides; alginates for pharmaceutical purposes; alkaline iodides for pharmaceutical purposes; alkaloids for medical purposes; alcohol for pharmaceutical purposes; aloe vera preparations for pharmaceutical purposes; dental amalgams; amino acids for medical purposes; amino acids for veterinary purposes; analgesics; anaesthetics; angostura bark for medical purposes; antibiotics; antiseptics; antiseptic cotton; appetite suppressants for medical purposes; appetite suppressant pills; medicines for human purposes; medicines for veterinary purposes; medicines for dental purposes; constipation (medicines for alleviating -); aseptic cotton; asthmatic tea; ethers for pharmaceutical purposes; caustics for pharmaceutical purposes; caustic pencils; collyrium; eyepatches for medical purposes; acetates for pharmaceutical purposes; babies' diaper-pants; infant formula; bath salts for medical purposes; bath preparations for medical purposes; bath (therapeutic preparations for the -); bacterial poisons; bacterial preparations for medical and veterinary use; bacteriological prepara-

tions for medical and veterinary use; fibre (dietary -); balms for medical purposes; balsamic preparations for medical purposes; sanitary wear; bandages for dressings; barks for pharmaceutical purposes; wadding for medical purposes; tranquillizers; biological tissue cultures for medical purposes; biological tissue cultures for veterinary purposes; biological preparations for medical purposes; biological preparations for veterinary purposes; biocides; goulard water; blood for medical purposes; haematogen; leeches for medical purposes; blood plasma; lozenges for pharmaceutical purposes; tanning pills; bromine for pharmaceutical purposes; powder of cantharides; chemical preparations to treat wheat blight [smut]; phylloxera (chemical preparations for treating -); vine disease treating chemicals; chemico-pharmaceutical preparations; contraceptives (chemical -); chemical conductors for electrocardiograph electrodes; mildew (chemical preparations to treat -); pregnancy (chemical preparations for the diagnosis of -); chemical preparations for medical purposes; chemical preparations for pharmaceutical purposes; chemical preparations for veterinary purposes; chemical reagents for medical or veterinary purposes; quinine for medical purposes; chinoline for medical purposes; surgical tissues; surgical implants [living tissues]; hydrated chloral for pharmaceutical purposes; chloroform; condurango bark for medical purposes; curare; sanitary towels; decoctions for pharmaceutical purposes; dental cement; deodorants, other than for human beings or for animals; deodorants for clothing and textiles; disinfectants for chemical toilets; disinfectants for hygiene purposes; detergents for medical purposes; diabetic bread adapted for medical use; diagnostic preparations; diastase for medical purposes; dietetic substances adapted for medical use; dietetic foods adapted for medical use; digitalin; dill oil for medical purposes; drugs for medical purposes; alloys of precious metals for dental purposes; albuminous preparations for medical purposes; elixirs [pharmaceutical preparations]; gentian for pharmaceutical purposes; enzymes for medical purposes; enzymes for veterinary purposes; enzyme preparations for medical purposes; enzyme preparations for veterinary purposes; aluminium acetate for pharmaceutical purposes; esters for pharmaceutical purposes; eucalyptol for pharmaceutical purposes; eucalyptus for pharmaceutical purposes; fennel for medical purposes; ferments for pharmaceutical purposes; greases for medical purposes; greases for veterinary purposes; febrifuges; fish meal for pharmaceutical purposes; fly catching paper; fly catching adhesives; fly destroying preparations; formic aldehyde for pharmaceutical purposes; chilblain preparations; frostbite salve for pharmaceutical purposes; fungicides; gallic acid for pharmaceutical purposes; gases for medical purposes; gelatine for medical purposes; royal jelly for pharmaceutical purposes; poisons; glycerine for medical purposes; glycerophosphates; gold (dental amalgams of -); guaiacol for

pharmaceutical purposes; gum for medical purposes; gamboge for medical purposes; gurjun [gurjon, gurjan] balsam for medical purposes; belts for sanitary napkins [towels]; haemostatic pencils; adhesives for dentures; haemoglobin; hemorrhoid preparations; dry rot fungus (preparations for destroying -); yeast for pharmaceutical purposes; remedies for foot perspiration; remedies for perspiration; charcoal for pharmaceutical purposes; hops (extracts of -) for pharmaceutical purposes; hormones for medical purposes; cement for animal hooves; corn remedies; corn rings for the feet; repellents for dogs; dog lotions for veterinary purposes; dog washes; hydrastine; hydrastinine; vaccines; pants, absorbent, for incontinents; insecticides; insect repellents; personal sexual lubricants; irish moss for medical purposes; isotopes for medical purposes; jalap; iodine for pharmaceutical purposes; iodides for pharmaceutical purposes; iodoform; tincture of iodine; jujube, medicated; potassium salts for medical purposes; preparations of lime for pharmaceutical purposes; calomel [fungicide]; cooling sprays for medical purposes; camphor for medical purposes; camphor oil for medical purposes; candy for medical purposes; capsules for medicines; carbolineum [parasiticide]; compresses; cachou for pharmaceutical purposes; chewing gum for medical purposes; rubber for dental purposes; germicides; adhesive bands for medical purposes; bone cement for surgical and orthopaedic purposes; cocaine; collodion for pharmaceutical purposes; compresses; headache pencils; smoking herbs for medical purposes; herbal teas for medicinal purposes; creosote for pharmaceutical purposes; croton bark; preparations of microorganisms for medical or veterinary use; liquorice for pharmaceutical purposes; larvae exterminating preparations; cod liver oil; flaxseed for pharmaceutical purposes; flaxseed meal for pharmaceutical purposes; lecithin for medical purposes; liniments; solutions for contact lenses; solvents for removing adhesive plasters; lotions for pharmaceutical purposes; lotions for veterinary purposes; air purifying preparations; lupulin for pharmaceutical purposes; magnesia for pharmaceutical purposes; malt for pharmaceutical purposes; malted milk beverages for medical purposes; almond milk for pharmaceutical purposes; mangrove bark for pharmaceutical purposes; mice (preparations for destroying -); beverages adapted for medicinal purposes; medicinal herbs; medicinal infusions; medicinal hair growth preparations; medicinal tea; sea water for medicinal bathing; flour for pharmaceutical purposes; melissa water for pharmaceutical purposes; milking grease; menthol; articles for headache; milk ferments for pharmaceutical purposes; milk sugar for pharmaceutical purposes; mineral food supplements; mineral water salts; burns (preparations for the treatment of -); soil-sterilising preparations; anti-uric preparations; callouses (preparations for -); air deodorising preparations; teething (preparations to facilitate -); douching preparations for medical purposes; reducing sexual activity (preparations

for -); moulding wax for dentists; moleskin for medical purposes; sanitary pants; mud for baths; mud (medicinal -); mothproofing preparations; paper (mothproof -); mouthwashes for medical purposes; ergot for pharmaceutical purposes; myrobalan bark for pharmaceutical purposes; mediums (bacteriological culture -); powdered milk for babies; albuminous foodstuffs for medical purposes; nutritive substances for microorganisms; nutritional supplements; albumin dietary supplements; alginate dietary supplements; enzyme dietary supplements; royal jelly dietary supplements; glucose dietary supplements; yeast dietary supplements; casein dietary supplements; flaxseed dietary supplements; flaxseed oil dietary supplements; lecithin dietary supplements; pollen dietary supplements; propolis dietary supplements; protein dietary supplements; wheat germ dietary supplements; dietary supplements for animals; narcotics; bicarbonate of soda for pharmaceutical purposes; sodium salts for medical purposes; by-products of the processing of cereals for dietetic or medical purposes; nervines; cachets for pharmaceutical purposes; medicinal oils; opiates; opium; opodeldoc; organotherapy preparations; antioxidant pills; paper for mustard poultices; antiparasitic collars for animals; parasiticides; pectin for pharmaceutical purposes; pepsins for pharmaceutical purposes; peptones for pharmaceutical purposes; pearl powder for medical purposes; mint for pharmaceutical purposes; pharmaceutical preparations; pharmaceutical preparations for treating dandruff; pharmaceutical preparations for skin care; phenol for pharmaceutical purposes; phosphates for pharmaceutical purposes; anticryptogamic preparations; pomades for medical purposes; porcelain for dental prostheses; bronchodilating preparations; trace elements (preparations of -) for human and animal use; sterilising preparations; propolis for pharmaceutical purposes; protein supplements for animals; pyrethrum powder; quassia for medical purposes; quebracho for medical purposes; mercurial ointments; radioactive substances for medical purposes; radium for medical purposes; rat poison; fumigating pastilles; fumigation preparations for medical purposes; contact lens cleaning preparations; medicine cases, portable, filled; rhubarb roots for pharmaceutical purposes; smelling salts; castor oil for medical purposes; radiological contrast substances for medical purposes; ointments for pharmaceutical purposes; salts for medical purposes; salts for mineral water baths; sarsaparilla for medical purposes; oxygen for medical purposes; oxygen baths; acids for pharmaceutical purposes; pesticides; lint for medical purposes; soporifics; dental abrasives; slug exterminating preparations; flowers of sulfur for pharmaceutical purposes; sulfur sticks [disinfectants]; mustard for pharmaceutical purposes; mustard oil for medical purposes; mustard poultices; serums; serotherapeutic medicines; siccatives [drying agents] for medical purposes; syrups for pharmaceutical purposes; scapulars for surgical purposes; sunburn oint-

ments; sunburn preparations for pharmaceutical purposes; semen for artificial insemination; stem cells for medical purposes; stem cells for veterinary purposes; starch for dietetic or pharmaceutical purposes; steroids; breast-nursing pads; strychnine; styptic preparations; sulfonamides [medicines]; suppositories; tobacco extracts [insecticides]; tampons; turpentine for pharmaceutical purposes; oil of turpentine for pharmaceutical purposes; thermal water; thymol for pharmaceutical purposes; animal washes [insecticides]; tinctures for medical purposes; tonics [medicines]; glucose for medical purposes; tissues impregnated with pharmaceutical lotions; vermin destroying preparations; herbicides; vaginal washes for medical purposes; petroleum jelly for medical purposes; gauze for dressings; first-aid boxes, filled; dressings, medical; surgical dressings; absorbent cotton; digestives for pharmaceutical purposes; vesicants; veterinary preparations; cattle washes [insecticides]; vitamin preparations; wart pencils; hydrogen peroxide for medical purposes; insect repellent incense; cream of tartar for pharmaceutical purposes; incontinence pads; bismuth preparations for pharmaceutical purposes; bismuth subnitrate for pharmaceutical purposes; vulnerary sponges; anthelmintics; medicinal roots; teeth filling material; dental lacquer; cedar wood for use as an insect repellent; cellulose ethers for pharmaceutical purposes; cellulose esters for pharmaceutical purposes; sugar for medical purposes algaecide for use in the manufacture of roof shingles and tiles, and for use in other applications to roofs and roofing materials; disinfectant soap; medicated soap.

6 – Common metals and their alloys; metal building materials; transportable buildings of metal; materials of metal for railway tracks; non-electric cables and wires of common metal; ironmongery, small items of metal hardware; pipes and tubes of metal; safes; goods of metal, not included in other classes, namely castings, forgings, moldings and welded semi-finished products of iron, steel, metals and their alloys, unwrought, semi-wrought and wrought metals and forgings thereof, machine- or hand-wrought, moulded components of metal, goods and building components of rolled and cast metal, machined castings, unprocessed or semi-processed materials for the manufacture of machines, foundry, forge and mill products, goods of raw steel, pressure vessels of metal; high-pressure and specialised fittings of metal; packaging containers of metal, high-pressure pipes; metallurgical products: castings, forging, pressing, ingots of common metal; ores; gutter pipes of metal; bicycle parking installations of metal; branching pipes of metal; aluminium; aluminium wire; aluminum foil paper; anvils; anchors; mooring buoys of metal; tie plates; jets of metal; fittings of metal for compressed air ducts; reinforcing materials of metal for machine belts; reinforcing materials of metal for building; outdoor blinds of metal; cabanas of metal; beacons of



metal, non-luminous; metal beams; metal joists; hoop steel; bindings of metal; bands of metal for tying-up purposes; hoop iron; ingots of common metal; building or furniture fittings of nickel-silver; fittings of metal for building; tree protectors of metal; building boards of metal; buildings of metal; clips of metal for cables and pipes; containers of metal for compressed gas or liquid air; tanks of metal; closures of metal for containers; glucinium [beryllium]; broom handles, of metal; shuttering of metal for concrete; fittings of metal for beds; bed casters of metal; thread of metal for tying-up purposes; binding thread of metal for agricultural purposes; sheets and plates of metal; lead, unwrought or semi-wrought; lead seals; bolts of metal; vats of metal; iron slabs; letter boxes of metal; bronze; bronzes for tombstones; bronzes [works of art]; letters and numerals of common metal, except type; busts of common metal; cermet; chromium; chrome ores; containers of metal [storage, transport]; metal roofing; metal roofing; tiles of metal; cornices of metal; mooring bollards of metal; monuments of metal; box fasteners of metal; wire; wire of common metal alloys, except fuse wire; wire gauze; wire rope; telpher cables; ropes of metal; drain pipes of metal; metal turnstiles; turntables [railways]; metal window fasteners; penstock pipes of metal; metal pegs; nozzles of metal; brackets of metal for building; iron, unwrought or semi-wrought; ironmongery; railroad ties of metal; railway points; iron wire; iron ores; ice moulds of metal; badges of metal for vehicles; locks of metal for vehicles; traps for wild animals; paint spray booths of metal; metal casks; metal casks; taps for casks, of metal; springs [metal hardware]; filings of metal; windows of metal; lintels of metal; ironwork for windows; fittings of metal for windows; sash fasteners of metal for windows; shutters of metal; metal window frames; window casement bolts; sash pulleys; chrome iron; ferrotitanium; tungsten iron; firedogs [andirons]; refractory construction materials of metal; furnace fireguards of metal; statues of common metal; flanges of metal [collars]; bottle closures of metal; bottle closures of metal; insect screens of metal; foils of metal for wrapping and packaging; handling pallets of metal; hoppers of metal, non-mechanical; door scrapers; metal floors; galena [ore]; sheaf binders of metal; hooks of metal for clothes rails; memorial plates of metal; collecting boxes (metal -); germanium; framework of metal for building; scaffolding of metal; cornices of metal; greenhouses of metal, transportable; greenhouse frames of metal; foundry molds [moulds] of metal; latticework of metal; bars for metal railings; bells; gold solder; tombs (monuments of metal for -); enclosures of metal for tombs; burial vaults of metal; vaults of metal [burial]; tombstones of metal; tombstone stelae of metal; metal tomb plaques; knobs of metal; ferrules of metal for handles; cast iron, unwrought or semi-wrought; hafnium [celtium]; pot hooks of metal; anvils [portable]; handcuffs; towel dispensers, fixed, of metal; brazing alloys; house

numbers of metal, non-luminous; slings of metal for handling loads; horseshoe nails; chicken-houses, of metal; identity plates of metal; indium; jalousies of metal; binding screws of metal for cables; cable joints of metal, non-electric; tiles of metal for building; cadmium; platforms, prefabricated, of metal; chimney pots of metal; chimney pots of metal; boxes of common metal; rope thimbles of metal; flashing of metal for building; angle irons; couplings of metal for chains; bins of metal; cramps of metal; drain traps [valves] of metal; water-pipe valves of metal; metal clothes hooks; vice claws of metal; pitons of metal [mountaineering equipment]; chill-molds [foundry]; tin cans; baskets of metal; skating rinks [structures of metal]; works of art of common metal; copper, unwrought or semi-wrought; copper wire, not insulated; copper rings; loading pallets, of metal; loading gauge rods, of metal, for railway wagons; cask stands of metal; anti-friction metal; belts of metal for handling loads; laths of metal; arbours [structures of metal]; duckboards of metal; alloys of common metal; crash barriers of metal for roads; guard rails of metal; ducts of metal for ventilating and air conditioning installations; reinforcing materials of metal for pipes; limonite; rods of metal for brazing; rods of metal for welding; blooms [metallurgy]; magnesium; manganese; porches of metal [building]; masts of metal; wall claddings of metal [building]; brass, unwrought or semi-wrought; reinforcing materials, of metal, for concrete; ores of metal; bottles [metal containers] for compressed gas or liquid air; grilles of metal; metal cages for wild animals; chains of metal; metals in powder form; frames of metal for building; rings of metal; metal rods for brazing and welding; fittings of metal for furniture; furniture casters of metal; molybdenum; iron (molybdenum -); troughs of metal for mixing mortar; sleeves [metal hardware]; nails; identification bracelets of metal; german silver; non-electric wires of common metal; nickel; rivets of metal; niobium; numberplates, of metal; casement windows of metal; furnace screens; materials of metal for funicular railway permanent ways; armour plate; armor plate; mobile boarding stairs (metal -) for passengers; posts of metal; palings of metal; paving blocks of metal; advertisement columns of metal; floor tiles, of metal; floor tiles of metal; stops of metal; pyrophoric metals; wheel clamps [boots]; rocket launching platforms of metal; moldings of metal for cornices; flat bolts; bolts (lock -); cobalt, raw; metal pipes; elbows of metal for pipes; metal tubing; junctions of metal for pipes; roller blinds of steel; locks of metal for bags; fittings of metal for coffins; pillars of metal for buildings; containers of metal for storing acids; tubing of metal; manhole covers of metal; strap-hinges of metal; hinges of metal; washers of metal; hooks for slate [metal hardware]; metal rails; fish plates [rails]; signboards of metal; reels of metal, non-mechanical, for flexible hoses; winding spools of metal, non-mechanical, for flexible hoses; non-electric locks of metal;

keys of metal; split rings of common metal for keys; grease nipples; spring locks; chimneys of metal; chimney shafts of metal; nuts of metal; braces of metal for load handling; soldering wire of metal; sills of metal; eye bolts; swimming pools [metal structures]; floating containers of metal; floating docks of metal, for mooring boats; pulleys of metal, other than for machines; safes [strong boxes]; safety chains of metal; signs, non-luminous and non-mechanical, of metal; signalling panels, non-luminous and non-mechanical, of metal; nickel-silver; silver solder; silicon iron; silos of metal; tension links; wire stretchers [tension links]; iron bands (stretchers for -) [tension links]; stretchers for metal bands [tension links]; cotter pins of metal; spurs; metal stepladders; diving boards of metal; plugs of metal; pilings of metal; barbed wire; steel, unwrought or semi-wrought; steel sheets; steel wire; cast steel; steel buildings; balls of steel; steel alloys; steel masts; steel pipes; poles of metal; tinfoil; statues of common metal; steps [ladders] of metal; ice nails [climbing irons]; pins [hardware]; ferrules of metal for walking sticks; signs, non-luminous and non-mechanical, of metal, for roads; posts of metal for electric lines; props of metal; wainscoting of metal; containers of metal for liquid fuel; tantalum [metal]; telephone boxes of metal; telegraph posts of metal; titanium; tombac; barrel hoops of metal; gates of metal; transport pallets of metal; machine belt fasteners of metal; belt stretchers of metal; partitions of metal; staircases of metal; stair treads [steps] of metal; stringers [parts of staircases] of metal; ironwork for doors; door fittings, of metal; door bolts of metal; doors of metal; door stops of metal; door panels of metal; door handles of metal; non-electric door chimes; latch bars of metal; door knockers; door openers (non-electric); metal door frames; latches of metal; runners of metal for sliding doors; door closers, non-electric; common metals, unwrought or semi-wrought; shims; vanadium; valves of metal, other than parts of machines; linings of metal for building; tinsplate packings; packaging containers of metal; casings of metal for oilwells; sealing caps of metal; silver plated tin alloy; manifolds of metal for pipelines; bells for animals; cattle chains; bird baths [structures of metal]; aviaries of metal [structures]; padlocks; wall linings of metal [building]; water-pipes of metal; tin; white metal; tool boxes of metal, empty; tool chests of metal, empty; weather vanes of metal; wind-driven bird-repelling devices made of metal; tungsten; metal hooks; fences of metal; tent pegs of metal; pipes of metal, for central heating installations; ceilings of metal; zinc; tin; zirconium; brads; sleeves [metal hardware]; casting alloys; iron castings [semi-finished]; steel forgings; alloy forgings (rough or semi-finished -) [metal]; extrusions of metal; white metal; alloys of metal; brazing alloys; containers of metal for industrial purposes; metallic containers; structures of metal; building structures of metal; bridges [structures] of metal; bins [metal structures]; prefabricated metal buildings;

containers of metal for compressed gas or liquid air; gas storage tanks of metal; packaging containers of metal; housing units of metal; fittings of metal for pipes; prefabricated metal bridges; storage tanks; turntables.

7 – Machines of all kinds, and parts therefor, other than steam turbines, parts and accessories therefor, in particular surface capacitors, heat exchanger units and feedwater heaters, turbo alternators and electricity generators; machine tools and power tools; motors and engines (except for land vehicles); machine coupling and transmission components (except for land vehicles); agricultural implements, other than hand-operated hand tools; incubators for eggs; automatic vending machines; machines and equipment for the rolling of metal; rolling mills, apparatus for the handling and transport of rolled products, cooling beds, winders, coilers and unwinders, equipment for the treatment of rolls, scissors, saws, wrappers; machines and equipment for mines, hoisting equipment, hoist cable reels, hoist cages, brake machinery, pit equipment and pit head towers, collision and vehicle circulation equipment, transport equipment for mines, skip stations; machinery and equipment for treating coal and ores, washing coal and ores, sorting plants for coal and ores; filling equipment for industrial furnaces, industrial furnaces; machinery and equipment for crushing, grinding and sorting, crushers, grinders, granulators, molculators, vibrators, mixing machines, sorters, conveyors; high-pressure machinery and equipment; hydraulic presses, hydro-pneumatic accumulators, pressure intensifiers, pipe expanders, jacks, lifting platforms and tables, high-pressure and specialised fittings, high-pressure vessels, piston expansion heaters, boilers; steam engine boilers for power generation, other than for land vehicles; machinery and equipment for the chemical and foodstuff industries, sugar refineries, breweries, distilleries, gasworks, oxygen plants, extractors, paper-working machines and apparatus, rolling mills, detachable pipe links, blenders, thickening drums, filters, knotters, grit chambers, fortraps, hydropulpers, hydrorefiners, high-pressure inflow agitators, cylinders, converters, automatic regulators, wet presses, mangles, cutters, winders and rewinders; glass machinery, automated machinery for the manufacture of bottles, automated machinery for the production of light bulbs, automated machinery for light bulbs, automated machinery for the manufacture of beads of glass, presses for objects of glass, machinery for the manufacture of sheet glass, machinery for the production of cast glass; tobacco and cigarette machines; printing machines and apparatus, rotary printing presses, stereotyping equipment; measuring machines; packing machines; sizing machines; machine tools, lathes, turret lathes, horizontal borers, milling machines; wood-working machines; drilling machines, bores, die chasers, thread-cutting heads and apparatus, reamers,

broaches, reamers, shaped drill bits, drilling bits, forming apparatus; clamping devices, mounting elements, tensioning apparatus, expanding mandrels, bushings, rings, feeders, inserts, centring inserts and bolts [parts of machines], drill sockets and inserts, drill bushings, separators, tables and stands, grinding and sharpening apparatus, drilling lever presses; general machine parts and equipment, crankshafts, gear casings, springs; cranes [lifting and hoisting apparatus], tracers, drop tables; compressors (turbo compressors), blowing machines, superchargers; aerated water making apparatus; mineral water making machines; bottle washing machines; machines for the rubber and plastics industries, tyre vulcanisation presses, electric machinery, engines of all kinds, other than electric engines for means of transport; parts of machines, namely fittings, taps (faucets), slide valves, couplings for machine, chains, gear wheels and transmission case; machines and equipment for the manufacture of glass and ceramics machines for the manufacture of bottles, cast and sheet glass, presses, casting machines, grinding machines, rolling mills, vibrators, mixing machines, separators, loading and unloading installations, drying machines, painting equipment, equipment for applying glazes (spraying equipment); earth moving machines; grinding machines; road construction machines; road sweeping machines [self-propelled]; mine borers; machinery and equipment for treating coal and ores, washing coal and ores, sorting plants for coal and ores; oil refining machines; ore treating machines; construction machines; concrete mixers [machines]; roller bridges; diggers [machines]; belt conveyors; machines for the energy sector, other than steam turbines, parts and accessories therefor, in particular surface capacitors, heat exchanger units and feedwater heaters, turbo alternators and electricity generators; electricity generating machines included in this class, namely electricity generators, electric motors, other than for land use; wind turbines; drilling rigs, floating or non-floating; motors and engines (except for land vehicles); boat motors; airplane motors; hydraulic engines and motors; engines for air cushion vehicles; electricity and heat generators, related spare parts within this class; waste compacting machines; catalytic converters; separators; sewage pulverizers; drainage machines; separators for liquids; filtering machines, separators and centrifuges; clutch starter transmissions, other than for cars or lorries; engine starters, other than for cars or lorries; anti-friction pads for machines; transmission chains, other than for cars or lorries; transmission shafts, other than for cars or lorries; exhaust manifold for engines, other than for cars or lorries; exhausts for motors and engines, other than for cars or lorries; silencers for motors and engines, other than for cars or lorries; brakes (parts), other than for cars or lorries; self-regulating fuel pumps, other than for cars or lorries; fuel conversion apparatus for internal combustion engines, other than for cars or lo-

ries; torque converters, other than for land vehicles; speed regulators for motors and engines, other than for cars or lorries; printing machines; printing plates; printing cylinders; industrial printing machines; pneumatic transporters; compressors [machines]; compressed air engines; compressed air pumps, other than for cars or lorries; compressed air guns for the extrusion of mastics; jet engines, other than for cars or lorries; dynamo brushes; dynamo belts; dynamos, other than for cars or lorries; bicycle dynamos; brushes, electrically operated [parts of machines]; electrodes for welding machines; power hammers; electroplating machines; elevator belts; elevator chains [parts of machines]; painting machines; dyeing machines; paint spray guns; filters, parts of machines or engines, other than for cars or lorries; filtering machines; finishing machines; galvanizing machines; blowing machines for the compression, exhaustion and transport of gases; blowing engines; crank cases for machines, motors and engines, other than for cars or lorries; railroad constructing machines; glow plugs for diesel engines, other than for cars or lorries; hand-held tools, other than hand-operated; reeling apparatus, mechanical; elevating apparatus; jacks [machines]; stitching machines; raking machines; high pressure washers; woodworking machines; lifts; tilt hammers; hydraulic controls for machines, motors and engines, other than for cars or lorries; hydraulic door openers and closers [parts of machines]; universal joints [cardan joints]; card clothing [parts of carding machines]; carding machines; notchers [machine tools]; tubes (boiler -) [parts of machines]; machine boiler scale collectors; chain saws; valves (clack -) [parts of machines]; glue guns, electric; blades [parts of machines]; kneading machines; carbon brushes [electricity]; pistons for engines, other than for cars or lorries; pistons (parts of machines or engines), other than for cars or lorries; piston rings, other than for cars or lorries; compressors for refrigerators; condensing installations (not for turbines); basket presses; fuel dispensing pumps for service stations; fuel economisers for engines and motors, other than for cars or lorries; ball-bearings; ball rings for bearings; condensers for motors and engines, other than for cars or lorries; motorized cultivators; cranks [parts of machines]; crankshafts, other than for cars or lorries; handling apparatus for loading and unloading; derricks; loading ramps; superchargers; bearings [parts of machines]; bearing brackets for machines; journals [parts of machines]; moving pavements [sidewalks]; leather-working machines; leather paring machines; electric arc cutting apparatus; electric arc welders; type-setting machines [photocomposition]; punches for punching machines; punching machines; electric welding apparatus; electric soldering irons; soldering irons, gas-operated; soldering lamps; soldering blow pipes, gas-operated; filters for cleaning cooling air, for engines; air condensers, other than for cars or lorries; aerocondensers; mangles; racket stringing machines; bicycle assembling

machines; textile production machines; lace making machines; housings [parts of machines]; steam engine boilers; machine wheels; stands for machines; tables for machines; axles for machines; materials handling elevators; matrices for use in printing; boxes for matrices [printing]; agricultural machines; mechanized livestock feeders; scissors, electric; chisels for machines; paring machines; milking machines; cream/milk separators; reapers and binders; knives for mowing machines; feeders [parts of machines]; dairy machines; flour mill machines; domestic crushers/grinders, electric; agitators; mills [machines]; millstones; electric flour mills; waste disposals; sewing machines; riveting machines; pneumatic door openers and closers [parts of machines]; electric polishing machines and apparatus; die-stamping machines; tympan [parts of printing presses]; presses [machines for industrial purposes]; filter presses; pneumatic hammers; road rollers; puddling machines; pumps (machines), other than for cars or lorries; pumps (parts of machines and engines), other than for cars or lorries; pump diaphragms, other than for cars or lorries; gears, other than for cars or lorries; rams [machines]; lawn mowers; turf removing ploughs; friezing machines; regulators [parts of machines]; steam traps; electric cleaning machines and apparatus; trimming machines; belts for machines; diggers [machines]; roller bearings; moving staircases [escalators]; rotary printing presses; beaters, electric; agitators; saw blades [parts of machines]; saw benches [parts of machines]; saws; satini-zing machines; air suction machines; suction machines for industrial purposes; hemming machines; silencers for motors and engines, other than for cars or lorries; peeling machines; shovels, mechanical; electric shearing machines; chisels for machines; rail-laying machines; beating machines; mud catchers and collectors [machines]; reels, mechanical, for flexible hoses; trueing machines; grindstones [parts of machines]; carriages for knitting machines; slide rests [parts of machines]; grease boxes [parts of machines]; lubricating pumps; rings (grease -) [parts of machines]; grease boxes [parts of machines]; snowplows; machine guides [parts of machines]; kitchen machines [electric utensils]; metalworking machines; broaches; feeders; fuel economisers; road rollers; aircraft engines; components of aircraft engines.

8 – Hand tools and implements (hand-operated); cutlery; side arms; razors; wire strippers [hand tools]; priming irons [hand tools]; leather strops; awls; oyster openers; axes; hatchets; bayonets; beard clippers; tree pruners; pruning shears; fireplace bellows [hand tools]; bow saws; bits [parts of hand tools]; perforating tools [hand tools]; gimlets [hand tools]; drill holders [hand tools]; ratchets [hand tools]; extension pieces for braces for screw-taps; bits [hand tools]; cutter bars; breast drills; crow bars; holing axes; branding irons; flat irons; caulking irons; daggers; can openers, non-electric; drills; pin punches; egg slicers, non-electric;

irons [non-electric hand tools]; ice picks; manicure sets, electric; tableware [knives, forks and spoons]; razor cases; palette knives; penknives; tweezers; files [tools]; nail buffers, electric or non-electric; meat choppers [hand tools]; milling cutters [hand tools]; hand implements for hair curling; table forks; pitchforks; pruning knives; secateurs; garden tools, hand-operated; goffering irons; mitre [miter (Am.)] boxes [hand tools]; nail drawers [hand tools]; vegetable slicers; instruments and tools for skinning animals; apparatus and instruments for skinning butcher's animals; slaughtering butchers' animals (apparatus and instruments for -); plant parasite killing apparatus; frames for handsaws; taps [hand tools]; dies [hand tools]; foundry ladles [hand tools]; glaziers' diamonds [parts of hand tools]; glazing irons; sand trap rakes; engraving needles; curling tongs; depilation appliances, electric and non-electric; hair clippers for personal use, electric and non-electric; ditchers [hand tools]; cleavers; hammers [hand tools]; borers; decanting liquids (implements for -) [hand tools]; hand pumps; rams [hand tools]; hand tools, hand-operated; rakes [hand tools]; harpoons; harpoons for fishing; levers; hackles [hand tools]; sickles; bill-hooks; planes; plane irons; hollowing bits [parts of hand tools]; gouges [hand tools]; sledgehammers; farriers' knives; sharpening instruments; hunting knives; hoes [hand tools]; draw wires [hand tools]; instruments for punching tickets; cheese slicers, non-electric; moulding irons; ladles [hand tools]; scraping tools [hand tools]; mortise chisels; bushhammers; agricultural implements, hand-operated; hand-operated jigsaws; wick trimmers [scissors]; perforating tools [hand tools]; punch pliers [hand tools]; spoons; machetes; manicure sets; masons' trowels; graving tools [hand tools]; knives; blades for planes; blades [hand tools]; blades [weapons]; scaling knives; cutlery; mortars for pounding [hand tools]; money scoops; needle files; emery files; nail files, electric; nail clippers, electric or non-electric; nail nippers; nail extractors; nail punches; riveting hammers [hand tools]; riveters [hand tools]; numbering punches; fruit pickers [hand tools]; ear piercing apparatus; budding knives; pedicure sets; trowels [gardening]; rammers (earth -) [hand tools]; grafting tools [hand tools]; hoes; hair-removing tweezers; guns [hand tools]; guns, hand-operated, for the extrusion of mastics; pizza cutters, non-electric; punches [hand tools]; braiders [hand tools]; lawn clippers [hand instruments]; razor blades; razors, electric or non-electric; leather strops; shaving cases; reamers; reamer sockets; rasps [hand tools]; hoop cutters [hand tools]; annular screw plates; diggers [hand tools]; tube cutters [hand tools]; tube cutting instruments; sabres; sword scabbards; saw blades [parts of hand tools]; saws [hand tools]; saw holders; scrapers [hand tools]; shovels [hand tools]; shears; shear blades; shearers [hand instruments]; mallets [hand instruments]; knuckle dusters; police batons; masons' hammers; blade sharpening instruments; abrading instruments [hand

instruments]; wheels (sharpening -) [hand tools]; whetstones; wrenches (hand tools); emery files; emery grinding wheels; cutters; cutting tools [hand tools]; edge tools [hand tools]; cutting tools; screwdrivers; vices; clamps for carpenters or coopers; lasts [shoemakers' hand tools]; paring knives; swords; scythes; scythe rings; whetstones; fullers [hand tools]; sickles; rabbeting planes; spatulas [hand tools]; expanders [hand tools]; metal wire stretchers [hand tools]; spades; picks [hand tools]; centre punches [hand tools]; marline spikes; syringes for spraying insecticides; insecticide sprayers [hand tools]; augers [hand tools]; embossers [hand tools]; embossers [hand tools]; stone hammers; chisels; fire irons; holing axes; paring irons [hand tools]; rammers [hand tools]; silver plate [knives, forks and spoons]; apparatus for tattooing; hair clippers for animals [hand instruments]; weeding forks [hand tools]; thistle extirpators [hand tools]; stunning apparatus (cattle -); livestock marking tools; cattle shearers; lifting jacks, hand-operated; crimping irons; fulling tools [hand tools]; tool belts [holders]; sharpening steels; whetstone holders; sharpening steels; choppers [knives]; vegetable choppers; eyelash curlers; tap wrenches; squares [hand tools]; pliers; drawing knives; carpenters' augers; turning tools for lathes, milling cutters [hand tools], screw-thread cutters; holding devices (a part of hand tools for metalworking); cutters, blades (metalworking), screw-thread cutters, bolt die, thread cutting die heads and apparatus, reamers, hollowing bits [parts of hand tools], reamers, shaped drill bits; gripping tools, sheaths, ring hooks, vices, inserts, centring inserts and bolts, drill sockets and inserts, drill bushings, separators, tables, stands, grinding and sharpening apparatus, drilling lever presses (assembly); hand tools and implements, hand-operated; adjustable bevells, limit rings, thread plug gauges; cutters, blades (metalworking), vices; knife handles of metal; scythe handles of metal; tool handles of metal; scrapers for skis.

9 – Scientific, nautical, surveying, photographic, cinematographic, optical, other than for passenger vehicles or lorries, weighing, measuring, signalling, checking (supervision), life-saving and teaching apparatus, other than for passenger vehicles or lorries; apparatus and instruments for conducting, switching, transforming, accumulating, regulating or controlling electricity; apparatus for recording, transmission or reproduction of sound or images, other than for cars or lorries; magnetic data carriers, recording discs; compact discs, dvds and other digital recording media; mechanisms for coin-operated apparatus; cash registers, calculating machines, data processing equipment, computers; computer software, other than for cars or lorries; fire-extinguishing apparatus, other than for cars or lorries; telecommunications apparatus, other than for cars or lorries; portable telecommunications apparatus; mobile telecommunications handsets; digital communications apparatus and equipment, other

than for cars or lorries; digital tablets, other than for cars or lorries; tablets, other than for cars or lorries; computers, other than for cars or lorries; computer hardware, other than for cars or lorries; computer application software, other than for cars or lorries; software downloadable from the internet; recorded computer programs, other than for cars or lorries; mobile software applications, other than for cars or lorries; downloadable applications for multimedia devices, other than for cars or lorries; games software; personal digital assistants; pocket PCs; cell phones; selfie sticks [hand-held monopods]; smart rings; smartphones; smartwatches; laptop computers; telecommunications network apparatus; PC drivers for telecommunications networks and for telecommunications apparatus; protective clothing; head protection; television apparatus; headphones; navigation equipment, global positioning systems (GPS), other than for cars or lorries; satellite navigational apparatus, other than for cars or lorries; software recorded on CD-ROMs, other than for cars or lorries; sd-cards (secure digital cards); spectacles [optics]; spectacle lenses; sunglasses; protective glasses and cases therefor; contact lenses; cameras; photographic lenses; MP3 players; audio tapes and audio cassettes; audio discs; audio-video tapes; audio-video cassettes; (audio-video) discs; video cassettes; videodiscs; cds, dvds; downloadable electronic publications, other than for cars or lorries; downloadable image files; downloadable music files; mouse pads; magnetic coils; cell phone covers; cases adapted for mobile phones; hands-free kits for telephones, other than for cars or lorries; magnetic card; encoded cards; application software for mobile phones; computer programmes for use in telecommunications; software for the processing of financial transactions; electronic notice boards; batteries, electric; battery chargers, other than for cars or lorries; security alarms, other than for cars or lorries; security cameras, other than for cars or lorries; security warning devices, other than for cars or lorries; security checking apparatus, other than for cars or lorries; security surveillance apparatus; computer software for security purposes; computer software for insurance purposes; sim cards; interactive touch screen terminals; antennas; alarms, other than for cars or lorries; electric cables; chemistry apparatus and instruments; chips; computer operating programs, recorded; peripherals adapted for use with computers; data processing apparatus; diagnostic apparatus, not for medical purposes; distance measuring apparatus; distance recording apparatus; downloadable ring tones for mobile phones; electronic tags for goods; eyepieces; sports glasses; identity cards, magnetic; intercommunication apparatus; loudspeakers; magnetic data media; mathematical instruments; modems; monitoring apparatus, electric; television apparatus; testing apparatus not for medical purposes; transmitting sets [telecommunication]; mobile device management apparatus; software for mobile device

management; middleware for management of software functions on electronic devices; anti-virus software; computer antivirus software privacy protection software; parts and fittings for all the aforesaid goods; bar code readers; electronic book readers; baby monitors; monitors; navigational apparatus, other than for cars or lorries; USB flash drives; electrical equipment for land vehicles and underground vehicles, other than for cars or lorries, in particular electrical and electronic information, instruction, control and diagnostic equipment for land vehicles and urban vehicles, other than for cars and lorries, namely electrical and electronic equipment for land vehicles and metro carriages, other than for cars or lorries, namely sockets, plugs and other connections (electrical connectors) (for recharging); electronic connections for use in electric vehicles, namely plugs, sockets and other contacts for fast charging; manual or semi-automatic collectors being parts of vehicle engines and electrical equipment for the movement of electric vehicles; braking resistors, electronic measuring and control equipment, in particular electrical and electronic diagnostic systems, consisting principally of hardware and software based on microprocessors, used for monitoring the operational reliability of vehicles and the costs of operating and maintaining vehicles, other than cars or lorries; electrical and electronic current surge protection systems, consisting principally of sensors, imaging units, signal processors, communication and memory modules and fuses, used for the protection of electrical equipment from the damage caused by surges; information and control units for monitoring the consumption of electricity and promoting lower energy consumption; electrical and electronic automatic testing systems consisting principally of principally of sensors, imaging units, signal processors, communication and memory modules, used to diagnose problems with vehicles, for the easier and quicker maintenance thereof, other than cars or lorries; electrical and electronic insulating protective systems consisting principally of sensors, imaging units, signal processors, communication modules and fuses, used to monitor the status of the insulation of electrically conductive vehicle components, other than for cars or lorries; electrical and electronic control systems for traction and tilting traction systems, consisting principally of sensors, imaging units, signal processors, memory and communication modules, used to prevent the sliding and displacement of wheels, in the event of sudden braking or braking on slippery surfaces, for land vehicles and metro vehicles, other than cars or lorries; electrical traction equipment, namely traction inverters, traction converters, static inverters, converters for main and auxiliary drives and voltage converters, traction collectors and pantographs, being parts of trams, auxiliary power units, auxiliary power supplies (aps), bms battery management systems, battery chargers and accumulator chargers for land vehicles and metro vehicles, other

than cars or lorries; diesel-electric aggregates (generators), super-capacitors, traction batteries, electronic ticketing systems for transport systems; traction batteries for land, rail and electric metro carriages; electro-dynamic apparatus for the remote control of railway points; railway traffic safety appliances; measuring, detecting and monitoring apparatus, indicators and control apparatus for public means of transport, other than cars or lorries; electrical control circuits; electric and electronic security apparatus and instruments; electrical control devices for energy management (electrical control circuits); levelling instruments; measuring, detecting and monitoring apparatus, indicators and regulators, other than for cars or lorries; weighing machines; electrical equipment for means of transport by land or underground, other than for cars or lorries, electrical traction equipment, being converters for main and auxiliary drives and voltage inverters, electrical and electronic information, control, checking and diagnostic equipment for means of transport by land or underground, other than for cars or lorries, batteries and battery chargers for land vehicles and underground vehicles, other than for cars or lorries; chargers for electric batteries; accelerometers; ammeters; automatic steering apparatus for vehicles, other than cars or lorries; autonomous driving control systems for vehicles; automatic ticket dispensing machines; mileage recorders for vehicles; power distribution apparatus (electricity generating equipment); electric power distribution apparatus; electricity mains apparatus; apparatus and instruments for controlling electricity; apparatus and instruments for accumulating and storing electricity; electricity storage apparatus; switchgear [electric]; electricity conduits; electric power controllers; process controlling apparatus [electronic]; switchboards; power distributing boxes; regulating apparatus, electric; relays; transformers of all kinds, reactors, contact breakers, switches, telerupters, electric converters, switches, electric, isolating switches, splitters; electrical machinery, electrical apparatus; endurance testing machines; central processing units; voltage surge protectors; radiology screens for industrial purposes; detectors; dosimeters; electrolyzers; galvanometers; electric loss indicators; printed circuit boards; integrated circuits; circuit breakers, mains chargers, fuses; connectors [electricity]; connections for electric lines; protective masks; bullet-proof clothing; radar apparatus; X-ray apparatus not for medical purposes; illuminated signs; coils, electric; galvanic cells, solar batteries; decompression chambers; life saving apparatus and equipment; batteries, electric; photovoltaic installations for generating electricity [photovoltaic power plants]; gauges, measuring rulers, go/no-go gauges, tooling plates, tooling prisms, vibrating plates, scribing apparatus, scribing apparatus, measuring and testing apparatus, levels [instruments for determining the horizontal]; fire-extinguishing apparatus; weighing machines; electrolyzers; testing machines; sensors.

10 – Surgical, medical, dental and veterinary apparatus and instruments, artificial limbs, eyes and teeth; orthopedic articles; suture materials; aerosol dispensers for medical purposes; acupuncture needles; apparatus for use in medical analysis; apparatus for artificial respiration; apparatus and installations for the production of x-rays, for medical purposes; apparatus, devices and articles for nursing infants; apparatus for the treatment of deafness; rehabilitation apparatus (body -) for medical purposes; microdermabrasion apparatus; instrument cases for use by surgeons and doctors; respirators for artificial respiration; basins for medical purposes; receptacles for applying medicines; teething rings; blood testing apparatus; sphygmomanometers; hernia bandages; artificial breasts; incubators for medical purposes; surgical apparatus and instruments; thread, surgical; surgical implants [artificial materials]; surgical cutlery; suture needles; sponges (surgical -); mirrors for surgeons; defibrillators; bougies [surgery]; diagnostic apparatus for medical purposes; dialyzers; drainage tubes for medical use; insufflators; ice bags for medical purposes; bandages, elastic; electric acupuncture instruments; electrodes for medical use; electrocardiographs; tips for crutches for invalids; finger guards for medical purposes; feeding bottle teats; dental burs; galvanic belts for medical purposes; galvanic therapeutic appliances; gastroscopes; uterine syringes; cattle (obstetric apparatus for -); obstetric apparatus; forceps; hearing protectors; physiotherapy apparatus; body cavities (appliances for washing -); plaster bandages for orthopedic purposes; belts, electric, for medical purposes; belts for medical purposes; belts for orthopaedic purposes; hair prostheses; hematimeters; gloves for medical purposes; urinals [vessels]; urethral probes; urethral syringes; invalids' hoists; blankets, electric, for medical purposes; pads (heating -), electric, for medical purposes; hot air vibrators for medical purposes; heart pacemakers; hearing aids for the deaf; hearing aids; corsets for medical purposes; corn knives; injection syringes; inhalers; medical syringes; incubators for babies; douche bags; enema apparatus for medical purposes; cannulae; castrating pincers; catgut; catheters; cushions for medical purposes; pads [pouches] for preventing pressure sores on patient bodies; cases fitted for use by surgeons and doctors; compressors [surgical]; soporific pillows for insomnia; stockings for varices; ambulance stretchers; draw-sheets for sick beds; crutches; artificial eyes; artificial skin for surgical purposes; artificial jaws; lenses [intraocular prostheses] for surgical implantation; artificial teeth; lamps for medical purposes; lancets; lasers for medical purposes; abdominal belts; abdominal corsets; air pillows for medical purposes; air pillows for medical purposes; air mattresses, for medical purposes; masks for use by medical personnel; massage apparatus; esthetic massage apparatus; gloves for massage; child-birth mattresses; medical apparatus and instruments;

medical guidewires; physical exercise apparatus, for medical purposes; spoons for administering medicine; surgical knives; breast pumps; umbilical belts; commode chairs; needles for medical purposes; anaesthetic apparatus; anaesthetic masks; contraceptive devices; ear picks; ear plugs [ear protection devices]; clothing especially for operating rooms; operating tables; surgical drapes; ophthalmometers; ophthalmoscopes; arch supports for footwear; bandages for joints, anatomical; knee bandages, orthopedic; orthotic footwear; orthotic inserts for footwear; pessaries; balling guns; condoms; artificial limbs; pulse meters; pumps for medical purposes; quartz lamps for medical purposes; radiological apparatus for medical purposes; fumigation apparatus for medical purposes; x-ray apparatus for medical purposes; x-ray tubes for medical purposes; radiology screens for medical purposes; radium tubes for medical purposes; saws for surgical purposes; feeding bottle receptacles; feeding bottle valves; scissors for surgery; surgical splints; slings [supporting bandages]; teats; cupping glasses; supports for flat feet; protection devices against x-rays, for medical purposes; armchairs for medical or dental purposes; love dolls [sex dolls]; scalpels; probes for medical purposes; containers especially made for medical waste; beds, specially made for medical purposes; cases fitted for medical instruments; furniture especially made for medical purposes; spirometers [medical apparatus]; syringes for medical purposes; spittoons for medical purposes; bed pans; stents; sterile sheets, surgical; stethoscopes; boots for medical purposes; radiotherapy apparatus; traction apparatus for medical purposes; elastic stockings for surgical purposes; hypodermic syringes; suspensory bandages; hot air therapeutic apparatus; thermal packs for first aid purposes; thermometers for medical purposes; stretchers, wheeled; trocars; dropper bottles for medical purposes; drop counting phials for medical purposes; filters for ultraviolet rays, for medical purposes; ultraviolet ray lamps for medical purposes; maternity belts; incontinence sheets; hypogastric belts; abdominal pads; urological apparatus and instruments; vaginal syringes; sprayers for medical purposes; veterinary apparatus and instruments; bed vibrators; vibromassage apparatus; compresses (thermo-electric -) [surgery]; hydrostatic [water] beds for medical purposes; water bags for medical purposes; resuscitation apparatus; brushes for cleaning body cavities; surgical staples; dental apparatus and instruments; dental apparatus, electric; mirrors for dentists; dental examination chairs; dentures; dental braces; pins for artificial teeth; tongue scrapers; strait jackets; anti-rheumatism bracelets; anti-rheumatism rings; bracelets for medical purposes.

11 – Apparatus for lighting, heating (other than for cars or lorries), steam generating, cooking, refrigerating, drying, ventilating, water supply and sanitary purposes; flare stacks for use in the oil industry; air

valves for steam heating installations; sinks; sewage purification installations; exhaust hoods for kitchens; brackets for gas burners; igniters; hot air bath fittings; hydromassage bath apparatus; apparatus for the dehydration of foodstuffs; furnace ash boxes; ash conveyor installations, automatic; expansion tanks for central heating installations; watering installations, automatic; acetylene burners; acetylene generators; acetylene flares; heaters, electric, for feeding bottles; baking ovens; bath fittings; heaters for baths; bathtubs; bath linings; bath installations; barbecues; aquarium lights; lighting installations for air vehicles; lighting apparatus and installations, other than for cars or lorries; lighting equipment for means of transport, other than cars or lorries; leds (lighting), other than for cars or lorries; lamps, other than for cars or lorries; ventilation hoods; ventilation hoods for laboratories; warming pans; warming pans; watering machines for agricultural purposes; bidets; anti-dazzle devices for vehicles, other than cars or lorries; searchlights; arc lamps; tanning apparatus [sun beds]; burners; germicidal burners; furnaces, other than for laboratory use; bread-making machines; bread baking machines; toasters; swimming pool chlorinating apparatus; electric lights for Christmas trees; chromatography apparatus for industrial purposes; pressure cookers [autoclaves], electric; steam generating installations; steam boilers, other than parts of machines; steamers (fabric -); steam accumulators; ceiling lights; dental ovens; disinfectant apparatus; disinfectant dispensers for toilets; deodorising apparatus, not for personal use; distillation apparatus; distillation columns; distillation apparatus; fruit roasters; roasting jacks; pressure water tanks; showers; shower stalls; heaters for heating irons; ice machines and apparatus; refrigerators; electrically heated carpets; heating filaments, electric; fans (electric -) for personal use; kettles, electric; discharge tubes, electric, for lighting; flares; bicycle lights; sockets for electric lights; forges, portable; flues for heating boilers; filters [parts of household or industrial installations]; aquarium filtration apparatus; curling lamps; deep fryers, electric; kiln furniture [supports]; filling equipment for industrial furnaces; forage drying apparatus; footmuffs, electrically heated; footwarmers, electric or non-electric; friction lighters for igniting gas; gas lighters; gas burners; gas boilers; gas condensers, other than parts of machines; gas lamps; gas scrubbing apparatus; gas scrubbers [parts of gas installations]; freezers; steam facial apparatus [saunas]; beverage cooling apparatus; electric light bulbs, other than for cars or lorries; filaments for electric lamps; roasting devices; barbecues; roasting spits; miners' lamps; hair driers; taps [faucets]; hand drying apparatus for washrooms; luminous house numbers; blankets, electric, not for medical purposes; heating apparatus, electric; aquarium heaters; heating apparatus for solid, liquid or gaseous fuels; furnace boilers; boilers, other than parts of machines; heating cushions [pads], electric, not for medical purposes;

heating elements, other than for cars or lorries; radiator caps; hot air ovens; heating plates; radiators [heating]; apparatus for heating; apparatus for heating, heating equipment, other than for cars or lorries; hydrants; ionization apparatus for the treatment of air or water; electric appliances for making yogurt; electric coffee filters; electric coffeepots; electric coffee percolators; coffee roasters; nuclear reactors; air conditioning installations; air-conditioning installations for vehicles, other than for cars or lorries; oxyhydrogen burners; cooking apparatus and installations; kilns; cookers; cooking hobs; carbon for arc lamps; chandeliers; kitchen ranges; cooling installations for liquids; cooling installations for tobacco; cooling installations and machines; refrigerating cabinets; refrigerating appliances and installations; refrigerating containers; coolers for furnaces; cold storage rooms; refrigerating display cabinets [display cases]; laboratory burners; laboratory lamps; electric lamps; light bulbs for directional signals for vehicles, other than for cars or lorries; burners for lamps; lamp casings; lamp casings; lamp globes; lamp chimneys; lamp shades; lampshade holders; chinese lanterns; lanterns for lighting; lava rocks for use in barbecue grills; glue-heating appliances; water-pipes for sanitary installations; luminous tubes for lighting; light diffusers; humidifiers for central heating radiators; air deodorising apparatus; air heating apparatus; filters for air conditioning; air filtering installations; air cooling apparatus; air purifying apparatus and machines; germicidal lamps for purifying air; spa baths [vessels]; air sterilisers; air driers; ventilation [air-conditioning] installations and apparatus; magnesium filaments for lighting; malt roasters; sea water desalination plants; microwave ovens; microwave ovens for industrial purposes; milk cooling installations; mixer taps for water pipes; anti-splash tap nozzles; level controlling valves in tanks; stoves [heating apparatus]; framework of metal for ovens; fittings, shaped, for ovens; oven fittings made of fireclay; fire bars; oil burners; oil lamps; oil-scrubbing apparatus; pasteurisers; gas burners; polymerisation installations; projector lamps; radiators, electric; refining towers for distillation; fumigation apparatus, not for medical purposes; dampers [heating]; chimney flues; lamp reflectors, other than for cars or lorries; regulating and safety accessories for gas pipes; regulating and safety accessories for gas apparatus; regulating and safety accessories for water apparatus; regulating accessories for water or gas apparatus and pipes; clean chambers [sanitary installations]; boiler pipes [tubes] for heating installations; taps [cocks, spigots] [faucets (am.)] for pipes; coils [parts of distilling, heating or cooling installations]; roasters; sanitary apparatus and installations; sauna bath installations; heating equipment for defrosting vehicle windows, other than for cars or lorries; electric pressure cooking saucepans; chimney blowers; safety lamps; safety accessories for water or gas apparatus and pipes; bath tubs for sitz baths; solar



furnaces; feeding apparatus for heating boilers; alcohol burners; fountains; street lamps; sterilisers; stoves [heating apparatus]; tobacco roasters; electric torches; pocket warmers; diving lights; immersion heaters; hotplates; solar thermal collectors [heating]; valves (thermostatic -) [parts of heating installations]; refrigerating appliances and installations; water closets; toilet bowls; toilet seats; flushing apparatus; turkish bath cabinets, portable; toilets, portable; filters for drinking water; drying installations; drying apparatus and installations; drying apparatus; drip irrigation emitters [irrigation fittings]; ultraviolet ray lamps, not for medical purposes; washers for water taps; urinals [sanitary fixtures]; fans, other than for cars or lorries; heat pumps; heat regenerators; heat accumulators; hot water bottles; hot plates; water heaters [apparatus]; hot water heating installations; bathroom sinks; laundry room boilers; laundry dryers, electric; water softening installations; water filtering installations; flushing tanks; water cooling installations; water conduits installations; water purifying installations; water purifying apparatus and machines; water sterilizers; water supply installations; water distribution installations; water intake apparatus; whirlpool-jet apparatus; central heating radiators; decorative water fountains; fireplaces, domestic; bicycle lights; spirit stoves, alcohol burners, petroleum stoves, petrol stoves; industrial furnaces; purification installations for sewage (wastewater); refuse incineration plant; air cleaning apparatus; air circulators; nuclear power plant installations; nuclear cogeneration plants; processing installations for fuel and nuclear moderating material; processing installations for fuel and nuclear moderating material; nuclear reactors; nuclear generators; pressure water tanks; safety accessories for water or gas apparatus and pipes; water cooling installations; heat exchangers, other than parts of machines; catalytic oxidation machinery and equipment for checking atmospheric pollution in industrial environments; thermal oxidizers for industrial air pollution control. autoclaves; spigots; spigots.

12 – Apparatus for locomotion by land, water or air, other than passenger vehicles or lorries, apparatus for locomotion below ground, parts, accessories and components of all kinds therefor; means of transport of all kinds, other than cars or lorries, parts, accessories and components therefor, other than for cars or lorries; streetcars, in particular trams, buses, trolley buses and carriages for underground railways; rail vehicles, in particular trains, locomotives, train passenger carriages, power units, engine carriages and units (diesel), parts, components and accessories therefor; motor vehicles of all kinds, in particular tractors and accessories and components therefor, other than cars or lorries; aeroplanes; ships, boat and ship engines and components therefor, bridges; electrically powered vehicles, other than cars or lorries, and accessories and components therefor, being trolley bu-

ses, electric buses; electrically powered special vehicles / utility vehicles, other than cars or lorries; battery powered buses; zero-emission vehicles, being buses with fuel cells (zero-emission buses), electrically powered mining vehicles, hybrid vehicles, other than cars or lorries, parts, components and accessories therefor; traction engines of all kinds and electrical traction equipment for means of transport by land, underground or rail; electrical traction equipment for electric means of transport of all kinds, namely traction inverters for means of transport; traction converters for main and auxiliary drives and voltage converters for land vehicles, metro carriages, trolleybuses and railway rolling stock of all kinds; transport traction engines of all kinds; traction inverters for means of transport; converters for main and auxiliary drives and voltage converters for land vehicles, metro carriages and railway rolling stock of all kinds; electric motors for means of transport of all kinds; pedal bicycles; structural parts of bicycles; frames for bicycles, cycles; fork crown covers [bicycle parts]; brakes for bicycles, cycles; wheels for bicycles, cycles; disc brakes for land vehicles, other than cars or lorries; forks [bicycle parts]; handle bars for bicycles, cycles; brake segments for vehicles; brake cables for bicycles; bells for bicycles, cycles; tubeless tires [tyres] for bicycles, cycles; bicycle tires [tyres]; inner tubes for bicycles, cycles; casings for pneumatic tires [tyres]; tyre repair outfits; patches for inner tubes of tyres; pumps for bicycles, cycles; rims for wheels of bicycles, cycles; wheel hubs; spoke clips for wheels; pedals for cycles; chains for bicycles, cycles; bicycle gears; lever speed transmissions for land vehicles, other than cars or lorries; motorcycle engines; bicycle stands; bicycle stabilisers; side view mirrors for vehicles, other than cars or lorries; trailers for transporting bicycles; child carrying seats for use in vehicles; anti-theft devices for vehicles; bicycle carriers; luggage nets for vehicles; baskets adapted for bicycles; saddlebags adapted for bicycles; water bottle cages for bicycles; cycle saddles; covers for bicycle saddles; drive trains [bicycle parts]; handle bar stems [bicycle parts]; special vehicles, being fork lift trucks or loading trucks, lift trucks, sprinkling vehicles, hose carts, refrigerated vehicles, vehicles adapted for military purposes, other than cars or lorries, tilting-carts, snowmobiles (snow vehicles), remote control vehicles, other than toys, other than passenger vehicles or lorries, axles for vehicles, other than passenger vehicles or lorries; sleeping cars, gear boxes for land vehicles, other than cars or lorries; bodies for vehicles, other than passenger vehicles or lorries; torque converters for land vehicles, other than passenger vehicles or lorries, tankers, cable car cabins, cleaning trolleys, water vehicles, air cushion vehicles, wheels for land vehicles, other than cars or lorries, vehicle chassis, other than for cars or lorries; doors for means of transport, other than cars or lorries; vehicle seats, other than cars or lorries; upholstery for vehicles other

than cars or lorries; wheels, axles, bands for wheel hubs, brakes, other than for cars or lorries, silencers, other than for cars or lorries, disc brakes, other than for cars or lorries; electrical equipment for vehicles, in particular railway rolling stock; armoured vehicles.

13 – Firearms; ammunition and projectiles; explosives; fireworks; nitrate of ammonia explosives; apparatus for filling cartridge belts; cannons; acetyl nitrocellulose; ballistic missiles; bengal lights; lead shot for hunting; dynamite; side arms [firearms]; gun carriages [artillery]; trigger guards for rifles; gun cases; hammers for guns; rifle barrels; gunstocks; shells [projectiles]; hand grenades; guns (harpoon -) [weapons]; cannons; rifles; firecrackers; trunnions for heavy weapons; air pistols [weapons]; fuses for explosives; machine guns; mines [explosives]; mortars [firearms]; ammunition; firearms (ammunition for -); automatic firearm ammunition belts; belts adapted for ammunition; fog signals, explosive; tanks [weapons]; cartridges; cartridges; cartridge loading apparatus; cartridge pouches; pistols [arms]; projectiles [weapons]; powder horns; pyrophoric substances; pyrotechnic products; rockets [projectiles]; rocket launchers; revolvers; cleaning brushes for firearms; silencers for guns; gun cotton; firing platforms; gunpowder; bandoliers for weapons; hunting firearms; sprays for personal defence purposes; signal rockets; detonating plugs; explosive cartridges; torpedoes; tear gas weapons; breeches of firearms; firearm sights; motorized weapons; primings [fuses]; guns (sighting mirrors for -); sights, other than telescopic sights, for guns [artillery]; sights, other than telescopic sights, for firearms; detonating caps, other than toys; primings [fuses]; fuses for explosives, for use in mines; firing lanyards for explosives.

14 – Precious metals and imitations thereof; jewellery, precious stones; horological and chronometric instruments; badges of precious metal; agates; amulets [jewellery, jewelry (Am.)]; anchors [clock- and watchmaking]; pins being jewelry; bracelets [jewellery, jewelry (Am.)]; wristwatches; atomic clocks; ingots of precious metals; jewelry of yellow amber; brooches [jewellery]; busts of precious metal; chronographs [watches]; chronoscopes; chronoscopes; cloisonné jewellery; diamonds; threads of precious metals; precious metals, unwrought or semi-wrought; precious stones; clocks and watches, electric; ivory [jewellery, jewelry (Am.)]; barrels [clock- and watchmaking]; figurines of precious metal; jet, unwrought or semi-wrought; ornaments of jet; gold, unwrought or beaten; gold thread [jewellery]; semi-precious stones; necklaces [jewellery]; hat jewellery; iridium; boxes of precious metal; chains [jewelry]; tie bars; tie pins; works of art of precious metal; copper tokens; alloys of precious metal; cuff links; medals; locket [jewellery]; coins; earrings; olivine [gems]; osmium; palladium; pearls made of ambroid [pressed amber]; beads for making jewelry; pearls [jewellery]; platinum

[metal]; rhodium; rings [jewellery, jewelry (Am.)]; ruthenium; key rings [trinkets or fobs]; jewel cases; ornamental pins; ornaments [jewellery, jewelry (Am.)]; jewels; shoe jewellery; silver, unwrought or beaten; silver thread; spun silver [silver wire]; sundials; spinel [precious stones]; statues of precious metal; stopwatches; paste jewellery [costume jewelry (Am.)]; watches; clocks; watch bands; cases for clock- and watchmaking; clock cases; watch cases; pendulums [clock- and watchmaking]; cases for watches [presentation]; watch springs; watch glasses; watch fobs; pendants; movements for clocks and watches; clock hands; alarm clocks; clockworks; time instruments; control clocks [master clocks]; dials (clock and watchmaking); chaplets.

15 – Musical instruments; accordions; bamboo flutes; bandonions; basses [musical instruments]; cymbals; bellows for musical instruments; bows for musical instruments; bow nuts for musical instruments; horsehair for bows for musical instruments; sticks for bows for musical instruments; buccins [trumpets]; clarions; dampers for musical instruments; catgut for musical instruments; barrel organs; bagpipes; electronic musical instruments; flutes; cases for musical instruments; violins; guitars; chimes [musical instruments]; gongs; harps; harp strings; harmonicas; harmoniums; horns [musical instruments]; huqin [chinese violins]; castanets; chin rests for violins; clarionets; piano keyboards; keyboards for musical instruments; piano strings; piano keys; pianos; double basses; concertinas; lyres; perforated music rolls; mandolins; jews' harps [musical instruments]; mouthpieces for musical instruments; music synthesizers; music rolls [piano]; stands for musical instruments; turning apparatus for sheet music; music stands; oboes; ocarinas; organs; kettledrum frames; pedals for musical instruments; pianos; pipa [chinese guitars]; horns [musical instruments]; guitar picks; trombones; reeds; strings for musical instruments; stringed musical instruments; saxophones; handbells [musical instruments]; hats with bells [musical instruments]; sheng [chinese musical wind instruments]; musical boxes; bridges for musical instruments; tuning forks; tuning hammers; suona [chinese trumpets]; conductors' batons; tomtoms; tambourines; keys for musical instruments; intensity regulators for mechanical pianos; triangles [musical instruments]; skins for drums; drums [musical instruments]; kettledrums; drumsticks; trumpets; valves for musical instruments; violas; wind pipes for organs; pegs for musical instruments; xylophones; zithers.

16 – Paper and cardboard; printed matter; bookbinding material; photographs; stationery and office requisites (except furniture); adhesives for stationery or household purposes; artists' and drawing materials; paint brushes; teaching materials [except apparatus]; plastic sheets, film and bags for wrapping and packaging; printers' type printing blocks; stationery; ty-

pewriters and office requisites (except furniture); instructional and teaching material (except apparatus); plastic materials for packaging (not included in other classes); printers' type; printing blocks; garbage bags of paper or of plastics; napkins of paper for removing make-up; rub down transfers; address plates for addressing machines; address stamps; addressing machines; folders for papers; document files [stationery]; scrapbooks; almanacs; moisteners [office requisites]; announcement cards [stationery]; document laminators for office use; aquarelles; architectural models; calculating tables; wristbands for the retention of writing instruments; atlases; stickers [stationery]; money clips; moisteners [office requisites]; stationery (cabinets for -) [office requisites]; mats for beer glasses; paintings; paintings [pictures], framed or unframed; biological samples for use in microscopy [teaching materials]; blueprints; pencils; pencil holders; pencil leads; pencil sharpeners; pencil sharpening machines, electric or non-electric; pads [stationery]; pamphlets; paperweights; letter trays; stamps; note-paper; bookbinding material; bookbinding cords; bookbinding apparatus and machines [office equipment]; cloth for bookbinding; fabrics for bookbinding; bookbindings; bookends; office requisites; paper clasps; comic books; diagrams; document holders [stationery]; printers' galleys; electrotypes; printing blocks; inking sheets for document reproducing machines; inking sheets for duplicators; printers' blankets, not of textile; printing type; printers' type; covers [stationery]; tickets; labels of paper or cardboard; stencil cases; flags of paper; folders [stationery]; binding strips [bookbinding]; ink ribbons; inking ribbons for computer printers; typewriter ribbons; spools for inking ribbons; chromos; watercolor saucers (artists' -); paint boxes [articles for use in school]; paint trays; penholders; pen clips; pencil cases; pens [office requisites]; pen wipers; humidity control sheets of paper or plastic for foodstuff packaging; figurines [statuettes] of papier mâché; filter paper; finger-stalls [office requisites]; isinglass for stationery or household purposes; bottle wrappers of cardboard or paper; bottle wrappers of cardboard or paper; correcting fluids [office requisites]; newsletters; plastic film for wrapping; sheets of reclaimed cellulose for wrapping; modelling clays (moulds for -) [artists' materials]; forms, printed; photographs [printed]; photo-engravings; postage meters for office use; fountain pens; trays for sorting and counting money; geographical maps; song books; terrestrial globes; greeting cards; graphic prints; graphic reproductions; etching needles; engraving plates; engravings; pastes and other adhesives for stationery or household purposes; elastic bands for offices; gummed tape [stationery]; gummed cloth for stationery purposes; stands for pens and pencils; manuals [handbooks]; hand labelling appliances; hand-rests for painters; stapling presses [office requisites]; hectographs; histological sections for teaching purposes; wood pulp paper; wood pulp

board [stationery]; envelopes [stationery]; hat boxes of cardboard; paper coffee filters; calendars; coasters of paper; file cards; maps; tags for index cards; cardboard tubes; catalogues; self-adhesive tapes for stationery or household purposes; apparatus for mounting photographs; pastes and other adhesives for stationery or household purposes; adhesive bands for stationery or household purposes; dispensers (adhesive tape -) [office requisites]; clipboards; bags for microwave cooking; carbon paper; copying paper [stationery]; correcting tapes [office requisites]; correcting ink [heliography]; credit card imprinters, non-electric; chalk for lithography; chalk holders; balls for ball-point pens; french curves; bibs of paper; teaching materials [except apparatus]; pastes and other adhesives for stationery or household purposes; bookmarkers; steel letters; luminous paper; lithographs; lithographic works of art; lithographic stones; office hole punchers; perforated cards for jacquard looms; punches [office requisites]; blotting paper; loose-leaf binders; plastic bubble packs for wrapping or packaging; artists' brushes; canvas for painting; palettes for painters; house painters' rollers; painters' easels; marking chalk; highlighting markers; graining combs; stencils; pencil lead holders; modelling paste; modelling materials; plastics for modelling; modelling clay; modelling wax, not for dental purposes; musical greeting cards; sketch pads; numbering apparatus; oleographs; file sorters [office requisites]; pantographs [drawing instruments]; paper; electrocardiograph paper; paper for recording machines; stationery; paper tapes and cards for the recordal of computer programmes; paper tapes; paper sheets [stationery]; filtering materials [paper]; face towels of paper; towels of paper; papier mâché; flower-pot covers of paper; letter-openers; paper bows; paper towels; handkerchiefs of paper; conical paper bags; paperboard; painting pencils; tracing paper; tracing cloth; tracing paper; parchment paper; seals [stamps]; posters; placards of paper or cardboard; advertisement boards of paper or cardboard; plastic cling film, extensible, for palletization; paper doilies; portraits; postcards; prospectuses; erasing products; rubber erasers; scrapers [erasers] for offices; erasing shields; etchings; paper for radiograms; ledgers [books]; passport cases; drawing boards; drawing pens; tracing needles for drawing purposes; push pins; t-squares for drawing; newsletters; indexes; cream containers of paper; trading cards other than for games; absorbent sheets of paper or plastic for foodstuff packaging; stencils [stationery]; boxes of cardboard or paper; checkbook covers; slate pencils; writing slates; signboards of paper or cardboard; shields [paper seals]; tailors' chalk; manifolds [stationery]; patterns for dressmaking; patterns for making clothes; drawer liners of paper, perfumed or not; nibs; nibs of gold; pen sets; writing instruments; writing or drawing books; writing chalk; writing portfolios; typewriters, electric or non-electric; typewriter keys; rollers for typewriters; writing cases [sets];

writing brushes; blotters; printed publications; stencil plates; handwriting specimens for copying; school supplies [stationery]; self-adhesive tapes for stationery or household purposes; composing frames [printing]; galley racks [printing]; sealing wax; sealing machines for offices; sealing compounds for stationery purposes; sealing wafers; stamps [seals]; silver paper; steel pens; photograph stands; starch paste [adhesive] for stationery or household purposes; steatite [tailor's chalk]; holders for stamps [seals]; cases for stamps [seals]; stamp pads; stamp pads; stamp stands; prints [engravings]; embroidery designs [patterns]; ink; inkwells; inkstones; ink sticks; tablecloths of paper; table linen of paper; toilet paper; printing sets, portable [office requisites]; transparencies [stationery]; indian inks; envelope sealing machines, for offices; place mats of paper; bags [envelopes, pouches] of paper or plastics, for packaging; cardboard articles; packaging material made of starches; wrapping paper; duplicators; mimeograph apparatus and machines; rulers; vignetting apparatus; viscose sheets for wrapping; waxed paper; blackboards; composing sticks; writing board erasers; drawing materials; sketchbooks; drawing sets; drawing instruments; charcoal pencils; squares for drawing; drawing squares; chart pointers, non-electronic; printed tables; paper shredders for office use; staples for offices; numbers [type]; cigar bands; compasses for drawing; disposable sterilization pouches.

17 – Unprocessed and semi-processed rubber, gutta-percha, gum, mica and substitutes for all these materials; plastics and resins in extruded form for use in manufacture; packing, stopping and insulating materials; flexible pipes, tubes and hoses, not of metal; rubber, gutta-percha, gum, asbestos, mica and goods made from these materials, not included in other classes, other than passenger vehicles or lorries; plastics in extruded form for use in manufacture, other than for cars or lorries; packing, stopping and insulating materials, other than for cars or lorries; flexible pipes, not of metal; acrylic resins [semi-finished products]; high pressure pipe fittings not of metal, other than for cars or lorries; balata; bark coverings for sound insulation; cotton wool for packing [caulking]; anti-dazzle films for windows (tinted films), other than for cars or lorries; flower arrangements (foam supports for -) [semi-finished products]; packing, other than for cars or lorries; expansion joint fillers, other than for cars or lorries; packing materials, other than for cars or lorries; sealing rings, other than for cars or lorries; door or window seals, other than for cars or lorries; dielectrics [insulators]; elastic yarns, not for use in textiles; substances for insulating buildings against moisture; insulating refractory materials, other than for cars or lorries; synthetic filtration substances or semi-processed foams, other than for cars or lorries; foil of regenerated cellulose, other than for packing; molds (ebonite -); insulating mastics and

sealants, other than for cars or lorries; watering hose; fibreglass fabrics for insulation; fibreglass for insulation; glass wool for insulation; mica, raw or partly processed; raw or partly-processed rubber, other than for cars or lorries; threads of rubber, not for use in textiles; valves of rubber, other than for cars or lorries; rubber solutions; casings of rubber for the protection of parts of machines, other than for cars or lorries; stops of rubber; shock absorbers of rubber, other than for cars or lorries; rings of rubber, other than for cars or lorries; cords of rubber; rubber stoppers; materials for affixing brakes, being semi-finished products, other than for cars or lorries; ebonite [vulcanite]; electrical conductance insulators, other than for cars or lorries; insulators for railway tracks; insulating materials, other than for cars or lorries; insulating paints, other than for cars or lorries; insulating tapes, other than for cars or lorries; insulating felt, other than for cars or lorries; insulating varnish; insulating foils of metal, other than for cars or lorries; insulating materials; insulating gloves; insulators; insulators for cables; transformers (insulating oil for -); insulating oils, other than for cars or lorries; insulating paper; insulating plaster; liquid rubber; adhesive bands, other than stationery and not for medical or household purposes; carbon fibres, other than for cars or lorries; artificial resins (semi-processed products), other than for cars or lorries; semi-processed plastic substances, other than for cars or lorries; threads of plastic materials, not for textile use, other than for cars or lorries; plastic sheet, other than for wrapping, other than for cars or lorries; plastic sheeting for agricultural purposes; threads of plastic materials, not for textile use; clutch linings, other than for cars or lorries; latex [rubber]; chemical compositions for repairing leaks; canvas hose pipes, other than for cars or lorries; reinforcing materials for pipes, other than for cars or lorries; joint packings for pipes, other than for cars or lorries; mineral wool (insulator), other than for cars or lorries; compositions to prevent the radiation of heat; boiler composition to prevent the radiation of heat; paper for electrical capacitors, other than for cars or lorries; stuffing of rubber or plastic; sealing materials of rubber or plastics, other than for cars or lorries; pipe jackets, not of metal, other than for cars or lorries; junctions, not of metal, for pipes, other than for cars or lorries; sound insulation materials, other than for cars or lorries; wool (slag -) [insulator]; hoses of textile material; flexible hoses, not of metal, other than for cars or lorries; soldering threads of plastic, other than for cars or lorries; floating anti-pollution barriers, other than for cars or lorries; self-adhesive tapes, other than stationery and not for medical or household purposes; asbestos safety curtains; synthetic rubber, other than for cars or lorries; washers of rubber or vulcanised fibres, other than for cars or lorries; valves of india rubber or vulcanised fibre, other than for cars or lorries; bags [envelopes, pouches] of rubber, for packaging; viscose sheets, other

than for wrapping, other than for cars or lorries; vulcanized fiber [fibre]; materials for retaining heat, other than for cars or lorries; seals, other than for cars or lorries; cellulose acetate, semi-processed; cylinder gaskets, other than for cars or lorries; adhesive tape for industrial purposes.

18 – Leather and imitations of leather, and goods made of these materials, not included in other classes, other than for cars or lorries; animal skins, hides, other than for cars or lorries; trunks and travelling bags; umbrellas and parasols; walking sticks; whips, harness and saddlery; diplomatic bags; pouch baby carriers; slings for carrying infants; beach bags; clothing for pets; alpenstocks; harness fittings; wallets; bags for campers; kid (leather), other than for cars or lorries; attaché cases; boxes of leather or leather board; net bags for shopping, other than for cars or lorries; shopping bags; casings of leather for springs, other than for cars or lorries; covers of fur, other than for cars or lorries; umbrella or parasol ribs; satchels; bits for animals [harness]; purses; animal harnesses; skin (goldbeaters' -); parts of rubber for stirrups; collars for animals; suitcases; small suitcases; suitcase handles, other than for cars or lorries; handbags; handbag frames; skins of slaughtered animals, other than for cars or lorries; curried skins, other than for cars or lorries; horseshoes; hat boxes of leather; game bags [hunting accessories]; card cases [notecases]; cases, of leather or leatherboard; boxes of vulcanised fibre; chain mesh purses; chin straps, of leather; garment bags for travel; cat o' nine tails; knee-pads for horses; vanity cases, not fitted; leather, unworked or semi-worked, other than for cars or lorries; leather leads; straps (leather -); imitation leather, other than for cars or lorries; dog leashes; leatherboard; straps of leather [saddlery]; leather straps; leather laces; valves of leather; straps for soldiers' equipment; muzzles; leather trimmings for furniture; furniture coverings of leather; moleskin (imitation of leather), other than for cars or lorries; music cases; whips; fur (animal skins), other than for cars or lorries; horse blankets; headstalls; horse collars; umbrellas; umbrella handles; travel cases; travelling sets [leatherware]; travelling bags; butts [parts of hides]; backpacks; bags for climbers; riding saddles; saddle trees; covers for horse-saddles; fastenings for saddles; saddlery; blinkers [harness]; umbrella covers; frames for umbrellas or parasols; umbrella rings; umbrella sticks; straps for skates; key cases; book bags; leather shoulder belts; walking stick seats; parasols; duffel bags; stirrups; leathers (stirrup —); walking sticks; cane handles; trolley duffels; leather, other than for cars or lorries; haversacks; bridoons; covers for horse saddles; pouches, of leather, for packaging; tool bags, empty; harness straps; reins; horse bridles; traces [harness]; rucksacks, chest pouches, travelling bags, money belts, kitbags.

19 – Building materials (non-metallic); non-metallic rigid pipes for building; asphalt, pitch and bitumen; non-metallic transportable buildings; monuments, not of metal; gutter pipes, not of metal; bicycle parking installations, not of metal; branching pipes, not of metal; alabaster; alabaster glass; aquaria [structures]; aquarium gravel; aquarium sand; reinforcing materials, not of metal, for building; asbestos mortar; asbestos cement; asphalt; asphalt paving; blinds [outdoor], not of metal and not of textile; cabanas not of metal; beacons, not of metal, non-luminous; non-metal beams; huts; felt for building; building glass; building timber; building materials, not of metal; building panels, not of metal; building stone; buildings, not of metal; tanks of masonry; quartz; concrete; concrete building elements; shuttering, not of metal, for concrete; binding agents for making stones; bitumen; bituminous products for building; bituminous coatings for roofing; planks [wood for building]; letter boxes of masonry; rubble; busts of stone, concrete or marble; non-metal roof coverings; roofing, not of metal; roofing, not of metal, incorporating solar cells; non-metal roofing tiles; roof gutters, not of metal; scantlings [carpentry]; roofing slates; roofing shingles; mooring bollards, not of metal; stave wood; monuments, not of metal; safety glass; drain pipes, not of metal; penstock pipes, not of metal; railroad ties, not of metal; paint spraying booths, not of metal; non-metal windows; lintels, not of metal; shutters, not of metal; non-metal window frames; window glass, for building; prefabricated houses [kits]; refractory construction materials, not of metal; statuettes of stone, concrete or marble; flyscreens (non-metallic); folding doors, not of metal; bagasses of cane (agglomerated -) [building material]; veneer wood; floors, not of metal; memorial plaques, not of metal; perches; balustrading; geotextiles; scaffolding, not of metal; framework for building, not of metal; non-metal cornices; greenhouses, transportable, not of metal; horticultural frames, not of metal; foundry molds [moulds], not of metal; plaster; gypsum; latticework, not of metal; window glass; glass granules for road marking; plate glass [windows] for building; tombs [monuments], not of metal; grave or tomb enclosures, not of metal; tombs, not of metal; grave slabs, not of metal; tombstones; tombstone stelae, not of metal; granite; blast furnaces (cement for -); manufactured timber; moldable wood; wood, semi-worked; wood for making household utensils; xylolith; veneers; furrings of wood; wood pulp board for building; wood paving; wood paneling; chicken-houses, not of metal; insulating glass [building]; jalousies, not of metal; tiles, not of metal, for building; platforms, prefabricated, not of metal; lime; calcareous marl; calcareous stone; chimney pots, not of metal; chimney cowls, not of metal; flashing, not of metal, for building; angle irons, not of metal; roof flashing, not of metal; potters' clay [raw material]; gravel; stained-glass windows; drain traps [valves], not of metal or plastic; water-pipe valves,

not of metal or plastic; cork [compressed]; skating rinks [structures, not of metal]; works of art of stone, concrete or marble; artificial stone; laths, not of metal; arbours [structures not of metal]; duckboards, not of metal; crash barriers, not of metal, for roads; ducts, not of metal, for ventilating and air-conditioning installations; lighting slabs; magnesia cement; macadam; porches, not of metal, for building; fair huts; marble; masts [poles], not of metal; wall claddings, not of metal, for building; mortar for building; mosaics for building; casement windows, not of metal; cement for furnaces; olivine for building; building paper; building cardboard; parquet flooring; parquet floor boards; pitch; palisading, not of metal; paving blocks, not of metal; cement posts; posts, not of metal; advertisement columns, not of metal; cement slabs; paving slabs, not of metal; tile floorings, not of metal; porphyry [stone]; coatings [building materials]; rocket launching platforms, not of metal; moldings, not of metal, for cornices; raw chalk; sandstone tubes; rigid pipes, not of metal [building]; sand, except foundry sand; silver sand; sandstone for building; manhole covers, not of metal; fireclay; slate; slate powder; reeds for building; slag [building material]; clinker stone; sawn timber; chimneys, not of metal; mantle-pieces; chimney shafts, not of metal; pigsties; sills, not of metal; swimming pools [structures, not of metal]; floating docks, not of metal, for mooring boats; caissons for construction work under water; non-luminous and non-mechanical signs, not of metal; signalling panels, non-luminous and non-mechanical, not of metal; silos, not of metal; hips for roofing; plywood; diving boards, not of metal; pilings, not of metal; stables, not of metal; statues of stone, concrete or marble; stone; fire burrs; coal tar; stonemasonry (works of -); street gutters, not of metal; binding material for road repair; materials for making and coating roads; signs, non-luminous and non-mechanical, not of metal, for roads; road coating materials; road marking sheets and strips of synthetic material; poles, not of metal, for electric power lines; props, not of metal; wall claddings, not of metal, for building; tar; tarred strips, for building; building cardboard [asphalted]; telephone booths, not of metal; telegraph posts, not of metal; terra cotta [building material]; clay; potters' clay; non-metal gates; non-metal beams; non-metallic transportable structures; partitions, not of metal; staircases, not of metal; stair-treads [steps], not of metal; stringers [parts of staircases], not of metal; tufa; non-metal doors; door panels, not of metal; door casings, not of metal; building sheets (non-metallic -); vinyl siding; bird baths [structures, not of metal]; aviaries, not of metal [structures]; wall claddings, not of metal, for building; water-pipes, not of metal; fences, not of metal; cement; fireproof cement coatings; fire burrs; earth for bricks; ceilings, not of metal; mastics, other than for cars or lorries.

20 – Furniture, mirrors, picture frames; containers, not of metal, for storage or transport; unworked or semi-worked bone, horn, whalebone or mother-of-pearl; tortoiseshell; meerschaum; yellow amber; furniture shelves; index cabinets; ambroid plates; ambroid bars; mooring buoys, not of metal; dinner wagons; display boards; trestles [furniture]; stuffed animals; stuffed birds; oyster shells; bamboo; bamboo curtains; benches [furniture]; cable or pipe clips of plastics; reservoirs, not of metal nor of masonry; closures, not of metal, for containers; funerary urns; bed fittings, not of metal; beds; bed frames; bed casters, not of metal; bedding, except linen; beehives; picture frames; flower-stands [furniture]; bolts, not of metal; vats, not of metal; letter boxes, not of metal or masonry; book rests [furniture]; library shelves; sideboards; dinner wagons; office furniture; brush mountings; busts of wood, wax, plaster or plastic; containers, not of metal [storage, transport]; decorations of plastic for food-stuffs; boxes of wood or plastic; dowels, not of metal; wall plugs, not of metal; ivory, unworked or semi-worked; furniture shelves; hand fans; hand-held flag-poles, not of metal; locks, not of metal, for vehicles; staves of wood; barrels, not of metal; casks, not of metal; taps for casks, not of metal; furniture fittings, not of metal; statuettes of wood, wax, plaster or plastic; whalebone, unworked or semi-worked; fishing baskets; non-metal bottle caps; bottle racks; corks for bottles; bottle casings of wood; non-metal bottle caps; handling pallets, not of metal; hairdressers' chairs; fodder racks; coathooks, not of metal; curtain hooks; curtain holders, not of textile material; curtain rollers; plaited straw, except matting; wooden blinds; plate racks; gun racks; hand-held mirrors [toilet mirrors]; towel closets [furniture]; towel dispensers, fixed, not of metal; crates; house numbers, not of metal, non-luminous; stag antlers; workbenches; wood ribbon; reels of wood for yarn, silk, cord; honeycombs; horn, unworked or semi-worked; covers (garment -) [storage]; kennels; hat stands; kennels for household pets; nameplates, not of metal; interior textile window blinds; indoor window roller blinds (indoor window blinds), other than for cars or lorries; slatted indoor blinds; cable clips, not of metal; fireguards; divans; edgings of plastic for furniture; carts for computers [furniture]; index cabinets; chests, not of metal; non-metal dog tags; high chairs for babies; infant walkers; pillows; pet cushions; drain traps [valves] of plastic; water-pipe valves of plastic; clothes hangers and clothes hooks; clothes hooks, not of metal; mannequins and tailors' dummies; coatstands; knobs, not of metal; chests of drawers; pillows; bolsters; head-rests [furniture]; hampers [baskets] for the transport of items; baskets, non-metallic; trays, not of metal; wicker-work; corks; cork bands; hospital beds; scratching posts for cats; works of art, of wood, wax, plaster or plastic; plastic key cards, not encoded and not magnetic; cabinet work; counters [tables]; loading pallets, not of metal; loading gauge rods, not of metal,

for railway waggons [wagons]; cask stands, not of metal; playpens for babies; lecterns; beds for household pets; easy chairs; air pillows, not for medical purposes; air cushions, not for medical purposes; air mattresses, not for medical purposes; massage tables; mattresses; mats for infant playpens; furniture; furniture of metal; furniture fittings, not of metal; furniture partitions of wood; furniture casters, not of metal; doors for furniture; mobiles [decoration]; troughs, not of metal, for mixing mortar; identification bracelets, not of metal; nesting boxes for household pets; rivets, not of metal; nesting boxes; paper blinds; screens [furniture]; boarding stairs, not of metal, mobile, for passengers; bead curtains for decoration; mother-of-pearl, unworked or semi-worked; placards of wood or plastics; armchairs; picture frame moldings; curtain tie-backs; sections of wood for beehives; picture frame moldings; rattan; stands for calculating machines; shelves for filing-cabinets [furniture]; saw horses; coffin fittings, not of metal; coffins; hinges, not of metal; display stands; footrests; deck chairs; signboards of wood or plastics; tortoiseshell; imitation tortoiseshell; reeds [plaiting materials]; umbrella stands; reels, not of metal, non-mechanical, for flexible hoses; winding spools, not of metal, non-mechanical, for flexible hoses; locks, other than electric, not of metal; keyboards for hanging keys; costume stands; cupboards; screws, not of metal; nuts, not of metal; vice benches, not of metal; shelves for typewriters; writing desks; writing desks; drawers [furniture parts]; school furniture; covers for clothing [wardrobe]; floating containers, not of metal; trolleys [furniture]; seats of metal; sofas; ottomans; stakes for plants or trees; meat chests, not of metal; mirrors (silvered glass); mirror tiles; chests for toys; ladders of wood or plastics; mats, removable, for sinks; bungs, not of metal; flower-pot pedestals; poles, not of metal; statues of wood, wax, plaster or plastic; steps [ladders], not of metal; standing desks; corozo; embroidery frames; straw edgings; straw plaits; mattress (straw -); seats; containers, not of metal, for liquid fuel; bakers' bread baskets; stair rods; animal horns; animal hooves; animal claws; tables; tables of metal; table tops; dressing tables; cask hoops, not of metal; shoulder poles [yokes]; transport pallets, not of metal; door fittings, not of metal; latches, not of metal; door handles, not of metal; latches, not of metal; valves, not of metal, other than parts of machines; packaging containers of plastic; stoppers and sealing caps, not of metal, other than for cars or lorries; silvered glass [mirrors]; showcases; curtain rings; pulleys of plastics for blinds; support rails for curtains; curtain rods; waxcomb for beehives; waxcomb for beehives; wax figures; baby changing platforms; water beds, not for medical purposes; casks of wood for decanting wine; inflatable publicity objects; changing mats; bassinets; wind chimes [decoration]; draughtsman's tables; magazine racks; newspaper display stands; tent pegs, not of

metal; camping furniture; sleeping mats; vice benches of metal; meat safes of metal.

21 – Household or kitchen utensils and containers; cookware and tableware, except forks, knives and spoons; combs and sponges; brushes (except paint-brushes); brush-making materials; articles for cleaning purposes; unworked or semi-worked glass (except building glass); glassware, porcelain and earthenware; unworked or semi-worked glass (except glass used in building); glassware, porcelain and earthenware not included in other classes; aquarium hoods; dustbins; make-up removing appliances; dusting apparatus, non-electric; aerosol dispensers, not for medical purposes; cinder sifters for household purposes; eyebrow brushes; baby baths, portable; heaters for feeding bottles, non-electric; cotton waste for cleaning; goblets; basins [receptacles]; watering devices; brooms; beer mugs; holders for flowers and plants [flower arranging]; sprinklers for watering flowers and plants; window-boxes; flower pots; cloth for washing floors; scrubbing brushes; candy boxes; hair for brushes; frying pans; pins of metal (cooking -); roses for watering cans; bread boards; bread bins; bread baskets for household purposes; ironing boards; flat-iron stands; brushes; lamp-glass brushes; toilet brushes; brushes; busts of china, terra-cotta or glass; butter dishes; butter-dish covers; buckskin for cleaning; china ornaments; hot pots, not electrically heated; closures for pot lids; deodorising apparatus for personal use; egg cups; pails; demijohns; ice pails; electric brushes, except parts of machines; comb (electric); enamelled glass; oil cruets; cruet sets for oil; chopsticks; mouse traps; drinking flasks; figurines [statuettes] of porcelain, ceramic, earthenware or glass; strainers for household use; flasks; bottles; bottle openers, electric and non-electric; fly catchers [traps or whisks]; ice cube molds; moulds [kitchen utensils]; deep fryers, non-electric; fruit presses, non-electric, for household purposes; mangers for animals; gardening gloves; containers for household or kitchen use; poultry rings; vegetable dishes; spice sets; watering cans; pouring spouts; glass incorporating fine electrical conductors, other than for cars or lorries; glass, unworked or semi-worked, except building glass; glass vials [receptacles]; glass flasks [containers]; boxes of glass; glasses [receptacles]; fiberglass thread, not for textile use; fibreglass, other than for insulation or textile use; glass bowls; mosaics of glass, not for building; powdered glass for decoration; glass stoppers; painted glassware; glass wool other than for insulation; grills [cooking utensils]; grill supports; plungers for clearing blocked drains; glove stretchers; towel holders; utensils for household purposes; gloves for household purposes; abrasive sponges for scrubbing the skin; trouser presses; electric devices for attracting and killing insects; insect traps; heat-insulated containers; vacuum bottles; vacuum flasks for holding drinks; thermally insulated contain-

ners for food; cabarets [trays]; coffee filters, non-electric; coffeepots, non-electric; coffee grinders, hand-operated; coffee makers, non-electric; coffee services [tableware]; beer jugs; tar-brushes, long handled; combs; combs for the hair (large-toothed -); comb cases; jugs; decanters; coasters, not of paper or textile; cheese-dish covers; saucepans; cookie jars; ceramics for household purposes; candle extinguishers; candlesticks; clothing stretchers; presses (garlic -) [kitchen utensils]; buttonhooks; cookery molds [moulds]; mess-tins; cauldrons; cooking pots; cooking utensils, non-electric; baskets for household purposes; corkscrews, electric and non-electric; cosmetic utensils; tie presses; crystal [glassware]; cake moulds; kitchen containers; kitchen utensils; cooking pot sets; food cooling devices, containing heat exchange fluids, for household purposes; refrigerating bottles; isothermic bags; works of art, of porcelain, terra-cotta or glass; glue-pots; candlesticks; liqueur sets; majolica; covers, not of paper, for flower pots; knife rests for the table; shakers; blenders, non-electric, for household purposes; furniture dusters; mops; mills for household purposes, hand-operated; water apparatus for cleaning teeth and gums; chamber pots; nail brushes; nest eggs, artificial; noodle machines, hand-operated; fruit bowls; opal glass; opaline glass; cups of paper or plastic; paper towel dispensers; waste paper baskets; paper plates; perfume vaporizers; apparatus for wax-polishing, non-electric; pepper mills, hand-operated; pepper pots; horse brushes; picnic baskets (fitted -), including dishes; plates to prevent milk boiling over; cookie [biscuit] cutters; polishing apparatus and machines, for household purposes, non-electric; polishing gloves; polishing leather; polishing materials for making shiny, except preparations, paper and stone; porcelain ware; lunch boxes; cosmetic powder compacts; powder puffs; cleaning instruments, hand-operated; pads for cleaning; cleaning rags; cleaning tow; vitreous silica fibers [fibres], not for textile use; sprinklers; shaving brushes; shaving brush stands; rat traps; perfume burners; smoke absorbers for household purposes; graters; beaters, non-electric; mixing spoons [kitchen utensils]; cocktail stirrers; salad bowls; salt shakers; spatulas [kitchen utensils]; brushes for cleaning tanks and containers; basins [bowls]; scoops [tableware]; saucepan scourers of metal; abrasive pads for kitchen purposes; signboards of porcelain or glass; whisks, non-electric, for household purposes; cutting boards for the kitchen; autoclaves, non-electric, for cooking; basting spoons [cooking utensils]; shoe horns; boot brushes; wax-polishing appliances, non-electric, for shoes; shoe trees; dish covers; dishes; trivets [table utensils]; sponges for household purposes; sponge holders; pig bristles for brush-making; earthenware saucepans; soap boxes; soap dishes; soap dispensers; sieves [household utensils]; lazy susans; napkin rings; strainers; sifters [household utensils]; siphon bottles for carbonated water; piggy banks; vessels of metal for making ices and iced drinks;

menu card holders; plate glass [raw material]; confectioners' decorating bags [pastry bags]; nozzles for watering hose; dishwashing brushes; steel wool for cleaning; towel rails and rings; figurines [statuettes] of porcelain, ceramic, earthenware or glass; dusters; feather-dusters; crockery; boot jacks; fabrics (buckets made of woven -); litter trays for pets; currycombs; soup bowls; trays for domestic purposes, of paper; trays for household purposes; epergnes; tableware, other than knives, forks and spoons; services [dishes]; cups; tea balls; tea caddies; teapots; tea cosies; tea services [tableware]; tea strainers; pastry cutters; rolling pins, domestic; plates; carpet sweepers; carpet beaters [hand instruments]; bristles (animal -) [brushware]; combs for animals; crumb trays; toilet utensils; toilet cases; toilet roll dispensers; toilet roll dispensers; toilet sponges; pot lids; pots; pottery; pie servers; portable cool boxes, non-electric; drinking troughs; cages for household pets; funnels; drinking vessels; beverage glassware; straws for drinking; horns (drinking -); feeding troughs; ironing board covers, shaped; saucers; urns; vases; bird baths; birdcages; rings for birds; waffle irons, non-electric; washing boards; clothes-pegs; laundry drying racks; clothes drying racks; washtubs; kettles, non-electric; disposable table plates; pipettes [wine-tasters]; mop wringers; wool waste for cleaning; toothbrushes; toothbrushes, electric; floss for dental purposes; toothpicks; toothpick holders; kitchen grinders, non-electric; indoor aquaria; terrariums (indoor -) [plant cultivation]; indoor terrariums [vivariums]; sugar bowls; cookware and tableware, except forks, knives and spoons; combs and sponges; brushes (except paintbrushes); brush-making materials; articles for cleaning purposes; unworked or semi-worked glass (except building glass); glassware, porcelain and earthenware; nutcrackers; ladles for wine; sugar tongs.

22 – Ropes, string, nets, tents, awnings, tarpaulins, sails, sacks and bags (not included in other classes); padding and stuffing materials, not of rubber, plastics, paper or cardboard; raw fibrous textile materials; cords for hanging pictures; strips for tying-up vines; wrapping or binding bands, not of metal; bands, not of metal, for wrapping or binding; liber; cotton waste [flock] for padding and stuffing; raw cotton; cotton tow; fibrous gaskets for ships; thread, not of metal, for wrapping or binding; binding thread, not of metal, for agricultural purposes; string; packaging string; down feathers; eiderdown; vehicle covers, not fitted; feathers for stuffing upholstery; feathers for bedding; wadding for filtering; fishing nets; bottle envelopes of straw; silk flock; sheaf-binding yarns; raw fibrous textile; glass fibers [fibres] for textile use; grasses for upholstery; hemp; hemp bands; hammocks; slings, not of metal, for handling loads; wood shavings; wool; ladder tapes for venetian blinds; jute; cables, other than of metal, other than for cars or lorries;



camel hair; combed wool; kapok; carbon fibers [fibres] for textile use; cocoons; fiber (coconut -); plastic fibers [fibres] for textile use; belts, not of metal, for handling loads; body bags; linters; awnings of synthetic materials; awnings of textile; nets; twine for nets; network; twine made of paper; wax ends; whipcord; tarpaulins; flock [stuffing]; stuffing materials, not of rubber or plastic; stuffing or padding materials, other than of rubber or plastics, other than for cars or lorries; mail bags; vitreous silica fibers [fibres] for textile use; ramie fibre; raffia; raw linen [flax]; raw silk; horsehair; bags [sacks] for the transport and storage of materials in bulk; sawdust; fleece wool; silk waste; sails; snares [nets]; sash cords; harness, not of metal, for handling loads; shorn wool; sea wrack; sails for ski sailing; ropes; sisal; esparto grass; carded wool; rope ladders; straw for stuffing upholstery; camouflage (nets for -); camouflage (covers for -); ropes, not of metal; textile fibers; cattle hair; bags [envelopes, pouches] of textile, for packaging; packing rope; bags for washing hosiery; wadding for padding and stuffing upholstery; tow; tarred brattice cloth; upholstery wool [stuffing]; raw or treated wool; wool flock; tents; angling nets.

23 – Yarns and threads for textile use; spun cotton; cotton yarn; chenille yarn; elastic thread and yarn for textile use; yarn; fiberglass thread for textile use; thread of metal for embroidery; rubber thread for textile use; hemp thread and yarn; jute thread and yarn; coir thread and yarn; rayon thread and yarn; threads of plastic materials for textile use; linen thread and yarn; sewing thread and yarn; spun silk; silk yarn; embroidery thread and yarn; darning thread and yarn; spun thread and yarn; worsted; wool yarn.

24 – Textiles and substitutes for textiles; furnishing fabrics; curtains of textile or plastic, other than for cars or lorries; textiles and textile goods, not included in other classes, other than for cars or lorries; bed covers; table covers; cloths for removing make-up; bath linen, except clothing; fabric, impervious to gases, for aeronautical balloons; banners; dimity; bed covers of paper; bed linen; bed linen; pillowcases; billiard cloth; brocades; chenille fabric; cheviots [cloth]; cotton fabrics, textiles, other than for cars or lorries; crepon; damask; tick [linen]; drugget; printers' blankets of textile; shower curtains of textile or plastic; bunting of textile or plastic; bolting cloth; flags of textile or plastic; eiderdowns [down coverlets]; filtering materials of textile, other than for cars or lorries; felt, other than for cars or lorries; linen cloth; flannel [fabric]; frieze (cloth), other than for cars or lorries; linings [textile]; lining fabric for footwear; curtains of textile or plastic, other than for cars or lorries; curtain holders of textile material; gauze [cloth]; sanitary flannel; fabrics for textile use; fiberglass fabrics for textile use; haircloth [sackcloth]; gummed cloth, other than for stationery; trellis [cloth]; hemp cloth, other than

for cars or lorries; jute fabric, other than for cars or lorries; linens; hat linings, of textile, in the piece; calico; ticks [mattress covers]; jersey [fabric]; jute cloth; canvas for tapestry or embroidery; textile coasters; cheese cloth; calico; shams; pillowcases; crepe [fabric]; rayon fabric; fabric of imitation animal skins, other than for cars or lorries; shrouds; marabouts [cloth]; mattress covers; furniture coverings of plastic; upholstery fabrics; furniture coverings of textile; moleskin [fabric]; mosquito nets; table mats of textile; door curtains; ramie fabric; glass cloths [towels]; velvet, other than for cars or lorries; net curtains, other than for cars or lorries; sleeping bags; loose covers for furniture; silk cloth; silk fabrics for printing patterns; esparto fabric; buckram; bed throws; textile material; labels of cloth; knitted fabric; taffeta [cloth]; plastic material (substitute for fabrics), other than for cars or lorries; face towels [made of textile materials]; towels of textile; fabric for footwear; cloth; textile tissues; tablemats, not of paper; table runners; serviettes of textile; tablecloths, not of paper; table linen, not of paper; fitted toilet lid covers of fabric; cloth; bed sheets; tulle; non-woven textile fabrics; oilcloth for use as tablecloths; wall hangings of textile; lingerie fabric; diapered linen; washing mitts; elastic woven material; adhesive fabric for application by heat; traced cloth for embroidery; woollen cloth; zephyr [cloth]; sleeping bags; sleeping bags for camping.

25 – Clothing, footwear, headgear; heels; heelpieces for footwear; babies' pants [clothing]; layettes [clothing]; swimming costumes; bathing drawers; bathrobes; bathing caps; bath sandals; bath slippers; bandanas [neckerchiefs]; berets; leg warmers; clothing of imitations of leather; motorists' clothing, other than for cars or lorries; clothing; paper clothing; boas [necklets]; teddies [underclothing]; chasubles; shower caps; insoles; pocket squares; mittens; fishing vests; football boots; footmuffs, not electrically heated; gabardines [clothing]; goloshes; gaiters; belts (money -) [clothing]; non-slipping devices for footwear; belts [clothing]; clothing for gymnastics; gymnastic shoes; half-boots; scarves; gloves [clothing]; slippers [underclothing]; shirt yokes; shirts; shirt fronts; wooden shoes; trousers; knee-high stockings; garters; girdles; hats; frames (hat -) [skeletons]; jackets [clothing]; jumpers; stuff jackets [clothing]; skull caps; hoods [clothing]; linings (ready-made -) [parts of clothing]; pockets for clothing; ready-to-wear clothing; camisoles; shoulder wraps; detachable collars; short-sleeve shirts; bibs, not of paper; leather clothing; leggings [trousers]; underwear; liveries; coats; pelisses; mantillas; miters [hats]; muffs [clothing]; caps [headwear]; cap peaks; outerclothing; ear muffs [clothing]; combinations [clothing]; slippers; hats (paper -) [clothing]; parkas; pelerines; furs [clothing]; ponchos; sweaters; cyclists' clothing; welts for footwear; mackintoshes; skirts; sandals; saris; sarongs; neck scarves [mufflers];

sashes for wear; sleep masks; veils [clothing]; wimples; knickers; lace boots; fittings of metal for footwear; footwear; insoles; footwear uppers; tips for footwear; overalls; aprons [clothing]; dress shields; ski gloves; ski boots; skorts; briefs; socks; sock suspenders; athletic shoes; sneakers; boots; footwear uppers; headbands [clothing]; espadrilles; stoles; fur stoles; studs for football boots; beachwear; beach shoes; stockings; sweat-absorbent stockings; heelpieces for stockings; tights; tee-shirts; togas; pinafore dresses; knitwear [clothing]; singlets; turbans; top-coats; uniforms; sweat-absorbent underwear; pants; wetsuits for water-skiing; gilets; hosiery; top hats; clothing, including clothing of leather, imitations of leather, or of fur, and gloves; caps (headwear), scarves, footwear including boots, shoes and slippers.

26 – Lace and embroidery, ribbons and braid; buttons, hooks and eyes, pins and needles; artificial flowers; badges for wear, not of precious metal; badges [buttons] (ornamental novelty -); brassards; expanding bands for holding sleeves; elastic ribbons; ribbons [haberdashery]; cords for clothing; lace for edgings; trimmings for clothing; brooches [clothing accessories]; chenille [passementerie]; heat adhesive patches for decoration of textile articles; snap fasteners; false beards; false moustaches; tapes for curtain headings; feathers [clothing accessories]; festoons [embroidery]; sewing thimbles; corset busks; heat adhesive patches for decoration of textile articles; orsedew [trimmings for clothing]; fringes; artificial garlands; mica spangles; gold embroidery; belt clasps; hair bands; hair coloring caps; barrettes; hair pins; hair nets; bows for the hair; hair ornaments; bobby pins; false hair; tresses of hair; hooks [haberdashery]; binding needles; trouser clips for cyclists; fastenings for braces; hat ornaments, not of precious metal; frills [lacework]; edgings for clothing; eyelets for clothing; frills for clothing; clasps for clothing; skirt flounces; hook and pile fastening tapes; buttons; rug hooks; collar stays; artificial flower wreaths; artificial fruit; haberdashery, except thread; hair curlers; curlpapers; human hair; needle cases; needle cases; needle cushions; needles; needles for wool combing machines; sewing boxes; sewing needles; false hems; curling pins; spangles for clothing; beads, other than for making jewelry; wigs; false hair; picot [lace]; passementerie; prize ribbons; top-knots [pompoms]; zippers; zippers for bags; rosettes [haberdashery]; saddlers' needles; braids; shuttles for making fishing nets; hooks for corsets; blouse fasteners; buckles [clothing accessories]; bodkins; shoe laces; shoe hooks; shoemakers' needles; shoe eyelets; shoe buckles; shoe buckles; shoe trimmings; shoulder pads for clothing; silver embroidery; bobbins for retaining embroidery floss or wool [not parts of machines]; competitors' numbers; needle cushions; pins, other than jewellery [jewelry (am.)]; embroidery; embroidering crochet hooks; darning lasts; darning needles; ostrich feathers [clothing ac-

cessories]; knitting needles; toupees; braids; tassels [haberdashery]; birds' feathers [clothing accessories]; numerals for marking linen; woollen laces; needle-threaders.

27 – Carpets, rugs, matting, linoleum and other materials for covering existing floors, other than for cars or lorries; wall hangings (non-textile); bath mats; vinyl floor coverings; floor coverings; door mats; non-slip mats; artificial turf; linoleum; door mats; mats of woven rope for ski slopes; wallpaper; reed mats; carpet underlay; textile wallpaper; gymnasium mats.

28 – Toys and games; video game apparatus; gymnastic and sporting articles; decorations for Christmas trees; games and playthings, in the form of games or scale models, other than for cars or lorries; gymnastic and sporting articles not included in other classes; fishing equipment; fish hooks; gut for fishing; reels for fishing; rods for fishing; rattles [playthings]; baseball gloves; building games; building blocks [toys]; billiard table cushions; bowling pins; billiard cue chalk; billiard balls; billiard cues; billiard tables; coin-operated billiard tables; bingo cards; bite sensors [fishing tackle]; bob-sleighs; body boards; body-training apparatus; bows for archery; archery implements; boxing gloves; board games; ornaments for Christmas trees, except illumination articles and confectionery; Christmas tree stands; checkers [games]; checkerboards; gut for rackets; divot repair tools [golf accessories]; dominoes; kites; scent lures for hunting or fishing; skating boots with skates attached; electronic targets; elbow guards [sports articles]; chest expanders [exercisers]; stationary exercise bicycles; guns (paintball -) [sports apparatus]; carnival masks; fencing gauntlets; fencing masks; fencing weapons; shuttlecocks; amusement machines, automatic and coin-operated; gaming machines for gambling; fitness exercise machines; games (apparatus for -); conjuring apparatus; parlour games; weight lifting belts [sports articles]; paragliders; bells for Christmas trees; golf gloves; golf clubs; golf bags, with or without wheels; gymnastic articles; gloves for games; hang gliders; bar-bells; guns (harpoon -) [sports articles]; rosin used by athletes; kite reels; hockey sticks; horseshoe games; chips for gambling; counters for games; kaleidoscopes; card games; fairground ride apparatus; candle holders for Christmas trees; climbers' harness; explosive bonbons [Christmas crackers]; knee guards [sports articles]; decoys for hunting or fishing; confetti; spinning tops [toys]; cricket bags; bait [artificial]; billiard cue tips; hunting game calls; balloons; bladders of balls for games; air pistols [toys]; mah-jong; puppets; bowling apparatus and machinery; masts for sailboards; mobiles [toys]; paintballs [ammunition for paintball guns] [sports apparatus]; nets for sports; pachinkos; paper party hats; piñatas; toy pistols; stuffed toys; plush toys; quoits; punching bags; billiard markers; dolls; dolls' beds; dolls' feeding

bottles; doll houses; dolls' clothes; doll rooms; jigsaw puzzles; creels [fishing traps]; surfboard leashes; ring games; slides [playthings]; rollers for stationary exercise bicycles; scooters [toys]; roller skates; in-line roller skates; roulette wheels; scratch cards for playing lottery games; strings for rackets; chessboards; chess games; rocking horses; party favors; practical jokes [novelties]; shin guards [sports articles]; targets; batting gloves [accessories for games]; sleds [sports articles]; ice skates; butterfly nets; snow for Christmas trees (artificial -); snow globes; snowshoes; paddings (protective -) [parts of sports suits]; pools (swimming -) [play articles]; swimming kick boards; floats for fishing; bite indicators [fishing tackle]; flippers for swimming; water wings; swimming belts; swimming jackets; seal skins [coverings for skis]; soap bubbles [toys]; skateboards; sole coverings for skis; ski bindings; skis; edges of skis; snowboards; bags especially designed for skis and surfboards; slot machines [gaming machines]; balls for games; games; playing balls; marbles; indoor football tables; dice; toys for domestic pets; rackets; poles for pole vaulting; starting blocks for sports; ascenders [mountaineering equipment]; sling shots [sports articles]; sailboards; surfboards; surf skis; twirling batons; screens (camouflage -) [sports articles]; teddy bears; tennis ball throwing apparatus; tennis nets; theatrical masks; supporters (men's athletic -) [sports articles]; tables for table tennis; clay pigeons [targets]; clay pigeon traps; portable games with liquid crystal displays; trampolines; spring boards [sports articles]; harness for sailboards; backgammon games; arcade video game machines; Christmas trees of synthetic material; swings; cups for dice; darts; discs for sports; flying discs [toys]; pistols (caps for -) [toys]; detonating caps [toys].

29 – Meat, fish, poultry and game; meat extracts; preserved, frozen, dried and cooked fruits and vegetables; jellies, jams, compotes; eggs; milk and milk products; edible oils and fats; ajvar [preserved peppers]; protein milk; weed extracts for food; alginates for culinary purposes; non-alcoholic eggnog; apple purée; oysters, not live; black pudding; beans, preserved; stock; fat-containing mixtures for bread slices; butter; buttercream; dates; curd; yolk of eggs; powdered eggs; albumen for culinary purposes; white of eggs; peas, preserved; peanut butter; peanuts, prepared; gherkins; low-fat potato crisps; fatty substances for the manufacture of edible fats; salted fish; fish, preserved; fish, not live; fish fillets; foods made from fish; fish, tinned [canned (am.)]; gelatine; fish meal for human consumption; mousses (fish -); fish roe, prepared; meat; preserved meat; broth concentrates; meat jellies; canned meat; salted meats; fruit preserved in alcohol; dried fruit; fruit jellies; fruit pulp; fruit-based snack food; jellies for food; prawns, not live; poultry, not live; vegetables, cooked; vegetables, dried; vegetable preserves; vegetables, tinned [canned

(am.)]; mousses (vegetable -); vegetable salads; toasted laver; herrings; lobsters, not live; ginger jam; yoghurt; vegetable soup preparations; cocoa butter; tripe; frozen fruits; potato chips; potato flakes; potato fritters; cheese; caviar; kefir [milk beverage]; hummus [chickpea paste]; animal marrow for food; bone oil, edible; coconut butter; coconut oil and fat [for food]; coconut, desiccated; coconut oil for food; jams; garlic [preserved]; consommés; crayfish, not live; croquettes; crustaceans, not live; rennet; salmon; spiny lobsters, not live; fermented vegetable-based foodstuffs (kimchi); liver; liver pâté; linseed oil for culinary purposes; lecithin for culinary purposes; lentils, preserved; maize oil for food; almonds, prepared; margarine; marmalade; milk; ferments (milk -) for culinary purposes; milk beverages, milk predominating; milk products; milk shakes; whey; mussels, not live; prepared nuts; cooked fruits; fruits, tinned [canned (am.)]; fruits, tinned [canned (am.)]; fruit salads; oils for food; olives, preserved; olive oil for food; palm kernel oil for food; palm kernel oil for food; pectin for culinary purposes; vegetable juices for cooking; pickled vegetables; mushrooms, preserved; pollen prepared as foodstuff; cranberry sauce [compote]; rape oil for food; raisins; seeds, prepared; anchovy, not live; sardines; sauerkraut; fruit peel; shellfish, not live; ham; whipped cream; snail eggs for consumption; pork; lard; sea-cucumbers, not live; silkworm chrysalis, for human consumption; sesame oil for food; tahini [sesame seed paste]; shrimps, not live; soya beans, preserved, for food; soya milk [milk substitute]; sunflower seeds, prepared; sunflower oil for food; bacon; edible fats; suet for food; soup (preparations for making -); tuna fish; tofu; tomato purée; tomato juice for cooking; truffles, preserved; aloe vera prepared for human consumption; edible birds' nests; game; sausages; sausages in batter; charcuterie; preparations for making bouillon; onions, preserved.

30 – Coffee, tea, cocoa and artificial coffee; rice; tapioca and sago; flour and preparations made from cereals; bread, pastry and confectionery; ice cream; sugar, honey, treacle; yeast, baking-powder; salt; mustard; vinegar, sauces (condiments); spices; ice; seaweed [condiment]; aniseed; flavourings, other than essential oils, for beverages; flavorings, other than essential oils; wheat flour; flavourings, other than essential oils, for cakes; baking powder; cake powder; beer vinegar; thickening agents for cooking foodstuffs; ice cream (binding agents for -); bean meal; candy; buns; bread; unleavened bread; sandwiches; petit-beurre biscuits; cheeseburgers [sandwiches]; chow-chow [condiment]; chutneys [condiments]; couscous [semolina]; curry [spice]; puddings; mousses (dessert -) [confectionery]; iced tea; peanut confectionery; essences for foodstuffs, except etheric essences and essential oils; vinegar; noodles; meat tenderizers, for household purposes; meat pies; meat

gravies; fondants; fruit sauces; spring rolls; royal jelly; fruit jellies [confectionery]; hominy grits; pearl barley; barley meal; barley (crushed -); chips [cereal products]; cereal preparations; cereal-based snack food; condiments; cloves [spice]; glucose for culinary purposes; gluten additives for culinary purposes; semolina; groats for human food; oat flakes; halvah; yeast; honey; ginger [spice]; frozen yoghurt [confectionery ices]; coffee; artificial coffee; vegetal preparations for use as coffee substitutes; coffee flavorings [flavourings]; coffee-based beverages; cocoa; cocoa-based products; cocoa-based beverages; capers; caramels; potato flour; bubble gum; catsup; cooking salt; salt for preserving foodstuffs; crackers; infusions, not medicinal; cake frosting [icing]; garden herbs, preserved [seasonings]; cake powder; turmeric; liquorice [confectionery]; stick liquorice [confectionery]; linseed for culinary purposes [seasoning]; maize, milled; maize, roasted; maize flakes; maize flour; macaroni; macaroons [pastry]; maltose; malt for human consumption; almond confectionery; marinades; marzipan; almond paste; mayonnaise; sea water for cooking; flour; farinaceous foods; golden syrup; gruel, with a milk base, for food; coffee beverages with milk; cocoa beverages with milk; chocolate beverages with milk; ham glaze; farinaceous products; nutmeg; muesli; oat-based food; noodle-based prepared meals; breadcrumbs; pâtés en croûte; moon cakes; lozenges [confectionery]; pesto [sauce]; petits fours [cakes]; pancakes; pepper; gingerbread; mint for confectionery; peppermint candy; peppers [seasonings]; pizza; bee glue; high-protein cereal bars; popcorn; quiches; ravioli; rice cakes; rice-based snack food; relish [condiment]; ice, natural or artificial; coffee (unroasted -); saffron [seasoning]; sago; whipped cream (preparations for stiffening -); dressings for salad; leaven; chocolate; drinking chocolate; mousses (chocolate -); allspice; celery salt; bread rolls; mustard meal; soya bean paste [condiment]; soya flour; soya sauce; sherbets [ices]; sauces [condiments]; spaghetti; powders for ice cream; baking soda [bicarbonate of soda for cooking purposes]; starch for food; star aniseed; sushi; sweeteners (natural -); tabbouleh; tacos; tapioca; tapioca flour; tea; ferments for pastes; farinaceous food pastes; tomato sauce; cakes; tortillas; vanilla flavourings for culinary purposes; vanillin [vanilla substitute]; waffles; cream of tartar for culinary purposes; wheat germ for human consumption; sausage binding materials; aromatic preparations for food; chicory [coffee substitute]; cinnamon [spice]; gluten prepared as foodstuff; sugar; pralines; confectionery for decorating christmas trees; rusks.

31 – Raw and unprocessed agricultural and aquacultural crops, horticulture and aquaculture products; raw and unprocessed grains and seeds; fresh fruits and vegetables, fresh herbs; natural plants and flowers; bulbs, seedlings and seeds for planting; live animals; foodstuffs and beverages for animals; malt; agricul-

tural, horticultural and forestry products and grains and cereals not included in other classes; fresh pulses; seeds.

32 – Beers; mineral and aerated waters and other non-alcoholic beverages; fruit beverages and fruit juices; syrups and other preparations for making beverages; non-alcoholic beverages; concentrates, syrups and powder for making soft drinks; mineral waters and aerated waters; non-alcoholic drinks; energy drinks, isotonic drinks, hypertonic drinks, hypotonic drinks; fruit and vegetable drinks and juices; frozen fruit drinks, non-carbonated, non-alcoholic frozen flavoured beverages; beverages enriched with added vitamins (not for medical purposes) beers; ales; non-alcoholic beer.

33 – Alcoholic beverages (except beer).

34 – Tobacco; tobacco products; tobacco substitutes not for medical purposes; cigarettes; cigarillos; cigars; pocket machines for rolling cigarettes; cigarette tubes; cigarette filters; cigarette paper; electronic cigarettes; liquid solutions for use in electronic cigarettes; matches and smokers' articles.

40 – Treatment of materials, in particular of metals and plastics; energy production; treatment of oil and gas; decontamination of hazardous materials, destruction of waste, recycling of waste, waste incineration, treatment of waste; sorting of waste; leasing of energy generating equipment; generation of electricity from solar energy; surface energy patterning for electronic circuitry; information and advisory services all relating to the generation of electricity; production of thermal energy, heat and steam; generation and treatment of gas; generation and treatment of water; metal coating [not painting]; application of wear-resistant coatings on metals and plastics; application of wear resistant coatings to engineering components; application of protective surface coatings to machines and tools; bookbinding; cloth cutting; clothing alteration; custom tailoring; dressmaking; dyeing services; engraving; cloth waterproofing; food and drink preservation; framing of works of art; galvanizing; grinding; key cutting; laminating; leather working; material treatment information; paper finishing; photographic printing; printing; processing of oil; rental of air-conditioning apparatus; soldering; cloth treating; treatment of waste; welding services; woodworking; information and advice relating to the aforesaid services; information and advisory services relating to the aforesaid services provided on-line from a computer database or the internet; information and advisory services in relation to the aforesaid services provided over a telecommunications network; information in the field of custom manufacturing; information and consultancy provided via telecommunications networks in the field of custom manufacturing.

41 – Education, providing of training, entertainment and sporting activities, other than services relating to passenger vehicles or lorries; boarding schools, club services (entertainment or education); museum services, organisation of exhibitions for cultural or educational purposes, other than relating to cars or lorries, arranging and conducting of workshops [training], operating of lotteries, rental of sports grounds, educational services provided by schools, training, organization of shows [impresario services], movie studios, production of cinematographic films, reporting included in this class, amusement park services, photography, golf facilities (providing -); translation and interpretation; training and educational activities, education, providing of training, and entertainment, sporting and cultural activities, other than relating to cars or lorries; professional training services, other than relating to cars or lorries; videotaping; education information; recreation information; vocational retraining; vocational guidance [education or training advice]; bookmobile services; night clubs; sport camp services; lending libraries; recreational services; disc jockey services; language interpreter services; health club services, fitness club services; personal trainer services [fitness training]; zoological garden services; sign language interpretation; conducting fitness classes; photographic reporting; gymnastic instruction; calligraphy services; music composition services; layout services, other than for advertising purposes; microfilming; modelling for artists; videotape editing; orchestra services; organization of fashion shows for entertainment purposes; religious education; dubbing; animal training; organization of balls; scriptwriting services; writing of texts, other than publicity texts; rental of audio equipment; rental of lighting apparatus for theatrical sets or television studios; rental of show scenery; rental of movie projectors and accessories; rental of motion pictures; rental of radio and television sets; games equipment rental; toy rental; rental of sports equipment, except vehicles; rental of sports grounds; rental of skin diving equipment; rental of tennis courts; rental of theatre scenery; rental of sound recordings; rental of video cameras; videotape production; rental of videotapes; rental of video cassette recorders; circuses.

43 – Services for providing food and drink; temporary accommodation; bar services; providing campground facilities; holiday camp services [lodging]; hotel services; motels; animal boarding; catering for the provision of food and beverages; day-nurseries [crèches]; retirement homes; guesthouses; tourist homes; providing temporary housing accommodations; rental of cooking apparatus; rental of chairs, tables, table linen, glassware; rental of portable buildings; rental of drinking water dispensers; rental of meeting rooms; rental of tents; café services; cafeterias; restaurants; snack-bars; self-service restaurant services; temporary accommodation reservations; hotel reservations;

boarding house bookings; accommodation bureaux [hotels, boarding houses].

44 – Medical services; veterinary services; hygienic and beauty care for human beings or animals; agriculture, horticulture and forestry services; pharmaceutical services, sanatoriums, health spa services, hospitals, rental of medical equipment, medical services, advisory services relating to health, medical clinic services; dentistry, convalescent home services; advisory services relating to health; consulting services relating to health care; providing information relating to medical services; providing health information.

45 – Legal services; legal assistance for legal and natural persons in matters relating to their business activities; security services for the physical protection of tangible property and individuals; intellectual property consultancy services, licensing of intellectual property, monitoring of intellectual property rights for legal consultancy purposes, domain names (registration of -) [legal services], licensing of computer software [legal services], intellectual property consultancy, litigation services, copyright management; personal and social services rendered by others to meet the needs of individuals, namely adoption agencies; dating services; baby sitting; bereavement support; burial services; cat feeding services [in owners absence]; chaperoning; rental of clothing; companionship services for the elderly and disabled; consulting in the field of personal relationships; crime prevention consultancy services; detective agency services; dog walking services; escort services; providing information relating to personal wardrobe styling; genealogical services; guardianship services; rental of jewellery; house sitting; on-line social networking services; lobbying services, other than for commercial purposes; lost and found bureau services; maintaining lists of wedding presents for selection by others; mediation services for marital disputes; mentoring [spiritual]; online social networking services accessible by means of downloadable mobile applications; personal fashion consulting services; personal shopper services; pet sitting; social escort agency services; planning and arranging of wedding ceremonies; security services for the protection of property and individuals; information and advisory services relating to the aforesaid services; information and advisory services relating to the aforesaid services provided on-line from a computer database or the internet; information and advisory services provided over a telecommunications network; leasing of internet domain names; political lobbying services.

- (260) AM 2021 105589 A
- (800) 1495423
- (151) 2019 02 26
- (891) 2019 02 26
- (731) ŠKODA INVESTMENT a.s.  
Emila Škody 2922/1, Jižní Předměstí  
CZ-301 00 Plzeň, Czech Republic
- (540)



- (591) Black and white
- (531) 03.07.17; 03.07.24; 24.15.11; 26.01.01;  
26.01.03; 26.01.16
- (511)

1 – Chemicals used in industry, science, photography, horticulture and forestry; unprocessed artificial resins, unprocessed plastics; manures; tempering and soldering preparations; chemical substances for preserving foodstuffs; tanning substances; adhesives and adhesive materials for industrial purposes, other than for cars or lorries; glues for metal and plastics; carpet glue; hot-melt adhesives; spray adhesives; structural adhesives, mastic compounds, glue sticks, all for industrial purposes; adhesive preparations for surgical bandages; adhesives for billposting; adhesives for floor, ceiling and wall tiles, adhesives for paperhanging; cement in the form of adhesives for repairing broken articles; epoxy resins, unprocessed; gums in the form of adhesives and gum solvents; ungluing preparations; refrigerants; chemicals in the form of foams for use in industry; foaming agents; foaming agents in the form of sprays; chemical compositions for use in grout, and for ceramic tiles, and ceramic, porcelain and vitreous china glazings repairs; chemicals for general manufacture use in cleaning electronic components and medical devices; surfactants, surface active agents, chemical compositions for modifying the surface characteristics of liquids, coatings and inks; fluids for use in heat transfer, refrigeration, metal working and drilling, film cleaning, latent fingerprint development, medical device manufacturing, wet cleaning of dry etcher parts, cleaning of liquid oxygen and gaseous oxygen lines, pharmaceutical and chemical processing; chemical cleaning and drying agents for electronic parts, components, subassemblies, assemblies, precision parts, optics, optoelectronics, aerospace components, aircraft engines and aircraft; sterilization indicators, colorimetric indicators, chemically treated paper, chemically treated paper indicators, chemical composition for application to fabric and apparel to release stains, substances for the

impregnation and finish of any material, chemical compositions for cleaning carpet, fabrics and upholstery; chemical compositions for application to fabric, upholstery, carpet and other flooring materials to repel stains and liquids; chemicals to ensure the efficacy of water and oil-repellent materials, chemical products, including chemical mixes for application to various surfaces, materials for repelling greases and oils and stains, liquid polymer coating mixes for application to printed surfaces to improve the adhesion of the aforesaid printing to the aforesaid surfaces; fluorinated products for repelling water and stains, that can be used on woven fabrics, leather and carpets of nylon and polypropylene, microbeads of glass fixed to a substrate of plastic, which, when affixed to the aforesaid fabrics, endow those fabrics with retroreflective properties, enhancing the night-time visibility of clothing made from those fabrics; form release agents for use in the concrete industry; mould-release preparations; roofing adhesives; weatherproofing coating kit consisting primarily of a polymer adhesive and a sealer coating for roof installation; high temperature silicone compound used for forming gaskets; emulsifiers for use in the manufacture of polymers; surfactants for use in the manufacture of polymers and emulsifier for the emulsion polymerization of monomers to create fluoropolymers for use in the manufacture of plastic articles; chemicals, namely filtration agents, filter media, and molecular separation media for general industrial use, including the pharmaceutical, chemical and paint industries; filter media incorporating silica absorbents for the removal of impurities from fluids and other filtrable substances, for use in the pharmaceutical, food and beverage, chemical, paint and electronics industries; unprocessed plastics in the nature of filtering materials for the removal of impurities from fluids and other filtrable substances, for use in the pharmaceutical, food and beverage, chemical, paint and electronics industries; fluoropolymers, fluoroplastics, fluoroelastomers, polytetrafluoroethylene, fluorinated thermoplastic elastomers, perfluorinated elastomers and perfluorinated plastics, including suspensions, solutions, emulsions, dispersions, powders, pellets, granules, gums and extrudates of the same; chemical compositions containing fluoropolymers, compositions containing fluoropolymers and/or non-fluorinated polymers and/or other chemical additives; vulcanizable fluororubber compositions, filled fluoropolymer compositions, electrically conductive fluororubbers and fluoroplastics, and polytetrafluoroethylene compounds; chemical additives for plastics (including engineering plastics) polyolefin processing additives, antiblocking agents, nucleating agents, clarifying agents, chemical based lubricating agents, release agents and flame retardant additives; fluoropolymer bonding agents, rubber processing additives, rubber curatives, internal and external mold release agents for rubbers and plastics, chemical additives that promote or improve the vulcanization of fluoro-

elastomers and chemical additives that improve or modify the post-vulcanization properties of fluoroelastomers, chemicals used in the manufacture of fluoropolymers, chemicals used in the manufacture of fluoroelastomers, chemicals used in the manufacture of fluoroplastics, fluorinated monomers, tetrafluoroethylene, hexafluoropropylene, vinylidene fluoride, fluorinated ether-containing monomers, halogenated and nitrile cure-site monomers; catalysts; benzene; benzol; fissionable material for nuclear energy.

2 – Paints and washes, coatings, lacquers, other than for cars or lorries; preservatives against rust, other than for cars or lorries, and against deterioration of wood; paints, dyes; inks for printing, marking and engraving; raw natural resins; metals in foil and powder form for painters, decorators, printers and artists; mordants; metals in foil and powder form for painters, decorators, printers and artists; protective coatings and sealer coatings for grout, ceramic tiles, wood floors, concrete floors and surfaces, bath tubs, showers, toilets, sinks; interior and exterior house and building paints; coating compositions in the nature of paint; protective coatings for electronic components, other than for cars or lorries, chemicals for use in stripping wood to repair the surfaces of furniture and for other purposes, chemical compositions for application to substrates of wood to provide a protective stain, solvent and abrasion-resistant coating thereto; light-reflective materials, not in sheets, reflective paints, protective coating compositions [paints], reflective coating compositions for ophthalmic lenses, lenses for photographic apparatus and other optical lenses, epoxy resin coatings, protective coatings for metals [paints], coating for industrial use designed for application to welded pipe joints and fittings and other metal, wood, concrete, and similar materials to protect them from rust, corrosion and deterioration, both above and below ground, clear protective coatings for vehicles; enamels; undersealing for vehicle chassis, other than for cars or lorries; paint thinners, undercoatings for surfaces to be painted; hardeners for paints, primers, coatings, thinners and glazes, other than for passenger vehicles or lorries; coatings for the repair of surfaces of glass fibres and plastics; rubberized non-skid compound in the nature of a paint for application to walkways in and around marine vehicles; unprocessed resins and coloring agents therefor for application to marine surfaces to prevent corrosion and deterioration thereof.

3 – Non-medicated cosmetics and toiletry preparations; non-medicated dentifrices; perfumery, essential oils; bleaching preparations and other substances for laundry use; cleaning, polishing, scouring and abrasive preparations; soaps; perfumery, essential oils, cosmetics, hair lotions; dentifrices; scouring solutions; make-up removing preparations; astringents for cosmetic purposes; shaving stones [astringents]; aloe vera preparations for cosmetic purposes; amber [perfume];

antistatic preparations for household purposes; antiperspirants (toiletries); aromatics [essential oils]; flavourings for beverages [essential oils]; breath freshening strips; breath freshening sprays; ethereal essences; essential oils; cedarwood (essential oils of -); eyebrow cosmetics; cosmetic pencils; soap for brightening textile; cake flavorings [essential oils]; bath salts, not for medical purposes; baths (cosmetic preparations for -); balms, other than for medical purposes; beard dyes; moustache wax; bergamot oil; pumice stone; skin whitening creams; bleaching preparations [decolorants] for cosmetic purposes; laundry bleach; bleaching salts; bleaching soda; extracts of flowers [perfumes]; polish for furniture and flooring; floor wax; deodorants for pets; deodorants for human beings or for animals; deodorant soap; detergents other than for use in manufacturing operations and for medical purposes; diamantine [abrasive]; canned pressurized air for cleaning and dusting purposes; scented wood; sachets for perfuming linen; perfume water; javelle water; depilatory preparations; wax (depilatory -); descaling preparations for household purposes; color- [colour-] brightening chemicals for household purposes [laundry]; laundry blue; colorants for toilet purposes; color-removing preparations; paint stripping preparations, cosmetic dyes; greases for cosmetic purposes; degreasers other than for use in manufacturing processes; varnish-removing preparations; stain removers; gaultheria oil; geraniol; shining preparations [polish]; laundry glaze; starch glaze for laundry purposes; glass cloth [abrasive cloth]; smoothing preparations [starching]; smoothing stones; flower perfumes (bases for -); hair dye; hair spray; hair tonic; cosmetic creams; cosmetic preparations for skin care; heliotropine; ionone [perfumery]; jasmine oil; adhesives for affixing false hair; adhesives for cosmetic purposes; eyelashes (adhesives for affixing false -); cologne; corundum [abrasive]; cosmetics; cosmetic kits; cosmetic pencils; cleaning chalk; false nails; false eyelashes; varnish-removing preparations; lavender oil; lavender water; leather bleaching preparations; creams for leather; preservatives for leather [polishes]; lip gloss; lipstick; floor wax removers [scouring preparations]; lotions for cosmetic purposes; air fragranting preparations; almond milk for cosmetic purposes; almond oil; almond soap; massage gels, other than for medical purposes; carbides of metal [abrasives]; cloths impregnated with a detergent for cleaning; preparations for unblocking drain pipes; plants (preparations to make shiny the leaves of -); douching preparations for personal sanitary or deodorant purposes [toiletries]; musk [perfumery]; mouth washes, not for medical purposes; nail art stickers; nail polish; nail care preparations; washing soda, for cleaning; soda lye; neutralizers for permanent waving; oils for toilet purposes; oils for cosmetic purposes; oils for cleaning purposes; hair waving preparations; oils for perfumes and scents; perfumery; perfume; pastes for razor strops; mint for perfumery; mint essence [essen-

tial oil]; polishing creams; polishing preparations; denture polishes; polishing paper; jewellers' rouge; polishing stones; polishing wax; pomades for cosmetic purposes; potpourris [fragrances]; dry-cleaning preparations; refurbishing preparations; quillaia bark for washing; shaving preparations; shaving soap; after-shave preparations; fumigation preparations [perfumes]; joss sticks; windscreen cleaning liquids, other than for cars or lorries; cleansing milk for toilet purposes; cleaning preparations; preparations for cleaning dentures; rose oil; rust removers; non-slipping liquids for floors; non-slipping wax for floors; safrol; ammonia [volatile alkali] [detergent]; sandpaper; whiting; cosmetic preparations for slimming purposes; grinding preparations; abrasive paper; grinding preparations; make-up preparations; make-up preparations; make-up powder; emery; emery cloth; sandcloth; tailors' wax; beauty masks; boot cream; shoe wax; cobblers' wax; shoemakers' wax; antiperspirant soap; soap for foot perspiration; shampoo; silicon carbide [abrasive]; tanning preparations; sun-tanning preparations [cosmetics]; laundry starch; badian essence; talcum powder, for toilet use; wallpaper cleaning preparations; terpenes [essential oils]; turpentine, for degreasing; oil of turpentine for degreasing; cosmetics for animals; shampoos for pets [non-medicated grooming preparations]; toiletries; cakes of soap; toilet water; tripoli stone for polishing; dry shampoos; drying agents for dishwashing machines; tissues impregnated with cosmetic lotions; petroleum jelly for cosmetic purposes; volcanic ash for cleaning; laundry wax; bluing for laundry; laundry soaking preparations; laundry preparations; hydrogen peroxide for cosmetic purposes; cotton wool for cosmetic purposes; cotton sticks for cosmetic purposes; fabric softener for laundry; incense; cosmetic preparations for eyelashes; mascara; dental bleaching gels; decorative transfers for cosmetic purposes; essential oils of lemon.

4 – Industrial oils, other than for cars or lorries, and greases; lubricants, other than for cars or lorries, and greases; dust absorbing, wetting and binding compositions; lighting fuel; candles and wicks for lighting; oils for paints; anthracite; moistening oil; bees-wax; firewood; fuel oil; vaporized fuel mixtures; fuel in the form of briquettes; Christmas tree candles; tallow; wicks for candles; perfumed candles; coal briquettes; oils for releasing form work [building]; electrical energy; dust removing preparations; illuminating grease; fish oil, not edible; lubricating graphite; wood briquettes; coal; wood spills for lighting; carnauba wax; kerosene; candles for lighting; bone oil for industrial purposes; lignite; firelighters; coke; oil for the preservation of masonry; lamp wicks; wool grease; grease for leather; greases for the preservation of leather; gas for lighting; motor oil; nightlights [candles]; naphtha; non-chemical fuel additives; industrial lubricants; textile oil; oleine; oil-gas; ozocerite [ozokerite]; paper spills for lighting; paraffin; petroleum

ether; grease for belts; non-slipping preparations for belts; belting wax; castor oil for technical purposes; rape oil for industrial purposes; lubricating grease; cutting fluids; grease for footwear; producer gas; soya bean oil preparations for non-stick treatment of cooking utensils; sunflower oil for industrial purposes; dust controlling compositions; dust binding compositions for sweeping; stearine; coal naphtha; coal tar oil; peat [fuel]; peat (blocks of -) [fuel]; carburants; petroleum jelly for industrial purposes; illuminating wax; industrial wax; wax [raw material]; arms [weapons] (grease for -); ceresine; tinder; wax for skis.

5 – Pharmaceutical and veterinary preparations; sanitary preparations for medical purposes; dietetic food and substances adapted for medical or veterinary use, food for babies; dietary supplements for humans and animals; plasters, materials for dressings; material for stopping teeth, dental wax; disinfectants; preparations for destroying vermin; fungicides, herbicides; dental impression materials; laxatives; medical preparation for slimming purposes; slimming pills; adjuvants for medical purposes; acaricides; aconitine; aldehydes for pharmaceutical purposes; algicides; alginates for pharmaceutical purposes; alkaline iodides for pharmaceutical purposes; alkaloids for medical purposes; alcohol for pharmaceutical purposes; aloe vera preparations for pharmaceutical purposes; dental amalgams; amino acids for medical purposes; amino acids for veterinary purposes; analgesics; anaesthetics; angostura bark for medical purposes; antibiotics; antiseptics; antiseptic cotton; appetite suppressants for medical purposes; appetite suppressant pills; medicines for human purposes; medicines for veterinary purposes; medicines for dental purposes; constipation (medicines for alleviating -); aseptic cotton; asthmatic tea; ethers for pharmaceutical purposes; caustics for pharmaceutical purposes; caustic pencils; collyrium; eyepatches for medical purposes; acetates for pharmaceutical purposes; babies' diaper-pants; infant formula; bath salts for medical purposes; bath preparations for medical purposes; bath (therapeutic preparations for the -); bacterial poisons; bacterial preparations for medical and veterinary use; bacteriological preparations for medical and veterinary use; fibre (dietary -); balms for medical purposes; balsamic preparations for medical purposes; sanitary wear; bandages for dressings; barks for pharmaceutical purposes; wadding for medical purposes; tranquillizers; biological tissue cultures for medical purposes; biological tissue cultures for veterinary purposes; biological preparations for medical purposes; biological preparations for veterinary purposes; biocides; goulard water; blood for medical purposes; haematogen; leeches for medical purposes; blood plasma; lozenges for pharmaceutical purposes; tanning pills; bromine for pharmaceutical purposes; powder of cantharides; chemical preparations to treat wheat blight [smut]; phylloxera (chemical preparations for treating -); vine



disease treating chemicals; chemico-pharmaceutical preparations; contraceptives (chemical -); chemical conductors for electrocardiograph electrodes; mildew (chemical preparations to treat -); pregnancy (chemical preparations for the diagnosis of -); chemical preparations for medical purposes; chemical preparations for pharmaceutical purposes; chemical preparations for veterinary purposes; chemical reagents for medical or veterinary purposes; quinine for medical purposes; chinoline for medical purposes; surgical tissues; surgical implants [living tissues]; hydrated chloral for pharmaceutical purposes; chloroform; condurango bark for medical purposes; curare; sanitary towels; decoctions for pharmaceutical purposes; dental cement; deodorants, other than for human beings or for animals; deodorants for clothing and textiles; disinfectants for chemical toilets; disinfectants for hygiene purposes; detergents for medical purposes; diabetic bread adapted for medical use; diagnostic preparations; diastase for medical purposes; dietetic substances adapted for medical use; dietetic foods adapted for medical use; digitalin; dill oil for medical purposes; drugs for medical purposes; alloys of precious metals for dental purposes; albuminous preparations for medical purposes; elixirs [pharmaceutical preparations]; gentian for pharmaceutical purposes; enzymes for medical purposes; enzymes for veterinary purposes; enzyme preparations for medical purposes; enzyme preparations for veterinary purposes; aluminium acetate for pharmaceutical purposes; esters for pharmaceutical purposes; eucalyptol for pharmaceutical purposes; eucalyptus for pharmaceutical purposes; fennel for medical purposes; ferments for pharmaceutical purposes; greases for medical purposes; greases for veterinary purposes; febrifuges; fish meal for pharmaceutical purposes; fly catching paper; fly catching adhesives; fly destroying preparations; formic aldehyde for pharmaceutical purposes; chilblain preparations; frostbite salve for pharmaceutical purposes; fungicides; gallic acid for pharmaceutical purposes; gases for medical purposes; gelatine for medical purposes; royal jelly for pharmaceutical purposes; poisons; glycerine for medical purposes; glycerophosphates; gold (dental amalgams of -); guaiacol for pharmaceutical purposes; gum for medical purposes; gamboge for medical purposes; gurjun [gurjon, gurjan] balsam for medical purposes; belts for sanitary napkins [towels]; haemostatic pencils; adhesives for dentures; haemoglobin; hemorrhoid preparations; dry rot fungus (preparations for destroying -); yeast for pharmaceutical purposes; remedies for foot perspiration; remedies for perspiration; charcoal for pharmaceutical purposes; hops (extracts of -) for pharmaceutical purposes; hormones for medical purposes; cement for animal hooves; corn remedies; corn rings for the feet; repellents for dogs; dog lotions for veterinary purposes; dog washes; hydrastine; hydrastinine; vaccines; pants, absorbent, for incontinents; insecticides; insect repellents; personal sexual lubricants; irish

moss for medical purposes; isotopes for medical purposes; jalap; iodine for pharmaceutical purposes; iodides for pharmaceutical purposes; iodoform; tincture of iodine; jujube, medicated; potassium salts for medical purposes; preparations of lime for pharmaceutical purposes; calomel [fungicide]; cooling sprays for medical purposes; camphor for medical purposes; camphor oil for medical purposes; candy for medical purposes; capsules for medicines; carbolineum [parasiticide]; compresses; cachou for pharmaceutical purposes; chewing gum for medical purposes; rubber for dental purposes; germicides; adhesive bands for medical purposes; bone cement for surgical and orthopaedic purposes; cocaine; collodion for pharmaceutical purposes; compresses; headache pencils; smoking herbs for medical purposes; herbal teas for medicinal purposes; creosote for pharmaceutical purposes; croton bark; preparations of microorganisms for medical or veterinary use; liquorice for pharmaceutical purposes; larvae exterminating preparations; cod liver oil; flaxseed for pharmaceutical purposes; flaxseed meal for pharmaceutical purposes; lecithin for medical purposes; liniments; solutions for contact lenses; solvents for removing adhesive plasters; lotions for pharmaceutical purposes; lotions for veterinary purposes; air purifying preparations; lupulin for pharmaceutical purposes; magnesia for pharmaceutical purposes; malt for pharmaceutical purposes; malted milk beverages for medical purposes; almond milk for pharmaceutical purposes; mangrove bark for pharmaceutical purposes; mice (preparations for destroying -); beverages adapted for medicinal purposes; medicinal herbs; medicinal infusions; medicinal hair growth preparations; medicinal tea; sea water for medicinal bathing; flour for pharmaceutical purposes; melissa water for pharmaceutical purposes; milking grease; menthol; articles for headache; milk ferments for pharmaceutical purposes; milk sugar for pharmaceutical purposes; mineral food supplements; mineral water salts; burns (preparations for the treatment of -); soil-sterilising preparations; anti-uric preparations; callouses (preparations for -); air deodorising preparations; teething (preparations to facilitate -); douching preparations for medical purposes; reducing sexual activity (preparations for -); moulding wax for dentists; moleskin for medical purposes; sanitary pants; mud for baths; mud (medicinal -); mothproofing preparations; paper (mothproof -); mouthwashes for medical purposes; ergot for pharmaceutical purposes; myrobalan bark for pharmaceutical purposes; mediums (bacteriological culture -); powdered milk for babies; albuminous foodstuffs for medical purposes; nutritive substances for microorganisms; nutritional supplements; albumin dietary supplements; alginate dietary supplements; enzyme dietary supplements; royal jelly dietary supplements; glucose dietary supplements; yeast dietary supplements; casein dietary supplements; flaxseed dietary supplements; flaxseed oil dietary supplements; lecithin dietary supplements;

pollen dietary supplements; propolis dietary supplements; protein dietary supplements; wheat germ dietary supplements; dietary supplements for animals; narcotics; bicarbonate of soda for pharmaceutical purposes; sodium salts for medical purposes; by-products of the processing of cereals for dietetic or medical purposes; nervines; cachets for pharmaceutical purposes; medicinal oils; opiates; opium; opodeldoc; organotherapy preparations; antioxidant pills; paper for mustard poultices; antiparasitic collars for animals; parasiticides; pectin for pharmaceutical purposes; pepsins for pharmaceutical purposes; peptones for pharmaceutical purposes; pearl powder for medical purposes; mint for pharmaceutical purposes; pharmaceutical preparations; pharmaceutical preparations for treating dandruff; pharmaceutical preparations for skin care; phenol for pharmaceutical purposes; phosphates for pharmaceutical purposes; anticryptogamic preparations; pomades for medical purposes; porcelain for dental prostheses; bronchodilating preparations; trace elements (preparations of -) for human and animal use; sterilising preparations; propolis for pharmaceutical purposes; protein supplements for animals; pyrethrum powder; quassia for medical purposes; quebracho for medical purposes; mercurial ointments; radioactive substances for medical purposes; radium for medical purposes; rat poison; fumigating pastilles; fumigation preparations for medical purposes; contact lens cleaning preparations; medicine cases, portable, filled; rhubarb roots for pharmaceutical purposes; smelling salts; castor oil for medical purposes; radiological contrast substances for medical purposes; ointments for pharmaceutical purposes; salts for medical purposes; salts for mineral water baths; sarsaparilla for medical purposes; oxygen for medical purposes; oxygen baths; acids for pharmaceutical purposes; pesticides; lint for medical purposes; soporifics; dental abrasives; slug exterminating preparations; flowers of sulfur for pharmaceutical purposes; sulfur sticks [disinfectants]; mustard for pharmaceutical purposes; mustard oil for medical purposes; mustard poultices; serums; serotherapeutic medicines; siccatives [drying agents] for medical purposes; syrups for pharmaceutical purposes; scapulars for surgical purposes; sunburn ointments; sunburn preparations for pharmaceutical purposes; semen for artificial insemination; stem cells for medical purposes; stem cells for veterinary purposes; starch for dietetic or pharmaceutical purposes; steroids; breast-nursing pads; strychnine; styptic preparations; sulfonamides [medicines]; suppositories; tobacco extracts [insecticides]; tampons; turpentine for pharmaceutical purposes; oil of turpentine for pharmaceutical purposes; thermal water; thymol for pharmaceutical purposes; animal washes [insecticides]; tinctures for medical purposes; tonics [medicines]; glucose for medical purposes; tissues impregnated with pharmaceutical lotions; vermin destroying preparations; herbicides; vaginal washes for medical purposes; petroleum jelly for medical purposes; gauze

for dressings; first-aid boxes, filled; dressings, medical; surgical dressings; absorbent cotton; digestives for pharmaceutical purposes; vesicants; veterinary preparations; cattle washes [insecticides]; vitamin preparations; wart pencils; hydrogen peroxide for medical purposes; insect repellent incense; cream of tartar for pharmaceutical purposes; incontinence pads; bismuth preparations for pharmaceutical purposes; bismuth subnitrate for pharmaceutical purposes; vulnerary sponges; anthelmintics; medicinal roots; teeth filling material; dental lacquer; cedar wood for use as an insect repellent; cellulose ethers for pharmaceutical purposes; cellulose esters for pharmaceutical purposes; sugar for medical purposes algaeicide for use in the manufacture of roof shingles and tiles, and for use in other applications to roofs and roofing materials; disinfectant soap; medicated soap.

6 – Common metals and their alloys; metal building materials; transportable buildings of metal; materials of metal for railway tracks; non-electric cables and wires of common metal; ironmongery, small items of metal hardware; pipes and tubes of metal; safes; goods of metal, not included in other classes, namely castings, forgings, moldings and welded semi-finished products of iron, steel, metals and their alloys, unwrought, semi-wrought and wrought metals and forgings thereof, machine- or hand-wrought, moulded components of metal, goods and building components of rolled and cast metal, machined castings, unprocessed or semi-processed materials for the manufacture of machines, foundry, forge and mill products, goods of raw steel, pressure vessels of metal; high-pressure and specialised fittings of metal; packaging containers of metal, high-pressure pipes; metallurgical products: castings, forging, pressing, ingots of common metal; ores; gutter pipes of metal; bicycle parking installations of metal; branching pipes of metal; aluminium; aluminium wire; aluminum foil paper; anvils; anchors; mooring buoys of metal; tie plates; jets of metal; fittings of metal for compressed air ducts; reinforcing materials of metal for machine belts; reinforcing materials of metal for building; outdoor blinds of metal; cabanas of metal; beacons of metal, non-luminous; metal beams; metal joists; hoop steel; bindings of metal; bands of metal for tying-up purposes; hoop iron; ingots of common metal; building or furniture fittings of nickel-silver; fittings of metal for building; tree protectors of metal; building boards of metal; buildings of metal; clips of metal for cables and pipes; containers of metal for compressed gas or liquid air; tanks of metal; closures of metal for containers; glucinium [beryllium]; broom handles, of metal; shuttering of metal for concrete; fittings of metal for beds; bed casters of metal; thread of metal for tying-up purposes; binding thread of metal for agricultural purposes; sheets and plates of metal; lead, unwrought or semi-wrought; lead seals; bolts of metal; vats of metal; iron slabs; letter boxes of metal;

bronze; bronzes for tombstones; bronzes [works of art]; letters and numerals of common metal, except type; busts of common metal; cermets; chromium; chrome ores; containers of metal [storage, transport]; metal roofing; metal roofing; tiles of metal; cornices of metal; mooring bollards of metal; monuments of metal; box fasteners of metal; wire; wire of common metal alloys, except fuse wire; wire gauze; wire rope; telfer cables; ropes of metal; drain pipes of metal; metal turnstiles; turntables [railways]; metal window fasteners; penstock pipes of metal; metal pegs; nozzles of metal; brackets of metal for building; iron, unwrought or semi-wrought; ironmongery; railroad ties of metal; railway points; iron wire; iron ores; ice moulds of metal; badges of metal for vehicles; locks of metal for vehicles; traps for wild animals; paint spray booths of metal; metal casks; metal casks; taps for casks, of metal; springs [metal hardware]; filings of metal; windows of metal; lintels of metal; ironwork for windows; fittings of metal for windows; sash fasteners of metal for windows; shutters of metal; metal window frames; window casement bolts; sash pulleys; chrome iron; ferrotitanium; tungsten iron; firedogs [andirons]; refractory construction materials of metal; furnace fireguards of metal; statues of common metal; flanges of metal [collars]; bottle closures of metal; bottle closures of metal; insect screens of metal; foils of metal for wrapping and packaging; handling pallets of metal; hoppers of metal, non-mechanical; door scrapers; metal floors; galena [ore]; sheaf binders of metal; hooks of metal for clothes rails; memorial plates of metal; collecting boxes (metal -); germanium; framework of metal for building; scaffolding of metal; cornices of metal; greenhouses of metal, transportable; greenhouse frames of metal; foundry molds [moulds] of metal; latticework of metal; bars for metal railings; bells; gold solder; tombs (monuments of metal for -); enclosures of metal for tombs; burial vaults of metal; vaults of metal [burial]; tombstones of metal; tombstone stelae of metal; metal tomb plaques; knobs of metal; ferrules of metal for handles; cast iron, unwrought or semi-wrought; hafnium [celtium]; pot hooks of metal; anvils [portable]; handcuffs; towel dispensers, fixed, of metal; brazing alloys; house numbers of metal, non-luminous; slings of metal for handling loads; horseshoe nails; chicken-houses, of metal; identity plates of metal; indium; jalousies of metal; binding screws of metal for cables; cable joints of metal, non-electric; tiles of metal for building; cadmium; platforms, prefabricated, of metal; chimney pots of metal; chimney pots of metal; boxes of common metal; rope thimbles of metal; flashing of metal for building; angle irons; couplings of metal for chains; bins of metal; cramps of metal; drain traps [valves] of metal; water-pipe valves of metal; metal clothes hooks; vice claws of metal; pitons of metal [mountaineering equipment]; chill-molds [foundry]; tin cans; baskets of metal; skating rinks [structures of metal]; works of art of common metal; copper, unw-

rought or semi-wrought; copper wire, not insulated; copper rings; loading pallets, of metal; loading gauge rods, of metal, for railway wagons; cask stands of metal; anti-friction metal; belts of metal for handling loads; laths of metal; arbours [structures of metal]; duckboards of metal; alloys of common metal; crash barriers of metal for roads; guard rails of metal; ducts of metal for ventilating and air conditioning installations; reinforcing materials of metal for pipes; limonite; rods of metal for brazing; rods of metal for welding; blooms [metallurgy]; magnesium; manganese; porches of metal [building]; masts of metal; wall claddings of metal [building]; brass, unwrought or semi-wrought; reinforcing materials, of metal, for concrete; ores of metal; bottles [metal containers] for compressed gas or liquid air; grilles of metal; metal cages for wild animals; chains of metal; metals in powder form; frames of metal for building; rings of metal; metal rods for brazing and welding; fittings of metal for furniture; furniture casters of metal; molybdenum; iron (molybdenum -); troughs of metal for mixing mortar; sleeves [metal hardware]; nails; identification bracelets of metal; german silver; non-electric wires of common metal; nickel; rivets of metal; niobium; numberplates, of metal; casement windows of metal; furnace screens; materials of metal for funicular railway permanent ways; armour plate; armor plate; mobile boarding stairs (metal -) for passengers; posts of metal; palings of metal; paving blocks of metal; advertisement columns of metal; floor tiles, of metal; floor tiles of metal; stops of metal; pyrophoric metals; wheel clamps [boots]; rocket launching platforms of metal; moldings of metal for cornices; flat bolts; bolts (lock -); cobalt, raw; metal pipes; elbows of metal for pipes; metal tubing; junctions of metal for pipes; roller blinds of steel; locks of metal for bags; fittings of metal for coffins; pillars of metal for buildings; containers of metal for storing acids; tubing of metal; manhole covers of metal; strap-hinges of metal; hinges of metal; washers of metal; hooks for slate [metal hardware]; metal rails; fish plates [rails]; signboards of metal; reels of metal, non-mechanical, for flexible hoses; winding spools of metal, non-mechanical, for flexible hoses; non-electric locks of metal; keys of metal; split rings of common metal for keys; grease nipples; spring locks; chimneys of metal; chimney shafts of metal; nuts of metal; braces of metal for load handling; soldering wire of metal; sills of metal; eye bolts; swimming pools [metal structures]; floating containers of metal; floating docks of metal, for mooring boats; pulleys of metal, other than for machines; safes [strong boxes]; safety chains of metal; signs, non-luminous and non-mechanical, of metal; signalling panels, non-luminous and non-mechanical, of metal; nickel-silver; silver solder; silicon iron; silos of metal; tension links; wire stretchers [tension links]; iron bands (stretchers for -) [tension links]; stretchers for metal bands [tension links]; cotter pins of metal; spurs; metal stepladders;

diving boards of metal; plugs of metal; pilings of metal; barbed wire; steel, unwrought or semi-wrought; steel sheets; steel wire; cast steel; steel buildings; balls of steel; steel alloys; steel masts; steel pipes; poles of metal; tinfoil; statues of common metal; steps [ladders] of metal; ice nails [climbing irons]; pins [hardware]; ferrules of metal for walking sticks; signs, non-luminous and non-mechanical, of metal, for roads; posts of metal for electric lines; props of metal; wainscoting of metal; containers of metal for liquid fuel; tantalum [metal]; telephone boxes of metal; telegraph posts of metal; titanium; tombac; barrel hoops of metal; gates of metal; transport pallets of metal; machine belt fasteners of metal; belt stretchers of metal; partitions of metal; staircases of metal; stair treads [steps] of metal; stringers [parts of staircases] of metal; ironwork for doors; door fittings, of metal; door bolts of metal; doors of metal; door stops of metal; door panels of metal; door handles of metal; non-electric door chimes; latch bars of metal; door knockers; door openers (non-electric); metal door frames; latches of metal; runners of metal for sliding doors; door closers, non-electric; common metals, unwrought or semi-wrought; shims; vanadium; valves of metal, other than parts of machines; linings of metal for building; tinsplate packings; packaging containers of metal; casings of metal for oilwells; sealing caps of metal; silver plated tin alloy; manifolds of metal for pipelines; bells for animals; cattle chains; bird baths [structures of metal]; aviaries of metal [structures]; padlocks; wall linings of metal [building]; water-pipes of metal; tin; white metal; tool boxes of metal, empty; tool chests of metal, empty; weather vanes of metal; wind-driven bird-repelling devices made of metal; tungsten; metal hooks; fences of metal; tent pegs of metal; pipes of metal, for central heating installations; ceilings of metal; zinc; tin; zirconium; brads; sleeves [metal hardware]; casting alloys; iron castings [semi-finished]; steel forgings; alloy forgings (rough or semi-finished -) [metal]; extrusions of metal; white metal; alloys of metal; brazing alloys; containers of metal for industrial purposes; metallic containers; structures of metal; building structures of metal; bridges [structures] of metal; bins [metal structures]; prefabricated metal buildings; containers of metal for compressed gas or liquid air; gas storage tanks of metal; packaging containers of metal; housing units of metal; fittings of metal for pipes; prefabricated metal bridges; storage tanks; turntables.

7 – Machines of all kinds, and parts therefor, other than steam turbines, parts and accessories therefor, in particular surface capacitors, heat exchanger units and feedwater heaters, turbo alternators and electricity generators; machine tools and power tools; motors and engines (except for land vehicles); machine coupling and transmission components (except for land vehicles); agricultural implements, other than hand-operated hand tools; incubators for eggs; automatic

vending machines; machines and equipment for the rolling of metal; rolling mills, apparatus for the handling and transport of rolled products, cooling beds, winders, coilers and unwinders, equipment for the treatment of rolls, scissors, saws, wrappers; machines and equipment for mines, hoisting equipment, hoist cable reels, hoist cages, brake machinery, pit equipment and pit head towers, collision and vehicle circulation equipment, transport equipment for mines, skip stations; machinery and equipment for treating coal and ores, washing coal and ores, sorting plants for coal and ores; filling equipment for industrial furnaces, industrial furnaces; machinery and equipment for crushing, grinding and sorting, crushers, grinders, granulators, molculators, vibrators, mixing machines, sorters, conveyors; high-pressure machinery and equipment; hydraulic presses, hydro-pneumatic accumulators, pressure intensifiers, pipe expanders, jacks, lifting platforms and tables, high-pressure and specialised fittings, high-pressure vessels, piston expansion heaters, boilers; steam engine boilers for power generation, other than for land vehicles; machinery and equipment for the chemical and foodstuff industries, sugar refineries, breweries, distilleries, gasworks, oxygen plants, extractors, paper-working machines and apparatus, rolling mills, detachable pipe links, blenders, thickening drums, filters, knotters, grit chambers, fortraps, hydropulpers, hydrorefiners, high-pressure inflow agitators, cylinders, converters, automatic regulators, wet presses, mangles, cutters, winders and rewinders; glass machinery, automated machinery for the manufacture of bottles, automated machinery for the production of light bulbs, automated machinery for light bulbs, automated machinery for the manufacture of beads of glass, presses for objects of glass, machinery for the manufacture of sheet glass, machinery for the production of cast glass; tobacco and cigarette machines; printing machines and apparatus, rotary printing presses, stereotyping equipment; measuring machines; packing machines; sizing machines; machine tools, lathes, turret lathes, horizontal borers, milling machines; woodworking machines; drilling machines, bores, die chasers, thread-cutting heads and apparatus, reamers, broaches, reamers, shaped drill bits, drilling bits, forming apparatus; clamping devices, mounting elements, tensioning apparatus, expanding mandrels, bushings, rings, feeders, inserts, centring inserts and bolts [parts of machines], drill sockets and inserts, drill bushings, separators, tables and stands, grinding and sharpening apparatus, drilling lever presses; general machine parts and equipment, crankshafts, gear casings, springs; cranes [lifting and hoisting apparatus], traversers, drop tables; compressors (turbo compressors), blowing machines, superchargers; aerated water making apparatus; mineral water making machines; bottle washing machines; machines for the rubber and plastics industries, tyre vulcanisation presses, electric machinery, engines of all kinds, other than electric engines for

means of transport; parts of machines, namely fittings, taps (faucets), slide valves, couplings for machine, chains, gear wheels and transmission case; machines and equipment for the manufacture of glass and ceramics machines for the manufacture of bottles, cast and sheet glass, presses, casting machines, grinding machines, rolling mills, vibrators, mixing machines, separators, loading and unloading installations, drying machines, painting equipment, equipment for applying glazes (spraying equipment); earth moving machines; grinding machines; road construction machines; road sweeping machines [self-propelled]; mine borers; machinery and equipment for treating coal and ores, washing coal and ores, sorting plants for coal and ores; oil refining machines; ore treating machines; construction machines; concrete mixers [machines]; roller bridges; diggers [machines]; belt conveyors; machines for the energy sector, other than steam turbines, parts and accessories therefor, in particular surface capacitors, heat exchanger units and feedwater heaters, turbo alternators and electricity generators; electricity generating machines included in this class, namely electricity generators, electric motors, other than for land use; wind turbines; drilling rigs, floating or non-floating; motors and engines (except for land vehicles); boat motors; airplane motors; hydraulic engines and motors; engines for air cushion vehicles; electricity and heat generators, related spare parts within this class; waste compacting machines; catalytic converters; separators; sewage pulverizers; drainage machines; separators for liquids; filtering machines, separators and centrifuges; clutch starter transmissions, other than for cars or lorries; engine starters, other than for cars or lorries; anti-friction pads for machines; transmission chains, other than for cars or lorries; transmission shafts, other than for cars or lorries; exhaust manifold for engines, other than for cars or lorries; exhausts for motors and engines, other than for cars or lorries; silencers for motors and engines, other than for cars or lorries; brakes (parts), other than for cars or lorries; self-regulating fuel pumps, other than for cars or lorries; fuel conversion apparatus for internal combustion engines, other than for cars or lorries; torque converters, other than for land vehicles; speed regulators for motors and engines, other than for cars or lorries; printing machines; printing plates; printing cylinders; industrial printing machines; pneumatic transporters; compressors [machines]; compressed air engines; compressed air pumps, other than for cars or lorries; compressed air guns for the extrusion of mastics; jet engines, other than for cars or lorries; dynamo brushes; dynamo belts; dynamos, other than for cars or lorries; bicycle dynamos; brushes, electrically operated [parts of machines]; electrodes for welding machines; power hammers; electroplating machines; elevator belts; elevator chains [parts of machines]; painting machines; dyeing machines; paint spray guns; filters, parts of machines or engines, other than for cars or lorries; filtering machines; finis-

hing machines; galvanizing machines; blowing machines for the compression, exhaustion and transport of gases; blowing engines; crank cases for machines, motors and engines, other than for cars or lorries; railroad constructing machines; glow plugs for diesel engines, other than for cars or lorries; hand-held tools, other than hand-operated; reeling apparatus, mechanical; elevating apparatus; jacks [machines]; stitching machines; raking machines; high pressure washers; woodworking machines; lifts; tilt hammers; hydraulic controls for machines, motors and engines, other than for cars or lorries; hydraulic door openers and closers [parts of machines]; universal joints [cardan joints]; card clothing [parts of carding machines]; carding machines; notchers [machine tools]; tubes (boiler -) [parts of machines]; machine boiler scale collectors; chain saws; valves (clack -) [parts of machines]; glue guns, electric; blades [parts of machines]; kneading machines; carbon brushes [electricity]; pistons for engines, other than for cars or lorries; pistons (parts of machines or engines), other than for cars or lorries; piston rings, other than for cars or lorries; compressors for refrigerators; condensing installations (not for turbines); basket presses; fuel dispensing pumps for service stations; fuel economisers for engines and motors, other than for cars or lorries; ball-bearings; ball rings for bearings; condensers for motors and engines, other than for cars or lorries; motorized cultivators; cranks [parts of machines]; crankshafts, other than for cars or lorries; handling apparatus for loading and unloading; derricks; loading ramps; superchargers; bearings [parts of machines]; bearing brackets for machines; journals [parts of machines]; moving pavements [sidewalks]; leather-working machines; leather paring machines; electric arc cutting apparatus; electric arc welders; type-setting machines [photocomposition]; punches for punching machines; punching machines; electric welding apparatus; electric soldering irons; soldering irons, gas-operated; soldering lamps; soldering blow pipes, gas-operated; filters for cleaning cooling air, for engines; air condensers, other than for cars or lorries; aerocondensers; mangles; racket stringing machines; bicycle assembling machines; textile production machines; lace making machines; housings [parts of machines]; steam engine boilers; machine wheels; stands for machines; tables for machines; axles for machines; materials handling elevators; matrices for use in printing; boxes for matrices [printing]; agricultural machines; mechanized livestock feeders; scissors, electric; chisels for machines; paring machines; milking machines; cream/milk separators; reapers and binders; knives for mowing machines; feeders [parts of machines]; dairy machines; flour mill machines; domestic crushers/grinders, electric; agitators; mills [machines]; millstones; electric flour mills; waste disposals; sewing machines; riveting machines; pneumatic door openers and closers [parts of machines]; electric polishing machines and apparatus; die-stamping machines; tympan

[parts of printing presses]; presses [machines for industrial purposes]; filter presses; pneumatic hammers; road rollers; puddling machines; pumps (machines), other than for cars or lorries; pumps (parts of machines and engines), other than for cars or lorries; pump diaphragms, other than for cars or lorries; gears, other than for cars or lorries; rams [machines]; lawn mowers; turf removing ploughs; friezing machines; regulators [parts of machines]; steam traps; electric cleaning machines and apparatus; trimming machines; belts for machines; diggers [machines]; roller bearings; moving staircases [escalators]; rotary printing presses; beaters, electric; agitators; saw blades [parts of machines]; saw benches [parts of machines]; saws; satinizing machines; air suction machines; suction machines for industrial purposes; hemming machines; silencers for motors and engines, other than for cars or lorries; peeling machines; shovels, mechanical; electric shearing machines; chisels for machines; rail-laying machines; beating machines; mud catchers and collectors [machines]; reels, mechanical, for flexible hoses; trueing machines; grindstones [parts of machines]; carriages for knitting machines; slide rests [parts of machines]; grease boxes [parts of machines]; lubricating pumps; rings (grease -) [parts of machines]; grease boxes [parts of machines]; snowplows; machine guides [parts of machines]; kitchen machines [electric utensils]; metalworking machines; broaches; feeders; fuel economisers; road rollers; aircraft engines; components of aircraft engines.

8 – Hand tools and implements (hand-operated); cutlery; side arms; razors; wire strippers [hand tools]; priming irons [hand tools]; leather strops; awls; oyster openers; axes; hatchets; bayonets; beard clippers; tree pruners; pruning shears; fireplace bellows [hand tools]; bow saws; bits [parts of hand tools]; perforating tools [hand tools]; gimlets [hand tools]; drill holders [hand tools]; ratchets [hand tools]; extension pieces for braces for screwtaps; bits [hand tools]; cutter bars; breast drills; crow bars; holing axes; branding irons; flat irons; caulking irons; daggers; can openers, non-electric; drills; pin punches; egg slicers, non-electric; irons [non-electric hand tools]; ice picks; manicure sets, electric; tableware [knives, forks and spoons]; razor cases; palette knives; penknives; tweezers; files [tools]; nail buffers, electric or non-electric; meat choppers [hand tools]; milling cutters [hand tools]; hand implements for hair curling; table forks; pitchforks; pruning knives; secateurs; garden tools, hand-operated; goffering irons; mitre [miter (Am.)] boxes [hand tools]; nail drawers [hand tools]; vegetable slicers; instruments and tools for skinning animals; apparatus and instruments for skinning butcher's animals; slaughtering butchers' animals (apparatus and instruments for -); plant parasite killing apparatus; frames for handsaws; taps [hand tools]; dies [hand tools]; foundry ladles [hand tools]; glaziers' diamonds [parts of hand tools]; glazing irons; sand

trap rakes; engraving needles; curling tongs; depilation appliances, electric and non-electric; hair clippers for personal use, electric and non-electric; ditchers [hand tools]; cleavers; hammers [hand tools]; borers; decanting liquids (implements for -) [hand tools]; hand pumps; rams [hand tools]; hand tools, hand-operated; rakes [hand tools]; harpoons; harpoons for fishing; levers; hackles [hand tools]; sickles; bill-hooks; planes; plane irons; hollowing bits [parts of hand tools]; gouges [hand tools]; sledgehammers; farriers' knives; sharpening instruments; hunting knives; hoes [hand tools]; draw wires [hand tools]; instruments for punching tickets; cheese slicers, non-electric; moulding irons; ladles [hand tools]; scraping tools [hand tools]; mortise chisels; bushhammers; agricultural implements, hand-operated; hand-operated jigsaws; wick trimmers [scissors]; perforating tools [hand tools]; punch pliers [hand tools]; spoons; machetes; manicure sets; masons' trowels; graving tools [hand tools]; knives; blades for planes; blades [hand tools]; blades [weapons]; scaling knives; cutlery; mortars for pounding [hand tools]; money scoops; needle files; emery files; nail files, electric; nail clippers, electric or non-electric; nail nippers; nail extractors; nail punches; riveting hammers [hand tools]; riveters [hand tools]; numbering punches; fruit pickers [hand tools]; ear piercing apparatus; budding knives; pedicure sets; trowels [gardening]; rammers (earth -) [hand tools]; grafting tools [hand tools]; hoes; hair-removing tweezers; guns [hand tools]; guns, hand-operated, for the extrusion of mastics; pizza cutters, non-electric; punches [hand tools]; braiders [hand tools]; lawn clippers [hand instruments]; razor blades; razors, electric or non-electric; leather strops; shaving cases; reamers; reamer sockets; rasps [hand tools]; hoop cutters [hand tools]; annular screw plates; diggers [hand tools]; tube cutters [hand tools]; tube cutting instruments; sabres; sword scabbards; saw blades [parts of hand tools]; saws [hand tools]; saw holders; scrapers [hand tools]; shovels [hand tools]; shears; shear blades; shearers [hand instruments]; mallets [hand instruments]; knuckle dusters; police batons; masons' hammers; blade sharpening instruments; abrading instruments [hand instruments]; wheels (sharpening -) [hand tools]; whetstones; wrenches (hand tools); emery files; emery grinding wheels; cutters; cutting tools [hand tools]; edge tools [hand tools]; cutting tools; screwdrivers; vices; clamps for carpenters or coopers; lasts [shoemakers' hand tools]; paring knives; swords; scythes; scythe rings; whetstones; fullers [hand tools]; sickles; rabbeting planes; spatulas [hand tools]; expanders [hand tools]; metal wire stretchers [hand tools]; spades; picks [hand tools]; centre punches [hand tools]; marline spikes; syringes for spraying insecticides; insecticide sprayers [hand tools]; augers [hand tools]; embossers [hand tools]; embossers [hand tools]; stone hammers; chisels; fire irons; holing axes; paring irons [hand tools]; rammers [hand tools]; silver plate [knives, forks and spoons];

apparatus for tattooing; hair clippers for animals [hand instruments]; weeding forks [hand tools]; thistle extirpators [hand tools]; stunning apparatus (cattle -); livestock marking tools; cattle shearers; lifting jacks, hand-operated; crimping irons; fulling tools [hand tools]; tool belts [holders]; sharpening steels; whetstone holders; sharpening steels; choppers [knives]; vegetable choppers; eyelash curlers; tap wrenches; squares [hand tools]; pliers; drawing knives; carpenters' augers; turning tools for lathes, milling cutters [hand tools], screw-thread cutters; holding devices (a part of hand tools for metalworking); cutters, blades (metalworking), screw-thread cutters, bolt die, thread cutting die heads and apparatus, reamers, hollowing bits [parts of hand tools], reamers, shaped drill bits; gripping tools, sheaths, ring hooks, vices, inserts, centring inserts and bolts, drill sockets and inserts, drill bushings, separators, tables, stands, grinding and sharpening apparatus, drilling lever presses (assembly); hand tools and implements, hand-operated; adjustable bevells, limit rings, thread plug gauges; cutters, blades (metalworking), vices; knife handles of metal; scythe handles of metal; tool handles of metal; scrapers for skis.

9 – Scientific, nautical, surveying, photographic, cinematographic, optical, other than for passenger vehicles or lorries, weighing, measuring, signalling, checking (supervision), life-saving and teaching apparatus, other than for passenger vehicles or lorries; apparatus and instruments for conducting, switching, transforming, accumulating, regulating or controlling electricity; apparatus for recording, transmission or reproduction of sound or images, other than for cars or lorries; magnetic data carriers, recording discs; compact discs, dvds and other digital recording media; mechanisms for coin-operated apparatus; cash registers, calculating machines, data processing equipment, computers; computer software, other than for cars or lorries; fire-extinguishing apparatus, other than for cars or lorries; telecommunications apparatus, other than for cars or lorries; portable telecommunications apparatus; mobile telecommunications handsets; digital communications apparatus and equipment, other than for cars or lorries; digital tablets, other than for cars or lorries; tablets, other than for cars or lorries; computers, other than for cars or lorries; computer hardware, other than for cars or lorries; computer application software, other than for cars or lorries; software downloadable from the internet; recorded computer programs, other than for cars or lorries; mobile software applications, other than for cars or lorries; downloadable applications for multimedia devices, other than for cars or lorries; games software; personal digital assistants; pocket PCs; cell phones; selfie sticks [hand-held monopods]; smart rings; smartphones; smartwatches; laptop computers; telecommunications network apparatus; PC drivers for telecommunications networks and for telecommunica-

tions apparatus; protective clothing; head protection; television apparatus; headphones; navigation equipment, global positioning systems (GPS), other than for cars or lorries; satellite navigational apparatus, other than for cars or lorries; software recorded on CD-ROMs, other than for cars or lorries; sd-cards (secure digital cards); spectacles [optics]; spectacle lenses; sunglasses; protective glasses and cases therefor; contact lenses; cameras; photographic lenses; MP3 players; audio tapes and audio cassettes; audio discs; audio-video tapes; audio-video cassettes; (audio-video) discs; video cassettes; videodiscs; cds, dvds; downloadable electronic publications, other than for cars or lorries; downloadable image files; downloadable music files; mouse pads; magnetic coils; cell phone covers; cases adapted for mobile phones; hands-free kits for telephones, other than for cars or lorries; magnetic card; encoded cards; application software for mobile phones; computer programmes for use in telecommunications; software for the processing of financial transactions; electronic notice boards; batteries, electric; battery chargers, other than for cars or lorries; security alarms, other than for cars or lorries; security cameras, other than for cars or lorries; security warning devices, other than for cars or lorries; security checking apparatus, other than for cars or lorries; security surveillance apparatus; computer software for security purposes; computer software for insurance purposes; sim cards; interactive touch screen terminals; antennas; alarms, other than for cars or lorries; electric cables; chemistry apparatus and instruments; chips; computer operating programs, recorded; peripherals adapted for use with computers; data processing apparatus; diagnostic apparatus, not for medical purposes; distance measuring apparatus; distance recording apparatus; downloadable ring tones for mobile phones; electronic tags for goods; eyepieces; sports glasses; identity cards, magnetic; intercommunication apparatus; loudspeakers; magnetic data media; mathematical instruments; modems; monitoring apparatus, electric; television apparatus; testing apparatus not for medical purposes; transmitting sets [telecommunication]; mobile device management apparatus; software for mobile device management; middleware for management of software functions on electronic devices; anti-virus software; computer anti-virus software privacy protection software; parts and fittings for all the aforesaid goods; bar code readers; electronic book readers; baby monitors; monitors; navigational apparatus, other than for cars or lorries; USB flash drives; electrical equipment for land vehicles and underground vehicles, other than for cars or lorries, in particular electrical and electronic information, instruction, control and diagnostic equipment for land vehicles and urban vehicles, other than for cars and lorries, namely electrical and electronic equipment for land vehicles and metro carriages, other than for cars or lorries, namely sockets, plugs and other connections (electrical connectors) (for recharging);

electronic connections for use in electric vehicles, namely plugs, sockets and other contacts for fast charging; manual or semi-automatic collectors being parts of vehicle engines and electrical equipment for the movement of electric vehicles; braking resistors, electronic measuring and control equipment, in particular electrical and electronic diagnostic systems, consisting principally of hardware and software based on microprocessors, used for monitoring the operational reliability of vehicles and the costs of operating and maintaining vehicles, other than cars or lorries; electrical and electronic current surge protection systems, consisting principally of sensors, imaging units, signal processors, communication and memory modules and fuses, used for the protection of electrical equipment from the damage caused by surges; information and control units for monitoring the consumption of electricity and promoting lower energy consumption; electrical and electronic automatic testing systems consisting principally of principally of sensors, imaging units, signal processors, communication and memory modules, used to diagnose problems with vehicles, for the easier and quicker maintenance thereof, other than cars or lorries; electrical and electronic insulating protective systems consisting principally of sensors, imaging units, signal processors, communication modules and fuses, used to monitor the status of the insulation of electrically conductive vehicle components, other than for cars or lorries; electrical and electronic control systems for traction and tilting traction systems, consisting principally of sensors, imaging units, signal processors, memory and communication modules, used to prevent the sliding and displacement of wheels, in the event of sudden braking or braking on slippery surfaces, for land vehicles and metro vehicles, other than cars or lorries; electrical traction equipment, namely traction inverters, traction converters, static inverters, converters for main and auxiliary drives and voltage converters, traction collectors and pantographs, being parts of trams, auxiliary power units, auxiliary power supplies (aps), bms battery management systems, battery chargers and accumulator chargers for land vehicles and metro vehicles, other than cars or lorries; diesel-electric aggregates (generators), super-capacitors, traction batteries, electronic ticketing systems for transport systems; traction batteries for land, rail and electric metro carriages; electro-dynamic apparatus for the remote control of railway points; railway traffic safety appliances; measuring, detecting and monitoring apparatus, indicators and control apparatus for public means of transport, other than cars or lorries; electrical control circuits; electric and electronic security apparatus and instruments; electrical control devices for energy management (electrical control circuits); levelling instruments; measuring, detecting and monitoring apparatus, indicators and regulators, other than for cars or lorries; weighing machines; electrical equipment for means of transport by land or underground,

other than for cars or lorries, electrical traction equipment, being converters for main and auxiliary drives and voltage inverters, electrical and electronic information, control, checking and diagnostic equipment for means of transport by land or underground, other than for cars or lorries, batteries and battery chargers for land vehicles and underground vehicles, other than for cars or lorries; chargers for electric batteries; accelerometers; ammeters; automatic steering apparatus for vehicles, other than cars or lorries; autonomous driving control systems for vehicles; automatic ticket dispensing machines; mileage recorders for vehicles; power distribution apparatus (electricity generating equipment); electric power distribution apparatus; electricity mains apparatus; apparatus and instruments for controlling electricity; apparatus and instruments for accumulating and storing electricity; electricity storage apparatus; switchgear [electric]; electricity conduits; electric power controllers; process controlling apparatus [electronic]; switchboards; power distributing boxes; regulating apparatus, electric; relays; transformers of all kinds, reactors, contact breakers, switches, telerupters, electric converters, switches, electric, isolating switches, splitters; electrical machinery, electrical apparatus; endurance testing machines; central processing units; voltage surge protectors; radiology screens for industrial purposes; detectors; dosimeters; electrolyzers; galvanometers; electric loss indicators; printed circuit boards; integrated circuits; circuit breakers, mains chargers, fuses; connectors [electricity]; connections for electric lines; protective masks; bullet-proof clothing; radar apparatus; X-ray apparatus not for medical purposes; illuminated signs; coils, electric; galvanic cells, solar batteries; decompression chambers; life saving apparatus and equipment; batteries, electric; photovoltaic installations for generating electricity [photovoltaic power plants]; gauges, measuring rulers, go/no-go gauges, tooling plates, tooling prisms, vibrating plates, scribing apparatus, scribing apparatus, measuring and testing apparatus, levels [instruments for determining the horizontal]; fire-extinguishing apparatus; weighing machines; electrolyzers; testing machines; sensors.

10 – Surgical, medical, dental and veterinary apparatus and instruments, artificial limbs, eyes and teeth; orthopedic articles; suture materials; aerosol dispensers for medical purposes; acupuncture needles; apparatus for use in medical analysis; apparatus for artificial respiration; apparatus and installations for the production of x-rays, for medical purposes; apparatus, devices and articles for nursing infants; apparatus for the treatment of deafness; rehabilitation apparatus (body -) for medical purposes; microdermabrasion apparatus; instrument cases for use by surgeons and doctors; respirators for artificial respiration; basins for medical purposes; receptacles for applying medicines; teething rings; blood testing apparatus; sphygmomanometers; hernia bandages; artificial breasts; incuba-



tors for medical purposes; surgical apparatus and instruments; thread, surgical; surgical implants [artificial materials]; surgical cutlery; suture needles; sponges (surgical -); mirrors for surgeons; defibrillators; bougies [surgery]; diagnostic apparatus for medical purposes; dialyzers; drainage tubes for medical use; insufflators; ice bags for medical purposes; bandages, elastic; electric acupuncture instruments; electrodes for medical use; electrocardiographs; tips for crutches for invalids; finger guards for medical purposes; feeding bottle teats; dental burs; galvanic belts for medical purposes; galvanic therapeutic appliances; gastroscopes; uterine syringes; cattle (obstetric apparatus for -); obstetric apparatus; forceps; hearing protectors; physiotherapy apparatus; body cavities (appliances for washing -); plaster bandages for orthopedic purposes; belts, electric, for medical purposes; belts for medical purposes; belts for orthopaedic purposes; hair prostheses; hematimeters; gloves for medical purposes; urinals [vessels]; urethral probes; urethral syringes; invalids' hoists; blankets, electric, for medical purposes; pads (heating -), electric, for medical purposes; hot air vibrators for medical purposes; heart pacemakers; hearing aids for the deaf; hearing aids; corsets for medical purposes; corn knives; injection syringes; inhalers; medical syringes; incubators for babies; douche bags; enema apparatus for medical purposes; cannulae; castrating pincers; catgut; catheters; cushions for medical purposes; pads [pouches] for preventing pressure sores on patient bodies; cases fitted for use by surgeons and doctors; compressors [surgical]; soporific pillows for insomnia; stockings for varices; ambulance stretchers; draw-sheets for sick beds; crutches; artificial eyes; artificial skin for surgical purposes; artificial jaws; lenses [intraocular prostheses] for surgical implantation; artificial teeth; lamps for medical purposes; lancets; lasers for medical purposes; abdominal belts; abdominal corsets; air pillows for medical purposes; air pillows for medical purposes; air mattresses, for medical purposes; masks for use by medical personnel; massage apparatus; esthetic massage apparatus; gloves for massage; childbirth mattresses; medical apparatus and instruments; medical guidewires; physical exercise apparatus, for medical purposes; spoons for administering medicine; surgical knives; breast pumps; umbilical belts; commode chairs; needles for medical purposes; anaesthetic apparatus; anaesthetic masks; contraceptive devices; ear picks; ear plugs [ear protection devices]; clothing especially for operating rooms; operating tables; surgical drapes; ophthalmometers; ophthalmoscopes; arch supports for footwear; bandages for joints, anatomical; knee bandages, orthopedic; orthotic footwear; orthotic inserts for footwear; pessaries; balling guns; condoms; artificial limbs; pulse meters; pumps for medical purposes; quartz lamps for medical purposes; radiological apparatus for medical purposes; fumigation apparatus for medical purposes; x-ray apparatus for medical purposes; x-ray tubes for medi-

cal purposes; radiology screens for medical purposes; radium tubes for medical purposes; saws for surgical purposes; feeding bottle receptacles; feeding bottle valves; scissors for surgery; surgical splints; slings [supporting bandages]; teats; cupping glasses; supports for flat feet; protection devices against x-rays, for medical purposes; armchairs for medical or dental purposes; love dolls [sex dolls]; scalpels; probes for medical purposes; containers especially made for medical waste; beds, specially made for medical purposes; cases fitted for medical instruments; furniture especially made for medical purposes; spirometers [medical apparatus]; syringes for medical purposes; spittoons for medical purposes; bed pans; stents; sterile sheets, surgical; stethoscopes; boots for medical purposes; radiotherapy apparatus; traction apparatus for medical purposes; elastic stockings for surgical purposes; hypodermic syringes; suspensory bandages; hot air therapeutic apparatus; thermal packs for first aid purposes; thermometers for medical purposes; stretchers, wheeled; trocars; dropper bottles for medical purposes; drop counting phials for medical purposes; filters for ultraviolet rays, for medical purposes; ultraviolet ray lamps for medical purposes; maternity belts; incontinence sheets; hypogastric belts; abdominal pads; urological apparatus and instruments; vaginal syringes; sprayers for medical purposes; veterinary apparatus and instruments; bed vibrators; vibromassage apparatus; compresses (thermo-electric -) [surgery]; hydrostatic [water] beds for medical purposes; water bags for medical purposes; resuscitation apparatus; brushes for cleaning body cavities; surgical staples; dental apparatus and instruments; dental apparatus, electric; mirrors for dentists; dental examination chairs; dentures; dental braces; pins for artificial teeth; tongue scrapers; strait jackets; anti-rheumatism bracelets; anti-rheumatism rings; bracelets for medical purposes.

11 – Apparatus for lighting, heating (other than for cars or lorries), steam generating, cooking, refrigerating, drying, ventilating, water supply and sanitary purposes; flare stacks for use in the oil industry; air valves for steam heating installations; sinks; sewage purification installations; exhaust hoods for kitchens; brackets for gas burners; igniters; hot air bath fittings; hydromassage bath apparatus; apparatus for the dehydration of foodstuffs; furnace ash boxes; ash conveyor installations, automatic; expansion tanks for central heating installations; watering installations, automatic; acetylene burners; acetylene generators; acetylene flares; heaters, electric, for feeding bottles; baking ovens; bath fittings; heaters for baths; bathtubs; bath linings; bath installations; barbecues; aquarium lights; lighting installations for air vehicles; lighting apparatus and installations, other than for cars or lorries; lighting equipment for means of transport, other than cars or lorries; leds (lighting), other than for cars or lorries; lamps, other than for cars or lorries;

ventilation hoods; ventilation hoods for laboratories; warming pans; watering machines for agricultural purposes; bidets; anti-dazzle devices for vehicles, other than cars or lorries; searchlights; arc lamps; tanning apparatus [sun beds]; burners; germicidal burners; furnaces, other than for laboratory use; bread-making machines; bread baking machines; toasters; swimming pool chlorinating apparatus; electric lights for Christmas trees; chromatography apparatus for industrial purposes; pressure cookers [autoclaves], electric; steam generating installations; steam boilers, other than parts of machines; steamers (fabric -); steam accumulators; ceiling lights; dental ovens; disinfectant apparatus; disinfectant dispensers for toilets; deodorising apparatus, not for personal use; distillation apparatus; distillation columns; distillation apparatus; fruit roasters; roasting jacks; pressure water tanks; showers; shower stalls; heaters for heating irons; ice machines and apparatus; refrigerators; electrically heated carpets; heating filaments, electric; fans (electric -) for personal use; kettles, electric; discharge tubes, electric, for lighting; flares; bicycle lights; sockets for electric lights; forges, portable; flues for heating boilers; filters [parts of household or industrial installations]; aquarium filtration apparatus; curling lamps; deep fryers, electric; kiln furniture [supports]; filling equipment for industrial furnaces; forage drying apparatus; footmuffs, electrically heated; footwarmers, electric or non-electric; friction lighters for igniting gas; gas lighters; gas burners; gas boilers; gas condensers, other than parts of machines; gas lamps; gas scrubbing apparatus; gas scrubbers [parts of gas installations]; freezers; steam facial apparatus [saunas]; beverage cooling apparatus; electric light bulbs, other than for cars or lorries; filaments for electric lamps; roasting devices; barbecues; roasting spits; miners' lamps; hair driers; taps [faucets]; hand drying apparatus for washrooms; luminous house numbers; blankets, electric, not for medical purposes; heating apparatus, electric; aquarium heaters; heating apparatus for solid, liquid or gaseous fuels; furnace boilers; boilers, other than parts of machines; heating cushions [pads], electric, not for medical purposes; heating elements, other than for cars or lorries; radiator caps; hot air ovens; heating plates; radiators [heating]; apparatus for heating; apparatus for heating, heating equipment, other than for cars or lorries; hydrants; ionization apparatus for the treatment of air or water; electric appliances for making yogurt; electric coffee filters; electric coffeepots; electric coffee percolators; coffee roasters; nuclear reactors; air conditioning installations; air-conditioning installations for vehicles, other than for cars or lorries; oxyhydrogen burners; cooking apparatus and installations; kilns; cookers; cooking hobs; carbon for arc lamps; chandeliers; kitchen ranges; cooling installations for liquids; cooling installations for tobacco; cooling installations and machines; refrigerating cabinets; refrigerating appliances and installations; refrigerating containers; coolers for

furnaces; cold storage rooms; refrigerating display cabinets [display cases]; laboratory burners; laboratory lamps; electric lamps; light bulbs for directional signals for vehicles, other than for cars or lorries; burners for lamps; lamp casings; lamp casings; lamp globes; lamp chimneys; lamp shades; lampshade holders; chinese lanterns; lanterns for lighting; lava rocks for use in barbecue grills; glue-heating appliances; water-pipes for sanitary installations; luminous tubes for lighting; light diffusers; humidifiers for central heating radiators; air deodorising apparatus; air heating apparatus; filters for air conditioning; air filtering installations; air cooling apparatus; air purifying apparatus and machines; germicidal lamps for purifying air; spa baths [vessels]; air sterilisers; air driers; ventilation [air-conditioning] installations and apparatus; magnesium filaments for lighting; malt roasters; sea water desalination plants; microwave ovens; microwave ovens for industrial purposes; milk cooling installations; mixer taps for water pipes; anti-splash tap nozzles; level controlling valves in tanks; stoves [heating apparatus]; framework of metal for ovens; fittings, shaped, for ovens; oven fittings made of fireclay; fire bars; oil burners; oil lamps; oil-scrubbing apparatus; pasteurisers; gas burners; polymerisation installations; projector lamps; radiators, electric; refining towers for distillation; fumigation apparatus, not for medical purposes; dampers [heating]; chimney flues; lamp reflectors, other than for cars or lorries; regulating and safety accessories for gas pipes; regulating and safety accessories for gas apparatus; regulating and safety accessories for water apparatus; regulating accessories for water or gas apparatus and pipes; clean chambers [sanitary installations]; boiler pipes [tubes] for heating installations; taps [cocks, spigots] [faucets (am.)] for pipes; coils [parts of distilling, heating or cooling installations]; roasters; sanitary apparatus and installations; sauna bath installations; heating equipment for defrosting vehicle windows, other than for cars or lorries; electric pressure cooking saucepans; chimney blowers; safety lamps; safety accessories for water or gas apparatus and pipes; bath tubs for sitz baths; solar furnaces; feeding apparatus for heating boilers; alcohol burners; fountains; street lamps; sterilisers; stoves [heating apparatus]; tobacco roasters; electric torches; pocket warmers; diving lights; immersion heaters; hotplates; solar thermal collectors [heating]; valves (thermostatic -) [parts of heating installations]; refrigerating appliances and installations; water closets; toilet bowls; toilet seats; flushing apparatus; turkish bath cabinets, portable; toilets, portable; filters for drinking water; drying installations; drying apparatus and installations; drying apparatus; drip irrigation emitters [irrigation fittings]; ultraviolet ray lamps, not for medical purposes; washers for water taps; urinals [sanitary fixtures]; fans, other than for cars or lorries; heat pumps; heat regenerators; heat accumulators; hot water bottles; hot plates; water heaters [apparatus]; hot water heating installations; bathroom sinks; laun-

dry room boilers; laundry dryers, electric; water softening installations; water filtering installations; flushing tanks; water cooling installations; water conduits installations; water purifying installations; water purifying apparatus and machines; water sterilizers; water supply installations; water distribution installations; water intake apparatus; whirlpool-jet apparatus; central heating radiators; decorative water fountains; fireplaces, domestic; bicycle lights; spirit stoves, alcohol burners, petroleum stoves, petrol stoves; industrial furnaces; purification installations for sewage (wastewater); refuse incineration plant; air cleaning apparatus; air circulators; nuclear power plant installations; nuclear cogeneration plants; processing installations for fuel and nuclear moderating material; processing installations for fuel and nuclear moderating material; nuclear reactors; nuclear generators; pressure water tanks; safety accessories for water or gas apparatus and pipes; water cooling installations; heat exchangers, other than parts of machines; catalytic oxidation machinery and equipment for checking atmospheric pollution in industrial environments; thermal oxidizers for industrial air pollution control. autoclaves; spigots; spigots.

12 – Apparatus for locomotion by land, water or air, other than passenger vehicles or lorries, apparatus for locomotion below ground, parts, accessories and components of all kinds therefor; means of transport of all kinds, other than cars or lorries, parts, accessories and components therefor, other than for cars or lorries; streetcars, in particular trams, buses, trolley buses and carriages for underground railways; rail vehicles, in particular trains, locomotives, train passenger carriages, power units, engine carriages and units (diesel), parts, components and accessories therefor; motor vehicles of all kinds, in particular tractors and accessories and components therefor, other than cars or lorries; aeroplanes; ships, boat and ship engines and components therefor, bridges; electrically powered vehicles, other than cars or lorries, and accessories and components therefor, being trolley buses, electric buses; electrically powered special vehicles / utility vehicles, other than cars or lorries; battery powered buses; zero-emission vehicles, being buses with fuel cells (zero-emission buses), electrically powered mining vehicles, hybrid vehicles, other than cars or lorries, parts, components and accessories therefor; traction engines of all kinds and electrical traction equipment for means of transport by land, underground or rail; electrical traction equipment for electric means of transport of all kinds, namely traction inverters for means of transport; traction converters for main and auxiliary drives and voltage converters for land vehicles, metro carriages, trolleybuses and railway rolling stock of all kinds; transport traction engines of all kinds; traction inverters for means of transport; converters for main and auxiliary drives and voltage converters for land vehicles, metro carria-

ges and railway rolling stock of all kinds; electric motors for means of transport of all kinds; pedal bicycles; structural parts of bicycles; frames for bicycles, cycles; fork crown covers [bicycle parts]; brakes for bicycles, cycles; wheels for bicycles, cycles; disc brakes for land vehicles, other than cars or lorries; forks [bicycle parts]; handle bars for bicycles, cycles; brake segments for vehicles; brake cables for bicycles; bells for bicycles, cycles; tubeless tires [tyres] for bicycles, cycles; bicycle tires [tyres]; inner tubes for bicycles, cycles; casings for pneumatic tires [tyres]; tyre repair outfits; patches for inner tubes of tyres; pumps for bicycles, cycles; rims for wheels of bicycles, cycles; wheel hubs; spoke clips for wheels; pedals for cycles; chains for bicycles, cycles; bicycle gears; lever speed transmissions for land vehicles, other than cars or lorries; motorcycle engines; bicycle stands; bicycle stabilisers; side view mirrors for vehicles, other than cars or lorries; trailers for transporting bicycles; child carrying seats for use in vehicles; anti-theft devices for vehicles; bicycle carriers; luggage nets for vehicles; baskets adapted for bicycles; saddlebags adapted for bicycles; water bottle cages for bicycles; cycle saddles; covers for bicycle saddles; drive trains [bicycle parts]; handle bar stems [bicycle parts]; special vehicles, being fork lift trucks or loading trucks, lift trucks, sprinkling vehicles, hose carts, refrigerated vehicles, vehicles adapted for military purposes, other than cars or lorries, tilting-carts, snowmobiles (snow vehicles), remote control vehicles, other than toys, other than passenger vehicles or lorries, axles for vehicles, other than passenger vehicles or lorries; sleeping cars, gear boxes for land vehicles, other than cars or lorries; bodies for vehicles, other than passenger vehicles or lorries; torque converters for land vehicles, other than passenger vehicles or lorries, tankers, cable car cabins, cleaning trolleys, water vehicles, air cushion vehicles, wheels for land vehicles, other than cars or lorries, vehicle chassis, other than for cars or lorries; doors for means of transport, other than cars or lorries; vehicle seats, other than cars or lorries; upholstery for vehicles other than cars or lorries; wheels, axles, bands for wheel hubs, brakes, other than for cars or lorries, silencers, other than for cars or lorries, disc brakes, other than for cars or lorries; electrical equipment for vehicles, in particular railway rolling stock; armoured vehicles.

13 – Firearms; ammunition and projectiles; explosives; fireworks; nitrate of ammonia explosives; apparatus for filling cartridge belts; cannons; acetyl nitrocellulose; ballistic missiles; bengal lights; lead shot for hunting; dynamite; side arms [firearms]; gun carriages [artillery]; trigger guards for rifles; gun cases; hammers for guns; rifle barrels; gunstocks; shells [projectiles]; hand grenades; guns (harpoon -) [weapons]; cannons; rifles; firecrackers; trunnions for heavy weapons; air pistols [weapons]; fuses for explosives; machine guns; mines [explosives]; mortars [fire-

arms]; ammunition; firearms (ammunition for -); automatic firearm ammunition belts; belts adapted for ammunition; fog signals, explosive; tanks [weapons]; cartridges; cartridges; cartridge loading apparatus; cartridge pouches; pistols [arms]; projectiles [weapons]; powder horns; pyrophoric substances; pyrotechnic products; rockets [projectiles]; rocket launchers; revolvers; cleaning brushes for firearms; silencers for guns; gun cotton; firing platforms; gunpowder; bandoliers for weapons; hunting firearms; sprays for personal defence purposes; signal rockets; detonating plugs; explosive cartridges; torpedoes; tear gas weapons; breeches of firearms; firearm sights; motorized weapons; primings [fuses]; guns (sighting mirrors for -); sights, other than telescopic sights, for guns [artillery]; sights, other than telescopic sights, for firearms; detonating caps, other than toys; primings [fuses]; fuses for explosives, for use in mines; firing lanyards for explosives.

14 – Precious metals and imitations thereof; jewellery, precious stones; horological and chronometric instruments; badges of precious metal; agates; amulets [jewellery, jewelry (Am.)]; anchors [clock- and watchmaking]; pins being jewelry; bracelets [jewellery, jewelry (Am.)]; wristwatches; atomic clocks; ingots of precious metals; jewelry of yellow amber; brooches [jewellery]; busts of precious metal; chronographs [watches]; chronoscopes; chronoscopes; cloisonné jewellery; diamonds; threads of precious metals; precious metals, unwrought or semi-wrought; precious stones; clocks and watches, electric; ivory [jewellery, jewelry (Am.)]; barrels [clock- and watchmaking]; figurines of precious metal; jet, unwrought or semi-wrought; ornaments of jet; gold, unwrought or beaten; gold thread [jewellery]; semi-precious stones; necklaces [jewellery]; hat jewellery; iridium; boxes of precious metal; chains [jewelry]; tie bars; tie pins; works of art of precious metal; copper tokens; alloys of precious metal; cuff links; medals; locket [jewellery]; coins; earrings; olivine [gems]; osmium; palladium; pearls made of ambroid [pressed amber]; beads for making jewelry; pearls [jewellery]; platinum [metal]; rhodium; rings [jewellery, jewelry (Am.)]; ruthenium; key rings [trinkets or fobs]; jewel cases; ornamental pins; ornaments [jewellery, jewelry (Am.)]; jewels; shoe jewellery; silver, unwrought or beaten; silver thread; spun silver [silver wire]; sundials; spinel [precious stones]; statues of precious metal; stopwatches; paste jewellery [costume jewelry (Am.)]; watches; clocks; watch bands; cases for clock- and watchmaking; clock cases; watch cases; pendulums [clock- and watchmaking]; cases for watches [presentation]; watch springs; watch glasses; watch fobs; pendants; movements for clocks and watches; clock hands; alarm clocks; clockworks; time instruments; control clocks [master clocks]; dials (clock and watchmaking); chaplets.

15 – Musical instruments; accordions; bamboo flutes; bandonions; basses [musical instruments]; cymbals; bellows for musical instruments; bows for musical instruments; bow nuts for musical instruments; horsehair for bows for musical instruments; sticks for bows for musical instruments; buccins [trumpets]; clarions; dampers for musical instruments; catgut for musical instruments; barrel organs; bagpipes; electronic musical instruments; flutes; cases for musical instruments; violins; guitars; chimes [musical instruments]; gongs; harps; harp strings; harmonicas; harmoniums; horns [musical instruments]; huqin [chinese violins]; castanets; chin rests for violins; clarionets; piano keyboards; keyboards for musical instruments; piano strings; piano keys; pianos; double basses; concertinas; lyres; perforated music rolls; mandolins; jews' harps [musical instruments]; mouthpieces for musical instruments; music synthesizers; music rolls [piano]; stands for musical instruments; turning apparatus for sheet music; music stands; oboes; ocarinas; organs; kettledrum frames; pedals for musical instruments; pianos; pipa [chinese guitars]; horns [musical instruments]; guitar picks; trombones; reeds; strings for musical instruments; stringed musical instruments; saxophones; handbells [musical instruments]; hats with bells [musical instruments]; sheng [chinese musical wind instruments]; musical boxes; bridges for musical instruments; tuning forks; tuning hammers; suona [chinese trumpets]; conductors' batons; tomtoms; tambourines; keys for musical instruments; intensity regulators for mechanical pianos; triangles [musical instruments]; skins for drums; drums [musical instruments]; kettledrums; drumsticks; trumpets; valves for musical instruments; violas; wind pipes for organs; pegs for musical instruments; xylophones; zithers.

16 – Paper and cardboard; printed matter; bookbinding material; photographs; stationery and office requisites (except furniture); adhesives for stationery or household purposes; artists' and drawing materials; paint brushes; teaching materials [except apparatus]; plastic sheets, film and bags for wrapping and packaging; printers' type printing blocks; stationery; typewriters and office requisites (except furniture); instructional and teaching material (except apparatus); plastic materials for packaging (not included in other classes); printers' type; printing blocks; garbage bags of paper or of plastics; napkins of paper for removing make-up; rub down transfers; address plates for addressing machines; address stamps; addressing machines; folders for papers; document files [stationery]; scrapbooks; almanacs; moisteners [office requisites]; announcement cards [stationery]; document laminators for office use; aquarelles; architectural models; calculating tables; wristbands for the retention of writing instruments; atlases; stickers [stationery]; money clips; moisteners [office requisites]; stationery (cabinets for -) [office requisites]; mats for beer glasses;

paintings; paintings [pictures], framed or unframed; biological samples for use in microscopy [teaching materials]; blueprints; pencils; pencil holders; pencil leads; pencil sharpeners; pencil sharpening machines, electric or non-electric; pads [stationery]; pamphlets; paperweights; letter trays; stamps; notepaper; book-binding material; bookbinding cords; bookbinding apparatus and machines [office equipment]; cloth for bookbinding; fabrics for bookbinding; bookbindings; bookends; office requisites; paper clasps; comic books; diagrams; document holders [stationery]; printers' reglets; electrotypes; printing blocks; inking sheets for document reproducing machines; inking sheets for duplicators; printers' blankets, not of textile; printing type; printers' type; covers [stationery]; tickets; labels of paper or cardboard; stencil cases; flags of paper; folders [stationery]; binding strips [bookbinding]; ink ribbons; inking ribbons for computer printers; typewriter ribbons; spools for inking ribbons; chromos; watercolor saucers (artists' -); paint boxes [articles for use in school]; paint trays; penholders; pen clips; pencil cases; pens [office requisites]; pen wipers; humidity control sheets of paper or plastic for foodstuff packaging; figurines [statuettes] of papier mâché; filter paper; finger-stalls [office requisites]; isinglass for stationery or household purposes; bottle wrappers of cardboard or paper; bottle wrappers of cardboard or paper; correcting fluids [office requisites]; newsletters; plastic film for wrapping; sheets of reclaimed cellulose for wrapping; modelling clays (moulds for -) [artists' materials]; forms, printed; photographs [printed]; photo-engravings; postage meters for office use; fountain pens; trays for sorting and counting money; geographical maps; song books; terrestrial globes; greeting cards; graphic prints; graphic reproductions; etching needles; engraving plates; engravings; pastes and other adhesives for stationery or household purposes; elastic bands for offices; gummed tape [stationery]; gummed cloth for stationery purposes; stands for pens and pencils; manuals [handbooks]; hand labelling appliances; hand-rests for painters; stapling presses [office requisites]; hectographs; histological sections for teaching purposes; wood pulp paper; wood pulp board [stationery]; envelopes [stationery]; hat boxes of cardboard; paper coffee filters; calendars; coasters of paper; file cards; maps; tags for index cards; cardboard tubes; catalogues; self-adhesive tapes for stationery or household purposes; apparatus for mounting photographs; pastes and other adhesives for stationery or household purposes; adhesive bands for stationery or household purposes; dispensers (adhesive tape -) [office requisites]; clipboards; bags for microwave cooking; carbon paper; copying paper [stationery]; correcting tapes [office requisites]; correcting ink [heliography]; credit card imprinters, non-electric; chalk for lithography; chalk holders; balls for ball-point pens; french curves; bibs of paper; teaching materials [except apparatus]; pastes and other adhesives for sta-

tionery or household purposes; bookmarks; steel letters; luminous paper; lithographs; lithographic works of art; lithographic stones; office hole punches; perforated cards for jacquard looms; punches [office requisites]; blotting paper; loose-leaf binders; plastic bubble packs for wrapping or packaging; artists' brushes; canvas for painting; palettes for painters; house painters' rollers; painters' easels; marking chalk; highlighting markers; graining combs; stencils; pencil lead holders; modelling paste; modelling materials; plastics for modelling; modelling clay; modelling wax, not for dental purposes; musical greeting cards; sketch pads; numbering apparatus; oleographs; file sorters [office requisites]; pantographs [drawing instruments]; paper; electrocardiograph paper; paper for recording machines; stationery; paper tapes and cards for the recordal of computer programmes; paper tapes; paper sheets [stationery]; filtering materials [paper]; face towels of paper; towels of paper; papier mâché; flower-pot covers of paper; letter-openers; paper bows; paper towels; handkerchiefs of paper; conical paper bags; paperboard; painting pencils; tracing paper; tracing cloth; tracing paper; parchment paper; seals [stamps]; posters; placards of paper or cardboard; advertisement boards of paper or cardboard; plastic cling film, extensible, for palletization; paper doilies; portraits; postcards; prospectuses; erasing products; rubber erasers; scrapers [erasers] for offices; erasing shields; etchings; paper for radiograms; ledgers [books]; passport cases; drawing boards; drawing pens; tracing needles for drawing purposes; push pins; t-squares for drawing; newsletters; indexes; cream containers of paper; trading cards other than for games; absorbent sheets of paper or plastic for foodstuff packaging; stencils [stationery]; boxes of cardboard or paper; checkbook covers; slate pencils; writing slates; signboards of paper or cardboard; shields [paper seals]; tailors' chalk; manifolds [stationery]; patterns for dressmaking; patterns for making clothes; drawer liners of paper, perfumed or not; nibs; nibs of gold; pen sets; writing instruments; writing or drawing books; writing chalk; writing portfolios; typewriters, electric or non-electric; typewriter keys; rollers for typewriters; writing cases [sets]; writing brushes; blotters; printed publications; stencil plates; handwriting specimens for copying; school supplies [stationery]; self-adhesive tapes for stationery or household purposes; composing frames [printing]; galley racks [printing]; sealing wax; sealing machines for offices; sealing compounds for stationery purposes; sealing wafers; stamps [seals]; silver paper; steel pens; photograph stands; starch paste [adhesive] for stationery or household purposes; steatite [tailor's chalk]; holders for stamps [seals]; cases for stamps [seals]; stamp pads; stamp pads; stamp stands; prints [engravings]; embroidery designs [patterns]; ink; inkwells; inkstones; ink sticks; tablecloths of paper; table linen of paper; toilet paper; printing sets, portable [office requisites]; transparencies [stationery]; indian

inks; envelope sealing machines, for offices; place mats of paper; bags [envelopes, pouches] of paper or plastics, for packaging; cardboard articles; packaging material made of starches; wrapping paper; duplicators; mimeograph apparatus and machines; rulers; vignetting apparatus; viscose sheets for wrapping; waxed paper; blackboards; composing sticks; writing board erasers; drawing materials; sketchbooks; drawing sets; drawing instruments; charcoal pencils; squares for drawing; drawing squares; chart pointers, non-electronic; printed tables; paper shredders for office use; staples for offices; numbers [type]; cigar bands; compasses for drawing; disposable sterilization pouches.

17 – Unprocessed and semi-processed rubber, gutta-percha, gum, mica and substitutes for all these materials; plastics and resins in extruded form for use in manufacture; packing, stopping and insulating materials; flexible pipes, tubes and hoses, not of metal; rubber, gutta-percha, gum, asbestos, mica and goods made from these materials, not included in other classes, other than passenger vehicles or lorries; plastics in extruded form for use in manufacture, other than for cars or lorries; packing, stopping and insulating materials, other than for cars or lorries; flexible pipes, not of metal; acrylic resins [semi-finished products]; high pressure pipe fittings not of metal, other than for cars or lorries; balata; bark coverings for sound insulation; cotton wool for packing [caulking]; anti-dazzle films for windows (tinted films), other than for cars or lorries; flower arrangements (foam supports for -) [semi-finished products]; packing, other than for cars or lorries; expansion joint fillers, other than for cars or lorries; packing materials, other than for cars or lorries; sealing rings, other than for cars or lorries; door or window seals, other than for cars or lorries; dielectrics [insulators]; elastic yarns, not for use in textiles; substances for insulating buildings against moisture; insulating refractory materials, other than for cars or lorries; synthetic filtration substances or semi-processed foams, other than for cars of lorries; foil of regenerated cellulose, other than for packing; molds (ebonite -); insulating mastics and sealants, other than for cars or lorries; watering hose; fibreglass fabrics for insulation; fibreglass for insulation; glass wool for insulation; mica, raw or partly processed; raw or partly-processed rubber, other than for cars or lorries; threads of rubber, not for use in textiles; valves of rubber, other than for cars or lorries; rubber solutions; casings of rubber for the protection of parts of machines, other than for cars or lorries; stops of rubber; shock absorbers of rubber, other than for cars or lorries; rings of rubber, other than for cars or lorries; cords of rubber; rubber stoppers; materials for affixing brakes, being semi-finished products, other than for cars or lorries; ebonite [vulcanite]; electrical conductance insulators, other than for cars or lorries; insulators for railway tracks; insulating materials, other than for cars

or lorries; insulating paints, other than for cars or lorries; insulating tapes, other than for cars or lorries; insulating felt, other than for cars or lorries; insulating varnish; insulating foils of metal, other than for cars or lorries; insulating materials; insulating gloves; insulators; insulators for cables; transformers (insulating oil for -); insulating oils, other than for cars or lorries; insulating paper; insulating plaster; liquid rubber; adhesive bands, other than stationery and not for medical or household purposes; carbon fibres, other than for cars or lorries; artificial resins (semi-processed products), other than for cars or lorries; semi-processed plastic substances, other than for cars or lorries; threads of plastic materials, not for textile use, other than for cars or lorries; plastic sheet, other than for wrapping, other than for cars or lorries; plastic sheeting for agricultural purposes; threads of plastic materials, not for textile use; clutch linings, other than for cars or lorries; latex [rubber]; chemical compositions for repairing leaks; canvas hose pipes, other than for cars or lorries; reinforcing materials for pipes, other than for cars or lorries; joint packings for pipes, other than for cars or lorries; mineral wool (insulator), other than for cars or lorries; compositions to prevent the radiation of heat; boiler composition to prevent the radiation of heat; paper for electrical capacitors, other than for cars or lorries; stuffing of rubber or plastic; sealing materials of rubber or plastics, other than for cars or lorries; pipe jackets, not of metal, other than for cars or lorries; junctions, not of metal, for pipes, other than for cars or lorries; sound insulation materials, other than for cars or lorries; wool (slag -) [insulator]; hoses of textile material; flexible hoses, not of metal, other than for cars or lorries; soldering threads of plastic, other than for cars or lorries; floating anti-pollution barriers, other than for cars or lorries; self-adhesive tapes, other than stationery and not for medical or household purposes; asbestos safety curtains; synthetic rubber, other than for cars or lorries; washers of rubber or vulcanised fibres, other than for cars or lorries; valves of india rubber or vulcanised fibre, other than for cars or lorries; bags [envelopes, pouches] of rubber, for packaging; viscose sheets, other than for wrapping, other than for cars or lorries; vulcanized fiber [fibre]; materials for retaining heat, other than for cars or lorries; seals, other than for cars or lorries; cellulose acetate, semi-processed; cylinder gaskets, other than for cars or lorries; adhesive tape for industrial purposes.

18 – Leather and imitations of leather, and goods made of these materials, not included in other classes, other than for cars or lorries; animal skins, hides, other than for cars or lorries; trunks and travelling bags; umbrellas and parasols; walking sticks; whips, harness and saddlery; diplomatic bags; pouch baby carriers; slings for carrying infants; beach bags; clothing for pets; alpenstocks; harness fittings; wallets; bags for campers; kid (leather), other than for cars or

lorries; attaché cases; boxes of leather or leather board; net bags for shopping, other than for cars or lorries; shopping bags; casings of leather for springs, other than for cars or lorries; covers of fur, other than for cars or lorries; umbrella or parasol ribs; satchels; bits for animals [harness]; purses; animal harnesses; skin (goldbeaters' -); parts of rubber for stirrups; collars for animals; suitcases; small suitcases; suitcase handles, other than for cars or lorries; handbags; handbag frames; skins of slaughtered animals, other than for cars or lorries; curried skins, other than for cars or lorries; horseshoes; hat boxes of leather; game bags [hunting accessories]; card cases [notecases]; cases, of leather or leatherboard; boxes of vulcanised fibre; chain mesh purses; chin straps, of leather; garment bags for travel; cat o' nine tails; knee-pads for horses; vanity cases, not fitted; leather, unworked or semi-worked, other than for cars or lorries; leather leads; straps (leather -); imitation leather, other than for cars or lorries; dog leashes; leatherboard; straps of leather [saddlery]; leather straps; leather laces; valves of leather; straps for soldiers' equipment; muzzles; leather trimmings for furniture; furniture coverings of leather; moleskin (imitation of leather), other than for cars or lorries; music cases; whips; fur (animal skins), other than for cars or lorries; horse blankets; headstalls; horse collars; umbrellas; umbrella handles; travel cases; travelling sets [leatherware]; travelling bags; butts [parts of hides]; backpacks; bags for climbers; riding saddles; saddle trees; covers for horse-saddles; fastenings for saddles; saddlery; blinkers [harness]; umbrella covers; frames for umbrellas or parasols; umbrella rings; umbrella sticks; straps for skates; key cases; book bags; leather shoulder belts; walking stick seats; parasols; duffel bags; stirrups; leathers (stirrup —); walking sticks; cane handles; trolley duffels; leather, other than for cars or lorries; haversacks; bridoons; covers for horse saddles; pouches, of leather, for packaging; tool bags, empty; harness straps; reins; horse bridles; traces [harness]; rucksacks, chest pouches, travelling bags, money belts, kitbags.

19 – Building materials (non-metallic); non-metallic rigid pipes for building; asphalt, pitch and bitumen; non-metallic transportable buildings; monuments, not of metal; gutter pipes, not of metal; bicycle parking installations, not of metal; branching pipes, not of metal; alabaster; alabaster glass; aquaria [structures]; aquarium gravel; aquarium sand; reinforcing materials, not of metal, for building; asbestos mortar; asbestos cement; asphalt; asphalt paving; blinds [outdoor], not of metal and not of textile; cabanas not of metal; beacons, not of metal, non-luminous; non-metal beams; huts; felt for building; building glass; building timber; building materials, not of metal; building panels, not of metal; building stone; buildings, not of metal; tanks of masonry; quartz; concrete; concrete building elements; shuttering, not of metal, for conc-

rete; binding agents for making stones; bitumen; bituminous products for building; bituminous coatings for roofing; planks [wood for building]; letter boxes of masonry; rubble; busts of stone, concrete or marble; non-metal roof coverings; roofing, not of metal; roofing, not of metal, incorporating solar cells; non-metal roofing tiles; roof gutters, not of metal; scantlings [carpentry]; roofing slates; roofing shingles; mooring bollards, not of metal; stave wood; monuments, not of metal; safety glass; drain pipes, not of metal; penstock pipes, not of metal; railroad ties, not of metal; paint spraying booths, not of metal; non-metal windows; lintels, not of metal; shutters, not of metal; non-metal window frames; window glass, for building; prefabricated houses [kits]; refractory construction materials, not of metal; statuettes of stone, concrete or marble; flyscreens (non-metallic); folding doors, not of metal; bagasses of cane (agglomerated -) [building material]; veneer wood; floors, not of metal; memorial plaques, not of metal; perches; balustrading; geotextiles; scaffolding, not of metal; framework for building, not of metal; non-metal cornices; greenhouses, transportable, not of metal; horticultural frames, not of metal; foundry molds [moulds], not of metal; plaster; gypsum; latticework, not of metal; window glass; glass granules for road marking; plate glass [windows] for building; tombs [monuments], not of metal; grave or tomb enclosures, not of metal; tombs, not of metal; grave slabs, not of metal; tombstones; tombstone stelae, not of metal; granite; blast furnaces (cement for -); manufactured timber; moldable wood; wood, semi-worked; wood for making household utensils; xylolith; veneers; furrings of wood; wood pulp board for building; wood paving; wood panelling; chicken-houses, not of metal; insulating glass [building]; jalousies, not of metal; tiles, not of metal, for building; platforms, prefabricated, not of metal; lime; calcareous marl; calcareous stone; chimney pots, not of metal; chimney cowls, not of metal; flashing, not of metal, for building; angle irons, not of metal; roof flashing, not of metal; potters' clay [raw material]; gravel; stained-glass windows; drain traps [valves], not of metal or plastic; water-pipe valves, not of metal or plastic; cork [compressed]; skating rinks [structures, not of metal]; works of art of stone, concrete or marble; artificial stone; laths, not of metal; arbours [structures not of metal]; duckboards, not of metal; crash barriers, not of metal, for roads; ducts, not of metal, for ventilating and air-conditioning installations; lighting slabs; magnesia cement; macadam; porches, not of metal, for building; fair huts; marble; masts [poles], not of metal; wall claddings, not of metal, for building; mortar for building; mosaics for building; casement windows, not of metal; cement for furnaces; olivine for building; building paper; building cardboard; parquet flooring; parquet floor boards; pitch; palisading, not of metal; paving blocks, not of metal; cement posts; posts, not of metal; advertisement columns, not of metal; cement

slabs; paving slabs, not of metal; tile floorings, not of metal; porphyry [stone]; coatings [building materials]; rocket launching platforms, not of metal; moldings, not of metal, for cornices; raw chalk; sandstone tubes; rigid pipes, not of metal [building]; sand, except foundry sand; silver sand; sandstone for building; manhole covers, not of metal; fireclay; slate; slate powder; reeds for building; slag [building material]; clinker stone; sawn timber; chimneys, not of metal; mantle-pieces; chimney shafts, not of metal; pigsties; sills, not of metal; swimming pools [structures, not of metal]; floating docks, not of metal, for mooring boats; caissons for construction work under water; non-luminous and non-mechanical signs, not of metal; signalling panels, non-luminous and non-mechanical, not of metal; silos, not of metal; hips for roofing; plywood; diving boards, not of metal; pilings, not of metal; stables, not of metal; statues of stone, concrete or marble; stone; fire burrs; coal tar; stonemasonry (works of -); street gutters, not of metal; binding material for road repair; materials for making and coating roads; signs, non-luminous and non-mechanical, not of metal, for roads; road coating materials; road marking sheets and strips of synthetic material; poles, not of metal, for electric power lines; props, not of metal; wall claddings, not of metal, for building; tar; tarred strips, for building; building cardboard [asphalted]; telephone booths, not of metal; telegraph posts, not of metal; terra cotta [building material]; clay; potters' clay; non-metal gates; non-metal beams; non-metallic transportable structures; partitions, not of metal; staircases, not of metal; stair-treads [steps], not of metal; stringers [parts of staircases], not of metal; tufa; non-metal doors; door panels, not of metal; door casings, not of metal; building sheets (non-metallic -); vinyl siding; bird baths [structures, not of metal]; aviaries, not of metal [structures]; wall claddings, not of metal, for building; water-pipes, not of metal; fences, not of metal; cement; fireproof cement coatings; fire burrs; earth for bricks; ceilings, not of metal; mastics, other than for cars or lorries.

20 – Furniture, mirrors, picture frames; containers, not of metal, for storage or transport; unworked or semi-worked bone, horn, whalebone or mother-of-pearl; tortoiseshell; meerschaum; yellow amber; furniture shelves; index cabinets; ambroid plates; ambroid bars; mooring buoys, not of metal; dinner wagons; display boards; trestles [furniture]; stuffed animals; stuffed birds; oyster shells; bamboo; bamboo curtains; benches [furniture]; cable or pipe clips of plastics; reservoirs, not of metal nor of masonry; closures, not of metal, for containers; funerary urns; bed fittings, not of metal; beds; bed frames; bed casters, not of metal; bedding, except linen; beehives; picture frames; flower-stands [furniture]; bolts, not of metal; vats, not of metal; letter boxes, not of metal or masonry; book rests [furniture]; library shelves; sideboards; dinner wagons; office furniture; brush mountings; busts of

wood, wax, plaster or plastic; containers, not of metal [storage, transport]; decorations of plastic for foodstuffs; boxes of wood or plastic; dowels, not of metal; wall plugs, not of metal; ivory, unworked or semi-worked; furniture shelves; hand fans; hand-held flagpoles, not of metal; locks, not of metal, for vehicles; staves of wood; barrels, not of metal; casks, not of metal; taps for casks, not of metal; furniture fittings, not of metal; statuettes of wood, wax, plaster or plastic; whalebone, unworked or semi-worked; fishing baskets; non-metal bottle caps; bottle racks; corks for bottles; bottle casings of wood; non-metal bottle caps; handling pallets, not of metal; hairdressers' chairs; fodder racks; coathooks, not of metal; curtain hooks; curtain holders, not of textile material; curtain rollers; plaited straw, except matting; wooden blinds; plate racks; gun racks; hand-held mirrors [toilet mirrors]; towel closets [furniture]; towel dispensers, fixed, not of metal; crates; house numbers, not of metal, non-luminous; stag antlers; workbenches; wood ribbon; reels of wood for yarn, silk, cord; honeycombs; horn, unworked or semi-worked; covers (garment -) [storage]; kennels; hat stands; kennels for household pets; nameplates, not of metal; interior textile window blinds; indoor window roller blinds (indoor window blinds), other than for cars or lorries; slatted indoor blinds; cable clips, not of metal; fireguards; divans; edgings of plastic for furniture; carts for computers [furniture]; index cabinets; chests, not of metal; non-metal dog tags; high chairs for babies; infant walkers; pillows; pet cushions; drain traps [valves] of plastic; water-pipe valves of plastic; clothes hangers and clothes hooks; clothes hooks, not of metal; mannequins and tailors' dummies; coatstands; knobs, not of metal; chests of drawers; pillows; bolsters; head-rests [furniture]; hampers [baskets] for the transport of items; baskets, non-metallic; trays, not of metal; wickerwork; corks; cork bands; hospital beds; scratching posts for cats; works of art, of wood, wax, plaster or plastic; plastic key cards, not encoded and not magnetic; cabinet work; counters [tables]; loading pallets, not of metal; loading gauge rods, not of metal, for railway waggons [wagons]; cask stands, not of metal; playpens for babies; lecterns; beds for household pets; easy chairs; air pillows, not for medical purposes; air cushions, not for medical purposes; air mattresses, not for medical purposes; massage tables; mattresses; mats for infant playpens; furniture; furniture of metal; furniture fittings, not of metal; furniture partitions of wood; furniture casters, not of metal; doors for furniture; mobiles [decoration]; troughs, not of metal, for mixing mortar; identification bracelets, not of metal; nesting boxes for household pets; rivets, not of metal; nesting boxes; paper blinds; screens [furniture]; boarding stairs, not of metal, mobile, for passengers; bead curtains for decoration; mother-of-pearl, unworked or semi-worked; placards of wood or plastics; armchairs; picture frame moldings; curtain tie-backs; sections of wood for beehives; picture frame mol-



dings; rattan; stands for calculating machines; shelves for filing-cabinets [furniture]; saw horses; coffin fittings, not of metal; coffins; hinges, not of metal; display stands; footrests; deck chairs; signboards of wood or plastics; tortoiseshell; imitation tortoiseshell; reeds [plaiting materials]; umbrella stands; reels, not of metal, non-mechanical, for flexible hoses; winding spools, not of metal, non-mechanical, for flexible hoses; locks, other than electric, not of metal; keyboards for hanging keys; costume stands; cupboards; screws, not of metal; nuts, not of metal; vice benches, not of metal; shelves for typewriters; writing desks; writing desks; drawers [furniture parts]; school furniture; covers for clothing [wardrobe]; floating containers, not of metal; trolleys [furniture]; seats of metal; sofas; ottomans; stakes for plants or trees; meat chests, not of metal; mirrors (silvered glass); mirror tiles; chests for toys; ladders of wood or plastics; mats, removable, for sinks; bungs, not of metal; flower-pot pedestals; poles, not of metal; statues of wood, wax, plaster or plastic; steps [ladders], not of metal; standing desks; corozo; embroidery frames; straw edgings; straw plaits; mattress (straw -); seats; containers, not of metal, for liquid fuel; bakers' bread baskets; stair rods; animal horns; animal hooves; animal claws; tables; tables of metal; table tops; dressing tables; cask hoops, not of metal; shoulder poles [yokes]; transport pallets, not of metal; door fittings, not of metal; latches, not of metal; door handles, not of metal; latches, not of metal; valves, not of metal, other than parts of machines; packaging containers of plastic; stoppers and sealing caps, not of metal, other than for cars or lorries; silvered glass [mirrors]; showcases; curtain rings; pulleys of plastics for blinds; support rails for curtains; curtain rods; waxcomb for beehives; waxcomb for beehives; wax figures; baby changing platforms; water beds, not for medical purposes; casks of wood for decanting wine; inflatable publicity objects; changing mats; bassinets; wind chimes [decoration]; draughtsman's tables; magazine racks; newspaper display stands; tent pegs, not of metal; camping furniture; sleeping mats; vice benches of metal; meat safes of metal.

21 – Household or kitchen utensils and containers; cookware and tableware, except forks, knives and spoons; combs and sponges; brushes (except paintbrushes); brush-making materials; articles for cleaning purposes; unworked or semi-worked glass (except building glass); glassware, porcelain and earthenware; unworked or semi-worked glass (except glass used in building); glassware, porcelain and earthenware not included in other classes; aquarium hoods; dustbins; make-up removing appliances; dusting apparatus, non-electric; aerosol dispensers, not for medical purposes; cinder sifters for household purposes; eyebrow brushes; baby baths, portable; heaters for feeding bottles, non-electric; cotton waste for cleaning; goblets; basins [receptacles]; watering devices;

brooms; beer mugs; holders for flowers and plants [flower arranging]; sprinklers for watering flowers and plants; window-boxes; flower pots; cloth for washing floors; scrubbing brushes; candy boxes; hair for brushes; frying pans; pins of metal (cooking -); roses for watering cans; bread boards; bread bins; bread baskets for household purposes; ironing boards; flat-iron stands; brushes; lamp-glass brushes; toilet brushes; brushes; busts of china, terra-cotta or glass; butter dishes; butter-dish covers; buckskin for cleaning; china ornaments; hot pots, not electrically heated; closures for pot lids; deodorising apparatus for personal use; egg cups; pails; demijohns; ice pails; electric brushes, except parts of machines; comb (electric); enamelled glass; oil cruets; cruet sets for oil; chopsticks; mouse traps; drinking flasks; figurines [statuettes] of porcelain, ceramic, earthenware or glass; strainers for household use; flasks; bottles; bottle openers, electric and non-electric; fly catchers [traps or whisks]; ice cube molds; moulds [kitchen utensils]; deep fryers, non-electric; fruit presses, non-electric, for household purposes; mangers for animals; gardening gloves; containers for household or kitchen use; poultry rings; vegetable dishes; spice sets; watering cans; pouring spouts; glass incorporating fine electrical conductors, other than for cars or lorries; glass, unworked or semi-worked, except building glass; glass vials [receptacles]; glass flasks [containers]; boxes of glass; glasses [receptacles]; fiberglass thread, not for textile use; fibreglass, other than for insulation or textile use; glass bowls; mosaics of glass, not for building; powdered glass for decoration; glass stoppers; painted glassware; glass wool other than for insulation; grills [cooking utensils]; grill supports; plungers for clearing blocked drains; glove stretchers; towel holders; utensils for household purposes; gloves for household purposes; abrasive sponges for scrubbing the skin; trouser presses; electric devices for attracting and killing insects; insect traps; heat-insulated containers; vacuum bottles; vacuum flasks for holding drinks; thermally insulated containers for food; cabarets [trays]; coffee filters, non-electric; coffee-pots, non-electric; coffee grinders, hand-operated; coffee makers, non-electric; coffee services [tableware]; beer jugs; tar-brushes, long handled; combs; combs for the hair (large-toothed -); comb cases; jugs; decanters; coasters, not of paper or textile; cheese-dish covers; saucepans; cookie jars; ceramics for household purposes; candle extinguishers; candlesticks; clothing stretchers; presses (garlic -) [kitchen utensils]; buttonhooks; cookery molds [moulds]; mess-tins; cauldrons; cooking pots; cooking utensils, non-electric; baskets for household purposes; corkscrews, electric and non-electric; cosmetic utensils; tie presses; crystal [glassware]; cake moulds; kitchen containers; kitchen utensils; cooking pot sets; food cooling devices, containing heat exchange fluids, for household purposes; refrigerating bottles; isothermic bags; works of art, of porcelain, terra-cotta or glass; glue-

pots; candlesticks; liqueur sets; majolica; covers, not of paper, for flower pots; knife rests for the table; shakers; blenders, non-electric, for household purposes; furniture dusters; mops; mills for household purposes, hand-operated; water apparatus for cleaning teeth and gums; chamber pots; nail brushes; nest eggs, artificial; noodle machines, hand-operated; fruit bowls; opal glass; opaline glass; cups of paper or plastic; paper towel dispensers; waste paper baskets; paper plates; perfume vaporizers; apparatus for wax-polishing, non-electric; pepper mills, hand-operated; pepper pots; horse brushes; picnic baskets (fitted -), including dishes; plates to prevent milk boiling over; cookie [biscuit] cutters; polishing apparatus and machines, for household purposes, non-electric; polishing gloves; polishing leather; polishing materials for making shiny, except preparations, paper and stone; porcelain ware; lunch boxes; cosmetic powder compacts; powder puffs; cleaning instruments, hand-operated; pads for cleaning; cleaning rags; cleaning tow; vitreous silica fibers [fibres], not for textile use; sprinklers; shaving brushes; shaving brush stands; rat traps; perfume burners; smoke absorbers for household purposes; graters; beaters, non-electric; mixing spoons [kitchen utensils]; cocktail stirrers; salad bowls; salt shakers; spatulas [kitchen utensils]; brushes for cleaning tanks and containers; basins [bowls]; scoops [tableware]; saucepan scourers of metal; abrasive pads for kitchen purposes; signboards of porcelain or glass; whisks, non-electric, for household purposes; cutting boards for the kitchen; autoclaves, non-electric, for cooking; basting spoons [cooking utensils]; shoe horns; boot brushes; wax-polishing appliances, non-electric, for shoes; shoe trees; dish covers; dishes; trivets [table utensils]; sponges for household purposes; sponge holders; pig bristles for brush-making; earthenware saucepans; soap boxes; soap dishes; soap dispensers; sieves [household utensils]; lazy susans; napkin rings; strainers; sifters [household utensils]; siphon bottles for carbonated water; piggy banks; vessels of metal for making ices and iced drinks; menu card holders; plate glass [raw material]; confectioners' decorating bags [pastry bags]; nozzles for watering hose; dishwashing brushes; steel wool for cleaning; towel rails and rings; figurines [statuettes] of porcelain, ceramic, earthenware or glass; dusters; feather-dusters; crockery; boot jacks; fabrics (buckets made of woven -); litter trays for pets; currycombs; soup bowls; trays for domestic purposes, of paper; trays for household purposes; epergnes; tableware, other than knives, forks and spoons; services [dishes]; cups; tea balls; tea caddies; teapots; tea cosies; tea services [tableware]; tea strainers; pastry cutters; rolling pins, domestic; plates; carpet sweepers; carpet beaters [hand instruments]; bristles (animal -) [brushware]; combs for animals; crumb trays; toilet utensils; toilet cases; toilet roll dispensers; toilet roll dispensers; toilet sponges; pot lids; pots; pottery; pie servers; portable cool boxes, non-

electric; drinking troughs; cages for household pets; funnels; drinking vessels; beverage glassware; straws for drinking; horns (drinking -); feeding troughs; ironing board covers, shaped; saucers; urns; vases; bird baths; birdcages; rings for birds; waffle irons, non-electric; washing boards; clothes-pegs; laundry drying racks; clothes drying racks; washtubs; kettles, non-electric; disposable table plates; pipettes [wine-tasters]; mop wringers; wool waste for cleaning; toothbrushes; toothbrushes, electric; floss for dental purposes; toothpicks; toothpick holders; kitchen grinders, non-electric; indoor aquaria; terrariums (indoor -) [plant cultivation]; indoor terrariums [vivariums]; sugar bowls; cookware and tableware, except forks, knives and spoons; combs and sponges; brushes (except paintbrushes); brush-making materials; articles for cleaning purposes; unworked or semi-worked glass (except building glass); glassware, porcelain and earthenware; nutcrackers; ladles for wine; sugar tongs.

22 – Ropes, string, nets, tents, awnings, tarpaulins, sails, sacks and bags (not included in other classes); padding and stuffing materials, not of rubber, plastics, paper or cardboard; raw fibrous textile materials; cords for hanging pictures; strips for tying-up vines; wrapping or binding bands, not of metal; bands, not of metal, for wrapping or binding; liber; cotton waste [flock] for padding and stuffing; raw cotton; cotton tow; fibrous gaskets for ships; thread, not of metal, for wrapping or binding; binding thread, not of metal, for agricultural purposes; string; packaging string; down feathers; eiderdown; vehicle covers, not fitted; feathers for stuffing upholstery; feathers for bedding; wadding for filtering; fishing nets; bottle envelopes of straw; silk flock; sheaf-binding yarns; raw fibrous textile; glass fibers [fibres] for textile use; grasses for upholstering; hemp; hemp bands; hammocks; slings, not of metal, for handling loads; wood shavings; wood wool; ladder tapes for venetian blinds; jute; cables, other than of metal, other than for cars or lorries; camel hair; combed wool; kapok; carbon fibers [fibres] for textile use; cocoons; fiber (coconut -); plastic fibers [fibres] for textile use; belts, not of metal, for handling loads; body bags; linters; awnings of synthetic materials; awnings of textile; nets; twine for nets; network; twine made of paper; wax ends; whipcord; tarpaulins; flock [stuffing]; stuffing materials, not of rubber or plastic; stuffing or padding materials, other than of rubber or plastics, other than for cars or lorries; mail bags; vitreous silica fibers [fibres] for textile use; ramie fibre; raffia; raw linen [flax]; raw silk; horsehair; bags [sacks] for the transport and storage of materials in bulk; sawdust; fleece wool; silk waste; sails; snares [nets]; sash cords; harness, not of metal, for handling loads; shorn wool; sea wrack; sails for ski sailing; ropes; sisal; esparto grass; carded wool; rope ladders; straw for stuffing upholstery; camouflage (nets for -); camouflage (covers for -);

ropes, not of metal; textile fibers; cattle hair; bags [envelopes, pouches] of textile, for packaging; packing rope; bags for washing hosiery; wadding for padding and stuffing upholstery; tow; tarred brattice cloth; upholstery wool [stuffing]; raw or treated wool; wool flock; tents; angling nets.

23 – Yarns and threads for textile use; spun cotton; cotton yarn; chenille yarn; elastic thread and yarn for textile use; yarn; fiberglass thread for textile use; thread of metal for embroidery; rubber thread for textile use; hemp thread and yarn; jute thread and yarn; coir thread and yarn; rayon thread and yarn; threads of plastic materials for textile use; linen thread and yarn; sewing thread and yarn; spun silk; silk yarn; embroidery thread and yarn; darning thread and yarn; spun thread and yarn; worsted; wool yarn.

24 – Textiles and substitutes for textiles; furnishing fabrics; curtains of textile or plastic, other than for cars or lorries; textiles and textile goods, not included in other classes, other than for cars or lorries; bed covers; table covers; cloths for removing make-up; bath linen, except clothing; fabric, impervious to gases, for aeronautical balloons; banners; dimity; bed covers of paper; bed linen; bed linen; pillowcases; billiard cloth; brocades; chenille fabric; cheviots [cloth]; cotton fabrics, textiles, other than for cars or lorries; crepon; damask; tick [linen]; drugget; printers' blankets of textile; shower curtains of textile or plastic; bunting of textile or plastic; bolting cloth; flags of textile or plastic; eiderdowns [down coverlets]; filtering materials of textile, other than for cars or lorries; felt, other than for cars or lorries; linen cloth; flannel [fabric]; frieze (cloth), other than for cars or lorries; linings [textile]; lining fabric for footwear; curtains of textile or plastic, other than for cars or lorries; curtain holders of textile material; gauze [cloth]; sanitary flannel; fabrics for textile use; fibreglass fabrics for textile use; haircloth [sackcloth]; gummed cloth, other than for stationery; trellis [cloth]; hemp cloth, other than for cars or lorries; jute fabric, other than for cars or lorries; linens; hat linings, of textile, in the piece; calico; ticks [mattress covers]; jersey [fabric]; jute cloth; canvas for tapestry or embroidery; textile coasters; cheese cloth; calico; shams; pillowcases; crepe [fabric]; rayon fabric; fabric of imitation animal skins, other than for cars or lorries; shrouds; marabouts [cloth]; mattress covers; furniture coverings of plastic; upholstery fabrics; furniture coverings of textile; moleskin [fabric]; mosquito nets; table mats of textile; door curtains; ramie fabric; glass cloths [towels]; velvet, other than for cars or lorries; net curtains, other than for cars or lorries; sleeping bags; loose covers for furniture; silk cloth; silk fabrics for printing patterns; esparto fabric; buckram; bed throws; textile material; labels of cloth; knitted fabric; taffeta [cloth]; plastic material (substitute for fabrics), other than for cars or lorries; face towels [made of textile materials]; towels of textile; fabric for footwear; cloth; textile tissues;

tablemats, not of paper; table runners; serviettes of textile; tablecloths, not of paper; table linen, not of paper; fitted toilet lid covers of fabric; cloth; bed sheets; tulle; non-woven textile fabrics; oilcloth for use as tablecloths; wall hangings of textile; lingerie fabric; diapered linen; washing mitts; elastic woven material; adhesive fabric for application by heat; traced cloth for embroidery; woollen cloth; zephyr [cloth]; sleeping bags; sleeping bags for camping.

25 – Clothing, footwear, headgear; heels; heelpieces for footwear; babies' pants [clothing]; layettes [clothing]; swimming costumes; bathing drawers; bathrobes; bathing caps; bath sandals; bath slippers; bandanas [neckerchiefs]; berets; leg warmers; clothing of imitations of leather; motorists' clothing, other than for cars or lorries; clothing; paper clothing; boas [necklets]; teddies [underclothing]; chasubles; shower caps; insoles; pocket squares; mittens; fishing vests; football boots; footmuffs, not electrically heated; gabardines [clothing]; goloshes; gaiters; belts (money -) [clothing]; non-slipping devices for footwear; belts [clothing]; clothing for gymnastics; gymnastic shoes; half-boots; scarves; gloves [clothing]; slippers [underclothing]; shirt yokes; shirts; shirt fronts; wooden shoes; trousers; knee-high stockings; garters; girdles; hats; frames (hat -) [skeletons]; jackets [clothing]; jumpers; stuff jackets [clothing]; skull caps; hoods [clothing]; linings (ready-made -) [parts of clothing]; pockets for clothing; ready-to-wear clothing; camisoles; shoulder wraps; detachable collars; short-sleeve shirts; bibs, not of paper; leather clothing; leggings [trousers]; underwear; liveries; coats; pelisses; mantillas; miters [hats]; muffs [clothing]; caps [headwear]; cap peaks; outerclothing; ear muffs [clothing]; combinations [clothing]; slippers; hats (paper -) [clothing]; parkas; pelerines; furs [clothing]; ponchos; sweaters; cyclists' clothing; welts for footwear; mackintoshes; skirts; sandals; saris; sarongs; neck scarves [mufflers]; sashes for wear; sleep masks; veils [clothing]; wimples; knickers; lace boots; fittings of metal for footwear; footwear; insoles; footwear uppers; tips for footwear; overalls; aprons [clothing]; dress shields; ski gloves; ski boots; skorts; briefs; socks; sock suspenders; athletic shoes; sneakers; boots; footwear uppers; headbands [clothing]; espadrilles; stoles; fur stoles; studs for football boots; beachwear; beach shoes; stockings; sweat-absorbent stockings; heelpieces for stockings; tights; tee-shirts; togas; pinafore dresses; knitwear [clothing]; singlets; turbans; topcoats; uniforms; sweat-absorbent underwear; pants; wet-suits for water-skiing; gilets; hosiery; top hats; clothing, including clothing of leather, imitations of leather, or of fur, and gloves; caps (headwear), scarves, footwear including boots, shoes and slippers.

26 – Lace and embroidery, ribbons and braid; buttons, hooks and eyes, pins and needles; artificial flowers; badges for wear, not of precious metal; badges [buttons] (ornamental novelty -); brassards; expanding

bands for holding sleeves; elastic ribbons; ribbons [haberdashery]; cords for clothing; lace for edgings; trimmings for clothing; brooches [clothing accessories]; chenille [passementerie]; heat adhesive patches for decoration of textile articles; snap fasteners; false beards; false moustaches; tapes for curtain headings; feathers [clothing accessories]; festoons [embroidery]; sewing thimbles; corset busks; heat adhesive patches for decoration of textile articles; orsedew [trimmings for clothing]; fringes; artificial garlands; mica spangles; gold embroidery; belt clasps; hair bands; hair coloring caps; barrettes; hair pins; hair nets; bows for the hair; hair ornaments; bobby pins; false hair; tresses of hair; hooks [haberdashery]; binding needles; trouser clips for cyclists; fastenings for braces; hat ornaments, not of precious metal; frills [lacework]; edgings for clothing; eyelets for clothing; frills for clothing; clasps for clothing; skirt flounces; hook and pile fastening tapes; buttons; rug hooks; collar stays; artificial flower wreaths; artificial fruit; haberdashery, except thread; hair curlers; curlpapers; human hair; needle cases; needle cases; needle cushions; needles; needles for wool combing machines; sewing boxes; sewing needles; false hems; curling pins; spangles for clothing; beads, other than for making jewelry; wigs; false hair; picot [lace]; passementerie; prize ribbons; top-knots [pompoms]; zippers; zippers for bags; rosettes [haberdashery]; saddlers' needles; braids; shuttles for making fishing nets; hooks for corsets; blouse fasteners; buckles [clothing accessories]; bodkins; shoe laces; shoe hooks; shoemakers' needles; shoe eyelets; shoe buckles; shoe buckles; shoe trimmings; shoulder pads for clothing; silver embroidery; bobbins for retaining embroidery floss or wool [not parts of machines]; competitors' numbers; needle cushions; pins, other than jewellery [jewelry (am.)]; embroidery; embroidering crochet hooks; darning lasts; darning needles; ostrich feathers [clothing accessories]; knitting needles; toupees; braids; tassels [haberdashery]; birds' feathers [clothing accessories]; numerals for marking linen; woollen laces; needle-threaders.

27 – Carpets, rugs, matting, linoleum and other materials for covering existing floors, other than for cars or lorries; wall hangings (non-textile); bath mats; vinyl floor coverings; floor coverings; door mats; non-slip mats; artificial turf; linoleum; door mats; mats of woven rope for ski slopes; wallpaper; reed mats; carpet underlay; textile wallpaper; gymnasium mats.

28 – Toys and games; video game apparatus; gymnastic and sporting articles; decorations for Christmas trees; games and playthings, in the form of games or scale models, other than for cars or lorries; gymnastic and sporting articles not included in other classes; fishing equipment; fish hooks; gut for fishing; reels for fishing; rods for fishing; rattles [playthings]; baseball gloves; building games; building blocks [toys]; billiard table cushions; bowling pins; billiard cue

chalk; billiard balls; billiard cues; billiard tables; coin-operated billiard tables; bingo cards; bite sensors [fishing tackle]; bob-sleighs; body boards; body-training apparatus; bows for archery; archery implements; boxing gloves; board games; ornaments for Christmas trees, except illumination articles and confectionery; Christmas tree stands; checkers [games]; checkerboards; gut for rackets; divot repair tools [golf accessories]; dominoes; kites; scent lures for hunting or fishing; skating boots with skates attached; electronic targets; elbow guards [sports articles]; chest expanders [exercisers]; stationary exercise bicycles; guns (paintball -) [sports apparatus]; carnival masks; fencing gauntlets; fencing masks; fencing weapons; shuttlecocks; amusement machines, automatic and coin-operated; gaming machines for gambling; fitness exercise machines; games (apparatus for -); conjuring apparatus; parlour games; weight lifting belts [sports articles]; paragliders; bells for Christmas trees; golf gloves; golf clubs; golf bags, with or without wheels; gymnastic articles; gloves for games; hang gliders; bar-bells; guns (harpoon -) [sports articles]; rosin used by athletes; kite reels; hockey sticks; horseshoe games; chips for gambling; counters for games; kaleidoscopes; card games; fairground ride apparatus; candle holders for Christmas trees; climbers' harness; explosive bonbons [Christmas crackers]; knee guards [sports articles]; decoys for hunting or fishing; confetti; spinning tops [toys]; cricket bags; bait [artificial]; billiard cue tips; hunting game calls; balloons; bladders of balls for games; air pistols [toys]; mah-jong; puppets; bowling apparatus and machinery; masts for sailboards; mobiles [toys]; paintballs [ammunition for paintball guns] [sports apparatus]; nets for sports; pachinkos; paper party hats; piñatas; toy pistols; stuffed toys; plush toys; quoits; punching bags; billiard markers; dolls; dolls' beds; dolls' feeding bottles; doll houses; dolls' clothes; doll rooms; jigsaw puzzles; creels [fishing traps]; surfboard leashes; ring games; slides [playthings]; rollers for stationary exercise bicycles; scooters [toys]; roller skates; in-line roller skates; roulette wheels; scratch cards for playing lottery games; strings for rackets; chessboards; chess games; rocking horses; party favors; practical jokes [novelties]; shin guards [sports articles]; targets; batting gloves [accessories for games]; sleds [sports articles]; ice skates; butterfly nets; snow for Christmas trees (artificial -); snow globes; snowshoes; paddings (protective -) [parts of sports suits]; pools (swimming -) [play articles]; swimming kick boards; floats for fishing; bite indicators [fishing tackle]; flippers for swimming; water wings; swimming belts; swimming jackets; seal skins [coverings for skis]; soap bubbles [toys]; skateboards; sole coverings for skis; ski bindings; skis; edges of skis; snowboards; bags especially designed for skis and surfboards; slot machines [gaming machines]; balls for games; games; playing balls; marbles; indoor football tables; dice; toys for domestic pets; rackets; poles for pole vaulting; star-

ting blocks for sports; ascenders [mountaineering equipment]; sling shots [sports articles]; sailboards; surfboards; surf skis; twirling batons; screens (camouflage -) [sports articles]; teddy bears; tennis ball throwing apparatus; tennis nets; theatrical masks; supporters (men's athletic -) [sports articles]; tables for table tennis; clay pigeons [targets]; clay pigeon traps; portable games with liquid crystal displays; trampolines; spring boards [sports articles]; harness for sailboards; backgammon games; arcade video game machines; Christmas trees of synthetic material; swings; cups for dice; darts; discs for sports; flying discs [toys]; pistols (caps for -) [toys]; detonating caps [toys].

29 – Meat, fish, poultry and game; meat extracts; preserved, frozen, dried and cooked fruits and vegetables; jellies, jams, compotes; eggs; milk and milk products; edible oils and fats; ajvar [preserved peppers]; protein milk; weed extracts for food; alginates for culinary purposes; non-alcoholic eggnog; apple purée; oysters, not live; black pudding; beans, preserved; stock; fat-containing mixtures for bread slices; butter; buttercream; dates; curd; yolk of eggs; powdered eggs; albumen for culinary purposes; white of eggs; peas, preserved; peanut butter; peanuts, prepared; gherkins; low-fat potato crisps; fatty substances for the manufacture of edible fats; salted fish; fish, preserved; fish, not live; fish fillets; foods made from fish; fish, tinned [canned (am.)]; gelatine; fish meal for human consumption; mousses (fish -); fish roe, prepared; meat; preserved meat; broth concentrates; meat jellies; canned meat; salted meats; fruit preserved in alcohol; dried fruit; fruit jellies; fruit pulp; fruit-based snack food; jellies for food; prawns, not live; poultry, not live; vegetables, cooked; vegetables, dried; vegetable preserves; vegetables, tinned [canned (am.)]; mousses (vegetable -); vegetable salads; toasted laver; herrings; lobsters, not live; ginger jam; yoghurt; vegetable soup preparations; cocoa butter; tripe; frozen fruits; potato chips; potato flakes; potato fritters; cheese; caviar; kefir [milk beverage]; hummus [chickpea paste]; animal marrow for food; bone oil, edible; coconut butter; coconut oil and fat [for food]; coconut, desiccated; coconut oil for food; jams; garlic [preserved]; consommés; crayfish, not live; croquettes; crustaceans, not live; rennet; salmon; spiny lobsters, not live; fermented vegetable-based foodstuffs (kimchi); liver; liver pâté; linseed oil for culinary purposes; lecithin for culinary purposes; lentils, preserved; maize oil for food; almonds, prepared; margarine; marmalade; milk; ferments (milk -) for culinary purposes; milk beverages, milk predominating; milk products; milk shakes; whey; mussels, not live; prepared nuts; cooked fruits; fruits, tinned [canned (am.)]; fruits, tinned [canned (am.)]; fruit salads; oils for food; olives, preserved; olive oil for food; palm kernel oil for food; palm kernel oil for food; pectin for culinary purposes; vegetable juices for cooking; pickled vegetables; mushrooms, preserved; pollen prepa-

red as foodstuff; cranberry sauce [compote]; rape oil for food; raisins; seeds, prepared; anchovy, not live; sardines; sauerkraut; fruit peel; shellfish, not live; ham; whipped cream; snail eggs for consumption; pork; lard; sea-cucumbers, not live; silkworm chrysalis, for human consumption; sesame oil for food; tahini [sesame seed paste]; shrimps, not live; soya beans, preserved, for food; soya milk [milk substitute]; sunflower seeds, prepared; sunflower oil for food; bacon; edible fats; suet for food; soup (preparations for making -); tuna fish; tofu; tomato purée; tomato juice for cooking; truffles, preserved; aloe vera prepared for human consumption; edible birds' nests; game; sausages; sausages in batter; charcuterie; preparations for making bouillon; onions, preserved.

30 – Coffee, tea, cocoa and artificial coffee; rice; tapioca and sago; flour and preparations made from cereals; bread, pastry and confectionery; ice cream; sugar, honey, treacle; yeast, baking-powder; salt; mustard; vinegar, sauces (condiments); spices; ice; seaweed [condiment]; aniseed; flavourings, other than essential oils, for beverages; flavorings, other than essential oils; wheat flour; flavourings, other than essential oils, for cakes; baking powder; cake powder; beer vinegar; thickening agents for cooking foodstuffs; ice cream (binding agents for -); bean meal; candy; buns; bread; unleavened bread; sandwiches; petit-beurre biscuits; cheeseburgers [sandwiches]; chow-chow [condiment]; chutneys [condiments]; couscous [semolina]; curry [spice]; puddings; mousses (dessert -) [confectionery]; iced tea; peanut confectionery; essences for foodstuffs, except etheric essences and essential oils; vinegar; noodles; meat tenderizers for household purposes; meat pies; meat gravies; fondants; fruit sauces; spring rolls; royal jelly; fruit jellies [confectionery]; hominy grits; pearl barley; barley meal; barley (crushed -); chips [cereal products]; cereal preparations; cereal-based snack food; condiments; cloves [spice]; glucose for culinary purposes; gluten additives for culinary purposes; semolina; groats for human food; oat flakes; halvah; yeast; honey; ginger [spice]; frozen yoghurt [confectionery ices]; coffee; artificial coffee; vegetal preparations for use as coffee substitutes; coffee flavorings [flavourings]; coffee-based beverages; cocoa; cocoa-based products; cocoa-based beverages; capers; caramels; potato flour; bubble gum; catsup; cooking salt; salt for preserving foodstuffs; crackers; infusions, not medicinal; cake frosting [icing]; garden herbs, preserved [seasonings]; cake powder; turmeric; liquorice [confectionery]; stick liquorice [confectionery]; linseed for culinary purposes [seasoning]; maize, milled; maize, roasted; maize flakes; maize flour; macaroni; macarons [pastry]; maltose; malt for human consumption; almond confectionery; marinades; marzipan; almond paste; mayonnaise; sea water for cooking; flour; farinaceous foods; golden syrup; gruel, with a milk base, for food; coffee beverages with milk; cocoa

beverages with milk; chocolate beverages with milk; ham glaze; farinaceous products; nutmeg; muesli; oat-based food; noodle-based prepared meals; bread-crumbs; pâtés en croûte; moon cakes; lozenges [confectionery]; pesto [sauce]; petits fours [cakes]; pancakes; pepper; gingerbread; mint for confectionery; peppermint candy; peppers [seasonings]; pizza; bee glue; high-protein cereal bars; popcorn; quiches; ravioli; rice cakes; rice-based snack food; relish [condiment]; ice, natural or artificial; coffee (unroasted -); saffron [seasoning]; sago; whipped cream (preparations for stiffening -); dressings for salad; leaven; chocolate; drinking chocolate; mousses (chocolate -); allspice; celery salt; bread rolls; mustard meal; soya bean paste [condiment]; soya flour; soya sauce; sherbets [ices]; sauces [condiments]; spaghetti; powders for ice cream; baking soda [bicarbonate of soda for cooking purposes]; starch for food; star aniseed; sushi; sweeteners (natural -); tabbouleh; tacos; tapioca; tapioca flour; tea; ferments for pastes; farinaceous food pastes; tomato sauce; cakes; tortillas; vanilla flavourings for culinary purposes; vanillin [vanilla substitute]; waffles; cream of tartar for culinary purposes; wheat germ for human consumption; sausage binding materials; aromatic preparations for food; chicory [coffee substitute]; cinnamon [spice]; gluten prepared as foodstuff; sugar; pralines; confectionery for decorating christmas trees; rusks.

31 – Raw and unprocessed agricultural and aquacultural crops, horticulture and aquaculture products; raw and unprocessed grains and seeds; fresh fruits and vegetables, fresh herbs; natural plants and flowers; bulbs, seedlings and seeds for planting; live animals; foodstuffs and beverages for animals; malt; agricultural, horticultural and forestry products and grains and cereals not included in other classes; fresh pulses; seeds.

32 – Beers; mineral and aerated waters and other non-alcoholic beverages; fruit beverages and fruit juices; syrups and other preparations for making beverages; non-alcoholic beverages; concentrates, syrups and powder for making soft drinks; mineral waters and aerated waters; non-alcoholic drinks; energy drinks, isotonic drinks, hypertonic drinks, hypotonic drinks; fruit and vegetable drinks and juices; frozen fruit drinks, non-carbonated, non-alcoholic frozen flavoured beverages; beverages enriched with added vitamins (not for medical purposes) beers; ales; non-alcoholic beer.

33 – Alcoholic beverages (except beer).

34 – Tobacco; tobacco products; tobacco substitutes not for medical purposes; cigarettes; cigarillos; cigars; pocket machines for rolling cigarettes; cigarette tubes; cigarette filters; cigarette paper; electronic cigarettes; liquid solutions for use in electronic cigarettes; matches and smokers' articles.

37 – Building construction; repairs, other than services relating to cars or lorries; installation services; Delivery, assembly, putting into operation, service, maintenance and revision, repair and overhaul of machines and equipment for power plants, heating plants, chemical and petrochemical plants, water treatment plants and plants for treatment and/or disposal of various kinds of wastes, assembly, putting into operation, service, maintenance, repair, reconstruction and modernization of land and subway vehicles (excluding automobiles) and transport equipment, their parts, components and accessories; machinery retrofit and conversion services; machinery installation, maintenance and repair; building construction supervision, building consultancy, maintenance and repair of computer equipment (hardware), construction information, building construction, civil engineering construction; construction services, brokerage in the field of investment construction; locksmithery, repair of security locks, joinery services, restoration and maintenance of furniture, heating, plumbing, heating equipment installation and repair, repair, inspection and testing of dedicated electrical equipment, electric appliance installation and repair; mining for precious metals; mining extraction; quarrying services; mining for precious stones; assembly, commissioning, servicing, maintenance, repair, restoration and refurbishment of means of transport by land or underground and transport equipment, parts, components and accessories therefor, other than cars or lorries; servicing, repair, maintenance, restoration of motorised and non-motorised passenger rail vehicles; servicing, repair, maintenance, restoration and refurbishment of machinery and equipment in the field of nuclear energy, installation of machinery and equipment in the field of nuclear energy; maintenance and revision, repair and overhaul of machines and equipment for nuclear power plants, nuclear plants installation and maintenance; repair or maintenance of power distribution or control machines and apparatus; Installation of access control systems; construction, alteration and removal of buildings; maintenance of property, engineering activities for investment construction, in particular procuring and providing professional assistance, assessments, advice, recommendations and opinions regarding the security preparation and construction of building projects and providing technical supervision; wiring of buildings for telecommunication transmission; maintenance and repair of electronic installations; installation of telephone lines; antenna installation and repair; installation and maintenance of photovoltaic installations; installation and repair of telecommunications networks; installation and repair of computer hardware; alarm, lock and safe installation, maintenance and repair; installation, maintenance and repair of electrical machinery and generators; installation of communication equipment; installation, repair and maintenance of computers and computer peripherals; installation, repair and maintenance

nance of industrial installations; installation of solar powered systems; installation, maintenance and repair of broadcasting apparatus; building consultancy; information in the field of construction, installation and servicing; information and consultancy provided via telecommunications networks in the field of construction, installation and servicing.

40 – Treatment of materials, in particular of metals and plastics; energy production; treatment of oil and gas; decontamination of hazardous materials, destruction of waste, recycling of waste, waste incineration, treatment of waste; sorting of waste; leasing of energy generating equipment; generation of electricity from solar energy; surface energy patterning for electronic circuitry; information and advisory services all relating to the generation of electricity; production of thermal energy, heat and steam; generation and treatment of gas; generation and treatment of water; metal coating [not painting]; application of wear-resistant coatings on metals and plastics; application of wear resistant coatings to engineering components; application of protective surface coatings to machines and tools; bookbinding; cloth cutting; clothing alteration; custom tailoring; dressmaking; dyeing services; engraving; cloth waterproofing; food and drink preservation; framing of works of art; galvanizing; grinding; key cutting; laminating; leather working; material treatment information; paper finishing; photographic printing; printing; processing of oil; rental of air-conditioning apparatus; soldering; cloth treating; treatment of waste; welding services; woodworking; information and advice relating to the aforesaid services; information and advisory services relating to the aforesaid services provided on-line from a computer database or the internet; information and advisory services in relation to the aforesaid services provided over a telecommunications network; information in the field of custom manufacturing; information and consultancy provided via telecommunications networks in the field of custom manufacturing.

41 – Education, providing of training, entertainment and sporting activities, other than services relating to passenger vehicles or lorries; boarding schools, club services (entertainment or education); museum services, organisation of exhibitions for cultural or educational purposes, other than relating to cars or lorries, arranging and conducting of workshops [training], operating of lotteries, rental of sports grounds, educational services provided by schools, training, organization of shows [impresario services], movie studios, production of cinematographic films, reporting included in this class, amusement park services, photography, golf facilities (providing -); translation and interpretation; training and educational activities, education, providing of training, and entertainment, sporting and cultural activities, other than relating to cars or lorries; professional training services, other than relating to cars or lorries; videotaping; education informa-

tion; recreation information; vocational retraining; vocational guidance [education or training advice]; bookmobile services; night clubs; sport camp services; lending libraries; recreational services; disc jockey services; language interpreter services; health club services, fitness club services; personal trainer services [fitness training]; zoological garden services; sign language interpretation; conducting fitness classes; photographic reporting; gymnastic instruction; calligraphy services; music composition services; layout services, other than for advertising purposes; microfilming; modelling for artists; videotape editing; orchestra services; organization of fashion shows for entertainment purposes; religious education; dubbing; animal training; organization of balls; scriptwriting services; writing of texts, other than publicity texts; rental of audio equipment; rental of lighting apparatus for theatrical sets or television studios; rental of show scenery; rental of movie projectors and accessories; rental of motion pictures; rental of radio and television sets; games equipment rental; toy rental; rental of sports equipment, except vehicles; rental of sports grounds; rental of skin diving equipment; rental of tennis courts; rental of theatre scenery; rental of sound recordings; rental of video cameras; videotape production; rental of videotapes; rental of video cassette recorders; circuses.

42 – Scientific and technological services and research and design relating thereto, other than relating to cars or lorries; industrial analysis and research services; design and development of computer hardware and software; updating of computer programs, architectural consultation, bacteriological research, biological research, electronic storage of data, installation of computer software, clinical studies (clinical research), chemical research, chemical analysis, engineering, clinical trials, computer software consultancy, information technology [it] consultancy, scientific laboratory services, recovery of computer data, computer programming and maintenance of computer programs; construction drafting; designing; conducting technical project studies; rental of computer software; computer system design, computer software design, scientific research, product research and development for others; technical engineering for investment construction; computer technology consultancy, scientific and technological services and research and design services relating thereto; industrial analysis and research; creation and development of computer software and hardware, with the express exclusion of cartography services; forensic services relating to databases, data, electronic apparatus and/or computer software; mathematical modelling services; road surveying services; weather forecasting; disaster recovery services; providing weather information; creation of maps; encryption and decryption services for communication purposes; disaster recovery services (computer -); design and development of computer software

relating to credit or risk management, credit institutions, banking, debt collection, vehicles, call centres, data cleansing, fraud prevention, identity verification, geodemographic analysis, providing information regarding businesses or consumers or payment processing, analysis of computer systems, construction project planning, creation and maintenance of web-sites for others; technical project studies (surveying); updating of computer software; graphic design; hosting web sites; scientific and technological services and research and design relating thereto; design and development of computer hardware and software for industrial applications; calibration [measuring]; cloud seeding; computer rental; construction drafting; consultancy in the field of energy-saving; conversion of data or documents from physical to electronic media; conversion of computer programs and data, other than physical conversion; digitization of documents [scanning]; duplicating computer programs; industrial design; installation of software; laboratory (scientific -) services; land surveying; material testing; mechanical research; monitoring of computer systems by remote access; packaging design; providing search engines for the internet; providing scientific information and consultancy in the field of mechanical engineering; quality control; rental of web servers; research and development for others; surveying; technical research; it programming services; programming of data processing equipment; application service provider services; creating and maintaining blogs for others; expert advice and expert opinion relating to technology; rental services relating to data processing equipment and computers; technical services relating to projection and planning of equipment for telecommunications; research relating to telecommunication techniques; monitoring of network systems in the field of telecommunications; technical support services relating to telecommunications and apparatus; data security services; data security services [firewalls]; research relating to security; computer security system monitoring services; maintenance of computer software relating to computer security and prevention of computer risks; updating of computer software relating to computer security and prevention of computer risks; it security services in the nature of protection and recovery of computer data; internet security consultancy; programming of internet security programs; professional consultancy relating to computer security; consultancy in the field of security software; computer security threat analysis for protecting data; design and development of electronic data security systems; design and development of internet data security systems; computer virus protection services; unlocking of mobile phones; information, advisory and consultancy relating to the aforesaid services; information and advisory services relating to the aforesaid services provided on-line from a computer database or the internet; information and advisory services relating to the aforesaid services provided

over a telecommunications network; consultancy and engineering activities and services in the field of transport engineering, research, development, project planning and construction of means of transport by land or underground, other than cars or lorries and of transport equipment, components, parts and accessories therefor; testing, measuring and analysis relating to land vehicles and underground vehicles, other than cars or lorries, and parts, components and accessories therefor; creation of computer software of all kinds in the field of industry; civil engineering services; technical consultancy in the field of heavy industry, public transport vehicles, excluding automobiles; engineering project studies; testing, authentication and quality control; consultancy and engineering in the field of information technology; design services; consultancy and engineering in the field of nuclear engineering, research, development, design, construction and installation of machinery and equipment and facilities in the field of nuclear engineering; information in the field of research, development and design; information and consultancy provided via telecommunications networks in the field of research, development and design; architectural design; engineering relating to capital construction; technological engineering analysis in the field of nuclear energy; analysis of materials in the field of nuclear energy; technological advisory services relating to machine engineering analysis in the field of nuclear energy; environmental testing and inspection services analysis in the field of nuclear energy; inspection of apparatus analysis in the field of nuclear energy; quality control services analysis in the field of nuclear energy; engineering services for investment construction.

43 – Services for providing food and drink; temporary accommodation; bar services; providing campground facilities; holiday camp services [lodging]; hotel services; motels; animal boarding; catering for the provision of food and beverages; day-nurseries [crèches]; retirement homes; guesthouses; tourist homes; providing temporary housing accommodations; rental of cooking apparatus; rental of chairs, tables, table linen, glassware; rental of portable buildings; rental of drinking water dispensers; rental of meeting rooms; rental of tents; café services; cafeterias; restaurants; snack-bars; self-service restaurant services; temporary accommodation reservations; hotel reservations; boarding house bookings; accommodation bureaux [hotels, boarding houses].

44 – Medical services; veterinary services; hygienic and beauty care for human beings or animals; agriculture, horticulture and forestry services; pharmaceutical services, sanatoriums, health spa services, hospitals, rental of medical equipment, medical services, advisory services relating to health, medical clinic services; dentistry, convalescent home services; advisory services relating to health; consulting services relating



to health care; providing information relating to medical services; providing health information.

45 – Legal services; legal assistance for legal and natural persons in matters relating to their business activities; security services for the physical protection of tangible property and individuals; intellectual property consultancy services, licensing of intellectual property, monitoring of intellectual property rights for legal consultancy purposes, domain names (registration of -) [legal services], licensing of computer software [legal services], intellectual property consultancy, litigation services, copyright management; personal and social services rendered by others to meet the needs of individuals, namely adoption agencies; dating services; baby sitting; bereavement support; burial services; cat feeding services [in owners absence]; chaperoning; rental of clothing; companionship services for the elderly and disabled; consulting in the field of personal relationships; crime prevention consultancy services; detective agency services; dog walking services; escort services; providing information relating to personal wardrobe styling; genealogical services; guardianship services; rental of jewellery; house sitting; on-line social networking services; lobbying services, other than for commercial purposes; lost and found bureau services; maintaining lists of wedding presents for selection by others; mediation services for marital disputes; mentoring [spiritual]; online social networking services accessible by means of downloadable mobile applications; personal fashion consulting services; personal shopper services; pet sitting; social escort agency services; planning and arranging of wedding ceremonies; security services for the protection of property and individuals; information and advisory services relating to the aforesaid services; information and advisory services relating to the aforesaid services provided online from a computer database or the internet; information and advisory services provided over a telecommunications network; leasing of internet domain names; political lobbying services.

(260) AM 2021 106487 A\*  
 (800) 1507644  
 (151) 2019 08 02  
 (891) 2019 08 02  
 (731) "AnviLab" Company Limited  
 Festivalnaya str., 10, Sergiev-Posad municipal district, Urban settlement Sergiev Posad, RU-141302 Moscow Region, Russian Federation

(540)



(591) Red, blue, white, gray, yellow, green  
 (531) 05.07.12; 05.07.22; 11.03.04; 25.05.03;  
 26.01.06; 28.05; 29.01.15

(511)

5 – First-aid boxes, filled; medicines for human purposes; vitamin preparations; pharmaceutical preparations; pharmaceuticals; febrifuges; suppositories; anti-oxidant pills.

(260) AM 2021 107739 A  
 (800) 1522598  
 (151) 2019 09 23  
 (891) 2019 09 23  
 (731) "TANECO" Joint Stock Company  
 Promzona, Nizhnokamsk, RU-423570 Republic of Tatarstan, Russian Federation

(540)

**ТАНЕКО  
 ТОПЛИВО  
 ЧЕМПИОНОВ**

(591) Black, white  
 (531) 28.05  
 (511)  
 39 – Transport, including transport by pipeline; wrapping of goods; storage of goods.

(260) AM 2021 107970 A  
 (800) 851977  
 (151) 2005 04 25  
 (891) 2020 03 20  
 (731) Paulaner Brauerei Gruppe GmbH & Co. KgaA  
 Ohlmüllerstrasse 42, 81541 München, Germany  
 (540)

**PAUL'S**

(591) Black, white  
 (511)  
 32 – Beers; mineral and aerated waters and other non-alcoholic beverages; fruit beverages and fruit juices.

(260) AM 2021 108001 A  
 (800) 1526373  
 (151) 2020 03 20  
 (891) 2020 03 20  
 (731) HUAWEI TECHNOLOGIES CO., LTD.  
 Administration Building, Huawei Technologies  
 Co., Ltd., Bantian, Longgang District,  
 Shenzhen, China  
 (540)

## Smarfin

(591) Black, white  
 (531) 27.05.01  
 (511)  
 9 – Remote control apparatus; photocopiers (photo-graphic, electrostatic, thermic); computers; computer programs (downloadable software); anti-theft warning apparatus; eyeglasses; electric batteries; projection apparatus; data processing apparatus; navigation apparatus for vehicles (on-board computers); satellite navigational apparatus; communication transmission apparatus; humanoid robots with artificial intelligence; smartglasses; selfie sticks for mobile phones; wearable video display monitors; security surveillance robots; virtual reality headsets; telepresence robots; radio beacon devices and apparatus; rearview cameras for vehicles; laptop computers; dictating machines; navigational instruments; radios (vehicle -); mobile power source (rechargeable batteries); television apparatus; camcorders; television cameras; smartwatches; wearable activity trackers; remote control apparatus for household purposes; computer programs, recorded; tablet computers; network communication apparatus; personal digital assistants (PDAs); smartphones; bathroom scales; intercommunication apparatus; television apparatus for vehicles; document printers for use with computers; human face recognition devices; telecommunication apparatus in the form of jewellery; measuring apparatus; wide area network (WAN) routers; wearable computers; cabinets for loudspeakers; detectors; speed checking apparatus for vehicles; downloadable mobile phone software applications; automatic indicators of low pressure in vehicle tyres; steering apparatus, automatic, for vehicles; integrated circuits; portable media players; sensors; video screens; smart rings; interactive touch screen terminals; electronic key fobs being remote control apparatus; earphones; set-top boxes; cameras (photography); 3D spectacles; baby monitors; optical communication apparatus; network routers.  
 42 – Computer virus protection services; outsource service providers in the field of information technology; software as a service (SaaS); installation of computer software; data conversion of computer programs and data (not physical conversion); rental of web servers; providing search engines for the internet; monitoring of computer systems by remote access; meteorological information; updating of computer

software; recovery of computer data; maintenance of computer software; computer systems analysis; electronic data storage; technical project studies; weather forecasting; computer software design; off-site data backup; cloud computing; data encryption services; research and development of new products for others; unlocking of mobile phones.

(260) AM 2021 108003 A  
 (800) 1526385  
 (151) 2020 03 27  
 (891) 2020 03 27  
 (731) Shenzhen FangWeiDa Technology Co., Ltd.  
 No.2 Newyi Street, Dongkeng Community,  
 Gongming Street, Guangming New District,  
 Shenzhen, 518106 Guangdong Province, China  
 (540)

## ONTEN

(591) Black, white  
 (531) 27.05.01  
 (511)  
 9 – Computers; transmitters of electronic signals; signal lanterns; cameras [photography]; transformer; electric installations for the remote control of industrial operations; theft prevention installations, electric; monitoring apparatus, electric; battery; laser alignment telescope.

(260) AM 2021 108004 A  
 (800) 1526396  
 (151) 2020 02 14  
 (891) 2020 02 14  
 (731) Obshchestvo s ogranichennoy otvetstvennostyu  
 "Kvadrat-C"  
 2-y Irtyshtskiy proezd, 4B, kor. 5, RU-107143  
 Moscow, Russian Federation  
 (540)

## БРОНХОАКТИВ

(591) Black, white  
 (531) 28.05  
 (511)  
 5 – Nutritional supplements for medical use; nutritional supplements; glucose dietary supplements; propolis dietary supplements; mineral biologically active supplements; dietary biologically active supplements.

(260) AM 2021 108005 A  
 (800) 1526400  
 (151) 2019 11 27  
 (891) 2019 11 27  
 (731) Oriflame Cosmetics AG  
 c/o Oriflame Global Management AG,  
 Bleicheplatz 3, CH-8200 Schaffhausen,  
 Switzerland

(540)

## ORIFLAME ALL OR NOTHING

(591) Black, white

(511)

3 – Non-medicated conditioning and care preparations for application to the hair, scalp, skin and nails; shampoos; hair conditioner; soaps; perfumes; perfumery; eau de cologne; toilet waters; essential and herbal oils; cosmetics; make-up; make-up preparations; lipsticks; nail varnishes; nail varnish removers; eyeliner; mascara; non-medicated toilet preparations; hair lotions; hair sprays and hair gels; preparations for use in the bath or shower; bath and shower oils, gels, creams and foams; face and body masks; face and body scrubs; facial washes; skin cleansers and hydrators; skin toners; skin moisturizers; blemish creams and blemish gels; deodorants; antiperspirants; shaving soaps; shaving creams; shaving gels; after-shave preparations; pre-shave preparations; talcum powders; toiletries; dentifrices; toothpastes; foot care preparations (non-medicated).

(260) AM 2021 108006 A

(800) 1526499

(151) 2019 12 21

(891) 2019 12 21

(731) International Fruit Genetics, LLC  
8224 Espresso Drive, Suite 200, Bakersfield  
CA 93312, USA

(540)

## SWEET JUBILEE

(591) Black, white

(511)

31 – Fresh fruits and vegetables; grape vines, plants and plant propagating material.

(260) AM 2021 108007 A

(800) 1526521

(151) 2020 02 28

(891) 2020 02 28

(731) Open-Type Joint Stock Company "Krasnyj Oktyabr"  
ul. Malaya Krasnoselskaya, d. 7, RU-107140  
Moscow, Russian Federation

(540)

## ВОСТОЧНЫЙ БАЗАР

(591) Black, white

(531) 28.05

(511)

30 – Confectionery; caramels [sweets]; sweets; chocolate; pralines.

(260) AM 2021 108008 A

(800) 1526540

(151) 2020 01 16

(891) 2020 01 16

(731) Petroproduct-Otradnoe Ltd.  
Zheleznodorozhnaya Street, 1, Otradnoe,  
RU-187330 Kirovsky District, Leningradskaya  
Region, Russian Federation

(540)



(591) Blue, white, yellow

(531) 26.04.04; 26.04.06; 26.04.09; 26.13.25; 28.05;  
29.01.13

(511)

29 – Margarine; vegetable oils for food; sunflower oil for food; corn oil for food; soft butter; cheese.

30 – Mayonnaise; ketchup [sauce]; mustard; chocolate-based spreads.

(260) AM 2021 108010 A

(800) 1526651

(151) 2020 02 21

(891) 2020 02 21

(731) Closed Joint-Stock Company "Fabrika "Russkiy shokolad"  
ul. Vereyskaya, d. 29, str. 143, RU-121357  
Moscow, Russian Federation

(540)

## НАША СТРАНА

(591) Black, white

(531) 28.05

(511)

30 – Coffee; tea; cocoa; sugar; rice; tapioca; sago; artificial coffee; flour and preparations made from cereals; bread, pastries; confectionery; ice cream; honey; yeast; salt; mustard; vinegar; condiments; spices; edible ices.

(260) AM 2021 108011 A

(800) 1526662

(151) 2019 11 11

(891) 2019 11 11

(731) S.C. BIOFARM S.A.  
Str. Logofătul Tăutu Nr. 99, Sector 3,  
Bucuresti, Romania

(540)



(591) Turquoise (Pantone 7711C) and orange  
(Pantone 7549C)

(531) 26.15.01; 27.05.01; 29.01.12

(511)

3 – Aromatics (essential oils); non-medicated breath freshening sprays; breath freshening preparations for personal hygiene; cosmetic creams; cosmetic preparations for skin care; cosmetics; cosmetics for children; douching preparations for personal sanitary or deodorant purposes [toiletries]; essential oils of cedarwood; essential oils of lemon; essential oils of citron; essential oils/ ethereal essences; ethereal essences; greases for cosmetic purposes; lotions for cosmetic purposes; mouthwashes, not for medical purposes; vaginal washes for personal sanitary or disinfectant purposes.

5 – Acne treatment preparations; adhesive plaster / band-aids; adhesive tapes for medical purposes / adhesive bands for medical purposes; amino acids for medical purposes; anaesthetics; analgesics; anti-uric preparations; antibacterial handwashes; antibiotics; antiseptics; appetite suppressant pills; bandages for dressings; bath preparations for medical purposes; bath salts for medical purposes; biocides; bronchodilating preparations; candy, medicated; candy for medical purposes; chewing gum for medical purposes; cod liver oil; compresses; solutions for contact lenses / solutions for use with contact lenses; contact lens cleaning preparations; preparations for callouses; depuratives; diagnostic preparations for medical purposes; dietary supplements with a cosmetic effect; dietetic foods adapted for medical purposes; dietetic beverages adapted for medical use; dietetic substances adapted for medical use; digestives for pharmaceutical purposes; disinfectants; dressings, medical; drugs for medical purposes; febrifuges; food for babies; unguent for pharmaceutical frostbite; fungicides, gauze for dressings; germicides; dietary supplements based on glucose; hemorrhoid preparations; immunostimulants; laxatives; lecithin for medical purposes; lecithin dietary supplements; lice treatment preparations [pediculicides]; pharmaceutical preparations based on calcium oxide; medicinal ointments; linseed oil dietary supplements; flaxseed dietary supplements; lotions for pharmaceutical purposes; slimming medical preparations; medicated eye-washes; medicated toothpaste; medicinal oils; medicinal drinks; medicinal hair growth preparations; medicines for alleviating constipation; medicines for human purposes; food supplements based on minerals; mouthwashes for medical purposes; nutritional supplements; nervines; nicotine gum for use as an aid to stop smoking; nicotine patches for use as aids to stop smoking; ointments for pharmaceutical purposes; pharmaceutical preparations; pharmaceuticals; pharmaceutical preparations for treating sunburn; pharmaceutical preparations for skin care; pharmaceutical preparations for treating dandruff; pollen dietary

supplements; propolis dietary supplements; protein dietary supplements; purgatives / evacuants; preparations for reducing sexual activity; remedies for foot perspiration; remedies for perspiration; royal jelly dietary supplements; sedatives / tranquillizers; slimming pills; soporifics; steroids; styptic preparations; suppositories; syrups for pharmaceutical purposes; tanning pills; thermal water; tonics [medicines]; treatment of burns preparations; vaginal washes for medical purposes; vermifuges / anthelmintics; antiparasitic preparations; vitamin preparations; vitamin supplement patches; wheat germ dietary supplements; yeast dietary supplements.

10 – Surgical, medical, dental and veterinary apparatus and instruments; artificial limbs, eyes and teeth; orthopaedic articles; suture materials; therapeutic and assistive devices adapted for the disabled; massage apparatus; apparatus, devices and articles for nursing infants; sexual activity apparatus, devices and articles.

35 – Advertising; business management; business administration; office functions.

(260) AM 2021 108013 A

(800) 1526687

(151) 2020 03 20

(891) 2020 03 20

(731) HUAWEI TECHNOLOGIES CO., LTD.

Administration Building, Huawei Technologies Co., Ltd., Bantian, Longgang District, Shenzhen, China

(540)

# Yolanda

(591) Black, white

(531) 27.05.01

(511)

9 – Interactive touch screen terminals; humanoid robots with artificial intelligence; computer programs (downloadable software); personal digital assistants (PDAs); network routers; wide area network (WAN) routers; communication transmission apparatus; radio beacon devices and apparatus; smartphones; optical communication apparatus; network communication apparatus; human face recognition devices; intercommunication apparatus; mobile power source (rechargeable batteries); projection apparatus; cameras (photography); detectors; measuring apparatus; integrated circuits; sensors; anti-theft warning apparatus; smartwatches; wearable video display monitors; television cameras; set-top boxes; portable media players; cabinets for loudspeakers; navigational instruments; computers; earphones; dictating machines; remote control apparatus for household purposes; television apparatus; television apparatus for vehicles; telepresence robots; smartglasses; smart rings; photocopyers (photographic, electrostatic, thermic); document prin-

ters for use with computers; bathroom scales; camcorders; security surveillance robots; virtual reality headsets; baby monitors; rearview cameras for vehicles; speed checking apparatus for vehicles; telecommunication apparatus in the form of jewellery; remote control apparatus; video screens; electronic key fobs being remote control apparatus; steering apparatus, automatic, for vehicles; navigation apparatus for vehicles (on-board computers); radios (vehicle -); satellite navigational apparatus; selfie sticks for mobile phones; automatic indicators of low pressure in vehicle tyres; wearable activity trackers; electric batteries; eyeglasses; 3D spectacles; computer programs, recorded; wearable computers; downloadable mobile phone software applications; tablet computers; laptop computers; data processing apparatus.

42 – Monitoring of computer systems by remote access; off-site data backup; electronic data storage; cloud computing; outsource service providers in the field of information technology; unlocking of mobile phones; data encryption services; software as a service (SaaS); meteorological information; weather forecasting; technical project studies; research and development of new products for others; computer software design; updating of computer software; recovery of computer data; maintenance of computer software; computer systems analysis; installation of computer software; data conversion of computer programs and data (not physical conversion); rental of web servers; computer virus protection services; providing search engines for the internet.

(260) AM 2021 108014 A  
 (800) 1526688  
 (151) 2020 03 13  
 (891) 2020 03 13  
 (731) KIA MOTORS CORPORATION  
 12, Heolleung-ro, Seocho-gu, Seoul 06797,  
 Republic of Korea  
 (540)



(591) Black, white  
 (531) 27.05.01; 27.05.17; 27.05.19; 27.05.22;  
 27.05.23

(511)  
 9 – GPS navigation devices; downloadable multimedia files; theft prevention apparatus; software for controlling robots; robotic electrical control apparatus; electric power distribution machines; remote control apparatus for industrial automation instruments; smart phone applications (software); smartphones; eyeglasses; remote control apparatus; wearable computers; apparatus for broadcasting, recording, transmission or reproduction of sound, data or images; humanoid robots with artificial intelligence; automatic vehicle speed control apparatus; electronic keyless

entry system for automobiles; batteries for automobiles; black box for cars; fire extinguishing apparatus for automobiles; charging appliances for rechargeable equipment; charging stations for electric vehicles; batteries for electric vehicles; electric cables, wires, conductors and connection fittings therefor; electric batteries; black box camera for cars; air sensor for vehicles; telecommunication apparatus for use in cars; computer application software; computer programs and software; computer hardware.

(260) AM 2021 108015 A  
 (800) 1526689  
 (151) 2020 03 13  
 (891) 2020 03 13  
 (731) KIA MOTORS CORPORATION  
 12, Heolleung-ro, Seocho-gu, Seoul 06797,  
 Republic of Korea  
 (540)



(591) Black, white  
 (531) 27.05; 27.05.01; 27.05.01; 27.05.17; 27.05.19;  
 27.05.22; 27.05.23

(511)  
 10 – Massaging apparatus for personal use; suture materials; medical instruments; medical apparatus and instruments; medical robots; blankets for medical purposes; masks for use by medical personnel; sanitary masks for medical purposes; medical thread; medical clothing; gloves for medical purposes; body rehabilitation apparatus for medical purposes; medical thermometer; body fat measuring devices for medical use; artificial limbs, eyes and teeth; orthopedic articles; feeding bottles; dental apparatus and instruments; contraceptive apparatus; blood glucose meters; bed pans for patients; portable arterial blood pressure measuring apparatus.

(260) AM 2021 108016 A  
 (800) 1526717  
 (151) 2020 03 03  
 (891) 2020 03 03  
 (731) CTEK Sweden AB  
 Rostugnsvägen 3, SE-776 70 Vikmanshyttan,  
 Sweden  
 (540)



(591) Black, white  
 (511)  
 9 – Battery chargers for vehicles.

(260) AM 2021 108017 A  
 (800) 1526742  
 (151) 2019 10 30  
 (891) 2019 10 30  
 (731) Bushueva Inna Vladimirovna  
 Prokhorova Str., 16A, apt. 1, Yoshkar-Ola,  
 RU-424028 Republic of Mari El, Russian  
 Federation

(540)

## АРГУС

(591) Black, white  
 (531) 28.05  
 (511)  
 6 – Doors of metal; locks of metal, other than electric; locking systems of metal, other than electric; iron-work for doors; works of art of common metal; forged works of common metal.  
 19 – Doors, not of metal; stained-glass windows.  
 21 – Works of art of ceramics.  
 40 – Metal treating, including custom manufacturing of goods of simple metals and their alloys for others; blacksmithing; custom assembling of materials for others.

(260) AM 2021 108028 A  
 (800) 1526942  
 (151) 2020 02 04  
 (891) 2020 02 04  
 (731) "MOON LIGHT D.SH.D" OOD  
 Professor Ivan Georgov str. 2, residence area  
 Voenna rampa, BG-1220 Sofia, Bulgaria

(540)



(591) Blue, light blue, yellow, violet, brown, green, white  
 (531) 26.01.03; 26.01.19; 26.01.24; 27.01.09; 27.05.02; 27.05.03; 27.05.09; 29.01.15  
 (511)  
 28 – Toys; toy figures; soap bubbles [toys]; toy imitation cosmetics; toy vehicles; dolls; toy models; toy mobiles; toy pistols; play balloons; rattles [playthings]; novelty toys for parties; toy air pistols; baby gyms; masks [playthings]; board games; flying discs [toys]; teddy bears; Matryoshka dolls; stuffed toys; swimming pool air floats; dolls' clothes; plush toys; sling shots [sports articles]; spinning tops [toys]; jigsaw puzzles; toy robots; in-line roller skates; scale model kits [toys]; playing balls; marbles for games;

scale model vehicles; kites; games, toys and playthings.

30 – Cereal-based snack food; sugar confectionery; candies; chewing gum for breath freshening; almond confectionery; biscuits; waffles; high-protein cereal bars; dessert mousses [confectionery]; cereal bars; corn flakes; cereal preparations; cocoa-based beverages; caramels [candies]; bread rolls; buns; crackers; croissants; ice pops; peppermint sweets; petit-beurre biscuits; oat flakes; rice crackers; pancakes; pasta; petits fours; pies; fruit jellies [confectionery]; tarts; pastilles [confectionery]; pralines; profiteroles; popcorn; confectionery; cakes; ice cream; muesli; fondants [confectionery]; Halvah; maize flakes; tea-based beverages; chips [cereal products]; chocolate; chocolate-based beverages; chocolate-coated nuts.

(260) AM 2021 108035 A  
 (800) 1527105  
 (151) 2020 02 14  
 (891) 2020 02 14  
 (731) Obshchestvo s ogranichennoy otvetstvennostyu "Kvadrat-C"  
 2-y Irtyshskiy proezd, 4B, kor. 5, RU-107143  
 Moscow, Russian Federation

(540)

## ФЕРМЕНТОЗИМ

(591) Black, white  
 (531) 28.05  
 (511)  
 5 – Dietetic substances adapted for medical use; dietary fiber; mineral food supplements; nutritional supplements; albumin dietary supplements; protein supplements for animals; glucose dietary supplements; casein dietary supplements; lecithin dietary supplements; protein dietary supplements; protein supplements for animals; enzyme dietary supplements; biological preparations for medical purposes; pharmaceutical preparations; enzyme preparations for veterinary purposes; enzyme preparations for medical purposes; chemico-pharmaceutical preparations; digestives for pharmaceutical purposes; dietary biologically active supplements; nutritional supplements for medical use.

(260) AM 2021 108036 A  
 (800) 1527120  
 (151) 2019 12 13  
 (891) 2019 12 13  
 (731) SHANGHAI HARDEN TOOLS CO., LTD.  
 ROOM 2006, No.1, Lane 100, East Sport  
 Club Road, Hongkou District, Shanghai, China

(540)

## HARDEN PLUS

(591) Black, white

(511)

7 – Agricultural machinery; electric scissors; hand-held tools, other than hand-operated; electric screwdrivers; hand electric drills (excluding electric coal drills); electric grinders; hydraulic machines and apparatus; wind turbines; angle polishing machine; paint spray guns.

8 – Abrasive tools (hand tools); hand-operated hand tools; agricultural implements, hand-operated; garden tools, hand-operated; tools for livestock marking; harpoon; nail clippers (electric or non-electric); drill bit (hand tool part); nail puller (hand tool); saw (hand tool); wrench (hand tool); axe; hammer (hand tool); manual jack; ratchet (hand tool); riveters (hand-operated hand tools); engraving tools (hand tools); knives; carry-on weapons, namely, blades; tableware (knives, forks and spoons); non-electric screwdrivers; pliers.

9 – Weighing apparatus; measuring instrument; automatic measuring instrument; ruler (measuring tool); measuring tool; ruler (gauge); graduated rulers; gauges; vernier.

(260) AM 2021 108037 A

(800) 1527175

(151) 2019 10 03

(891) 2019 10 03

(731) Dua Lipa Limited

88-90 Baker Street, London W1U 6TQ,  
United Kingdom

(540)

## DUA LIPA

(591) Black, white

(511)

3 – Soaps; perfumery; eau de toilette, eau de parfum, eau de cologne, cologne; essential oils; cosmetics; hair lotions; toiletries; deodorants; hair conditioners; hair shampoos; depilatories; artificial eyelashes and nails; bleach; bleaching preparations; hair colourants; temporary tattoos for cosmetic purposes; make-up; nail varnish; parts and fittings for the aforesaid goods.

9 – Apparatus for recording, transmission or reproduction of sound or images; magnetic data carriers, recording discs; film, sound and video recordings; magnetic tapes, cassettes, vinyl records and other analogue recording media; compact discs, DVDs and other digital recording media; digital music and podcasts (downloadable); telephone ringtones (downloadable); publications (downloadable); computer software and computer games (including software and games downloadable from the internet); sunglasses; eyeglasses; parts and fittings for the aforementioned goods.

14 – Precious metals and their alloys; jewellery; precious and semi-precious stones; paste jewellery

[costume jewellery]; pins [jewellery]; shoe jewellery; rings; earrings; necklaces; chokers; pendants; bracelets; bangles; badges of precious metals; badges coated with precious metals; pin badges; brooches; tie clips; tie bars; cuff links; cuff bracelets; charms; horological and chronometric instruments; clocks; watch bands; watches; wristwatches with pedometer feature; jewellery boxes; key rings, key fobs; charms for key chains; charms for key rings; decorative key rings; key chain tags; key chains for use as jewellery; key holders; leather key rings; lanyards for keys; parts and fittings for the aforementioned goods.

16 – Paper; cardboard; printed matter and printed publications; posters, books, song books, magazines, leaflets, brochures, journals and event programmes; autograph books; flyers; stickers; sheet music; book-binding material; photographs; stationery; works of art and figurines of paper and cardboard; architects' models; instructional and teaching material (except apparatus); articles for packaging, wrapping and storage of paper, cardboard or plastics; disposable paper products; printers' type; printing blocks; money clips; travel pass holders, passport holders; parts and fittings for the aforementioned goods.

18 – Leather and imitations of leather; animal skins and hides; luggage and carrying bags; umbrellas and parasols; walking sticks; collars, leashes and clothing for animals; chain mesh purses; frames for umbrellas or parasols; handbag frames; net bags for shopping; umbrella covers; umbrella handles; umbrella or parasol ribs; umbrella rings; umbrella sticks; walking cane handles; purses, coin purses, wallets, handbags; luggage tags, suitcases, rucksacks, backpacks, sports bags, school bags, shopping bags, canvas bags, fashion bags, holdalls, wash bags, make up bags, flight bags, swim bags, shoe bags, pyjama bags; beach bags; trunks and travelling bags; vanity cases sold empty; parts and fittings for the aforementioned goods.

25 – Clothing; footwear; headgear; parts and fittings for the aforementioned goods.

35 – Advertising; business management; business administration; office functions; wholesale and retail services for the sale of precious metals and their alloys, jewellery, precious and semi-precious stones, paste jewellery [costume jewellery], pins [jewellery], shoe jewellery, rings, earrings, necklaces, chokers, pendants, bracelets, bangles, badges, pin badges, brooches, tie clips, tie bars, cuff links, cuff bracelets, charms, horological and chronometric instruments, clocks, watch bands, watches, wristwatches with pedometer feature, badges, jewellery boxes, key rings, key fobs, charms for key chains, charms for key rings, decorative key rings, key chain tags, key chains for use as jewellery, key holders, leather key rings, lanyards for keys, leather and imitations of leather, animal skins and hides, luggage and carrying bags, umbrellas and parasols, walking sticks, collars, leas-

hes and clothing for animals, chain mesh purses, frames for umbrellas or parasols, handbag frames, net bags for shopping, umbrella covers, umbrella handles, umbrella or parasol ribs, umbrella rings, umbrella sticks, walking cane handles, purses, coin purses, wallets, travel pass holders, passport covers, handbags, luggage tags, suitcases, rucksacks, backpacks, sports bags, school bags, shopping bags, canvas bags, fashion bags, holdalls, wash bags, make up bags, flight bags, swim bags, shoe bags, pyjama bags, beach bags, trunks and travelling bags, vanity cases sold empty, soaps, perfumery, eau de toilette, eau de parfum, eau de cologne, cologne, essential oils, cosmetics, hair lotions, toiletries, deodorants, hair conditioners, hair shampoos, depilatories, artificial eyelashes and nails, bleach, bleaching preparations, hair colourants, temporary tattoos for cosmetic purposes, make-up, nail varnish, apparatus for recording, transmission or reproduction of sound or images, magnetic data carriers, recording discs, film, sound and video recordings, tapes, cassettes, vinyl records and other analogue recording media, compact discs, DVDs and other digital recording media, digital music and podcasts (downloadable), telephone ringtones (downloadable), publications (downloadable), computer software and computer games (including software and games downloadable from the internet), sunglasses, eyeglasses, paper, cardboard, printed matter and printed publications, posters, books, song books, magazines, leaflets, brochures, journals and event programmes, autograph books, flyers, stickers, sheet music, bookbinding material, photographs, stationery, works of art and figurines of paper and cardboard, architects' models, instructional and teaching material (except apparatus), articles for packaging, wrapping and storage of paper, cardboard or plastics, disposable paper products, printers' type, printing blocks, money clips, clothing, footwear, headgear; information, advisory and consultancy services relating to all the aforesaid.

41 – Entertainment; cultural services, namely, arranging and conducting of cultural events; live performances; publishing services; audio recording services; performing of music and singing; production of audio visual performances; production of text; entertainment services; providing electronic publications (non-downloadable); consultancy, advisory and information services relating to the foregoing services.

(260) AM 2021 108038 A  
 (800) 1527199  
 (151) 2020 01 31  
 (891) 2020 01 31  
 (731) ANGEL SCHLESSER, S.L.  
 Cardenal Cisneros, 82-84, E-28010 Madrid,  
 Spain

(540)

## LES EAUX D'UN INSTANT

(591) Black, white

(511)

3 – Non-medicinal toiletry preparations and cosmetic products; non-medicinal dentifrices; perfumery products, essential oils; bleaching preparations and other substances for laundry use; cleaning, polishing, degreasing and abrasive preparations; soaps; hair lotions; deodorants for personal use (perfumery).

(260) AM 2021 108043 A

(800) 1527318

(151) 2019 09 23

(891) 2019 09 23

(731) UAB «VIČIŪNŲ GRUPĖ»

V. Krėvės pr. 97, LT-50369 Kaunas, Lithuania

(540)



(591) Black, white

(531) 03.06.01; 27.05.02

(511)

29 – anchovy, not live; yakitori; oysters, not live; bacon; hot dog sausages; sausages; sausages in batter; spiny lobsters, not live; animal marrow for food; caviar; edible bird's nests; liver; liver pastes; liver pate; galbi (grilled meat dish); pork; eggs; white of eggs; powdered eggs; yolk of eggs; meat, preserved; meat, canned; fish, preserved; fish, canned; bulgogi (Korean beef dish); blood sausage; shrimps, not live; prawns, not live; ham; salmon, not live; game, not live; lyophilised meat; klipfish (salted and dried cod); meat; meat jellies; meat extracts; charcuterie; mussels, not live; shellfish, not live; poultry, not live; sausage casings, natural or artificial; lobsters, not live; fish roe, prepared; sardines, not live; herrings, not live; snail eggs for consumption; salted fish; salted meats; freeze-dried meat; silkworm chrysalis for human consumption; edible insects, not live; crustaceans, not live; crayfish, not live; tripe; fish-based foodstuffs; fish, not live; fish fillets; fish meal for human consumption; fish mousses.

(260) AM 2021 108074 A

(800) 1527403

(151) 2020 03 11

(891) 2020 03 11

(731) Alcon Inc.

Rue Louis-d'Affry 6, CH-1701 Fribourg,  
 Switzerland



(540)

## JOIN THE SEE WHAT HAPPENS TRY ON

(591) Black, white

(511)

9 – Contact lenses.

35 – Advertising; commercial business management; commercial administration; office functions.

(260) AM 2021 108075 A

(800) 1527411

(151) 2020 03 20

(891) 2020 03 20

(731) COMPAGNIE GERVAIS DANONE

17 boulevard Haussmann, F-75009 PARIS,  
France

(540)

## РАСТИШКА

(591) Black, white

(531) 28.05

(511)

29 – Milk, dairy products and substitutes thereof; powdered milk; flavored jellied milks and buttermilk; milk desserts; yogurts; drinking yogurts; white cheese; petit suisse; beverages mainly consisting of milk or dairy products; milk beverages, milk predominating; milk beverages containing fruit; unflavored or flavored fermented dairy products; milk substitutes of vegetable origin; substitutes of dairy products based on plants or nuts; fruit or vegetable beverages consisting mainly of milk products; compotes; fruit compotes.

30 – Cocoa, chocolate, cocoa-based beverages, chocolate-based beverages, coffee-based beverages, tea-based beverages; custard; chocolate mousses, dessert mousses [confectionery], confectionery, sugar confectionery, sugar, puffed rice, preparations made from cereals, breakfast cereals; biscuits (sweet or savory); cakes; pastries; waffles; cereal-based desserts; rice cakes; semolina cakes; rice pudding, rice-based snack food, cereal-based snack food; edible ices, edible ices consisting primarily of yogurt, ice-cream, sherbet (edible ices), frozen yogurts (edible ices), edible ice-cream made with flavored frozen water; fruit coulis [sauces].

32 – Still or sparkling waters (mineral or other), fruit or vegetable juices, beverages with fruits or vegetables, lemonades, soda water, sherbets (beverages), preparations for making beverages, syrups for beverages, vegetable or fruit extract without alcohol, non-alcoholic beverages; plant-based beverages; vegetable-based beverages.

(260) AM 2021 108076 A

(800) 1527559

(151) 2020 03 12

(891) 2020 03 12

(731) DAL-BO A/S

Bindeballevej 69, DK-7183 Randbøl, Denmark

(540)

## DALBO

(591) Blue

(531) 27.05.01; 27.05.17; 29.01.04

(511)

7 – Agricultural equipment; earth compacting machines; earth moving machines; scarifiers [earth moving machines]; tillers [agricultural implements]; machines for processing the earth or soil; excavators [earth moving machines]; agricultural machines for ground cultivation; soil spreading machines; soil screening machines; soil grading machines; rollers [tractor towed agricultural implements]; stubble cutting machines; land packers.

35 – Retail services in relation to agricultural equipment; wholesale services in relation to agricultural equipment.

44 – Farming equipment rental.

(260) AM 2021 108077 A

(800) 1527580

(151) 2020 02 21

(891) 2020 02 21

(731) Open-Type Joint Stock Company

"Confectionary Concern Babayevsky"

ul. Malaya Krasnoselskaya, d. 7, RU-107140

Moscow, Russian Federation

(540)

## ГВАРДЕЙСКИЙ

(591) Black, white

(531) 28.05

(511)

30 – Confectionery.

(260) AM 2021 108078 A

(800) 1527604

(151) 2020 01 13

(891) 2020 01 13

(731) Raytron Technology Co., Ltd.

No.11, Guiyang Street, Development Zone,

Yantai, Shandong, China

(540)



(591) Black, white  
(531) 26.01.03; 26.01.19; 26.01.24; 27.05.09  
(511)  
9 – Detectors; temperature indicators; telescopes; chips [integrated circuits]; infrared sensors; photoelectric sensors; photosensors; sensors for determining temperature; temperature sensors; remote sensors for use in measuring thermal and infrared radiation energy waves; electric sensors; ultrasonic sensors; alarm sensors; vehicle mounted gps sensor for determining the rate of motion for a vehicle; theft prevention installations, electric; protection devices for personal use against accidents; monitoring apparatus, electric; thermal imaging cameras; infrared detectors.

(260) AM 2021 108079 A  
(800) 1527619  
(151) 2020 02 28  
(891) 2020 02 28  
(731) Open-Type Joint Stock Company "Krasnyj Oktyabr"  
ul. Malaya Krasnoselskaya, d. 7, RU-107140  
Moscow, Russian Federation

(540)

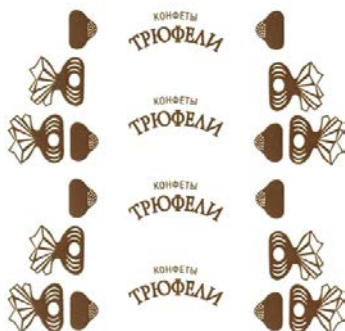

(591) White, brown  
(531) 08.01.13; 08.01.23; 19.03.24; 25.01.15;  
27.01.12; 27.05.10; 28.05; 29.01.07  
(526) The words in Cyrillic transliterated into konfety tryufeli.  
(511)  
30 – Sweets.

(260) AM 2021 108080 A  
(800) 1527665  
(151) 2020 03 31  
(891) 2020 03 31  
(731) JONATHAN MARINI  
Via Don Quaranta 2/C, I-12089 Villanova  
Mondovì, Italy

(540)

## ORIGINARIO

(591) Black, white  
(511)  
33 – Alcoholic beverages (except beer); gin.

(260) AM 2021 108081 A  
(800) 1527691  
(151) 2020 03 31  
(891) 2020 03 31  
(731) Richter Gedeon Nyrt.  
Gyömrői út 19-21, H-1103 Budapest, Hungary  
(540)

## RICHTER

(591) Black, white  
(511)  
5 – Pharmaceutical preparations for human purposes.

(260) AM 2021 108082 A  
(800) 1527698  
(151) 2020 03 13  
(891) 2020 03 13  
(731) KIA MOTORS CORPORATION  
12, Heolleung-ro, Seocho-gu, Seoul 06797,  
Republic of Korea

(540)



(591) Black, white  
(531) 27.05.01; 27.05.17; 27.05.17; 27.05.19;  
27.05.22; 27.05.23

(511)  
42 – Technological advisory services relating to machine engineering analysis; research relating to mechanical engineering; design of machinery; testing, inspection or research on agriculture, livestock breeding or fisheries; development of data processing programs; engineering services relating to robotics; rental of robots for scientific and research services; rental of laboratory robots for laboratory testing; rental of laboratory robots for laboratory research and analysis; programming of multimedia applications; development of technologies for the fabrication of circuits for wireless communication, electronic data processing, consumer electronic, automotive electronics; design of industrial robots; design and development of software; software engineering; testing of new products; testing, inspection or research of pharmaceuticals, cosmetics or foodstuff; engineering services of land vehicle industry; computer programming services for remote data management of medical diagnostic instruments; development of vehicles; design of mechanical equipment for car manufacturing; computer software planning for vehicle manufacturing; automobile technology research, including self-driving cars, electric cars, hybrid cars, hydrogen fueled cars and connected cars; design services for parts of motor vehicles; motor vehicle design; textile design services for motor vehicle trim; product research and development; design of products; design of apparatus

and machines for filling purposes; computer programming services; computer software design and development; computer hardware development; marine, aerial and land surveying.

(260) AM 2021 108083 A

(800) 1527700

(151) 2019 11 01

(891) 2019 11 01

(731) Limited Liability Company "DomBytChim"  
Lenina Str., 39A, Yablonovskiy urban-type settlement, Takhtamukayskiy region, RU-385140 Adygeya republic, Russian Federation

(540)

## ЧИСТОЛЮБ

(591) Black, white

(531) 28.05

(511)

3 – Oils for perfumes and scents; essential oils of cedarwood; nail care preparations; shaving preparations; false nails; adhesives for affixing false hair; cosmetic preparations for skin care; sachets for perfuming linen; shampoos for pets; shoemakers' wax; adhesives for affixing false eyelashes; tissues impregnated with make-up removing preparations; toilet water; perfumery; wax for linen (terms considered too vague by the International Bureau – Rule 13(2)(b) of the Common Regulations); laundry bleach; potpourris [fragrances]; sandpaper; cleansing milk for toilet purposes; polish for furniture and flooring; talcum powder, for toilet use; aromatics [essential oils]; sun-tanning preparations [cosmetics]; safrol; floor wax removers [scouring preparations]; wallpaper cleaning preparations; balms, other than for medical purposes; ethereal essences; rust removing preparations; heliotropine; lipsticks; deodorant soap; breath freshening strips; lavender oil; almond soap; cosmetics for animals; hair spray; cotton sticks for cosmetic purposes; mascara; cosmetic dyes; antistatic preparations for household purposes; make-up preparations; cobblers' wax; quillaia bark for washing; corundum [abrasive]; volcanic ash for cleaning; amber [perfume]; soap for brightening textile; essential oils of citron; varnish-removing preparations; cotton wool for cosmetic purposes; shaving stones [astringents]; neutralizers for permanent waving; ionone [perfumery]; flavorings for beverages [essential oils]; hair dyes; eyebrow pencils; drying agents for dishwashing machines; emery; aloe vera preparations for cosmetic purposes; make-up; shampoos; henna [cosmetic dye]; soap; pomades for cosmetic purposes; soda lye; non-slipping wax for floors; preservatives for leather [polishes]; cosmetics and toiletries; cosmetic preparations for baths; scented water; Javelle water; cosmetic kits; massage gels, other than for medical purposes; abrasives; scouring solutions; emery cloth; cosmetic preparations for sli-

mming purposes; polishing creams; colorants for toilet purposes; floor wax; cleaning preparations; essential oils of lemon; beauty masks; silicon carbide [abrasive]; bleaching preparations [decolorants] for cosmetic purposes; fumigation preparations [perfumes]; color-removing preparations; degreasers, other than for use in manufacturing processes; ammonia [volatile alkali] [detergent]; hair waving preparations; tissues impregnated with cosmetic lotions; polishing stones; polishing paper; bleaching salts; air fragranting preparations; cakes of toilet soap; eyebrow cosmetics; polishing wax; denture polishes; incense; cosmetics; whitening; mustache wax; after-shave lotions; cake flavorings [essential oils]; lotions for cosmetic purposes; astringents for cosmetic purposes; rose oil; laundry soaking preparations; scented wood; cleaning chalk; deodorants for human beings or for animals; almond milk for cosmetic purposes; preparations for unblocking drain pipes; refurbishing preparations; shaving soap; shining preparations [polish]; creams for leather; breath freshening sprays; mouthwashes, not for medical purposes; lavender water; shoe care preparations; skin whitening creams; mint for perfumery; polishing rouge; oil of turpentine for degreasing; adhesives for cosmetic purposes; cloths impregnated with a detergent for cleaning; antiperspirant soap; lacquer-removing preparations; badian essence; laundry glaze; make-up powder; make-up removing preparations; lip glosses; pumice stone; gaultheria oil; douching preparations for personal sanitary or deodorant purposes [toiletries]; hair conditioners; false eyelashes; depilatory wax; abrasive paper; tripoli stone for polishing; deodorants for pets; grinding preparations; almond oil; canned pressurized air for cleaning and dusting purposes; eau de Cologne; smoothing preparations [starching]; smoothing stones; leather bleaching preparations; color-brightening chemicals for household purposes [laundry]; laundry starch; stain removers; emery paper; bath preparations, not for medical purposes; hair straightening preparations; polishing preparations; glass cloth [abrasive cloth]; dental bleaching gels; abrasive cloth; petroleum jelly for cosmetic purposes; sunscreen preparations; oils for toilet purposes; antiperspirants [toiletries]; dentifrices; nail art stickers; fabric softeners for laundry use; shoe cream; windshield cleaning liquids; shoe polish; hair lotions; descaling preparations for household purposes; carbides of metal [abrasives]; tailors' wax; oils for cosmetic purposes; paint stripping preparations; detergents, other than for use in manufacturing operations and for medical purposes; jasmine oil; greases for cosmetic purposes; laundry preparations; perfumes; pastes for razor strops; musk [perfumery]; starch glaze for laundry purposes; essential oils; dry shampoos; bases for flower perfumes; diamantine [abrasive]; cosmetic creams; lipstick cases; turpentine for degreasing; nail polish; laundry blueing; bleaching soda; preparations for cleaning dentures; cosmetic pencils; extracts of flowers [perfumes]; hydrogen peroxide for

cosmetic purposes; bath salts, not for medical purposes; geraniol; decorative transfers for cosmetic purposes; mint essence [essential oil]; soap for foot perspiration; dry-cleaning preparations; alum stones [astringents]; terpenes [essential oils]; beard dyes; cosmetic preparations for eyelashes; oils for cleaning purposes; bergamot oil; depilatory preparations; non-slipping liquids for floors; joss sticks.

(260) AM 2021 108084 A  
(800) 1527703  
(151) 2020 01 15  
(891) 2020 01 15  
(731) MYWALIT.COM S.R.L.  
Via del Brennero 1040 BK, I-55100 Lucca  
(LU), Italy  
(540)



MYWALIT

(591) Black, white  
(531) 03.02.01; 03.02.24  
(511)  
18 – Leather bags; leather purses [handbags]; leather wallets; card wallets; coin holders; daypacks; carrying cases for documents; business card cases; small coin purses; handbags made of leather; clutch bags; cross-body bags; work bags.  
24 – Damask; jersey [fabric]; jersey fabrics for clothing; textile material; fabric imitating animal skins; non-woven textile fabrics.  
25 – Leather or hide belts; gloves including those made of leather; scarfs; trousers; skirts; sweaters; T-shirts; dresses; shirts.  
35 – Retailing services, also online, of bags, wallets, coin purses, rucksacks and leather items, clothing and fabrics.

(260) AM 2021 108085 A  
(800) 1527759  
(151) 2020 03 12  
(891) 2020 03 12  
(731) JIANGSU DONGCHENG POWER TOOLS  
Co., LTD.  
Industrial Park, Tianfen Town, Qidong City,  
226244 Jiangsu, China  
(540)



(591) Black, white  
(531) 14.07.12; 27.05.08; 27.05.17  
(511)  
7 – Lawnmowers (machines); shearing machines for animals; saw blades being parts of machines; electromechanical food preparation machines, namely, shredders, mixing machines; electric wood routers; packaging machines; electric food processing machines, for household purposes, namely, electric fruit presses, electric food blenders; pharmacy processing machines, namely, drug pulverizers; polishing machines for polishing glass; concrete vibrators (machines); electric marble cutters; elevating apparatus; hoods being parts of machines; drilling bits for machine; circular saws; grinding wheels for machines; router bits for machines; threading machines; chain saws; cutting machines; metal drawing machines; knives being parts of machines; hand-held tools other than hand-operated, namely, electric hand-held drills, electric impact drills, electric screwdrivers, electric mixers, electric wrenches, electric diamond core drills, diamond drills with water source, electric rotary hammers, electric demolition hammers, electric percussion hammers, electric power scrapers & excavators, electric reciprocating saws, electric table saws, electric band saws, electric chain saws, electric circular saws, electric jig saws, electric mitre saws, electric cut-off machines, electric angle grinders, electric disc grinders, electric straight grinders, electric bench grinders, electric grinders, electric sanders, electric belt sanders, electric disc polishers & sanders, electric die grinders, electric grinders with tungsten steel saw blade, electric shears, electric groove cutters, electric trimmers, electric plate jointers, electric wood routers, electric planers, planing machines, industrial electric blowers for dust removing not for ventilation and air conditioner, power operated blowers, electric lawn croppers, electric fence croppers, electric secateurs & pruners, electric hedge trimmers, electric grass shears, grinding and polishing machines, hinge boring bits, FRP hole saws, HSS hole saws, electric weld joint bevellers, drywall sanders, shear wrenches, electric impact drivers, electric driver drills, electric pipelayers, electric dust-free saws, airless high-pressure spraying units, hot air guns, magnetic drills, electric adhesive spray guns, electric caulk guns, hot glue guns, cordless sabre saws, cordless blind riveting guns, cordless screw guns, cordless pruners, cordless power tools, and parts therefore; hand-held pneumatic tools, namely, pneumatic nail guns, pneumatic drills, pneumatic sanders, pneumatic screwdrivers, pneumatic grinders, pneumatic polishers, pneumatic hammers, pneumatic shears, pneumatic air blow guns, and parts therefore; spray guns for paint; spray-paint machines; brushes being parts of machines; carbon brushes being parts of machines; stators being parts of machines; generators; electric motors other than for land vehicles; compressed air pumps; pumps (machines); air compressors; grease rings being parts of machines;

transmissions for machines; gears other than for land vehicles; mechanical seals being parts of machines; bearings being parts of machines; belts for machines; electric welding apparatus; electric welding machines; vacuum cleaners; electric cleaning machines & apparatus for garbage disposal; high pressure washers; electric machines and apparatus for wax-polishing; sewage pulverisers; electric shoe polishers; electric machines and apparatus for polishing; metalworking machines tools; electric motors other than for land vehicles; electrically-operated brushes, being parts of machines; garbage disposal units; 3D printers.

8 – Emery grinding wheels; nail clippers, electric or non-electric; hand-operated hand tools, namely, emery grinding wheels, wrenches, spanners, pliers, hand drills, chisels, hammers, screwdrivers, files, knives, bits, cutting tools, scraping tools, bush hammers, pick hammers, shovels, spades, riveters, three-jaw bearing pullers, graving tools, saw blades, scissors, shears; handles for hand-operated hand tools; razors, electric or non-electric; hair clippers for personal use, electric and non-electric; beard clippers; depilation appliances, electric and non-electric; tweezers; electric hair clippers; manicure sets, electric; cutting tools; saw blades being parts of hand tools.

9 – Measuring tools; carpenters' rules; marking gauges for joinery purposes; verniers; micrometers gauges; signal lanterns; monitoring apparatus, other than for medical purposes; measuring apparatus, namely, laser levels, surveyors' levels, line lasers, laser range finders, laser direction instruments, bevels, levels, distance measuring apparatus, altimeters, levelling staffs, clinometers; camera tripod; probes for scientific purposes; electric wires and cables; armatures for use in electrical apparatus; commutators; electric switches; electric regulating apparatus; electric junction boxes; electric control panels; electric resistances; electric connections; electricity conduits; plugs, sockets and other electric connecting attachments; capacitors; protection devices for personal use against accidents, namely, protective helmets, protective masks, safety belts other than for vehicle seat and sports equipments, dust protective goggles and masks, safety goggles, clothing for protection against accidents, irradiation and fire; personal security alarms; eyeglasses; electric batteries; battery chargers; electric accumulators.

---

(260) AM 2021 108086 A  
 (800) 1527782  
 (151) 2020 03 04  
 (891) 2020 03 04  
 (731) Apple Inc.  
 One Apple Park Way, Cupertino CA 95014,  
 USA

(540)

## DEEP FUSION

(591) Black, white

(511)

9 – Cameras; downloadable computer software for capturing and processing digital images, photos, videos and other multimedia content; downloadable computer software for editing and enhancing digital images, photos, videos and other multimedia content.

---

(260) AM 2021 108087 A

(800) 1527786

(151) 2020 02 28

(891) 2020 02 28

(731) Nature's Sunshine Products, Inc.  
 2901 W. Bluegrass Blvd., Suite 100,  
 Lehi UT 84043, USA

(540)

## NATURE'S SUNSHINE

(591) Black, white

(531) 27.05.01; 27.05.15

(511)

3 – Non-medicated skin care preparations, namely, creams, lotions, gels, toners, cleaners and moisturizers; non-medicated personal care products, namely, hand and body soaps, hand and body creams, hand and body lotions; non-medicated soaps; hair care products, namely, shampoos, conditioners and hair nourishers; essential oils used as a skin emollient or skin moisturizer; massage oils and lotions; toothpaste; non-medicated anti-aging creams and serums; breath freshening tablets and oils; substances and preparations for aromatherapy, namely, essential oils.

5 – Nutritional supplements, namely, herbal preparations and combinations in the forms of capsules, tablets, and/or powders, herbal supplements, namely, herb extract liquids and powders, herbal dietary supplements made of capsuled herbs and herbal combinations; supplemental vitamins and minerals and trace mineral supplements and trace mineral supplements suspended in liquid and liquid chlorophyll; dietary supplement beverage concentrates for promoting weight control and dietary supplement tablets; powdered nutritional supplement drink mixes; dietary and nutritional supplements for weight loss; nutritional supplements for eliminating toxins from the body; meal replacement and dietary supplement drink mixes for medical use; nutritional drink mix for use as a meal replacement for medical use; nutritional shakes for use as a meal substitute for medical use; probiotic supplements; non-medicated homeopathic medicines and preparations for treating various ailments, namely, aches and pains, sunburn, cuts and abrasions; me-

dical preparations, namely, herbal skin discomfort cream and herbal cough syrup; and powdered protein, vitamins and minerals for making beverages.

32 – Powders used in the preparation of energy drinks; fruit juices and fruit drinks; aloe vera juice.

35 – Offering business management assistance in the establishment and/or operation of person to person wholesale and retail multi-level marketing services in the field of cosmetic and toilet preparations, nutritional and dietary supplements, air purifying units, water filtering apparatus; wholesale and retail distributorship services in the field of skin, hair and body care preparations, namely, body and facial cleansers, toners, moisturizers, creams, lotions, non-medicated anti-aging creams and serums, shampoos, conditioners, and hair nourishers, and essential oils, health foods, food supplements, herbs, vitamins and minerals.

(260) AM 2021 108088 A

(800) 1527799

(151) 2020 03 13

(891) 2020 03 13

(731) KIA MOTORS CORPORATION

12, Heolleung-ro, Seocho-gu, Seoul 06797,  
Republic of Korea

(540)



(591) Black, white

(531) 27.05.01; 27.05.17; 27.05.19; 27.05.22;  
27.05.23

(511)

1 – Gallium; by-products of the processing of cereals for industrial purposes; chemicals used in industry, science and photography as well as in agriculture, horticulture and forestry; chemicals used in industry and microorganisms other than for medical and veterinary use; flour for industrial purposes; chemicals used in industry and unprocessed artificial resins; chemicals and adhesives used in industry; coolants; unprocessed artificial resins and pulp; antifreeze; brake fluid; fertilisers; hydraulic oils; artificial sweeteners [chemical preparations]; metalloids; anti-puncture preparations; transmission fluids; compositions for the manufacture of technical ceramics; power steering fluid; chemical test paper.

(260) AM 2021 108089 A

(800) 1527823

(151) 2020 02 21

(891) 2020 02 21

(731) Open-Type Joint Stock Company

"ROT FRONT"

2-oy Novokuznetskiy pereulok, d. 13/15,  
RU-113184 Moscow, Russian Federation

(540)



(591) White, black and bronze

(531) 25.01.15; 25.01.25; 26.07.04; 28.05; 29.01.13

(526) КОНФЕТА, РОТ ФРОНТ, МОСКВА.

(511)

30 – Coffee; tea; sugar; rice; tapioca; sago; coffee substitutes; flour; ice cream; honey; molasses syrup for culinary purposes; yeast; baking powder; salt; mustard; vinegar; sauces [condiments]; spices; ice; confectionery; pastries.

(260) AM 2021 108090 A

(800) 1527830

(151) 2020 03 12

(891) 2020 03 12

(731) AVVA PHARMACEUTICALS LTD

SPYROU KYPRIANOU 23A, CY-4001

LIMASSOL, Cyprus

(540)

## MICRAZYM

(591) Black, white

(511)

5 – Dental preparations and articles, and medicated dentifrices; dietary supplements and dietetic preparations; dental preparations and articles; hygienic preparations and articles; sanitary preparations and articles; pharmaceuticals and natural remedies; capsules for medicines; diagnostic preparations and materials.

44 – Human healthcare services; human hygiene and beauty care.

(260) AM 2021 108091 A

(800) 1527838

(151) 2020 01 14

(891) 2020 01 14

(731) CHINA KWEICHOW MOUTAI DISTILLERY

(GROUP) CO., LTD.

No. 4 East Mountain Lane, East Road of  
Loop, Guiyang City, Guizhou Province,  
China

(540)



(591) Black, white, gray  
 (531) 01.01.02; 01.01.10; 05.13.01; 25.01.15;  
 26.01.03; 26.01.16; 26.11.09; 27.05.01; 28.03  
 (526) The applicant wishes to disclaim protection for  
 the following element(s) of the mark, 53%V/V 500  
 ML.  
 (511)  
 33 – Fruit extracts, alcoholic; alcoholic beverages;  
 spirits [beverages]; alcoholic beverages, except beer;  
 aperitifs; bitters; cooking alcohol; wine; frozen alco-  
 holic beverages; digesters [liqueurs and spirits].

(260) AM 2021 108092 A  
 (800) 1527840  
 (151) 2020 03 18  
 (891) 2020 03 18  
 (731) ROLEX SA  
 Rue François-Dussaud 3-5-7, CH-1211  
 Genève 26, Switzerland

(540)

## CYCLOPS

(591) Black, white  
 (511)  
 14 – Timepieces, namely, watches, wrist-watches,  
 component parts for timepieces and accessories for  
 timepieces not included in other classes, clocks and  
 other chronometric instruments, chronometers, chro-  
 nographs (timepieces), watch bands, dials (timepie-  
 ces), boxes and cases for timepieces and jewelry,  
 watch movements and their parts; jewelry; precious  
 stones and semi-precious stones; precious metals and  
 their alloys; pins (jewelry).

(260) AM 2021 108093 A  
 (800) 1527873  
 (151) 2019 11 01  
 (891) 2019 11 01  
 (731) D ET VE ET ÜRÜNLERİ GIDA  
 PAZARLAMA TİCARET ANONİM ŞİRKETİ  
 Dikilitaş Mahallesi, Üzengi Sokak, No:8,  
 Beşiktaş – İstanbul, Turkey

(540)



(591) Black and red are the feature of the mark  
 (531) 27.05.01; 27.05.02; 27.05.04; 29.01.12  
 (511)

25 – Clothing, including underwear and outer clothing,  
 other than special purpose protective clothing; socks,  
 mufflers [clothing], shawls, bandanas, scarves, belts  
 [clothing]; footwear, shoes, slippers, sandals; head-  
 gear, hats, caps with visors, berets, caps [headwear],  
 skull caps.

29 – Meat, fish, poultry and game; processed meat  
 products; dried pulses; soups, bouillon; processed  
 olives, olive paste; pickles; milk and milk products,  
 butter; edible oils; margarine; dried, preserved, fro-  
 zen, cooked, smoked or salted fruits and vegetables;  
 tomato paste; prepared nuts and dried fruits as snacks;  
 hazelnut spreads and peanut butter; tahini (sesame  
 seed paste); jams, marmalades, fruit jellies; eggs and  
 powdered eggs; potato chips.

30 – Coffee, cocoa; coffee or cocoa based beverages,  
 chocolate based beverages; pasta, stuffed dumplings,  
 noodles; macaroni, ravioli; pastries and bakery pro-  
 ducts based on flour; desserts based on flour and cho-  
 colate; bread, honey; royal jelly for human consump-  
 tion; bee glue for human consumption, propolis for  
 food purposes; condiments for foodstuff, vanilla (fla-  
 voring), spices, sauces (condiments), tomato sauce;  
 yeast, baking powder; flour, semolina, starch for food;  
 sugar, cube sugar, powdered sugar; tea, iced tea; con-  
 fectionery, chocolate, candies, biscuits, crackers, wa-  
 fers; chewing gums; ice-cream, edible ices; salt; cer-  
 eal-based snack food, popcorn, crushed oats, corn  
 chips, breakfast cereals, processed wheat for human  
 consumption, crushed barley for human consumption,  
 processed oats for human consumption, processed rye  
 for human consumption, rice; molasses for food.

35 – Advertising, marketing and public relations; or-  
 ganization of exhibitions and trade fairs for com-  
 mercial or advertising purposes; design of advertising  
 materials; provision of an online marketplace for  
 buyers and sellers of goods and services; office func-  
 tions; secretarial services; arranging newspaper subs-  
 criptions for others; compilation of statistics; rental of  
 office machines; systemization of information into  
 computer databases; telephone answering for unavai-  
 lable subscribers; business management, business  
 administration and business consultancy; accounting;  
 commercial consultancy services; personnel recruit-  
 ment, personnel placement, employment agencies, im-  
 port-export agencies; temporary personnel placement  
 services; auctioneering; the bringing together, for the

benefit of others, of a variety of goods, namely, clothing, including underwear and outer clothing, other than special purpose protective clothing, socks, mufflers [clothing], shawls, bandanas, scarves, belts [clothing], footwear, shoes, slippers, sandals, headgear, hats, caps with visors, berets, caps [headwear], skull caps, meat, fish, poultry and game, processed meat products, dried pulses, soups, bouillon, processed olives, olive paste, pickles, milk and milk products, butter, edible oils, margarine, dried, preserved, frozen, cooked, smoked or salted fruits and vegetables, tomato paste, prepared nuts and dried fruits as snacks, hazelnut spreads and peanut butter, tahini (sesame seed paste), jams, marmalades, fruit jellies, eggs and powdered eggs, potato chips, coffee, cocoa, coffee or cocoa based beverages, chocolate based beverages, pasta, stuffed dumplings, noodles, macaroni, ravioli, pastries and bakery products based on flour, desserts based on flour and chocolate, bread, honey, royal jelly for human consumption, bee glue for human consumption, propolis for food purposes, condiments for foodstuff, vanilla (flavoring), spices, sauces (condiments), tomato sauce, yeast, baking powder, flour, semolina, starch for food, sugar, cube sugar, powdered sugar, tea, iced tea, confectionery, chocolate, candies, biscuits, crackers, wafers, chewing gums, ice-cream, edible ices, salt, cereal-based snack food, popcorn, crushed oats, corn chips, breakfast cereals, processed wheat for human consumption, crushed barley for human consumption, processed oats for human consumption, processed rye for human consumption, rice, molasses for food, enabling customers to conveniently view and purchase those goods, such services may be provided by retail stores, wholesale outlets, by means of electronic media or through mail order catalogues.

(260) AM 2021 108094 A

(800) 1527900

(151) 2020 02 10

(891) 2020 02 10

(731) Bit Bio Limited

Pioneer House Vision Park, Histon,  
Cambridge, Cambridgeshire CB24 9NL,  
United Kingdom

(540)

## BIT BIO

(591) Black, white

(511)

1 – Stem cells for research purposes; stem cells for scientific purposes; stem cells other than for medical or veterinary purposes; skeletal myocytes for research purposes; cortical neurons for research purposes; biological tissue for research and scientific purposes; biological tissue cultures other than for medical or veterinary purposes; cultures of cell media [other than for medical or veterinary use]; chemical reagents for use in biotechnology, other than for medical or veterinary use; nutritive agents for processing living cells

[other than for medical use]; semi-processed natural proteins for manufacturing food; proteins for use in the manufacture of food products; proteins for use in recombinant DNA technology [other than for medical use].

5 – Cell therapeutics; genetically or otherwise modified cells; cells which are propagated, cultivated and expanded in bioreactors; cells for the purpose of tissue regeneration; living cells for medical use; cells for medical use; biological preparations for medical use; diagnostic preparations for medical and/or veterinary purposes; cell preparations for drug screening; cell preparations for genetic testing, screening; stem cells for medical purposes; stem cells for veterinary purposes; cell growth media, tissue culture media, cytokines, antibodies, and reagents for medical, medical research or diagnostic use; tissue culture media, growth factors, growth media, serum, and nutritional supplements for in vitro culturing, development, maintenance, expansion, assay or manipulation of cells; cell separation reagents, magnetic cell separation equipment; dietary supplements; protein supplements; nutrition supplements.

9 – Computer software and computer hardware for the separation of biological and non-biological materials; bioreactors; bioreactors for biomanufacturing; bioreactors for research use; bioreactor for cell culturing; bioreactors for laboratory use; manufacturing software; smart manufacturing system controls; electronic control units.

29 – Meat; meat substitutes; tissue engineered meat; synthetic meat; cultured meat; laboratory-grown meat; fish, not live.

40 – Custom manufacture of biopharmaceuticals; processing of biopharmaceutical materials for others; custom manufacture of stem cells for research purposes, stem cells for scientific purposes, stem cells other than for medical or veterinary purposes, skeletal myocytes for research purposes, cortical neurons for research purposes, biological tissue for research and scientific purposes, biological tissue cultures other than for medical or veterinary purposes, cultures of cell media [other than for medical or veterinary use], chemical reagents for use in biotechnology, other than for medical or veterinary use, nutritive agents for processing living cells [other than for medical use], semi-processed natural proteins for manufacturing food, proteins for use in the manufacture of food products, proteins for use in recombinant DNA technology [other than for medical use], cell therapeutics, genetically or otherwise modified cells, cells which are propagated, cultivated and expanded in bioreactors, cells for the purpose of tissue regeneration, living cells for medical use, cells for medical use, biological preparations for medical use, diagnostic preparations for medical and/or veterinary purposes, cell preparations for drug screening, cell preparations for gene-



tic testing, screening, stem cells for medical purposes, stem cells for veterinary purposes, cell growth media, tissue culture media, cytokines, antibodies, and reagents for medical, medical research or diagnostic use, tissue culture media, growth factors, growth media, serum, and nutritional supplements for in vitro culturing, development, maintenance, expansion, assay or manipulation of cells, cell separation reagents, magnetic cell separation equipment, dietary supplements, protein supplements, nutrition supplements, meat, meat substitutes, tissue engineered meat, synthetic meat, cultured meat, laboratory-grown meat and fish, not live.

42 – Biotechnology research; biotechnology testing; stem cell research; synthetic biology services; stem cell biology services; scientific services relating to the isolation and cultivation of human tissues and cells; research and development in the field of microorganisms and cells; research and development in relation to genetic testing, screening; research and development in relation to drug screening; cell separation technology services; cell separation research services; consultancy relating to biotechnology; consultancy relating to drug screening; consultancy relating to genetic screening; consultancy relating to cell therapy; laboratory research; research on food; research and development in the field of animal cells cultivated within bioreactors; research in the reduction of carbon emissions.

(260) AM 2021 108095 A

(800) 1527944

(151) 2019 12 05

(891) 2019 12 05

(731) Comité International Olympique

Château de Vidy, CH-1007 Lausanne,  
Switzerland

(540)



(591) Gold, blue, yellow, black, green and red

(531) 01.15.05; 02.03.01; 02.03.16; 02.03.23;  
24.11.18; 26.01.03; 26.01.06; 26.01.13;  
26.01.14; 27.05.01; 27.07.01; 29.01.15

(526) კომბინირებული

(511)

35 – Advertising; dissemination of advertising matter via all media, in particular in the form of thematic messages centered on human values; advertising by

sponsoring; online advertising and marketing services; business management; business administration; office functions; advertising promotion of the goods and services of others, by means of contractual agreements, in particular sponsoring and licensing agreements, enabling them to gain notoriety, enhanced image and sympathy derived from cultural and sporting events, in particular international events; advertising promotion of the goods and services of others by means of what is referred to as the initial interest factor leading the public to consider goods or services presented to the public bearing signs, emblems or messages able to capture its attention; promoting the goods and services of others by means of the so-called image transfer; rental of advertising space of all type and on all media, whether digital or not; business administration of the participation of national teams to an international athletic competition, and promoting the support to said teams with the public and the concerned circles; inventory management services; consultation relating to stock monitoring services; advertising by means of direct marketing for others consisting in marketing of databases; consultation for advertising by means of direct marketing for others consisting in marketing of databases; consultation services in connection with business reorganization; truck and automobile fleet management services, namely billing and consulting in connection with the administrative management of truck and automobile fleets; business administration consultancy; administrative management of power plants of others; business consultation in connection with the management of power plants; commercial administration of contracts for repair and servicing; supply chain commercial management services; business consulting services relating to the purchase and supply of chemical services and products; commercial supply management of products; establishing product inventory; consulting, marketing, analysis of prices and costs concerning devices for electrochemical purification of liquids for industrial use; administrative, commercial and technical management of computer files; data input and processing services; department store retail services connected with the sale of beauty products, toiletries, machines for household use, hand tools, optical goods, domestic electrical and electronic equipment; information services concerning the sale of raw materials; commercial information services; commercial information agency services; photocopier rental services; promoting the sale of goods and services of others by means of advertisements, promotional competitions, awarding of prizes and bonuses in the form of promotional lotteries, discounts, reduction tokens and value-added offers in connection with the use of payment cards; promoting sporting competitions and events for use by others; promoting concerts and cultural events for others, organization of exhibitions for commercial or advertising purposes; provision of documentation, namely direct mail advertising, distribu-

tion of advertising material, distribution of samples, reproduction of documents; advertising concerning the promotion of commercial sales of goods and services for retail sale purposes; provision of information in connection with e-commerce and electronic retail sale; provision of information concerning the purchase of goods and services on line via the Internet and other computer networks; advertising concerning transport, travel, hotels, accommodation, food and meals, sports, entertainment and sightseeing tours provided through tourist agencies; maintenance of computerized databases; digital file management comprising a portfolio of images and video sequences intended for one use under license in traditional advertising and in the promotion of behavior [moral advertising]; providing online markets for the buyer and seller of goods and services; retail services or wholesale services for tires; retail services or wholesale services for clothing, footwear, headgear; retail services or wholesale services for sports goods; retail services or wholesale services for bicycles and parts and fittings for bicycles; retail or wholesale services for pharmaceutical, veterinary and sanitary preparations and medical supplies; presentation of goods on communication media, for retail purposes; procurement services for others [purchasing goods and services for other businesses]; retail services or wholesale services of jewellery, horological instruments, fashion accessories, bags, memorabilia.

41 – Education; training; entertainment; sporting and cultural activities, televised sporting and cultural entertainment; organization of exhibitions for cultural and educational purposes; organization of lotteries and competitions; betting and gambling services in connection with or relating to sports; entertainment services provided during sporting events or concerning sporting events; organization of sporting and cultural events and activities; organization of real or virtual sporting competitions; providing sports facilities; entertainment in the nature of television news; entertainment services in the nature of creation, development and production of television programming; entertainment services in the nature of an ongoing reality based television program; entertainment in the nature of ongoing television programs in the field of sport; rental of audio and video equipment; production of films, other than advertising films; production of sound and video recordings; presentation and distribution of films and of sound and video recordings; rental of films and of sound and video recordings; rental and/or provision via a computer network of interactive education and entertainment products, namely interactive compact discs, CD-ROMs, computer games; entertainment, namely presentation of interactive education and entertainment products, namely interactive compact discs, CD-ROMs, computer games; radio and television coverage of sporting events; production of television and radio programs and of

videotapes; production of cartoons; production of animated programs for television; reservation of tickets for sporting events and shows; timing of sports events; organization of beauty contests; interactive entertainment; on-line betting services; provision of games on the Internet; provision of raffle services; services of provision of information concerning entertainment or education, provided on line from a data bank or the Internet; electronic game services provided by means of the Internet; providing on line electronic publications; publication of books, magazines, texts (other than publicity texts) and periodicals; on line publication of electronic books, magazines, texts (other than publicity texts) and periodicals; provision of digital music from the Internet; provision of sporting results; services of provision of information concerning sports and sporting events; rental of recorded sounds and images; audio production services; services of provision of information concerning sporting events provided on line from a computer database or the Internet; editing and publishing services; provision of digital music (non-downloadable); offering digital music by means of telecommunications; publication of statistics regarding sporting results and audience ratings for sporting competitions; training in the use and operation of systems for signaling and notification of crossings for the railway and transit industries; conducting of seminars, conferences, symposiums or workshops in the field of medical imaging and diagnosis intended for medical practitioners and employees of pharmaceutical companies; education services, namely conducting of seminars, conferences, symposiums or workshops in the field of life sciences and biotechnology for scientists and researchers; conducting of seminars on problems in connection with industrial water treatment; training services in all the aforesaid fields; training services in the field of management and medicine by means of the use of instructions and demonstrations provided on line, via the Internet, intranets and extranets; education services, namely conducting of practical training workshops, courses and seminars including demonstrations in the field of medicine and management; design, conducting and hosting of courses, seminars and all training activities in the field of information technology; organization and performance of concerts; booking of seats for shows; movie presentations; services of provision of information in terms of entertainment; film production; show production; theater production services; operation of golf facilities; health club services (fitness training); sports camp services; presentation of live performances; film projection; organization of shows (impresario services); holiday camp services [entertainment]; movie studios; news reporter services; provision of on-line electronic publications, not downloadable; music hall services; education services, namely conducting of courses, seminars, presentations, video presentations; provision of educational material, namely dissemination of material in

the field of financial knowledge; education services in the field of tourism; services of provision of information in the field of tourism, namely services of provision of information regarding reservation of tickets for recreational events; services of provision of information in the field of tourism, namely services of provision of information regarding entertainment; services of provision of information in the field of tourism, namely services of provision of information regarding planned sporting, cultural and recreational activities; services in connection with entertainment for tourist assistance; tourist reservation services, namely activity and entertainment reservation services; assistance services for tourists concerning reservation of tickets for recreational events; assistance services for tourists concerning planned sporting, cultural and recreational activities; presenting of prizes rewarding the authors of exceptional acts or performances; arranging and conducting ceremonies relating to the presentation of prizes and awards.

(260) AM 2021 108096 A  
 (800) 1527977  
 (151) 2019 12 11  
 (891) 2019 12 11  
 (731) Oriflame Cosmetics AG  
 c/o Oriflame Global Management AG,  
 Bleicheplatz 3, CH-8200 Schaffhausen,  
 Switzerland  
 (540)



(591) Black, white  
 (531) 27.05.01; 27.05.23  
 (511)  
 3 – Non-medicated conditioning and care preparations for application to the hair, scalp, skin and nails; shampoos; hair conditioner; soaps; perfumes; perfumery; eau de cologne; toilet waters; essential and herbal oils; cosmetics; make-up; make-up preparations; lipsticks; nail varnishes; nail varnish removers; eyeliner; mascara; non-medicated toilet preparations; hair lotions; hair sprays and hair gels; preparations for use in the bath or shower; bath and shower oils, gels, creams and foams; face and body masks; face and body scrubs; facial washes; skin cleansers and hydrators; skin toners; skin moisturizers; blemish creams and blemish gels; deodorants; antiperspirants; shaving soaps; shaving creams; shaving gels; after-shave preparations; pre-shave preparations; talcum powders; toiletries; dentifrices; toothpastes; foot care preparations (non-medicated).

(260) AM 2021 108097 A  
 (800) 1528050  
 (151) 2020 01 17  
 (891) 2020 01 17  
 (731) VIENNA INSURANCE GROUP AG Wiener  
 Versicherung Gruppe  
 Schottenring 30, A-1010 Wien, Austria  
 (540)



(591) Turquoise, yellow, red and black  
 (531) 26.11.01; 26.11.08; 27.05.11; 27.05.21;  
 29.01.14  
 (511)  
 36 – Insurance; financial affairs; monetary affairs;  
 real estate affairs.

(260) AM 2021 108098 A  
 (800) 1528067  
 (151) 2020 01 13  
 (891) 2020 01 13  
 (731) CHINA KWEICHOW MOUTAI DISTILLERY  
 (GROUP) CO., LTD.  
 No. 4 East Mountain Lane, East Road of  
 Outside Loop, Guiyang City, 200030 Guizhou  
 Province, China  
 (540)



(591) Black, white  
 (531) 28.03  
 (511)  
 33 – Edible alcohol; gin; digesters [liqueurs and spirits]; curacao; baijiu [chinese distilled alcoholic beverage]; nira [sugarcane-based alcoholic beverage]; pre-mixed alcoholic beverages, other than beer-based; vodka; rum; rice alcohol; alcoholic beverages containing fruit; alcoholic beverages, except beer; alcoholic extracts; alcoholic essences; whisky; sake; perry; piquette; yellow rice wine; peppermint liqueurs; arrack; light sparkling wine; cocktails; cider; distilled beverages; arak [arrack]; aperitifs; anisette [liqueur]; anise [liqueur]; bitters; fruit extracts, alcoholic; brandy; spirits [beverages]; kirsch; hydromel [mead]; liqueurs; wine.

(260) AM 2021 108099 A  
 (800) 1528131  
 (151) 2019 10 10  
 (891) 2019 10 10  
 (731) HUILERIE CROIX VERTE  
 Z.A.de la Ronde, 138 rue de l'Aunay,  
 F-49650 ALLONNES, France

(540)

## LA TOURANGELLE

(591) Black, white

(511)

29 – Edible oils and fats; spiced oils; flavoured oils; vegetable oils for food; olive oil; coconut oil for food; coconut fat; maize oil for food; sesame oil for food; chili oil; groundnut oil; canola oil; soybean oil; butter oil; nut oils; cooking oils; hardened oils (hydrogenated oil for food); sunflower oil for food; palm oil (for food); colza oil for food; rape oil for food; truffle-based oils; soya bean oil for food; linseed oil for food; blended oil (for food); rice bran oil for food; whale oil for food; perilla oil for culinary purposes; palm nut oil for food; palm kernel oil for food; grapeseed oil; camellia seed oil for food; pumpkin seed oil for food; chia seed oil for food; bone oil for food; animal oils for food; hydrogenated oils for food; preserved vegetables (in oil); olives stuffed with pesto in sunflower oil; olives stuffed with feta cheese in sunflower oil; butter; mixed pickles.

30 – Flavorings and seasonings; condiments; spices; salts; culinary herbs; dried herbs; preserved herbs; chili oil for use as a seasoning or condiment; coffee oils; vinegar; flavoured vinegar; vinaigrettes; mayonnaise; mayonnaise based sauces; mayonnaise-based spreads; mayonnaise and ketchup-based spreads; prepared foodstuffs in the form of sauces; sauce (edible); food dressings (sauces); sauces; concentrated sauce; spicy sauces; hot sauce; chili sauce; ketchup (sauce); teriyaki sauce; satay sauces; spaghetti sauce; tomato sauce; barbecue sauce; tartare sauce; soya sauce; pesto (sauce); Worcestershire sauce; remoulade sauce; kebab sauce; sambals; cheese sauce; sweet and sour sauce; oyster sauce; shrimp sauce; pasta sauce; sauces for rice; dressings for salad; sauces for pizzas; curry sauces; sauces for chicken; mushroom sauces; hot chili pepper sauce; sauces for fish; horseradish sauces; pepper sauces; fish sauce; meat gravies; herb sauces; truffle cream sauces; sauce powders; ready-made sauces; chocolate topping; apple sauce (condiment); fruit coulis (sauces); sauces for ice cream; cranberry sauce (condiment); sauces flavoured with dried fruits; sauces containing nuts; sweetmeat made of sesame oil; marinades; marinades containing seasonings; marinades containing herbs; sweet pickle (condiment).

(260) AM 2021 108100 A  
 (800) 1528144  
 (151) 2019 11 15  
 (891) 2019 11 15  
 (731) Ferdinand Bilstein GmbH + Co. KG  
 Wilhelmstraße 47, 58256 Ennepetal, Germany

(540)

## bilstein group

(591) Black, white

(511)

1 – Chemicals used in industry, science and photography; unprocessed artificial resins, unprocessed plastics; fire extinguishing compositions; tempering and soldering preparations; adhesives used in industry; brake fluid; chemical additives for motor fuels; engine coolants; anti-knock substances for internal combustion engines; battery liquids; fuel economising compositions; deflocculation agents for oil and crude oil; oil dispersants; oil-separating chemicals; fluids for hydraulic circuits; transmission fluid; power steering fluids; refrigerants; heat transfer fluids; shock absorbing fluids; oil-purifying chemicals; tire repair pastes; tires (mastic for -); cleaning additives for fuel; chemical propellant additives; acidulated waters for the refilling and recharging of accumulators and batteries; distilled water; anti-freeze for windscreen washer systems, anti-freeze for radiators, de-icing preparations for windows, door lock de-icing agents, additives for the after-treatment of exhaust gas from combustion engines, in particular additives for reducing nitrogen oxides in exhaust gas from diesel engines in connection with a catalytic converter; transmission oil; hydraulic oils.

4 – Industrial oils and greases, lubricating oils and greases; motor oil; lubricants and lubricating greases; lubricants being gear oils; lubricants, carburants, drilling lubricants; dust absorbing, wetting and binding compositions; motor fuel and fuels (including motor spirit); non-chemical additives for oils and fuels; olefins (fuel); propane (combustion and heating gas); lighting fuel; oils for heating and lighting.

(260) AM 2021 108101 A  
 (800) 1528151  
 (151) 2020 03 19  
 (891) 2020 03 19  
 (731) Dukascopy Bank SA  
 Route de Pré-bois 20, CH-1217 Meyrin,  
 Switzerland

(540)

## DUKAS BANK

(591) Black, white

(511)

36 – Banking; bank card, credit card, debit card and electronic payment card services; issuing electronic payment cards in connection with bonus and reward

schemes; banking services in relation to the electronic transfer of funds; internet banking; issuing tokens of value as a reward for customer loyalty; issue and redemption of tokens of value; providing information relating to the issue of tokens of value; financial transactions via blockchain; financial services in relation to digital currencies; electronic wallet services (payment services); transfer of funds via electronic communication networks; electronic payment services; virtual currency transfer services; financial data analysis; computerised financial data services; financial forecasting; financial spread betting; brokerage services on the financial markets; financial exchange; electronic financial trading services; foreign exchange services; foreign exchange market; computerised financial services relating to foreign currency dealings; on-line real-time currency trading.

(260) AM 2021 108102 A  
 (800) 1528183  
 (151) 2020 03 05  
 (891) 2020 03 05  
 (731) TOOL-TEMP AG  
 Industriestrasse 30, CH-8583 Sulgen,  
 Switzerland  
 (540)



(591) Black, white  
 (531) 27.05.17; 27.05.22  
 (511)

7 – Electric motors for machines, particularly for cooling installations, heating apparatus, temperature-control apparatus and conditioning baths; machine tables; regulators for machines; stands (machinery); hangers [parts of machines]; housings (parts of machines); fittings for engine boilers; condensers (steam parts of machines); compressors (machines); compressors for cooling installations; condensing installations; steam engine boilers; pumps (machines); pumps as machine parts; pumps for heating installations; regulators (machine parts); water separator; water heaters (parts of machines); conditioning baths (machines).

9 – Measuring, signaling and checking apparatus and instruments, particularly for cooling apparatus, cooling installations, water cooling apparatus, temperature-control apparatus, conditioning baths and heating apparatus or installations; electric and electronic control apparatus, particularly for cooling apparatus, cooling installations, water cooling apparatus, temperature-control apparatus, conditioning baths, heating apparatus or installations; thermostats; software for industrial processes.

11 – Cooling appliances and installations; cooling installations; electric heating apparatus; air cooling devices; water cooling apparatus; temperature-control apparatus.

(260) AM 2021 108103 A  
 (800) 1528241  
 (151) 2020 03 05  
 (891) 2020 03 05  
 (731) TOOL-TEMP AG  
 Industriestrasse 30, CH-8583 Sulgen,  
 Switzerland  
 (540)

## TOOLTEMP

(591) Black, white  
 (511)  
 7 – Electric motors for machines, particularly for cooling installations, heating apparatus, temperature-control apparatus and conditioning baths; machine tables; regulators for machines; stands (machinery); hangers [parts of machines]; housings (parts of machines); fittings for engine boilers; condensers (steam parts of machines); compressors (machines); compressors for cooling installations; condensing installations; steam engine boilers; pumps (machines); pumps as machine parts; pumps for heating installations; regulators (machine parts); water separator; water heaters (parts of machines); conditioning baths (machines).

9 – Measuring, signaling and checking apparatus and instruments, particularly for cooling apparatus, cooling installations, water cooling apparatus, temperature-control apparatus, conditioning baths and heating apparatus or installations; electric and electronic control apparatus, particularly for cooling apparatus, cooling installations, water cooling apparatus, temperature-control apparatus, conditioning baths, heating apparatus or installations; thermostats; software for industrial processes.

11 – Cooling appliances and installations; cooling installations; electric heating apparatus; air cooling devices; water cooling apparatus; temperature-control apparatus.

(260) AM 2021 108104 A  
 (800) 1528258  
 (151) 2020 04 01  
 (891) 2020 04 01  
 (731) SOREMARTEC S.A.  
 16, route de Trèves, L-2633 Senningerberg,  
 Luxembourg

(540)



(591) Yellow, white, several shades of brown and beige  
 (531) 05.07.06; 08.01.21; 29.01.13  
 (511)  
 30 – Pastries and confectionery; chocolate; ice cream; sorbets and other edible ices; chocolate confectionery; cocoa-based beverages; all the aforementioned goods containing peanut butter.

(260) AM 2021 108106 A  
 (800) 863045  
 (151) 2005 09 09  
 (891) 2020 04 14  
 (731) DISTILLERIE MERLET & FILS (Société par Actions Simplifiée)  
 Lieu-dit Chevessac, F-17610 SAINT SAUVANT, France

(540)



(591) Black, white  
 (531) 27.05.01; 27.05.22  
 (511)  
 33 – Alcoholic beverages (except beers), liqueurs and spirits.

(260) AM 2021 108136 A  
 (800) 1528385  
 (151) 2020 04 08  
 (891) 2020 04 08  
 (731) Shanghai Fusion Tech Co., Ltd.  
 Room 901-73, No.323, Guoding Road, Yangpu District; 200082 Shanghai, China

(540)



(591) Black, white  
 (531) 27.05.01; 27.07.01  
 (511)  
 7 – Agricultural machines; type-setting machines [printing]; washing machines [laundry]; embossing machines; dust removing installations for cleaning purposes; vending machines; 3D printers.

(260) AM 2021 108137 A  
 (800) 1528405  
 (151) 2020 02 28  
 (891) 2020 02 28  
 (731) EuroChem Group AG  
 Baarerstrasse 37, CH-6300 Zug, Switzerland  
 (540)



(591) Black, white  
 (511)  
 1 – Chemical products for use in agriculture, horticulture and forestry; fertilizers; chemical products for fertilizers.

(260) AM 2021 108138 A  
 (800) 1528411  
 (151) 2020 03 04  
 (891) 2020 03 04  
 (731) Huawei Technologies Co., Ltd.  
 Administration Building, Huawei Technologies Co., Ltd. Bantian, Longgang District, Shenzhen, China

(540)



(591) Black, red and white  
 (531) 26.04.04; 26.04.07; 26.04.12; 26.04.18; 26.04.24; 26.11.01; 26.11.12; 27.05.10; 27.05.24; 29.01.13  
 (511)  
 9 – Virtual reality headsets; laptop computers; humanoid robots with artificial intelligence; computer software applications, downloadable; facial recognition apparatus; wearable activity trackers; computer programs, recorded; computer software platforms, recorded or downloadable; smartphones; tablet computers; network communication equipment; downloadable software applications for mobile phones.

35 – Provision and rental of advertising space on the Internet; online advertising on computer communication networks; providing commercial information and advice for consumers in the choice of products and services; providing business information via a web site; commercial administration of the licensing of the goods and services of others; providing business information via the Internet, wired network, or other forms of data transmission; promoting the goods and services of others; procurement services for others [purchasing goods and services for other businesses]; provision of an online marketplace for buyers and sellers of goods and services; compiling indexes of information for commercial or advertising purposes;

search engine optimization for sales promotion; advertising.

42 – Quality checking and testing; technological research; software as a service [SaaS]; cloud computing; platform as a service [PaaS]; research and development of computer software; design and development of computer software; electronic data storage; quality system certification; providing information relating to computer technology and programming via a web site.

(260) AM 2021 108139 A

(800) 1528443

(151) 2019 11 13

(891) 2019 11 13

(731) SDCIC Construction Group Shares CO., LTD  
Block A, SDCIC mansion, NO.6 Guanglan  
Road, Futian Free Trade Zone, Futian District,  
Shenzhen City, 518000 Guangdong Province,  
China

(540)

**SDCIC**

(591) Black, white

(531) 27.05.01; 27.05.17

(511)

37 – Building construction supervision; construction information; construction of steel structures; construction of airports; construction; damp-proofing [building]; building insulating; building construction; building maintenance and repair; commercial housing construction; building of fair stalls and shops; upholstery; heating equipment installation and repair; electric appliance installation and repair; machinery installation, maintenance and repair; interference suppression in electrical apparatus; installation and repair of sanitary apparatus; installation and repair medical equipment; vehicle breakdown repair services; photographic apparatus repair; clock and watch repair; safe maintenance and repair; rustproofing; retreading of tires; carpentry services; laundering; disinfecting; pump repair and maintenance; cleaning of storage tanks; telephone installation and repair; elevator installation and repair; burglar alarm installation and repair; septic tank cleaning; restoration of musical instruments; knife sharpening; rental of drainage pumps; artificial snow-making services; repair of hand tools; book repair and restoration; repair of binoculars; repair of toys or dolls; repair of power lines; rental of dish washing machines; luggage repair; shoe repair; restoration of works of art; repair of game machines and game apparatus; swimming-pool maintenance; installation and repair of entertainment and sports apparatus; umbrella repair; jewelry repair.

42 – Weighing goods for others; marine chart updating services; graphic design; technological research; engineering drawing; engineering design services;

quality testing; surveying; chemical analysis; biological research; meteorological information; material testing; industrial design; construction drafting; design of interior decor; construction project development; planning and design of entertainment venue buildings; exhibition venue design; architectural design; dress designing; computer software design; authenticating works of art; graphic arts design; cloud seeding; handwriting analysis [graphology]; cartography services.

(260) AM 2021 108145 A

(800) 1528561

(151) 2020 02 21

(891) 2020 02 21

(731) Open-Type Joint Stock Company  
"ROT FRONT"

2-oy Novokuznetskiy pereulok, d. 13/15,  
RU-113184 Moscow, Russian Federation

(540)



(591) Golden, brown, white

(531) 24.01.15; 24.01.20; 25.01.10; 25.01.15;

25.01.25; 25.12.03; 25.12.25; 28.05; 29.01.13

(526) The word in Cyrillic transliterated into "Aktionernoe obshchestvo Moskva Konfety Moskva".

(511)

30 – Candies.

(260) AM 2021 108146 A

(800) 1528606

(151) 2020 01 22

(891) 2020 01 22

(731) Reemtsma Cigarettenfabriken GmbH

Max-Born Strasse 4, 22761 Hamburg, Germany

(540)

**BE INSPIRED**

(591) Black, white

(511)

34 – Tobacco, whether manufactured or unmanufactured; tobacco products; tobacco substitutes, none being for medicinal or curative purposes; cigarettes; cigarillos; cigars; hand-held machines for making cigarettes; cigarette tubes; cigarette filters; cigarette papers; electronic cigarettes; liquids for electronic cigarettes; matches and smokers articles.

(260) AM 2021 108147 A  
 (800) 1528638  
 (151) 2020 01 28  
 (891) 2020 01 28  
 (731) Otkrytoe aktsionernoje obshchestvo "Minskiy molochny zavod №1"  
 ul. Vokzalnaya 11, 223034 Zaslavl, Minskiy rayon, Belarus



(591) Black, white  
 (531) 28.05  
 (511)  
 16 – Paper and cardboard; printed matter; bookbinding material; photographs [printed]; stationery; adhesives [glues] for stationery or household purposes; artists' and drawing materials; paintbrushes; typewriters and office requisites [except furniture]; instructional and teaching materials; plastic materials for packaging; printing type; printing blocks.

29 – Meat, fish, poultry and game; meat extracts; preserved, frozen, dried and cooked fruits and vegetables; jellies, jams, compotes; eggs; milk and milk products; oils and fats for food.

30 – Coffee; tea; cocoa; sugar; rice; tapioca; sago; artificial coffee; flour and preparations made from cereals; bread, pastries and confectionery; ice cream; honey, treacle; yeast, baking-powder; salt; mustard; vinegar, sauces [condiments]; spices; edible ices.

(260) AM 2021 108148 A  
 (800) 1528642  
 (151) 2020 01 31  
 (891) 2020 01 31  
 (731) Ivoclar Vivadent AG  
 Bendererstrasse 2, FL-9494 Schaan,  
 Liechtenstein



(591) Black, white  
 (511)  
 9 – Software for dental use.

(260) AM 2021 108149 A  
 (800) 1528686  
 (151) 2020 03 02  
 (891) 2020 03 02  
 (731) Riedel Communications International GmbH  
 Uellendahler Str. 353, 42109 Wuppertal,  
 Germany

(540)

**Embrionix**

(591) Black, white  
 (511)  
 9 – Telecommunications equipment and systems, networks and network components, in particular intercom stations, radio apparatus, cameras [photography], microphones, mixing desks, gateways, converters, transceivers, receivers; software; signalling and inspecting apparatus and instruments, apparatus for recording, transmitting or reproducing sound, images or data; data-processing equipment and computers.

38 – Telecommunications, rental of telecommunications apparatus.

(260) AM 2021 108155 A  
 (800) 1528760  
 (151) 2020 02 18  
 (891) 2020 02 18  
 (731) IMMATICS BIOTECHNOLOGIES GMBH  
 Paul-Ehrlich-Straße 15, 72076 Tübingen,  
 Germany



(591) Black, white  
 (511)  
 42 – Medical and pharmacological research services.  
 44 – Medical and pharmacological services.

(260) AM 2021 108156 A  
 (800) 1528777  
 (151) 2020 02 21  
 (891) 2020 02 21  
 (731) Open-Type Joint Stock Company  
 "Krasnyj Ochyabr"  
 ul. Malaya Krasnoselskaya, d. 7, str. 24,  
 RU-107140 Moscow, Russian Federation

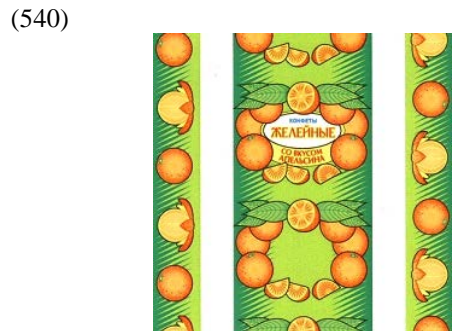

(591) Light green, green, white, orange, yellow, dark yellow, red, blue and black.  
 (531) 05.07.11; 25.05.25; 25.07.23; 26.01.18;  
 26.04.02; 28.05; 29.01.15  
 (526) КОНФЕТЫ ЖЕЛЕЙНЫЕ СО ВКУСОМ АПЕЛЬСИНА



(511)  
30 – Confectionery.

(260) AM 2021 108160 A  
(800) 1528836  
(151) 2019 11 26  
(891) 2019 11 26  
(731) Fohoway (Tianjin) Technology Development Co., Ltd.  
Room 1-4302, Block E, 6 HuaFeng Road,  
HuaMing High-tech Industrial Zone, DongLi District, Tianjin, China

(540)

**FOHOWAY**

(591) Black, white  
(531) 27.05.01; 27.05.17  
(511)

16 – Paper; paper for recording machines; toilet paper; advertisement boards of paper or cardboard; note books; cardboard tubes; printed publications; newspapers; lithographic works of art; packaging material made of starches; bookbinding material; files [office requisites]; ink; stamps [seals]; writing materials; gummed tape [stationery]; drawing instruments; drawing materials; prints [engravings]; teaching materials [except apparatus]; architects' models; copying paper [stationery]; oil paintings.

25 – Clothing; vests; bodices [lingerie]; underwear; underpants; brassieres; clothing made of infrared radiation reflective cloth to keep warm, not for medical purpose; layettes [clothing]; footwear; caps being headwear; hosiery; panty hose; gloves [clothing]; scarfs; girdles; religious clothing; sleep masks.

28 – Apparatus for games; conjuring apparatus; toys; chess; balls for games; body-building apparatus; fitness bed; fitness swing machine; archery implements; machines for physical exercises; hunting game calls; swimming pools [play articles]; plastic track; shin guards [sports articles]; elbow guards [sports articles]; knee guards (sports articles); waist guards for athletic use; leg guards for athletic use; arm guards for athletic use; sports belt; wrist guards for athletic use; snowshoes; christmas trees of synthetic material; fishing tackle; twirling batons; camouflage screens [sports articles]; scratch cards for playing lottery games; sweatband for sports; racket sweatband.

29 – Edible birds' nests; seaweed extracts for food; fish-based foodstuffs; canned fishery products; pollen prepared as foodstuff; snacks, mainly of fruits or vegetables; processed areca; vegetables, dried; eggs; milk products; edible fats; fruit jellies; dried edible mushrooms; tofu products (bean curd products); sausage casings, natural or artificial; edible birds' nests.

35 – Advertising; commercial administration of the licensing of the goods and services of others; marketing; personnel management consultancy; relocation services for businesses; systemization of information into computer databases; accounting; rental of vending machines; sponsorship search; rental of sales stands.

(260) AM 2021 108162 A  
(800) 1528887  
(151) 2020 02 27  
(891) 2020 02 27  
(731) LIMITED LIABILITY MANUFACTURING AND TRADING COMPANY "ACME"  
5 Promyslova Str., Ukrainka, Obukhivsky r-n, Kyivska obl. 08720, Ukraine

(540)

**LO  
RE  
N<sup>COLOR</sup>**

(591) Black, white  
(531) 27.05.09; 27.05.10; 27.05.25  
(511)

3 – Non-medicated cosmetics and toiletry preparations; non-medicated dentifrices; perfumery, essential oils; bleaching preparations and other substances for laundry use; cleaning, polishing, scouring and abrasive preparations; abrasive paper; abrasives; adhesives for affixing false eyelashes; adhesives for affixing false hair; adhesives for cosmetic purposes; after-shave lotions; air fragrance reed diffusers; air fragrancing preparations; almond milk for cosmetic purposes; almond oil; almond soap; aloe vera preparations for cosmetic purposes; alum stones [astringents]; amber [perfume]; ammonia [volatile alkali] [detergent]/volatile alkali [ammonia] [detergent]; antiperspirant soap; antiperspirants [toiletries]; antistatic dryer sheets / antistatic drier sheets; antistatic preparations for household purposes; aromatics [essential oils]; astringents for cosmetic purposes; baby wipes impregnated with cleaning preparations; badian essence; balms, other than for medical purposes; bases for flower perfumes; basma [cosmetic dye]; bath preparations, not for medical purposes; bath salts, not for medical purposes; beard dyes; beauty masks; bergamot oil; bleaching preparations [decolorants] for cosmetic purposes; bleaching preparations [decolorants] for household purposes; bleaching salts; bleaching soda; body paint for cosmetic purposes; breath freshening preparations

for personal hygiene; breath freshening sprays; breath freshening strips; cake flavourings [essential oils] / cake flavorings [essential oils]; cakes of toilet soap / cakes of soap; canned pressurized air for cleaning and dusting purposes; carbides of metal [abrasives]; chemical cleaning preparations for household purposes; cleaning chalk; cleaning preparations; preparations for cleaning dentures; cleansers for intimate personal hygiene purposes, non medicated; cleansing milk for toilet purposes; cloths impregnated with a detergent for cleaning; cobblers' wax; collagen preparations for cosmetic purposes; colorants for toilet purposes; colour run prevention laundry sheets / color run prevention laundry sheets; colour-brightening chemicals for household purposes [laundry] / color-brightening chemicals for household purposes [laundry]; colour-removing preparations / color-removing preparations; corundum [abrasive]; cosmetic creams; cosmetic dyes; cosmetic kits; cosmetic pencils; cosmetic preparations for baths; cosmetic preparations for eyelashes; cosmetic preparations for skin care; cosmetic preparations for slimming purposes; cosmetics; cosmetics for animals; cosmetics for children; cotton swabs for cosmetic purposes / cotton sticks for cosmetic purposes; cotton wool for cosmetic purposes; cotton wool impregnated with make-up removing preparations; creams for leather / waxes for leather; decorative transfers for cosmetic purposes; degreasers, other than for use in manufacturing processes; dental bleaching gels; dentifrices; denture polishes; deodorant soap; deodorants for human beings or for animals; deodorants for pets; depilatory preparations / depilatories; depilatory wax; descaling preparations for household purposes; detergents, other than for use in manufacturing operations and for medical purposes; diamantine [abrasive]; douching preparations for personal sanitary or deodorant purposes [toiletries]; dry shampoos; dry-cleaning preparations; drying agents for dishwashing machines; eau de Cologne; emery; emery cloth; emery paper; essential oils / ethereal oils; essential oils of cedarwood; essential oils of citron; essential oils of lemon; ethereal essences; extracts of flowers [perfumes]; eye-washes, not for medical purposes; eyebrow cosmetics; eyebrow pencils; fabric softeners for laundry use; false eyelashes; false nails; flavourings for beverages [essential oils] / flavorings for beverages [essential oils]; floor wax; floor wax removers [scouring preparations]; food flavourings [essential oils] / food flavorings [essential oils]; fumigation preparations [perfumes]; gaultheria oil; gel eye patches for cosmetic purposes; geraniol; glass cloth [abrasive cloth]; greases for cosmetic purposes; grinding preparations / sharpening preparations; hair conditioners; hair dyes / hair colorants; hair lotions; hair spray; hair straightening preparations; hair waving preparations / waving preparations for the hair; heliotropine; henna [cosmetic dye]; herbal extracts for cosmetic purposes; hydrogen peroxide for cosmetic purposes; incense; ionone [perfumery]; jasmine oil; javelle water / potas-

sium hypochloride; joss sticks; lacquer-removing preparations; laundry bleach / laundry bleaching preparations; laundry blueing; laundry glaze; laundry preparations; laundry soaking preparations / preparations for soaking laundry; lavender oil; lavender water; leather bleaching preparations, leather preservatives [polishes] / preservatives for leather [polishes]; preparations to make the leaves of plants shiny; lip glosses; lipstick cases; lipsticks; liquid latex body paint for cosmetic purposes; lotions for cosmetic purposes; make-up; make-up powder; make-up preparations; make-up removing preparations; mascara; massage candles for cosmetic purposes; massage gels, other than for medical purposes; micellar water; mint essence [essential oil]; mint for perfumery; moustache wax / moustache wax; mouthwashes, not for medical purposes; musk [perfumery]; nail art stickers, nail care preparations; nail glitter; nail varnish / nail polish; nail varnish removers / nail polish removers; neutralizers for permanent waving; non-slipping liquids for floors; non-slipping wax for floors; oil of turpentine for degreasing; oils for cleaning purposes; oils for cosmetic purposes; oils for perfumes and scents; oils for toilet purposes; paint stripping preparations; pastes for razor strops; perfumery; perfumes; petroleum jelly for cosmetic purposes; phytocosmetic preparations; polish for furniture and flooring; polishing creams; polishing paper; polishing preparations; polishing rouge / jewellers' rouge; polishing stones; polishing wax; pomades for cosmetic purposes; potpourris [fragrances]; pumice stone; quillaia bark for washing; rose oil; rust removing preparations; sachets for perfuming linen; saffrol; sandcloth / abrasive cloth; sandpaper / glass paper; scented water; scented wood; scouring solutions; shampoos for animals [non-medicated grooming preparations]; shampoos for pets [non-medicated grooming preparations]; shampoos; shaving preparations; shaving soap; shaving stones [astringents]; shining preparations [polish]; shoe cream; shoe polish; shoe wax; shoemakers' wax; silicon carbide [abrasive]; skin whitening creams / cream for whitening the skin; smoothing preparations [starching]; smoothing stones; soap for brightening textile; soap for foot perspiration; soap; soda lye; stain removers; starch for laundry purposes / laundry starch; starch glaze for laundry purposes; sun-tanning preparations [cosmetics]; sunscreen preparations; tailors' wax; talcum powder, for toilet use; teeth whitening strips; terpenes [essential oils]; tissues impregnated with cosmetic lotions; tissues impregnated with make-up removing preparations; toilet water; toiletry preparations; toothpaste; Tripoli stone for polishing; turpentine for degreasing; preparations for unblocking drain pipes; vaginal washes for personal sanitary or deodorant purposes; varnish-removing preparations; volcanic ash for cleaning; wallpaper cleaning preparations; washing soda, for cleaning; wax for parquet floors; whiting; windscreen cleaning liquids / windshield cleaning liquids.

(260) AM 2021 108163 A

(800) 1528968

(151) 2019 12 19

(891) 2019 12 19

(731) CLIVET S.P.A.

Via Camp Lonc, 25, Feltre frazione località,  
VILLAPAIERA (BELLUNO), Italy

(540)



(591) Black, white

(531) 26.01.01; 26.01.10; 26.01.12; 26.11.03;  
26.11.08; 27.05.01

(511)

11 – Heat pumps; infrared heating panels; air-conditioning units; fans [air-conditioning]; central air-conditioning installations; air filters for air-conditioning units; evaporators for air-conditioning apparatus; heating boilers; heating elements; heating installations; central heating boilers; heaters for central heating; solar thermal collectors [heating]; heating filaments, electric; central heating radiators; flues for heating boilers; solar thermal conversion collectors [heating]; heat sinks for use in heating apparatus; hot water heating installations; hot plates for household purposes; radiators [heating]; thermostatic valves [parts of heating installations]; coils [parts of distilling, heating or cooling installations]; dosing valves [parts of heating or gas installations]; expansion tanks for central heating installations; solar water heaters; heat accumulators; heat recovery systems; heat sinks for use in cooling apparatus; heat sinks for use in ventilating apparatus, water distribution installations; storage water heaters; hot air apparatus; hot water boilers; hot water tanks; hot water heaters; hot air blowers; sanitary apparatus and installations; pipes [parts of sanitary installations]; air purifying apparatus; air conditioners for vehicles; heating apparatus, electric; radiant heating apparatuses; refrigerators; air-conditioning apparatus; fan heaters; dehumidifiers; air filtering installations; radiators, electric; ionization apparatus for the treatment of air; air deodorizing apparatus; household air cleaners; air-conditioning apparatus; air filters; centralized air-conditioning installations; air reheaters; humidifiers; air purifying units; direct-expansion VRF [variable refrigerant flow] air-conditioning systems; split-system direct expansion air-conditioning systems; apparatus and installations for lighting, heating, cooling, steam generating, cooking, drying, ventilating, water supply and sanitary purposes.

(260) AM 2021 108164 A

(800) 1529020

(151) 2020 03 19

(891) 2020 03 19

(731) FNC International BV

Rijksstraatweg 7, NL-3316 EE Dordrecht,  
Netherlands

(540)



(591) Purple and white

(531) 10.05.19; 19.07.01; 19.07.10; 19.07.12;  
19.07.17; 19.07.25; 27.05.10; 29.01.05

(511)

35 – Online wholesale and retail store services in the fields of cosmetics, perfumery, aromatherapy, candles and haircare preparation; wholesale and retail store services in the fields of cosmetics, perfumery, aromatherapy, candles and haircare preparation.

(260) AM 2021 108165 A

(800) 1529038

(151) 2020 03 17

(891) 2020 03 17

(731) Apple Inc.

One Apple Park Way, Cupertino CA 95014,  
USA

(540)



(591) The color(s) green, blue, purple, red, orange, and yellow is/are claimed as a feature of the mark

(531) 26.01.01; 26.04.04; 26.07.05; 26.07.25;  
26.11.07; 29.01.15

(511)

9 – Computer software used in connection with health and medical research studies.

(260) AM 2021 108166 A

(800) 1529056

(151) 2019 11 08

(891) 2019 11 08

(731) SWAG Autoteile GmbH

Am Kiesberg 4-6, 42117 Wuppertal,  
Germany

(540)

**SWAG**

(591) Black, white

(511)

1 – Chemicals used in industry, science and photography; unprocessed artificial resins, unprocessed plastics; fire extinguishing compositions; tempering and soldering preparations; adhesives used in industry; brake fluid; chemical additives for motor fuels; engine coolants; anti-knock substances for internal combustion engines; acidulated water for recharging batteries; fuel economising compositions; deflocculation agents for oil and crude oil; oil dispersants; oil-separating chemicals; fluids for hydraulic circuits; transmission fluid; power steering fluids; refrigerants; heat transfer fluids; oil-purifying chemicals; tire repair pastes; tires (mastic for -); cleaning additives for fuel; chemical propellant additives; acidulated waters for the refilling and recharging of accumulators and batteries; distilled water; anti-freeze for windscreen washer systems, anti-freeze for radiators, de-icing preparations for windows, door lock de-icing agents, additives for the after-treatment of exhaust gas from combustion engines, in particular additives for reducing nitrogen oxides in exhaust gas from diesel engines in connection with a catalytic converter.

4 – Industrial oils and greases, lubricating oils and greases; motor and transmission oil, hydraulic oils; lubricants and lubricating greases; lubricants being gear oils; dust absorbing, wetting and binding compositions; motor fuel and fuels (including motor spirit); non-chemical additives for oils and fuels; olefins (fuel); propane (combustion and heating gas); lighting fuel; oils for heating and lighting; lubricants, carburetors, drilling lubricants; shock absorbing fluids.

(260) AM 2021 108167 A

(800) 1529092

(151) 2020 02 25

(891) 2020 02 25

(731) SYNGENTA PARTICIPATIONS AG

Rosentalstrasse 67, CH-4058 Basel,  
Switzerland

(540)

## ADEPIDYN

(591) Black, white

(511)

1 – Active chemical ingredients for manufacture of fungicides, herbicides, insecticides, nematocides; chemical products used in agriculture, horticulture and forestry; bio-stimulant products; preparations for improving crops; preparations for fortifying plants; chemical and/or biological preparations for stress management in plants; plant growth regulating preparations; chemical preparations for seed treatment; additives.

(260) AM 2021 108168 A

(800) 1529096

(151) 2020 03 01

(891) 2020 03 01

(731) Nature's Sunshine Products, Inc.

2901 W. Bluegrass Blvd., Lehi UT 84043, USA

(540)



(591) Black, white

(531) 05.01.03; 05.01.16; 05.05.20; 26.11.25

(511)

3 – Non-medicated skin care preparations, namely, creams, lotions, gels, toners, cleaners and moisturizers; non-medicated personal care products, namely, hand and body soaps, hand and body creams, hand and body lotions; non-medicated soaps; hair care products, namely, shampoos, conditioners and hair nourishers; essential oils used as a skin emollient or skin moisturizer; massage oils and lotions; toothpaste; non-medicated anti-aging creams and serums; breath freshening tablets and oils; substances and preparations for aromatherapy, namely, essential oils.

5 – Nutritional supplements, namely, herbal preparations and combinations in the forms of capsules, tablets, and/or powders, herbal supplements, namely, herb extract liquids and powders, herbal dietary supplements made of capsuled herbs and herbal combinations; supplemental vitamins and minerals and trace mineral supplements and trace mineral supplements suspended in liquid and liquid chlorophyll; dietary supplement beverage concentrates for promoting weight control and dietary supplement tablets; powdered nutritional supplement drink mixes; dietary and nutritional supplements for weight loss; nutritional supplements for eliminating toxins from the body; meal replacement and dietary supplement drink mixes for medical use; nutritional drink mix for use as a meal replacement for medical use; nutritional shakes for use as a meal substitute for medical use; probiotic supplements; non-medicated homeopathic medicines and preparations for treating various ailments, namely, aches and pains, sunburn, cuts and abrasions; medical preparations, namely, herbal skin discomfort cream and herbal cough syrup; and powdered protein, vitamins and minerals for making beverages.

32 – Powders used in the preparation of energy drinks; fruit juices and fruit drinks; aloe vera juice.

35 – Offering business management assistance in the establishment and/or operation of person to person

wholesale and retail multi-level marketing services in the field of cosmetic and toilet preparations, nutritional and dietary supplements, air purifying units, water filtering apparatus; wholesale and retail distributorship services in the field of skin, hair and body care preparations, namely, body and facial cleansers, toners, moisturizers, creams, lotions, non-medicated anti-aging creams and serums, shampoos, conditioners, and hair nourishers, and essential oils, health foods, food supplements, herbs, vitamins and minerals.

- (260) AM 2021 108169 A  
 (800) 1529122  
 (151) 2020 02 18  
 (891) 2020 02 18  
 (731) Obshchestvo s ogranichennoy otvetstvennostyu "Kvadrat-C"  
 2-y Irtyskiy proezd, 4B, kor. 5, RU-107143  
 Moscow, Russian Federation

(540)



- (591) Grey, black, green, light green, crimson and turquoise  
 (531) 02.09.25; 24.17.20; 25.05.25; 28.05; 29.01.15  
 (511)  
 5 – Vitamin preparations and substances; calcium supplements; nutritional supplements; mineral biologically active supplements; vitamin supplement patches; vitamin and mineral supplements; dietary supplements for controlling cholesterol; dietary biologically active supplements; dietary food supplemental drinks; dietary supplements; dietary supplements for humans; wheat dietary supplements; zinc dietary supplements; herbal dietary supplements; food supplements consisting of amino acids; dietary supplements consisting of vitamins; food supplements consisting of trace elements; food supplements consisting of minerals; mineral food supplements; colostrum dietary supplements; albumin dietary supplements; vitamin and mineral food supplements; yeast dietary supplements; alginate dietary supplements; glucose dietary supplements; casein dietary supplements; lecithin dietary supplements; propolis dietary supplements; protein dietary supplements; protein supplements for animals; pollen dietary supplements; wheat germ dietary supplements; linseed dietary supplements; dietary supplements with a cosmetic effect; enzyme dietary supplements; mineral preparations and substances for medical purposes; vitamin and mineral supplements

for pets; nutritional supplements for animal foodstuffs; dietary biologically active and nutritious supplements; soy protein dietary supplements; natural dietary supplements for treatment of claustrophobia; linseed oil dietary supplements; royal jelly dietary supplements; acai powder dietary supplements; nutraceuticals for use as dietary supplements; dietetic substances consisting of vitamins, minerals, amino acids and trace elements; food supplements consisting of amino acids, minerals and trace elements; powdered fruit-flavored dietary supplement drink mix; nutritional supplements made of starch adapted for medical purposes; nutritional supplements in the nature of powdered drink mixes; ground flaxseed fiber for use as a dietary supplement; bee pollen for use as a dietary food supplement; vitamin supplements in tablet form for making effervescent beverages when added to water; tissues impregnated with insect repellents.

- (260) AM 2021 108170 A  
 (800) 1529164  
 (151) 2020 02 28  
 (891) 2020 02 28  
 (731) HUAWEI TECHNOLOGIES CO., LTD.  
 Administration Building Huawei Technologies Co., Ltd. Bantian, Longgang District, Shenzhen City, Guangdong Province, China

(540)

## HONOR Hunter

- (591) Black, white  
 (531) 27.05.01  
 (511)  
 9 – Wireless router; network cards; smartglasses; smartwatches; smartphones; wearable activity trackers; digital photo frames; microphones; computer hardware; computer memory devices; integrated circuit cards; cabinets for loudspeakers; network communication equipment; batteries; battery chargers; portable power supplies (rechargeable batteries); tablet computers; protective cases for tablet computers; portable computers; laptop computers; headsets; virtual reality headsets; set-top boxes; loudspeakers; portable media players; sound transmitting apparatus; video cameras; cameras [photography]; computer keyboards; mouse [computer peripheral]; video monitors; computer programs, recorded; computer software applications, downloadable; interactive touch screen terminals; humanoid robots with artificial intelligence; smart rings; facial recognition equipment; video screens; personal digital assistants [PDAs]; computer software platforms, recorded or downloadable; thin client computers; hand-held electronic dictionaries; wearable computers; telecommunication apparatus in the form of jewelry; televisions; electronic publications, downloadable; downloadable image files; downloadable music files; digital music downloadable from the Internet; chatting robot software for conversation

simulation; touch screen pens; video game cartridges; joysticks for use with computers, other than for video games; virtual reality game software.

(260) AM 2021 108171 A

(800) 1529165

(151) 2020 04 15

(891) 2020 04 15

(731) ZHEJIANG HEHE EMBROIDERY CO., LTD.  
No. 586, Sunjia, Jiyang Street, Zhuji, Shaoxing  
City, Zhejiang Province, China

(540)

**FORTEVER**

(591) Black, white

(531) 27.05.01; 27.05.17

(511)

7 – Sewing machines; stitching machines; pedal drives for sewing machines; reels [parts of machines]; tambours for embroidery machines; hemming machines; ironing machines; rotary steam presses, portable, for fabrics; lasts for shoes [parts of machines]; embroidery machines.

(260) AM 2021 108172 A

(800) 1529215

(151) 2020 03 04

(891) 2020 03 04

(731) Obshestvo s ogranichennoy otvetstvennostyu  
"Orbita"  
ul. Zolotorozhskij Val, d. 11, str. 9, jetazh 2,  
komn. 205, RU-111033 Moscow, Russian  
Federation

(540)



(591) White and red

(531) 01.01.02; 01.01.10; 07.05.02; 26.04.05;  
26.04.16; 28.05; 29.01.12

(511)

28 – Arcade video game machines; video game machines; gaming machines for gambling; amusement machines, automatic and coin-operated; trampolines; scratch cards for playing lottery games; starting blocks for sports; bodyboards; skating boots with skates attached; boomerangs; dolls' feeding bottles; stationary exercise bicycles; shuttlecocks; dumb-bells;

gyroscopes and flight stabilizers for model aircraft; jigsaw puzzles; punching bags; hang gliders; joysticks for video games; discs for sports; dolls' houses; dominoes; swimming kickboards; paddleboards; surfboards; skateboards; sailboards; chessboards; checkerboards; darts; christmas trees of synthetic material; cups for dice; swimming jackets; kites; needles for pumps for inflating balls for games; toys for pets; stuffed toys; plush toys; novelty toys for playing jokes; parlor games; board games; ring games; building games; toy imitation cosmetics; swimming pool air floats; kaleidoscopes; bladders of balls for games; rosin used by athletes; edges of skis; trading cards for games; bingo cards; playing cards; reels for fishing; swings; yoga swings; skittles; billiard cues; golf clubs; hockey sticks; baby gyms; bells for christmas trees; dolls' rooms; confetti; ice skates; roller skates; in-line roller skates; dice; ski bindings; dolls' beds; roulette wheels; fish hooks; dolls; flippers for swimming; rhythmic gymnastics ribbons; fishing lines; gut for fishing; bows for archery; skis; waterskis; roller skis; mah-jong; hunting game calls; puppets; carnival masks; theatrical masks; fencing masks; toy putty; matryoshka dolls; masts for sailboards; ball pitching machines; teddy bears; chalk for billiard cues; targets; electronic targets; scale model vehicles; kite reels; balls for games; artificial fishing bait; billiard table cushions; billiard cue tips; backgammon games; pumps specially adapted for use with balls for games; dolls' clothes; fencing weapons; play tents; ski sticks for roller skis; ski sticks; twirling batons; paragliders; pachinkos; baseball gloves; boxing gloves; golf gloves; fencing gauntlets; pinatas; toy pistols; toy air pistols; toy dough; protective films adapted for screens for portable games; horseshoe games; candle holders for christmas trees; christmas tree stands; sole coverings for skis; water wings; floats for fishing; portable games with liquid crystal displays; swimming belts; waist trimmer exercise belts; decoys for hunting or fishing; scent lures for hunting or fishing; archery implements; billiard markers; video game consoles; hand-held consoles for playing video games; rackets; surfboard leashes; harness for sailboards; toy robots; rollers for stationary exercise bicycles; plush toys with attached comfort blanket; bob-sleighs; butterfly nets; landing nets for anglers; nets for sports; tennis nets; appliances for gymnastics; quoits; barbells; climbers' harness; fishing tackle; artificial snow for christmas trees; snowshoes; snowboards; remote-controlled toy vehicles; clay pigeon traps; billiard tables; coin-operated billiard tables; tables for table tennis; strings for rackets; gut for rackets; golf bags, with or without wheels; golf bag carts; body-building apparatus; rods for fishing; tennis ball throwing apparatus; bowling apparatus and machinery; chips for gambling; foosball tables; bags especially designed for skis and surfboards; marbles for games; billiard balls; playing balls; play balloons; snow globes; chess games; poles for pole vaulting; paper party hats.

35 – Arranging subscriptions to telecommunication services for others; import-export agency services; commercial information agency services; advertising agency services; cost price analysis; rental of office equipment in co-working facilities; rental of advertising space; business auditing; financial auditing; business intermediary services relating to the matching of potential private investors with entrepreneurs needing funding; employment agency services; computerized file management; book-keeping; invoicing; demonstration of goods; business investigations; business research; marketing research; personnel recruitment; business management and organization consultancy; business organization consultancy; business management consultancy; personnel management consultancy; professional business consultancy; consultancy regarding advertising communication strategies; consultancy regarding public relations communication strategies; layout services for advertising purposes; marketing; marketing in the framework of software publishing; business management of performing artists; business management of sports people; writing of résumés for others; scriptwriting for advertising purposes; news clipping services; updating and maintenance of information in registries; updating and maintenance of data in computer databases; updating of advertising material; word processing; organization of exhibitions for commercial or advertising purposes; arranging newspaper subscriptions for others; organization of fashion shows for promotional purposes; shop window dressing; business appraisals; payroll preparation; sponsorship search; business management assistance; providing business information via a web site; providing commercial and business contact information; economic forecasting; auctioneering; sales promotion for others; promotion of goods and services through sponsorship of sports events; production of teleshopping programmes; production of advertising films; office machines and equipment rental; rental of advertising time on communication media; publicity material rental; rental of vending machines; rental of sales stands; rental of photocopying machines; publication of publicity texts; radio advertising; bill-posting; dissemination of advertising matter; direct mail advertising; writing of publicity texts; online advertising on a computer network; advertising by mail order; television advertising; compilation of statistics; compilation of information into computer databases; business inquiries; systemization of information into computer databases; advisory services for business management; negotiation of business contracts for others; negotiation and conclusion of commercial transactions for third parties; compiling indexes of information for commercial or advertising purposes; tax preparation; telemarketing services; psychological testing for the selection of personnel; interim business management; business management of hotels; business management for freelance service providers; business project management services for

construction projects; commercial administration of the licensing of the goods and services of others; business management of reimbursement programs for others; administrative processing of purchase orders; public relations; commercial lobbying services; competitive intelligence services; modelling for advertising or sales promotion; typing; market intelligence services; web site traffic optimization; tax filing services; search engine optimization for sales promotion; gift registry services; price comparison services; pay per click advertising; secretarial services; telephone answering for unavailable subscribers; photocopying services; business efficiency expert services.

---

(260) AM 2021 108173 A  
 (800) 1529304  
 (151) 2020 03 13  
 (891) 2020 03 13  
 (731) PASCHAL-Werk G. Maier GmbH  
 Kreuzbühlstrasse 5, 77790 Steinach, Germany  
 (540)

## Neor

(591) Black, white  
 (511)  
 6 – Building and construction materials and elements of metal; formwork of metal; formwork elements with formwork shell mainly made of metal; accessories [of metal] for formwork and formwork elements; lateral protection [of metal] for formwork and formwork elements; small items of metal hardware, in particular nuts, bolts and fasteners of metal; formwork parts of metal for concrete, in particular formwork boards and panels, formwork tables for slab formwork, formwork corners, compensation parts, connecting bolts, formwork tension rods, spacers of metal, conical stop elements for spacers; spacers being building elements made of metal; shuttering and cladding of metal for use in moulding concrete; scaffolding and scaffolding parts of metal, in particular the aforesaid for application on or of formwork walls, panels and railings for panels in the form of mounts for formwork walkways, formwork supports; profile rails, end rails and crossbeams each made of metal for overlapping and aligning adjacent formwork panels; girders and beams of metal; building panels of metal; metal frames of metal for building; wall formwork, ceiling formwork and support formwork of metal; work platforms, concreting platforms and support scaffolding of metal.

---

(260) AM 2021 108174 A  
 (800) 1529380  
 (151) 2020 01 09  
 (891) 2020 01 09  
 (731) KABUSHIKI KAISHA KOBE SEIKO SHO,  
 trading also as KOBE STEEL, LTD.  
 2-4, Wakinohama-Kaigandori 2-chome,  
 Chuo-ku, Kobe-shi, Hyogo 651-8585, Japan

(540)

**KOBELCO**

(591) Black, white

(531) 27.05.01; 27.05.17

(511)

2 – Preservatives against rust and against deterioration of wood; anti-corrosive preparations; anti-rust preparations; dyestuffs; pigments; glazes [paints, lacquers]; paints; printing ink; anti-rust greases; anti-rust oils; metals in foil and powder form for use in painting, decorating, printing and art; filled toner cartridges; paper for dyeing Easter eggs; watercolor paints for use in art; oil colors.

3 – Rust removing preparations; canned pressurized air for dusting and cleaning purposes; adhesives for cosmetic use; breath fresheners; deodorants for animals; cotton sticks for cosmetic purposes; paint stripping preparations; shoe cream; polishing, scouring and abrasive preparations; soaps and detergents; cleaning preparations; scouring powders; dentifrices; mouthwashes, not for medical purposes; bath preparations, not for medical purposes; cosmetics; perfumery; essential oils; air fragrancing preparations; shoemakers' wax; abrasive cloth and paper; abrasive preparations; sand for sandblasting; abrasives for sandblasting; false nails; false eyelashes.

5 – Air purifying preparations; pharmaceutical preparations; chemical preparations for pharmaceutical purposes; air deodorizing preparations; bactericides; fungicides; insecticides; preparations for destroying vermin; herbicides; adhesive plasters; teeth filling material; biological implants; baby diapers; fly catching paper; diapers for pets; mothproofing paper; lacteal flour for babies; dietary supplements; dietetic foods adapted for medical purposes; food for babies; dietary supplements for animals; semen for artificial insemination; paper pads for changing diapers.

8 – Tweezers; braiders [hand tools]; agricultural implements, hand-operated; lasts [shoemakers' hand tools]; apparatus for tattooing; flat irons; electric or non-electric hair trimmers; cutting tools [hand tools]; scissors; edge tools [hand tools]; hand tools and implements [hand-operated]; tableware [knives, forks and spoons]; side arms, other than firearms; metal wire stretchers [hand tools]; hand-operated grease guns; screwdrivers, non-electric; spanners [hand tools]; hammers [hand tools]; wrenches [hand tools]; whetstones; kitchen mandolines; dressmakers' chalk sharpeners; fire irons; bludgeons; guns [hand tools]; hair-removing tweezers; scrapers for skis; ice axes; diving knives; palette knives.

13 – Firearms; projecting apparatus for grenades, bombs and other missiles; pyrotechnics; explosives; detonators; sprays for personal defense purposes;

tanks [weapons]; highway flares, explosive or pyrotechnical.

14 – Precious metals and their alloys; jewellery, precious and semi-precious stones; unwrought precious stones; key rings [split rings with trinket or decorative fob]; key rings of leather; bottle caps of precious metal; jewellery boxes; works of art of precious metal; commemorative medals; tombstones of precious metal; imitation jewellery; earrings; tie clips; necklaces [jewellery]; bracelets [jewellery]; ornamental pins; cuff links; shoe jewellery; clocks; watches; sculptures of precious metal.

16 – Stationery and office requisites, except furniture; pastes and other adhesives for stationery or household purposes; correcting ink [heliography]; sealing wax; printing type; drawing instruments; paper shredders for office use; stencil plates; staplers [office requisites]; marking templates; histological sections for teaching purposes; pencil sharpeners; paint rollers; binding materials for books and papers; bibs of paper; paper containers; wrapping paper; paper bags; cardboard cartons; plastic or paper bags for merchandise packaging [envelopes, pouches]; plastic film for packaging; elastic bands for offices; grocery bags of paper or plastic; garbage bags of paper or of plastics; marking chalk; banners of paper; flags of paper; paper party decorations; towels of paper; table napkins of paper; paper toilet bowl liners; shipping labels of paper; toilet seat cover paper; paper shopping bags; bookends; file boxes for storage of business and personal records; tablecloths of paper; figures made of paper; portraits; signboards of paper or cardboard; printed paper signs; paper badges; passport covers; money clips; architects' models; plastics for modelling; paper and cardboard; tissue paper; filtering materials of paper; bookmarkers; greeting cards; stickers; day planners; note books; memo pads; adhesive note paper; binders [office supplies]; paper folders; writing instruments; pens; paperweights; name badge holders [office requisites]; retractable reels for name badge holders [office requisites]; clips for name badge holders [office requisites]; business cards; letterhead paper; envelopes; mechanical pencils; ball-point pens; pencils; highlighting markers; albums; paper clips; rubber stamps; seals [stationery]; paper knives [letter openers]; stamp cases; seals for offices; pen trays; pen cases; stands for pens and pencils; postcards; teaching materials [except apparatus]; printed matter; printed publications; books; booklets; catalogues; pamphlets; posters; instruction manuals; house organs; newsletters; newspapers; general feature magazines; calendars; drawings; textbooks; tickets; geographical maps; diaries; calligraphic works; paintings; pictures; photographs [printed]; photograph stands; omikujii [sacred lots] [printed strips of paper used for fortune telling].

18 – Straps for soldiers' equipment; feed bags for animals; poultry blinkers to prevent fighting; casings,



of leather, for springs; valves of leather; handbag frames; baby carriers worn on the body; leather straps; boxes of vulcanized fiber; leather cases; clothing for pets; leather trimmings for furniture; reins for guiding children; bags; sports bags; tote bags; travelling bags; luggage tags; rucksacks; key cases; wallets; coin purses; card cases [notecases]; business card cases; cosmetic bags sold empty; umbrellas; parasols; canes; straps for skates; saddlery; alpenstocks; labels of leather; leather and imitations of leather; fur; artificial fur.

19 – Asphalt, pitch and bitumen; non-metallic minerals for building or construction; gypsum [building material]; sand; gravel; construction materials, not of metal; reinforcing materials, not of metal, for building; materials for making and coating roads; refractory bricks, not of metal; building panels, not of metal; wall panels, not of metal; refractory construction materials, not of metal; paving blocks, not of metal; ceramic backing materials for welding; non-metal ventilating ducts; ducts, not of metal, for ventilating and air-conditioning installations; plaster for building purposes; rockslide retention nets of textiles [construction materials]; crash barriers of plastic for roads; plastic pipes for plumbing purposes; flux backing materials for welding; buildings, not of metal; plastic security windows allowing communication; road marking sheets and strips of synthetic material; aggregate; concrete; concrete building elements; blocks of concrete; penstock pipes, not of metal; building timber; building stone; slag [building material]; paving stone; building glass; foundry molds, not of metal; non-metal artificial fish reefs; aviaries [structures], not of metal; paint spraying booths, not of metal; bicycle parking installations, not of metal; water-pipe valves, not of metal or plastic; non-luminous and non-mechanical signs, not of metal; road signs, non-luminous and non-mechanical, not of metal; beacons, not of metal, non-luminous; storage tanks of masonry; tanks of masonry; mooring bollards, not of metal; bird baths [structures], not of metal; letter boxes of masonry; aquaria [structures]; works of art of stone, concrete or marble; outdoor blinds, not of metal and not of textile; stone lanterns [garden ornaments of stone]; greenhouses, transportable, not of metal; memorial plaques, not of metal; gravestones; diving boards, not of metal; plaster boards; slag.

21 – Dental floss; mosaics of glass and ceramic tiles, not for construction; glassware, porcelain and earthenware; glass, unworked or semi-worked, except building glass; mangers for animals; poultry rings; make-up removing appliances; bottle openers, electric and non-electric; cosmetic utensils; brushes; electric toothbrushes; wire brushes, not being machine parts; gloves for household purposes; household or kitchen utensils and containers; flasks of precious metal; bottles; glasses [receptacles]; plastic bottles; pottery; glass stoppers; non-electric coffee makers; non-electric cooking pots and pans; dishware; tableware, other

than knives, forks and spoons; cups; coffee mugs; tumblers; beer mugs; lunch boxes; portable cool boxes, non-electric; water bottles sold empty; heat-insulated containers for beverages; insulating sleeve holders for bottles; chopsticks; chopstick rests; toothpicks; salt shakers; articles for cleaning purposes; scrubbing brushes; brooms; steel wool; mops; cloths for cleaning; washing brushes; wash basins [bowls, not parts of sanitary installations]; clothes drying hangers; sponges for household purposes; ironing boards; aerosol dispensers, not for medical purposes; baby baths, portable; bathroom pails; candlesticks; coal scuttles; insect traps; flower pots; watering cans; hydroponic growing containers for household purposes; sprinkling devices; feeding vessels for pets; brushes for pets; cages for household pets; litter trays for pets; clothes brushes; potties for children; chamber pots; piggy banks; cold packs for chilling food and beverages; dispensers for facial tissues; soap dispensers; indoor aquaria; toilet paper holders; thermally insulated wraps for cans to keep the contents hot or cold; vases; signboards of porcelain or glass; incense burners; fitted vanity cases; hair combs; hair brushes; toothbrushes; toilet cases; bath sponges; shoe horns; portable pots and pans for camping; material for brush-making.

24 – Printers' blankets of textile; woven fabrics; textile material; felt and non-woven textile fabrics; filtering materials of textile; rubberized cloth; baby bunnings; towels of textile; handkerchiefs of textile; household linen; lap blankets; bed linen; table linen, not of paper; tea towels; shower curtains; banners of textile or plastic; flags of textile or plastic; blankets for household pets; fitted toilet seat covers of textile; draperies [thick drop curtains]; curtains; tablecloths, not of paper; coverings of plastic for furniture; wall hangings of textile; shrouds; bath mitts; billiard cloth; sleeping bags; labels of textile.

25 – Clothing, footwear, headgear; articles of clothing, footwear and headgear for babies and toddlers; ready-made clothing; tops [clothing]; bottoms [clothing]; shirts; t-shirts; clothing for children; clothing for babies; rugby tops; non-Japanese style outerclothing; vests; overalls; liveries; jackets [clothing]; sweatshirts; sweatpants; sports shirts; trousers; parkas; polo shirts; ponchos; wristbands [clothing]; collared shirts; rugby shorts; uniforms; rainwear; pajamas; underwear; baby bodysuits; swimwear; kimonos; Japanese traditional clothing; scarfs; socks; neckties; ear muffs [clothing]; plastic baby bibs; bibs, not of cloth or paper; gloves [clothing]; baseball caps; headwear; suspenders [braces]; belts [clothing]; shoes and boots; shoes; footwear; work boots; non-slipping devices for footwear; Japanese style wooden clogs [geta]; slippers; bath sandals; masquerade costumes; athletic footwear; clothing for sports; rugby shoes; wristbands [clothing].

28 – Amusement park rides; video game machines; amusement game machines; golf bag carts; toys for pets; games, toys and playthings; toy models; scale model kits [toys]; scale model vehicles; toy vehicles; accessories for toy vehicles; ride-on toys; toy helmets; dolls; toy figures; stuffed toys; puzzles; stacking toys; toy construction sets; playing balls; board games; parlor games; dice; playing cards; conjuring apparatus; game machines and apparatus; slot machines [gaming machines]; darts; billiard equipment; sports equipment; cases specially adapted for sports equipment; balls for sports; rugby balls; golf equipment; golf balls; markers for golf balls; climbers' harness; fishing tackle; confetti; butterfly nets.

41 – Organization of lotteries; dubbing; educational and training services relating to sport; driving instruction; education and training services; distance learning services; practical training in the field of welding; arranging and conducting of conferences, congresses, seminars, symposiums, training courses, classes and lectures; organization of educational, entertainment, sporting and cultural events; animal training; zoological garden services; providing electronic publications, not downloadable; museum services; publication of printed matter in electronic form; publication and editing of printed matter, books, newspapers and periodicals, other than for advertising purposes; organization of shows and concerts; recreation information; entertainment and sporting activities; entertainment information; recording, production and distribution of films, video and audio recordings, radio and television programs; presentation of musical performances; production of radio and television programmes; providing information relating to sports; organization of sporting events; arranging of film events, musical events, cultural and sporting events and live entertainment events; organization of entertainment events; organization of cultural events; organization, arranging and conducting of horse races; organization, arranging and conducting of bicycle races; organization, arranging and conducting of boat races; organization, arranging and conducting of auto races; providing audio or video studio services; providing sports facilities; providing golf facilities; providing golf driving range facilities; providing amusement facilities; providing museum facilities [presentation, exhibitions]; providing facilities for educational purposes; ticket reservation and booking services for entertainment, sporting and cultural events; rental of cinematographic apparatus; rental of musical instruments; rental of sports equipment, except vehicles; rental services for audio and video equipment; rental of sound recordings and video recordings; rental of game machines and apparatus; rental of artwork; rental of indoor aquaria; modelling for artists; photography; photographic reporting; translation; news reporters services.

(260) AM 2021 108186 A  
 (800) 1529649  
 (151) 2020 03 18  
 (891) 2020 03 18  
 (731) ENEOS Corporation  
 1-2, Otemachi 1-chome, Chiyoda-ku,  
 Tokyo 100-8162, Japan

(540)

**ENEOS X PRIME**

(591) Black, white  
 (531) 27.05.01  
 (511)  
 1 – Chemical additives for engine oils; chemical additives for lubricants; transmission fluid.

(260) AM 2021 108187 A  
 (800) 1529685  
 (151) 2020 01 31  
 (891) 2020 01 31  
 (731) YANDEX LLC  
 Leo Tolstoy Str., 16, RU-119021 Moscow,  
 Russian Federation

(540)

**Яндекс Go**

(591) Red and black  
 (531) 28.05; 29.01.12  
 (511)  
 9 – 3D spectacles; dvd players; ticket dispensers; juke boxes, musical; answering machines; electrical adapters; batteries for electronic cigarettes; accumulators, electric; accumulators, electric, for vehicles; accelerometers; actinometers; alidades; altimeters; ear pads for headphones; ammeters; nanoparticle size analyzers; anemometers; anodes; antennas; anticathodes; apertometers [optics]; high-frequency apparatus; testing apparatus not for medical purposes; remote control apparatus; electro-dynamic apparatus for the remote control of railway points; electro-dynamic apparatus for the remote control of signals; monitoring apparatus, other than for medical purposes; sound recording apparatus; global Positioning System [GPS] apparatus; distillation apparatus for scientific purposes; diffraction apparatus [microscopy]; air analysis apparatus; apparatus to check franking; sound transmitting apparatus; apparatus for fermentation [laboratory apparatus]; breathing apparatus for underwater swimming; breathing apparatus, except for artificial respiration; apparatus and installations for the production of X-rays, not for medical purposes; cash registers; electric apparatus for commutation; magnetic resonance imaging [MRI] apparatus, not for medical purposes; intercommunication apparatus; stills for laboratory experiments; projection apparatus; fire extinguishing apparatus; radiological apparatus for industrial purposes;

roentgen apparatus not for medical purposes; blue-  
 rint apparatus; blinkers [signalling lights]; stereosco-  
 pic apparatus; telephone apparatus; facsimile machi-  
 nes; phototelegraphy apparatus; igniting apparatus,  
 electric, for igniting at a distance; acid hydrometers;  
 salinometers; acidimeters for batteries; aerometers;  
 beacons, luminous; battery jars; automated teller ma-  
 chines [ATM]; barometers; anode batteries; galvanic  
 batteries; batteries for lighting; solar batteries; solar  
 panels for the production of electricity; batteries, elec-  
 tric; balances [steelyards]; betatrons; binoculars; bioc-  
 hips; electronic tags for goods; lens hoods; magnetic  
 tape units for computers; computer memories; fire  
 hose nozzles; encoded identification bracelets, mag-  
 netic; connected bracelets [measuring instruments];  
 safety tarpaulins; electronic key fobs being remote  
 control apparatus; bullet-proof clothing; signalling  
 buoys; life buoys; marking buoys; directional compa-  
 sses; vacuum gauges; electrolyzers; variometers; ver-  
 niers; scales; baby scales; bathroom scales; letter sca-  
 les; weighbridges; precision balances; scales with bo-  
 dy mass analysers; levelling staffs [surveying instru-  
 ments]; camcorders; video baby monitors; video cas-  
 settes; video telephones; video screens; viewfinders,  
 photographic; electric plugs; micrometer screws for  
 optical instruments; viscosimeters; circuit closers; wa-  
 vemeters; voltmeters; mechanical signs; signs, lumi-  
 nous; switchboxes [electricity]; current rectifiers; gas  
 testing instruments; gasometers [measuring instru-  
 ments]; galvanometers; hands-free kits for telephones;  
 heliographic apparatus; hygrometers; hydrometers;  
 weights; peepholes [magnifying lenses] for doors;  
 hairdressing training heads [teaching apparatus]; ho-  
 lograms; plotters; loudspeakers; sounding leads;  
 plumb bobs; range finders; piezoelectric sensors; den-  
 simeters; densitometers; detectors; smoke detectors;  
 infrared detectors; counterfeit [false] coin detectors;  
 joysticks for use with computers, other than for video  
 games; slides [photography]; slide projectors; diap-  
 hrags [photography]; dictating machines; dynamo-  
 meters; light-emitting diodes [LED]; quantum dot  
 light-emitting diodes [QLED]; organic light-emitting  
 diodes [OLED]; floppy disks; phonograph records;  
 disks, magnetic; optical discs; disk drives for compu-  
 ters; juke boxes for computers; wearable video dis-  
 play monitors; electronic numeric displays; dna chips;  
 electronic interactive whiteboards; electronic notice  
 boards; electric wire harnesses for automobiles; bu-  
 llet-proof waistcoats; life jackets; reflective safety  
 vests; identification threads for electric wires; nose  
 clips for divers and swimmers; locks, electric; bells  
 [warning devices]; alarm bells, electric; electric door  
 bells; signal bells; audio interfaces; acoustic conduits;  
 mirrors for inspecting work; road signs, luminous or  
 mechanical; downloadable emoticons for mobile pho-  
 nes; marine depth finders; probes for scientific pur-  
 poses; buzzers; needles for surveying compasses;  
 needles for record players; eyewear; reflective articles  
 for wear, for the prevention of accidents; gauges;

pressure measuring apparatus; simulators for the  
 steering and control of vehicles; inverters [electricity];  
 pressure indicators; automatic indicators of low pre-  
 ssure in vehicle tires; temperature indicators; incu-  
 bators for bacteria culture; measuring instruments;  
 cosmographic instruments; mathematical instruments;  
 levelling instruments; instruments containing eyepi-  
 eces; surveying instruments; azimuth instruments;  
 interfaces for computers; ionization apparatus not for  
 the treatment of air or water; satellite finder meters;  
 spark-guards; coaxial cables; fiber optic cables; cab-  
 les, electric; calipers; slide calipers; screw-tapping  
 gauges; calorimeters; calculating machines; pocket  
 calculators; decompression chambers; rearview came-  
 ras for vehicles; cinematographic cameras; thermal  
 imaging cameras; mouth guards for sports; life-saving  
 capsules for natural disasters; electronic pens [visual  
 display units]; holders for electric coils; identity cards,  
 magnetic; video game cartridges; toner cartridges, un-  
 filled, for printers and photocopiers; ink cartridges,  
 unfilled, for printers and photocopiers; memory cards  
 for video game machines; encoded magnetic cards;  
 riding helmets; protective helmets; carriers for dark  
 plates [photography]; cathodes; spools [photography];  
 choking coils [impedance]; coils, electric; electromag-  
 netic coils; cinematographic film, exposed; computer  
 keyboards; solenoid valves [electromagnetic swit-  
 ches]; wire connectors [electricity]; thin client compu-  
 ters; encoded key cards; electronic book readers; el-  
 ectronic agendas; push buttons for bells; mouse pads;  
 magnetic encoders; visors for helmets; collectors,  
 electric; calibrating rings; smart rings; ring sizers;  
 protective suits for aviators; commutators; compact  
 discs [audio-video]; compact discs [read-only me-  
 mory]; comparators; marine compasses; computers;  
 laptop computers; tablet computers; notebook com-  
 puters; wearable computers; capacitors; contacts, elec-  
 tric; wind socks for indicating wind direction; traffic  
 cones; branch boxes [electricity]; distribution boxes  
 [electricity]; junction boxes [electricity]; connectors  
 [electricity]; accumulator boxes; cabinets for louds-  
 peakers; diving suits; galena crystals [detectors]; cir-  
 cular slide rules; covers for electric outlets; logs [mea-  
 suring instruments]; lasers, not for medical purposes;  
 lactodensimeters; lactometers; vacuum tubes [radio];  
 darkroom lamps [photography]; thermionic tubes; am-  
 plifying tubes; flashlights [photography]; head clea-  
 ning tapes [recording]; magnetic tapes; videotapes;  
 surveying chains; fire escapes; rulers [measuring ins-  
 truments]; square rulers for measuring; slide-rules;  
 contact lenses; correcting lenses [optics]; close-up  
 lenses; optical lenses; optical condensers; sounding  
 lines; electricity conduits; measuring spoons; magni-  
 fying glasses [optics]; thread counters; magnets; de-  
 corative magnets; crash test dummies; resuscitation  
 mannequins [teaching apparatus]; mouse [computer  
 peripheral]; trackballs [computer peripherals]; mano-  
 meters; security tokens [encryption devices]; divers'  
 masks; solderers' helmets; protective masks; respira-

tory masks, other than for artificial respiration; materials for electricity mains [wires, cables]; voting machines; money counting and sorting machines; material testing instruments and machines; furniture especially made for laboratories; megaphones; portable media players; diaphragms [acoustics]; diaphragms for scientific apparatus; metal detectors for industrial or military purposes; digital weather stations; metronomes; rules [measuring instruments]; carpenters' rules; dressmakers' measures; mechanisms for coin-operated apparatus; mechanisms for counter-operated apparatus; coin-operated mechanisms for television sets; shutter releases [photography]; micrometer gauges; microprocessors; microscopes; microtomes; microphones; audio mixers; modems; lightning arresters; monitors [computer hardware]; monitors [computer programs]; selfie sticks [hand-held monopods]; terminals [electricity]; junction sleeves for electric cables; teeth protectors; temperature indicator labels, not for medical purposes; knee-pads for workers; headphones; surveyors' levels; sound recording carriers; magnetic data media; optical data media; electronic sheet music, downloadable; computer software, recorded; sheaths for electric cables; identification sheaths for electric wires; weighing machines; computer hardware; punched card machines for offices; life saving apparatus and equipment; shoes for protection against accidents, irradiation and fire; objectives [lenses] [optics]; lenses for astrophotography; selfie lenses; egg-candlers; fire extinguishers; rescue laser signalling flares; electrified fences; limiters [electricity]; clothing for protection against accidents, irradiation and fire; clothing for protection against fire; asbestos clothing for protection against fire; clothing especially made for laboratories; survival blankets; ozonisers [ozonators]; octants; eyepieces; ohmmeters; wrist rests for use with computers; spectacle frames; oscillographs; plumb lines; mirrors [optics]; spectacles [optics]; sunglasses; goggles for sports; electronic collars to train animals; finger sizers; signalling panels, luminous or mechanical; wah-wah pedals; radio pagers; eyeglasses; electronic pocket translators; transmitters [telecommunication]; telephone transmitters; transmitters of electronic signals; switches, electric; periscopes; data gloves; gloves for divers; gloves for protection against accidents; gloves for protection against X-rays for industrial purposes; asbestos gloves for protection against accidents; furnaces for laboratory experiments; droppers for measuring, other than for medical or household purposes; laboratory pipettes; pyrometers; planimeters; plane tables [surveying instruments]; plates for batteries; computer software platforms, recorded or downloadable; wafers for integrated circuits; printed circuit boards; compact disc players; cassette players; protective films adapted for computer screens; protective films adapted for smartphones; sound recording strips; roentgen films, exposed; films, exposed; life-saving rafts; laboratory trays; digital signs; stands adapted for laptops; semi-conduc-

tors; polarimeters; personal digital assistants [PDAs]; fire engines; measuring glassware; life belts; fuses; circuit breakers; converters, electric; telerupters; food analysis apparatus; diagnostic apparatus, not for medical purposes; distance recording apparatus; distance measuring apparatus; speed measuring apparatus [photography]; apparatus for measuring the thickness of skins; speed checking apparatus for vehicles; teaching apparatus; time recording apparatus; apparatus and instruments for astronomy; surveying apparatus and instruments; weighing apparatus and instruments; nautical apparatus and instruments; optical apparatus and instruments; apparatus and instruments for physics; chemistry apparatus and instruments; measuring apparatus; measuring devices, electric; boiler control instruments; meteorological instruments; naval signalling apparatus; observation instruments; navigation apparatus for vehicles [on-board computers]; satellite navigational apparatus; regulating apparatus, electric; telecommunication apparatus in the form of jewelry; precision measuring apparatus; audio- and video-receivers; prisms [optics]; computer software applications, downloadable; printers for use with computers; hemline markers; retorts' stands; apparatus for changing record player needles; drainers for use in photography; cleaning apparatus for phonograph records; fire beaters; sighting telescopes for firearms; telescopic sights for artillery; test tubes; pressure indicator plugs for valves; magnetic wires; telegraph wires; telephone wires; wires, electric; conductors, electric; copper wire, insulated; fuse wire; computer operating programs, recorded; computer game software, downloadable; computer game software, recorded; computer programs, downloadable; computer screen saver software, recorded or downloadable; record players; central processing units [processors]; rods for water diviners; electronic publications, downloadable; distribution consoles [electricity]; control panels [electricity]; radar apparatus; baby monitors; masts for wireless aerials; transmitting sets [telecommunication]; radios; vehicle radios; sprinkler systems for fire protection; frames for photographic transparencies; screens for photoengraving; flowmeters; walkie-talkies; voltage surge protectors; voltage regulators for vehicles; stage lighting regulators; light dimmers [regulators], electric; speed regulators for record players; cell switches [electricity]; washing trays [photography]; marking gauges [joinery]; t-squares for measuring; time switches, automatic; relays, electric; safety restraints, other than for vehicle seats and sports equipment; x-ray photographs, other than for medical purposes; rheostats; respirators for filtering air; retorts; refractometers; refractors; grids for batteries; security surveillance robots; laboratory robots; teaching robots; telepresence robots; humanoid robots with artificial intelligence; electric sockets; height measuring instruments; speaking tubes; horns for loudspeakers; subwoofers; saccharometers; optical fibers [light conducting filaments]; traffic-light apparatus [signalling

devices]; dog whistles; signalling whistles; sports whistles; sextants; inductors [electricity]; life nets; nets for protection against accidents; fire alarms; signals, luminous or mechanical; rescue flares, non-explosive and non-pyrotechnic; sirens; electronic access control systems for interlocking doors; scanners [data processing equipment]; hand-held electronic dictionaries; integrated circuit cards [smart cards]; smartglasses; smartphones; smartwatches; connections for electric lines; connections, electric; sonars; sound locating instruments; lighting ballasts; resistances, electric; spectrograph apparatus; spectrosopes; speed indicators; alcoholmeters; satellites for scientific purposes; protection devices for personal use against accidents; audiovisual teaching apparatus; charging stations for electric vehicles; radiotelegraphy sets; radiotelephony sets; spectacle lenses; anti-glare glasses; optical glass; personal stereos; stereoscopes; stands for photographic apparatus; stroboscopes; fire boats; sulphitometers; bags adapted for laptops; drying racks [photography]; spherometers; integrated circuits; printed circuits; counters; parking meters; kilometer recorders for vehicles; revolution counters; abacuses; egg timers [sandglasses]; taximeters; ear plugs for divers; tachometers; television apparatus; telegraphs [apparatus]; telescopes; teleprompters; teleprinters; mobile telephones; cordless telephones; cellular phones; theodolites; interactive touch screen terminals; thermo-hygrometers; thermometers, not for medical purposes; thermostats; thermostats for vehicles; climate control digital thermostats; crucibles [laboratory]; tone arms for record players; totalizers; transistors [electronic]; transponders; protractors [measuring instruments]; transformers [electricity]; battery chargers; resuscitation training simulators; vehicle breakdown warning triangles; triodes; starter cables for motors; discharge tubes, electric, other than for lighting; capillary tubes; neon signs; pitot tubes; X-ray tubes not for medical purposes; telephone receivers; headgear being protective helmets; squares for measuring; quantity indicators; gasoline gauges; water level indicators; electric loss indicators; light-emitting electronic pointers; clinometers; levels [instruments for determining the horizontal]; mercury levels; spirit levels; urinometers; amplifiers; particle accelerators; electric installations for the remote control of industrial operations; steering apparatus, automatic, for vehicles; balancing apparatus; video recorders; sound reproduction apparatus; invoicing machines; tape recorders; protection devices against x-rays [roentgen rays], not for medical purposes; railway traffic safety appliances; data processing apparatus; oxygen transvasing apparatus; theft prevention installations, electric; devices for the projection of virtual keyboards; film cutting apparatus; drying apparatus for photographic prints; optical character readers; centering apparatus for photographic transparencies; dosage dispensers; chargers for electric accumulators; chargers for electronic cigarettes; acoustic [sound] alarms;

sounding apparatus and machines; editing appliances for cinematographic films; cathodic anti-corrosion apparatus; couplers [data processing equipment]; wearable activity trackers; anti-theft warning apparatus; computer peripheral devices; anti-interference devices [electricity]; demagnetizing apparatus for magnetic tapes; acoustic couplers; alarms; fog signals, non-explosive; whistle alarms; adding machines; readers [data processing equipment]; heat regulating apparatus; photocopiers [photographic, electrostatic, thermic]; electric and electronic effects units for musical instruments; bar code readers; downloadable ring tones for mobile phones; downloadable image files; downloadable music files; animated cartoons; filters for respiratory masks; filters for ultraviolet rays, for photography; filters [photography]; USB flash drives; magic lanterns; optical lamps; signal lanterns; cameras [photography]; glazing apparatus for photographic prints; shutters [photography]; darkrooms [photography]; photometers; flash-bulbs [photography]; digital photo frames; enlarging apparatus [photography]; photovoltaic cells; containers for contact lenses; spectacle cases; containers for microscope slides; cases for smartphones; cases especially made for photographic apparatus and instruments; chromatography apparatus for laboratory use; chronographs [time recording apparatus]; laboratory centrifuges; eyeglass chains; cyclotrons; compasses for measuring; frequency meters; time clocks [time recording devices]; petri dishes; sleeves for laptops; covers for personal digital assistants [PDAs]; covers for tablet computers; covers for smartphones; fire blankets; chips [integrated circuits]; jigs [measuring instruments]; pedometers; meteorological balloons; electrified rails for mounting spot lights; asbestos screens for firemen; fire hose; virtual reality headsets; protective helmets for sports; head guards for sports; lifeboats; snorkels; cell phone straps; eyeglass cords; switchboards; distribution boards [electricity]; equalizers [audio apparatus]; screens [photography]; workmen's protective face-shields; projection screens; radiology screens for industrial purposes; fluorescent screens; exposure meters [light meters]; ducts [electricity]; galvanic cells; downloadable graphics for mobile phones; epidiascopes; ergometers; armatures [electricity]; black boxes [data recorders].

12 – Motor buses; motor coaches; motor homes; gyrocopters; driverless cars [autonomous cars]; motor racing cars; cars; robotic cars; sports cars; concrete mixing vehicles; refrigerated vehicles; caravans; shock absorbers for automobiles; suspension shock absorbers for vehicles; space vehicles; aircraft; aeronautical apparatus, machines and appliances; air cushion vehicles; hot air balloons; ski carriers for cars; luggage carriers for vehicles; bumpers for automobiles; vehicle bumpers; tires for vehicle wheels; barges; brake shoes for vehicles; tailboard lifts [parts of land vehicles]; armored vehicles; buffers for railway

rolling stock; waggons; tilt trucks; railway carriages; sleeping cars; dining cars; refrigerated wagons [railroad vehicles]; transmission shafts for land vehicles; bicycles; electric bicycles; valves for vehicle tires; helicopters; helicams; automobile hoods; stroller hoods; hoods for vehicles; oars; paddles for canoes; sculls; screws [propellers] for ships; lug nuts for vehicle wheels; hydroplanes; self-balancing scooters; flanges for railway wheel tires; lorries; trucks with a crane feature incorporated; horns for vehicles; treads for vehicles [tractor type]; doors for vehicles; bicycle motors; motorcycle engines; engines for land vehicles; jet engines for land vehicles; driving motors for land vehicles; screw-propellers; screw-propellers for boats; airships; brake discs for vehicles; cable cars; self-balancing boards; dredgers [boats]; hand cars; military drones; civilian drones; delivery drones; camera drones; clips adapted for fastening automobile parts to automobile bodies; vehicle bonnet pins; adhesive rubber patches for repairing inner tubes; bicycle bells; rearview mirrors; side view mirrors for vehicles; portholes; cars for cable transport installations; inner tubes for pneumatic tires; inner tubes for bicycle tires; canoes; hoods for vehicle engines; crankcases for land vehicle components, other than for engines; boats; caissons [vehicles]; bicycle wheels; vehicle wheels; mine cart wheels; steering wheels for vehicles; casters for trolleys [vehicles]; brake pads for automobiles; hub caps; baby carriages; pet strollers; side cars; brake linings for vehicles; ships; baskets adapted for bicycles; gear boxes for land vehicles; ships' hulls; panniers adapted for bicycles; panniers adapted for motorcycles; fenders for ships; bands for wheel hubs; ejector seats for aircraft; wheelchairs; caps for vehicle fuel tanks; boat hooks; automobile bodies; tipping bodies for lorries [trucks]; bodies for vehicles; treads for re-reading tires; locomotives; masts for boats; golf carts [vehicles]; sprinkling trucks; propulsion mechanisms for land vehicles; self-balancing electric unicycles; mopeds; motor scooters; motorcycles; garbage trucks; tire mousse inserts; fitted footmuffs for pushchairs; fitted footmuffs for prams; freewheels for land vehicles; clutches for land vehicles; repair outfits for inner tubes; air pumps [vehicle accessories]; pumps for bicycle tires; upholstery for vehicles; rims for bicycle wheels; rims for vehicle wheels; windows for vehicles; engine mounts for land vehicles; axles for vehicles; headlight wipers; parachutes; ferry boats; bicycle pedals; ashtrays for automobiles; gearing for land vehicles; carts; head-rests for vehicle seats; bicycle kickstands; vehicle running boards; air bags [safety devices for automobiles]; ski lifts; chairlifts; casings for pneumatic tires; sleeping berths for vehicles; pontoons; torque converters for land vehicles; cigar lighters for automobiles; non-skid devices for vehicle tires; anti-dazzle devices for vehicles; anti-theft devices for vehicles; sun-blinds adapted for automobiles; trailers for transporting bicycles; bicycle trailers; balance weights for vehicle wheels; shock ab-

sorbing springs for vehicles; bicycle frames; motorcycle frames; spars for ships; reduction gears for land vehicles; safety belts for vehicle seats; security harness for vehicle seats; vehicle suspension springs; rudders; bicycle handle bars; motorcycle handlebars; vehicle joysticks; bicycle cranks; aeroplanes; amphibious airplanes; sleighs [vehicles]; rescue sleds; kick sledges; brake segments for vehicles; bicycle saddles; motorcycle saddles; luggage nets for vehicles; dress guards for bicycles; fitted pushchair mosquito nets; anti-theft alarms for vehicles; reversing alarms for vehicles; safety seats for children, for vehicles; vehicle seats; bellows for articulated buses; hydraulic circuits for vehicles; push scooters [vehicles]; mobility scooters; snowmobiles; rolling stock for railways; rolling stock for funicular railways; spokes for bicycle wheels; vehicle wheel spokes; spoilers for vehicles; air vehicles; vehicles for locomotion by land, air, water or rail; ambulances; autonomous underwater vehicles for seabed inspections; water vehicles; remotely operated vehicles for underwater inspections; remote control vehicles, other than toys; electric vehicles; tricycles; carrier tricycles; inclined ways for boats; windcreens; windscreen wipers; motorcycle kickstands; hubs for bicycle wheels; hubs for vehicle wheels; bags adapted for pushchairs; saddlebags adapted for bicycles; railway couplings; trailer hitches for vehicles; couplings for land vehicles; wheelbarrows; handling carts; luggage trucks; shopping trolleys; fishing trolleys; hose carts; bogies for railway cars; casting carriages; tilting-carts; roll cage trolleys; fork lift trucks; cleaning trolleys; bicycle brakes; brakes for vehicles; torsion bars for vehicles; tractors; tramcars; transmissions, for land vehicles; military vehicles for transport; aerial conveyors; trailers [vehicles]; funnels for ships; funnels for locomotives; cleats [nautical]; turbines for land vehicles; signal arms for vehicles; rowlocks; disengaging gear for boats; steering gears for ships; cable transport apparatus and installations; spoke clips for wheels; tipping apparatus, parts of trucks and waggons; funiculars; vans [vehicles]; automobile chains; bicycle chains; motorcycle chains; driving chains for land vehicles; anti-skid chains; transmission chains for land vehicles; undercarriages for vehicles; stroller covers; spare wheel covers; covers for vehicle steering wheels; saddle covers for bicycles; saddle covers for motorcycles; seat covers for vehicles; vehicle covers [shaped]; automobile chassis; vehicle chassis; connecting rods for land vehicles, other than parts of motors and engines; axle journals; gears for bicycles; tubeless tires for bicycles; bicycle tires [tyres]; automobile tires [tyres]; pneumatic tires [tyres]; solid tires for vehicle wheels; spikes for tires [tyres]; davits for boats; launches; timbers [frames] for ships; mudguards; bicycle mudguards; tow trucks; motors, electric, for land vehicles; yachts.

18 – Alpenstocks; slings for carrying infants; luggage tags; pocket wallets; saddlecloths for horses; business

card cases; reins; reins for guiding children; sling bags for carrying infants; harness fittings; credit card cases [wallets]; parts of rubber for stirrups; chamois leather, other than for cleaning purposes; umbrellas; parasols; saddlery; frames for umbrellas or parasols; handbag frames; card cases [notecases]; cases of leather or leatherboard; valves of leather; whips; imitation leather; leather, unworked or semi-worked; leatherboard; casings, of leather, for springs; umbrella rings; hat boxes of leather; boxes of leather or leather board; boxes of vulcanised fibre; purses; chain mesh purses; fastenings for saddles; butts [parts of hides]; saddle trees; bags [envelopes, pouches] of leather, for packaging; moleskin [imitation of leather]; travelling sets [leatherware]; knee-pads for horses; muzzles; halters; vanity cases, not fitted; furniture coverings of leather; clothing for pets; covers for animals; trimmings of leather for furniture; collars for animals; hiking sticks; conference folders; music cases; gold beaters' skin; cat o' nine tails; leather leashes; pads for horse saddles; horseshoes; girths of leather; leathercloth; horse blankets; garment bags for travel; shoulder belts [straps] of leather; briefcases; traces [harness]; fur; randsels [Japanese school satchels]; haversacks; leather straps; straps for soldiers' equipment; harness straps; straps for skates; straps of leather [saddlery]; chin straps, of leather; stirrup leathers; umbrella handles; walking cane handles; suitcase handles; grips for holding shopping bags; backpacks; travelling bags; riding saddles; net bags for shopping; umbrella or parasol ribs; stirrups; bags; bags for climbers; tool bags, empty; handbags; beach bags; saddlebags; compression cubes adapted for luggage; bags for sports; bags for campers; shopping bags; wheeled shopping bags; school bags; pouch baby carriers; travelling trunks; trunks [luggage]; nose bags [feed bags]; bridons; canes; umbrella sticks; walking stick seats; tefillin [phylacteries]; bits for animals [harness]; bridles [harness]; harness for animals; key cases; horse collars; motorized suitcases; suitcases with wheels; suitcases; attache cases; covers for horse-saddles; umbrella covers; kid; curried skins; animal skins; cattle skins; leather laces; blinkers [harness]; labels of leather; game bags [hunting accessories].

25 – Wimples; bandanas [neckerchiefs]; corselets; sweat-absorbent underclothing [underwear]; berets; overalls; boas [necklets]; teddies [undergarments]; boxer shorts; ankle boots; ski boots; boots for sports; breeches for wear; trousers; football boots; brassieres; valenki [felted boots]; mittens; collars [clothing]; detachable collars; shirt yokes; veils [clothing]; gabardines [clothing]; galoshes; neckties; ascots; leggings [leg warmers]; gaiters; boot uppers; jerseys [clothing]; vests; singlets; hosiery; heels; hoods [clothing]; hat frames [skeletons]; pockets for clothing; caps being headwear; kimonos; cap peaks; visors being headwear; tights; slips [undergarments]; combinations [clothing]; wet suits for water-skiing; bodices [linge-

rie]; corsets [underclothing]; suits; bathing suits; masquerade costumes; beach clothes; leotards; jackets [clothing]; stuff jackets [clothing]; fishing vests; leggings [trousers]; liveries; camisoles; sports singlets; cuffs; chemisettes [shirt fronts]; mantillas; coats; sleep masks; furs [clothing]; miters [hats]; muffs [clothing]; footmuffs, not electrically heated; bibs, not of paper; bibs, sleeved, not of paper; fur stoles; hairdressing capes; heel protectors for shoes; ear muffs [clothing]; socks; sweat-absorbent socks; footwear; beach shoes; clothing; paper clothing; outerclothing; embroidered clothing; ready-made clothing; motorists' clothing; cyclists' clothing; clothing for gymnastics; clothing of imitations of leather; clothing of leather; waterproof clothing; uniforms; clothing containing slimming substances; iron fittings for boots; maniples; overcoats; panties; parkas; pelerines; gloves [clothing]; fingerless gloves; ski gloves; pajamas; bathing drawers; shirt fronts; scarfs; pocket squares; dresses; headbands [clothing]; garters; sock suspenders; stocking suspenders; ready-made linings [parts of clothing]; dress shields; soles for footwear; heelpieces for footwear; braces for clothing [suspenders]; half-boots; lace boots; ponchos; girdles; belts [clothing]; money belts [clothing]; layettes [clothing]; non-slipping devices for boots and shoes; pullovers; heelpieces for stockings; welts for boots and shoes; chasubles; shirts; wooden shoes; sandals; bath sandals; boots; jumper dresses; saris; sarongs; sweaters; footwear uppers; inner soles; albs; bath slippers; togas; knitwear [clothing]; underpants; shoes; gymnastic shoes; slippers; skull caps; turbans; headwear; aprons [clothing]; judo uniforms; karate uniforms; tee-shirts; bath robes; top hats; tips for footwear; stockings; sweat-absorbent stockings; shawls; paper hats [clothing]; shower caps; bathing caps; sashes for wear; studs for football boots; hats; babies' pants [underwear]; gaiter straps; pelisses; esparto shoes or sandals; skirts; petticoats; skorts.

35 – Arranging subscriptions to telecommunication services for others; import-export agency services; commercial information agency services; advertising agency services; cost price analysis; rental of office equipment in co-working facilities; rental of advertising space; business auditing; financial auditing; business intermediary services relating to the matching of potential private investors with entrepreneurs needing funding; employment agency services; computerized file management; book-keeping; invoicing; demonstration of goods; transcription of communications [office functions]; opinion polling; market studies; business information; commercial information and advice for consumers in the choice of products and services; business research; marketing research; personnel recruitment; business management and organization consultancy; business organization consultancy; business management consultancy; personnel management consultancy; professional business consultancy; consultancy regarding advertising communi-

cation strategies; consultancy regarding public relations communication strategies; layout services for advertising purposes; marketing; marketing in the framework of software publishing; targeted marketing; business management of performing artists; business management of sports people; writing of resumes for others; scriptwriting for advertising purposes; news clipping services; updating and maintenance of information in registries; updating and maintenance of data in computer databases; updating of advertising material; word processing; online retail services for downloadable and pre-recorded music and movies; online retail services for downloadable ring tones; online retail services for downloadable digital music; retail and wholesale services, including via the Internet; organization of exhibitions for commercial or advertising purposes; arranging newspaper subscriptions for others; organization of fashion shows for promotional purposes; organization of trade fairs for commercial or advertising purposes; shop window dressing; development of advertising concepts; business appraisals; payroll preparation; data search in computer files for others; sponsorship search; administrative assistance in responding to calls for tenders; business management assistance; commercial or industrial management assistance; commercial intermediation services; providing business information via a web site; provision of commercial and business contact information; provision of an on-line marketplace for buyers and sellers of goods and services; web indexing for commercial or advertising purposes; provision of an online marketplace for buyers and sellers of goods and services; presentation of goods on communication media, for retail purposes; media relations services; economic forecasting; auctioneering; wholesale services for pharmaceutical, veterinary and sanitary preparations and medical supplies; retail services for works of art provided by art galleries; retail services for pharmaceutical, veterinary and sanitary preparations and medical supplies; sales promotion for others; promotion of goods and services through sponsorship of sports events; production of teleshopping programs; production of advertising films; office machines and equipment rental; rental of advertising time on communication media; publicity material rental; rental of billboards [advertising boards]; rental of vending machines; rental of sales stands; rental of photocopying machines; publication of publicity texts; radio advertising; bill-posting; distribution of samples; direct mail advertising; registration of written communications and data; writing of publicity texts; advertising; on-line advertising on a computer network; outdoor advertising; advertising by mail order; television advertising; document reproduction being photocopying services; compilation of statistics; compilation of information into computer databases; business inquiries; systemization of information into computer databases; advisory services for business management; corporate communications services; negotiation

of business contracts for others; negotiation and conclusion of commercial transactions for third parties; compiling indexes of information for commercial or advertising purposes; tax preparation; drawing up of statements of accounts; telemarketing services; psychological testing for the selection of personnel; interim business management; outsourced administrative management for companies; business management of hotels; business management for freelance service providers; business project management services for construction projects; commercial administration of the licensing of the goods and services of others; business management of reimbursement programs for others; administration of consumer loyalty programs; administration of frequent flyer programs; administrative processing of purchase orders; public relations; commercial lobbying services; competitive intelligence services; modelling for advertising or sales promotion; typing; market intelligence services; appointment reminder services [office functions]; web site traffic optimization; administrative services for the relocation of businesses; tax filing services; search engine optimization for sales promotion; appointment scheduling services [office functions]; gift registry services; price comparison services; pay per click advertising; secretarial services; procurement services for others [purchasing goods and services for other businesses]; shorthand; outsourcing services [business assistance]; telephone answering for unavailable subscribers; photocopying services; business efficiency expert services.

36 – Credit bureau services; debt collection agency services; real estate agency services; financial analysis; rental of apartments; rental of offices for co-working; rental of real estate; rental of offices [real estate]; rental of farms; hire-purchase financing; savings bank services; accommodation bureau services [apartments]; rent collection; issuing of travellers' checks [cheques]; issuance of credit cards; issue of tokens of value; capital investments; insurance information; financial information; financial research; clearing, financial; insurance consultancy; financial consultancy; debt advisory services; stock exchange quotations; lending against security; business liquidation services, financial; brokerage; financial management; exchanging money; online banking; processing of debit card payments; processing of credit card payments; factoring; organization of monetary collections; arranging finance for construction projects; antique appraisal; jewellery appraisal; financial evaluation of standing timber; stamp appraisal; real estate appraisal; numismatic appraisal; art appraisal; financial evaluation of development costs relating to the oil, gas and mining industries; financial evaluation of wool; financial evaluation [insurance, banking, real estate]; financial appraisals in responding to requests for proposals [RFPs]; repair costs evaluation [financial appraisal]; electronic funds transfer; securities



brokerage; real estate brokerage; brokerage of carbon credits; insurance brokerage; providing rebates at participating establishments of others through use of a membership card; loans [financing]; providing financial information via a web site; check verification; investment of funds; charitable fund raising; stocks and bonds brokerage; financial sponsorship; mortgage banking; instalment loans; accident insurance underwriting; life insurance underwriting; health insurance underwriting; marine insurance underwriting; fire insurance underwriting; apartment house management; real estate management; financial management of reimbursement payments for others; actuarial services; banking; stock brokerage services; retirement payment services; bail-bonding; trusteeship; provident fund services; financial customs brokerage services; mutual funds; financing services; safe deposit services; deposits of valuables; fiscal valuation.

37 – Asphaltting; drilling of deep oil or gas-wells; drilling of wells; rebuilding engines that have been worn or partially destroyed; rebuilding machines that have been worn or partially destroyed; renovation of clothing; retreading of tires; vulcanization of tires [repair]; building sealing; linen ironing; pressing of clothing; disinfecting; rat exterminating; mining extraction; vehicle battery charging; knife sharpening; building insulating; repair information; construction information; bricklaying; riveting; construction consultancy; varnishing; re-tinning; installation of utilities in construction sites; scaffolding; road paving; window cleaning; vehicle washing; building construction supervision; tuning of musical instruments; upholstery; rustproofing; anti-rust treatment for vehicles; sanding; pumicing; strong-room maintenance and repair; vehicle maintenance; paper hanging; painting or repair of signs; cleaning of buildings [exterior surface]; vehicle polishing; vehicle breakdown repair services; rental of bulldozers; rental of drainage pumps; rental of dish drying machines; rental of road sweeping machines; rental of cleaning machines; rental of cranes [construction equipment]; rental of dishwashing machines; rental of laundry washing machines; rental of construction equipment; rental of excavators; laying of cable; plumbing; masonry; roofing services; painting, interior and exterior; carpentry services; underwater repair; plastering; quarrying services; repair of security locks; umbrella repair; parasol repair; motor vehicle maintenance and repair; burner maintenance and repair; film projector repair and maintenance; airplane maintenance and repair; safe maintenance and repair; clock and watch repair; repair of power lines; pump repair; upholstery repair; shoe repair; clothing repair; photographic apparatus repair; furniture restoration; restoration of musical instruments; restoration of works of art; vehicle lubrication [greasing]; demolition of buildings; warehouse construction and repair; vehicle service stations [refuelling and maintenance]; sterilization of medical instruments;

washing of linen; construction; pier breakwater building; pipeline construction and maintenance; underwater construction; harbour construction; factory construction; building of fair stalls and shops; shipbuilding; cleaning of buildings [interior]; snow removal; street cleaning; vermin exterminating, other than for agriculture, aquaculture, horticulture and forestry; tire balancing; pest control services, other than for agriculture, aquaculture, horticulture and forestry; hydraulic fracturing services; refilling of toner cartridges; refilling of ink cartridges; artificial snow-making services; laundering; services of electricians; installation of doors and windows; irrigation devices installation and repair; elevator installation and repair; installation and repair of flood protection equipment; heating equipment installation and repair; burglar alarm installation and repair; furnace installation and repair; telephone installation and repair; air conditioning apparatus installation and repair; fire alarm installation and repair; freezing equipment installation and repair; electric appliance installation and repair; kitchen equipment installation; installation, maintenance and repair of computer hardware; machinery installation, maintenance and repair; office machines and equipment installation, maintenance and repair; interference suppression in electrical apparatus; swimming-pool maintenance; furniture maintenance; chimney sweeping; boiler cleaning and repair; cleaning of clothing; dry cleaning; vehicle cleaning; diaper cleaning; leather care, cleaning and repair; fur care, cleaning and repair.

39 – Air transport; motor coach rental; boat rental; garage rental; rental of vehicle roof racks; aircraft rental; parking place rental; rental of electric wine cellars; rental of warehouses; rental of tractors; booking of seats for travel; travel reservation; transport reservation; towing; vehicle breakdown towing services; bottling services; water distribution; delivery of newspapers; message delivery; parcel delivery; delivery of goods; delivery of goods by mail order; flower delivery; replenishment of vending machines; launching of satellites for others; traffic information; transportation information; storage information; transportation logistics; rescue operations [transport]; arranging of cruises; arranging of passenger transportation services for others via an online application; arranging of transportation for travel tours; armored-car transport; hauling; carting; transport and storage of trash; transporting furniture; lighterage services; ferry-boat transport; removal services; transport of travellers; guarded transport of valuables; bus transport; car transport; barge transport; boat transport; railway transport; marine transport; passenger transport; river transport; ambulance transport; streetcar transport; portering; refloating of ships; cash replenishment of automated teller machines; shipbrokerage; transport brokerage; freight brokerage; providing driving directions for travel purposes; car rental; truck rental; rental of di-

ving bells; rental of diving suits; rental of motor racing cars; rental of aircraft engines; railway coach rental; rental of wheelchairs; rental of storage containers; horse rental; rental of freezers; rental of navigational systems; frozen-food locker rental; vehicle rental; stevedoring; unloading cargo; electricity distribution; distribution of energy; packaging of goods; collection of recyclable goods [transport]; ice-breaking; piloting; water supplying; escorting of travellers; transport by pipeline; wrapping of goods; operating canal locks; car parking; chauffeur services; pleasure boat transport; car sharing services; courier services [messages or merchandise]; salvaging; salvage of ships; gift wrapping; underwater salvage; taxi transport; transport; transport services for sightseeing tours; luggage storage; franking of mail; freight [shipping of goods]; freighting; physical storage of electronically-stored data or documents; boat storage; storage of goods; storage; freight forwarding.

41 – Modelling for artists; academies [education]; rental of indoor aquaria; rental of artwork; rental of sports grounds; rental of tennis courts; lending library services; booking of seats for shows; videotaping; physical education; production of music; discotheque services; animal training; dubbing; gambling services; publication of books; education information; recreation information; entertainment information; film distribution; movie studio services; health club services [health and fitness training]; nightclub services [entertainment]; layout services, other than for advertising purposes; microfilming; videotape editing; production of radio and television programmes; screenplay writing; religious education; aikido instruction; gymnastic instruction; judo instruction; correspondence courses; practical training [demonstration]; training services provided via simulators; organization of balls; organization of exhibitions for cultural or educational purposes; providing recreation facilities; arranging and conducting of colloquiums; arranging and conducting of congresses; arranging and conducting of conferences; arranging and conducting of concerts; arranging and conducting of workshops [training]; arranging and conducting of in-person educational forums; arranging and conducting of seminars; arranging and conducting of symposiums; organization of competitions [education or entertainment]; arranging of beauty contests; organization of cosplay entertainment events; organization of lotteries; organization of fashion shows for entertainment purposes; organization of shows [impresario services]; organization of sports competitions; vocational guidance [education or training advice]; amusement park services; sign language interpretation; know-how transfer [training]; television entertainment; mobile library services; vocational retraining; providing on-line videos, not downloadable; providing on-line music, not downloadable; providing television programmes, not downloadable, via video-on-demand services; providing films,

not downloadable, via video-on-demand services; providing golf facilities; providing sports facilities; providing amusement arcade services; cinema presentations; providing online electronic publications, not downloadable; presentation of circus performances; presentation of variety shows; presentation of live performances; theatre productions; conducting guided climbing tours; conducting fitness classes; educational examination; film production, other than advertising films; rental of audio equipment; rental of video cameras; rental of video cassette recorders; rental of videotapes; rental of show scenery; rental of sound recordings; toy rental; rental of cinematographic apparatus; rental of motion pictures; games equipment rental; rental of stadium facilities; rental of lighting apparatus for theatrical sets or television studios; rental of radio and television sets; rental of skin diving equipment; rental of sports equipment, except vehicles; rental of stage scenery; electronic desktop publishing; publication of electronic books and journals on-line; publication of texts, other than publicity texts; radio entertainment; entertainer services; entertainment services; writing of texts; sado instruction [tea ceremony instruction]; zoological gardens; news reporters services; film directing, other than advertising films; party planning [entertainment]; music composition services; subtitling; tutoring; holiday camp services [entertainment]; video editing services for events; conducting guided tours; disc jockey services; sound engineering services for events; game services provided online from a computer network; personal trainer services [fitness training]; providing casino facilities [gambling]; calligraphy services; karaoke services; club services [entertainment or education]; songwriting; cultural, educational or entertainment services provided by art galleries; providing museum facilities [presentation, exhibitions]; educational services; educational services provided by special needs assistants; educational services provided by schools; orchestra services; translation; script-writing, other than for advertising purposes; ticket agency services [entertainment]; educational examination for users to qualify to pilot drones; coaching [training]; lighting technician services for events; sport camp services; recording studio services; language interpreter services; nursery schools; photography; photographic reporting; timing of sports events; boarding school education; production of shows.

42 – Water analysis; computer systems analysis; handwriting analysis [graphology]; chemical analysis; energy auditing; recovery of computer data; business card design; graphic design of promotional materials; interior design; industrial design; graphic arts designing; computer virus protection services; oil-field surveys; geological surveys; engineering; installation of computer software; meteorological information; clinical trials; material testing; textile testing; bacteriological research; biological research; geological research;

research in the field of environmental protection; cosmetic research; mechanical research; research in the field of welding; research in the field of building construction; research in the field of telecommunications technology; physics [research]; chemical research; research and development of new products for others; medical research; scientific and technological research relating to patent mapping; scientific and technological research in the field of natural disasters; scientific research; analysis for oil-field exploitation; underwater exploration; technological research; calibration [measuring]; web site design consultancy; computer security consultancy; information technology [IT] consultancy; consultancy in the design and development of computer hardware; architectural consultancy; internet security consultancy; computer software consultancy; data security consultancy; technological consultancy; oil-well testing; quality control; vehicle roadworthiness testing; land surveying; dress designing; updating of computer software; monitoring of computer systems to detect breakdowns; monitoring of computer systems for detecting unauthorized access or data breach; monitoring of computer systems by remote access; software as a service [SaaS]; maintenance of computer software; authenticating works of art; design of interior decor; quality evaluation of standing timber; quality evaluation of wool; digitization of documents [scanning]; conversion of data or documents from physical to electronic media; urban planning; providing information on computer technology and programming via a web site; provision of scientific information, advice and consultancy in relation to carbon offsetting; providing search engines for the internet; platform as a service [PaaS]; conversion of computer programs and data, other than physical conversion; conducting technical project studies; computer system design; rental of web servers; computer rental; rental of computer software; unlocking of mobile phones; geological prospecting; oil prospecting; hosting computer sites [web sites]; server hosting; development of computer platforms; construction drafting; computer software design; software development in the framework of software publishing; cloud seeding; consultancy in the field of energy-saving; creating and designing website-based indexes of information for others [information technology services]; creating and maintaining web sites for others; computer programming; technical writing; duplication of computer programs; cloud computing; architectural services; chemistry services; outsource service providers in the field of information technology; packaging design services; off-site data backup; computer technology consultancy; telecommunications technology consultancy; scientific laboratory services; weather forecasting; styling [industrial design]; cartography services; exploration services in the field of the oil, gas and mining industries; data encryption services; electronic data storage; surveying; electronic monitoring of credit card activity to detect fraud via the in-

ternet; electronic monitoring of personally identifying information to detect identity theft via the internet.

43 – Accommodation bureau services [hotels, boarding houses]; rental of temporary accommodation; rental of meeting rooms; tourist home services; hotel reservations; boarding house bookings; temporary accommodation reservations; hotel services; retirement home services; snack-bar services; information and advice in relation to the preparation of meals; cafe services; cafeteria services; motel services; boarding house services; boarding for animals; rental of cooking apparatus; rental of chairs, tables, table linen, glassware; rental of lighting apparatus; rental of tents; rental of transportable buildings; rental of drinking water dispensers; restaurant services; self-service restaurant services; reception services for temporary accommodation [management of arrivals and departures]; food sculpting; canteen services; decorating of food; cake decorating; holiday camp services [lodging]; bar services; providing campground facilities; personal chef services; food and drink catering; washoku restaurant services; udon and soba restaurant services; day-nursery [crèche] services.

---

(260) AM 2021 108188 A  
 (800) 1529725  
 (151) 2020 04 01  
 (891) 2020 04 01  
 (731) BASF Agro B.V., Arnhem (NL),  
 Zweigniederlassung Freienbach  
 Huobstrasse 3, CH-8808 Pfäffikon SZ,  
 Switzerland  
 (540)

## REVYCARE

(591) Black, white  
 (511)  
 1 – Chemical products for use in agriculture, horticulture and forestry, particularly plant fortifiers, chemical or biological preparations for stress management in plants, preparations for regulating plant growth, seed genes for agricultural production, seed treatment preparations.  
 5 – Products for destroying and combating vermin, insecticides, fungicides, herbicides, pesticides.

---

(260) AM 2021 108189 A  
 (800) 1529739  
 (151) 2020 03 06  
 (891) 2020 03 06  
 (731) IBSA INSTITUT BIOCHIMIQUE SA  
 Via al Ponte 13, CH-6903 Lugano, Switzerland  
 (540)

## PLEYRIS

(591) Black, white

(511)  
5 – Fertility-related diagnostic and treatment preparations; pharmaceutical products; medicines.

(260) AM 2021 108191 A  
(800) 570113  
(151) 1991 05 16  
(891) 2019 12 23  
(731) B. A. I. D.  
83, rue Michel Ange, F-75016 Paris, France  
(540)

**THOMANN-HANRY**

(591) Black, white  
(531) 27.05.01  
(511)  
3 – Cleaning products, particularly products for building facade restoration.  
19 – Non-metallic building materials; non-metallic rigid pipes for building; asphalt, pitch and bitumen; transportable buildings not of metal; monuments not of metal.  
37 – Restoration services; building cleaning, maintenance and repair services.

(260) AM 2021 108192 A  
(800) 902845  
(151) 2006 09 07  
(891) 2020 03 20  
(731) Limited Liability Company "Scientific and production enterprise Rogneda"  
g. Staraya Kupavna, Dorozhnaja str., 4B,  
RU-142450 Moscow region, Noginskij district,  
Russian Federation  
(540)



(591) Black, white  
(531) 26.01.09; 26.01.19; 28.05  
(526) ®  
(511)  
1 – Solvents for varnishes; concrete preservatives, except paints and oils; glass-staining chemicals; enamel and glass staining-chemicals; enamel-staining chemicals; chemical preparations, except pigments, for the manufacture of enamel; color-brightening chemicals for industrial purposes.  
2 – Ink for leather; shoe dyes; cobalt oxide (colorant); aluminium paints; distempers; blues (colorants or paints); black Japan; bitumen varnish; bronzing lacqu-

ers; copal varnish; wallpaper removing preparations; badigeon; fixatives (varnishes); enamels (varnishes).

(260) AM 2021 108193 A  
(800) 1002342  
(151) 2009 04 21  
(891) 2020 04 02  
(731) HANGZHOU FASHION-POWER  
INDUSTRIAL & TRADING CO., LTD.  
Fl. 22-23, Yindu Mansion, No. 385 Desheng  
Road, Gongshu District, Hangzhou City,  
Zhejiang Province, China

(540)



(591) Black, white  
(531) 27.05.01  
(511)  
25 – Clothing; shoes; hats; hosiery; gloves (clothing); boas (necklets); neckties; leather belts (clothing); waterproof clothing; swimsuits.

(260) AM 2021 108194 A  
(800) 1035399  
(151) 2009 12 04  
(891) 2020 02 18  
(731) Rulmenti S.A.  
320 Republicii Boulevard, 731130 Barlad,  
Vaslui, Romania  
(540)



(591) White, green, grey  
(531) 15.07.11; 29.01.13  
(511)  
4 – Industrial oils and greases; lubricants; dust absorbing, wetting, and binding compositions; fuels (including motor spirit) and illuminants; candles and wicks for lighting.  
6 – Common metals and their alloys; metal building materials; transportable buildings of metal; materials of metal for railway tracks; non-electric cables and wires of common metal; ironmongery, small items of metal hardware; pipes and tubes of metal; safes; goods of common metal not included in other classes; ores.

7 – Machines and machine tools; motors and engines (except for land vehicles); machine coupling and transmission components (except for land vehicles); agricultural implements other than hand-operated; incubators for eggs.

12 – Vehicles; apparatus for locomotion by land, air or water.

35 – Advertising; business management; business administration; office functions.

37 – Building construction; repair; installation services.

40 – Treatment of materials.

42 – Scientific and technological services and research and design relating thereto; industrial analysis and research services; design and development of computer hardware and software.

---

(260) AM 2021 108195 A  
 (800) 1155935  
 (151) 2013 02 08  
 (891) 2020 03 20  
 (731) Closed Joint-Stock Company "Nauchno-proizvodstvennoe, predpriyatie ROGNEDA"  
 3 Tverskaya zastava square, RU-125047  
 Moscow, Russian Federation

(540)

**ДАЛИ**

**DALI**

(591) Black, white  
 (531) 28.05  
 (511)

1 – Chemical preparations for industrial, scientific, agricultural purposes, for photography, gardening, forestry; synthetic resins, unprocessed; plastic materials, unprocessed; fertilizing preparations; metal hardening and soldering preparations; chemical substances for preserving foodstuffs; tanning substances; adhesives for industrial purposes; fire extinguishing composition.

2 – Paints; oil varnishes; lacquers; protective anti-corrosive preparations for metals and protective preparations for wood preservation; dyes; mordants; natural resins, raw; sheet metals and metals in powder form for painters, decorators, printers and artists.

(260) AM 2021 108196 A  
 (800) 1233442  
 (151) 2014 11 26  
 (891) 2020 04 23  
 (731) INNOVATION FABRICATION  
 COMMERCIALISATION INFACO  
 Bois de Rozies, F-81140 Cahuzac sur Vere,  
 France

(540)

**INFACO**

(591) Black, white  
 (511)  
 7 – Agricultural implements other than hand-operated; portable power tools, namely, in particular, electric pruning shears; electric fastener; electric saw; electric vibrator for picking olives; electric sharpener.

---

(260) AM 2021 108197 A  
 (800) 1339116  
 (151) 2016 12 23  
 (891) 2020 03 23  
 (731) Tessengerlo Kerley, Inc.  
 2255 N. 44th Street, Suite 300, Phoenix  
 AZ 85008, USA

(540)

**SURROUND**

(591) Black, white  
 (511)  
 1 – Chemical preparations for use in agriculture, horticulture and forestry, namely, chemical preparations for protecting plants, trees, fruits and vegetables from sunburn and heat stress.

5 – Pesticides and pest repellants for agriculture and domestic use.

---

(260) AM 2021 108199 A  
 (800) 1435084  
 (151) 2018 10 12  
 (891) 2020 03 31  
 (731) NOVARTIS AG  
 CH-4002 Basel, Switzerland

(540)

**ATECTURA**

(591) Black, white  
 (511)  
 5 – Pharmaceutical preparations.

---

(260) AM 2021 108200 A  
 (800) 1436525  
 (151) 2018 10 08  
 (891) 2020 04 20  
 (731) Syngenta Participations AG  
 Rosentalstrasse 67, CH-4058 Basel,  
 Switzerland

(540)

## YOOM

(591) Black, white

(511)

31 – Tomatoes; tomato seeds; tomato seedlings.

(260) AM 2021 108202 A

(800) 1472022

(151) 2019 05 14

(891) 2020 04 20

(731) Seattle Genetics, Inc.

21823 30th Drive S.E., Bothell WA 98021,  
USA

(540)

## TUKYSA

(591) Black, white

(511)

5 – Pharmaceutical preparations for the treatment of cancer.

(260) AM 2021 108203 A

(800) 1505799

(151) 2019 10 02

(891) 2020 04 22

(731) Happygum G.m.b.H

Bauernmarkt 8/8, A-1010 Wien, Austria

(540)

## HAPPYGUM

(591) Black, white

(511)

5 – Chewing gum for medical purposes; pharmaceuticals and natural remedies.

30 – Sweets (candy), candy bars and chewing gum.

35 – Retail or wholesale services for pharmaceutical, veterinary and sanitary preparations and medical supplies; retail services relating to candy; wholesale services relating to candy.

(260) AM 2021 108204 A

(800) 1512334

(151) 2019 10 09

(891) 2020 02 05

(731) Trade House "CSK" Limited Liability Company  
ul. Molodezhnaya, d. 46, of. 523, Odintsovsky  
r-n, g. Odintsovo, Moskovskaya obl., Russian  
Federation

(540)



(591) Red, dark blue

(531) 24.01.25; 28.05; 29.01.13

(526) торговый дом", "ЦСК".

(511)

35 – Arranging subscriptions to telecommunication services for others; import-export agency services; commercial information agency services; advertising agency services; cost price analysis; rental of advertising space; business auditing; business intermediary services relating to the matching of potential private investors with entrepreneurs needing funding; employment agency services; computerized file management; book-keeping; invoicing; demonstration of goods; transcription of communications [office functions]; opinion polling; market studies; business information; commercial information and advice for consumers in the choice of products and services; business investigations; business research; marketing research; personnel recruitment; business management and organization consultancy; business organization consultancy; business management consultancy; personnel management consultancy; professional business consultancy; consultancy regarding public relations communication strategies; consultancy regarding advertising communication strategies; layout services for advertising purposes; consultancy regarding public relations communication strategies; consultancy regarding advertising communication strategies; marketing; business management of performing artists; business management of sports people; writing of résumés for others; scriptwriting for advertising purposes; news clipping services; updating and maintenance of information in registries; updating and maintenance of data in computer databases; updating of advertising material; word processing; organization of exhibitions for commercial or advertising purposes; arranging newspaper subscriptions for others; organization of fashion shows for promotional purposes; organization of trade fairs for commercial or advertising purposes; shop window dressing; design of advertising materials; business appraisals; payroll preparation; data search in computer files for others; sponsorship search; business management assistance; commercial or industrial management assistance; commercial intermediation services; providing business information via a web site; provision of commercial and business contact information; provision of an online marketplace for buyers and sellers of goods and services; web indexing for commercial or advertising purposes; presentation of goods on communication media, for retail purposes; economic forecasting; auctioneering; retail services for pharmaceutical, veterinary and sanitary preparations and medical supplies; wholesale services for pharmaceutical, veterinary and sanitary preparations and medical supplies; sales promotion for others; production of teleshopping programmes; production of advertising films; office machines and equipment rental; rental of advertising time on communication media; publicity material ren-

tal; rental of billboards [advertising boards]; rental of vending machines; rental of sales stands; rental of photocopying machines; publication of publicity texts; radio advertising; bill-posting; distribution of samples; dissemination of advertising matter; direct mail advertising; registration of written communications and data; writing of publicity texts; advertising; online advertising on a computer network; advertising by mail order; television advertising; document reproduction; compilation of statistics; compilation of information into computer databases; business inquiries; systemization of information into computer databases; advisory services for business management; negotiation of business contracts for others; negotiation and conclusion of commercial transactions for third parties; compiling indexes of information for commercial or advertising purposes; tax preparation; drawing up of statements of accounts; telemarketing services; psychological testing for the selection of personnel; outsourced administrative management for companies; business management of hotels; business management for freelance service providers; business project management services for construction projects; commercial administration of the licensing of the goods and services of others; business management of reimbursement programs for others; administration of consumer loyalty programs; administration of frequent flyer programs; administrative processing of purchase orders; public relations; typing; appointment reminder services [office functions]; web site traffic optimization; relocation services for businesses; tax filing services; search engine optimization for sales promotion; appointment scheduling services [office functions]; price comparison services; pay per click advertising; secretarial services; procurement services for others [purchasing goods and services for other businesses]; shorthand; outsourcing services [business assistance]; telephone answering for unavailable subscribers; photocopying services; business efficiency expert services.

(260) AM 2021 108205 A  
 (800) 1518465  
 (151) 2019 12 17  
 (891) 2020 04 02  
 (731) Henkel AG & Co. KgaA  
 Henkelstrasse 67; 40589 Düsseldorf, Germany  
 (540)



FIBRE  
 CLINIX

(591) Black, white  
 (531) 02.01.01; 02.01.16; 02.03.01; 02.03.02;  
 27.05.09; 27.05.10  
 (511)  
 3 – Preparations for the conditioning, cleaning, tinting, dyeing, bleaching, fixing and waving of hair, hair lotions and shampoos for cosmetic purposes.

(260) AM 2021 108244 A  
 (800) 1530006  
 (151) 2020 03 24  
 (891) 2020 03 24  
 (731) Obshchestvo s ogranichennoy otvetstvennostyu  
 "OKTAVA HOLDING"  
 Proezd Shokalskogo, d. 50, RU-127224  
 Moscow, Russian Federation  
 (540)

## AKVION

(591) Black, white  
 (511)  
 3 – Bleaching preparations and other substances for laundry use; cleaning, polishing, scouring and abrasive preparations; soap; perfumery, essential oils, cosmetics, hair lotions; non-medicated dentifrices.

(260) AM 2021 108245 A  
 (800) 1530013  
 (151) 2019 11 21  
 (891) 2019 11 21  
 (731) PepsiCo, Inc., (a North Carolina corporation)  
 700 Anderson Hill Road, Purchase, New York  
 10577, USA  
 (540)



(591) white, black, red, green, beige, brown, light brown  
 (531) 08.01.09; 26.05.01; 28.05; 29.01.14  
 (526) БАГЕТ  
 (511)  
 30 – Cereal-based snack food; bread sticks; rusks; cereal preparations.

(260) AM 2021 108246 A  
(800) 1530026  
(151) 2019 12 20  
(891) 2019 12 20  
(731) Yiwu Joyluck Sanitary Ware Co., Ltd.  
No. 719 Huimin Road, Niansanli Street,  
Yiwu City, 322000 Zhejiang, China

(540)



(591) Black, white  
(531) 18.02.01; 27.03.15; 27.05; 27.05.09; 27.05.11  
(511)

11 – Mixer faucets for water pipes; lighting apparatus and installations; heaters for baths; toilets [water-closets]; lamps; water purifying apparatus and machines; anti-splash tap nozzles; bath tubs; bath installations; water filtering apparatus; hand-held electric hair dryers; refrigerators; water supply installations; radiators, electric; lighters; air filtering installations.

(260) AM 2021 108247 A  
(800) 1530033  
(151) 2019 11 21  
(891) 2019 11 21  
(731) PepsiCo, Inc., (a North Carolina corporation)  
700 Anderson Hill Road, Purchase,  
New York 10577, USA

(540)



(591) White, black, red, yellow  
(531) 26.05.01; 28.05; 29.01.14  
(511)

30 – Cereal bars; cereal-based snack food; crackers; bread sticks; biscuits; petit-beurre biscuits; cereal preparations; oat-based food; rusks.

(260) AM 2021 108248 A  
(800) 1530038  
(151) 2019 12 17  
(891) 2019 12 17  
(731) Mast-Jägermeister SE  
Jägermeisterstr. 7-15, 38302 Wolfenbüttel,  
Germany

(540)



(591) Black, white, orange, grey, silver  
(531) 03.04.15; 05.13.03; 25.01.15; 26.01.01;  
26.01.03; 26.01.16; 27.05.09; 27.05.10;  
27.05.11; 29.01.15

(511)  
33 – Alcoholic beverages, except beers, in particular herbal liqueur; spirits (beverages); spirits (beverages) and herbal liqueur, coffee-based liqueurs; cocktails; alcoholic preparations for making beverages.

(260) AM 2021 108249 A  
(800) 1530041  
(151) 2020 01 06  
(891) 2020 01 06  
(731) Shijiazhuang Lanhai Tools Co., Ltd  
No. 10 Fangxing Road, Yuhua district,  
Shijiazhuang, Hebei, China

(540)



(591) Black, white  
(531) 27.05.12; 27.05.17  
(511)

7 – Punching machine for metal working; electric hand drills; machine tools; cutting machines; circular saw blade (part of machine); broaching machines; hand-held tools, other than hand-operated; drilling heads [parts of machines]; blades [parts of machines]; tools [parts of machines].

(260) AM 2021 108250 A  
(800) 1530095  
(151) 2020 02 21  
(891) 2020 02 21  
(731) Obshchestvo s ogranichennoy  
otvetstvennostyu "AmantisMed"  
Minskaya Str. 2i-125, 223141 Logoyisk, Belarus

(540)



(591) Black, white  
(531) 28.05



(511)  
5 – Pharmaceuticals and veterinary preparations; drugs for medical purposes; sanitary preparations for medical purposes; chemico-pharmaceutical preparations; ferments for pharmaceutical and medical purposes; herbal teas for medical purposes; disinfectants for hygiene purposes; vitamin preparations; bacterial preparations for medical and veterinary use; dietetic substances adapted for medical use; medicinal oils; food for babies; plasters, materials for dressings; material for dental fillings and dental impressions; disinfectants; dietary supplements; lotions for pharmaceutical purposes; nutritional supplements for medical purposes; radioactive substances for medical purposes; nutritive substances for microorganisms; cachets for pharmaceutical purposes.

(260) AM 2021 108251 A  
(800) 1530105  
(151) 2019 11 26  
(891) 2019 11 26  
(731) ASCENZA AGRO  
Av. Rio Tejo, Herdade das Praias; P-2910-442  
Setúbal, Portugal  
(540)



(591) Blue, green, white  
(531) 05.01.03; 05.01.04; 05.01.05; 05.01.16;  
27.05.10; 29.01.12  
(511)  
1 – Fertilisers, and chemicals for use in agriculture, horticulture and forestry.  
5 – Herbicides; fungicides for agricultural use; insecticides; pest control preparations and articles.

(260) AM 2021 108252 A  
(800) 1530114  
(151) 2020 02 21  
(891) 2020 02 21  
(731) Obshchestvo s ogranichennoy otvetstvennostyu  
"AmantisMed"  
Minskaya Str. 2i-125, 223141 Logoyusk, Belarus  
(540)

## ВИТАВИРИН

(591) Black, white  
(531) 28.05  
(511)  
5 – Pharmaceuticals and veterinary preparations; drugs for medical purposes; sanitary preparations for

medical purposes; chemico-pharmaceutical preparations; ferments for pharmaceutical and medical purposes; herbal teas for medical purposes; disinfectants for hygiene purposes; vitamin preparations; bacterial preparations for medical and veterinary use; dietetic substances adapted for medical use; medicinal oils; food for babies; plasters, materials for dressings; material for dental fillings and dental impressions; disinfectants; dietary supplements; lotions for pharmaceutical purposes; nutritional supplements for medical purposes; radioactive substances for medical purposes; nutritive substances for microorganisms; cachets for pharmaceutical purposes.

(260) AM 2021 108253 A  
(800) 1530146  
(151) 2020 03 06  
(891) 2020 03 06  
(731) BERWICK BIOTECH S.a.r.l.  
3, Rue Belle-Vue, L-1227 Luxembourg,  
Luxembourg  
(540)

## FORTEZA

(591) Black, white  
(511)  
3 – Breath freshening sprays; balms, other than for medical purposes; dentifrices; mouthwashes, not for medical purposes.  
5 – Analgesics; anaesthetics; antiseptics; balms for medical purposes; astringents for medical purposes; disinfectants; disinfectants for hygiene purposes; chewing gum for medical purposes; nervines; styptic preparations; medicines for dental purposes; medicated dentifrices; mouthwashes for medical purposes; coloring sprays for medical purposes; lozenges for pharmaceutical purposes; preparations to facilitate teething.

(260) AM 2021 108254 A  
(800) 1530168  
(151) 2020 01 13  
(891) 2020 01 13  
(731) CHINA KWEICHOW MOUTAI DISTILLERY  
(GROUP) CO., LTD.  
No. 4 East Mountain Lane, East Road of Outside  
Loop, Guiyang City, Guizhou Province, China  
(540)



(591) Black, white  
(531) 01.01.02; 01.01.10; 05.13.01; 25.01.15;  
26.01.03; 26.01.16; 26.11.09; 27.05.01; 28.03  
(526) 53% V/V 500ML  
(511)  
33 – Fruit extracts, alcoholic; alcoholic drinks; spirits  
[beverages]; alcoholic beverages, except beer; aperiti-  
fifs; bitters; alcoholic drinks for use in cooking; wine;  
alcohol for drinking; digesters [liqueurs and spirits].

---

(260) AM 2021 108255 A  
(800) 1530170  
(151) 2020 03 06  
(891) 2020 03 06  
(731) BERWICK BIOTECH S.a.r.l.  
3, Rue Belle-Vue, L-1227 Luxembourg,  
Luxembourg  
(540)

**ΦΟΡΤΕΖΑ**

(591) Black, white  
(531) 28.05  
(511)  
3 – Breath freshening sprays; balms, other than for  
medical purposes; dentifrices; mouthwashes, not for  
medical purposes.

5 – Analgesics; anaesthetics; antiseptics; balms for  
medical purposes; astringents for medical purposes;  
disinfectants; disinfectants for hygiene purposes; che-  
wing gum for medical purposes; nervines; styptic pre-  
parations; medicines for dental purposes; medicated  
dentifrices; mouthwashes for medical purposes; cool-  
ing sprays for medical purposes; lozenges for phar-  
maceutical purposes; preparations to facilitate teet-  
hing.

---

(260) AM 2021 108256 A  
(800) 1530180  
(151) 2020 03 04  
(891) 2020 03 04  
(731) FORANS International AG  
Haldenstrasse 5, CH-6340 Baar, Switzerland  
(540)

**ULTRA PORE**

(591) Black, white  
(511)  
5 – Medical and veterinary preparations; sanitary pro-  
ducts for medical purposes; plasters, materials for  
dressings; disinfectants.

10 – Surgical, medical, dental and veterinary appar-  
atus and instruments; orthopedic articles; massage ap-  
paratus; apparatus, devices and articles for child care;  
apparatus, devices and articles for sexual activities.

(260) AM 2021 108257 A  
(800) 1530185  
(151) 2019 12 10  
(891) 2019 12 10  
(731) Opel Automobile GmbH  
Bahnhofsplatz, 65428 Rüsselsheim, Germany  
(540)

**MANTA**

(591) Black, white  
(511)  
12 – Motor vehicles, their parts and spare parts, as far  
as included in this class.  
27 – Foot mats for vehicles.

---

(260) AM 2021 108258 A  
(800) 1530188  
(151) 2020 02 11  
(891) 2020 02 11  
(731) Tovarystvo z obmezhenoiu vidpovidalnistiu  
"Mehateks"  
vul. Yevropeiska, bud. 1A, m. Kostiantynivka,  
Donetska obl. 85110, Ukraine  
(540)



(591) Black, white  
(531) 26.04.02; 26.04.05; 27.05.02; 27.05.09  
(511)  
9 – Electrical adapters; accumulators, electric; accu-  
mulators, electric, for vehicles; acidimeters for batte-  
ries; accumulator jars; batteries, electric; batteries, el-  
ectric, for vehicles; electric plugs; measuring devices,  
electric; galvanic batteries; battery chargers; chargers  
for electric accumulators; couplings, electric; electri-  
city conduits; contacts, electric; accumulator boxes;  
plates for batteries; conductors, electric; regulating  
apparatus, electric; grids for batteries; electric sockets;  
solar batteries; solar panels for the production of el-  
ectricity.

---

(260) AM 2021 108259 A  
(800) 1530211  
(151) 2020 02 18  
(891) 2020 02 18  
(731) Otkrytoe aktsionernoe obshchestvo "Minskiy  
molochny zavod №1"  
ul. Vokzalnaya 11, 223034 Zaslavl, Minskiy  
rayon, Belarus  
(540)



(591) Red, blue and white  
 (531) 26.04.04; 26.04.05; 26.04.17; 26.04.18;  
 26.04.24; 27.05.17; 27.05.24; 27.07.17;  
 27.07.24; 28.05; 29.01.13

(511)  
 29 – Milk and milk products; yogurt; kephir [milk beverage]; buttermilk; curd [soured milk]; kumys [milk beverage]; whey; milk beverages, milk predominating; cream [dairy products]; whipped cream; ryazhenka [fermented baked milk]; cheese; cottage cheese; smetana [sour cream]; curd snacks; butter; margarine; rennet.

(260) AM 2021 108260 A  
 (800) 1530241  
 (151) 2020 02 27  
 (891) 2020 02 27  
 (731) FORANS International AG  
 Haldenstrasse 5, CH-6340 Baar, Switzerland  
 (540)

## EVOLU

(591) Black, white  
 (511)  
 9 – Pressure recorders.

10 – Oxygen inhalers for medical use; hydrogen inhalers; inhalers; medical apparatus and instruments; thermometers for medical use; clinical thermometers; temperature labels for medical use.

(260) AM 2021 108261 A  
 (800) 1530250  
 (151) 2020 04 06  
 (891) 2020 04 06  
 (731) European Gymnastics  
 12, avenue de la Gare, CH-1003 Lausanne,  
 Switzerland  
 (540)



(591) Black, white  
 (531) 04.05.03; 26.13.25  
 (511)  
 25 – Clothing, footwear, headwear; all the aforesaid goods of European origin.  
 28 – Gymnastic and sporting articles, gymnastic apparatus, games, toys; all the aforesaid goods of European origin.

35 – Advertising; commercial business management; commercial administration; office functions; organization and conducting of trade fairs, events and exhibitions for commercial or advertising purposes; administrative assistance services, administrative advice and administrative information for participants, visitors and exhibitors attending a conference; services for compiling and entering information into computer databases; all the aforesaid services are of European origin.

38 – Broadcasting of television programs and other audiovisual and multimedia content in connection with sports events via the Internet protocol and communication networks; sending of regular newsletters by email; all the aforesaid services are of European origin.

41 – Education, training, sporting and cultural activities, organization of sports activities in particular of sports competitions, production of films, video recording services for sports activities, publication of information in the field of sports other than for advertising purposes, namely, publication of brochures, leaflets, books, texts, letters and newsletters; provision of sports facilities; consulting services in the field of the organization of sports competitions, writing of texts, namely of regulations for sports competitions, arranging and conducting of colloquiums, conferences or congresses; all the aforesaid services are of European origin.

45 – Arbitration services in the field of sports, litigation services in the field of sports, legal advisory services in the field of sports, legal services in the field of sports, namely regulation interpretation services for sports competitions and monitoring of the application of regulations for sports competitions, advisory services relating to safety in the framework of sports; all the aforesaid services are of European origin.

(260) AM 2021 108262 A  
 (800) 1530387  
 (151) 2020 03 12  
 (891) 2020 03 12  
 (731) DANHSON-BG OOD  
 St. "Otets Paisiy" 26, BG-2400 Radomir,  
 Bulgaria

## ВИРУПРИНОЛ VIRUPRINOL

(591) Black, white  
 (531) 28.05  
 (511)  
 5 – Veterinary preparations; immunostimulants; medicine; medicated food supplements; medical preparations; syrups for pharmaceutical purposes; pharmaceutical drugs; pharmaceutical preparations for the treatment of viral diseases; pharmaceutical prepara-

tions for regulating the immune system; pharmaceutical preparations for the treating and prevention of diseases and disorders of the immune system; pharmaceutical preparations and substances; nutritional supplements.

(260) AM 2021 108263 A  
(800) 1530397  
(151) 2019 12 25  
(891) 2019 12 25  
(731) Limited Liability Company "Association, "Soyuzpichsheprom"  
pos. Melkombinat-2, uchastok 1, d. 37,  
RU-454080 Chelyabinsk, Russian Federation  
(540)



(591) Red, dark red, black, golden and white  
(531) 07.01.05; 26.01.03; 26.01.16; 26.01.18;  
26.11.12; 27.01.12; 27.05.03; 28.03; 29.01.13  
(511)  
29 – Oils for food; linseed oil for food; sunflower oil for food; mustard oil for food.  
30 – Pasta; vermicelli [noodles]; ribbon vermicelli; macaroni; spaghetti; soba noodles; udon noodles; flour; wheat flour; buckwheat flour; groats for human food; hominy grits; semolina; oatmeal; crushed barley; buckwheat, processed; rice; cereal preparations; oat-based food; chips [cereal products]; corn flakes; oat flakes; bread; bread rolls; croutons; rusks; malt biscuits; crackers; pastries; pies; cereal bars; rice-based snack food; cereal-based snack food; muesli.

(260) AM 2021 108264 A  
(800) 1530432  
(151) 2020 02 06  
(891) 2020 02 06  
(731) GOLD ART S.R.L.  
Via Giacomo Konz 45, I-52100 AREZZO, Italy  
(540)



(591) Black, white  
(531) 03.09.04; 27.05.01  
(511)  
14 – Jewelry; jewels; cloisonné jewelry; jewelry for the head; precious and semi-precious jewels; amulets

[jewellery and imitation jewellery]; rings [jewellery and imitation jewellery]; body-piercing rings; body-piercing studs; bangles; bracelets made of embroidered textile [jewellery and imitation jewellery]; chains [jewellery and imitation jewellery]; neck chains; ankle bracelets; necklaces [jewellery and imitation jewellery]; chokers; jewellery charms; pendants [jewellery]; crucifixes as jewelry; crosses [jewellery and imitation jewellery]; wedding rings; tie clips; cuff links; lockets [jewellery and imitation jewellery]; misbaha [prayer beads]; rosaries; earrings; pins [jewellery and imitation jewellery]; cloisonné pins; tie pins; ornamental pins; brooches [jewellery and imitation jewellery]; jewellery hat pins; tiaras; cameos [jewellery and imitation jewellery]; clasps for jewelry; jewelry findings; shoe jewelry; hat jewelry; plastic jewelry; jewelry plated with precious metals; jewellery articles; shoe ornaments of precious metal; hat ornaments of precious metal; jewelry cases [caskets], not of precious metal; presentation boxes for jewelry; jewelry boxes; caskets, being cases, for jewels; jewellery caskets; jewelry rolls; key rings [split rings with trinket or decorative fob]; retractable key rings; split rings of precious metal for keys; charms for key rings; key tags of plastic; lanyards [keycords]; timepieces; watches; table clocks; clocks; anchors [clock- and watchmaking]; barrels [clock- and watchmaking]; pendulums [clock- and watchmaking]; watch bands; watch cases [parts of watches]; clock cases; watch chains; buckles for watch bands; clock hands; watch hands; movements for clocks and watches; watch springs; dials [clock- and watchmaking]; clockworks; watch glasses; stands for clocks; cases for clocks and watches; watch pouches; presentation boxes for watches; chronometric apparatus and instruments; chronographs [watches]; chronoscopes; alarm clocks; statues of precious metal; figurines of precious metal; busts of precious metal; figures of precious metal; model figures [ornaments] made of precious metal; works of art of precious metal; ingots of precious metals; medals; coins; copper tokens; jewelry cases [caskets]; boxes of precious metal; crucifixes of precious metal, other than jewelry; commemorative statuary cups made of precious metal; trophies of precious metal; trophy columns of precious metal; badges of precious metals; drawer pulls of precious metal; bottle caps of precious metal; badges of precious metal; precious and semi-precious gems; precious stones; semi-precious stones; cabochons; pearls [jewelry]; beads for making jewelry; paste jewelry [costume jewelry]; precious metals, unwrought or semi-wrought; alloys of precious metal; threads of precious metal [jewelry]; precious metals and their alloys; jewellery, precious and semi-precious stones; horological and chronometric instruments.

(260) AM 2021 108265 A  
 (800) 1530453  
 (151) 2020 03 04  
 (891) 2020 03 04  
 (731) Huawei Technologies Co., Ltd.  
 Administration Building, Huawei Technologies  
 Co., Ltd. Bantian, Longgang District, Shenzhen,  
 China  
 (540)



(591) Red and white  
 (531) 26.04.04; 26.04.05; 26.04.22; 26.04.24;  
 27.05.24; 29.01.12

(511)  
 9 – Virtual reality headsets; laptop computers; humanoid robots with artificial intelligence; computer software applications, downloadable; facial recognition apparatus; wearable activity trackers; computer programs, recorded; computer software platforms, recorded or downloadable; smartphones; tablet computers; network communication equipment; downloadable software applications for mobile phones.

35 – Provision and rental of advertising space on the Internet; online advertising on computer communication networks; providing commercial information and advice for consumers in the choice of products and services; providing business information via a web site; commercial administration of the licensing of the goods and services of others; providing business information via the Internet, wired network, or other forms of data transmission; promoting the goods and services of others; procurement services for others [purchasing goods and services for other businesses]; provision of an online marketplace for buyers and sellers of goods and services; compiling indexes of information for commercial or advertising purposes; search engine optimization for sales promotion; advertising.

42 – Quality checking and testing; technological research; software as a service [SaaS]; cloud computing; platform as a service [PaaS]; research and development of computer software; design and development of computer software; electronic data storage; quality system certification; providing information relating to computer technology and programming via a web site.

(260) AM 2021 108267 A  
 (800) 1530561  
 (151) 2020 02 28  
 (891) 2020 02 28  
 (731) Joint-Stock Company "Fabrika "Russkiy  
 shokolad"  
 ul. Vereyskaya, d. 29, str. 143, etazh 1, pom.  
 III, kom. 1, RU-121357 Moscow, Russian  
 Federation  
 (540)

**MIX IT**

(591) Black, white  
 (531) 27.05.17  
 (511)

30 – Vanilla flavorings for culinary purposes; flavorings, other than essential oils, for cakes; flavorings, other than essential oils, for beverages; coffee flavorings; food flavorings, other than essential oils; star aniseed; cereal bars; high-protein cereal bars; pancakes; noodle-based prepared meals; freeze-dried dishes with the main ingredient being pasta; freeze-dried dishes with the main ingredient being rice; buns; bulgur; bread rolls; edible rice paper; edible paper; vanillin [vanilla substitute]; waffles; vermicelli; natural sweeteners; sausage binding materials; binding agents for ice cream; sea water for cooking; seaweed [condiment]; malt biscuits; cloves [spice]; mirror icing [mirror glaze]; cake frosting [icing]; glucose for culinary purposes; mustard; croûtons; buckwheat, processed; gluten additives for culinary purposes; yeast; thickening agents for cooking foodstuffs; leaven; rice-based snack food; cereal-based snack food; artificial coffee; vegetal preparations for use as coffee substitutes; dressings for salad; zephyr [confectionery]; fruit jellies [confectionery]; candy decorations for cakes; confectionery for decorating Christmas trees; cakes; pastries; peanut confectionery; almond confectionery; pasta; frozen yogurt [confectionery ices]; cocoa; cream of tartar for culinary purposes; capers; caramels [sweets]; curry [spice]; ketchup [sauce]; quinoa, processed; quiches; gluten prepared as foodstuff; flour-based dumplings; sweets; liquorice [confectionery]; peppermint sweets; mints for breath freshening; dulce de leche; cinnamon [spice]; coffee; starch for food; crackers; custard; hominy grits; semolina; oatmeal; crushed barley; groats for human food; corn, milled; corn, roasted; meat pies; turmeric; noodles; soba noodles; udon noodles; ice for refreshment; ice, natural or artificial; edible ices; rice cakes; mayonnaise; macarons; macaroni; maltose; hominy; piccalilli; marinades; marzipan; honey; royal jelly; ice cream; bean meal; buckwheat flour; tapioca flour; potato flour; corn flour; nut flours; flour; wheat flour; soya flour; barley meal; dessert mousses [confectionery]; chocolate mousses; muesli; mint for confectionery; cocoa beverages with milk; coffee beverages with milk; coffee-based beverages; cocoa-based beverages; chamomile-based beverages; tea-based beverages; chocolate

beverages with milk; chocolate-based beverages; infusions, not medicinal; crushed oats; husked oats; onigiri; nutmegs; chocolate-coated nuts; stick liquorice [confectionery]; pastilles [confectionery]; molasses for food; pepper; allspice; peppers [seasonings]; cookies; petit-beurre biscuits; bibimbap [rice mixed with vegetables and beef]; pies; pizzas; meat gravies; fondants [confectionery]; popcorn; powders for making ice cream; baking powder; mustard meal; pralines; condiments; meat tenderizers for household purposes; cereal preparations; oat-based food; propolis; gingerbread; spices; petits fours; puddings; cake powder; fruit coulis [sauces]; ravioli; chewing gum; chewing gum for breath freshening; relish [condiment]; rice; instant rice; wheat germ for human consumption; spring rolls; sago; sugar; palm sugar; sesame seeds [seasonings]; linseed for culinary purposes [seasoning]; processed seeds for use as a seasoning; aniseed; agave syrup [natural sweetener]; golden syrup; confectionery; baking soda [bicarbonate of soda for cooking purposes]; malt for human consumption; salt for preserving foodstuffs; cooking salt; celery salt; sorbets [ices]; ham glaze; cranberry sauce [condiment]; soya sauce; tomato sauce; apple sauce [condiment]; sauces [condiments]; pasta sauce; spaghetti; seasonings; chocolate-based spreads; chocolate spreads containing nuts; preparations for stiffening whipped cream; shaved ice with sweetened red beans; rusks; breadcrumbs; sushi; sandwiches; tabbouleh; tapioca; dough; pastry dough; cake dough; chocolate decorations for cakes; vinegar; halvah; bread; unleavened bread; chips [cereal products]; corn flakes; oat flakes; hot dog sandwiches; chicory [coffee substitute]; tea; iced tea; chocolate; essences for foodstuffs, except etheric essences and essential oils; husked barley.

(260) AM 2021 108268 A  
 (800) 1530573  
 (151) 2020 01 31  
 (891) 2020 01 31  
 (731) FERRERO TRADING LUX SA  
 16, route de Trèves, Senningerberg, L-2633,  
 Luxembourg  
 (540)



(591) Grey, white and several shades of green, orange, red, pink, purple, beige, brown and blue  
 (531) 01.01.03; 15.07.01; 15.07.03; 20.01.03; 20.07.01; 20.07.02; 25.01.10; 26.04.01; 26.04.09; 26.04.18; 27.05.04; 27.05.07; 27.05.08; 27.05.17; 27.05.19; 29.01.15

(511)  
 9 – Software; downloadable software; software applications for mobile telephony apparatus; downloadable software for playing games; compact discs; DVDs and other digital recording media.

41 – Education; providing of training; entertainment services; sporting and cultural activities; radio, internet and television entertainment; organization and providing of games and competitions via the internet [entertainment, education and sport]; electronic games services provided by means of the internet or other communication networks; providing of educational material; providing of online information relating to entertainment and / or education; entertainment provided through a global communication network.

(260) AM 2021 108269 A  
 (800) 1530609  
 (151) 2020 02 07  
 (891) 2020 02 07  
 (731) COASTROCK HOLDINGS LIMITED  
 Thasou 3, Dadlaw House, CY-1520 Nicosia,  
 Cyprus  
 (540)



(591) Black, white  
 (531) 27.05.09  
 (511)

6 – Transportable construction of metal; small items of metal hardware; loading pallets of metal; containers of metal [storage, transport]; packaging containers of metal; pitons of metal; hooks [metal hardware]; clothes hooks of metal; hooks of metal for clothes rails; latticework of metal; trellis of metal; cabanas of metal; buildings of metal; bicycle parking installations of metal; guard rails of metal; baskets of metal; boxes of common metal; sheets and plates of metal; linings of metal for building; wall linings of metal for building; cladding of metal for building; wall claddings of metal for building; duckboards of metal; tinplate packings; belts of metal for handling loads; straps of metal for handling loads; transport pallets of metal; handling pallets of metal; props of metal; partitions of metal; lintels of metal; platforms, prefabricated, of metal; joists of metal; frames of metal for building; rails of metal; gratings of metal; scaffolding of metal; identity plates of metal; roller blinds of steel; cashboxes of metal; tool boxes of metal, empty; braces of metal for handling loads; steel buildings; steel masts; stair treads [steps] of metal; staircases of metal; turnstiles of metal; fittings of metal for furniture; chests of metal; chests of metal for food; tool chests of metal, empty; bins of metal; chests of metal; arbours [structures] of metal; anchor plates; beams of metal; girders of metal; safety cashboxes; screw rings; bolts

of metal; casks of metal; signboards of metal; nuts of metal; screws of metal; dispensers for dog waste bags, fixed, of metal; greenhouse frames of metal; cornices of metal; ferrules of metal; furniture casters of metal; bed casters of metal; runners of metal for sliding doors; pillars of metal for building; brackets of metal for building; chicken-houses of metal; metal cages for wild animals; registration plates of metal; building panels of metal; wainscotting of metal; cask stands of metal; laths of metal; letter boxes of metal; safes [strong boxes]; advertisement columns of metal; greenhouses of metal, transportable; balustrades of metal; barrels of metal; framework of metal for building; building materials of metal; containers of metal for compressed gas or liquid air; tanks of metal; ladders of metal; steps [ladders] of metal; wire of common metal; wire of common metal alloys, except fuse wire; wire gauze; poles of metal; strap-hinges of metal; cotter pins of metal; rivets of metal; iron wire; locks of metal, other than electric; padlocks; spring locks; safety chains of metal; lock bolts; prefabricated houses [kits] of metal; outdoor blinds of metal; booths of metal for spraying paint; washers of metal; loading gauge rods, of metal, for railway wagons; fences of metal; floors of metal; floor tiles of metal; stringers [parts of staircases] of metal; towel dispensers, fixed, of metal; signalling panels, non-luminous and non-mechanical, of metal; step stools of metal; posts of metal; stops of metal; bars for metal railings; slings of metal for handling loads; telephone boxes of metal; ice moulds of metal; box of metal for use in retail and advertising; beams (construction of metal); fittings for shelving, metal; upright profile, metal; metal fittings for checkout counters (retail furniture); metal guard barriers and crash barriers, metal skirting for protecting warehouse and retailers' equipment; profile of metal; guard barriers and guide rails of metal; metal containers for storage or transporting meat, fruits; transportable metal constructions for hanging meat and half carcasses; metal pallet containers (for storage, transportation); barriers for pallets (metal); small hardware of metal for hanging goods for use in trade or presentation; metal gratings for use in the construction of trade displays; metal gratings (elements of warehouse, trade and presentation equipment).

7 – Machines and machine tools; motors and engines (except for land vehicles); machine coupling and transmission components (except for land vehicles); agricultural implements other than hand-operated; apparatus for drawing up beer under pressure; hoppers [mechanical discharging]; door openers, hydraulic; door openers, electric; door openers, pneumatic; door closers, hydraulic; door closers, electric; door closers, pneumatic; elevator chains [parts of machines]; apparatus for aerating water; apparatus for aerating beverages; vending machines; belt conveyors; loading ramps; handling apparatus for loading and unloading; conveyors [machines]; moving pavements [side-

walks]; compressors for refrigerators; elevating apparatus; lifts, other than ski-lifts; jacks [machines]; hoists; handling machines, automatic [manipulators]; fans for motors and engines; food preparation machines, electromechanical; beverage preparation machines, electromechanical; electromechanical machines for chemical industry; moving staircases [escalators]; labellers [machines]; elevator operating apparatus; hydraulic controls for machines, motors and engines; control mechanisms for machines, engines or motors; pneumatic controls for machines, motors and engines; cranes [lifting and hoisting apparatus]; hangers [parts of machines]; elevators [lifts]; washing apparatus; high pressure washers; lifting apparatus; pneumatic transporters; pneumatic tube conveyors; rack and pinion jacks; robots [machines]; brewing machines; rolling mill cylinders; derricks; water separators; pneumatic jacks; clutches other than for land vehicles; belts for conveyors; self-service automatic vending machines; secure self-service vending machines equipped with payment terminals; parcel terminals (parcel handling machines for sending or receiving postal items); protected parcel terminals (parcel handling machines for sending or receiving postal items); machines for dispensing bulk food.

9 – Apparatus and instruments for conducting, switching, transforming, accumulating, regulating or controlling electricity; cash registers; computers; ticket dispensers; remote control apparatus; furniture especially made for laboratories; weighing, measuring, signalling, checking (supervision) apparatus and instruments; calculating machines; data processing equipment; automated teller machines [ATM]; computer software; lever scales [steelyards]; scales; mechanical signs; signs, luminous; bar code readers; mechanisms for counter-operated apparatus; mechanisms for coin-operated apparatus; invoicing machines; scanners [data processing equipment]; digital signs; apparatus to check stamping mail; weights; detectors; counterfeit [false] coin detectors; dosage dispensers; furnaces for laboratory use; electric installations for the remote control of industrial operations; electronic tags for goods; electronic notice boards; readers [data processing equipment]; computer hardware; computer programs [downloadable software]; computer programmes [programs], recorded; computer operating programs, recorded; electric apparatus for commutation; laboratory trays; counters; weighing machines; money counting and sorting machines; letter scales; computer software applications, downloadable; weighing apparatus and instruments; control panels [electricity]; light regulators [dimmers], electric; distribution consoles [electricity]; distribution boxes [electricity]; distribution boards [electricity]; light-emitting electronic pointers; signalling panels, luminous or mechanical; temperature indicators; temperature indicator labels, not for medical purposes; heat regulating apparatus; thermometers, not for medical purposes; automated

self-service paying terminals; protected automated self-service paying terminals; dividers (non-metallic fittings, and parts for cash registers).

11 – Apparatus for lighting, heating, steam generating, cooking, refrigerating, drying, ventilating, water supply and sanitary purposes; heat accumulators; hand drying apparatus for washrooms; air purifying apparatus and machines; hot air apparatus; air deodorising apparatus; apparatus for dehydrating food waste; ionization apparatus for the treatment of air or water; oil-scrubbing apparatus; coffee roasters; framework of metal for ovens; laundry room boilers; washing coppers; bath tubs; spa baths [vessels]; waffle irons, electric; fans [air-conditioning]; fans [parts of air-conditioning installations]; electric fans for personal use; ventilation [air-conditioning] installations for vehicles; ventilation [air-conditioning] installations and apparatus; kilns; evaporators; ventilation hoods; pressure water tanks; whirlpool-jet apparatus; water heaters [apparatus]; water softening apparatus and installations; water heaters; water purification installations; water purifying apparatus and machines; hearths; ro-tisseries; disinfectant apparatus; deodorising apparatus, not for personal use; chimney flues; stills; distillation apparatus; distillation columns; showers; electrically heated carpets; roasters; malt roasters; roasting apparatus; roasting spits; mixer taps for water pipes; cooking utensils, electric; cooking rings; kitchen ranges [ovens]; cookers; microwave ovens [cooking apparatus]; microwave ovens for industrial purposes; heating elements; hot plates; heaters for baths; plate warmers; coolers for furnaces; steam boilers, other than parts of machines; pasteurisers; anti-splash tap nozzles; sanitary apparatus and installations; drying apparatus for fodder and forage; tobacco roasters; fruit roasters; laundry dryers, electric; refrigerating containers; freezers; sinks; heated display cabinets; refrigerators; wash-hand basins [parts of sanitary installations]; refrigerating display cabinets; cooling appliances and installations; refrigerating appliances and installations; ventilation hoods for laboratories; water conduits installations; water intake apparatus; water supply installations; water distribution installations; ice machines and apparatus; clean chambers [sanitary installations]; drying apparatus and installations; drying apparatus; air cooling apparatus; air driers; cooling installations for water; cooling installations for liquids; cooling installations for tobacco; beverage cooling apparatus; refrigerating apparatus and machines; refrigerating containers; refrigerating chambers; refrigerating cabinets; bath fittings; deep fryers, electric; extractor hoods for kitchens; bread baking machines; bread-making machines; bakers' ovens; milk cooling installations; dental ovens; commercial refrigerators; refrigerators for warehouse; cold cabinets; bath tubs; wash basins [parts of sanitary installations]; freezer showcases operating in low temperature; lighting equipment for shelves (accessories

commercial and walk-in refrigerators, refrigerating displays); gastronomic refrigerated showcases.

12 – Forklift trucks; apparatus for locomotion by land, air or water; carts; two-wheeled trolleys; shopping trolleys; hose carts; roll cage trolleys; casters for trolleys [vehicles]; aerial conveyors; handling carts; wheelbarrows; tilting-carts.

19 – Building materials (non-metallic); non-metallic transportable buildings; girders, not of metal; beams, not of metal; silos, not of metal; cabanas, not of metal; greenhouse frames, not of metal; horticultural frames, not of metal; brackets, not of metal, for building; platforms, prefabricated, not of metal; scaffolding, not of metal; buildings, not of metal; advertisement columns, not of metal; stair-treads [steps], not of metal; stair-cases, not of metal; turnstiles, not of metal; arbours [structures], not of metal; balustrades, not of metal; latticework, not of metal; wood for making household utensils; wood, semi-worked; wood panelling; wooden floor boards; prefabricated houses [kits], not of metal; framework, not of metal, for building; pillars, not of metal, for building; installations, not of metal, for parking bicycles; manufactured timber; sawn timber; fences, not of metal; partitions, not of metal; props, not of metal; stringers [parts of staircases], not of metal; joists, not of metal; non-luminous and non-mechanical signs, not of metal; signalling panels, non-luminous and non-mechanical, not of metal; non-metal road barriers; uprights (building structures), non-metal, for mounting racks.

20 – Furniture; library shelves; vats, not of metal; bamboo; barrels, not of metal; bolts, not of metal; rattan; high chairs for babies; coat hangers; clothes hangers; coathooks, not of metal; hooks, not of metal, for clothes rails; towel dispensers, fixed, not of metal; reservoirs, not of metal nor of masonry; nuts, not of metal; clothes hooks, not of metal; screws, not of metal; doors for furniture; divans; ladders of wood or plastics; stair rods; display boards; settees; desks; office furniture; armchairs; seats; medicine cabinets; plate racks; bakers' bread baskets; hinges, not of metal; school furniture; casks, not of metal; shoulder poles [yokes]; coatstands; towel stands [furniture]; curtain hooks; keyboards for hanging keys; steps [ladders], not of metal; poles, not of metal; locks, other than electric, not of metal; chopping blocks [tables]; decorations of plastic for foodstuffs; crates; writing desks; head-rests [furniture]; stands for calculating machines; chests for toys; carts for computers [furniture]; placards of wood or plastics; trays, not of metal; loading pallets, not of metal; tool chests, not of metal, empty; signboards of wood or plastics; trolleys [furniture]; display stands; showcases [furniture]; jewellery organizer displays; containers, not of metal [storage, transport]; packaging containers of plastic; newspaper display stands; shelving units; magazine racks; index cabinets [furniture]; book rests [furnitu-



re]; furniture casters, not of metal; baskets, not of metal; hampers [baskets]; partitions of wood for furniture; furniture shelves; furniture fittings, not of metal; furniture of metal; edgings of plastic for furniture; freestanding partitions [furniture]; dinner wagons [furniture]; transport pallets, not of metal; handling pallets, not of metal; trestles [furniture]; cask stands, not of metal; slatted indoor blinds; shelves for storage; counters [tables]; shelves for file cabinets; letter boxes, not of metal or masonry; racks [furniture]; bottle racks; table tops; seats of metal; step stools, not of metal; shelves for typewriters; tea carts; standing desks; tables of metal; tables; washstands [furniture]; cupboards; meat chests, not of metal; filing cabinets; covers for clothing [wardrobe]; screens [furniture]; lockers; bins, boxes, cases of wood or plastic; bins, boxes of wood or plastic; tool boxes, not of metal, empty; sideboards; loading gauge rods, not of metal, for railway wagons [wagons]; closures, not of metal, for containers; clips, not of metal, for cables and pipes; bungs, not of metal; plugs [dowels], not of metal; bottle closures, not of metal; latches, not of metal; identity plates, not of metal; garment covers [storage]; mats, removable, for sinks; dressing tables; split rings, not of metal, for keys; numberplates, not of metal; counters for making or displaying pizza; furniture for point of sale equipment for trade; hangers, barriers, partitions, sidewalls, bars, bars, shelves, holders, restraints, corners, frames for advertising, hooks, holders for price tags, dividers (non-metal furniture and parts for shelving (furniture)); partitions, restraints, bumpers, as parts of commercial furniture, frames for advertising; multi-level warehouse furniture; showcases (furniture) for trade and presentations; coat racks (furniture); exhibition, presentation, retail, laboratory, industrial, warehouse racks (furniture); hooks for hanging goods in trade or presentation equipment (not of metal); non-metallic stationary containers for storing and dispensing goods for commercial use; exhibition stands (furniture for trade and presentations); small non-metallic articles for displaying goods on trading equipment or presentation boards; demountable racks (furniture); combined racks for retail and warehouse (furniture); checkout counters (retail furniture); stands (furniture) for confectionery; meat counter (tables); modules for checkout counters (retail furniture); modular retail and presentation equipment (retail furniture); hanging cabinets; fitted bumper guards for warehouse and retail furniture, not of metal; overhead tobacco displays and cabinets (retail equipment); pallet racking (furniture); trade furniture that is mounted above average human height, including display cases with cigarette dispensers; angled racks for pellets; pallet furniture racks; shelves (furniture) for placement of trade, warehouse, laboratory, production equipment; shelves for retail, warehouse, laboratory, industrial furniture; metal shelves (furniture); shelves for racks (furniture); presentation racks (furniture); shelving for drying dishes (furniture); step

shelves for displaying goods, front bumpers, shelves for bags, holders for packages, partitions (parts of furniture); non-metallic partitions, curtains (interior items) for commercial and warehouse premises, which contain refrigerators and refrigerated showcases; hermetic partitions (parts of furniture); step shelves for displaying goods, fitted front bumper guards for displays, shelves for bags, racks for holding for packages, partitions (parts of furniture); trolleys (furniture) in the form of racks on wheels for confectionery; metal cupboards (furniture); meat safes of metal; poles, not of metal; metal gratings, being parts for racks and displays for trade and presentations; metal wire grilles being parts for racks and displays for trade and presentations.

35 – Demonstration of goods; writing of publicity texts; scriptwriting for advertising purposes; organization of trade fairs for commercial or advertising purposes; organization of exhibitions for commercial or advertising purposes; outsourcing services [business assistance]; rental of billboards [advertising boards]; rental of vending machines; rental of sales stands; advertising; development of advertising concepts; sales promotion for others; marketing research; procurement services for others [purchasing goods and services for other businesses]; presentation of goods on communication media, for retail purposes.

37 – Building of fair stalls and shops; elevator installation and repair; electric appliance installation and repair; heating equipment installation and repair; installation and repair of air-conditioning apparatus; freezing equipment installation and repair; kitchen equipment installation; machinery installation, maintenance and repair; repair information; construction information; construction consultancy; installation services; furniture restoration; construction; warehouse construction and repair; furniture maintenance.

42 – Scientific and technological services and research and design relating thereto; industrial analysis and research services; construction drafting; architectural consultancy; architectural services; technical project studies; interior design; engineering; software as a service [SaaS]; rental of computer software; industrial design; technological consultancy; styling [industrial design]; graphic arts design; design of interior decor; design of warehouse systems and equipment; design of retail equipment; designing presentation equipment; consultancy on design of warehouses including development of new products, design of new retail equipment for others, including development of new products; design of automated warehouse systems.

(260) AM 2021 108270 A  
(800) 1530616  
(151) 2020 03 16  
(891) 2020 03 16  
(731) Toruńskie Zakłady Materiałów, Opatrunkowych Spółka Akcyjna  
Żółkiewskiego 20/26, PL-87-100 Toruń, Poland  
(540)

# pregips

(591) Black, white  
(531) 27.05.01  
(511)  
10 – Plaster bandages for orthopaedic purposes.

(260) AM 2021 108271 A  
(800) 1530706  
(151) 2020 02 21  
(891) 2020 02 21  
(731) Open-Type Joint Stock Company "Krasnyj Ocyabr"  
ul. Malaya Krasnoselskaya, d. 7, str. 24,  
RU-107140 Moscow, Russian Federation  
(540)



(591) White, brown, dark brown and light brown  
(531) 24.01.25; 24.03.07; 24.03.18; 24.03.19;  
25.01.09; 25.01.15; 28.05; 29.01.13  
(526) КОНФЕТЫ СЛИВОЧНАЯ ПОМАДКА С ЦУКАТОМ  
(511)  
30 – Sweets; fondants [confectionery].

(260) AM 2021 108272 A  
(800) 1530719  
(151) 2020 03 25  
(891) 2020 03 25  
(731) Intel Corporation  
2200 Mission College Boulevard, Santa Clara  
CA 95052-8119, USA  
(540)

# INTEL EVO

(591) Black, white  
(511)  
9 – Computer software; computer firmware; computing modules; computers; tablet computers, notebook and laptop computers; portable computers; wireless communication devices for voice, data or image trans-

mission over the internet; computer hardware; computer software and firmware used to maintain and operate a computer system; computer software and firmware for providing control, monitoring and data manipulation of engineered products and systems; graphics cards; high definition graphics chipsets; integrated circuits; semiconductor processors; microprocessors; software programmable data processors; data processing equipment.

(260) AM 2021 108273 A  
(800) 1530793  
(151) 2019 09 10  
(891) 2019 09 10  
(731) Bellman & Symfon Europe AB  
S. Långebergsgatan 30, SE-436 32 Askim,  
Sweden  
(540)



# Bellman & Symfon

(591) Black, white  
(531) 16.01.04; 26.11.22; 27.05.01  
(511)  
9 – Apparatus and instruments for signalling, alerting, transforming, recording, transmitting, receiving or reproducing sound and images, all for the purpose of helping, facilitating and making possible for the ear to perceive faint and distant sounds and signals; apparatus and instruments for tactile signalling, transmitting or receiving; amplifiers; alarms for deaf people, people with defect hearing and/or people with defect vision; luminous and/or mechanical signals; listening devices for televisions, radios, computers and Internet; video reader; radio-, infrared and wire based communication devices, except telephones and not including antennas or inverters; ear phones and head phones; loud telephone signals; flashing telephone signals; telephone amplifiers; in ear monitoring systems; microphones; warning signals; warning bells; blinkers [signalling lights]; buzzers; receivers; hearing aid batteries; parts and accessories to the mentioned products.

10 – Medical apparatus and instruments for helping, facilitating and making possible to hear and/or in any other way perceive sounds and signals for deaf people, people with defect hearing and/or people with defect vision; surgical and medical apparatus and instruments for protecting, examining and treating hearing impairment, deafness and the ear and the function of the ear; hearing aids; hearing protectors; cleaning kits for hearing aids in the nature of cleaning brushes; ear plugs; ear picks; surgical implants and artificial limbs; orthopaedic articles; parts and accessories to the mentioned products.

(260) AM 2021 108274 A

(800) 1530817

(151) 2019 11 19

(891) 2019 11 19

(731) BKV VANA MAKİNA İNŞAAT TESİSAT, SANAYİ VE TİCARET LİMİTED ŞİRKETİ  
Fevzi Çakmak Mahallesi, Aslım Caddesi,  
Atiker 1., Sanayi Sitesi, No: 40/G, Karatay,  
Konya, Turkey

(540)

## BKV

(591) Black, white

(511)

6 – Ores of non-precious metal; common metals and their alloys and semi-finished products made of these materials; irons for construction; mats and stirrups of common metals for buildings; common metals in the form of plate, billet, stick, profile, sheet and sheeting; goods and materials of common metal used for storage, wrapping, packaging and sheltering purposes, containers of metal (storage, transport), buildings of metal, frames of metal for building, poles of metal for building, metal boxes, packaging containers of metal, aluminium foil, fences made of metal, guard barriers of metal, metal tubes, storage containers of metal, metal containers for the transportation of goods, ladders of metal; goods of common metal for filtering and sifting purposes, namely ducts and vents; doors, windows, shutters, jalousies and their cases and fittings of metal; non-electric cables and wires of metal; ironmongery; small hardware of metal; screws of metal; nails; bolts of metal; nuts of metal; pegs of metal; flakes of metal; pitons of metal; metal chains; furniture casters of metal; fittings of metal for furniture; industrial metal wheels; door handles of metal; window handles of metal; hinges of metal; metal latches; metal locks; metal keys for locks; metal rings; metal pulleys; ventilation ducts, vents, vent covers, pipes, chimney caps, manhole covers, grilles of metal for ventilation, heating, sewage, telephone, underground electricity and air conditioning installations; metal panels or boards (non-luminous and non-mechanical) used for signalling, route showing, publicity purposes, signboards of metal, advertisement columns of metal, signaling panels of metal, non-luminous and non-mechanical traffic signs of metal; pipes of metal for transportation of liquids and gas, drilling pipes of metal and their metal fittings, valves of metal, couplings of metal for pipes, elbows of metal for pipes, clips of metal for pipes, connectors of metal for pipes; safes (strong boxes) of metal; metal railway materials, metal rails, metal railway ties, railway switches; bollards of metal, floating docks of metal, mooring buoys of metal, anchors; metal moulds for casting, other than machine parts; works of art made of common metals or their alloys, trophies of common metal; metal closures, bottle caps of metal; metal poles; metal pillars; scaffolding of metal; metal stakes,

scaffolding towers of metal; metal pallets and metal ropes for lifting, loading and transportation purposes; metal hangers, ties, straps, tapes and bands used for load-lifting and load-carrying; wheel chocks made primarily of metal; metal profile laths for vehicles for the purposes of decoration.

11 – Lighting installations; lights for vehicles and interior-exterior spaces; heating installations using solid, liquid or gas fuels or electricity, central heating boilers, boilers for heating installations, radiators (heating), heat exchangers, not parts of machines, stoves, kitchen stoves, solar thermal collectors (heating); steam, gas and fog generators, steam boilers, other than parts of machines, acetylene generators, oxygen generators, nitrogen generators; installations for air-conditioning and ventilating; cooling installations and freezers; electric and gas-powered devices, installations and apparatus for cooking, drying and boiling, cookers, electric cooking pots, electric water heaters, barbecues, electric laundry driers; hair driers; hand drying apparatus; sanitary installations, taps (faucets), shower installations, toilets (water-closets), shower and bathing cubicles, bath tubs, toilet seats, sinks, wash-hand basins (parts of sanitary installations), washers for water taps; water softening apparatus; water purification apparatus; water purification installations; waste water purification installations; electric bed warmers and electric blankets, not for medical use; electric pillow warmers; electric or non-electric footwarmers; hot water bottles, electrically heated socks; filters for aquariums and aquarium filtration apparatus; industrial type installations for cooking, drying and cooling purposes; pasteurizers and sterilizers.

(260) AM 2021 108278 A

(800) 1530834

(151) 2019 10 21

(891) 2019 10 21

(731) Hydroscand AB

Box 401, SE-128 06 Sköndal, Sweden

(540)

## HYDROSCAND

(591) Black, white

(511)

6 – Metal hardware; metal mountings; pipes, tubes and hoses, and fittings therefor, including valves, of metal; junctions of metals for pipes; couplings and connectors of metal for pipes, hoses and tubes.

7 – Machines and machine tools for treatment of materials and for manufacturing; engines, powertrains, and machine parts, and hydraulic controls for the operation of machines and engines; metal hoses as parts of machines, for use in hydraulic systems in machines; motors (except for land vehicles); pneumatic actuators for control valves; assembly machines; hose

and tube assembly machines and machines for cutting, stripping, pressing and pressure testing of hoses and tubes, including parts and components thereof; pipe bending machines; machine coupling and belting components (except for land vehicles); power transmission couplings; crimping machines; machine tools for hose and tube assembly and for cutting, stripping, pressing and pressure testing of hoses and tubes, including parts and components thereof; adapters for machine tools; ball valves being parts of machines; pipes (fitted parts of machines); filtering machines, separators and centrifuges; filters for machines; filters for motors and engines; fuel and oil filters.

17 – Packing, stopping and insulating materials; junctions, not of metal for flexible pipes, tubes and hoses; flexible pipes, tubes, hoses and fittings therefor (including valves of rubber), and fittings for rigid pipes, all non-metallic; couplings and connectors (non-metallic) for pipes, hoses and tubes.

35 – Wholesale and retail services relating to hoses, pipes, fittings and thereto related products.

37 – Installation, maintenance and reparation services within the field of hoses, pipes, fittings, machine and machine tools for treatment of material and manufacturing, and thereto related products.

40 – Pipe bending services.

---

(260) AM 2021 108288 A  
(800) 1471191  
(151) 2019 04 24  
(891) 2020 04 28  
(731) Janssen Pharmaceutica NV  
Turnhoutseweg 30, B-2340 Beerse,  
Belgium

(540)

## ERZYDO

(591) Black, white

(511)

5 – Pharmaceutical preparations for the treatment of oncological diseases and disorders.

---

(260) AM 2021 108341 A  
(800) 1531326  
(151) 2020 04 10  
(891) 2020 04 10  
(731) Gesellschaft mit beschränkter Haftung  
"Ehrmann"  
pos. RAOS, 15, Ramenskiy r-n, RU-140126  
Moscow Region, Russian Federation

(540)

## Grand Duet

(591) Black, white

(531) 27.05.01; 27.05.17

(511)

29 – Milk and milk products.

---

(260) AM 2021 108342 A  
(800) 1531332  
(151) 2020 02 28  
(891) 2020 02 28  
(731) FERRERO TRADING LUX SA  
16, route de Trèves, Senningerberg, L-2633,  
Luxembourg

(540)

## 4ANIMALS

(591) Black, white

(511)

28 – Games; toys; video game apparatus; gymnastic and sporting articles; decorations for christmas trees; figurines (toys); positionable toy figure.

30 – Pastry and confectionery; chocolate and chocolate-based products.

41 – Education; providing of training; entertainment services; sporting and cultural activities; interactive entertainment services; organisation and providing of games and competitions (education or entertainment) via the internet; entertainment provided through a global communication network.

---

(260) AM 2021 108346 A  
(800) 1531518  
(151) 2020 04 03  
(891) 2020 04 03  
(731) Yiwu target electric appliance co., LTD  
NO.17222, district2, Yiwu International trade  
city, Yiwu city, Zhejiang province, China

(540)



(591) Black, white

(531) 27.05.09; 27.05.21

(511)

8 – Beard clippers; curling tongs; razors, electric or non-electric; hair clippers for personal use, electric or non-electric; depilation appliances, electric and non-electric; manicure sets, electric; razors cases; scissors; razor blades; ear-piercing apparatus; hand implements for hair curling; eyelash curlers; crimping irons; flat irons; hand tools, hand-operated.

11 – Hair driers; fabric steamers; steam facial apparatus [saunas]; radiators, electric.

(260) AM 2021 108347 A  
 (800) 1531522  
 (151) 2020 03 12  
 (891) 2020 03 12  
 (731) ASENA DİDEM ALPEREN  
 Bağlarbaşı Mah., Beşevler Sk. No:3/1 Maltepe,  
 İstanbul, Turkey  
 (540)



(591) Black, white  
 (531) 27.05.11; 27.05.24  
 (511)

32 – Beers, preparations for making beer; mineral water, spring water, table water, soda water; fruit and vegetable juices, fruit and vegetable concentrates and extracts for making beverages, non-alcoholic soft drinks; energy drinks, protein-enriched sports beverages.

(260) AM 2021 108348 A  
 (800) 1531524  
 (151) 2020 04 06  
 (891) 2020 04 06  
 (731) Vetprom AD  
 St. "Otets Paisiy" 26, BG-2400 Radomir,  
 Bulgaria  
 (540)

**ВИШНЕВСКИ WISHNEVSKY**

(591) Black, white  
 (531) 28.05  
 (511)  
 5 – Antibacterial soap; anti-bacterial preparations; balms for pharmaceutical purposes; veterinary preparations and substances; disinfectants and antiseptics; disinfectants for veterinary use; disinfectants for medical use; disinfectant soap; disinfectants for hygiene purposes; detergents for medical purposes; medicated and sanitising soaps and detergents; medicines for human purposes; medical preparations; sanitary preparations and articles; pharmaceutical compositions; pharmaceutical, medical and veterinary preparations; fungicides; herbicides; hygienic preparations and articles; food supplements; dietary supplements for animals; sanitary preparations for medical purposes; hygienic preparations for veterinary use; chemical preparations for sanitary purposes.

(260) AM 2021 108349 A  
 (800) 1531555  
 (151) 2020 02 13  
 (891) 2020 02 13  
 (731) Abaco S.p.A.  
 C.so Umberto I 43, I-46100 Mantova, Italy  
 (540)



(591) Black, white  
 (531) 26.11.07; 26.11.09; 27.05.10  
 (511)

9 – Computer software; downloadable software; software for management, analysis and monitoring of data, computerized files and databases; computer programs for data processing.

41 – Organization of training courses, refresh courses, events, conventions, exhibitions, workshops or any other activities and events for educational, training, cultural, recreational purposes; training courses relating to agriculture, horticulture and forestry.

42 – Services of design, development, updating, maintenance, rental of computer software.

44 – Consultancy and advisory services relating to agriculture, horticulture and forestry; information services relating to agriculture, horticulture and forestry.

(260) AM 2021 108361 A  
 (800) 1532009  
 (151) 2019 12 16  
 (891) 2019 12 16  
 (731) UPL LTD.  
 upl house, 610 b/2, bandra village, off  
 western express highway, bandra (east),  
 mumbai, maharashtra 400051, India  
 (540)



(591) Black, white  
 (531) 26.01.06; 26.13.25

(554) მოცულობითი

(511)

1 – Fertilizer and chemical products for use in agriculture, plant nutrient, additive chemical to fungicides, additive chemical to insecticides, flower preservatives, chemicals for forestry, phosphorus, plant growth regulating preparations, carbolineum for the protection of plant.

5 – Pesticides, insecticides, fungicides, herbicides, vermicides, rodenticides, weedicides, preparations for killing weeds and destroying vermin.

31 – Seeds, seedlings, agricultural, horticultural and forestry products and grains not included in other classes, fresh fruits and vegetable seeds, natural plants and flowers.

35 – Advertising, business management, business administration, office functions, retail, online and wholesale trade all pertaining to the field of manufacturing and marketing agrochemicals, seeds and other agricultural related products, industrial chemicals, chemical intermediates, and specialty chemicals and providing crop protection solutions.

41 – Education; providing of training; entertainment; sporting and cultural activities; vocational guidance.

44 – Medical services; veterinary services; hygienic and beauty care for human beings or animals; agriculture, horticulture and forestry services.

(260) AM 2021 108362 A

(800) 1532033

(151) 2020 02 04

(891) 2020 02 04

(731) "Intelligent Systems of Business Control" Ltd.

Zavodskaja, 1b, str. 1, fl. 1, room 7,

Zelenograd, RU-124365 Moscow, Russian

Federation

(540)

# JEWETAG

(591) Black, white

(531) 27.05.01; 27.05.17

(511)

9 – Radio frequency identification devices (RFID systems); details, components of radio frequency identification devices (RFID systems), including module RFID readers and readers, RFID tags, readers, recording devices for transmitting information and communication with RFID tags, programming devices for programming RFID tags, where RFID tags are in form of cards, tags or key rings; contact smart chips; chips (integrated circuits), namely RFID cards; computer network data routers used in security and access control; computer software for issuing and managing RFID tags; magnetic data media; optical data media;

computer hardware for processing and protecting information.

(260) AM 2021 108363 A

(800) 1532038

(151) 2019 11 15

(891) 2019 11 15

(731) HECKL s.r.o.

Přemyslova 153, CZ-278 01 Kralupy nad

Vltavou, Mikovice, Czech Republic

(540)

## LANSANIT

(591) Black, white

(511)

11 – Shower cubicles; showers; mixer taps for water pipes; taps [especially pipe laying]; bathroom sinks; bath tubs; spa baths; bath tubs for sitz baths; bath equipment; shower cabins; sanitary apparatus and installations; toilet bowls; toilet seats; water flushing installations; toilets, portable; toilets [water-closets]; hand drying apparatus for washrooms; heaters for baths; bath fittings; sanitary equipment components and accessories; sauna bath installations; gas boilers; safety devices for gas or water installations and pipelines; pipelines as part of sanitary installations; bath linings; bath installations; heat pumps; hot air bath fittings; Turkish bath cabinets, portable; water softening apparatus and installations; water sterilizers; equipment for hot-water heating; washers for water taps; installation material for baths; hydrants; refrigerating chambers; clean chambers [sanitary installations]; equipment for saunas; cooling apparatus and appliances; heating plates; disinfectant container for toilets; fountains; steam generators, except generators as parts of machines; sinks; refrigerators; cool boxes, electric; freezing apparatus and equipment; sanitary installations; lighting installations; heating installations; fireplaces; apparatus and equipment for cooking, refrigerating, drying, ventilating; air-conditioning installations; air purification and treatment equipment; water distribution equipment; equipment for water purification and treatment; heat exchangers, other than parts of machines; stoves [heating apparatus]; furnaces and stoves for solid, liquid and gaseous fuels and for electric current and parts and accessories thereof; apparatus for baking, roasting, grilling and accessories; barbecues; electrical heating, cooling and ventilation systems; lighting of scaffolding and excavations; air heating apparatus and equipment; equipment for the production of steam; ventilation hoods; greenhouse heating and ventilation apparatus; drying apparatus for fodder and forage; solar thermal accumulators-collectors; lamp lights and lanterns; garden lamps and lamps for lighting plants; electric torches; chlorinating apparatus and equipment for swimming pools, for swirling and heating water, especially storage tanks and instantaneous water heaters; lighting apparatus of

all kinds; solaria, other than for medical purposes; anti-glare devices for vehicles [lamp fittings]; lamps; light bulbs, electric; search lights; lighting apparatus and installations; apparatus for ventilating; window demisting and de-icing equipment; compressors as integral parts of heating and air-conditioning equipment; bedside lamps; burners; aquarium heating apparatus; distillation apparatus; coffee percolators, electric; blankets, electric, not for medical purposes; boilers for laundries; heat regenerators; water control valves for water cisterns; regulating accessories for water or gas apparatus and pipes; air dryers; heat pumps; hot-water heating apparatus; fans [air-conditioning]; water filtering installations.

20 – Bathroom furniture; furniture including metal and camping furniture; mirrors; products of wood, cork, reed, cane, wicker, horn, bone, ivory, whalebone, shell, amber, mother-of-pearl, meerschaum, cellulose, not included in other classes; plastic products, not included in other classes; bedding; mattresses; bolsters; seats, beds, deck-chairs, tables; armchairs; chairs, window fittings, not of metal; tables for flowers; edgings of plastic for furniture; school furniture; wall shelves furniture; shelves for file cabinets; bamboo curtains; barrels, non-metallic; non-metallic tuns [casks]; bins, not of metal; dog kennels; beds for household pets; nests for pets; magazine racks; parts of furniture of wood; screw bolts, not of metal; house numbers, not of metal, non-luminous; towel dispensers, fixed, not of metal; mobiles [decoration]; table tops; typing desks; umbrella stands; brush mountings; newspaper holders; curtain holders, not of textile material; indoor window blinds of woven wood; doors for furniture; coffin fittings, not of metal; ottomans; clothes hooks, not of metal; curtain hooks; hooks for coat racks, not of metal; toy boxes [furniture]; infant walkers; coat pegs [stands] non-metallic; vats, not of metal; office furniture; filing cabinets; keyboards for hanging keys; hat stands; scratching columns for cats; cradles; furniture casters, not of metal; chests of drawers; containers for transport, not of metal; curtain rails; bead curtains for decoration; baskets, non-metallic; boxes of wood or plastic; screens for fireplaces [furniture]; hairdressers' chairs; flower-pot pedestals; bottle racks; benches [furniture]; cable trays of non-metallic materials [other than electric]; camp beds; medicine chests; chaise longues; slatted indoor blinds; indoor window blinds [furniture]; waterbeds, not for medical purposes; bedding, except linen; adjustable beds; massage tables; air mattresses, not for medical purposes; plate racks; garment covers [storage]; coat hangers; playpens for babies; head-rests [furniture]; bakers' bread baskets; decorations of plastic for food-stuffs; loading pallets, not of metal; handling pallets, not of metal; screens [furniture]; bed frames of wood; trolleys for computers [furniture]; footrests; pillows; air pillows, not for medical purposes; divans; furniture shelves; library shelves; pet cushions; letter boxes, not

of metal or masonry; placards of wood or plastics; chests of drawers; wickerwork; sideboards; standing desks; counters [tables]; coffins; picture frames; embroidery frames; rattan; furniture shelves; index cabinets [furniture]; inflatable publicity objects; writing desks; dinner wagons [furniture]; mobile boarding stairs, not of metal, for passengers; silvered glass [mirrors]; cupboards being furniture; food cabinets, not of metal; plaited straw, except matting; sofas; gun racks; side tables; dressing tables; drafting tables; worktables; locksmith tables, not of metal; gate valves, not of metal, except gate valves as parts of machines; chopping blocks [tables]; nameplates, not of metal; signboards of wood or plastics; display boards; cabinet work; bins, not of metal; stakes, not of metal, for plants; works of art made of wood, wax, plaster or plastic; funerary urns; shoulder poles [yokes]; hand fans; showcases [furniture]; stuffed animals; locks, other than electric, not of metal; screens [furniture]; screens for fireplaces [furniture]; drawers [furniture parts]; mirrors [silvered glass]; ladders of wood or plastics; hand-held flagpoles, not of metal; high chairs for babies; footrests; folding seats; guest towel shelves; shelf brackets, not of metal; shelves; towel hooks, not of metal.

21 – Household and kitchen utensils and containers of common metals, wood, earthenware, porcelain, glass and plastic; sponges and other toilet and kitchen utensils included in this class; bathroom equipment, namely soap holders, soap dishes, toothbrush holders, towel racks, circular pegs for towels, towel holders, paper roll holders, bottles; combs; sponges; brushes; articles for cleaning purposes; toilet utensils; soap and towels dispensers; glass, earthenware and porcelain ornamental products; small hand-held kitchen appliances without electric drive; household or kitchen utensils and containers; glasses [receptacles]; glass and products made of glass, porcelain and earthenware, especially souvenirs and miniatures, glasses, goblets, diner, coffee and tea services, bowls, trays, plates, saucers, mugs, jugs, vases; souvenirs and goods made of glass, porcelain, earthenware and plastic, not included in other classes, including ceramic miniatures, and other artistic and souvenir items within this class; toilet cases; drinking horns; cups; porcelain; bottle openers, electric and non-electric; mugs; drinking vessels; tea kettles, non-electric, not of precious metal; cookie jars; cooking pot sets; cooking pots; cauldrons; spice sets; salt cellars; pepper pots; pepper mills, hand-operated; egg cups; serving spoons; flower pots; lunch boxes; menu card holders; non-metal coin banks.

(260) AM 2021 108364 A

(800) 1532055

(151) 2019 12 02

(891) 2019 12 02

(731) D ET VE ET ÜRÜNLERİ GIDA  
PAZARLAMA TİCARET ANONİM  
ŞİRKETİ

Dikilitaş Mahallesi, Üzengi Sokak, No:8,  
Beşiktaş, İstanbul, Turkey

(540)

# SALTBAE

(591) Black, white

(531) 27.05.01

(511)

25 – Clothing, including underwear and outer clothing, other than special purpose protective clothing; socks, mufflers [clothing], shawls, bandanas, scarves, belts [clothing]; footwear, shoes, slippers, sandals; headgear, hats, caps with visors, berets, caps [headwear], skull caps.

29 – Meat, fish, poultry and game; processed meat products; dried pulses; soups, bouillon; processed olives, olive paste; pickles; milk and milk products, butter; edible oils; margarine; dried, preserved, frozen, cooked, smoked or salted fruits and vegetables; tomato paste; prepared nuts and dried fruits as snacks; hazelnut spreads and peanut butter; tahini (sesame seed paste); jams, marmalades, fruit jellies; eggs and powdered eggs; potato chips.

30 – Coffee, cocoa; coffee or cocoa based beverages, chocolate based beverages; pasta, stuffed dumplings, noodles; macaroni, ravioli; pastries and bakery products based on flour; desserts based on flour and chocolate; bread, honey; royal jelly for human consumption; bee glue for human consumption, propolis for food purposes; condiments for foodstuff, vanilla (flavoring), spices, sauces (condiments), tomato sauce; yeast, baking powder; flour, semolina, starch for food; sugar, cube sugar, powdered sugar; tea, iced tea; confectionery, chocolate, candies, biscuits, crackers, wafers; chewing gums; ice-cream, edible ices; salt; cereal-based snack food, popcorn, crushed oats, corn chips, breakfast cereals, processed wheat for human consumption, crushed barley for human consumption, processed oats for human consumption, processed rye for human consumption, rice; molasses for food.

35 – Advertising, marketing and public relations; organization of exhibitions and trade fairs for commercial or advertising purposes; design of advertising materials; provision of an online marketplace for buyers and sellers of goods and services; office functions; secretarial services; arranging newspaper subscriptions for others; compilation of statistics; rental of office machines; systemization of information into computer databases; telephone answering for unavailable subscribers; business management, business

administration and business consultancy; accounting; commercial consultancy services; personnel recruitment, personnel placement, employment agencies, import-export agencies; temporary personnel placement services; auctioneering; the bringing together, for the benefit of others, of a variety of goods, namely, clothing, including underwear and outer clothing, other than special purpose protective clothing, socks, mufflers [clothing], shawls, bandanas, scarves, bells [clothing], footwear, shoes, slippers, sandals, headgear, hats, caps with visors, berets, caps [headwear], skull caps, meat, fish, poultry and game, processed meat products, dried pulses, soups, bouillon, processed olives, olive paste, pickles, milk and milk products, butter, edible oils, margarine, dried, preserved, frozen, cooked, smoked or salted fruits and vegetables, tomato paste, prepared nuts and dried fruits as snacks, hazelnut spreads and peanut butter, tahini (sesame seed paste), jams, marmalades, fruit jellies, eggs and powdered eggs, potato chips, coffee, cocoa, coffee or cocoa based beverages, chocolate based beverages, pasta, stuffed dumplings, noodles, macaroni, ravioli, pastries and bakery products based on flour, desserts based on flour and chocolate, bread, honey, royal jelly for human consumption, bee glue for human consumption, propolis for food purposes, condiments for foodstuff, vanilla (flavoring), spices, sauces (condiments), tomato sauce, yeast, baking powder, flour, semolina, starch for food, sugar, cube sugar, powdered sugar, tea, iced tea, confectionery, chocolate, candies, biscuits, crackers, wafers, chewing gums, ice-cream, edible ices, salt, cereal-based snack food, popcorn, crushed oats, corn chips, breakfast cereals, processed wheat for human consumption, crushed barley for human consumption, processed oats for human consumption, processed rye for human consumption, rice, molasses for food, enabling customers to conveniently view and purchase those goods, such services may be provided by retail stores, wholesale outlets, by means of electronic media or through mail order catalogues.

(260) AM 2021 108365 A

(800) 1532106

(151) 2020 02 26

(891) 2020 02 26

(731) Mazunin Oleksandr Volodymyrovych  
vul. Maiakovskoho, bud. 20, kv. 134, m. Kyiv  
02230, Ukraine;  
Oleksiienko Valerii Mykhailovych  
vul. Pohrebniaka, bud. 13, kv. 96,  
s. Chubynske, Boryspil'skyi r-n,  
Kyiv'ska obl. 08231, Ukraine

(540)

# Магнєквин

(591) Black, white

(531) 28.05



(511)

5 – Pharmaceuticals, medical and veterinary preparations; sanitary preparations for medical purposes; dietetic food and substances adapted for medical or veterinary use, food for babies; dietary supplements for human beings and animals; plasters, materials for dressings; disinfectants; adjuvants for medical purposes; albumin dietary supplements; alginate dietary supplements; amino acids for medical purposes; analgesics; anti-uric preparations; anti-oxidants for pharmaceutical purposes; multicomponent preparations for medical purposes; germicides; balms for medical purposes; medicinal herb, fruit and root balms; balsamic preparations for medical purposes; royal jelly for pharmaceutical purposes; albuminous preparations for medical purposes; albuminous foodstuffs for medical purposes; biological preparations for medical purposes; nutritional supplements; bronchodilating preparations; decoctions for pharmaceutical purposes; vitamin preparations; vitamin and mineral preparations; dietary fiber; homeopathic supplements; homogenized food adapted for medical purposes; dietary supplements for human beings; dietary supplements for reducing fatigue evidences; dietary supplements with antioxidant and general tonic properties for humans; dietary supplements to protect against cancer for humans; dietary supplements that contribute to normalization of the functioning of gastrointestinal tract, fat metabolism improvement, immunity improvement, improvement of vision acuity, ageing process inhibition for humans; dietary supplements that normalize metabolism and cholesterol level; royal jelly dietary supplements; glucose dietary supplements; pollen dietary supplements; dietary supplements with a cosmetic effect; linseed dietary supplements; linseed oil dietary supplements; acai powder dietary supplements; propolis dietary supplements; wheat germ dietary supplements; dietary supplements based on natural ingredients; dietetic beverages adapted for medical purposes; dietetic substances adapted for medical use; yeast dietary supplements; plant extracts for pharmaceutical purposes; herbal extracts for medical purposes; elixirs (pharmaceutical preparations); enzyme dietary supplements; gastrointestinal adsorbents; esters for pharmaceutical purposes; ethers for pharmaceutical purposes; febrifuges; iron dietary supplements; nutritional meal replacements; nervines; immunobiological preparations for medical purposes; immunomodulating preparations for medical purposes; immunostimulants; casein dietary supplements; barks for pharmaceutical purposes; collyrium; depuratives; starch for dietetic or pharmaceutical purposes; lecithin dietary supplements; medicines for human purposes; medicated toiletry preparations; medicinal roots; medicinal tea; medicinal water; medicated dentifrices; medicinal drinks; medicinal infusions; medicinal oils; medicated toiletry preparations; herbal preparations for medical purposes; medicated eye-washes; medicinal herbs; therapeutic drugs and agents; liniments; lotions for pharmaceuti-

cal purposes; ointments for pharmaceutical purposes; medical preparations for slimming purposes; mineral food supplements; vitamin supplement patches; linseed for pharmaceutical purposes; tinctures for medical purposes; mouthwashes for medical purposes; pastilles for pharmaceutical purposes; antioxidant pills; appetite suppressant pills; slimming pills; by-products of the processing of cereals for dietetic or medical purposes; nutritional supplements; laxatives; pre-filled syringes for medical purposes; hemorrhoid preparations; preparations for renewal sexual activity; pharmaceutical preparations for the treatment of cardiovascular disease; pharmaceutical preparations for the treatment and the prevention of diffuse diseases of the connective tissue and joints, urinary diseases and diseases of the digestive system; pharmaceutical preparations for the treatment and the prevention of female and male genital zone, impotency and sterility; pharmaceutical preparations for the treatment and the prevention of blood diseases, anemia, immunologic diseases and diseases of endocrine system, endocrine disorders, brain disorders, diseases of the nervous system and nervous emotional disturbances; pharmaceutical preparations for the treatment and the prevention of diseases of the respiratory system, diseases of ear, throat, vision, severe virus diseases, inflammatory conditions, dermatological diseases, allergic manifestations; opotherapy preparations; appetite suppressants for medical purposes; preparations of trace elements for human use; preparations to accelerate rehabilitation process during recovery for medical purposes; preparations to normalize blood pressure; medicinal preparations to improve work of nervous system and to improve memory and attention; preparations to restore muscle work after strenuous exercise for medical purposes; propolis for pharmaceutical purposes; protein dietary supplements; asthmatic tea; antivirals; anti-inflammatories; antiparasitic preparations; antitumor drugs; digestives for pharmaceutical purposes; sedatives; syrups for pharmaceutical purposes; soporifics; sorbents (pharmaceutical preparations); sport nutrition and beverages (functional food products, dietary supplements); douching preparations for medical purposes; freeze-dried food adapted for medical purposes; therapeutic preparations for the bath; tonics (medicines); herbal teas for medicinal purposes; pharmaceutical substances; ferments for pharmaceutical purposes; phytocomposites for medical purposes; phytotherapy preparations for medical purposes; functional foodstuffs for medical purposes to avoid emergence and prevent human disease or alleviate its progress; food products and beverages for the treatment and the prevention of various diseases; medicated sweets; crystallized rock sugar for medical purposes.

(260) AM 2021 108373 A  
 (800) 735019  
 (151) 2000 04 21  
 (891) 2020 04 29  
 (731) PAPETERIES DE CLAIREFONTAINE  
 19, rue de l'Abbaye, F-88480 ETIVAL-  
 CLAIREFONTAINE, France

(540)



(591) Black, white  
 (531) 01.03.01; 01.03.16; 05.05.04; 25.01.15;  
 27.05.01  
 (511)  
 16 – Paper and cardboard (unprocessed, semi-proces-  
 sed for stationery or printing purposes); bookbinding  
 material; photographs; stationery; adhesives for statio-  
 nery or household purposes; artists' supplies; paint-  
 brushes; pencil cases.  
 18 – School bags, document wallets, rucksacks.

(260) AM 2021 108375 A  
 (800) 1127674  
 (151) 2011 12 14  
 (891) 2020 01 20  
 (731) SISMA S.P.A.  
 Piazza Vilfredo Pareto, 9, I-46100 Mantova,  
 Italy

(540)



(591) Black, white  
 (531) 01.15.11; 26.01.06; 27.05.10  
 (511)  
 3 – Cotton wool for cosmetic purposes; absorbent  
 puffs for cosmetic purposes; cotton balls for cosmetic  
 purposes; absorbent puffs for cosmetic purposes;  
 cleanser; cotton discs for removing make-up; wipes  
 for removing make-up; detergent wipes for cosmetic  
 purposes and for intimate feminine and masculine  
 hygienic use excluding moist toilet tissue and toilet  
 paper, sanitary wipes, wipes for babies and young  
 children; wipes impregnated or not impregnated with  
 liquid soap for cosmetic purposes and for intimate  
 feminine and masculine hygienic use excluding moist

toilet tissue and toilet paper, sanitary wipes, wipes for  
 babies and young children; wipes impregnated with  
 detergents, moisturizers and cosmetics for cosmetic  
 purposes and for intimate feminine and masculine  
 hygienic use excluding moist toilet tissue and toilet  
 paper, sanitary wipes, wipes for babies and young  
 children; impregnated and moistened wipes for cos-  
 metic purposes and for intimate feminine and mas-  
 culine hygienic use excluding moist toilet tissue and  
 toilet paper, sanitary wipes, wipes for babies and  
 young children; self-tan wipes; face wipes; non-medi-  
 cated wipes for cosmetic purposes and for intimate  
 feminine and masculine hygienic use excluding moist  
 toilet tissue and toilet paper, sanitary wipes, wipes for  
 babies and young children; tissues and wipes impre-  
 gnated with toiletries for cosmetic purposes and for  
 intimate feminine and masculine hygienic use exclu-  
 ding moist toilet tissue and toilet paper, sanitary wip-  
 es, wipes for babies and young children; swabs  
 (toiletries).

21 – Combs; sponges; toothbrushes; brushes.

(260) AM 2021 108376 A  
 (800) 1355987  
 (151) 2017 05 31  
 (891) 2020 04 28  
 (731) De Roblin, Inc.  
 17070 Green Drive, City of Industry CA 91745,  
 USA

(540)

## MIA SECRET

(591) Black, white  
 (511)  
 3 – Cosmetics; adhesives for affixing false eyelashes,  
 hair and nails, false nails; nail care preparations,  
 namely, nail conditioner; nail-polish corrector pen;  
 false nails, namely, acrylic artificial nails in liquid  
 form; false nails, namely, acrylic artificial nails in  
 powder form; lotions for strengthening the nails, nail  
 care preparations, nail buffing preparations, nail care  
 preparations, namely, nail softeners; nail cream; nail  
 enamel; nail enamels; nail glitter; nail grooming pro-  
 ducts, namely, tips, glue, lacquer and glitter; nail har-  
 deners; nail polish; nail polish base coat; nail polish  
 remover; nail polish top coat; nail strengtheners; nail  
 tips; nail varnish for cosmetic purposes; gel nail po-  
 lish, tint nail polish; glitter nail polish; and ultra violet  
 gel nail polish; ultra violet acrylic nail powder for  
 shaping or sculpting nails; nail art liner, gel eye  
 masks; acrylic nail hardeners; glitter for cosmetic pur-  
 poses; fingernail decals and stickers for cosmetic or  
 nail art purposes; beads for nail art purposes; nail pa-  
 int for nail art purposes; coloring pens for nail art  
 purposes; nail tape for nail art purposes; striping tape  
 for nail art purposes; nail wraps for nail repair pur-  
 poses; coloring preparations for cosmetic purposes;

nail care oils; cuticle remover; acetone for cosmetic purposes, namely, acetone for nail polish removal, artificial nails; nail art kits consisting of adhesives, glitter and decorative adhesive decals; preparations for forming artificial nails, namely, acrylic nail maker and sculpture gel; nail art decals, namely, crushed sea shell, ice polyester film, metallic bead, gimo, and dry flowers; mood color changing nail polish; false nail extensions tips; nail art dropper; fingernail cosmetics kit containing finger rest, nail polish, false nails, nail glitter, nail decals, nail stamp device, nail sequins, and emery board; pumice pads for personal use.

35 – Online retail store services featuring cosmetics and accessories thereof, nail care products and accessories thereof, and salon equipment and accessories thereof; retail store services featuring cosmetics and accessories thereof, nail care products and accessories thereof, and salon equipment and accessories thereof.

(260) AM 2021 108377 A  
 (800) 1378942  
 (151) 2017 08 02  
 (891) 2020 01 10  
 (731) Company "Polihim-Voronezh" Limited Liability Company  
 Leninskiy prospekt, 39-182, RU-394004  
 Voronezh, Russian Federation  
 (540)



(591) Black, white and red  
 (531) 26.11.03; 26.11.12; 27.05.10; 27.05.24;  
 29.01.13  
 (526) Professional.  
 (511)

2 – Annatto [dyestuff]; dyes; binding preparations for paints; primers; titanium dioxide [pigment]; repositionable paint patches; indigo [colorant]; colophony; alizarine dyes; aniline dyes; dyewood; paints; aluminium paints; asbestos paints; distempers; fireproof paints; enamels for painting; black japan; bitumen varnish; bronzing lacquers; copal varnish; lacquers; anti-corrosive bands; anti-rust oils; mastic [natural resin]; cobalt oxide [colorant]; zinc oxide [pigment]; silver paste; pigments; coatings [paints]; undercoating for vehicle chassis; anti-fouling paints; varnishes; aluminium powder for painting; silvering powders; anti-co-

rosive preparations; protective preparations for metals; thinners for paints; thinners for lacquers; soot [colorant]; thickeners for paints; siccatives [drying agents] for paints; anti-rust greases; badigeon; anti-tarnishing preparations for metals; anti-rust preparations; turpentine [thinner for paints]; fixatives [varnishes]; yellowwood [colorant]; enamels [varnishes]; silver emulsions [pigments].

(260) AM 2021 108378 A  
 (800) 1396305  
 (151) 2017 12 04  
 (891) 2020 03 17  
 (731) Autowini Inc.  
 (Dogok-dong, Handok building), 3F, 2645,  
 Nambusunhwan-ro, Gangnam-gu, Seoul 06271,  
 Republic of Korea

(540)  
**Autowini**

(591) Black, white  
 (531) 27.05.01  
 (511)  
 35 – Consultancy relating to public relations; business management of hotels; business management consultancy; systemization of information into computer databases; management and compilation of computerised databases; import-export agency services; sales promotion for others through membership card schemes; sales promotion for others through membership card schemes involving discounts and purchase points; auctioneering; auctioneering provided on the internet; used automobiles sales agency; heavy equipment sales agency; sales arranging of used automobiles; sales arranging of heavy equipment; business intermediary services relating to used automobiles; automobiles sales agency; sales agency of parts and fittings for automobiles; business intermediary services relating to automobiles; business intermediary services relating to parts and fittings for automobiles; business intermediary services relating to heavy equipment; bicycles sales agency; sales arranging of bicycles; business intermediary services relating to bicycles; sales agency of parts and fittings for bicycles; sales arranging of parts and fittings for bicycles; business intermediary services relating to parts and fittings for bicycles; tires sales agency; sales arranging of tires; business intermediary services relating to tires; automobiles auctioneering; advertising in the internet for others; advertising of published texts; marketing consulting.

(260) AM 2021 108379 A

(800) 1402623

(151) 2017 12 26

(891) 2020 04 22

(731) MELTEM MODULER MOBILYA, KOLTUK SANAYI VE TICARET ANONIM ŞİRKETİ  
Yenice Koy Mahallesi Ova Caddesi No. 27,  
TR-16419 Inegol/Bursa, Turkey

(540)



(591) Yellow, blue, light blue, lilac

(531) 26.13.25; 27.05.01; 27.05.10; 29.01.15

(511)

20 – Furniture, namely, tables, chairs, armchairs, sofas, beds, wardrobes, dressing tables, cupboards; writing and drawing desks; tea carts; deck chairs; counters (tables) not of metal; work benches (not of metal); furniture chests; coat hangers; coat stands; furniture casters, not of metal; mattresses; spring mattresses; pillows; air mattresses and pillows, not for medical purposes; mirrors; picture frames; furniture fittings, not of metal; furniture parts; chair legs, table leaves, arm rests; beds; bed bases, bed frames, bed headboards; bedding, except linen.

35 – Advertising; business management and organizational consultancy; the bringing together, for the benefit of others, of a variety of goods, enabling customers to conveniently view and purchase those goods, namely, furniture, namely, tables, chairs, armchairs, sofas, beds, wardrobes, dressing tables, cupboards, writing and drawing desks, tea carts, deck chairs, counters (tables) not of metal, work benches (not of metal), furniture chests, coat hanger, coat stand, furniture casters, not of metal, mattresses, spring mattresses, pillows, air mattresses and pillows, not for medical purposes, mirrors, picture frames, furniture fittings, not of metal, furniture parts, chair legs, table leaves, arm rests, beds, bed bases, bed frames, bed headboards, bedding, except linen (stated services may be provided by retail stores, wholesale outlets, electronic media, catalog and other similar methods).

(260) AM 2021 108381 A

(800) 1422730

(151) 2018 08 07

(891) 2020 02 03

(731) FIDIA FARMACEUTICI S.p.A.  
Via Ponte della Fabbrica, 3/A, I-35031 Abano  
Terme (PD), Italy

(540)

**Hy-tissue**

(591) Black, white

(511)

5 – Pharmaceutical and veterinary preparations; sanitary preparations for medical purposes; blood plasma; anticoagulants; diagnostic preparations for medical purposes; dietetic food and substances adapted for medical or veterinary use; food for babies; dietary supplements for humans and animals; plasters; materials for dressings; material for stopping teeth, dental wax; disinfectants; fungicides; medicines; medical preparations for prevention, monitoring, treatment or relief of injuries or diseases; dermocosmetic preparations for medical and surgical use; dermatological preparations; dermatological preparations for the treatment and care of chronic ulcers; dermal tissues for the care of burns; tissues or gauzes impregnated with antibacterial preparations; pharmaceutical creams and lotions; creams, sprays, lotions, gels or ointments for dermatological purposes, for wound healing and tissue repair; vitamins and minerals for medical and veterinary use; nutritional and dietetic additives for medical and veterinary use; antioxidants; parapharmaceutical products for dermatological use.

10 – Medical and veterinary devices; medical and surgical, medical and veterinary apparatus and instruments; diagnostic apparatus for medical purposes; apparatus and instruments for separating human and animal tissues and cells; devices for mechanical disaggregation of biological material for preparing cellular suspensions and micro-insert of tissue; medical devices for the care of diseases concerning human tissue and for veterinary medicine; blood testing apparatus; cannulas; catheters; hemocytometers; hypodermic syringes; injectors for medical purposes; injection needles; syringes for injection; kits comprising apparatus for blood collection, separation of blood components, treatment of blood and reinjection of blood for medical purposes; orthopedic articles; suture materials; applicators and devices for the administration of pharmaceutical, cosmetic and dermocosmetic products for medical purposes.

(260) AM 2021 108382 A

(800) 1449041

(151) 2018 12 10

(891) 2020 04 13

(731) GUANGDONG OPPO MOBILE  
TELECOMMUNICATIONS CORP., LTD.  
No. 18 Haibin Road, Wusha, Chang'an,  
Dongguan, Guangdong, China

(540)

(591) Black, white

(531) 01.15.03; 27.05.08

(511)

9 – Tablet computers; computer peripheral devices; computer game software, recorded; computer game software, downloadable; facsimile machines; voltage stabilizing power supply; smartphones; satellite navigational apparatus; portable media players; cabinets for loudspeakers; USB cables; materials for electricity mains [wires, cables]; power adapters; low voltage power supply; rechargeable batteries; theft prevention installations, electric; batteries, electric; batteries, electric, for vehicles; chargers for electric batteries.

(260) AM 2021 108383 A

(800) 1460868

(151) 2018 12 20

(891) 2020 04 01

(731) Homan Mykhailo Yuriiiovych

Korchahintsiv str., bldg. 25, apt. 469, Kharkiv c., 61176, Ukraine

(540)

## Ziplex

(591) Black, white

(511)

11 – Acetylene burners; acetylene flares; acetylene generators; air conditioners for vehicles; air-conditioning apparatus; air-conditioning installations; air cooling apparatus; air deodorising apparatus; air driers [dryers]; air filtering installations; air purifying apparatus and machines; air reheaters; air sterilisers; air valves for steam heating installations; alcohol burners; anti-dazzle devices for automobiles [lamp fittings]; anti-glare devices for vehicles [lamp fittings]; anti-splash tap nozzles; apparatus for dehydrating food waste; aquarium filtration apparatus; aquarium heaters; aquarium lights; arc lamps; ash conveyor installations, automatic; bakers' ovens; barbecues; bath fittings; bath installations; bath tubs; bath tubs for sitz baths; bed warmers; beverage cooling apparatus; bicycle lights; bidets; blankets, electric, not for medical purposes; boiler pipes [tubes] for heating installations; boilers, other than parts of machines; book sterilization apparatus; brackets for gas burners; bread baking machines; bread-making machines; toasters; burners; burners for lamps; carbon for arc lamps; ceiling lights; central heating radiators; chandeliers; chimney blowers; chimney flues; Chinese lanterns; chromatography apparatus for industrial purposes; clean chambers [sanitary installations]; coffee machines, electric; coffee percolators, electric; coffee roasters; coils [parts of distilling, heating or cooling installations]; cooking stoves; cooking apparatus and installations; cooking rings; cooking utensils, electric; cool boxes, coolers, electric; cooling vats for furnaces; cooling appliances and installations; cooling installations and machines; cooling installations for liquids; cooling installations for tobacco; cooling installations for water; curling lamps; dampers [heating]; deep fryers,

electric; defrosters for vehicles; dental ovens; deodorising apparatus, not for personal use; desalination plants; desiccating apparatus; discharge tubes, electric, for lighting; disinfectant apparatus; disinfectant apparatus for medical purposes; disinfectant distributors for toilets; distillation apparatus; distillation columns; diving lights; drip irrigation emitters [irrigation fittings]; drying apparatus; drying apparatus and installations; electrically heated carpets; electric appliances for making yogurt; electric fans for personal use; electric lamps; lights, electric, for Christmas trees; electric torches; evaporators; expansion tanks for central heating installations; extractor hoods for kitchens; fabric steamers; fans [air-conditioning]; fans [parts of air-conditioning installations]; feeding apparatus for heating boilers; filaments for electric lamps; filters for air conditioning, filters for drinking water, fireplaces, domestic; fittings, shaped, for furnaces; flare stacks for use in the oil industry; flues for heating boilers; flushing tanks; food steamers, electric; footmuffs, electrically heated; footwarmers, electric or non-electric; forges, portable; fountains; freezers; friction lighters for igniting gas; fruit roasters; fumigation apparatus, not for medical purposes; ash pits for furnaces; fire bars; furnaces, other than for laboratory use; gas boilers; gas burners; gas condensers, other than parts of machines; gas lamps; gas lighters; gas scrubbers [parts of gas installations]; gas scrubbing apparatus; germicidal burners; germicidal lamps for purifying air; glue-heating appliances; grills [cooking appliances]; hair dryers; hand drying apparatus for washrooms; headlights for automobiles; hearths; heat accumulators; heated display cabinets; heaters, electric, for feeding bottles; heaters for baths; heaters for heating irons; heaters for vehicles; heat exchangers, other than parts of machines; heating apparatus; heating apparatus, electric; heating apparatus for defrosting vehicle windows; heating apparatus for solid, liquid or gaseous fuels; heating boilers; heating cushions [pads], electric, not for medical purposes; heating elements; heating filaments, electric; heating installations; heating plates; heat pumps; heat regenerators; hot air apparatus; hot air bath fittings; hot air ovens; hot plates; hot water bottles; hot water heating installations; humidifiers for central heating radiators; hydrants; hydromassage bath apparatus; ice machines and apparatus; immersion heaters; incandescent burners; incinerators; installations for processing nuclear fuel and nuclear moderating material; ionization apparatus for the treatment of air or water; kettles, electric; kiln furniture [supports]; kilns; kitchen ranges [ovens]; laboratory burners; laboratory lamps; lamp chimneys; lamp glasses; globes for lamps; lamp mantles; lamp reflectors; lamps; lamps for directional signals of automobiles; lampshade holders; lamp shades; lanterns for lighting; laundry dryers, electric; laundry room boilers; lava rocks for use in barbecue grills; level controlling valves in tanks; light bulbs; light bulbs, electric; light bulbs for directional signals for vehic-

les; light diffusers; light-emitting diodes [led] lighting apparatus; lighters; lighting apparatus and installations; lighting apparatus for vehicles; lighting installations for air vehicles; lights for automobiles; lights for vehicles; loading apparatus for furnaces; luminous house numbers; luminous tubes for lighting; magnesium filaments for lighting; malt roasters; microwave ovens [cooking apparatus]; microwave ovens for industrial purposes; milk cooling installations; miners' lamps; mixer taps for water pipes; motorcycle lights; multicookers; nuclear reactors; oil burners; oil lamps; oil-scrubbing apparatus; ornamental fountains; oven fittings made of fireclay; oxyhydrogen burners; pasteurisers; petrol burners, pipes [parts of sanitary installations]; plate warmers; pocket warmers; polymerisation installations; pressure cookers, electric; pressure cooking saucepans, electric; pressure water tanks; purification installations for sewage; radiator caps; radiators, electric; radiators [heating]; refining towers for distillation; refrigerating apparatus and machines; refrigerating appliances and installations; refrigerating cabinets; refrigerating chambers; refrigerating containers; refrigerating display cabinets; refrigerators; regulating accessories for water or gas apparatus and pipes; regulating and safety accessories for gas apparatus; regulating and safety accessories for gas pipes; regulating and safety accessories for water apparatus; roasters; roasting jacks; roasting spits; rotisseries; safety accessories for water or gas apparatus and pipes; safety lamps; sanitary apparatus and installations; sauna bath installations; shower cubicles [enclosures (am.)]; showers; sinks; sockets for electric lights; solar furnaces; solar thermal collectors [heating]; spa baths [vessels]; steam accumulators; steam boilers, other than parts of machines; steam facial apparatus [saunas]; steam generating installations; sterilizers; stills; stoves [heating apparatus]; standard lamps; framework of metal for ovens; swimming pool chlorinating apparatus; tanning apparatus [sun beds]; cocks for pipes and pipelines; taps [faucets]; thermostatic valves [parts of heating installations]; tobacco roasters; toilet bowls; toilet seats; toilets, portable; water closets; tortilla presses, electric; turkish bath cabinets, portable; ultraviolet ray lamps, not for medical purposes; urinals [sanitary fixtures]; vehicle headlights; vehicle reflectors; ventilation [air-conditioning] installations and apparatus; ventilation [air-conditioning] installations for vehicles; ventilation hoods; ventilation hoods for laboratories; waffle irons, electric; warming pans; washers for water taps; wash-hand bowls [parts of sanitary installations]; water conduits installations; water distribution installations; water filtering apparatus; flushing apparatus; water heaters; water heaters [apparatus]; watering installations, automatic; watering machines for agricultural purposes; water intake apparatus; water purification installations; water purifying apparatus and machines; water softening apparatus and installations; water sterilizers; water supply installations; whirlpool-jet apparatus.

20 – Air cushions, not for medical purposes; air mattresses, not for medical purposes; air pillows, not for medical purposes; ambroid bars; ambroid plates; animal claws; animal hooves; animal horns; armchairs; baby changing mats; bakers' bread baskets; bamboo; bamboo curtains; barrel hoops, not of metal; barrels, not of metal; baskets, not of metal; bathtub grab bars, not of metal; bead curtains for decoration; bed bases; bed casters, not of metal; bedding, except linen; bed fittings, not of metal; beds; beds for household pets; bedsteads of wood; beehives; benches [furniture]; binding screws, not of metal, for cables; birdhouses; bolsters; bolts, not of metal; bookcases; book rests [furniture]; bottle caps, not of metal; bottle casings of wood; stoppers for bottles, not of glass, metal or rubber; bottle racks; boxes of wood or plastic; brush mountings; bumper guards for cots, other than bed linen; plugs, not of metal; busts of wood, wax, plaster or plastic; cabinet work; carts for computers [furniture]; casks, not of metal; casks of wood for decanting wine; cask stands, not of metal; chairs [seats]; chaise lounges; chests for toys; bins, not of metal; chests of drawers; chopping blocks [tables]; clips, not of metal, for cables and pipes; clips of plastic for sealing bags; closures, not of metal, for containers; clothes hooks, not of metal; coat hangers; coatstands; coffin fittings, not of metal; coffins; collars, not of metal, for fastening pipes; comb foundations for beehives; console tables; containers, not of metal, for liquid fuel; containers, not of metal [storage, transport]; coral; corks; corks for bottles; corozo; costume stands; cribs for babies; counters [tables]; covers for clothing [wardrobe]; cradles; crates; cupboards; curtain holders, not of textile material; curtain hooks; curtain rails; curtain rings; curtain rods; curtain rollers; curtain tie-backs; cushions; deck chairs; decorations of plastic for foodstuffs; desks; dinner wagons [furniture]; dispensers for dog waste bags, fixed, not of metal; display boards; display stands; divans; dog kennels; door bells, not of metal, non-electric; door bolts, not of metal; door fasteners, not of metal; door fittings, not of metal; door handles, not of metal; door knockers, not of metal; doors for furniture; door stops, not of metal or rubber; drafting tables; drain traps [valves] of plastic; dressing tables; edgings of plastic for furniture; embroidery frames; fans for personal use, non-electric; feet for furniture; figurines [statuettes] of wood, wax, plaster or plastic; filing cabinets; fishing baskets; floating containers, not of metal; flower-pot pedestals; flower-stands [furniture]; fodder racks; footstools; freestanding partitions [furniture]; funerary urns; furniture; furniture casters, not of metal; furniture fittings, not of metal; furniture of metal; partitions of wood for furniture; furniture shelves; garment covers [storage]; gun racks; hairdressers' chairs; hampers [baskets] for the transport of items; hand-held mirrors [toilet mirrors]; handling pallets, not of metal; hat stands; head-rests [furniture]; high chairs for babies; hinges, not of metal; honeycombs; coathooks, not of

metal; horn, unworked or semi-worked; hospital beds; house numbers, not of metal, non-luminous; hydrostatic beds, not for medical purposes; identification bracelets, not of metal; identity plates, not of metal; imitation tortoiseshell; index cabinets [furniture]; indoor window blinds [shades] [furniture]; infant walkers; inflatable furniture; inflatable publicity objects; interior textile window blinds; ivory, unworked or semi-worked; jewelry organizer displays; kennels for household pets; keyboards for hanging keys; knobs, not of metal; labels of plastic; ladders of wood or plastics; latches, not of metal; lecterns; legs for furniture; letter boxes, not of metal or masonry; library shelves; loading gauge rods, not of metal, for railway waggons [wagons]; loading pallets, not of metal; lockers; locks, not of metal, for vehicles; locks, other than electric, not of metal; magazine racks; mannequins; massage tables; mats for infant playpens; mattresses; meat safes; medicine cabinets; meerscham; mirrors [looking glasses]; mirror tiles; mobile boarding stairs, not of metal, for passengers; mobiles [decoration]; moldings [mouldings] for picture frames; mooring buoys, not of metal; moses baskets; mother-of-pearl, unworked or semi-worked; nesting boxes; nesting boxes for household pets; newspaper display stands; nuts, not of metal; office furniture; oyster shells; packaging containers of plastic; paper blinds; pegs [pins], not of metal; pet cushions; picture frame brackets; picture frames; pillows; placards of wood or plastics; plaited straw, except matting; plastic key cards, not encoded and not magnetic; plate racks; playpens for babies; plugs [dowels], not of metal; poles, not of metal; pulleys of plastics for blinds; racks [furniture]; rattan; reeds [plaiting materials]; reels, not of metal, non-mechanical, for flexible hoses; reels of wood for yarn, silk, cord; registration plates, not of metal; mats, removable, for sinks; rivets, not of metal; sash fasteners, not of metal, for windows; saw benches [furniture]; saw horses; school furniture; scratching posts for cats; screens for fireplaces [furniture]; screens [furniture]; screws, not of metal; screw tops, not of metal, for bottles; seats of metal; sections of wood for beehives; settees; shells; shelves for file cabinets; shelves for storage; shelving units; shoe dowels, not of metal; shoulder poles [yokes]; showcases [furniture]; sideboards; signboards of wood or plastics; silvered glass [mirrors]; slatted indoor blinds; sleeping pads; sofas; split rings, not of metal, for keys; stag antlers; stair rods; stakes, not of metal, for plants or trees; standing desks; stands for calculating machines; statues of wood, wax, plaster or plastic; staves of wood; steps [ladders], not of metal; step stools, not of metal; stools; stoppers, not of metal; straw edgings; straw mattress; straw plaits; stuffed animals; stuffed birds; tables; tables of metal; table tops; tanks, not of metal nor of masonry; taps, not of metal, for casks; tea trolleys; tent pegs, not of metal; tool boxes, not of metal, empty; tool chests, not of metal, empty; tortoiseshell; towel dispensers, fixed, not of metal; towel

stands [furniture]; transport pallets, not of metal; trays, not of metal; trestles [furniture]; trolleys [furniture]; troughs, not of metal, for mixing mortar; typing desks; umbrella stands; valet stands; valves, not of metal, other than parts of machines; vats, not of metal; vice benches [furniture]; wall-mounted baby changing platforms; wardrobes; washstands [furniture]; water-pipe valves of plastic; whalebone, unworked or semi-worked; wickerwork; wind chimes [decoration]; winding spools, not of metal, non-mechanical, for flexible hoses; window fasteners, not of metal; window fittings, not of metal; window stops, not of metal or rubber; wood ribbon; work benches; works of art of wood, wax, plaster or plastic; woven timber blinds [furniture]; writing desks; yellow amber.

35 – Administrative processing of purchase orders; administration of consumer loyalty programs; administration of frequent flyer programs; cost price analysis; business auditing; auctioneering; outsourced administrative management for companies; accounting; web indexing for commercial or advertising purposes; market studies; opinion polling; invoicing; arranging newspaper subscriptions for others; arranging subscriptions to telecommunication services for others; payroll preparation; tax preparation; demonstration of goods; business inquiries; business management assistance; commercial or industrial management assistance; advisory services for business management; business research; economic forecasting; providing business information via a web site; compilation of information into computer databases; compilation of statistics; business information; business management of performing artists; business management for freelance service providers; business management of hotels; business management of sports people; business management of reimbursement programmes for others; commercial information and advice for consumers in the choice of products and services; commercial administration of the licensing of the goods and services of others; personnel management consultancy; business management consultancy; business organization consultancy; marketing; marketing research; typing; provision of commercial and business contact information; provision of an on-line marketplace for buyers and sellers of goods and services; writing of curriculum vitae for others; writing of publicity texts; scriptwriting for advertising purposes; word processing; updating of advertising material; updating and maintenance of data in computer databases; web site traffic optimization; organization of exhibitions for commercial or advertising purposes; organization of fashion shows for promotional purposes; organization of trade fairs for commercial or advertising purposes; rental of advertising space; shop window dressing; business appraisals; personnel recruitment; business management and organization consultancy; commercial information agency services; employment agency services; business efficiency expert services; outsour-

cing services [business assistance]; business project management services for construction projects; commercial intermediation services; layout services for advertising purposes; appointment reminder services [office functions]; news clipping services; price comparison services; procurement services for others [purchasing goods and services for other businesses]; relocation services for businesses; photocopying services; appointment scheduling services [office functions]; tax filing services; import-export agency services; modelling for advertising or sales promotion; advertising agency services; secretarial services; public relations; wholesale services for pharmaceutical, veterinary and sanitary preparations and medical supplies; data search in computer files for others; sponsorship search; search engine optimization for sales promotion; presentation of goods on communication media, for retail purposes; telephone answering for unavailable subscribers; rental of billboards [advertising boards]; office machines and equipment rental; publicity material rental; rental of advertising time on communication media; rental of vending machines; rental of sales stands; rental of photocopying machines; direct mail advertising; psychological testing for the selection of personnel; publication of publicity texts; radio advertising; advertising; pay per click advertising; outdoor advertising, advertising by mail order; on-line advertising on a computer network; document reproduction; bill-posting; distribution of samples; dissemination of advertising matter; design of advertising materials; business investigations; systemization of information into computer databases; drawing up of statements of accounts; sales promotion for others; production of advertising films; shorthand, transcription of communications [office functions]; television advertising; telemarketing services; negotiation and conclusion of commercial transactions for third parties; professional business consultancy.

- (260) AM 2021 108436 A  
 (800) 1532340  
 (151) 2020 02 25  
 (891) 2020 02 25  
 (731) Yerevan Brandy Company, CJSC  
 Admiral Isakov Avenue 2, 0082 Yerevan,  
 Armenia  
 (540)



- (591) Blue, gold and white  
 (531) 06.01.02; 26.04.16; 26.04.18; 26.04.24;  
 27.05.01; 29.01.13

(511)  
 33 – Armenian brandy; brandy; vodka; fruit vodka; wines; whiskey; alcoholic beverages; cider; bitters; anise [liqueur]; anisette [liqueur]; aperitifs; distilled beverages; cocktails; gin; rum; liqueurs; spirits [beverages]; alcoholic essences; alcoholic extracts; alcoholic beverages containing fruit; pre-mixed alcoholic beverages, other than beer-based.

- (260) AM 2021 108444 A  
 (800) 1532393  
 (151) 2020 03 10  
 (891) 2020 03 10  
 (731) Sovmestnoe obchtchestvo s ogranitchennoy  
 otvetstvennostiyu "Conte Spa"  
 d. 30, Pobedy Street, 230026 Grodno, Belarus  
 (540)



- (591) Dark-blue, blue, white and green  
 (531) 26.03.01; 26.03.06; 26.03.07; 26.03.22;  
 26.03.24; 26.04.01; 26.13.25; 27.05.17;  
 27.05.24; 29.01.14

(511)  
 25 – Wimples; underwear; sweat-absorbent underwear; berets; overalls; boas [necklets]; boxer shorts; ankle boots; ski boots; boots for sports; breeches for wear; trousers; football boots; brassieres; valenki [felted boots]; collars [clothing]; detachable collars; shirt yokes; veils [clothing]; gabardines [clothing]; galoshes; neckties; ascots; leggings [leg warmers]; gaiters; boot uppers; corselets; jerseys [clothing]; vests; sports jerseys; hosiery; heels; hoods [clothing]; hat frames [skeletons]; pockets for clothing; scarfs; kimonos; visors being headwear; tights; slippers [underclothing]; wet suits for water-skiing; combinations [clothing]; bodices [lingerie]; corsets [underclothing]; suits; bathing suits; masquerade costumes; beach clothes; leotards; stuff jackets [clothing]; jackets [clothing]; fishing vests; leggings [trousers]; liveries; camisoles; sports singlets; cuffs; short-sleeve shirts; mantillas; coats; sleep masks; furs [clothing]; fingerless gloves; miters [hats]; footmuffs, not electrically heated; muffs [clothing]; bibs, not of paper; bibs, sleeved, not of paper; fur stoles; ear muffs [clothing]; socks; sweat-absorbent socks; footwear; beach shoes; sports shoes; clothing; paper clothing; outerclothing; ready-made clothing; cyclists' clothing; clothing for gymnastics; clot-



hing of imitations of leather; clothing of leather; waterproof clothing; uniforms; fittings of metal for footwear; overcoats; panties; parkas; pelerines; ski gloves; gloves [clothing]; pajamas; bathing trunks; shirt fronts; neckerchiefs; pocket squares; dresses; sock suspenders; stocking suspenders; ready-made linings [parts of clothing]; dress shields; soles for footwear; braces for clothing [suspenders]; half-boots; lace boots; ponchos; girdles; money belts [clothing]; belts [clothing]; layettes [clothing]; non-slipping devices for footwear; heelpieces for stockings; welts for footwear; chasubles; shirts; wooden shoes; sandals; bath sandals; boots; jumper dresses; saris; sarongs; sweaters; footwear uppers; inner soles; albs; bath slippers; togas; knitwear [clothing]; underpants; shoes; gymnastic shoes; slippers; skull caps; turbans; headwear; aprons [clothing]; judo uniforms; karate uniforms; tee-shirts; dressing gowns; bath robes; top hats; sweat-absorbent stockings; shawls; paper hats [clothing]; hats [clothing]; shower caps; bathing caps; neck gaiters; studs for football boots; hats; babies' pants [underwear]; trouser straps; pelisses; esparto shoes or sandals; skirts; petticoats; skorts.

35 – Import-export agency services; commercial information agency services; rental of advertising space; computerized file management; demonstration of goods; opinion polling; market studies; providing business information; providing commercial information and advice for consumers in the choice of products and services; marketing research; marketing; targeted marketing; updating and maintenance of data in computer databases; online retail services for downloadable and pre-recorded music and movies; online retail services for downloadable ring tones; online retail services for downloadable digital music; organization of exhibitions for commercial or advertising purposes; arranging and conducting of marketing events; arranging and conducting of advertising events; organization of fashion shows for promotional purposes; organization of trade fairs; business appraisals; business management assistance; commercial intermediation services; provision of an online marketplace for buyers and sellers of goods and services; presentation of goods on communication media, for retail purposes; conducting on-line surveys; auctioneering; sales promotion for others; promotion of goods and services through sponsorship of sports events; production of teleshopping programmes; office machines and equipment rental; rental of vending machines; rental of sales stands; publication of publicity texts; radio advertising; direct mail advertising; online advertising on a computer network; advertising by mail order; advertising; television advertising; telemarketing services; commercial administration of the licensing of the goods and services of others; business management of reimbursement programs for others; administration of consumer loyalty programs; administrative processing of purchase orders; modelling

for advertising or sales promotion; procurement services for others [purchasing goods and services for other businesses]; outsourcing services [business assistance]; retail services connected to the sale of clothing, footwear, headgear, including via online stores.

(260) AM 2021 108454 A  
 (800) 1532679  
 (151) 2019 12 23  
 (891) 2019 12 23  
 (731) MK Group d.o.o. Beograd  
 Bulevar Mihajla Pupina 115 e, 11070 Novi  
 Beograd, Serbia  
 (540)



(591) Grey, gold and white  
 (531) 26.11.01; 26.11.06; 26.11.11; 27.05.09;  
 27.05.22; 29.01.13

(511)  
 29 – Meat, fish, poultry and game; charcuterie; meat extracts; preserved, frozen, dried and cooked fruits and vegetables; legumes, processed; cream cheese; shelled nuts; jellies, jams, compotes; eggs; potages (soups); meat pâtés; caviar; croquettes (food); milk, cheese, butter, yogurt and other dairy products; processed mushrooms; tofu; processed edible seeds; oils and fats for food.

30 – Coffee, tea, cocoa and coffee substitutes; rice, pasta and noodles; tapioca and sago; flour and preparations made from cereals; bread, pastry and confectionery products; chocolate; ice cream, sherbets and other edible ices; sugar, honey, golden syrup; yeast, baking-powder; salt, seasonings, spices, preserved herbs; vinegar, sauces and other condiments; ice for refreshment.

31 – Unprocessed and non-transformed agricultural, aquacultural, horticultural and forestry products; unprocessed and raw grains and seeds; fresh fruits and vegetables, fresh aromatic herbs; natural plants and flowers; bulbs, seedlings and seeds; live animals; food products and beverages for animals; malt.

35 – Advertising; commercial management, in particular retail sale and wholesale sales services of meat, fish, poultry and game, charcuterie, meat extracts, preserved, frozen, dried and cooked fruits and vegetables, pulses, processed, cream cheese, shelled nuts, jellies, jams, compotes, eggs, soups, meat pâtés, caviar, food croquettes, milk, cheese, butter, yogurt and other dairy products, processed mushrooms, tofu, pro-

cessed edible seeds, oils and fats for food, coffee, tea, cocoa and coffee substitutes, rice, pasta and noodles, tapioca and sago, flour and cereal preparations, bread, pastries and confectionery, chocolate, ice-cream, sorbets and other edible ices, sugar, honey, molasses syrup, yeast, baking powder, salt, seasonings, spices, preserved herbs, vinegar, sauces and other condiments, ice, raw and unprocessed agricultural, aquacultural, horticultural and forestry products, raw and unprocessed grains and seeds, fresh fruit and vegetables, fresh herbs, natural flowers and plants, bulbs, seedlings and seeds, live animals, foodstuff and drinks for animals, malt; commercial administration; office functions.

36 – Insurance services; financial affairs; monetary affairs; real estate affairs.

43 – Catering services [food] especially, cafes; restaurants; preparation of food and drink and catering services; waiter services and decoration of food and beverages; supplying of meals for immediate consumption; preparation and provision of food and beverages for consumption in retail establishments; rental of cooking apparatus; rental of cooking equipment for industrial use; rental services of beverage vending machines, bar equipment, crockery, silverware, dishes and table accessories for special events; temporary accommodation services in hotels, motels and boarding houses; rental of temporary accommodation, bungalows, beds, futons, towels and bedcovers; rental of furniture for hotels; services for the rental of facilities for banquets, conferences, seminars, meetings, wedding receptions, cocktail parties and social functions for special occasions; information and advice with respect to meal preparation; consultancy provided by telephone call centers and hotlines in the field of temporary accommodation; consultancy services in the field of culinary arts; Provision of information relating to hosting by means of the Internet; providing information relating to hotels; provision of on-line information relating to vacation accommodation reservations; provision of conference facilities; providing ratings and reviews of restaurants; restaurant services; bar services; online accessibility to hotel and restaurant reviews; hotel accommodation services; provision of food and beverages as a hospitality service; reservation of temporary accommodation via the Internet; accommodation agency services [hotels, boarding houses]; cafeteria and restaurant services; home chef services; hotel services; hotel services reserved for loyal customers.

(260) AM 2021 108455 A  
 (800) 1532684  
 (151) 2020 03 17  
 (891) 2020 03 17  
 (731) Closed joint-stock company "Igristie Vina"  
 Sverdlovskaya naberezhnaya, 34, RU-195027  
 Saint-Petersburg, Russian Federation  
 (540)

## Lev Golitsin Coronation

(591) Black, white  
 (511)  
 33 – Aperitifs; arak; brandy; wine; piquette; whiskey; vodka; gin; digesters [liqueurs and spirits]; cocktails; liqueurs; alcoholic beverages containing fruit; distilled beverages; peppermint liqueurs; bitters; rum; sake; ciders; rice alcohol; alcoholic extracts; fruit extracts, alcoholic.

(260) AM 2021 108456 A  
 (800) 1532719  
 (151) 2020 01 16  
 (891) 2020 01 16  
 (731) Fédération Internationale de Basketball (FIBA)  
 Route Suisse 5, Case Postale 29, CH-1295  
 Mies, Switzerland  
 (540)

## FIBA BASKETBALL NATIONS CUP

(591) Black, white  
 (511)  
 25 – Clothing, footwear, headwear; sports clothing; footwear for sports; basketball shoes.  
 28 – Games, toys; gymnastic and sporting articles not included in other classes; balls for games and for sports; basketballs; basketball nets, posts and backboards; bags and cases adapted for carrying sports equipment; entertainment apparatus (automatic or by prepayment) for use with an external display screen or monitor; lottery tickets; scratch cards; bags and cases specially adapted for carrying sports equipment.  
 38 – Telecommunications; information transmission via wireless or cable networks; electronic transmission of data, images, voice messaging; network telecommunication; electronic messaging services; services of an Internet service provider, namely provision of access to the Internet; providing access to search engines and to search portals on the Internet; providing access to chat forums and other forums on the Internet; electronic data exchange via chat lines, chat rooms and other forums on the Internet; providing access to interactive Internet forums; provision and rental of access time to data banks, in particular online data banks in the field of sports; transmission of messages and images by computer, by short messages

(SMS), by third generation mobile telephone technology known as "3G" or "UMTS", and by wireless data transfer via wireless application protocols (WAP); broadcasting of films, television programs, videos, radio programs, also on the Internet; radio or televised program broadcasting relating to sports or sports events; provision of access to data banks containing digital music, to websites and MP3 files.

41 – Education; training; entertainment; sporting and cultural activities; theater and cinematographic entertainment services; amusement park services; organization of events and competitions in the field of basketball; entertainment services during customer care; ticket reservation services for sports or entertainment events; entertainment services provided at or relating to sports events; entertainment services during the public retransmission of sports events; providing on-line non-downloadable publications also via the Internet; provision of entertainment via television, radio and the Internet; interactive entertainment; provision of online computer games, including non-downloadable games on the Internet; organization of lotteries; organization of contests; betting and gambling services concerning or related to sports, also on the Internet; production, presentation and rental of films, audio and video recordings; publication of interactive educational and entertainment products, namely compact disks, DVDs, mini-disks, CD-ROMs; rental of interactive educational and entertainment products, namely compact disks, DVDs, mini-disks, CD-ROMs; rental of recorded data media for entertainment and educational purposes; publication of multimedia material online, including interactive multimedia entertainment and educational material; entertainment services, namely provision of on-line computer games via a computer network or mobile telephone network; electronic game competitions organized on-line via the Internet; entertainment information in the field of sports; provision of information in the field of sports events; publication of statistics; publication of statistics and information on sports performances; reservation of tickets for sporting and cultural activities; provision of digital music on the Internet and from MP3 websites; rental of audio and video recordings; timing services relating to sports events.

(260) AM 2021 108457 A

(800) 1532754

(151) 2020 02 18

(891) 2020 02 18

(731) UNION DES ASSOCIATIONS

EUROPEENNES DE FOOTBALL (UEFA)

Route de Genève 46, CH-1260 Nyon,

Switzerland

(540)

## UEFA EUROPA CONFERENCE LEAGUE

(591) Black, white

(511)

1 – Sensitized films (unexposed); chemical products used in science and/or photography; tanning materials; artificial sweeteners; chemical products for industrial use; chemical products for use in industry and/or in manufacturing processes; synthetic materials for absorbing oil; detergent additives for motor fuel; chemical additives for fuels, lubricants and greases; adhesives for industrial use; antifreeze; brake fluids; clutch fluids; brazing products; degreasing products used in manufacturing processes; oil dispersants; fluids for hydraulic circuits; chemical preparations for welding; transmission fluids; transmission oils; cutting and milling fluids; coolants; chemical preparations for treating cooling systems; coolant preparations for cutting fluids; dehumidifying fluids; all the aforesaid goods for industrial use; chemical products for preserving foodstuffs.

3 – Cosmetic products; soaps; cosmetic preparations for baths; powders for the body, the face, for cosmetic use and for the bath; perfumes, eaux de Cologne; pre-shave and after-shave lotions; shaving creams; shampoos, conditioners; dentifrices, mouthwashes; deodorants and antiperspirants for personal use; care creams, cosmetic creams; make-up removing creams for the face; make-up removing preparations; lip treatment products; lip gloss; lip balms [non-medicated]; lipstick; lip liner pencils; breath fresheners; tooth whitening creams; tooth whitening products (tapes or pastes); sun-tanning creams and lotions; hair lotions, hair sprays; toiletry creams; make-up products, eye shadows, face powders, cosmetic pencils; decorative transfers for cosmetic use; cotton sticks for cosmetic use; cotton balls for cosmetic use; shampoos for babies; baby oils [toiletries]; baby lotions [toiletries]; liquid soaps for babies' bodies; talcum powder for infants; wet wipes for infants; baby wipes; cleaning, polishing, scouring and abrasive preparations for household use; laundry powder detergents; synthetic cleaning products; shoe waxes and creams; leather care products.

4 – Lubricants; engine oils and fuels, including gasoline, diesel oil, gases and bio-fuels; candles; waxes; industrial greases; natural gas; liquid gases; industrial oils; lubricating oils and greases; carburants; liquefied petroleum gas; non-chemical additives for fuel, lubricants and greases; dust absorbing, wetting and binding compositions; lighting fuel; lubricants, oils and greases, and lubricating preparations for industrial use; cutting oils for industrial use; milling oils.

6 – Aluminum foils; metal rings and chains for keys; figurines, festive ornaments of common metals other

than tree ornaments, statues, statuettes, sculptures and trophies; fixed towel dispensers of metal; towel dispensers (of metal); printed metal disks for collection purposes (pogs); badges of metal for vehicles; registration plates of metal; all the aforesaid goods made of common metals or their alloys.

7 – Aerated beverage making machines; electric can openers; electric knives, electromechanical machines for producing food; mixing apparatus for household use; electric whisks for household use; electric fruit presses for household use; electric food processors; electric blenders for household use; dishwashers; washing machines for household use; spin driers; iron pressing machines; sewing machines; vacuum cleaners and accessories thereof included in this class; compressors, electronic superchargers; components of vehicle motors and engines; vending machines; elevators; electric apparatus, equipment and instruments for the production of electricity; turbines; generators generating electricity from solar or wind power.

8 – Hand-operated hand tools and implements; electric and non-electric razors, including razor blades; cutlery, forks; spoons; apparatus for depilation; tweezers; curling tongs; screwdrivers; scissors for household use; scissors for stationery; non-electric flat irons; electric irons.

9 – Exposed films, slides, video game disks; software (recorded programs), including game software; computer databases and programs; recorded or downloaded sounds, images or data; videotapes, magnetic tapes, magnetic disks, DVDs, mini-disks, diskettes, optical disks, compact disks, CD-ROMs, videodisks, memory cards, USB flash drives, whether blank or prerecorded with music, sound or images (which may be animated cartoons); holograms; electronic publications provided by means of CD-ROMs, databases and the Internet; spectacles, sunglasses, diving and swimming goggles; cases, cords and chains for sunglasses and spectacles; binoculars; magnets and decorative magnets; directional compasses; sound and image recording, transmitting and reproducing apparatus; satellite dishes; decoders, namely, electronic hardware and software which can convert, supply and transmit audio and video data; television sets; flat screens, liquid crystal display screens, high-definition screens and plasma screens; radios; home cinema systems; video recorders; CD players; DVD players; MP3 players; cassette players; mini-disk players; digital music players; loudspeakers; headphones, earphones; computers, including laptop computers and electronic tablets; karaoke machines; systems for editing sounds and for mixing sounds; systems for editing video images, and for mixing video images; apparatus for computer data processing; computer keyboards; computer screens; modems; accessories for computers included in this class; computer mice, mouse pads; navigation apparatus; personal digital assistants

(PDAs); electronic pocket translators; dictating machines; electronic agendas; scanners; printers; photocopiers; facsimile machines; telephones; answering machines; video telephones; cellular telephones; cellular telephone accessories included in this class, namely cases for cellular telephones, hands-free apparatus for cellular telephones, earphones and headsets for cellular telephones, keypads for cellular telephones, straps for cellular telephones, special cases for cellular telephones, photographic cameras and video cameras integrated in cellular telephones and hard covers for mobile telephones; remote controls for television sets and video systems; teleconferencing systems; calculating machines; credit card readers; currency converting machines; automated teller machines; video cameras, portable video cameras with built-in videocassette recorders (camcorders); photographic equipment, photographic apparatus, cameras (cinematographic apparatus), projectors, flash lamps, special cases and cords for photographic apparatus and instruments, electric cells and batteries; screen saver programs for computers; magnetic, digital or analog recording media, recorded or not, for sounds or images; magnetic cards (encoded); memory cards; integrated circuit cards (smart cards); microchip or magnetic credit cards, microchip or magnetic telephone cards, microchip or magnetic cards for cash dispensers, microchip or magnetic cards for automated teller machines and money exchange machines, prepaid microchip or magnetic cards for cellular telephones, microchip or magnetic travel and show admission cards, microchip or magnetic check guarantee cards and microchip or magnetic debit cards; alarms; wind socks (for indicating wind direction); distance-measuring apparatus; apparatus for measuring and displaying speed; protective gloves; audio receivers, sound amplifiers; television tubes; cathode ray tubes; decoders, namely computer hardware and software which can convert, supply and transmit audio and video data; disk drives for computers; protected semiconductors; integrated circuits containing programs for processing audio, visual or computer data; rechargeable batteries; audio and video data processors and converters; data transmission cables; payment apparatus for electronic commerce; protective helmets for sports; magnetic identification bracelets; components of electronic instruments; fuel/air coefficient analyzers; remote control devices for locking cars; photovoltaic cells; video game cassettes; scientific apparatus and instruments for weighing, measuring, signaling, checking (supervision), emergency (life-saving) and teaching, included in class 09; burglar alarms, anti-theft alarm apparatus, fire alarms; measuring apparatus and instruments; remote control equipment, remote controls; navigation apparatus, navigational instruments; telematic apparatus; telematic terminals; encoded electronic tickets; tickets in the form of magnetic cards; electronic electricity distribution machines.

10 – Personal diagnostic apparatus for medical use; medical measurement apparatus and instruments; massage apparatus for personal use; apparatus for physical training for medical purposes; imaging apparatus for medical diagnosis; feeding bottles; babies' pacifiers (teats); condoms; support bandages; ice and thermal bags for medical use.

11 – Flashlights; flashlights for lighting; table lamps; decorative lamps; lamp shades; incandescent lamps; light bulbs; lighting apparatus; bicycle lights; refrigerators, freezers; ovens; gas cookers, electric cookers; barbecues; cooking ranges, microwave ovens; electric coffee machines; electric kettles; electric bread toasters; electric deep fryers; electric laundry driers or electric hair driers; heating apparatus; air humidifiers; air conditioning apparatus, air purifying apparatus; water filters; drinking water fountains; fans for air conditioning for personal use; toilet seats; paper lanterns; headlights for vehicles; air conditioners for vehicles; drying machines.

12 – Bicycles, motorcycles, motor cars, trucks, vans, utility vehicles, buses, camper vans, refrigerated vehicles; airplanes and boats; air balloons, dirigible balloons [airships]; vehicle accessories, namely sun visors, pneumatic tires, tire covers, luggage racks, ski racks, rims and hub caps for wheels; seat linings, vehicle covers, baby carriages, strollers, safety seats for infants and children (for vehicles); engines and motors for land vehicles; bull bars; headlamp covers; steering wheels for vehicles; trailers; motors, engines and distributors for land vehicles; alarm systems for vehicles, anti-theft devices for vehicles.

14 – Jewelry, necklaces; jewelry; watches; wristwatches, clocks; chronographs; wall clocks; medallions, pendants, brooches; bracelets; pins (jewelry); lapel pins (jewelry); tie clips and tie pins; cuff links; commemorative medals of precious metal; prize cups, commemorative plates, trophies, statues, sculptures, all of precious metal; decorative hat pins, key rings (trinkets or fobs), printed metal disks for collection purposes (pogs), all made of precious metal; decorative key holders; coins; medals for clothing; cases for watches; badges of precious metal; alarm clocks; badges and pins (jewelry); leather bracelets; bracelets of plastic materials; ornamental key rings of plastic materials.

15 – Musical instruments; musical boxes; electric and electronic musical instruments.

16 – Coloring and drawing books; activity books; magazines; newspapers; books and journals, including those concerning sportsmen, sportswomen or sports events; bookmarks; printed teaching material; score sheets; event programs; albums for events; photograph albums; autograph books; printed timetables; pamphlets; collectible photographs of players; bumper stickers, stickers, albums, sticker albums; posters;

photographs; tablecloths of paper; napkins of paper; bags of paper; invitation cards; greeting cards; gift wrapping paper; coasters and place mats of paper; garbage bags of paper or of plastics; food wrapping paper; small bags for preserving foodstuffs; coffee filters of paper; labels (not of textile); hand towels of paper; wet hand-wipes of paper; toilet paper; tissues of paper for removing make-up; paper and cardboard boxes for pocket handkerchiefs; tissues of paper; stationery and instructional and teaching material (except apparatus); typewriter paper; copying paper; envelopes; notepads; folders for papers; tissue paper; writing books; paper sheets for note-taking; writing paper; binder paper; files; covering paper; luminous paper; adhesive paper for notes; paperweights; crêpe paper; tissue paper; badges or insignia of paper; flags of paper; pennants (flags) of paper; writing instruments; fountain pens; pencils; ballpoint pens; ballpoint pen and pencil sets; felt-tip pens (marking pens); fiber-tip pens and felt-tip pens; marking pens; writing ink, ink for pens, ink pads, rubber stamps; typewriters (electric or non-electric); lithograph prints, lithographic works of art; paintings (pictures), framed or unframed; paint boxes, paints and colored pencils; chalks; pencil ornaments [stationery]; printing blocks; address books; diaries (planners); personal organizers of paper; road maps; tickets, entry tickets; checks; comic books; calendars; postcards; advertising boards, banners and material included in this class; transfers (decalcomanias); sticking labels; office requisites (except furniture); correction fluids; rubber erasers; pencil sharpeners; stands for pens and pencils; paper clips; thumbtacks; drawing rulers; adhesive tapes for stationery purposes, adhesive tape dispensers; staples; stencils; document holders (stationery); paper clips; holders for notepads; bookends; stamps (seals); postage stamps, foreign postage stamps, collectible postage stamps, postage stamps for collectors; Commemorative stamp sheets; credit cards, telephone cards, ATM cards, cards for traveling and for shows, check guarantee cards and debit cards, non-magnetic, and of paper or cardboard; baggage tags of paper; passport cases; travelers' checks; holders for checkbooks; money clips of metal; letter trays.

18 – Leather and imitations of leather; thongs [straps] of leather; umbrellas, parasols; sports bags (other than those adapted for products they are designed to contain); leisure bags; travel bags, backpacks; school bags; bags for hanging on belts; handbags, leather bags; beach bags; garment bags; suitcases; document cases; identity card holders; belts for suitcases; briefcases (leather goods); cases for toiletry articles known as vanity cases (not fitted); toiletry bags; key cases (leather goods); business card cases; wallets; purses (coin purses); whips; collars for animals; luggage tags of leather.

20 – Mirrors; goods made of plastic, namely statues, figurines, statuettes, trophies; souvenirs made of wo-

od, wax, plaster or plastic; identification badges (not encoded), in particular ID badges, key cards (not encoded), all the aforementioned goods being made of plastic; cushions; cushions as accessories for cars; furniture, furnishings; Chairs for indoor and outdoor use; racks (furniture); racks or display stands for merchandise; fixed towel dispensers (not of metal); coat hangers, fans for personal use; inflatable or rigid advertising objects made of plastic; bookshelves; display stands or sales panels for points of sale (furniture); display racks for stationery supplies; advertising objects of plastic materials; book shelves; printed plastic disks for collection purposes (pogs); plastic strips; frames; frames for photographs; number plates, not of metal; book rests; inflatable publicity objects; non-metal tool boxes; identification bracelets of plastic.

21 – Household or kitchen utensils and containers (non-electric); tankards, drinking vessels, beer mugs, tumblers, cups and glasses, plates and trays, trivets, decanters, coasters for glasses or bottles, saucers; teapots; kitchen gloves; household gloves; bottle openers; corkscrews; bottle cap removers; bottles; insulating flasks; non-electric containers for food and beverages; combs and hair brushes; toothbrushes; dental floss; statues, sculptures and trophies relating to football made of porcelain, terracotta or glass; decorative bottles for cosmetic use; rotary washing lines; money boxes not of metal; money boxes of metal; drinking flasks for travelers; souvenir plates; beer pitchers; beer pitchers, tankards, teapots, all of precious metal; waste paper baskets; baskets for domestic use.

24 – Sleeping bags; bed linen; sheets; eiderdowns [quilts]; bed covers; pillowcases; curtains, shower curtains; curtain fabrics; linen; hand towels, bath towels, dish towels; blankets; handkerchiefs made from textile materials, wall hangings made from textile materials, pavilions (flags); flags; pennants; table linen not of paper; labels of cloth; banners of plastic.

25 – Clothing; shoes and footwear; headwear; shirts; knitwear (clothing); pullovers; slipovers; T-shirts; vests; singlets; sleeveless jerseys, dresses; skirts; underwear, functional underwear, brassieres; swimsuits; bathrobes; shorts; trousers; sweaters; caps (bonnets); caps; hats; sashes for wear; scarves, shawls; peaked caps; tracksuits; sweatshirts; jackets, sports jackets, stadium jackets (jumpers); blazers; waterproof clothing; coats; uniforms; neckties; wrist bands; headbands; gloves; aprons; bibs (not of paper); pajamas; play suits for infants and children; socks and stockings; tights and leggings, garters; belts; suspenders; sandals; sports shoes, namely, shoes for outdoor sports, basketball shoes, multi-sport shoes, cycling shoes, indoor sports shoes, track and field shoes, football shoes (indoor and outdoor), canvas shoes, tennis shoes, sneakers, sailing shoes, shoes for aerobics; hiking boots; flip-flops; sportswear, namely, fleece tops, jogging suits, knitted sportswear, casual

sports pants, polo shirts, sweat shirts, sweat pants football shirts, rugby shirts, bathing suits, sports jerseys, leotards, ski suits, ski jackets, ski trousers; wrist bands [clothing].

26 – Braids; tassels (haberdashery); ribbons; buttons; sewing needles; sewing boxes; badges for clothing (other than of precious metal); brooches (clothing accessories); decorative pins and needles not of precious metal; ornament pins for hats not of precious metal; hair nets, hair bands; barrettes (hair slides); hair pins; hair ribbons; pins not of precious metal; clothing cords, embroidery cords; bands for clothing (strips); competitors' numbers for advertising use; shoe ornaments not of precious metal; other decorative articles for the hair included in this class; badges of all kinds not of precious metal (including numbers and letters); plastic badges; badges and lapel pins (badges not of precious metal).

27 – Linoleum and other floor coverings; floor coverings, artificial turf; artificial turf for sports fields; beach mats; carpets, mats, rugs (also for cars).

28 – Games and toys; sports balls; play balloons; board games; tables for indoor football; dolls and plush toys; vehicles (toys); jigsaw puzzles; balloons; inflatable toys; play disks (pogs); playing cards; confetti; gymnastic and sporting articles; football equipment, namely balls for football, gloves, knee guards, elbow guards, shoulder guards, shin guards; football goals; sports bags and containers (adapted to objects) for carrying sports articles; party hats (toys); small electronic games designed for use with a television set; video game apparatus; game consoles, electronic games other than those adapted for use with television receivers only; steering wheels for video games and mats for video games (for dancing upon); hands made of rubber or foam (toys); entertainment robots; appliances for gymnastics; kites; roller skates; scooters; skateboards; coin-operated video games for game halls (arcade games); electronic games with liquid crystal display; joysticks for video games, manually or voice-activated joysticks for video games; lottery tickets; lottery cards, scratch tickets for lottery games; toys for household pets; computer game joysticks; joysticks on computers activated manually or voice-activated; wrist straps for sports.

29 – Meat; fish; poultry; game; meat extracts; canned fish and meat; cooked fruits and vegetables; canned fruits and vegetables; edible oils and fats; potato chips; French fries; prepared nuts; jams; marmalades and jellies; milk; milk products (milk predominating), dairy products; cheeses; soy milk (milk substitute); consommés (soups); bouillons.

30 – Coffee; tea; cocoa; chocolates; sugar; honey; coffee substitutes; flours; cereal preparations; cereals; bread; pastry; pastes (pastry); pasta; cakes; biscuits, cookies; crackers; candy; edible ices; confectionery;

rice; dried cereal flakes; mustard; vinegar; sauces (condiments); spices; salt; honey, molasses, yeast, salt, mustard, vinegar or spices; products with added vitamins for culinary use and food additives for culinary use based on coffee, tea, cocoa, sugar, rice, tapioca, sago, flour or cereal preparations, honey, molasses, yeast, salt, mustard, vinegar or spices; salt and salt-based products for preserving foodstuffs; pizzas; fresh pizzas; pizza doughs; burgers inserted in brioche bread, namely hamburgers; hot dogs (sandwiches); sandwiches filled with meat; cheeseburgers (sandwiches); fish sandwiches; tea-based beverages; iced tea; instant cocoa.

32 – Non-alcoholic beverages; syrups and powders for making non-alcoholic beverages; mineral and aerated waters; energy drinks, isotonic drinks, hypertonic and hypotonic drinks; fruit and vegetable beverages; fruit and vegetable juices; sports beverages; frozen fruit drinks, frozen flavored drinks, non-carbonated and non-alcoholic; drinks enriched with added vitamins, not for medical use; beers; strong dark beers; lagers and ales; non-alcoholic or low-alcohol beers.

33 – Alcoholic beverages (except beers) including alcoholic beverages made with fruit, cider.

34 – Matches; lighters for smokers; cigarette cases, ashtrays, smokers' articles; cigarettes; tobacco; ashtrays and cigarette cases of precious metal.

35 – Employment agency services; personnel recruitment; advertising services; services provided by an agency publishing advertising texts; advertising agency services; advertising agency services on a global computer network (the Internet) or via wireless electronic communication devices; dissemination of advertisements; rental of advertising space; rental of advertising time in film credits; television advertising, radio advertising; advertising in the form of animated cartoons; promotion agency services, promotion agency services for sports and public relations; promotion of football events; market study services; market research services; public opinion polling services; organization of exhibitions for commercial or advertising purposes; organization of advertising for trade fairs; compilation and systematization of data in data banks; data bank management services; compilation of statistics; advertising for sports events in the field of football; retail sale services for and bringing together of various goods for the benefit of others (excluding the transport thereof), namely clothing, footwear, headgear, sports articles, stationery, apparatus for recording, transmission and reproduction of sound and images, books, newspapers, magazines, publications, video games, toys, dolls, badges of all kinds, key rings, tickets, watches and jewelry, souvenir items in connection with football, bags, luggage, briefcases, umbrellas, flags and pennants, alcoholic and non-alcoholic beverages, confectionery, medical apparatus and

instruments, vehicles and accessories for motor cars; retail sale services for solvents, paraffin, waxes, bitumen and petroleum; bringing together of the following goods for the benefit of others (excluding transport thereof) to enable customers to conveniently view and purchase these goods in a store or on a global computer network (the Internet) or via wireless electronic communication devices, namely clothing, footwear, headgear, sports articles, stationery, apparatus for recording, transmission and reproduction of sound and images, books, newspapers, magazines, publications, video games, toys, dolls, badges of all kinds, key rings, tickets, watches and jewelry, souvenir items in connection with football, bags, luggage, briefcases, umbrellas, flags and pennants, alcoholic and non-alcoholic beverages, confectionery, medical apparatus and instruments, vehicles and accessories for motor cars; advertising and promotion services, information services with regard to advertising and promotion, commercial information agencies, all the aforesaid services provided on-line from a computer database or via a global computer network (the Internet) or via wireless electronic communication devices; design and compilation of advertisements for use as a web site on a global computer network (the Internet) or via wireless electronic communication devices; provision of space on web sites, for advertising of goods and services; auctioneering on a global computer network (the Internet) or via wireless electronic communication devices; collection of directories for publication on the Internet and on wireless electronic communication networks; business administration services for processing commercial services on a global computer network (Internet) or via wireless electronic communication devices; compilation, creation and management of databases, namely collection of domain names in a register; sales promotion, namely creation of preferential programs for customers; implementation of bonus programs for customers in stadiums by distributing encoded loyalty and membership cards which can contain the personal data of the user; development, launch and administration of loyalty programs, namely issuing loyalty cards to fans, containing personal information on the identity of the card holder; electronic commerce (e-commerce) services, namely provision of information on goods via telecommunication networks for advertising or sales purposes; compilation of data into a computer database, especially still or animated images; e-commerce services, namely online services for providing contracts for the purchase and sale of goods on behalf of others; promotion of sports events in the field of football; promotion of the goods and services of others, through contractual agreements, particularly partnership (sponsoring) and licensing agreements, providing them with increased notoriety and enhanced image derived from cultural and sporting events, particularly international events; compilation and recording of data and information on sporting performances; provision of personnel, parti-

cularly for selling beverages and foods; promotion of football events; retail sale of interactive educational and entertainment products, interactive compact disks, CD-ROMs and computer games; retail sale services, particularly on a global computer network, for interactive educational and entertainment products, interactive compact disks, CD-ROMs and computer games; presentation of computer programs for retail sale purposes; procurement services for others [purchasing goods and services for other businesses]; procurement services for others [purchasing goods and services for other businesses] for sports events or entertainment; promotion of the goods and services of others, through contractual agreements, particularly partnership (sponsoring) and licensing agreements, providing them with increased notoriety and/or enhanced image and/or affinity derived from cultural and sporting events, particularly international events; retail and wholesale services for motor vehicles, motor vehicle parts and motor vehicle accessories; retail and wholesale trading services on the Internet for motor vehicles, motor vehicle parts and motor vehicle accessories; compilation of data in computer data banks.

36 – Issuance and management of credit cards and travelers' checks; financial services; banking, credit and investment services; insurance services; lease-purchase financing; hire-purchase services; financial sponsorship of sports events; information services related to finance and insurance, provided from a computer database or the Internet or on all wireless electronic communication networks; home banking services; banking services on the Internet or on all wireless electronic communication networks; payment services, including services provided from a computer database or via the Internet or via mobile telephones; safe deposit services; issue of vouchers, namely issue of loyalty cards to fans, which contain personal data on the identity of the cardholder and are used for access control at sports stadiums; financial promotion of events in the field of football; financial payment services for electronic commerce, namely transfer of funds, all via electronic communication networks; financial sponsorship search for football competitions; financial payment services for electronic commerce in connection with the purchase of goods and services provided by others, all via electronic communication networks, and clearing and settlement of financial transactions via electronic communication networks; issue of vouchers in the form of travel vouchers.

37 – Installation and maintenance of wireless electronic communication networks (hardware); computer connection installation services related to sports; installation and repair of sports grounds with natural or artificial turf; vehicle cleaning and washing; vehicle lubrication; repair, disassembly, maintenance and servicing of vehicles; vehicle breakdown assistance [repair]; installation and repair of burglar alarms; overhaul, lubrication, maintenance and repair of vehicles,

engines and machinery; anti-rust treatment for vehicles; tire trim fitting and tire puncture repair; construction and maintenance of pipelines; extraction of gas and petroleum; construction of structures for the production of crude oil; installation of apparatus for the production of oil; installation of solar power systems; installation of wind power systems; installation of hydraulic power systems; mining extraction services; construction of electric power plants; adaptation and customization of mass-produced automobiles and engines therefor; tuning of motors and engines.

38 – Telecommunication services; communication by mobile telephones; communication by telex; communication via electronic computer terminals linked to telecommunication networks, data banks and the Internet or via wireless electronic communication devices; communication by telegraphs; communication by telephones; communications by facsimile; paging services; telephone or video conferencing services; television program broadcasting; broadcasting of cable television programs; radio program broadcasting; transmission of radio and television programs of sports and sports events; news and press agency services; other message transmission services; rental of telephones, facsimile machines and other telecommunication apparatus; transmission of commercial Internet pages online or via wireless electronic communication devices; services for transmitting and broadcasting television and radio programs provided via the Internet or via any wireless electronic communication network; electronic transmission of messages; simultaneous broadcasting of film recordings and sound and video recordings; provision of access to telematic servers and real-time chat forums; computer-aided transmission of messages and images; telecommunication via fiber-optic networks; provision of access to a global computer network or interactive communication technologies for access to private and commercial purchasing and ordering services; transmission of information and other data via websites and computers; transmission of information (including sites by telematic means) via telecommunication, computer programs and other data; transmission of information, computer programs and other data by telematic means; electronic mail transmission; provision of access via the Internet or on any wireless electronic communication network (telecommunication services); providing connections for telecommunications with a global computer network (the Internet) or data banks; provision of access to websites offering digital music on the Internet by means of a global computer network or via wireless electronic communication devices; rental of access time to MP3 websites on the Internet, via a global computer network or via wireless electronic communication devices; rental of access time to a database server center (telecommunication services); rental of access time to a computer database (telecommunication services); transmission of digital



music by telecommunications; online transmission of electronic publications; digital music transmission via the Internet or on any wireless electronic communication network; digital music transmission via MP3 Internet sites; simultaneous broadcasting and/or netcasting of film recordings and sound and video recordings (telecommunications); simultaneous broadcasting and/or netcasting of interactive educational and entertainment products, interactive compact disks, CD-ROMs, computer programs and computer games (telecommunications); provision of access to blackboards (bulletin and announcement boards), a blog and discussion forums (chat rooms) in real time via a global computer network; rental and provision of access time to blackboards (boards for displaying information and advertisements) and to chat rooms in real time by means of a global computer network (communication services); telecommunication services dedicated to retail sale by means of interactive communications with customers; multimedia telecommunication; videotext and teletext transmission services; information transmission via communication satellite, microwave or by electronic, digital or analog means; transmission of digital information by cable, wire or fiber; transmission of information by mobile telephones, telephones, facsimile and telex; telecommunication services for receiving and exchanging information, messages, images and data; telecommunication services for setting up discussion groups on the Internet and on any wireless electronic communication network; provision of access to search engines on the Internet, provision of access to platforms on the Internet (also on the mobile Internet) in the form of customized online pages featuring information defined or specified by users, personal profiles, audio contents, video contents, photographic images, texts, graphic illustrations and data; provision of access to search engines for obtaining data and information on global networks.

39 – Services of a travel agency, namely, travel arrangement and reservation; ticket reservation and information services for travel; transport by airplane, railway, bus and truck; boat transport; boat travel services; tourist travel services; rental of vehicles and automobiles; rental of parking spaces; taxi services; boat transport services for goods; distribution of water, heat, gas or electricity; distribution of newspapers, magazines and books; postal services, mail delivery and courier services; storage of goods; delivery of solvents, paraffins, waxes, bitumens and oil products, excluding liquid gas; distribution (delivery) of films and sound and image recordings; distribution (delivery) of interactive educational and entertainment products, interactive compact disks, CD-ROMs, computer programs and computer games; ticket distribution (transport); navigation services by global positioning system; advice relating to power and electricity distribution; transport services; packaging and storage of

goods; towing, transport and taxi; car transport; motor vehicle fleet tracking and monitoring services using electronic positioning and navigation devices; professional advisory services relating to the distribution of electricity and energy.

40 – Processing of cinematographic films; printing house services; enlargement of photographs, printing of photographs, photographic film development; rental of machines and equipment for developing, printing, enlarging and finishing photographs; waste disposal services; services provided by a fashion designer; treatment of substances and materials; petroleum and gas treatment; transformation and refining of organic substances; production of energy; petroleum refining; refining services; advisory services relating to energy and electricity production.

41 – Education; training; entertainment; organization of lotteries, raffles and competitions; betting and gaming services in connection with sports; provision of entry tickets and information brochures on sports for VIPs, as well as guiding and gathering VIPs for sports or entertainment events, provision of online information in the field of sports or sports events from a computer database or the Internet; customer reception services (entertainment services) including provision of access tickets during sports or entertainment events; entertainment services relating to sporting events; entertainment services in the form of public gatherings during the retransmission of sports events; sporting and cultural activities; organization of sporting and cultural events and activities; amusement park services; sports club services [health and fitness training]; organization of sports competitions; organization of events in the field of football; sports camp services; provision of sports facilities; rental of video and audiovisual installations; production, presentation, distribution and/or rental of film recordings and sound and video recordings; presentation, distribution and/or rental of interactive educational and entertainment products, interactive compact disks, CD-ROMs, and computer games; radio and television coverage of sporting events; production services for radio, television programs and video films; ticket reservation services and information services for sports or entertainment events; timing services relating to sports events; organization of beauty contests; interactive entertainment; on-line betting and gaming services on the Internet or on any wireless electronic communication network; information in the field of entertainment (including in the field of sports), provided on-line from a computer database or via the Internet or via any wireless electronic communication network; electronic game services transmitted via the Internet or on mobile telephones; editing of books; publication of books and electronic journals on-line; audio and video recording services; production of animated cartoons for the cinema, production of animated cartoons for television; rental of sound and image recordings for

entertainment purposes; information in the field of education provided on-line from a computer database or via the Internet or any wireless electronic communication network; translation services; photography services; provision of entertainment infrastructure; ticket agencies in connection with sports events; entertainment information in the field of sports; provision of information in the field of sports events; publication of statistics; publication of statistics and information on sports performances; provision of entertainment infrastructure, namely VIP boxes and boxes inside and outside stadiums.

42 – Computer consultancy services; data processing (programming); provision or rental of computer software; computer rental; compilation of websites in computer networks (particularly the Internet) or via wireless electronic communication devices; introduction of websites in computer networks (particularly the Internet) or via wireless electronic communication devices; provision of search engines for obtaining data and information on global networks; hosting services for Internet sites or wireless electronic communication sites; creation and maintenance of websites and of wireless electronic communication networks; networking and/or rental of computer programs; installation and maintenance of computer software; computer software development; Application service provider [ASP], namely hosting of third-party application software; development of software application solutions; cloud computing; design and development of operating software for access to a computer network in the cloud [cloud computing] as well as use thereof; providing computer software to enable or facilitate the uploading, downloading, streaming, posting, displaying, blogging, linking, sharing or providing via other means of multimedia content or electronic information over communication networks; providing temporary use of non-downloadable software applications for social networking, creation of a virtual community and transmission of audio content, video content, photographic images, texts, graphic illustrations and data; providing software via an online site which technology enables online users to create personal profiles with social networking information and to transfer and share such information on multiple online sites; calibration; provision of Internet search engines; analysis, testing and monitoring (supervision) of oils, coolants, greases and lubricants; analysis and diagnosis of degrees of wear, faults and breakdown on motors, engines and machines; advice relating to the aforesaid fields and provided on the basis of results from the aforesaid analysis and diagnosis; quality control services in connection with overhaul, lubrication, maintenance and repair of vehicles, motors, engines and machinery; programming of computer programs; design and development of computer programs; technical development of discussion forums on the Internet or on any wireless electronic communica-

tion network; testing services relating to prospecting in the oil and gas industry; prospecting to locate oil and gas; analyses services for exploitation of oil deposits; assistance services related to technology in the oil industry; analysis, advice, assistance and design services related to technology in the oil industry; advice on technology and services for the technical development, technical design and technical planning of photovoltaic facilities; advice on technology and services for the technical development, technical design and technical planning of wind power facilities; advisory services relating to electronic control devices for the monitoring of solar and/or wind-powered electric systems; design of energy and electricity systems; analysis of the energy requirements of others; development of energy and electricity management systems; project study and technical advice and development services, all in connection with the needs of others for electricity and energy; technical design services for electrical installations; technical developments relating to energy and electricity distribution; technical developments relating to energy and electricity production; electronic calibration services for motors, engines and transmissions; technical development services relating to the distribution of power and electricity.

43 – Providing food and drink, snack-bars; hospitality services, namely provision of food and drink; catering services; hotel services; providing accommodation and food and drink, booking hotels and temporary accommodation; hospitality services, namely provision of food and drink during sports or entertainment events.

44 – Medical and dental services, hospital services; doping control services; hairdressing and beauty salon services.

45 – Intellectual property licensing; management of copyright on films and video and sound and image recordings as well as interactive compact disks, DVDs, mini-disks, CD-ROMs, computer software and computer games; granting licenses for televised program broadcasting (including football matches) on giant screens; granting of licenses for data banks; software licensing (legal services); registration of domain names (legal services); intellectual property consultancy; security inspection services for third parties; clothing rental; granting of licenses for databases and computer files.

(260) AM 2021 108460 A  
 (800) 1532798  
 (151) 2020 02 18  
 (891) 2020 02 18  
 (731) BİLEŞİM TURİZM İNŞAAT SANAYİ VE  
 TİCARET ANONİM ŞİRKETİ  
 Merkez Mahallesi, Çukurçeşme Caddesi No:51,  
 Gaziosmanpaşa, İstanbul, Turkey  
 (540)



(591) Blue, white, grey, red  
 (531) 03.11.01; 26.01.01; 26.01.04; 26.01.15;  
 26.01.18; 26.04.02; 26.04.07; 26.04.18;  
 27.05.10; 27.05.17; 29.01.13  
 (511)  
 44 – Medical services; hygienic and beauty care for  
 human beings, consulting services in the field of  
 workplace and personnel health.

(260) AM 2021 108461 A  
 (800) 1532806  
 (151) 2020 03 26  
 (891) 2020 03 26  
 (731) Zakrytoe Aktsionernoe Obshchestvo, "Minsky  
 Zavod Vinogradnykh Vin"  
 k. 23, d. 52A, ul. Kazintsya, 220099 Minsk,  
 Belarus  
 (540)



(591) Green, red, cherry, white, blue, yellow, black,  
 beige and light green  
 (531) 02.03.01; 02.03.23; 05.07.16; 05.13.07;  
 25.01.06; 25.01.15; 25.07.25; 28.05; 29.01.15  
 (511)  
 33 – Alcoholic beverages, except beer.

(260) AM 2021 108462 A  
 (800) 1532811  
 (151) 2020 01 16  
 (891) 2020 01 16  
 (731) Koninklijke Philips N.V.  
 High Tech Campus 5, NL-5656 AE Eindhoven,  
 Netherlands

(540)

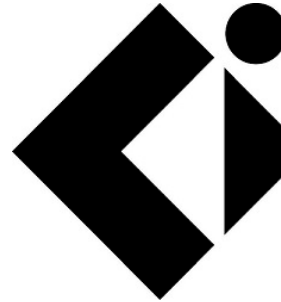

(591) Black, white  
 (531) 26.03.04; 26.04.03; 26.04.07; 26.07.03;  
 26.07.05; 26.07.15

(511)  
 7 – Small electric apparatus, machines and articles for  
 domestic use, not included in other classes, including  
 food processors, electric blenders, electric mixers, el-  
 ectric hand blenders, electric coffee mills, electric  
 grinders, electric can openers, electric knives, electric  
 knife-sharpeners, electric fruit presses and juicers, and  
 kitchen machines for cutting, slicing, grating, mincing  
 and chopping food items.

9 – Instruments for conducting, switching, transform-  
 ing, accumulating, regulating and controlling elec-  
 tricity; standalone wireless power transmitters and wi-  
 reless power transmitters integrated in tables, counter-  
 tops, furniture and fixtures.

9 – Software for controlling and regulating electricity  
 and for operating wirelessly powered devices.

11 – Electric devices for food preparation, cooking,  
 baking, roasting, grilling, toasting; electric cooking  
 and kitchen appliances not covered in other classes,  
 including induction cooktops, induction furnaces,  
 induction heaters, induction ovens, induction cookers,  
 induction water heaters, electric hotplates, stoves, de-  
 frosting and heating apparatus, electric kettles, electric  
 frying pans, electric smart pans, rice cookers, multi-  
 cookers, smart cookware, electric coffee makers, elec-  
 tric espresso makers, electric tea makers, electric ice  
 cream machines, electric toasters, electric waffle ma-  
 king machines, wine chillers, water coolers, electric  
 grills, stone grills, electric sandwich presses, sand-  
 wich makers, electric toaster ovens, microwave ovens,  
 electric convection ovens, hot air ovens, electric slow  
 cookers, electric skillets, electric woks, electric grid-  
 dles, electric pressure cookers, electric food steamers,  
 electric bread makers, electric pasta makers, noodle  
 makers, electric deep fat fryers, electric light fryers,  
 heaters and warmers for feeding bottles, foodstuffs,  
 liquids and solids, sterilizers, sterilizing apparatus and  
 accessories therefor; parts for all the aforesaid goods;  
 all the aforesaid goods for household purposes only;  
 machines for making for making ice.

35 – Promotion services for the development and  
 adoption of a voluntary specification for wireless po-  
 wer charging interoperability; business administrati-

on; accounting for data; lobbying services for commercial uses; business management; office functions; processing of data, involving also statistical processing for data; production for statistical information; analyzing for business information; consultancy and information in the field of all aforementioned services; consumer information services; providing consumer product information; business analysis, research and information services; market research; market campaigns; market reports and studies; public relations services; opinion polling.

42 – Technical services, including developing, defining, promoting, testing and verification services related to standards and specifications for wireless power charging interoperability.

(260) AM 2021 108464 A  
 (800) 1532862  
 (151) 2020 02 25  
 (891) 2020 02 25  
 (731) Yerevan Brandy Company CJSC  
 Admiral Isakov Avenue 2, 0082 Yerevan,  
 Armenia

(540)

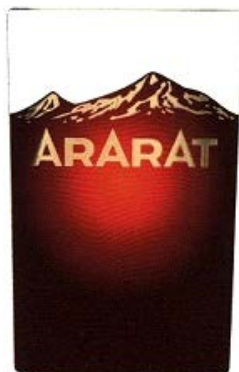

(591) Burgundy, orange, white and gold  
 (531) 06.01.02; 06.01.04; 25.01.15; 27.05.01;  
 27.05.24; 29.01.14

(511)  
 33 – Armenian brandy; brandy, vodka; fruit vodka; wines; whiskey; alcoholic drinks; cider; herbs bitter; anise-flavored liqueur; anise-flavored vodka; aperitifs; distilled drinks; cocktails; gin; rum; liqueurs; alcoholic drinks; alcoholic spirit (essences), alcohol solvents, alcoholic drinks containing fruit.

(260) AM 2021 108466 A  
 (800) 1532927  
 (151) 2019 07 16  
 (891) 2019 07 16  
 (731) LIMITED LIABILITY MANUFACTURING,  
 AND TRADING COMPANY "ACME"  
 5 Promyslova Str., Ukrainka, Obukhivsky r-n,  
 Kyivska obl. 08720, Ukraine

(540)



(591) Black, white  
 (531) 03.13.01; 03.13.24; 27.05.07; 27.05.09;  
 27.05.10

(511)  
 3 – Antiperspirants (perfumery and cosmetic preparations); vaginal cleansers for personal hygiene or for deodorization; dental powders and pastes; conditioners for hair care; makeup; cosmetic masks; bath cosmetics; cosmetic products for skin care; cream cosmetic; hair lotions; lotions for cosmetic needs; antiperspirant soap; soap for foot perspiration; soap; sets of cosmetics; cleansing agents for intimate hygiene non-therapeutic; douching preparations for personal sanitary or deodorant purposes (toiletries); shampoos.

5 – Absorbent cotton wool; absorption wool; albumin dietary supplements; alginates for pharmaceutical needs; alginate dietary supplements; antibacterial soap; antibacterial detergents for hands; antiseptics; antiseptic cotton wool; aseptic cotton wool; cotton wool for medical needs; bactericidal agents; bacterial medicines for medical and veterinary use; balms for medical needs; balms for medical purposes; royal jelly bee for pharmaceutical needs; protein supplements for medical purposes; biological preparations for medical needs; vaginal cleansers for medical needs; vaseline for medical needs; cotton wool for medical needs; cotton sticks for medical needs; broths for pharmaceutical needs; vitamins; mineral water for medical needs; dietary fiber; hygienic napkins; hygienic tampons; menstrual tampons; hygienic panties; hygienic pantaloons; mud baths; medicinal mud; disinfectant soap; disinfectants; disinfectants for hygienic needs; deodorants for clothes and textiles; food mixtures for babies; dietary substances for medical use; eucalyptus for pharmaceutical needs; eucalyptol for pharmaceutical use; plant extracts for pharmaceutical purposes; extracts of herbs for medical needs; hop extracts for pharmaceutical needs; elixirs (pharmaceuticals); acids for pharmaceutical needs; oxygen baths; adhesive tapes for medical needs; adhesive strips for medical needs; collagen for medical needs; compresses; angostura bark for medical needs; buckthorn for medical needs; croton's bark; mangrove bark for pharmaceutical needs; mirobalan's bark for pharmaceutical needs; bark for pharmaceutical needs; bark of honey bee for medical purposes; culture of microorganisms for medical or veterinary use; adhesive plaster; medical roots; therapeutic tea use in curative care; medicines from corns; remedies for excessive sweating; remedies for excessive sweating of the legs; therapeutic dental powders and pastes; medicated hair lotions; medical drinks; healing infusions; medical oils; medi-

cal perfumery-cosmetic preparations; therapeutic preparations for hair growth; therapeutic solutions for washing eyes; healing dry shampoos; herbs; healing shampoos; lotions for pharmaceutical needs; ointment from sunburn; ointment for pharmaceutical needs; ointment frostbite for pharmaceutical needs; melissa water for pharmaceutical needs; menthol; almond milk for pharmaceutical needs; mineral biologically active food supplements; moleskin for medical needs; sea water for medical baths; mint for pharmaceutical needs; tinctures for medical needs; wart pencils; oral rinsers for medical purposes; diapers absorbing for infants; diapers for babies; absorbent diapers for incontinence patients; diapers for incontinence patients; pearl powder for medical needs; diapers for children (panties); lipstick for medical needs; belt for sanitary napkins; preparations for rough skin of legs; preparations for frostbite; bath preparations for medical needs; preparations for deodorizing air; preparations for the treatment of burns; drugs for the treatment of pediculosis (pediculicides); aloe vera drugs for pharmaceutical use; drugs with trace elements for humans and animals; medicines from microorganisms for medical or veterinary use; preparations that facilitate teething; poultices; baby food products; protein dietary supplements; antispasmodic rings for the legs; solutions for contact lenses; solvents for removing adhesive plaster; napkins impregnated with pharmaceutical solutions; salts for baths from mineral waters; bath salts for medical needs; potassium salts for medical purposes; mineral water salts; salts for medical needs; therapeutic preparations for baths; thermal water; tonics (medicines); herbal teas for medical needs; pantyhose absorbent for incontinence patients; pharmaceuticals; pharmaceuticals for treating dandruff; pharmaceuticals for skin care; pharmaceuticals for the treatment of sunburn; pharmaceutical products; fennel for medical needs; ferments for pharmaceutical purposes; phylotherapeutic preparations for medical purposes; chemical and pharmaceutical preparations medical and veterinary purposes; chemical preparations for medical purposes; pharmaceutical preparations for pharmaceutical purposes; medicated candies; candy for medical purposes; shampoos against pediculosis; daily pads (hygiene).

(260) AM 2021 108474 A  
 (800) 1533235  
 (151) 2020 04 14  
 (891) 2020 04 14  
 (731) Public Joint Stock Company TATNEFT named after V.D. Shashin  
 Lenina str., 75, Almetyevsk, RU-423450  
 Republic of Tatarstan, Russian Federation

(540)



(591) Green, white and red  
 (531) 01.15.05; 19.01.01; 29.01.13  
 (526) Schematic image of a barrel made by a dotted line.  
 (511)  
 4 – Industrial oils and greases; lubricants; motor oil; fuel oil; industrial oil; lubricating oil; mazut.

(260) AM 2021 108476 A  
 (800) 1533418  
 (151) 2019 12 04  
 (891) 2019 12 04  
 (731) ALSTOM  
 48 rue Albert Dhalenne, F-93400 Saint-Ouen-sur-Seine, France  
 (540)



(591) Red and blue  
 (531) 01.15.23; 24.17.02; 26.01.04; 27.01.01;  
 27.05.01; 29.01.12  
 (511)  
 9 – Scientific, research, nautical, geodesic, audiovisual, optical, weighing, measuring, signaling, detection, testing, checking, life-saving and teaching apparatus and instruments; apparatus and instruments for conducting, switching, transforming, accumulating, regulating or controlling the distribution or use of electricity; apparatus and instruments for recording, transmitting, reproducing or processing sound, images or data; downloadable or recorded media, software, blank digital or analog recording and storage media; mechanisms for coin-operated apparatus; cash registers, calculating device; computers and computer peripherals; fire extinguishers; all goods for land vehicles, buses, coaches, autonomous electric vehicles and rail vehicles for transporting passengers and/or goods, railway rolling stock, including locomotives, rail cars and self-propelled vehicles, high-speed and very high-speed rail vehicles, underground trains and other sets of passenger vehicles, automatic or non-automatic,

namely iron-wheeled rail vehicles or guided vehicles with pneumatic or other types of ground liaison, railway couplings, railway infrastructures, coatings, rails and their components parts; smart meters, electronically or computationally connected devices for guiding and directing persons to take transport and validate their transport tickets.

12 – Vehicles, particularly buses, coaches, autonomous electric vehicles and rail vehicles; railway rolling stock, including locomotives, rail cars and self-propelled vehicles, high-speed and very high-speed rail vehicles; underground trains and other sets of passenger vehicles, automatic or non-automatic, namely iron-wheeled rail vehicles or guided vehicles on wheels with pneumatic or other types of ground liaison; motor buses; motor coaches; railway couplings; electric vehicles in particular trams and buses; unmanned vehicles; the aforesaid motors for land vehicles and their parts; pneumatic shock absorbers for the aforementioned land vehicles; drive belts and related gearings for the aforementioned land vehicles; air pumps (vehicle accessories); transmission shafts for the aforementioned land vehicles; propulsion mechanisms for the aforementioned land vehicles; brakes, axles, wagon bodies; carriages [railway]; railway couplings; tank wagons, parts for land vehicles; shock absorbers for road and rail vehicles; rail vehicle bogies, vehicle engines, vehicle traction systems.

16 – Containers and packaging of paper or cardboard and goods made of these materials; paper, cardboard and goods made of these materials, not included in other classes; printing products (printed matter); photographs; instructional or teaching material (except apparatus); plastic materials for packaging (not included in other classes); printing blocks, albums, pamphlets, catalogs, newspapers, manuals; wrapping paper; architects' models; badges; identification badges; identification badge holders; calendars; notebooks; pens; pencils.

35 – Business organization and management assistance and consultancy; commercial business management; commercial administration; market research and studies; organization and conducting of exhibitions, conferences and congresses for commercial or advertising purposes; commercial information agencies; procurement services for others (purchasing goods and services for other businesses); commercial information and advice; data compilation and systemization of information into computer databases; computer file management; updating of advertising material; demonstration and presentation of goods on any means of communication for retail sale; sales promotion for others; computerized file management services; compilation, updating and maintenance of data in computer databases; monitoring of signals, images and information processed by computers or telecommunication apparatus; storage (inputting, filing and

archiving, including micrographic and electronic) of data, documents and plans (including digital); retail services or wholesale services for signaling apparatus and devices, rolling stock, railway vehicles and infrastructures; all in the field of railway, road transport, transport of passengers and/or goods.

37 – Construction, management of works, servicing, repair, renovation, maintenance and installation; information on construction and repair of land vehicles including buses, coaches, autonomous electric vehicles and rail vehicles for transporting passengers and/or goods, railway rolling stock, including locomotives, rail cars and self-propelled vehicles, high-speed and very high-speed rail vehicles, underground trains and other sets of passenger vehicles, automatic or non-automatic, namely iron-wheeled rail vehicles or guided vehicles with pneumatic or other types of ground liaison, railway couplings, railway infrastructures, coatings, rails and their components parts; technical construction consultancy.

42 – Scientific and technological services as well as research and design services relating thereto; industrial analysis and industrial research services; design and development of computers and software; engineering work, research and development of new equipment and apparatus; advice related to energy saving; quality control; surveying [engineering work]; testing of materials; mechanical research; research and development of new products for third parties; technical research; technical project study; engineering; industrial tests; design, development, maintenance, updating and installation of computer systems and software; urban planning; environmental protection-related research; monitoring services for rail and road infrastructures; software consultancy; software as a service [SaaS]; scientific research and design services relating to the establishment of modeling (static or dynamic) and integration of such models (engineering work) for road and rail applications; supervision (control, monitoring) services for computer networks for digital security of rail and/or road operations; design, installation, maintenance, updating or rental of software, of databases; design and development of computer languages for simulation and modeling; creation and installation of web pages; design of computer systems and embedded systems; provision of computer programs for plotting of maps and routes and guidance via a communication network; all in the field of railways, road transport, transport of passengers and/or goods.

---

(260) AM 2021 108541 A  
 (800) 1533745  
 (151) 2020 04 01  
 (891) 2020 04 01  
 (731) WOCA Denmark A/S  
 Tværvej 6, DK-6640 Lunderskov,  
 Denmark

(540)



(591) Black, white

(531) 07.01.18; 25.01.09; 27.05.11

(511)

2 – Paints, varnishes, lacquers; anti-rust preparations and wood preservatives; colorants; mordants; raw natural resins; metal in foil and powder form for painters, decorators, printers and artists.

3 – Non-medicated cosmetics and toiletry preparations; non-medicated dentifrices; perfumery; essential oils; bleaching preparations and other substances for laundry use; cleaning, polishing, scouring and abrasive preparation.

(260) AM 2021 108542 A

(800) 1533804

(151) 2020 04 15

(891) 2020 04 15

(731) SYNGENTA PARTICIPATIONS AG

Rosentalstrasse 67, CH-4058 Basel,  
Switzerland

(540)

## SYNGENTA

(591) Black, white

(511)

9 – Computer software and hardware for use in the field of agricultural, horticultural and forestry companies; mobile applications for use in the field of agriculture, horticulture and forestry; downloadable mobile application in the field of agricultural, horticultural and forestry companies; downloadable software in the field of agricultural, horticultural and forestry companies.

16 – Packaging material of plastics, only for agricultural chemicals; paper and cardboard; printing products (printed matter); sheets, films and bags of plastic materials for wrapping and packaging.

20 – Packaging containers and storage tanks of plastic for chemicals used in agriculture.

42 – Scientific and technological research services; all the aforesaid services in the field of agriculture, horticulture and forestry; computer platform as a service [PaaS] featuring computer software platforms for providing professional consultancy services in the field of agricultural, horticultural and forestry companies; services of an application service provider (ASP), namely, providing an application programming interface (API) software for use in managing, control and tracking of drones; software as a service (saas) in the field of agricultural, horticultural and forestry companies; agricultural analysis services, na-

mely, analysis of the state of crops and plants and agricultural fields, for the purpose of creating a recommendation for the application of agricultural chemicals and pesticides in a sustainable manner and with a field by field approach to improve the efficiency and sustainability of operations.

(260) AM 2021 108543 A

(800) 1533864

(151) 2020 01 18

(891) 2020 01 18

(731) ACULIFE HEALTHCARE PRIVATE  
LIMITED

Commerce House-V, Besides Vodafone House,  
Prahladnagar Corporate Road, Ahmedabad  
380051, Gujarat, India

(540)

## ACUTRAN

(591) Black, white

(531) 27.05.01; 27.05.17

(511)

5 – Medicinal and pharmaceutical preparations.

(260) AM 2021 108545 A

(800) 1533908

(151) 2020 04 23

(891) 2020 04 23

(731) Audemars Piguet Holding SA

Route de France 16, CH-1348 Le Brassus,  
Switzerland

(540)

## BORN IN LE BRASSUS RAISED AROUND THE WORLD

(591) Black, white

(511)

14 – Watch bands; watches; timepieces; fine jewelry; jewelry; all the aforesaid goods are from Switzerland.

(260) AM 2021 108546 A

(800) 1533910

(151) 2020 05 06

(891) 2020 05 06

(731) ChangXin Memory Technologies, Inc.

Room 630, Haiheng Building, No. 6 Cuiwei  
Road, Economic And, Technological  
Development Zone, Hefei, 230000 Anhui,  
China

(540)



(591) Black, white

(531) 26.04.03; 27.05.01; 27.05.17

(511)

9 – Semi-conductors; wafers for integrated circuits; printed circuits; integrated circuits; integrated circuit chips; printed circuit boards; electronic transistors; triodes; semi-conductor devices; magnetic materials and devices.

(260) AM 2021 108550 A

(800) 1534015

(151) 2020 03 20

(891) 2020 03 20

(731) PIAGGIO & C. S.P.A.

Viale Rinaldo Piaggio, 25, I-56025

PONTEREDERA, PISA, Italy

(540)



(591) Red, black, white and grey

(531) 26.04.09; 27.05.03; 29.01.14

(511)

12 – Two, three, four wheeled vehicles; electrically powered scooters; bodies for vehicles; brakes for vehicles; caps for land vehicle gas tanks; luggage nets for vehicles; seat covers for vehicles; shock absorbing springs for vehicles; suspension shock absorbers for vehicles; vehicle chassis; vehicle seats; pneumatic tires; casings for pneumatic tires; non-skid devices for vehicle tires; adhesive rubber patches for repairing inner tubes; tire pumps for bicycles and motorcycles; repair outfits for inner tubes, namely, tire repair patches; rims for vehicle wheels; valves for vehicle tires; air bags in the nature of safety devices for automobiles; electric cigarette lighters for land vehicles; anti-theft devices for vehicles; anti-theft alarms for vehicles; horns for vehicles; safety seats for children for vehicles; bells for cycles; stands for bicycles and motorcycles as parts of bicycles and motorcycles; mudguards; direction signals for vehicles; frames for bicycles and motorcycles; luggage carriers for vehicles; pedals for bicycles and motorcycles; rearview mirrors; saddle covers for bicycles and motorcycles; saddlebags adapted for bicycles and motorcycles; saddles for bicycles and motorcycles; engines for land vehicles; electric motors for land vehicles; bags specially adapted for motorcycles, namely tank bags, sissy bar bags, tail bags, side hardbags, top cases.

(260) AM 2021 108551 A

(800) 1534040

(151) 2020 02 21

(891) 2020 02 21

(731) Open-Type Joint Stock Company "Krasnyj Ocyabr"

ul. Malaya Krasnoselskaya, d. 7, str. 24,

RU-107140 Moscow, Russian Federation

(540)

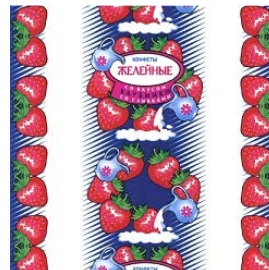

(591) Blue, white, cyan, light blue, red, light red, dark pink, green and light green

(531) 05.07.08; 08.03.02; 19.03.01; 25.01.15; 26.01.18; 28.05; 29.01.15

(526) КОНФЕТЫ ЖЕЛЕЙНЫЕ со вкусом КЛУБНИКИ со сливками

(511)

30 – Sweetmeats [candy].

(260) AM 2021 108557 A

(800) 1534147

(151) 2020 04 28

(891) 2020 04 28

(731) Montres Tudor SA

Rue François-Dussaud 3, CH-1211 Genève 26, Switzerland

(540)

## TUDOR ROYAL

(591) Black, white

(511)

14 – Timepieces, namely, watches, wrist-watches, component parts for timepieces and accessories for timepieces not included in other classes, clocks and other chronometric instruments, chronometers, chronographs (timepieces), watch bands, dials (timepieces), boxes and cases for timepieces and jewelry, watch movements and their parts; jewelry; precious stones and semi-precious stones; precious metals and their alloys; pins (jewelry).

(260) AM 2021 108558 A

(800) 1534194

(151) 2020 05 11

(891) 2020 05 11

(731) Guangzhou Jetinno Intelligent Equipment Co., LTD.

4/F, Building A, No. 2, Ruitai Road, Huangpu, Guangzhou, Guangdong, China



(540)

**JETINNO**

(591) Black, white

(531) 27.05.17; 27.05.19

(511)

7 – Coffee grinders, other than hand-operated; vending machines; beverage preparation machines, electromechanical; juice extractors, electric; tea processing machines; industrial robots; automatic packing machines for food; food processors, electric; kitchen machines, electric; machines and apparatus for cleaning, electric.

(260) AM 2021 108559 A

(800) 1534201

(151) 2020 03 27

(891) 2020 03 27

(731) Aktsionernoe obshchestvo "DIAL Engineering"  
Pervomaiskaya St., 1, korp. 27, pom. 5,  
Losino-Petrovsky, RU-141150 Moscow  
Region, Russian Federation

(540)

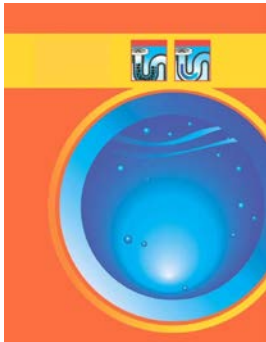

(591) Orange, yellow, yellow orange, light blue, cyan, blue, white, red, black and gray

(531) 01.15.21; 14.01.01; 26.01.05; 26.01.16;  
26.04.16; 29.01.13

(511)

3 – Cleaning preparations; preparations for unblocking drain pipes.

(260) AM 2021 108560 A

(800) 1534280

(151) 2020 05 11

(891) 2020 05 11

(731) Guangdong Breath Walker Health Technology  
Co., Ltd  
Room 1401, No.45 East Houjie Avenue, Houjie  
Town, Dongguan City, Guangdong Province,  
China

(540)

**Breath Walker**

(591) Black, white

(531) 27.05.01

(511)

25 – Clothing; sandals; shoes; sports shoes; caps being headwear; hosiery; scarves; belts [clothing].

(260) AM 2021 108561 A

(800) 1534287

(151) 2019 12 18

(891) 2019 12 18

(731) Oriflame Cosmetics AG

c/o Oriflame Global Management AG,  
Bleicheplatz 3, CH-8200 Schaffhausen,  
Switzerland

(540)

**ORIFLAME BABY O'**

(591) Black, white

(511)

3 – Non-medicated conditioning and care preparations for application to the hair, scalp, skin and nails; shampoos; hair conditioner; soaps; perfumes; perfumery; eau de cologne; toilet waters; essential and herbal oils; cosmetics; make-up; make-up preparations; lipsticks; nail varnishes; nail varnish removers; eyeliner; mascara; non-medicated toilet preparations; hair lotions; hair sprays and hair gels; preparations for use in the bath or shower; bath and shower oils, gels, creams and foams; face and body masks; face and body scrubs; facial washes; skin cleansers and hydrators; skin toners; skin moisturizers; blemish creams and blemish gels; deodorants; antiperspirants; preparations for use before shaving and after shaving; shaving soaps; shaving creams; shaving gels; after-shave preparations; pre-shave preparations; talcum powders; toiletries; dentifrices; toothpastes; foot care preparations (non-medicated).

(260) AM 2021 108562 A

(800) 1534320

(151) 2020 04 29

(891) 2020 04 29

(731) Alcon Inc.

Rue Louis-d'Affry 6, CH-1701 Fribourg,  
Switzerland

(540)

**AcrySof IQ Vivity**

(591) Black, white

(531) 27.05.01

(511)

10 – Intra-ocular lenses.

(260) AM 2021 108563 A  
(800) 1534384  
(151) 2020 05 11  
(891) 2020 05 11  
(731) CHANGHAI GREENROAD  
INTERNATIONAL LOGISTICS CO., LTD.  
A-12, 3241 Fengtuo Road, Qianqiao  
Community Centre, Qingcun Town, Fengxian  
District, Shanghai, China

(540)



(591) As per the color in the basic application  
(531) 27.05.01; 28.03; 29.01.13  
(511)  
39 – Advisory services relating to the delivery of goods.

(260) AM 2021 108565 A  
(800) 740041  
(151) 2000 05 18  
(891) 2020 05 19  
(731) Bernhard Förster GmbH  
Westliche Karl-Friedrich-Straße 151, 75172  
Pforzheim, Germany

(540)

## SPRINT

(591) Black, white  
(511)  
10 – Products for use in maxillo-facial orthopedics and orthodontia in the form of apparatus and of components made of metal, plastic, filled plastic or ceramic, particularly expansion screws, screws for individual tooth movements, wires, preformed wires, arch wires, brackets, buccal tubes, bands and molar bands with and without parts welded thereto, springs, screws having a spring-loaded piston, parts of the aforementioned goods.

(260) AM 2021 108566 A  
(800) 1390984  
(151) 2018 01 15  
(891) 2020 04 03  
(731) Novartis AG  
CH-4002 Basel, Switzerland

(540)

## KESIMPTA

(591) Black, white  
(511)  
5 – Pharmaceutical preparations.

(260) AM 2021 108567 A  
(800) 1427671  
(151) 2018 09 12  
(891) 2020 05 20  
(731) UCB BIOPHARMA SPRL  
Allée de la Recherche 60, B-1070 Bruxelles,  
Belgium

(540)

## BIMZELX

(591) Black, white  
(511)  
5 – Pharmaceutical preparations and substances limited to immunology disorders and diseases.

(260) AM 2021 108568 A  
(800) 1477633  
(151) 2019 06 13  
(891) 2020 05 20  
(731) UCB Biopharma SPRL  
Intellectual Property – Trademarks, Allée de la  
Recherche 60, B-1070 Bruxelles, Belgium

(540)

## ROZIIGGO

(591) Black, white  
(511)  
5 – Pharmaceutical preparations and substances.

(260) AM 2021 108569 A  
(800) 1480178  
(151) 2019 06 17  
(891) 2020 05 15  
(731) Uppercut Deluxe Pty Ltd  
PO BOX 5331, DAISY HILL QLD 4127,  
Australia

(540)



(591) Red, white  
(531) 01.01.03; 26.04.04; 26.04.18; 27.05.24;  
29.01.12  
(511)  
3 – Body creams (cosmetics); oils for cosmetic purposes; multi-purpose household cleaning preparations; paper face towels impregnated with a cosmetic preparation; pomades for cosmetic purposes; powders for cosmetic purposes; skin care products (cosmetic); sprays for use on the body (cosmetics); varnishes (cosmetics); wipes (tissues) impregnated with cosmetic lotions; anti-aging creams; vanishing cream; cosmetic acne cleansers; personal deodorants; deodorants for the feet; shampoos for personal use; conditioners for use on the hair; chemical preparations for the hair;

conditioning preparations for the hair; hair care preparations; hair colorants; hair cream; hair dyes; cosmetic acne creams; hair gel; hair lacquer; hair moisturisers; hair mousse; hair products; hair spray; hair styling preparations; hair styling waxes; lotions for the hair; tints for the hair; cosmetic kits; topical preparations for promoting hair growth; wax treatments for the hair; balms other than for medical purposes; dermatological creams (other than medicated); body lotions (other than for medical purposes); body moisturisers; gels for use on the body; sun block; soap; scouring preparations; cosmetic masks; pre-shave creams; pre-shave foams; pre-shave gels; pre-shave lotions; pre-shave preparations; preparations for shaving; aftershave balm; aftershave cologne; aftershave creams; aftershave gels; cosmetics; aftershave milk; aftershave moisturising preparations; aftershave preparations; perfumes; cream perfumes; cologne; cologne impregnated disposable wipes; eau de cologne; essential oils; non-medicated moisturisers; lotions for cosmetic purposes; shoe cream; shoe polish; abrasive substances (other than for dental purposes); air fresheners (fragrant preparations); bath concentrates, not medicated; bath crystals, not medicated; bath essences, not medicated; bath foams, not medicated; bath gels, not medicated; bath lotions, not medicated; moisturisers (cosmetics); bath oils, not medicated; bath powders, not medicated; bath preparations, not medicated; after shower creams; foams for use in the shower; gels for use in the shower; non-medicated preparations for use in the shower; shower preparations; beauty products; depilatories; nourishing creams (cosmetics); mouth (breath) fresheners, not for medical use; mouth rinses, not for medical use; mouth sprays, not for medical use; mouth washes, not for medical purposes; nail varnish; pumice stones for use on the body; toothpaste; toiletry products; cleaning preparations; laundry detergents for household cleaning use.

(260) AM 2021 108644 A  
 (800) 1535486  
 (151) 2020 02 12  
 (891) 2020 02 12  
 (731) SQUALIO GROUP, SIA  
 Krišjāņa Valdemāra iela 21-19, LV-1010 Rīga  
 Latvia  
 (540)



(591) Light orange and black.  
 (531) 26.11.01; 26.11.11; 27.05.09; 29.01.12  
 (511)  
 9 – Scientific, photographic, audiovisual, inspecting (supervision), storage and teaching apparatus, appara-

tus and instruments for recording, transmitting, reproducing or processing sound, images or data, recorded and downloadable media, computer software, blank digital or analogue recording and storage media, computers and computer peripheral devices.

35 – Advertising; business management; business administration; office functions.

38 – Telecommunications.

42 – Scientific and technological services, research and design relating thereto; design, development and improvement of computer hardware and software.

(260) AM 2021 108645 A  
 (800) 1535553  
 (151) 2020 03 12  
 (891) 2020 03 12  
 (731) Shenzhen Jasic Technology Co., Ltd.  
 No.3, Qinglan 1st Road, Pingshan District,  
 Shenzhen, China

(540)



(591) Black, white  
 (531) 26.03.04; 26.03.05; 26.03.06; 26.03.24;  
 27.05.01

(511)

6 – Rods of metal for welding; soldering wire of metal; gold solder; silver solder; brazing alloys; rods of metal for brazing; rods of metal for brazing and welding; bottles [metal containers] for compressed gas or liquid air; welded wire mesh; rods of metal for brazing and welding including those from alloy steel and titanium.

7 – Welding machines, electric; electric arc welders; gas welding machines; welding machines; soldering irons, gas-operated; soldering blow pipes, gas-operated; electrodes for welding machines; electric welding apparatus; welding torches; industrial robots.

9 – Solderers' helmets; welding masks; spark-guards; protective masks; safety goggles; gloves for protection against accidents; shoes for protection against accidents, irradiation and fire; clothing for protection against accidents, irradiation and fire; clothing especially made for laboratories; radiological apparatus for industrial purposes.

11 – Lighting apparatus and installations; head torches; ventilation [air-conditioning] installations and apparatus; acetylene burners; acetylene generators; burners; heating apparatus for solid, liquid or gaseous fuels; heating elements; heat guns; gas lighters.

(260) AM 2021 108646 A

(800) 1535665

(151) 2020 04 03

(891) 2020 04 03

(731) Swile

561 rue Georges Méliès, Immeuble l'Altis,  
Bâtiment A @ 7Center, F-34000 Montpellier,  
France

(540)

## SWILE

(591) Black, white

(511)

9 – Data processing apparatus, computer hardware, firmware and peripherals; communication equipment; apparatus for recording, transmission or reproduction of sound or images; magnetic, optical and digital data media; computer software; application software for mobile telephones; electronic payment apparatus; software for managing financial transactions; electronic point-of-sale systems; downloadable computer software enabling users to carry out electronic business transactions via a global computer network; software in connection with services for ordering for goods and services, transportation, delivery and connecting consumers and professionals; navigation and tracking apparatus and software for a delivery vehicle; application software for mobile telephones providing access to restaurant menus, for placing orders for food, for monitoring the status of the preparation and location of food orders; application software for mobile telephones enabling customers to place orders and pay for food, goods and services through local vendors; software programs for accessing restaurant customer loyalty schemes as well as promotional information and satisfaction surveys for restaurant customers; computer hardware and software for merchandise inventory management; application software for mobile telephones; portable media players and laptops; software for sending digital photographs, videos, images and texts to others via the global computer network; computer software for the collection, publication, organization, modification, bookmarking, transmission, storage and sharing of data and information; computer application software for use in advertising and marketing; software platforms; programming interfaces, software and software development kits for creating software applications; computer software for creating indexes of information, sites, and other resources available on computer networks; software applications for mobile telephones; portable multimedia players and other portable computers or communication devices; mobile telephones; pagers and personal communication devices; computer data banks; information, codes, texts, computer software and other downloadable media or multimedia content; magnetic cards for commercial and/or financial use, smart cards, memory cards or microprocessor cards; magnetic gift cards; magnetic loyalty cards; electronic publications in connection

with food and drinks, including restaurants and take-away restaurants; electronic publications concerning the selling, ordering and provision of goods, including restaurant and take-away restaurant meals; electronic publications, including food and drink menus, electronic publications in connection with electronic point-of-sale systems, systems and to software for order management, order tracking and order delivery.

35 – Analysis of business data; systemization and recording of data in computer databases; computerized file management; market study; opinion polls and surveys; commercial auditing, creation and development of strategies for institutional, advertising and commercial communications; price comparison; opinion polls about restaurants and takeaway and delivery services; statistics concerning restaurants, orders placed by customers and take-away and delivery services; marketing advisory services relating to restaurants, customer orders and takeout and delivery services; compilation of consumer-generated reviews of restaurants and take-away and delivery restaurants for consumer research purposes (data compilation); ordering services for restaurants and restaurants serving takeout and deliveries; organization of promotional operations and rewards with a view to developing customer loyalty; organization of promotional campaigns; commercial management of cards for non-financial use with a view to developing customer loyalty; services for monitoring the preparation and location of food and drink orders for commercial purposes; business marketing; public relations; business management and organization consultancy; commercial business management; personnel recruitment; commercial intermediary services (caretaking); advertising and sales promotion; dissemination of advertising material; rental of advertising space and time on communication media; dissemination of advertisements on all types of media; publication of advertising texts and/or images; administrative processing of purchase orders; commercial information and advice for consumers; compiling, updating and archiving (capture, collection, systemization) of databases; collection, capture, systematization and processing of data, business information, images and documents (data); providing information, namely, business intelligence on companies and professional trades in a central file or via the Internet; services linking (business consulting and looking for commercial partners, organization of administrative and commercial relations) buyers, professional sales people and consumers; consulting, analysis and expertise in connection with evaluating the administrative means necessary for the management of commercial orders (purchases); market research, market analysis; broadcasting of classified ads including on the Internet.

36 – Banking, financial and monetary affairs; insurance services; financial, monetary and banking consultation; financial, monetary and banking transactions;

payment processing and management services; online payment services; payment services using telecommunication devices; payment services via contactless devices; processing of electronic payments carried out by means of prepaid cards; electronic fund transfer services; financial management of business expenses and payment flows between professionals; issuing of physical payment instruments; issuing of non-physical payment instruments; issuance of tokens of value; issuing of magnetic cards, optical cards, memory or electronic chip cards, chip cards, disposable or rechargeable, for prepaid or postpaid use, with or without contact, able to contain one or more electronic cash cards to pay for food, meals and for purchasing goods or paying for services; issuance of payment cards, credit and debit cards and discount cards; issuing of gift certificates; issuance of tokens of value as a reward for customer loyalty; debit and credit card services; financial management of reimbursement payments for others; compensation and refunding of vouchers, checks and cards used as means of payment; financial services and management of financial benefits related to use of a loyalty card.

38 – Telecommunication; interactive telecommunication services; communication and transmission of data and messages; information on telecommunications; electronic display (telecommunications), telecommunications; press and information agency, news; provision of access to e-commerce platforms on the Internet; provision of an online portal for the delivery of take-away meals, restaurant meals and other goods, providing access to an online portal for the delivery of take-away meals, restaurant meals and other goods; transmission of information by means of an online portal for the delivery of take-away meals, restaurant meals and other goods; provision of an online portal for ordering take-away meals and restaurant meals, providing access to an online portal for ordering take-away meals and restaurant meals; transmission of information by means of an online portal for ordering take-away meals and restaurant meals; providing access to content, websites and portals; audiovisual communication services; transmission services for electronic messages; electronic order transmission services; transmission of online consumer-generated reviews for restaurants and take-away restaurants; electronic transmission of shopping vouchers, coupons redeemable for the purchase of goods or services, vouchers to be exchanged for goods or services, money-off coupons, gift vouchers, prepaid gift cards, promotional codes, promotional cards, loyalty cards, subscription cards, notes, tickets, debit and credit cards, computer-assisted payment cards; transmission and dissemination of data, logos, ringtones, games; transmission and dissemination of messages; transmission and dissemination of photographs, dispatches, still and/or animated images; transmission and dissemination of multimedia films, videos, sounds, songs,

music, texts, software and programs; especially via global communication networks such as the Internet or private or restricted-access networks such as an intranet or extranet; transmission and distribution of vouchers of value, credit notes for the purchase of goods or services, vouchers to be exchanged for goods or services, money-off coupons, gift vouchers, prepaid gift cards, promotional codes, promotional cards, loyalty cards, subscription cards, notes, tickets, debit and credit cards, computer-assisted payment cards; electronic transmission and distribution of debit and credit cards, payment cards, especially via global communication networks such as the Internet or private or restricted access networks such as an intranet or extranet; telecommunication services for geographically locating the visitors to a website to inform them of the nearest sales outlets where the products and services sought are proposed; communication by computer terminals; audiovisual communication, namely, communication via sound and image-based techniques; telegraphic, radio, telephone and television communications; transmission and dissemination of information, images and sounds via telematic, audiovisual, telephone, electronic means, especially via global communication networks such as the Internet or private or restricted-access networks such as an intranet or extranet; provision of telecommunication channels for teleshopping services; computer, electronic and data communication messaging systems; electronic mail; transmission of small advertisements, including via the Internet; provision of discussion forums on the Internet; transmission of information on-line on the establishment of social networks and virtual communities of Internet users; communication between computer terminals or via fiber-optic networks; transmission of information accessible by access code to computer or data communication databases and database servers; transmission and dissemination of information on digital communication networks or computer networks; rental of access time to a computer system, to databases and to database servers, especially via global communication networks such as the Internet or private or restricted-access networks such as an intranet or extranet; transmission of data, multimedia, video and audio files, including downloadable files and streaming files over a global computer network; information, assistance and advisory services relating to the aforesaid services; providing access to a website offering information concerning transportation and delivery services.

39 – Transport; delivery services; location of vehicles and merchandise; chartering of vehicles; home delivery of products purchased in stores or remotely (by means of mail order and the Internet); packaging and storage of merchandise; transport of merchandise; meal home delivery services; packaging and storage of merchandise; preparation, packaging and home delivery of prepared, pre-cooked foods.

42 – Platform as a Service (PaaS); Platform as a Service (PaaS) offering software platforms for the transmission of images, audiovisual content, video content and messages; Platform as a Service (PaaS) featuring computer software platforms for group communication, namely, publications, memos and instant messaging, file sharing and calendar synchronization; computer services, namely, creating an online community enabling registered users to organize groups and events, participate in discussions, get feedback from their peers, form virtual communities and engage in social networking; computer services in the form of customized web pages featuring information defined or specified by the user, personal profiles, audio content, video content, photographs, text, graphics and data; providing temporary use of non-downloadable software applications for social networking, creation of a virtual community and transmission of audio content, video content, photographic images, texts, graphic illustrations and data; computer services in the form of customized online pages offering information, personal profiles, audio content, video content, photographic images, texts, graphic illustrations and user-defined or user-specified data; Software as a Service (SaaS); online non-downloadable software for sending and receiving electronic messages; online non-downloadable software for group communication, namely, publications, memos and instant messaging, file sharing and calendar synchronization.

43 – Services for providing food and beverages; booking services for restaurants and take-away and delivery restaurants; take-away services (meal preparation); bar services; catering services; canteens; temporary accommodation; accommodation agency (hotels, boarding houses); rental of temporary accommodation; temporary accommodation reservation; day care center; providing campground facilities; retirement homes; boarding for animals; rental of mobile structures (transportable buildings) for all types of events (excluding entertainment), of tents, meeting rooms, congress rooms; rental of furniture, rental of chairs, tables, table linen, glassware; rental of transportable buildings; search and directory services for restaurants and for take-away, delivery and menu services on the Internet and via a mobile application (information with respect to food and drink provision).

45 – Social introduction and social networking services on the Internet; online social networking between preselected user groups; information with respect to online social networking; licensing of technology, source codes, software.

(260) AM 2021 108699 A  
 (800) 1535778  
 (151) 2020 04 28  
 (891) 2020 04 28  
 (731) Zakrytoe aktsionernoe obshchestvo  
 "Farmatsevticheskoe predpriyatie "MELIGEN"  
 pos. Shcheglovo, 53-A, Vsevolozhskiy r-n,  
 RU-188676 Leningradskaya oblast, Russian  
 Federation

(540)

## ALTAISKIY SPASATEL

(591) Black, white

(511)

3 – Abrasives; amber [perfume]; breath freshening sprays; balms, other than for medical purposes; lip glosses; petroleum jelly for cosmetic purposes; cotton wool for cosmetic purposes; creams for leather; massage gels, other than for medical purposes; deodorants for human beings or for animals; depilatory preparations; perfumes; greases for cosmetic purposes; perfumery; eyebrow pencils; cosmetic pencils; hair conditioners; cosmetic dyes; cosmetic creams; skin whitening creams; hair spray; nail polish; hair lotions; lotions for cosmetic purposes; beauty masks; oils for perfumes and scents; oils for cosmetic purposes; oils for toilet purposes; essential oils; soap; cosmetic kits; eau de Cologne; dentifrices; teeth whitening strips; lipsticks; pomades for cosmetic purposes; shaving preparations; cosmetic preparations for baths; bath preparations, not for medical purposes; hair waving preparations; polishing preparations; nail care preparations; cleaning preparations; preparations for cleaning dentures; laundry preparations; aloe vera preparations for cosmetic purposes; sunscreen preparations; false eyelashes; tissues impregnated with cosmetic lotions; tissues impregnated with make-up removing preparations; potpourris [fragrances]; astringents for cosmetic purposes; eyebrow cosmetics; make-up preparations; hair dyes; cosmetic preparations for eyelashes; cosmetic preparations for skin care; cosmetics; mascara; cleansers for intimate personal hygiene purposes, non medicated; degreasers, other than for use in manufacturing processes; toiletry preparations; cotton sticks for cosmetic purposes; shampoos; herbal extracts for cosmetic purposes; ethereal essences.

5 – Antiseptics; germicides; balms for medical purposes; petroleum jelly for medical purposes; dietetic substances adapted for medical use; glycerine for medical purposes; vitamin supplement patches; mineral food supplements; nutritional supplements; albumin dietary supplements; dietary supplements for animals; yeast dietary supplements; alginate dietary supplements; glucose dietary supplements; casein dietary supplements; lecithin dietary supplements; linseed oil dietary supplements; propolis dietary supple-

ments; protein dietary supplements; protein supplements for animals; royal jelly dietary supplements; pollen dietary supplements; wheat germ dietary supplements; linseed dietary supplements; enzyme dietary supplements; cod liver oil; camphor for medical purposes; adhesive plasters; medicated hair lotions; lotions for pharmaceutical purposes; ointments for pharmaceutical purposes; sunburn ointments; mercurial ointments; frostbite salve for pharmaceutical purposes; dental impression materials; teeth filling material; dressings, medical; surgical dressings; drugs for medical purposes; medicines for veterinary purposes; medicines for human purposes; medicines for dental purposes; menthol; medicinal drinks; dietetic beverages adapted for medical purposes; medicinal infusions; eucalyptol for pharmaceutical purposes; tinctures for medical purposes; decoctions for pharmaceutical purposes; food for babies; bacterial preparations for medical and veterinary use; balsamic preparations for medical purposes; albuminous preparations for medical purposes; biological preparations for medical purposes; veterinary preparations; vitamin preparations; bath preparations for medical purposes; therapeutic preparations for the bath; hemorrhoid preparations; preparations for callouses; preparations for the treatment of burns; preparations for destroying noxious animals; pharmaceutical preparations for skin care; aloe vera preparations for pharmaceutical purposes; pharmaceutical preparations; chemico-pharmaceutical preparations; chilblain preparations; albuminous food-stuffs for medical purposes; dietetic foods adapted for medical purposes; pharmaceuticals; syrups for pharmaceutical purposes; turpentine for pharmaceutical purposes; greases for medical purposes; bath salts for medical purposes; salts for mineral water baths; salts for medical purposes; adjuvants for medical purposes; astringents for medical purposes; disinfectants; disinfectants for hygiene purposes; mouthwashes for medical purposes; tonics [medicines]; digestives for pharmaceutical purposes; nervines; jujube, medicated; medicinal herbs; fungicides; medicinal tea; elixirs [pharmaceutical preparations].

(260) AM 2021 108723 A  
 (800) 1536586  
 (151) 2020 03 16  
 (891) 2020 03 16  
 (731) Toruńskie Zakłady Materiałów, Opatrunkowych Spółka Akcyjna  
 Żółkiewskiego 20/26, PL-87-100 Toruń, Poland

(540)



(591) Black, white  
 (531) 27.05.01

(511)  
 10 – Plaster bandages for orthopaedic purposes, splints for medical purposes.

(260) AM 2021 108724 A  
 (800) 1536598  
 (151) 2020 03 12  
 (891) 2020 03 12  
 (731) HEMING SU  
 Shop 911, 9th Floor, No. 193, Zhanqian Road, Yuexiu District, Guangzhou, 510000 Guangdong, China

(540)



(591) Black, white  
 (531) 26.13.25; 27.05.01  
 (511)  
 25 – Vests; clothing; corsets [undergarments]; underpants; underwear; brassieres; dressing gowns; clothing for children; hosiery; down jackets.

(260) AM 2021 108726 A  
 (800) 1536704  
 (151) 2020 03 25  
 (891) 2020 03 25  
 (731) FERRERO S.P.A.  
 Piazzale Pietro Ferrero 1, I-12051 Alba, Cuneo, Italy

(540)



(591) Black, red-orange and brown  
 (531) 27.05.01; 27.05.02; 27.05.09; 27.05.10; 29.01.13  
 (511)  
 30 – Pastries; confectionery; bakery products; cereal-based snack food; rice-based snack food; chocolate-based snack bars; cereal-based confectionery products; bread; cookies; stuffed wafers; chocolate; chocolate products; caramels [sweets]; chocolate spreads containing nuts; cocoa-based beverages; ice cream.

(260) AM 2021 108728 A

(800) 1536720

(151) 2020 03 02

(891) 2020 03 02

(731) Apple Inc.

One Apple Park Way, Cupertino CA 95014,  
USA

(540)

## **SUPER RETINA XDR**

(591) Black, white

(511)

9 – Electronic display screens; computer display screens; interfaces for computers, namely, electronic display interfaces.

(260) AM 2021 108729 A

(800) 1536774

(151) 2020 02 26

(891) 2020 02 26

(731) Mazunin Oleksandr Volodymyrovych

vul. Maiakovskoho, bud. 20, kv. 134, m. Kyiv  
02230, Ukraine;

Oleksiienko Valerii Mykhailovych

vul. Pohrebniaka, bud. 13, kv. 96,

s. Chubynske, Boryspil'skyi r-n, Kyivska obl.  
08231, Ukraine

(540)

## **ФОЛИКВИН**

(591) Black, white

(531) 28.05

(511)

5 – Pharmaceuticals, medical and veterinary preparations; sanitary preparations for medical purposes; dietetic food and substances adapted for medical or veterinary use, food for babies; dietary supplements for human beings and animals; adjuvants for medical purposes; albumin dietary supplements; alginate dietary supplements; amino acids for medical purposes; analgesics; anti-uric preparations; anti-oxidants for pharmaceutical purposes; multicomponent preparations for medical purposes; germicides; balms for medical purposes; medicinal herb, fruit and root balms; balsamic preparations for medical purposes; albuminous foodstuffs for medical purposes; biological preparations for medical purposes; nutritional supplements; vitamin preparations; vitamin and mineral preparations; dietary fiber; homeopathic supplements; homogenized food adapted for medical purposes; dietary supplements for human beings; dietary supplements for reducing fatigue evidences; dietary supplements with antioxidant and general tonic properties for humans; dietary supplements to protect against cancer for humans; dietary supplements that contribute to normalization of the functioning of gastrointestinal tract, fat metabolism improvement, immunity improvement, improvement of vision acuity, ageing process inhibi-

tion for humans; dietary supplements to improve the reproductive system of women, which help to conceive and bear a healthy baby; dietary supplements that normalize metabolism and cholesterol level; royal jelly dietary supplements; glucose dietary supplements; pollen dietary supplements; dietary supplements with a cosmetic effect; linseed dietary supplements; linseed oil dietary supplements; acai powder dietary supplements; propolis dietary supplements; wheat germ dietary supplements; dietary supplements based on natural ingredients; dietetic beverages adapted for medical purposes; dietetic substances adapted for medical use; yeast dietary supplements; plant extracts for pharmaceutical purposes; herbal extracts for medical purposes; elixirs (pharmaceutical preparations); enzyme dietary supplements; iron dietary supplements; nutritional meal replacements; nervines; immunobiological preparations for medical purposes; immunomodulating preparations for medical purposes; immunostimulants; casein dietary supplements; combination drugs with folic acid and vitamin B12, which improve the reproductive system of women (dietary supplements); depuratives; starch for dietetic or pharmaceutical purposes; lecithin dietary supplements; medicines for human purposes; medicated toiletry preparations; medicinal roots; medicinal tea; medicinal water; medicinal drinks; medicated toiletry preparations; herbal preparations for medical purposes; medicinal herbs; therapeutic drugs and agents; mineral food supplements; vitamin supplement patches; pastilles for pharmaceutical purposes; antioxidant pills; nutritional supplements; pharmaceutical preparations for the treatment and the prevention of female and male genital zone, impotency and sterility; pharmaceutical preparations for the treatment and the prevention of blood diseases, anemia, immunologic diseases and diseases of endocrine system, endocrine disorders, brain disorders, diseases of the nervous system and nervous emotional disturbances; pharmaceutical preparations for the treatment and the prevention of diseases of the respiratory system, diseases of ear, throat, vision, severe virus diseases, inflammatory conditions, dermatological diseases, allergic manifestations; opotherapy preparations; preparations of trace elements for human use; protein dietary supplements; antivirals; anti-inflammatories; antiparasitic preparations; antitumor drugs; sedatives; sport nutrition and beverages (functional food products, dietary supplements); freeze-dried food adapted for medical purposes; therapeutic preparations for the bath; tonics (medicines); herbal teas for medicinal purposes; pharmaceutical substances; ferments for pharmaceutical purposes; phytocomposites for medical purposes; phytotherapy preparations for medical purposes; functional foodstuffs for medical purposes to avoid emergence and prevent human disease or alleviate its progress; food products and beverages for the treatment and the prevention of various diseases; medicated sweets.



(260) AM 2021 108731 A  
 (800) 1536823  
 (151) 2020 04 21  
 (891) 2020 04 21  
 (731) Apple Inc.  
 One Apple Park Way, Cupertino CA 95014,  
 USA  
 (540)



## Find My

(591) The color(s) light grey, blue, white, green, light green and medium green is/are claimed as a feature of the mark  
 (531) 16.01.01; 16.03.01; 26.04.04; 26.11.22; 29.01.13  
 (511)  
 9 – Downloadable computer software for use in finding, tracking, displaying, and sharing the geographic location of individuals and consumer electronics goods, sending notifications on the geographic location of individuals, locating lost or missing consumer electronics goods, and preventing unauthorized access to consumer electronics goods.

(260) AM 2021 108732 A  
 (800) 1163163  
 (151) 2013 04 30  
 (891) 2020 06 02  
 (731) Lebosol Dünger GmbH  
 Wiesengasse 28, 67471 Elmstein, Germany  
 (540)

## LEBOSOL

(591) Black, white  
 (511)  
 1 – Chemicals used in science and photography, as well as in agriculture, horticulture and forestry; manures.

(260) AM 2021 108733 A  
 (800) 1469025  
 (151) 2019 04 02  
 (891) 2020 06 04  
 (731) Renault s.a.s  
 13-15 Quai Alphonse le Gallo, F-92100  
 BOULOGNE-BILLANCOURT, France  
 (540)

## TALIAN

(591) Black, white  
 (531) 27.05.01  
 (511)  
 12 – Vehicles, apparatus for locomotion by land, automobiles, their components, namely suspension shock absorbers for vehicles; shock absorbers for automobiles; headrests for vehicle seats; transmission shafts for land vehicles; gear boxes for land vehicles; hoods for vehicles; automobile hoods; hoods for vehicle engines; automobile bodies; safety belts for vehicle seats; automobile chassis; hydraulic circuits for vehicles; air bags [safety devices for automobiles]; brake disks for vehicles; clutches for land vehicles; hub caps; windshield wipers; brakes for vehicles; vehicle wheel rims; vehicle running boards; motors and engines for land vehicles; windshields; bumpers for automobiles; tires; luggage carriers for vehicles; doors for vehicles; vehicle wheels; rearview mirrors; vehicle seats; windows for vehicles; steering wheels for vehicles; fitted vehicle covers.

(260) AM 2021 108790 A  
 (800) 1536857  
 (151) 2020 04 24  
 (891) 2020 04 24  
 (731) Gesellschaft mit beschränkter Haftung  
 "Ehrmann"  
 pos. RAOS, 15, Ramenskiy r-n, RU-140126  
 Moscow Region, Russian Federation  
 (540)

## Mama Jama

(591) Black, white  
 (531) 28.05  
 (511)  
 29 – Vegetables, preserved and cooked, including vegetable purées; fruits, preserved and stewed, including fruit purées; compotes.  
 30 – Cookies; porridge; cereal porridge; kasha; oat porridge; instant porridge; gruel; gruel, with a milk base, for food; porridge, with a milk base, for food; cereal puddings, including semolina pudding, rice pudding.  
 32 – Morses, including berry mors; fruit juices.

(260) AM 2021 108791 A  
 (800) 1536889  
 (151) 2020 02 18  
 (891) 2020 02 18  
 (731) Euro Games Technology Ltd.  
 "Maritsa" Str. 4, "Vranya-Lozen-Triugulnika",  
 BG-1151 Sofia, Bulgaria  
 (540)

## IMPERIAL WARS

(591) Black, white

(511)

9 – Software; computer gaming software; computer software packages; computer operating system software; computer software, recorded; software drivers; virtual reality software; games software; entertainment software for computer games; computer programs for network management; operating computer software for mainframe computers; monitors (computer hardware); computer hardware; apparatus for recording images; monitors (computer programs); computer game programs; computer programs for recorded games; apparatus for recording, transmission or reproduction of sound or images; communications servers [computer hardware]; electronic components for gambling machines; computer application software featuring games and gaming; computer software for the administration of on-line games and gaming; computer hardware for games and gaming; electronic components and computer software for gambling, gambling machines, gambling games on the internet and via telecommunication network.

28 – Gaming machines for gambling; chips for gambling; mah-jong; arcade games; gambling machines operating with coins, notes and cards; games; electronic games; parlor games; gaming chips; gaming tables; slot machines [gaming machines]; LCD game machines; slot machines, bingo machines and arcade game machines; coin-operated amusement machines; roulette chips; poker chips; chips and dice [gaming equipment]; equipment for casinos; roulette tables; gaming roulette wheels; casino games; gambling machines and amusement machines, automatic and coin-operated; coin-operated amusement machines and/or electronic coin-operated amusement machines with or without the possibility of gain; electronic or electro-technical amusement machines and apparatus, gaming machines, coin-operated entertainment machines; housings for coin-operated machines, gaming equipment, gaming machines, machines for gambling; electropneumatic and electrical gambling machines (slot machines).

41 – Gambling; services related to gambling; gaming services for entertainment purposes; casino, gaming and gambling services; training in the development of software systems; provision of equipment for gambling halls; providing casino equipment [gambling]; gaming machine entertainment services; providing casino facilities [gambling]; gaming hall services; amusement arcade services; games equipment rental; rental of gaming machines; providing amusement arcade services; rental of gaming machines with images of fruits; editing or recording of sounds and images; sound recording and video entertainment services; hire of sound reproducing apparatus; provision of gaming equipment for casinos; providing of casino facilities; online gambling services; casino services; provision of gaming establishments, gaming halls, Internet casinos, online gaming services.

(260) AM 2021 108792 A

(800) 1536962

(151) 2020 04 17

(891) 2020 04 17

(731) Shanghai Fangfang Daily Chemical Co., Ltd  
Room 1603, No.518 Anyuan Road, Putuo  
District, Shanghai, China

(540)

蝴蝶

BUTTERFLY

(591) Black, white

(531) 28.03

(511)

3 – Hair rinses [shampoo-conditioners]; laundry glaze; buffing compounds; cosmetics; cosmetics for animals; air fragrancing preparations.

(260) AM 2021 108793 A

(800) 1536968

(151) 2019 12 10

(891) 2019 12 10

(731) Sander Plane Overseas Limited  
P.O. Box 3321, Drake Chambers, Road Town,  
Tortola, Virgin Islands (British)

(540)

**Sodrusoy 62% Premium**

(591) Black, white

(511)

1 – Manures; chemical substances for preserving foodstuffs; lecithin and fatty acids; lecithin for industrial purpose; lecithin for the food industry; corn gluten; gluten for industrial use; gluten for the food industry; amino-acids for industrial purposes; dl-methionine for industrial purposes; l-lysine for industrial purposes; l-threonine for industrial purposes; glycerin for industrial purposes; fertilizer; nitrate (fertilizer); phosphate (fertilizer); potash (fertilizer); wheat proteins [raw material]; by-products of the processing of cereals for industrial purposes; industrial chemicals; emulsifiers; chemical preparations for stabilizing soil; chemical stabilizers for preserving foodstuffs; surfactants for industrial purposes; fatty acids; chemicals for the manufacture of pigments; industrial phospholipids for wood, construction and metal industry; soy adhesives for plywood; catalysts for use in the manufacture of polymers; polyols; plasticizers; protein for industrial purposes; soy protein concentrate for industrial use; soy protein isolate for industrial use.

4 – Fuels (including motor spirit) and illuminants; biofuel; biodiesel fuel; electrical energy; industrial fats and oils.

5 – Dietary and nutritional supplements; lecithin for medical purposes; pet food additives in the form of vitamins and minerals; fish oils for medical use; protein dietary supplement; dietary fiber; supplements, namely, soy protein concentrate for human and animal consumption; supplements, namely, soy protein isolate for human and animal consumption.

29 – Preserved, frozen, dried and cooked fruits and vegetables; soy bean; soy hull; lecithin for culinary purposes; edible oil; linseed oil for food; soybean oil; camelina oil; rapeseed oil; sunflower seeds, prepared; corn oil; edible oils derived from fish [other than cod liver oil]; prepared meals made from fish (including salmon meal and shrimp meal); prepared meals made from poultry (poultry predominating); edible seeds; edible sunflower seeds; edible rapeseed; peas (processed); whiteflake; linseed for human consumption; textured vegetable protein for use as a meat extender.

30 – Flour and preparations made from cereals; meal for human consumption; linseed meal; camelina meal; rapeseed meal; sun flower meal; barley meal; molasses; corn meal; corn gluten; dried wheat gluten; gluten prepared as foodstuff; gluten additives for culinary purposes; soy flour; corn (processed); wheat (processed); rye flour; cereals for food for consumption by humans; raw sugar.

31 – Agricultural, horticultural and forestry products and grains; foodstuffs for animals; linseed for animal consumption; linseed meal for animal consumption; feather meal for animal consumption; soybean meal for animal consumption; rapeseed meal for animal consumption; sunflower meal for animal consumption; camelina meal for animal consumption; whiteflake for animal consumption; fishmeal for animal consumption; meal for animal; edible seeds for animal consumption (unprocessed); cereal seeds (unprocessed); crop seeds; seeds, natural plants and flowers; cereals for animal consumption; corn (unprocessed); corn seeds; wheat (unprocessed); wheat seeds; barley (unprocessed); beets (unprocessed); sugarcane; soy protein concentrate and soy protein isolate for animal consumption; fresh peas; rye; rye seeds; soy bean meal.

35 – Business management in the field of chemicals, fuel and energy; business management in the field of cereals and in the food industry; business management in the field of oils for human consumption, meals and preparations made from cereals for human and animal consumption; business management in the field of agricultural, horticultural and forestry products and grains; provision of business management services in the field of transport by land, air or water; provision of business management services in the field of transport of chemicals, fuel, cereals, food, crop, meals, oils and energy; import-export agency services of chemicals, fuel, cereals, food, crop, meals, oils and energy.

37 – Building construction; construction of industrial factories; repair services of modern grain cars and heavy tonnage vessels; maintenance of equipment of modern grain cars and heavy tonnage vessels; technical maintenance and repair of vehicles (including railcars); consulting in the sphere of construction (terms considered linguistically incorrect by the International Bureau – rule 13 (2) (b) of the Common Regulations).

39 – Transport; packaging and storage of goods; packing of goods using sustainable or biodegradable packaging and shipping materials; freight forwarding services, other than the customs clearance of goods for third parties; goods handling services; transport of goods by ship; ship towing services (tow boats); distribution of energy.

40 – Treatment of toxic waste; treatment of chemicals, fuel, cereals, food, crop, meals, oils; refining services; transesterification services; refining and transesterification from oils; refining and transesterification from fuel; production of energy; production of electricity; recycling of drainage; oleo-chemistry, namely processing of oils; processing of chemicals, fuel, cereals, food, crop, meals, oil; production of energy; production of fertilizers, nitrate, phosphate, potash.

42 – Architectural consultancy; biological research; chemical analysis; chemical research; chemistry services; conducting technical project studies; construction drafting; consultancy in the field of energy-saving; energy auditing; engineering; geological prospecting; geological research; geological surveys; land surveying; mechanical research; quality control; research and development of new products for others; scientific research; surveying; technical research; technological consultancy.

44 – Agriculture, horticulture and forestry services.

(260) AM 2021 108794 A

(800) 1536976

(151) 2020 03 25

(891) 2020 03 25

(731) Pryvatne aktsionerne tovarystvo, "Kharkivska biskvitna fabryka"

vul. Lozivska. 8, Kharkiv 61017, Ukraine

(540)

## Magic tale

(591) Black, white

(531) 27.05.01; 27.05.17

(511)

30 – Peanut confectionery; sponge cakes; cereal bars; high-protein cereal bars; flour-based dumplings; buns; sweet buns; waffles; flour confectionery; oat flakes; biscuits; cookies; cake frosting [icing]; chocolate-coated nuts; mirror icing [mirror glaze]; custard; zephyr

[confectionery]; cocoa; caramels [candy]; quiches; confectionery; sugar confectionery; confectionery for decorating Christmas trees; crackers; corn flakes; liquorice [confectionery]; macaroons [pastry]; marmalade [confectionery]; marzipan; almond paste; almond confectionery; dessert mousses [confectionery]; chocolate mousses; mint for confectionery; peppermint sweets; stick liquorice [confectionery]; pastila [confectionery]; lozenges [confectionery]/pastilles [confectionery]; petits fours [cakes]; pies; flakes (cereal preparations); fondants [confectionery]; popcorn; pralines; candy decorations for cakes; chocolate decorations for cakes; cake powder; rice cakes; malt biscuits; sweetmeats [candy]; petit-beurre biscuits; tarts; cakes; dough; cake batter/cake dough; pastry dough; fruit jellies [confectionery]; halvah; candy; chocolate.

(260) AM 2021 108832 A  
(800) 1537982  
(151) 2020 06 03  
(891) 2020 06 03

(731) GUANGDONG SWEETNIGHT HOME CO., LTD  
F3-F4, Comprehensive Building, No.2, Zhenye West 1st Rd., Nanjin Section, Zone A, Shatou Ind., Jiujiang Town, Nanhai Dist., Foshan City, 100088 Guangdong Province, China

(540)

**SWEETNIGHT**

(591) Black, white

(531) 27.05.01

(511)

20 – Bedsteads of wood; office furniture; furniture; seats; mattresses; beds; sofas; bed bases; cushions; bedding, except linen.

(260) AM 2021 108836 A  
(800) 1538102  
(151) 2020 04 14  
(891) 2020 04 14

(731) GUANGDONG OPPO MOBILE TELECOMMUNICATIONS CORP., LTD.  
No.18 Haibin Road, Wusha, Chang'an, Dongguan, Guangdong, China

(540)

**VOOC**

(591) Black, white

(531) 01.15.03; 27.05.08

(511)

9 – Materials for electricity mains [wires, cables]; USB cables; electronic chips; connections, electric; power adapters; electrical adapters; computers;

notebook computers; computer programs, downloadable; smartwatches; smartglasses; interactive touch screen terminals; humanoid robots with artificial intelligence; intercommunication apparatus; video telephones; cell phones; smartphones; mobile telephones; cabinets for loudspeakers; wireless speakers; earphones; headphones; camcorders; virtual reality headsets; security surveillance robots; batteries, electric; batteries, electric, for vehicles; battery chargers; rechargeable batteries; cell phone battery chargers for use in vehicles; wireless chargers for smartphones; battery chargers for tablet computers; battery chargers for mobile phones; car batteries; solar batteries; charging appliances for rechargeable equipment.

(260) AM 2021 108925 A  
(800) 1539093

(151) 2020 04 09

(891) 2020 04 09

(731) Pryvatne aktsionerne tovarystvo "Chumak"  
vul. Kozatska, 3, m. Kakhovka, Khersonska obl. 74800, Ukraine

(540)



(591) Blue and white

(531) 25.01.06; 28.05; 29.01.12

(511)

29 – Meat, fish, poultry and game; meat extracts; preserved, frozen, dried and cooked fruits and vegetables; jellies, jams, compotes; eggs; milk, cheese, butter, yogurt and other milk products; oils and fats for food; agar-agar for culinary purposes; aloe vera prepared for human consumption; albumin milk; alginates for culinary purposes; andouillettes; anchovy, not live; peanuts, prepared; peanut butter; peanut milk; peanut milk for culinary purposes; artichokes, preserved; bacon; albumen for culinary purposes; white of eggs; beans, preserved; bulgogi; bouillon; bouillon concentrates; compotes; cream [dairy products]; potato-based dumplings; oat milk; laver, preserved; sea-cucumbers, not live; cabbage rolls stuffed with meat; flavored nuts; nuts, prepared; peas, preserved; mushrooms, preserved; guacamole; potato fritters; jams; game, not live; non-alcoholic eggnog; seaweed extracts for food; gelatine; meat jellies; jellies for food; bone oil for food; lard; suet for food; fatty substances for the manufacture of edible fats; fat-containing mixtures for bread slices; yolk of eggs; cranberry compote; fruit-based snack food; milk substitutes; frozen fruits; salted fish; candied nuts; whipped cream; condensed milk; eggplant paste; vegetable marrow paste; fish roe, prepared; ginger, preserved; crystallized ginger; pickled ginger; ginger jam; edible

insects, not live; yogurt; sauerkraut; potato flakes; cassoulet; quark; edible flowers, dried; kefir; onion rings; kimchi; clams, not live; klipfish [salted and dried cod]; black pudding; white pudding; charcuterie; coconut oil for food; coconut butter; coconut milk; coconut milk for culinary purposes; coconut fat; coconut, desiccated; milk shakes; arrangements of processed fruit; duck confits; vegetable-based concentrate for cooking; fruit-based concentrate for cooking; corn dogs; gherkins; tofu patties; shrimps, not live; prawns, not live; vegetable-based cream; croquettes; sweet corn, processed; corn oil for food; kumys; sesame oil for food; spiny lobsters, not live; lecithin for culinary purposes; lemon juice for culinary purposes; edible ant larvae, prepared; silkworm chrysalis for human consumption; margarine; butter; cocoa butter for food; buttercream; almond milk; almond milk for culinary purposes; almonds, ground; mussels, not live; milk; fermented baked milk; soured milk; powdered milk; milk beverages, milk predominating; milk products; molluscs, not live; vegetable mousses; fish mousses; meat, tinned; meat; meat, preserved; vegetable-based spreads; lactic acid drinks; peanut milk-based beverages; coconut milk-based beverages; almond milk-based beverages; seeds, prepared; sunflower seeds, prepared; sausage casings, natural or artificial; vegetables, tinned; vegetable salads; vegetable juices for cooking; vegetables, preserved; vegetables, processed; vegetables, cooked; vegetables, dried; hash browns; olives, preserved; olive oil for food; extra virgin olive oil for food; linseed oil for food; lobsters, not live; omelettes; herrings, not live; palm oil for food; palm kernel oil for food; liver pate; pectin for culinary purposes; preserved peppers; liver; pollen prepared as foodstuff; pickles; tofu skin; marmalade; vegetable soup preparations; poultry, not live; crayfish, not live; crustaceans, not live; ratatouille; fish, preserved; fish, not live; salmon, not live; fish meal for human consumption; fish fillets; fish, tinned; isinglass for food; rice milk; rice milk for culinary purposes; colza oil for food; raisins; sardines, not live; satay; pork; cottage cheese; cheese; curd; cottage cheese fritters; whey; rennet; preparations for making bouillon; smetana; soya bean oil for food; soya milk; soya beans, preserved, for food; soya patties; salted meats; sunflower oil for food; sausages; hot dog sausages; sausages in batter; lentils, preserved; nut-based spreads; freeze-dried meat; freeze-dried vegetables; preparations for making soup; soups; tahini; tajine [prepared meat, fish or vegetable dish]; animal marrow for food; tripe; tempeh; tomato paste; tomato purée; tomato juice for cooking; tofu; truffles, preserved; tuna, not live; oysters, not live; falafel; milk ferments for culinary purposes; dates; fruit, preserved; crystallized fruits; fruit, processed; fruit, stewed; fruit preserved in alcohol; fruit peel; pressed fruit paste; fruit pulp; fruit jellies; fruits, tinned; fruit salads; hazelnuts, prepared; edible fats; oils for food; fish-based foodstuffs; edible birds' nests; hummus; onions, preserved;

preserved garlic; shellfish, not live; potato chips; low-fat potato chips; fruit chips; caviar; ham; choucroute garnie; apple puree; berries, preserved; powdered eggs; snail eggs for consumption; yakitori.

30 – Coffee, tea, cocoa and artificial coffee; rice; tapioca and sago; flour and preparations made from cereals; bread, pastries and confectionery; edible ices; sugar, honey, treacle; yeast, baking-powder; salt; mustard; vinegar, sauces (condiments); spices; ice (frozen water); peanut confectionery; flavorings, other than essential oils, for beverages; flavorings, other than essential oils, for cakes; food flavorings, other than essential oils; aromatic preparations for food; baozi; cereal bars; high-protein cereal bars; royal jelly; bibimbap [rice mixed with vegetables and beef]; bean meal; nut flours; buckwheat flour; tapioca flour; flour; bulgur; bread rolls; pains au chocolat; buns; burritos; vanillin [vanilla substitute]; vanilla flavorings for culinary purposes; waffles; vermicelli; flour-based dumplings; oatmeal; oat flakes; orange blossom water for culinary purposes; sausage binding materials; binding agents for ice cream; cookies; harissa [condiment]; cloves [spice]; mustard meal; cake frosting [icing]; glucose for culinary purposes; chocolate-coated nuts; garden herbs, preserved [seasonings]; buckwheat, processed; mirror icing [mirror glaze]; gluten additives for culinary purposes; yeast; dulce de leche; essences for foodstuffs, except etheric essences and essential oils; chewing gum for breath freshening; chewing gum; cranberry sauce [condiment]; custard; thickening agents for cooking foodstuffs; leaven; ferments for pastes; cereal-based snack food; rice-based snack food; artificial coffee; frozen yogurt [confectionery ices]; dressings for salad; wheat germ for human consumption; cereal preparations; ground ginger; edible paper; edible rice paper; coffee; unroasted coffee; coffee flavorings; coffee capsules, filled; coffee beverages with milk; cocoa; cocoa beverages with milk; capers; caramels [sweets]; curry [spice]; potato flour; flowers or leaves for use as tea substitutes; ketchup [sauce]; quinoa, processed; quiches; gluten prepared as foodstuff; confectionery; confectionery for decorating Christmas trees; cinnamon [spice]; crackers; rice crackers; cream of tartar for culinary purposes; crème brûlée; starch for food; croissants; hominy grits; groats for human food; ice cubes; corn, milled; corn, roasted; corn flour; corn flakes; turmeric; couscous; cooking salt; laksa; ice for refreshment; ice, natural or artificial; shaved ice with sweetened red beans; liquorice [confectionery]; noodles; soba noodles; udon noodles; ice pops; mints for breath freshening; mayonnaise; macaroni; pasta; macarons; coconut macaroons; maltose; hominy; semolina; marinades; marzipan; honey; molasses for food; almond paste; almond confectionery; miso; pancakes; kimchi pancakes; savory pancakes; ice cream; sea water for cooking; seaweed [condiment]; dessert mousses [confectionery]; chocolate mousses; nutmegs; muesli; me-

at gravies; mint for confectionery; peppermint sweets; coffee-based beverages; cocoa-based beverages; chamomile-based beverages; tea-based beverages; chocolate-based beverages; aniseed; star aniseed; sesame seeds [seasonings]; linseed for culinary purposes [seasoning]; infusions, not medicinal; nougat; processed seeds for use as a seasoning; crushed oats; onigiri; vinegar; husked oats; husked barley; stick liquorice [confectionery]; palm sugar; edible paper wafers; ginger paste [seasoning]; pastilles [confectionery]; baking powder; pelmeni; allspice; peppers [seasonings]; pepper; pesto; petits fours; beer vinegar; pies; pâtés en croûte; meat pies; piccalilli; pizzas; chips [cereal products]; fondants [confectionery]; popcorn; powders for making ice cream; pralines; candy decorations for cakes; chocolate decorations for cakes; condiments; natural sweeteners; seasonings; oat-based food; propolis; profiteroles; gingerbread; puddings; cake powder; wheat flour; ravioli; ramen; relish [condiment]; meat tenderizers for household purposes; preparations for stiffening whipped cream; instant rice; prepared rice rolled in seaweed; rice pulp for culinary purposes; rice pudding; rice cakes; vegetal preparations for use as coffee substitutes; sago; sandwiches; hot dog sandwiches; celery salt; agave syrup [natural sweetener]; golden syrup; salt for preserving foodstuffs; soya flour; soya sauce; malt for human consumption; malt biscuits; malt extract for food; sweets; sorbets [ices]; sauces [condiments]; pasta sauce; spaghetti; chocolate-based spreads; chocolate spreads containing nuts; spring rolls; noodle-based prepared meals; freeze-dried dishes with the main ingredient being pasta; freeze-dried dishes with the main ingredient being rice; ham glaze; savory pancake mixes; batter mixes; croûtons; rusks; bread-crumbs; petit-beurre biscuits; sushi; tabbouleh; tacos; tamarind [condiment]; tapioca; tarts; cakes; dough; cake dough; pastry dough; tomato sauce; potato-based flatbreads; tortillas; fruit jellies [confectionery]; fruit confectionery; fruit coulis [sauces]; halvah; baking soda [bicarbonate of soda for cooking purposes]; gluten-free bread; unleavened bread; bread; pastries; jiaozi; chicory [coffee substitute]; crystallized rock sugar; sugar; kelp tea; iced tea; tea; minced garlic [condiment]; chutneys [condiments]; cheeseburgers [sandwiches]; chow-chow [condiment]; saffron [seasoning]; chocolate; chocolate beverages with milk; apple sauce [condiment]; barley meal; crushed barley.

31 – Raw and unprocessed agricultural, aquacultural, horticultural and forestry products; raw and unprocessed grains and seeds; fresh fruits and vegetables, fresh herbs; natural plants and flowers; bulbs, seedlings and seeds for planting; live animals; foodstuffs and beverages for animals; malt; algarovilla for animal consumption; anchovy, live; oranges, fresh; peanuts, fresh; peanut cake for animals; peanut meal for animals; aromatic sand [litter] for pets; artichokes, fresh; draff; beans, fresh; meal for animals; flax meal [fod-

der]; linseed meal for animal consumption; beet, fresh; lime for animal forage; grapes, fresh; vine plants; bran; bran mash for animal consumption; bagasses of cane [raw material]; wreaths of natural flowers; dog biscuits; squashes, fresh; sea-cucumbers, live; kola nuts; nuts, unprocessed; garden herbs, fresh; peas, fresh; buckwheat, unprocessed; mushrooms, fresh; mushroom spawn for propagation; trees; wood chips for the manufacture of wood pulp; turf, natural; yeast for animal consumption; live animals; rye; edible chews for animals; residue in a still after distillation; wheat germ for animal consumption; menagerie animals; grains [cereals]; grains for animal consumption; ginger, fresh; edible insects, live; vegetable marrows, fresh; cocoa beans, raw; potatoes, fresh; chestnuts, fresh; flowers, natural; flowers, dried, for decoration; edible flowers, fresh; quinoa, unprocessed; cuttle bone for birds; coconuts; arrangements of fresh fruit; copra; rough cork; roots for animal consumption; chicory roots; bird food; animal foodstuffs; pet food; fodder; distillery waste for animal consumption; koi carp, live; nettles; groats for poultry; maize; maize cake for cattle; edible sesame, unprocessed; shrubs; spiny lobsters, live; lemons, fresh; palms [leaves of the palm tree]; oil cake; almonds [fruits]; mussels, live; mash for fattening livestock; molluscs, live; algae, unprocessed, for human or animal consumption; straw mulch; fruit residue [marc]; fishing bait, live; freeze-dried fishing bait; beverages for pets; seeds for planting; cereal seeds, unprocessed; linseed for animal consumption; edible linseed, unprocessed; undressed timber; raw barks; unprocessed sweet corn ears [husked or unhusked]; unsawn timber; Christmas trees; oats; vegetables, fresh; cucumbers, fresh; olives, fresh; lobsters, live; herrings, live; palm trees; sanded paper [litter] for pets; peppers [plants]; pollen [raw material]; litter for animals; bred stock; locust beans, raw; animal fattening preparations; by-products of the processing of cereals, for animal consumption; preparations for egg laying poultry; seed germ for botanical purposes; poultry, live; wheat; crayfish, live; crustaceans, live; rhubarb, fresh; fish, live; salmon, live; fish meal for animal consumption; fish spawn; rice, unprocessed; rice meal for forage; rape cake for cattle; seedlings; plants; aloe vera plants; plants, dried, for decoration; cannabis plants; cannabis, unprocessed; lettuce, fresh; sardines, live; salt for cattle; hay; seedlings; soya beans, fresh; malt for brewing and distilling; straw [forage]; straw litter; pine cones; lentils, fresh; stall food for animals; trunks of trees; litter peat; rose bushes; truffles, fresh; tuna, live; oysters, live; fruit, fresh; hazelnuts, fresh; strengthening animal forage; hop cones; hops; flower bulbs; leeks, fresh; onions, fresh; chicory, fresh; citrus fruit, fresh; sugarcane; garlic, fresh; shellfish, live; coconut shell; silkworms; spinach, fresh; berries, fresh; eggs for hatching, fertilized; silkworm eggs; juniper berries; barley.

32 – Beers; non-alcoholic beverages; mineral and aerated waters; fruit beverages and fruit juices; syrups and other non-alcoholic preparations for making beverages; aperitifs, non-alcoholic; non-alcoholic essences for making beverages; non-alcoholic dried fruit beverages; non-alcoholic beverages flavored with coffee; non-alcoholic beverages flavored with tea; non-alcoholic honey-based beverages; non-alcoholic preparations for making beverages; non-alcoholic fruit extracts; non-alcoholic fruit juice beverages; grape must, unfermented; waters [beverages]; aerated water; extracts of hops for making beer; seltzer water; isotonic beverages; ginger beer; kvass; cocktails, non-alcoholic; beer-based cocktails; lemonades; lithia water; mineral water [beverages]; energy drinks; aloe vera drinks, non-alcoholic; rice-based beverages, other than milk substitutes; soya-based beverages, other than milk substitutes; whey beverages; vegetable juices [beverages]; orgeat; beer wort; beer; powders for effervescing beverages; sarsaparilla [non-alcoholic beverage]; cider, non-alcoholic; syrups for lemonade; syrups for beverages; preparations for making aerated water; smoothies; soda water; fruit juices; malt beer; malt wort; protein-enriched sports beverages; table waters; must; pastilles for effervescing beverages; tomato juice [beverage]; soft drinks; fruit nectars, non-alcoholic; shandy; sherbets [beverages]; barley wine [beer].

(260) AM 2021 108926 A  
 (800) 1539113  
 (151) 2020 05 29  
 (891) 2020 05 29  
 (731) Open-Type Joint Stock Company "ROT FRONT"  
 2-oy Novokuznetskiy pereulok, d. 13/15,  
 RU-115184 Moscow, Russian Federation

(540)



(591) white, orange, light orange, yellow, light yellow, green and red  
 (531) 05.03.13; 05.07.11; 05.07.22; 25.01.15;  
 25.05.25; 25.07.25; 26.15.25; 28.05; 29.01.15  
 (526) words in Cyrillic letters "karamel" .  
 (511)  
 30 – Caramels.

(260) AM 2021 108927 A  
 (800) 1539143  
 (151) 2020 02 07  
 (891) 2020 02 07  
 (731) Ahrefs Pte. Ltd.  
 16 Raffles Quay, #33-03 Hong Leong  
 Building, Singapore 048581, Singapore  
 (540)

# AHREFS

(591) Black, white  
 (531) 27.05.17  
 (511)  
 35 – Business analysis; digital marketing data analysis; business data analysis; business data management; business data retrieval; market analysis and research; search engine optimization; retail services; online retail services; online retail store services featuring computer software programs; providing business information via an online searchable database; data compilation for others; compilation and systemization of information into computer databases; business management; business administration; electronic publication of publicity texts and material; data and information retrieval, including retrieval of images, graphics, photographs, digital content and multimedia content.

42 – Technical data analysis services; providing temporary use of non-downloadable software for analyzing financial data and generating reports; providing temporary use of non-downloadable software for data mining, data query, and data analysis; data mining; electronic data storage; providing search engines for the Internet; design, development and maintenance of search engines.

(260) AM 2021 108928 A  
 (800) 1539169  
 (151) 2020 05 19  
 (891) 2020 05 19  
 (731) Open-Type Joint Stock Company "ROT FRONT"  
 2-oy Novokuznetskiy pereulok, d. 13/15,  
 RU-115184 Moscow, Russian Federation

(540)



(591) Dark red, red, green, dark green, yellow, dark yellow and white  
 (531) 05.01.15; 05.03.13; 05.05.04; 05.05.19;  
 05.07.08; 19.03.24; 25.05.25; 25.07.25; 28.05;  
 29.01.15

(526) Words in Cyrillic letters "karamel' ".  
 (511)  
 30 – Caramels.

(260) AM 2021 108990 A  
 (800) 1539916  
 (151) 2020 03 12  
 (891) 2020 03 12  
 (731) TCHIBO C.I.S. LLC  
 Horoshevskoe shosse, d. 32A; RU-123007  
 Moscow, Russian Federation

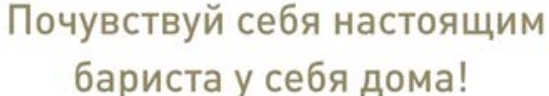
(540)  

(591) Yellow-brown  
 (531) 28.05; 29.01.07  
 (511)  
 8 – Cutlery; table forks; table knives, forks and spoons for babies; table knives, forks and spoons of plastic; knives.

11 – Cooking apparatus and installations; coffee roasters; coffee machines, electric; coffee percolators, electric.

16 – Plastic bags for wrapping and packaging; absorbent sheets of paper or plastic for foodstuff packaging; humidity control sheets of paper or plastic for foodstuff packaging; viscose sheets for wrapping; sheets of reclaimed cellulose for wrapping; plastic bubble packs for wrapping or packaging; packaging material made of starches; packing [cushioning, stuffing] materials of paper or cardboard; filtering materials of paper; bags [envelopes, pouches] of paper or plastics, for packaging; conical paper bags; plastic film for wrapping; table napkins of paper; place mats of paper; tablemats of paper; tablecloths of paper; paper coffee filters.

21 – Household or kitchen utensils and containers; cookware and tableware, except forks, knives and spoons; containers for household or kitchen use; kitchen containers; glass jars [carboys]; heat-insulated containers; heat-insulated containers for beverages; thermally insulated containers for food; coffee percolators, non-electric; coffeepots, non-electric; coffee grinders, hand-operated; coffee filters, non-electric.

24 – Textiles and substitutes for textiles; household linen; curtains of textile or plastic; handkerchiefs of textile; picnic blankets; travelling rugs [lap robes]; tablecloths, not of paper; oilcloth for use as tablecloths.

25 – Clothing, footwear, headgear.

29 – Milk; almond milk; almond milk for culinary purposes; albumin milk; cream [dairy products]; vegetable-based cream.

30 – Coffee flavorings; artificial coffee; vegetal preparations for use as coffee substitutes; coffee; unroasted coffee; coffee beverages with milk; coffee-based beverages; chicory [coffee substitute].

32 – Syrups and other non-alcoholic preparations for making beverages; non-alcoholic beverages flavored with coffee; syrups for beverages.

35 – Advertising; business management; business administration; office functions; demonstration of goods; commercial information and advice for consumers in the choice of products and services; sales promotion for others; distribution of samples; procurement services for others [purchasing goods and services for other businesses].

43 – Services for providing food and drink; snack-bar services; information and advice in relation to the preparation of meals; café services; cafeteria services; rental of cooking apparatus; restaurant services; self-service restaurant services.

(260) AM 2021 108991 A  
 (800) 1539935  
 (151) 2020 02 08  
 (891) 2020 02 08  
 (731) ENVASADOS EVA S.A.  
 Poligono Industrial 18, E-31870 Lecumberri  
 (Navarra), Spain

(540)



(591) Red, green, light rose  
 (531) 05.07.13; 05.13.07; 05.13.10; 25.01.15;  
 29.01.15

(511)  
 33 – Cider.

(260) AM 2021 108992 A  
 (800) 1539970  
 (151) 2020 05 20  
 (891) 2020 05 20  
 (731) "UNITED PETROKEMIKALS" Limited  
 Liability Company  
 Kievskoye sh., 63, RU-249030 Obninsk,  
 Kaluga Region, Russian Federation

(540)

**NOBU**



(591) Black, white  
 (511)  
 3 – Balms, other than for medical purposes; soap; deodorant soap; rust removing preparations; tissues impregnated with cosmetic lotions; preservatives for leather [polishes]; shampoos; dry shampoos.  
 5 – Antiseptics; medicine cases, portable, filled; first-aid boxes, filled; germicides; balms for medical purposes; diagnostic biomarker reagents for medical purposes; disinfectants; deodorants, other than for human beings or for animals; deodorants for clothing and textiles; carbolineum; acids for pharmaceutical purposes; lotions for pharmaceutical purposes; liniments; ointments for pharmaceutical purposes; medicinal oils; antibacterial soap; disinfectant soap; medicated soap; sulfur sticks; bacterial preparations for medical and veterinary use; bacteriological preparations for medical and veterinary use; air purifying preparations; sterilising preparations; pharmaceutical preparations for skin care; aloe vera preparations for pharmaceutical purposes; pharmaceutical preparations; enzyme preparations for medical purposes; phytotherapy preparations for medical purposes; chemico-pharmaceutical preparations; chemical preparations for medical purposes; chemical preparations for pharmaceutical purposes; pharmaceuticals; tissues impregnated with pharmaceutical lotions; alcohol for pharmaceutical purposes; medicinal alcohol; antibacterial handwashes; adjuvants for medical purposes; disinfectants for hygiene purposes; disinfectants for chemical toilets; detergents for medical purposes; insecticidal veterinary washes; medicated toiletry preparations.

(260) AM 2021 108993 A  
 (800) 1540015  
 (151) 2020 06 03  
 (891) 2020 06 03  
 (731) HYUNDAI MOTOR COMPANY  
 12, Heolleung-ro, Seocho-gu, Seoul, Republic of Korea  
 (540)



(591) Black, white  
 (531) 03.07.17; 24.01.15; 24.01.17; 27.05.02  
 (511)  
 11 – Light emitting diode lights for automobiles; lighting apparatus and devices for automobiles.

(260) AM 2021 109055 A  
 (800) 1540303  
 (151) 2020 06 03  
 (891) 2020 06 03  
 (731) HYUNDAI MOTOR COMPANY  
 12, Heolleung-ro, Seocho-gu, Seoul, Republic of Korea  
 (540)



(591) Black, white  
 (531) 03.07.16; 24.01.15; 24.01.17; 27.05.02  
 (511)  
 43 – Canteen services; snack-bar services; restaurant services; cafe services; buffet restaurants; self-service restaurant services; food and drink catering; teahouse services; restaurant and hotel services; street stall services; kids play cafe services; providing food and drink catering services for sports events, concerts, conventions and exhibitions; restaurant services in the framework of franchise; hotel services; providing travel lodging information services and travel lodging booking agency services for travelers.

(260) AM 2021 109056 A  
 (800) 1540363  
 (151) 2020 06 11  
 (891) 2020 06 11  
 (731) BERDOUES PARFUMS ET  
 COSMETIQUES  
 131 route de Toulouse, F-31270 CUGNAUX,  
 France  
 (540)

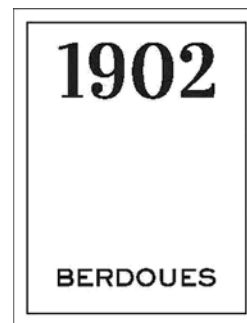

(591) Black, white  
 (531) 25.01.09; 27.07.01  
 (511)  
 3 – Perfumes; perfumery products; eaux de toilette; eaux de parfum; extracts of perfumes; musk [perfumery]; eau de cologne; essential oils; deodorants; antiperspirant products; dentifrices; hair gels; hair mousses; hair lotions; hair conditioners for men; hair coloring products; hair care creams; hair preparations and treatments; shampoos; hair-conditioning products;

washes or deodorants for intimate hygiene; cosmetics and cosmetic products; cosmetic products for skin care; suntan creams; sunscreens; sun lotions; depilatory products; bleaching preparations; hair bleaching products; color-removing preparations; bleaching preparations [decolorants] for cosmetic use; make-up products; make-up removing products; lipsticks; beauty masks; shaving products; shaving lotions; aftershave; pre-shave products; shaving balms; shaving gels; shaving soap; lotions for beards; beard oils; beard balms; beard dyes; cleansing milk; moisturizing milks; nail polish; nail polish; nail polish removers; nail cosmetics; soaps; bath foams; bath gels; bath oils; perfumed bath salts; bath salts for non-medical use; skin whitening preparations; air fragrances.

(260) AM 2021 109083 A  
 (800) 1541170  
 (151) 2020 04 08  
 (891) 2020 04 08  
 (731) Zhejiang Yige Enterprise Management Group Co., Ltd.  
 Unit 8, 6/F, Building 5, 2 Kejiyuan Road,  
 Baiyang Sub-district, Hangzhou Economic &  
 Technological Development Area, Jianggan  
 District, Hangzhou Zhejiang Province, China

(540)



花西子  
 florasis

(591) Black, white  
 (531) 05.05.19; 05.05.20; 27.03.11; 27.05.01;  
 27.05.14; 28.03  
 (511)  
 3 – Lip rouge; cosmetic kits comprising non-medicated cosmetics; lipsticks; rose oil for cosmetic purpose; beauty masks; eyebrow pencils.

(260) AM 2021 109084 A  
 (800) 1541185  
 (151) 2020 02 27  
 (891) 2020 02 27  
 (731) Oriflame Cosmetics AG  
 c/o Oriflame Global Management AG,  
 Bleicheplatz 3, CH-8200 Schaffhausen,  
 Switzerland

(540)

**ORIFLAME MIND & MOOD**

(591) Black, white  
 (511)  
 3 – Non-medicated conditioning and care preparations for application to the hair, scalp, skin and nails; shampoos; hair conditioner; soaps; perfumes; perfumery; eau de cologne; toilet waters; essential and herbal oils; cosmetics; make-up; make-up preparations; make-up removers; lipsticks; nail varnishes; nail varnish removers; eyeliner; mascara; non-medicated toilet preparations; hair lotions; hair sprays and hair gels; preparations for use in the bath or shower; bath and shower oils, gels, creams and foams; face and body masks; face and body scrubs; facial washes; skin cleansers and hydrators; skin toners; skin moisturizers; blemish creams and blemish gels; deodorants; antiperspirants; shaving soaps; shaving creams; shaving gels; after-shave preparations; pre-shave preparations; talcum powders; toiletries; dentifrices; toothpastes; mouth washes; foot care preparations (non-medicated); cotton for cosmetic purposes; cotton wool, sticks, buds, swabs, puffs, balls and pads; cotton wool in the form of wipes for cosmetic use; cotton puffs and pads impregnated with make-up removing preparations.

5 – Pharmaceutical preparations; sanitary preparations; vitamins; dietetic substance adapted for medical use; medicated food supplements; dietary food supplements; mineral food supplements; food supplements for non-medical purposes; food for babies; plasters, materials for dressings; material for stopping teeth, dental wax; disinfectants; nutritional supplements; protein supplements; protein supplement shakes; dietary supplement drinks; vitamin drinks.

(260) AM 2021 109085 A  
 (800) 1541193  
 (151) 2020 02 28  
 (891) 2020 02 28  
 (731) Sony Interactive Entertainment Inc.  
 1-7-1 Konan, Minato-ku, Tokyo 108-0075,  
 Japan

(540)



(591) Black, white  
 (531) 27.05.01; 27.07.01  
 (511)  
 9 – Downloadable video game software; recorded video game software; arcade video game programs; downloadable or installable computer and video game programs for arcade video game machines; downloadable or installable additional image data containing artwork for arcade video game machines; batteries for hand-held games with liquid crystal displays; batteries for home video game machines; batteries for mobile computer terminals; batteries; ear buds for mobile

computer terminals; cleaning discs for cleaning the lens of optical disc drives used in computers and digital video recorders; ear phones; loudspeakers; home theater systems comprising television receivers, DVD players, audio amplifiers and audio speakers; audio recorders; video recorders; digital cameras; television receivers; modems; headphones; microphones for telecommunication apparatus; headphones for mobile computer terminals; microphones for mobile computer terminals; straps for mobile phones; smartphones; mobile telephones; set-top boxes; optical disc players; optical disc recorders; DVD players; DVD recorders; compact disc players; compact disc recorders; navigation apparatus for vehicles [on-board computers]; electric capacitors for telecommunication apparatus; receiving tuners for television broadcasting; webcams; videocameras [camcorders]; cameras for video game consoles; head-mounted video displays; virtual reality headsets with built in display adapted for use in playing video games; motion sensor for virtual reality headsets with built in display adapted for use in playing video games; camera accessories for virtual reality headsets with built in display adapted for use in playing video games; 3D spectacles adapted for use with televisions; three-dimensional television monitors; three-dimensional video monitors; three-dimensional LCD monitors; three-dimensional computer monitors; video baby monitors; video monitors; digital video recorders; video reproducing apparatus; combination video players and recorders; digital audio recorders; digital audio players; digital video players; video disc players; thin film transistor liquid crystal display [TFT-LCD] panels; protective films adapted for liquid crystal display screens; audio amplifiers namely, audio amplifiers, audio receivers, electrical audio cables, electrical speaker cables, electrical audio connectors, and electrical speaker connectors; downloadable video game programs via mobile computer terminals; downloadable computer game programs via mobile computer terminals; computer keyboards; memory cards exclusively for use with hand-held games with liquid crystal displays; downloadable electronic game programs via portable computer terminal; portable computer terminals; keyboards for mobile computer terminals; mouse for mobile computer terminals; memory cards for mobile computer terminals; remote controllers for mobile computer terminals; battery chargers for mobile computer terminals; chargers used for controllers for game consoles; downloadable computer game programs for mobile phones; computer game programmes; memory cards for home video game consoles used with televisions; computer optical mouse; electronic tags for goods; personal digital assistants; touch panels for computer; tablet computers; computer operating programs; downloadable or installable computer game programs; downloadable or installable computer and video game programs for mobile phone; downloadable or installable

computer and video game programs by personal digital assistance; computer game programs for mobile phones; electronic book readers; game programs for home video computer game consoles used with televisions; ear phones for home video game machines; headphones specially adapted for home video game machines; microphones specially adapted for home video game machines; webcams specially adapted for video game machines; microphones specially adapted for use with hand-held games with liquid crystal displays; keyboards specially adapted for use with hand-held games with liquid crystal displays; computer mice specially adapted for use with hand-held games with liquid crystal displays; electric connectors for chargers for home video game machines; keyboards specially adapted for home video game machines; computer game software for hand-held games with liquid crystal display; downloadable or installable computer and video game programs for home video game machines; downloadable or installable additional image data containing artwork for home video game machines; downloadable or installable computer and video game programs for hand-held games with liquid crystal displays; downloadable or installable additional image data containing artwork for hand-held games with liquid crystal displays; downloadable image files; recorded video discs and video tapes featuring entertainment in the nature of action adventure, drama, comedy, romance, science fiction, horror and mystery; downloadable video recordings; prerecorded music compact discs; phonograph records featuring music; downloadable music files; downloadable musical sound recordings; downloadable ring tones for mobile phones; ring tones, graphics and music downloadable via a global computer network and wireless devices; downloadable ring tones and graphics for mobile telephones; downloadable electronic publications in the nature of books, manuals, magazines, newspapers in the field of video games, game software, music and video movies; battery chargers for controllers for home game consoles; battery charging stand for controllers for home game consoles.

16 – Addressing machines; typewriters, electric or non-electric; inking ribbons; envelope sealing machines for offices; automatic stamp affixing machines [office requisites]; electric staplers for offices; stamp shredding machines; drawing instruments; relief duplicators; paper shredders for office use; franking machines for office use; rotary duplicators; electric pencil sharpeners; hygienic hand towels of paper; towels of paper; table napkins of paper; handkerchiefs of paper; hand towels of paper; filter paper; toilet paper; postcard paper; printing paper; paper and cardboard; bookmarkers; photographic albums; cards, stationery; crayons; felt writing pens; seals, stationery; mechanical pencils; sketch books; stickers, stationery; note books; pen cases; stationery cases; stapling presses,

non-electric; ball-point pens; pocket memorandum books; memo pads containing adhesive on one side of the sheets for attachment to surfaces; pencils; plastic underlays for writing paper; picture postcards; painting sets for artists; rubber erasers; adhesive tapes for stationery or household purposes; drafting rulers; pen and pencil holders; envelopes for stationery use; writing pads; paper tags containing adhesive on one side of the sheets for attachment to surfaces; catalogues in the fields of video games, music and cinemas; calendars; newsletters in the field of computer games, music and videos; pamphlets in the field of video games, computer games, music and cinemas; specification manuals for video game programs; strategic manuals for video games; song books; sheet music; magazines in the field of video games, computer games, music and cinemas; printed timetables; instruction manuals in the field of video games and computer games; books in the field of video games, computer games, music and cinemas; newspapers; geographical maps; diaries; graphic art prints; photographs, printed; photograph stands.

28 – Coin-operated arcade video game machines; arcade video game machines; action figure toys; cards for trading card games; electronic educational game machines for children; consumer video game consoles for use with an external display screen or monitor; home video game consoles used with televisions; video game consoles; mounts specially adapted for home video game machines; controllers for home game consoles; controllers for game consoles; controllers for game consoles in the nature of keyboards and mice sold together as a unit; controllers for game consoles in the nature of motion controllers; controllers for game consoles in the nature of flight sticks; controllers for game consoles in the nature of racing steering wheels; joysticks exclusively for use with home video game consoles used with televisions; protective carrying cases specially adapted for handheld video games; portable games with liquid crystal displays; mounts connectable to AC adapters and High-Definition Multimedia Interface cables exclusively for use with hand-held games with liquid crystal displays; mounts specially adapted for use with hand-held games with liquid crystal displays; stands and protective covers for hand-held game with liquid crystal displays; molded toy figures; toy models; radio control receivers and transmitters for radio-controlled model toys; player-operated electronic motor controllers for model toys; dolls; dice games; game cards; parlour games; chess games; checker sets; playing cards; trading card games; dominoes; conjuring apparatus in the nature of magic tricks; billiard equipment; chest expanders; golf ball markers; golf clubs; golf bags; surfboards; ski cases; ski bindings; golf tees; paragliders; bowling bags; boxing gloves; rackets for tennis or badminton; table tennis bats; guts for rackets for tennis or badminton; racket cases for tennis or bad-

minton; table tennis paddle cases; roller skates; stationary exercise bicycles and rollers therefor; water skis; baseball gloves; archery bows; fishing rods; fishing tackle; face plates for home game consoles; motion sensor and camera accessories for home game consoles; mouse specially adapted for home video game machines; computer mice specially adapted for use with hand-held games with liquid crystal displays.

37 – Repair and maintenance of arcade video game machines; repair and maintenance of parts and accessories of arcade video game machines; repair and maintenance of home video game machines; repair and maintenance of parts and accessories of home video game machines; repair and maintenance of portable games with liquid crystal displays; repair and maintenance of parts and accessories of portable games with liquid crystal displays; repair and maintenance of toys or dolls; repair and maintenance of telecommunication machines and apparatus; repair and maintenance of parts and accessories for telecommunication machines and apparatus; repair or maintenance of electronic machines and apparatus; repair or maintenance of parts and accessories for electronic machines and apparatus; repair or maintenance of computers; repair or maintenance of parts and accessories for computers; repair and maintenance of telephone; repair and maintenance of parts and accessories for telephone; repair and maintenance of mobile phone; repair and maintenance of parts and accessories for mobile phone.

38 – Transmitting streamed sound, audiovisual recordings, video, films, images, picture, texts, video contents and audio contents via the Internet; communication by electronic computer terminals and video game consoles; teleconferencing and videoconferencing services; digital transmission services for audio and video data; communication via satellite; providing e-mail services; providing telecommunications connections to a global computer network; electronic bulletin board services; video-on-demand transmission services for images and voices; data transmission and reception services via telecommunication means; providing information relating to data communications; providing information relating to computer communication via computer databases; information about telecommunication other than broadcasting; transmission and broadcasting of video file of quiz programs, game programs and other entertainment programs via Internet; transmission of voice, data, graphics, images, audio and video by means of computer networks, and the Internet; broadcasting of television programs using video-on-demand and pay-per-view television services; broadcasting and transmission of pay-per-view television programs; cable radio broadcasting; satellite television broadcasting; broadcasting services and provision of telecommunication access to video and audio content provided via a video-on-demand service via the Internet; transmission and broadcasting

of audio and video data file via Internet; broadcasting of television programmes provided via a video-on-demand; cable television broadcasting of television programmes provided via a video-on-demand; cable broadcasting via video on demand service; digital terrestrial television broadcasting via a video-on-demand; terrestrial digital one-segment audio, video and data broadcasting services via interactive communication using mobile phones; broadcasting of television and radio programs via satellite or digital terrestrial television broadcasting; television broadcasting; providing information about cable television broadcasting, radio broadcasting and digital terrestrial television broadcasting; providing information about broadcasting of radio and television programs via computer or mobile communications networks; rental of set-top boxes; rental of equipment for broadcasting, other than rental of TV and radio receivers; rental of modems; rental of cable modems; rental of telecommunication equipment including telephones and facsimile apparatus; providing information relating to rental of telecommunication equipment including telephones and facsimile apparatus.

41 – Providing on-line non-downloadable music and film via a video-on-demand service via communications networks by means of computer terminals, fiber optic networks and telephones; provision of non-downloadable films and television programs via a video-on-demand source; providing on-line non-downloadable videos and music via a video-on-demand service via communications networks by means of computer terminals, fiber optic networks and telephones; providing on-line images and pictures about fictional characters appearing in games and animations; providing non-downloadable photographic images containing artwork via communications networks by means of computer terminals, fiber optic networks and telephones; providing non-downloadable videos in the field of education, culture, entertainment or sports via communications networks by means of computer terminals, fiber optic networks and telephones; providing non-downloadable music and video featuring television programs using a video-on-demand service via computer network communications; providing non-downloadable music and video featuring television programs using video-on-demand and pay-per-view television services; movie showing, movie film production, or movie film distribution; providing non-downloadable video and audio for computer games via communications networks by means of computer terminals, fiber optic networks and telephones; providing non-downloadable music via the Internet or computer network; providing non-downloadable music via the Internet, computer network, cable network, computer network using an on-demand service and interactive communication using mobile phones; providing non-downloadable audio and video featuring presentation of theatrical performances via

the Internet, computer network, cable network, computer network using an on-demand service and interactive communication using mobile phones; providing non-downloadable photographic images and animation films via the Internet, computer network, cable network, computer network using an on demand service and interactive communication using mobile phones; providing computer games via the Internet, computer network, cable network, computer network using an on-demand service and interactive communication using mobile phones; providing non-downloadable video, still and moving images containing film and television programs and artwork by streaming via the Internet; providing non-downloadable films via the Internet or computer network; providing on-line non-downloadable music via an on-demand service and information relating thereto; providing non-downloadable videos for television program featuring regional information via the Internet or computer network; providing non-downloadable videos containing television programs via the Internet or computer network; providing non-downloadable films via an on-demand service via cable network, computer network and the Internet; providing non-downloadable videos containing films and television programs via an on-demand service via cable network, computer network and the Internet; providing non-downloadable films via an on-demand service via interactive communication using mobile phones; direction or presentation of live show performances; organization, arranging and conducting of live music concerts; live performances by a musical group; presentation of musical performances; production and distribution of interactive television programs; production and distribution of cable television or television programs; production and distribution of radio programs; production and distribution of programs for cable television providers; production and distribution of television quiz programs, television prize programs, television game programs, and television entertainment programs for others; production and distribution of programs for television, cable television, radio, satellite radio, movies and film; production and distribution of television programs features of educations by means of computer networks; production and distribution of television programs in the field of news; production and distribution of radio or television programs featuring regional information; production and distribution of radio or television programs featuring traditional Japanese culture; production of radio or television programs; organization of sporting events in the field of football, hockey, golf, car races, basketball, baseball, soccer, lacrosse, volleyball, tennis, curling, squash, swimming, cycling; organization of sporting events; organization, production, presentation and conducting of events for the purpose of cultural exchange between people and region; organization, production, presentation and conducting of events related to cultural exchange between Japan and overseas;

organization, production, presentation and conducting of live talk show events; organization of entertainment events excluding movies, shows, plays, musical performances, sports, horse races, bicycle races, boat races and auto races; entertainment in the nature of video game competitions; providing non-downloadable videos, music and lyrics for karaoke via communications networks by means of computer terminals, fiber optic networks and telephones; providing amusement facilities; providing online, non-downloadable electronic match games via communications networks by means of computer terminals, fiber optic networks and telephones; providing online, non-downloadable electronic games via communications networks by means of home video game machines and personal computers; providing online, non-downloadable electronic games via communications networks by means of mobile telephone or computer terminals; game services provided by means of communications by computer terminals, optical fiber networks or mobile telephone; rental of cinematographic machines and apparatus; rental of cine-films; rental of records or sound-recorded magnetic tapes; rental of image-recorded magnetic tapes; news reporters services using the Internet; news reporters services and providing information relating thereto; news reporters services.

42 – Providing meteorological information; design of home video game machines; design services; data conversion from physical to electronic media; duplication of computer programs; rental of system security programs for home video game consoles used with televisions which is recorded on magnetic tapes, CD-ROMs, DVD-ROMs or optical discs; video game software programming services for others for video game machines for use with television for business and personal use; computer programming; information services relating to computer programming in order to protect the security of the computer network to protect the system from unauthorized access; rental of measuring apparatus; rental of web servers; rental of web server's memory for entry of diaries and schedules of individuals and corporations and storage of electronic data; rental of web server's memory; rental of computers; rental of computer programs; installation of computer software; providing temporary use of online non-downloadable computer software; software as a service; platform as a service; hosting of platform on the internet; platform for gaming as software as a service; providing user authentication and identification services in e-commerce transactions via a global computer networks for others; providing temporary use of non-downloadable game software.

45 – Providing information via a web site in the fields of personal introduction services for social network users; Internet-based dating, matchmaking and personal introduction services; Internet based marriage partner introduction or dating services; on-line social networking services; Internet based social networking,

introduction, and dating services; marriage partner introduction or dating services; introduction services in the fields of personal relationships and dating for the social networking via a communication networks; personal body guarding by using global navigation system (GPS); providing information relating to personal background; providing information relating to investigation or surveillance on background profiles; provision of present location information for others about lost property by using communication terminal; provision of location information in relation to lost objects and animals via communication terminal.

(260) AM 2021 109086 A  
 (800) 1541194  
 (151) 2020 04 15  
 (891) 2020 04 15  
 (731) RFX + Care International A/S  
 Bakkegårdsvej 408, DK-3050 Humlebæk,  
 Denmark

(540)



(591) Blue and red  
 (531) 26.05.03; 26.15.25; 29.01.14  
 (511)

3 – Non-medicated cosmetics and toiletries; non-medicated toothpaste; perfumery, essential oils; bleaches and other substances for laundry; after-sun cream; aftershave cream; anti-wrinkle creams; aromatic essential oils; cosmetic preparations in the form of creams; toiletry lotions; body cream; body oil [for cosmetic use]; body scrubs; bubble bath preparations; cleansing milk for toiletry use; bath salts, not for medical use; cosmetic creams; cosmetic oils; cosmetic soap; cosmetic sun protection preparations; cosmetics and cosmetic preparations; makeup; deodorants for body care; eye cream; hair conditioner; preparations for hair and treatment of hair; shampoo; hand creams; perfumes; shower creams; cream for skin cleansing; moisturising preparations for skin; soap for body care; sunscreens; preparations for cleaning the body and beauty care; hand gels; body gels; disposable wipes impregnated with cleansers for use on the face; cosmetics fluid creams; functional cosmetic preparations; hand washing agents; cosmetic preparations for skincare; non-medicated, moist cleaning wipes for use on humans; impregnated tissues (for cosmetic use); preparations for cleaning of hands; cleaning preparations for personal use; wet wipes for hygienic and cosmetic use; washing preparations for personal use.

5 – Pharmaceutical and medical preparations; hygienic preparations for medical purposes; dietetic food and preparations adapted for medical use; food for infants; dietary supplements for humans; plasters, materials for dressings; disinfectants; preparations for extermination of pests; insect repellents; paper tissues impregnated with insect repellents for medical purposes; first aid kits; first aid kits including contents; dressing materials for first aid; tooth preparations- and articles together with medical toothpastes; disinfecting and antiseptic agents; hygienic preparations and articles; alcohol for medical uses; antibacterial hand lotions; antibacterial preparations; antibacterial tissues; antibacterial sprays; antiseptic preparations; antiseptic aerosol spray for use on skin; disinfection agents for hygienic purposes; disinfections agents for use in households; preparations for hand disinfection; cleaning wipes impregnated with disinfectants for hygiene purposes; antibacterial soap; antibacterial hand wash; bactericidal cleaners; disinfecting handwashing agents; disinfecting soap.

10 – Surgical and medical apparatus and instruments; clothing, headgear and footwear and support devices for medical purposes; facemasks for medical purposes; facemasks for surgical purposes; protective clothing for medical purposes; protective clothing for surgical purposes; disposable protective gloves for medical purposes; protective gloves for use by surgeons during operations; protective gloves for medical purposes; protective masks for medical personnel; protective masks for medical purposes; disposable gloves for surgical purposes; disposable gloves for veterinary purposes; rubber gloves for surgical use; rubber gloves for medical purposes; latex gloves for medical use; gloves for use in hospitals; gloves for use during operations; gloves for medical purposes; surgical gloves; masks for use by medical personnel; masks for medical purposes; medical gloves; medical masks; surgical masks.

(260) AM 2021 109145 A  
 (800) 1541274  
 (151) 2020 05 21  
 (891) 2020 05 21  
 (731) ZAMBON S.p.A.  
 Via Lillo del Duca 10, I-20091 Bresso (MI),  
 Italy  
 (540)

**FIDEVRY**

(591) Black, white  
 (511)  
 5 – Pharmaceutical preparations for the treatment of respiratory diseases and disorders.

(260) AM 2021 109146 A  
 (800) 1541299  
 (151) 2020 05 21  
 (891) 2020 05 21  
 (731) ZAMBON S.p.A.  
 Via Lillo del Duca 10, I-20091 Bresso (MI),  
 Italy  
 (540)

**MIDELVY**

(591) Black, white  
 (511)  
 5 – Pharmaceutical preparations for the treatment of respiratory diseases and disorders.

(260) AM 2021 109150 A  
 (800) 1541320  
 (151) 2020 05 21  
 (891) 2020 05 21  
 (731) ZAMBON S.p.A.  
 Via Lillo del Duca 10, I-20091 Bresso (MI),  
 Italy  
 (540)

**MYBEMO**

(591) Black, white  
 (511)  
 5 – Pharmaceutical preparations for the treatment of respiratory diseases and disorders.

(260) AM 2021 109182 A  
 (800) 1542206  
 (151) 2020 06 09  
 (891) 2020 06 09  
 (731) AGRO SELECTIONS FRUITS  
 La Prade de Mousseillous, F-66200 ELNE,  
 France  
 (540)



(591) Red, green, light green, white  
 (531) 05.07.13; 27.03.11; 29.01.14  
 (511)  
 31 – Fresh fruit; fruit, not prepared; flat fruits; nectarines; raw peaches; fresh peaches; peaches, not prepared; all these goods other than those of the botanical genus Ribes.

- (260) AM 2021 109184 A
- (800) 1542254
- (151) 2020 03 03
- (891) 2020 03 03
- (731) MATIUKHA ANDRII VALERIOVYCH  
AV. GEROIV STALINGRADU, BUILD.  
12-G. AP. 79, KYIV 04210, Ukraine
- (540)



- (591) Red, blue and white
- (531) 24.09.25; 26.03.01; 26.04.04; 26.04.16;  
26.04.22; 26.04.24; 27.05.17; 29.01.13
- (511)  
35 – Administrative assistance in responding to requests for proposals in the field of gaming and entertainment activities, sport events; web indexing for commercial or advertising purposes for gaming and entertainment activities, sport events; market studies relating to gaming and entertainment activities, sport events; demonstration of goods and services for the gaming and entertainment activities, sport events; business inquiries in the field of gaming and entertainment activities, sport events; business research on gaming and entertainment activities, sport events; economic forecasting in the field of gaming and entertainment activities, sport events; providing business information in the field of gaming and entertainment activities, sport events via website; compilation of information into computer databases regarding gaming and entertainment activities, sport events; compilation of statistics relating to gaming and entertainment activities, sport events; providing business information relating to gaming and entertainment activities, sport events; business management of sports people; commercial information and advice for consumers in the choice of products and services in the field of gaming and entertainment activities, sport events; commercial administration of the licensing of the goods and services of others in the field of gaming and entertainment activities, sport events; computerized file management in the field of gaming and entertainment activities, sport events; business management consultancy in the field of gaming and entertainment activities, sport events, marketing in the field of gaming and entertainment activities, sport events; marketing in the framework of software publishing for gaming and entertainment activities, sport events; marketing research in the field of gaming and entertainment activities, sport events; provision of an online marketplace for buyers and sellers of goods and services in the field of gaming and entertainment activities, sport events; updating and maintenance of data in computer databases in the field of gaming and entertainment activities, sport events; organization of exhibitions for commercial or advertising purposes in the field of ga-

ming and entertainment activities, sport events; commercial information agency services in the field of gaming and entertainment activities, sport events; advertising agency services in the field of gaming and entertainment activities, sport events; presentation of goods in the field of gaming and entertainment activities, sport events, on communication media, for retail purposes; rental of vending machines relating to gaming and entertainment activities, sport events; advertising of gaming and entertainment activities, sport events; sales promotion for other in the field of gaming and entertainment activities, sport events; promotion of gaming and entertainment services through sponsorship of sport events; professional business consultancy in the field of gaming and entertainment activities, sport events.

41 – Arranging of sport and cultural events; arranging of entertaining events; arranging and conducting of congresses; providing sports facilities; providing casino facilities [gambling]; agency services for gambling, competitions, lotteries, poker, poker tournaments, arcade services, roulette games, casino games, betting activity; providing gambling facilities offline and online over a computer network; providing equipment for lottery services, arcade services, poker, poker tournaments, betting activity; game services provided on-line from a computer network; recreation information; entertainment information; providing of-line and online information relating to lottery services, arcade services, poker, poker tournaments, betting activity, casinos; organization of lotteries; organization of sports competitions; organization of sports competitions offline and online over a computer network; providing amusement arcade services; club services [entertainment or education]; gambling services; organization of gambling, competitions, lotteries, poker, poker tournaments, arcade services, roulette games, casino games; organization of sports games; organizing and conducting online gaming competitions; betting services; games equipment rental; rental of sports grounds; rental of sports equipment, except vehicles; entertainment services; production of shows; physical education; timing of sports events.

- 
- (260) AM 2021 109185 A
  - (800) 1542287
  - (151) 2020 06 22
  - (891) 2020 06 22
  - (731) VALORIA INVESTMENTS 2011, S.L.U.  
Calle Maria Rosa Molas, 6, bajo, E-12004  
Castellón, Spain

(540)



(591) Black, white



(511)

9 – Scientific, research, navigation, surveying, photographic, cinematographic, audiovisual, optical, weighing, measuring, signaling, detecting, testing, inspecting, life-saving and teaching apparatus and instruments; apparatus and instruments for conducting, switching, transforming, accumulating, regulating or controlling electricity consumption or distribution; apparatus and instruments for recording, transmitting, reproducing or processing sound, images or data; recorded or downloadable media, software, blank digital recording and storage media or similar products; mechanisms for coin-operated apparatus; cash registers, calculating devices; computers and computer peripherals; diving suits, diving masks, earplugs for divers, nose clips for divers and swimmers, gloves for divers, breathing apparatus for underwater swimming; fire extinguishers; electrical energy transmission apparatus; communication apparatus; telecommunications apparatus and instruments; programs for data processing.

42 – Scientific and technological services, as well as associated research and design services; industrial analysis, industrial research and industrial design services; quality control and authentication services; design and development of computer equipment and software; computer engineering services; Research services; research and development services; technical engineering; technological consultancy services in the field of alternative energy generation.

(260) AM 2021 109186 A

(800) 1542295

(151) 2020 06 04

(891) 2020 06 04

(731) PUBLIC JOINT STOCK COMPANY  
GAZPROM NEFT

Pochtamtskaya Ulitsa, Dom 3-5, Liter A,  
Ch. Pom. 1N, Kab. 2401, RU-190000 ST  
PETERSBURG, Russian Federation

(540)



(591) White, orange, grey and black

(531) 25.07.01; 27.05.01; 27.05.09; 27.05.24;  
29.01.13

(511)

1 – Acetate of cellulose, unprocessed; acetates [chemicals]; acetic anhydride; acetone; acetylene; acetylene tetrachloride; acid proof chemical compositions;

acids; acidulated water for recharging accumulators; acidulated water for recharging batteries; acrylic resins, unprocessed; actinium; activated carbon; activated charcoal; additives, chemical, to drilling muds; chemical additives to drilling muds; additives, chemical, to fungicides; chemical additives to fungicides; additives, chemical, to insecticides; chemical additives to insecticides; additives, chemical, to motor fuel; chemical additives to motor fuel; adhesive preparations for surgical bandages; adhesives for billposting; adhesives for industrial purposes; adhesives for wallpaper; adhesives for paperhanging; adhesives for wall tiles; adjuvants, other than for medical or veterinary purposes; agar-agar; agglutinants for concrete; agricultural chemicals, except fungicides, herbicides, insecticides and parasiticides; albumenized paper; albumin [animal or vegetable, raw material]; alcohol; aldehydes; alginates for industrial purposes; alginates for the food industry; alkalies; alkaline-earth metals; alkaline iodides for industrial purposes; alkaline metals; alkaloids; alum; alumina; aluminium acetate; aluminium alum; aluminium chloride; aluminium hydrate; aluminium iodide; aluminium silicate; americium; ammonia; ammonia alum; ammoniacal salts; ammonia [volatile alkali] for industrial purposes; volatile alkali [ammonia] for industrial purposes; ammonium aldehyde; ammonium nitrate; ammonium salts; amyl acetate; amyl alcohol; anhydrides; anhydrous ammonia; animal albumen [raw material]; animal carbon; animal carbon preparations; animal charcoal; animal manure; anthranilic acid; anti-boil preparations for engine coolants; anti-frothing solutions for accumulators; anti-frothing solutions for batteries; anti-incrustants; anti-knock substances for internal combustion engines; anti-sprouting preparations for vegetables; anti-tarnishing chemicals for windows; antifreeze; antimony; antimony oxide; antimony sulfide; antioxidants for use in manufacture; antioxidants for use in the manufacture of cosmetics; antioxidants for use in the manufacture of food supplements; antioxidants for use in the manufacture of pharmaceuticals; antistatic preparations, other than for household purposes; argon; arsenic; arsenious acid; artificial sweeteners [chemical preparations]; astatine; auxiliary fluids for use with abrasives; bacterial preparations, other than for medical and veterinary use; bacteriological preparations, other than for medical and veterinary use; bacteriological preparations for acetification; barium; barium compounds; barium sulfate; baryta; baryta paper; barytes; bases [chemical preparations]; basic gallate of bismuth; bate for dressing skins; dressing, except oils, for skins; bauxite; beer-clarifying and preserving agents; beer preserving agents; bentonite; benzene; benzene-based acids; benzene derivatives; benzoic acid; benzoic sulfimide; benzol; berkelium; bicarbonate of soda for chemical purposes; bichloride of tin; bichromate of potassium; bichromate of soda; biochemical catalysts; biological preparations, other than for medical or veterinary purposes; biological

tissue cultures, other than for medical or veterinary purposes; birdlime; bismuth; bismuth subnitrate for chemical purposes; bleaching preparations [decolorants] for industrial purposes; decolorants for industrial purposes; blood charcoal; blueprint cloth; blueprint paper; blue vitriol; copper sulfate [blue vitriol]; bone charcoal; borax; boric acid for industrial purposes; brake fluid; brazing fluxes; brazing preparations; brickwork preservatives, except paints and oils; bromine for chemical purposes; by-products of the processing of cereals for industrial purposes; caesium; calcined soda; calcium carbide; calcium cyanamide [fertilizer]; calcium cyanamide [fertiliser]; calcium salts; californium; calomel [mercurous chloride]; camphor, for industrial purposes; carbide; carbolinum for the protection of plants; carbon; carbonates; carbon black for industrial purposes; carbon disulfide; carbon for filters; carbonic acid; carbonic hydrates; carbon tetrachloride; casein for industrial purposes; casein for the food industry; catalysts; catechu; caustic alkali; caustics for industrial purposes; caustic soda for industrial purposes; cellulose; cellulose derivatives [chemicals]; cellulose esters for industrial purposes; cellulose ethers for industrial purposes; cement-waterproofing chemicals, except paints; cement for footwear; cement for mending broken articles; cement preservatives, except paints and oils; cement [metallurgy]; ceramic compositions for sintering [granules and powders]; ceramic glazings; ceramic materials in particulate form, for use as filtering media; cerium; chemical additives for oils; chemical coatings for ophthalmic lenses; chemical condensation preparations; chemical intensifiers for paper; chemical intensifiers for rubber; chemical preparations for facilitating the alloying of metals; chemical preparations for scientific purposes, other than for medical or veterinary use; chemical preparations for smoking meat; chemical preparations for use in photography; chemical preparations to prevent diseases affecting cereal plants; chemical preparations to prevent diseases affecting vine plants; chemical preparations to prevent mildew; chemical preparations to prevent wheat blight; chemical preparations to prevent wheat smut; chemical reagents, other than for medical or veterinary purposes; chemicals, except pigments, for the manufacture of enamel; chemicals for the manufacture of paints; chemicals for the manufacture of pigments; chemicals for use in forestry, except fungicides, herbicides, insecticides and parasiticides; chemical substances for analyses in laboratories, other than for medical or veterinary purposes; chemical preparations for analyses in laboratories, other than for medical or veterinary purposes; chemical substances for preserving foodstuffs; chimney cleaners, chemical; chlorates; chlorides; chlorine; cholic acid; chromates; chrome alum; chrome salts; chromic acid; chromic salts; chromium oxide; cinematographic films, sensitized but not exposed; cinematographic film, sensitized but not exposed; citric acid for industrial purposes;

ses; coal saving preparations; cobalt oxide for industrial purposes; collagen for industrial purposes; collodion; color-brightening chemicals for industrial purposes; colour-brightening chemicals for industrial purposes; combusting preparations [chemical additives to motor fuel]; compositions for repairing inner tubes of tyres; compositions for repairing inner tubes of tires; compositions for repairing tyres; compositions for repairing tires; compositions for the manufacture of phonograph records; compositions for the manufacture of technical ceramics; compositions for threading; compost; concrete-aeration chemicals; concrete preservatives, except paints and oils; condensation-preventing chemicals; coolants for vehicle engines; corrosive preparations; cream of tartar for chemical purposes; cream of tartar for industrial purposes; cream of tartar for the food industry; creosote for chemical purposes; crotonic aldehyde; cryogenic preparations; cultures of microorganisms, other than for medical and veterinary use; curium; currying preparations for leather; currying preparations for skins; cyanides [prussiates]; prussiates; cymene; damp-proofing chemicals, except paints, for masonry; defoliants; degreasing preparations for use in manufacturing processes; grease-removing preparations for use in manufacturing processes; degumming preparations; gum solvents; dehydrating preparations for industrial purposes; dendrimer-based polymers for use in the manufacture of capsules for pharmaceuticals; descaling preparations, other than for household purposes; detergent additives to gasoline; detergent additives to petrol; detergents for use in manufacturing processes; dextrin [size]; diagnostic preparations, other than for medical or veterinary purposes; diastase for industrial purposes; diatomaceous earth; diazo paper; disincrustants; dispersions of plastics; distilled water; dolomite for industrial purposes; drilling muds; dry ice [carbon dioxide]; dysprosium; electrophoresis gels; emollients for industrial purposes; emulsifiers; enamel-staining chemicals; engine-decarbonising chemicals; chemical preparations for decarbonising engines; enzyme preparations for industrial purposes; enzyme preparations for the food industry; enzymes for industrial purposes; enzymes for the food industry; epoxy resins, unprocessed; erbium; esters; ethane; ethers; ethyl alcohol; ethyl ether; europium; expanded clay for hydroponic plant growing [substrate]; fat-bleaching chemicals; fatty acids; ferments for chemical purposes; fermium; ferrocyanides; ferrotype plates [photography]; fertilizers; fertilisers; fertilizing preparations; fertilising preparations; filtering materials of chemical substances; filtering materials of mineral substances; filtering materials of unprocessed plastics; filtering materials of vegetable substances; filtering preparations for the beverages industry; finishing preparations for use in the manufacture of steel; fire extinguishing compositions; fireproofing preparations; fish meal fertilizers; fish meal fertilisers; fissionable chemical elements; fissionable material for nuclear

energy; fixing baths [photography]; fixing solutions [photography]; flashlight preparations; flavonoids [phenolic compounds] for industrial purposes; flocculants; flour for industrial purposes; flower preservatives; flowers of sulfur for chemical purposes; fluids for hydraulic circuits; liquids for hydraulic circuits; fluorine; fluorspar compounds; formic acid; formic aldehyde for chemical purposes; foundry binding substances; foundry molding preparations; foundry moulding preparations; foundry sand; francium; fuel-saving preparations; fuel for nuclear reactors; fuller's earth for use in the textile industry; fulling preparations; fulling preparations for use in the textile industry; gadolinium; gallic acid for the manufacture of ink; gallium; gallnuts; gallotannic acid; galvanizing baths; baths for galvanizing; galvanizing preparations; gambier; gas purifying preparations; preparations for the purification of gas; gelatine for industrial purposes; gelatine for photographic purposes; genes of seeds for agricultural production; getters [chemically active substances]; glass-frosting chemicals; glass-staining chemicals; glaziers' putty; glucose for industrial purposes; glucose for the food industry; glucosides; glue for industrial purposes; glutamic acid for industrial purposes; gluten for industrial purposes; gluten for the food industry; gluten [glue], other than for stationery or household purposes; glutinous tree-grafting preparations; glutinous tree-banding preparations; glutinous preparations for tree-banding; glutinous preparations for tree-grafting; glycerides; glycerine for industrial purposes; glycol; glycol ether; gold salts; grafting mastic for trees; grafting wax for trees; graphene; graphite for industrial purposes; guano; gum arabic for industrial purposes; gums [adhesives] for industrial purposes; gum tragacanth for industrial purposes; gurjun balsam for use in the manufacture of varnish; gypsum for use as a fertilizer; heavy water; helium; holmium; hormones for hastening the ripening of fruit; horticultural chemicals, except fungicides, herbicides, insecticides and parasiticides; humus; humus top dressing; hydrates; hydrazine; hydrochlorates; hydrochloric acid; hydrofluoric acid; hydrogen; hydrogen peroxide for industrial purposes; hypochlorite of soda; hyposulfites; industrial chemicals; iodic acid; iodine for chemical purposes; iodine for industrial purposes; iodised albumen; iodised salts; ion exchangers [chemicals]; iron salts; isinglass, other than for stationery, household or alimentary purposes; isotopes for industrial purposes; kainite; kaolin; china slip; china clay; ketones; kieselgur; krypton; lactic acid; lactose for industrial purposes; lactose for the food industry; lactose [raw material]; lamp black for industrial purposes; lanthanum; lead acetate; lead arsenate; lead oxide; leather-dressing chemicals; leather-impregnating chemicals; leather-renovating chemicals; leather-waterproofing chemicals; leather glues; lecithin for industrial purposes; lecithin for the food industry; lecithin [raw material]; lime acetate; lime carbonate; lime chloride; limestone hardening substances; liquids

for removing sulfates from accumulators; liquids for removing sulfates from batteries; lithia [lithium oxide]; lithium; litmus paper; loam; lutetium [cassiopium]; cassiopium [lutetium]; magnesite; magnesium carbonate; magnesium chloride; magnetic fluid for industrial purposes; malt albumen; manganate; manganese dioxide; mangrove bark for industrial purposes; masonry preservatives, except paints and oils; mastic for leather; mastic for tires; mastic for tyres; meat tenderizers for industrial purposes; mercuric oxide; mercury; mercury salts; metal annealing preparations; metal hardening preparations; metalloids; metal tempering preparations; methane; methyl benzene; methyl benzol; methyl ether; milk ferments for chemical purposes; milk ferments for industrial purposes; milk ferments for the food industry; mineral acids; moderating materials for nuclear reactors; moistening [wetting] preparations for use in bleaching; wetting preparations for use in bleaching; moistening [wetting] preparations for use in dyeing; wetting preparations for use in dyeing; moistening [wetting] preparations for use in the textile industry; wetting preparations for use in the textile industry; mould-release preparations; mould-release preparations; mordants for metals; must-fining preparations; nanopowders for industrial purposes; naphthalene; neodymium; neon; neptunium; nitrate paper; nitrates; nitric acid; nitrogen; nitrogenous fertilisers; nitrogenous fertilizers; nitrous oxide; oenological bactericides [chemical preparations for use in wine making]; oil-bleaching chemicals; oil-purifying chemicals; oil-separating chemicals; oil cement [putty]; oil dispersants; oils for currying leather; oils for preparing leather in the course of manufacture; oils for tanning leather; oils for the preservation of food; oleic acid; olivine [silicate mineral]; opacifiers for enamel; opacifiers for glass; organic digestate [fertilizer]; organic digestate [fertiliser]; oxalates; oxalic acid; oxygen for industrial purposes; palladium chloride; paper pulp; paste fillers for automobile body repair; paste fillers for car body repair; peat pots for horticulture; peat [fertiliser]; peat [fertilizer]; pectin for industrial purposes; pectin for the food industry; pectin [photography]; perborate of soda; percarbonates; perchlorates; persulfates; persulfuric acid; petroleum dispersants; phenol for industrial purposes; phosphates [fertilisers]; phosphates [fertilizers]; phosphatides; phosphoric acid; phosphorus; photographic developers; photographic emulsions; photographic paper; photographic sensitizers; photometric paper; photosensitive plates; picric acid; plant growth regulating preparations; plasticizers; plastics, unprocessed; plastisols; plutonium; polish removing substances; substances for removing polish; polonium; polymer resins, unprocessed; potash; potash water; potassium; potassium dioxalate; potato flour for industrial purposes; potting soil; power steering fluid; praseodymium; preparations for preventing the tarnishing of glass; preparations for preventing the tarnishing of lenses; preparations for stimulating cooking for industrial

purposes; preparations for the separation of greases; preparations of microorganisms, other than for medical and veterinary use; preparations of the distillation of wood alcohol; preparations of trace elements for plants; preservatives for tiles, except paints and oils; preservatives for use in the pharmaceutical industry; promethium; propellant gases for aerosols; protactinium; protective gases for welding; proteins for the food industry; proteins for use in manufacture; proteins for use in the manufacture of food supplements; protein [raw material]; purification preparations; clarification preparations; pyrogallol; pyrogallol for industrial purposes; radiator flushing chemicals; radioactive elements for scientific purposes; radium for scientific purposes; radon; rare earths; reagent paper, other than for medical or veterinary purposes; reducing agents for use in photography; refrigerants; renovating preparations for phonograph records; rhenium; rock salt; rubber preservatives; rubidium; saccharin; sal ammoniac; sal ammoniac spirits; salicylic acid; salt, raw; salt for preserving, other than for foodstuffs; saltpeter; saltpetre; salts for coloring metal; salts for colouring metal; salts for galvanic cells; salts for galvanic batteries; salts for industrial purposes; salts from rare earth metals; salts of alkaline metals; salts of precious metals for industrial purposes; salts [chemical preparations]; salts [fertilisers]; salts [fertilizers]; samarium; sauce for preparing tobacco; scandium; seawater for industrial purposes; seaweeds [fertilizers]; seaweeds [fertilisers]; sebacic acid; seed preserving substances; selenium; self-toning paper [photography]; sensitized cloth for photography; sensitized films, unexposed; sensitized paper; sensitized photographic plates; sensitized plates for offset printing; separating and unsticking [ungluing] preparations; ungluing preparations; unsticking and separating preparations; silicates; silicon; silicon carbide [raw material]; silicones; silver nitrate; silver salt solutions for silvering; size for finishing and priming; size for use in the textile industry; sizing preparations; slag [fertilisers]; slag [fertilizers]; soap [metallic] for industrial purposes; soda ash; sodium; sodium salts [chemical compounds]; soil conditioning preparations; soil for growing; soldering fluxes; solidified gases for industrial purposes; solutions for cyanotyping; solvents for varnishes; soot for industrial or agricultural purposes; sorrel salt; spinel [oxide mineral]; spirits of salt; spirits of vinegar [dilute acetic acid]; stain-preventing chemicals for use on fabrics; starch-liquifying chemicals [ungluing agents]; ungluing agents [chemical preparations for liquifying starch]; starch for industrial purposes; starch paste [adhesive], other than for stationery or household purposes; stearic acid; stem cells, other than for medical or veterinary purposes; strontium; substances for preventing runs in stockings; substrates for soil-free growing [agriculture]; sulfates; sulfides; sulfonic acids; sulfur; sulfuric acid; sulfuric ether; sulfurous acid; sumac for use in tanning; superphosphates [fertilisers]; superphosphates [fertilizers]; surface-active

chemical agents; tensio-active agents; synthetic materials for absorbing oil; synthetic resins, unprocessed; artificial resins, unprocessed; talc [magnesium silicate]; tan; tan-wood; tannic acid; tannin; tanning substances; tapioca flour for industrial purposes; tartar, other than for pharmaceutical purposes; tartaric acid; tea extracts for the food industry; tea extracts for use in the manufacture of cosmetics; tea extracts for use in the manufacture of pharmaceuticals; technetium; tellurium; terbium; test paper, chemical; tetrachlorides; textile-brightening chemicals; textile-impregnating chemicals; textile-waterproofing chemicals; thallium; thiocarbonyl; thorium; thulium; thymol for industrial purposes; titanite; titanium dioxide for industrial purposes; toluene; toluol; toning baths [photography]; toning salts [photography]; topsoil; toxic gas neutralizers; transmission fluid; transmission oil; tree cavity fillers [forestry]; tungstic acid; uranium; uranium nitrate; uranium oxide; vinic alcohol; viscose; vitamins for the food industry; vitamins for use in the manufacture of cosmetics; vitamins for use in the manufacture of food supplements; vitamins for use in the manufacture of pharmaceuticals; vulcanization accelerators; vulcanizing preparations; wallpaper removing preparations; water-purifying chemicals; water-softening preparations; water glass [soluble glass]; wax-bleaching chemicals; welding chemicals; soldering chemicals; wine finings; witherite; wood alcohol; wood pulp; wood vinegar [pyroligneous acid]; pyroligneous acid [wood vinegar]; X-ray films, sensitized but not exposed; xenon; xylene; xylol; ytterbium; yttrium; zirconia.

4 – Additives, non-chemical, to motor fuel; alcohol [fuel]; anthracite; beeswax; beeswax for use in the manufacture of cosmetics; belting wax; benzene fuel; benzine; biomass fuel; bone oil for industrial purposes; candles; tapers; carburants; motor fuel; carnauba wax; castor oil for industrial purposes; ceresine; charcoal [fuel]; Christmas tree candles; coal; coal briquettes; coal dust [fuel]; coal naphtha; coal tar oil; coke; combustible briquettes; cutting fluids; diesel oil; gas oil; dust absorbing compositions; dust binding compositions for sweeping; dust laying compositions; dust removing preparations; electrical energy; ethanol [fuel]; firelighters; firewood; fish oil, not edible; fuel; fuel gas; fuel oil; combustible oil; fuel with an alcohol base; gas for lighting; grease for arms [weapons]; grease for belts; grease for footwear; grease for leather; greases for the preservation of leather; oils for lighting; illuminating wax; industrial grease; industrial oil; industrial wax; kerosene; lamp wicks; lanolin; wool grease; lanolin for use in the manufacture of cosmetics; lighting fuel; lignite; lignin; lubricants; lubricating graphite; lubricating grease; lubricating oil; mazut; methylated spirit; mineral fuel; moistening oil; motor oil; naphtha; nightlights [candles]; non-slipping preparations for belts; oil-gas; oils for paints; oils for releasing form work [building]; oils for the

preservation of leather; oils for the preservation of masonry; oleine; ozokerite; ozocerite; paper spills for lighting; paraffin; peat briquettes [fuel]; peat [fuel]; perfumed candles; petrol; gasoline; petroleum, raw or refined; petroleum ether; petroleum jelly for industrial purposes; producer gas; rape oil for industrial purposes; colza oil for industrial purposes; solidified gases [fuel]; soya bean oil preparations for non-stick treatment of cooking utensils; stearine; sunflower oil for industrial purposes; tallow; textile oil; tinder; vaporized fuel mixtures; wax for skis; wax [raw material]; wicks for candles; wood briquettes; wood spills for lighting; xylene fuel.

35 – Administration of consumer loyalty programs; administration of frequent flyer programs; administrative assistance in responding to calls for tenders; administrative assistance in responding to requests for proposals [RFPs]; administrative processing of purchase orders; advertising; publicity; advertising agency services; publicity agencies; advertising by mail order; advisory services for business management; appointment reminder services [office functions]; appointment scheduling services [office functions]; arranging newspaper subscriptions for others; arranging subscriptions to telecommunication services for others; auctioneering; bill-posting; book-keeping; accounting; business appraisals; business auditing; business efficiency expert services; business information; business inquiries; business intermediary services relating to the matching of potential private investors with entrepreneurs needing funding; business investigations; business management and organization consultancy; business management assistance; business management consultancy; business management for freelance service providers; business management of hotels; business management of performing artists; business management of reimbursement programs for others; business management of reimbursement programmes for others; business management of sports people; business organization consultancy; business project management services for construction projects; business research; commercial administration of the licensing of the goods and services of others; commercial information agency services; commercial information and advice for consumers in the choice of products and services; commercial intermediation services; commercial lobbying services; commercial or industrial management assistance; competitive intelligence services; compilation of information into computer databases; compilation of statistics; compiling indexes of information for commercial or advertising purposes; computerized file management; consultancy regarding advertising communication strategies; consultancy regarding public relations communication strategies; corporate communications services; cost price analysis; data search in computer files for others; demonstration of goods; development of advertising concepts; direct mail advertising; dissemination

of advertising matter; distribution of samples; drawing up of statements of accounts; economic forecasting; employment agency services; financial auditing; gift registry services; import-export agency services; interim business management; invoicing; layout services for advertising purposes; marketing; marketing in the framework of software publishing; marketing research; market intelligence services; market studies; media relations services; modelling for advertising or sales promotion; negotiation and conclusion of commercial transactions for third parties; negotiation of business contracts for others; news clipping services; office machines and equipment rental; online advertising on a computer network; online retail services for downloadable and pre-recorded music and movies; online retail services for downloadable digital music; online retail services for downloadable ring tones; opinion polling; organization of exhibitions for commercial or advertising purposes; organization of fashion shows for promotional purposes; organization of trade fairs for commercial or advertising purposes; outdoor advertising; outsourced administrative management for companies; outsourcing services [business assistance]; pay per click advertising; payroll preparation; personnel management consultancy; personnel recruitment; photocopying services; presentation of goods on communication media, for retail purposes; price comparison services; procurement services for others [purchasing goods and services for other businesses]; production of advertising films; production of teleshopping programmes; production of teleshopping programs; professional business consultancy; promotion of goods and services through sponsorship of sports events; providing business information via a web site; provision of an online marketplace for buyers and sellers of goods and services; provision of commercial and business contact information; psychological testing for the selection of personnel; publication of publicity texts; publicity material rental; public relations; radio advertising; registration of written communications and data; administrative services for the relocation of businesses; rental of advertising space; rental of advertising time on communication media; rental of billboards [advertising boards]; rental of office equipment in co-working facilities; rental of photocopying machines; rental of sales stands; rental of vending machines; retail services for pharmaceutical, veterinary and sanitary preparations and medical supplies; retail services for works of art provided by art galleries; sales promotion for others; scriptwriting for advertising purposes; search engine optimization for sales promotion; search engine optimisation for sales promotion; secretarial services; shop window dressing; shorthand; sponsorship search; systemization of information into computer databases; targeted marketing; tax filing services; tax preparation; telemarketing services; telephone answering for unavailable subscribers; television advertising; transcription of communications [office functions]; typing; upda-



technician services for events; microfilming; mobile library services; bookmobile services; modelling for artists; movie studio services; music composition services; news reporters services; nightclub services [entertainment]; nursery schools; online publication of electronic books and journals; orchestra services; organization of balls; organization of competitions [education or entertainment]; organization of cosplay entertainment events; organization of exhibitions for cultural or educational purposes; organization of fashion shows for entertainment purposes; organization of lotteries; organization of shows [impresario services]; organization of sports competitions; party planning [entertainment]; personal trainer services [fitness training]; photographic reporting; photography; physical education; practical training [demonstration]; presentation of circus performances; presentation of live performances; presentation of variety shows; production of music; production of radio and television programmes; production of shows; providing amusement arcade services; providing casino facilities [gambing]; providing films, not downloadable, via video-on-demand services; providing golf facilities; providing museum facilities [presentation, exhibitions]; providing online electronic publications, not downloadable; providing online music, not downloadable; providing online videos, not downloadable; providing recreation facilities; providing sports facilities; providing television programmes, not downloadable, via video-on-demand services; providing television programs, not downloadable, via video-on-demand services; publication of books; publication of texts, other than publicity texts; radio entertainment; recording studio services; recreation information; religious education; rental of artwork; rental of audio equipment; rental of cinematographic apparatus; rental of indoor aquaria; rental of lighting apparatus for theatrical sets or television studios; rental of motion pictures; rental of radio and television sets; rental of show scenery; rental of skin diving equipment; rental of sound recordings; rental of sports equipment, except vehicles; rental of sports grounds; rental of stadium facilities; rental of stage scenery; rental of tennis courts; rental of video cameras; rental of camcorders; rental of video cassette recorders; rental of videotapes; sado instruction [tea ceremony instruction]; screenplay writing; scriptwriting, other than for advertising purposes; sign language interpretation; songwriting; sound engineering services for events; sport camp services; subtitling; teaching; educational services; instruction services; television entertainment; theatre productions; ticket agency services [entertainment]; timing of sports events; toy rental; training services provided via simulators; translation; tutoring; video editing services for events; videotape editing; videotaping; vocational guidance [education or training advice]; vocational retraining; writing of texts; zoological garden services.

(260) AM 2021 109187 A  
 (800) 1542313  
 (151) 2020 06 01  
 (891) 2020 06 01  
 (731) Guangdong JINME Medical Technology Co., Ltd.  
 A15 Guangdong New Light Source Industrial Base, Luocun Langsha, Shishan Town, Nanhai District, Foshan, Guangdong, China

(540)



(591) Black, white  
 (531) 02.09.08; 26.11.01; 26.11.12  
 (511)  
 10 – Ear picks; scissors for surgery; forceps; dental apparatus and instruments; pins for artificial teeth; mirrors for dentists; dental burs; dental apparatus, electric; masks for use by medical personnel; medical apparatus and instruments.

(260) AM 2021 109265 A  
 (800) 1543327  
 (151) 2020 06 23  
 (891) 2020 06 23  
 (731) KMG International N.V.  
 Strawinskylaan 807, Tower A-8, NL-1077  
 XX Amsterdam, Netherlands

(540)



(591) Black, white  
 (531) 26.01.10; 26.15.25  
 (511)  
 35 – Advertising; business management; business administration; office functions; retail services in relation to fuels; office function; rental of advertising space; consumers (commercial information and advice for-) [consumer advice shop]; commercial information and commercial advice for consumers [consumer advice shop]; presentation of goods on communication media, for retail purposes; price comparison services; exhibitions (organization of-) for commercial or advertising purposes; public relations.

(260) AM 2021 109266 A  
(800) 1543343  
(151) 2020 04 30  
(891) 2020 04 30  
(731) Incyte Holdings Corporation  
1801 Augustine Cut-Off, Suite 3600,  
Wilmington DE 19803, USA  
(540)

## SOLVE ON

(591) Black, white  
(511)  
42 – Scientific and medical research relating to viral, hematological, oncological, auto-immune, inflammatory, metabolic, and dermatological disorders.  
44 – Providing information relating to viral, hematological, ontological, auto-immune, inflammatory, metabolic and dermatological disorders via a web site.

(260) AM 2021 109267 A  
(800) 1543384  
(151) 2020 03 31  
(891) 2020 03 31  
(731) GUANGZHOU ZIXI MANAGEMENT SERVICES CO., LTD.  
Suite 801, 379#, Shougouling Road, Tianhe District, Guangzhou, Guangdong, China  
(540)

# Cabbeen

(591) Black, white  
(531) 27.05.04  
(511)  
10 – Contraceptives; respiratory masks for artificial respiration; galvanic therapeutic appliances; gloves for medical purposes; eye massage instrument; thermometers for medical purposes; sanitary masks for medical purposes; sanitary masks; protective clothing for medical purpose; respiratory masks for medical purpose.

(260) AM 2021 109268 A  
(800) 1543398  
(151) 2020 02 18  
(891) 2020 02 18  
(731) Otkrytoe aktsionernoe obshchestvo "Minskiy molochny zavod №1"  
ul. Vokzalnaya 11, 223034 Zaslavl, Minskiy rayon, Belarus  
(540)



(591) Dark blue and white  
(531) 26.04.04; 26.04.05; 26.04.18; 26.04.24; 27.05.24; 29.01.12  
(511)  
29 – Ayran [fermented milk drink]; aloe vera prepared for human consumption; alginates for culinary purposes; anchovy, not live; peanuts, prepared; artichokes, preserved; acidophilus milk; albumen for culinary purposes; white of eggs; beans, preserved; soya beans, preserved, for food; bouillon; jam; ginger jam; ham; fatty substances for the manufacture of edible fats; laver, roasted; edible birds' nests; peas, preserved; mushrooms, preserved; game, not live; gelatin; meat jellies; jellies for food; fruit jellies; yolk of eggs; coconut fat; bone oil for food; lard; suet for food; edible fats; fruit-based snack food; charcuterie; raisins; caviar; eggplant paste; vegetable marrow paste; fish roe, prepared; yogurt; sauerkraut; kephir; isinglass for food; clams, not live; potato-based dumplings; milk shakes; black pudding; arrangements of processed fruit; compotes; meat, tinned; vegetables, tinned; fish, tinned; fruits, tinned; bouillon concentrates; gherkins; shrimps, not live; prawns, not live; buttercream; croquettes; silkworm chrysalis for human consumption; kumys; spiny lobsters, not live; lecithin for culinary purposes; salmon, not live; onions, preserved; margarine; oils for food; peanut butter; cocoa butter for food; coconut oil for food; coconut butter; corn oil for food; sesame oil for food; linseed oil for food; olive oil for food; palm oil for food; palm kernel oil for food; sunflower oil for food; colza oil for food; butter; clarified butter; shellfish, not live; almonds, ground; animal marrow for food; mussels, not live; milk; fermented baked milk; peanut milk for culinary purposes; goat's milk; almond milk for culinary purposes; sheep's milk; rice milk; condensed milk; soya milk; albumin milk; powdered milk; fish meal for human consumption; vegetable mousses; fish mousses; fruit pulp; meat; meat, preserved; milk beverages, milk predominating; lactic acid drinks; lactic acid drinks enriched with proteins; milk-based beverages containing fruit juice; frozen vegetables; vegetables, preserved; vegetables, cooked; vegetables, dried; potato fritters; olives, preserved; lobsters, not live; flavored nuts; candied nuts; coconut, desiccated; nuts, prepared; tomato puree; liver pate; pectin for culinary purposes; liver; pickles; jams; powdered eggs; milk products; fermented milk; food products made from fish; poultry, not live; curd; prostokvasha [soured milk]; bulgogi [Korean dish]; pollen prepared as foodstuff; cranberry compote; apple puree; crayfish, not live; crustaceans, not live; fish, preserved; fish, not live; salted fish; ryazhenka [fermented baked milk]; vegetable salads; fruit salads; bacon; sardines, not live; pork; herrings, not live; sunflower seeds, prepared; whipped cream; cream [dairy products]; fat-containing mixtures for bread slices; smetana; dried fruit mixes; snack mixes consisting of



processed fruits, processed nuts or raisins; vegetable juices for cooking; tomato juice for cooking; salted meats; sausages; sausages in batter; preparations for making bouillon; preparations for making soup; dairy-based spreads; tripe; soups; vegetable soup preparations; whey; smoked cheese; cheese spreads; cheese; cheese products, including processed ones; curd snacks; glazed curd cheese; tan [lactic acid drink]; tahini; tofu; cottage cheese; cereal curd, including fat-free and with greens; fruit preparations for cottage cheese, namely jams, preserves, marmalade; oysters, not live; milk ferments for culinary purposes; rennet; fish fillets; dates; crystallized fruits; frozen fruits; fruit, preserved; fruit, dried; fruit preserved in alcohol; fruit, stewed; hazelnuts, prepared; potato flakes; hummus; fruit peel; preserved garlic; lentils, preserved; potato chips; low-fat potato chips; fruit chips; non-alcoholic eggnog; seaweed extracts for food; meat extracts; berries, preserved; eggs; snail eggs for consumption; yakitori; peanut milk; almond milk.

30 – Aromatic preparations for food; vanilla flavorings for culinary purposes; flavorings, other than essential oils, for cakes; flavorings, other than essential oils, for beverages; coffee flavorings; food flavorings, other than essential oils; star aniseed; baozi; cereal bars; high-protein cereal bars; pancakes; freeze-dried dishes with the main ingredient being pasta; freeze-dried dishes with the main ingredient being rice; noodle-based prepared meals; buns; bread rolls; edible rice paper; edible paper; burritos; vanillin [vanilla substitute]; vareniki [stuffed dumplings]; waffles; vermicelli; natural sweeteners; sausage binding materials; binding agents for ice cream; sea water for cooking; seaweed [condiment]; malt biscuits; cloves [spice]; mirror icing [mirror glaze]; cake frosting [icing]; glucose for culinary purposes; mustard; gluten additives for culinary purposes; yeast; thickening agents for cooking foodstuffs; leaven; rice-based snack food; cereal-based snack food; vegetal preparations for use as coffee substitutes; artificial coffee; dressings for salad; fruit jellies [confectionery]; candy decorations for cakes; confectionery for decorating Christmas trees; cakes; pastries; peanut confectionery; almond confectionery; pasta; ginger; frozen yogurt [confectionery ices]; cocoa; cream of tartar for culinary purposes; capers; caramels [sweets]; curry [spice]; ketchup [sauce]; kimbap [Korean rice-based dish]; quiches; gluten prepared as foodstuff; flour-based dumplings; sweets; liquorice [confectionery]; peppermint sweets; dulce de leche; cinnamon [spice]; coffee; unroasted coffee; starch for food; crackers; custard; hominy grits; semolina; oatmeal; crushed barley; groats for human food; ice cubes; corn, milled; corn roasted; meat pies; turmeric; couscous; noodles; ice for refreshment; fruit drops [confectionery]; ice, natural or artificial; edible ices; rice cakes; mayonnaise; macarons; macaroni; maltose; hominy; piccalilli; marinades; marzipan; honey; royal jelly; ice cream;

bean meal; tapioca flour; potato flour; corn flour; nut flours; flour; wheat flour; soya flour; barley meal; dessert mousses [confectionery]; chocolate mousses; muesli; mint for confectionery; cocoa beverages with milk; coffee beverages with milk; coffee-based beverages; cocoa-based beverages; chamomile-based beverages; tea-based beverages; chocolate beverages with milk; chocolate-based beverages; infusions, not medicinal; crushed oats; husked oats; okonomiyaki [Japanese piquant pancakes]; onigiri; chocolate-coated nuts; nutmegs; stick liquorice [confectionery]; soybean paste; pastilles [confectionery]; molasses for food; pâtés en croûte; pelmeni; pepper; allspice; peppers [seasonings]; pesto; cookies; petit-beurre biscuits; bibimbap [rice mixed with vegetables and beef]; pies; pizzas; meat gravies; fondants [confectionery]; popcorn; powders for making ice cream; baking powder; mustard meal; pralines; condiments; meat tenderizers for household purposes; cereal preparations; oat-based food; propolis; gingerbread; spices; petits fours; puddings; rice pudding; cake powder; fruit coulis [sauces]; ravioli; ramen; chewing gum, not for medical purposes; relish [condiment]; rice; instant rice; wheat germ for human consumption; spring rolls; sago; sugar; palm sugar; sesame seeds [seasonings]; linseed for culinary purposes [seasoning]; processed seeds for use as a seasoning; aniseed; agave syrup [natural sweetener]; golden syrup; confectionery; batter mixes for okonomiyaki [Japanese piquant pancakes]; baking soda [bicarbonate of soda for cooking purposes]; malt for human consumption; ham glaze; soya sauce; tomato sauce; pasta sauce; sauces [condiments]; spaghetti; seasonings; chocolate-based spreads; chocolate spreads containing nuts; preparations for stiffening whipped cream; breadcrumbs; sushi; sandwiches; tabbouleh; tacos; tapioca; tarts; dough; pastry dough; almond paste; rice pulp for culinary purposes; cake dough; tortillas; garden herbs, preserved [seasonings]; chocolate decorations for cakes; vinegar; beer vinegar; ferments for pastes; halvah; bread; unleavened bread; bakery products; corn flakes; oat flakes; chips [cereal products]; hot dog sandwiches; flowers or leaves for use as tea substitutes; jiaozi; chicory [coffee substitute]; tea; iced tea; chutneys [condiments]; minced garlic [condiment]; cheeseburgers [sandwiches]; chow-chow [condiment]; saffron [seasoning]; chocolate; malt extract for food; essences for foodstuffs, except etheric essences and essential oils; husked barley.

32 – Aperitifs, non-alcoholic; lithia water; seltzer water; soda water; aerated water; mineral water [beverages]; waters [beverages]; table waters; kvass; cocktails, non-alcoholic; beer-based cocktails; lemonades; non-alcoholic beverages; isotonic beverages; non-alcoholic honey-based beverages; rice-based beverages, other than milk substitutes; soya-based beverages, other than milk substitutes; aloe vera drinks, non-alcoholic; whey beverages; protein-enriched

sports beverages; non- alcoholic beverages flavored with coffee; non-alcoholic beverages flavored with tea; non-alcoholic fruit juice beverages; fruit nectars, non-alcoholic; orgeat; beer; powders for effervescing beverages; sarsaparilla [non-alcoholic beverage]; syrups for lemonade; syrups for beverages; smoothies; vegetable juices [beverages]; fruit juices; tomato juice [beverage]; cider, non-alcoholic; preparations for making aerated water; non-alcoholic preparations for making beverages; must; grape must, unfermented; malt wort; pastilles for effervescing beverages; sherbets [beverages]; non-alcoholic fruit extracts; extracts of hops for making beer; non-alcoholic essences for making beverages.

---

(260) AM 2021 109269 A

(800) 1543401

(151) 2020 06 01

(891) 2020 06 01

(731) CHEN HONG

Room 305, #9 Qiangwei, Nanpu Street  
Bridgehead, Lucheng District, Wenzhou City,  
Zhejiang, China

(540)



(591) Black, white

(531) 26.04.09; 26.04.18; 26.04.19; 26.04.24;  
27.05.01; 27.05.24

(511)

21 – Basins [receptacles]; drying racks for laundry; toothbrushes; fitted vanity cases; vacuum bottles; stew-pans; cauldrons; glue-pots; knife rests for the table; dishes; tableware, other than knives, forks and spoons; cooking pots; griddles [cooking utensils]; grills [cooking utensils]; kitchen grinders, non-electric; mills for domestic purposes, hand-operated; pie servers; autoclaves, non-electric, for cooking; pressure cookers, non-electric; beaters, non-electric; kettles, non-electric; deep fryers, non-electric; kitchen utensils; hot pots, not electrically heated; glass flasks [containers]; porcelain ware; drinking vessels; coffee grinders, hand-operated; coffee services (tableware); coffeepots, non-electric.

---

**საერთაშორისო სასაქონლო ნიშნები,  
რომლებსაც მიენიჭათ დაცვა საქართველოში**

(260) AM 2021 94618 A  
(800) 1369852  
(151) 2017 08 08  
(181) 2027 08 08  
(891) 2017 08 08  
(511) 09

(260) AM 2021 106489 A  
(800) 1507662  
(151) 2019 11 15  
(181) 2029 11 15  
(891) 2019 11 15  
(511) 09

(260) AM 2021 99145 A  
(800) 976476  
(151) 2008 08 26  
(181) 2018 08 26  
(891) 2018 06 22  
(511) 12

(260) AM 2021 106490 A  
(800) 1507716  
(151) 2019 11 01  
(181) 2029 11 01  
(891) 2019 11 01  
(511) 05

(260) AM 2021 102867 A  
(800) 1462814  
(151) 2019 02 27  
(181) 2029 02 27  
(891) 2019 02 27  
(511) 30

(260) AM 2021 106533 A  
(800) 1507739  
(151) 2019 07 31  
(181) 2029 07 31  
(891) 2019 07 31  
(511) 09, 10, 44

(260) AM 2021 102982 A  
(800) 1464765  
(151) 2018 11 02  
(181) 2028 11 02  
(891) 2018 11 02  
(511) 07

(260) AM 2021 106534 A  
(800) 1507754  
(151) 2019 10 28  
(181) 2029 10 28  
(891) 2019 10 28  
(511) 09, 42

(260) AM 2021 105389 A  
(800) 1492806  
(151) 2019 08 02  
(181) 2029 08 02  
(891) 2019 08 02  
(511) 02, 17

(260) AM 2021 106547 A  
(800) 1508051  
(151) 2019 11 06  
(181) 2029 11 06  
(891) 2019 11 06  
(511) 31

(260) AM 2021 106476 A  
(800) 1507308  
(151) 2019 10 08  
(181) 2029 10 08  
(891) 2019 10 08  
(511) 05

(260) AM 2021 106548 A  
(800) 1508099  
(151) 2019 10 07  
(181) 2029 10 07  
(891) 2019 10 07  
(511) 05

(260) AM 2021 106488 A  
(800) 1507648  
(151) 2019 05 21  
(181) 2029 05 21  
(891) 2019 05 21  
(511) 03, 05, 09, 10, 16, 35, 41, 42, 44

(260) AM 2021 106561 A  
(800) 1508409  
(151) 2019 10 09  
(181) 2029 10 09  
(891) 2019 10 09  
(511) 38

(260) AM 2021 106563 A  
(800) 1508481  
(151) 2019 08 26  
(181) 2029 08 26  
(891) 2019 08 26  
(511) 29, 30, 32, 35

---

(260) AM 2021 106569 A  
(800) 1508565  
(151) 2019 06 21  
(181) 2029 06 21  
(891) 2019 06 21  
(511) 09, 35, 36, 38, 39, 42

---

(260) AM 2021 106570 A  
(800) 1508581  
(151) 2019 10 18  
(181) 2029 10 18  
(891) 2019 10 18  
(511) 35

---

(260) AM 2021 106571 A  
(800) 1508598  
(151) 2019 07 08  
(181) 2029 07 08  
(891) 2019 07 08  
(511) 29, 30, 32, 35, 39, 43

---

(260) AM 2021 106573 A  
(800) 1508651  
(151) 2019 10 25  
(181) 2029 10 25  
(891) 2019 10 25  
(511) 09, 42

---

(260) AM 2021 106574 A  
(800) 1508678  
(151) 2019 08 13  
(181) 2029 08 13  
(891) 2019 08 13  
(511) 03, 05, 10, 11, 16, 21, 24, 25, 37

---

(260) AM 2021 106575 A  
(800) 1508679  
(151) 2019 11 04  
(181) 2029 11 04  
(891) 2019 11 04  
(511) 06, 07, 19

---

(260) AM 2021 106576 A  
(800) 1508696  
(151) 2019 12 03  
(181) 2029 12 03  
(891) 2019 12 03

(511) 09

---

(260) AM 2021 106579 A  
(800) 1284608  
(151) 2015 11 18  
(181) 2025 11 18  
(891) 2019 12 20  
(511) 02, 03, 04

---

(260) AM 2021 106619 A  
(800) 1508923  
(151) 2019 07 19  
(181) 2029 07 19  
(891) 2019 07 19  
(511) 35, 36

---

(260) AM 2021 106620 A  
(800) 1508953  
(151) 2019 07 10  
(181) 2029 07 10  
(891) 2019 07 10  
(511) 29, 30

---

(260) AM 2021 106621 A  
(800) 1508985  
(151) 2019 12 03  
(181) 2029 12 03  
(891) 2019 12 03  
(511) 09

---

(260) AM 2021 106623 A  
(800) 1509078  
(151) 2019 08 02  
(181) 2029 08 02  
(891) 2019 08 02  
(511) 12

---

(260) AM 2021 106624 A  
(800) 1509107  
(151) 2019 11 22  
(181) 2029 11 22  
(891) 2019 11 22  
(511) 35, 42

---

(260) AM 2021 106625 A  
(800) 1509142  
(151) 2019 12 05  
(181) 2029 12 05  
(891) 2019 12 05  
(511) 25

---

(260) AM 2021 106626 A  
(800) 1509165  
(151) 2019 08 14

(181) 2029 08 14  
 (891) 2019 08 14  
 (511) 09, 10, 14, 17, 18, 25, 35, 41

(260) AM 2021 106637 A  
 (800) 1509394  
 (151) 2019 10 17  
 (181) 2029 10 17  
 (891) 2019 10 17  
 (511) 10

(260) AM 2021 106685 A  
 (800) 1509473  
 (151) 2019 11 26  
 (181) 2029 11 26  
 (891) 2019 11 26  
 (511) 05

(260) AM 2021 106686 A  
 (800) 1509475  
 (151) 2019 11 26  
 (181) 2029 11 26  
 (891) 2019 11 26  
 (511) 05

(260) AM 2021 106687 A  
 (800) 1509481  
 (151) 2019 12 03  
 (181) 2029 12 03  
 (891) 2019 12 03  
 (511) 09

(260) AM 2021 106688 A  
 (800) 1509499  
 (151) 2019 11 20  
 (181) 2029 11 20  
 (891) 2019 11 20  
 (511) 30, 32

(260) AM 2021 106689 A  
 (800) 1509522  
 (151) 2019 07 16  
 (181) 2029 07 16  
 (891) 2019 07 16  
 (511) 09

(260) AM 2021 106690 A  
 (800) 1509527  
 (151) 2019 11 26  
 (181) 2029 11 26  
 (891) 2019 11 26  
 (511) 05

(260) AM 2021 106691 A  
 (800) 1509530  
 (151) 2019 09 24  
 (181) 2029 09 24  
 (891) 2019 09 24  
 (511) 12

(260) AM 2021 106692 A  
 (800) 1509545  
 (151) 2019 11 26  
 (181) 2029 11 26  
 (891) 2019 11 26  
 (511) 05

(260) AM 2021 106693 A  
 (800) 1509551  
 (151) 2019 09 24  
 (181) 2029 09 24  
 (891) 2019 09 24  
 (511) 12

(260) AM 2021 106694 A  
 (800) 1509605  
 (151) 2019 07 17  
 (181) 2029 07 17  
 (891) 2019 07 17  
 (511) 09, 36, 42

(260) AM 2021 106695 A  
 (800) 1509627  
 (151) 2019 11 15  
 (181) 2029 11 15  
 (891) 2019 11 15  
 (511) 30

(260) AM 2021 106697 A  
 (800) 1509659  
 (151) 2019 10 04  
 (181) 2029 10 04  
 (891) 2019 10 04  
 (511) 07, 09, 35, 36, 37, 39, 40, 42

(260) AM 2021 106698 A  
 (800) 1509741  
 (151) 2019 06 25  
 (181) 2029 06 25  
 (891) 2019 06 25  
 (511) 11, 19, 20

(260) AM 2021 106699 A  
 (800) 1509757  
 (151) 2019 05 14  
 (181) 2029 05 14

(891) 2019 05 14  
(511) 29, 30

---

(260) AM 2021 106700 A  
(800) 1509761  
(151) 2019 10 23  
(181) 2029 10 23  
(891) 2019 10 23  
(511) 32

---

(260) AM 2021 106701 A  
(800) 1509762  
(151) 2019 10 23  
(181) 2029 10 23  
(891) 2019 10 23  
(511) 32

---

(260) AM 2021 106705 A  
(800) 1509807  
(151) 2019 11 26  
(181) 2029 11 26  
(891) 2019 11 26  
(511) 05

---

(260) AM 2021 106706 A  
(800) 1509835  
(151) 2019 11 15  
(181) 2029 11 15  
(891) 2019 11 15  
(511) 30

---

(260) AM 2021 106707 A  
(800) 1509851  
(151) 2019 11 19  
(181) 2029 11 19  
(891) 2019 11 19  
(511) 12

---

(260) AM 2021 106709 A  
(800) 1509860  
(151) 2019 11 26  
(181) 2029 11 26  
(891) 2019 11 26  
(511) 05

---

(260) AM 2021 106710 A  
(800) 1509868  
(151) 2019 09 17  
(181) 2029 09 17  
(891) 2019 09 17  
(511) 09

---

(260) AM 2021 106738 A  
(800) 1510358  
(151) 2019 08 09  
(181) 2029 08 09  
(891) 2019 08 09  
(511) 07, 12

---

(260) AM 2021 106739 A  
(800) 1510363  
(151) 2019 11 20  
(181) 2029 11 20  
(891) 2019 11 20  
(511) 18, 25

---

(260) AM 2021 106740 A  
(800) 227292  
(151) 1959 12 31  
(181) 2029 12 31  
(891) 2020 01 07  
(511) 05

---

(260) AM 2021 106744 A  
(800) 1301842  
(151) 2016 01 20  
(181) 2026 01 20  
(891) 2019 12 13  
(511) 03, 04, 08, 14, 16, 18, 21, 24, 25, 29, 32, 34,  
35, 43

---

(260) AM 2021 106745 A  
(800) 1312512  
(151) 2016 06 06  
(181) 2026 06 06  
(891) 2019 10 21  
(511) 28

---

(260) AM 2021 106835 A  
(800) 1510371  
(151) 2019 08 14  
(181) 2029 08 14  
(891) 2019 08 14  
(511) 03, 07, 09, 11, 35, 37, 39

---

(260) AM 2021 106836 A  
(800) 1510382  
(151) 2019 12 05  
(181) 2029 12 05  
(891) 2019 12 05  
(511) 25

---

(260) AM 2021 106837 A  
(800) 1510386  
(151) 2019 11 19  
(181) 2029 11 19

(891) 2019 11 19  
(511) 03

---

(260) AM 2021 106838 A  
(800) 1510390  
(151) 2019 12 06  
(181) 2029 12 06  
(891) 2019 12 06  
(511) 03, 05, 35, 44

---

(260) AM 2021 106839 A  
(800) 1510401  
(151) 2019 11 26  
(181) 2029 11 26  
(891) 2019 11 26  
(511) 05

---

(260) AM 2021 106840 A  
(800) 1510402  
(151) 2019 11 26  
(181) 2029 11 26  
(891) 2019 11 26  
(511) 05

---

(260) AM 2021 106841 A  
(800) 1510403  
(151) 2019 11 26  
(181) 2029 11 26  
(891) 2019 11 26  
(511) 05

---

(260) AM 2021 106843 A  
(800) 1510405  
(151) 2019 11 26  
(181) 2029 11 26  
(891) 2019 11 26  
(511) 05

---

(260) AM 2021 106844 A  
(800) 1510412  
(151) 2019 11 20  
(181) 2029 11 20  
(891) 2019 11 20  
(511) 07, 09, 11, 12, 28, 42

---

(260) AM 2021 106845 A  
(800) 1510414  
(151) 2019 11 11  
(181) 2029 11 11  
(891) 2019 11 11  
(511) 03, 08, 10, 16, 17, 20, 21, 22, 25

---

(260) AM 2021 106846 A  
(800) 1510417  
(151) 2019 09 16  
(181) 2029 09 16  
(891) 2019 09 16  
(511) 03

---

(260) AM 2021 106847 A  
(800) 1510421  
(151) 2019 11 05  
(181) 2029 11 05  
(891) 2019 11 05  
(511) 09, 36, 42

---

(260) AM 2021 106849 A  
(800) 1510484  
(151) 2019 10 02  
(181) 2029 10 02  
(891) 2019 10 02  
(511) 10, 35, 44

---

(260) AM 2021 106860 A  
(800) 1510789  
(151) 2019 12 16  
(181) 2029 12 16  
(891) 2019 12 16  
(511) 07

---

(260) AM 2021 106861 A  
(800) 1510827  
(151) 2019 12 16  
(181) 2029 12 16  
(891) 2019 12 16  
(511) 18, 25, 35

---

(260) AM 2021 106862 A  
(800) 1510833  
(151) 2019 12 05  
(181) 2029 12 05  
(891) 2019 12 05  
(511) 05

---

(260) AM 2021 106863 A  
(800) 1510846  
(151) 2019 12 16  
(181) 2029 12 16  
(891) 2019 12 16  
(511) 14

---

(260) AM 2021 106864 A  
(800) 1510853  
(151) 2019 10 23  
(181) 2029 10 23

(891) 2019 10 23  
(511) 08, 21

---

(260) AM 2021 106865 A  
(800) 1510891  
(151) 2019 12 20  
(181) 2029 12 20  
(891) 2019 12 20  
(511) 34

---

(260) AM 2021 106866 A  
(800) 1510892  
(151) 2019 12 16  
(181) 2029 12 16  
(891) 2019 12 16  
(511) 14

---

(260) AM 2021 106867 A  
(800) 1510902  
(151) 2019 12 25  
(181) 2029 12 25  
(891) 2019 12 25  
(511) 35

---

(260) AM 2021 106868 A  
(800) 1510903  
(151) 2019 12 11  
(181) 2029 12 11  
(891) 2019 12 11  
(511) 05

---

(260) AM 2021 106869 A  
(800) 1510937  
(151) 2019 08 15  
(181) 2029 08 15  
(891) 2019 08 15  
(511) 35, 37, 41, 42

---

(260) AM 2021 106888 A  
(800) 1511279  
(151) 2019 12 17  
(181) 2029 12 17  
(891) 2019 12 17  
(511) 09

---

(260) AM 2021 106889 A  
(800) 1511328  
(151) 2019 12 05  
(181) 2029 12 05  
(891) 2019 12 05  
(511) 05

---

(260) AM 2021 106906 A  
(800) 1511698  
(151) 2019 11 26  
(181) 2029 11 26  
(891) 2019 11 26  
(511) 25

---

(260) AM 2021 106986 A  
(800) 1512466  
(151) 2019 11 01  
(181) 2029 11 01  
(891) 2019 11 01  
(511) 01, 03

---

(260) AM 2021 106999 A  
(800) 1512871  
(151) 2019 07 05  
(181) 2029 07 05  
(891) 2019 07 05  
(511) 09

---

(260) AM 2021 107006 A  
(800) 1513101  
(151) 2019 06 20  
(181) 2029 06 20  
(891) 2019 06 20  
(511) 07, 09, 12, 35, 36, 37, 42, 45

---

(260) AM 2021 107007 A  
(800) 1513108  
(151) 2019 12 17  
(181) 2029 12 17  
(891) 2019 12 17  
(511) 29

---

(260) AM 2021 107026 A  
(800) 1438256  
(151) 2018 05 21  
(181) 2028 05 21  
(891) 2019 12 26  
(511) 05

---

(260) AM 2021 107027 A  
(800) 1446953  
(151) 2018 11 14  
(181) 2028 11 14  
(891) 2019 12 28  
(511) 43

---

(260) AM 2021 107028 A  
(800) 1510727  
(151) 2019 11 07  
(181) 2029 11 07



(891) 2020 01 23  
(511) 29, 30, 35

---

(260) AM 2021 107069 A  
(800) 1513400  
(151) 2019 09 30  
(181) 2029 09 30  
(891) 2019 09 30  
(511) 09, 28

---

(260) AM 2021 107070 A  
(800) 1513421  
(151) 2019 12 30  
(181) 2029 12 30  
(891) 2019 12 30  
(511) 09, 36

---

(260) AM 2021 107071 A  
(800) 1513441  
(151) 2019 10 09  
(181) 2029 10 09  
(891) 2019 10 09  
(511) 29, 30, 43

---

(260) AM 2021 107072 A  
(800) 1513469  
(151) 2019 12 19  
(181) 2029 12 19  
(891) 2019 12 19  
(511) 06

---

(260) AM 2021 107073 A  
(800) 1513506  
(151) 2018 12 19  
(181) 2028 12 19  
(891) 2018 12 19  
(511) 09, 28

---

(260) AM 2021 107074 A  
(800) 1513512  
(151) 2019 10 02  
(181) 2029 10 02  
(891) 2019 10 02  
(511) 41

---

(260) AM 2021 107075 A  
(800) 1513523  
(151) 2019 11 20  
(181) 2029 11 20  
(891) 2019 11 20  
(511) 05

---

(260) AM 2021 107089 A  
(800) 1514040  
(151) 2019 12 18  
(181) 2029 12 18  
(891) 2019 12 18  
(511) 30

---

(260) AM 2021 107090 A  
(800) 1514043  
(151) 2019 11 27  
(181) 2029 11 27  
(891) 2019 11 27  
(511) 07, 35

---

(260) AM 2021 107146 A  
(800) 1501333  
(151) 2019 10 17  
(181) 2029 10 17  
(891) 2020 01 17  
(511) 29, 30

---

(260) AM 2021 107186 A  
(800) 1514818  
(151) 2019 11 21  
(181) 2029 11 21  
(891) 2019 11 21  
(511) 05, 35

---

(260) AM 2021 107188 A  
(800) 1514820  
(151) 2019 12 16  
(181) 2029 12 16  
(891) 2019 12 16  
(511) 30

---

(260) AM 2021 107189 A  
(800) 1514821  
(151) 2019 12 16  
(181) 2029 12 16  
(891) 2019 12 16  
(511) 30

---

(260) AM 2021 107190 A  
(800) 1514822  
(151) 2019 12 16  
(181) 2029 12 16  
(891) 2019 12 16  
(511) 30

---

(260) AM 2021 107191 A  
(800) 1514823  
(151) 2019 12 10  
(181) 2029 12 10

(891) 2019 12 10  
(511) 18, 25

---

(260) AM 2021 107193 A  
(800) 1514924  
(151) 2019 12 16  
(181) 2029 12 16  
(891) 2019 12 16  
(511) 30

---

(260) AM 2021 107194 A  
(800) 1514947  
(151) 2019 12 16  
(181) 2029 12 16  
(891) 2019 12 16  
(511) 30

---

(260) AM 2021 107195 A  
(800) 1514981  
(151) 2020 01 13  
(181) 2030 01 13  
(891) 2020 01 13  
(511) 09, 11

---

(260) AM 2021 107324 A  
(800) 1516527  
(151) 2019 12 18  
(181) 2029 12 18  
(891) 2019 12 18  
(511) 17, 19

---

(260) AM 2021 107325 A  
(800) 1516534  
(151) 2019 12 18  
(181) 2029 12 18  
(891) 2019 12 18  
(511) 17, 19

---

(260) AM 2021 107327 A  
(800) 1516539  
(151) 2019 10 01  
(181) 2029 10 01  
(891) 2019 10 01  
(511) 01, 05, 31, 44

---

(260) AM 2021 107419 A  
(800) 1517896  
(151) 2019 10 29  
(181) 2029 10 29  
(891) 2019 10 29  
(511) 30, 33, 35, 43

---

(260) AM 2021 107421 A  
(800) 1518006  
(151) 2019 09 30  
(181) 2029 09 30  
(891) 2019 09 30  
(511) 20

---

(260) AM 2021 107423 A  
(800) 1518079  
(151) 2019 11 01  
(181) 2029 11 01  
(891) 2019 11 01  
(511) 05

---

(260) AM 2021 107427 A  
(800) 1518163  
(151) 2019 10 10  
(181) 2029 10 10  
(891) 2019 10 10  
(511) 11, 17, 20, 21

---

(260) AM 2021 107428 A  
(800) 1518178  
(151) 2019 09 18  
(181) 2029 09 18  
(891) 2019 09 18  
(511) 19, 20

---

(260) AM 2021 107429 A  
(800) 1518203  
(151) 2019 10 04  
(181) 2029 10 04  
(891) 2019 10 04  
(511) 21

---

(260) AM 2021 107431 A  
(800) 1518267  
(151) 2020 02 01  
(181) 2030 02 01  
(891) 2020 02 01  
(511) 09

---

(260) AM 2021 107542 A  
(800) 1356943  
(151) 2016 11 15  
(181) 2026 11 15  
(891) 2020 01 21  
(511) 10, 11, 21, 27, 28

---

(260) AM 2021 107543 A  
(800) 1362620  
(151) 2017 05 05  
(181) 2027 05 05

(891) 2020 01 30  
(511) 43

---

(260) AM 2021 107544 A  
(800) 1380445  
(151) 2017 09 25  
(181) 2027 09 25  
(891) 2020 01 30  
(511) 43

---

(260) AM 2021 107545 A  
(800) 1401020  
(151) 2017 11 07  
(181) 2027 11 07  
(891) 2020 01 31  
(511) 09, 16, 25, 28, 41

---

(260) AM 2021 107546 A  
(800) 1465399  
(151) 2019 01 14  
(181) 2029 01 14  
(891) 2020 01 27  
(511) 25, 35

---

(260) AM 2021 107547 A  
(800) 1517728  
(151) 2020 02 03  
(181) 2030 02 03  
(891) 2020 02 21  
(511) 43

---

(260) AM 2021 107592 A  
(800) 1520096  
(151) 2020 02 17  
(181) 2030 02 17  
(891) 2020 02 17  
(511) 12

---

(260) AM 2021 107603 A  
(800) 1520444  
(151) 2019 10 26  
(181) 2029 10 26  
(891) 2019 10 26  
(511) 21, 35

---

(260) AM 2021 107635 A  
(800) 1521286  
(151) 2020 02 07  
(181) 2030 02 07  
(891) 2020 02 07  
(511) 03

---

(260) AM 2021 107640 A  
(800) 959852  
(151) 2008 02 20  
(181) 2028 02 20  
(891) 2019 10 29  
(511) 32

---

(260) AM 2021 107642 A  
(800) 1126123  
(151) 2012 04 12  
(181) 2022 04 12  
(891) 2020 02 06  
(511) 05

---

(260) AM 2021 107735 A  
(800) 1522566  
(151) 2020 01 08  
(181) 2030 01 08  
(891) 2020 01 08  
(511) 09, 25

---

(260) AM 2021 107736 A  
(800) 1522570  
(151) 2019 10 28  
(181) 2029 10 28  
(891) 2019 10 28  
(511) 07, 12

---

(260) AM 2021 107737 A  
(800) 1522584  
(151) 2019 09 17  
(181) 2029 09 17  
(891) 2019 09 17  
(511) 03, 05, 16, 20, 21, 35, 39, 42, 44

---

(260) AM 2021 107738 A  
(800) 1522597  
(151) 2019 12 19  
(181) 2029 12 19  
(891) 2019 12 19  
(511) 09

---

(260) AM 2021 107740 A  
(800) 1522643  
(151) 2020 02 18  
(181) 2030 02 18  
(891) 2020 02 18  
(511) 43

---

(260) AM 2021 107741 A  
(800) 1522678  
(151) 2019 12 27  
(181) 2029 12 27

(891) 2019 12 27  
(511) 07, 12, 37

---

(260) AM 2021 107742 A  
(800) 475751  
(151) 1983 04 07  
(181) 2023 04 07  
(891) 2020 02 10  
(511) 14

---

(260) AM 2021 107744 A  
(800) 1126518  
(151) 2012 06 19  
(181) 2022 06 19  
(891) 2020 03 10  
(511) 03

---

---

# ოზიციალური შეტყობინებები ბამობონებები

## პატენტების მოქმედების აღდგენა

(21) AP 2007 11265  
(11) P 2012 5568 B  
(73) ტაკედა ფარმასეუტიკალ კომპანი ლიმიტიდ  
(54) მიტასტინის წარმოებულები და მათი გამოყენება  
პატენტის გაუქმების თარიღი: 2020 10 24  
პატენტის მოქმედების აღდგენის თარიღი: 2021 02 25

---

(21) AP 2014 14088  
(11) P 2018 6904 B  
(73) კრისტალ ლაგუნს (კურასაო) ბ.ვ.  
(54) მოტივტივი ხელოვნური ტბა და ამ ტბაში წყლის დამუშავების ხერხი  
პატენტის გაუქმების თარიღი: 2020 11 04  
პატენტის მოქმედების აღდგენის თარიღი: 2021 02 25

---

(21) AP 2014 14152  
(11) P 2018 6854 B  
(73) კრისტალ ლაგუნს (კურასაო) ბ.ვ.  
(54) შიმწოვი მოწყობილობა დიდი ხელოვნური წყალსატევებისათვის  
პატენტის გაუქმების თარიღი: 2020 11 12  
პატენტის მოქმედების აღდგენის თარიღი: 2021 02 25

---

## პატენტების გაუქმება აღდგენის უფლებით

(21) AP 2014 13369  
(11) P 2015 6323 B  
(73) ავთანდილ თევდორაძე  
(54) ზურბსაკიდი სასხურბელი აპარატი  
პატენტის გაუქმების თარიღი: 2021 01 31  
პატენტის მოქმედების აღდგენის ზღვრული თარიღი: 2022 01 31

---

(21) AP 2015 13724  
(11) P 2016 6563 B  
(73) ვლადიმერ ლოლაძე;  
ვახტანგ ლოლაძე;  
გიორგი ლოლაძე ;  
ნინო ლოლაძე  
(54) მოწყობილობა ხანძრის ჩასაქრობად და დაზიანებული ჯაჭურლილის პირიდან  
ან მილსადენიდან გამონატყორცნი ენერგომატარებლების ასარიცხვად  
პატენტის გაუქმების თარიღი: 2021 02 05  
პატენტის მოქმედების აღდგენის ზღვრული თარიღი: 2022 02 05

---

## პატენტის მოქმედების აღდგენის ვადის ამოწურვა

(21) AP 2010 12356

(11) P 2013 5960 B

(73) ლე ლაბორატუარ სერვიე

(54) ივარაღების და მისი ვარგისი მასალის მისაღები მშავა - ალიტიური მარილების სინთეზის ახალი ხერხი

პატენტის გაუქმების თარიღი: 2020 02 03

პატენტის მოქმედების აღდგენის ვადის ამოწურვის თარიღი: 2021 02 03

---

(21) AP 2010 12363

(11) P 2014 6004 B

(73) ტაკედა ფარმასიუტიკალ კომპანი ლიმიტიდ

(54) პირიდოლინური ნაერთები

პატენტის გაუქმების თარიღი: 2020 02 04

პატენტის მოქმედების აღდგენის ვადის ამოწურვის თარიღი: 2021 02 04

---

(21) AP 2013 13566

(11) P 2017 6688 B

(73) სენეკს ბიოტექნოლოჯი ინკ.

(54) CDK8/CDK19 სელექტიური ინჰიბიტორები და მათი გამოყენება ანტიმეტასტაზურ და კიბოს ქიმიოთერაპიულ ხერხებში

პატენტის გაუქმების თარიღი: 2020 02 01

პატენტის მოქმედების აღდგენის ვადის ამოწურვის თარიღი: 2021 02 01

---

(21) AP 2013 14080

(11) P 2018 6818 B

(73) სენეკს ბიოტექნოლოჯი ინკ.

(54) CDK8/CDK19 სელექტიური ინჰიბიტორები და მათი გამოყენება ანტი-მეტასტაზურ საშუალებად და კიბოს ქიმიოთერაპიულ ხერხებში

პატენტის გაუქმების თარიღი: 2020 02 01

პატენტის მოქმედების აღდგენის ვადის ამოწურვის თარიღი: 2021 02 01

---

(21) AP 2017 14403

(11) P 2019 7001 B

(54) ბეტონის ნარევის მომზადების ხერხი

პატენტის გაუქმების თარიღი: 2020 02 02

პატენტის მოქმედების აღდგენის ვადის ამოწურვის თარიღი: 2021 02 02

---

(21) AP 2017 14405

(11) P 2019 7002 B

(73) სსიპ საქართველოს ტექნიკური უნივერსიტეტი

(54) ავტომატის და მიწისხედა ნაბეჭდების საფუძვლების მშენებლობის ხერხი

პატენტის გაუქმების თარიღი: 2020 02 02

პატენტის მოქმედების აღდგენის ვადის ამოწურვის თარიღი: 2021 02 02

---

## პატენტების მოქმედების ვადის ამოწურვა

(21) AP 2011 12103  
(73) ზურაბ ადამია  
(11) P 2012 1694 B  
(54) ელექტრული წინაღობის გაზომვის ხერხი  
პატენტის მოქმედების ვადის ამოწურვის თარიღი: 11 02 2021

---

(21) AP 2001 6569  
(73) ეუროსელტიკ ს.ა. (LU)  
(11) P 2005 3614 B  
(54) ოპიოიდ აბონისტის შემცველი ორალური შემადგენლობები  
პატენტის მოქმედების ვადის ამოწურვის თარიღი: 08 02 2021

---

(21) AP 2001 6585  
(73) პრაიზერ პროდაქტს ინკ.  
(11) P 2005 3454 B  
(54) არილ-შეუღლებული აზაპოლიციკლური ნაერთები, მათი შემცველი ფარმაცევტული კომპოზიციები და გამოყენება  
პატენტის მოქმედების ვადის ამოწურვის თარიღი: 08 02 2021

---

## სასარბებლო მოდელები პატენტების მოქმედების აღდგენა

(21) AU 2015 14021  
(11) U 2016 1914 Y  
(73) შექსპირ იუსუფოვი;  
დანიელ იოსებაშვილი;  
მუხრან ბედიანიძე  
(54) კურის წარმოების ხერხი  
პატენტის გაუქმების თარიღი: 2020 12 21  
პატენტის მოქმედების აღდგენის თარიღი: 2021 02 25

---

(21) AU 2016 14374  
(11) U 2017 1951 Y  
(73) ლევან ალექსიშვილი  
(54) ტელესაკომუნიკაციო სისტემა საკვები და სამომხმარებლო პროდუქტების შექმნისა და აღბილწე მიწოდების განსახორციელებლად  
პატენტის გაუქმების თარიღი: 2020 12 30  
პატენტის მოქმედების აღდგენის თარიღი: 2021 02 25

---

(21) AU 2017 14407  
(11) U 2018 1982 Y  
(73) გიორგი ხმიადაშვილი  
(54) ხილისა და ბოსტნეულის საშრობი დანაღბარი  
პატენტის გაუქმების თარიღი: 2021 02 03  
პატენტის მოქმედების აღდგენის თარიღი: 2021 02 25

---

(21) AU 2019 14990  
(11) U 2020 2045 Y  
(73) პაატა გოგოლაძე  
(54) ბადე-ძეოვილის დამზადების ხერხი ასფალტბეტონის დასაარმატებლად  
პატენტის გაუქმების თარიღი: 2021 01 25  
პატენტის მოქმედების აღდგენის თარიღი: 2021 02 25

---

### პატენტების გაუქმება აღდგენის უფლებით

(21) AU 2017 14407  
(11) U 2018 1982 Y  
(73) გიორგი ხმიადაშვილი  
(54) ხილისა და ბოსტნეულის საშრობი დანაღბარი  
პატენტის გაუქმების თარიღი: 2021 02 03  
პატენტის მოქმედების აღდგენის ზღვრული თარიღი: 2023 02 03

---

(21) AU 2019 14990  
(11) U 2020 2045 Y  
(73) პაატა გოგოლაძე  
(54) ბადე-ძეოვილის დამზადების ხერხი ასფალტბეტონის დასაარმატებლად  
პატენტის გაუქმების თარიღი: 2021 01 25  
პატენტის მოქმედების აღდგენის ზღვრული თარიღი: 2023 01 25

---

### პატენტების მოქმედების აღდგენის ვადის ამოწურვა

(21) AU 2016 14047  
(11) U 2018 1984 Y  
(73) სსიპ რაფიელ დვალის მანქანათა მექანიკის ინსტიტუტი  
(54) კოლიმერული კომპოზიტი  
პატენტის გაუქმების თარიღი: 2020 01 29  
პატენტის მოქმედების აღდგენის ვადის ამოწურვის თარიღი: 2021 01 29

---



(21) AU 2016 14050

(11) U 2017 1956 Y

(73) იამზე ბეშვენაძე

(54) ხელატური თუთიის გამოყენება ვერმიკულტივირებაში

პატენტის გაუქმების თარიღი: 2020 02 02

პატენტის მოქმედების აღდგენის ვადის ამოწურვის თარიღი: 2021 02 02

## უფლების გადაცემა

(21) AU 2018 14892

(11) U 2019 2014 Y

(54) ეპილეუსიის სამკურნალო საშუალება

ახალი პატენტმფლობელი და მისამართი: მარინე ნიკოლაიშვილი (GE)

შევარდენიძის ქ. 9, ბ. 13, 0164, თბილისი, საქართველო (GE);

სოფიო კასრაძე (GE)

ი. ჭავჭავაძის გამზ. 37დ, ბ. 48, 0186, თბილისი,

საქართველო (GE);

ბესო ნანობაშვილი (GE)

ვაჟა-ფშაველას გამზ., V კვარტ., კორპ. 32, ბ. 6, თბილისი,

საქართველო (GE);

ნოდარ მითაგვარია (GE)

სააკაძის ქ. 32ბ, თბილისი, საქართველო (GE);

ნარგიზ ნაჭყებია (GE)

უზნაძის ქ. 12, თბილისი, საქართველო (GE)

ყოფილი პატენტმფლობელი და მისამართი: სოფიო კასრაძე (GE)

ი. ჭავჭავაძის გამზ. 37დ, ბ. 48, 0186, თბილისი,

საქართველო (GE);

მარინე ნიკოლაიშვილი (GE)

შევარდენიძის ქ. 9, ბ. 13, 0164, თბილისი, საქართველო (GE)

რეესტრში შეტანის თარიღი: 16 02 2021

## დიზაინები

### დიზაინის რეგისტრაციის გაუქმება

(11) D 2015 640 S

(73) ჰარინგტონ დეველოპმენტ ინკ. (PA)

ელვირა მენდესის სტრიტი, ვალერიინო ზლდგ, მე-3 სართული, პანამა, პანამის რესპუბლიკა (PA)

(54) სიზარპტი

(18) 2020 07 29

(58) 2021 02 09

---

### საერთაშორისო დიზაინების რეგისტრაციის მოქმედების გაუქმება

(11) DM/65715

(73) DAIMLERCHRYSLER AG

Epplestrasse 225, 70567 Stuttgart (DE)

რეგისტრაციის მოქმედების გაუქმების თარიღი: 2019 08 17

(58) 2021 02 03

---

(11) DM/65832

(73) DAIMLERCHRYSLER AG

Epplestrasse 225 70567 Stuttgart (DE)

რეგისტრაციის მოქმედების გაუქმების თარიღი: 2019 09 08

(58) 2021 02 03

---

(11) DM/66264

(73) DAIMLERCHRYSLER AG

Epplestrasse 225, 70567 Stuttgart (DE)

რეგისტრაციის მოქმედების გაუქმების თარიღი: 2020 01 18

(58) 2021 02 03

---

(11) DM/66459

(73) SARA LEE HOUSEHOLD AND BODY CARE NEDERLAND B.V.,

Traverse 2, NL-3905 NL Veenendaal (NL)

რეგისტრაციის მოქმედების გაუქმების თარიღი: 2020 03 02

(58) 2021 02 03

---

(11) DM/72335

(73) SWATCH AG (SWATCH SA) (SWATCH LTD.)

Jakob-Stämpfli-Strasse 94, CH-2502 Biel/Bienne (CH)

რეგისტრაციის მოქმედების გაუქმების თარიღი: 2019 09 23

(58) 2021 02 03

---

## სასაქონლო ნიშნები

### რეგისტრაციის მოქმედების ვადის გაგრძელება

(111) M 2000 13544 R2  
 (156) 2000 10 27  
 (186) 2030 10 27  
 (732) მედესინ სან ფრონტიერ ინტერნასიონალ  
 რიუ დე ლოზან 78, სპ 116, CH-1211  
 ქენევა 21, შვეიცარია

(111) M 2001 13806 R2  
 (156) 2001 03 02  
 (186) 2031 03 02  
 (732) ზე ჯილლეტტ კომპანი ლლკ  
 უან ჯილლეტტ პარკ, ბოსტონი,  
 მასაჩუსეტსი 02127, აშშ

(111) M 2001 13758 R2  
 (156) 2001 02 20  
 (186) 2031 02 20  
 (732) პლეიბოი ენტერპრაიზის ინტერნეშ-  
 ნელ ინკ.  
 10960 უილშირ ბულვარ, სუიტი 2200,  
 ლოს-ანჯელესი, კალიფორნია 90024,  
 აშშ

(111) M 2001 13842 R2  
 (156) 2001 04 04  
 (186) 2031 04 04  
 (732) დალი-ვერკე გმბჰ & კო. კგ  
 ცვაიფალერ შტრასე 120, 52224  
 შტოლბერგი, გერმანია

(111) M 2001 13726 R2  
 (156) 2001 02 20  
 (186) 2031 02 20  
 (732) იუროპიენ ტობაკო ინკ.  
 პალმ ჩემბერს 3, როუდ-ტაუნი,  
 ტორტოლა, ვირჯინის კუნძულები  
 (ბრიტანეთის)

(111) M 2001 13866 R2  
 (156) 2001 05 29  
 (186) 2031 05 29  
 (732) ჯოვან კროპ პროტეკშენ ლიმიტიდ  
 ჰაილენდ ჰაუზ ბესინგსტოუკ როუდ  
 სპენსერს ვუდ რიდინგი, ბერკშირი,  
 ინგლისი RG7 1NT, გაერთიანებული  
 სამეფო

(111) M 2001 13802 R2  
 (156) 2001 03 02  
 (186) 2031 03 02  
 (732) ზე ჯილლეტტ კომპანი ლლკ  
 უან ჯილლეტტ პარკ, ბოსტონი,  
 მასაჩუსეტსი 02127, აშშ

(111) M 2001 13854 R2  
 (156) 2001 05 29  
 (186) 2031 05 29  
 (732) ჯოვან კროპ პროტეკშენ ლიმიტიდ  
 ჰაილენდ ჰაუზ ბესინგსტოუკ როუდ  
 სპენსერს ვუდ რიდინგი, ბერკშირი,  
 ინგლისი RG7 1NT, გაერთიანებული  
 სამეფო

(111) M 2001 13805 R2  
 (156) 2001 03 02  
 (186) 2031 03 02  
 (732) კოლგეიტ-პალმოლივ კომპანი  
 300 პარკ ავენიუ, ნიუ-იორკი,  
 NY 10022, აშშ

(111) M 2001 14106 R2  
 (156) 2001 10 18  
 (186) 2031 10 18  
 (732) გლაქსო გრუპ ლიმიტიდ  
 980 გრიტ უესტ როუდი, ბრენტფორდი,  
 მიდლსექსი TW8 9GS, გაერთიანებული  
 სამეფო

(111) M 2001 14129 R2  
(156) 2001 10 31  
(186) 2031 10 31  
(732) გლაქსო გრუპ ლიმიტიდ  
980 გრიტ უესტ როუდი, ბრენტფორდი,  
მიდლსექსი TW8 9GS, გაერთიანებული  
სამეფო

(111) M 2001 14188 R2  
(156) 2001 12 13  
(186) 2031 12 13  
(732) გლაქსო გრუპ ლიმიტიდ  
980 გრიტ უესტ როუდი, ბრენტფორდი,  
მიდლსექსი TW8 9GS, გაერთიანებული  
სამეფო

(111) M 2002 14291 R2  
(156) 2002 02 18  
(186) 2032 02 18  
(732) ვმ. ვრიგლი ჯრ. კომპანი  
1132 ვესტ ბლექჰოლმ სტრიტი, ჩიკაგო,  
ილინოისი 60642, აშშ

(111) M 2011 21301 R1  
(156) 2011 03 24  
(186) 2031 03 24  
(732) ექსელთის ილაჩ სანაი ვე თიჯარეთ  
ანონიმ შირქეთი  
მასლაქ მაჰალესი, სუმერ სოქაქ აიაზადა  
თიჯარეთ მერქეზი No: 3/9 TR-34398  
სარიერი/ სტამბოლი, თურქეთი

(111) M 2011 21168 R1  
(156) 2011 02 24  
(186) 2031 02 24  
(732) ელგუჯა გვილავა  
ი. პეტრიწის ქ. 6, ბ. 62, 0131, თბილისი,  
საქართველო

(111) M 2010 20767 R1  
(156) 2010 09 24  
(186) 2030 09 24  
(732) უორლდ მედისინ ლიმიტიდ  
ქომონველს ტრასტ ლიმიტიდ, დრეიკ  
ჩეიმბერს, ტორტოლა, ვირჯინის  
კუნძულები (ბრიტანეთის)

(111) M 2010 20666 R1  
(156) 2010 08 16  
(186) 2030 08 16  
(732) ბოსნალიჟეკი, ფარმაციუტიკალ ენდ  
ქემიკალ ინდასტრი, ჯოინტ სტოკ  
კომპანი  
71000 სარაევო, ყუკიჩევა 53, ბოსნია  
და ჰერცეგოვინა

(111) M 2010 20980 R1  
(156) 2010 12 13  
(186) 2030 12 13  
(732) შპს „სააფთიაქო სახლი“  
ტაშკენტის ქ. 22, 0160, თბილისი,  
საქართველო

(111) M 2010 20981 R1  
(156) 2010 12 13  
(186) 2030 12 13  
(732) როტაფარმ ლიმიტიდ  
48 ქუინ ენ სტრიტი, ლონდონი W1G9JJ,  
გაერთიანებული სამეფო

(111) M 2011 21132 R1  
(156) 2011 02 11  
(186) 2031 02 11  
(732) ეიჩ აი ლიმიტიდ პარტნერშიპ  
ე ლიმიტიდ პარტნერშიპ ფორმდ  
ანდერ ზე ლოზ ოვ ზე სტეიტ ოვ  
ფლორიდა, ვიზ ჰუტერს ენტერპრაისიზ,  
ლლკ (ე ჯორჯია  
ლიმიტიდ ლაიაბილიტი კომპანი) ეზ  
ჯენერალ პარტნერ 1815 ზე იქსჩეინჯი,  
ატლანტა, ჯორჯიის შტატი 30339, აშშ

(111) M 2011 21133 R1  
(156) 2011 02 11  
(186) 2031 02 11  
(732) ეიჩ აი ლიმიტიდ პარტნერშიპ  
ე ლიმიტიდ პარტნერშიპ ფორმდ  
ანდერ ზე ლოზ ოვ ზე სტეიტ ოვ  
ფლორიდა, ვიზ ჰუტერს ენტერპრაისიზ,  
ლლკ (ე ჯორჯია  
ლიმიტიდ ლაიაბილიტი კომპანი) ეზ  
ჯენერალ პარტნერ 1815 ზე იქსჩეინჯი,  
ატლანტა, ჯორჯიის შტატი 30339, აშშ

(111) M 2011 21400 R1 (156) 2011 04 27 (186) 2031 04 27 (732) მიცუბიში ჯიდომა კოგიო კაბუშიკი კაიმა 33-8, შიბა 5-ჩომე, მინატო-კუ, ტოკიო, იაპონია	300 პარკ ავენიუ, ნიუ-იორკი, N.Y. 10022, აშშ
(111) M 2011 21406 R1 (156) 2011 04 27 (186) 2031 04 27 (732) მჰკს 9, ავენიუ დე შამპანი, 51200 ეპერნე, საფრანგეთი	(111) M 2011 21541 R1 (156) 2011 06 14 (186) 2031 06 14 (732) გროლსხ ინტერნაციონალ ბ.ვ. ბრაუვერსლაან 1, 7548 XA ენსხედე, ნიდერლანდები
(111) M 2011 21278 R1 (156) 2011 03 15 (186) 2031 03 15 (732) ტოიო თაიერ კორპორეიშენ 2-2-13 ფუჯინოკი, იტამი-ში, ჰიოგო, იაპონია	(111) M 2011 21576 R1 (156) 2011 06 27 (186) 2031 06 27 (732) სააქციო საზოგადოება „სილქნეტი“ წინამძღვრიშვილის ქ. 95, 0107, თბილისი, საქართველო
(111) M 2011 21067 R1 (156) 2011 01 17 (186) 2031 01 17 (732) იმკლონ ლლკ 450 ისტ 29თ სტრიტი, ნიუ-იორკი, ნიუ-იორკი 10016, აშშ	(111) M 2011 21371 R1 (156) 2011 04 13 (186) 2031 04 13 (732) ვიივ ჰელსქეა უკ ლიმიტიდ 980 გრეიტ უესტ როუდი, ბრენტფორდი, მიდლსექსი TW8 9GS, გაერთიანებული სამეფო
(111) M 2011 21068 R1 (156) 2011 01 17 (186) 2031 01 17 (732) იმკლონ ლლკ 450 ისტ 29თ სტრიტი, ნიუ-იორკი, ნიუ-იორკი 10016, აშშ	(111) M 2011 21581 R1 (156) 2011 06 27 (186) 2031 06 27 (732) ვმ. ვრიგლი ჯრ. კომპანი 1132 ვესტ ბლექჰოუკ სტრიტი, ჩიკაგო, ილინოისი 60642, აშშ
(111) M 2011 21337 R1 (156) 2011 04 06 (186) 2031 04 06 (732) შპს „ორი ნაბიჯი“ გუდიაშვილის მოედანი 4, 0105, თბილისი, საქართველო	(111) M 2011 21629 R1 (156) 2011 07 13 (186) 2031 07 13 (732) ინგა ნიჟარაძე ვაჟა-ფშაველას მე-2 კვარ. მე-14 კორპ. ბ. 30, 0186, თბილისი, საქართველო
(111) M 2011 21280 R1 (156) 2011 03 15 (186) 2031 03 15 (732) კოლგეიტ-პალმოლივ კომპანი	(111) M 2011 21746 R1 (156) 2011 09 16 (186) 2031 09 16 (732) შპს „ფარმაცევტული სახლი +“ ლვოვის ქ. 92, თბილისი, საქართველო

(111) M 2011 21938 R1

(156) 2011 10 28

(186) 2031 10 28

(732) ვმ. ვრიგლი ჯრ. კომპანი

1132 ვესტ ბლექჰოუკ სტრიტი, ჩიკაგო,  
ილინოისი 60642, აშშ

---

(111) M 2011 22067 R1

(156) 2011 12 14

(186) 2031 12 14

(732) ესპინალ ოფ ლანდონ ლიმიტიდ

ესპინალ ჰაუსი, ლონგფილდი, მიდჰერსტ  
როუდი, ფერნჰერსტი, უესტ სასექსი  
GU27 3HA, გაერთიანებული სამეფო

---

(111) M 2011 22154 R1

(156) 2011 12 29

(186) 2031 12 29

(732) ვმ. ვრიგლი ჯრ. კომპანი

1132 ვესტ ბლექჰოუკ სტრიტი, ჩიკაგო,  
ილინოისი 60642, აშშ

---

(111) M 2012 22192 R1

(156) 2012 01 11

(186) 2032 01 11

(732) პენდუით კორპ.

18900 პენდუით დრაივი, თინლი პარკი,  
შტატი ილინოისი 60487, აშშ

---

უფლებების სრული ბალანსი

(111) M 2020 33302 R

(732) ად ტრეიდმარკ ს.რ.ლ.  
ვია პასკუალე პაოლი 3, 20143 მილანი,  
იტალია

(770) ან დემელმეისტერი  
ბოგაერტშიედ 2, B-2560 კესელ-ნიჯლენი,  
ბელგია

(580) 2021 02 03

(111) M 1998 11318 R

(732) კონტინენტალ ფრუიტ ბ.ვ.  
ალბუმტრაატ 5, 4903 რჯ ოოსტერჰუტი,  
ნიდერლანდები

(770) პასი ავ  
ინდუსტრივეგ 14, 4852 როთრისტი,  
შვეიცარია

(580) 2021 01 20

(111) M 1998 11270 R

(732) აპჟონ უეს 1 ელელსი  
235 ისტ 42-ე სტრიტი, ნიუ-იორკი,  
N.Y. 10017, აშშ

(770) უორნერ-ლამბერტ კომპანი ლღკ  
235 ისტ 42-ე სტრიტი, ნიუ-იორკი,  
ნიუ იორკი 10017, აშშ

(580) 2021 02 05

(111) M 2002 14348 R

(732) ქუინგდაო ჰაიშანგ ჟიცაი მენეჯმენტ  
კონსალტინგ კო., ლტდ.  
ჰაიერ ინდასტრიალ პარკ, N 1 ჰაიერ  
როუდ, ლაოშან დისტრიქტ, ქინგდაო  
სიტი, შანდონ პროვანს, ჩინეთის  
სახალხო რესპუბლიკა

(770) ქუინგდაო ჰაიერ ინვესტმენტ  
დიველოპმენტ კო., ლტდ  
ჰაიერ ინდასტრიალ ზონა,  
ქუინგდაო ჰაი-ტექ ინდუსტრიალ არია,  
ქუინგდაო 266101, შენდონგის  
პროვინცია, ჩინეთის სახალხო  
რესპუბლიკა

(580) 2021 02 05

(111) M 2003 15064 R

(732) აპჟონ უეს 1 ელელსი  
235 ისტ 42-ე სტრიტი, ნიუ-იორკი,  
N.Y. 10017, აშშ

(770) უორნერ-ლამბერტ კომპანი ლღკ  
235 ისტ 42 სტრიტი, ნიუ-იორკი,  
ნიუ-იორკი 10017, აშშ

(580) 2021 02 05

(111) M 2012 22681 R

(732) შპს „კუპერსბერგ ჯორჯია“  
საირმის ქ. კორპ. 3, ბ. 35, ვაკე-  
საბურთალოს რაიონი, თბილისი,  
საქართველო

(770) ზაზა გორგიჯანოვი  
ვ. ლაცისას ქ., სახლი 25, კორპ. 1, ბ. 137,  
მოსკოვი 125480, რუსეთის ფედერაცია;  
ანდიჯან მოსიევი

კრასნოპრეცენსკაია ნაბერეჟნაია, სახლი  
2/1, ბ. 12, მოსკოვი, რუსეთის ფედერაცია

(580) 2020 12 31

(111) M 2014 25263 R

(732) შპს „ასკანელი ვაინერი & დისტილერი“  
კახეთის გზატკ. 110ა, სამგორის რაიონი,  
თბილისი, საქართველო

(770) შპს „კახური ტრადიციული მეღვინეობა“  
ქსნის ქ. 12, 0141, თბილისი, საქართველო

(580) 2021 02 15

(111) M 2013 23707 R

(732) შპს „ასკანელი ვაინერი & დისტილერი“  
კახეთის გზატკ. 110ა, სამგორის რაიონი,  
თბილისი, საქართველო

(770) შპს „კახური ტრადიციული მეღვინეობა“  
ქსნის ქ. 12, 0141, თბილისი, საქართველო

(580) 2021 02 15

(111) M 2016 27335 R

(732) შპს „ქელივო“  
რაზმაძის ქ. 27, ვაკის რაიონი, თბილისი,  
საქართველო

(770) შპს „ქართული ბრენდის კომპანია“  
კახეთის გზატ. 110ა, 0198, თბილისი,  
საქართველო

(580) 2021 02 13

(111) M 2017 29103 R

(732) შპს „კახური ტრადიციული მეღვინეობა“  
ს. ცინცაძის ქ. 12, სართ. 3, არასაცხო-  
ვრებელი ფართი 3-6, 0160, თბილისი,  
საქართველო

(770) შპს „ასკანელი ვაინერი & დისტილერი“  
კახეთის გზატკ. 110ა, სამგორის რაიონი,  
თბილისი, საქართველო

(580) 2021 02 15

---

(111) M 2018 29579 R

(732) შპს „ვოთერ ლენდი“  
ნოდარ ბოხუას ქ. 4, დიდუბის რაიონი,  
თბილისი, საქართველო

(770) შპს „ჯეოიმპექს“  
ნოდარ ბოხუას ქ. 4, სართ. 3, 0159,  
თბილისი, საქართველო

(580) 2021 02 15

---

(111) M 2019 31570 R

(732) შპს „ელექსირ გლობალი“  
ომარ ხიზანიშვილის ქ. 264 (თბილისის  
ტექნოლოგიური პარკის თავისუფალი  
ინდუსტრიული ზონა), გლდანის  
რაიონი, თბილისი, საქართველო

(770) შპს „ინო-ლაბი“  
მარი ბროსეს ქ. 2, 0108, თბილისი  
საქართველო

(580) 2021 02 16

---



მფლობელის სახელის და/ან მისამართის ცვლილება

(111) M 2000 13544 R  
 (732) მედესინ სან ფრონტიერ ინტერნასიონალ რიუ დე ლოზან 78, სპ 116, CH-1211 ქენევა 21, შვეიცარია  
 (770) ბიურო ინტერნასიონალ დე მედესინ სან ფრონტიერ, შვეიცარიის კომპანია რიუ დე ლოზან 78, სპ 116, CH-1211 ქენევა 21, შვეიცარია  
 (580) 2021 02 10

(111) M 2001 13758 R  
 (732) პლეიბოი ენტერპრაიზის ინტერნემენელ ინკ. 10960 უილშირ ბულვარ, სუიტი 2200, ლოს-ანჯელესი, კალიფორნია 90024, აშშ  
 (770) პლეიბოი ენტერპრაიზის ინტერნემენელ, ინკ. 680 ნორთ ლეიკ შორ დრაივი, ჩიკაგო, ილინოისი 60611, აშშ  
 (580) 2021 02 08

(111) M 2002 14291 R  
 (732) ვმ. ვრიგლი ჯრ. კომპანი 1132 ვესტ ბლექჰოუკ სტრიტი, ჩიკაგო, ილინოისი 60642, აშშ  
 (770) ვმ. ვრიგლი ჯრ. კომპანი 410 ნორთ მიჩიგან ავენიუ, ჩიკაგო, ილინოისი 60611, აშშ  
 (580) 2021 01 28

(111) M 1995 1070 R  
 (732) ჰაიეტ ინტერნემენელ კორპორეიშენ 150 ნორს რივერსაიდ პლაზა, 14 ფლორი, ჩიკაგო, ილინოისი 60606, აშშ  
 (770) ჰაიეტ ინტერნემენელ კორპორეიშენ 71 S. ვოკერ დრაივი, 14 ფლორი, ჩიკაგო, ილინოისი 60606, აშშ  
 (580) 2021 02 09

(111) M 1995 1069 R  
 (732) ჰაიეტ ინტერნემენელ კორპორეიშენ 150 ნორს რივერსაიდ პლაზა, 14 ფლორი, ჩიკაგო, ილინოისი 60606, აშშ

(770) ჰაიეტ ინტერნემენელ კორპორეიშენ 71 S. ვოკერ დრაივი, 14 ფლორი, ჩიკაგო, ილინოისი 60606, აშშ  
 (580) 2021 02 09

(111) M 2003 15064 R  
 (732) უორნერ-ლამბერტ კომპანი ლლკ 235 ისტ 42 სტრიტი, ნიუ-იორკი, ნიუ-იორკი 10017, აშშ  
 (770) უორნერ-ლამბერტ კომპანი ლლკ 201 ტაბორ როუდი, მორის-პლეინზი, ნიუ-ჯერზი 07950, აშშ  
 (580) 2021 02 05

(111) M 1996 3920 R  
 (732) პერნო რიკარ უსა, ლლკ 250 პარკ ავე., 17ზ ფლორი, ნიუ-იორკი, ნიუ-იორკი 10177, აშშ  
 (770) პერნო რიკარ უსა, ლლკ 100 მანჰეტენვილ როუდი, ვერჩეზი, NY 10577, აშშ  
 (580) 2021 01 29

(111) M 2007 17218 R  
 (732) ვერაიზონ ტრეიდმარკ სერვისიზ ლლკ დელავერის შეზღუდული პასუხისმგებლობის კომპანია 1300 I სტრიტი, NW, სუიტი 500 ისტ. ვაშინგტონი, DC 20005, აშშ  
 (770) ვერაიზონ ტრეიდმარკ სერვისიზ ლლკ, დელავერის შეზღუდული პასუხისმგებლობის კომპანია 1320 ნორთ კორტ ჰაუზ როუდი, არლინგტონი, ვირჯინია 22201, აშშ  
 (580) 2020 12 16

(111) M 2009 19153 R  
 (732) სოირა ინვესტმენტს ლიმიტიდ კირიაკოუ მატსი, 16, იგლ ჰაუზი, 6თ ფლორი, 1082, ნიქოზია, კვიპროსი  
 (770) სოირა ინვესტმენტს ლიმიტიდ 3076, სერ ფრენსის დრეიკზ ჰაიუეი, ს/ყ 3463, როუდ-ტაუნი, ტორტოლა, ვირჯინის კუნძულები (ბრიტანეთის)  
 (580) 2021 01 14

(111) M 2009 19154 R  
(732) სოირა ინვესტმენტს ლიმიტიდ  
კირიაკოუ მატსი, 16, იგლ ჰაუზი, 6თ  
ფლორი, 1082, ნიქოზია, კვიპროსი  
(770) სოირა ინვესტმენტს ლიმიტიდ  
3076, სერ ფრენსის დრეიკზ ჰაიუეი,  
ს/ყ 3463, როუდ-ტაუნი, ტორტოლა,  
ვირჯინის კუნძულები (ბრიტანეთის)  
(580) 2021 01 14

(111) M 2009 19155 R  
(732) სოირა ინვესტმენტს ლიმიტიდ  
კირიაკოუ მატსი, 16, იგლ ჰაუზი, 6თ  
ფლორი, 1082, ნიქოზია, კვიპროსი  
(770) სოირა ინვესტმენტს ლიმიტიდ  
3076, სერ ფრენსის დრეიკზ ჰაიუეი,  
ს/ყ 3463, როუდ-ტაუნი, ტორტოლა,  
ვირჯინის კუნძულები (ბრიტანეთის)  
(580) 2021 01 14

(111) M 1995 470 R  
(732) პერნო რიკარ უსა, ლლკ  
250 პარკ ავე., 17ზ ფლორი, ნიუ-იორკი,  
ნიუ-იორკი 10177, აშშ  
(770) პერნო რიკარ უსა, ლლკ  
100 მანჰეტენვილ როუდი, ფერჩეზი,  
NY 10577, აშშ  
(580) 2021 01 29

(111) M 1995 487 R  
(732) პერნო რიკარ უსა, ლლკ  
250 პარკ ავე., 17ზ ფლორი, ნიუ-იორკი,  
ნიუ-იორკი 10177, აშშ  
(770) პერნო რიკარ უსა, ლლკ  
100 მანჰეტენვილ როუდი, ფერჩეზი,  
NY 10577, აშშ  
(580) 2021 01 29

(111) M 2009 19729 R  
(732) სოირა ინვესტმენტს ლიმიტიდ  
კირიაკოუ მატსი, 16, იგლ ჰაუზი, 6თ  
ფლორი, 1082, ნიქოზია, კვიპროსი  
(770) სოირა ინვესტმენტს ლიმიტიდ  
3076, სერ ფრენსის დრეიკზ ჰაიუეი,  
ს/ყ 3463, როუდ-ტაუნი, ტორტოლა,  
ვირჯინის კუნძულები (ბრიტანეთის)  
(580) 2021 01 14

(111) M 2009 20114 R  
(732) სოირა ინვესტმენტს ლიმიტიდ  
კირიაკოუ მატსი, 16, იგლ ჰაუზი, 6თ  
ფლორი, 1082, ნიქოზია, კვიპროსი  
(770) სოირა ინვესტმენტს ლიმიტიდ  
3076, სერ ფრენსის დრეიკზ ჰაიუეი,  
ს/ყ 3463, როუდ-ტაუნი, ტორტოლა,  
ვირჯინის კუნძულები (ბრიტანეთის)  
(580) 2021 01 14

(111) M 2011 21067 R  
(732) იმკლონ ლლკ  
450 ისტ 29თ სტრიტი, ნიუ-იორკი,  
ნიუ-იორკი 10016, აშშ  
(770) იმკლონ ლლკ  
180 ვერიკ სტრიტი, ნიუ-იორკი,  
ნიუ-იორკი, 10014, აშშ  
(580) 2021 01 13

(111) M 2011 21068 R  
(732) იმკლონ ლლკ  
450 ისტ 29თ სტრიტი, ნიუ-იორკი,  
ნიუ-იორკი 10016, აშშ  
(770) იმკლონ ლლკ  
180 ვერიკ სტრიტი, ნიუ-იორკი,  
ნიუ-იორკი, 10014, აშშ  
(580) 2021 01 13

(111) M 2011 21581 R  
(732) ვმ. ვრიგლი ჯრ. კომპანი  
1132 ვესტ ბლექჰოუკ სტრიტი, ჩიკაგო,  
ილინოისი 60642, აშშ  
(770) ვმ. ვრიგლი ჯრ. კომპანი  
410 ნორთ მიჩიგან ავენიუ, ჩიკაგო,  
ილინოისი 60611, აშშ  
(580) 2021 01 28

(111) M 2011 21938 R  
(732) ვმ. ვრიგლი ჯრ. კომპანი  
1132 ვესტ ბლექჰოუკ სტრიტი, ჩიკაგო,  
ილინოისი 60642, აშშ  
(770) ვმ. ვრიგლი ჯრ. კომპანი  
410 ნორთ მიჩიგან ავენიუ, ჩიკაგო,  
ილინოისი 60611, აშშ  
(580) 2021 01 28

(111) M 2011 22154 R  
 (732) ვმ. ვრიგლი ჯრ. კომპანი  
 1132 ვესტ ბლექჰოუკ სტრიტი, ჩიკაგო,  
 ილინოისი 60642, აშშ  
 (770) ვმ. ვრიგლი ჯრ. კომპანი  
 410 ნორთ მიჩიგან ავენიუ, ჩიკაგო,  
 ილინოისი 60611, აშშ  
 (580) 2021 01 28

(111) M 2012 22430 R  
 (732) როუზფილდ პორტუგალ, ს.ა.  
 რუა დუ სისტელო - ლუგარ დე  
 სანტეგანსი, 4435-429 რიო ტინტო,  
 გონდომარი, პორტუგალია  
 (770) როუზფილდ ლუქსემბურგ, სა  
 რუა დუ სისტელო - ლუგარ დე  
 სანტეგანსი, 4435-429 რიო ტინტო,  
 გონდომარი, პორტუგალია  
 (580) 2021 02 10

(111) M 2012 22681 R  
 (732) ზაზა გორგიჯანოვი  
 ვ. ლაცისას ქ. სახლი 25, კორპ. 1, ბ. 137,  
 მოსკოვი, 125480, რუსეთის ფედერაცია;  
 ანდიჯან მოსიევი  
 კრასნოპრენენსკაია ნაბერეჟნაია, სახლი  
 2/1, ბ. 12, მოსკოვი, რუსეთის ფედერაცია  
 (770) ზაზა გორგიჯანოვი  
 125480, ქ. მოსკოვი, ვ. ლაცისას ქ. სახლი  
 25, კორპ. 1, ბ. 137, რუსეთის ფედერაცია;  
 ანდიჯან მოსიევი  
 117218, ქ. მოსკოვი, პროფსაიუზის ქ.  
 სახლი 19, ბინა 36, რუსეთის ფედერაცია  
 (580) 2020 12 31

(111) M 2014 24678 R  
 (732) ჰაიატ ინტერნეშენელ კორპორეიშენ  
 150 ნორს რივერსაიდ პლაზა, 14 ფლორი,  
 ჩიკაგო, ილინოისი 60606, აშშ  
 (770) ჰაიატ ინტერნეშენელ კორპორეიშენ  
 71 ს. უეკერ დრაივი, 14თ ფლორ, ჩიკაგო,  
 შტატი ილინოისი 60606, აშშ  
 (580) 2021 02 09

(111) M 2014 24679 R  
 (732) ჰაიატ ინტერნეშენელ კორპორეიშენ  
 150 ნორს რივერსაიდ პლაზა, 14  
 ფლორი, ჩიკაგო, ილინოისი 60606, აშშ

(770) ჰაიატ ინტერნეშენელ კორპორეიშენ  
 71 ს. უეკერ დრაივი, 14თ ფლორ, ჩიკაგო,  
 შტატი ილინოისი 60606, აშშ  
 (580) 2021 02 09

(111) M 2014 24680 R  
 (732) ჰაიატ ინტერნეშენელ კორპორეიშენ  
 150 ნორს რივერსაიდ პლაზა, 14  
 ფლორი, ჩიკაგო, ილინოისი 60606, აშშ  
 (770) ჰაიატ ინტერნეშენელ კორპორეიშენ  
 71 ს. უეკერ დრაივი, 14თ ფლორ,  
 ჩიკაგო, შტატი ილინოისი 60606, აშშ  
 (580) 2021 02 09

(111) M 2014 24681 R  
 (732) ჰაიატ ინტერნეშენელ კორპორეიშენ  
 150 ნორს რივერსაიდ პლაზა, 14 ფლორი,  
 ჩიკაგო, ილინოისი 60606, აშშ  
 (770) ჰაიატ ინტერნეშენელ კორპორეიშენ  
 71 ს. უეკერ დრაივი, 14თ ფლორ,  
 ჩიკაგო, შტატი ილინოისი 60606, აშშ  
 (580) 2021 02 09

(111) M 2015 25880 R  
 (732) ჰაიატ ინტერნეშენელ კორპორეიშენ  
 150 ნორს რივერსაიდ პლაზა, 14  
 ფლორი, ჩიკაგო, ილინოისი 60606, აშშ  
 (770) ჰაიატ ინტერნეშენელ კორპორეიშენ  
 71 ს. უეკერ დრაივი, 14თ ფლორ, ჩიკაგო,  
 შტატი ილინოისი 60606, აშშ  
 (580) 2021 02 09

(111) M 2016 26990 R  
 (732) ჰაიატ ინტერნეშენელ კორპორეიშენ  
 150 ნორს რივერსაიდ პლაზა, 14  
 ფლორი, ჩიკაგო, ილინოისი 60606, აშშ  
 (770) ჰაიატ ინტერნეშენელ კორპორეიშენ  
 71 ს. უეკერ დრაივი, 14თ ფლორ,  
 ჩიკაგო, შტატი ილინოისი 60606, აშშ  
 (580) 2021 02 09

(111) M 2016 26991 R  
 (732) ჰაიატ ინტერნეშენელ კორპორეიშენ  
 150 ნორს რივერსაიდ პლაზა, 14 ფლორი,  
 ჩიკაგო, ილინოისი 60606, აშშ  
 (770) ჰაიატ ინტერნეშენელ კორპორეიშენ

71 ს. უეკერ დრაივი, 14თ ფლორ, ჩიკაგო,  
შტატი ილინოისი 60606, აშშ  
(580) 2021 02 09

---

(111) M 2016 27149 R  
(732) სან ფარმასიუტიკალ ინდასტრიზ ლტდ.  
სან ჰაუს, 201 B/1 ვესტერნ ექსპრეს  
ჰაივეი, გორეგაონ-ისტ, მუმბაი 400 063;  
სპარკ, ტანდალჟა, ვადოდარა ვადოდარა  
GJ 390012, ინდოეთი  
(770) სან ფარმასიუტიკალ ინდასტრიზ ლტდ.  
აკმე პლაზა, ანდჰერი კურლა როუდი,  
ანდჰერი (ისტ), მუმბაი - 400 059,  
მაჰარაშტრა, ინდოეთი  
(580) 2021 01 27

---

(111) M 2016 26864 R  
(732) ჰაიატ ინტერნეშენელ კორპორეიშენ  
150 ნორს რივერსაიდ პლაზა, 14 ფლორი,  
ჩიკაგო, ილინოისი 60606, აშშ  
(770) ჰაიატ ინტერნეშენელ კორპორეიშენ  
71 ს. უეკერ დრაივი, 14თ ფლორ, ჩიკაგო,  
შტატი ილინოისი 60606, აშშ  
(580) 2021 02 09

---

(111) M 2017 28060 R  
(732) ვერაიზონ ტრეიდმარკ სერვისიზ ლლკ  
დელავერის შეზღუდული  
პასუხისმგებლობის კომპანია  
1300 I სტრიტ, NW, სუიტ 500 ისტ,  
ვაშინგტონი, DC 20005, აშშ  
(770) ვერაიზონ ტრეიდმარკ სერვისიზ ლლკ,  
დელავერის შეზღუდული  
პასუხისმგებლობის კომპანია  
1320 ნორთ კორტ ჰაუს როუდი, 9თ  
ფლორ, არლინგტონი, ვირჯინია 22201,  
აშშ  
(580) 2020 12 16

---

(111) M 2017 29103 R  
(732) შპს „ასკანელი ვაინერი & დისტილერი“  
კახეთის გზატკ. 110ა, სამგორის რაიონი,  
თბილისი, საქართველო  
(770) შპს „კაპიტალკლუბი“  
კახეთის გზატკ. 110ა, 0198, თბილისი,  
საქართველო  
(580) 2021 02 18

---

(111) M 2017 28933 R  
(732) ჰაიატ ინტერნეშენელ კორპორეიშენ  
150 ნორს რივერსაიდ პლაზა, 14 ფლორი,  
ჩიკაგო, ილინოისი 60606, აშშ  
(770) ჰაიატ ინტერნეშენელ კორპორეიშენ  
71 ს. უეკერ დრაივი, 14თ ფლორ, ჩიკაგო,  
შტატი ილინოისი 60606, აშშ  
(580) 2021 02 09

---

(111) M 2017 29160 R  
(732) სოირა ინვესტმენტზ ლიმიტიდ  
კირიაკოუ მატსი, 16, იგლ ჰაუზი, 6თ  
ფლორი, 1082, ნიქოზია, კვიპროსი  
(770) სოირა ინვესტმენტზ ლიმიტიდ  
3076 სირ ფრენსის დრეიკ'ზ ჰაიუეი,  
პ.ო. ბოქს 3463, როუდ ტაუნი, ტორტოლა,  
ვირჯინის კუნძულები (ბრიტანეთის)  
(580) 2021 01 14

---

სასაქონლო ნიშნების რეგისტრაციის გაუქმება

(111) M 2000 13446 R (151) 2000 07 26 (732) ინვენსის პლკ პორტლენდ ჰაუსი, ბრესენდენ პლეისი, ლონდონი, SW1E 5BF, გაერთიანებული სამეფო (141) 2021 02 10	წინამძღვრიშვილის ქ. 94, 0164, თბილისი, საქართველო (141) 2021 02 12
(111) M 2000 13448 R (151) 2000 07 26 (732) ბრიტიშ ამერიკან ტობაკო (ბრენდუ) ლიმიტიდ გლოუზ ჰაუზი, 4 ტემპლ პლეისი, ლონდონი, WC2R 2PG, გაერთიანებული სამეფო (141) 2021 02 10	(111) M 2010 20614 R (151) 2010 07 26 (732) მარს, ინკორპორეტიდ 6885 ელმ სტრიტი, მაკ-ლინი, ვირჯინია 22101-3883, აშშ (141) 2021 02 10
(111) M 2000 13447 R (151) 2000 07 26 (732) ფულმარკ პტე ლტდ 10 სუნ ლი როუდი, სინგაპური 628074, სინგაპური (141) 2021 02 10	(111) M 2010 20625 R (151) 2010 07 27 (732) შპს „ავერსი-ფარმა“ დავით აღმაშენებლის გამზ. 148/2, 0112, თბილისი, საქართველო (141) 2021 02 11
(111) M 2009 19938 R (151) 2009 11 02 (732) შპს „ქარვასლა“ თ. აბულაძის ქ. 21, 0162, თბილისი, საქართველო (141) 2021 02 16	(111) M 2010 20623 R (151) 2010 07 27 (732) შპს „მილენიუმ ტრანსი“ ილია ჭავჭავაძის 1-ლი ჩიხი 35, II ბლოკი, 1-ლი სარ. 0179, თბილისი, საქართველო (141) 2021 02 11
(111) M 2010 20601 R (151) 2010 07 26 (732) შპს „თავადური“ მტკვრის მარცხენა სანაპირო, მაიაკოვსკის ქ. 2/4, 0112, თბილისი, საქართველო (141) 2021 02 10	(111) M 2010 20626 R (151) 2010 07 27 (732) შპს „ავერსი-ფარმა“ დავით აღმაშენებლის გამზ. 148/2, 0112, თბილისი, საქართველო (141) 2021 02 11
(111) M 2010 20631 R (151) 2010 07 28 (732) რ/კ „სტრატეგიული კვლევის ინსტიტუტი“	(111) M 1996 3571 R (151) 1996 10 10 (732) ზე კვაკერ ოუტზ კომპანი 555, ვესტ მონრო სტრიტი, ჩიკაგო, ილინოისი 60661, აშშ (141) 2021 02 16

## სისტემური საპიუბლეპი გამოგონებები

საერთაშორისო კლასიფიკაციის ინდექსის და ბანაცხალის  
გამოქვეყნების ნომრის შესაბამისობის ცხრილი

საერთაშორისო კლასიფიკაციის ინდექსი (51)	ბანაცხალის გამოქვეყნების ნომერი (10)
A 61 K 31/4427; A 61 K 31/497; A 61 P 3/00; C 07 D 401/14; C 07 D 405/14; C 07 D 413/14; C 07 D 471/04; C 07 D 487/04	AP 2021 15110 A
A 61 K 39/12; A 61 P 31/14	AP 2021 15344 A
B 60 P 3/40; B 60 P 3/41	AP 2021 15272 A
C 07 D 213/75; C 07 D 401/12; A 61 K 31/44; A 61 P 29/00	AP 2021 13922 A
F 03 D 1/06	AP 2021 15001 A

ბანაცხალის გამოქვეყნების ნომრის და საერთაშორისო  
კლასიფიკაციის ინდექსის შესაბამისობის ცხრილი

ბანაცხალის გამოქვეყნების ნომერი (10)	საერთაშორისო კლასიფიკაციის ინდექსი (51)
AP 2021 13922 A	C 07 D 213/75; C 07 D 401/12; A 61 K 31/44; A 61 P 29/00
AP 2021 15001 A	F 03 D 1/06
AP 2021 15110 A	A 61 K 31/4427; A 61 K 31/497; A 61 P 3/00; C 07 D 401/14; C 07 D 405/14; C 07 D 413/14; C 07 D 471/04; C 07 D 487/04
AP 2021 15272 A	B 60 P 3/40; B 60 P 3/41
AP 2021 15344 A	A 61 K 39/12; A 61 P 31/14

საერთაშორისო კლასიფიკაციის ინდექსის, პატენტის ნომრისა  
და გამოქვეყნების ნომრის შესაბამისობის ცხრილი

საერთაშორისო კლასიფიკაციის ინდექსი (51)	პატენტის ნომერი (11)	ბანაცხალის გამოქვეყნების ნომერი (10)
A 01 G 17/00	P 2021 7225 B	AP 2020 15155 A
A 61 K 31/4168; A 61 P 3/10; A 61 P 9/00; A 61 P 3/04; C 07 D 233/91	P 2021 7227 B	AP 2020 15132 A
E 04 H 6/04	P 2021 7228 B	AP 2020 14905 A
G 06 F 17/10; G 10 L 19/26; G 10 L 19/24; G 10 L 19/22; G 10 L 19/02	P 2021 7226 B	AP 2020 15136 A

პატენტის ნომრის, ბანაცხაღის გამოქვეყნების ნომრისა  
და საერთაშორისო კლასიფიკაციის ინდექსის შესაბამისობის ცხრილი

პატენტის ნომერი (11)	ბანაცხაღის გამოქვეყნების ნომერი (10)	საერთაშორისო კლასიფიკაციის ინდექსი (51)
P 2021 7225 B	AP 2020 15155 A	A 01 G 17/00
P 2021 7226 B	AP 2020 15136 A	G 06 F 17/10; G 10 L 19/26; G 10 L 19/24; G 10 L 19/22; G 10 L 19/02
P 2021 7227 B	AP 2020 15132 A	A 61 K 31/4168; A 61 P 3/10; A 61 P 9/00; A 61 P 3/04; C 07 D 233/91
P 2021 7228 B	AP 2020 14905 A	E 04 H 6/04

ბანაცხაღის ნომრის, ბანაცხაღის გამოქვეყნების ნომრისა  
და პატენტის ნომრის შესაბამისობის ცხრილი

ბანაცხაღის ნომერი (21)	ბანაცხაღის გამოქვეყნების ნომერი (10)	პატენტის ნომერი (11)
AP 2018 14905	AP 2020 14905 A	P 2021 7228 B
AP 2018 15132	AP 2020 15132 A	P 2021 7227 B
AP 2018 15136	AP 2020 15136 A	P 2021 7226 B
AP 2019 15155	AP 2020 15155 A	P 2021 7225 B

**სასარბებლო მოდელები**

საერთაშორისო კლასიფიკაციის ინდექსის და ბანაცხაღის  
გამოქვეყნების ნომრის შესაბამისობის ცხრილი

საერთაშორისო კლასიფიკაციის ინდექსი (51)	ბანაცხაღის გამოქვეყნების ნომერი (10)
A 47 G 19/14; A 47 J 27/21; A 47 J 36/06	AU 2021 15285 U
A 47 G 19/14; A 47 J 27/21; A 47 J 36/06	AU 2021 15286 U
A 47 G 19/14; A 47 J 36/06; A 47 J 27/21	AU 2021 15287 U
A 47 G 19/14; A 47 J 27/21; A 47 J 36/06	AU 2021 15288 U
A 47 G 19/14; A 47 J 36/06; A 47 J 27/21	AU 2021 15289 U
F 16 D 65/06; F 65 D 69/00	AU 2021 15331 U
G 01 J 3/28	AU 2021 15217 U

ბანაცხაღის გამოქვეყნების ნომრის და საერთაშორისო კლასიფიკაციის ინდექსის შესაბამისობის ცხრილი

ბანაცხაღის გამოქვეყნების ნომერი (10)	საერთაშორისო კლასიფიკაციის ინდექსი (51)
AU 2021 15217 U	G 01 J 3/28
AU 2021 15285 U	A 47 G 19/14; A 47 J 27/21; A 47 J 36/06
AU 2021 15286 U	A 47 G 19/14; A 47 J 27/21; A 47 J 36/06
AU 2021 15287 U	A 47 G 19/14; A 47 J 36/06; A 47 J 27/21
AU 2021 15288 U	A 47 G 19/14; A 47 J 27/21; A 47 J 36/06
AU 2021 15289 U	A 47 G 19/14; A 47 J 36/06; A 47 J 27/21
AU 2021 15331 U	F 16 D 65/06; F 65 D 69/00

საერთაშორისო კლასიფიკაციის ინდექსის, პატენტის ნომრისა და გამოქვეყნების ნომრის შესაბამისობის ცხრილი

საერთაშორისო კლასიფიკაციის ინდექსი (51)	პატენტის ნომერი (11)	ბანაცხაღის გამოქვეყნების ნომერი (10)
A 61 N 5/00	U 2021 2071 Y	AU 2020 14972 U
C 04 B 7/00	U 2021 2070 Y	AU 2020 15116 U

პატენტის ნომრის, ბანაცხაღის გამოქვეყნების ნომრისა და საერთაშორისო კლასიფიკაციის ინდექსის შესაბამისობის ცხრილი

პატენტის ნომერი (11)	ბანაცხაღის გამოქვეყნების ნომერი (10)	საერთაშორისო კლასიფიკაციის ინდექსი (51)
U 2021 2070 Y	AU 2020 15116 U	C 04 B 7/00
U 2021 2071 Y	AU 2020 14972 U	A 61 N 5/00

ბანაცხაღის ნომრის, ბანაცხაღის გამოქვეყნების ნომრისა და პატენტის ნომრის შესაბამისობის ცხრილი

ბანაცხაღის ნომერი (21)	ბანაცხაღის გამოქვეყნების ნომერი (10)	პატენტის ნომერი (11)
AU 2018 14972	AU 2020 14972 U	U 2021 2071 Y
AU 2019 15116	AU 2020 15116 U	U 2021 2070 Y



## ღიზინები

საერთაშორისო კლასიფიკაციის ინდექსის, პატენტის ნომრისა  
და გამომქვეყნების ნომრის შესაბამისობის ცხრილი

საერთაშორისო კლასიფიკაციის ინდექსი (51)	პატენტის ნომერი (11)	ბანაცხაღის გამომქვეყნების ნომერი (10)
09-03	D 2021 879 S	AD 2020 1156 S
09-05	D 2021 878 S	AD 2020 1155 S
19-08	D 2021 880 S	AD 2020 1153 S
19-08	D 2021 881 S	AD 2020 1154 S

პატენტის ნომრის, ბანაცხაღის გამომქვეყნების ნომრისა  
და საერთაშორისო კლასიფიკაციის ინდექსის შესაბამისობის ცხრილი

პატენტის ნომერი (11)	ბანაცხაღის გამომქვეყნების ნომერი (10)	საერთაშორისო კლასიფიკაციის ინდექსი (51)
D 2021 878 S	AD 2020 1155 S	09-05
D 2021 879 S	AD 2020 1156 S	09-03
D 2021 880 S	AD 2020 1153 S	19-08
D 2021 881 S	AD 2020 1154 S	19-08

ბანაცხაღის ნომრის, ბანაცხაღის გამომქვეყნების ნომრისა  
და პატენტის ნომრის შესაბამისობის ცხრილი

ბანაცხაღის ნომერი (21)	ბანაცხაღის გამომქვეყნების ნომერი (10)	პატენტის ნომერი (11)
AD 2020 1153	AD 2020 1153 S	D 2021 880 S
AD 2020 1154	AD 2020 1154 S	D 2021 881 S
AD 2020 1155	AD 2020 1155 S	D 2021 878 S
AD 2020 1156	AD 2020 1156 S	D 2021 879 S

## სასაქონლო ნიშნები

რეგისტრაციის ნომრის, განაცხადის ნომრის, განაცხადის გამოქვეყნების ნომრისა და ბიულეტენის ნომრის შესაბამისობის ცხრილი

რეგისტრაციის ნომერი (111)	განაცხადის ნომერი (210)	განაცხადის გამოქვეყნების ნომერი (260)	ბიულეტენის ნომერი
M 2021 33658 R	AM 111433	-	3(559)2021
M 2021 33659 R	AM 111442	-	3(559)2021
M 2021 33660 R	AM 111444	-	3(559)2021
M 2021 33661 R	AM 111445	-	3(559)2021
M 2021 33662 R	AM 111510	-	3(559)2021
M 2021 33663 R	AM 111266	-	3(559)2021
M 2021 33664R	AM 111443	-	3(559)2021
M 2021 33665 R	AM 111515	-	3(559)2021
M 2021 33666 R	AM 111581	-	3(559)2021
M 2021 33667 R	AM 111582	-	3(559)2021
M 2021 33668 R	AM 111527	-	3(559)2021
M 2021 33669 R	AM 103187	AM 2020 103187 A	19(551) 2020
M 2021 33670 R	AM 104202	AM 2020 104202 A	19(551) 2020
M 2021 33671 R	AM 104203	AM 2020 104203 A	19(551) 2020
M 2021 33672 R	AM 104204	AM 2020 104204 A	19(551) 2020
M 2021 33673 R	AM 106509	AM 2020 106509 A	15(547) 2020
M 2021 33674 R	AM 106517	AM 2020 106517 A	16(548) 2020
M 2021 33675 R	AM 106518	AM 2020 106518 A	16(548) 2020
M 2021 33676 R	AM 106592	AM 2020 106592 A	15(547) 2020
M 2021 33677 R	AM 106600	AM 2020 106600 A	16(548) 2020
M 2021 33678 R	AM 106645	AM 2020 106645 A	15(547) 2020
M 2021 33679 R	AM 106657	AM 2020 106657 A	15(547) 2020
M 2021 33680 R	AM 106671	AM 2020 106671 A	15(547) 2020
M 2021 33681 R	AM 106751	AM 2020 106751 A	20(552) 2020
M 2021 33682 R	AM 106752	AM 2020 106752 A	20(552) 2020
M 2021 33683 R	AM 106799	AM 2020 106799 A	16(548) 2020
M 2021 33684 R	AM 106800	AM 2020 106800 A	16(548) 2020
M 2021 33685 R	AM 106826	AM 2020 106826 A	17(549) 2020
M 2021 33686 R	AM 106827	AM 2020 106827 A	17(549) 2020
M 2021 33687 R	AM 106828	AM 2020 106828 A	16(548) 2020
M 2021 33688 R	AM 106830	AM 2020 106830 A	16(548) 2020
M 2021 33689 R	AM 106831	AM 2020 106831 A	16(548) 2020
M 2021 33690 R	AM 106952	AM 2020 106952 A	16(548) 2020
M 2021 33691 R	AM 107294	AM 2020 107294 A	20(552) 2020
M 2021 33692 R	AM 107307	AM 2020 107307 A	17(549) 2020
M 2021 33693 R	AM 107311	AM 2020 107311 A	20(552) 2020
M 2021 33694 R	AM 107391	AM 2020 107391 A	19(551) 2020
M 2021 33695 R	AM 107490	AM 2020 107490 A	20(552) 2020
M 2021 33696 R	AM 107491	AM 2020 107491 A	20(552) 2020
M 2021 33697 R	AM 107552	AM 2020 107552 A	20(552) 2020
M 2021 33698 R	AM 107814	AM 2020 107814 A	20(552) 2020
M 2021 33699 R	AM 111596	-	3(559)2021
M 2021 33700 R	AM 111540	-	3(559)2021
M 2021 33701 R	AM 111597	-	3(559)2021
M 2021 33702 R	AM 111598	-	3(559)2021
M 2021 33703 R	AM 111599	-	3(559)2021
M 2021 33704 R	AM 111609	-	3(559)2021

1	2	3	4
M 2021 33705 R	AM 111603	-	3(559)2021
M 2021 33706 R	AM 111589	-	3(559)2021
M 2021 33707 R	AM 111690	-	3(559)2021
M 2021 33708 R	AM 105671	AM 2020 105671 A	21(553) 2020
M 2021 33709 R	AM 105672	AM 2020 105672 A	21(553) 2020
M 2021 33710 R	AM 106520	AM 2020 106520 A	15(547) 2020
M 2021 33711 R	AM 106603	AM 2020 106603 A	15(547) 2020
M 2021 33712 R	AM 106606	AM 2020 106606 A	15(547) 2020
M 2021 33713 R	AM 106755	AM 2020 106755 A	15(547) 2020
M 2021 33714 R	AM 106819	AM 2020 106819 A	17(549) 2020
M 2021 33715 R	AM 106820	AM 2020 106820 A	17(549) 2020
M 2021 33716 R	AM 106931	AM 2020 106931 A	18(550) 2020
M 2021 33717 R	AM 106934	AM 2020 106934 A	16(548) 2020
M 2021 33718 R	AM 107047	AM 2020 107047 A	17(549) 2020
M 2021 33719 R	AM 107060	AM 2020 107060 A	18(550) 2020
M 2021 33720 R	AM 107174	AM 2020 107174 A	17(549) 2020
M 2021 33721 R	AM 107175	AM 2020 107175 A	17(549) 2020
M 2021 33722 R	AM 107185	AM 2020 107185 A	19(551) 2020
M 2021 33723 R	AM 107309	AM 2020 107309 A	19(551) 2020
M 2021 33724 R	AM 107310	AM 2020 107310 A	19(551) 2020
M 2021 33725 R	AM 107392	AM 2020 107392 A	19(551) 2020
M 2021 33726 R	AM 107921	AM 2020 107921 A	21(553) 2020

ბანაცხადის გამომქვეყნების ნომრისა და ბანაცხადის ნომრის  
შესაბამისობის ცხრილი

ბანაცხადის გამომქვეყნების ნომერი (260)	ბანაცხადის ნომერი (210)	1	2
		1	2
AM 2021 102358 A*	AM 102358	AM 2021 109021 A	AM 109021
AM 2021 104328 A	AM 104328	AM 2021 109022 A	AM 109022
AM 2021 105234 A*	AM 105234	AM 2021 109023 A	AM 109023
AM 2021 105661 A	AM 105661	AM 2021 109025 A	AM 109025
AM 2021 105662 A	AM 105662	AM 2021 109027 A	AM 109027
AM 2021 108514 A	AM 108514	AM 2021 109034 A	AM 109034
AM 2021 108953 A	AM 108953	AM 2021 109035 A	AM 109035
AM 2021 108954 A	AM 108954	AM 2021 109041 A	AM 109041
AM 2021 108960 A	AM 108960	AM 2021 109046 A	AM 109046
AM 2021 108962 A	AM 108962	AM 2021 109052 A	AM 109052
AM 2021 108964 A	AM 108964	AM 2021 109054 A	AM 109054
AM 2021 108965 A	AM 108965	AM 2021 109115 A	AM 109115
AM 2021 109009 A	AM 109009	AM 2021 109120 A	AM 109120
AM 2021 109013 A	AM 109013	AM 2021 109123 A	AM 109123
AM 2021 109014 A	AM 109014	AM 2021 109208 A	AM 109208
AM 2021 109015 A	AM 109015	AM 2021 109210 A	AM 109210
AM 2021 109016 A	AM 109016	AM 2021 109211 A	AM 109211
AM 2021 109017 A	AM 109017	AM 2021 109227 A	AM 109227
AM 2021 109018 A	AM 109018	AM 2021 109293 A	AM 109293
		AM 2021 109294 A	AM 109294
		AM 2021 109295 A	AM 109295
		AM 2021 109300 A	AM 109300
		AM 2021 109381 A	AM 109381
		AM 2021 109382 A	AM 109382

ბანაცხაღის ბამოქვეყნების ნომრის საძიებელი საქონლისა  
ღა/ან მომსახურების კლასის მიხედვით

საქონლისა ღა/ან მომსახურების კლასი (511)	ბანაცხაღის ბამოქვეყნების ნომერი (260)
1	2
5	AM 2021 108962 A
5	AM 2021 108964 A
5	AM 2021 109013 A
5	AM 2021 109014 A
5	AM 2021 109015 A
5	AM 2021 109016 A
5	AM 2021 109017 A
5	AM 2021 109018 A
5	AM 2021 109021 A
5	AM 2021 109022 A
5	AM 2021 109023 A
5	AM 2021 109052 A
5	AM 2021 109227 A
5	AM 2021 109293 A
5	AM 2021 109294 A
10	AM 2021 109123 A
11	AM 2021 109123 A
12	AM 2021 109115 A
16	AM 2021 105661 A
16	AM 2021 105662 A
18	AM 2021 109115 A
20	AM 2021 109115 A
25	AM 2021 109123 A
26	AM 2021 109123 A
29	AM 2021 105234 A*
29	AM 2021 105661 A
29	AM 2021 105662 A
29	AM 2021 108953 A
29	AM 2021 108954 A
29	AM 2021 109208 A
30	AM 2021 105234 A*
30	AM 2021 105661 A
30	AM 2021 105662 A
30	AM 2021 108954 A
30	AM 2021 109027 A

1	2
30	AM 2021 109120 A
31	AM 2021 108953 A
32	AM 2021 102358 A*
32	AM 2021 105661 A
32	AM 2021 105662 A
32	AM 2021 109054 A
32	AM 2021 109300 A
33	AM 2021 105661 A
33	AM 2021 105662 A
33	AM 2021 108960 A
33	AM 2021 108965 A
33	AM 2021 109009 A
33	AM 2021 109025 A
33	AM 2021 109035 A
33	AM 2021 109054 A
33	AM 2021 109295 A
34	AM 2021 109046 A
34	AM 2021 109381 A
34	AM 2021 109382 A
35	AM 2021 104328 A
35	AM 2021 105661 A
35	AM 2021 105662 A
35	AM 2021 108514 A
35	AM 2021 109041 A
35	AM 2021 109123 A
39	AM 2021 109123 A
40	AM 2021 109123 A
41	AM 2021 105661 A
41	AM 2021 105662 A
41	AM 2021 109210 A
41	AM 2021 109211 A
42	AM 2021 109210 A
42	AM 2021 109211 A
43	AM 2021 105661 A
43	AM 2021 105662 A
43	AM 2021 108514 A
43	AM 2021 109009 A
43	AM 2021 109025 A
43	AM 2021 109034 A

დაჩქარებული პროცედურით რეგისტრირებული სასაქონლო ნიშნის ნომრის  
საძიებელი საქონლისა და/ან მომსახურების კლასის მიხედვით

საქონლისა და/ან მომსახურების კლასი (511)	დაჩქარებული პროცედურით რეგისტრირებული სასაქონლო ნიშნის ნომერი (111)
5	M 2021 33705 R
9	M 2021 33707 R
25	M 2021 33668 R
29	M 2021 33665 R
30	M 2021 33658 R
30	M 2021 33666 R
30	M 2021 33667 R
33	M 2021 33659 R
33	M 2021 33660 R
33	M 2021 33661 R
33	M 2021 33700 R
35	M 2021 33662 R
35	M 2021 33663 R
35	M 2021 33666 R
35	M 2021 33667 R
35	M 2021 33668 R
35	M 2021 33699 R
35	M 2021 33701 R
35	M 2021 33702 R
35	M 2021 33703 R
35	M 2021 33704 R
35	M 2021 33706 R
35	M 2021 33707 R
36	M 2021 33662 R
37	M 2021 33662 R
37	M 2021 33701 R
37	M 2021 33702 R
37	M 2021 33703 R
37	M 2021 33704 R
38	M 2021 33662 R
38	M 2021 33707 R
39	M 2021 33662 R
41	M 2021 33707 R
42	M 2021 33662 R
43	M 2021 33659 R
43	M 2021 33660 R
43	M 2021 33661 R
43	M 2021 33664 R

სამრეწველო საკუთრების  
ოფიციალური ბიულეტენი

3(559)

გამოგონებები  
სასარგებლო მოდელები  
დიზაინები  
სასაქონლო ნიშნები

მთავარი რედაქტორი:	ნ. ბებრიშვილი
კორექტორი:	ლ. ჭანტურია
დამკაბადონებლები:	მ. ორდენიძე ქ. სვანიძე
პოლიგრაფიული ჯგუფი:	მ. მეჩტიშვილი ი. გოგოლაშვილი ლ. დოლიძე

ხელმოწერილია გამოსაცემად 2021 02 24

ტირაჟი 10  
შეკვეთა №3

ბიულეტენის ელექტრონული ვერსიის გაცნობა შესაძლებელია საქპატენტის ვებგვერდზე

---

სათაო ოფისი: 3300 ქ. მცხეთა, ანტოქიის ქ. №5; ფაქსი: (+995 32) 2252531  
0179 ქ. თბილისი, ნინო რამიშვილის ქ. №31; ტელ.: (+995 32) 2252531  
info@sakpatenti.org.ge  
www.sakpatenti.gov.ge