



**NATIONAL INTELLECTUAL PROPERTY CENTER OF GEORGIA
SAKPATENTI**

**OFFICIAL BULLETIN
OF THE INDUSTRIAL PROPERTY**

4(440)

**2016
TBILISI**

INID CODES FOR IDENTIFICATION OF BIBLIOGRAPHIC DATA

INVENTIONS, UTILITY MODELS

- (10) Number of publication for application, which has been examined
- (11) Number of patent and kind of document
- (21) Serial number of application
- (22) Date of filing of the application
- (23) Date of exhibition or the date of the earlier filing and the number of application, if any
- (24) Date from which patent may have effect
- (31) Number of priority application
- (32) Date of filing of priority application
- (33) Code of the country or regional organization allotting priority application number
- (44) Date of publication of application not granted, but examined and number of bulletin
- (45) Date of publication of registered document
- (51) International Patent Classification Index
- (54) Title of the invention
- (57) Abstract
- (60) Number of examined patent document granted by foreign patent office, date from which patent has effect and country code
- (62) Number of the earlier application and in case of divided application, date of filing an application
- (71) Name, surname and address of applicant (country code)
- (72) Name, surname of inventor (country code)
- (73) Name, surname and address of patent owner (country code)
- (74) Name, surname of representative or patent attorney
- (85) Date of commencement of the national phase of International Application
- (86) Number and date of filing of international application
- (87) Number and date of publication of international application

DESIGNS

- (10) Number of publication for application
- (11) Number of patent and kind of document or number of registration
- (15) Date of registration/Date of patent renewal
- (18) Expected expiration date of patent or registration
- (21) Serial number of application
- (22) Date of filing of the application
- (23) Date of exhibition or the date of the earlier filing and the number of application, if any
- (24) Date from which patent may have effect
- (28) Number of designs included in the application
- (30) Data relating to priority (number of application, date of filing of application, two-letter code identifying the authority with whom the priority application was made)
- (31) Number of priority application
- (32) Date of filing of priority application
- (33) Code of the country or regional organization allotting priority application number
- (34) Two-letter code according to WIPO St.3 identifying the authority with which the priority application was made
- (44) Date of publication of design and number of bulletin (the first publication)
- (45) Date of publication of design registered by WIPO and number of bulletin
- (51) International Classification for designs (class and subclass of the Locarno Classification)
- (54) Title of the invention
- (55) Reproduction of the design
- (57) Description of characteristic features of the design including indication of colors
- (58) Date of recording of any kind of amendment in the Register
- (62) Number of the earlier application, registration and document number and if available the date of filing an application in case of divided application
- (71) Name, surname and address of applicant (country code)
- (72) Name, surname of creator (country code)
- (73) Name, surname and address of patent owner (country code)
- (74) Name, surname of representative or patent attorney
- (81) Contracting states concerned
 - II designated contracting states according to the 1960 Act
 - III designated contracting states according to the 1999 Act
- (85) Owner's permanent address
- (86) Owner's nationality
- (87) Owner's residence
- (88) State in which the owner has a real and effective industrial or commercial establishment

TRADEMARKS

- (111) – Number of registration
- (151) – Date of registration
- (156) – Date of the renewal
- (181) – Expected expiration date of registration
- (186) – Renewal expiration date of registration
- (141) – Date of cancel of duration of the mark
- (210) – Serial number of application
- (220) – Date of filing of the application
- (230) – Date concerning exhibition
- (260) – Number of application, for which favorable decision of examination about registration has been taken (publication number)
- (310) – Number of the first application
- (320) – Date of filing of the first application
- (330) – Code, identifying national or regional Office where the first application was made
- (511) – International Classification of Goods and Services for the purposes of registration of trade marks and/or list of goods and/or services classified according thereto
- (531) – Description of figurative elements of Trade Marks according to the International Classification of the Figurative Elements of Marks
- (540) – Reproduction of Trade Mark
- (550) – Nature and kind of Trade Mark
- (580) – Date of recording of any kind changes in respect of applications or registrations
- (591) – Information concerning colors claimed
- (731) – Name and address of the applicant
- (732) – Name and address of the holder of the registration
- (740) – Name and address of the representative
- (750) – Address for correspondence
- (770) – Name and address of the previous applicant or holder in case of change in ownership
- (771) – Previous name and address of the applicant or holder in case of change in ownership
- (791) – Name and address of the licensee
- (793) – Indication of conditions and/or restrictions under the license (Type of license, number of license agreement, data of license, data of validity of license)
- (800) – Certain data relating to the international registration of Trade Marks under the Protocol Relating to Madrid Agreement (International registration number)

CODES FOR PUBLICATION IN BULLETIN

- (21) AP 0000 000000 – serial number of application for invention
- (10) AP 0000 0000 A – number of published application for invention (first publication)
- (11) P 0000 0000 B – number of patent for invention (second publication)
- (21) API 0000 000000 – number of application for imported patent
- (11) PI 0000 0000 A – number of imported patent (first publication)
- (21) AU 0000 000000 – serial number of application for utility model
- (10) AU 0000 000 U – number of published application for utility model (first publication)
- (11) U 0000 000 Y – number of patent for utility model (second publication)
- (21) AD 0000 000000 – serial number of application for design
- (10) AD 0000 000 S – number of published application for design (first publication)
- (11) D 0000 000 S – number of patent for design (second publication)

INTERNATIONAL PATENT CLASSIFICATION FOR INVENTIONS AND UTILITY MODELS

- SECTION A – HUMAN NECESSITIES
- SECTION B – PERFORMING OPERATIONS; TRANSPORTING
- SECTION C – CHEMISTRY; METALLURGY
- SECTION D – TEXTILES; PAPER
- SECTION E – FIXED CONSTRUCTIONS
- SECTION F – MECHANICAL ENGINEERING; LIGHTING; HEATING; WEAPONS; BLASTING
- SECTION G – PHYSICS
- SECTION H – ELECTRICITY

-
- M – Trade Mark
 - (210) AM 0000 000000 – Serial number of application;
 - (260) AAM 0000 00000 A – Publication number of application;
 - (111) M 0000 00000 R – Number of registration;
 - (111) MMM0000 00000 Rn – Number of renewals, in which n=1,2,3;
 - (111) M 0000 00000 R(P) – Number of registration under partial assignment of rights
-

LIST OF CODES, IN ALPHABETIC SEQUENCE, AND THE CORRESPONDING (SHORT) NAMES OF STATES, OTHER ENTITIES AND INTERGOVERNMENTAL ORGANIZATIONS
(WIPO STANDARD ST.3)

AD	Andorra				
AE	United Arab Emirates				
AF	Afghanistan				
AG	Antigua and Barbuda				
AI	Anguilla				
AL	Albania				
AM	Armenia				
AN	Netherlands Antilles				
AO	Angola				
AP	African Regional Intellectual Property Organization (ARIPO)				
AR	Argentina				
AT	Austria				
AU	Australia				
AW	Aruba				
AZ	Azerbaijan				
BA	Bosnia and Herzegovina				
BB	Barbados				
BD	Bangladesh				
BE	Belgium				
BF	Burkina Faso				
BG	Bulgaria				
BH	Bahrain				
BI	Burundi				
BJ	Benin				
BM	Bermuda				
BN	Brunei Darussalam				
BO	Bolivia				
BR	Brazil				
BS	Bahamas				
BT	Bhutan				
BV	Bouvet Island				
BW	Botswana				
BX	Benelux Office for Intellectual Property (BOIP)				
BY	Belarus				
BZ	Belize				
CA	Canada				
CD	Democratic Republic of the Congo				
CF	Central African Republic				
CG	Congo				
CH	Switzerland				
CI	Cote d'Ivoire				
CK	Cook Islands				
CL	Chile				
CM	Cameroon				
CN	China				
CO	Colombia				
CR	Costa Rica				
CU	Cuba				
CV	Cape Verde				
CY	Cyprus				
CZ	Czech Republic				
DE	Germany				
DJ	Djibouti				
DM	Dominica				
DO	Dominican Republic				
DZ	Algeria				
EA	Eurasian Patent Organization (EAPO)				
EC	Ecuador				
EE	Estonia				
EG	Egypt				
EH	Western Sahara				
EM	Office for Harmonization in the Internal Market (Trademarks and Designs)(OHIM)				
EP	European Patent Office (EPO)				
ER	Eritrea				
ES	Spain				
ET	Ethiopia				
FI	Finland				
FJ	Fiji				
FK	Falkland Islands (Malvinas)				
FO	Faroe Islands				
FR	France				
GA	Gabon				
GB	United Kingdom				
GC	Patent Office of the Cooperation Council				
			for the Arab States of the Gulf (GCC)		
		GD	Grenada		
		GG	Guernsey		
		GH	Ghana		
		GI	Gibraltar		
		GT	Guatemala		
		GW	Guinea- Bissau		
		GY	Guyana		
		HK	The Hong Kong Special Administrative Region of the People's Republic of China		
		HN	Honduras		
		HR	Croatia		
		HT	Haiti		
		HU	Hungary		
		IB	International Bureau of the World Intellectual Property Organization (WIPO)		
		ID	Indonesia		
		IE	Ireland		
		IL	Israel		
		IM	Isle of Man		
		IN	India		
		IQ	Iraq		
		ID	Indonesia		
		IE	Ireland		
		IL	Israel		
		IM	Isle of Man		
		IN	India		
		IQ	Iraq		
		IR	Iran (Islamic Republic of)		
		IS	Iceland		
		IT	Italy		
		JE	Jersey		
		JM	Jamaica		
		JO	Jordan		
		JP	Japan		
		KE	Kenya		
		KG	Kyrgyzstan		
		KH	Cambodia		
		KI	Kiribati		
		KM	Saint Kitts and Nevis		
		KP	Democratic People's Republic of Korea		
		KR	Republic of Korea		
		KW	Kuwait		
		KY	Cayman Islands		
		KZ	Kazakhstan		
		LA	Lao People's Democratic Republic		
		LB	Lebanon		
		LC	Saint Lucia		
		LI	Liechtenstein		
		LK	Sri Lanka		
		LR	Liberia		
		LS	Lesotho		
		LT	Lithuania		
		LU	Luxembourg		
		LV	Latvia		
		LY	Libyan Arab Jamahiriya		
		MA	Morocco		
		MC	Monaco		
		MD	Republic of Moldova		
		ME	Montenegro		
		MG	Madagascar		
		MK	The former Yugoslav Republic of Macedonia		
		ML	Mali		
		MM	Myanmar		
		MN	Mongolia		
		MO	Macao		
		MP	Northern Mariana Islands		
		MR	Mauritania		
		MS	Montserrat		
		MT	Malta		
		MU	Mauritius		
		MV	Maldives		
		MW	Malawi		
		MX	Mexico		
		MY	Malaysia		
		MZ	Mozambique		
		NA	Namibia		
		NE	Niger		
		NG	Nigeria		
		NI	Nicaragua		
		NL	Netherlands		
		NO	Norway		
		NP	Nepal		
		NR	Nauru		
		NZ	New Zealand		
		OA	African Intellectual Property Organization (OAPI)		
		OM	Oman		
		PA	Panama		
		PE	Peru		
		PG	Papua New Guinea		
		PH	Philippines		
		PK	Pakistan		
		PL	Poland		
		PT	Portugal		
		PW	Palau		
		PY	Paraguay		
		QA	Qatar		
		QZ	Community Plant Variety Office (European Community) (CPVO)		
		RO	Romania		
		RS	Serbia		
		RU	Russian Federation		
		RW	Rwanda		
		SA	Saudi Arabia		
		SB	Solomon Islands		
		SC	Seychelles		
		SD	Sudan		
		SG	Singapore		
		SH	Saint Helena		
		SI	Slovenia		
		SK	Slovakia		
		SL	Sierra Leone		
		SM	San Marino		
		SN	Senegal		
		SO	Somalia		
		SR	Suriname		
		ST	Sao Tome and Principe		
		SV	El Salvador		
		SY	Syrian Arab Republic		
		SZ	Swaziland		
		TC	Turks and Caicos Islands		
		TD	Chad		
		TG	Togo		
		TH	Thailand		
		TJ	Tajikistan		
		TL	Timor-Leste		
		TM	Turkmenistan		
		TN	Tunisia		
		TO	Tonga		
		TR	Turkey		
		SE	Sweden		
		TT	Trinidad and Tobago		
		TV	Tuvalu		
		TW	Taiwan, Province of China		
		TZ	United Republic of Tanzania		
		UA	Ukraine		
		UG	Uganda		
		US	United States of America		
		UY	Uruguay		
		UZ	Uzbekistan		
		VA	Holy See		
		VC	Saint Vincent and the Grenadines		
		VE	Venezuela		
		VG	Virgin Islands (British)		
		VN	Viet Nam		
		VU	Vanuatu		
		WO	World Intellectual Property Organization (WIPO)		
		WS	Samoa		
		XN	Nordic Patent Institute (NPI)		
		YE	Yemen		
		ZA	South Africa		
		ZM	Zambia		
		ZW	Zimbabwe		

**NATIONAL INTELLECTUAL PROPERTY CENTER OF GEORGIA
SAKPATENTI**

**OFFICIAL BULLETIN
OF THE INDUSTRIAL PROPERTY**

4(440)

INVENTIONS

UTILITY MODELS

DESIGNS

TRADEMARKS

APPELLATIONS OF ORIGIN OF GOODS

DATE OF PUBLICATION

2016 02 25

CONTENTS

PUBLISHED TITLES OF PROTECTION	3
INVENTIONS	
▪ APPLICATIONS APPROVED FOR GRANTING PATENTS	4
▪ PATENTED INVENTIONS	7
UTILITY MODELS	
▪ PATENTED UTILITY MODELS	8
DESIGNS	
▪ DESIGN REGISTERED ACCORDING TO THE ACCELERATED PROCEDURE	10
TRADEMARKS	
▪ APPLICATIONS FILED UNDER THE NATIONAL PROCEDURE APPROVED FOR REGISTRATION	11
▪ REGISTERED TRADEMARKS	21
▪ TRADEMARKS REGISTERED ACCORDING TO THE ACCELERATED PROCEDURE	25
▪ INTERNATIONAL TRADEMARKS FOR WHICH A DECISION ON GANTING PROTECTION IS TAKEN	28
▪ INTERNATIONAL TRADEMARKS PROTECTED IN GEORGIA	78
APPELLATIONS OF ORIGIN OF GOODS	
▪ APPLICATIONS OF ORIGIN OF GOODS IN GEORGIA FOR EXAMINAYION UNDER LISBON AGREEMENT, ON THE BASIS OF THE INTERNATIONAL REGISTRATION	86
OFFICIAL NOTIFICATIONS	
TRADEMARKS	
▪ INVALIDATION OF TRADEMARKS REGISTRATION	91
CLASSIFICATION INDEXES	
INVENTIONS	93
UTILITY MODELS	94
DESIGNS	95
TRADEMARKS	96

PUBLISHED TITLES OF PROTECTION

INVENTIONS

- **APPLICATIONS APPROVED FOR GRANTING PATENTS:**
13717; 13742, 13743; 12905; 13563; 13082; 12885
- **PATENTED INVENTIONS:**
6435-6438

UTILITY MODELS

- **PATENTED UTILITY MODELS:**
1885-1888

DESIGN

- **DESIGN REGISTERED ACCORDING TO THE ACCELERATED PROCEDURE:**
663

TRADEMARKS

- **APPLICATIONS FILED UNDER THE NATIONAL PROCEDURE APPROVED FOR REGISTRATION:**
64922-64931**; 65149**; 78742; 79775; 79777; 79780-79783; 79982; 80212; 80445; 80676; 81388; 81428; 81625, 81626; 81725; 81846, 81847; 81926-81929; 81932; 81969; 81985, 81986; 81993, 81994; 81996; 81999; 82156; 82173; 82218; 82251, 82252; 82254, 82255; 82282; 82390, 82391; 82408; 82448; 82492; 82548, 82549; 82588; 82679; 82823-82825
- **REGISTERED TRADEMARKS:**
26736-26769; 26773, 26774; 26779, 26780
- **TRADEMARKS REGISTERED ACCORDING TO THE ACCELERATED PROCEDURE:**
26770-27772; 26775-26778; 26781-26789
- **INTERNATIONAL TRADEMARKS FOR WHICH A DECISION ON GRANTING PROTECTIONS IS TAKEN:**
70162**; 81167; 81285; 81289; 81337; 81518; 81577; 81579-81582; 81585-81594; 81596; 81598-81602; 81605-81608; 81612-81614; 81627; 81629; 81635-81637; 81640-81642; 81644; 81656; 81663-81666; 81670; 81705; 81712; 81714, 81715; 81718-81720; 81739; 81742; 81744-81746; 81774, 81775; 81782-81784; 81791-81798; 81805-81807; 81809; 81811; 81817-81819; 81821-81823; 81829, 81830; 81833, 81834; 81839; 81841; 81843-81845; 81849; 81854-81856; 81858, 81859; 81869-81873; 81875; 81877; 81948-81951; 81953; 81955, 81956; 81958, 81959; 81963, 81964; 81972; 81975; 81978-81984; 82004-82020; 82157; 82160, 82161; 82165; 82167-82172; 82201; 82287-82290
- **INTERNATIONAL TRADEMARKS PROTECTED IN GEORGIA:**
74483; 74701; 79626; 79772; 80352; 80408-80410; 80414; 80424-80426; 80428-80434; 80530, 80531; 80535, 80536; 80545, 80546; 80550; 80562, 80563; 80568; 80570; 80572, 80573; 80584; 80586; 80588-80593; 80608; 80610; 80613, 80614; 80618-80620; 80631; 80645; 80650; 80652, 80653; 80657; 80659; 80661, 80662; 80667; 80670-80673; 80683, 80684; 80690; 80692; 80694, 80695; 80697-80700; 80702; 80705-80708; 80712; 80714, 80715; 80720; 80722; 80724; 80729, 80730; 80734; 80737-80739; 80741; 80744-80748; 80750-80756; 80897, 80898; 80900; 80902; 80904

APPELLATIONS OF ORIGIN OF GOODS

- **APPELLATIONS OF ORIGIN OF GOODS FILED IN GEORGIA FOR EXAMINATION UNDER LISBON AGREEMENT, ON THE BASIS OF THE INTERNATIONAL REGISTRATION**
1265-1268; 1270-1280

INVENTIONS

APPLICATIONS APPROVED FOR GRANTING PATENTS

The decision can be appealed at the Chamber of Appeal of Sakpatenti within 3 months from the publication or at the Mtskheta District Court Administrative Cases Board (Address: №17, Samkhedro str., Mtskheta), within 1 month following the publication.

PART A

A 01

(10) AP 2016 13717 A (51) Int. Cl. (2006)
A 01 B 19/02

(21) AP 2015 013717 (22) 2015 02 03

(71) LEPL SCIENTIFIC RESEARCH CENTER
OF AGRICULTURE (GE)

Marshal Gelovanis Gamz. 6, 0159,
Tbilisi (GE)

(72) Vazha Japaridze (GE);

Vladimer Miruashvili (GE)

(54) **SOIL SURFACE RIPPER**

(57) A ripper includes connected to tractor 1 hinge mechanism 2 the cross bar girt 5 having an actuator attached thereon. The actuator is executed as ski-shaped flat flexible componentry 9, and soil ripping vertical teeth 10 is fixed on horizontal parts thereof.

Claims: 1 independent

Fig.: 2

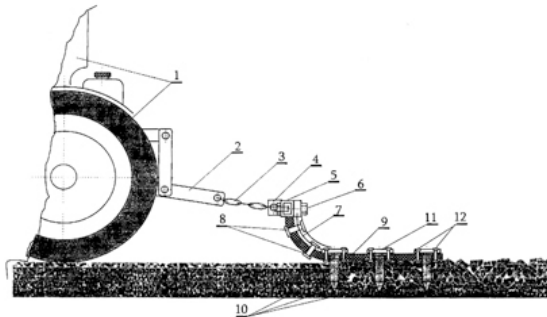

Fig. 1

(10) AP 2016 13742 A (51) Int. Cl. (2006)
A 01 D 46/04

(21) AP 2015 013742 (22) 2015 02 24

(71) LEPL SCIENTIFIC RESEARCH
CENTER OF AGRICULTURE (GE)

Marshal Gelovanis Gamz. 6, 0159,
Tbilisi (GE)

(72) Nugzar Ebanoidze (GE);

Giorgi Kutelia (GE);

Nodar Natenadze (GE)

(54) **COMBINED AGGREGATE FOR
TEA GARDENS RESTORATION**

(57) An aggregate includes an apparatus for cutting and crumbling bushes connected to energetic source 1 by means of connecting system. The appa-

ratus is executed as tiered in casing 4 the rotor drums 5 and 6 equipped with cutters 7 and having a drive. Rotor drums are executed double-sectional, and cutters thereof are inclined opposite relative to each other. Rotable couple of disk-shaped saws 9 and 10 is disposed in front of rotor drums inclined relative to horizontal line. The aggregate is additionally equipped with mineral fertilizer double-sectional measuring hopper 18 disposed back to energetic source, a furrow breaker 19 and soil cultivating mill 20.

Claims: 1 independent

2 dependent

Fig.: 2

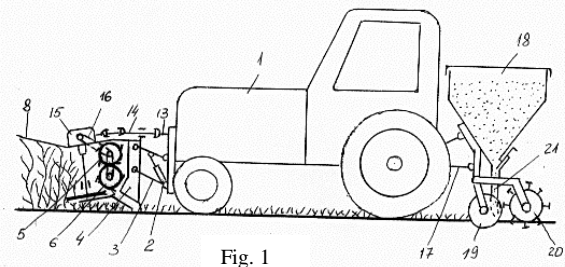

Fig. 1

(10) AP 2016 13743 A (51) Int. Cl. (2006)
A 01 D 46/26

(21) AP 2015 013743 (22) 2015 02 24

(71) LEPL SCIENTIFIC RESEARCH
CENTER OF AGRICULTURE (GE)

Marshal Gelovanis Gamz. 6, 0159,
Tbilisi (GE)

(72) Nugzar Ebanoidze (GE);

Giorgi Kutelia (GE);

Nodar Natenadze (GE)

(54) **FRUIT HARVESTING MACHINE**

(57) A machine includes energetic source frame 1 – motor vehicle chassis and connected to energetic source drive – takeoff shaft 2 by means of driveline 3 and belting 4 actuator disposed on drive both sides. The actuator is executed as couple of discs 6 installed rotatable on horizontal shaft 5. Each disc has eccentrically disposed pin 7 whereon flexible claw 8 is hinged; for example, a chain ended with a belt 9 having a hook 10. The machine is equipped with trapper – fruit harvester executed as an axle 13 placed in casing 11, connected to flat springs 12 and fixed by one edge onto axle of dense fabric, for

example canvas or awning material rectangular trap
14 capable to be unrolled and rolled on said axle.

Claims: 1 independent

Fig.: 2

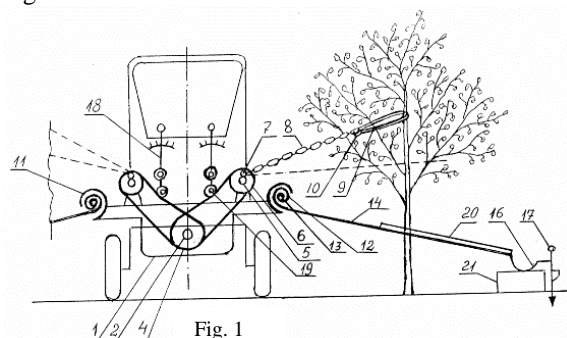

A 61

(10) AP 2016 12905 A (51) Int. Cl. (2006)

A 61 K 9/22
A 61 K 9/32
A 61 K 31/495
A 61 K 47/02
A 61 K 47/32
A 61 K 47/34
A 61 P 25/24

(21) AP 2011 012905 (22) 2011 04 28

(31) 2010-105666

(32) 2010 04 30

(33) JP

(71) TAKEDA PHARMACEUTICAL
COMPANY LIMITED (JP)

1-1, Doshomachi 4-chome, Chuo-ku,
Osaka-shi, Osaka 5410045 (JP)

(72) MISAKI, Masafumi (JP);

TSUSHIMA, Yuki (JP);

NIWA, Masahiro (JP);

(74) Shalva Gvaramadze

(85) 2012 11 27

(86) PCT/JP2011/060483, 2011 04 28

(54) **ENTERIC TABLET**

(57) A tablet includes core containing 1-[2-(2,4-dimethyl phenylsulfanyl)phenyl]piperazine and covering containing polymeric component and talk.

Claims: 2 independent

5 dependent

PART C

C 07

(10) AP 2016 13563 A (51) Int. Cl. (2006)
C 07 D 401/12
C 09 D 401/14
A 61 K 31/454
A 61 K 31/4545
A 61 P 3/00
A 61 P 25/00
A 61 P 29/00
A 61 P 35/00
C 07 D 405/14

(21) AP 2013 013563 (22) 2013 02 07

(31) 12156292.0

(32) 2012 02 21

(33) EP

(71) AZIENDE CHIMICHE RIUNITE
ANGELINI FRANCESCO A.C.R.A.F.
S.P.A. (IT)

Viale Amelia, 70 I-00181 Roma (IT)

(72) ALISI, Maria Alessandra (IT);

CAZZOLLA, Nicola (IT);

DRAGONE, Patrizia (IT);

FURLOTTI, Guido (IT);

MAUGERI, Caterina (IT);

OMBRATO, Rosella (IT);

MANCINI, Francesca (IT)

(74) Liliana Darakhvelidze

(85) 2014 09 01

(86) PCT/EP2013/052400, 2013 02 07

(54) **1H-INDAZOLE-3-CARBOXAMIDE
COMPOUNDS AS GLYCOGEN
SYNTHASE KINASE 3 BETA
INHIBITORS**

(57) 1H-indazole-3-carboxamide compounds are applied at the treatment of diseases caused by GSK-3 β uncontrolled activation and/or extra expression.

Claims: 3 independent

19 dependent

(10) AP 2016 13082 A (51) Int. Cl. (2006)

C 07 D 401/14

C 07 D 211/58

C 07 D 213/81

C 07 D 401/04

A 61 K 31/454

A 61 P 31/00

(21) AP 2011 013082 (22) 2011 10 06

(31) 10186901.4

(32) 2010 10 07

(33) EP

(71) BOEHRINGER INGELHEIM
INTERNATIONAL GMBH (DE)

Binger Straße 173 55216 Ingelheim

Am Rhein (DE)

(72) FRANK, Markus (DE);
 HAEBERLE, Hans (DE);
 HENRY, Manuel (FR);
 PACHUR, Thorsten (DE);
 SANTAGOSTINO, Marco (IT);
 STERTZ, Uwe (DE);
 TREBING, Thomas (DE);
 WERTHMANN, Ulrike (DE)

(74) Tamar Kochlamazashvili

(85) 2013 05 07

(86) PCT/EP2011/067437, 2011 10 06

(54) **CO-CRYSTALS AND SALTS
 OF CCR3-INHIBITORS**

(57) Co-crystals of compound of formula (1),

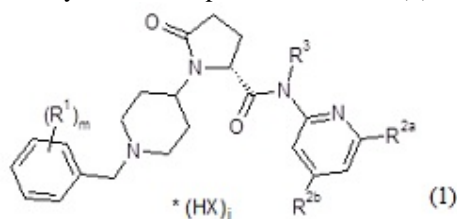

wherein values of group R¹, R^{2a}, R^{2b}, R³ and variable m, j are provided in the claims; and salts thereof; pharmaceutical composition on basis thereof; usage of said co-crystals and salts as drugs and prevention or treatment of various inflammatory and immunoregulatory disorders and diseases.

Claims: 6 independent
 8 dependent

Table: 4

(10) AP 2016 12885 A (51) Int. Cl. (2006)
 C 07 K 16/28

(21) AP 2011 012885 (22) 2011 03 30

(31) 61/319,574

(32) 2010 03 31

(33) US

(71) BOEHRINGER INGELHEIM
 INTERNATIONAL GMBH (DE)
 Binger Straße 173 55216 Ingelheim Am
 Rhein (DE)

(72) BARRETT, Rachel (US);
 BRODEUR, Scott (US);
 CANADA, Keith A. (US);
 LITZENBURGER, Tobias (DE);
 SINGH, Sanjaya (US)

(74) Tamar Kochlamazashvili

(85) 2012 10 30

(86) PCT/US2011/030427, 2011 03 30

(54) **ANTI-CD40 ANTIBODIES**

(57) Novel humanized antagonistic anti-CD40 antibodies applicable at autoimmune and inflammatory diseases treatment are disclosed.

Claims: 4 independent
 6 dependent

Fig.: 13

PATENTED INVENTIONS

PART A

A 61

- (11) P 2016 6436 B (51) Int. Cl. (2006)
A 61 K 36/064
A 61 K 38/44
A 61 P 3/04
- (10) AP 2015 13368 A (44) 21(433)/2015
 (21) AP 2012 013368
 (22) 2012 08 02
 (24) 2012 08 02
 (31) MI2011A001488
 (32) 2011 08 03
 (33) IT
 (86) PCT/EP2012/065119, 2012 08 02
 (73) GNOSIS S.P.A. (IT)
 Piazza del Carmine, 4 I-20121 Milano (IT)
 (72) CASTAGLIUOLO, Ignazio (IT);
 BRUN, Paola (IT);
 BUSIELLO, Immacolata (IT);
 MIRAGLIA, Niccolò (IT)
 (74) Shalva Gvaramadze
 (54) **FORMULATIONS COMPRISING
 SACCHAROMYCES BOULARDII AND
 SUPEROXIDE DISMUTASE FOR
 CONTROLLING OBESITY**

- MAH, Robert (CH);
 MAO, Liang (CN);
 MASUYA, Keiichi (CH);
 SCHLAPBACH, Achim (CH);
 STUTZ, Stefan (CH);
 VAUPEL, Andrea (CH)
 (74) Aleksandre Kartvelishvili
 (54) **IMIDAZOPYRROLIDINONE
 COMPOUNDS**

- (11) P 2016 6435 B (51) Int. Cl. (2006)
C 07 K 7/08
C 07 K 14/47
- (10) AP 2015 12738 A (44) 21(433)/2015
 (21) AP 2010 012738
 (22) 2010 11 09
 (24) 2010 11 09
 (31) 61/259,264
 (32) 2009 11 09
 (33) US
 (86) PCT/US2010/056042, 2010 11 09
 (73) IRONWOOD PHARMACEUTICALS,
 INC. (US)
 301 Binney Street Cambridge,
 MA 02142 (US)
 (72) CURRIE, Mark, G. (US);
 FRETZEN, Angelika (DE);
 KESSLER, Marco (US);
 ZIMMER, Daniel, P. (US)
 (74) Shalva Gvaramadze
 (54) **TREATMENTS FOR GASTROINTESTINAL
 DISORDERS**

PART C

C 07

- (11) P 2016 6438 B (51) Int. Cl. (2006)
C 07 D 487/04
A 61 K 31/4188
A 61 P 35/00
- (10) AP 2015 13535 A (44) 21(433)/2015
 (21) AP 2013 013535
 (22) 2013 01 25
 (24) 2013 01 25
 (31) 61/591,001; 61/669,902;
 PCT/CN2012/086703
 (32) 2012 01 26; 2012 07 10; 2012 12 14
 (33) US; US; CN
 (86) PCT/IB2013/050655, 2013 01 25
 (73) NOVARTIS AG (CH)
 Lichtstrasse 35 CH-4056 Basel (CH)
 (72) FURET, Pascal (CH);
 GUAGNANO, Vito (CH);
 HOLZER, Philipp (CH);
 KALLEN, Joerg (CH);
 LIAO, Lv (CN);

C 12

- (11) P 2016 6437 B (51) Int. Cl. (2006)
C 12 G 3/06
- (10) AP 2016 13436 A (44) 21(433)/2015
 (21) AP 2014 013436
 (22) 2014 04 03
 (24) 2014 04 03
 (73) Iuri Ramazashvili (GE)
 Nutsubidzis perd. IV mkr., korp. 28, b. 41,
 0186, Tbilisi (GE);
 Aleksandre Ustiashvili (GE)
 Adigenis q. 2, 0102, Tbilisi (GE);
 Lukhum Vacheishvili (GE)
 Sop. Lechuri, 2214, Telavis raioni (GE)
 (72) Iuri Ramazashvili (GE);
 Aleksandre Ustiashvili (GE);
 Lukhum Vacheishvili (GE)
 (54) **ALCOHOLIC BEVERAGE WITH
 BIO-PROTECTIVE CHARACTERISTICS**

PATENTED UTILITY MODELS

PART A

A 23

- (11) U 2016 1887 Y (51) Int. Cl. (2006)
A 23 K 1/22
- (10) AU 2015 13620 U (44) 21(433)/2015
(21) AU 2014 013620
(22) 2014 10 31
(24) 2014 10 31
(73) Iamze Beshkenadze (GE)
Vazisubani, IV mkr., I kvart., korp. 8.,
b. 99, 0152, Tbilisi (GE)
- (72) Iamze Beshkenadze (GE);
Nani Zhorzholiani (GE);
Maia Gogaladze (GE);
Spartak Urotadze (GE);
Avtandil Chagelishvili (GE);
Givi Begheluri (GE)
- (54) **ADDITIVE CONTAINING
HETERONUCLEAR CITRATES FOR
BIRDSEED**

A 61

- (11) U 2016 1888 Y (51) Int. Cl. (2006)
A 61 M 5/14
- (10) AU 2015 13782 U (44) 21(433)/2015
(21) AU 2015 013782
(22) 2015 04 03
(24) 2015 04 03
(73) Zurab Chkhaidze (GE)
Broses q. 2, 0108, Tbilisi (GE);
Nodar Khodeli (GE)
Budapeshtis q. 40, 0160, Tbilisi (GE);
Otar Shengelia (GE)
Garejis q. 49, 0141, Tbilisi (GE)
- (72) Zurab Chkhaidze (GE);
Nodar Khodeli (GE);
Otar Shengelia (GE)
- (54) **ARTIFICIAL APPARATUS FOR
BLOOD CIRCULATION**

PART C

C 05

- (11) U 2016 1885 Y (51) Int. Cl. (2006)
C 05 C 9/02
- (10) AU 2015 13255 U (44) 14(426)/2015
(21) AU 2013 013255
(22) 2013 10 04
(24) 2013 10 04
(73) Givi Papava (GE)
Shatberashvilis q. 4, b. 5, 0179, Tbilisi (GE);
Eldar Gugava (GE)
Iosebidsis q. 51, b. 92, 0160, Tbilisi (GE);
Nora Dokhturishvili (GE)
Dolidzis q. 25, b. 98, 0171, Tbilisi (GE);
Nunu Maisuradze (GE)
Dolidzis q. 25, b. 128, 0171, Tbilisi (GE);
Nazi Gelashvili (GE)
Dolidzis q., korp. 14, b. 24, 0171, Tbilisi (GE);
Marina Gurgenshvili (GE)
Sop. Kandaure, 3812, Sagarejo (GE);
Ketevan Papava (GE)
Amaghebis q. 8, 0107, Tbilisi (GE);
Nanuli Khotenashvili (GE)
Iv. Javakhishvilis q. 13, 0102, Tbilisi (GE);
Riva Liparteliani (GE)
Didi Dighomi, Giorgi Brtskinvalis q. 41,
0131, Tbilisi (GE)
- (72) Givi Papava (GE);
Eldar Gugava (GE);
Nora Dokhturishvili (GE);
Nunu Maisuradze (GE);
Nazi Gelashvili (GE);
Marina Gurgenshvili (GE);
Ketevan Papava (GE);
Nanuli Khotenashvili (GE);
Riva Liparteliani (GE)
- (54) **METHOD FOR NITROGEN
FERTILIZER PRODUCTION OF
PROLONGED ACTIVITY**

C 23

- (11) U 2016 1886 Y (51) Int. Cl. (2006)
C 23 C 18/38
- (10) AU 2015 13256 U (44) 14(426)/2015
(21) AU 2013 013256
(22) 2013 10 04
(24) 2013 10 04
(73) Givi Papava (GE)

- Shatberashvilis q. 4, b. 5, 0179, Tbilisi (GE);
Vitali Sherozia (GE)
Nutsubidzis q. 14a, b. 4, 0177, Tbilisi (GE);
Eldar Gugava (GE)
Iosebidzis q. 51, b. 92, 0160, Tbilisi (GE);
Nora Dokhturishvili (GE)
Dolidzis q. 25, b. 98, 0171, Tbilisi (GE);
Nunu Maisuradze (GE)
Dolidzis q., korp. 25, b. 128, 0171,
Tbilisi (GE);
Marina Gurgenishvili (GE)
Sop. Kandaure, 3812, Sagarejo (GE);
Ia Chitrekashvili (GE)
Tsulukidzis q. 23, b. 56, 0190, Tbilisi (GE);
Eter Gavashelidze (GE)
Vazha-Phavelas Gamz., IV kvart., korp. 25,
b. 14, 0186, Tbilisi (GE);
Shalva Papava (GE)
Shatberashvilis q. 4, b. 5, 0179, Tbilisi (GE)
- (72) Givi Papava (GE);
Vitali Sherozia (GE);
Eldar Gugava (GE);
Nora Dokhturishvili (GE);
Nunu Maisuradze (GE);
Marina Gurgenishvili (GE);
Ia Chitrekashvili (GE);
Eter Gavashelidze (GE);
Shalva Papava (GE)
- (54) **METHOD FOR GRAPHITE
COMPOSITION PRODUCTION
PLATED WITH COPPER**
-

DESIGN

DESIGN REGISTERED ACCORDING TO THE ACCELERATED PROCEDURE

The decision can be appealed at the Chamber of Appeal of Sakpatenti within 3 months from the publication.

(11) **D 2016 663 S** (51) **09-01**
(21) AD 2016 000898 (22) 2016 02 03
(24) 2016 02 03
(28) 1
(18) 2021 02 03
(73) Gocha Pipia (GE)
 Budapeshtis q. 11, b. 55, 0160, Tbilisi (GE)
(72) Gocha Pipia (GE)
(74) Aleksandre Kvernadze
(54) **DECORATIVE BEVERAGE VESSEL WITH TAP**
(55)



1

TRADEMARKS

APPLICATIONS FILED UNDER THE NATIONAL PROCEDURE APPROVED FOR REGISTRATION

The decision can be appealed at the Chamber of Appeal of Sakpatenti within 3 months from the publication or at the Mtskheta District Court Administrative Cases Board (Address: №17, Samkhedro St., Mtskheta), within 1 month following the publication.

(260) AM 2016 64922 A**
(210) AM 64922
(220) 2011 11 16
(731) LTD "AGROGEORGIA.AG"
Dighmis mas. me-5 kv., I korp., b. 38,
0159, Tbilisi, Georgia
(540)

Conquer
კონკერი
Конкер

(591) Black,white
(511) 5

(260) AM 2016 64923 A**
(210) AM 64923
(220) 2011 11 16
(731) LTD "AGROGEORGIA.AG"
Dighmis mas. me-5 kv., I korp., b. 38,
0159, Tbilisi, Georgia
(540)

Victory
ვიქტორი
Виктори

(591) Black,white
(511) 5

(260) AM 2016 64924 A**
(210) AM 64924
(220) 2011 11 16
(731) LTD "AGROGEORGIA.AG"
Dighmis mas. me-5 kv., I korp., b. 38,
0159, Tbilisi, Georgia
(540)

Avanguard
ავანგარდი
Авангард

(591) Black,white
(511) 5

(260) AM 2016 64925 A**
(210) AM 64925
(220) 2011 11 16
(731) LTD "AGROORJIA.AG"
Dighmis mas. me-5 kv., I korp., b. 38,
0159, Tbilisi, Georgia
(540)

Tanchant
ტენჩანტი
Тэнчант

(591) Black,white
(511) 5

(260) AM 2016 64926 A**
(210) AM 64926
(220) 2011 11 16
(731) LTD "AGROGEORGIA.AG"
Dighmis mas. me-5 kv., I korp., b. 38,
0159, Tbilisi, Georgia
(540)

Pinnacle
პინაკლი
Пинакл

(591) Black,white
(511) 5

(260) AM 2016 64927 A**
(210) AM 64927
(220) 2011 11 16
(731) LTD "AGROGEORGIA.AG"
Dighmis mas. me-5 kv., I korp., b. 38,
0159, Tbilisi, Georgia
(540)

Majestic
მაჯესტიკი
Маджестик

(591) Black,white
(511) 5

(260) AM 2016 64928 A**
 (210) AM 64928
 (220) 2011 11 16
 (731) LTD "AGROGEORGIA.AG"
 Dighmis mas. me-5 kv., I korp., b. 38,
 0159, Tbilisi, Georgia
 (540)

Maize
მაისი
Маиз

(591) Black,white
 (511) 5

(260) AM 2016 64929 A**
 (210) AM 64929
 (220) 2011 11 16
 (731) LTD "AGROGEORGIA.AG"
 Dighmis mas. me-5 kv., I korp., b. 38,
 0159, Tbilisi, Georgia
 (540)

Gliacent
გლიაცენტი
Глиацент

(591) Black,white
 (511) 5

(260) AM 2016 64930 A**
 (210) AM 64930
 (220) 2011 11 16
 (731) LTD "AGROGEORGIA.AG"
 Dighmis mas. me-5 kv., I korp., b. 38,
 0159, Tbilisi, Georgia
 (540)

Fungiking
ფუნგიკინგი
Фунгикинг

(591) Black,white
 (511) 5

(260) AM 2016 64931 A**
 (210) AM 64931
 (220) 2011 11 16
 (731) LTD "AGROGEORGIA.AG"
 Dighmis mas. me-5 kv., I korp., b. 38,
 0159, Tbilisi, Georgia
 (540)

Nikosh
ნიკოშო
Никош

(591) Black,white
 (511) 5

(260) AM 2016 65149 A**
 (210) AM 65149
 (220) 2011 11 30
 (731) LTD "AGROGEORGIA.AG"
 Dighmis mas. me-5 kv., I korp., b. 38,
 0159, Tbilisi, Georgia
 (540)

მეტსი
Metsy
Метси

(591) Black,white
 (511) 5

(260) AM 2016 78742 A
 (210) AM 78742
 (220) 2014 09 19
 (731) LTD "KARTU-UNIVERSAL"
 Kakhetis gzat., II chikhi 11, 0190, Tbilisi,
 Georgia
 (740) Gocha Gogishvili
 (540)

ნუვო
NUVO
НУВО

(511) 29

(260) AM 2016 79775 A
 (210) AM 79775
 (220) 2014 12 04
 (310) UK00003065677
 (320) 2014 07 24
 (330) GB
 (731) BRITISH AMERICAN TOBACCO
 (BRANDS) INC. (a Delaware corporation).
 2711 Centerville Road, Suite 300,
 Wilmington, Delaware 19808, USA
 (740) Tamar Kochlamazashvili
 (540)



(591) Black,white
 (531) 10.01.25, 25.01.01, 25.07.15
 (511) 34

(260) AM 2016 79777 A
 (210) AM 79777
 (220) 2014 12 04
 (310) UK00003073728
 (320) 2014 09 23
 (330) GB
 (731) CARRERAS LIMITED
 Globe House, 4 Temple Place, London WC2R
 2PG, United Kingdom
 (740) Tamar Kochlamazashvili
 (540)



(591) Blue, sky-blue, black, red, yellow, light yellow
 (531) 03.01.06, 25.07.15, 26.04.10, 26.04.12,
 27.01.12, 27.05.21, 29.01.15
 (511) 34

(260) AM 2016 79780 A
 (210) AM 79780
 (220) 2014 12 04
 (310) 2014 31504
 (320) 2014 10 23
 (330) AZ
 (731) BRITISH AMERICAN TOBACCO
 (BRANDS) LIMITED
 Globe House, 4 Temple Place, London
 WC2R 2PG, United Kingdom
 (740) Tamar Kochlamazashvili
 (540)

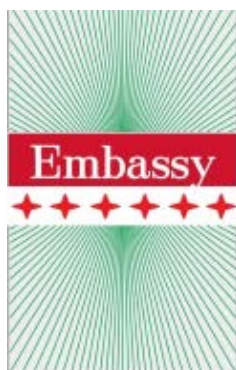

(591) White, green, red
 (531) 01.01.09, 01.01.13, 01.15.09, 26.04.22,
 26.04.24, 27.05.24, 29.01.13
 (511) 34

(260) AM 2016 79781 A
 (210) AM 79781
 (220) 2014 12 04
 (310) 2014 31503
 (320) 2014 10 23
 (330) AZ
 (731) BRITISH AMERICAN TOBACCO
 (BRANDS) LIMITED
 Globe House, 4 Temple Place, London
 WC2R 2PG, United Kingdom
 (740) Tamar Kochlamazashvili
 (540)



(591) Grey, black, white
 (531) 02.01.12, 18.03.02, 26.01.21, 02.01.01,
 27.05.13
 (511) 34

(260) AM 2016 79782 A
 (210) AM 79782
 (220) 2014 12 04
 (310) 2014 31502
 (320) 2014 10 23
 (330) AZ
 (731) BRITISH AMERICAN TOBACCO
 (BRANDS) LIMITED
 Globe House, 4 Temple Place, London
 WC2R 2PG, United Kingdom
 (740) Tamar Kochlamazashvili
 (540)



(591) Black,white
 (531) 27.05.22, 24.09.01
 (511) 34

(260) AM 2016 79783 A
 (210) AM 79783
 (220) 2014 12 04
 (310) 2014 31514
 (320) 2014 10 27
 (330) AZ
 (731) BRITISH AMERICAN TOBACCO
 (BRANDS) LIMITED
 Globe House, 4 Temple Place, London
 WC2R 2PG, United Kingdom

(740) Tamar Kochlamazashvili
(540)



(591) Black, white, purple, grey
(531) 26.04.24, 27.05.24, 29.01.13, 24.01.03,
25.07.17, 26.04.08, 03.03.17
(511) 34

(260) AM 2016 79982 A
(210) AM 79982
(220) 2014 12 23
(731) ABBOTT LABORATORIES
100 Abbott Park Road, Abbott Park, Illinois
60064, USA
(740) Tamar Kochlamazashvili
(540)

ABBOTT

(511) 32, 41, 44, 45

(260) AM 2016 80212 A
(210) AM 80212
(220) 2015 01 23
(731) THE PROCTER & GAMBLE COMPANY
One Procter & Gamble Plaza, Cincinnati
Ohio 45202, USA
(740) Shalva Gvaramadze
(540)

3 MINUTE MIRACLE

(511) 3

(260) AM 2016 80445 A
(210) AM 80445
(220) 2015 01 23
(731) HANKOOK TIRE WORLDWIDE CO., LTD.
647-15, Yoksam-dong, Kangnam-gu, Seoul,
Republic of Korea
(740) Merab Kvimsadze
(540)

**SMARTEC Hankook TBR
Technology**

(591) Black, white
(531) 27.05.10
(526) The trademark is protected as a whole. "TBR
Technology" shall not be subject to independent le-
gal protection.
(511) 12

(260) AM 2016 80676 A
(210) AM 80676
(220) 2015 02 10
(731) LTD "JENERATIONS"
Gamarjebis q. 3, 2200, Telavi, Georgia
(740) Temur Dakishvili
(540)

**Vita Vinea
Вита Винеа
ვიტა ვინეა**

(511) 32, 33, 35

(260) AM 2016 81388 A
(210) AM 81388
(220) 2015 03 25
(731) GOOGLE INC.
1600 Amphitheatre Parkway, Mountain View,
CA 94043, USA
(740) Tamaz Shilakadze
(540)

BLOGSPOT

(511) 41

(260) AM 2016 81428 A
(210) AM 81428
(220) 2015 03 26
(731) LTD "GEORGAS NERGEBI"
Atenis q.6/8, b.75, 0179 Tbilisi, Georgia
(740) Viktoria Begheladze
(540)

გაამწვანე მომავალი

(511) 35, 44

(260) AM 2016 81625 A
(210) AM 81625
(220) 2015 04 08
(731) LTD "G-M-P"
Sop. Ponichala 65, 0165, Tbilisi, Georgia
(740) Nugzar Ksovreli
(540)

**კორვალ-Г
КОРВАЛ-Г
KORVAL-G**

(511) 5

(260) AM 2016 81626 A
(210) AM 81626
(220) 2015 04 09
(731) Pharmaceutical Chemical Cosmetic industry
ALKALOID AD - Skopje
Bul. Aleksandar Makedonski, 12, The Former

Yugoslav Republic of Macedoni
(740) Vakhtang Torotadze
(540)

GastroGuard

(511) 5

(260) AM 2016 81725 A
(210) AM 81725
(220) 2015 04 21
(731) ELDAR IUKURIDZE

Zhukovskis q. 19, b. 9, Odessa, Ukraine;
LTD "SHABO-GEORGIA"
Il. Chavchavadze av. 29/31/33, 0179, Tbilisi,
Georgia

(740) Giorgi Taktakishvili
(540)

ERISIONI

(511) 33

(260) AM 2016 81846 A
(210) AM 81846
(220) 2015 04 27
(731) LTD "OMEGA-2"

Sarajishvilis q. 13-15-17, Vakis raioni,
Vashlijvari, Tbilisi, Georgia

(740) Givi Akopashvili
(540)



(591) White, silver, red, blue, light blue
(531) 01.15.17, 03.03.01, 25.01.19, 27.05.25,
29.01.14

(526) The trademark is protected as a whole.
"SIBIRSKAYA VODKA, Classic, VODKA FROM
RUSSIA" shall not be subject to independent legal
protection.

(511) 33, 35

(260) AM 2016 81847 A
(210) AM 81847
(220) 2015 04 27
(731) LTD "OMEGA-2"

Sarajishvilis q. 13-15-17, Vakis raioni,
Vashlijvari, Tbilisi, Georgia
(740) Givi Akopashvili
(540)



(591) White, silver, black, re
(531) 01.15.17, 03.03.01, 25.01.19, 27.01.02,
29.01.14

(526) The trademark is protected as a whole.
"SIBIRSKAYA VODKA, Strong, VODKA FROM
RUSSIA" shall not be subject to independent legal
protection.

(511) 33, 35

(260) AM 2016 81926 A
(210) AM 81926
(220) 2015 05 04
(731) LTD "Standard Tobacco Incorporated"
Abuseridze-Tbelis q. 13, 0120, Tbilisi,
Georgia
(740) Giorgi Meipariani
(540)



(591) Black, white
(531) 24.01.03, 24.01.15, 10.01.25, 19.03.03,
25.01.01, 27.05.24

(526) The trademark is protected as a whole.
"Lights" shall not be subject to independent legal
protection.

(511) 34

(260) AM 2016 81927 A
(210) AM 81927
(220) 2015 05 04
(731) ANAIT LIMITED
P.O. Box 957, Offshore Incorporations Centre,
Road Town, Tortola, British Virgin Islands
(740) Pavle Meipariani

(540)

HYDROGEN

(511) 14

(260) AM 2016 81928 A

(210) AM 81928

(220) 2015 05 04

(731) ANAIT LIMITED

P.O. Box 957, Offshore Incorporations Centre,
Road Town, Tortola, British Virgin Islands

(740) Pavle Meipariani

(540)



(591) Black,white

(531) 02.09.23

(511) 14

(260) AM 2016 81929 A

(210) AM 81929

(220) 2015 05 04

(731) ANAIT LIMITED

P.O. Box 957, Offshore Incorporations Centre,
Road Town, Tortola, British Virgin Islands

(740) Pavle Meipariani

(540)

HYDR**SKULL**GEN

(591) Black,white

(531) 02.09.23, 27.03.02

(511) 14

(260) AM 2016 81932 A

(210) AM 81932

(220) 2015 05 05

(731) KENDA RUBBER INDUSTRIAL CO., LTD.

No.146, Sector 1, Chung Shan Road,
Yuanlin Township, Changhua County,
Taiwan, Province of China

(740) Pavle Meipariani

(540)

KENDA

(591) Black,white

(531) 27.05.17

(511) 12

(260) AM 2016 81969 A

(210) AM 81969

(220) 2015 05 06

(731) LTD "DUTY FREE INTERNATIONAL"

Besikis q. 4, Buizness Centre, office 203,
0108, Tbilisi, Georgia

(740) Levan Nikoladze

(540)



(591) Golden

(531) 03.07.01, 26.01.18, 27.05.23, 29.01.12

(511) 34

(260) AM 2016 81985 A

(210) AM 81985

(220) 2015 05 07

(731) LTD "AVERSI PHARMA"

Davit Aghmasheneblis gamz. 148/2, 0112,
Tbilisi, Georgia

(540)

იბუნალი
Ибунал
Ibunal

(511) 5

(260) AM 2016 81986 A

(210) AM 81986

(220) 2015 05 07

(731) LTD "AVERSI PHARMA"

Davit Aghmasheneblis gamz. 148/2, 0112,
Tbilisi, Georgia

(540)

მიგოფენი
Мигофен
Migofen

(511) 5

(260) AM 2016 81993 A

(210) AM 81993

(220) 2015 05 07

(731) WALTON INTERNATIONAL LTD.

P.O. Box 1586, George Town, Grand Cayman,
KY1-1110, Cayman Islands

(740) Giorgi Meipariani

(540)



(591) Black, white
(531) 27.05.22
(511) 25

(260) AM 2016 81994 A
(210) AM 81994
(220) 2015 05 07
(731) SHULTON, INC
One Procter & Gamble Plaza, Cincinnati OH
45202, USA
(740) Shalva Gvaramadze
(540)

OLD SPICE MANTASTIC

(511) 3

(260) AM 2016 81996 A
(210) AM 81996
(220) 2015 05 07
(731) LTD "DAZGA"
Al. Kazbegis gamz. 4a, 0160, Tbilisi, Georgia
(740) Anatoli Mkurnali
(540)



(591) Blue, carrot-red, black
(531) 01.03.15, 26.11.12, 27.05.10, 29.01.13
(526) The trademark is protected as a whole. "TM"
shall not be subject to independent legal protection.
(511) 7, 9, 17, 35, 40

(260) AM 2016 81999 A
(210) AM 81999
(220) 2015 05 08
(731) INTERSUN HOLDING FZCO.
P.O. Box 61051 Jebel Ali Free Zone, Dubai,
United Arab Emirates
(740) Tamar Kochlamazashvili
(540)

TOMASO

(511) 29, 30, 31, 32, 35

(260) AM 2016 82156 A
(210) AM 82156
(220) 2015 05 19
(731) NOBEL ILAC SANAYII VE TICARET

ANONIM SIKRET representation
of Georgia
Tavisuplebis moedani 4, Tbilisi, Georgia

(740) Tinatin Tskhvediani
(540)

KANDIZOL
კანდიზოლი

(511) 5, 35

(260) AM 2016 82173 A
(210) AM 82173
(220) 2015 05 19
(731) JSC "LOMISI"
Sop. Natakhtari, 3308, Mtskhethis raioni,
Georgia
(740) Elguja Amozashvili
(540)



(591) Black, white
(531) 19.07.16
(511) 32

(260) AM 2016 82218 A
(210) AM 82218
(220) 2015 05 21
(731) NOVARTIS AG
4002 Basel, Switzerland
(740) Pavle Meipariani
(540)

ROSUROSE

(511) 5

(260) AM 2016 82251 A
(210) AM 82251
(220) 2015 05 27
(731) LTD "Lvovskaya Tobachnaya Fabrika"
Ul. Zelenaya 149, k. 184, Lviv, 79035,
Ukraine
(740) Tamaz Shilakadze
(540)

CONRAD

(511) 34

(260) AM 2016 82252 A
 (210) AM 82252
 (220) 2015 05 27
 (731) LTD "Lvovskaya Tobachnaya Fabrika"
 Ul. Zelenaya 149, k. 184, Lviv, 79035,
 Ukraine

(740) Tamaz Shilakadze
 (540)

WALDEN

(511) 34

(260) AM 2016 82254 A
 (210) AM 82254
 (220) 2015 05 27
 (731) LTD "Lvovskaya Tobachnaya Fabrika"
 Ul. Zelenaya 149, k. 184, Lviv, 79035,
 Ukraine

(740) Tamaz Shilakadze
 (540)

POLICE

(511) 34

(260) AM 2016 82255 A
 (210) AM 82255
 (220) 2015 05 27
 (731) LTD "Lvovskaya Tobachnaya Fabrika"
 Ul. Zelenaya 149, k. 184, Lviv, 79035,
 Ukraine

(740) Tamaz Shilakadze
 (540)

MARVEL

(511) 34

(260) AM 2016 82282 A
 (210) AM 82282
 (220) 2015 05 29
 (731) LTD "SUPERBET 2014"
 Oniashvilis q. 1, 0160, Tbilisi, Georgia

(740) Gela Peradze
 (540)



(591) Black, white
 (531) 27.05.22
 (511) 9, 35, 41

(260) AM 2016 82390 A
 (210) AM 82390
 (220) 2015 06 04
 (731) LTD "ALEXSANDRE"
 Ghambashidzis q. 8, 0179, Tbilisi, Georgia

(740) Viacheslav Beradze
 (540)



(591) Black, white, cornelian-red
 (531) 27.05.01, 26.04.18, 27.05.10, 27.05.21,
 29.01.13
 (511) 35

(260) AM 2016 82391 A
 (210) AM 82391
 (220) 2015 06 04
 (731) LTD "ALEXANDRE"
 Ghambashidzis q. 8, 0179, Tbilisi, Georgia
 (740) Viacheslav Beradze
 (540)



(591) Black, white, cornelian-red
 (531) 28.19, 29.01.13, 26.04.18
 (511) 35

(260) AM 2016 82408 A
 (210) AM 82408
 (220) 2015 06 05
 (731) DAEWOONG CO., LTD.,
 244, Galmachi-ro, Jungwon-gu, Seongnam-si,
 Gyeonggi-do, Republic of Korea
 (740) Tamaz Shilakadze
 (540)

EPIFA

(511) 5

(260) AM 2016 82448 A
 (210) AM 82448
 (220) 2015 06 09
 (731) AKTSIONERNO DROUJESTVO
 BULGARTABAC HOLDING
 1000 Sofia, 62 Graf Ignatiev Str. Bulgaria
 (740) Liliana Darakhvelidze
 (540)



(591) Black, white, grey
 (531) 03.01.02, 03.01.22, 25.01.01, 25.07.15,
 26.03.23
 (511) 34

(260) AM 2016 82492 A
 (210) AM 82492
 (220) 2015 06 11
 (731) LTD "NEO PLASTIK"
 Sop. Kesalo, 1327, Gardabani, Georgia
 (740) Jalil Ismailov
 (540)

MARQUIS®

(591) Blue, vitriol
 (531) 29.01.04, 27.01.05
 (526) The trademark is protected as a whole. "®"
 shall not be subject to independent legal protection.
 (511) 6, 17

(260) AM 2016 82548 A
 (210) AM 82548
 (220) 2015 06 15
 (731) WALTON INTERNATIONAL LTD.
 P.O. Box 1586, George Town, Grand Cayman,
 KY1-1110, Cayman Islands
 (740) Giorgi Meipariani
 (540)

Beau Monde

(591) Black, white
 (531) 27.05.01, 27.05.19
 (511) 18, 25, 35

(260) AM 2016 82549 A
 (210) AM 82549
 (220) 2015 06 15
 (731) VISA INTERNATIONAL SERVICE
 ASSOCIATION
 900 Metro Center Boulevard, Foster City,
 California 94404, USA
 (740) Giorgi Meipariani
 (540)

VISA PAYWAVE

(511) 36

(260) AM 2016 82588 A
 (210) AM 82588
 (220) 2015 06 18
 (731) LTD "NATURA TEA COMPANY"
 Vazha-Pshavelas gamz, 6 kv. 29 korp.
 b.54, 0186, Tbilisi, Georgia

(540)



NATURA TEA COMPANY

(591) Green, golden and black
 (531) 05.13.08, 26.01.18, 27.05.21, 29.01.13
 (511) 30, 35

(260) AM 2016 82679 A
 (210) AM 82679
 (220) 2015 06 25
 (731) SUCAMPO AG
 Baarerstrasse 22, CH-6300, Zug, Switzerland
 (740) Pavle Meipariani
 (540)

АМИТИЗА

(591) Black, white
 (531) 28.05
 (511) 5

(260) AM 2016 82823 A
 (210) AM 82823
 (220) 2015 07 04
 (731) LTD "G-M-P"
 Sop. Ponichala 65, 0165, Tbilisi, Georgia
 (740) Nugzar Ksovreli
 (540)

ვაგიფლორი

**ВАГИФЛОР
 VAGIFLOR**

(511) 5

(260) AM 2016 82824 A
 (210) AM 82824
 (220) 2015 07 04
 (731) LTD "G-M-P"
 Sop. Ponichala 65, 0165, Tbilisi, Georgia
 (740) Nugzar Ksovreli
 (540)

ლაქტოკარბონი

**ЛАКТОКАРБОН
 LACTOCARBON**

(511) 5

(260) AM 2016 82825 A

(210) AM 82825

(220) 2015 07 04

(731) LTD "G-M-P"

Sop. Ponichala 65, 0165, Tbilisi, Georgia

(740) Nugzar Ksovreli

(540)

ვიტაბულარდი
ВИТАБУЛАРД
VITABOULARD

(511) 5

REGISTERED TRADEMARKS

(111) M 2016 26736 R
 (151) 2016 01 27
 (181) 2026 01 27
 (260) AM 2015 75933 A
 (220) 2014 02 17
 (732) SOFADES LTD.

Quijano Chambers, P.O. Box 3159, Road
 Town, Tortola, British Virgin Islands

(111) M 2016 26737 R
 (151) 2016 01 27
 (181) 2026 01 27
 (260) AM 2015 76082 A
 (220) 2014 02 25

(732) ARIAN KIMYA TICARET VE SANAYI
 ANONIM SIRKETI
 Tem Otoyolu Üzeri , Tekstil Kent Koza Plaza,
 B Blok, Kat:31 NO:118 Esenler Istanbul
 Turkey

(111) M 2016 26738 R
 (151) 2016 01 27
 (181) 2026 01 27
 (260) AM 2015 76608 A
 (220) 2014 04 07

(732) JSC "GEORGIAN BEER COMPANY"
 Sop. Saguramo, 3311, Mtskheta, Georgia

(111) M 2016 26739 R
 (151) 2016 01 27
 (181) 2026 01 27
 (260) AM 2015 76609 A
 (220) 2014 04 07

(732) JSC "GEORGIAN BEER COMPANY"
 Sop. Saguramo, 3311, Mtskheta, Georgia

(111) M 2016 26740 R
 (151) 2016 01 27
 (181) 2026 01 27
 (260) AM 2015 77602 A
 (220) 2014 06 18

(732) LTD "ASPHARMA GEORGIA
 PHARMACEUTICAL COMPANY"
 Mtskheta q. 8, Tbilisi, Georgia

(111) M 2016 26741 R
 (151) 2016 01 27
 (181) 2026 01 27
 (260) AM 2015 78893 A
 (220) 2014 09 30

(732) MEGUIN GMBH & CO. KG
 MINERALOELWERKE
 Rodener Strasse 25, 66740 Saarlouis,
 Germany

(111) M 2016 26742 R
 (151) 2016 01 27
 (181) 2026 01 27

(260) AM 2015 78909 A
 (220) 2014 10 01

(732) EURO PARFUMS FZE
 P.O. Box 49138, Sharjah, United Arab
 Emirates

(111) M 2016 26743 R
 (151) 2016 01 27
 (181) 2026 01 27

(260) AM 2015 78956 A
 (220) 2014 10 03

(732) HANWHA CORPORATION
 86 Cheonggyecheon-ro, Jung-gu, Seoul
 100-797, Republic of Korea

(111) M 2016 26744 R
 (151) 2016 01 27
 (181) 2026 01 27

(260) AM 2015 79069 A
 (220) 2014 10 13

(732) AKTSIONERNO DROUJESTVO
 "BULGARTABAC HOLDING"
 62 Graf Ignatiev Str, 1000 Sofia, Bulgaria

(111) M 2016 26745 R
 (151) 2016 01 27
 (181) 2026 01 27

(260) AM 2015 79072 A
 (220) 2014 10 13

(732) GOCHA PIPIA
 Budapeshtis q. 11, b. 55, 0160, Tbilisi,
 Georgia

(111) M 2016 26746 R
 (151) 2016 01 27
 (181) 2026 01 27

(260) AM 2015 79217 A
 (220) 2014 10 27

(732) LTD "AROMAPRODUCT"
 Guramishvilis gamz. 17, Tbilisi, Georgia

(111) M 2016 26747 R
 (151) 2016 01 27
 (181) 2026 01 27
 (260) AM 2015 79447 A
 (220) 2014 11 11
 (732) GENERAL MOTORS LTD.
 300 Renaissance Center, City of Detroit, State
 of Michigan 48265-3000, USA

(111) M 2016 26748 R
 (151) 2016 01 27
 (181) 2026 01 27
 (260) AM 2015 79448 A
 (220) 2014 11 11
 (732) GENERAL MOTORS LTD.
 300 Renaissance Center, City of Detroit, State
 of Michigan 48265-3000, USA

(111) M 2016 26749 R
 (151) 2016 01 27
 (181) 2026 01 27
 (260) AM 2015 79449 A
 (220) 2014 11 11
 (732) GENERAL MOTORS LTD.
 300 Renaissance Center, City of Detroit, State
 of Michigan 48265-3000, USA

(111) M 2016 26750 R
 (151) 2016 01 27
 (181) 2026 01 27
 (260) AM 2015 79450 A
 (220) 2014 11 11
 (732) GENERAL MOTORS LTD.
 300 Renaissance Center, City of Detroit, State
 of Michigan 48265-3000, USA

(111) M 2016 26751 R
 (151) 2016 01 27
 (181) 2026 01 27
 (260) AM 2015 79451 A
 (220) 2014 11 11
 (732) GENERAL MOTORS LTD.
 300 Renaissance Center, City of Detroit, State
 of Michigan 48265-3000, USA

(111) M 2016 26752 R
 (151) 2016 01 27
 (181) 2026 01 27
 (260) AM 2015 79480 A
 (220) 2014 11 13
 (732) GENERAL MOTORS LTD.
 300 Renaissance Center, City of Detroit, State
 of Michigan 48265-3000, USA

(111) M 2016 26753 R
 (151) 2016 01 28
 (181) 2026 01 28
 (260) AM 2015 79481 A
 (220) 2014 11 13
 (732) GENERAL MOTORS LTD.
 300 Renaissance Center, City of Detroit, State
 of Michigan 48265-3000, USA

(111) M 2016 26754 R
 (151) 2016 01 28
 (181) 2026 01 28
 (260) AM 2015 79482 A
 (220) 2014 11 13
 (732) GENERAL MOTORS LTD.
 300 Renaissance Center, City of Detroit, State
 of Michigan 48265-3000, USA

(111) M 2016 26755 R
 (151) 2016 01 28
 (181) 2026 01 28
 (260) AM 2015 79483 A
 (220) 2014 11 13
 (732) GENERAL MOTORS LTD.
 300 Renaissance Center, City of Detroit, State
 of Michigan 48265-3000, USA

(111) M 2016 26756 R
 (151) 2016 01 28
 (181) 2026 01 28
 (260) AM 2015 79484 A
 (220) 2014 11 13
 (732) GENERAL MOTORS LTD.
 300 Renaissance Center, City of Detroit, State
 of Michigan 48265-3000, USA

(111) M 2016 26757 R
 (151) 2016 01 28
 (181) 2026 01 28
 (260) AM 2015 79845 A
 (220) 2014 12 08
 (732) KENTUCKY FRIED CHICKEN
 INTERNATIONAL HOLDINGS, INC.
 1441 Gardiner Lane, Louisville, Kentucky
 40213, USA

(111) M 2016 26758 R
 (151) 2016 01 28
 (181) 2026 01 28
 (260) AM 2015 79846 A
 (220) 2014 12 08
 (732) KENTUCKY FRIED CHICKEN
 INTERNATIONAL HOLDINGS, INC.
 1441 Gardiner Lane, Louisville, Kentucky
 40213, USA

(111) M 2016 26759 R
 (151) 2016 01 28
 (181) 2026 01 28
 (260) AM 2015 79884 A
 (220) 2014 12 11
 (732) LTD „SAIRME MINERAL WATERS"
 Spa Sairme, 1000, Baghdatis raioni,
 Georgia

(111) M 2016 26760 R
 (151) 2016 01 28
 (181) 2026 01 28
 (260) AM 2015 79924 A
 (220) 2014 12 12
 (732) RATIONAL INTELLECTUAL HOLDINGS
 LIMITED
 Douglas Bay Complex, King Edward Road,
 IM3 1DZ Onchan, Isle of Man, (British)

(111) M 2016 26761 R
 (151) 2016 01 28
 (181) 2026 01 28
 (260) AM 2015 79926 A
 (220) 2014 12 12
 (732) RATIONAL INTELLECTUAL HOLDINGS
 LIMITED
 Douglas Bay Complex, King Edward Road,
 IM3 1DZ Onchan, Isle of Man, (British)

(111) M 2016 26762 R
 (151) 2016 01 28
 (181) 2026 01 28
 (260) AM 2015 79927 A
 (220) 2014 12 12
 (732) RATIONAL INTELLECTUAL HOLDINGS
 LIMITED
 Douglas Bay Complex, King Edward Road,
 IM3 1DZ Onchan, Isle of Man, (British)

(111) M 2016 26763 R
 (151) 2016 01 28
 (181) 2026 01 28
 (260) AM 2015 79944 A
 (220) 2014 12 16
 (732) MANANA KORKOTADZE
 Vazha-Pshavelas gamz. 39, b. 4, 0177,
 Tbilisi, Georgia

(111) M 2016 26764 R
 (151) 2016 01 28
 (181) 2026 01 28
 (260) AM 2015 79966 A
 (220) 2014 12 19

(732) SURABANGYIKHAN COMPANY
 LIMITED
 82 Moo 3 Tambol Bangkuwat, Amphur
 Muang Pathumthani, Pathumthani Province
 12000, Thailand

(111) M 2016 26765 R
 (151) 2016 01 28
 (181) 2026 01 28
 (260) AM 2015 80481 A
 (220) 2015 01 26
 (731) LTD "G-M-P"
 Sop. Ponitchala 65, 0165, Tbilisi, Georgia

(111) M 2016 26766 R
 (151) 2016 01 28
 (181) 2026 01 28
 (260) AM 2015 80482 A
 (220) 2015 01 26
 (731) LTD "G-M-P"
 Sop. Ponitchala 65, 0165, Tbilisi, Georgia

(111) M 2016 26767 R
 (151) 2016 01 28
 (181) 2026 01 28
 (260) AM 2015 80483 A
 (220) 2015 01 26
 (731) LTD "G-M-P"
 Sop. Ponitchala 65, 0165, Tbilisi, Georgia

(111) M 2016 26768 R
 (151) 2016 01 28
 (181) 2026 01 28
 (260) AM 2015 80910 A
 (220) 2015 02 19
 (732) LTD "BATONO"
 Iakob Nikoladzis q. 12, 0179, Tbilisi, Georgia

(111) M 2016 26769 R
 (151) 2016 01 28
 (181) 2026 01 28
 (260) AM 2015 80911 A
 (220) 2015 02 19
 (732) (732) LTD "BATONO"
 Iakob Nikoladzis q. 12, 0179, Tbilisi, Georgia

(111) M 2016 26773 R
 (151) 2016 01 29
 (181) 2026 01 29
 (260) AM 2015 79071 A
 (220) 2014 10 13
 (732) GELA POTSKHISHVILI
 Balanchivadzis q. 69, 0177, Tbilisi, Georgia

(111) M 2016 26774 R
(151) 2016 01 29
(181) 2026 01 29
(260) AM 2015 78350 A
(220) 2014 08 22
(732) MUCOS EMULSIONSGESELLSCHAFT MBH
CHEMISCH-PHARMAZEUTISCHE
BETRIEBE
Miraustraße 17, Berlin, Germany

(111) M 2016 26779 R
(151) 2016 02 09
(181) 2026 02 09
(260) AM 2015 79897 A
(220) 2014 12 11
(732) LTD "M&G COMPANY"
Kandelakis q. 43, 0160, Tbilisi, Georgia

(111) M 2016 26780 R
(151) 2016 02 09
(181) 2026 02 09
(260) AM 2015 79899 A
(220) 2014 12 11
(732) LTD "M&G COMPANY"
Kandelakis q. 43, 0160, Tbilisi, Georgia

TRADEMARKS REGISTERED ACCORDING TO THE ACCELERATED PROCEDURE

The decision can be appealed at the Chamber of Appeal of Sakpatenti within 3 months from the publication.

(111) M 2016 26770 R

(151) 2016 01 28

(181) 2026 01 28

(210) AM 85699

(220) 2016 01 12

(732) LTD "COMPANY ORBITA"
Ak. Tseretlis gamz. 126, 0119,
Tbilisi, Georgia

(740) Giorgi Taktakishvili

(540)

VIVA

(511) 30

(111) M 2016 26771 R

(151) 2016 01 28

(181) 2026 01 28

(210) AM 85681

(220) 2016 01 11

(732) LEONARDO BERAIA
Gumistis mas. 8, b.21, Sokhumi, Georgia;
LTD "KAKHETIAN TRADITIONAL
WINEMAKING-AGRO-CHOKHATAURI"
Sulkhan Tsintsadze q. 12, 0160, Tbilisi,
Georgia

(740) Ekaterine Gogoladze

(540)

**გამარჯობა
Гамарджоба
Gamardjoba**

(511) 29, 32

(111) M 2016 26772 R

(151) 2016 01 29

(181) 2026 01 29

(210) AM 85746

(220) 2016 01 14

(732) LTD "AGHMASHENEBELI-4"
Garekakhethis 5/24, 0144, Tbilisi, Georgia

(740) Irakli Masurashvili

(540)



(591) Black, white, golden

(531) 27.05.24, 29.01.13, 24.09.11, 24.09.12,
26.04.24

(526) The trademark is protected as a whole.
"HOTEL" shall not be subject to independent legal
protection.

(511) 43

(111) M 2016 26775 R

(151) 2016 02 02

(181) 2026 02 02

(210) AM 85777

(220) 2016 01 18

(732) LTD "S.M.T GROUP"
Sop. Vaziani, 1300, Gardabani, Georgia

(740) Tamila Gornakashvili

(540)

DEVECIOĞLU

(511) 11, 21, 35

(111) M 2016 26776 R

(151) 2016 02 03

(181) 2026 02 03

(210) AM 84083

(220) 2015 10 06

(732) LTD "ASKANELI BROTHERS"
Kakhetis gzat. 110a, 0198, Tbilisi, Georgia

(740) Khatia Khatiasvili

(540)

ირმა ნიორაძე

Ирма Ниорадзе

Irma Nioradze

(511) 33

(111) 2016 26777 R

(151) 2016 02 09

(181) 2026 02 09

(210) AM 85848

(220) 2016 01 26

(732) LTD "SEVENFRIDAY CAUCASUS"
SevenFriday Caucasus"
Politkovskays q. 9a, b. 41, 0186, Tbilisi,
Georgia

(740) Bezhan Zazashvili

(540)

SEVENFRIDAY

(591) Black,white

(526) The trademark is protected as a whole. "®" Technology" shall not be subject to independent legal protection.

(511) 14, 35

(111) M 2016 26778 R

(151) 2016 02 09

(181) 2026 02 09

(210) AM 85890

(220) 2016 01 27

(732) LTD "PRADA"

Nutsubidzis me-3 mkr., me-4 kvart., 3 korp., b. 93, 0181, Tbilisi, Georgia

(740) Lena Grigalashvili

(540)

Ellegance
ელეგანსი
Елеганс

(511) 43

(111) M 2016 26781 R

(151) 2016 02 11

(181) 2026 02 11

(210) AM 85689

(220) 2016 01 11

(732) LTD "NEW LIGHT"

Sanzona, korp. 6, b. 28, 0141, Tbilisi, Georgia

(740) Vladimer Bidzinashvili

(540)

NEW LIGHT
ახალი ნათება

(511) 35

(111) M 2016 26782 R

(151) 2016 02 11

(181) 2026 02 11

(210) AM 85357

(220) 2015 12 23

(732) LTD "AMORE GEO"

Mshenebelta q., korp. 32, b. 8, 3704, Rustavi, Georgia

(740) Giorgi Taktakishvili

(540)



(591) Yellow, blue, black

(531) 07.03.02, 27.05.10, 29.01.13

(511) 19

(111) M 2016 26783 R

(151) 2016 02 12

(181) 2026 02 12

(210) AM 85894

(220) 2016 01 29

(732) JSC "IQ INVEST"

Kargaretelis q. 4, me-2 sart., b. 1, 0112, Tbilisi, Georgia

(540)



(591) Blue, white

(531) 27.05.22, 29.01.12

(511) 36

(111) M 2016 26784 R

(151) 2016 02 18

(181) 2026 02 18

(210) AM 85899

(220) 2016 01 29

(732) LTD "MAQRO CONSTRUCTION"

Panjikidzis (Ex Budapesht) q. 22, 0160, Tbilisi, Georgia

(740) Teona Kakhidze

(540)

GREEN

(511) 37

(111) M 2016 26785 R

(151) 2016 02 18

(181) 2026 02 18

(210) AM 85900

(220) 2016 01 29

(732) LTD "MAQRO CONSTRUCTION"

Panjikidzis (Ex Budapesht) q. 22, 0160, Tbilisi, Georgia

(740) Teona Kakhidze

(540)

MAQRO
CONSTRUCTION

(591) Black,white

(531) 27.05.01, 27.05.10

(511) 20, 36, 37, 43

(111) M 2016 26786 R

(151) 2016 02 18

(181) 2026 02 18

(210) AM 85897

(220) 2016 01 29

(732) LTD "MAQRO CONSTRUCTION"
Panjikidzis (Ex Budapesht) q. 22, 0160,
Tbilisi, Georgia

(740) Teona Kakhidze
(540)



(591) Green, crimson, purple
(531) 26.03.23, 26.04.03, 26.15.09, 29.01.13
(511) 37

(111) M 2016 26787 R

(151) 2016 02 18

(181) 2026 02 18

(210) AM 85898

(220) 2016 01 29

(732) LTD "MAQRO CONSTRUCTION"
Panjikidzis (Ex Budapesht) q. 22, 0160,
Tbilisi, Georgia

(740) Teona Kakhidze

(540)

მწკნევი

(511) 37

(111) M 2016 26788 R

(151) 2016 02 19

(181) 2026 02 19

(210) AM 86034

(220) 2016 02 08

(732) LTD "DOKA"
Josef-Umdasch-Platz 1, 3300 Amstetten,
Austria

(740) Natela Otariidze

(540)

DOKA

(511) 6, 19, 37

(111) M 2016 26789 R

(151) 2016 02 19

(181) 2026 02 19

(210) AM 86035

(220) 2016 02 08

(732) LTD "DOKA"
Josef-Umdasch-Platz 1, 3300 Amstetten,
Austria

(740) Natela Otariidze

(540)

doka

(591) Black, white

(531) 27.05.01, 27.05.17

(511) 6, 19, 37

INTERNATIONAL TRADEMARKS FOR WHICH A DECISION ON GRANTING PROTECTIONS IS TAKEN

The decision can be appealed at the Chamber of Appeal of Sakpatenti within 3 months from the publication or at the Mtskheta District Court Administrative Cases Board (Address: №17, Samkhedro str., Mtskheta), within 1 month following the publication.

(260) AM 2016 70162 A **

(800) 1139121

(731) GULFSTREAM AEROSPACE CORPORATION

500 Gulfstream Road Savannah GA 31407, USA

(540)

GULFSTREAM

(591) Black, white

(511)

12 – Airplanes.

(260) AM 2016 81167 A

(800) 1237616

(891) 2014 11 17

(731) KESHT VA SANAT GOLBARG BAHARAN CO.

no. 1, Nader Blind Alley, Ahuramazda st., East 37th st., Alvand Ave., Argentina Sq., Tehran, Iran (Islamic Republic of)

(540)

اویلا

Oila

(591) Black

(511)

29 – Edible oils and fats; olive oil for food; canned fish; canned mushrooms; canned peas; canned beans; canned corn; tomato paste; pomegranate paste.

30 – Sauces (condiments); honey; vinegar; pasta sauce.

31 – Olives fresh.

32 – Non-alcoholic beer; mineral water; aerated waters and other non-alcoholic drinks; fruit juices; sherbets (beverages); syrups and other preparations for making beverages.

(260) AM 2016 81285 A

(800) 831046

(891) 2014 09 25

(731) S. Tous, S.L.

Ctra. de Vic, El Guix, 3, E-08243 MANRESA (Barcelona), Spain

(540)



(591) Black, white

(511)

14 – Precious metals and their alloys and goods made of or coated with these materials not included in other classes; jewelry, precious stones; timepieces and chronometric instruments.

16 – Paper, cardboard and goods made thereof, not included in other classes; printed matter; bookbinding material; photographs; stationery; adhesives for stationery or household purposes; artists' supplies; paintbrushes; typewriters and office requisites (except furniture); instructional or teaching material (except apparatus); plastic packaging materials (not included in other classes); printing type; printing blocks.

18 – Leather and imitation leather, goods made of these materials not included in other classes; animal skins and hides; trunks and suitcases; umbrellas, parasols and walking sticks; whips and saddlery; accessories included in this class.

25 – Clothing, footwear, headgear, neck scarves, scarves, belts; clothing accessories included in this class.

(260) AM 2016 81289 A

(800) 925259

(891) 2014 09 25

(731) S. Tous, S.L.

Ctra. de Vic, El Guix, 3, E-08243 MANRESA (Barcelona), Spain

(540)



(591) Blue, white

(511)

9 – Scientific, nautical, surveying, electric, photographic, cinematographic, optical, weighing, measuring, signalling, checking (supervision), life-saving and teaching apparatus and instruments; apparatus for recording, transmitting, reproducing sound or images; magnetic recording media, sound recording disks; automatic vending machines and mechanisms for coin operated apparatus; cash registers, calculating machines, data processing equipment and computers; fire extinguishers.

(260) AM 2016 81337 A

(800) 1238565

(891) 2014 11 21

(731) EVYAP SABUN YAĞ GLİSERİN SANAYİ VE TİCARET ANONİM ŞİRKETİ
Ayazağa Cendere Yolu No.10, Levent
İstanbul, Turkey

(540)

Arko Men Shield Effect

(526) Men Shield Effect

(511)

3 – Bleaching and cleaning preparations, perfumery, cosmetics, fragrances, deodorants for personal use and for animals, abrasive preparations, emery cloth, sandpaper, pumice stone, abrasive pastes, polishing preparations for leather, vinyl, metal and wood.

(260) AM 2016 81518 A

(800) 1240527

(891) 2015 02 27

(731) APPLE INC.

1 Infinite Loop, Cupertino CA 95014, USA

(540)

WATCH OS

(511)

14 – Horological and chronometric instruments and cases therefor; horological and chronometric instruments and parts thereof; timepieces.

(260) AM 2016 81577 A

(800) 1241334

(891) 2015 02 20

(731) SOCIÉTÉ DES PRODUITS NESTLÉ S.A.
CH-1800 Vevey, Switzerland

(540)

INTRIGA

(511)

30 – Ice cream, water ices, sherbets, frozen confectionery, frozen cakes, frozen yogurts; powders and binding agents (included in this class) for making ice cream, water ices, sherbets, frozen confectionery, frozen cakes, frozen yogurts.

(260) AM 2016 81579 A

(800) 1241347

(891) 2015 02 04

(731) BOKSHAN VIRA YURIIVNA
vul. Palubna, 12, kv. 75, m. Odesa 65010,
Ukraine

(540)

МЯКУШ

(511)

33 – Alcoholic beverages, except beer; aperitifs; wine; brandy; whisky; gin; arak [arrack]; anisette [liqueur]; anise [liqueur]; hydromel [mead]; vodka; kirsch; perry; cocktails; curacao; liqueurs; peppermint liqueurs; distilled beverages; pre-mixed alcoholic beverages, other than beer-based; alcoholic beverages containing fruit; bitters; nira [sugarcane-based alcoholic beverage]; piquette; rice alcohol; rum; sake; cider; spirits [beverages]; alcoholic extracts; alcoholic essences; fruit extracts, alcoholic; digesters [liqueurs and spirits]; fruit extracts, alcoholic.

(260) AM 2016 81580 A

(800) 1241348

(891) 2014 06 17

(731) AKDEMİR MAKİNA PAZARLAMA
SANAYİ VE DIŞ TİCARET LİMİTED
ŞİRKETİ

Yesilbayir Mah. Simsir Sok. No:5 Hadimkoy,
Arnavutkoy, TR-34555 ISTANBUL, Turkey

(540)

BONDIT

(591) Black, white

(511)

1 – Chemicals used in industry, science, photography, agriculture, horticulture and forestry; manures and soils; unprocessed artificial resins and unprocessed plastics; fire extinguishing compositions; adhesives not for medical, household and stationery purposes.

2 – Paints; varnishes; lacquers; preservatives against rust; preservatives against deterioration of wood;

thinners and binders for paints; pigments; preservatives for metals; shoe dyes; printing dyes and ink; toners (including filled toner cartridges); colorants for food, pharmaceuticals and beverages; raw natural resins; metals in foil and powder form for painters, decorators, printers and artists.

16 – Paper, cardboard and goods made from these materials included in this class, other than stationery products; paper towels; toilet paper; paper napkins; paper for packaging and wrapping purposes; cardboard boxes; plastic materials for packaging and wrapping purposes; printing blocks and types; bookbinding material; printed matter; printed publications; calendars; posters; photographs (printed); paintings; stickers (stationery); postage stamps; stationery, office stationery, instructional and teaching material (except furniture and apparatus); writing and drawing implements; artists' materials; paper products for stationery purposes; adhesives for stationery purposes; office requisites; paint rolls and paintbrushes for painting.

17 – Rubber, gutta-percha, gum, asbestos, mica and semi-finished synthetic goods made from these materials in the form of powder, bars, panels and foils included in this class; insulation, stopping and sealing materials; joint sealant compounds for joints, gaskets, O-rings for sealing purposes; flexible pipes made from rubber and plastic; hoses made of plastic and rubber, including those used for vehicles; junctions for pipes of plastic and rubber; pipe jackets of plastic and rubber; hoses of textile material; junctions for pipes, not of metal; pipe jackets, not of metal; connecting hose for vehicle radiators.

(260) AM 2016 81581 A

(800) 1241354

(891) 2014 09 08

(731) PEGAS TOURISTIK UK LIMITED

Office suite No:6, 1st Floor, 2-4 Eastern
Road, Romford RM1 3PJ, United Kingdom

(540)

Pegas Select

(591) Black,white

(511)

41 – Modelling for artists; academies [education]; rental of sports grounds; rental of tennis courts; lending libraries; booking of seats for shows; videotaping; physical education; discotheque services; animal training; dubbing; gambling; publication of books; education information; recreation information; entertainment information; movie studios; health club services [health and fitness training]; night clubs; layout services, other than for advertising purposes; microfilming; videotape editing; production of radio and television programmes; music-halls; production of music; game services provided on-line from a computer network; providing on-line electro-

nic publications, not downloadable; religious education; gymnastic instruction; correspondence courses; practical training [demonstration]; organization of balls; organization of exhibitions for cultural or educational purposes; providing recreation facilities; arranging and conducting of colloquiums; arranging and conducting of congresses; arranging and conducting of conferences; arranging and conducting of concerts; arranging and conducting of workshops [training]; arranging and conducting of seminars; arranging and conducting of symposiums; organization of competitions [education or entertainment]; arranging of beauty contests; operating lotteries; organization of fashion shows for entertainment purposes; organization of shows [impresario services]; organization of sports competitions; vocational guidance [education or training advice]; amusement parks; sign language interpretation; television entertainment; mobile library services; vocational retraining; providing karaoke services; providing golf facilities; providing sports facilities; providing amusement arcade services; cinema presentations; presentation of live performances; theatre productions; conducting fitness classes; educational examination; timing of sports events; videotape film production, other than advertising films; film production, other than advertising films; rental of audio equipment; rental of video cameras; rental of video cassette recorders; rental of videotapes; rental of show scenery; rental of sound recordings; toy rental; rental of movie projectors and accessories; rental of motion pictures; games equipment rental; rental of stadium facilities; rental of lighting apparatus for theatrical sets or television studios; rental of radio and television sets; rental of skin diving equipment; rental of sports equipment, except vehicles; rental of stage scenery; electronic desktop publishing; publication of electronic books and journals on-line; publication of texts, other than publicity texts; radio entertainment; entertainer services; entertainment; writing of texts, other than publicity texts; zoological garden services; news reporters services; party planning [entertainment]; music composition services; subtitling; holiday camp services [entertainment]; disc jockey services; personal trainer services [fitness training]; providing casino facilities [gambling]; calligraphy services; club services [entertainment or education]; providing museum facilities [presentation, exhibitions]; teaching; orchestra services; translation; scriptwriting services; ticket agency services [entertainment]; coaching [training]; sport camp services; recording studio services; language interpreter services; nursery schools; photography; photographic reporting; circuses; boarding schools; production of shows.

42 – Water analysis; computer system analysis; handwriting analysis [graphology]; chemical analysis; architecture; recovery of computer data; industrial design; graphic arts design; computer virus pro-

tection services; technical project studies; oil-field surveys; geological surveys; engineering; installation of computer software; meteorological information; material testing; textile testing; bacteriological research; biological research; geological research; research in the field of environmental protection; cosmetic research; mechanical research; chemical research; research and development of new products for others; analysis for oil-field exploitation; underwater exploration; technical research; calibration [measuring]; consultancy in the design and development of computer hardware; architectural consultation; computer software consultancy; oil-well testing; quality control; vehicle roadworthiness testing; land surveying; dress designing; updating of computer software; monitoring of computer systems by remote access; maintenance of computer software; authenticating works of art; design of interior decor; quality evaluation of standing timber; quality evaluation of wool; digitization of documents [scanning]; conversion of data or documents from physical to electronic media; urban planning; provision of scientific information, advice and consultancy in relation to carbon offsetting; providing search engines for the internet; data conversion of computer programs and data [not physical conversion]; computer system design; rental of web servers; computer rental; rental of computer software; geological prospecting; oil prospecting; hosting computer sites [web sites]; duplication of computer programs; construction drafting; computer software design; cloud seeding; consultancy in the field of energy-saving; creating and maintaining web sites for others; computer programming; chemistry services; packaging design; scientific laboratory services; styling [industrial design]; physics [research]; surveying.

43 – Accommodation bureaux [hotels, boarding houses]; rental of temporary accommodation; rental of meeting rooms; tourist homes; hotel reservations; boarding house bookings; temporary accommodation reservations; hotels; retirement homes; snack-bars; cafés; cafeterias; motels; boarding houses; boarding for animals; rental of cooking apparatus; rental of chairs, tables, table linen, glassware; rental of tents; rental of transportable buildings; rental of drinking water dispensers; restaurants; self-service restaurants; canteens; holiday camp services [lodging]; bar services; providing campground facilities; food and drink catering; day-nurseries [crèches].

(260) AM 2016 81582 A
 (800) 1241365
 (891) 2014 12 01
 (731) BRICE
 152 avenue Alfred Motte, F-59100
 ROUBAIX, France
 (540)

BRICE

(511)

14 – Precious metals and their alloys; jewelry, precious stones, cuff links, tie pins, tie clips, medals, medallions; rings, bracelets, earrings, chains, necklaces, pendants, brooches; key rings [trinkets or fobs]; timepieces and chronometric instruments, watches, watch bracelets, watch chains, watch cases, watch glasses, cases or presentation cases for timepieces, jewelry cases; boxes of precious metal.

18 – Leather and imitation leather; trunks and suitcases; umbrellas, parasols and walking sticks; bags, satchels (leather goods); backpacks, school bags, beach bags, handbags, wheeled bags, traveling sets and bags (leather goods), garment bags (for travel), satchels, card cases (wallets), wallets, key cases of leather (leather goods), briefcases, coin purses, vanity cases (not fitted); net bags for shopping.

25 – Clothing, footwear (excluding orthopedic footwear), headgear, clothing of leather or imitation leather; articles of clothing, trousers, shorts, Bermuda shorts, jeans, shirts, tee-shirts, sweatshirts, pullovers, sweaters, jackets, vests, coats, raincoats, suits, tuxedos, rainwear, skirts, dresses, bathing suits, dressing gowns, lingerie and underwear, nightwear, gloves (clothing), mittens and mitts, socks, stockings, tights, hosiery articles, belts (clothing), hats, caps, bonnets, bandanas (neckerchiefs), headbands (clothing), suspenders, money belts (clothing), neckties, sashes for wear, stoles (fur stoles), scarves (clothing), shawls, furs (clothing, coats, jackets, hats, gloves), boots, half-boots, footwear for sports, footwear for the beach, slippers.

(260) AM 2016 81585 A

(800) 1241149

(891) 2014 11 11

(731) Shenzhen DEESS Science & Technology Co., Ltd.
 3rd Floor, Bldg A, Fengyeyuan Indus Zone
 Second Liuxian Road, Xin'an Street, Bao'an
 District Shenzhen, China

(540)



DEESS·蒂丝

(591) Black and white, turquoise

(511)

3 – Cleansing milk; stain removers; preparations to make the leaves of plants shiny; beauty masks; cosmetics; perfumery for cosmetics; cosmetics for animals; incense; abrasive cloth; denture polishes.

10 – Esthetic massage apparatus; medical apparatus and instruments; dental apparatus, electric; lasers for medical purposes; physiotherapy apparatus; gloves for massage; suture materials; vibromassage apparatus; ultrasonic apparatus and parts for medical purposes.

(260) AM 2016 81586 A
 (800) 1241153
 (891) 2014 05 13
 (731) FIRST LINE LTD
 Chalker Way, Banbury, Oxfordshire
 OX16 4XD, United Kingdom

(540)

BORG & BECK

(511)

7 – Cooling fans for vehicles; cooling radiators for vehicles; bushes for vehicles, bushes; ignition wires, electronic ignitions, starter motors, alternators, glow plugs, spark plugs; filters for vehicles, diesel particulate filters; exhausts for vehicles; timing belts for vehicles; timing belt kits (not including tools); tensioner bearings; parts for all the aforesaid goods.

9 – Thermostats for vehicles, thermostat kits (not including tools), switches (electrical) for vehicles; ignition batteries, cables or leads; parts for all the aforesaid goods.

11 – Radiator caps.

12 – Spare parts for vehicles; brakes for vehicles, brake discs, brake pads, brake drums, brake shoes, wear leads, brake fitting kits (not including tools); cables for vehicles, throttle cables, brake cables, clutch cables, speedometer cables; clutches for vehicles, clutches, friction clutches, clutch operating mechanisms, clutch disks, clutch release bearings, clutch cover assemblies, clutch lining, clutch feeds, clutch covers and clutch plates, clutch driven plates and hubs thereof; couplings for vehicles, couplings, mechanisms for controlling a coupling, release bearings for coupling mechanisms, constant velocity joints, constant velocity boots, constant velocity boot kits (not including tools); hydraulics for vehicles, brake hoses, brake cylinders, clutch hoses, slave cylinders; steering mechanisms for vehicles, steering gaiters, drag links, tie rods, tie rod ends, king pins, stabiliser links; suspension mechanisms for vehicles, ball joints, suspension arms, track control arms, wishbones; wheel bearings for vehicles, wheel bearing kits (not including tools); mountings for vehicles, top strut mountings; wipers for vehicles; tensioner bearings; parts for all the aforesaid goods.

(260) AM 2016 81587 A
 (800) 1241433
 (891) 2014 12 05
 (731) STRICKMODEN BRUNO BARTHEL
 GMBH & Co. KG
 Clemens-Winkler-Strasse 6a, 09116
 Chemnitz, Germany

(540)

maximo

(511)

24 – Cuddle clothes of textile material, especially for babies.

25 – Clothes; socks; tights; gloves; bandanas; rain-wear; headgear; shoes; cuddle clothes (bandanas).

28 – Soft toys; cuddle clothes [toys].

(260) AM 2016 81588 A
 (800) 1241164
 (891) 2014 07 25
 (731) "KRISTALA VASILEIOU ETERIA
 PERIORISMENIS EFTHINIS"
 28th October, GR-340 02 Vasilico Chalkidos,
 Greece

(540)



(591) Light blue, blue marine, dark blue, bright blue and light gray.

(526) The trademark is protected as a whole. "GLASS" and "TECHNOLOGIES" shall not be subject to independent legal protection.

(511)

19 – Glass for building.

20 – Mirrors.

21 – Glass, unworked and semi-worked, except use for building; semi-worked glass for vehicle windows; aquariums.

37 – Installation of glass.

(260) AM 2016 81589 A
 (800) 1241169
 (891) 2014 09 11
 (731) APPLE INC.
 1 Infinite Loop, Cupertino CA 95014, USA

(540)

APPLE WATCH

(511)

9 – Computers; computer peripheral devices; computer hardware; personal digital assistants; electronic organizers; electronic notepads; sound recording and reproducing apparatus; MP3 and other digital format audio players; digital audio recorders; radios, radio transmitters, and receivers; earphones, headphones; audio speakers; microphones; audio components and accessories; network communication apparatus; electronic communication equipment and instruments; telecommunications apparatus and instruments; global positioning system (GPS) devices; telephones; wireless communication devices for voice, data or image transmission; cables; apparatus for data storage; chips; cameras; batteries; computer software; electrical and electronic connectors, couplers, wires, cables, chargers, docks, docking stations, interfaces,

and adapters for use with all of the aforesaid goods; computer equipment for use with all of the aforesaid goods; electronic apparatus with multimedia functions for use with all of the aforesaid goods; electronic apparatus with interactive functions for use with all of the aforesaid goods; accessories, parts, fittings, and testing apparatus for all of the aforesaid goods; covers, bags and cases adapted or shaped to contain all of the aforesaid goods.

28 – Electronic games.

(260) AM 2016 81590 A

(800) 1241190

(891) 2014 10 06

(731) JOINT STOCK COMPANY UNITED METALLURGICAL COMPANY

Ozerkovskaya Nab., 28, BLD. 1, room 1,
RU-115184 Moscow, Russian Federation

(540)



(591) Red and grey

(511)

1 – Nitrogen; ammonia; acetylene; foundry binding substances; hydrogen; graphite for industrial purposes; dextrin [size]; cement [metallurgy]; catalysts; oxygen; diagnostic preparations, other than for medical or veterinary purposes; metal hardening preparations; metal annealing preparations; metal tempering preparations; finishing preparations for use in the manufacture of steel; sizing preparations; corrosive preparations; chemical preparations for facilitating the alloying of metals; galvanizing baths; chemical reagents, other than for medical or veterinary purposes; industrial chemicals.

6 – Fittings of metal for building; girders of metal; joists of metal; blooms [metallurgy]; ingots of common metal; vanadium; valves of metal, other than parts of machines; iron, unwrought or semi-wrought; hardware of metal, small; framework of metal for building; elbows of metal for pipes; buildings of metal; steel buildings; steel sheets; water-pipe valves of metal; drain traps [valves] of metal; cast steel; reinforcing materials of metal for pipes; reinforcing materials of metal for building; sheets and plates of metal; common metals, unwrought or semi-wrought; building materials of metal; railway material of metal; refractory construction materials of metal; pipe muffs of metal; hoop steel; steel alloys; safes [strong boxes]; junctions of metal for pipes; ores; pipes of metal; water-pipes of metal; steel pipes; ducts and pipes of metal for Central heating installations; branching

pipes of metal; angle irons; cast iron, unwrought or semi-wrought; hinges of metal; bands of metal for tying-up purposes; windows of metal; alloys of common metal; steel, unwrought or semi-wrought; cables of metal, non-electric.

7 – Pressure valves [parts of machines]; clack valves [parts of machines].

8 – Forks; hoes [hand tools]; rakes [hand tools]; mattocks; shovels [hand tools]; ice picks; drawing knives; mortise chisels; hoop cutters [hand tools]; cutting tools [hand tools]; weeding forks [hand tools]; trowels [gardening].

12 – Shock absorbers for automobiles; suspension shock absorbers for vehicles; transmission shafts for land vehicles; wheels for railway cars, including wheels for subway cars; axles for vehicles; anti-theft devices for vehicles; shock absorbing springs for vehicles; vehicle suspension springs; axle journals.

16 – Fountain pens; posters; forms, printed; note books; booklets; bags [envelopes, pouches] of paper, for packaging; calendars; graphic prints; covers [stationery]; greeting cards; conical paper bags; folders for papers; magazines [periodicals]; seals [stamps]; inkstands, printed matter.

17 – Flexible tubes, not of metal; junctions, not of metal, for pipes; plastic film, not for wrapping.

19 – Door casings, not of metal; doors, not of metal; folding doors, not of metal; windows, not of metal; window frames, not of metal; casement windows, not of metal; manufactured timber; parquet flooring; clinker ballast.

20 – Coat hangers; office furniture; school furniture; racks [furniture]; trestles [furniture]; tables; chairs; cupboards; furniture fittings, not of metal; bins of wood or plastic.

21 – Covers, not of paper, for flower pots; pails; basins [receptacles]; flower pots; containers for household use; pot lids; glasses [receptacles]; table plates.

35 – Business auditing; demonstration of goods; marketing studies; business investigations; business management and organization consultancy; professional business consultancy; organization of exhibitions for commercial or advertising purposes; presentation of goods on communication media, for retail purposes; sales promotion for others; advertising; administrative processing of purchase orders; business information; commercial or industrial management assistance; procurement services for others [purchasing goods and services for other businesses].

36 – Financial analysis; capital investments; loans [financing]; financial sponsorship.

37 – Construction; repair; machinery installation.

39 – Boat rental; towing; transportation Information; storage Information; barge transport; freight [shipping of goods]; boat transport; marine transport; transport brokerage; freight brokerage; stevedoring; freighting.

40 – Metal casting; metal treating; metal plating; laminating; sorting of waste and recyclable material [transformation].

42 – Technical project studies; engineering; material testing; technical research; quality control; research and development of new products for others; construction drafting; surveying; calibration [measuring].

(260) AM 2016 81591 A

(800) 1241434

(891) 2015 01 19

(731) ENERGETIX GmbH & Co. KG

Franz-Kirsten-Str.1, 55411 Bingen, Germany

(540)



(591) Dark blue, red and white.

(511)

25 – Clothing; footwear and headgear, in particular outerclothing for women; outerclothing for men; clothing for children; shirts; pants (Am.); gowns; skirts; jackets; jackets [clothing]; parkas; pullovers; slipovers; cardigans; sweat shirts; tee-shirts; tights; sportswear; articles of swimwear; bath shoes; footwear for women; men's shoes; infants' footwear; rain boots; slippers; sandals; sports shoes; walking shoes; socks; hosiery; gaiters; ready-made linings (parts of clothing); soles for footwear; ties; headbands [clothing]; headgear; head scarves; caps [headwear]; ear muffs; sweatbands; scarves; wrist warmers; gloves, neckerchiefs; shawls.

(260) AM 2016 81592 A

(800) 1241209

(891) 2014 11 10

(731) AVIAGEN LIMITED

Stratford Hatchery Alscott Industrial Estate,
Atherstone On Stour, Stratford-Upon-Avon,
Warwickshire CV37 8BH, United Kingdom

(540)



(591) blue, red, white

(526) The trademark is protected as a whole. "Specialty MALES" shall not be subject to independent legal protection.

(511)

31 – Live poultry; live game; live chickens, turkeys and chicks; chickens and turkeys for breeding and growing; fertilized eggs for hatching; animal feed.

(260) AM 2016 81593 A

(800) 1241218

(891) 2014 10 09

(731) SHERKATE TOLIDE FARAVARDEHAYE
LABANI KALLEH PRIVATE JOINT
STOCK COMPANY

East Azarbaijan Avenue 103, Beyne
Daneshgah and Farvardin St., 1316633931
Tehran, Iran (Islamic Republic of)

(540)

KALLEH

(511)

29 – Meat, poultry and game; meat extracts; preserved, frozen, dried and cooked fruits and vegetables; jellies, jams, compotes; eggs; milk and milk products; edible oils and fats; processed and dried meat; salami, sausages, delicatessen meat; meat extracts; preserved fruit and vegetables, food products, namely pickled vegetables, pickles; lemon juice for cooking; processed olives; pasteurized milk, UHT milk, milk beverages with added flavourings, flavoured milk, milk powder, butter, margarine, sweetened cream, sour cream, whipped cream, whey, milk proteins for nutrition purposes, yogurt, cheese; none of the aforementioned goods consisting of or containing fish, fish preserves or caviar, or spreads consisting of or containing fish, fish preserves or caviar.

30 – Rice; tapioca and sago; flour and preparations made from cereals; bread; ices; sugar, honey, treacle; yeast, baking-powder; salt; mustard; vinegar, sauces (condiments); spices; ice; flavoured and sweetened gelatine desserts; relish; pickled relish; preserved relish; pickled ginger; puddings; none of the aforementioned goods consisting of or containing fish, fish preserves or caviar, or spreads consisting of or containing fish, fish preserves or caviar; fruit coulis.

31 – Grains and agricultural, horticultural and forestry products not included in other classes; live animals excluding fish; fresh fruits and vegetables; seeds; natural plants and flowers; foodstuffs for animals; malt.

32 – Mineral and aerated waters and other non-alcoholic beverages; fruit beverages and fruit juices; syrups and other preparations for making beverages.

(260) AM 2016 81594 A

(800) 1241226

(891) 2014 12 05

(731) WOLF PLASTICS VERPACKUNGEN
GMBH

Mühlgraben 8, A-8773 Kammern im
Liesingtal, Austria

(540)

WOLF PLASTICS

(591) Red and black

(511)

16 – Bags made of plastics for packaging; ice cube bags; bags [envelopes, pouches] of paper or plastics, for packaging.

20 – Boxes of wood or plastic; packaging containers of plastic; packaging containers of plastic; egg containers [packaging] of plastic; non-metallic window baskets; closures, not of metal, for containers; non-metallic child resistant security closures for containers; non-metallic end closures for containers [other than for household or kitchen use]; combined closures for containers [non-metallic and not for household or kitchen use]; stoppers for bottles, not of glass, metal or rubber; stoppers for bottles, not of glass, metal or rubber; composite caps of non-metallic materials for closing bottles; non-metallic child resistant security closures for bottles; screw tops, not of metal, for bottles; non-metallic cap closures for containers; sealing caps, not of metal; stoppers for bottles, not of glass, metal or rubber; caps made of non-metallic materials for containers; containers, not of metal [storage, transport]; non-metallic frames for containers; non-metallic transport containers; containers made of synthetic material [other than for household or kitchen use]; combined lids for containers [non-metallic and not for household or kitchen use]; non-metallic containers for the handling of goods [other than household or kitchen use]; combined stoppers for containers [non-metallic and not for household or kitchen use].

21 – Window-boxes; flower pots; saucers for flower pots.

(260) AM 2016 81596 A

(800) 1241243

(891) 2014 12 22

(731) SHENZHEN SIKEQI WEIYE CO., LTD.

Rm 1109, 1st Floor, Building 1, Meilin
Duoli Industrial Zone, Meihua Road, Meilin
Street, Futian District, Shenzhen City,
518049 Guangdong; China

(540)

CHB

(591) Red

(511)

21 – Make-up removing appliances, namely make-up removing appliances, electric.

26 – Hair curlers, other than hand implements, namely hair-curlers, electrically heated.

(260) AM 2016 81598 A

(800) 1241445

(891) 2015 01 12

(731) SPORT VISION D.O.O.

Milentija Popovića 5v, 11070 Novi Beograd,
Serbia

(540)



(591) Black,white

(511)

18 – Animal skins, hides; imitation leather; attaché cases; purses; vanity cases, not fitted; trunks and suitcases; traveling trunks; leather shoulder straps; haversacks; bags; bags for campers; bags for climbers; backpacks; handbags; card holders; key cases; credit card holders; wallets; school satchels; umbrellas and parasols.

24 – Fabrics and textile goods not included in other classes; bed and table covers.

25 – Clothing, footwear, headgear.

28 – Games and toys; gymnastic and sporting articles not included in other classes; decorations for Christmas trees.

35 – Advertising; business management; business administration; office functions; wholesale and retail sale services for the following goods: leather and imitations of leather, trunks and suitcases, umbrellas, parasols and walking sticks, whips, harness and saddlery, clothing, footwear, headgear, games and toys, gymnastic and sporting articles; provision online of all the aforesaid goods via the global computer network or wireless electronic communication devices.

(260) AM 2016 81599 A

(800) 1241273

(891) 2015 01 07

(731) Omega SA (Omega AG) (Omega Ltd.)

Jakob-Stämpfli-Strasse 96, CH-2502
Biel/Bienne, Switzerland

(540)

**SPEEDMASTER GREY SIDE
OF THE MOON**

(511)

14 – Precious metals and their alloys and goods made of these materials or coated therewith included in this class; jewelry, jewelry boxes, cases, precious stones; timepieces and chronometric instruments, watch chains, presentation cases for timepieces, cases for timepieces.

(260) AM 2016 81600 A
 (800) 1241274
 (891) 2015 01 06
 (731) Omega SA (Omega AG) (Omega Ltd.)
 Jakob-Stämpfli-Strasse 96, CH-2502
 Biel/Bienne Switzerland

(540)
**SPEEDMASTER FROM THE
 MOON TO SEDNA**

(511)
 14 – Precious metals and their alloys and goods made of these materials or coated therewith included in this class; jewelry, jewelry boxes, cases, precious stones; timepieces and chronometric instruments, watch chains, presentation cases for timepieces, cases for timepieces.

(260) AM 2016 81601 A
 (800) 1241289
 (891) 2015 01 20
 (731) Tovaristchestvo s ogranitchennoy otvetstvennostyu "GT"
 Prospect Al-Farabi 17, korpus 4"V", office 1503, VS "Nurly Tau", 050059 Almaty, (KZ) Kazakstan



(591) green, brown, orange, beige, blue, red, yellow
 (511)
 35 – Advertising; business management; business administration; office functions.

41 – Education; training; entertainment; open/covered recreational parks for children, amusement gardens, amusement parks; organization of sporting and cultural activities.

43 – Services for providing food and drink; temporary accommodation.

(260) AM 2016 81602 A
 (800) 1241462
 (891) 2015 03 04
 (731) TRIBUTE PORTFOLLO IP, LLC
 One StarPoint, Stamford CT 06902, (US)
 USA

(540)
TRIBUTE PORTFOLIO

(511)
 43 – Temporary accommodation services; hotel services and resort services.

(260) AM 2016 81605 A
 (800) 1241325
 (891) 2015 02 06
 (731) PHILIP MORRIS PRODUCTS S.A.
 Quai Jeanrenaud 3, CH-2000 Neuchâtel,
 Switzerland



(591) Black and white
 (511)
 34 – Tobacco, raw or manufactured; tobacco products; cigars, cigarettes, cigarillos, tobacco for roll-your-own cigarettes, pipe tobacco, chewing tobacco, snuff tobacco, kretek; snus; tobacco substitutes (not for medical purposes); electronic cigarettes; tobacco products for the purpose of being heated; electronic devices and their parts for the purpose of heating cigarettes or tobacco in order to release nicotine-containing aerosol for inhalation; smokers' articles, cigarette paper, cigarette tubes, cigarette filters, tobacco tins, cigarette cases, ashtrays, pipes, pocket apparatus for rolling cigarettes, lighters, matches.

(260) AM 2016 81606 A
 (800) 1241466
 (891) 2015 03 04
 (731) Tribute Portfollo IP, LLC
 One StarPoint, Stamford CT 06902 (US),
 USA

(540)
**TRIBUTE HOTELS &
 RESORTS**

(526) The trademark is protected as a whole. "HOTELS" "RESORTS" shall not be subject to independent legal protection.

(511)
 43 – Temporary accommodation services; hotel and resort services.

(260) AM 2016 81607 A
 (800) 1241482
 (891) 2015 02 13
 (731) BOURJOIS
 56 quai de Dion Bouton, F-92800 PUTEAUX,
 France

(540)
MAT ILLUSION

(511)
 3 – Soaps, perfumery products, essential oils, cosmetics, hair lotions; dentifrices.

(260) AM 2016 81608 A
 (800) 1241500
 (891) 2015 02 11
 (731) BIOFARMA
 50 rue Carnot, F-92284 SURESNES CEDEX,
 France

(540)

ПИКСУВРИ

(591) Black, white

(511)

5 – Pharmaceutical and veterinary products; sanitary products for medical purposes; dietetic food and substances for medical or veterinary use, food for babies; food supplements for humans and animals; plasters, materials for dressings; material for dental fillings and dental impressions; disinfectants; products for destroying vermin; fungicides, herbicides.

(260) AM 2016 81612 A
 (800) 1241586
 (891) 2014 08 08
 (731) TRİMPEKS İTHALAT İHRACAT TURİZM
 VE TİCARET ANONİM ŞİRKETİ
 Eski Büyükdere Caddesi, Yunus Emre
 Sokak Topçu İş Merkezi 1/12 4. Levent,
 İstanbul, Turkey

(540)

TRİMPEKS
plusmed
 health management

(591) Grey, yellow, blue, green

(511)

10 – Surgical, medical, dental and veterinary apparatus and instruments; furniture especially made for medical purposes; artificial limbs and prostheses; medical orthopaedic articles; surgical gowns and surgical sterile sheets; adult sexual aids; condoms; babies' bottles; babies' pacifiers; teats; teethers for babies.

(260) AM 2016 81613 A
 (800) 1241603
 (891) 2014 09 11
 (731) WORLD MEDICINE İLAÇ SANAYİ VE
 TİCARET ANONİM ŞİRKETİ
 Evren Mah. Camiyolu Cad. No:50 K:1 B
 Zemin 4-5-6, Güneşli Bağcılar, İstanbul,
 Turkey

(540)

FENOSTER
ФЕНОСТЕР

(591) Black, white

(511)

5 – Medicines for human purposes, medicines for veterinary purposes, vitamin preparations, chemical

preparations for medical purposes, dietetic substances adapted for medical use; dietetic foods adapted for medical purposes; baby foods, medicinal herbs, herbal beverages adapted for medical purposes, nutritional supplements, pollen dietary supplements, mineral food supplements, protein dietary supplements; dietary supplements for animals; fodder supplements for veterinary purposes; medicines for dental purposes, hygienic products for medical purposes including sanitary pads, breast-nursing pads and bunion pads, waddings for medical purposes, plasters for medical purposes, dressings for medical purposes, babies' napkins, preparations for destroying noxious plants, preparations for destroying noxious animals, fungicides, deodorants other than for human beings or for animals, air deodorising preparations, disinfectants for hygiene purposes, antiseptics, detergents for medical purposes.

(260) AM 2016 81614 A
 (800) 1241607
 (891) 2014 10 07
 (731) APPLE INC.
 1 Infinite Loop, Cupertino CA 95014, USA

(540)



(591) Red, blue, green, orange, and white

(511)

9 – Computer software for organizing, storing, providing access to, redeeming, scanning, sharing, and providing information about goods, services, discounts, tickets, boarding passes, coupons, consumer loyalty programs, and gift cards concerning a wide range of consumer products, services, and cultural, sporting and entertainment events; computer software for promoting the goods, services and providing information of others over a global communications network in any format, namely, handheld digital mobile communications devices; computer software for downloading and storing vouchers and tickets for admission to sporting, cultural and entertainment events; data synchronization software; computer software for capturing, managing, and storing credit card and debit card information; computer software to facilitate electronic payments through the use of biometric technology.

(260) AM 2016 81627 A
 (800) 1241635
 (891) 2014 11 12

(731) DAN FOAM, APS
Holmelund 43, DK-5660 Aarup, Denmark

(540)

TEMPUR + SEALY

(511)

35 – Business management and consultation services for the manufacture, marketing, distribution and sale of bedding and seating products, namely mattresses and cushions.

36 – Financial services namely, providing investment, research and advisory services.

(260) AM 2016 81629 A

(800) 1233037

(891) 2014 09 25

(731) SHENZHEN KENXINDA TECHNOLOGY CO., LTD

No.1806, 1807, 1808, 1809 of 18th Floor,
Fuchun Orient Building, Shennan Road,
Futian District, Shenzhen, China

(540)



(591) Black,white

(511)

9 – Computer peripheral devices; walkie-talkies; mobile phones; intercommunication apparatus; optical communication instruments; earplug ware; measuring instruments; charges for electric batteries; electric batteries; cell phones.

(260) AM 2016 81635 A

(800) 1240792

(891) 2014 11 13

(731) WORDEN ENTERPRISES, INC.

1612 NW 84th Ave., Miami FL 33126, USA

(540)

YEZZ

(591) Black,white

(511)

9 – Cellular telephones; cellular telephone accessories, namely, headsets, ear buds, batteries, battery chargers.

(260) AM 2016 81636 A

(800) 1240794

(891) 2014 12 04

(731) SO. SE. PHARM S.R.L.

Via Dei Castelli Romani, 22, I-00040 Rome,
Italy

(540)

eva/qu

(591) Black, white

(511)

5 – Laxatives.

(260) AM 2016 81637 A

(800) 1240795

(891) 2014 12 17

(731) ITALIAN EYEWEAR FACTORY S.R.L.

Via Elba, 10, I-20144 Milano (MI), Italy

(540)

RODS ++ CONES

(591) Black,white

(511)

9 – Scientific, nautical, surveying, photographic, cinematographic, optical, weighing, measuring, signalling, checking (supervision), life-saving and teaching apparatus and instruments; apparatus and instruments for conducting, switching, transforming, accumulating, regulating or controlling electricity; apparatus for recording, transmission or reproduction of sound or images; magnetic data carriers, recording discs; compact discs, DVDs and other digital recording media; mechanisms for coin-operated apparatus; cash registers, calculating machines, data processing equipment, computers; computer software; fire-extinguishing apparatus.

(260) AM 2016 81640 A

(800) 1240848

(891) 2014 11 28

(731) MERKUR GAMING GMBH

Borsigstr. 22, 32312 Lübbecke, Germany

(540)

Electric Burst

(511)

9 – Scientific, nautical, surveying, photographic, cinematographic, optical, weighing, measuring, signalling, checking (supervision), life-saving and teaching apparatus and instruments; apparatus and instruments for conducting, switching, transforming, accumulating, regulating or controlling electricity; apparatus for recording, transmission or reproduction of sound or images; magnetic data carriers, recording discs; compact discs, DVDs and other digital recording media; cash registers, calculating machines, data processing equipment, computers; computer software; fire-extinguishing apparatus; musical jukeboxes and parts for the aforesaid automatic machines; automatic cash dispensers, automatic money counting and money changing machines; mechanisms for coin-operated apparatus; computer and video games software; games software for use on any computer platform, including electronic entertainment and games consoles; programs for computer games; computer games; video games (software); computer games provided through a global

computer network or supplied by means of multimedia electronic broadcast or through telecommunications or electronic transmission or via the internet; computer games, leisure and recreational software, video games programs and computer software, all being provided in the form of storage media; programs for operating electric and electronic apparatus for games, amusement and/or entertainment purposes; automatic lottery machines; computer software for computer games on the internet; online games (software); computer software in the form of an app for mobile devices and computers; calculating apparatus in coin-operated machines and parts for the aforesaid goods; apparatus for recording, transmission, processing or reproduction of data, including sound or images, including parts for all the aforesaid goods, except radio sets, television receivers, hi-fi systems, video recorders, telephone apparatus, fax machines and telephone answering machines; computer hardware and software for casino and amusement arcade games, for gaming machines, slot machines or video lottery gaming machines or games of chance via the internet; electric, electronic, optical or automatic apparatus, for identifying data carriers, identity cards and credit cards, bank notes and coins; electric, electronic or optical alarm and monitoring installations, including video cameras and apparatus for image transmission and image processing; data processing equipment and computers, including data processing apparatus and computers being components for data networks and parts facilitating data network communications; electric wiring harnesses; circuit boards, printed board assemblies (electronic components) and combinations thereof being assemblies and equipment parts, included in this class.

28 – Games; toys; gymnastic and sporting articles not included in other classes; decorations for christmas trees; gaming apparatus (including coin-operated apparatus); coin-operated arcade games (machines); games for amusement arcades (included in this class); coin-operated video gaming apparatus; video games apparatus adapted for use with external screens or monitors only; casino fittings, namely roulette tables, roulette wheels; coin-operated automatic gaming machines and gaming machines, in particular for gaming arcades, with or without a prize payout; electronic or electrotechnical gaming apparatus, automatic gaming machines, games machines and slot machines operated by coins, tokens, banknotes, tickets or by means of electronic, magnetic or biometric storage media, in particular for commercial use in casinos and amusement arcades, with or without a prize payout; automatic gaming machines and gaming machines, in particular for commercial use in casinos and gaming arcades, with or without a prize payout; coin-operated gaming machines and/or electronic money-based gaming apparatus (machines), with or without prizes; housings adapted for

gaming machines, gaming apparatus and automatic gaming machines, operated by means of coins, tokens, tickets or by means of electronic, magnetic or biometric storage media, in particular for commercial use in casinos and gaming arcades, with or without a prize payout; electronic games; apparatus for electronic games and parts thereof; video output game machines; drawing apparatus for prize games and lotteries, draws or raffles; housings of metal, plastic and/or wood for coin-operated automatic machines; apparatus for games (including video games), other than adapted for use with external screens or monitors only; electropneumatic and electric slot machines (gaming machines); gaming tables, in particular for table football, billiards, sliding games; quoits (playthings) and darts; apparatus for games, namely, electric, electronic or electromechanical apparatus for bingo games, lotteries or video lottery games and for betting offices, networked or unnetworked; lcd games consoles; automatic gaming machines; automatic gaming machines, gaming machines and apparatus operated in computer networks; apparatus and devices for accepting and storing money, being fittings for the aforesaid automatic machines, included in this class.

41 – Education; providing of training; entertainment; sporting and cultural activities; rental of automatic slot machines and entertainment machines for casinos; arranging and conducting games; gambling; operating lotteries; conducting of games on the internet, also on the mobile internet; online game services provided via a computer network; provision of entertainment and/or educational content for apps for mobile devices and computers; conducting quizzes by means of smartphone applications; providing casino facilities (gambling), betting offices; operating gaming establishments, arcades and/or online internet casinos and betting platforms; gambling services via the internet.

(260) AM 2016 81641 A

(800) 1240864

(891) 2014 12 18

(731) SAFT

12 rue Sadi Carnot, F-93170 BAGNOLET,
France

(540)

Xcelion

(511)

9 – Apparatus and devices for electric energy storage and for supply in electric energy, particularly primary and secondary electrochemical generators, batteries, electric storage batteries; electric storage batteries; electrochemical generator batteries, electrochemical capacitors, super capacitors, apparatus and cabinets for supplying electric energy, apparatus and cabinets for uninterruptible supply in electric

energy, chargers; apparatus and devices for electric current transformation, particularly inverters, electric current and voltage regulators, frequency converters, voltage converters, rectifiers and inverters of electric current; apparatus and devices for control, management, supervision, whether local or remote, and security of the aforesaid apparatus and devices, particularly circuit breakers, measuring and thermal control apparatus, fire protection devices, overvoltage protection devices; software, particularly software for control, management and supervision, whether local or remote, of the aforesaid apparatus and devices.

(260) AM 2016 81642 A
(800) 1240865
(891) 2014 12 18
(731) SAFT

12 rue Sadi Carnot, F-93170 BAGNOLET,
France

(540)

XceliGn

(591) Black,white
(511)

9 – Apparatus and devices for electric energy storage and for supply in electric energy, particularly primary and secondary electrochemical generators, batteries, electric storage batteries; electric storage batteries; electrochemical generator batteries, electrochemical capacitors, super capacitors, apparatus and cabinets for supplying electric energy, apparatus and cabinets for uninterruptible supply in electric energy, chargers; apparatus and devices for electric current transformation, particularly inverters, electric current and voltage regulators, frequency converters, voltage converters, rectifiers and inverters of electric current; apparatus and devices for control, management, supervision, whether local or remote, and security of the aforesaid apparatus and devices, particularly circuit breakers, measuring and thermal control apparatus, fire protection devices, overvoltage protection devices; software, particularly software for control, management and supervision, whether local or remote, of the aforesaid apparatus and devices.

(260) AM 2016 81644 A
(800) 1240883
(891) 2014 12 05
(731) D.K.Z. S.r.l.

Via Dell'Artigianato, 18, I-38037 Predazzo
(TN), Italy

(540)

F
FIEMME

(591) Black,white
(511)
19 – Wooden flooring.

(260) AM 2016 81656 A
(800) 1240946
(891) 2015 02 20
(731) COOPERVISION INTERNATIONAL
HOLDING COMPANY, LP
Suite #2, Edghill House, Wildey Business
Park, St. Michael, Barbados
(540)

PROCLEAR

(511)
9 – Optical apparatus and instruments; contact lenses; contact lens blanks; containers for contact lenses; parts and fittings for all the aforesaid goods.

(260) AM 2016 81663 A
(800) 1241695
(891) 2014 11 17
(731) UNIEURO S.R.L.
Via Schiaparelli, 31, I-47121 Forlì, Italy
(540)



(591) Black,white
(511)
35 – Wholesaling and retailing, mail order sales, provided online and offline, of general consumer goods in the fields of: electrical, electronic, photographic and optical appliances, apparatus for recording, transmission or reproduction of sound or images, computers, hi-fi apparatus, televisions, telecommunications equipment, house equipment, namely, washing machines, dryers, dishwashers, refrigerators, juicers, blenders, electric and non-electric coffee machines, electric irons, electric and hand mixers, fruit and vegetables juice extractors, apparatus for lighting, heating, steam generating, cooking, refrigerating, drying, ventilating, water supply and sanitary purposes, household goods and gifts items and sets, coffee pods; sales promotion services; organization and management of exhibitions for commercial and advertising purposes.

(260) AM 2016 81664 A
(800) 1241701
(891) 2014 12 08

(731) KISH CHIPS COMPANY
No.55, Zeynali Sharghi St., Chaharah-e
Keyhan, Sohrevardi shomali St., Tehran,
Iran (Islamic Republic of)

(540)

Mazeh

(591) Black, white

(511)

29 – Processed nuts, potato based products and snacks included in this class, dates, pickles, tomato paste, salted vegetables (vegetables such as cucumber, olives, cauliflower kept in saltwater).

30 – Spices, processed cereals and cereal products, salad sauces, chocolates.

35 – Advertising, export services, retail and wholesale services for all aforementioned goods in classes 29 and 30.

(260) AM 2016 81665 A

(800) 1241062

(891) 2014 12 29

(731) PAGO INTERNATIONAL

GESELLSCHAFT MBH

Pummerinfeld 1B, A-4490 St. Florian, Austria

(540)

PAGO

(511)

29 – Meat, fish, poultry and game; meat extracts; frozen, preserved, dried and cooked fruits and vegetables; jellies, jams, compotes; eggs, milk and milk products; edible oils and fats.

30 – Coffee, tea, cocoa and artificial coffee; rice; tapioca, sago; flours and preparations made from cereals including cereal bars; bread, pastry and confectionery, filled and unfilled chocolates, chocolate products (not included in other classes), candies, fruit gum, chewing gum (except for medical purposes) and other sweets, ices; sugar, honey, treacle; yeast, baking powder; salt mustard; vinegar, sauces (condiments); spices; ice for refreshment.

32 – Beers; mineral waters and aerated waters and other non alcoholic beverages; lemonades; fruit beverages and fruit juices; beverages prepared using tea, fruit infusions and/or herbal infusions; syrups and other preparations for making beverages.

(260) AM 2016 81666 A

(800) 1241721

(891) 2015 01 29

(731) HUANG WEN-TANG

No.7, Jiaotang Industrial One Road, Shajing
Street, Bao'an District, Shenzhen,
GUANGDONG, China

(540)



MOSSO

(591) Black, white

(511)

12 – Bicycles; bicycle stands; pumps for bicycles, cycles; tires for bicycles, cycles; repair outfits for inner tubes; brake linings for vehicles; electric vehicles; driving motors for land vehicles; air cushion vehicles; hand cars.

(260) AM 2016 81670 A

(800) 412011

(891) 2015 01 07

(731) INSTAND e.V. Gesellschaft zur Förderung
der Qualitätssicherung in medizinischen
Laboratorien e.V.

Ubierstr. 20, 40223 Düsseldorf, Germany

(540)



(591) Reddish orange

(511)

1 – Chemical products for scientific purposes, especially preparations for clinical-chemical analyses; control preparations for medical exams; standard solutions or substances, by means of which measuring apparatus can be adjusted, especially for photometric examinations; reagents for use in laboratories, especially in medical laboratories.

5 – Medicines.

16 – Printed matter.

(260) AM 2016 81705 A

(800) 1242108

(891) 2015 03 11

(731) SSAB Technology AB

Box 70, SE-101 21 Stockholm, Sweden

(540)

GREENCOAT

(511)

6 – Steel, unwrought or semi-wrought; steel alloys; cast steel; steel sheets; steel pipes; pipes of metal; steel buildings; common metals and their alloys; metal building materials; transportable buildings of metal; materials of metal for railway tracks; non-electric cables and wires of common metal; ironmon-

gery, small items of metal hardware; pipes and tubes of metal; safes; goods of common metal not included in other classes; ores.

(260) AM 2016 81712 A

(800) 1242437

(891) 2015 01 15

(731) Open-Type Joint Stock Company

"ROT FRONT"

2-oy Novokuznetskiy pereulok, d. 13/15,

RU-113184 Moscow, Russian Federation

(540)

ΦΟΚΤΡΟΤ

(511)

30 – Confectionery.

(260) AM 2016 81714 A

(800) 491902

(891) 2015 02 20

(731) MAIMERI S.p.A.

Via Gianni Maimeri, 1, Fraz. Berrolino,

I-20060 MEDIGLIA (MI), Italy

(540)



(591) Black, white

(511)

2 – Colours, colouring agents for fine arts, colorants in tubes for painting, plates containing colours, colours of all types; paints, lacquers; products for preserving metals and metal alloys against rust and for wood conservation; dry-cleaning products; mordants; natural resins; metals in foil form for painters and decorators; oils for preserving wood; dessicative compositions.

16 – Plastics for modelling; cardboards, canvases and boards prepared for painting; fine arts utensils, nibs, pencils, paintbrushes; dictionaries, newspapers, photo novels, periodicals, reviews, brochures, leaflets, newsletters, registers; paper, paper articles; cardboard, cardboard articles; blotting paper, paper for photocopying; bookbinding material included in this class; photographs; office articles; adhesives and glues for office use; artists' supplies, artists' paintbrushes; typewriters; staplers for office use; metal drawing pins; drawing pin removers; metal staples; office punches; instructional or teaching material; document folders, files for office use; playing cards; type, printing blocks; inking pads, stamps, stamp racks, date stamps; pencil sharpeners; office articles, office equipment; office seals; rubber erasers; adhe-

sive tapes for stationery or household use; paper tapes for calculating machines; penholders, ballpoint pens, pens; letter clips; correcting fluids for documents; drawing compasses, squares and rulers for drawing; office machines for inserting letters in envelopes; envelopes, letter paper, carbon paper; paper cutters.

(260) AM 2016 81715 A

(800) 586134

(891) 2015 01 20

(731) KONINKLIJKE DOUWE EGBERTS B.V.

Oosterdoksstraat 80 NL-1011 DK

Amsterdam, Netherlands

(540)

PIAZZA D'ORO

(591) Black, white

(511)

30 – Coffee, also coffee packed in filters, coffee extracts, instant coffee, artificial coffee; coffee and artificial coffee blends; mixtures of coffee, powdered milk and artificial coffee; coffee containing cereals, fruit and spices; tea, tea extracts, tea substitutes; cocoa, chocolate and chocolate extracts in powdered, granular or liquid form; sugar; cookies and biscuits, edible ice; honey; mixes of herbs and spices for preparing beverages; mixes mainly consisting of spices with added dried fruit for preparing beverages; non-medicinal infusions.

(260) AM 2016 81718 A

(800) 919327

(891) 2015 02 26

(731) SUMITOMO RUBBER INDUSTRIES, LTD.

6-9, Wakinohamacho 3-chome, Chuo-ku,

Kobe-shi, Hyogo 651-0072, Japan

(540)

SINCERA

(591) Black, white

(511)

12 – Tires (for automobiles); automobiles and their parts and fittings.

(260) AM 2016 81719 A

(800) 1094079

(891) 2015 02 26

(731) SUMITOMO RUBBER INDUSTRIES, LTD.

6-9, Wakinohamacho 3-chome, Chuo-ku,

Kobe-shi, Hyogo 651-0072, Japan

(540)

ECORUN

(591) Black, white

(511)

12 – Automobile tires (tyres).

(260) AM 2016 81720 A
 (800) 1095489
 (891) 2015 02 26
 (731) SUMITOMO RUBBER INDUSTRIES, LTD.
 6-9, Wakinohamacho 3-chome, Chuo-ku,
 Kobe-shi, Hyogo 651-0072, Japan

(540)
Z I E X

(591) Black, white
 (511)
 12 – Automobile tires (tyres); tires for two-wheeled motor vehicles.

(260) AM 2016 81739 A
 (800) 1241794
 (891) 2014 10 17
 (731) PIERRE FABRE DERMO-COSMETIQUE
 45 place Abel Gance, F-92100 BOULOGNE,
 France
 (540)

DENSIAGE

(511)
 3 – Cosmetic hair and scalp care and maintenance products; shampoos; dermo-cosmetic hair and scalp care and hygiene products.
 5 – Dermatological hair and scalp care products.

(260) AM 2016 81742 A
 (800) 1241803
 (891) 2014 10 10
 (731) SYNTHON HOLDING B.V.
 Microweg 22, NL-6545 CM Nijmegen,
 Netherlands

(540)
SYNTHON

(511)
 40 – Treatment of materials on request, for others, for the manufacture of pharmaceutical preparations; treatment of materials, for others, for the manufacture of pharmaceutical preparations; custom manufacture of biopharmaceuticals; custom manufacture of medicines, for others; custom manufacture of preparations and raw materials for the pharmaceutical industry.

42 – Consulting services in the field of pharmaceutical research; biomedical research services; chemistry and biology laboratories; scientific laboratory services; pharmaceutical research and development in the pharmaceutical field; information relating to medical and scientific research in the field of pharmaceutical preparations; providing information on the results of clinical trials for pharmaceutical preparations; quality control of products for the purpose of certification; laboratory research and laboratory

analysis; research and design for the pharmaceutical industry; research and development for others; drug discovery; testing in the context of quality control; conducting clinical trials for pharmaceutical preparations; conducting quality control of pharmaceutical preparations; providing information and data relating to medical research and developments; scientific and medical research and development; development of medicines to be sold by and under the trademark of third parties; development of pharmaceutical ingredients for the pharmaceutical industry.

(260) AM 2016 81744 A
 (800) 1241878
 (891) 2014 12 10
 (731) FICOSOTA OOD
 Madara Blvd. 48, BG-9700 Shumen, Bulgaria
 (540)



(591) Dark pink and white
 (511)
 3 – Laundry glaze; almond oil; almond milk for cosmetic purposes; balms other than for medical purposes; petroleum jelly for cosmetic purposes; dental rinses, non-medicated; massage gels other than for medical purposes; lip gloss; skincare cosmetics; disinfectant soap; deodorant soap; detergents other than for use in manufacturing operations and for medical purposes; extracts of flowers [perfumes]; ethereal essences; essential oils; dental bleaching gels; cosmetic kits; cosmetics; cosmetic creams; cloths impregnated with a detergent for cleaning; tissues impregnated with cosmetic lotions; baby wipes; baby bath mousse; baby shampoo mousse; baby oils; babies' creams [non-medicated]; baby lotions; baby body milks; non-medicated baby care products, namely, creams and lotions, bath preparations, and shampoos and conditioners for the hair; non-medicated talcum powder for babies; baby shampoo; lavender water; lavender oil; lotions for cosmetic purposes; greases for cosmetic purposes; oils for cosmetic purposes; bath preparations, not for medical purposes; degreasers other than for use in manufacturing processes; fabric softeners for laundry use; laundry bleach; cleaning preparations; floor cleaning preparations; dishwashing preparations; washing soda, for cleaning; dentifrices; laundry soaking preparations; laundry preparations; scale removing preparations for household purposes; stain removing preparations; sun-tanning preparations [cosmetics]; aloe vera preparations for cosmetic purposes; antiperspirants [toiletries]; soaps; sun tan lotion; bath salts, not for medical purposes; talcum powder, for toilet use;

non-slipping liquids for floors; eau de cologne; toilettries; colour-brightening chemicals for household purposes [laundry]; shampoo.

(260) AM 2016 81745 A

(800) 1241880

(891) 2014 12 04

(731) STRICKMODEN BRUNO BARTHEL
GMBH & CO. KG
Clemens-Winkler-Strasse 6a, 09116
Chemnitz, Germany

(540)

maximo

(591) Black and White

(511)

24 – Cuddle clothes of textile material, especially for babies.

25 – Clothes; socks; tights; gloves; bandanas; rain-wear; headgear; shoes; cuddle clothes (bandanas).

28 – Soft toys; cuddle clothes [toys].

(260) AM 2016 81746 A

(800) 1241893

(891) 2014 12 19

(731) Meffert AG Farbwerke
Sandweg 15, 55543 Bad Kreuznach, Germany

(540)



(591) Black, white and yellow

(511)

1 – Adhesives for industrial purposes, mounting adhesives.

2 – Paints, varnishes, lacquers; preservatives against rust and against deterioration of wood, colorants, mordants, raw natural resins; metals in foil and powder form for painters and decorators.

17 – Sealing compounds, sealants, acrylic and silicone sealants, PU foam; adhesive compounds for use in sealing, cement, insulating boards.

19 – Adhesive and joint mortar, plaster; mastics.

(260) AM 2016 81774 A

(800) 1242319

(891) 2014 12 09

(731) H. Lundbeck A/S
Ottiliavej 9, DK-2500 Valby, Denmark

(540)

PROGRESS IN MIND

(511)

5 – Pharmaceutical and veterinary preparations; vaccines; pharmaceutical preparations and substances for the prevention and treatment of disorders and diseases in, generated from or acting on the central nervous system; pharmaceutical preparations and substances for the prevention and treatment of disorders and diseases in, generated from or acting on the brain; pharmaceutical preparations and substances acting on the central nervous system; central nervous system stimulants; pharmaceutical preparations and substances for the prevention and treatment of psychiatric and neurological disorders and diseases; pharmaceutical preparations and substances for the prevention and treatment of Alzheimer's disease and disorder, depression, mood disorder, psychosis, stroke, anxiety, epilepsy, multiple sclerosis, porphyria, Huntington's disease and disorder, insomnia, Parkinson's disease and disorder, schizophrenia, bipolar disorder and disease, oncology, pain, alcoholism and dependency; preparations, substances, reagents and agents for diagnostic and medical purposes.

41 – Arranging and conducting seminars, conferences, symposiums, workshops (training) and courses; educational and training services in the field of research and development, science, clinical tests and trials, diagnostic, medicine, pharmaceuticals, disorders, diseases, treatment and prevention; educational and training services in the field of research and development, science, clinical tests and trials, diagnostic, medicine, pharmaceuticals, disorders, diseases, treatment and prevention provided electronically, on-line, via cable or Internet or other electronic media; arranging and conducting of expert forums, including on-line, in the form of seminars, conferences, symposia, workshops (education) and courses; on-line training programs; providing on-line publications (not downloadable), including of books, reports, brochures, booklets, leaflets, including patient information leaflets, magazines, journals, teaching and educational material in the field of research and development, science, clinical tests and trials, diagnostic, medicine, pharmaceuticals, disorders, diseases, treatment and prevention.

42 – Scientific and technological services and research and design relating thereto; industrial analysis and research services; providing software and access to data and information in the field of research and development, science, clinical tests and trials, diagnostic, medicine, pharmaceuticals, disorders, diseases, treatment and prevention; arranging and conducting of expert forums, including on-line, in the field of research and development, science, clinical tests and trials, diagnostic, medicine, pharmaceuticals, disorders, diseases, treatment and prevention; pharmaceutical research and development; scientific and technological services and research in the field of disorders, diseases and prevention; scientific and

technological services and research in the field of the central nervous system, brain disorders and central nervous system related disorders, diseases and pharmaceuticals; medical research, trials and tests; clinical research, trials and tests; diagnostic research and tests, including clinical trials; providing for medical and medicinal information in the field of research and development, science, clinical tests and trials.

44 – Medical services; services in the field of psychiatry and psychology; advice related to medical and pharmaceutical preparations and substances; medical clinical services; medical treatment services; therapeutic treatment services; healthcare and medical services related to central nervous system disorders, diseases and pharmaceuticals; providing for medical and medicinal information in the field of diagnostic, medicine, pharmaceuticals, disorders, diseases, treatment and prevention; medical information services; providing on-line medical data and analyses designed to provide patients and clients customized information, including medical dose, diagnosis, therapeutic issues and medical management.

(260) AM 2016 81775 A

(800) 1242326

(891) 2014 11 11

(731) KRKA, tovarna zdravil, d.d., Novo mesto
Šmarješka cesta 6, SI-8501 Novo mesto,
Slovenia

(540)

PEMREXID

(511)

5 – Pharmaceutical preparations.

(260) AM 2016 81782 A

(800) 1242367

(891) 2014 09 04

(731) BÜROTIME MOBİLYA SANAYİ VE
TİCARET LİMİTED ŞİRKETİ
Konya Organize Sanayi Bölgesi, Evrenköy
Caddesi. No:5, Konya, Turkey

(540)

bürotime®

(591) Red and white.

(526) (R)

(511)

20 – Furniture, namely, tables, chairs, armchairs, sofas, beds, wardrobes, dressing tables, cupboards; display stands and boards; index cabinets; medicine cabinets; writing and drawing desks; tea carts; deck chairs; counters (tables) not of metal; work benches (not of metal); vice benches, not of metal; furniture chests; non-metal mailboxes; fixed towel dispensers (not of metal); coat hangers; coat stands; mattresses;

spring mattresses; pillows; air mattresses and pillows; hydrostatic (water) beds, not for medical purposes; straw mattresses and sleeping bags for camping; mirrors; beehives; comb foundations for beehives; sections of wood for beehives; playpens for babies; high chairs for babies; bassinets; infant walkers; inflatable plastic signs, signboards of wood or plastics; picture frames; picture frame brackets; moldings (mouldings) for picture frames; identity plates, not of metal; nameplates, not of metal; registration plates, not of metal; number plates, not of metal; knife handles, not of metal; broom handles, not of metal; windows handles, not of metal; door handles, not of metal; chair legs, not of metal; tool handles, not of metal; latches not of metal; bottle closures, not of metal; bottle caps, not of metal; corks for bottles; cork bands; window fittings, not of metal; door fittings, not of metal; locks, not of metal and non-electric; racks; door handles, not of metal; drawer rails, not of metal; casters, not of metal; bolts, not of metal; screws, not of metal; dowels, not of metal; pipe or cable clips, not of metal; plugs (dowels) not of metal; furniture fittings (not of metal); furniture parts, namely, chair legs, table leaves, arm rests; works of art in this class, of wood, wax, plaster or plastic; sculptures of bone, ivory, plaster, plastic, wax or wood, busts of bone, ivory, plaster, plastic, wax or wood; mannequins, mobiles (decoration), wall plaques made of plastic or wood (furniture); baskets, not of metal; bakers bread baskets; hamper baskets; reed baskets; fishing baskets; kennels, nesting boxes, cushions, beds for household pets; portable steps (ladders), not of metal, of wood or plastic; mobile boarding stairs not of metal for passengers; curtain holders, not of textile material; curtain hooks; curtain rails; curtain rings; curtain rods; curtain rollers; curtain tie-backs; bamboo curtains; indoor window blinds (shades); slatted indoor blinds; bead curtains for decoration; non-metal mounting brackets for vehicle tyres.

35 – Advertising agencies services, marketing and publicity bureaus services including commercial or advertisement exhibition and trade fair organization services; providing office functions; secretarial services, document reproduction, photocopying, typing services, word processing, compilation of information into computer databases, systemization of information into computer databases, telephone answering services, arranging newspaper subscriptions, rental of office machines and equipments, business management; business administration; business management and organization consultancy, accounting; personnel recruitment; import and export agencies; business investigations, evaluations, expert business appraisals; auctioneering; the bringing together, for the benefit of others, of furniture, mirrors, picture frames, excluding the transport thereof), enabling customers to conveniently view and purchase those goods; all of the aforementioned retail services may

be provided by retail stores, wholesale outlets, through mail order catalogues or by means of electronic media, including, through web sites or television shopping programmes.

(260) AM 2016 81783 A

(800) 1242374

(891) 2014 09 01

(731) VGC INVESTMENTS LTD

Arch. Makariou III, 155 Proteas House,
5th floor, CY-3026 Limassol, Cyprus

(540)



(591) White, green and bronze.

(511)

5 – Dietetic foods adapted for medical purposes; food for babies.

29 – Ajvar [preserved peppers]; aloe vera prepared for human consumption; albumin milk; alginates for culinary purposes; anchovy; peanuts, prepared; peanut butter; bacon; albumen for culinary purposes; white of eggs; beans, preserved; bouillon; bouillon concentrates; marmalade; cream [dairy products]; toasted laver; nuts, prepared; peas, preserved; mushrooms, preserved; hummus [chickpea paste]; potato fritters; jams; game, not live; non-alcoholic eggnog; seaweed extracts for food; gelatine; meat jellies; jellies for food; bone oil, edible; lard; suet for food; fatty substances for the manufacture of edible fats; fat-containing mixtures for bread slices; yolk of eggs; cranberry sauce [compote]; frozen fruits; salted fish; whipped cream; condensed milk; caviar; fish roe, prepared; ginger jam; yogurt; cocoa butter; sauerkraut; potato flakes; potato crisps; kefir [milk beverage]; curd; kimchi [fermented vegetable dish]; isinglass for food; clams, not live; charcuterie; coconut oil; coconut butter; coconut fat; coconut, desiccated; milk shakes; compotes; shrimps, not live; prawns, not live; black pudding [blood sausage]; croquettes; corn oil; koumiss [koumiss] [milk beverage]; sesame oil; spiny lobsters, not live; lecithin for culinary purposes; salmon; flaxseed oil for culinary purposes; margarine; butter; buttercream; almonds, ground; mussels, not live; milk; milk beverages, milk predominating; milk products; shellfish, not live; sea-cucumbers, not live; vegetable mousses; fish mousses; meat extracts; meat, tinned [canned]; meat; meat, preserved; seeds, prepared; sunflower seeds, prepared; vegetables, tinned [canned]; vegetable salads; vegetable juices for cooking; vegetable soup preparations; vegetables, preserved; vegetables, cooked; vegetables, dried; gherkins; olives, preserved; olive oil for food; lobsters, not live; her-

rings; palm oil for food; palm kernel oil for food; liver pastes; pectin for culinary purposes; liver; pollen prepared as foodstuff; piccalilli; prostokvasha [soured milk]; poultry, not live; crayfish, not live; crustaceans, not live; fish, preserved; fish, not live; fish meal for human consumption; fish fillets; fish, tinned [canned]; foods made from fish; colza oil for food; raisins; ryazhenka [fermented baked milk]; sardines; pork; cheese; whey; rennet; preparations for making bouillon; smetana [sour cream]; soya milk [milk substitute]; tofu; soya beans, preserved, for food; salted meats; pickles; sunflower oil for food; sausages; sausages in batter; lentils, preserved; preparations for making soup; soups; tahini [sesame seed paste]; animal marrow for food; tripe; tomato paste; tomato purée; tomato juice for cooking; truffles, preserved; tuna fish; oysters, not live; milk ferments for culinary purposes; dates; fruit, preserved; crystallized fruits; fruit preserved in alcohol; fruit peel; fruit pulp; fruit jellies; fruit-based snack food; fruit, stewed; fruits, tinned [canned]; fruit chips; fruit salads; edible fats; edible oils; edible birds' nests; onions, preserved; preserved garlic; low-fat potato chips; ham; silkworm chrysalis, for human consumption; apple purée; powdered eggs; eggs; snail eggs for consumption.

30 – Aniseed; peanut confectionery; cereal bars; high-protein cereal bars; bean meal; flour; tapioca flour; farinaceous foods; pastries; bread rolls; buns; sandwiches; vanillin [vanilla substitute]; vanilla [flavoring] [flavouring]; waffles; vermicelli [noodles]; cream of tartar for culinary purposes; oatmeal; oat flakes; oat-based food; sausage binding materials; binding agents for ice cream [edible ices]; biscuits; cookies; cloves [spice]; mustard; mustard meal; cake frosting [icing]; glucose for culinary purposes; relish [condiment]; gluten additives for culinary purposes; yeast; essences for foodstuffs, except etheric essences and essential oils; chewing gum; custard; leaven; rice-based snack food; cereal-based snack food; artificial coffee; frozen yogurt [confectionery ices]; flavorings, other than essential oils, for beverages; flavorings, other than essential oils, for cakes; aromatic preparations for food; flavorings, other than essential oils; wheat germ for human consumption; thickening agents for cooking foodstuffs; cereal preparations; ginger [spice]; coffee; unroasted coffee; coffee flavorings [flavourings]; coffee-based beverages; coffee beverages with milk; cocoa; cocoa beverages with milk; cocoa-based beverages; capers; caramels [candy]; lozenges [confectionery]; curry [spice]; potato flour; flowers or leaves for use as tea substitutes; ketchup [sauce]; gluten prepared as foodstuff; confectionery; tortillas; cinnamon [spice]; starch for food; hominy grits; groats for human food; corn, milled; corn, roasted; corn flour; popcorn; corn flakes; turmeric; couscous [semolina]; cooking salt; confectionery for decorating Christmas trees; ice for refreshment; ice, natural or artificial; liquorice [con-

fectionery]; noodles; candy; flaxseed for human consumption; mayonnaise; macaroni; pasta; maltose; hominy; semolina; chow-chow [condiment]; marinades; marzipan; royal jelly; honey; molasses for food; macarons [pastry]; almond paste; almond confectionery; flour-milling products; pancakes; spring rolls; ice cream; sea water for cooking; seaweed [condiment]; dessert mousses [confectionery]; chocolate mousses; nutmegs; muesli; meat tenderizers, for household purposes; meat gravies; mint for confectionery; peppermint sweets; tea-based beverages; star aniseed; infusions, not medicinal; crushed oats; vinegar; husked oats; husked barley; stick liquorice [confectionery]; palm sugar; soya bean paste [condiment]; ravioli; pepper; peppers [seasonings]; allspice; pesto [sauce]; beer vinegar; meat pies; quiches; natural sweeteners; pizzas; chips [cereal products]; pies; fondants [confectionery]; powders for ice cream; pralines; condiments; dressings for salad; seasonings; unleavened bread; propolis; gingerbread; spices; puddings; cake powder; wheat flour; fruit coulis [sauces]; preparations for stiffening whipped cream; rice; rice cakes; baking powder; ferments for pastes; vegetal preparations for use as coffee substitutes; sago; garden herbs, preserved [seasonings]; celery salt; golden syrup; salt for preserving foodstuffs; soya flour; soya sauce; malt for human consumption; malt biscuits; malt extract for food; sauces [condiments]; pasta sauce; spaghetti; noodle-based prepared meals; ham glaze; rusks; breadcrumbs; petit-beurre biscuits; sushi; tabbouleh; tacos; tapioca; cakes; petits fours [cakes]; dough; cake dough; pastry dough; tomato sauce; crackers; tarts; pâtés en croûte; sherbets [ices]; fruit jellies [confectionery]; halvah; bicarbonate of soda for cooking purposes [baking soda]; edible ices; bread; chicory [coffee substitute]; sweetmeats [candy]; sugar; tea; iced tea; chutneys [condiments]; cheeseburgers [sandwiches]; saffron [seasoning]; chocolate; chocolate-based beverages; chocolate beverages with milk; barley meal; crushed barley.

40 – Food smoking; food and drink preservation.

(260) AM 2016 81784 A
(800) 1242391
(891) 2014 09 24
(731) ZHEJIANG TIGER LIGHTER CO., LTD.
No.2 Jucheng Road, Juguang Zone, Wenzhou
City, 325000 Zhejiang, China

(540)

TIGER

(591) Black

(511)

34 – Lighters for smokers; gas containers for cigar lighters; gas containers for butane lighters; tobacco pipes; cigar cutters; cigarette cases; cigarette holders; snuff boxes; ashtrays for smokers.

(260) AM 2016 81791 A

(800) 1242511

(891) 2014 12 15

(731) WORLD MEDICINE İLAÇ SANAYİ VE
TİCARET ANONİM ŞİRKETİ
Evren Mah. Camiyolu Cad. No:50 K:1 B,
Zemin 4-5-6, Güneşli Bağcılar İstanbul, Turkey

(540)

NILOPROL
НИЛОПРОЛ

(591) Black and white

(511)

5 – Medicines for human purposes, medicines for veterinary purposes, vitamin preparations, chemical preparations for medical purposes, dietetic substances adapted for medical use; dietetic foods adapted for medical purposes; baby foods, medicinal herbs, herbal beverages adapted for medical purposes, nutritional supplements, pollen dietary supplements, mineral food supplements, protein dietary supplements; dietary supplements for animals; fodder supplements for veterinary purposes; medicines for dental purposes, hygienic products for medical purposes including sanitary pads, breast-nursing pads and bunion pads, waddings for medical purposes, plasters for medical purposes, dressings for medical purposes, babies' napkins, preparations for destroying noxious plants, preparations for destroying noxious animals, fungicides, deodorants other than for human beings or for animals, air deodorising preparations, disinfectants for hygiene purposes, antiseptics, detergents for medical purposes.

(260) AM 2016 81792 A

(800) 1242534

(891) 2014 09 25

(731) Wer liefert was? GmbH
ABC-Straße 21, 20354 Hamburg, Germany

(540)

wlw.com

(511)

9 – Economic data and information and/or business data and information recorded on data carriers; apparatus for recording, transmission and reproduction of sound and images; data processing apparatus; computers; disk drives (for computers); computer accessories, included in this class; software; printers; magnetic data carriers; recording discs; DVDs; DVD-ROMs; computer discs; video cassettes; nautical, surveying, cinematographic, weighing, measuring, signal, regulating, lifesaving and teaching apparatus and instruments; photographic and optical apparatus and instruments.

16 – Paper; paper cardboard; booklets; flyers; brochures; note books; calendars; printed matter; books,

in particular reference works for economic data and information and/or business data and information; bookbinding material; photographs; stationery; adhesives for paper goods, stationery or household purposes; artists' materials; paint brushes, included in this class; typewriters and office requisites (except furniture); instructional and teaching material (except apparatus); packaging material made of plastic (included in this class); printers' type; printing blocks.

35 – Compilation, systematization and updating of economic data and information and/or business data and information; providing business and/or economic data and information; compilation of statistics; statistical analysis of data for market research and advertising purposes (data mining); advertising and marketing; procurement of commercial transactions for third parties; arranging contracts for the buying and selling of goods for others; advertising for others via online electronic communication networks; provision and rental of advertising space, in particular on the Internet; updating and maintenance of data in computer databases via global computer networks (Internet); systematization and compilation of data relating to the supply and demand for goods and services in computer databases; systematization and compilation of data in computer databases; rental of personnel for call centers; business information on the Internet relating to economic data and information; distribution of advertising matters, also via the Internet; presentation of companies on the Internet and other media; publication of printed matter (also in electronic form) for advertising purposes; organization of exhibitions for commercial or advertising purposes; online advertising on a computer network; provision of commercial and economic contacts, also via the Internet; on-line advertising on a computer and mobile network.

38 – Telecommunication services, in particular for data, image and speech services; network telecommunication; collecting and sending of news (news agencies); providing access to data and information on computer networks; computer aided transmission of data and images; online press agency services, namely gathering and supplying of information, texts, drawings and images via telecommunications networks; computer aided transmission of messages and images; rental of telecommunication apparatus for call centers; call center telephone services; Internet services, namely providing access to information on the Internet; providing and renting access time to the Internet; integrated speech and data telecommunication; e-mail data services; providing access to databases in computer networks; transmission of data; renting access time to a data base for downloading information via electronic media (Internet); providing access to software in data networks for Internet access; providing access to information on

the Internet; providing access to computer programs in data networks; telecommunication via platforms and portals on the Internet; providing access to data bases; provision of online forums; transmission of business and economic information and/or data.

41 – Publication of books containing economic data and information and/or business data and information, other than for advertising purposes; editing of sound data (recording studio services); training of call center personnel; publication of printed matter (also in electronic form), except for advertising purposes; online publication of electronic books, periodicals and reference works; publication of periodicals, books and reference works in electronic form, also in the Internet; providing online electronic publications, not downloadable.

42 – Electronic storage of economic data and information and/or business data and information; updating of database software; digital image processing (graphic arts design); rental of software for Internet access; setting up webpages in the Internet, for others; providing search engines for the Internet; providing (programming) of web space for advertising goods and services; development, maintenance and updating of a telecommunication network search engine.

45 – Licensing of databases.

(260) AM 2016 81793 A
 (800) 1242539
 (891) 2014 11 12
 (731) DAN FOAM, APS
 Holmelund 43, DK-5560 Aarup, Denmark
 (540)

TEMPUR SEALY

(511)
 35 – Business management and consultation services for the manufacture, marketing, distribution and sale of bedding and seating products, namely mattresses and cushions.

36 – Financial services namely, providing investment, research and advisory services.

(260) AM 2016 81794 A
 (800) 1242542
 (891) 2014 11 13
 (731) POLİYA POLİESTER SANAYİ VE
 TİCARET LİMİTED ŞİRKETİ
 Firuzköy Bulvarı, No.46, Avcılar İstanbul, Turkey
 (540)



(591) black, dark blue and white

(511)

35 – Advertising, marketing and public relations; organization of exhibitions and trade fairs for commercial or advertising purposes; office functions; secretarial services; arranging newspaper subscriptions for others; compilation of statistics; rental of office machines; systemization of information into computer databases; telephone answering for unavailable subscribers; business management, business administration and business consultancy; accounting; commercial consultancy services; personnel recruitment, personnel placement, employment agencies, import-export agencies; temporary personnel placement services; business appraisals; auctioneering; the bringing together, for the benefit of others, of chemicals used in industry, science, photography, agriculture, horticulture and forestry, manures and soils, unprocessed artificial resins and unprocessed plastics, fire extinguishing compositions, adhesives not for medical, household and stationery purposes, paints, varnishes, lacquers, preservatives against rust, preservatives against deterioration of wood, thinners and binders for paints, pigments, preservatives for metals, shoe dyes, printing dyes and ink, toners (including filled toner cartridges), colorants for food, pharmaceuticals and beverages, raw natural resins, metals in foil and powder form for painters, decorators, printers and artists, industrial oils and greases, cutting fluids, dust absorbing, wetting and binding compositions, solid fuels, firewood, liquid and gas fuels and their non-chemical additives, candles, wicks, semi-finished wax, wax and paraffin for lighting purposes, rubber, gutta-percha, gum, asbestos, mica and semi-finished synthetic goods made from these materials in the form of powder, bars, panels and foils included in this class, insulation, stopping and sealing materials, joint sealant compounds for joints, gaskets, O-rings for sealing purposes, flexible pipes made from rubber and plastic, hoses made of plastic and rubber, including those used for vehicles, junctions for pipes of plastic and rubber, pipe jackets of plastic and rubber, hoses of textile material, junctions for pipes, not of metal, pipe jackets, not of metal, connecting hose for vehicle radiators, sand, gravel, crushed stone, asphalt, bitumen, cement, gypsum for use in construction, road construction, repair and covering work, building materials (as finished products) made of concrete, gypsum, clay, potters' clay, natural or artificial stone, wood, plastics and synthetic materials for building, construction, road construction purposes, included in this class, non-metallic buildings, non-metallic building materials, non-metallic transportable buildings, poles not of metal for power lines, barriers not of metal, doors and windows of wood and synthetic materials, traffic signs not of metal, non-luminous and non-mechanical, for roads, monuments and statuettes of stone, concrete and marble, natural and

synthetic surface coatings in the form of panels and sheets, being building materials, heat adhesive synthetic surface coating, being building materials, bitumen cardboard coatings for roofing, bitumen coating for roofing, building glass, prefabricated swimming pools not of metal (structures), aquarium sand (excluding the transport thereof), enabling customers to conveniently view and purchase those goods, such services may be provided by retail stores, wholesale outlets, by means of electronic media or through mail order catalogues.

(260) AM 2016 81795 A

(800) 1242597

(891) 2015 01 12

(731) VIONNET S.p.A.

CORSO MONTFORTE 16, I-20121 MILAN,
Italy

(540)

VIONNET

(591) Black and white

(511)

3 – Soaps; perfumes, eaux de parfum, eaux de toilette, deodorant, after-shave lotion, shaving foam; mascara, lipstick, lip gloss; face cream, body cream, moisturizing body lotion, body oil, toiletry milk for the body; hair lotions, hair creams, hair moisturizers, hair spray, shampoos, dry shampoos; make-up removing lotions, make-up removing products; face lotions, face moisturizing cream; dentifrices; nail polish, eyeliner pencils, eye liners, make-up foundation, make-up powder; depilatories.

14 – Jewelry, jewelry articles namely rings, necklaces, earrings, bracelets, tiara, bracelets, charms (jewelry), brooches (jewelry), chains (jewelry), tie pins, ornamental pins, paste jewelry; precious stones; timepieces and chronometric instruments namely watches, watch straps, wristwatches; cuff links; key rings [trinkets or fobs].

18 – Leather and imitations of leather, products made of leather, namely briefcases [leather goods], document portfolios, school bags, traveling bags, traveling sets, card cases, wallets, key cases, handbags, coin purses; trunks and suitcases; umbrellas, parasols and walking sticks; furs [animal skins]; whips, harness and saddlery.

25 – Belts, gloves (clothing); clothing, namely socks, shirts, suits, neckties, sashes for wear, scarves, bathing suits, waterproof coats, skirts, coats, trousers, pullovers, pajamas, t-shirts, sweatshirts, jackets, blousons, stockings, tights, shorts, underpants, tank tops, suspenders, overalls, cardigans, parkas, dressing gowns, underwear, bras; footwear (except orthopedic footwear) namely shoes, moccasins, sandals, pumps, boots, bedroom slippers, slip-

pers, half-boots; headgear, namely caps, knitted caps, hats, headbands, berets.

35 – Retail sale services for soaps, scented candles, perfumes, eaux de parfum, toilet water, deodorants, dentifrices, after-shave lotion, shaving foam, lipstick, lip brighteners, face cream, body cream, moisturizing body lotion, body oil, toiletry milk for the body, soaps, hair lotions, creams for the hair, hair moisturizers, hair spray, shampoos, dry shampoos, make-up removing lotions, make-up removing products, face lotions, moisturizing face cream, nail polish, eye pencils, eyeliners, facial foundation, make-up powder, depilatories, spectacles, eyeglasses, sunglasses, spectacle cases, protective cases for mobile telephones or digital tablets, goods made of leather namely briefcases (leather goods), document holders, school bags, travel bags, traveling sets, card holders, wallets, key cases, handbags, purses (coin purses), trunks and suitcases, umbrellas, parasols and walking sticks, combs for the hair, animal skins, whips, harness and saddlery, belts (clothing), gloves (clothing), clothing, socks, shirts, suits, neckties, sashes for wear, scarves, bathing suits, waterproof coats, skirts, coats, trousers, pullovers, pajamas, t-shirts, sweatshirts, jackets, blousons, stockings, tights, shorts, tank tops, suspenders, briefs, blouse, cardigans, parkas, dressing gowns, underwear (lingerie), bras, footwear (except orthopedic footwear), namely shoes, moccasins, sandals, pumps, boots, bedroom slippers, slippers, half-boots, headgear for wear, namely caps, head coverings, hats, headbands, berets, shoe laces; Services provided by a franchiser namely assistance in the operation or management of retail stores for ready-made clothing; assistance in the operation or management of a commercial company within a network of shops, within a network of points of sale for goods in the field of ready-made clothing; commercial administration of licenses for goods and services of others in the field of ready-made clothing.

(260) AM 2016 81796 A

(800) 1242609

(891) 2014 02 07

(731) GEORGIOS ZACHARIOUDAKIS KAI SIA
O.E.

Agios Ioannis, Kainourgio Chorio, Episcopi,
GR-700 08 Heraklion Krete, P.C., Greece

(540)



The Secret of Natural Beauty

(591) Green, brown and gold-yellow

(511)

3 – Bleaching preparations and other substances for laundry use; cleaning, polishing, scouring and abra-

sive preparations; soaps; perfumery, essential oils, cosmetics, hair lotions; dentifrices; cosmetics in the form of lotions; nail polish removers (cosmetics); cosmetic preparations for slimming purposes; sunscreen preparations for tanning (cosmetics); cosmetics for eyelashes; cosmetics for tanning the skin; cosmetics for protecting the skin from sunburn; cosmetic lip coatings; perfumery, essential oils, cosmetics, hair lotions; compositions for bleaching the skin (cosmetics); nail strengthening preparations (cosmetics); skin whitening preparations (cosmetics); skin whitening preparations [cosmetic]; mineral oils (cosmetics); cleansing milk for toilet purposes; cleansing milk for toilet purposes; non-medicated cosmetics; facial washes [cosmetic]; oils for the body [cosmetics]; sunscreen creams (cosmetics); sun barriers [cosmetics]; sun blocks (cosmetics); cosmetic rouges; toning creams [cosmetic]; cosmetic oils; antiperspirants (toiletries); cosmetics for animals; eyeliner (cosmetics); moisturising skin lotions [cosmetic]; facial creams [cosmetic]; beauty tonics for application to the body; facial packs [cosmetic]; skin balms (cosmetic); after-sun oils (cosmetics); slimming aids (cosmetics), not for medical purposes; oil for use when sunbathing (cosmetics); sun-tanning oil (cosmetics); cosmetic preparations for slimming purposes; cosmetics in the form of creams; essential oils, cosmetics; eye liner; cosmetic preparations for baths; cosmetic eye pencils; cosmetics in the form of oils; cosmetics all for sale in kit form; cleansing preparations for toilet purposes; skin care creams [cosmetic]; facial wipes impregnated with cosmetics; cosmetic preparations for eyelashes; cosmetic preparations for sun-tanning; moisturising gels [cosmetic]; suntan oils [cosmetics]; cosmetics in the form of gel; facial scrubs [cosmetic]; cosmetic colours for eyes; preparations for refilling powder compacts (cosmetics); cosmetics in the form of powders; moisturisers [cosmetics]; eyebrow cosmetics; cosmetics in the form of nail polish; nail base coat (cosmetics); cosmetics preparations; cosmetics; cosmetic moisturisers; facial moisturizers [cosmetic]; skin creams [cosmetic]; nail polish removers [cosmetics]; cosmetic lip protectors; hair cosmetics; cosmetics in general; topical skin sprays for cosmetic purposes; facial toners (cosmetics); cosmetic hair dressing preparations; moisturising lotions for the body [cosmetic]; moisturising concentrates [cosmetic]; cosmetics for personal use; skincare cosmetics; cosmetics in the form of eye shadow; cosmetic preparations for slimming purposes; cosmetic toners; cosmetic preparations for skin care; non-medicated beauty preparations; sun blocking lipsticks (cosmetics); cosmetics in the form of rouge; oils for toilet purposes; sun-tanning preparations [cosmetics]; self-tanning preparations (cosmetics); body creams [cosmetics]; cosmetics for the treatment of dry skin; cosmetic kits; skin care oils (cosmetic); toiletries; cosmetic wipes impregnated with resin; night creams

[cosmetics]; hair cosmetics; antiperspirants [toiletries]; cosmetic preparations for use as aids to slimming; sunscreen preparations (cosmetics); cosmetics for use on the skin; cosmetic pads; beauty tonics for application to the face; cosmetic eye gels; after-sun gels (toiletries); tissues impregnated with cosmetics; cosmetic kits; sun-tanning gels (cosmetics); cosmetic preparations for cleansing the skin; skin cleansing preparations [cosmetic]; moisturising skin creams [cosmetic]; skin cleansers [cosmetic]; cosmetics for use in the treatment of wrinkled skin; cosmetics in the form of milks; eyebrow cosmetics; self-tanning creams (cosmetics); lipsticks; sun blocking lipsticks (cosmetics); face masks; face and body masks; masks for the skin (cosmetics); facial beauty masks; body masks; beauty masks; cleansing masks; beauty masks; moisturising masks for the skin; beauty masks; mud based face masks; cleansing masks for the face; facial exfoliators; exfoliants; exfoliating creams; exfoliants for the cleansing of the skin; body exfoliating preparations; facial scrubs [cosmetic]; facial exfoliating preparations; facial peelings; exfoliants for the care of the skin; non-medicated face scrubs; soap for foot perspiration; soaps for personal hygiene; household soaps; soaps in gel form; soap for foot perspiration; soaps for body care; sponges impregnated with soaps; soap for brightening textile; soap for laundry use; medicated soap; disinfectant soap; medicinal soaps; non-medicated soap; disinfectant soap; soaps in liquid form; personal soaps; deodorant soap; deodorant soap; perfumed soaps; soaps; skin soap; shaving soap; soaps in gel form; soaps for laundry use; non-medicated toilet soaps; soaps for household purposes; soaps for the hand; bar soap; carbolice soap; shampoo for vehicles; medicated shampoos; shampoo-conditioners; shampoos for pets; car shampoos; carpet shampoo; shampoos; shampoos for the hair; body shampoos; dry shampoos; non-medicated shampoos; shampoos for personal use; baby shampoo mousse; non-medicated hair shampoos; animal shampoos; hair rinses (shampoo-conditioners); baby shampoo; non-medicated bath foams; foam baths; baby bath mousse; shower gels; shower bath gel; hair oils; massage oils; flavourings made with essential oils; essential oils for personal use; mineral oils (cosmetics); oils for the body [cosmetics]; ethereal oils; oils for cleaning purposes; oils for cleaning purposes; massage oils, not medicated; after-sun oils (cosmetics); essential oils; sun-tanning oil (cosmetics); essential oils, cosmetics; scented oils for burning to produce fragrance; oils for cosmetic purposes; distilled oils for beauty care; oils for cosmetic purposes; oils for cosmetic purposes; essential oils of lemon; essential oils for cosmetic purposes; bath oils being hair care preparations; oils for hair conditioning; essential oils of lemon; emulsified essential oils; flavorings for beverages [essential oils]; Japanese hair fixing oil (bint-suke-abura); aromatic oils for bath; skin care oils

(cosmetic); skin care oils (non-medicated); essential oils for use in foodstuffs; essential oils of citron; aromatics [essential oil]; suntan oils for cosmetic purposes; aromatic essential oils; flavorings for beverages [essential oils]; essential oils of cedarwood; perfumery, essential oils, cosmetics, hair lotions; non-medicated oils; essential oils for the care of the skin; flavour enhancers for food (essential oils); cosmetic oils; aromatics [essential oils]; cake flavourings [essential oils]; body oil; ethereal oils; suntan oils [cosmetics]; essential oils for use in air fresheners; natural oils for cleaning purposes; sunscreen oils for protection against tanning; baby oil; bath oil; non-medicated hand oils; textile finishing oils; natural oils for cosmetic purposes; oils for toilet purposes; cake flavourings [essential oils]; oils, creams and lotions for the skin; creams for the hair; tanning creams; hair cream; pre-shave creams; cosmetic creams; polishing creams; non-medicated creams for the eyes; anti-wrinkle creams; depilatory creams; sunscreen creams (cosmetics); toning creams [cosmetic]; shaving creams; anti-freckle creams; non-medicated foot cream; baby creams (non-medicated); facial creams [cosmetic]; creams for tanning the skin; beauty masks; aromatherapy creams; non-medicated creams for the body; day creams; skin creams; washing creams; creams (non-medicated) for the skin; skin creams [non-medicated]; cream for polishing boots; face creams for cosmetic use; skin care creams, other than for medical use; hand barrier creams; cosmetic creams for skin care; skin care creams [cosmetic]; non-medicated creams; preservative creams for leather; exfoliating creams; non-medicated cream bath; non-medicated face creams; anti-cellulite creams; skin creams [cosmetic]; depilatory creams; creams for firming the skin; fragrant creams; massage creams, not medicated; under-eye enhancers; conditioning creams; dermatological creams (other than medicated); creams for wrinkles; non-medicated nourishing creams; skin cleansing cream; hand cream; creams for reducing age spots; aftershave creams; barrier creams for the skin; non-medicated cleansing creams; body creams [cosmetics]; facial cream; face creams; self-tanning creams; protective creams; self-tanning creams (cosmetics); make-up foundation creams; anti-aging creams; sunscreen creams; moisturising creams; moisturising skin creams [cosmetic]; cleansing creams; non-medicated cleansing creams for the skin; shoe cream; non-medicated scalp treatment cream; oils, creams and lotions for the skin; hair protection creams; night creams [cosmetics]; perfumes; aromatherapy creams; aromatherapy lotions; aromatherapy preparations; sachets for perfuming linen; fragrances for personal use; perfumed talcum powder; fragrance preparations; perfume body spray; aromatic oils for bath; perfumery, essential oils, cosmetics, hair lotions; perfumed tissues; scented room sprays; fragrance sachets; fragrant creams; perfumed lotions

(toilet preparations); scented water; perfumed soaps; perfume oils.

(260) AM 2016 81797 A

(800) 1242610

(891) 2014 01 31

(731) BYSTRONIC LASER AG

Industriestrasse 21, CH-3362 Niederönz,
Switzerland

(540)

BYSTRONIC

(511)

7 – Bending machines; bending presses; stamping machines; presses (machines for industrial use); straighteners; deep-drawing presses; molding machines; drills; drilling heads (parts of machines); chisels for machines; engraving machines; milling machines; hole punching machines; stamping machines; saws (machines); cutting machines; cutting machines (cutters); lathes; electric generators; coils for machines; control apparatus for machines, motors or engines; controllers (machine parts); filtering machines; filters (parts of machines, motors or engines); pumps (machines); pumps (parts of machines, motors or engines); pump diaphragms; sludge collectors (machines); vacuum pumps (machines); guides for machines; bearings (parts of machines); machine housings; machinery gears; machine stands; machine tables; machine shafts; tools (parts of machines); tool holders (parts of machines); roller bearings; chucks (parts of machines); machine bearings; gas-operated cutting torches; plasma cutting and welding machines; gas-operated welding apparatus; gas-operated welding machines; glass-working machines; machine tools for glass processing, namely for the manufacture of structural glazing and glazing and glass plates for land vehicles and aircraft; glass cutting machines; lifting platforms; lifting apparatus; elevating apparatus; loading equipment, namely for installations for transport and storage of raw materials and semi-finished and finished parts; automatic magazines; mechanical storage installations; hydraulic motors and engines; hydraulic drives for machines, motors and engines; pneumatic drives for machines, motors and engines; cylinders for machines; cylinder pistons; electric arc cutting apparatus; electric arc welding apparatus; welding apparatus (electric); welding machines (electric); automatic welding machines (electric); machinery for the textile industry; machinery for the sugar industry; machinery for making pasta; machinery for the food industry; metal processing machines; machine tools; robots (machines); machine tools for beam machining of workpieces; water jet cutting machines; laser cutting machines; laser welding machines; accessories and auxiliary equipment (machines and machine parts) for beam machining of workpieces, spare parts for these items; parts and accessories of the above

machines and tools, included in this class, in particular machine tools, handling devices; spare parts for machines.

8 – Drills; borers; mills (hand tools); pipe cutting tools; threading tools; shears; scissors (sheet metal shears); shear blades; shearing tools (hand-operated); cutting tools; grinding implements (hand tools); dies (hand tools); scraping tools; hand-operated tools; parts and accessories of hand-operated tools, included in this class.

9 – Anodes; cathodes; transformers to increase the voltage; distance measuring apparatus; range finders (telemeters); distance measuring equipment; measuring machines, measuring apparatus and instruments; frequency meters; speed indicators; length meters; goniometers; computers; computer operating programs (recorded); computer programs (recorded); computer programs (downloadable); computer software (recorded); data processing apparatus; data transmission devices; USB flash drives; electronic publications (downloadable); data input and display apparatus; screens; video projectors; monitors (computer hardware); monitors (computer programs); interfaces (interface apparatus or programs for computers); holograms; control devices for loading apparatus; numerical controls for machine tools; electronic controllers; sensors, electrical and electronic apparatus for remote control of industrial operations; transmitters and receivers for electronic signals; detectors; dosing devices; pressure gages; pressure recorders; high-frequency apparatus; lasers not for medical use, particularly for material machining, marking lasers; light guides; laser sources, not for medical use; electrical, hydraulic, pneumatic and optical adjustment devices for lasers and laser beams; beam and mirror guides, positioning components, optical fiber components, facilities for beam and process forming as well as sensors for this purpose; objectives (lenses) (optics); optical fiber cables; optical lenses; lens hoods; prisms (optics); mirrors (optics); actinometers (beam meters); logs; magnifiers (optics); microphones; barcode readers; compasses (measuring instruments).

11 – Hydraulic accumulators; ionization apparatus for the treatment of air or water; refrigeration installations and machines; refrigeration apparatus; cooling apparatus and installations; cooling apparatus and machines; cooling devices for lasers; regulating and safety accessories for gas apparatus; heat exchangers; water filtration apparatus; water cooling installations.

37 – Installation and repair of electric apparatus; installation and repair of refrigerating apparatus; installation, maintenance and repair of machines; repair of pumps; installation of machine tools and associated auxiliary equipment; maintenance work on machine tools and laser installations; repair services;

installation services to provide Internet access on machinery control systems and to provide Internet applications on machinery control systems; installation of hardware for Internet access.

40 – Information about material processing; milling; engraving; cutting; water jet cutting; laser cutting; laser engraving; metal machining; sawing; sanding; welding; water jet machining; water treatment; trimming of materials on order (for others); material processing, namely identifying and marking; rental of machines for material machining; providing information in the field of material processing, especially of machine-specific information, on the Internet and on screen.

41 – Recording of video recordings; demonstration lessons in practical exercises; on-line providing of electronic, non-downloadable publications; on-line publication of electronic books (and magazines); organization of fairs for cultural and entertainment purposes, conferences, congresses, meetings and symposiums; organization and conducting of seminars; organization and conducting of workshops (training); training in the operation and maintenance of machine tools; training in the creation of computer programs for machine tools; education and further training, in particular in the field of material processing, IT and business organization; organization of competitions; organization of exhibitions for courses; production of video films.

42 – Updating of computer software; consultancy in the field of energy saving; computer software consulting; computer system analyses; design of computer software; design of computer systems; provision of engineering services; creation of programs for data processing; preparation of technical expert reports; research in the field of technology; research in the field of mechanical engineering; hosting of Internet sites; installation of computer programs; conversion of computer programs and data (other than physical conversion); copying of computer programs; testing of materials; quality control (tests); research and development services for others regarding new products; technical project planning; rental of computer software; maintenance of computer software; water analysis; recovery of computer data; scientific laboratory services; scientific and industrial research; technical development and engineering activities; preparation of computer programming aids and tools (programming tools) and programs for machine tools; monitoring, control, maintenance of machine software via data lines (teleservice), also via the internet, in particular remote control, remote malfunction diagnosis, troubleshooting, including remote programming of machine controls for troubleshooting, maintenance and installation of machinery control software, installation of firmware updates in machine controls for troubleshooting; development, installation, maintenance, copying, co-

version, updating of computer programs and computer software including via the Internet; remote programming of machine controls; operation of on-line services in the field of machinery, namely, providing software via data lines/computer networks and providing information, namely machine-specific information on the Internet; providing machine control software on the Internet; project management and planning of telecommunication solutions in the field of machinery, particularly of telecommunication solutions for remote diagnostics of machine malfunctions as well as for machine maintenance using telecommunication technology; design and development of software for the control, regulation and monitoring of laser and water jet systems and press brakes; computer consulting, namely hardware and software consultancy; technical support relating to software, including technical project planning and technical project management; construction planning; scientific and industrial research, especially in the field of mechanical engineering; information technology services, namely project management and provision of Internet access on machine controls, as well as planning and provision of Internet applications on machine controls.

45 – Licensing of computer programs and software.

(260) AM 2016 81798 A

(800) 1242736

(891) 2015 01 15

(731) KRKA, tovarna zdravil, d.d., Novo Mesto
Šmarješka cesta 6, SI-8501 Novo mesto,
Slovenia

(540)

АТОРДАПИН

(540) АТОРДАПИН

(591) Black

(511)

5 – Pharmaceutical preparations.

(260) AM 2016 81805 A

(800) 1242630

(891) 2014 08 05

(731) Loewe, S.A.

C/ Goya, 4, E-28001 Madrid, Spain

(540)



(591) Black and white

(511)

3 – Perfumes, eau de toilette, eau de Cologne; soaps for personal use; essential oils for cosmetic use; deodorants for personal use; cosmetics, cosmetic gels and preparations for bath and shower, cosmetic

creams and lotions for hair, face and body; shampoos; shaving preparations, after-shave lotions, balms and gels.

(260) AM 2016 81806 A

(800) 1242631

(891) 2014 09 17

(731) INNJOO TECHNOLOGY CO., LTD

Room 508-509, 523B-533, No.8 Building,
Area A, Bao An Internet Industry Base,
Baoyuan Road, Bao An District, Shenzhen,
China

(540)

innjoo

(591) Black and white

(511)

9 – Keyboard cover; calculating machines; data processing apparatus; computer memory devices; computers; computer programmes [programs], recorded; computer keyboards; computer operating programs, recorded; computer peripheral devices; computer software, recorded; couplers [data processing equipment]; electronic pens [visual display units]; mouse [computer peripheral]; notebook computers; pocket calculators; computer programs [downloadable software]; mouse pads; wrist rests for use with computers; computer game software; encoded identification bracelets, magnetic; USB flash drives; laptop computers; bags adapted for laptops; sleeves for laptops; computer software applications, downloadable; tablet computers; pedometers; counters; time recording apparatus; electronic agendas; optical communication device; network communication device; radios; intercommunication apparatus; navigational instruments; video telephones; navigation apparatus for vehicles [on-board computers]; portable telephones; global positioning system [GPS] apparatus; cell phone straps; smartphones; earphones; learning machines; electronic teaching and learning machines; audio books; cabinets for loudspeakers; loudspeakers; megaphones; microphones; television apparatus; video recorders; horns for loudspeakers; camcorders; headphones; portable media players; digital photo frames; eyeglasses; chargers for electric batteries; batteries, electric; accumulators, electric.

42 – Technical research; research and development of new products for others; industrial design; packaging design; computer software design; updating of computer software; consultancy in the design and development of computer hardware; information technology [IT] consultancy; providing information on computer technology and programming via a web site; cloud computing.

(260) AM 2016 81807 A

(800) 1242636

(891) 2014 09 03

(731) GÜZEL METAL İNŞAAT MALZEMELERİ
SANAYİ VE TİCARET LİMİTED ŞİRKETİ
İkitelli Organize Sanayi Bölgesi, İsteks
Sanayi Sitesi, Sosyal Merkez Binası, Kat:2,
No:33, Başakşehir – İstanbul, Turkey

(540)



(591) Turquoise, blue and white

(511)

6 – Non-precious metal ores; common metals and their alloys and semi-manufactured products of common metals and their alloys; metal building products for sheltering, preserving, conserving, covering, warehousing (including metal ladders), metal floors, metal staircases, metal gates and fences, metal railings for fences, metal roofing, metal palings; metal products manufactured for sifting, filtering and similar purposes; namely, metal window screens, drain traps (valves) of metal; metal doors and windows, metal rolling shutters, metal jalousies, metallic door handles, metallic window handles, metal panels of doors and windows; metal cables and wires not for electrical purposes; ironmongery (hardware) articles, small items of metal hardware, namely, screws, nails, bolts, nuts, metal chains, pulley; ducts of metal for ventilating and air conditioning and heating installations, metal roof vents for residential and commercial buildings, metal vent covers for HVAC ducts, drains and pitch pans, metal chimneys, chimney cowls of metal, metal manhole covers for drains, poles of metal for electric power lines, metal gratings; signs, non-luminous and non-mechanical, of metal; signaling panels, non-luminous and non-mechanical, of metal; identity plates of metal; metal pipes for liquid or gas transfer and their connection parts (including valves of metal, drilling pipes of metal); metal cash boxes; materials of metal for railway construction; metal bollards, metal mooring buoys, anchors for sea vehicles; metallic moulds for metal casting; works of art made of common metals and their alloys; metal bottle caps; poles of metal; metal pallets, metal ropes for lifting, loading and transportation, metal wires, cords, columns, strips, bands and tapes for use in lifting and carrying loads; metal mounting brackets for vehicle tyres.

9 – Measurement apparatus, equipment and indicators including those for scientific and laboratory use, laboratory equipment and apparatus; apparatus for recording, transmission or reproduction of sound or images; data processing apparatus, telecommunication apparatus, sound or image reproducing apparatus.

tus, computer peripheral devices; magnetic and optic data carriers and computer software and programmes recorded thereto, downloadable and recordable electronic publications, encoded magnetic and optic cards; antennas, satellite antennas, amplifiers for antennas, parts of the aforementioned goods; ticket dispensers, automatic teller machines (ATM); electronic components used in the electronic parts of machines and apparatus; counters and quantity indicators for measuring the quantity of consumption, automatic time switches; clothing for protection against accidents, irradiation and fire, safety vests and life-saving apparatus and equipment; eyeglasses, sunglasses, optical lenses and cases, containers, parts and components thereof; apparatus and instruments for conducting, transforming, accumulating or controlling electricity; electric cables and electrical power supplies, batteries, electric accumulators; alarms and anti-theft alarms, other than for vehicles, electric bells; signalling apparatus and instruments, luminous or mechanical signs for traffic use; fire extinguishing apparatus, fire engines, fire hose and fire hose nozzles; radar apparatus, sonars, night vision apparatus and instruments; decorative magnets.

11 – Lighting installations; lights for vehicles and interior-exterior spaces; heating and steam generating installations; stoves for heating purposes using solid, liquid or gas fuels; electric stoves for heating purposes; kitchen stoves; installations for air-conditioning and ventilating; cooling installations and freezers; electric and gas-powered devices, installations and apparatus for cooking, drying and boiling; electric laundry driers; hair driers; hand drying apparatus; sanitary installations; taps (faucets); shower installations; toilets (water-closets); shower and bathing cubicles; bath tubs; sinks; wash-hand basins (parts of sanitary installations); water softening apparatus; water purification apparatus; water purification installations; waste water purification installations; electric bed warmers and electric blankets, not for medical use; electric pillow warmers; electric or non-electric footwarmers; hot water bottles; filters for aquariums and aquarium filtration apparatus; industrial type installations for cooking, drying and cooling purposes; pasteurizers and sterilizers.

20 – Furniture, made of any kind of material; mattresses, pillows, air mattresses and cushions, not for medical purposes, sleeping bags for camping, water beds, not for medical purposes; mirrors; beehives, artificial honeycombs and sections of wood for honeycombs; bouncing chairs for babies, playpens for babies, cradles, infant walkers; display boards, frames for pictures and paintings, identification plates, identification tags, nameplates, identification labels made of wood or synthetic materials; packaging containers of wood or plastics, casks for use in transportation or storage, barrels, storage drums, tanks, boxes, storage containers, transportation containers,

chests, loading pallets and closures for the aforementioned goods, of wood or plastics; small hardware goods of wood or synthetic materials included in this class, furniture fittings, of wood or synthetic materials, opening and closing mechanisms of wood or synthetic materials; ornaments and decorative goods of wood, wax, beeswax, plastic or plaster bone, ivory or plaster, included in this class; baskets, fishing baskets; kennels, nesting boxes and beds for household pets; portable ladders and mobile boarding stairs of wood or synthetic materials; bamboo curtains, roller indoor blinds, slatted indoor blinds, trip curtains, bead curtains for decoration, curtain hooks, curtain rings, curtain tie-backs, curtain rods.

(260) AM 2016 81809 A

(800) 1242657

(891) 2014 09 30

(731) DAPSAN AŞANSÖR SANAYİ VE
TİCARET LİMİTED ŞİRKETİ

Atatürk Caddesi, Soner Apartmanı Altı,
No:116, Antakya Hatay, Turkey

(540)



Skyelevator

(591) Black, white, green, Blue

(511)

7 – Machines, machine tools and industrial robots for processing and shaping wood, metals, glass, plastics and minerals; construction machines and robotic mechanisms (machines) for use in construction, namely, glass, stone, leather or metal working machines; wood working machines; lifting, loading and transmission machines and robotic mechanisms (machines) for lifting, loading and transmission purposes; lifting and mechanical hoisting apparatus, namely, moving pavements (sidewalks), elevating platforms, lifts, cranes, hoists, belt conveyors; elevators and parts thereof, elevator belts, elevator chains being parts of machines, elevator doors, elevator gears, elevator motors; machines and robotic mechanisms (machines) for use in agriculture and animal breeding, machines and robotic mechanisms (machines) for processing cereals, fruits, vegetables and food; engines and motors, other than for land vehicles, parts and fittings therefor; parts of land vehicle motors and engines, included in this class, namely, air compressors for vehicles; bearings (parts of machines), roller or ball bearings, machines for mounting and detaching tires; alternators, current generators, electric generators, current generators operated with solar energy; painting machines, automatic spray guns for paint, electric, hydraulic and pneumatic punching machines and guns, electric adhesive tape dispensers (machines), electric guns for compressed gas or liquid spraying machines, el-

electric hand drills, electric hand saws, electric jigsaw machines, spiral machines, compressed air machines, compressors (machines), vehicle washing installations, robotic mechanisms (machines) with the abovementioned functions; electric and gas-operated welding apparatus, electric arc welding apparatus, electric soldering apparatus, electric arc cutting apparatus, electrodes for welding machines, industrial robots (machines) with the abovementioned functions; printing machines and apparatus; packaging machines, filling, plugging and sealing machines, bottling and capping machines, industrial printing machines, labelers (machines), sorting machines, industrial robots (machines) with the abovementioned functions, machine tools for forming, riveting and swaging of metal and plastics, electric packing machines for plugging and sealing of plastics; machines for textile processing, sewing machines, electric clothing pressing machines, industrial robots (machines) with the abovementioned functions; pumps other than parts of machines or engines, fuel dispensing pumps for service stations, self-regulating fuel pumps; electric kitchen machines for chopping, grinding, crushing, mixing and mincing foodstuff, washing machines, laundry washing machines, dishwashers, spin driers (not heated), electric cleaning machines for cleaning floors, carpets or floorings, vacuum cleaners and parts thereof; automatic vending machines; galvanizing and electroplating machines; electric door openers and closers.

(260) AM 2016 81811 A
(800) 1242715
(891) 2015 01 28
(731) Bitfury Group Limited, c/o Harneys Services (Cayman) Limited
4th Floor, Harbour Place, 103 South Church Street, PO Box 10240, KY1-1002 George Town, Cayman Islands
(540)

BITFURY

(511)
9 – Computers; computer servers; computer peripheral devices; computer hardware; silicon chips; microchips; microprocessors; microchip sets; computer chip boards; printed circuit boards; semiconductors for use in computers; software; firmware; computer applications; computer programs; data processors; downloadable software; downloadable computer applications; downloadable electronic publications; data storage media; computer drives; telecommunications equipment.

35 – Business services for the management and operation of data centres; data processing; data transcription; automated data processing; collection of data.

36 – Financial services; facilitation of financial transactions using unconventional currency systems and bartering; facilitation of cryptocurrency transactions.

42 – Computer design and research; microchip design and research; microprocessor design and research; design and research into semiconducting and superconducting materials; design and research into semiconductor topography; software and firmware design and development; leasing and rental of computers, computer servers, virtual computer data storage, software and firmware; scientific and technical research into computers; electronic storage of data; computer networking services for the operation of data centres; computer technical support services for the operation of data centres; data encryption and decryption; data coding and decoding; encryption, decryption, and authentication of information, data and messages; data mining; software as a service [SaaS]; cloud computing services.

(260) AM 2016 81817 A
(800) 928475
(891) 2015 03 16
(731) APPLE INC.
1 Infinite Loop Cupertino, CA 95014, USA
(540)

APPLE TV

(511)
9 – Computer hardware; computer networking hardware; set top boxes; digital electronic devices for recording, organizing, transmitting, receiving, manipulating, playing and reviewing text, data, image, audio and video files; computer software for use in organizing, transmitting, receiving, manipulating, playing and reviewing text, data, image, audio, and video files; computer hardware and computer software for the reproduction, processing and streaming of audio, video and multimedia content; computer hardware and software for controlling the operation of audio and video devices and for viewing, searching and/or playing audio, video, television, movies, photographs and other digital images, and other multimedia content.

(260) AM 2016 81818 A
(800) 949281
(891) 2015 02 02
(731) BOUCHERON HOLDING
26 Place Vendôme, F-75001 PARIS, France
(540)

BOUCHERON

(511)
3 – Perfumes, toilet water, eau de Cologne, deodorants for personal use (perfumery), essential oils, oils for cosmetic use, oils for toilet purposes, soaps, toiletries and toiletry milks, cosmetics, make-up and

make-up removing products, cosmetic products and preparations for skin and hair care, for slimming, for bathing, for sun-tanning; beauty masks; hair lotions, cosmetic sets; cosmetic creams; incense, incense sticks, after-shave lotions; shaving products; nail polish (varnish); shampoos.

14 – Jewelry and precious stones; goods made of precious metals or coated therewith, namely: rings, bracelets, necklaces (jewelry), earrings, brooches (jewelry), pendants (jewelry), medals; cuff links, tie pins; key rings [trinkets or fobs]; caskets; jewelry cases [caskets]; timepieces and chronometric instruments; watches, wristwatches, clocks, wall clocks, chronometers, chronographs (watches), watch cases, movements for timepieces, watch straps, watch chains, watch glasses, presentation cases for timepieces, cases for timepieces; statues and statuettes of precious metal.

(260) AM 2016 81819 A

(800) 1072011

(891) 2015 03 18

(731) HOSPIRA, INC.

Dept. NLEG, Bldg. H-1 275 North Field
Drive, Lake Forest IL 60045, USA

(540)

RETACRIT

(591) Black, white

(511)

5 – Pharmaceutical drug for the treatment of anemia.

(260) AM 2016 81821 A

(800) 1242766

(891) 2015 03 13

(731) JANSSEN PHARMACEUTICA NV

Turnhoutseweg 30, B-2340 Beers, Belgium

(540)

XEPLION TRELAY

(511)

5 – Human pharmaceutical preparations.

(260) AM 2016 81822 A

(800) 1242772

(891) 2014 12 15

(731) WORLD MEDICINE İLAÇ SANAYİ VE

TİCARET ANONİM ŞİRKETİ

Evren Mah. Camiyolu Cad. No.50, Kat 1 B

Zemin 4-5-6 Güneşli / Bağcılar / İstanbul,

Turkey

(540)

FLUTEL

ФЛУТЕЛ

(591) Black

(511)

5 – Medicines for human purposes, medicines for veterinary purposes, vitamin preparations, chemical preparations for medical purposes, dietetic substances adapted for medical use; dietetic foods adapted for medical purposes; baby foods, medicinal herbs, herbal beverages adapted for medical purposes, nutritional supplements, pollen dietary supplements, mineral food supplements, protein dietary supplements; dietary supplements for animals; fodder supplements for veterinary purposes; medicines for dental purposes, hygienic products for medical purposes including sanitary pads, breast-nursing pads and bunion pads, waddings for medical purposes, plasters for medical purposes, dressings for medical purposes, babies' napkins, preparations for destroying noxious plants, preparations for destroying noxious animals, fungicides, deodorants other than for human beings or for animals, air deodorising preparations, disinfectants for hygiene purposes, antiseptics, detergents for medical purposes.

(260) AM 2016 81823 A

(800) 1242828

(891) 2014 11 03

(731) AB Lindec

P.O. Box 5, SE-421 21 Västra Frölunda,
Sweden

(540)

LITHURIN

(511)

37 – Building, construction and demolition; rental of tools, plant and equipment for construction and demolition; building construction; building construction supervision; custom building construction; building construction services; construction of buildings; supervision of building construction; building and construction services; underwater building and construction; building construction and repair; construction supervision of buildings; custom construction of buildings; consultation in building construction supervision; residential and commercial building construction; rental of building construction machinery; construction of parts of buildings; supervision during construction of buildings; insulation of buildings during construction; construction of foundations for buildings; sealing of buildings during construction; waterproofing of buildings during construction; sealing of buildings during construction; building inspection [in the course of building construction]; advisory services relating to building construction; fire proofing of buildings during construction; construction of steel structures for buildings; services for the construction of buildings; damp-proofing of buildings during construction; advisory services relating to the construction of buildings; information services relating to the construction of buildings;

services for the damp proofing of buildings during construction; on site project management relating to the construction of buildings; rental of apparatus for use in the construction of buildings; maintenance and repair of flooring.

40 – Metal treatment; electrochemical treatment; burnishing by abrasion; burnishing services; damp-proofing to existing buildings.

42 – Scientific research; scientific consultancy; scientific research; scientific advisory services; scientific testing services; scientific laboratory services; scientific research services; provision of surveys [scientific]; scientific and industrial research; scientific and technological services; rental of scientific equipment; leasing of scientific instruments; scientific research relating to ecology; scientific research relating to chemistry; preparation of scientific reports; issuing of scientific information; provision of scientific information; technological planning services; technological consultation services; technological advisory services; technological analysis services; safety technological testing services; consultancy services relating to technological research; advisory services relating to technological research; technological services and research relating thereto; services for the provision of technological information; technological advisory services relating to machine engineering analysis.

(260) AM 2016 81829 A

(800) 1242882

(891) 2015 02 10

(731) BIOFARMA

50 rue Carnot, F-92284 SURESNES CEDEX,
France

(540)

PIXOREL

(511)

5 – Pharmaceutical and veterinary products; sanitary products for medical purposes; dietetic food and substances for medical or veterinary use, food for babies; food supplements for humans and animals; plasters, materials for dressings; material for dental fillings and dental impressions; disinfectants; products for destroying vermin; fungicides, herbicides.

(260) AM 2016 81830 A

(800) 1242893

(891) 2015 03 13

(731) JANSSEN PHARMACEUTICA NV

Turnhoutseweg 30, B-2340 Beerse, Belgium

(540)

XEPLION TREVICTA

(511)

5 – Human pharmaceutical preparations.

(260) AM 2016 81833 A

(800) 1080874

(891) 2015 03 09

(731) VIBER MEDIA S.À R.L.

2, rue du Fossé, L-1536 Luxembourg,
Luxembourg

(540)

VIBER

(591) Black, white

(511)

38 – Internet and peer-to-peer computer services, namely, electronic transmission of audio, video and other data and documents among computers, electronic transmission of data and documents over computer terminals and instant messaging services; communications by means of or aided by computer, namely, transmission of voice, data, graphics, images, audio and video by means of telecommunications networks, wireless communication networks, and the Internet; transmission of audio, video, images, text and other data by means of a communications network; communication services, namely, providing electronic transmission of information and data; electronic, electric and digital transmission of voice, data, images, signals and messages; Telecommunications and information technology services, namely, transmission of voice, data, images, audio, video and information via telephone and global communication networks; wireless telecommunications services, namely, the wireless transmission of voice and data; telecommunications services, namely, providing voice over Internet protocol services; telecommunications services, namely, providing network access point for third party users; telecommunications services, namely, providing voice over Internet protocol services; providing network access point services for the exchange of Internet traffic among Internet traffic carriers; telecommunication services, namely, transmission of voice, data, graphics, images, audio and video by means of telecommunications networks, wireless communication networks, and the Internet; telecommunications services, namely, electronic transmission of data, messages and information; computer aided transmission of messages and images; electronic messaging services, namely, sending, receiving and forwarding messages in the form of text, audio, images or video; provision and operation of electronic conferencing, discussion groups and chat rooms via the Internet; Internet and video-conference services; conference services, namely, conferences across a computer network; instant messaging services; streaming of audio-visual material on the Internet; providing on-line electronic bulletin boards and forums for transmission of messages among computer users; electronic transmission of messages and data; electronic messaging services, namely, simple message service (SMS) and multimedia message service (MMS) via telecommunications and computer networks; communication servi-

ces, namely, computer transmission of information, messaging, VOIP, video calling and conferencing accessed by means of an access number; communications services through the use of subscriber identity module (SIM) cards, namely, computer transmission of information, VOIP, messaging, video calling and conferencing; personal communications services; telecommunication services, namely, transmission of data and information via pagers; electronic mail services; providing multiple user interactive access to a global communications network; transmission and broadcast of audio and video programming of all types via telephone, television, and global communications networks; video and audio teleconferencing via the Internet, asynchronous transfer mode services, Integrated Service Digital Network (ISDN) services, Internet Protocol (IP) communications services, namely, VOIP, IPTV services; communication services, namely, Virtual Private Network (VPN) services and private telephone line services; switched voice, data, video and multimedia services, namely, computer transmission of information, VOIP, messaging, video calling and conferencing; providing facsimile transmission services; voice mail services; telecommunications services, namely, providing toll free telephone services and call routing services; messaging center services in the nature of telephone voice messaging services; video, audio and data telephone conference services; electronic messaging services; telecommunication services, namely, cellular telephone services; providing multiple-user access to a communications network; on-line forums for transmission of messages among computer users concerning software development; online chat rooms and electronic bulletin boards for registered users for transmission of messages concerning collegiate life, general interest, classifieds, virtual community, social networking, photo sharing, and transmission of photographic images; provision of on-line forums for the transmission of photographic images; provision of on-line forums for transmission of messages on topics of general interest; providing access to computer, electronic and online databases; providing online forums for transmission of messages on topics of general interest; providing online communications links which transfer web site users to other local and global web pages; providing internet access to web sites for others hosted on computer servers accessible via a global computer network; providing internet access to third party web sites by enabling users to log in through a universal username and password via a global computer network and other communication networks; providing online chat rooms and electronic bulletin boards for transmission of messages among users in the field of general interest; audio, text and video broadcasting services over the Internet or other communications networks featuring the uploaded, posted and tagged

audio, text and video content of others; audio, text and video broadcasting services over the Internet or other communications networks, namely, electronically transmitting audio clips, text and video clips of others; providing access to computer databases in the fields of social networking.

(260) AM 2016 81834 A

(800) 1084263

(891) 2015 03 27

(731) HANGZHOU YONGDIAN

ILLUMINATION CO., LTD

No.650 Wangmei Road, Linping Street,

Yuhang District, Hangzhou City, China

(540)

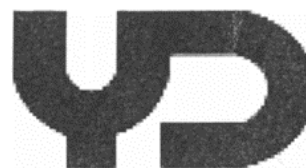

(591) Black, white

(511)

11 – Lighting apparatus and installations; light bulbs; incandescent burners; ceiling lights; lamp casings; luminous tubes for lighting; street lamps; aquarium lights; light diffusers; lighting protection device.

(260) AM 2016 81839 A

(800) 1123206

(891) 2015 02 23

(731) MOGENS JEPSEN HOLDING ApS

Baltikavej 20, 1 DK-2150 Nordhavn,

Denmark

(540)

MOLO

(511)

25 – Children clothing, children footwear, children headgear.

35 – Retail services in connection with clothing, clothing for children, footwear, headgear.

(260) AM 2016 81841 A

(800) 1178649

(891) 2015 02 17

(731) ZHEBROVSKA FILYA

6, vul. Starytskoho Kyiv 04078, Ukraine

(540)

БЕТАСПАН

(591) Black, white

(511)

5 – Pharmaceutical preparations; medicines for human purposes.

(260) AM 2016 81843 A
 (800) 1183702
 (891) 2015 02 17
 (731) ZHEBROVSKA FILYA
 6, vul. Starytskoho, Kyiv 04078, Ukraine
 (540)

ЛИЗАК

(511)
 5 – Pharmaceutical preparations; medicines for human purposes.

(260) AM 2016 81844 A
 (800) 1184373
 (891) 2015 04 01
 (731) JOE & THE JUICE A/S
 Grønnegade 10, 1., DK-1107 Copenhagen,
 Denmark
 (540)



(591) Black, white
 (511)
 30 – Coffee, tea, cocoa, sugar, rice, tapioca, sago, artificial coffee, flour and preparations made from cereals, bread, pastry and confectionery, ices, honey, treacle, yeast, baking-powder, salt, mustard, vinegar, sauces (condiments), spices, ice.
 32 – Beers; mineral and aerated waters and other non-alcoholic drinks, fruit drinks and fruit juices, syrups and other preparations for making beverages.
 43 – Services for providing food and drink; temporary accommodation.

(260) AM 2016 81845 A
 (800) 1236955
 (891) 2015 02 26
 (731) SUMITOMO RUBBER INDUSTRIES, LTD.
 6-9, Wakinohama-cho 3-chome, Chuo-ku,
 Kobe-shi, Hyogo 651-0072, Japan
 (540)

ESP I A

(591) Black, white
 (511)
 12 – Automobile tires [tyres]; tires for two-wheeled motor vehicles.

(260) AM 2016 81849 A
 (800) 1242929
 (891) 2015 01 12
 (731) VIONNET S.p.A.
 CORSO MONTFORTE 16, I-20121 MILAN,
 Italy

(540)



(591) Black and White
 (511)
 3 – Soaps; perfumes, eaux de parfum, eaux de toilette, deodorant, after-shave lotion, shaving foam; mascara, lipstick, lip gloss; face cream, body cream, moisturizing body lotion, body oil, toiletry milk for the body; hair lotions, hair creams, hair moisturizers, hair spray, shampoo, dry shampoos; make-up removing lotions, make-up removing products; face lotions, face moisturizing cream; dentifrices; nail polish, eyeliner pencils, eye liners, make-up foundation, make-up powder; depilatories.

14 – Jewelry, jewelry articles, namely rings, necklaces, earrings, bracelets, tiara, bracelets, charms [jewelry], brooches [jewelry], chains [jewelry], tie pins, ornamental pins, paste jewelry; precious stones; timepieces and chronometric instruments namely watches, watch straps, wristwatches; cuff links; key rings [trinkets or fobs].

18 – Leather and imitations of leather, products made of leather, namely briefcases [leather goods], document portfolios, school bags, traveling bags, traveling sets, card cases, wallets, key cases, handbags, spectacle cases; trunks and suitcases; umbrellas, parasols and walking sticks; furs [animal skins]; whips, harness and saddlery.

25 – Belts, gloves (clothing); clothing, namely socks, shirts, suits, neckties, sashes for wear, scarves, bathing suits, waterproof coats, skirts, coats, trousers, pullovers, pajamas, t-shirts, sweatshirts, jackets, blousons, stockings, tights, shorts, underpants, tank tops, suspenders, overalls, cardigans, parkas, dressing gowns, underwear, bras; footwear (except orthopedic footwear), namely shoes, moccasins, sandals, pumps, boots, bedroom slippers, slippers, half-boots; headgear, namely caps, knitted caps, hats, headbands, berets.

35 – Retail sale services for soaps, scented candles, perfumes, eaux de parfum, toilet water, deodorants, dentifrices, after-shave lotion, shaving foam, lipstick, lip brighteners, face cream, body cream, moisturizing body lotion, body oil, toiletry milk for the body, soaps, hair lotions, creams for the hair, hair moisturizers, hair spray, shampoos, dry shampoos, make-up removing lotions, make-up removing products, face lotions, moisturizing face cream, nail polish, eye pencils, eyeliners, facial foundation, make-up powder, depilatories, spectacles, eyeglasses, sunglasses, spectacle cases, protective cases for mobile telephones or digital tablets, goods made of

leather namely briefcases [leather goods], document holders, school bags, travel bags, traveling sets, card holders, wallets, key cases, handbags, purses [coin purses], trunks and suitcases, umbrellas, parasols and walking sticks, combs for the hair, animal skins, whips, harness and saddlery, belts [clothing], gloves [clothing], clothing, namely socks, shirts, suits, neckties, sashes for wear, scarves, bathing suits, water-proof coats, skirts, coats, trousers, pullovers, pajamas, tee-shirts, sweatshirts, jackets, blouses, stockings, tights, shorts, tank tops, suspenders, briefs, blouse, cardigans, parkas, dressing gowns, underwear [lingerie], bras, footwear [excluding orthopedic footwear], namely shoes, moccasins, sandals, pumps, boots, bedroom slippers, slippers, half-boots, headgear for wear, namely caps, head coverings, hats, headbands, berets, shoe laces; services provided by a franchiser, namely assistance in the operation or management of retail stores for ready-made clothing; assistance in the operation or management of a commercial company within a network of shops, within a network of points of sale for goods in the field of ready-made clothing; commercial administration of licenses for goods and services of others in the field of ready-made clothing.

(260) AM 2016 81854 A
(800) 1243060
(891) 2014 10 24
(731) HUAWEI TECHNOLOGIES CO., LTD.
Administration Building, Huawei
Technologies Co., Ltd., Bantian, Longgang
District, Shenzhen, China

(540)

Groufie

(591) Black and White
(511)
9 – Computer software applications, downloadable; smart mobile phones; tablet computers; network communication apparatus; computer peripheral devices.

(260) AM 2016 81855 A
(800) 1243103
(891) 2015 02 02
(731) Open-Type Joint Stock Company
"CONFECTIONARY CONCERN
BABAEVSKY"
ul. Malaya Krasnoselskaya, d. 7, RU-107140
Moscow, Russian Federation

(540)

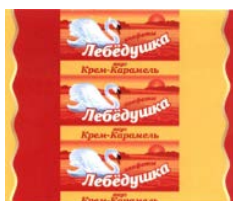

(591) Yellow, light yellow, dark yellow, red, dark red, orange, white, black and grey

(511)

30 – Confectionery made of sugar, namely, sweets.

(260) AM 2016 81856 A
(800) 1243104
(891) 2015 01 29
(731) POLICHEM S.A.
Val Fleuri 50, L-1526 Luxembourg,
Luxembourg

(540)

BELIAC

(511)

3 – Cosmetic preparations, in particular cosmetic preparations for skin care.

5 – Pharmaceutical preparations for skin care; medicinal preparations for skin.

(260) AM 2016 81858 A
(800) 1243164
(891) 2014 12 30
(731) SER DAYANIKLI TUKETIM MALLARI IC
VE DIS TICARET SANAYI ANONIM
SIRKETI
Evren Mah. Bahar Caddesi Polat Is Merkezi,
A Blok K:4 No:9 Günesli Bagcilar,
ISTANBUL, Turkey

(540)



(591) Blue

(511)

11 – Apparatus for lighting, heating, steam generating, cooking, refrigerating, drying, ventilating, water supply and sanitary purposes.

(260) AM 2016 81859 A
(800) 1243165
(891) 2014 12 30
(731) SER DAYANIKLI TUKETIM MALLARI IC
VE DIS TICARET SANAYI ANONIM
SIRKETI
Evren Mah. Bahar Caddesi Polat Is Merkezi,
A Blok K:4 No:9 Günesli Bagcilar,
ISTANBUL, Turkey

(540)



(591) Red

(511)
11 – Apparatus for lighting, heating, steam generating, cooking, refrigerating, drying, ventilating, water supply and sanitary purposes.

(260) AM 2016 81869 A
(800) 1243191
(891) 2015 03 05
(731) BRUPHARMEXPORT SPRL
Rue de la Grotte 14, B-1020 Bruxelles,
Belgium

(540)
FOODSUP SBcaps

(511)
5 – Pharmaceutical and veterinary products; sanitary products for medical purposes; dietetic food and substances for medical or veterinary use, food for babies; food supplements for humans and animals; plasters, materials for dressings; material for dental fillings and dental impressions; disinfectants; products for destroying vermin; fungicides, herbicides.

(260) AM 2016 81870 A
(800) 1243192
(891) 2015 03 05
(731) BRUPHARMEXPORT SPRL
Rue de la Grotte 14, B-1020 Bruxelles,
Belgium

(540)
FOODSUP SBstick

(511)
5 – Pharmaceutical and veterinary products; sanitary products for medical purposes; dietetic food and substances for medical or veterinary use, food for babies; food supplements for humans and animals; plasters, materials for dressings; material for dental fillings and dental impressions; disinfectants; products for destroying vermin; fungicides, herbicides.

(260) AM 2016 81871 A
(800) 1243193
(891) 2015 03 05
(731) BRUPHARMEXPORT SPRL
Rue de la Grotte 14, B-1020 Bruxelles,
Belgium

(540)
FOODSUP IMUcaps

(511)
5 – Pharmaceutical and veterinary products; sanitary products for medical purposes; dietetic food and substances for medical or veterinary use, food for babies; food supplements for humans and animals; plasters, materials for dressings; material for dental fillings and dental impressions; disinfectants; pro-

ducts for destroying vermin; fungicides, herbicides.

(260) AM 2016 81872 A
(800) 1243194
(891) 2015 03 05

(731) BRUPHARMEXPORT SPRL
Rue de la Grotte 14, B-1020 Bruxelles,
Belgium

(540)
FOODSUP IMUstick

(511)
5 – Pharmaceutical and veterinary products; sanitary products for medical purposes; dietetic food and substances for medical or veterinary use, food for babies; food supplements for humans and animals; plasters, materials for dressings; material for dental fillings and dental impressions; disinfectants; products for destroying vermin; fungicides, herbicides.

(260) AM 2016 81873 A
(800) 1243195
(891) 2015 03 05
(731) BRUPHARMEXPORT SPRL
Rue de la Grotte 14, B-1020 Bruxelles,
Belgium

(540)
FOODSUP Sstick

(511)
5 – Pharmaceutical and veterinary products; sanitary products for medical purposes; dietetic food and substances for medical or veterinary use, food for babies; food supplements for humans and animals; plasters, materials for dressings; material for dental fillings and dental impressions; disinfectants; products for destroying vermin; fungicides, herbicides.

(260) AM 2016 81875 A
(800) 1243196
(891) 2015 03 05
(731) BRUPHARMEXPORT SPRL
Rue de la Grotte 14, B-1020 Bruxelles,
Belgium

(540)
FOODSUP Gtabs

(511)
5 – Pharmaceutical and veterinary products; sanitary products for medical purposes; dietetic food and substances for medical or veterinary use, food for babies; food supplements for humans and animals; plasters, materials for dressings; material for dental fillings and dental impressions; disinfectants; products for destroying vermin; fungicides, herbicides.

(260) AM 2016 81877 A
 (800) 1243197
 (891) 2015 03 05
 (731) BRUPHARMEXPORT SPRL
 Rue de la Grotte 14, B-1020 Bruxelles,
 Belgium

(540)
FOODSUP Gstick

(511)
 5 – Pharmaceutical and veterinary products; sanitary products for medical purposes; dietetic food and substances for medical or veterinary use, food for babies; food supplements for humans and animals; plasters, materials for dressings; material for dental fillings and dental impressions; disinfectants; products for destroying vermin; fungicides, herbicides.

(260) AM 2016 81948 A
 (800) 1244792
 (891) 2014 10 17
 (731) BOOM MAKİNA TİCARET VE SANAYİ
 LİMİTED ŞİRKETİ
 İMES Sanayi Sitesi A, Blok 109. Sk. No.9/B,
 Y. Dudullu Ümraniye, İstanbul, Turkey

(540)



(591) Black, white, yellow
 (511)

7 – Construction machines, bulldozers, diggers (machines), excavators, road making machines, drilling machines, rock drilling machines, loaders (earth moving machines), cranes, road sweeping machines; compressors (machines); presses (machines for industrial purposes), grinding machines; crushing machines; rammers (machines), rolling mills, rolling mill cylinders, mixing machines, molding machines, garbage disposals, casting machines, milling machines and millstones; hydrophores, water pumps (electrical, motor pumps), concrete pumps, concrete plants, concrete mixers, concrete compression machines.

(260) AM 2016 81949 A
 (800) 1244052
 (891) 2015 01 15
 (731) SİM-ART TEKSTİL SANAYİ TİCARET
 LİMİTED ŞİRKETİ
 Mezarlık üstü cad. No:20, Firuzköy - Avcılar
 İstanbul, Turkey

(540)



(591) Brown

(526) "®"

(511)

10 – Corsets for medical purposes.

25 – Clothing; underwear; girdles; yoga pants; thermal clothing; thermal underwear.

(260) AM 2016 81950 A

(800) 1244841

(891) 2014 12 17

(731) WIZZ Air Hungary Kft.

BUD Nemzetközi Repulotér, (BUD
 International Airport) 221. ép., H-1185
 Budapest, Hungary

(540)



(591) Blue, purple, pink

(511)

12 – Vehicles; apparatus for locomotion by land, air or water; adhesive rubber patches for repairing inner tubes; aerial conveyors; aeronautical apparatus, machines and appliances; aeroplanes; air balloons; air vehicles; air pumps; air bags; air cushion vehicles; aircraft; ambulances; amphibious airplanes; anti-dazzle devices for vehicles, anti-glare devices for vehicles; anti-skid chains; anti-theft devices for vehicles; anti-theft alarms for vehicles; audible warning systems for cycles; automobile tires; automobile chassis; automobile bodies; automobile hoods; automobile chains; axle journals; axles for vehicles; balance weights for vehicle wheels; bands for wheel hubs; barges; baskets adapted for cycles; bicycle tires; bicycle stands; bicycle saddles; bicycle bells; bicycles; boat hooks; boats; bodies for vehicles; bogies for railway cars; brake pads for automobiles; brake shoes for vehicles; brake linings for vehicles; brake segments for vehicles; brake discs for vehicles; brakes for bicycles; brakes for vehicles; buffers for railway rolling stock; bumpers for automobiles; cable transport apparatus and installations; caissons; camping cars, motor homes; caps for vehicle petrol tanks; caravans; carriages; cars for cable transport installations; carts; casings for pneumatic tires; casters for trolleys; casting carriages, casting cars, ladle carriages, ladle cars; chains for bicycles, cycles; chairlifts; cigar lighters for automobiles; hydraulic circuits for vehicles; cleaning trolleys; cleats; clutches for land vehicles; concrete mixing vehicles; connecting rods for land vehicles, other than parts of mo-

tors and engines; couplings for land vehicles; covers for baby carriages, fitted perambulator covers, pushchair covers, stroller covers; covers for vehicle steering wheels; crankcases for land vehicle components, other than for engines; cranks for cycles; cycle cars; cycle stands; cycle mudguards; cycle hubs; cycle bells; davits for boats; delivery tricycles; dining cars; dinner wagons; direction signals for vehicles; direction indicators for bicycles; dirigible balloons, airships; disengaging gear for boats; doors for vehicles; dredgers; dress guards for bicycles, cycles; driving motors for land vehicles; driving chains for land vehicles; ejector seats for aircraft; engines for land vehicles; fenders for ships; ferry boats; flanges for railway wheel tires; frames for bicycles, cycles; freewheels for land vehicles; funiculars; funnels for ships; funnels for locomotives; gear boxes for land vehicles; gearing for land vehicles; gears for cycles; golf carts; handle bars for bicycles, cycles; handling carts; head-rests for vehicle seats; headlight wipers; hoods for vehicles; hoods for vehicle engines; horns for vehicles; hose carts; hub caps; hubs for vehicle wheels; hydroplanes; inclined ways for boats; jet engines for land vehicles; kick sledges; launches; lifting cars, fork lift trucks; locomotives; lorries, trucks; luggage carriers for vehicles; luggage nets for vehicles; masts for boats; military vehicles for transport; mine cart wheels; mopeds; motor cars, automobiles, cars; motor buses; motor coaches; motorcycles; motors for cycles; motors, electric, for land vehicles; mudguards; non-skid devices for vehicle tires; oars; omnibuses; paddles for canoes; panniers adapted for cycles; parachutes; pedals for cycles; pontoons; portholes; propulsion mechanisms for land vehicles; pumps for bicycles, cycles; pushchair hoods, hoods for baby carriages; pushchairs, baby carriages, prams, strollers; railway couplings; rearview mirrors; reduction gears for land vehicles; refrigerated wagons; refrigerated vehicles; remote control vehicles, other than toys; repair outfits for inner tubes; reversing alarms for vehicles; rims for vehicle wheels; rims for wheels of bicycles, cycles; rolling stock for funicular railways; rolling stock for railways; rowlocks, oarlocks; rudders; saddle covers for bicycles or motorcycles; saddlebags adapted for bicycles; saddles for bicycles, cycles or motorcycles; safety belts for vehicle seats; safety seats for children, for vehicles; scooters; screw-propellers; screw-propellers for boats; screws for ships; sculls, stern oars; seaplanes; seat covers for vehicles; security harness for vehicle seats; ships; ships' hulls; shock absorbers for automobiles; shock absorbing springs for vehicles; shopping trolleys; side cars; ski carriers for cars; ski lifts; sleeping cars; sleeping berths for vehicles; sleighs; snowmobiles; space vehicles; spare wheel covers, spare tire covers; spars for ships; spikes for tires, studs for tires; spoilers for vehicles; spoke clips for wheels; spokes for bicycles, cycles; sports cars; sprinkling trucks; stee-

ring gears for ships; steering wheels for vehicles; sun-blinds adapted for automobiles; suspension shock absorbers for vehicles; tailboard lifts, elevating tailgates, power tailgates; telfer railways, cable cars; tilt trucks; tilting-carts; timbers for ships; tipping bodies for lorries; tipping apparatus, parts of trucks and wagons; pneumatic tires, tires, solid, for vehicle wheels; torque converters for land vehicles; torsion bars for vehicles; traction engines; tractors; trailer hitches for vehicles; trailers; tramcars; transmission chains for land vehicles; transmission shafts for land vehicles; transmissions, for land vehicles; treads for vehicles; treads for retreading tires; tricycles; trolleys, hand cars; tubeless tires for bicycles, cycles; inner tubes for pneumatic tires; inner tubes for bicycles, cycles; turbines for land vehicles; two-wheeled trolleys, luggage trucks, sack-barrows; tires for vehicle wheels; undercarriages for vehicles; upholstery for vehicles; valves for vehicle tires; vans; vehicle wheels; vehicle wheel tires; vehicle wheel spokes; vehicle running boards; vehicle chassis; vehicle covers; vehicle bumpers; vehicle seats; vehicle suspension springs; electric vehicles; vehicles for locomotion by land, air, water or rail; wagons; water vehicles; wheelbarrows; wheelchairs; wheels for bicycles, cycles; windows for vehicles; windscreens, windshields; windshield wipers, windscreen wipers.

16 – Paper and paper products; brochures, printed matter; newspapers, magazines, books.

21 – Household and gift articles made of glass, porcelain and earthenware, utensils and containers (not for precious metal or coated therewith); glass- and porcelain ware.

25 – Clothing, footwear, headgear; aprons; ascots; babies' pants; bandanas; bath robes; bath sandals; bath slippers; bathing caps; bathing trunks, bathing drawers; bathing suits, swimsuits; beach clothes; beach shoes; belts; berets; bibs, not of paper; boas; bodices; boot uppers; boots; boots for sports; boxer shorts; brassieres; breeches for wear; camisoles; cap peaks; caps; chasubles; clothing; clothing of imitations of leather; clothing of leather; clothing for gymnastics; coats; collar protectors; collars; combinations; corselets; corsets; cuffs, wristbands; cyclists' clothing; detachable collars; dress shields; dresses; dressing gowns; ear muffs; esparto shoes or sandals; fishing vests; fittings of metal for footwear; football shoes, football boots; footmuffs, not electrically heated; footwear; footwear uppers; fur stoles; furs; gabardines; galoshes; garters; girdles; gloves; gymnastic shoes; half-boots; hat frames; hats; headbands; headgear for wear; heelpieces for stockings; heels; hoods; hosiery; jackets; jerseys; jumper dresses, pinafore dresses; knickers, panties; knitwear; lace boots; layettes; leggings, leg warmers; liveries; maniples; mantillas; masquerade costumes; miters; mittens; money belts; motorists' clothing; muffs; neckties; non-slipping devices for footwear; outerc-

lothing; overalls, smocks; overcoats, topcoats; paper clothing; paper hats; parkas; pelerines; pelisses; petticoats; pocket squares; pockets for clothing; ponchos; pyjamas; ready-made clothing; ready-made linings; sandals; saris; sarongs; sashes for wear; scarves; shawls; shirt fronts; shirt yokes; shirts; shoes; short-sleeve shirts; shower caps; ski gloves; ski boots; skirts; skorts; skull caps; sleep masks; slippers; slips; sock suspenders; socks; inner soles; soles for footwear; spats, gaiters; sports jerseys; sports singlets; sports shoes; stocking suspenders; stockings; studs for football boots; stuff jackets; suits; suspenders, braces for clothing; sweat-absorbent stockings; sweat-absorbent underclothing, sweat-absorbent underwear; sweaters, jumpers, pullovers; teddies; tee-shirts; tights; tips for footwear; togas; top hats; trouser straps, gaiter straps; trousers, pants; turbans; underpants; underwear, underclothing; uniforms; veils; visors; waistcoats, vests; waterproof clothing; welts for footwear; wet suits for water-skiing; wimples; wooden shoes.

35 – Advertising.

38 – Computer aided transmission of messages and images.

39 – Transport of passengers; transport of goods; travel arrangement.

41 – Entertainment; publishing.

43 – Catering services; temporary accommodation.

(260) AM 2016 81951 A
(800) 1244873
(891) 2015 01 29
(731) NOVARTIS AG
CH-4002 Basel, Switzerland

(540)

SEQUADRA

(511)

5 – Pharmaceutical preparations.

(260) AM 2016 81953 A
(800) 1244903
(891) 2015 03 03
(731) GOLDEN LADY (BEIJING)
DISTRIBUTION CO., LTD.
1207 Tower 1 Sanlitun SOHO, No.8
Gongrentiyuchang North Road, Chaoyang
District, Beijing, China

(540)

FASCINO

(591) Black, white

(511)

25 – Leggings [trousers]; long underwear; tights; panty hose; stocking suspenders; stockings; leg warmers; socks.

(260) AM 2016 81955 A
(800) 1244913
(891) 2015 03 11
(731) SALZMANN (NINGBO) REFLECTIVE
MATERIAL CO., LTD.
Room 6-6, No.588 Canghai Road, Gaoxin
District, Ningbo, Zhejiang, China

(540)

Salzmann

(591) Black, white

(511)

18 – School satchels; shopping bags; bags [envelopes, pouches] of leather, for packaging; envelopes, of leather, for packaging; bags for sports; umbrellas; canes; leather leashes; covers for animals; clothing for pets.

(260) AM 2016 81956 A
(800) 1244953
(891) 2015 03 23
(731) FARMAPRIM SRL
Str. Crinilor nr. 5, s. Porumbeni, MD-4829
r-nul Criuleni MD;
Farmaprim S.R.L.
Str. Gheorghe Tudor nr. 3, MD-2028
Chişinău, Republic of Moldova

(540)

**KLYNTOPIС
КЛИНТОПИК**

(591) Black, white

(511)

5 – Pharmaceutical and veterinary products; sanitary products for medical purposes; dietetic food and substances for medical or veterinary use, food for babies; food supplements for humans and animals; plasters and materials for dressings; material for dental fillings and dental impressions; disinfectants.

(260) AM 2016 81958 A
(800) 413197
(891) 2014 12 16
(731) BRICORAMA FRANCE
Rue du Moulin Paillason, F-42300
ROANNE, France

(540)

BRICORAMA

(591) Black, white

(511)

6 – Hardware; anvils, building materials of metal, laminated and cast materials; non-electric wires of metal; ironmongery, pipes of metal; nails and screws, vices, wires and metals for welding; pipework of metal, joinery of metal.

7 – Sliding and screw cutting lathes, drills, milling and grinding machines; lawnmowers, power saws,

wood and band saws, power lawnmowers, motor-driven lawnmowers, power tools.

(260) AM 2016 81959 A

(800) 490302

(891) 2015 05 04

(731) ZAMBON S.p.A.

Via Lillo Del Duca, 10, I-20091 BRESSO
(MI), Italy

(540)

FLUIMUCIL

(511)

5 – Pharmaceutical, veterinary and sanitary preparations; dietetic preparations for children and the sick; plasters, materials for dressings; material for dental fillings and dental impressions; disinfectants; preparations for destroying weeds and vermin.

(260) AM 2016 81963 A

(800) 1244064

(891) 2015 02 20

(731) UAB Prekybos namai "Hermis"

Savanoriu pr. 404, LT-50300 Kaunas,
Lithuania

(540)

Columbus

(591) Black and white

(511)

29 – Milk; milk products; yogurt; kephir [milk beverage]; cheese; smetana [sour cream]; cream [dairy products]; strained cheese.

(260) AM 2016 81964 A

(800) 534606

(891) 2015 01 26

(731) ELPOZO ALIMENTACION, S.A.

Avenida Antonio Fuertes, 1, E-30840
ALHAMA DE MURCIA (Murcia), Spain

(540)

EL POZO

(511)

29 – Meat, fish, poultry and game; meat extracts; preserved, dried and cooked fruits and vegetables; jellies, jams; eggs, milk and dairy products; edible oils and fats; dressings for salads; tinned foodstuffs.

(260) AM 2016 81972 A

(800) 1244147

(891) 2014 10 22

(731) ATLANTIC TRADE & INVESTMENT
COMPANY SRL

Strada nr.67-77, corp C, etaj 1, camera nr. 12,
Sector 1, BUCUREȘTI, Romania

(540)

BADSTER

(591) Black and white

(511)

32 – Beer; mineral and aerated waters and other non-alcoholic beverages; fruit beverages and fruit juices; syrups and other preparations for making beverages.

(260) AM 2016 81975 A

(800) 1244179

(891) 2014 12 02

(731) HOSPIRA, INC.

Department NLEG, Building H-1, 275 North
Field Drive, Lake Forest IL 60045, USA

(540)

QUELICIN

(591) Black and white

(511)

5 – Medicinal preparation for parenteral use as a muscle relaxant.

(260) AM 2016 81978 A

(800) 1121653

(891) 2015 04 14

(731) ENERGIZER SA

8, Impasse Colombelle, CH-1218 Le
Grand-Saconnex, Switzerland

(540)

ENERGIZER MAX

(511)

9 – Electric cells, batteries and accumulators.

11 – Electric lamps.

(260) AM 2016 81979 A

(800) 1244200

(891) 2014 12 19

(731) Joint Stock Company "YASNAYA
POLYANA"

83, Odoyevskoye shosse, RU-300036 g. Tula,
Russian Federation

(540)

ЧУДО - ЯГОДА

(591) Black and white

(511)

30 – Confectionery made of sugar, namely caramels, sweets, chocolate, pralines, gingerbread, biscuits, waffles, marshmallow, fruit jellies [confectionery].

(260) AM 2016 81980 A

(800) 1169720

(891) 2015 03 20

(731) GEONEXT – PRODUTOS ELÉTRICOS, S.A.

Rua António Silva Marinho 197, P-4100-064
PORTO, Portugal

(540)



(591) Light green and black

(526) "®"

(511)

7 – Agricultural implements other than hand-operated; incubators for eggs; machine tools; motors, electric, other than for land vehicles; agricultural implements other than hand-operated; soldering lamps.

9 – Electrical and electronic control apparatus for use with apparatus or installations for heating; connectors [electricity]; electrical and electronic control apparatus and instruments; distribution boxes [electricity]; accumulators, electric; transformers [electricity]; light dimmers [regulators], electric.

11 – Heating apparatus, electric; steam generating installations; water distribution installations; magnesium filaments for lighting; filaments for electric lamps; light diffusers; lamps; light bulbs; laboratory lamps; electric lamps; safety lamps; electric lights for christmas trees; projector lamps; lanterns for lighting; ceiling lights; sockets for electric lights; pipes [parts of sanitary installations]; lighting apparatus and installations; cooking apparatus and installations.

(260) AM 2016 81981 A

(800) 1177093

(891) 2015 04 15

(731) UCB Biopharma SPRL

Allée de la Recherche 60B-1070 Bruxelles,
Belgium

(540)

IMZEPAR

(511)

5 – Pharmaceutical and veterinary products; sanitary products for medicine; dietetic food and substances adapted for medical or veterinary use, food for babies; food supplements for humans and animals; plasters, materials for dressings; material for dental fillings and dental impressions; disinfectants; products for destroying vermin; fungicides, herbicides.

(260) AM 2016 81982 A

(800) 1197924

(891) 2014 12 19

(731) SPI INVESTMENTS GROUP, S.L.

Avda. Diagonal, 646, 7^o-1^a, E-08017
Barcelona, Spain

(540)

LOVIUM

(511)

3 – Bleaching preparations and other substances for laundry use; cleaning, polishing, degreasing and abrasive preparations; soaps; perfumery, essential oils, cosmetics, hair lotions; dentifrices.

(260) AM 2016 81983 A

(800) 1220986

(891) 2014 12 16

(731) GILEAD SCIENCES IRELAND UC

IDA Business and Technology Park,
Carrigtohill, Co. Cork, Ireland

(540)

EPCLUSA

(511)

5 – Pharmaceutical preparations.

(260) AM 2016 81984 A

(800) 1229142

(891) 2015 02 19

(731) HOCHIKI CORPORATION

2-10-43, Kamiosaki, Shinagawa-ku, Tokyo
141-8660, Japan

(540)



(591) Red, Rouge

(511)

9 – Automatic fire extinguishing systems; sprinkler systems for fire protection; fire plugs; fire hose nozzles; fire alarms; fire detectors; smoke detectors; smoke alarms; fire and smoke detectors; gas leak alarms; security monitoring system; electric locks; access control system recorded with control programs using card readers, contactless card readers or numerical keypads; wire communication machines and apparatus; transmission machines and apparatus [for telecommunication]; broadcasting machines and apparatus; radio communication machines and apparatus; radio application machines and apparatus; display units for computers; electronic circuits; computer programs.

17 – Safety curtains using sprinklers.

37 – Machinery installation; plumbing; electrical installation services; telecommunication wiring; other construction; consultancy relating to construction; operation and maintenance of building equipments; repair or maintenance of automatic fire extinguishing system; repair or maintenance of sprinkler systems for fire protection; repair or repair or maintenance of electric locks; repair or maintenance of access control system recorded with computer programs for access control using card readers, contactless card readers or numerical keypads; provi-

ding information concerning repair of electric locks; providing information concerning repair of access control system.

42 – Technological consultancy services relating to research and development of technology in the field of fire prevention; testing or research services relating to fire and smoke detection and alarm; design and development of computer software for detection and alarm of fire and smoke; installation, maintenance and repair of computer software.

(260) AM 2016 82004 A
(800) 1244221
(891) 2015 02 06
(731) MANN & SCHRÖDER GMBH
Bahnhofstr. 14, 74936 Siegelbach, Germany
(540)

fruttini

(591) Gray
(511)
3 – Perfumery; eau de toilette, perfumes, perfume oils, essential oils, hair lotions; soaps; soap free washing emulsions for the body; cosmetics, particularly bath preparations, body scrub, shower soap, shower foam, shower creams, shower gels, non-medicated balms, after-shave balm, hand creams, nail polish, nail care preparations, body oils, body milk, perfumed body lotion [toilet preparations], body oil spray, topical skin sprays for cosmetic purposes, body sprays, body butter, foaming bath gels, bath oils, bath foam, bath gels, non-medicated bath preparations, moisturising gels [cosmetic], facial beauty masks, lip coatings [cosmetic], lip balm, lip gloss, lipsticks, nail creams, cosmetic masks, non-medicated foot care preparations, non-medicated foot balms, eye gels, eye creams, cosmetic pencils, eye stylers, eye shadow, eyebrow pencils, eyelid shadow, eye make-up remover, eyebrow cosmetics, eye make-up, eye wrinkle lotions, shampoos, body cleaning and beauty care preparations, massage oils, massage gels other than for medical purposes, non-medicated massage creams, cosmetic cotton wool, cotton sticks for cosmetic purposes, facial wipes impregnated with cosmetics, cloths and pads impregnated with cleaning preparations, sponges impregnated with soaps.

(260) AM 2016 82005 A
(800) 1244390
(891) 2015 03 03
(731) NOKIAN TYRES PLC
Pirkkalaistie 7, FI-37100 Nokia, Finland
(540)

Nokian Tyres Go all the Way

(511)
12 – Vehicle tyres.

(260) AM 2016 82006 A
(800) 1244438
(891) 2014 10 29
(731) EGIS GYÓGYSZERGYÁR ZRT.
Keresztúri út 30-38, H-1106 Budapest,
Hungary
(540)

MYLOGRAF

(511)
5 – Pharmaceutical preparations for human use.

(260) AM 2016 82007 A
(800) 1244459
(891) 2014 11 10
(731) Nissan Jidosha Kabushiki Kaisha (also trading as Nissan Motor Co., LTD.)
No.2 Takara-cho, Kanagawa-ku, Yokohama-shi,
Kanagawa-ken 221-8623, Japan
(540)

KICKS

(591) Black and White
(511)
12 – Non-electric prime movers for land vehicles (not including "their parts"); shafts, axles or spindles [for land vehicles]; bearings [for land vehicles]; shaft couplings or connectors [for land vehicles]; transmissions, for land vehicles; shock absorbers [for land vehicles]; springs [for land vehicles]; brakes [for land vehicles]; AC motors or DC motors for land vehicles (not including "their parts"); automobiles and their parts and fittings; electric automobiles and their parts and fittings; fuel cell automobiles and their parts and fittings.

(260) AM 2016 82008 A
(800) 1244460
(891) 2014 10 14
(731) HUAWEI TECHNOLOGIES CO., LTD.
Administration Building, Huawei
Technologies Co., Ltd., Bantian, Longgang
District, Shenzhen, China
(540)

Ascend Mate

(591) Black and White
(511)
9 – Mobile phones; USB modems/wireless modems; data cards; gateways; video telephones; modems; computers; set-top boxes; household network communication terminal devices and equipments for accessing Internet, making phone calls, viewing videos and playing games; digital readers; ADSL broadband accessing terminal devices and equipments;

routers; communication modules; PDAs (personal digital assistants); telephones for remote telephone conferencing; digital photo frames; intelligent control apparatus for video conference; electric batteries; battery chargers; mouses; headphones; software in communication field; microphones; tablet computers; ebook devices; computer hardware used to enable the subscribers to proceed with video conference in different places simultaneously; computer software used to enable the subscribers to proceed with video conference in different places simultaneously; network communication apparatus used to enable the subscribers to proceed with video conference in different places simultaneously.

(260) AM 2016 82009 A

(800) 1244491

(891) 2013 10 10

(731) GÖÇMAKSAN MAKİNA SANAYİ VE
TİCARET LİMİTED ŞİRKETİ

34. Sokak No:5, Ostim, Ankara, Turkey

(540)

GÖÇMAK

(591) Black and White

(511)

7 – Machines, machine tools and industrial robots to process and give shape to wood, metal, glass, plastic materials and mined materials; machine tools, namely, powered machines for cutting or shaping or finishing metals; metal working machines, namely, saws and cutters; bending machines for metalworking; power-operated shears; power-operated floor burnishers; floor staining and floor polishing machines; ground surface finishing and compacting machines; road rollers; electrolysis apparatus for electroplating purposes and galvanizing machines; construction machines, glass working machines, stone working machines, leather working machines, metal working machines, wood working machines; lifting, carrying and transmission machines, namely, elevators, moving staircases and winches; machines and robots to process grain, fruit, vegetable and food; agricultural machinery and tools other than hand-operated; engines and motors not for land vehicles, electrical motors, their parts and apparatus except for land vehicles; parts for land vehicles which are included in this class, namely, air compressors, alternators, distributors, electronic ignitions, engine cylinders, engine gaskets, exhaust pipes, fuel pumps, generators, ignition devices for motors of land vehicles, ignition wires for motor vehicles, mechanical engine parts for land vehicles, oil pumps for land vehicles, parts for non-electric prime movers for land vehicles, shaft bearings for land vehicles, starter motors for land vehicles, timing belts for engines for land vehicles, water pumps for land vehicles; bearings ball and rolling bearings; hydraulic jacks for wheel removing and mounting alternators, generators, elec-

tricity generator, solar-powered electricity generators; machines for painting, automatic spray guns for paint, electric punching machines and guns, electric glue guns, spray guns for paints compressed air guns for the extrusion of mastics, electric band drills, electric chain saws, electric air compressors, washing installations for vehicles; welding machines, namely, electric arc welding machines, electric soldering machines, electric arc cutting apparatus, electrodes for welding machines; printing machines and apparatus; packaging machines, bottling and capping machines, industrial printing machines, namely, labelers classifiers; machine tools for forming, riveting, swaging and flaring or metal and plastics, electrical apparatus for sealing) plastic (packaging); machines for the textile industry, sewing machines; centrifugal pumps, compressed air pumps, pumps for heating installations; fuel dispensing pumps for service stations self regulating fuel pumps; electrically operated kitchen machines used for chopping, grinding, crushing, trimming and crumbling; washing machines dishwashers, spin driers (not heated), floor polishing machines, carpet cleaning machines; electric vacuum cleaners and their parts; automatic vending machines.

8 – Table cutlery, namely, knives, spoons and forks; non-electric egg and cheese slicers, non-electric pizza cutters, non-electric vegetable and fruit peelers; side arms, not including firearms, namely, swords, daggers, hunting knives; hand tools for personal use, namely, electric and non-electric razors, razor blades, electric hair removing devices, scissors, eyelash curlers; pedicure and manicure implements, namely, nail scissors, nail files cuticle pushers, tweezers; cases for manicure instruments; electric hair curling irons, electric hair straightening irons; manually operated hand tools, namely, adzes, saws, planes, gardening shears and scissors, pipe wrenches, spanners, spatulas, scythes, hatchets, hammers, mauls, hand operated pumps, hand operated tools for applying paint to surfaces, chisels screwdrivers, drills, sharpening stones, shovels, sharpening wheels for knives and blades, socket sets, socket wrenches, pliers, pincers, hand jacks crowbar, metal cutting saws; metal vice jaws; metal-cutting scissors; metal cutting scissors; hand-operated shears; hand tools, namely, stretchers for wire and metal bands, rigid and rod hand benders for use on metal rods; non-electric soldering irons; irons, namely, electric and steam irons, electric clothing pressing machines for commercial dry cleaning and laundry purposes.

(260) AM 2016 82010 A

(800) 1244494

(891) 2014 07 21

(731) ZAO "OBNINSKORGSIINTEZ"

57, Kievskoye Shosse, RU-249032 Obninsk,
Kaluga region, Russian Federation

(540)

ГОСТИН GOSTIN

(591) Black and White

(511)

1 – Acetate of cellulose, unprocessed; acetates [chemicals]; acetic anhydride; acetone; acetylene; acids; acidulated water for recharging batteries; acrylic resins, unprocessed; actinium; additives, chemical, to drilling muds; additives, chemical, to fungicides; additives, chemical, to insecticides; additives, chemical, to motor fuel; adhesives for billposting; adhesives for industrial purposes; adhesives for paperhanging; adhesives for wall tiles; agar-agar; agglutinants for concrete; agricultural chemicals, except fungicides, weedkillers, herbicides, insecticides and parasiticides; albumin [animal or vegetable, raw material]; albuminized paper; alcohol; aldehydes; alginates for industrial purposes; alkalies; alkaline iodides for industrial purposes; alkaline metals; alkaline-earth metals; alkaloids; alum; alumina; aluminium acetate; aluminium alum; aluminium hydrate; aluminium iodide; aluminium silicate; americium; ammonia [volatile alkali] for industrial purposes; ammonium alum; ammonia; ammonium aldehyde; amyl acetate; anhydrides; anhydrous ammonia; animal albumen [raw material]; animal carbon preparations; anti-boil preparations for engine coolants; antifreeze; anti-frothing solutions for batteries; anti-knock substances for internal combustion engines; antimony oxide; antistatic preparations, other than for household purposes; anti-tarnishing chemicals for windows; anthranilic acid; argon; arsenic; arsenious acid; artificial resins, unprocessed; artificial sweeteners [chemical preparations]; astatine; auxiliary fluids for use with abrasives; bacterial preparations other than for medical and veterinary use; bacteriological preparations for acetification; bacteriological preparations other than for medical and veterinary use; balm of gurjun [gurjon, gurjan] for making varnish; barium; baryta paper; baryta; barytes; bases [chemical preparations]; basic gallate of bismuth; baths for galvanizing; bauxite; beer preserving agents; beer-clarifying and preserving agents; bentonite; benzene derivatives; benzene-based acids; benzoic acid; berkelium; bicarbonate of soda for chemical purposes; bichloride of tin; bichromate of potassium; bichromate of soda; biochemical catalysts; biological preparations, other than for medical or veterinary purposes; birdlime; bismuth nitrite for chemical purposes; bismuth; bleaching preparations [decolorants] for industrial purposes; blueprint paper; borax; boric acid for industrial purposes; brake fluid; brazing preparations; brickwork preservatives, except paints and oils; bromine for chemical purposes; calcined soda; calcium carbide; calcium cyanamide [fertilizer]; californium; camphor, for industrial purposes;

carbide; carbolineum for the protection of plants; carbon for filters; carbon sulphide; carbonates; carbonic acid; casein for industrial purposes; cassio-pium [lutetium]; catalysts; catechu; caustic soda for industrial purposes; caustics for industrial purposes; cement [metallurgy]; cement for mending broken articles; cement preservatives, except paints and oils; cement-waterproofing chemicals, except paints; ceramic compositions for sintering [granules and powders]; ceramic glazings; ceramic materials in particulate form, for use as filtering media; chemical additives for oils; chemical condensation preparations; chemical preparations for facilitating the alloying of metals; chemical preparations for scientific purposes, other than for medical or veterinary use; chemical preparations for smoking meat; chemical preparations for the manufacture of paints; chemical preparations to prevent mildew; chemical preparations to prevent wheat smut; chemical preparations, except pigments, for the manufacture of enamel; chemical substances for analyses in laboratories, other than for medical or veterinary purposes; chemical substances for preserving foodstuffs; china slip; cholic acid; chrome alum; chromic acid; chromium oxide; cinematographic film, sensitized but not exposed; citric acid for industrial purposes; clarification preparations; coal saving preparations; cobalt oxide for industrial purposes; collodion; color-brightening chemicals for industrial purposes; combusting preparations [chemical additives to motor fuel]; compositions for repairing inner tubes of tires [tyres]; compost; concrete-aeration chemicals; condensation-preventing chemicals; preparations for stimulating cooking for industrial purposes; coolants for vehicle engines; copper sulphate [vitriol]; corrosive preparations; creosote for chemical purposes; crotonic aldehyde; cryogenic preparations; cultures of microorganisms, other than for medical and veterinary use; curium; currying preparations for leather; currying preparations for skins; damp-proofing chemicals, except paints, for masonry; defoliants; degreasing preparations for use in manufacturing processes; degumming preparations; dehydrating preparations for industrial purposes; detergent additives to petrol [gasoline]; detergents for use in manufacturing processes; diagnostic preparations, other than for medical or veterinary purposes; diastase for industrial purposes; diatomaceous earth; diazo paper; dioxide of hydrogen; disincrustants; dispersions of plastics; distilled water; dolomite for industrial purposes; dressing and finishing preparations for textiles; dressing, except oils, for skins; dry ice [carbon dioxide]; dysprosium; earth for growing; electrophoresis gels, other than for medical or veterinary purposes; emollients for industrial purposes; emulsifiers; enamel and glass-staining chemicals; enamel-staining chemicals; engine-decarbonising chemicals; enzyme preparations for industrial purposes; epoxy resins, unprocessed; ethyl alcohol; europium;

expanded-clay for hydroponic plant growing [substrate]; fat-bleaching chemicals; fatty acids; fertilizers; fertilizing preparations; fillers for automobile bodies; filtering materials [chemical preparations]; filtering materials [mineral substances]; filtering materials [unprocessed plastics]; filtering materials [vegetable substances]; filtering preparations for the beverages industry; finishing preparations for use in the manufacture of steel; fire extinguishing compositions; fissionable material for nuclear energy; fixing baths [photography]; fixing solutions [photography]; flashlight preparations; flocculants; flour for industrial purposes; flower preservatives; fluids for hydraulic circuits; formic acid; foundry binding substances; foundry molding [moulding] preparations; foundry sand; fuel-saving preparations; fuller's earth for use in the textile industry; fulling preparations for use in the textile industry; gadolinium; gallic acid for the manufacture of ink; gallium; gallnuts; gallotannic acid; galvanizing preparations; gambier; propellant gases for aerosols; gelatine for industrial purposes; gelatine for photographic purposes; getters [chemically active substances]; glass-frosting chemicals; glass-staining chemicals; glaziers' putty; glucose for industrial purposes; glucosides; glue for industrial purposes; gluten [glue], other than for stationery or household purposes; glycerides; glycerine for industrial purposes; glycol; grafting mastic for trees; grafting wax for trees; graphite for industrial purposes; guano; gum arabic for industrial purposes; gums [adhesives], other than for stationery or household purposes; heavy water; helium; holmium; hormones for hastening the ripening of fruit; horticultural chemicals, except fungicides, herbicides, insecticides and parasiticides; humus top dressing; humus; hydrates; hydrazine; hydrochloric acid; hydrofluoric acid; hydrogen; hypochlorite of soda; hyposulphites; iodic acid; iodine for chemical purposes; iodine for industrial purposes; iodised albumen; ion exchangers [chemical preparations]; isinglass other than for stationery, household or alimentary purposes; isotopes for industrial purposes; kainite; ketones; kieselgur; krypton; lactic acid; lanthanum; lead acetate; lead arsenate; lead oxide; leather glues; leather-dressing chemicals; leather-impregnating chemicals; leather-waterproofing chemicals; lecithin [raw material]; lime acetate; lime carbonate; lime chloride; limestone hardening substances; liquids for removing sulphates from accumulators; lithia [lithium oxide]; lithium; litmus paper; magnesite; magnesium carbonate; magnetic fluid for industrial purposes; malt albumen; manganate; manganese dioxide; mangrove bark for industrial purposes; masonry preservatives, except paints and oils; mastic for leather; mastic for tires [tyres]; meat tenderizers for industrial purposes; mercuric oxide; earth metals; metal hardening preparations; metal tempering preparations; metalloids; methane; methyl benzol; mineral acids; moderating materials for nuc-

lear reactors; moistening [wetting] preparations for use in bleaching; moistening [wetting] preparations for use in dyeing; moistening [wetting] preparations for use in the textile industry; mold-release preparations; mordants for metals; must-fining preparations; naphthalene; neodymium; neon; neptunium; nitrate of uranium; nitrate paper; nitrates; nitric acid; nitric monoxide; nitrogen; nitrogenous fertilizers; oenological bactericides [chemical preparations used in wine making]; oil cement [putty]; oil dispersants; oil-bleaching chemicals; oil-purifying chemicals; oils for currying leather; oils for preparing leather in the course of manufacture; oils for tanning leather; oils for the preservation of food; oil-separating chemicals; oleic acid; olivine [chemical preparations]; opacifiers for enamel or glass; opacifiers for enamel; opacifiers for glass; organic-bleaching chemicals; oxalates; oxalic acid; oxygen; paper pulp; peat pots for horticulture; pectin [photography]; perborate of soda; percarbonates; perchlorates; persulphates; persulphuric acid; petroleum dispersants; phenol for industrial purposes; phosphoric acid; photometric paper; picric acid; plant growth regulating preparations; plasticizers; plastics unprocessed; plastisols; plutonium; polish removing substances; polonium; potash water; potash; potassium dioxalate; potassium; potato flour for industrial purposes; power steering fluid; praseodymium; preparations for preventing the tarnishing of glass; preparations for preventing the tarnishing of lenses; preparations for the separation of greases; preparations of the distillation of wood alcohol; preparations of trace elements for plants; preservatives for pharmaceutical preparations; preservatives for tiles, except paints and oils; protective gases for welding; pyrogallic acid; quebracho for industrial purposes; radiator flushing chemicals; rare earths; reagent paper, other than for medical or veterinary purposes; reducing agents for use in photography; refrigerants; renovating preparations for phonograph records; rubber preservatives; sal ammoniac; salicylic acid; salpetre; salts for galvanic cells; salts for industrial purposes; salts of precious metals for industrial purposes; scale removing preparations, other than for household purposes; sea water for industrial purposes; seaweeds [fertilizers]; sebacic acid; seed preserving substances; sensitized paper; sensitized plates for offset printing; separating and unsticking [ungluing] preparations; silicates; silicon; silicones; silver nitrate; sizing preparations; soap [metallic] for industrial purposes; soda ash; sodium; soldering chemicals; solidified gases for industrial purposes; solutions for cyanotyping; solvents for varnishes; sorrel salt; spirits of vinegar [dilute acetic acid]; stain-preventing chemicals for use on fabrics; starch for Industrial purposes; starch paste [adhesive], other than for stationery or household purposes; starch-liquifying chemicals [ungluing agents]; stearic acid; substances for preventing runs in stockings; substrates for soil-

free growing [agriculture]; sulphuric acid; sulphurous acid; surface-active chemical agents; synthetic materials for absorbing oil; synthetic resins, unprocessed; tan; tannic acid; tanning substances; tanwood; tapioca flour for industrial purposes; tartar other than for pharmaceutical purposes; tartaric acid; test paper, chemical; textile-brightening chemicals; textile-impregnating chemicals; textile-waterproofing chemicals; tire repairing compositions; titanium dioxide for industrial purposes; toxic gas neutralizers; transmission fluid; tree cavity fillers [forestry]; tungstic acid; uranium oxide; wallpaper removing preparations; water glass [soluble glass]; water purifying chemicals; water-softening preparations; wax-bleaching chemicals; vine disease preventing chemicals; wine finings; viscose; witherite; wood pulp; vulcanisation accelerators; vulcanising preparations; xenon; x-ray films, sensitized but not exposed; ytterbium; yttrium; zirconia.

3 – Abrasive cloth; abrasive paper; abrasives; adhesives for affixing false eyelashes; adhesives for affixing false hair; adhesives for cosmetic purposes; after-shave lotions; almond milk for cosmetic purposes; almond oil; almond soap; alum stones [astringents]; amber [perfume]; ammonia [volatile alkali] [detergent]; antiperspirant soap; antiperspirants [toiletries]; antistatic preparations for household purposes; aromatics [essential oils]; astringents for cosmetic purposes; badian essence; bases for flower perfumes; bath salts, not for medical purposes; beard dyes; beauty masks; bergamot oil; bleaching preparations [decolorants] for cosmetic purposes; bleaching salts; bleaching soda; breath freshening sprays; cake flavourings [essential oils]; cakes of toilet soap; canned pressurized air for cleaning and dusting purposes; carbides of metal [abrasives]; cleaning chalk; cleaning preparations; cleansing milk for toilet purposes; cloths impregnated with a detergent for cleaning; cobblers' wax; colorants for toilet purposes; color-brightening chemicals for household purposes [laundry]; color-removing preparations; corundum [abrasive]; cosmetic creams; cosmetic dyes; cosmetic kits; cosmetic pencils; cosmetic preparations for baths; cosmetic preparations for eyelashes; cosmetic preparations for skin care; cosmetic preparations for slimming purposes; cosmetics; cotton sticks for cosmetic purposes; cotton wool for cosmetic purposes; creams for leather; decorative transfers for cosmetic purposes; degreasers other than for use in manufacturing processes; dental bleaching gels; dentifrices; denture polishes; deodorant soap; deodorants for human beings or for animals; depilatories; depilatory wax; detergents other than for use in manufacturing operations and for medical purposes; diamantine [abrasive]; disinfectant soap; dry-cleaning preparations; eau de cologne; emery paper; emery; essential oils of cedarwood; essential oils of lemon; essential oils; ethereal essences; extracts of flowers [perfumes]; eyebrow cosmetics;

eyebrow pencils; fabric softeners for laundry use; false eyelashes; false nails; flavorings for beverages [essential oils]; floor wax removers [scouring preparations]; floor wax; fumigation preparations [perfumes]; furbishing preparations; gaultheria oil; geraniol; glass cloth; glass paper; greases for cosmetic purposes; grinding preparations; hair colorants; hair lotions; hair spray; hair waving preparations; heliotropine; hydrogen peroxide for cosmetic purposes; incense; ionone [perfumery]; jasmine oil; javelle water; joss sticks; lacquer-removing preparations; laundry bleach; laundry blueing; laundry glaze; laundry preparations; laundry soaking preparations; laundry starch; laundry wax; lavender oil; lavender water; leather bleaching preparations; leather preservatives [polishes]; lipsticks; lotions for cosmetic purposes; make-up powder; make-up preparations; make-up removing preparations; make-up; mascara; medicated soap; mint essence [essential oil]; mint for perfumery; moustache wax; mouth washes, not for medical purposes; musk [perfumery]; nail care preparations; nail varnish; neutralizers for permanent waving; non-slipping liquids for floors; non-slipping wax for floors; oil of turpentine for degreasing; oils for cleaning purposes; oils for cosmetic purposes; oils for perfumes and scents; oils for toilet purposes; paint stripping preparations; pastes for razor strops; perfumery; perfumes; petroleum jelly for cosmetic purposes; polish for furniture and flooring; polishing creams; polishing paper; polishing preparations; polishing rouge; polishing stones; polishing wax; pomades for cosmetic purposes; potpourris [fragrances]; preparations for cleaning dentures; preparations for unblocking drain pipes; preparations to make shiny the leaves of plants; pumice stone; quillaia bark for washing; rose oil; rust removing preparations; sachets for perfuming linen; saffrol; scale removing preparations for household purposes; scented water; scented wood; scouring solutions; shampoos for pets; shampoos; shaving preparations; shaving soap; shaving stones [astringents]; shining preparations [polish]; shoe cream; shoe wax; shoemakers' wax; silicon carbide [abrasive]; skin whitening creams; smoothing preparations [starching]; smoothing stones; soap for brightening textile; soap for foot perspiration; soap; soda lye; stain removers; starch glaze for laundry purposes; sun-tanning preparations [cosmetics]; tailors' wax; talcum powder, for toilet use; terpenes [essential oils]; tissues impregnated with cosmetic lotions; toilet water; toiletries; tripoli stone for polishing; turpentine, for degreasing; varnish-removing preparations; volcanic ash for cleaning; wallpaper cleaning preparations; washing soda, for cleaning; whitening; windscreen cleaning liquids.

4 – Additives, non-chemical, to motor-fuel; alcohol [fuel]; anthracite; beeswax; belting wax; bone oil for industrial purposes; candles; carnauba wax; castor oil for technical purposes; ceresine; charcoal [fuel];

christmas tree candles; coal briquettes; coal dust [fuel]; coal naphtha; coal tar oil; coal; coke; combustible briquettes; combustible oil; cutting fluids; diesel oil; dust binding compositions for sweeping; dust laying compositions; dust removing preparations; electrical energy; firelighters; firewood; fish oil, not edible; fuel with an alcoholic base; grease for arms [weapons]; grease for belts; grease for boots; grease for leather; illuminating grease; illuminating wax; industrial grease; industrial oil; industrial wax; kerosene; lamp wicks; lighting fuel; lignite; lignoin; lubricants; lubricating graphite; lubricating grease; lubricating oil; mazut; methylated spirit; mineral fuel; moistening oil; motor oil; nightlights [candles]; non-slipping preparations for belts; oil for the preservation of leather; oil for the preservation of masonry; oils for paints; oils for releasing form work [building]; oleine; ozocerite [ozokerite]; paper spills for lighting; paraffin; peat [fuel]; peat briquettes [fuel]; perfumed candles; petroleum ether; petroleum jelly for industrial purposes; preservatives for leather [oils and greases]; rape oil for industrial purposes; soya bean oil preparations for non-stick treatment of cooking utensils; stearine; sunflower oil for industrial purposes; tallow; textile oil; vaporized fuel mixtures; wax [raw material]; wicks for candles; wood briquettes; wood spills for lighting; wool grease; xylene; xylol.

(260) AM 2016 82011 A

(800) 1244502

(891) 2014 09 16

(731) ZAO "OBNINSKORGSIINTEZ"

Im Mediapark 6, 50670 Köln, Germany

(540)



(591) Black and cyan

(511)

9 – Computer software, particularly for designing and updating the websites of companies as well as for integrating Internet technologies into various business processes.

35 – Advertising, particularly with regard to the Internet and other new media; provision and rental of advertising space, particularly on the Internet; public relations; organization of exhibitions and trade fairs for commercial or advertising purposes, particularly on the Internet; presentation of products; advertising services, particularly provided via the Internet; organisational project planning and management for advertising and online presentation of companies on the Internet as well as of other new media and generally with regard to EDP; professional business consultancy; advisory services relating to business organisation; business management and professional business consultancy with regard to the use of computer hardware and software as well as of new

media and the Internet for and in companies; operating service hotlines for users of the Internet and new media, namely receipt of customer complaints; business administration; collecting and updating data in terms of preconfigured content for complementing existing websites in computer databases.

38 – Telecommunications and communications services; transmission of images, messages and data via computers and mobile terminals; Internet service provider services, namely transmission of data via computer networks in terms of preconfigured content for complementing existing websites; providing access to computer programs on the Internet, particularly in terms of preconfigured content for complementing existing websites and for enabling the participation in electronic commerce; leasing access time to a computer database, particularly in terms of preconfigured content for complementing existing websites and for enabling the participation in electronic commerce.

42 – Electronic data storage of preconfigured content for complementing existing websites; design and development of computer software; content and website management services, namely creation of programs for data processing, particularly programs for setting up, designing and modifying websites and leasing such programs via the Internet; graphic design services, particularly designing websites; electronic storage of data in websites, particularly in terms of preconfigured content for complementing existing websites and enabling the participation in electronic commerce; provision or rental of webspace; rental of computing capacities; design, development, maintenance and installation of computer software, particularly for the Internet and electronic commerce; technical project planning, design and development of computers, computer hardware and computer networks, particularly for the Internet and electronic commerce; research in the field of computing, communication and information technology; providing temporary use of non-downloadable software via the Internet or other communications networks, particularly for enabling the participation in electronic commerce; online maintenance of computer software; computer system analysis.

45 – Licensing of computer programs.

(260) AM 2016 82012 A

(800) 1244516

(891) 2014 11 14

(731) EGIS GYÓGYSZERGYÁR ZRT.

Keresztúri út 30-38, H-1106 Budapest,

Hungary

(540)

ALARMIL

(511)

5 – Pharmaceutical preparations for human use.

(260) AM 2016 82013 A
 (800) 1244519
 (891) 2015 01 05
 (731) "AZ FP CO. LTD." LIMITED LAIBILITY
 COMPANY
 Yasamal District, M. Mushfiq Str., 12, Ap. 34,
 AZ-1073 BAKU, Azerbaijan

(540)

MILLA

(591) Black and White
 (511)
 29 – Milk and milk products.

(260) AM 2016 82014 A
 (800) 1244523
 (891) 2015 01 15
 (731) EGIS GYÓGYSZERGYÁR ZRT.
 Keresztúri út 30-38, H-1106 Budapest,
 Hungary

(540)

MANGRIT

(511)
 5 – Pharmaceutical preparations for human use.

(260) AM 2016 82015 A
 (800) 1244535
 (891) 2015 01 28
 (731) BAYER INTELLECTUAL PROPERTY
 GMBH
 Alfred-Nobel-Straße 10, 40789 Monheim am
 Rhein, Germany

(540)

ЖАНИН

(591) Black and White
 (511)
 5 – Pharmaceutical preparations; hormonal prepara-
 tions.

(260) AM 2016 82016 A
 (800) 1244560
 (891) 2015 03 13
 (731) JANSSEN PHARMACEUTICA NV
 Turnhouseweg 30, B-2340 BEERSE,
 Belgium

(540)

XEPLION TRINZA

(511)
 5 – Human pharmaceutical preparations.

(260) AM 2016 82017 A
 (800) 1244561
 (891) 2015 03 13
 (731) JANSSEN PHARMACEUTICA NV
 Turnhouseweg 30, B-2340 BEERSE,
 Belgium

(540)

XEPLION TRITAIN

(511)
 5 – Human pharmaceutical preparations.

(260) AM 2016 82018 A
 (800) 1244562
 (891) 2015 03 13
 (731) JANSSEN PHARMACEUTICA NV
 Turnhouseweg 30, B-2340 BEERSE,
 Belgium

(540)

XEPLION XEPTENA

(511)
 5 – Human pharmaceutical preparations.

(260) AM 2016 82019 A
 (800) 1244563
 (891) 2015 03 13
 (731) JANSSEN PHARMACEUTICA NV
 Turnhouseweg 30, B-2340 BEERSE,
 Belgium

(540)

XEPLION TRINETI

(511)
 5 – Human pharmaceutical preparations.

(260) AM 2016 82020 A
 (800) 1244564
 (891) 2015 03 13
 (731) JANSSEN PHARMACEUTICA NV
 Turnhouseweg 30, B-2340 BEERSE,
 Belgium

(540)

XEPTENA

(511)
 5 – Human pharmaceutical preparations.

(260) AM 2016 82157 A
 (800) 1246181
 (891) 2015 02 10
 (731) Limited Liability Company "NEARMEDIC
 PLUS"
 ul. Aviakonstruktora Mikoyana, 12,
 RU-125252 Moscow, Russian Federation

(540)

**NEARMEDIC**

(591) Black and white
 (511)
 1 – Chemicals used in industry; chemicals used in
 science; carbonic hydrates; albumin [animal or vege-

table, raw material]; animal albumen [raw material]; cellulose derivatives [chemicals]; chemical reagents, other than for medical or veterinary purposes; stem cells other than for medical or veterinary purposes; diagnostic preparations, other than for medical or veterinary purposes; chemical substances for analyses in laboratories, other than for medical or veterinary purposes.

5 – Pharmaceutical preparations including cell-based preparations for medical purposes including stem cells; biocides; biological preparations for medical purposes; medicines for human purposes; albuminous preparations for medical purposes; stem cells for medical purposes; surgical dressings; diagnostic preparations for medical purposes; chemical preparations for medical purposes; biological tissue cultures for medical purposes; cell implants.

10 – Medical apparatus and instruments; testing apparatus for medical purposes; suture materials; surgical thread; surgical implants [artificial materials].

(260) AM 2016 82160 A
(800) 1246210
(891) 2015 03 19
(731) KHALAF TURKI
vul. Itskhaka Rabina, 55, kv. 10, m. Odesa
65072, Ukraine
(540)



(591) Black and white
(511)
34 – Absorbent paper for tobacco pipes; ashtrays for smokers; books of cigarette papers; chewing tobacco; cigar cases; cigar cutters; cigar holders; cigarette cases; cigarette filters; cigarette holders; cigarette paper; cigarette tips; cigarettes; cigarettes containing tobacco substitutes, not for medical purposes; cigarillos; cigars; electronic cigarettes; firestones; gas containers for cigar lighters; herbs for smoking; humidors; lighters for smokers; match holders; matchboxes; matches; mouthpieces for cigarette holders; pipe cleaners for tobacco pipes; pipe racks for tobacco pipes; pocket machines for rolling cigarettes; snuff; snuff boxes; spittoons for tobacco users; tips of yellow amber for cigar and cigarette holders; tobacco; tobacco jars; tobacco pipes; tobacco pouches.

(260) AM 2016 82161 A
(800) 1246211
(891) 2015 03 19
(731) KHALAF TURKI
vul. Itskhaka Rabina, 55, kv. 10, m. Odesa
65072, Ukraine
(540)



(591) Black and white
(511)
34 – Absorbent paper for tobacco pipes; ashtrays for smokers; books of cigarette papers; chewing tobacco; cigar cases; cigar cutters; cigar holders; cigarette cases; cigarette filters; cigarette holders; cigarette paper; cigarette tips; cigarettes; cigarettes containing tobacco substitutes, not for medical purposes; cigarillos; cigars; electronic cigarettes; firestones; gas containers for cigar lighters; herbs for smoking; humidors; lighters for smokers; match holders; matchboxes; matches; mouthpieces for cigarette holders; pipe cleaners for tobacco pipes; pipe racks for tobacco pipes; pocket machines for rolling cigarettes; snuff; snuff boxes; spittoons for tobacco users; tips of yellow amber for cigar and cigarette holders; tobacco; tobacco jars; tobacco pipes; tobacco pouches.

(260) AM 2016 82165 A
(800) 1246232
(891) 2015 02 23
(731) Joint stock company "MOZYRSALT"
Gomel region, 247760 Mozyr, Belarus
(540)



(591) Black and white
(526) The trademark is protected as a whole. "вкусно и полезно" shall not be subject to independent legal protection.
(511)
30 – Salt; salt for preserving foodstuffs; cooking salt; condiments.

(260) AM 2016 82167 A
(800) 1246945
(891) 2015 03 10
(731) DR. NICOLAI VON FÜNER
Athener Platz 11, 81545 München, Germany
(540)

Stabskapitän von Fünér

- (511)
9 – Sound recordings, in particular records [sound recordings], compact discs.
16 – Printed matter; pictures; drawings; paintings.
21 – Drinking mugs made of earthenware or plastics.
25 – Clothing, in particular T-shirts.
26 – Ornamental novelty badges [buttons].
35 – Advertising, marketing and promotional services, particularly promotion [advertising] of events.
41 – Entertainment; cultural activities, particularly, arranging and conducting of concerts.
45 – Intellectual property consultancy.

(260) AM 2016 82168 A
(800) 1246235
(891) 2015 03 19
(731) F. Hoffmann-La Roche AG
Grenzacherstrasse 124, CH-4070 Basel,
Switzerland

(540)

OCREVUS

- (511)
5 – Pharmaceutical products.

(260) AM 2016 82169 A
(800) 1246959
(891) 2015 02 19
(731) REEMTSMA CIGARETTENFABRIKEN
GMBH
Max-Born Strasse 4, 22761 Hamburg,
Germany

(540)



- (591) Black, white
(511)
34 – Tobacco, whether manufactured or unmanufactured; tobacco products; tobacco substitutes, none being for medicinal or curative purposes; cigarettes; cigarillos; cigars; hand-held machines for making cigarettes; cigarette tubes; cigarette filters; cigarette papers; electronic cigarettes; liquids for electronic cigarettes; matches and smokers' articles.

(260) AM 2016 82170 A
(800) 1246278
(891) 2014 11 06
(731) HESHAN GUOJI NANLIAN
MOTORCYCLE INDUSTRY CO, LTD.
No.577, Xincheng Road, Shaping, Heshan
City Guangdong Province, China

(540)

SKM

- (591) Black, white
(511)
12 – Motorcycles; boats; yachts; vehicle tires; motorcycle wheel hubs; electric bicycles.

(260) AM 2016 82171 A
(800) 627384
(891) 2015 02 14
(731) MICHELIN RECHERCHE ET TECHNIQUE
S.A.
Route Louis-Braille 10, CH-1763 Granges-
Paccot, Switzerland

(540)

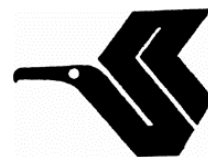

- (591) Black, white
(511)
12 – Tires for motor cars, tires for tractors, protectors of gum placed between the inner tube and rim.

(260) AM 2016 82172 A
(800) 1246297
(891) 2014 11 26
(731) EGIS GYÓGYSZERGYÁR ZRT.
Keresztúri út 30-38, H-1106 Budapest,
Hungary

(540)

PALIPROST

- (511)
5 - Pharmaceutical preparations for human use.

(260) AM 2016 82201 A
(800) 1246685
(891) 2014 10 20
(731) BETA KİMYA SANAYİ VE TİCARET
ANONİM ŞİRKETİ
Keresteciler Sitesi, 14 Blok, No:32, İkitelli,
Istanbul, Turkey

(540)



- (591) whitw, dazk Blue
(511)
1 – Chemicals used in industry, science, photography, agriculture, horticulture and forestry; unprocessed artificial resins and unprocessed plastics; manures and soils; fire extinguishing compositions; adhesives not for household and stationery purposes.

16 – Paper, cardboard and goods made from these materials included in this class, other than stationery products; plastic materials for packaging and wrapping purposes; printing blocks and types; bookbinding material; printed matter, printed publications, namely, calendars, posters, photographs (printed), paintings, stickers (stationery), postage stamps; stationery, office stationery, instructional and teaching material (except furniture and apparatus); office requisites, paint rolls and paintbrushes for painting.

17 – Rubber, gutta-percha, gum, asbestos, mica and semi-finished synthetic goods made from these materials in the form of powder, bars, panels and foils included in this class; insulation, stopping and sealing materials; joint sealant compounds for joints, gaskets, O-rings for sealing purposes; flexible pipes made from rubber and plastic hoses made of plastic and rubber, including those used for vehicles, junctions for pipes of plastic and rubber, pipe jackets of plastic and rubber, hoses of textile material, junctions for pipes, not of metal, pipe jackets, not of metal, connecting hose for vehicle radiators.

(260) AM 2016 82287 A
 (800) 1247628
 (891) 2015 03 13
 (731) ALNUS YATIRIM MENKUL DEĞERLER ANONİM ŞİRKETİ
 Esentepe Mah. Gazeteciler Sitesi Keskin Kalem Sok. No:27/8 Sisli Istanbul, Turkey
 (540)



(591) Blue and red.
 (511)
 36 – Insurance services; customs brokerage services; real estate brokers, real estate agencies and real estate management; financial and monetary affairs.

(260) AM 2016 82288 A
 (800) 1247353
 (891) 2015 04 15
 (731) COFEMEL-SOCIEDADE DE VESTUÁRIO, S.A
 Rua da Mabor, 104, P-4760-813 LOUSADO, Portugal
 (540)

ONE SIZE
 by TIFFOSI

(591) Blue
 (511)
 25 – Clothing, footwear, headgear.

(260) AM 2016 82289 A
 (800) 1247373
 (891) 2015 02 24
 (731) COLORIFICIO SAN MARCO spa
 Via Alta, 10, I-30020 MARCON (VE), Italy
 (540)

CADORO

(591) Black and white
 (511)
 2 – Paints, varnishes, lacquers, coatings.
 7 – Insulating paints and insulating varnishes.

(260) AM 2016 82290 A
 (800) 1247387
 (891) 2015 01 07
 (731) Beachbody, LLC
 Third Floor, 3301 Exposition Blvd., Santa Monica CA 90404, USA
 (540)

PiYO

(591) gray and white
 (511)
 9 – Pre-recorded DVDs featuring exercise, fitness, dietary information and instruction; computer application software for mobile phones, portable media players, handheld computers, namely, software for use in database management and use in electronic storage of data, in the field of exercise, fitness, dietary information and instruction.

INTERNATIONAL TRADEMARKS PROTECTED IN GEORGIA

(260) AM 2016 74483 A
(800) 1178434
(151) 2013 08 07
(181) 2023 08 07
(511) 14, 35, 37

(260) AM 2016 80410 A
(800) 1230582
(151) 2014 09 02
(181) 2024 09 02
(891) 2014 09 02
(511) 09, 22

(260) AM 2016 74701 A
(800) 894182
(151) 2006 06 28
(891) 2013 08 23
(181) 2016 06 28
(511) 14

(260) AM 2016 80414 A
(800) 1230601
(151) 2014 09 11
(181) 2024 09 11
(891) 2014 09 11
(511) 09

(260) AM 2016 79626 A
(800) 887509
(151) 2006 04 11
(181) 2026 04 11
(891) 2014 10 22
(511) 03

(260) AM 2016 80424 A
(800) 1230663
(151) 2014 09 22
(181) 2024 09 22
(891) 2014 09 22
(511) 30

(260) AM 2016 79772 A
(800) 1224028
(151) 2014 06 10
(181) 2024 06 10
(891) 2014 06 10
(511) 33

(260) AM 2016 80425 A
(800) 1230667
(151) 2014 10 24
(181) 2024 10 24
(891) 2014 10 24
(511) 03

(260) AM 2016 80352 A
(800) 1229944
(151) 2014 07 16
(181) 2024 07 16
(891) 2014 07 16
(511) 09

(260) AM 2016 80426 A
(800) 1230669
(151) 2014 09 26
(181) 2024 09 26
(891) 2014 09 26
(511) 05

(260) AM 2016 80408 A
(800) 1230554
(151) 2014 07 28
(181) 2024 07 28
(891) 2014 07 28
(511) 03, 09, 18, 25, 32, 35

(260) AM 2016 80428 A
(800) 1230691
(151) 2014 09 12
(181) 2024 09 12
(891) 2014 09 12
(511) 03

(260) AM 2016 80409 A
(800) 1230579
(151) 2014 09 02
(181) 2024 09 02
(891) 2014 09 02
(511) 35, 37

(260) AM 2016 80429 A
(800) 1230693
(151) 2014 10 20
(181) 2024 10 20
(891) 2014 10 20
(511) 32, 33

(260) AM 2016 80430 A
(800) 1230705
(151) 2014 06 16
(181) 2024 06 16
(891) 2014 06 16
(511) 39, 41, 43

(260) AM 2016 80431 A
(800) 1230735
(151) 2014 10 15
(181) 2024 10 15
(891) 2014 10 15
(511) 25

(260) AM 2016 80432 A
(800) 1230765
(151) 2014 08 06
(181) 2024 08 06
(891) 2014 08 06
(511) 06

(260) AM 2016 80433 A
(800) 1230767
(151) 2013 11 21
(181) 2023 11 21
(891) 2013 11 21
(511) 01, 03, 05, 10, 21, 24, 30, 32, 35

(260) AM 2016 80434 A
(800) 1230768
(151) 2014 01 13
(181) 2024 01 13
(891) 2014 01 13
(511) 09

(260) AM 2016 80530 A
(800) 1231891
(151) 2014 10 09
(181) 2024 10 09
(891) 2014 10 09
(511) 20, 35

(260) AM 2016 80531 A
(800) 1231907
(151) 2014 10 28
(181) 2024 10 28
(891) 2014 10 28
(511) 05

(260) AM 2016 80535 A
(800) 1231937
(151) 2014 09 17
(181) 2024 09 17

(891) 2014 09 17
(511) 09, 38, 42

(260) AM 2016 80536 A
(800) 1231939
(151) 2014 01 16
(181) 2024 01 16
(891) 2014 01 16
(511) 03, 05, 12

(260) AM 2016 80545 A
(800) 1231895
(151) 2014 09 24
(181) 2024 09 24
(891) 2014 09 24
(511) 18, 25

(260) AM 2016 80546 A
(800) 1232030
(151) 2014 09 17
(181) 2024 09 17
(891) 2014 09 17
(511) 12, 37, 39

(260) AM 2016 80550 A
(800) 1232090
(151) 2014 10 08
(181) 2024 10 08
(891) 2014 10 08
(511) 06, 07, 09, 12, 19

(260) AM 2016 80562 A
(800) 1232238
(151) 2014 10 31
(181) 2024 10 31
(891) 2014 10 31
(511) 05

(260) AM 2016 80563 A
(800) 1232250
(151) 2014 10 08
(181) 2024 10 08
(891) 2014 10 08
(511) 25

(260) AM 2016 80568 A
(800) 1232321
(151) 2014 09 25
(181) 2024 09 25
(891) 2014 09 25
(511) 03

(260) AM 2016 80570 A
(800) 1232327
(151) 2014 10 02
(181) 2024 10 02
(891) 2014 10 02
(511) 25, 35, 37, 40, 42

(260) AM 2016 80572 A
(800) 1232329
(151) 2014 09 26
(181) 2024 09 26
(891) 2014 09 26
(511) 05

(260) AM 2016 80573 A
(800) 1232330
(151) 2014 09 26
(181) 2024 09 26
(891) 2014 09 26
(511) 05

(260) AM 2016 80584 A
(800) 1232340
(151) 2014 09 23
(181) 2024 09 23
(891) 2014 09 23
(511) 25

(260) AM 2016 80586 A
(800) 1232372
(151) 2014 05 23
(181) 2024 05 23
(891) 2014 05 23
(511) 09, 16, 35, 41, 43

(260) AM 2016 80588 A
(800) 1232448
(151) 2014 11 11
(181) 2024 11 11
(891) 2014 11 11
(511) 12

(260) AM 2016 80589 A
(800) 1232460
(151) 2014 11 03
(181) 2024 11 03
(891) 2014 11 03
(511) 05

(260) AM 2016 80590 A
(800) 1232480
(151) 2014 11 06
(181) 2024 11 06

(891) 2014 11 06
(511) 03

(260) AM 2016 80591 A
(800) 1232483
(151) 2014 11 12
(181) 2024 11 12
(891) 2014 11 12
(511) 05

(260) AM 2016 80592 A
(800) 1232484
(151) 2014 11 19
(181) 2024 11 19
(891) 2014 11 19
(511) 01, 05

(260) AM 2016 80593 A
(800) 627824
(151) 1994 11 04
(181) 2024 11 04
(891) 2014 11 25
(511) 11

(260) AM 2016 80608 A
(800) 910529A
(151) 2006 06 22
(181) 2026 06 22
(891) 2014 12 08
(511) 32, 33

(260) AM 2016 80610 A
(800) 923992
(151) 2007 02 27
(181) 2017 02 27
(891) 2014 10 20
(511) 43

(260) AM 2016 80613 A
(800) 952841
(151) 2007 06 25
(181) 2017 06 25
(891) 2014 10 17
(511) 01, 04

(260) AM 2016 80614 A
(800) 1138504
(151) 2012 04 17
(181) 2022 04 17
(891) 2014 11 14
(511) 14, 18, 25

(260) AM 2016 80618 A
(800) 1169475
(151) 2013 01 09
(181) 2023 01 09
(891) 2014 11 14
(511) 03, 09, 14, 18, 25

(260) AM 2016 80619 A
(800) 1174137
(151) 2013 08 01
(181) 2023 08 01
(891) 2014 10 20
(511) 39

(260) AM 2016 80620 A
(800) 1108196
(151) 2012 01 12
(181) 2022 01 12
(891) 2013 12 30
(511) 01, 04

(260) AM 2016 80631 A
(800) 1232542
(151) 2014 10 30
(181) 2024 10 30
(891) 2014 10 30
(511) 01, 02, 19

(260) AM 2016 80645 A
(800) 1232613
(151) 2014 08 22
(181) 2024 08 22
(891) 2014 08 22
(511) 01, 02, 16, 17, 19, 27

(260) AM 2016 80650 A
(800) 1232651
(151) 2014 09 30
(181) 2024 09 30
(891) 2014 09 30
(511) 05

(260) AM 2016 80652 A
(800) 1232653
(151) 2014 09 26
(181) 2024 09 26
(891) 2014 09 26
(511) 05

(260) AM 2016 80653 A
(800) 1232654
(151) 2014 09 26
(181) 2024 09 26

(891) 2014 09 26
(511) 05

(260) AM 2016 80657 A
(800) 1232659
(151) 2014 11 04
(181) 2024 11 04
(891) 2014 11 04
(511) 05

(260) AM 2016 80659 A
(800) 1232670
(151) 2014 09 30
(181) 2024 09 30
(891) 2014 09 30
(511) 12

(260) AM 2016 80661 A
(800) 1232704
(151) 2014 11 28
(181) 2024 11 28
(891) 2014 11 28
(511) 05

(260) AM 2016 80662 A
(800) 1232713
(151) 2014 09 23
(181) 2024 09 23
(891) 2014 09 23
(511) 03

(260) AM 2016 80667 A
(800) 1232721
(151) 2014 10 10
(181) 2024 10 10
(891) 2014 10 10
(511) 30

(260) AM 2016 80670 A
(800) 1232763
(151) 2014 12 05
(181) 2024 12 05
(891) 2014 12 05
(511) 05

(260) AM 2016 80671 A
(800) 1232764
(151) 2014 12 05
(181) 2024 12 05
(891) 2014 12 05
(511) 05

(260) AM 2016 80672 A
(800) 1232765
(151) 2014 12 05
(181) 2024 12 05
(891) 2014 12 05
(511) 05

(260) AM 2016 80673 A
(800) 1232766
(151) 2014 12 05
(181) 2024 12 05
(891) 2014 12 05
(511) 05

(260) AM 2016 80683 A
(800) 1232826
(151) 2014 10 10
(181) 2024 10 10
(891) 2014 10 10
(511) 01, 03, 05, 29, 30

(260) AM 2016 80684 A
(800) 1232827
(151) 2014 10 10
(181) 2024 10 10
(891) 2014 10 10
(511) 01, 03, 05, 29, 30

(260) AM 2016 80690 A
(800) 1232859
(151) 2014 11 04
(181) 2024 11 04
(891) 2014 11 04
(511) 03, 05

(260) AM 2016 80692 A
(800) 1232898
(151) 2014 11 20
(181) 2024 11 20
(891) 2014 11 20
(511) 33

(260) AM 2016 80694 A
(800) 1232906
(151) 2014 08 25
(181) 2024 08 25
(891) 2014 08 25
(511) 09, 28

(260) AM 2016 80695 A
(800) 1232914
(151) 2014 09 04

(181) 2024 09 04
(891) 2014 09 04
(511) 03, 05

(260) AM 2016 80697 A
(800) 1232939
(151) 2014 09 25
(181) 2024 09 25
(891) 2014 09 25
(511) 07

(260) AM 2016 80698 A
(800) 1232943
(151) 2014 09 26
(181) 2024 09 26
(891) 2014 09 26
(511) 07

(260) AM 2016 80699 A
(800) 1232950
(151) 2014 09 10
(181) 2024 09 10
(891) 2014 09 10
(511) 09, 16, 35, 41

(260) AM 2016 80700 A
(800) 1232963
(151) 2014 06 16
(181) 2024 06 16
(891) 2014 06 16
(511) 05

(260) AM 2016 80702 A
(800) 1232979
(151) 2014 10 03
(181) 2024 10 03
(891) 2014 10 03
(511) 05

(260) AM 2016 80705 A
(800) 1233124
(151) 2014 12 01
(181) 2024 12 01
(891) 2014 12 01
(511) 30

(260) AM 2016 80706 A
(800) 1233125
(151) 2014 12 01
(181) 2024 12 01
(891) 2014 12 01
(511) 30

(260) AM 2016 80707 A
(800) 1233126
(151) 2014 10 13
(181) 2024 10 13
(891) 2014 10 13
(511) 33

(260) AM 2016 80708 A
(800) 1233127
(151) 2014 10 13
(181) 2024 10 13
(891) 2014 10 13
(511) 33

(260) AM 2016 80712 A
(800) 1233139
(151) 2014 07 07
(181) 2024 07 07
(891) 2014 07 07
(511) 05

(260) AM 2016 80714 A
(800) 1233162
(151) 2014 10 23
(181) 2024 10 23
(891) 2014 10 23
(511) 09, 12, 25

(260) AM 2016 80715 A
(800) 1233169
(151) 2014 12 02
(181) 2024 12 02
(891) 2014 12 02
(511) 12

(260) AM 2016 80720 A
(800) 1233174
(151) 2014 04 04
(181) 2024 04 04
(891) 2014 04 04
(511) 11

(260) AM 2016 80722 A
(800) 1233188
(151) 2014 01 27
(181) 2024 01 27
(891) 2014 01 27
(511) 01, 02, 03, 04, 05, 06, 07, 08, 09, 11, 12, 14,
16, 18, 19, 20, 21, 25, 27, 35, 36, 37, 38, 39,
40, 41, 42, 43, 44, 45

(260) AM 2016 80724 A
(800) 1233203
(151) 2014 02 26
(181) 2024 02 26
(891) 2014 02 26
(511) 08, 11, 20, 21, 24, 25, 27, 35

(260) AM 2016 80729 A
(800) 1233216
(151) 2014 10 20
(181) 2024 10 20
(891) 2014 10 20
(511) 30

(260) AM 2016 80730 A
(800) 1233225
(151) 2014 07 17
(181) 2024 07 17
(891) 2014 07 17
(511) 05

(260) AM 2016 80734 A
(800) 1233260
(151) 2014 07 17
(181) 2024 07 17
(891) 2014 07 17
(511) 05, 09

(260) AM 2016 80737 A
(800) 1233304
(151) 2014 10 07
(181) 2024 10 07
(891) 2014 10 07
(511) 05

(260) AM 2016 80738 A
(800) 1233315
(151) 2014 09 30
(181) 2024 09 30
(891) 2014 09 30
(511) 05

(260) AM 2016 80739 A
(800) 1233316
(151) 2014 09 30
(181) 2024 09 30
(891) 2014 09 30
(511) 05

(260) AM 2016 80741 A
(800) 1233317
(151) 2014 09 30
(181) 2024 09 30

(891) 2014 09 30
(511) 05

(260) AM 2016 80744 A
(800) 1233318
(151) 2014 09 30
(181) 2024 09 30
(891) 2014 09 30
(511) 05

(260) AM 2016 80745 A
(800) 1233324
(151) 2014 10 29
(181) 2024 10 29
(891) 2014 10 29
(511) 09, 35, 36, 38, 41, 42

(260) AM 2016 80746 A
(800) 1233333
(151) 2014 11 11
(181) 2024 11 11
(891) 2014 11 11
(511) 07

(260) AM 2016 80747 A
(800) 1233344
(151) 2014 10 22
(181) 2024 10 22
(891) 2014 10 22
(511) 05, 10

(260) AM 2016 80748 A
(800) 1233346
(151) 2014 11 20
(181) 2024 11 20
(891) 2014 11 20
(511) 45

(260) AM 2016 80750 A
(800) 1233351
(151) 2014 10 27
(181) 2024 10 27
(891) 2014 10 27
(511) 29, 32, 35

(260) AM 2016 80751 A
(800) 1233352
(151) 2014 10 24
(181) 2024 10 24
(891) 2014 10 24
(511) 30

(260) AM 2016 80752 A
(800) 1233353
(151) 2014 10 24
(181) 2024 10 24
(891) 2014 10 24
(511) 30

(260) AM 2016 80753 A
(800) 1233354
(151) 2014 10 10
(181) 2024 10 10
(891) 2014 10 10
(511) 30

(260) AM 2016 80754 A
(800) 1233360
(151) 2014 10 20
(181) 2024 10 20
(891) 2014 10 20
(511) 30

(260) AM 2016 80755 A
(800) 364846A
(151) 1970 01 20
(181) 2020 01 20
(891) 2014 11 06
(511) 32

(260) AM 2016 80756 A
(800) 596607
(151) 1992 12 22
(181) 2022 12 22
(891) 2015 01 14
(511) 29, 30, 31, 32

(260) AM 2016 80897 A
(800) 468505
(151) 1982 04 19
(181) 2022 04 19
(891) 2014 11 25
(511) 05

(260) AM 2016 80898 A
(800) 589879
(151) 1992 07 15
(181) 2022 07 15
(891) 2014 11 19
(511) 03

(260) AM 2016 80900 A
(800) 836845
(151) 2004 07 02

(181) 2024 07 02
(891) 2014 11 19
(511) 03

(260) AM 2016 80902 A
(800) 1217013
(151) 2014 07 02
(181) 2024 07 02
(891) 2015 01 09
(511) 33

(260) AM 2016 80904 A
(800) 1226502
(151) 2014 10 02
(181) 2024 10 02
(891) 2014 11 26
(511) 25

APPELLATIONS OF ORIGIN AND GEOGRAPHICAL

APPELLATIONS OF ORIGIN OF GOODS FILED IN GEORGIA FOR EXAMINATION UNDER LISBON AGREEMENT, ON THE BASIS OF THE INTERNATIONAL REGISTRATION

The decision can be appealed at the Chamber of Appeal of Sakpatenti within 3 months from the publication or at the Mtskheta District Court Administrative Cases Board (Address: №17, Samkhedro str., Mtskheta), within 1 month following the publication.

Number of Indication:1265

Number of International Registration: 961

Data of International Registration: 2014 10 23

Application Filing Date: 2015 03 26

Appellation of Origin of Good: **ACETO BALSAMICO TRADIZIONALE DI MODENA**

The Goods for which the Registration of Appellation of Origin is Required:

29 – Vinegars (other than wine vinegars).

30 – Vinegars (other than wine vinegars).

Name and Address of Applicant: 1. Ministero delle Politiche Agricole Alimentari e Forestali
Via XX Settembre, 20, 00187- Roma, Italy;
2. Consorzio Tutela Aceto Balsamico Tradizionale di Modena
Via Ganaceto 134 - 41100 - Modena, Italy

Number of Indication:1266

Number of International Registration: 962

Data of International Registration: 2014 10 23

Application Filing Date: 2015 03 26

Appellation of Origin of Good: **VAL DI MAZARA**

The Goods for which the Registration of Appellation of Origin is Required:

29 – Oil.

Name and Address of Applicant: 1. Ministero delle Politiche Agricole Alimentari e Forestali
Via XX Settembre, 20, 00187- Roma, Italy;
2. Consorzio Volontario per la Tutela dell'Olio Extravergine di Oliva Dop
Val di Mazara
Via Mariano d'Amelio, 78 - 90133 - Palermo, Italy

Number of Indication:1267

Number of International Registration: 963

Data of International Registration: 2014 10 23

Application Filing Date: 2015 03 26

Appellation of Origin of Good: **GARDA**

The Goods for which the Registration of Appellation of Origin is Required:

29 – Oil.

Name and Address of Applicant: 1. Ministero delle Politiche Agricole Alimentari e Forestali
Via XX Settembre, 20, 00187- Roma, Italy;
2. Consorzio di Tutela Olio Extravergine di Oliva Garda
Via Vittorio Veneto, 1 - 37010 - Cavaion Veronese (VR),
Italy

Number of Indication:1268

Number of International Registration: 964

Data of International Registration: 2014 10 23

Application Filing Date: 2015 03 26

Appellation of Origin of Good: **GRAPPA**

The Goods for which the Registration of Appellation of Origin is Required:

33 – Spirits.

- Name and Address of Applicant:
1. Ministero delle Politiche Agricole Alimentari e Forestali
Via XX Settembre, 20, 00187- Roma, Italy;
 2. Associazione Nazionale Industriali Distillatori di Alcoli ed Acquaviti
Via Torino, 146 - 00184 - Roma, Italy
-

Number of Indication:1270

Number of International Registration: 965

Data of International Registration: 2014 10 23

Application Filing Date: 2015 04 02

Appellation of Origin of Good: **BRESAOLA DELLA VALTELLINA**

The Goods for which the Registration of Appellation of Origin is Required:

29 – Meat products.

- Name and Address of Applicant:
1. Ministero delle Politiche Agricole Alimentari e Forestali
Via XX Settembre, 20, 00187- Roma, Italy;
 2. Consorzio per la tutela del nome Bresaola della Valtellina
Via Trieste, 66 - 23100 - Sondrio, Italy
-

Number of Indication:1271

Number of International Registration: 966

Data of International Registration: 2014 10 23

Application Filing Date: 2015 04 02

Appellation of Origin of Good: **MONTI IBLEI**

The Goods for which the Registration of Appellation of Origin is Required:

29 – Oils and fats.

- Name and Address of Applicant:
1. Ministero delle Politiche Agricole Alimentari e Forestali
Via XX Settembre, 20, 00187- Roma, Italy;
 2. Consorzio Tutela Olio DOP Monti Iblei
c/o CCIAA di Ragusa, Piazza Libertà - 97100 - Ragusa, Italy
-

Number of Indication:1272

Number of International Registration: 967

Data of International Registration: 2014 10 23

Application Filing Date: 2015 04 02

Appellation of Origin of Good: **SALAME BRIANZA**

The Goods for which the Registration of Appellation of Origin is Required:

29 – Meat products.

- Name and Address of Applicant:
1. Ministero delle Politiche Agricole Alimentari e Forestali
Via XX Settembre, 20, 00187- Roma, Italy;
 2. Consorzio Salame Brianza
Via Bergamo, 35 - 23807 - Merate (LC), Italy
-

Number of Indication:1273

Number of International Registration: 968

Data of International Registration: 2014 10 23

Application Filing Date: 2015 04 02

Appellation of Origin of Good: **CASTELMAGNO**

The Goods for which the Registration of Appellation of Origin is Required:

29 – Cheese.

Name and Address of Applicant:

1. Ministero delle Politiche Agricole Alimentari e Forestali
Via XX Settembre, 20, 00187- Roma, Italy;
2. Consorzio per la tutela del formaggio Castelmagno DOP
Piazza Caduti, 1 - Fr. Campomolino - 12020 - Castelmagno
(CN), Italy

Number of Indication:1274

Number of International Registration: 969

Data of International Registration: 2014 10 23

Application Filing Date: 2015 04 02

Appellation of Origin of Good: **LIMONE DI SORRENTO**

The Goods for which the Registration of Appellation of Origin is Required:

29 – Fruit, vegetables and cereals fresh or processed.

30 – Fruit, vegetables and cereals fresh or processed.

31 – Fruit, vegetables and cereals fresh or processed.

Name and Address of Applicant:

1. Ministero delle Politiche Agricole Alimentari e Forestali
Via XX Settembre, 20, 00187- Roma, Italy;
2. Consorzio di Tutela del Limone di Sorrento
Via dei Platani, 15 - 80063 - Piano di Sorrento (NA), Italy

Number of Indication:1275

Number of International Registration: 970

Data of International Registration: 2014 10 23

Application Filing Date: 2015 04 02

Appellation of Origin of Good: **RADICCHIO ROSSO DI TREVISO**

The Goods for which the Registration of Appellation of Origin is Required:

29 – Fruit, vegetables and cereals fresh or processed.

30 – Fruit, vegetables and cereals fresh or processed.

31 – Fruit, vegetables and cereals fresh or processed.

Name and Address of Applicant:

1. Ministero delle Politiche Agricole Alimentari e Forestali
Via XX Settembre, 20, 00187- Roma, Italy;
2. Consorzio tutela Radicchio Rosso di Treviso e Variegato di
Castelfranco
c/o C.C.I.A.A. di Treviso, Piazza Borsa, 1 -31100 - Treviso, Italy

Number of Indication:1276

Number of International Registration: 971

Data of International Registration: 2014 10 23

Application Filing Date: 2015 04 02

Appellation of Origin of Good: **SALAME CREMONA**

The Goods for which the Registration of Appellation of Origin is Required:

29 – Meat products.

Name and Address of Applicant: 1. Ministero delle Politiche Agricole Alimentari e Forestali
Via XX Settembre, 20, 00187- Roma, Italy;
2. Consorzio Salame Cremona
Piazza Cadorna, 6 - 26100 - Cremona, Italy

Number of Indication:1277

Number of International Registration: 972

Data of International Registration: 2014 10 23

Application Filing Date: 2015 04 02

Appellation of Origin of Good: **LIMONE COSTA D'AMALFI**

The Goods for which the Registration of Appellation of Origin is Required:

31 – Lemons in the natural state.

Name and Address of Applicant: 1. Ministero delle Politiche Agricole Alimentari e Forestali
Via XX Settembre, 20, 00187- Roma, Italy;
2. Consorzio di Tutela Limone Costa d'Amalfi
Corso Regina 71 – 84010 - Maiori (SA), Italy

Number of Indication:1278

Number of International Registration: 973

Data of International Registration: 2014 10 23

Application Filing Date: 2015 04 02

Appellation of Origin of Good: **CHIANTI CLASSICO**

The Goods for which the Registration of Appellation of Origin is Required:

29 – Oil.

Name and Address of Applicant: 1. Ministero delle Politiche Agricole Alimentari e Forestali
Via XX Settembre, 20, 00187- Roma, Italy;
2. Consorzio di tutela della denominazione di origine protetta olio
extravergine di oliva Chianti Classico
Via Scopeti, 155 - 50026 - Sant'Andrea in Percussina, San
Casciano in Val di Pesa (FI), Italy

Number of Indication:1279

Number of International Registration: 974

Data of International Registration: 2014 10 23

Application Filing Date: 2015 04 02

Appellation of Origin of Good: **ROBIOLA DI ROCCAVERANO**

The Goods for which the Registration of Appellation of Origin is Required:

29 – Cheese.

Name and Address of Applicant: 1. Ministero delle Politiche Agricole Alimentari e Forestali
Via XX Settembre, 20, 00187- Roma, Italy;
2. Consorzio per la Tutela del Formaggio Robiola di Roccaverano;
Via Roma, 8 - 14050 - Roccaverano (AT), Italy

Number of Indication:1280

Number of International Registration: 975

Data of International Registration: 2014 10 23

Application Filing Date: 2015 04 02

Appellation of Origin of Good: **LA BELLA DELLA DAUNIA**

The Goods for which the Registration of Appellation of Origin is Required:

29 – Fruit, vegetables and cereals fresh or processed.

30 – Fruit, vegetables and cereals fresh or processed.

31 – Fruit, vegetables and cereals fresh or processed.

Name and Address of Applicant:

1. Ministero delle Politiche Agricole Alimentari e Forestali
Via XX Settembre, 20, 00187- Roma, Italy;
2. Consorzio di Tutela Oliva da Mensa D.O.P. la Bella della
Daunia – Cultivar Bella di Cerignola
Piazza della Repubblica - Palazzo di Città - 71042 –
Cerignola (FG), Italy

OFFICIAL NOTIFICATIONS

TRADEMARKS

INVALIDATION OF TRADEMARKS REGISTRATION

(111) M 1999 12048 R1
(141) 2015 10 27, On demand of the owner
(732) THE GILLETTE COMPANY
One Gillette Park, Boston, Massachusetts
02127, US

(111) M 2005 15904 R
(141) 2015 10 01, Not payment for prolongation of
registration on the following of 10 years
(732) SANOVEL ILAC SANAYII VE TICARET
ANONIM SIRKETI
Buyukdere Caddesi Zagra Is Merkezi C blok
Maslak, Istanbul, TR

(111) M 2005 15908 R
(141) 2015 10 01, Not payment for prolongation of
registration on the following of 10 years
(732) NUGZAR ZAUTASHVILI
Gldani, I m/r, korp. 16, b. 79, Tbilisi, GE

(111) M 2005 15926 R
(141) 2015 11 03, Not payment for prolongation of
registration on the following of 10 years
(732) LTD "SLAVJANKA PLUS"
309530, Belgorodskaya obl., g. Staryj Oskol,
ul. Oktjabrskaya d. 20, RU

(111) M 2005 15936 R1
(141) 2015 11 03, Not payment for prolongation of
registration on the following of 10 years
(732) LTD "Gvinis kompania shumi"
Solomon Lionidzis q. 33, 2200, Telavi, GE

(111) M 2005 16000 R
(141) 2015 12 15, Not payment for prolongation of
registration on the following of 10 years
(732) NOVARTIS AG
4002 Basel, CH

(111) M 1996 4189 R1
(141) 2007 06 12, Not payment for prolongation of
registration on the following of 10 years
(732) UNILEVER N.V.
Weena 455, NL-3013 AL Rotterdam, NL

(111) M 1995 610 R1
(141) 2005 05 03, Not payment for prolongation of
registration on the following of 10 years
(732) MITSUBISHI CHEMICAL MEDIA CO. LTD.
6F, ANA Tamachi Building 31-19, Shiba 5
chome, Minato-ku, Tokyo 108-0014, JP

(111) M 1995 613 R1
(141) 2005 11 03, Not payment for prolongation of
registration on the following of 10 years
(732) H. H. SCOTT, INCORPORATION
9 Entin Road, Parsippany, New Jersey
07054-0430, US

(111) M 1995 616 R1
(141) 2005 11 03, Not payment for prolongation of
registration on the following of 10 years
(732) EMERSON RADIO CORPORATION
One Emerson Lane, North Bergen,
New Jersey 07047, US

(111) M 1995 627 R1
(141) 2005 11 03, Not payment for prolongation of
registration on the following of 10 years
(732) PHILIP MORRIS PRODUCTS S.A.
Quai Jeanrenaud 3, 2000 NEUCHATEL, CH

(111) M 1995 630 R1
(141) 2005 11 03, Not payment for prolongation of
registration on the following of 10 years
(732) H. H. SCOTT, INCORPORATION
9 Entin Road, Parsippany, New Jersey
07054-0430, US

(111) M 1995 656 R1
(141) 2005 06 28, Not payment for prolongation of
registration on the following of 10 years
(732) BAYER AG
D-51368 Leverkusen, DE

(111) M 1995 657 R1
(141) 2005 06 28, Not payment for prolongation of
registration on the following of 10 years
(732) BAYER INTELLECTUAL PROPERTY
GMBH

Alfred-Nobel-Strasse 10, 40789 Monheim am Rhein, DE

(111) M 1995 658 R1

(141) 2005 06 28, Not payment for prolongation of registration on the following of 10 years

(732) AWD.PHARMA GMBH & CO.KG
Leipziger Strasse 7-13, 01097 Drezden,
Germany

(111) M 1995 660 R1

(141) 2005 06 28, Not payment for prolongation of registration on the following of 10 years

(732) BAYER INTELLECTUAL PROPERTY
GMBH
Alfred-Nobel-Strasse 10, 40789 Monheim am Rhein, DE

(111) M 1995 686 R1

(141) 2005 07 06, Not payment for prolongation of registration on the following of 10 years

(732) CITIBANK, N.A.
399 Park Avenue, New York, New York US

(111) M 1995 689 R1

(141) 2005 07 07, Not payment for prolongation of registration on the following of 10 years

(732) MELLES GRIOT, INC.
2051 Palomar Airport Road, Suite 200,
Carlsbad, CA 92009, US

CLASSIFICATION INDEXES

INVENTIONS

CONCORDANCE TABLE OF INTERNATIONAL CLASSIFICATION INDEX AND PUBLICATION NUMBERS

INTERNATIONAL CLASSIFICATION INDEXES (51)	NUMBER OF PUBLISHED APPLICATION (10)
A 01 B 19/02	AP 2016 13717 A
A 01 D 46/04	AP 2016 13742 A
A 01 D 46/26	AP 2016 13743 A
A 61 K 9/22; A 61 K 9/32; A 61 K 31/495; A 61 K 47/02; A 61 K 47/32; A 61 K 47/34; A 61 P 25/24	AP 2016 12905 A
C 07 D 401/12; C 09 D 401/14; A 61 K 31/454; A 61 K 31/4545; A 61 P 3/00; A 61 P 25/00; A 61 P 29/00; A 61 P 35/00; C 07 D 405/14	AP 2016 13563 A
C 07 D 401/14; C 07 D 211/58; C 07 D 213/81; C 07 D 401/04; A 61 K 31/454; A 61 P 31/00	AP 2016 13082 A
C 07 K 16/28	AP 2016 12885 A

CONCORDANCE TABLE OF PUBLICATION NUMBERS AND INTERNATIONAL CLASSIFICATION INDEX

NUMBER OF PUBLISHED APPLICATION (10)	INTERNATIONAL CLASSIFICATION INDEXES (51)
AP 2016 12885 A	C 07 K 16/28
AP 2016 12905 A	A 61 K 9/22; A 61 K 9/32; A 61 K 31/495; A 61 K 47/02; A 61 K 47/32; A 61 K 47/34; A 61 P 25/24
AP 2016 13082 A	C 07 D 401/14; C 07 D 211/58; C 07 D 213/81; C 07 D 401/04; A 61 K 31/454; A 61 P 31/00
AP 2016 13563 A	C 07 D 401/12; C 09 D 401/14; A 61 K 31/454; A 61 K 31/4545; A 61 P 3/00; A 61 P 25/00; A 61 P 29/00; A 61 P 35/00; C 07 D 405/14
AP 2016 13717 A	A 01 B 19/02
AP 2016 13742 A	A 01 D 46/04
AP 2016 13743 A	A 01 D 46/26

CONCORDANCE TABLE OF INTERNATIONAL CLASSIFICATION INDEX, PATENT NUMBERS AND PUBLICATION NUMBERS

INTERNATIONAL CLASSIFICATION INDEX (51)	NUMBER OF PATENT (11)	NUMBER OF PUBLISHED APPLICATION (10)
A 61 K 36/064; A 61 K 38/44; A 61 P 3/04	P 2016 6436 B	AP 2015 13368 A
C 07 D 487/04; A 61 K 31/4188; A 61 P 35/00	P 2016 6438 B	AP 2015 13535 A
C 07 K 7/08; C 07 K 14/47	P 2016 6435 B	AP 2015 12738 A
C 12 G 3/06	P 2016 6437 B	AP 2015 13436 A

**CONCORDANCE TABLE OF PATENT NUMBERS,
PUBLICATION NUMBERS AND INTERNATIONAL CLASSIFICATION INDEX**

NUMBER OF PATENT (11)	NUMBER OF PUBLISHED APPLICATION (10)	INTERNATIONAL CLASSIFICATION INDEX (51)
P 2016 6435 B	AP 2015 12738 A	C 07 K 7/08; C 07 K 14/47
P 2016 6436 B	AP 2015 13368 A	A 61 K 36/064; A 61 K 38/44; A 61 P 3/04
P 2016 6437 B	AP 2015 13436 A	C 12 G 3/06
P 2016 6438 B	AP 2015 13535 A	C 07 D 487/04; A 61 K 31/4188; A 61 P 35/00

**CONCORDANCE TABLE OF APPLICATION NUMBERS, PUBLICATION NUMBERS
AND PATENTS**

NUMBER OF APPLICATION (21)	NUMBER OF PUBLISHED APPLICATION (10)	NUMBER OF PATENT (11)
AP 2010 012738	AP 2015 12738 A	P 2016 6435 B
AP 2012 013368	AP 2015 13368 A	P 2016 6436 B
AP 2014 013436	AP 2015 13436 A	P 2016 6437 B
AP 2013 013535	AP 2015 13535 A	P 2016 6438 B

UTILITY MODELS

**CONCORDANCE TABLE OF INTERNATIONAL CLASSIFICATION INDEX,
PATENT NUMBERS AND PUBLICATION NUMBERS**

INTERNATIONAL CLASSIFICATION INDEX (51)	NUMBER OF PATENT (11)	NUMBER OF PUBLISHED APPLICATION (10)
A 23 K 1/22	U 2016 1887 Y	AU 2015 13620 U
A 61 M 5/14	U 2016 1888 Y	AU 2015 13782 U
C 05 C 9/02	U 2016 1885 Y	AU 2015 13255 U
C 23 C 18/38	U 2016 1886 Y	AU 2015 13256 U

**CONCORDANCE TABLE OF PATENT NUMBERS,
PUBLICATION NUMBERS AND INTERNATIONAL CLASSIFICATION INDEX**

NUMBER OF PATENT (11)	NUMBER OF PUBLISHED APPLICATION (10)	INTERNATIONAL CLASSIFICATION INDEX (51)
U 2016 1885 Y	AU 2015 13255 U	C 05 C 9/02
U 2016 1886 Y	AU 2015 13256 U	C 23 C 18/38
U 2016 1887 Y	AU 2015 13620 U	A 23 K 1/22
U 2016 1888 Y	AU 2015 13782 U	A 61 M 5/14

**CONCORDANCE TABLE OF APPLICATION NUMBERS, PUBLICATION NUMBERS
AND PATENTS**

NUMBER OF APPLICATION (21)	NUMBER OF PUBLISHED APPLICATION (10)	NUMBER OF PATENT (11)
AU 2013 013255	AU 2015 13255 U	U 2016 1885 Y
AU 2013 013256	AU 2015 13256 U	U 2016 1886 Y
AU 2014 013620	AU 2015 13620 U	U 2016 1887 Y
AU 2015 013782	AU 2015 13782 U	U 2016 1888 Y

DESIGNS

**DESIGN REGISTERED ACCORDING TO THE
ACCELERATED PROCEDURE**

**CONCORDANCE TABLE OF INTERNATIONAL CLASSIFICATION INDEX
AND PATENTS NUMBERS**

INTERNATIONAL CLASSIFICATION INDEX (51)	NUMBER OF PATENT (11)
09-01	D 2016 663 S

**CONCORDANCE TABLE OF PATENT NUMBERS AND INTERNATIONAL
CLASSIFICATION INDEX**

NUMBER OF PATENT (11)	INTERNATIONAL CLASSIFICATION INDEX (51)
D 2016 663 S	09-01

**CONCORDANCE TABLE OF APPLICATION NUMBERS
AND PATENT NUMBERS**

NUMBER OF APPLICATION (21)	NUMBER OF PATENT (11)
AD 2016 000898	D 2016 663 S

TRADEMARKS

CONCORDANCE TABLE OF REGISTRATION NUMBERS, APPLICATION NUMBERS, PUBLICATION NUMBERS AND BULLETIN NUMBERS

NUMBER OF REGISTRATION (111)	NUMBER OF APPLICATIONS (210)	NUMBER OF PUBLISHED APPLICATIONS (260)	NUMBER OF BULLETIN
1	2	3	4
M 2016 26736 R	AM 75933	AM 2015 75933 A	9(421)2015
M 2016 26737 R	AM 76082	AM 2015 76082 A	10(422)2015
M 2016 26738 R	AM 76608	AM 2015 76608 A	9(421)2015
M 2016 26739 R	AM 76609	AM 2015 76609 A	9(421)2015
M 2016 26740 R	AM 77602	AM 2015 77602 A	12(424)2015
M 2016 26741 R	AM 78893	AM 2015 78893 A	16(428)2015
M 2016 26742 R	AM 78909	AM 2015 78909 A	15(427)2015
M 2016 26743 R	AM 78956	AM 2015 78956 A	17(429)2015
M 2016 26744 R	AM 79069	AM 2015 79069 A	17(429)2015
M 2016 26745 R	AM 79072	AM 2015 79072 A	10(422)2015
M 2016 26746 R	AM 79217	AM 2015 79217 A	14(426)2015
M 2016 26747 R	AM 79447	AM 2015 79447 A	13(425)2015
M 2016 26748 R	AM 79448	AM 2015 79448 A	14(426)2015
M 2016 26749 R	AM 79449	AM 2015 79449 A	14(426)2015
M 2016 26750 R	AM 79450	AM 2015 79450 A	14(426)2015
M 2016 26751 R	AM 79451	AM 2015 79451 A	15(427)2015
M 2016 26752 R	AM 79480	AM 2015 79480 A	13(425)2015
M 2016 26753 R	AM 79481	AM 2015 79481 A	15(427)2015
M 2016 26754 R	AM 79482	AM 2015 79482 A	15(427)2015
M 2016 26755 R	AM 79483	AM 2015 79483 A	14(426)2015
M 2016 26756 R	AM 79484	AM 2015 79484 A	14(426)2015
M 2016 26757 R	AM 79845	AM 2015 79845 A	17(429)2015
M 2016 26758 R	AM 79846	AM 2015 79846 A	17(429)2015
M 2016 26759 R	AM 79884	AM 2015 79884 A	17(429)2015
M 2016 26760 R	AM 79924	AM 2015 79924 A	17(429)2015
M 2016 26761 R	AM 79926	AM 2015 79926 A	17(429)2015
M 2016 26762 R	AM 79927	AM 2015 79927 A	17(429)2015
M 2016 26763 R	AM 79944	AM 2015 79944 A	17(429)2015
M 2016 26764 R	AM 79966	AM 2015 79966 A	17(429)2015
M 2016 26765 R	AM 80481	AM 2015 80481 A	18(430)2015
M 2016 26766 R	AM 80482	AM 2015 80482 A	18(430)2015
M 2016 26767 R	AM 80483	AM 2015 80483 A	18(430)2015
M 2016 26768 R	AM 80910	AM 2015 80910 A	18(430)2015
M 2016 26769 R	AM 80911	AM 2015 80911 A	18(430)2015
M 2016 26770 R	AM 85699	-	4(440)2016
M 2016 26771 R	AM 85681	-	4(440)2016
M 2016 26772 R	AM 85746	-	4(440)2016
M 2016 26773 R	AM 79071	AM 2015 79071 A	15(427)2015
M 2016 26774 R	AM 78350	AM 2015 78350 A	17(429)2015
M 2016 26775 R	AM 85777	-	4(440)2016
M 2016 26776 R	AM 84083	-	4(440)2016
M 2016 26777 R	AM 85848	-	4(440)016
M 2016 26778 R	AM 85890	-	4(440)2016
M 2016 26779 R	AM 79897	AM 2015 79897 A	19(431)2015
M 2016 26780 R	AM 79899	AM 2015 79899 A	19(431)2015
M 2016 26781 R	AM 85689	-	4(440)2016

1	2	1	2
M 2016 26782 R	AM 85357	-	4(440)2016
M 2016 26783 R	AM 85894	-	4(440)2016
M 2016 26784 R	AM 85899	-	4(440)2016
M 2016 26785 R	AM 85900	-	4(440)2016
M 2016 26786 R	AM 85897	-	4(440)2016
M 2016 26787 R	AM 85898	-	4(440)2016
M 2016 26788 R	AM 86034	-	4(440)2016
M 2016 26789 R	AM 86035	-	4(440)2016

**CONCORDANCE TABLE OF PUBLICATION NUMBERS
AND APPLICATION NUMBERS**

NUMBER OF PUBLISHED APPLICATION (260)	NUMBER OF APPLICATION (210)	1	2
AM 2016 64922 A**	AM 64922 A**	AM 2016 81847 A	AM 81847 A
AM 2016 64923 A**	AM 64923 A**	AM 2016 81926 A	AM 81926 A
AM 2016 64924 A**	AM 64924 A**	AM 2016 81927 A	AM 81927 A
AM 2016 64925 A**	AM 64925 A**	AM 2016 81928 A	AM 81928 A
AM 2016 64926 A**	AM 64926 A**	AM 2016 81929 A	AM 81929 A
AM 2016 64927 A**	AM 64927 A**	AM 2016 81932 A	AM 81932 A
AM 2016 64928 A**	AM 64928 A**	AM 2016 81969 A	AM 81969 A
AM 2016 64929 A**	AM 64929 A**	AM 2016 81985 A	AM 81985 A
AM 2016 64930 A**	AM 64930 A**	AM 2016 81986 A	AM 81986 A
AM 2016 64931 A**	AM 64931 A**	AM 2016 81993 A	AM 81993 A
AM 2016 65149 A**	AM 65149 A**	AM 2016 81994 A	AM 81994 A
AM 2016 78742 A	AM 78742 A	AM 2016 81996 A	AM 81996 A
AM 2016 79775 A	AM 79775 A	AM 2016 81999 A	AM 81999 A
AM 2016 79777 A	AM 79777 A	AM 2016 82156 A	AM 82156 A
AM 2016 79780 A	AM 79780 A	AM 2016 82173 A	AM 82173 A
AM 2016 79781 A	AM 79781 A	AM 2016 82218 A	AM 82218 A
AM 2016 79782 A	AM 79782 A	AM 2016 82251 A	AM 82251 A
AM 2016 79783 A	AM 79783 A	AM 2016 82252 A	AM 82252 A
AM 2016 79982 A	AM 79982 A	AM 2016 82254 A	AM 82254 A
AM 2016 80212 A	AM 80212 A	AM 2016 82255 A	AM 82255 A
AM 2016 80445 A	AM 80445 A	AM 2016 82282 A	AM 82282 A
AM 2016 80676 A	AM 80676 A	AM 2016 82390 A	AM 82390 A
AM 2016 81388 A	AM 81388 A	AM 2016 82391 A	AM 82391 A
AM 2016 81428 A	AM 81428 A	AM 2016 82408 A	AM 82408 A
AM 2016 81625 A	AM 81625 A	AM 2016 82448 A	AM 82448 A
AM 2016 81626 A	AM 81626 A	AM 2016 82492 A	AM 82492 A
AM 2016 81725 A	AM 81725 A	AM 2016 82548 A	AM 82548 A
AM 2016 81846 A	AM 81846 A	AM 2016 82549 A	AM 82549 A
		AM 2016 82588 A	AM 82588 A
		AM 2016 82679 A	AM 82679 A
		AM 2016 82823 A	AM 82823 A
		AM 2016 82824 A	AM 82824 A
		AM 2016 82825 A	AM 82825 A

CONCORDANCE TABLE OF INDEX OF GOODS AND/OR SERVICES
AND APPLICATION NUMBERS

INDEX OF GOODS AND/OR SERVICES (511)	NUMBER OF PUBLISHED APPLICATIONS (260)	1	2
1	2		
3	AM 2016 80212 A	30	AM 2016 78742 A
3	AM 2016 81994 A	30	AM 2016 81999 A
5	AM 2016 64922 A**	30	AM 2016 82588 A
5	AM 2016 64923 A**	31	AM 2016 81999 A
5	AM 2016 64924 A**	32	AM 2016 79982 A
5	AM 2016 64925 A**	32	AM 2016 80676 A
5	AM 2016 64926 A**	32	AM 2016 81999 A
5	AM 2016 64927 A**	32	AM 2016 82173 A
5	AM 2016 64928 A**	33	AM 2016 80676 A
5	AM 2016 64929 A**	33	AM 2016 81725 A
5	AM 2016 64930 A**	33	AM 2016 81846 A
5	AM 2016 64931 A**	33	AM 2016 81847 A
5	AM 2016 65149 A**	34	AM 2016 79775 A
5	AM 2016 81625 A	34	AM 2016 79777 A
5	AM 2016 81626 A	34	AM 2016 79780 A
5	AM 2016 81985 A	34	AM 2016 79781 A
5	AM 2016 81986 A	34	AM 2016 79782 A
5	AM 2016 82156 A	34	AM 2016 79783 A
5	AM 2016 82218 A	34	AM 2016 81926 A
5	AM 2016 82408 A	34	AM 2016 81969 A
5	AM 2016 82679 A	34	AM 2016 82251 A
5	AM 2016 82823 A	34	AM 2016 82252 A
5	AM 2016 82824 A	34	AM 2016 82254 A
5	AM 2016 82825 A	34	AM 2016 82255 A
6	AM 2016 82492 A	34	AM 2016 82448 A
7	AM 2016 81996 A	35	AM 2016 80676 A
9	AM 2016 81996 A	35	AM 2016 81428 A
9	AM 2016 82282 A	35	AM 2016 81846 A
12	AM 2016 80445 A	35	AM 2016 81847 A
12	AM 2016 81932 A	35	AM 2016 81996 A
14	AM 2016 81927 A	35	AM 2016 81999 A
14	AM 2016 81928 A	35	AM 2016 82156 A
14	AM 2016 81929 A	35	AM 2016 82282 A
17	AM 2016 81996 A	35	AM 2016 82390 A
17	AM 2016 82492 A	35	AM 2016 82391 A
18	AM 2016 82548 A	35	AM 2016 82548 A
25	AM 2016 81993 A	35	AM 2016 82588 A
25	AM 2016 82548 A	36	AM 2016 82549 A
29	AM 2016 78742 A	40	AM 2016 81996 A
29	AM 2016 81999 A	41	AM 2016 79982 A
		41	AM 2016 81388 A
		41	AM 2016 82282 A
		44	AM 2016 79982 A
		44	AM 2016 81428 A
		45	AM 2016 79982 A

CONCORDANCE TABLE OF INDEX OF GOODS AND/OR SERVICES
AND NUMBERS OF TRADEMARKS REGISTERED ACCORDING
TO THE ACCELERATED PROCEDURE

INDEX OF GOODS AND/OR SERVICES (511)	NUMBERS OF REGISTERED ACCORDING TO THE ACCELERATED PROCEDURE (111)
6	M 2016 26788 R
6	M 2016 26789 R
11	M 2016 26775 R
14	M 2016 26777 R
19	M 2016 26782 R
19	M 2016 26788 R
19	M 2016 26789 R
20	M 2016 26785 R
21	M 2016 26775 R
29	M 2016 26771 R
30	M 2016 26770 R
32	M 2016 26771 R
32	M 2016 26770 R
33	M 2016 26776 R
35	M 2016 26781 R
35	M 2016 26775 R
35	M 2016 26777 R
36	M 2016 26783 R
36	M 2016 26785 R
37	M 2016 26786 R
37	M 2016 26787 R
37	M 2016 26784 R
37	M 2016 26785 R
37	M 2016 26788 R
37	M 2016 26789 R
43	M 2016 26772 R
43	M 2016 26778 R
43	M 2016 26785 R

OFFICIAL BULLETIN OF THE INDUSTRIAL PROPERTY

4(440)

EDITOR-IN-CHIEF: N. Bebrishvili

EDITORS-TRANSLATORS: E. Gabunia

PROOFREADER: A. Shikhashvili

COMPUTER LAYOUT: M. Ordenidze
K. Svanidze

www.sakpatenti.org.ge

E-mail: info@sakpatenti.org.ge