



საქართველოს ინტელექტუალური საკუთრების ეროვნული ცენტრი
NATIONAL INTELLECTUAL PROPERTY CENTER OF GEORGIA

საქპატენტი
SAKPATENTI

**OFFICIAL BULLETIN
OF THE INDUSTRIAL PROPERTY**

4(512)

2019
TBILISI

INID CODES FOR IDENTIFICATION OF BIBLIOGRAPHIC DATA

INVENTIONS, UTILITY MODELS

- (10) Number of publication for application, which has been examined
- (11) Number of patent and kind of document
- (21) Serial number of application
- (22) Date of filing of the application
- (23) Date of exhibition or the date of the earlier filing and the number of application, if any
- (24) Date from which patent may have effect
- (31) Number of priority application
- (32) Date of filing of priority application
- (33) Code of the country or regional organization allotting priority application number
- (44) Date of publication of application not granted, but examined and number of bulletin
- (45) Date of publication of registered document
- (51) International Patent Classification Index
- (54) Title of the invention
- (57) Abstract
- (60) Number of examined patent document granted by foreign patent office, date from which patent has effect and country code
- (62) Number of the earlier application and in case of divided application, date of filing an application
- (71) Name, surname and address of applicant (country code)
- (72) Name, surname of inventor (country code)
- (73) Name, surname and address of patent owner (country code)
- (74) Name, surname of representative or patent attorney
- (85) Date of commencement of the national phase of International Application
- (86) Number and date of filing of international application
- (87) Number and date of publication of international application

DESIGNS

- (10) Number of publication for application
- (11) Number of patent and kind of document or number of registration
- (15) Date of registration/Date of patent renewal
- (18) Expected expiration date of patent or registration
- (21) Serial number of application
- (22) Date of filing of the application
- (23) Date of exhibition or the date of the earlier filing and the number of application, if any
- (24) Date from which patent may have effect
- (28) Number of designs included in the application
- (30) Data relating to priority (number of application, date of filing of application, two-letter code identifying the authority with whom the priority application was made)
- (31) Number of priority application
- (32) Date of filing of priority application
- (33) Code of the country or regional organization allotting priority application number
- (34) Two-letter code according to WIPO St.3 identifying the authority with which the priority application was made
- (44) Date of publication of design and number of bulletin (the first publication)
- (45) Date of publication of design registered by WIPO and number of bulletin
- (51) International Classification for designs (class and subclass of the Locarno Classification)
- (54) Title of the invention
- (55) Reproduction of the design
- (57) Description of characteristic features of the design including indication of colors
- (58) Date of recording of any kind of amendment in the Register
- (62) Number of the earlier application, registration and document number and if available the date of filing an application in case of divided application
- (71) Name, surname and address of applicant (country code)
- (72) Name, surname of creator (country code)
- (73) Name, surname and address of patent owner (country code)
- (74) Name, surname of representative or patent attorney
- (81) Contracting states concerned
 - II designated contracting states according to the 1960 Act
 - III designated contracting states according to the 1999 Act
- (85) Owner's permanent address
- (86) Owner's nationality
- (87) Owner's residence
- (88) State in which the owner has a real and effective industrial or commercial establishment

TRADEMARKS

- (111) – Number of registration
- (151) – Date of registration
- (156) – Date of the renewal
- (181) – Expected expiration date of registration
- (186) – Renewal expiration date of registration
- (141) – Date of cancel of duration of the mark
- (210) – Serial number of application
- (220) – Date of filing of the application
- (230) – Date concerning exhibition
- (260) – Number of application, for which favorable decision of examination about registration has been taken (publication number)
- (310) – Number of the first application
- (320) – Date of filing of the first application
- (330) – Code, identifying national or regional Office where the first application was made
- (511) – International Classification of Goods and Services for the purposes of registration of trade marks and/or list of goods and/or services classified according thereto
- (531) – Description of figurative elements of Trade Marks according to the International Classification of the Figurative Elements of Marks
- (540) – Reproduction of Trade Mark
- (550) – Nature and kind of Trade Mark
- (580) – Date of recording of any kind changes in respect of applications or registrations
- (591) – Information concerning colors claimed
- (731) – Name and address of the applicant
- (732) – Name and address of the holder of the registration
- (740) – Name and address of the representative
- (750) – Address for correspondence
- (770) – Name and address of the previous applicant or holder in case of change in ownership
- (771) – Previous name and address of the applicant or holder in case of change in ownership
- (791) – Name and address of the licensee
- (793) – Indication of conditions and/or restrictions under the license (Type of license, number of license agreement, data of license, data of validity of license)
- (800) – Certain data relating to the international registration of Trade Marks under the Protocol Relating to Madrid Agreement (International registration number)

CODES FOR PUBLICATION IN BULLETIN

- (21) AP 0000 000000 – serial number of application for invention
- (10) AP 0000 0000 A – number of published application for invention (first publication)
- (11) P 0000 0000 B – number of patent for invention (second publication)
- (21) API 0000 000000 – number of application for imported patent
- (11) PI 0000 0000 A – number of imported patent (first publication)
- (21) AU 0000 000000 – serial number of application for utility model
- (10) AU 0000 000 U – number of published application for utility model (first publication)
- (11) U 0000 000 Y – number of patent for utility model (second publication)
- (21) AD 0000 000000 – serial number of application for design
- (10) AD 0000 000 S – number of published application for design (first publication)
- (11) D 0000 000 S – number of patent for design (second publication)

INTERNATIONAL PATENT CLASSIFICATION FOR INVENTIONS AND UTILITY MODELS

- SECTION A – HUMAN NECESSITIES
- SECTION B – PERFORMING OPERATIONS; TRANSPORTING
- SECTION C – CHEMISTRY; METALLURGY
- SECTION D – TEXTILES; PAPER
- SECTION E – FIXED CONSTRUCTIONS
- SECTION F – MECHANICAL ENGINEERING; LIGHTING; HEATING; WEAPONS; BLASTING
- SECTION G – PHYSICS
- SECTION H – ELECTRICITY

-
- M – Trade Mark
 - (210) AM 0000 000000 – Serial number of application;
 - (260) AAM 0000 00000 A – Publication number of application;
 - (111) M 0000 00000 R – Number of registration;
 - (111) MMM0000 00000 Rn – Number of renewals, in which n=1,2,3;
 - (111) M 0000 00000 R(P) – Number of registration under partial assignment of rights
-

LIST OF CODES, IN ALPHABETIC SEQUENCE, AND THE CORRESPONDING (SHORT) NAMES OF STATES, OTHER ENTITIES AND INTERGOVERNMENTAL ORGANIZATIONS
(WIPO STANDARD ST.3)

AD	Andorra				
AE	United Arab Emirates				
AF	Afghanistan				
AG	Antigua and Barbuda				
AI	Anguilla				
AL	Albania				
AM	Armenia				
AN	Netherlands Antilles				
AO	Angola				
AP	African Regional Intellectual Property Organization (ARIPO)				
AR	Argentina				
AT	Austria				
AU	Australia				
AW	Aruba				
AZ	Azerbaijan				
BA	Bosnia and Herzegovina				
BB	Barbados				
BD	Bangladesh				
BE	Belgium				
BF	Burkina Faso				
BG	Bulgaria				
BH	Bahrain				
BI	Burundi				
BJ	Benin				
BM	Bermuda				
BN	Brunei Darussalam				
BO	Bolivia				
BR	Brazil				
BS	Bahamas				
BT	Bhutan				
BV	Bouvet Island				
BW	Botswana				
BX	Benelux Office for Intellectual Property (BOIP)				
BY	Belarus				
BZ	Belize				
CA	Canada				
CD	Democratic Republic of the Congo				
CF	Central African Republic				
CG	Congo				
CH	Switzerland				
CI	Cote d'Ivoire				
CK	Cook Islands				
CL	Chile				
CM	Cameroon				
CN	China				
CO	Colombia				
CR	Costa Rica				
CU	Cuba				
CV	Cape Verde				
CY	Cyprus				
CZ	Czech Republic				
DE	Germany				
DJ	Djibouti				
DM	Dominica				
DO	Dominican Republic				
DZ	Algeria				
EA	Eurasian Patent Organization (EAPO)				
EC	Ecuador				
EE	Estonia				
EG	Egypt				
EH	Western Sahara				
EM	Office for Harmonization in the Internal Market (Trademarks and Designs)(OHIM)				
EP	European Patent Office (EPO)				
ER	Eritrea				
ES	Spain				
ET	Ethiopia				
FI	Finland				
FJ	Fiji				
FK	Falkland Islands (Malvinas)				
FO	Faroe Islands				
FR	France				
GA	Gabon				
GB	United Kingdom				
GC	Patent Office of the Cooperation Council for the Arab States of the Gulf (GCC)				
GD	Grenada				
GG	Guernsey				
GH	Ghana				
GI	Gibraltar				
GT	Guatemala				
GW	Guinea- Bissau				
GY	Guyana				
HK	The Hong Kong Special Administrative Region of the People's Republic of China				
HN	Honduras				
HR	Croatia				
HT	Haiti				
HU	Hungary				
IB	International Bureau of the World Intellectual Property Organization (WIPO)				
ID	Indonesia				
IE	Ireland				
IL	Israel				
IM	Isle of Man				
IN	India				
IQ	Iraq				
ID	Indonesia				
IE	Ireland				
IL	Israel				
IM	Isle of Man				
IN	India				
IQ	Iraq				
IR	Iran (Islamic Republic of)				
IS	Iceland				
IT	Italy				
JE	Jersey				
JM	Jamaica				
JO	Jordan				
JP	Japan				
KE	Kenya				
KG	Kyrgyzstan				
KH	Cambodia				
KI	Kiribati				
KM	Saint Kitts and Nevis				
KP	Democratic People's Republic of Korea				
KR	Republic of Korea				
KW	Kuwait				
KY	Cayman Islands				
KZ	Kazakhstan				
LA	Lao People's Democratic Republic				
LB	Lebanon				
LC	Saint Lucia				
LI	Liechtenstein				
LK	Sri Lanka				
LR	Liberia				
LS	Lesotho				
LT	Lithuania				
LU	Luxembourg				
LV	Latvia				
LY	Libyan Arab Jamahiriya				
MA	Morocco				
MC	Monaco				
MD	Republic of Moldova				
ME	Montenegro				
MG	Madagascar				
MK	The former Yugoslav Republic of Macedonia				
ML	Mali				
MM	Myanmar				
MN	Mongolia				
MO	Macao				
MP	Northern Mariana Islands				
MR	Mauritania				
MS	Montserrat				
MT	Malta				
MU	Mauritius				
MV	Maldives				
MW	Malawi				
MX	Mexico				
MY	Malaysia				
MZ	Mozambique				
NA	Namibia				
NE	Niger				
NG	Nigeria				
NI	Nicaragua				
NL	Netherlands				
NO	Norway				
NP	Nepal				
NR	Nauru				
NZ	New Zealand				
OA	African Intellectual Property Organization (OAPI)				
OM	Oman				
PA	Panama				
PE	Peru				
PG	Papua New Guinea				
PH	Philippines				
PK	Pakistan				
PL	Poland				
PT	Portugal				
PW	Palau				
PY	Paraguay				
QA	Qatar				
QZ	Community Plant Variety Office (European Community) (CPVO)				
RO	Romania				
RS	Serbia				
RU	Russian Federation				
RW	Rwanda				
SA	Saudi Arabia				
SB	Solomon Islands				
SC	Seychelles				
SD	Sudan				
SG	Singapore				
SH	Saint Helena				
SI	Slovenia				
SK	Slovakia				
SL	Sierra Leone				
SM	San Marino				
SN	Senegal				
SO	Somalia				
SR	Suriname				
ST	Sao Tome and Principe				
SV	El Salvador				
SY	Syrian Arab Republic				
SZ	Swaziland				
TC	Turks and Caicos Islands				
TD	Chad				
TG	Togo				
TH	Thailand				
TJ	Tajikistan				
TL	Timor-Leste				
TM	Turkmenistan				
TN	Tunisia				
TO	Tonga				
TR	Turkey				
SE	Sweden				
TT	Trinidad and Tobago				
TV	Tuvalu				
TW	Taiwan, Province of China				
TZ	United Republic of Tanzania				
UA	Ukraine				
UG	Uganda				
US	United States of America				
UY	Uruguay				
UZ	Uzbekistan				
VA	Holy See				
VC	Saint Vincent and the Grenadines				
VE	Venezuela				
VG	Virgin Islands (British)				
VN	Viet Nam				
VU	Vanuatu				
WO	World Intellectual Property Organization (WIPO)				
WS	Samoa				
XN	Nordic Patent Institute (NPI)				
YE	Yemen				
ZA	South Africa				
ZM	Zambia				
ZW	Zimbabwe				

**OFFICIAL BULLETIN
OF THE INDUSTRIAL PROPERTY**

4(512)

**INVENTIONS
UTILITY MODELS
TRADEMARKS**

DATE OF PUBLICATION
2019 02 25

CONTENTS

PUBLISHED TITLES OF PROTECTION	3
INVENTIONS	
▪ APPLICATIONS APPROVED FOR GRANTING PATENTS	4
▪ PATENTED INVENTIONS	8
UTILITY MODELS	
▪ APPLICATIONS APPROVED FOR GRANTING PATENTS	9
▪ PATENTED UTILITY MODEL	10
TRADEMARKS	
▪ APPLICATIONS FILED UNDER THE NATIONAL PROCEDURE APPROVED FOR REGISTRATION	11
▪ REGISTERED TRADEMARKS	18
▪ TRADEMARKS REGISTERED ACCORDING TO THE ACCELERATED PROCEDURE	22
▪ INTERNATIONAL TRADEMARKS FOR WHICH A DECISION ON GANTING PROTECTION IS TAKEN	25
▪ INTERNATIONAL TRADEMARKS PROTECTED IN GEORGIA	108
OFFICIAL NOTIFICATIONS	
INVENTIONS	
▪ RENEWAL OF PATENTS	119
▪ CANCELLATION OF PATENTS	119
UTILITY MODELS	
CANCELLATION OF PATENTS	121
DESIGNS	
RENEWAL OF REGISTRATIONS	122
TRADEMARKS	
▪ RENEWAL OF REGISTRATIONS	123
▪ COMPLET TRANSFER OF RIGHT	131
▪ CHANGES IN NAMES AND/OR ADDRESSES OF OWNERS	132
▪ TERMINATION OF TRADEMARK REGISTRATIONS	141
CLASSIFICATION INDEXES	
INVENTIONS	145
UTILITY MODELS	146
TRADEMARKS	148

PUBLISHED TITLES OF PROTECTION

INVENTIONS

- **APPLICATIONS APPROVED FOR GRANTING PATENT:**
14581; 14237; 14215; 14284; 14604; 14403; 14426; 14142
- **PATENTED INVENTIONS:**
6949-6951

UTILITY MODELS

- **APPLICATION APPROVED FOR GRANTING PATENT:**
14814
- **PATENTED UTILITY MODELS:**
2001-2003

TRADEMARKS

- **APPLICATIONS FILED UNDER THE NATIONAL PROCEDURE APPROVED FOR REGISTRATION:**
78986*; 87174; 88279; 96309, 96310; 96312, 98186-98189; 98209; 98244; 98246, 98247; 98249; 98371; 98376; 98390; 98395; 98405; 98409-98411; 98417, 98418; 98421; 98426, 98427; 98432; 98437; 98442; 98550; 98559; 98565, 98566; 98570; 98574, 98575; 98661; 98683-98686; 98691; 98695; 98697
- **REGISTERED TRADEMARKS:**
30808-30845
- **TRADEMARKS REGISTERED ACCORDING TO THE ACCELERATED PROCEDURE:**
30794-30807; 97846
- **INTERNATIONAL TRADEMARKS FOR WHICH A DECISION ON GRANTING PROTECTIONS IS TAKEN:**
91372*; 92412*; 93306*; 93676*; 93970; 94826; 95617; 95628; 95748; 96514; 96849; 97052; 97116; 97253-97262; 97341; 97354; 97356, 97357; 97359-97362; 97486; 97488; 97500; 97509, 97510; 97512; 97520, 97521; 97523, 97524; 97530, 97531; 97533-97538; 97540-97547; 97553, 97554; 97569; 97571; 97575; 97579-97588; 97597; 97609-97612; 97614-97616; 97622-97625; 97627; 97636-97640; 97661; 97665; 97671, 97672; 97674, 97675; 97716-97718; 97731, 97732; 97736, 97737; 97747; 97816; 97820; 97834, 97835; 97843, 97844; 97906; 97908; 97950; 98027, 98028; 98030; 98032; 98036; 98146; 98319; 98369, 98370
- **INTERNATIONAL TRADEMARKS PROTECTED IN GEORGIA:**
88284; 89623; 90712; 92694; 93008; 93493; 93745; 95465; 95607; 95630; 95693; 95770; 95837; 95846; 95848; 95850; 95853; 95897; 95907; 95917- 95919; 95921; 95923-95925; 95953, 95954; 95963; 95966; 95968; 95971; 95979; 96010, 96011; 96014; 96017-96020; 96031-96040; 96043; 96045; 96090-96092; 96095; 96100; 96109-96111; 96114; 96125; 96127, 96128; 96132, 96133; 96136-96138; 96142, 96143; 96145; 96196-96198; 96223, 96224; 96230; 96232; 96246; 96248; 96250, 96251; 96254; 96256; 96263-96266; 96282; 96290; 96314-96316; 96342; 96344; 96346, 96347; 96355; 96357-96359; 96361; 96365, 96366; 96395; 96399; 96415, 96416; 96418; 96420, 96421; 96423; 96425; 96466-96471; 96527-96529; 96541; 96584- 96587; 96589-96593; 96607; 96615, 96616; 96623-96625; 96638, 96639; 96653; 96655; 96660, 96661; 96666-96690; 96716-96718; 96724, 96725; 96727-96729

INVENTIONS

APPLICATIONS APPROVED FOR GRANTING PATENTS

The decision can be appealed at the Chamber of Appeal of Sakpatenti within 3 months from the publication or at the Mtskheta District Court Administrative Cases Board (Address: №17, Samkhedro str., Mtskheta), within 1 month following the publication.

PART A

A 47

(10) AP 2019 14581 A (51) Int. Cl. (2006)

A 47 J 31/00
B 65 D 85/804
C 12 G 3/06

(21) AP 2016 14581 (22) 2016 02 16

(31) P201530209

(32) 2015 02 16

(33) ES

(71) SMART SPIRITS, S.L. (ES)

Poeta Querol, 1 1º 46002 Valencia (ES)

(72) SANCHEZ BOU, Carlos (ES);

SMART, Mark Francis Joseph (ES);

SANCHEZ LLOPIS, Carlos (ES)

(74) Shalva Gvaramadze

(85) 2017 08 29

(86) PCT/ES2016/070090, 2016 02 16

(54) **INFUSER FOR ALCOHOLIC BEVERAGES**

(57) The invention relates to an infuser for alcoholic beverages, comprising a container of ethyl alcohol and a water source, both of which are hydraulically connected to a volumetric mixing chamber, a water capsule holder located downstream of the volumetric chamber and intended to receive capsules containing single doses of essences, and means for extracting liquid from the volumetric chamber and injecting same into a capsule. The ethyl alcohol container and the water source are connected to the volumetric chamber by shut-off solenoid valves, and the volumetric chamber contains a main electrode and a plurality of secondary electrodes disposed above the main electrode at different levels.

Claims: 2 independent

9 dependent

Fig.: 3

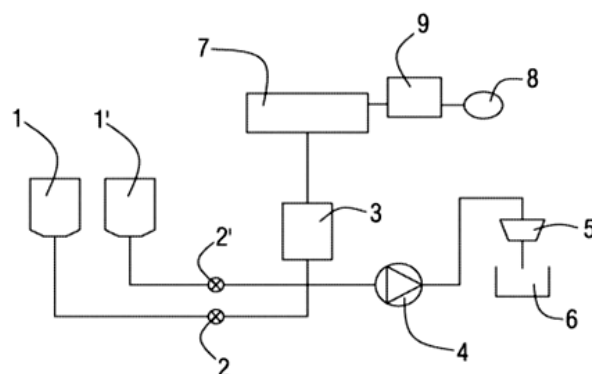

Fig. 1

A 61

(10) AP 2019 14237 A (51) Int. Cl. (2006)

A 61 K 31/44
C 07 D 213/22
C 07 D 401/04

(21) AP 2015 14237 (22) 2015 01 13

(31) 62/054,742; 61/927,055

(32) 2014 01 14; 2014 01 14

(33) US; US

(71) Millennium Pharmaceuticals Inc. (US)

40 Landsdowne Street Cambridge,
Massachusetts 02139 (US)

(72) BHARATHAN, Indu T. (US);

BLACKBURN, Chris (US);

CIAVARRI, Jeffrey P. (US);

CHOUTAR, Jouhara (US);

CULLIS, Courtney A. (US);

D'AMORE, Natalie (US);

FLEMING, Paul E. (US);

GIGSTAD, Kenneth M. (US);

GIPSON, Krista E. (US);

GIRARD, Mario (US);

HU, Yongbo (US);

LEE, Janice (US);

LI, Gang (US);

REZAEI, Mansoureh (US);

SINTCHAK, Michael D. (US);

SOUCY, Francois (US);

STROUD, Stephen G. (US);

VOS, Tricia J. (US);

WONG, Tzu-Tshin (US);

XU, He (US);

XU, Tianlin (US);
 YE, Yingchun (US)
 (74) Shalva Gvaramadze
 (85) 2016 08 09
 (86) PCT/US2015/011191, 2015 01 13
 (54) **HETEROARYLS AND USES THEREOF**
 (57) An invention relates to bipyridine compounds of formula I,

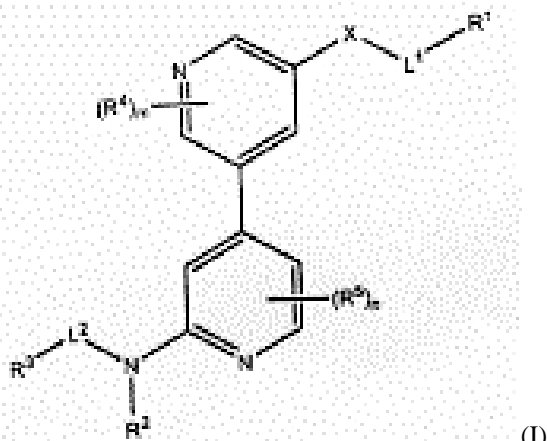

(I)
 pharmaceutically acceptable salts thereof, and pharmaceutical compositions containing them. Their usage is possible as VPS34 inhibitors for proliferative and cardiovascular disorders treatment.

Claims: 4 independent
 15 dependent

Fig.: 6

(10) AP 2019 14215 A (51) Int. Cl. (2006)
 A 61 K 31/444
 A 61 K 9/08
 A 61 K 47/04
 A 61 K 47/12
 A 61 K 47/18
 A 61 K 47/22
 A 61 K 47/32
 A 61 P 9/12
 A 61 P 27/02
 A 61 P 27/06

(21) AP 2015 14215 (22) 2015 01 08

(31) 2014-002810

(32) 2014 01 10

(33) JP

(71) Santen Pharmaceutical CO., LTD (JP)
 Osaka-shi, Osaka 533-8651 (JP)

(72) ENDO, Yoko (JP)

(74) Shalva Gvaramadze

(85) 2016 07 22

(86) PCT/JP2015/050334, 2015 01 08

(54) **PHARMACEUTICAL COMPOSITION CONTAINING PYRIDYLAMINO ACETIC ACID COMPOUND**

(57) Pharmaceutical composition contains isopropyl (6-{{[4-(pyrazol-1-yl)benzyl]}(pyridin-3-ylsulfonyl)aminomethyl}}pyridin-2-ylamino)acetate

or salt thereof, and ethylenediaminetetraacetic acid or salt thereof, additionally.

Claims: 4 independent

16 dependent

Table: 12

(10) AP 2019 14284 A (51) Int. Cl. (2006)
 A 61 K 31/501
 A 61 P 25/00
 A 61 P 25/14

(21) AP 2015 14284

(22) 2015 03 06

(31) 1403944.0

(32) 2014 03 06

(33) GB

(71) Takeda Pharmaceutical Company Limited (JP)
 1-1, Doshomachi 4-chome Chuo-ku,
 Osaka-shi, Osaka 541-0045 (JP)

(72) ALMOND, Sarah (JP)

(74) Aleksandre Gegechkori

(85) 2016 09 27

(86) PCT/GB2015/050654, 2015 03 06

(54) **PYRIDAZINE DERIVATIVES FOR USE IN THE PREVENTION OR TREATMENT OF AN ATAXIC DISORDER**

(57) An invention relates to hydroxypyridazine derivatives of formula (I),

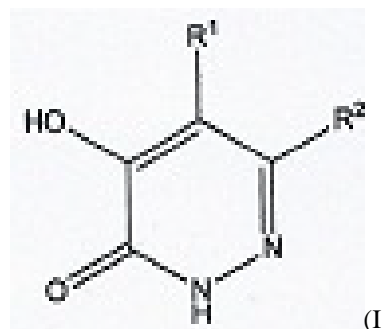

(I)
 pharmaceutically acceptable salts thereof, their usage for the prevention or treatment of an ataxic disorder.

Claims: 6 independent

13 dependent

(10) AP 2019 14604 A (51) Int. Cl. (2006)
 A 61 K 31/4439
 A 61 P 25/28
 A 61 P 25/00
 A 61 P 25/16

(21) AP 2016 14604

(22) 2016 03 18

(31) 055532/2015

(32) 2015 03 19

(33) JP

(71) KYOWA HAKKO KIRIN CO., LTD. (JP)
 1-6-1, Ohtemachi, Chiyoda-ku, Tokyo
 100-8185 (JP)

(72) HORITA, Takako (JP)

(74) Shalva Gvaramadze

(85) 2017 10 09

(86) PCT/JP2016/059788, 2016 03 18

**(54) THERAPEUTIC AGENT FOR
FRONTAL LOBE DYSFUNCTION**

(57) An agent for frontal lobe dysfunction treatment and/or prophylaxis, containing formula (I):

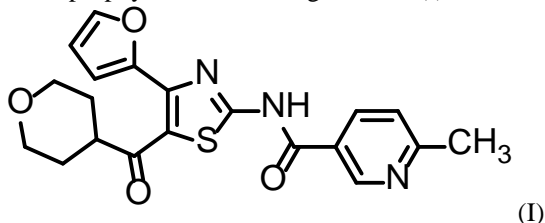

Claims: 6 independent

11 dependent

Table: 3

PART C**C 04****(10) AP 2019 14403 A (51) Int. Cl. (2006)
C 04 B 31/40**

(21) AP 2017 14403 (22) 2017 02 02

(71) LEPL GEORGIAN TECHNICAL
UNIVERSITY (GE)

Kostavas q. 77, 0175, Tbilisi (GE)

(72) Razhden Skhvitaridze (GE);
Malkhaz Turdzeladze (GE);
Merab Abazadze (GE);
Shalva Verulava (GE)

(74) Givi Sibashvili

**(54) METHOD FOR CONCRETE MIX
PREPARATION**

(57) A method for concrete mix preparation provides: metamorphic shale large filler treatment with chemical additive water solution, and mixing therewith concrete and water; at that, the river Duruji drift usage, as metamorphic shale large filler, that before treatment with modified polycarboxylate water solution is bolt through the sieve No. 40 to full passage.

Claims: 1 independent

C 22**(10) AP 2019 14426 A (51) Int. Cl. (2006)
C 22 B 3/10
C 01 F 5/00
C 01 F 5/30
C 22 B 26/22
C 22 B 3/22****C 22 B 3/44****C 25 C 3/04**

(21) AP 2015 14426 (22) 2015 07 17

(31) 62/026,105

(32) 2014 07 18

(33) US

(71) ALLIANCE MAGNÉSIUM (CA)

Office 410 9160 Leduc Blvd., Quartier DIX30
Brossard, Québec J4Y 0E3 (CA)(72) FOURNIER, Joël (CA);
GAUTHIER, Laury (CA)

(74) Tamaz Shilakadze

(85) 2017 02 15

(86) PCT/CA2015/050670, 2015 07 17

**(54) HYDROMETALLURGICAL PROCESS
TO PRODUCE PURE MAGNESIUM
METAL AND VARIOUS BY-PRODUCTS**(57) The present description relates to a process for producing magnesium metal from magnesium-bearing ores using serpentine. The process described herein consists generally in a mineral preparation and classification followed by leaching with dilute hydrochloric acid. The slurry is filtered and the non-leached portion, containing amorphous silica is recovered. The residual solution is neutralized and purified by chemical precipitation with non activated and activated serpentine. The nickel is also recovered by precipitation at higher pH. A final neutralisation and purification step of magnesium chloride solution by precipitation allows eliminating any traces of residual impurities. The purified magnesium chloride solution is evaporated until saturation and the MgCl₂·6H₂O is recovered by crystallization in an acid media. The salt is dehydrated and subsequent electrolysis of anhydrous magnesium chloride produces pure magnesium metal and hydrochloric acid.

Claims: 1 independent

24 dependent

Fig.: 3

Table: 10

C 30**(10) AP 2019 14142 A (51) Int. Cl. (2006)
C 30 B 11/00
C 30 B 30/04**

(21) AP 2016 14142 (22) 2016 05 11

(71) LEPL – F. Tavadze Institute of
Metallurgy And Materials Science (GE)
Mindelis q. 10, 0186, Tbilisi (GE)(72) Elza Khutsishvili (GE);
Nodar Kekelidze (GE);
Leonti Gabrichidze (GE);
Nana Kobulashvili (GE);
Tengiz Kamushadze (GE)

(74) Elza Khutsishvili

**(54) METHOD FOR OBTAINING
VOLUME CRYSTALS InAs-CaAs FROM
HARD SOLUTIONS**

(57) A method for obtaining volume crystals InAs-CaAs from hard solutions provides mixing the componentry: InAs and CaAs; melting and crystallization thereof; at that, the baking is carried out at the temperature of 942°C-1240°C.

Claims: 1 independent

Fig.: 4

PATENTED INVENTIONS
PART A**A 61**

- (11) P 2019 6949 B (51) Int. Cl. (2006)
 A 61 K 31/444
 A 61 K 31/506
 A 61 K 31/4439
 A 61 K 31/497
 A 61 P 25/28
 C 07 D 417/12
 C 07 D 413/12
 C 07 D 401/12
- (10) AP 2018 14485 A (44) 16 (500) 2018
 (21) AP 2015 14485
 (22) 2015 11 09
 (24) 2015 11 09
 (31) PA201500447; PA201400648
 (32) 2015 08 07; 2014 11 10
 (33) DK; DK
 (86) PCT/EP2015/076015, 2015 11 09
 (73)) H. LUNDBECK A/S (DK)
 Ottliavej 9 DK-2500 Valby (DK)
 (72) MARIGO, Mauro (DK);
 TAGMOSE, Lena (DK);
 JUHL, Karsten (DK)
 (74) Tamaz Shilakadze
 (54) **2-AMINO-6-(DIFLUOROMETHYL)-5, 5-DIFLUORO-6-PHENYL-3, 4, 5, 6-TETRAHYDROPYRIDINES AS BACE1 INHIBITORS**
-

PART C**C 07**

- (11) P 2019 6950 B (51) Int. Cl. (2006)
 C 07 D 487/04
 A 61 K 31/5025
 A 61 K 9/00
 A 61 P 11/00
 A 61 P 25/00
 A 61 P 27/02
- (10) AP 2018 14410 A (44) 21(505)/2018
 (21) AP 2015 14410
 (22) 2015 07 23
 (24) 2015 07 23
 (31) 62/033,684; 62/157,129
 (32) 2014 08 06; 2015 05 05
 (33) US; US
 (86) PCT/IB2015/055597, 2015 07 23
 (73) PFIZER INC. (US)
 235 East 42nd Street New York,
 NY 10017 (US)
 (72) CHAPPIE, Thomas Allen (US);
 HAYWARD, Matthew Merrill (US);
 HELAL, Christopher John (US);
 LACHAPELLE, Erik Alphie (US);
 PATEL, Nandini Chaturbhai (US);
 SCIABOLA, Simone (IT);
 VERHOEST, Patrick Robert (US);
 YOUNG, Joseph Michael (US)
 (74) Tamar Kochlamazashvili
 (54) **IMIDAZOPYRIDAZINE COMPOUNDS**
-

PART B**B 26**

- (11) P 2019 6951 B (51) Int. Cl. (2006)
 B 26 B 21/24
- (10) AP 2018 14619 A (44) 21 (505) 2018
 (21) AP 2017 14619
 (22) 2017 10 29
 (24) 2017 10 29
 (73) Temur Maisuradze (GE)
 Mukhianis I mkr., korp. 10, b. 139,
 0172, Tbilisi (GE)
 (72) Temur Maisuradze (GE)
 (54) **CHANGEABLE CARTRIDGE OF SHAVING MACHINE**
-

UTILITY MODELS

APPLICATION APPROVED FOR GRANTING PATENT

The decision can be appealed at the Chamber of Appeal of Sakpatenti within 3 months from the publication or at the Mtskheta District Court Administrative Cases Board (Address: №17, Samkhedro str., Mtskheta), within 1 month following the publication.

PART A

A 61

(10) AU 2019 14814 U (51) Int. Cl. (2006)

A 61 K 35/78

A 61 K 8/04

(21) AU 2018 14814 (22) 2018 06 15

(71) Khatuna Zenaishvili (GE)

Nutsubidzis IV mkr., korp. 12, b. 62,

Tbilisi, 0183 (GE)

(72) Khatuna Zenaishvili (GE)

(54) **COSMETIC SLIMMING AND ANTI-CELLULITE CREAM**

(57) A cream contains red pepper, grapeseed oil, olive oil and beeswax.

Claims: 1 independent

PATENTED UTILITY MODELS

PART A

A 61

- (11) U 2019 2002 Y (51) Int. Cl. (2006)
A 61 K 8/19
A 61 K 8/30
A 61 Q 15/00
- (10) AU 2018 14607 U (44) 19(503)/2018
 (21) AU 2017 14607
 (22) 2017 10 13
 (24) 2017 10 13
 (73) Nana Nebulishvili (GE)
 Kazbegis Gamz. 4, b. 12, 0160, Tbilisi (GE)
 (72) Nana Nebulishvili (GE)
 (54) **MEANS AGAINST HYPERHIDROSIS
 AND SWEAT SMELL**

-
- (11) U 2019 2003 Y (51) Int. Cl. (2006)
A 61 K 33/36
- (10) AU 2018 14383 U (44) 18(502)/2018
 (21) AU 2017 14383
 (22) 2017 01 17
 (24) 2017 01 17
 (73) Mamuchar Kipiani (GE)
 M. Aleksidzis q., korp. 1, sad. 1, b. 19,
 0193, Tbilisi (GE)
 Nikoloz Batselashvili (GE)
 Meunargias q. 22, korp. 73, b. 31, 0101,
 Tbilisi (GE);
 Ruslan Geladze (GE)
 Gldanis VII mkr., korp. 2, b. 51 (GE)
 (72) Mamuchar Kipiani (GE);
 Nikoloz Batselashvili (GE);
 Ruslan Geladze (GE)
 (54) **METHOD FOR HELMINTOX DRUG
 PREPARATION**

PART F

F 24

- (11) U 2019 2001 Y (51) Int. Cl. (2006)
F 24 D 19/00
F 24 H 9/00
- (10) AU 2018 14602 U (44) 21 (505) 2018
 (21) AU 2017 14602
 (22) 2017 10 04
 (24) 2017 10 04
 (73) Giorgi Tsiramua (GE)
 Nutsubidzis II mkr., I kv., korp. 5, b. 7,
 0183, Tbilisi (GE);
 Davit Tsiramua (GE)
 Nutsubidzis II mkr., I kv., korp. 5, b. 7,
 0183, Tbilisi (GE)
 (72) Giorgi Tsiramua (GE);
 Davit Tsiramua (GE)
 (54) **HEAT-INSULATING BOX FOR
 CENTRAL HEATING BOILER**

TRADEMARKS

APPLICATIONS FILED UNDER THE NATIONAL PROCEDURE APPROVED FOR REGISTRATION

The decision can be appealed at the Chamber of Appeal of Sakpatenti within 3 months from the publication or at the Mtskheta District Court Administrative Cases Board (Address: №17, Samkhedro St., Mtskheta), within 1 month following the publication.

(260) AM 2019 78986 A*
(210) AM 78986
(220) 06 10 2014
(731) LLC Firm "BIOCOR"
Lermontov str. 3, Pens, 440026,
Russian Federation
(740) Vakhtang Torotadze
(540)



(531) 26.02.09; 27.05.25
(511) 5

(260) AM 2019 87174 A
(210) AM 87174
(220) 05 05 2016
(731) LTD "Zhorzholiani Trading"
Nucubidzis IV mkr., korp. 17, 0183, Tbilisi,
Georgia
(540)



(591) Red, white, black
(531) 01.17.11; 28.19; 29.01.13
(526) Elements of Georgia Flag
(511) 29, 30, 31, 33, 35, 43

(260) AM 2019 88279 A
(210) AM 88279
(220) 15 08 2016
(731) LTD "Zhorzholiani Trading"
Nucubidzis IV mkr., korp. 17, 0183, Tbilisi,
Georgia
(540)



(591) Red, blue, white
(531) 01.17.11; 24.07.01; 27.05.02; 28.19; 29.01.12
(526) Elements of Georgia Flag
(511) 29, 30, 31, 32, 33, 35, 43

(260) AM 2019 96309 A
(210) AM 96309
(220) 12 02 2018
(731) Irakli Pkhaladze
Iosebidge Str. 24, 0160, Tbilisi, Georgia
(540)

DALIO
დალიო
ДАЛИО

(591) Black, white
(511) 33

(260) AM 2019 96310 A
(210) AM 96310
(220) 12 02 2018
(731) Irakli Pkhaladze
Iosebidge Str. 24, 0160, Tbilisi, Georgia
(540)



MOLDBREAKER

(591) Black, white, red
(531) 05.01.19; 05.03.04; 05.07.11; 27.05.17;
29.01.13
(511) 33

(260) AM 2019 96312 A
(210) AM 96312
(220) 10 08 2018
(731) AKADEMI SEMPOA & MENTAL
ARITMETIK U C MAS SDN. BHD.
BO3-A-11, Level 11, Butik-ofis 3, Menara
3 A, NO. 3 Jalan Bangsar, KI Eko Siti,
KUALA LUMPUR, 59200, Malaysia
(740) Liliana Darakhvelidze

(540)



(591) Black, white
(531) 02.03.01; 27.05.01
(511) 16

(260) AM 2019 98186 A
(210) AM 98186
(220) 22 06 2018
(731) SHELL BRANDS INTERNATIONAL AG
Baarermatte, 6340 Baar, Switzerland
(740) Tamaz Shilakadze
(540)

deli2go

(591) Black, white
(511) 29, 30, 31, 32, 35, 43

(260) AM 2019 98187 A
(210) AM 98187
(220) 22 06 2018
(731) SHELL BRANDS INTERNATIONAL AG
Baarermatte, 6340 Baar, Switzerland
(740) Tamaz Shilakadze
(540)

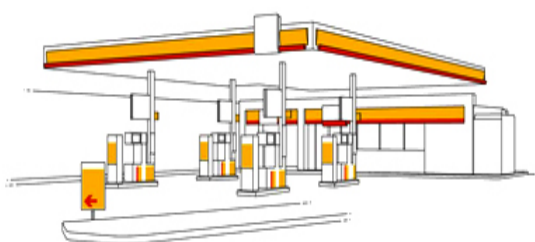

(554) Three-dimensional
(591) Red, yellow, white, black
(531) 07.01.15; 29.01.13
(511) 4, 35, 37

(260) AM 2019 98188 A
(210) AM 98188
(220) 22 06 2018
(731) SHELL BRANDS INTERNATIONAL AG
Baarermatte, 6340 Baar, Switzerland
(740) Tamaz Shilakadze

(540)



(591) Black, white
(531) 01.15.23; 15.07.02; 15.07.04; 26.01.01;
26.01.03; 26.01.16; 26.01.24
(511) 4

(260) AM 2019 98189 A
(210) AM 98189
(220) 22 06 2018
(731) SHELL BRANDS INTERNATIONAL AG
Baarermatte, 6340 Baar, Switzerland
(740) Tamaz Shilakadze
(540)

V-POWER

(591) Black, white
(511) 4

(260) AM 2019 98209 A
(210) AM 98209
(220) 26 06 2018
(731) N(N)LE Georgian Farmers Association
Ak. Khoravas q.4, Dzveli Tbilisi raionshi,
Tbilisi, Georgia
(740) Amza Kakauridze
(540)



(591) Green, blue, gray, white
(531) 01.05.02; 03.04.02; 03.04.11; 05.01.16;
05.07.24; 05.09.24; 27.03.11; 27.05.21;
29.01.13
(511) 41, 42

(260) AM 2019 98244 A
(210) AM 98244
(220) 02 07 2018

(731) SENSO VITA PHARMACY
Beliashvilis 1.43, 0159, Tbilisi, Georgia

(540)

SensoVita
Pharmacy

(591) Grey
(531) 27.05.01; 27.05.19
(511) 35

(260) AM 2019 98246 A

(210) AM 98246

(220) 02 07 2018

(731) MYLAN PHARMACEUTICALS PRIVATE LIMITED

Plot No.1-A/2, MIDC Industrial Estate,
Taloja, Panvel, District Raigad, Maharashtra –
410 208, India

(740) Merab Kvimsadze

(540)

HERTRAZ

(591) Black, white

(531) 27.05.01

(511) 5

(260) AM 2019 98247 A

(210) AM 98247

(220) 02 07 2018

(731) Vakhtang Pkhakadze

I. Chavchavadze Ave. 78, korp. 1, ap. 4,
0162, Tbilisi, Georgia

(740) Giorgi Taktakishvili

(540)

ლუტეცია

LUTECIA

(591) Black, white

(511) 3, 35, 44

(260) AM 2019 98249 A

(210) AM 98249

(220) 02 07 2018

(731) MCDONALD'S INTERNATIONAL PROPERTY COMPANY, LTD.

A corporation organized and existing under
the laws of the State of Delaware 110 North
arpenter Street, Chicago, Illinois 60607, USA

(740) Shalva Gvaramadze

(540)

მკვლე

(591) Black, white

(531) 28.19

(511) 29, 30, 32, 43

(260) AM 2019 98371 A

(210) AM 98371

(220) 03 07 2018

(731) LTD "MIKADO GEORGIA"

Dozaf Adjacent Territory, 3700, Rustavi,
Georgia

(540)



(591) Blue, red, black, gray

(531) 06.01.01; 18.01.09; 29.01.14

(511) 35

(260) AM 2019 98376 A

(210) AM 98376

(220) 04 07 2018

(731) BINGGRAE CO., LTD.

45, Dasansunhwan-ro, Namyangju-si,
Gyeonggi-do, Republic of Korea

(740) Giorgi Taktakishvili

(540)

ЗЯКИ-ЗЯКИ

(591) Black, white

(531) 28.05

(511) 30

(260) AM 2019 98390 A

(210) AM 98390

(220) 05 07 2018

(731) DRUSTRVO ZA MARKETINSKI,
PROMOTIVNI I PRODUKCISKI USLUGI
EEMM GROUP DOOEL SKOPJE
Ul. Naum Naumovski Borche Br. 50-11,
Skopje, Macedonia (the former Yugoslav
Republic of)

(740) Shalva Gvaramadze

(540)



(591) White, black, green
 (531) 22.01.10; 26.04.16; 26.04.18; 26.04.22;
 26.04.24; 27.05.24; 29.01.13
 (511) 41

(260) AM 2019 98395 A
 (210) AM 98395
 (220) 06 07 2018
 (731) COUTURE TECH LIMITED
 Trident Chambers P.o. Boqs 146, Road Town,
 Tortola, VG1110, Virgin Islands (British)
 (740) Nno Bakhtadze
 (540)

DENIS SIMACHËV

(591) Black, white
 (511) 43

(260) AM 2019 98405 A
 (210) AM 98405
 (220) 10 07 2018
 (731) LLC "Milania HOME"
 Ul. Shkolnaya, d. 20, 357748, Stavropol
 District, Kislovodsk, Russian Federation
 (740) Shalva Gvaramadze
 (540)

KAMHI KVEBI

(591) Black, white
 (511) 33, 35

(260) AM 2019 98409 A
 (210) AM 98409
 (220) 10 07 2018
 (731) VWR INTERNATIONAL HOLDINGS, INC.
 2751 Centerville Road, Suite 358,
 Wilmington, Delaware 19808, USA
 (740) Giorgi Meipariani
 (540)

AVANTOR

(591) Black, white
 (511) 1, 3, 5, 9, 11, 35, 40, 42

(260) AM 2019 98410 A
 (210) AM 98410
 (220) 10 07 2018
 (731) DECIEM BEAUTY GROUP INC.
 517 Richmond Street East, Toronto, Ontario
 M5A 1R4, Canada
 (740) Pacle Meipariani
 (540)

THE ORDINARY

(591) Black, white
 (511) 3, 35

(260) AM 2019 98411 A
 (210) AM 98411
 (220) 10 07 2018
 (731) VWR INTERNATIONAL HOLDINGS, INC.
 2751 Centerville Road, Suite 358,
 Wilmington, Delaware 19808, USA
 (740) Giorgi Meipariani
 (540)



(591) Blue, light blue, bright green, white, blue
 (531) 26.11.13; 27.05.01; 29.01.14
 (511) 1, 3, 5, 9, 11, 35, 40, 42

(260) AM 2019 98417 A
 (210) AM 98417
 (220) 11 07 2018
 (310) 2018-315
 (320) 17 04 2018
 (330) LI
 (731) EFL INK
 One Apple Park Way, California, Cupertino,
 95014, USA
 (740) Tamar Kochlamazashvili
 (540)

MEMOJI

(591) Black, white
 (511) 9

(260) AM 2019 98418 A
 (210) AM 98418
 (220) 11 07 2018
 (731) LAWAND GENERAL TRADING FZE.
 JAFZA VIEW - LOB 19 – 2603, JEBEL
 ALI, P.O. Box:113518, Dubai, United Arab
 Emirates
 (740) Merab Kvimsadze
 (540)

Candy

(591) Black, white
 (531) 27.05.01
 (511) 34

(260) AM 2019 98421 A
 (210) AM 98421
 (220) 12 07 2018
 (731) Giorgi Kamashidze
 Lermontov Str. 889, 6000, Batumi, Georgia
 (540)



(591) Green, yellow, white
 (531) 02.01.01; 05.07.27; 24.09.02; 24.09.11;
 26.01.14; 26.01.15; 26.01.21; 26.01.24;
 27.05.24; 28.19; 29.01.13
 (511) 30, 35

(260) AM 2019 98426 A
 (210) AM 98426
 (220) 12 07 2018
 (731) LTD "SUNNY GEORGIA TRAVEL"
 Baratashvili Str. 12/2, 0103, Tbilisi, Georgia
 (540)



(591) Yellow, white, black
 (531) 01.03.01; 01.03.02; 01.03.12; 27.05.01;
 29.01.13
 (526) Georgia
 (511) 39

(260) AM 2019 98427 A
 (210) AM 98427
 (220) 13 07 2018
 (731) Bosnalijek D.D.
 Pharmaceutical and Chemical Industry, JSC
 71000 Sarajevo, Jukićeva 53, Bosnia and
 Herzegovina
 (740) Giorgi Kankava
 (540)

FUNZOL

(591) Black, white
 (511) 5

(260) AM 2019 98432 A
 (210) AM 98432
 (220) 13 07 2018
 (731) OFRA Cosmetics LLC
 2141 Blaunt Roud, Pompano Bich, Florida
 33069, USA
 (740) Liliana Darakhvelidze
 (540)



(591) Black, white
 (531) 26.03.04; 26.03.18; 26.04.01; 26.04.03;
 26.04.07
 (511) 3

(260) AM 2019 98437 A
 (210) AM 98437
 (220) 13 07 2018
 (731) LTD "IVERTA"
 Sanapiro Str. 10, 0108, Tbilisi, Georgia
 (740) Salome Jeladze
 (540)

MARJIS მარჯის

(591) Black, white
 (511) 3, 5

(260) AM 2019 98442 A
 (210) AM 98442
 (220) 16 07 2018
 (731) SIX CONTINENTS LIMITED
 Broadwater Park, Denham, Buckinghamshire
 UB9 5HR, United Kingdom
 (740) Shalva Gvaramadze
 (540)



(591) Black, white
 (531) 27.05.10; 27.05.15
 (511) 35, 43,

(260) AM 2019 98550 A
 (210) AM 98550
 (220) 17 07 2018
 (731) INTERVET INTERNATIONAL AP. V.
 Wim de Korverstraat 35, NL-5831, AN
 Boxmeer, Netherlands
 (740) Tamaz Shilakadze
 (540)

VITRECTO

(591) Black, white
 (511) 5

(260) AM 2019 98559 A
 (210) AM 98559
 (220) 18 07 2018
 (731) Eka Kopaleishvili
 Ostojenka Str. 25, ap. 41, Moscow, Russian
 Federation
 (740) Giorgi Taktakishvili
 (540)

ამბასადორი AMBASSADORI

(591) Black, white
(511) 41, 43

(260) AM 2019 98565 A
(210) AM 98565
(220) 19 07 2018
(731) JOHNSON & JOHNSON
ONE JOHNSON & JOHNSON PLAZA,
NEW BRUNSWICK, NEW JERSEY 08933,
USA
(740) Giorgi Taktakishvili
(540)

MOTILEGAS

(591) Black, white
(511) 5

(260) AM 2019 98566 A
(210) AM 98566
(220) 19 07 2018
(731) JOHNSON & JOHNSON
ONE JOHNSON & JOHNSON PLAZA,
NEW BRUNSWICK, NEW JERSEY 08933,
USA
(740) Giorgi Taktakishvili
(540)

МОТИЛЕГАЗ

(591) Black, white
(511) 5

(260) AM 2019 98570 A
(210) AM 98570
(220) 19 07 2018
(731) LTD "DELIVERY"
Mtskheta Str. 31, ap. 9, 0179, Tbilisi, Georgia
(540)

მოიტანე.ge



moitane.ge

(591) Black, white
(531) 26.13.25; 27.05.01; 27.05.21; 28.19
(511) 35, 39

(260) AM 2019 98574 A
(210) AM 98574
(220) 19 07 2018
(731) EURODRAG LABORATORYES AP. V.
Regulusveg 11, 2516 AC, Hague, Netherlands
(740) Tamaz Shilakadze

(540)

DECORT

(591) Black, white
(511) 5

(260) AM 2019 98575 A
(210) AM 98575
(220) 19 07 2018
(731) YILDIZ HOLDİNG ANONİM ŞİRKETİ
Kısıklı Mahallesi, Çeşme Çıkmazı Sokak
No:6/1 Üsküdar İstanbul, Turkey
(740) Tamaz Shilakadze
(540)



(591) Blue, sky-blue, red, green, dark blue, white, brown
(531) 05.01.12; 05.07.06; 08.01.23; 19.03.03;
19.03.05; 19.03.25; 27.05.02; 29.01.14
(511) 30

(260) AM 2019 98661 A
(210) AM 98661
(220) 21 07 2018
(731) LTD "OTAKHI"
Brothers Zubalashvilebi Str. 6, 0108, Tbilisi,
Georgia
(540)

ბილამუში

(511) 29, 30

(260) AM 2019 98683 A
(210) AM 98683
(220) 24 07 2018
(731) LTD "GLOBALPHARM"
Almasiani Str. 13a/Berbuti Str. 8, 0171,
Tbilisi, Georgia
(540)

ლეტრანო

ЛЕТРАН LETRAN

(591) Black, white
(511) 5

(260) AM 2019 98684 A
(210) AM 98684
(220) 25 07 2018
(731) Ara Razmikovich Ispiryan

Ul. Khanjiyana, d. 45, Yerevan, Armenia
 (740) Giorgi Taktakishvili
 (540)

VINO & VINO
 premium alcohol

(591) Black, bordeaux, crimson
 (531) 01.15.15; 24.17.05; 24.17.09; 27.05.01;
 27.05.10; 29.01.12
 (511) 33, 35, 41, 43

(260) AM 2019 98685 A
 (210) AM 98685
 (220) 25 07 2018
 (731) Ara Razmikovich Ispiryan
 Ul. Khanjiyana, d. 45, Yerevan, Armenia
 (740) Giorgi Taktakishvili
 (540)

VINO & VINO
 wine-spirits-olive oil

(591) Black, bordeaux, crimson
 (531) 01.15.15; 24.17.05; 24.17.09; 27.05.10;
 29.01.13
 (511) 33, 35, 41, 43

(260) AM 2019 98686 A
 (210) AM 98686
 (220) 25 07 2018
 (731) LTD "EMEX"
 V. Dolidze Str., kor. 25, ap. 71, 0171, Tbilisi,
 Georgia
 (540)



ემექსი
 სასტუმრო

(591) Light brown, black, white
 (531) 24.13.23; 26.04.12; 28.19; 29.01.12
 (511) 43

(260) AM 2019 98691 A
 (210) AM 98691
 (220) 26 07 2018
 (731) LTD "MACRO FOOD"
 Rustaveli Ave. 28/Al. Chavchavadze Str. 2,
 0108, Tbilisi, Georgia
 (540)



(591) Black, white
 (531) 26.13.25; 27.05.01; 27.05.03; 27.05.10;
 27.05.24
 (511) 43

(260) AM 2019 98695 A
 (210) AM 98695
 (220) 27 07 2018
 (731) LEPL REVENUE SERVICE
 Vakhtang Gorgasali Str. 16, 0105, Tbilisi,
 Georgia
 (540)



(591) Blue, sky-blue, green, white
 (531) 26.01.03; 26.01.04; 26.02.03; 26.02.09;
 26.03.01; 26.03.24; 26.07.03; 29.01.13
 (511) 35, 36, 45

(260) AM 2019 98697 A
 (210) AM 98697
 (220) 27 07 2018
 (731) Giorgi Tsiramua
 Universiteti Str. 19, 0186, Tbilisi, Georgia
 (540)



biliki

(591) Yellow, gray, green, white
 (531) 26.01.01; 26.01.04; 26.03.01; 26.03.06;
 26.07.03; 27.05.01; 29.01.14
 (511) 9, 39, 42

REGISTERED TRADEMARKS

(111) M 2019 30808 R (151) 19 02 2019 (181) 19 02 2029 (260) AM 2017 92783 A (220) 14 06 2017 (732) HARRINGTON DEVELOPMENT INC. Elvira Mendez Street, Vallarino Bldg, 3rd Floor, Panama, Republic of Panama	Otskhelis q., korp. 24, b. 42, 0145, Tbilisi, Georgia
(111) M 2019 30809 R (151) 19 02 2019 (181) 19 02 2029 (260) AM 2017 92854 A (220) 20 06 2017 (732) HARRINGTON DEVELOPMENT INC. Elvira Mendez Street, Vallarino Bldg, 3-rd Floor, Panama, Republic of Panama	(111) M 2019 30814 R (151) 19 02 2019 (181) 19 02 2029 (260) AM 2018 93085 A (220) 19 04 2018 (732) LTD "BIH" Otskhelis q., korp. 24, b. 42, 0145, Tbilisi, Georgia
(111) M 2019 30810 R (151) 19 02 2019 (181) 19 02 2029 (260) AM 2017 92856 A (220) 20 06 2017 (732) HARRINGTON DEVELOPMENT INC. Elvira Mendez Street, Vallarino Bldg, 3-rd Floor, Panama, Republic of Panama	(111) M 2019 30815 R (151) 19 02 2019 (181) 19 02 2029 (260) AM 2018 93088 A (220) 19 04 2018 (732) LTD "BIH" Otskhelis q., korp. 24, b. 42, 0145, Tbilisi, Georgia
(111) M 2019 30811 R (151) 19 02 2019 (181) 19 02 2029 (260) AM 2018 93081 A (220) 19 04 2018 (732) LTD "BIH" Otskhelis q., korp. 24, b. 42, 0145, Tbilisi, Georgia	(111) M 2019 30816 R (151) 19 02 2019 (181) 19 02 2029 (260) AM 2018 93090 A (220) 19 04 2018 (732) LTD "BIH" Otskhelis q., korp. 24, b. 42, 0145, Tbilisi, Georgia
(111) M 2019 30812 R (151) 19 02 2019 (181) 19 02 2029 (260) AM 2018 93083 A (220) 19 04 2018 (732) LTD "BIH" Otskhelis q., korp. 24, b. 42, 0145, Tbilisi, Georgia	(111) M 2019 30817 R (151) 19 02 2019 (181) 19 02 2029 (260) AM 2018 93091 A (220) 19 04 2018 (732) LTD "BIH" Otskhelis q., korp. 24, b. 42, 0145, Tbilisi, Georgia
(111) M 2019 30813 R (151) 19 02 2019 (181) 19 02 2029 (260) AM 2018 93084 A (220) 19 04 2018 (732) LTD "BIH"	(111) M 2019 30818 R (151) 19 02 2019 (181) 19 02 2029 (260) AM 2017 95138 A (220) 20 11 2017 (732) BIAL – Portela & Ca ., S.A. E Avenida Da Siderurgia Nacional, 4745-457, Koronado (s. Romao E S. Mamede), Portugal

(111) M 2019 30819 R (151) 19 02 2019 (181) 19 02 2029 (260) AM 2017 95480 A (220) 11 12 2017 (732) LTD "VAZISUBNIS MAMULI" Marjanishvilis q. 7, 0102, Tbilisi, Georgia	(111) M 2019 30825 R (151) 19 02 2019 (181) 19 02 2029 (260) AM 2017 95717 A (220) 29 12 2017 (732) JSC "PROBUS CAPITAL" Amaghlebis q. 36, 0105, Tbilisi, Georgia
(111) M 2019 30820 R (151) 19 02 2019 (181) 19 02 2029 (260) AM 2017 95541 A (220) 18 12 2017 (732) LTD "VITE VERA" Z. Paliashvilis q. 33a, 0179, Tbilisi, Georgia	(111) M 2019 30826 R (151) 19 02 2019 (181) 19 02 2029 (260) AM 2017 95718 A (220) 29 12 2017 (732) JSC "SPIRIT AND VODKA COMPANY GOMI" Village Gomi, Khashuri district, Georgia
(111) M 2019 30821 R (151) 19 02 2019 (181) 19 02 2029 (260) AM 2017 95547 A (220) 18 12 2017 (732) LTD "VITE VERA" Z. Paliashvilis q. 33a, 0179, Tbilisi, Georgia	(111) M 2019 30827 R (151) 19 02 2019 (181) 19 02 2029 (260) AM 2018 95986 A (220) 16 01 2018 (732) ANA SALUKVADZE S. Tsintsadzis q. 18, 0160 Tbilisi, Georgia
(111) M 2019 30822 R (151) 19 02 2019 (181) 19 02 2029 (260) AM 2017 95667 A (220) 26 12 2017 (732) Milan Sarkisyan M. Toidzis q. 10, Tbilisi, Georgia	(111) M 2019 30828 R (151) 19 02 2019 (181) 19 02 2029 (260) AM 2018 96172 A (220) 31 01 2018 (732)) LTD "VINAGORA" G. Tabidzis q. 15, Tbilisi, Georgia
(111) M 2019 30823 R (151) 19 02 2019 (181) 19 02 2029 (260) AM 2017 95673 A (220) 27 12 2017 (732) Ilo Khobelia S. Chikovanis q. 4/6/8/10, b. 73, Tbilisi, Georgia	(111) M 2019 30829 R (151) 19 02 2019 (181) 19 02 2029 (260) AM 2018 96176 A (220) 01 02 2018 (732) Taras Gabisonia I. Chavchavadzis gamz. 39b, 0162, Tbilisi, Georgia; LEPL G. Eliava's House Bacteriophage, Microbiology and Viruses Institute Gotuas q. 3, 0160, Tbilisi, Georgia
(111) M 2019 30824 R (151) 19 02 2019 (181) 19 02 2029 (260) AM 2017 95716 A (220) 29 12 2017 (732) JSC "PROBUS CAPITAL" Amaghlebis q. 36, 0105, Tbilisi, Georgia	(111) M 2019 30830 R (151) 19 02 2019 (181) 19 02 2029 (260) AM 2018 96178 A (220) 01 02 2018 (732) Viktoria Shtorm I. Chavchavadzis gamz. 33b, b. 18, 0179, Tbilisi, Georgia

(111) M 2019 30831 R
(151) 19 02 2019
(181) 19 02 2029
(260) AM 2018 96305 A
(220) 09 02 2018
(732) BRITISH AMERICAN TOBACCO
(BRANDS) INC.
(a Delaware corporation)
251 Litl Fols Draiv, Suit 100, Delaveri,
Wilmington, 19808-1674, USA

(111) M 2019 30832 R
(151) 19 02 2019
(181) 19 02 2029
(260) AM 2018 96407 A
(220) 16 02 2018
(732) "WINEMAN LLC"
Gudiashvilis q. 11, 0105, Tbilisi, Georgia

(111) M 2019 30833 R
(151) 19 02 2019
(181) 19 02 2029
(260) AM 2018 96706 A
(220) 07 03 2018
(732) Irakli Kutalia
Vazha-Pshavelas I kvart., korp. 21, b. 16,
0177, Tbilisi, Georgia

(111) M 2019 30834 R
(151) 19 02 2019
(181) 19 02 2029
(260) AM 2018 96711 A
(220) 09 03 2018
(732) NICOVENTURES HOLDINGS LIMITED
Gloub Hauz, 1 Uoter Strit, London, WC2R
3LA, United Kingdom

(111) M 2019 30835 R
(151) 19 02 2019
(181) 19 02 2029
(260) AM 2018 96735 A
(220) 10 03 2018
(732) LLC "GEORGIAN ALLIANCE"
Giorgi Nadareishvilis q. 9, 0120, Tbilisi,
Georgia

(111) M 2019 30836 R
(151) 19 02 2019
(181) 19 02 2029
(260) AM 2018 96738 A
(220) 12 03 2018
(732) LLC "ALTA"
Akaki Beliashvilis q.104, 0159, Tbilisi,
Georgia

(111) M 2019 30837 R
(151) 19 02 2019
(181) 19 02 2029
(260) AM 2018 96782 A
(220) 12 03 2018
(732) INTEL CORPORATION
2200 Mission College Boulevard, Santa Clara,
California 95052-8119, USA

(111) M 2019 30838 R
(151) 19 02 2019
(181) 19 02 2029
(260) AM 2018 96807 A
(220) 13 03 2018
(732) Zurab Barbakadze
Varketilis III masivi, kvart. IV, korp. 13,
b.11, 0163, Tbilisi, Georgia

(111) M 2019 30839 R
(151) 19 02 2019
(181) 19 02 2029
(260) AM 2018 96842 A
(220) 15 03 2018
(732) ABBOTT POINT OF CARE INC.
(a corporation of the State of Delaware)
400 College Road East, New Jersey,
Princeton, 08540, USA

(111) M 2019 30840 R
(151) 19 02 2019
(181) 19 02 2029
(260) AM 2018 96852 A
(220) 15 03 2018
(732) ABBOTT POINT OF CARE INC.
(a corporation of the State of Delaware)
400 College Road East, New Jersey,
Princeton, 08540, USA

(111) M 2019 30841 R
(151) 19 02 2019
(181) 19 02 2029
(260) AM 2018 96864 A
(220) 16 03 2018
(732) LTD "AISI"
Varketili III, mkr. I, korp. 28, b.28, 0163,
Tbilisi, Georgia

(111) M 2019 30842 R
(151) 19 02 2019
(181) 19 02 2029
(260) AM 2018 96977 A
(220) 22 03 2018
(732) LLC "Nauchno-Vnedrencheskiy Tsentr
AGRIVETZACHITA"

129239, Moskow, Igarskiy proezd, dom 4,
stroenie 2, Russian Federation

(111) M 2019 30843 R
(151) 19 02 2019
(181) 19 02 2029
(260) AM 2018 96981 A
(220) 22 03 2018
(732) ABBOTT LABORATORIES
100 Abbott Park Road, Illinois, Abbott Park,
60064, USA

(111) M 2019 30844 R
(151) 19 02 2019
(181) 19 02 2029
(260) AM 2018 97032 A
(220) 28 03 2018
(732) ŠKODA AUTO a.s
Tr. Vaclava Klementa 869, Mlada Boleslav II,
Mlada Boleslav, CZ-293 01, Czech Republic

(111) M 2019 30845 R
(151) 19 02 2019
(181) 19 02 2029
(260) AM 2018 97090 A
(220) 29 03 2018
(732) LTD "GMP"
Sop. Ponitchala 65, 0165, Tbilisi, Georgia

TRADEMARKS REGISTERED ACCORDING TO THE ACCELERATED PROCEDURE

The decision can be appealed at the Chamber of Appeal of Sakpatenti within 3 months from the publication.

(111) M 2019 30794 R
 (151) 07 02 2019
 (181) 07 02 2029
 (210) AM 101303
 (220) 23 01 2019
 (732) LTD "SARKE STUDIO"
 Jikias q. 5, 0186, Tbilisi, Georgia
 (740) Irakli Dautashvili
 (540)



(591) Black, white, gray, golden
 (531) 02.05.03; 02.05.21; 03.05.01; 03.07.13;
 26.01.14; 26.01.15; 27.05.01
 (511) 35, 41

(111) M 2019 30795 R
 (151) 07 02 2019
 (181) 07 02 2029
 (210) AM 101494
 (220) 01 02 2019
 (732) LTD "PARK GIDA"
 Sop. Khutsubani, Ubani 5, q. 46a, 6200,
 Kobuleti, Georgia
 (740) Dato Jaiani
 (541)

ქროვ
KROW

(591) Black, white
 (511) 32

(111) M 2019 30796 R
 (151) 08 02 2019
 (181) 08 02 2029
 (210) AM 101390
 (220) 29 01 2019
 (732) BEKA BEGLARASHVILI
 Iloris q. 6, 0153, Tbilisi, Georgia

(540)

სანაპირო
Санапиро
sanapiro

(591) Black, white
 (511) 32

(111) M 2019 30797 R
 (151) 08 02 2019
 (181) 08 02 2029
 (210) AM 101379
 (220) 28 01 2019
 (732) JSC "Insurance Company Euroins Georgia"
 I. Mosashvilis q. 24, 0162, Tbilisi, Georgia
 (740) Salome Tsiklauri
 (540)



(591) Blue, white
 (531) 01.01.01; 01.01.05; 01.01.10; 01.11.08;
 26.01.01; 26.01.03; 26.01.12; 26.01.13; 28.19;
 29.01.12
 (511) 36

(111) M 2019 30798 R
 (151) 08 02 2019
 (181) 08 02 2029
 (210) AM 101380
 (220) 28 01 2019
 (732) JSC "Insurance Company Euroins Georgia"
 I. Mosashvilis q. 24, 0162, Tbilisi, Georgia
 (740) Salome Tsiklauri
 (540)



(591) Blue, white
 (531) 01.01.01; 01.01.05; 01.01.10; 01.11.08;
 26.01.12; 26.01.13; 26.01.24; 27.05.10;
 29.01.12
 (511) 36

(111) M 2019 30799 R
 (151) 08 02 2019
 (181) 08 02 2029
 (210) AM 101391
 (220) 29 01 2019
 (732) Narkom Iliazovi
 Sop. Mughanlo me-19 q. 5, Gardabani,
 Georgia
 (740) Natalia Saakiani
 (540)

 The logo for DORA features the word "DORA" in a bold, sans-serif font. The letter "O" is stylized with a red square above it and another red square below it, creating a central vertical gap.

(591) White, black, red
 (531) 05.03.15; 27.03.11; 27.05.01; 27.05.08;
 29.01.12
 (511) 25

(111) M 2019 30800 R
 (151) 11 02 2019
 (181) 11 02 2029
 (210) AM 101373
 (220) 25 01 2019
 (732) LTD "OXYGEN"
 Vazha-Pshavelas gamz. III kvart., korp. 21,
 b.1, Tbilisi, 0160, Georgia
 (540)

Revasid
რევასიდი

(591) Black, white
 (511) 5

(111) M 2019 30801 R
 (151) 11 02 2019
 (181) 11 02 2029
 (210) AM 101388
 (220) 29 01 2019
 (732) JSC "m² Real Estate"
 Ilia Chavchavadze Ave. 29, 3 fl.,
 Tbilisi, Georgia
 (740) Nikoloz Jalaghania
 (540)

Metaphor Hotel

(591) Black, white
 (511) 33, 35, 36, 37, 39, 43

(111) M 2019 30802 R
 (151) 11 02 2019
 (181) 11 02 2029
 (210) AM 101389
 (220) 29 01 2019
 (732) JSC "m² Real Estate"

Ilia Chavchavadze Ave. 29, 3 fl., Tbilisi,
 Georgia
 (740) Nikoloz Jalaghania
 (540)

სასტუმრო მეტაფორა

(591) Black, white
 (511) 33, 35, 36, 37, 39, 43

(111) M 2019 30803 R
 (151) 13 02 2019
 (181) 13 02 2029
 (210) AM 101528
 (220) 07 02 2019
 (732) METEL Inc.
 333 Continental boulevard, E-Segundo,
 California, 90245, USA
 (740) Giorgi Meifaryan
 (540)

HOT WHEELS

(591) Black, white
 (511) 8, 9, 16, 18, 20, 21, 24, 25, 28, 41

(111) M 2019 30804 R
 (151) 13 02 2019
 (181) 13 02 2029
 (210) AM 101307
 (220) 25 01 2019
 (732) The International Association of Lions Clubs
 300 W. 22nd Street, Oak Brook, Illinois
 60523, United States
 (740) Giorgi Taktakishvili
 (540)



(591) Black, white
 (531) 03.01.01; 03.01.02; 03.01.16; 25.03.03;
 26.04.02; 26.04.06
 (511) 36, 43

(111) M 2019 30805 R
 (151) 14 02 2019
 (181) 14 02 2029
 (210) AM 101405
 (220) 30 01 2019
 (732) LTD "Shilda Wine Bar"
 Gergetis q. 3, Mtatsminis r-ni, Tbilisi, Georgia

(540)

ლაგაზა
Lagaza

(591) Black, white
(511) 29, 33, 43

(111) M 2019 30806 R

(151) 18 02 2019

(181) 18 02 2029

(210) AM 101605

(220) 08 02 2019

(732) LTD "Global Tobako Partners"

Zgvisubnis Dasakhleba, III Mkr., I kvart.,
korp. 70, b. 17, 0191, Nadzaladevis r-ni,
Tbilisi, Georgia

(740) Nazel Kloyan

(540)

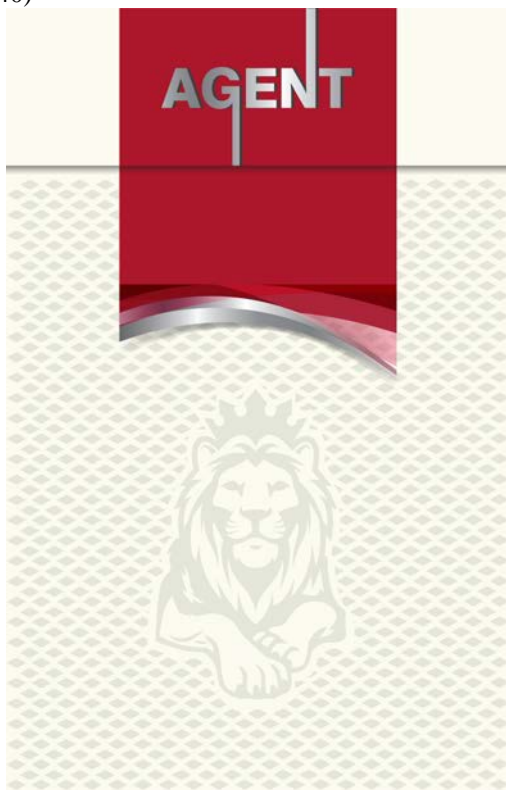

(591) Red, white, golden, pink, gray
(531) 03.01.01; 03.01.16; 03.01.28; 25.01.01;
25.07.02; 27.05.01; 29.01.14
(511) 34

(111) M 2019 30807 R

(151) 18 02 2019

(181) 18 02 2029

(210) AM 101529

(220) 08 02 2019

(732) LTD "ZE GVINO"

Taktakishvilis q. 7, b. 5, Tbilisi, Georgia

(540)



(591) Black, white

(531) 11.03.02; 11.03.08; 19.07.01; 25.01.10;
25.01.19; 26.04.02; 26.04.07; 28.19

(511) 33

(111) M 2019 30846 R

(151) 20 02 2019

(181) 20 02 2029

(210) AM 101516

(220) 05 02 2019

(732) Revaz Tsirekidze

Tamarashvilis q. 10, b. 43, 0177, Tbilisi,
Georgia

(540)



(591) Blue, black, white, green

(531) 03.04.01; 03.04.02; 03.04.13; 25.01.05;
26.01.01; 26.01.04; 26.01.15; 26.01.21;
27.05.24; 29.01.14

(511) 29, 30, 32

INTERNATIONAL TRADEMARKS FOR WHICH A DECISION ON GRANTING PROTECTIONS IS TAKEN

The decision can be appealed at the Chamber of Appeal of Sakpatenti within 3 months from the publication or at the Mtskheta District Court Administrative Cases Board (Address: №17, Samkhedro str., Mtskheta), within 1 month following the publication.

(260) AM 2019 91372 A*

(800) 1255373

(151) 2015 04 08

(891) 2017 01 17

(731) VESTEL TICARET A.S.

Organize Sanayi Bölgesi, TR-45030 Manisa,
Turkey

(540)

VESTEL venus

(591) Black, white

(531) 27.05.10; 27.05.17

(511)

9 – Telecommunication apparatus and instruments; telephones; battery chargers for phones; hardware and software for computer networking equipment; data communication equipment; computers, laptops, tablets; computer software; scanners and monitors (not for medical use); printers; computer peripherals.

(260) AM 2019 92412 A*

(800) 1344755

(151) 2016 12 07

(891) 2016 12 07

(731) ORIFLAME COSMETICS AG

c/o Oriflame Global Management AG,
Bleicheplatz 3 CH-8200 Schaffhausen,
Switzerland

(540)

ORIFLAME THE ONE

(591) Black and white

(511)

3 – on-medicated preparations for the application to, conditioning and care of hair, scalp, skin and nails; soaps; perfumes; perfumery; eau de cologne; toilet waters; essential and herbal oils; cosmetics; make-up preparations; lipsticks; nail varnishes; nail varnish removers; non-medicated toilet preparations; hair lotions; hair sprays and hair gels; preparations for use in the bath or shower; bath and shower oils, gels, creams and foams; face and body masks; face and body scrubs; facial washes; skin cleansers and hydrators; skin toners; skin moisturizers; blemish creams and blemish gels; deodorants; antiperspirants; preparations for use before shaving and after shaving; shaving soaps; shaving creams; shaving gels; after-shave preparations; pre-shave preparations; talcum powders; toiletries; dentifrices; toothpastes.

(260) AM 2019 93306 A*

(800) 1353392

(151) 2017 05 01

(891) 2017 05 01

(731) JANSSEN PHARMACEUTICA NV

Turnhoutseweg 30 B-2340 BEERSE, Belgium

(540)

NURSPRANA

(591) Black and white

(511)

5 – Human pharmaceutical preparations for the prevention and treatment of viral diseases, auto-immune and inflammatory diseases, cardiovascular diseases, central nervous system diseases, pain, dermatologic diseases, gastro-intestinal diseases, infectious-related diseases, metabolic diseases, oncologic diseases, ophthalmic diseases and respiratory diseases.

(260) AM 2019 93676 A*

(800) 1358268

(151) 2017 05 04

(891) 2017 05 04

(731) CHANEL SARL

Quai du Général-Guisan 24, CH-1204 Genève,
Switzerland

(540)

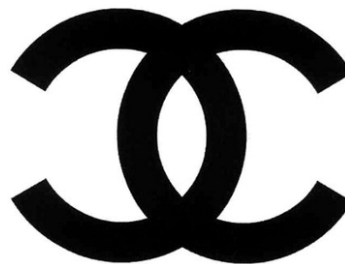

(591) Black and white

(531) 26.01.06; 27.05.22

(511)

9 – Optical apparatus and instruments; sunglasses, spectacles, binoculars; cases and cords for sunglasses, spectacles and binoculars; frames and lenses for spectacles and for sunglasses; shells, cases, covers and carrying bags for mobile telephones, apparatus and for telecommunication instruments; shells, cases, covers and carrying bags for tablet computers and for computer apparatus and instruments; shells, cases, covers and carrying bags for electronic apparatus; cards for mobile telephones; electronic publications relating to fashion or beauty; loyalty cards,

debit cards, credit cards; all these goods magnetically encoded; mechanism for coin-operated apparatus for dispensing perfumes and cosmetics, mouse pads; compact discs, CD-ROMs, DVDs and Blu-ray disks; USB flash drives; decorative magnets; graphic elements and downloadable ringtones for mobile telephones; accessories for mobile telephones, tablet computers and for portable computers; selfie sticks / telescopic poles; personal digital assistants; software; software applications for personal computers, portable computers, mobile telephones and for tablet computers; battery chargers; chargers for mobile telephones and for telecommunication apparatus and instruments; chargers for computer apparatus and instruments; chargers for electronic apparatus; luminous or mechanical signs; luminous or mechanical signals.

14 – Fashion jewelry.

18 – Leather and imitations of leather; animal skins; trunks, carrying cases, suitcases and traveling sets [leatherware]; umbrellas, parasols and walking sticks; whips, harness and saddlery; wallets; purses (coin purses); garment bags for travel; bags; card holders; business card cases; music cases; vanity cases, not fitted; briefcases; handbags, backpacks, wheeled bags; bags for climbers and campers, travel bags, beach bags, school bags; collars or clothing for animals; shopping bags; bags or small bags (envelopes, pouches) of leather for packaging; key cases; attaché cases; luggage tags of leather; hat boxes of leather; leather laces.

25 – Clothing, footwear, headgear; shirts; clothing of leather or imitation of leather; belts (clothing); furs (clothing); gloves (clothing); scarves; shawls; neckties; hosiery; socks; bedroom slippers; stockings; tights; beach, ski or sports footwear; underwear; sleep masks; uniforms; money belts [clothing].

(260) AM 2019 93970 A

(800) 1361552

(151) 2017 06 29

(891) 2017 06 29

(731) MIESZKO S.A.

Aleje Jerozolimskie 181, PL-02-222 Warsaw,
Poland

(540)

Dolcissimo

(591) Black, white

(511)

30 – Confectionery; sweets.

(260) AM 2019 94826 A

(800) 1372306

(151) 2017 08 29

(891) 2017 08 29

(731) MIKHAIL ALEKSANDROVICH ERIUTIN
ul. Glazunova, 10-7, RU-440066 g. Penza,
Russian Federation

(540)

F E T I C H E

(591) Black, white

(511)

18 – Leather goods, namely purses, business card cases, credit card cases, bags.

(260) AM 2019 95617 A

(800) 1378790

(151) 2017 06 07

(891) 2017 06 07

(731) Aktsionernoe obshchestvo "GOZNAK"
(AO"GOZNAK")

territoriya Petropavlovskaya krepost,
d. 3, liter G, RU-197046 Sankt-Peterburg,
Russian Federation

(540)



(591) Dark green

(531) 03.07.02; 24.01.09; 27.05.01

(511)

2 – Paints; mordants; varnishes; colorants for beverages; food dyes; food colorants; alizarine dyes; aluminium paints; aluminium powder for painting; asbestos paints; anti-corrosive preparations; fixatives for watercolors [watercolours]; fixatives for watercolours; silver paste; silver emulsions [pigments]; silvering powders; black japan; auramine; bactericidal paints; badigeon; anti-corrosive bands; Canada balsam; colorants for butter; colorants for beer; bitumen varnish; wood coatings [paints]; wood mordants; wood stains; sienna earth; bronzing lacquers; bronze powder for painting; ink for leather; caramel [food colorant]; malt caramel [food colorant]; coatings for roofing felt [paints]; coatings for tarred felt [paints]; ceramic paints; white lead; carbon black [pigment]; undercoating for vehicle chassis; undersealing for vehicle chassis; shoe dyes; lime wash; printers' pastes [ink]; cobalt oxide [colorant]; cochineal carmine; colophony; colorants; dyestuffs; malt colorants; wood preservatives; copal; aniline dyes; thinners for paints; thinners for lacquers; thickeners for paints; creosote for wood preservation; mordants for leather; stains

for leather; dyes; pigments; turmeric [colorant]; natural resins, raw; distempers; enamels [varnishes]; enamels for painting; enamel paints; printing ink; marking ink for animals; siccatives [drying agents] for paints; ink for skin-dressing; coatings [paints]; fixatives [varnishes]; lamp black [pigment]; yellow-wood [colorant]; glazes [paints, lacquers]; gamboge for painting; gum-lac; shellac; gum resins; anti-rust greases; engraving ink; zinc oxide [pigment]; oils for the preservation of wood; anti-rust oils; fireproof paints; indigo [colorant]; binding preparations for paints; agglutinants for paints; colorants for liqueurs; litharge; orange lead; metals in powder form for use in painting, decorating, printing and art; mastic [natural resin]; metal foil for use in painting, decorating, printing and art; anti-tarnishing preparations for metals; protective preparations for metals; minium; red lead; paper for dyeing Easter eggs; annatto [dyestuff]; annotto [dyestuff]; saffron [colorant]; sandarac; soot [colorant]; sumac for varnishes; titanium dioxide [pigment]; anti-rust preparations; primers; whitewash; dyewood; dye-wood; dyewood extracts; wood dyestuffs; carbonyl [wood preservative]; copal varnish; lacquers; toners [ink] for photocopiers; ink [toner] for photocopiers; anti-fouling paints; toner cartridges, filled, for printers and photocopiers; turpentine [thinner for paints]; repositionable paint patches; watercolour paints for use in art; watercolor paints for use in art; oil paints for use in art; edible inks; edible ink cartridges, filled, for printers.

6 – Steel, unwrought or semi-wrought; steel alloys; steel strip; hoop steel; steel wire; cast steel; steel masts; roller blinds of steel; steel sheets; steel pipes; steel tubes; machine belt fasteners of metal; railway points; railway switches; nozzles of metal; building or furniture fittings of nickel-silver; nickel-silver; aluminium; bronze; aluminium wire; anchor plates; tie plates; jets of metal; latch bars of metal; masts of metal; poles of metal; traps for wild animals; braces of metal for handling loads; harness of metal for handling loads; braces of metal for load handling; harness of metal for load handling; anti-friction metal; tree protectors of metal; cashboxes of metal; silver solder; German silver; silver-plated tin alloys; reinforcing materials, of metal, for concrete; safes [strong boxes]; window stops of metal; door stops of metal; washers of metal; rings of metal; stop collars of metal; strap-hinges of metal; floor tiles of metal; barbed wire; bars for metal railings; beryllium [glucinium]; glucinium [beryllium]; cattle chains; beak-irons [bick-irons]; white metal; armor-plating of metal; armour-plating of metal; box fasteners of metal; bolts of metal; bottles [metal containers] for compressed gas or liquid air; identification bracelets of metal; iron slabs; brazing alloys; flanges of metal [collars]; monuments of bronze for tombs; bronzes for tombstones; bronzes [works of art]; telpher cables; rope thimbles of metal; cable joints of metal, non-electric; cable linkages of metal, non-electric;

cadmium; padlocks; shims; ferrules of metal for walking sticks; containers of metal for storing acids; safety cashboxes; hafnium [celtium]; celtium [hafnium]; chains of metal; safety chains of metal; couplings of metal for chains; frames of metal for building; window pulleys; sash pulleys; ducts of metal, for central heating installations; pipes of metal, for central heating installations; ducts and pipes of metal for central heating installations; horseshoe nails; pegs of metal; chromium; chrome iron; chrome ores; cotter pins of metal; keys; nails; tacks [nails]; brads; wall plugs of metal; cobalt, raw; railway material of metal; pillars of metal for building; water-pipes of metal; sleeves [metal hardware]; tin cans; preserving boxes of metal; preserve tins; containers of metal [storage, transport]; guard rails of metal; chill-molds [foundry]; chill-moulds [foundry]; anvils; roof flashing of metal; elbows of metal for pipes; doors of metal; belt stretchers of metal; crampons of metal [cramps]; cramps of metal [crampons]; pot hooks of metal; window casement bolts; hooks [metal hardware]; ironwork for windows; wire of common metal; copper, unwrought or semi-wrought; copper rings; tubing of metal; containers of metal for compressed gas or liquid air; foot scrapers; door scrapers; drain pipes of metal; iron, unwrought or semi-wrought; fish plates [rails]; screws of metal; tinplate packings; letter boxes of metal; door bells of metal, non-electric; spurs; brackets of metal for building; staircases of metal; window fasteners of metal; pipes of metal; tubes of metal; rails of metal; fittings of metal for windows; iron strip; hoop iron; iron wire; cast iron, unwrought or semi-wrought; iron ores; door closers, non-electric; door springs, non-electric; molybdenum iron; silicon iron; titanium iron; ferrotitanium; tungsten iron; fittings of metal for building; pins [hardware]; eye bolts; screw rings; locks of metal, other than electric; galena [ore]; lead seals; germanium; weather- or wind-vanes of metal; weather vanes of metal; wind vanes of metal; crampons [climbing irons]; ice moulds of metal; grease nipples; grilles of metal; gratings of metal; spring locks; indium; badges of metal for vehicles; jalousies of metal; brass, unwrought or semi-wrought; outdoor blinds of metal; rocket launching platforms of metal; laths of metal; filings of metal; stringers [parts of staircases] of metal; limonite; ingots of common metal; lintels of metal; bed casters of metal; latches of metal; blooms [metallurgy]; magnesium; buildings, transportable, of metal; ferrules of metal for handles; pipe muffs of metal; manganese; handling pallets of metal; transport pallets of metal; steps [ladders] of metal; porches [structures] of metal; door knockers of metal; handcuffs; common metals, unwrought or semi-wrought; ores of metal; wire cloth; wire gauze; pyrophoric metals; furniture casters of metal; sheet piles of metal; pilings of metal; molybdenum; monuments of metal; vice claws of metal; wall claddings of metal for building; nickel; niobium; flashing of

metal, for building; house numbers of metal, non-luminous; shutters of metal; palings of metal; baskets of metal; signalling panels, non-luminous and non-mechanical, of metal; wall linings of metal for building; clothes hooks of metal; skating rinks [structures] of metal; lock bolts; posts of metal; springs [metal hardware]; pulleys of metal, other than for machines; tent pegs of metal; ceilings of metal; floors of metal; linings of metal for building; turntables [railways]; roofing tiles of metal; lead, unwrought or semi-wrought; diving boards of metal; door handles of metal; rivets of metal; gates of metal; door panels of metal; door bolts of metal; split rings of common metal for keys; telegraph posts of metal; zinc; beams of metal; girders of metal; joists of metal; platforms, prefabricated, of metal; hardware of metal, small; ironmongery; road signs, non-luminous and non-mechanical, of metal; junctions of metal for pipes; wire stretchers [tension links]; packaging containers of metal; tanks of metal; reservoirs of metal; sills of metal; signs, non-luminous and non-mechanical, of metal; greenhouses of metal, transportable; locks of metal for vehicles; stops of metal; silos of metal; bells for animals; bells; soldering wire of metal; valves of metal, other than parts of machines; statues of common metal; railroad ties of metal; railway sleepers of metal; tantalum [metal]; bolts, flat; anvils [portable]; tension links; titanium; roofing of metal; tombac; tombs of metal; turnstiles of metal; lattice-work of metal; trellis of metal; tungsten; pipework of metal; vanadium; casement windows of metal; ferrules of metal; aviaries [structures] of metal; zirconium; balls of steel; steel buildings; fittings of metal for compressed air lines; wire of common metal alloys, except fuse wire; alloys of common metal; aluminium foil; mooring bollards of metal; floating docks of metal, for mooring boats; anchors; wainscoting of metal; reinforcing materials of metal for pipes; reinforcing materials of metal for building; reinforcing materials of metal for machine belts; works of art of common metal; troughs of metal for mixing mortar; bird baths [structures] of metal; beacons of metal, non-luminous; stretchers for iron bands [tension links]; wrapping or binding bands of metal; bands of metal for tying-up purposes; thread of metal for tying-up purposes; barrels of metal; barrel hoops of metal; casks of metal; swimming pools [structures] of metal; building materials of metal; shuttering of metal for concrete; bicycle parking installations of metal; paving blocks of metal; boxes of common metal; bungs of metal; plugs of metal; sealing caps of metal; buckles of common metal [hardware]; bottle caps of metal; capsules of metal for bottles; sealing caps of metal for bottles; bottle closures of metal; bottle fasteners of metal; knobs of metal; rods of metal for brazing; rods of metal for brazing and welding; rods of metal for welding; straps of metal for handling loads; belts of metal for handling loads; straps of metal for load handling;

slings of metal for handling loads; busts of common metal; cabanas of metal; paint spraying booths of metal; booths of metal for spraying paint; cables of metal, non-electric; collars of metal for fastening pipes; clips of metal for cables and pipes; binding screws of metal for cables; window frames of metal; greenhouse frames of metal; duckboards of metal; chimney cowls of metal; binding thread of metal for agricultural purposes; door openers, non-electric; tiles of metal for building; tile floorings of metal; burial vaults of metal; fittings of metal for coffins; loading pallets of metal; loading gauge rods, of metal, for railway waggons; loading gauge rods, of metal, for railway wagons; hinges of metal; framework of metal for building; door frames of metal; door casings of metal; materials of metal for funicular railway permanent ways; chimney pots of metal; roof gutters of metal; drain traps [valves] of metal; partitions of metal; casings of metal for oilwells; containers of metal for liquid fuel; buildings of metal; floating containers of metal; ropes of metal; cornices of metal; moldings of metal for cornices; mouldings of metal for cornices; angle irons of metal; windows of metal; ironwork for doors; runners of metal for sliding doors; manhole covers of metal; roof coverings of metal; hooks of metal for roofing slates; hooks of metal for clothes rails; copper wire, not insulated; vats of metal; stair treads [steps] of metal; gutter pipes of metal; reels of metal, non-mechanical, for flexible hoses; towel dispensers, fixed, of metal; water-pipe valves of metal; scaffolding of metal; ladders of metal; mobile boarding stairs of metal for passengers; bindings of metal; nuts of metal; poles of metal for power lines; posts of metal for power lines; branching pipes of metal; enclosures of metal for tombs; fences of metal; winding spools of metal, non-mechanical, for flexible hoses; signboards of metal; props of metal; tin; tinfoil; tinplate; tinplate; sheets and plates of metal; locks of metal for bags; fittings of metal for furniture; building panels of metal; figurines [statuettes] of common metal; statuettes of common metal; stretchers for metal bands [tension links]; foundry molds [moulds] of metal; grave slabs of metal; tomb slabs of metal; monuments of metal for tombs; tombstone plaques of metal; tombstone stelae of metal; memorial plates of metal; memorial plaques of metal; furnace fireguards of metal; cask stands of metal; fittings of metal for beds; door fittings of metal; closures of metal for containers; sheaf binders of metal; crash barriers of metal for roads; chests of metal; bins of metal; identity plates of metal; registration plates of metal; numberplates of metal; cermets; taps of metal for casks; advertisement columns of metal; mooring buoys of metal; chimneys of metal; chimney shafts of metal; ducts of metal for ventilating and air conditioning installations; foils of metal for wrapping and packaging; gold solder; hoppers of metal, non-mechanical; letters and numerals of common metal, except type;

manifolds of metal for pipelines; penstock pipes of metal; telephone booths of metal; telephone boxes of metal; tool boxes of metal, empty; tool chests of metal, empty; chicken-houses of metal; wheel clamps [boots]; wire rope; insect screens of metal; pitons of metal; firedogs [andirons]; wind-driven bird-repelling devices made of metal; metal cages for wild animals; metals in powder form; refractory construction materials of metal; arbours [structures] of metal; stables of metal; pigsties of metal; prefabricated houses [kits] of metal; trays of metal; street gutters of metal; screw tops of metal for bottles; window openers, non-electric; window closers, non-electric; wall tiles of metal; paving slabs of metal; slabs of metal for building; step stools of metal; roofing of metal, incorporating solar cells; armored doors of metal; armoured doors of metal; bathtub grab bars of metal; dispensers for dog waste bags, fixed, of metal; metals in foil or powder form for 3D printers; sash fasteners of metal for windows; door fasteners of metal; pantiles of metal; balustrades of metal; cladding of metal for building.

9 – Coils, electric; particle accelerators; reflecting discs for wear, for the prevention of traffic accidents; protection devices for personal use against accidents; clothing for protection against accidents, irradiation and fire; accumulators, electric, for vehicles; batteries, electric, for vehicles; battery jars; accumulator jars; battery boxes; accumulator boxes; acidimeters for batteries; hydrometers; plates for batteries; whistle alarms; sound alarms; acoustic conduits; sound recording discs; phonograph records; speaking tubes; actinometers; adding machines; aerometers; enlarging apparatus [photography]; electro-dynamic apparatus for the remote control of railway points; magnets; electromagnetic coils; air analysis apparatus; alarms; alcoholmeters; alidades; food analysis apparatus; igniting apparatus, electric, for igniting at a distance; electric apparatus for remote ignition; batteries for lighting; altimeters; asbestos gloves for protection against accidents; asbestos clothing for protection against fire; ammeters; amplifiers; amplifying tubes; amplifying valves; anemometers; calibrating rings; fire extinguishers; anodes; anode batteries; high tension batteries; antennas; aerials; anti-glare glasses; anti-glare visors; anti-dazzle shades; anti-interference devices [electricity]; transformers [electricity]; apertometers [optics]; money counting and sorting machines; distribution boxes [electricity]; surveying instruments; surveying chains; lenses for astrophotography; thermionic tubes; thermionic valves; audiovisual teaching apparatus; coin-operated musical automata [juke boxes]; juke boxes, musical; mechanisms for coin-operated apparatus; mechanisms for counter-operated apparatus; calipers; comparators; fire alarms; automatic indicators of low pressure in vehicle tires [tyres]; automatic indicators of low pressure in

vehicle tyres; protective suits for aviators; alarm bells, electric; rods for water diviners; life-saving rafts; scales; meteorological balloons; demagnetizing apparatus for magnetic tapes; tape recorders; magnetic tapes; barometers; weighing machines; weighbridges; fire beaters; chargers for electric batteries; beatrons; ticket dispensers; cabinets for loudspeakers; close-up lenses; terminals [electricity]; pressure indicator plugs for valves; galvanometers; push buttons for bells; branch boxes [electricity]; tone arms for record players; spirit levels; punched card machines for offices; sheaths for electric cables; frames for photographic transparencies; circular slide rules; slide-rules; calculating machines; slide calipers; jigs [measuring instruments]; blueprint apparatus; cinematographic cameras; capillary tubes; sound recording carriers; protective helmets; respiratory masks, other than for artificial respiration; solderers' helmets; eyeglass chains; spectacle chains; Heat regulating apparatus; darkrooms [photography]; boiler control instruments; drying racks [photography]; editing appliances for cinematographic films; apparatus for editing cinematographic film; printed circuits; flashing lights [luminous signals]; blinkers [signalling lights]; signal bells; containers for microscope slides; collectors, electric; electric installations for the remote control of industrial operations; switchboxes [electricity]; commutators; marine compasses; eyepieces; thread counters; pedometers; counters; meters; metronomes; condensers [capacitors]; capacitors; conductors, electric; electricity conduits; circuit closers; connectors [electricity]; junction boxes [electricity]; switchboards; contacts, electric; apparatus to check franking; apparatus to check stamping mail; regulating apparatus, electric; monitoring apparatus, electric; speed checking apparatus for vehicles; converters, electric; photocopiers [photographic, electrostatic, thermic]; eyeglass cords; spectacle cords; retorts; retorts' stands; correcting lenses [optics]; objectives [lenses] [optics]; cosmographic instruments; diving suits; electric apparatus for commutation; switches, electric; limiters [electricity]; sockets, plugs and other contacts [electric connections]; plugs, sockets and other contacts [electric connections]; current rectifiers; cell switches [electricity]; reducers [electricity]; dressmakers' measures; crucibles [laboratory]; cupels [laboratory]; appliances for measuring the thickness of leather; cyclotrons; counterfeit [false] coin detectors; false coin detectors; shutter releases [photography]; densimeters; animated cartoons; laboratory trays; metal detectors for industrial or military purposes; sonars; detectors; shutters [photography]; diaphragms [acoustics]; centering apparatus for photographic transparencies; cameras [photography]; transparencies [photography]; slides [photography]; slide projectors; transparency projection apparatus; distance measuring apparatus; dictating machines; diffraction apparatus [microscopy]; loudspeakers; circuit brea-

kers; record players; microscopes; distance recording apparatus; apparatus for recording distance; range finders; telemeters; distribution boards [electricity]; distribution consoles [electricity]; compasses for measuring; measures; measuring apparatus; dynamometers; water level indicators; fire escapes; flash-bulbs [photography]; telephone receivers; fluorescent screens; projection screens; workmen's protective face-shields; screens [photography]; drainers for use in photography; photographic racks; electric loss indicators; measuring devices, electric; cables, electric; ducts [electricity]; control panels [electricity]; galvanic cells; connections for electric lines; couplings, electric; connections, electric; relays, electric; electrolyzers; transmitters of electronic signals; transmitting sets [telecommunication]; cleaning apparatus for sound recording discs; cleaning apparatus for phonograph records; sound recording strips; kilometer recorders for vehicles; milage recorders for vehicles; spools [photography]; mechanical signs; epidiascopes; test tubes; balancing apparatus; thermostats; ergometers; material testing instruments and machines; egg-candlers; gauges; gasoline gauges; petrol gauges; spark-guards; cases especially made for photographic apparatus and instruments; testing apparatus not for medical purposes; refractometers; exposure meters [light meters]; invoicing machines; apparatus for fermentation [laboratory apparatus]; railway traffic safety appliances; wires, electric; magnetic wires; plumb bobs; plumb lines; nets for protection against accidents; safety nets; life nets; safety tarpaulins; film cutting apparatus; filters for respiratory masks; filters [photography]; battery chargers; high-frequency apparatus; frequency meters; fuses; radios; galena crystals [detectors]; gloves for protection against accidents; gloves for divers; gloves for protection against X-rays for industrial purposes; gas testing instruments; gasometers [measuring instruments]; surveying apparatus and instruments; levelling staffs [surveying instruments]; rods [surveying instruments]; drying apparatus for photographic prints; glazing apparatus for photographic prints; rulers [measuring instruments]; measuring glassware; graduated glassware; screens for photoengraving; grids for batteries; clothing for protection against fire; garments for protection against fire; audio- and video-receivers; heliographic apparatus; holograms; hygrometers; identification threads for electric wires; identification sheaths for electric wires; life saving apparatus and equipment; fire hose nozzles; fire engines; fire pumps; slope indicators; clinometers; gradient indicators; inclinometers; taximeters; quantity indicators; vacuum gauges; speed indicators; inductors [electricity]; armatures [electricity]; data processing apparatus; mirrors for inspecting work; intercommunication apparatus; carriers for dark plates [photography]; inverters [electricity]; ionization apparatus not for the treatment of air or water; peepholes [magnifying lenses] for

doors; hemline markers; furniture especially made for laboratories; lactodensimeters; lactometers; dark-room lamps [photography]; optical lamps; optical lanterns; magic lanterns; signal lanterns; lasers, not for medical purposes; optical lenses; letter scales; logs [measuring instruments]; sounding lines; magnifying glasses [optics]; signs, luminous; neon signs; eyeglasses; instruments containing eyepieces; surveyors' levels; spectacle lenses; optical goods; pressure gauges; manometers; periscopes; protective masks; mathematical instruments; coin-operated mechanisms for television sets; megaphones; computer memory devices; carpenters' rules; mercury levels; speed measuring apparatus [photography]; precision measuring apparatus; measuring instruments; meteorological instruments; rules [measuring instruments]; micrometer screws for optical instruments; microphones; microtomes; time switches, automatic; mirrors [optics]; breathing apparatus for underwater swimming; nautical apparatus and instruments; naval signalling apparatus; navigational instruments; eyeglass frames; spectacle frames; batteries, electric; accumulators, electric; levels [instruments for determining the horizontal]; levelling instruments; prisms [optics]; observation instruments; octants; ohmmeters; wavemeters; optical apparatus and instruments; optical glass; computers; computer programmes [programs], recorded; oscillographs; oxygen transvasing apparatus; ozonisers [ozonators]; micrometers; micrometer gauges; signalling panels, luminous or mechanical; lightning conductors [rods]; lightning arresters; lightning conductors; parking meters; apparatus and instruments for astronomy; apparatus for measuring the thickness of skins; acid hydrometers; weighing apparatus and instruments; salinometers; washing trays [photography]; stands for photographic apparatus; viewfinders, photographic; photometers; phototelegraphy apparatus; apparatus and instruments for physics; steering apparatus, automatic, for vehicles; pince-nez; pipettes; plane tables [surveying instruments]; planimeters; ear plugs for divers; bells [warning devices]; weights; polarimeters; radiotelephony sets; radiotelegraphy sets; pressure measuring apparatus; pressure indicators; projection apparatus; cathodic anti-corrosion apparatus; teeth protectors; pyrometers; radar apparatus; vehicle radios; radiological apparatus for industrial purposes; protractors [measuring instruments]; apparatus and installations for the production of X-rays, not for medical purposes; X-ray tubes not for medical purposes; protection devices against X-rays, not for medical purposes; telephone apparatus; refractors; X-ray apparatus not for medical purposes; spectrocopes; resistances, electric; thermometers, not for medical purposes; respirators for filtering air; breathing apparatus, except for artificial respiration; rheostats; balances [steelyards]; lever scales [steelyards]; steelyards [lever scales]; signals, luminous or mechanical; saccharometers; probes for scientific

purposes; satellites for scientific purposes; diaphragms for scientific apparatus; teaching apparatus; choking coils [impedance]; wire connectors [electricity]; locks, electric; sextants; signalling whistles; vehicle breakdown warning triangles; electro-dynamic apparatus for the remote control of signals; simulators for the steering and control of vehicles; sirens; sound transmitting apparatus; sound recording apparatus; sound reproduction apparatus; sounding apparatus and machines; sounding leads; sound locating instruments; spectrograph apparatus; spherometers; stereoscopes; stereoscopic apparatus; needles for record players; styli for record players; sulfimeters; teleprinters; teletypewriters; tachometers; screw-tapping gauges; telegraphs [apparatus]; television apparatus; telegraph wires; remote control apparatus; masts for wireless aerials; teleprompters; telephone transmitters; telerupters; binoculars; telescopes; temperature indicators; time recording apparatus; theodolites; thermostats for vehicles; totalizers; revolution counters; speed regulators for record players; transmitters [telecommunication]; precision balances; marking gauges [joinery]; vacuum tubes [radio]; urinometers; variometers; verniers; videotapes; viscosimeters; theft prevention installations, electric; voltage regulators for vehicles; voting machines; voltmeters; apparatus for changing record player needles; stills for laboratory experiments; fuse wire; wires of metal alloys [fuse wire]; anticathodes; dog whistles; sighting telescopes for firearms; telescopic sights for firearms; anti-theft warning apparatus; azimuth instruments; beacons, luminous; holders for electric coils; films, exposed; road signs, luminous or mechanical; life buoys; signalling buoys; buzzers; directional compasses; fog signals, non-explosive; cash registers; radiology screens for industrial purposes; identity cards, magnetic; photovoltaic cells; densitometers; disks, magnetic; floppy disks; head cleaning tapes [recording]; video recorders; computer keyboards; integrated circuits; semi-conductors; chips [integrated circuits]; cathodes; life jackets; life belts; chemistry apparatus and instruments; cinematographic film, exposed; materials for electricity mains [wires, cables]; contact lenses; containers for contact lenses; incubators for bacteria culture; solar batteries; copper wire, insulated; discharge tubes, electric, other than for lighting; electric discharge tubes, other than for lighting; diaphragms [photography]; distillation apparatus for scientific purposes; dosage dispensers; dosimeters; electric door bells; eyeglass cases; spectacle cases; furnaces for laboratory use; ovens for laboratory use; optical fibers [fibres] [light conducting filaments]; light conducting filaments [optical fibers [fibres]]; telephone wires; X-ray films, exposed; filters for ultraviolet rays, for photography; horns for loudspeakers; tripods for cameras; bar code readers; bullet-proof waistcoats [vests (Am.)]; marking buoys; wafers for integrated circuits; chromatography apparatus for la-

boratory use; chronographs [time recording apparatus]; compact discs [audio-video]; compact discs [read-only memory]; computer operating programs, recorded; computer peripheral devices; computer software, recorded; optical condensers; acoustic couplers; couplers [data processing equipment]; decompression chambers; plotters; divers' masks; electronic pens [visual display units]; encoded magnetic cards; facsimile machines; fire boats; interfaces for computers; juke boxes for computers; knee-pads for workers; light dimmers [regulators], electric; light regulators [dimmers], electric; magnetic data media; magnetic encoders; magnetic tape units for computers; microprocessors; modems; monitors [computer hardware]; monitors [computer programs]; mouse [computer peripheral]; optical character readers; optical data media; optical discs; printers for use with computers; processors [central processing units]; central processing units [processors]; readers [data processing equipment]; safety restraints, other than for vehicle seats and sports equipment; scanners [data processing equipment]; smoke detectors; transistors [electronic]; X-ray photographs, other than for medical purposes; junction sleeves for electric cables; abacuses; electronic agendas; answering machines; camcorders; cassette players; compact disc players; diagnostic apparatus, not for medical purposes; disk drives for computers; electrified rails for mounting spot lights; electronic pocket translators; electronic tags for goods; fire blankets; flashlights [photography]; integrated circuit cards [smart cards]; smart cards [integrated circuit cards]; measuring spoons; notebook computers; electronic notice boards; pocket calculators; shoes for protection against accidents, irradiation and fire; sprinkler systems for fire protection; starter cables for motors; sunglasses; time clocks [time recording devices]; video cassettes; video game cartridges; video screens; video telephones; goggles for sports; nose clips for divers and swimmers; protective helmets for sports; electronic publications, downloadable; computer programs [downloadable software]; navigation apparatus for vehicles [on-board computers]; decorative magnets; cordless telephones; mouse pads; personal stereos; wrist rests for use with computers; coaxial cables; fibre [fiber (Am.)] optic cables; covers for electric outlets; marine depth finders; electrified fences; computer game software; headphones; lighting ballasts; radio pagers; satellite navigational apparatus; solenoid valves [electromagnetic switches]; voltage surge protectors; walkie-talkies; wind socks for indicating wind direction; light-emitting electronic pointers; resuscitation mannequins [teaching apparatus]; stage lighting regulators; egg timers [sandglasses]; hourglasses; DNA chips; DVD players; automated teller machines [ATM]; traffic-light apparatus [signalling devices]; hands-free kits for telephones; asbestos screens for firemen; riding helmets; clothing especially made for laboratories; encoded iden-

tification bracelets, magnetic; transponders; downloadable ring tones for mobile phones; downloadable music files; downloadable image files; crash test dummies; laboratory centrifuges; printed circuit boards; USB flash drives; Global Positioning System [GPS] apparatus; portable media players; cell phone straps; light-emitting diodes [LED]; triodes; step-up transformers; laptop computers; fire hose; bags adapted for laptops; sleeves for laptops; digital photo frames; Petri dishes; Pitot tubes; stroboscopes; traffic cones; temperature indicator labels, not for medical purposes; computer software applications, downloadable; electronic book readers; smartphones; toner cartridges, unfilled, for printers and photocopiers; baby monitors; video baby monitors; lens hoods; tablet computers; encoded key cards; 3D spectacles; memory cards for video game machines; bullet-proof clothing; accelerometers; electrical adapters; life-saving capsules for natural disasters; computer hardware; solar panels for the production of electricity; cellular phones; mobile telephones; cell phones; telescopic sights for artillery; digital signs; wearable activity trackers; chargers for electronic cigarettes; connected bracelets [measuring instruments]; covers for smartphones; cases for smartphones; selfie sticks [hand-held monopods]; calorimeters; flowmeters; reflective safety vests; electronic collars to train animals; joysticks for use with computers, other than for video games; smartglasses; smartwatches; fire extinguishing apparatus; protective films adapted for computer screens; mouth guards for sports; head guards for sports.

14 – Agates; clock hands; ingots of precious metals; jewelry of yellow amber; jewellery of yellow amber; pearls made of ambroid [pressed amber]; amulets [jewellery]; amulets [jewelry]; spun silver [silver wire]; silver thread [jewellery]; silver thread [jewelry]; clocks; pendulums [clock- and watchmaking]; barrels [clock- and watchmaking]; bracelets [jewellery]; bracelets [jewelry]; wristwatches; watch bands; watch straps; straps for wristwatches; charms for jewellery; jewellery charms; charms for jewelry; jewelry charms; brooches [jewellery]; brooches [jewelry]; dials [clock- and watchmaking]; sundials; clockworks; chains [jewellery]; chains [jewelry]; watch chains; chronographs [watches]; chronometers; chronoscopes; chronometric instruments; necklaces [jewellery]; necklaces [jewelry]; clocks and watches, electric; tie clips; coins; diamonds; threads of precious metal [jewellery]; threads of precious metal [jewelry]; wire of precious metal [jewellery]; wire of precious metal [jewelry]; atomic clocks; control clocks [master clocks]; master clocks; clock cases; iridium; ivory jewelry; ivory jewellery; ornaments of jet; jet, unwrought or semi-wrought; copper tokens; jewelry; jewellery; lockets [jewellery]; lockets [jewelry]; medals; precious metals, unwrought or semi-wrought; watches; watch springs; watch glasses; watch crystals; movements for clocks and

watches; olivine [gems]; peridot; gold, unwrought or beaten; gold thread [jewellery]; gold thread [jewelry]; osmium; palladium; ornaments [jewelry]; ornamental pins; pearls [jewellery]; pearls [jewelry]; semi-precious stones; precious stones; platinum [metal]; rhodium; ruthenium; spinel [precious stones]; statues of precious metal; paste jewellery; paste jewelry [costume jewelry]; alloys of precious metal; anchors [clock- and watchmaking]; rings [jewellery]; rings [jewelry]; works of art of precious metal; boxes of precious metal; hat ornaments of precious metal; earrings; shoe ornaments of precious metal; cuff links; busts of precious metal; watch cases [parts of watches]; presentation boxes for watches; figurines [statuettes] of precious metal; statuettes of precious metal; pins [jewellery]; pins [jewelry]; tie pins; badges of precious metal; key chains [trinkets or fobs]; silver, unwrought or beaten; stopwatches; cloisonne jewellery; cloisonne jewelry; jewellery boxes; jewelry boxes; beads for making jewelry; beads for making jewellery; clasps for jewelry; clasps for jewellery; jewelry findings; jewellery findings; jewelry rolls; jewellery rolls; cabochons for making jewellery; cabochons for making jewelry; split rings of precious metal for keys; presentation boxes for jewellery; presentation boxes for jewelry; watch hands; rosaries; chaplets.

16 – Steel letters; steel pens; adhesive tape dispensers [office requisites]; address stamps; addressing machines; paper; posters; advertisement boards of paper or cardboard; franking machines for office use; postage meters for office use; staples for offices; clips for offices; pen clips; stapling presses [office requisites]; albums; scrapbooks; pictures; prints [engravings]; cigar bands; pencil sharpening machines, electric or non-electric; bookends; hand-rests for painters; aquarelles; watercolors [paintings]; watercolours [paintings]; architects' models; document files [stationery]; writing slates; slate pencils; silver paper; modelling clay; arithmetical tables; calculating tables; engravings; lithographic works of art; paintings [pictures], framed or unframed; pencils; newspapers; periodicals; atlases; loose-leaf binders; gummed tape [stationery]; mats for beer glasses; tickets; biological samples for use in microscopy [teaching materials]; printing blocks; drawing pads; pads [stationery]; spools for inking ribbons; wristbands for the retention of writing instruments; pamphlets; embroidery designs [patterns]; drawing pins; thumbtacks; moisteners [office requisites]; painters' brushes; blotters; stamps [seals]; sealing stamps; inking pads; sealing wax; sealing machines for offices; sealing compounds for stationery purposes; writing or drawing books; trays for sorting and counting money; tracing patterns; tracing paper; tracing cloth; finger-stalls [office requisites]; printing type; carbon paper; paper for recording machines; note books; square rulers; cards; charts; teaching materials [except apparatus]; index cards [stationery]; paper she-

ets [stationery]; cardboard; hat boxes of cardboard; perforated cards for Jacquard looms; cardboard tubes; catalogues; tags for index cards; song books; composing frames [printing]; folders for papers; jackets for papers; painters' easels; numbers [type]; Indian inks; chromolithographs [chromos]; chromos; modelling wax, not for dental purposes; files [office requisites]; office perforators; toilet paper; hygienic paper; books; compasses for drawing; type [numerals and letters]; letters [type]; composing sticks; letter trays; conical paper bags; correcting fluids [office requisites]; correcting ink [heliography]; pencil leads; histological sections for teaching purposes; French curves; covers [stationery]; wrappers [stationery]; writing chalk; chalk for lithography; tailors' chalk; chalk holders; pencil holders; pencil lead holders; cream containers of paper; paper clasps; rollers for typewriters; transfers [decalcomanias]; decalcomanias; graphic prints; graining combs; drawing boards; drawing materials; drawing instruments; diagrams; envelopes [stationery]; duplicators; etchings; wrapping paper; packing paper; nibs; typewriters, electric or non-electric; pen cases; boxes for pens; nibs of gold; erasing products; writing materials; shields [paper seals]; erasing shields; rubber erasers; electrocardiograph paper; punches [office requisites]; ink; inking ribbons; inkwells; envelope sealing machines, for offices; photographs [printed]; pen wipers; seals [stamps]; fabrics for bookbinding; drawing sets; ledgers [books]; indexes; figurines [statuettes] of papier mâché; filter paper; filtering materials [paper]; forms, printed; office requisites, except furniture; charcoal pencils; stencils [stationery]; galley racks [printing]; electrotypes; geographical maps; terrestrial globes; artists' watercolor saucers; artists' watercolour saucers; graphic reproductions; graphic representations; scrapers [erasers] for offices; engraving plates; hectographs; printed timetables; moisteners for gummed surfaces [office requisites]; postcards; printed matter; hand labelling appliances; printers' blankets, not of textile; printing sets, portable [office requisites]; printed publications; manuals [handbooks]; handbooks [manuals]; writing paper; paperweights; tracing needles for drawing purposes; drawing pens; table linen of paper; lithographs; lithographic stones; booklets; luminous paper; papier mâché; manifolds [stationery]; marking chalk; plastics for modeling; modelling materials; modelling paste; handkerchiefs of paper; inking sheets for duplicators; tablecloths of paper; blackboards; paper-clips; numbering apparatus; oleographs; binding strips [bookbinding]; sealing wafers; palettes for painters; pantographs [drawing instruments]; stationery; parchment paper; pastels [crayons]; sewing patterns; stencil cases; house painters' rollers; canvas for painting; paint boxes [articles for use in school]; plastic film for wrapping; apparatus for mounting photographs; photograph stands; photo-engravings; blueprints; plans; folders [stationery];

fountain pens; stencil plates; stencils; portraits; covers of paper for flower pots; flower-pot covers of paper; mimeograph apparatus and machines; paper tapes and cards for the recordal of computer programmes; prospectuses; paper for radiograms; drawing rulers; printers' galleys; bookbinding material; bookbindings; bookbinding cloth; cloth for bookbinding; cords for bookbinding; bookbinding cords; inking sheets for document reproducing machines; pens [office requisites]; magazines [periodicals]; paper ribbons; typewriter ribbons; bags [envelopes, pouches] of paper or plastics, for packaging; stamp pads; school supplies [stationery]; bookmarkers; greeting cards; steatite [tailor's chalk]; balls for ballpoint pens; tablemats of paper; desk mats; typewriter keys; holders for stamps [seals]; cases for stamps [seals]; postage stamps; stamp stands; transparencies [stationery]; vignetting apparatus; gluten [glue] for stationery or household purposes; adhesives [glues] for stationery or household purposes; adhesive tapes for stationery or household purposes; adhesive bands for stationery or household purposes; address plates for addressing machines; almanacs; calendars; starch paste [adhesive] for stationery or household purposes; paintbrushes; self-adhesive tapes for stationery or household purposes; elastic bands for offices; bibs of paper; wood pulp board [stationery]; wood pulp paper; boxes of cardboard or paper; stands for pens and pencils; bottle envelopes of cardboard or paper; coasters of paper; announcement cards [stationery]; plastic bubble packs for wrapping or packaging; flags of paper; paper shredders for office use; sheets of reclaimed cellulose for wrapping; cabinets for stationery [office requisites]; glue for stationery or household purposes; pastes for stationery or household purposes; paper knives [cutters] [office requisites]; paper cutters [office requisites]; paper knives [office requisites]; garbage bags of paper or of plastics; pencil sharpeners, electric or non-electric; tissues of paper for removing make-up; table napkins of paper; place mats of paper; drawing squares; drawing T-squares; penholders; writing cases [stationery]; inkstands; writing cases [sets]; handwriting specimens for copying; bottle wrappers of cardboard or paper; placards of paper or cardboard; towels of paper; face towels of paper; labels, not of textile; etching needles; viscose sheets for wrapping; gums [adhesives] for stationery or household purposes; gummed cloth for stationery purposes; isinglass for stationery or household purposes; bags for microwave cooking; paper coffee filters; plastic cling film, extensible, for palletization; inking ribbons for computer printers; signboards of paper or cardboard; stickers [stationery]; bookbinding apparatus and machines [office equipment]; comic books; copying paper [stationery]; holders for checkbooks [cheque books]; ink sticks; ink stones [ink reservoirs]; musical greeting cards; newsletters; packaging material made of starches; waxed paper; passport holders; writing brus-

hes; writing instruments; drawer liners of paper, perfumed or not; credit card imprinters, non-electric; document laminators for office use; Xuan paper for Chinese painting and calligraphy; writing board erasers; clipboards; chart pointers, non-electronic; paper bows; molds for modelling clays [artists' materials]; moulds for modelling clays [artists' materials]; money clips; trading cards other than for games; absorbent sheets of paper or plastic for foodstuff packaging; humidity control sheets of paper or plastic for foodstuff packaging; correcting tapes [office requisites]; paint trays; marking pens [stationery]; flyers; document holders [stationery]; page holders; polymer modelling clay; obliterating stamps; packing [cushioning, stuffing] materials of paper or cardboard; stuffing of paper or cardboard; banknotes; spray chalk; printed coupons; rice paper.

18 – Mountaineering sticks; alpenstocks; animal skins; pelts; umbrella rings; saddle trees; leather leashes; leather leads; fastenings for saddles; umbrella or parasol ribs; goldbeaters' skin; purses; bridoons; straps for soldiers' equipment; music cases; umbrella sticks; walking sticks; canes; walking stick seats; bits for animals [harness]; frames for umbrellas or parasols; game bags [hunting accessories]; school bags; school satchels; card cases [notecases]; leatherboard; hat boxes of leather; horse collars; horse blankets; kid; muzzles; travelling trunks; collars for animals; leather laces; curried skins; harness straps; harness traces; straps of leather [saddlery]; straps for skates; leather straps; leather thongs; butts [parts of hides]; leather, unworked or semi-worked; leather thread; leather twist; trimmings of leather for furniture; leather trimmings for furniture; imitation leather; umbrellas; sling bags for carrying infants; parts of rubber for stirrups; stirrup leathers; tool bags, empty; whips; nose bags [feed bags]; umbrella covers; casings, of leather, for springs; casings, of leather, for plate springs; knee-pads for horses; clothing for pets; covers for animals; harness for animals; blinkers [harness]; blinders [harness]; traces [harness]; rucksacks; backpacks; halters; head-stalls; walking stick handles; walking cane handles; cat o' nine tails; chin straps, of leather; moleskin [imitation of leather]; handbag frames; parasols; fur; fur-skins; umbrella handles; pocket wallets; wheeled shopping bags; shopping bags; attache cases; bags for climbers; bags for campers; beach bags; handbags; travelling bags; bags [envelopes, pouches] of leather, for packaging; girths of leather; riding saddles; saddlery; briefcases; travelling sets [leatherware]; valises; suitcase handles; valves of leather; cattle skins; boxes of leather or leatherboard; chain mesh purses; cases of leather or leatherboard; trunks [luggage]; vanity cases, not fitted; chamois leather, other than for cleaning purposes; skins of chamois, other than for cleaning purposes; shoulder belts [straps] of leather; leather shoulder belts; leather shoulder straps; covers for horse saddles; boxes of vulcanised fibre;

garment bags for travel; bridles [harness]; key cases; net bags for shopping; furniture coverings of leather; pads for horse saddles; bags for sports; stirrups; harness fittings; horseshoes; slings for carrying infants; pouch baby carriers; bags; credit card cases [wallets]; business card cases; randsels [Japanese school satchels]; luggage tags; saddlecloths for horses; reins for guiding children.

26 – Shoe fasteners; needles; shoemakers' needles; sewing needles; needles for wool combing machines; binding needles; darning needles; saddlers' needles; knitting needles; fastenings for clothing; ostrich feathers [clothing accessories]; whalebones for corsets; corset busks; hair bands; false beards; hair grips; bobby pins; hat ornaments, not of precious metal; edgings for clothing; lace for edgings; darning lasts; buttons; snap fasteners; expanding bands for holding sleeves; brassards; arm bands [clothing accessories]; fastenings for suspenders; fastenings for braces; brooches [clothing accessories]; embroidery; fancy goods [embroidery]; belt clasps; numerals or letters for marking linen; monogram tabs for marking linen; shoe hooks; shoe laces; shoe ornaments, not of precious metal; shoe eyelets; chenille [passementerie]; decorative articles for the hair; hair curling pins; hair barrettes; hair slides; hair pins; hair nets; false hair; tresses of hair; plaited hair; numerals for marking linen; collar supports; cords for clothing; blouse fasteners; dress body fasteners; sewing boxes; sewing thimbles; crochet hooks; crochet needles; hooks [haberdashery]; zippers; zip fasteners; slide fasteners [zippers]; pin cushions; false hems; festoons [embroidery]; shuttles for making fishing nets; artificial flowers; fringes; artificial fruit; braids; tassels [haberdashery]; trimmings for clothing; artificial garlands; frills [lacework]; woollen laces; lace trimmings; passementerie; letters for marking linen; haberdashery, except thread; mica spangles; false moustaches; eyelets for clothing; birds' feathers [clothing accessories]; tinsels [trimmings for clothing]; orsedew [trimmings for clothing]; ribbons [haberdashery]; spangles for clothing; needle cushions; wigs; picot [lace]; heat adhesive patches for repairing textile articles; feathers [clothing accessories]; top-knots [pompoms]; skirt flounces; rosettes [haberdashery]; frills for clothing; zippers for bags; zip fasteners for bags; shoe buckles; toupees; bodkins; needle cases; boxes for needles; silver embroidery; gold embroidery; elastic ribbons; cords for rimming, for clothing; buckles [clothing accessories]; hooks for corsets; wreaths of artificial flowers; pins, other than jewellery [jewelry (Am.)]; badges for wear, not of precious metal; heat adhesive patches for decoration of textile articles [haberdashery]; competitors' numbers; ornamental novelty badges [buttons]; bows for the hair; hair coloring caps; hair colouring caps; hook and pile fastening tapes; prize ribbons; shoulder pads for clothing; trouser clips for cyclists; tapes for curtain headings; hair curling pa-

pers; rug hooks; beads, other than for making jewelry; beads, other than for making jewellery; bobbins for retaining embroidery floss or wool [not parts of machines]; hair extensions; human hair; hair curlers, other than hand implements; appliques [haberdashery]; artificial plants; sewing kits; entomological pins; embroidery needles.

28 – Bladders of balls for games; artificial fishing bait; caps for pistols [toys]; toys for pets; ring games; Christmas trees of synthetic material; bows for archery; archery implements; edges of skis; swings; balls for games; play balloons; billiard table cushions; rocking horses; batting gloves [accessories for games]; dolls' feeding bottles; stationary exercise bicycles; billiard balls; chalk for billiard cues; billiard markers; skittles; marbles for games; toys; building blocks [toys]; bob-sleighs; explosive bonbons [Christmas crackers]; coques [toy fireworks]; skating boots with skates attached; candle holders for Christmas trees; playing balls; bowling apparatus and machinery; boxing gloves; gut for rackets; golf clubs; rods for fishing; kites; kite reels; targets; bells for Christmas trees; counters [discs] for games; building games; strings for rackets; machines for physical exercises; body-building apparatus; body-training apparatus; body rehabilitation apparatus; novelties for parties, dances [party favors, favours]; shin guards [sports articles]; cricket bags; hockey sticks; checkers [games]; draughts [games]; dice; chest expanders [exercisers]; exercisers [expanders]; discuses for sports; dominoes; chess games; chessboards; checkerboards; draughtboards; toy pistols; rollers for stationary exercise bicycles; landing nets for anglers; golf bags, with or without wheels; practical jokes [novelties]; nets for sports; tennis nets; ski bindings; darts; floats for fishing; foosball tables; harpoon guns [sports articles]; gloves for games; cups for dice; bar-bells; fish hooks; rattles [playthings]; parlor games; parlour games; games; clay pigeon traps; rackets; bats for games; decoys for hunting or fishing; lures for hunting or fishing; fishing tackle; fishing lines; dolls' beds; dolls' houses; puppets; marionettes; dolls; theatrical masks; carnival masks; scale model vehicles; reels for fishing; flippers for swimming; swimming webs [flippers]; creels [fishing traps]; swimming pools [play articles]; artificial snow for Christmas trees; quoits; roller skates; ice skates; seal skins [coverings for skis]; clay pigeons [targets]; surfboards; dolls' clothes; dolls' rooms; conjuring apparatus; skittles [games]; ninepins; gut for fishing; sole coverings for skis; skis; tables for table tennis; spinning tops [toys]; sleds [sports articles]; backgammon games; scooters [toys]; shuttlecocks; toy air pistols; percussion caps [toys]; detonating caps [toys]; ornaments for Christmas trees, except illumination articles and confectionery; Christmas tree stands; billiard cues; billiard cue tips; billiard tables; coin-operated billiard tables; surf skis; sailboards; hang gliders; apparatus for ga-

mes; appliances for gymnastics; fencing weapons; fencing masks; fencing gauntlets; fencing gloves; baseball gloves; climbers' harness; elbow guards [sports articles]; knee guards [sports articles]; mobiles [toys]; paragliders; protective paddings [parts of sports suits]; skateboards; slides [playthings]; spring boards [sports articles]; teddy bears; waterskis; golf gloves; bite indicators [fishing tackle]; bite sensors [fishing tackle]; board games; fairground ride apparatus; flying discs [toys]; horseshoe games; mah-jong; plush toys; soap bubbles [toys]; toy vehicles; twirling batons; butterfly nets; bags especially designed for skis and surfboards; harness for sailboards; jigsaw puzzles; masts for sailboards; paintball guns [sports apparatus]; paintballs [ammunition for paintball guns] [sports apparatus]; surfboard leashes; tennis ball throwing apparatus; starting blocks for sports; snow globes; weight lifting belts [sports articles]; bodyboards; bingo cards; divot repair tools [golf accessories]; pitch mark repair tools [golf accessories]; hunting game calls; roulette wheels; in-line roller skates; piñatas; punching bags; radio-controlled toy vehicles; rosin used by athletes; snowshoes; sling shots [sports articles]; amusement machines, automatic and coin-operated; kaleidoscopes; playing cards; confetti; electronic targets; scent lures for hunting or fishing; camouflage screens [sports articles]; men's athletic supporters [sports articles]; snowboards; scale model kits [toys]; pacinkos; ascenders [mountaineering equipment]; gaming machines for gambling; slot machines [gaming machines]; paper party hats; swimming kick boards; chips for gambling; scratch cards for playing lottery games; stuffed toys; trampolines; poles for pole vaulting; water wings; swimming belts; swimming jackets; video game machines; portable games with liquid crystal displays; arcade video game machines; controllers for game consoles; toy models; toy figures; ball pitching machines; masks [playthings]; matryoshka dolls; controllers for toys; golf bag carts; golf bag trolleys; paddleboards; gyroscopes and flight stabilizers for model aircraft; joysticks for video games; protective films adapted for screens for portable games; drones [toys].

35 – Business management assistance; business inquiries; bill-posting; outdoor advertising; import-export agency services; commercial information agency services; dissemination of advertising matter; photocopying services; employment agency services; office machines and equipment rental; book-keeping; accounting; drawing up of statements of accounts; business auditing; business management and organization consultancy; personnel management consultancy; business management consultancy; typing; demonstration of goods; direct mail advertising; commercial or industrial management assistance; document reproduction; updating of advertising material; distribution of samples; business efficiency expert services; auctioneering; market stu-

dies; business appraisals; business investigations; publicity material rental; business organization consultancy; publication of publicity texts; advertising; publicity; radio advertising; business research; public relations; shorthand; television advertising; transcription of communications [office functions]; shop window dressing; publicity agency services; advisory services for business management; modelling for advertising or sales promotion; marketing research; computerized file management; professional business consultancy; economic forecasting; organization of exhibitions for commercial or advertising purposes; business information; opinion polling; payroll preparation; personnel recruitment; relocation services for businesses; rental of advertising space; sales promotion for others; secretarial services; tax preparation; telephone answering for unavailable subscribers; word processing; arranging newspaper subscriptions for others; advertising by mail order; business management of hotels; business management of performing artists; compilation of information into computer databases; systemization of information into computer databases; organization of trade fairs for commercial or advertising purposes; rental of photocopying machines; on-line advertising on a computer network; procurement services for others [purchasing goods and services for other businesses]; data search in computer files for others; rental of advertising time on communication media; news clipping services; rental of vending machines; psychological testing for the selection of personnel; price comparison services; presentation of goods on communication media, for retail purposes; commercial information and advice for consumers [consumer advice shop]; arranging subscriptions to telecommunication services for others; administrative processing of purchase orders; commercial administration of the licensing of the goods and services of others; outsourcing services [business assistance]; invoicing; writing of publicity texts; compilation of statistics; layout services for advertising purposes; sponsorship search; organization of fashion shows for promotional purposes; production of advertising films; business management of sports people; marketing; telemarketing services; retail or wholesale services for pharmaceutical, veterinary and sanitary preparations and medical supplies; rental of sales stands; provision of commercial and business contact information; search engine optimization for sales promotion; search engine optimisation for sales promotion; web site traffic optimization; pay per click advertising; commercial intermediation services; business management for freelance service providers; negotiation and conclusion of commercial transactions for third parties; updating and maintenance of data in computer databases; business project management services for construction projects; providing business information via a web site; provision of an on-line marketplace for buyers and se-

llers of goods and services; design of advertising materials; outsourced administrative management for companies; tax filing services; business management of reimbursement programs for others; business management of reimbursement programmes for others; rental of billboards [advertising boards]; writing of resumes for others; writing of curriculum vitae for others; web indexing for commercial or advertising purposes; administration of frequent flyer programs; appointment scheduling services [office functions]; appointment reminder services [office functions]; administration of consumer loyalty programs; scriptwriting for advertising purposes.

36 – Accident insurance underwriting; instalment loans; actuarial services; rental of real estate; brokerage; credit bureau services; real estate agency services; real estate brokerage; debt collection agency services; insurance brokerage; financial customs brokerage services; insurance underwriting; banking; real estate appraisal; charitable fund raising; mutual funds; capital investment; surety services; exchanging money; issuance of travelers' checks; issuance of travellers' cheques; clearing, financial; clearing-houses, financial; safe deposit services; organization of collections; loans [financing]; fiscal valuation; financial evaluation [insurance, banking, real estate]; factoring; trusteeship; fiduciary; financing services; financial management; pawnbrokerage; real estate management; apartment house management; fire insurance underwriting; rental of apartments; rental of farms; health insurance underwriting; marine insurance underwriting; mortgage banking; savings bank services; lease-purchase financing; hire-purchase financing; securities brokerage; life insurance underwriting; accommodation bureau services [apartments]; financial analysis; antique appraisal; art appraisal; check [cheque] verification; financial consultancy; insurance consultancy; processing of credit card payments; processing of debit card payments; electronic funds transfer; financial information; insurance information; jewellery [jewelry (Am.)] appraisal; numismatic appraisal; rent collection; stamp appraisal; issuance of tokens of value; deposits of valuables; stock exchange quotations; issuance of credit cards; rental of offices [real estate]; retirement payment services; financial sponsorship; online banking; business liquidation services, financial; repair costs evaluation [financial appraisal]; brokerage of carbon credits; financial evaluation of standing timber; financial valuation of standing timber; financial evaluation of wool; financial valuation of wool; lending against security; provident fund services; stock brokerage services; debt advisory services; arranging finance for construction projects; providing financial information via a web site; financial management of reimbursement payments for others; investment of funds; stocks and bonds brokerage; providing rebates at participating establishments of others through use of a membership card; bail-bonding.

38 – Radio broadcasting; message sending; television broadcasting; transmission of telegrams; telegraph services; communications by telegrams; telephone services; communications by telephone; telex services; news agency services; cable television broadcasting; communications by cellular phones; communications by computer terminals; computer aided transmission of messages and images; transmission of electronic mail; facsimile transmission; information about telecommunication; paging services [radio, telephone or other means of electronic communication]; rental of message sending apparatus; communications by fibre optic networks; communications by fiber optic networks; rental of facsimile apparatus; rental of modems; rental of telecommunication equipment; rental of telephones; satellite transmission; electronic bulletin board services [telecommunications services]; providing telecommunications connections to a global computer network; telecommunications routing and junction services; teleconferencing services; providing user access to global computer networks; rental of access time to global computer networks; providing telecommunication channels for teleshopping services; providing internet chatrooms; providing access to databases; voice mail services; transmission of greeting cards online; transmission of digital files; wireless broadcasting; videoconferencing services; providing online forums; streaming of data; radio communications; video-on-demand transmission.

40 – Abrasion; processing of cinematographic films; air purification; magnetization; applying finishes to textiles; paper finishing; silver plating; fabric bleaching; woodworking; cloth edging; soldering; dressmaking; cadmium plating; permanent-press treatment of fabrics; pottery firing; firing pottery; shoe staining; chromium plating; metal plating; leather staining; fur conditioning; cloth cutting; pattern printing; photographic film development; gilding; water treating; electroplating; tin plating; custom fashioning of fur; blacksmithing; fur mothproofing; millworking; fruit crushing; food smoking; galvanization; engraving; fabric waterproofing; cloth waterproofing; cloth fireproofing; fabric fireproofing; textile fireproofing; crease-resistant treatment for clothing; wool treating; laminating; grinding; metal treating; metal tempering; flour milling; nickel plating; warping [looms]; skin dressing; burnishing by abrasion; bookbinding; planing [saw mill]; saddlery working; sawing [saw mill]; custom tailoring; tanning; taxidermy; dyeing services; textile dyeing; textile treating; cloth treating; textile mothproofing; cloth dyeing; paper treating; glass-blowing; embroidering; leather working; window tinting treatment, being surface coating; food and drink preservation; timber felling and processing; recycling of waste and trash; cloth pre-shrinking; fur glossing; fur staining; fur dyeing; air deodorizing; air freshening; custom assembling of materials for others; framing of works

of art; gold plating; laser scribing; material treatment information; optical glass grinding; photographic printing; photogravure; processing of oil; quilting; refining services; slaughtering of animals; stripping finishes; waste treatment [transformation]; clothing alteration; boilermaking; metal casting; vulcanization [material treatment]; services of a dental technician; production of energy; rental of generators; destruction of waste and trash; incineration of waste and trash; colour separation services; key cutting; decontamination of hazardous materials; lithographic printing; printing; knitting machine rental; offset printing; photocomposing services; silkscreen printing; sorting of waste and recyclable material [transformation]; freezing of foods; rental of air conditioning apparatus; rental of space heating apparatus; fulling of cloth; cryopreservation services; sandblasting services; rental of boilers; upcycling [waste recycling]; welding services.

41 – Academies [education]; amusement park services; entertainment services; animal training; rental of cinematographic apparatus; entertainer services; movie studio services; presentation of circus performances; organization of competitions [education or entertainment]; correspondence courses; physical education; rental of show scenery; providing recreation facilities; radio entertainment; publication of texts, other than publicity texts; teaching; educational services; instruction services; rental of sound recordings; rental of motion pictures; film production, other than advertising films; gymnastic instruction; lending library services; publication of books; rental of radio and television sets; production of radio and television programmes; presentation of variety shows; orchestra services; theatre productions; production of shows; television entertainment; rental of stage scenery; zoological garden services; providing sports facilities; modelling for artists; mobile library services; bookmobile services; providing casino facilities [gambling]; club services [entertainment or education]; arranging and conducting of colloquiums; arranging and conducting of conferences; arranging and conducting of congresses; discotheque services; education information; educational examination; entertainment information; organization of exhibitions for cultural or educational purposes; gambling services; providing golf facilities; health club services [health and fitness training]; holiday camp services [entertainment]; presentation of live performances; cinema presentations; movie theatre presentations; nursery schools; organization of sports competitions; party planning [entertainment]; practical training [demonstration]; providing museum facilities [presentation, exhibitions]; recording studio services; recreation information; rental of skin diving equipment; rental of sports equipment, except vehicles; rental of stadium facilities; rental of video cassette recorders; rental of videotapes; arranging and conducting of seminars; sport camp services; ar-

ranging and conducting of symposiums; timing of sports events; boarding school education; arranging and conducting of workshops [training]; arranging of beauty contests; booking of seats for shows; dubbing; religious education; organization of lotteries; organization of balls; organization of shows [impresario services]; providing amusement arcade services; rental of audio equipment; rental of lighting apparatus for theatrical sets or television studios; rental of tennis courts; rental of video cameras; rental of camcorders; scriptwriting, other than for advertising purposes; videotape editing; on-line publication of electronic books and journals; electronic desktop publishing; subtitling; game services provided on-line from a computer network; karaoke services; music composition services; nightclub services [entertainment]; providing on-line electronic publications, not downloadable; photographic reporting; photography; vocational guidance [education or training advice]; news reporters services; translation; sign language interpretation; videotaping; microfilming; ticket agency services [entertainment]; writing of texts; arranging and conducting of concerts; calligraphy services; layout services, other than for advertising purposes; organization of fashion shows for entertainment purposes; coaching [training]; rental of sports grounds; disc jockey services; language interpreter services; personal trainer services [fitness training]; conducting fitness classes; vocational retraining; production of music; toy rental; games equipment rental; services of schools [education]; providing on-line music, not downloadable; providing on-line videos, not downloadable; tutoring; arranging and conducting of in-person educational forums; songwriting; screenplay writing; conducting guided tours.

42 – Chemical analysis; analysis for oil-field exploitation; architectural services; bacteriological research; chemistry services; chemical research; architectural consultancy; construction drafting; technical research; oil-well testing; cosmetic research; design of interior decor; industrial design; packaging design; material testing; conducting technical project studies; geological surveys; oil-field surveys; engineering; meteorological information; land surveying; computer rental; computer programming; physics [research]; mechanical research; textile testing; geological prospecting; geological research; authenticating works of art; calibration [measuring]; computer software design; updating of computer software; consultancy in the design and development of computer hardware; dress designing; graphic arts design; quality control; rental of computer software; research and development of new products for others; styling [industrial design]; underwater exploration; recovery of computer data; maintenance of computer software; computer system analysis; biological research; urban planning; surveying; computer system design; vehicle roadworthiness testing; duplication

of computer programs; conversion of data or documents from physical to electronic media; creating and maintaining web sites for others; hosting computer sites [web sites]; installation of computer software; cloud seeding; data conversion of computer programs and data [not physical conversion]; computer software consultancy; rental of web servers; computer virus protection services; consultancy in the field of energy-saving; research in the field of environmental protection; providing search engines for the internet; digitization of documents [scanning]; handwriting analysis [graphology]; provision of scientific information, advice and consultancy in relation to carbon offsetting; quality evaluation of standing timber; quality evaluation of wool; monitoring of computer systems by remote access; water analysis; scientific laboratory services; energy auditing; web site design consultancy; software as a service [SaaS]; information technology [IT] consultancy; scientific research; server hosting; clinical trials; off-site data backup; electronic data storage; providing information on computer technology and programming via a web site; cartography services; cloud computing; outsource service providers in the field of information technology; technological consultancy; computer technology consultancy; telecommunications technology consultancy; weather forecasting; computer security consultancy; technical writing; interior design.

44 – Animal breeding; landscape gardening; public bath services for hygiene purposes; Turkish bath services; beauty salon services; medical clinic services; chiropractic; hairdressing; wreath making; convalescent home services; hospital services; health care; horticulture; gardening; farming equipment rental; massage; medical assistance; opticians' services; plant nursery services; physical therapy; physiotherapy; sanatorium services; veterinary assistance; dentistry services; nursing home services; aerial and surface spreading of fertilizers and other agricultural chemicals; animal grooming; blood bank services; flower arranging; hospice services; lawn care; manicuring; midwife services; nursing, medical; pharmacy advice; plastic surgery; tree surgery; vermin exterminating for agriculture, horticulture and forestry; weed killing; pet grooming; hair implantation; services of a psychologist; rental of sanitation facilities; aromatherapy services; artificial insemination services; rehabilitation for substance abuse patients; in vitro fertilization services; tattooing; telemedicine services; landscape design; sauna services; solarium services; health spa services; visagists' services; pharmacists' services to make up prescriptions; therapy services; tree planting for carbon offsetting purposes; aquaculture services; medical equipment rental; health center services; health centre services; alternative medicine services; speech therapy services; health counselling; health counseling; depilatory waxing; orthodontic services; medical advice for indi-

viduals with disabilities; body piercing; reforestation services; palliative care; rest home services.

45 – Personal body guarding; escorting in society [chaperoning]; chaperoning; detective agency services; dating services; night guard services; opening of security locks; evening dress rental; crematorium services; missing person investigations; burial services; funerary undertaking; clothing rental; guard services; marriage agency services; security consultancy; horoscope casting; fire-fighting; organization of religious meetings; adoption agency services; monitoring of burglar and security alarms; baby sitting; baggage inspection for security purposes; house sitting; pet sitting; personal background investigations; lost property return; mediation; inspection of factories for safety purposes; rental of fire alarms; rental of fire extinguishers; arbitration services; intellectual property consultancy; copyright management; licensing of intellectual property; monitoring intellectual property rights for legal advisory purposes; legal research; litigation services; licensing of computer software [legal services]; registration of domain names [legal services]; alternative dispute resolution services; rental of safes; genealogical research; planning and arranging of wedding ceremonies; online social networking services; releasing doves for special occasions; embalming services; legal document preparation services; tracking of stolen property; legal administration of licences; astrology consultancy; spiritual consultancy; cartomancy services; personal wardrobe styling consultancy; personal letter writing; conducting funeral ceremonies.

(260) AM 2019 95628 A

(800) 1378787

(151) 2017 06 07

(891) 2017 06 07

(731) Aktsionernoe obshchestvo "GOZNAK"

(AO"GOZNAK")

territoriya Petropavlovskaya krepost, d. 3,

liter G, RU-197046 Sankt-Peterburg,

Russian Federation

(540)



(591) Dark green, White

(531) 03.07.02; 24.01.09

(511)

2 – Paints; mordants; varnishes; colorants for beverages; food dyes; food colorants; alizarine dyes; aluminium paints; aluminium powder for painting; asbestos paints; anti-corrosive preparations; fixatives for watercolors [watercolours]; fixatives for watercolours; fixatives for watercolours; silver paste; silver emulsions [pigments]; silvering powders; black japan; auramine; bactericidal paints; badigeon; anti-corrosive bands; Canada balsam; colorants for butter; colorants for beer; bitumen varnish; wood coatings [paints]; wood mordants; wood stains; sienna earth; bronzing lacquers; bronze powder for painting; ink for leather; caramel [food colorant]; malt caramel [food colorant]; coatings for roofing felt [paints]; coatings for tarred felt [paints]; ceramic paints; white lead; carbon black [pigment]; undercoating for vehicle chassis; undersealing for vehicle chassis; shoe dyes; lime wash; printers' pastes [ink]; cobalt oxide [colorant]; cochineal carmine; colophony; colorants; dyestuffs; malt colorants; wood preservatives; copal; aniline dyes; thinners for paints; thinners for lacquers; thickeners for paints; creosote for wood preservation; mordants for leather; stains for leather; dyes; pigments; turmeric [colorant]; natural resins, raw; distempers; enamels [varnishes]; enamels for painting; enamel paints; printing ink; marking ink for animals; siccatives [drying agents] for paints; ink for skin-dressing; coatings [paints]; fixatives [varnishes]; lamp black [pigment]; yellow-wood [colorant]; glazes [paints, lacquers]; gamboge for painting; gum-lac; shellac; gum resins; anti-rust greases; engraving ink; zinc oxide [pigment]; oils for the preservation of wood; anti-rust oils; fireproof paints; indigo [colorant]; binding preparations for paints; agglutinants for paints; colorants for liqueurs; litharge; orange lead; metals in powder form for use in painting, decorating, printing and art; mastic [natural resin]; metal foil for use in painting, decorating, printing and art; anti-tarnishing preparations for metals; protective preparations for metals; minium; red lead; paper for dyeing Easter eggs; annatto [dyestuff]; annatto [dyestuff]; saffron [colorant]; sandarac; soot [colorant]; sumac for varnishes; titanium dioxide [pigment]; anti-rust preparations; primers; whitewash; dyewood; dye-wood; dyewood extracts; wood dyestuffs; carbonyl [wood preservative]; copal varnish; lacquers; toners [ink] for photocopiers; ink [toner] for photocopiers; anti-fouling paints; toner cartridges, filled, for printers and photocopiers; turpentine [thinner for paints]; repositionable paint patches; watercolour paints for use in art; watercolor paints for use in art; oil paints for use in art; edible inks; edible ink cartridges, filled, for printers.

6 – Steel, unwrought or semi-wrought; steel alloys; steel strip; hoop steel; steel wire; cast steel; steel masts; roller blinds of steel; steel sheets; steel pipes; steel tubes; machine belt fasteners of metal; railway points; railway switches; nozzles of metal; building

or furniture fittings of nickel-silver; nickel-silver; aluminium; bronze; aluminium wire; anchor plates; tie plates; jets of metal; latch bars of metal; masts of metal; poles of metal; traps for wild animals; braces of metal for handling loads; harness of metal for handling loads; braces of metal for load handling; harness of metal for load handling; anti-friction metal; tree protectors of metal; cashboxes of metal; silver solder; German silver; silver-plated tin alloys; reinforcing materials, of metal, for concrete; safes [strong boxes]; window stops of metal; door stops of metal; washers of metal; rings of metal; stop collars of metal; strap-hinges of metal; floor tiles of metal; barbed wire; bars for metal railings; beryllium [glucinium]; glucinium [beryllium]; cattle chains; beak-irons [bick-irons]; white metal; armor-plating of metal; armour-plating of metal; box fasteners of metal; bolts of metal; bottles [metal containers] for compressed gas or liquid air; identification bracelets of metal; iron slabs; brazing alloys; flanges of metal [collars]; monuments of bronze for tombs; bronzes for tombstones; bronzes [works of art]; telfer cables; rope thimbles of metal; cable joints of metal, non-electric; cable linkages of metal, non-electric; cadmium; padlocks; shims; ferrules of metal for walking sticks; containers of metal for storing acids; safety cashboxes; hafnium [celtium]; celtium [hafnium]; chains of metal; safety chains of metal; couplings of metal for chains; frames of metal for building; window pulleys; sash pulleys; ducts of metal, for central heating installations; pipes of metal, for central heating installations; ducts and pipes of metal for central heating installations; horseshoe nails; pegs of metal; chromium; chrome iron; chrome ores; cotter pins of metal; keys; nails; tacks [nails]; brads; wall plugs of metal; cobalt, raw; railway material of metal; pillars of metal for building; water-pipes of metal; sleeves [metal hardware]; tin cans; preserving boxes of metal; preserve tins; containers of metal [storage, transport]; guard rails of metal; chill-molds [foundry]; chill-moulds [foundry]; anvils; roof flashing of metal; elbows of metal for pipes; doors of metal; belt stretchers of metal; crampons of metal [cramps]; cramps of metal [crampons]; pot hooks of metal; window casement bolts; hooks [metal hardware]; ironwork for windows; wire of common metal; copper, unwrought or semi-wrought; copper rings; tubing of metal; containers of metal for compressed gas or liquid air; foot scrapers; door scrapers; drain pipes of metal; iron, unwrought or semi-wrought; fish plates [rails]; screws of metal; tinplate packings; letter boxes of metal; door bells of metal, non-electric; spurs; brackets of metal for building; staircases of metal; window fasteners of metal; pipes of metal; tubes of metal; rails of metal; fittings of metal for windows; iron strip; hoop iron; iron wire; cast iron, unwrought or semi-wrought; iron ores; door closers, non-electric; door springs, non-electric; molybdenum iron; silicon iron; titanium iron; ferroti-

tanium; tungsten iron; fittings of metal for building; pins [hardware]; eye bolts; screw rings; locks of metal, other than electric; galena [ore]; lead seals; germanium; weather- or wind-vanes of metal; weather vanes of metal; wind vanes of metal; crampons [climbing irons]; ice moulds of metal; grease nipples; grilles of metal; gratings of metal; spring locks; indium; badges of metal for vehicles; jalousies of metal; brass, unwrought or semi-wrought; outdoor blinds of metal; rocket launching platforms of metal; laths of metal; filings of metal; stringers [parts of staircases] of metal; limonite; ingots of common metal; lintels of metal; bed casters of metal; latches of metal; blooms [metallurgy]; magnesium; buildings, transportable, of metal; ferrules of metal for handles; pipe muffs of metal; manganese; handling pallets of metal; transport pallets of metal; steps [ladders] of metal; porches [structures] of metal; door knockers of metal; handcuffs; common metals, unwrought or semi-wrought; ores of metal; wire cloth; wire gauze; pyrophoric metals; furniture casters of metal; sheet piles of metal; pilings of metal; molybdenum; monuments of metal; vice claws of metal; wall claddings of metal for building; nickel; niobium; flashing of metal, for building; house numbers of metal, non-luminous; shutters of metal; palings of metal; baskets of metal; signalling panels, non-luminous and non-mechanical, of metal; wall linings of metal for building; clothes hooks of metal; skating rinks [structures] of metal; lock bolts; posts of metal; springs [metal hardware]; pulleys of metal, other than for machines; tent pegs of metal; ceilings of metal; floors of metal; linings of metal for building; turntables [railways]; roofing tiles of metal; lead, unwrought or semi-wrought; diving boards of metal; door handles of metal; rivets of metal; gates of metal; door panels of metal; door bolts of metal; split rings of common metal for keys; telegraph posts of metal; zinc; beams of metal; girders of metal; joists of metal; platforms, prefabricated, of metal; hardware of metal, small; ironmongery; road signs, non-luminous and non-mechanical, of metal; junctions of metal for pipes; wire stretchers [tension links]; packaging containers of metal; tanks of metal; reservoirs of metal; sills of metal; signs, non-luminous and non-mechanical, of metal; greenhouses of metal, transportable; locks of metal for vehicles; stops of metal; silos of metal; bells for animals; bells; soldering wire of metal; valves of metal, other than parts of machines; statues of common metal; railroad ties of metal; railway sleepers of metal; tantalum [metal]; bolts, flat; anvils [portable]; tension links; titanium; roofing of metal; tombac; tombs of metal; turnstiles of metal; latticework of metal; trellis of metal; tungsten; pipework of metal; vanadium; casement windows of metal; ferrules of metal; aviaries [structures] of metal; zirconium; balls of steel; steel buildings; fittings of metal for compressed air lines; wire of common metal alloys, except fuse wire; allo-

ys of common metal; aluminium foil; mooring bollards of metal; floating docks of metal, for mooring boats; anchors; wainscoting of metal; reinforcing materials of metal for pipes; reinforcing materials of metal for building; reinforcing materials of metal for machine belts; works of art of common metal; troughs of metal for mixing mortar; bird baths [structures] of metal; beacons of metal, non-luminous; stretchers for iron bands [tension links]; wrapping or binding bands of metal; bands of metal for tying-up purposes; thread of metal for tying-up purposes; barrels of metal; barrel hoops of metal; casks of metal; swimming pools [structures] of metal; building materials of metal; shuttering of metal for concrete; bicycle parking installations of metal; paving blocks of metal; boxes of common metal; bungs of metal; plugs of metal; sealing caps of metal; buckles of common metal [hardware]; bottle caps of metal; capsules of metal for bottles; sealing caps of metal for bottles; bottle closures of metal; bottle fasteners of metal; knobs of metal; rods of metal for brazing; rods of metal for brazing and welding; rods of metal for welding; straps of metal for handling loads; belts of metal for handling loads; straps of metal for load handling; slings of metal for handling loads; busts of common metal; cabanas of metal; paint spraying booths of metal; booths of metal for spraying paint; cables of metal, non-electric; collars of metal for fastening pipes; clips of metal for cables and pipes; binding screws of metal for cables; window frames of metal; greenhouse frames of metal; duckboards of metal; chimney cowls of metal; binding thread of metal for agricultural purposes; door openers, non-electric; tiles of metal for building; tile floorings of metal; burial vaults of metal; fittings of metal for coffins; loading pallets of metal; loading gauge rods, of metal, for railway waggons; loading gauge rods, of metal, for railway wagons; hinges of metal; framework of metal for building; door frames of metal; door casings of metal; materials of metal for funicular railway permanent ways; chimney pots of metal; roof gutters of metal; drain traps [valves] of metal; partitions of metal; casings of metal for oilwells; containers of metal for liquid fuel; buildings of metal; floating containers of metal; ropes of metal; cornices of metal; moldings of metal for cornices; mouldings of metal for cornices; angle irons of metal; windows of metal; ironwork for doors; runners of metal for sliding doors; manhole covers of metal; roof coverings of metal; hooks of metal for roofing slates; hooks of metal for clothes rails; copper wire, not insulated; vats of metal; stair treads [steps] of metal; gutter pipes of metal; reels of metal, non-mechanical, for flexible hoses; towel dispensers, fixed, of metal; water-pipe valves of metal; scaffolding of metal; ladders of metal; mobile boarding stairs of metal for passengers; bindings of metal; nuts of metal; poles of metal for power lines; posts of metal for power lines; branching pipes of metal; enclosures of

metal for tombs; fences of metal; winding spools of metal, non-mechanical, for flexible hoses; signboards of metal; props of metal; tin; tinplate; tinfoil; sheets and plates of metal; locks of metal for bags; fittings of metal for furniture; building panels of metal; figurines [statuettes] of common metal; statuettes of common metal; stretchers for metal bands [tension links]; foundry molds [moulds] of metal; grave slabs of metal; tomb slabs of metal; monuments of metal for tombs; tombstone plaques of metal; tombstone stelae of metal; memorial plates of metal; memorial plaques of metal; furnace fireguards of metal; cask stands of metal; fittings of metal for beds; door fittings of metal; closures of metal for containers; sheaf binders of metal; crash barriers of metal for roads; chests of metal; bins of metal; identity plates of metal; registration plates of metal; numberplates of metal; cermets; taps of metal for casks; advertisement columns of metal; mooring buoys of metal; chimneys of metal; chimney shafts of metal; ducts of metal for ventilating and air conditioning installations; foils of metal for wrapping and packaging; gold solder; hoppers of metal, non-mechanical; letters and numerals of common metal, except type; manifolds of metal for pipelines; penstock pipes of metal; telephone booths of metal; telephone boxes of metal; tool boxes of metal, empty; tool chests of metal, empty; chicken-houses of metal; wheel clamps [boots]; wire rope; insect screens of metal; pitons of metal; firedogs [andirons]; wind-driven bird-repelling devices made of metal; metal cages for wild animals; metals in powder form; refractory construction materials of metal; harbours [structures] of metal; stables of metal; pigsties of metal; prefabricated houses [kits] of metal; trays of metal; street gutters of metal; screw tops of metal for bottles; window openers, non-electric; window closers, non-electric; wall tiles of metal; paving slabs of metal; slabs of metal for building; step stools of metal; roofing of metal, incorporating solar cells; armored doors of metal; armoured doors of metal; bathtub grab bars of metal; dispensers for dog waste bags, fixed, of metal; metals in foil or powder form for 3D printers; sash fasteners of metal for windows; door fasteners of metal; pantiles of metal; balustrades of metal; cladding of metal for building.

9 – Coils, electric; particle accelerators; reflecting discs for wear, for the prevention of traffic accidents; protection devices for personal use against accidents; clothing for protection against accidents, irradiation and fire; accumulators, electric, for vehicles; batteries, electric, for vehicles; battery jars; accumulator jars; battery boxes; accumulator boxes; acidimeters for batteries; hydrometers; plates for batteries; whistle alarms; sound alarms; acoustic conduits; sound recording discs; phonograph records; speaking tubes; actinometers; adding machines; aerometers; enlarging apparatus [photography]; electro-dynamic apparatus for the remote control of

railway points; magnets; electromagnetic coils; air analysis apparatus; alarms; alcoholmeters; alidades; food analysis apparatus; igniting apparatus, electric, for igniting at a distance; electric apparatus for remote ignition; batteries for lighting; altimeters; asbestos gloves for protection against accidents; asbestos clothing for protection against fire; ammeters; amplifiers; amplifying tubes; amplifying valves; anemometers; calibrating rings; fire extinguishers; anodes; anode batteries; high tension batteries; antennas; aerials; anti-glare glasses; anti-glare visors; anti-dazzle shades; anti-interference devices [electricity]; transformers [electricity]; apertometers [optics]; money counting and sorting machines; distribution boxes [electricity]; surveying instruments; surveying chains; lenses for astrophotography; thermionic tubes; thermionic valves; audiovisual teaching apparatus; coin-operated musical automata [juke boxes]; juke boxes, musical; mechanisms for coin-operated apparatus; mechanisms for counter-operated apparatus; calipers; comparators; fire alarms; automatic indicators of low pressure in vehicle tires [tyres]; automatic indicators of low pressure in vehicle tires; automatic indicators of low pressure in vehicle tyres; protective suits for aviators; alarm bells, electric; rods for water diviners; life-saving rafts; scales; meteorological balloons; demagnetizing apparatus for magnetic tapes; tape recorders; magnetic tapes; barometers; weighing machines; weigh-bridges; fire beaters; chargers for electric batteries; betatrons; ticket dispensers; cabinets for loudspeakers; close-up lenses; terminals [electricity]; pressure indicator plugs for valves; galvanometers; push buttons for bells; branch boxes [electricity]; tone arms for record players; spirit levels; punched card machines for offices; sheaths for electric cables; frames for photographic transparencies; circular slide rules; slide-rules; calculating machines; slide calipers; jigs [measuring instruments]; blueprint apparatus; cinematographic cameras; capillary tubes; sound recording carriers; protective helmets; respiratory masks, other than for artificial respiration; solderers' helmets; eyeglass chains; spectacle chains; Heat regulating apparatus; darkrooms [photography]; boiler control instruments; drying racks [photography]; editing appliances for cinematographic films; apparatus for editing cinematographic film; printed circuits; flashing lights [luminous signals]; blinkers [signalling lights]; signal bells; containers for microscope slides; collectors, electric; electric installations for the remote control of industrial operations; switchboxes [electricity]; commutators; marine compasses; eyepieces; thread counters; pedometers; counters; meters; metronomes; condensers [capacitors]; capacitors; conductors, electric; electricity conduits; circuit closers; connectors [electricity]; junction boxes [electricity]; switchboards; contacts, electric; apparatus to check franking; apparatus to check stamping mail; regulating apparatus, electric; moni-

toring apparatus, electric; speed checking apparatus for vehicles; converters, electric; photocopiers [photographic, electrostatic, thermic]; eyeglass cords; spectacle cords; retorts; retorts' stands; correcting lenses [optics]; objectives [lenses] [optics]; cosmographic instruments; diving suits; electric apparatus for commutation; switches, electric; limiters [electricity]; sockets, plugs and other contacts [electric connections]; plugs, sockets and other contacts [electric connections]; current rectifiers; cell switches [electricity]; reducers [electricity]; dressmakers' measures; crucibles [laboratory]; cupels [laboratory]; appliances for measuring the thickness of leather; cyclotrons; counterfeit [false] coin detectors; false coin detectors; shutter releases [photography]; densimeters; animated cartoons; laboratory trays; metal detectors for industrial or military purposes; sonars; detectors; shutters [photography]; diaphragms [acoustics]; centering apparatus for photographic transparencies; cameras [photography]; transparencies [photography]; slides [photography]; slide projectors; transparency projection apparatus; distance measuring apparatus; dictating machines; diffraction apparatus [microscopy]; loudspeakers; circuit breakers; record players; microscopes; distance recording apparatus; apparatus for recording distance; range finders; telemeters; distribution boards [electricity]; distribution consoles [electricity]; compasses for measuring; measures; measuring apparatus; dynamometers; water level indicators; fire escapes; flash-bulbs [photography]; telephone receivers; fluorescent screens; projection screens; workmen's protective face-shields; screens [photography]; drainers for use in photography; photographic racks; electric loss indicators; measuring devices, electric; cables, electric; ducts [electricity]; control panels [electricity]; galvanic cells; connections for electric lines; couplings, electric; connections, electric; relays, electric; electrolyzers; transmitters of electronic signals; transmitting sets [telecommunication]; cleaning apparatus for sound recording discs; cleaning apparatus for phonograph records; sound recording strips; kilometer recorders for vehicles; milage recorders for vehicles; spools [photography]; mechanical signs; epidiascopes; test tubes; balancing apparatus; thermostats; ergometers; material testing instruments and machines; egg-candlers; gauges; gasoline gauges; petrol gauges; spark-guards; cases especially made for photographic apparatus and instruments; testing apparatus not for medical purposes; refractometers; exposure meters [light meters]; invoicing machines; apparatus for fermentation [laboratory apparatus]; railway traffic safety appliances; wires, electric; magnetic wires; plumb bobs; plumb lines; nets for protection against accidents; safety nets; life nets; safety tarpaulins; film cutting apparatus; filters for respiratory masks; filters [photography]; battery chargers; high-frequency apparatus; frequency meters; fuses; radios; galena crystals [detec-

tors]; gloves for protection against accidents; gloves for divers; gloves for protection against X-rays for industrial purposes; gas testing instruments; gasometers [measuring instruments]; surveying apparatus and instruments; levelling staffs [surveying instruments]; rods [surveying instruments]; drying apparatus for photographic prints; glazing apparatus for photographic prints; rulers [measuring instruments]; measuring glassware; graduated glassware; screens for photoengraving; grids for batteries; clothing for protection against fire; garments for protection against fire; audio- and video-receivers; heliographic apparatus; holograms; hygrometers; identification threads for electric wires; identification sheaths for electric wires; life saving apparatus and equipment; fire hose nozzles; fire engines; fire pumps; slope indicators; clinometers; gradient indicators; inclinometers; taximeters; quantity indicators; vacuum gauges; speed indicators; inductors [electricity]; armatures [electricity]; data processing apparatus; mirrors for inspecting work; intercommunication apparatus; carriers for dark plates [photography]; inverters [electricity]; ionization apparatus not for the treatment of air or water; peepholes [magnifying lenses] for doors; hemline markers; furniture especially made for laboratories; lactodensimeters; lactometers; darkroom lamps [photography]; optical lamps; optical lanterns; magic lanterns; signal lanterns; lasers, not for medical purposes; optical lenses; letter scales; logs [measuring instruments]; sounding lines; magnifying glasses [optics]; signs, luminous; neon signs; eyeglasses; instruments containing eyepieces; surveyors' levels; spectacle lenses; optical goods; pressure gauges; manometers; periscopes; protective masks; mathematical instruments; coin-operated mechanisms for television sets; megaphones; computer memory devices; carpenters' rules; mercury levels; speed measuring apparatus [photography]; precision measuring apparatus; measuring instruments; meteorological instruments; rules [measuring instruments]; micrometer screws for optical instruments; microphones; microtomes; time switches, automatic; mirrors [optics]; breathing apparatus for underwater swimming; nautical apparatus and instruments; naval signalling apparatus; navigational instruments; eyeglass frames; spectacle frames; batteries, electric; accumulators, electric; levels [instruments for determining the horizontal]; levelling instruments; prisms [optics]; observation instruments; octants; ohmmeters; wavemeters; optical apparatus and instruments; optical glass; computers; computer programmes [programs], recorded; oscillographs; oxygen transvasing apparatus; ozonisers [ozonators]; micrometers; micrometer gauges; signalling panels, luminous or mechanical; lightning conductors [rods]; lightning arresters; lightning conductors; parking meters; apparatus and instruments for astronomy; apparatus for measuring the thickness of skins; acid hydrometers; weighing apparatus and instruments; salinometers;

washing trays [photography]; stands for photographic apparatus; viewfinders, photographic; photometers; phototelegraphy apparatus; apparatus and instruments for physics; steering apparatus, automatic, for vehicles; pince-nez; pipettes; plane tables [surveying instruments]; planimeters; ear plugs for divers; bells [warning devices]; weights; polarimeters; radiotelephony sets; radiotelegraphy sets; pressure measuring apparatus; pressure indicators; projection apparatus; cathodic anti-corrosion apparatus; teeth protectors; pyrometers; radar apparatus; vehicle radios; radiological apparatus for industrial purposes; protractors [measuring instruments]; apparatus and installations for the production of X-rays, not for medical purposes; X-ray tubes not for medical purposes; protection devices against X-rays, not for medical purposes; telephone apparatus; refractors; X-ray apparatus not for medical purposes; spectroscopes; resistances, electric; thermometers, not for medical purposes; respirators for filtering air; breathing apparatus, except for artificial respiration; rheostats; balances [steelyards]; lever scales [steelyards]; steelyards [lever scales]; signals, luminous or mechanical; saccharometers; probes for scientific purposes; satellites for scientific purposes; diaphragms for scientific apparatus; teaching apparatus; choking coils [impedance]; wire connectors [electricity]; locks, electric; sextants; signalling whistles; vehicle breakdown warning triangles; electro-dynamic apparatus for the remote control of signals; simulators for the steering and control of vehicles; sirens; sound transmitting apparatus; sound recording apparatus; sound reproduction apparatus; sounding apparatus and machines; sounding leads; sound locating instruments; spectrograph apparatus; spherometers; stereoscopes; stereoscopic apparatus; needles for record players; styli for record players; sulfimeters; teleprinters; teletypewriters; tachometers; screw-tapping gauges; telegraphs [apparatus]; television apparatus; telegraph wires; remote control apparatus; masts for wireless aerials; teleprompters; telephone transmitters; telerupters; binoculars; telescopes; temperature indicators; time recording apparatus; theodolites; thermostats for vehicles; totalizers; revolution counters; speed regulators for record players; transmitters [telecommunication]; precision balances; marking gauges [joinery]; vacuum tubes [radio]; urinometers; variometers; verniers; videotapes; viscosimeters; theft prevention installations, electric; voltage regulators for vehicles; voting machines; voltmeters; apparatus for changing record player needles; stills for laboratory experiments; fuse wire; wires of metal alloys [fuse wire]; anticathodes; dog whistles; sighting telescopes for firearms; telescopic sights for firearms; anti-theft warning apparatus; azimuth instruments; beacons, luminous; holders for electric coils; films, exposed; road signs, luminous or mechanical; life buoys; signalling buoys; buzzers; directional compasses; fog signals, non-

explosive; cash registers; radiology screens for industrial purposes; identity cards, magnetic; photovoltaic cells; densitometers; disks, magnetic; floppy disks; head cleaning tapes [recording]; video recorders; computer keyboards; integrated circuits; semiconductors; chips [integrated circuits]; cathodes; life jackets; life belts; chemistry apparatus and instruments; cinematographic film, exposed; materials for electricity mains [wires, cables]; contact lenses; containers for contact lenses; incubators for bacteria culture; solar batteries; copper wire, insulated; discharge tubes, electric, other than for lighting; electric discharge tubes, other than for lighting; diaphragms [photography]; distillation apparatus for scientific purposes; dosage dispensers; dosimeters; electric door bells; eyeglass cases; spectacle cases; furnaces for laboratory use; ovens for laboratory use; optical fibers [fibres] [light conducting filaments]; light conducting filaments [optical fibers [fibres]]; telephone wires; X-ray films, exposed; filters for ultraviolet rays, for photography; horns for loudspeakers; tripods for cameras; bar code readers; bullet-proof waistcoats [vests (Am.)]; marking buoys; wafers for integrated circuits; chromatography apparatus for laboratory use; chronographs [time recording apparatus]; compact discs [audio-video]; compact discs [read-only memory]; computer operating programs, recorded; computer peripheral devices; computer software, recorded; optical condensers; acoustic couplers; couplers [data processing equipment]; decompression chambers; plotters; divers' masks; electronic pens [visual display units]; encoded magnetic cards; facsimile machines; fire boats; interfaces for computers; juke boxes for computers; knee-pads for workers; light dimmers [regulators], electric; light regulators [dimmers], electric; magnetic data media; magnetic encoders; magnetic tape units for computers; microprocessors; modems; monitors [computer hardware]; monitors [computer programs]; mouse [computer peripheral]; optical character readers; optical data media; optical discs; printers for use with computers; processors [central processing units]; central processing units [processors]; readers [data processing equipment]; safety restraints, other than for vehicle seats and sports equipment; scanners [data processing equipment]; smoke detectors; transistors [electronic]; X-ray photographs, other than for medical purposes; junction sleeves for electric cables; abacuses; electronic agendas; answering machines; camcorders; cassette players; compact disc players; diagnostic apparatus, not for medical purposes; disk drives for computers; electrified rails for mounting spot lights; electronic pocket translators; electronic tags for goods; fire blankets; flashlights [photography]; integrated circuit cards [smart cards]; smart cards [integrated circuit cards]; measuring spoons; notebook computers; electronic notice boards; pocket calculators; shoes for protection against accidents, irradiation and fire; sprinkler systems for

fire protection; starter cables for motors; sunglasses; time clocks [time recording devices]; video cassettes; video game cartridges; video screens; video telephones; goggles for sports; nose clips for divers and swimmers; protective helmets for sports; electronic publications, downloadable; computer programs [downloadable software]; navigation apparatus for vehicles [on-board computers]; decorative magnets; cordless telephones; mouse pads; personal stereos; wrist rests for use with computers; coaxial cables; fibre [fiber (Am.)] optic cables; covers for electric outlets; marine depth finders; electrified fences; computer game software; headphones; lighting ballasts; radio pagers; satellite navigational apparatus; solenoid valves [electromagnetic switches]; voltage surge protectors; walkie-talkies; wind socks for indicating wind direction; light-emitting electronic pointers; resuscitation mannequins [teaching apparatus]; stage lighting regulators; egg timers [sandglasses]; hourglasses; DNA chips; DVD players; automated teller machines [ATM]; traffic-light apparatus [signalling devices]; hands-free kits for telephones; asbestos screens for firemen; riding helmets; clothing especially made for laboratories; encoded identification bracelets, magnetic; transponders; downloadable ring tones for mobile phones; downloadable music files; downloadable image files; crash test dummies; laboratory centrifuges; printed circuit boards; USB flash drives; Global Positioning System [GPS] apparatus; portable media players; cell phone straps; light-emitting diodes [LED]; triodes; step-up transformers; laptop computers; fire hose; bags adapted for laptops; sleeves for laptops; digital photo frames; Petri dishes; Pitot tubes; stroboscopes; traffic cones; temperature indicator labels, not for medical purposes; computer software applications, downloadable; electronic book readers; smartphones; toner cartridges, unfilled, for printers and photocopiers; baby monitors; video baby monitors; lens hoods; tablet computers; encoded key cards; 3D spectacles; memory cards for video game machines; bullet-proof clothing; accelerometers; electrical adapters; life-saving capsules for natural disasters; computer hardware; solar panels for the production of electricity; cellular phones; mobile telephones; cell phones; telescopic sights for artillery; digital signs; wearable activity trackers; chargers for electronic cigarettes; connected bracelets [measuring instruments]; covers for smartphones; cases for smartphones; selfie sticks [hand-held monopods]; calorimeters; flowmeters; reflective safety vests; electronic collars to train animals; joysticks for use with computers, other than for video games; smartglasses; smartwatches; fire extinguishing apparatus; protective films adapted for computer screens; mouth guards for sports; head guards for sports.

14 – Agates; clock hands; ingots of precious metals; jewelry of yellow amber; jewellery of yellow amber; pearls made of ambroid [pressed amber]; amulets

[jewellery]; amulets [jewelry]; spun silver [silver wire]; silver thread [jewellery]; silver thread [jewelry]; clocks; pendulums [clock- and watchmaking]; barrels [clock- and watchmaking]; bracelets [jewellery]; bracelets [jewelry]; wristwatches; watch bands; watch straps; straps for wristwatches; charms for jewellery; jewellery charms; charms for jewelry; jewelry charms; brooches [jewellery]; brooches [jewelry]; dials [clock- and watchmaking]; sundials; clockworks; chains [jewellery]; chains [jewelry]; watch chains; chronographs [watches]; chronometers; chronoscopes; chronometric instruments; necklaces [jewellery]; necklaces [jewelry]; clocks and watches, electric; tie clips; coins; diamonds; threads of precious metal [jewellery]; threads of precious metal [jewelry]; wire of precious metal [jewellery]; wire of precious metal [jewelry]; atomic clocks; control clocks [master clocks]; master clocks; clock cases; iridium; ivory jewelry; ivory jewellery; ornaments of jet; jet, unwrought or semi-wrought; copper tokens; jewelry; jewellery; lockets [jewellery]; lockets [jewelry]; medals; precious metals, unwrought or semi-wrought; watches; watch springs; watch glasses; watch crystals; movements for clocks and watches; olivine [gems]; peridot; gold, unwrought or beaten; gold thread [jewellery]; gold thread [jewelry]; osmium; palladium; ornaments [jewelry]; ornamental pins; pearls [jewellery]; pearls [jewelry]; semi-precious stones; precious stones; platinum [metal]; rhodium; ruthenium; spinel [precious stones]; statues of precious metal; paste jewellery; paste jewelry [costume jewelry]; alloys of precious metal; anchors [clock- and watchmaking]; rings [jewellery]; rings [jewelry]; works of art of precious metal; boxes of precious metal; hat ornaments of precious metal; earrings; shoe ornaments of precious metal; cuff links; busts of precious metal; watch cases [parts of watches]; presentation boxes for watches; figurines [statuettes] of precious metal; statuettes of precious metal; pins [jewellery]; pins [jewelry]; tie pins; badges of precious metal; key chains [trinkets or fobs]; silver, unwrought or beaten; stopwatches; cloisonne jewellery; cloisonne jewelry; jewellery boxes; jewelry boxes; beads for making jewelry; beads for making jewellery; clasps for jewelry; clasps for jewellery; jewelry findings; jewellery findings; jewelry rolls; jewellery rolls; cabochons for making jewellery; cabochons for making jewelry; split rings of precious metal for keys; presentation boxes for jewellery; presentation boxes for jewelry; watch hands; rosaries; chaplets.

16 – Steel letters; steel pens; adhesive tape dispensers [office requisites]; address stamps; addressing machines; paper; posters; advertisement boards of paper or cardboard; franking machines for office use; postage meters for office use; staples for offices; clips for offices; pen clips; stapling presses [office requisites]; albums; scrapbooks; pictures; prints [engravings]; cigar bands; pencil sharpening

machines, electric or non-electric; bookends; hand-rests for painters; aquarelles; watercolors [paintings]; watercolours [paintings]; architects' models; document files [stationery]; writing slates; slate pencils; silver paper; modelling clay; arithmetical tables; calculating tables; engravings; lithographic works of art; paintings [pictures], framed or unframed; pencils; newspapers; periodicals; atlases; loose-leaf binders; gummed tape [stationery]; mats for beer glasses; tickets; biological samples for use in microscopy [teaching materials]; printing blocks; drawing pads; pads [stationery]; spools for inking ribbons; wristbands for the retention of writing instruments; pamphlets; embroidery designs [patterns]; drawing pins; thumbtacks; moisteners [office requisites]; painters' brushes; blotters; stamps [seals]; sealing stamps; inking pads; sealing wax; sealing machines for offices; sealing compounds for stationery purposes; writing or drawing books; trays for sorting and counting money; tracing patterns; tracing paper; tracing cloth; finger-stalls [office requisites]; printing type; carbon paper; paper for recording machines; note books; square rulers; cards; charts; teaching materials [except apparatus]; index cards [stationery]; paper sheets [stationery]; cardboard; hat boxes of cardboard; perforated cards for Jacquard looms; cardboard tubes; catalogues; tags for index cards; song books; composing frames [printing]; folders for papers; jackets for papers; painters' easels; numbers [type]; Indian inks; chromolithographs [chromos]; chromos; modelling wax, not for dental purposes; files [office requisites]; office perforators; toilet paper; hygienic paper; books; compasses for drawing; type [numerals and letters]; letters [type]; composing sticks; letter trays; conical paper bags; correcting fluids [office requisites]; correcting ink [heliography]; pencil leads; histological sections for teaching purposes; French curves; covers [stationery]; wrappers [stationery]; writing chalk; chalk for lithography; tailors' chalk; chalk holders; pencil holders; pencil lead holders; cream containers of paper; paper clasps; rollers for typewriters; transfers [decalcomanias]; decalcomanias; graphic prints; graining combs; drawing boards; drawing materials; drawing instruments; diagrams; envelopes [stationery]; duplicators; etchings; wrapping paper; packing paper; nibs; typewriters, electric or non-electric; pen cases; boxes for pens; nibs of gold; erasing products; writing materials; shields [paper seals]; erasing shields; rubber erasers; electrocardiograph paper; punches [office requisites]; ink; inking ribbons; inkwells; envelope sealing machines, for offices; photographs [printed]; pen wipers; seals [stamps]; fabrics for bookbinding; drawing sets; ledgers [books]; indexes; figurines [statuettes] of papier mâché; filter paper; filtering materials [paper]; forms, printed; office requisites, except furniture; charcoal pencils; stencils [stationery]; galley racks [printing]; electrotypes; geographical maps; terrestrial globes; artists' water-

color saucers; artists' watercolour saucers; graphic reproductions; graphic representations; scrapers [erasers] for offices; engraving plates; hectographs; printed timetables; moisteners for gummed surfaces [office requisites]; postcards; printed matter; hand labelling appliances; printers' blankets, not of textile; printing sets, portable [office requisites]; printed publications; manuals [handbooks]; handbooks [manuals]; writing paper; paperweights; tracing needles for drawing purposes; drawing pens; table linen of paper; lithographs; lithographic stones; booklets; luminous paper; papier mâché; manifolds [stationery]; marking chalk; plastics for modeling; modelling materials; modelling paste; handkerchiefs of paper; inking sheets for duplicators; tablecloths of paper; blackboards; paper-clips; numbering apparatus; oleographs; binding strips [bookbinding]; sealing wafers; palettes for painters; pantographs [drawing instruments]; stationery; parchment paper; pastels [crayons]; sewing patterns; stencil cases; house painters' rollers; canvas for painting; paint boxes [articles for use in school]; plastic film for wrapping; apparatus for mounting photographs; photograph stands; photo-engravings; blueprints; plans; folders [stationery]; fountain pens; stencil plates; stencils; portraits; covers of paper for flower pots; flower-pot covers of paper; mimeograph apparatus and machines; paper tapes and cards for the recordal of computer programmes; prospectuses; paper for radiograms; drawing rulers; printers' galleys; bookbinding material; bookbindings; bookbinding cloth; cloth for bookbinding; cords for bookbinding; bookbinding cords; inking sheets for document reproducing machines; pens [office requisites]; magazines [periodicals]; paper ribbons; typewriter ribbons; bags [envelopes, pouches] of paper or plastics, for packaging; stamp pads; school supplies [stationery]; bookmarkers; greeting cards; steatite [tailor's chalk]; balls for ballpoint pens; tablemats of paper; desk mats; typewriter keys; holders for stamps [seals]; cases for stamps [seals]; postage stamps; stamp stands; transparencies [stationery]; vignetting apparatus; gluten [glue] for stationery or household purposes; adhesives [glues] for stationery or household purposes; adhesive tapes for stationery or household purposes; adhesive bands for stationery or household purposes; address plates for addressing machines; almanacs; calendars; starch paste [adhesive] for stationery or household purposes; paintbrushes; self-adhesive tapes for stationery or household purposes; elastic bands for offices; bibs of paper; wood pulp board [stationery]; wood pulp paper; boxes of cardboard or paper; stands for pens and pencils; bottle envelopes of cardboard or paper; coasters of paper; announcement cards [stationery]; plastic bubble packs for wrapping or packaging; flags of paper; paper shredders for office use; sheets of reclaimed cellulose for wrapping; cabinets for stationery [office requisites]; glue for stationery or household purposes; pastes for stationery or house-

hold purposes; paper knives [cutters] [office requisites]; paper cutters [office requisites]; paper knives [office requisites]; garbage bags of paper or of plastics; pencil sharpeners, electric or non-electric; tissues of paper for removing make-up; table napkins of paper; place mats of paper; drawing squares; drawing T-squares; penholders; writing cases [stationery]; inkstands; writing cases [sets]; handwriting specimens for copying; bottle wrappers of cardboard or paper; placards of paper or cardboard; towels of paper; face towels of paper; labels, not of textile; etching needles; viscose sheets for wrapping; gums [adhesives] for stationery or household purposes; gummed cloth for stationery purposes; isinglass for stationery or household purposes; bags for microwave cooking; paper coffee filters; plastic cling film, extensible, for palletization; inking ribbons for computer printers; signboards of paper or cardboard; stickers [stationery]; bookbinding apparatus and machines [office equipment]; comic books; copying paper [stationery]; holders for checkbooks [cheque books]; ink sticks; ink stones [ink reservoirs]; musical greeting cards; newsletters; packaging material made of starches; waxed paper; passport holders; writing brushes; writing instruments; drawer liners of paper, perfumed or not; credit card imprinters, non-electric; document laminators for office use; Xuan paper for Chinese painting and calligraphy; writing board erasers; clipboards; chart pointers, non-electronic; paper bows; molds for modelling clays [artists' materials]; moulds for modelling clays [artists' materials]; money clips; trading cards other than for games; absorbent sheets of paper or plastic for foodstuff packaging; humidity control sheets of paper or plastic for foodstuff packaging; correcting tapes [office requisites]; paint trays; marking pens [stationery]; flyers; document holders [stationery]; page holders; polymer modelling clay; obliterating stamps; packing [cushioning, stuffing] materials of paper or cardboard; stuffing of paper or cardboard; banknotes; spray chalk; printed coupons; rice paper.

18 – Mountaineering sticks; alpenstocks; animal skins; pelts; umbrella rings; saddle trees; leather leashes; leather leads; fastenings for saddles; umbrella or parasol ribs; goldbeaters' skin; purses; bridons; straps for soldiers' equipment; music cases; umbrella sticks; walking sticks; canes; walking stick seats; bits for animals [harness]; frames for umbrellas or parasols; game bags [hunting accessories]; school bags; school satchels; card cases [notecases]; leatherboard; hat boxes of leather; horse collars; horse blankets; kid; muzzles; travelling trunks; collars for animals; leather laces; curried skins; harness straps; harness traces; straps of leather [saddlery]; straps for skates; leather straps; leather thongs; butts [parts of hides]; leather, unworked or semi-worked; leather thread; leather twist; trimmings of leather for furniture; leather trimmings for furniture; imitation leather; umbrellas; sling bags for carrying infants;

parts of rubber for stirrups; stirrup leathers; tool bags, empty; whips; nose bags [feed bags]; umbrella covers; casings, of leather, for springs; casings, of leather, for plate springs; knee-pads for horses; clothing for pets; covers for animals; harness for animals; blinkers [harness]; blinders [harness]; traces [harness]; rucksacks; backpacks; halters; head-stalls; walking stick handles; walking cane handles; cat o' nine tails; chin straps, of leather; moleskin [imitation of leather]; handbag frames; parasols; fur; fur-skins; umbrella handles; pocket wallets; wheeled shopping bags; shopping bags; attache cases; bags for climbers; bags for campers; beach bags; handbags; travelling bags; bags [envelopes, pouches] of leather, for packaging; girths of leather; riding saddles; saddlery; briefcases; travelling sets [leatherware]; valises; suitcase handles; valves of leather; cattle skins; boxes of leather or leatherboard; chain mesh purses; cases of leather or leatherboard; trunks [luggage]; vanity cases, not fitted; chamois leather, other than for cleaning purposes; skins of chamois, other than for cleaning purposes; shoulder belts [straps] of leather; leather shoulder belts; leather shoulder straps; covers for horse saddles; boxes of vulcanised fibre; garment bags for travel; bridles [harness]; key cases; net bags for shopping; furniture coverings of leather; pads for horse saddles; bags for sports; stirrups; harness fittings; horseshoes; slings for carrying infants; pouch baby carriers; bags; credit card cases [wallets]; business card cases; randsels [Japanese school satchels]; luggage tags; saddlecloths for horses; reins for guiding children.

26 – Shoe fasteners; needles; shoemakers' needles; sewing needles; needles for wool combing machines; binding needles; darning needles; saddlers' needles; knitting needles; fastenings for clothing; ostrich feathers [clothing accessories]; whalebones for corsets; corset busks; hair bands; false beards; hair grips; bobby pins; hat ornaments, not of precious metal; edgings for clothing; lace for edgings; darning lasts; buttons; snap fasteners; expanding bands for holding sleeves; brassards; arm bands [clothing accessories]; fastenings for suspenders; fastenings for braces; brooches [clothing accessories]; embroidery; fancy goods [embroidery]; belt clasps; numerals or letters for marking linen; monogram tabs for marking linen; shoe hooks; shoe laces; shoe ornaments, not of precious metal; shoe eyelets; chenille [passementerie]; decorative articles for the hair; hair curling pins; hair barrettes; hair slides; hair pins; hair nets; false hair; tresses of hair; plaited hair; numerals for marking linen; collar supports; cords for clothing; blouse fasteners; dress body fasteners; sewing boxes; sewing thimbles; crochet hooks; crochet needles; hooks [haberdashery]; zippers; zip fasteners; slide fasteners [zippers]; pin cushions; false hems; festoons [embroidery]; shuttles for making fishing nets; artificial flowers; fringes; artificial fruit; braids; tassels [haberdashery]; trimmings for clothing; arti-

ficial garlands; frills [lacework]; woollen laces; lace trimmings; passementerie; letters for marking linen; haberdashery, except thread; mica spangles; false moustaches; eyelets for clothing; birds' feathers [clothing accessories]; tinsels [trimmings for clothing]; orsedew [trimmings for clothing]; ribbons [haberdashery]; spangles for clothing; needle cushions; wigs; picot [lace]; heat adhesive patches for repairing textile articles; feathers [clothing accessories]; top-knots [pompoms]; skirt flounces; rosettes [haberdashery]; frills for clothing; zippers for bags; zip fasteners for bags; shoe buckles; toupees; bodkins; needle cases; boxes for needles; silver embroidery; gold embroidery; elastic ribbons; cords for rimming, for clothing; buckles [clothing accessories]; hooks for corsets; wreaths of artificial flowers; pins, other than jewellery [jewelry (Am.)]; badges for wear, not of precious metal; heat adhesive patches for decoration of textile articles [haberdashery]; competitors' numbers; ornamental novelty badges [buttons]; bows for the hair; hair coloring caps; hair colouring caps; hook and pile fastening tapes; prize ribbons; shoulder pads for clothing; trouser clips for cyclists; tapes for curtain headings; hair curling papers; rug hooks; beads, other than for making jewelry; beads, other than for making jewellery; bobbins for retaining embroidery floss or wool [not parts of machines]; hair extensions; human hair; hair curlers, other than hand implements; appliques [haberdashery]; artificial plants; sewing kits; entomological pins; embroidery needles.

28 – Bladders of balls for games; artificial fishing bait; caps for pistols [toys]; toys for pets; ring games; Christmas trees of synthetic material; bows for archery; archery implements; edges of skis; swings; balls for games; play balloons; billiard table cushions; rocking horses; batting gloves [accessories for games]; dolls' feeding bottles; stationary exercise bicycles; billiard balls; chalk for billiard cues; billiard markers; skittles; marbles for games; toys; building blocks [toys]; bob-sleighs; explosive bonbons [Christmas crackers]; cosagues [toy fireworks]; skating boots with skates attached; candle holders for Christmas trees; playing balls; bowling apparatus and machinery; boxing gloves; gut for rackets; golf clubs; rods for fishing; kites; kite reels; targets; bells for Christmas trees; counters [discs] for games; building games; strings for rackets; machines for physical exercises; body-building apparatus; body-training apparatus; body rehabilitation apparatus; novelties for parties, dances [party favors, favours]; shin guards [sports articles]; cricket bags; hockey sticks; checkers [games]; draughts [games]; dice; chest expanders [exercisers]; exercisers [expanders]; discusses for sports; dominoes; chess games; chessboards; checkerboards; draughtboards; toy pistols; rollers for stationary exercise bicycles; landing nets for anglers; golf bags, with or without wheels; practical jokes [novelties]; nets for sports; tennis nets; ski

bindings; darts; floats for fishing; foosball tables; harpoon guns [sports articles]; gloves for games; cups for dice; bar-bells; fish hooks; rattles [playthings]; parlor games; parlour games; games; clay pigeon traps; rackets; bats for games; decoys for hunting or fishing; lures for hunting or fishing; fishing tackle; fishing lines; dolls' beds; dolls' houses; puppets; marionettes; dolls; theatrical masks; carnival masks; scale model vehicles; reels for fishing; flippers for swimming; swimming webs [flippers]; creels [fishing traps]; swimming pools [play articles]; artificial snow for Christmas trees; quoits; roller skates; ice skates; seal skins [coverings for skis]; clay pigeons [targets]; surfboards; dolls' clothes; dolls' rooms; conjuring apparatus; skittles [games]; ninepins; gut for fishing; sole coverings for skis; skis; tables for table tennis; spinning tops [toys]; sleds [sports articles]; backgammon games; scooters [toys]; shuttlecocks; toy air pistols; percussion caps [toys]; detonating caps [toys]; ornaments for Christmas trees, except illumination articles and confectionery; Christmas tree stands; billiard cues; billiard cue tips; billiard tables; coin-operated billiard tables; surf skis; sailboards; hang gliders; apparatus for games; appliances for gymnastics; fencing weapons; fencing masks; fencing gauntlets; fencing gloves; baseball gloves; climbers' harness; elbow guards [sports articles]; knee guards [sports articles]; mobiles [toys]; paragliders; protective paddings [parts of sports suits]; skateboards; slides [playthings]; spring boards [sports articles]; teddy bears; waterskis; golf gloves; bite indicators [fishing tackle]; bite sensors [fishing tackle]; board games; fairground ride apparatus; flying discs [toys]; horseshoe games; mah-jong; plush toys; soap bubbles [toys]; toy vehicles; twirling batons; butterfly nets; bags especially designed for skis and surfboards; harness for sailboards; jigsaw puzzles; masts for sailboards; paintball guns [sports apparatus]; paintballs [ammunition for paintball guns] [sports apparatus]; surfboard leashes; tennis ball throwing apparatus; starting blocks for sports; snow globes; weight lifting belts [sports articles]; bodyboards; bingo cards; divot repair tools [golf accessories]; pitch mark repair tools [golf accessories]; hunting game calls; roulette wheels; in-line roller skates; piñatas; punching bags; radio-controlled toy vehicles; rosin used by athletes; snowshoes; sling shots [sports articles]; amusement machines, automatic and coin-operated; kaleidoscopes; playing cards; confetti; electronic targets; scent lures for hunting or fishing; camouflage screens [sports articles]; men's athletic supporters [sports articles]; snowboards; scale model kits [toys]; pachinkos; ascenders [mountaineering equipment]; gaming machines for gambling; slot machines [gaming machines]; paper party hats; swimming kick boards; chips for gambling; scratch cards for playing lottery games; stuffed toys; trampolines; poles for pole vaulting; water wings; swimming belts; swimming jackets; vi-

deo game machines; portable games with liquid crystal displays; arcade video game machines; controllers for game consoles; toy models; toy figures; ball pitching machines; masks [playthings]; matryoshka dolls; controllers for toys; golf bag carts; golf bag trolleys; paddleboards; gyroscopes and flight stabilizers for model aircraft; joysticks for video games; protective films adapted for screens for portable games; drones [toys].

35 – Business management assistance; business inquiries; bill-posting; outdoor advertising; import-export agency services; commercial information agency services; dissemination of advertising matter; photocopying services; employment agency services; office machines and equipment rental; book-keeping; accounting; drawing up of statements of accounts; business auditing; business management and organization consultancy; personnel management consultancy; business management consultancy; typing; demonstration of goods; direct mail advertising; commercial or industrial management assistance; document reproduction; updating of advertising material; distribution of samples; business efficiency expert services; auctioneering; market studies; business appraisals; business investigations; publicity material rental; business organization consultancy; publication of publicity texts; advertising; publicity; radio advertising; business research; public relations; shorthand; television advertising; transcription of communications [office functions]; shop window dressing; publicity agency services; advisory services for business management; modelling for advertising or sales promotion; marketing research; computerized file management; professional business consultancy; economic forecasting; organization of exhibitions for commercial or advertising purposes; business information; opinion polling; payroll preparation; personnel recruitment; relocation services for businesses; rental of advertising space; sales promotion for others; secretarial services; tax preparation; telephone answering for unavailable subscribers; word processing; arranging newspaper subscriptions for others; advertising by mail order; business management of hotels; business management of performing artists; compilation of information into computer databases; systemization of information into computer databases; organization of trade fairs for commercial or advertising purposes; rental of photocopying machines; on-line advertising on a computer network; procurement services for others [purchasing goods and services for other businesses]; data search in computer files for others; rental of advertising time on communication media; news clipping services; rental of vending machines; psychological testing for the selection of personnel; price comparison services; presentation of goods on communication media, for retail purposes; commercial information and advice for consumers [consumer advice shop]; arranging subscriptions to telecommu-

nication services for others; administrative processing of purchase orders; commercial administration of the licensing of the goods and services of others; outsourcing services [business assistance]; invoicing; writing of publicity texts; compilation of statistics; layout services for advertising purposes; sponsorship search; organization of fashion shows for promotional purposes; production of advertising films; business management of sports people; marketing; telemarketing services; retail or wholesale services for pharmaceutical, veterinary and sanitary preparations and medical supplies; rental of sales stands; provision of commercial and business contact information; search engine optimization for sales promotion; search engine optimisation for sales promotion; web site traffic optimization; pay per click advertising; commercial intermediation services; business management for freelance service providers; negotiation and conclusion of commercial transactions for third parties; updating and maintenance of data in computer databases; business project management services for construction projects; providing business information via a web site; provision of an on-line marketplace for buyers and sellers of goods and services; design of advertising materials; outsourced administrative management for companies; tax filing services; business management of reimbursement programs for others; business management of reimbursement programmes for others; rental of billboards [advertising boards]; writing of resumes for others; writing of curriculum vitae for others; web indexing for commercial or advertising purposes; administration of frequent flyer programs; appointment scheduling services [office functions]; appointment reminder services [office functions]; administration of consumer loyalty programs; scriptwriting for advertising purposes.

36 – Accident insurance underwriting; instalment loans; actuarial services; rental of real estate; brokerage; credit bureau services; real estate agency services; real estate brokerage; debt collection agency services; insurance brokerage; financial customs brokerage services; insurance underwriting; banking; real estate appraisal; charitable fund raising; mutual funds; capital investment; surety services; exchanging money; issuance of travelers' checks; issuance of travellers' cheques; clearing, financial; clearing-houses, financial; safe deposit services; organization of collections; loans [financing]; fiscal valuation; financial evaluation [insurance, banking, real estate]; factoring; trusteeship; fiduciary; financing services; financial management; pawnbrokerage; real estate management; apartment house management; fire insurance underwriting; rental of apartments; rental of farms; health insurance underwriting; marine insurance underwriting; mortgage banking; savings bank services; lease-purchase financing; hire-purchase financing; securities brokerage; life insurance

underwriting; accommodation bureau services [apartments]; financial analysis; antique appraisal; art appraisal; check [cheque] verification; financial consultancy; insurance consultancy; processing of credit card payments; processing of debit card payments; electronic funds transfer; financial information; insurance information; jewellery [jewelry (Am.)] appraisal; numismatic appraisal; rent collection; stamp appraisal; issuance of tokens of value; deposits of valuables; stock exchange quotations; issuance of credit cards; rental of offices [real estate]; retirement payment services; financial sponsorship; online banking; business liquidation services, financial; repair costs evaluation [financial appraisal]; brokerage of carbon credits; financial evaluation of standing timber; financial valuation of standing timber; financial evaluation of wool; financial valuation of wool; lending against security; provident fund services; stock brokerage services; debt advisory services; arranging finance for construction projects; providing financial information via a web site; financial management of reimbursement payments for others; investment of funds; stocks and bonds brokerage; providing rebates at participating establishments of others through use of a membership card; bail-bonding.

38 – Radio broadcasting; message sending; television broadcasting; transmission of telegrams; telegraph services; communications by telegrams; telephone services; communications by telephone; telex services; news agency services; cable television broadcasting; communications by cellular phones; communications by computer terminals; computer aided transmission of messages and images; transmission of electronic mail; facsimile transmission; information about telecommunication; paging services [radio, telephone or other means of electronic communication]; rental of message sending apparatus; communications by fibre optic networks; communications by fiber optic networks; rental of facsimile apparatus; rental of modems; rental of telecommunication equipment; rental of telephones; satellite transmission; electronic bulletin board services [telecommunications services]; providing telecommunications connections to a global computer network; telecommunications routing and junction services; teleconferencing services; providing user access to global computer networks; rental of access time to global computer networks; providing telecommunication channels for teleshopping services; providing internet chatrooms; providing access to databases; voice mail services; transmission of greeting cards online; transmission of digital files; wireless broadcasting; videoconferencing services; providing online forums; streaming of data; radio communications; video-on-demand transmission.

40 – Abrasion; processing of cinematographic films; air purification; magnetization; applying finishes to textiles; paper finishing; silver plating; fabric bleac-

hing; woodworking; cloth edging; soldering; dress-making; cadmium plating; permanent-press treatment of fabrics; pottery firing; firing pottery; shoe staining; chromium plating; metal plating; leather staining; fur conditioning; cloth cutting; pattern printing; photographic film development; gilding; water treating; electroplating; tin plating; custom fashioning of fur; blacksmithing; fur mothproofing; millworking; fruit crushing; food smoking; galvanization; engraving; fabric waterproofing; cloth waterproofing; cloth fireproofing; fabric fireproofing; textile fireproofing; crease-resistant treatment for clothing; wool treating; laminating; grinding; metal treating; metal tempering; flour milling; nickel plating; warping [looms]; skin dressing; burnishing by abrasion; bookbinding; planing [saw mill]; saddlery working; sawing [saw mill]; custom tailoring; tanning; taxidermy; dyeing services; textile dyeing; textile treating; cloth treating; textile mothproofing; cloth dyeing; paper treating; glass-blowing; embroidering; leather working; window tinting treatment, being surface coating; food and drink preservation; timber felling and processing; recycling of waste and trash; cloth pre-shrinking; fur glossing; fur staining; fur dyeing; air deodorizing; air freshening; custom assembling of materials for others; framing of works of art; gold plating; laser scribing; material treatment information; optical glass grinding; photographic printing; photogravure; processing of oil; quilting; refining services; slaughtering of animals; stripping finishes; waste treatment [transformation]; clothing alteration; boilermaking; metal casting; vulcanization [material treatment]; services of a dental technician; production of energy; rental of generators; destruction of waste and trash; incineration of waste and trash; colour separation services; key cutting; decontamination of hazardous materials; lithographic printing; printing; knitting machine rental; offset printing; photocomposing services; silkscreen printing; sorting of waste and recyclable material [transformation]; freezing of foods; rental of air conditioning apparatus; rental of space heating apparatus; fulling of cloth; cryopreservation services; sandblasting services; rental of boilers; upcycling [waste recycling]; welding services.

41 – Academies [education]; amusement park services; entertainment services; animal training; rental of cinematographic apparatus; entertainer services; movie studio services; presentation of circus performances; organization of competitions [education or entertainment]; correspondence courses; physical education; rental of show scenery; providing recreation facilities; radio entertainment; publication of texts, other than publicity texts; teaching; educational services; instruction services; rental of sound recordings; rental of motion pictures; film production, other than advertising films; gymnastic instruction; lending library services; publication of books; rental of radio and television sets; production of radio and

television programmes; presentation of variety shows; orchestra services; theatre productions; production of shows; television entertainment; rental of stage scenery; zoological garden services; providing sports facilities; modelling for artists; mobile library services; bookmobile services; providing casino facilities [gambling]; club services [entertainment or education]; arranging and conducting of colloquiums; arranging and conducting of conferences; arranging and conducting of congresses; discotheque services; education information; educational examination; entertainment information; organization of exhibitions for cultural or educational purposes; gambling services; providing golf facilities; health club services [health and fitness training]; holiday camp services [entertainment]; presentation of live performances; cinema presentations; movie theatre presentations; nursery schools; organization of sports competitions; party planning [entertainment]; practical training [demonstration]; providing museum facilities [presentation, exhibitions]; recording studio services; recreation information; rental of skin diving equipment; rental of sports equipment, except vehicles; rental of stadium facilities; rental of video cassette recorders; rental of videotapes; arranging and conducting of seminars; sport camp services; arranging and conducting of symposiums; timing of sports events; boarding school education; arranging and conducting of workshops [training]; arranging of beauty contests; booking of seats for shows; dubbing; religious education; organization of lotteries; organization of balls; organization of shows [impresario services]; providing amusement arcade services; rental of audio equipment; rental of lighting apparatus for theatrical sets or television studios; rental of tennis courts; rental of video cameras; rental of camcorders; scriptwriting, other than for advertising purposes; videotape editing; on-line publication of electronic books and journals; electronic desktop publishing; subtitling; game services provided on-line from a computer network; karaoke services; music composition services; nightclub services [entertainment]; providing on-line electronic publications, not downloadable; photographic reporting; photography; vocational guidance [education or training advice]; news reporters services; translation; sign language interpretation; videotaping; microfilming; ticket agency services [entertainment]; writing of texts; arranging and conducting of concerts; calligraphy services; layout services, other than for advertising purposes; organization of fashion shows for entertainment purposes; coaching [training]; rental of sports grounds; disc jockey services; language interpreter services; personal trainer services [fitness training]; conducting fitness classes; vocational retraining; production of music; toy rental; games equipment rental; services of schools [education]; providing on-line music, not downloadable; providing on-line videos, not downloadable; tutoring; arran-

ging and conducting of in-person educational forums; songwriting; screenplay writing; conducting guided tours.

42 – Chemical analysis; analysis for oil-field exploitation; architectural services; bacteriological research; chemistry services; chemical research; architectural consultancy; construction drafting; technical research; oil-well testing; cosmetic research; design of interior decor; industrial design; packaging design; material testing; conducting technical project studies; geological surveys; oil-field surveys; engineering; meteorological information; land surveying; computer rental; computer programming; physics [research]; mechanical research; textile testing; geological prospecting; geological research; authenticating works of art; calibration [measuring]; computer software design; updating of computer software; consultancy in the design and development of computer hardware; dress designing; graphic arts design; quality control; rental of computer software; research and development of new products for others; styling [industrial design]; underwater exploration; recovery of computer data; maintenance of computer software; computer system analysis; biological research; urban planning; surveying; computer system design; vehicle roadworthiness testing; duplication of computer programs; conversion of data or documents from physical to electronic media; creating and maintaining web sites for others; hosting computer sites [web sites]; installation of computer software; cloud seeding; data conversion of computer programs and data [not physical conversion]; computer software consultancy; rental of web servers; computer virus protection services; consultancy in the field of energy-saving; research in the field of environmental protection; providing search engines for the internet; digitization of documents [scanning]; handwriting analysis [graphology]; provision of scientific information, advice and consultancy in relation to carbon offsetting; quality evaluation of standing timber; quality evaluation of wool; monitoring of computer systems by remote access; water analysis; scientific laboratory services; energy auditing; web site design consultancy; software as a service [SaaS]; information technology [IT] consultancy; scientific research; server hosting; clinical trials; off-site data backup; electronic data storage; providing information on computer technology and programming via a web site; cartography services; cloud computing; outsource service providers in the field of information technology; technological consultancy; computer technology consultancy; telecommunications technology consultancy; weather forecasting; computer security consultancy; technical writing; interior design.

44 – Animal breeding; landscape gardening; public bath services for hygiene purposes; Turkish bath services; beauty salon services; medical clinic services;

chiropractic; hairdressing; wreath making; convalescent home services; hospital services; health care; horticulture; gardening; farming equipment rental; massage; medical assistance; opticians' services; plant nursery services; physical therapy; physiotherapy; sanatorium services; veterinary assistance; dentistry services; nursing home services; aerial and surface spreading of fertilizers and other agricultural chemicals; animal grooming; blood bank services; flower arranging; hospice services; lawn care; manicuring; midwife services; nursing, medical; pharmacy advice; plastic surgery; tree surgery; vermin exterminating for agriculture, horticulture and forestry; weed killing; pet grooming; hair implantation; services of a psychologist; rental of sanitation facilities; aromatherapy services; artificial insemination services; rehabilitation for substance abuse patients; in vitro fertilization services; tattooing; telemedicine services; landscape design; sauna services; solarium services; health spa services; visagists' services; pharmacists' services to make up prescriptions; therapy services; tree planting for carbon offsetting purposes; aquaculture services; medical equipment rental; health center services; health centre services; alternative medicine services; speech therapy services; health counselling; health counseling; depilatory waxing; orthodontic services; medical advice for individuals with disabilities; body piercing; reforestation services; palliative care; rest home services.

45 – Personal body guarding; escorting in society [chaperoning]; chaperoning; detective agency services; dating services; night guard services; opening of security locks; evening dress rental; crematorium services; missing person investigations; burial services; funerary undertaking; clothing rental; guard services; marriage agency services; security consultancy; horoscope casting; fire-fighting; organization of religious meetings; adoption agency services; monitoring of burglar and security alarms; baby sitting; baggage inspection for security purposes; house sitting; pet sitting; personal background investigations; lost property return; mediation; inspection of factories for safety purposes; rental of fire alarms; rental of fire extinguishers; arbitration services; intellectual property consultancy; copyright management; licensing of intellectual property; monitoring intellectual property rights for legal advisory purposes; legal research; litigation services; licensing of computer software [legal services]; registration of domain names [legal services]; alternative dispute resolution services; rental of safes; genealogical research; planning and arranging of wedding ceremonies; online social networking services; releasing doves for special occasions; embalming services; legal document preparation services; tracking of stolen property; legal administration of licences; astrology consultancy; spiritual consultancy; cartomancy services; personal wardrobe styling consultancy; personal letter writing; conducting funeral ceremonies.

(260) AM 2019 95748 A
 (800) 1379908
 (151) 2017 08 15
 (891) 2017 08 15
 (731) "Cahan Tabak" Limited Liability Company
 Aziz Alivev Street 2, Nakhchivan city
 AZ-7000 Nakhchivan Autonomous Republic,
 Azerbaijan

(540)

WANT

(591) Black, white

(531) 27.05.17

(511)

34 – Tobacco; smokers' articles; matches.

(260) AM 2019 96514 A
 (800) 1387847
 (151) 2017 11 24
 (891) 2017 11 24
 (731) MUNDIPHARMA AG
 St. Alban-Rheinweg 74, CH-4020 Basel,
 Switzerland

(540)

BETASEPT

(591) Black, white

(511)

3 – Soaps; perfumery products; essential oils; cosmetics; hair treatments and preparations; hair lotions; toiletry products; sunscreen preparations, including sprays, lotions, creams, gels, oils for sun protection, sun balms and creams for lip care; cosmetic skin-tanning preparations; after-sun products (cosmetics); cosmetic preparations for skin care, including moisturizing treatments, protective creams, tonics for skin care, exfoliants, artificial sun-tanning preparations, degreasing products for use on the skin; cosmetic preparations, including cosmetics for the scalp, hair, skin and nails; wipes and tissues impregnated with cosmetic preparations; towels and wipes impregnated with cleaning preparations, including those for use on the skin.

(260) AM 2019 96849 A
 (800) 731115
 (151) 2000 03 08
 (891) 2018 02 08
 (731) Asclepion Laser Technologies GMBH
 Brüsseler Strasse 10, 07747 Jena, Germany

(540)

ASCLEPION

(591) Black, white

(511)

10 – Surgical, medical, dental and veterinary instruments and apparatus, in particular medical lasers and laser devices, accessories and parts for these devices,

and artificial limbs, eyes and teeth, orthopaedic articles, surgical suture material, included in this class; optical devices for eye examination and treatment with lasers, accessories and parts for these devices, included in this class.

(260) AM 2019 97052 A
 (800) 1394030
 (151) 2018 01 05
 (891) 2018 01 05
 (731) NOVARTIS AG
 CH-4002 Basel, Switzerland

(540)

STREAMLIGHT

(591) Black and white

(511)

41 – Training, namely hosting of seminars in the field of ophthalmology and distribution of course materials relating thereto.

(260) AM 2019 97116 A
 (800) 1395381
 (151) 2017 11 30
 (891) 2017 11 30
 (731) Obshchestvo s organichennoy
 otvetstvennost'yu "NAUCHNO-
 VNEDRENCHESKIY TSENTR
 AGROVETZASHCHITA"
 Igarskiy proyezd, dom 4, stroyeniye 2,
 RU-129329 Moskva, Russian Federation

(540)

ASD

(591) Black, white

(531) 27.05.17; 27.05.23

(511)

5 – Nutritional supplements; mineral food supplements; albumin dietary supplements; dietary supplements for animals; yeast dietary supplements; alginate dietary supplements; glucose dietary supplements; casein dietary supplements; lecithin dietary supplements; propolis dietary supplements; protein dietary supplements; protein supplements for animals; pollen dietary supplements; wheat germ dietary supplements; linseed dietary supplements; enzyme dietary supplements; linseed oil dietary supplements; royal jelly dietary supplements; amino acids for veterinary purposes; antibiotics; germicides; capsules for medicines; candy, medicated; cultures of microorganisms for medical or veterinary use; adhesive plasters; medicines for alleviating constipation; lotions for veterinary purposes; liniments; drugs for medical purposes; medicines for veterinary purposes; medicinal oils; medicinal drinks; fly glue; medicinal infusions; antiparasitic collars for animals;

compresses; anti-uric preparations; bacterial preparations for medical and veterinary use; bacteriological preparations for medical and veterinary use; biological preparations for veterinary purposes; veterinary preparations; vitamin preparations; therapeutic preparations for the bath; preparations for the treatment of burns; opotherapy preparations; pharmaceutical preparations for treating sunburn; sunburn ointments; chemical preparations for medical purposes; chilblain preparations; chemico-pharmaceutical preparations; pharmaceutical preparations for treating dandruff; preparations for destroying noxious animals; larvae exterminating preparations; fly destroying preparations; preparations for destroying mice; vermin destroying preparations; pharmaceutical preparations for skin care; bath preparations for medical purposes; anticryptogamic preparations; preparations of trace elements for human and animal use; sulfonamides [medicines]; pharmaceutical preparations; enzyme preparations for veterinary purposes; chemical preparations for veterinary purposes; chemical preparations for pharmaceutical purposes; vaginal washes for medical purposes; insect repellents; repellents for dogs; insect repellent incense; tissues impregnated with pharmaceutical lotions; milking grease; greases for veterinary purposes; bath salts for medical purposes; anaesthetics; antiseptics; styptic preparations; vermifuges; disinfectants for hygiene purposes; parasiticides; mouthwashes for medical purposes; febrifuges; animal washes [insecticides]; cattle washes [insecticides]; dog washes [insecticides]; remedies for perspiration; antiparasitic preparations; laxatives; tonics [medicines]; digestives for pharmaceutical purposes; vulnerary sponges; sedatives; enzymes for veterinary purposes; cement for animal hooves; elixirs [pharmaceutical preparations]; tobacco extracts [insecticides]; syrups for pharmaceutical purposes; fungicides; analgesics.

(260) AM 2019 97253 A

(800) 1396190

(151) 2017 07 06

(891) 2017 07 06

(731) IVOCLAR VIVADENT AG

Bendererstrasse 2, FL-9494 Schaan,
Liechtenstein

(540)

PrograMill one

(591) Black, white

(511)

5 – Materials for use in dentistry; materials and auxiliary materials for the manufacture of dental impressions, models, crowns, bridges, inlays, prostheses, artificial teeth; materials for the characterization of teeth; materials for polishing teeth; dental waxes, dental filling materials; materials for relining; materials for root canal filling; core build-up

materials for use in dentistry; dental luting materials; materials for pulp protection and root treatment; materials for cavity treatment; materials for dentin wound and pulp treatment; materials used for acid etching and for the caries prophylaxis; dental adhesive agents; protective varnishes for teeth; drying and degreasing materials for the use in dentistry; materials for cosmetic restoration of damaged teeth; diagnostic agents and preparations for medical purposes; dental materials for the bleaching of teeth; dental composites; dental cements; salivary diagnostic preparation; disinfectants; preparations for the hygiene of teeth and oral cavity; medical mouthwash; dental materials for the treatment of caries and periodontitis; color stains for use in dentistry; precious metal alloys and non-precious metal alloys for dental use; precious metals and non-precious metals for dental use; investment materials for dental use; dental adhesives; materials for repairing damaged teeth; opaque materials for dental use; metal primers; fiber-reinforced resin for the manufacture of crowns, bridges, and pontics; fissure sealants; mixing capsules for dental materials; materials for the detection of plaque; dental ceramic material; artificial veneers ingots made of resin, metal, or ceramic for the manufacture of dental crowns, bridges, inlays, prostheses, artificial teeth.

9 – Software for dental use; scanners, apparatus for the processing of images, and devices for CAD-CAM-processing.

10 – Apparatus, devices, tools, and instruments for dental use; impression devices for dental use; registration devices for dental use; articulators for dental use; mixing devices for dental use; blasting devices for dental use; dosing instruments and apparatus for dental use, milling, grinding, and drilling instruments for dental use; artificial teeth; dental plates; dental crowns and bridges; syringes; shade guides; dental matrices; dental strips; apparatus and instruments for the caries prophylaxis and for the treatment of periodontitis; tooth polishing appliances for use by dentists; dental ceramic mixing plates; tooth pins; dental applicators; dental apparatus for milling and parts thereof; prefabricated parts for crowns, bridges, and pontics; milling machines and grinding machines for dental use for the treatment of ceramics, metal and plastic materials, and parts thereof; milling and grinding tools for dental use as machine tools, and parts thereof; holding devices for machine tools and piece holders for milling and grinding machines for dental use.

11 – Dental furnaces.

38 – Providing access to databases.

42 – Cloud computing services.

(260) AM 2019 97254 A

(800) 1396201

(151) 2017 11 07

(891) 2017 11 07

(731) LARKPARK SERVICES INC.

Trident Trust Company (B.V.I.), Trident
Chambers, P.O. Box 146, Road Town,
Tortola, Virgin Islands (British)

(540)



(591) Black, white and yellow

(531) 04.03.09; 23.01; 23.01.01; 23.05; 23.05.05;
23.05.11; 24.01; 24.01.08; 24.01.09; 24.01.17;
25.01; 25.01.06; 29.01; 29.01.13

(511)

9 – Monitors [computer programs]; computer software, recorded; transmitters [telecommunication]; telephone transmitters; transmitters of electronic signals; digital signs; computer game software; computer operating programs, recorded; computer software applications, downloadable; audiovisual teaching apparatus; video recorders; sound reproduction apparatus; downloadable image files; downloadable music files; identity cards, magnetic; encoded magnetic cards; automated teller machines [ATM]; money counting and sorting machines; mechanisms for coin-operated apparatus; magnetic data media; computer programmes [programs], recorded; computer programs [downloadable software]; electronic publications, downloadable; integrated circuit cards [smart cards]; invoicing machines; data processing apparatus; readers [data processing equipment]; chips [integrated circuits]; couplers [data processing equipment]; downloadable ring tones for mobile phones.

35 – Arranging subscriptions to telecommunication services for others; import-export agency services; commercial information agency services; advertising agency services; cost price analysis; rental of advertising space; account auditing; employment agency services; computerized file management; book-keeping; invoicing; demonstration of goods; transcription of communications; opinion polling; market studies; business information; commercial information and advice for consumers [consumer advice shop]; business investigations; business research; marketing research; personnel recruitment; business management and organization consultancy; business organization consultancy; business management consultancy; personnel management consultancy; professional

business consultancy; layout services for advertising purposes; marketing; business management of performing artists; business management of sports people; news clipping services; updating of advertising material; word processing; organization of exhibitions for commercial or advertising purposes; arranging newspaper subscriptions for others; organization of fashion shows for promotional purposes; organization of trade fairs for commercial or advertising purposes; shop window dressing; business appraisals; payroll preparation; data search in computer files for others; sponsorship search; business management assistance; commercial or industrial management assistance; economic forecasting; auctioneering; copywriting in newspapers; promoting the goods and services of others; production of advertising films; office machines and equipment rental; rental of advertising time on communication media; publicity material rental; rental of vending machines; publication of publicity texts; radio advertising; distribution of samples; dissemination of advertising matter; direct mail advertising; writing of publicity texts; advertising; on-line advertising on a computer network; advertising by mail order; television advertising; document reproduction; compilation of statistics; compilation of information into computer databases; business inquiries; systemization of information into computer databases; tax preparation; drawing up of statements of accounts; telemarketing services; psychological testing for the selection of personnel; business management of hotels; commercial administration of the licensing of the goods and services of others; administrative processing of purchase orders; public relations; modelling for advertising or sales promotion; typing; relocation services for businesses; price comparison services; secretarial services; procurement services for others [purchasing goods and services for other businesses]; shorthand; outsourcing services [business assistance]; telephone answering for unavailable subscribers; photocopying services; business efficiency expert services; presentation of goods on communication media, for retail purposes; rental of photocopying machines; bill-posting; advisory services for business management.

36 – Credit bureau services; real estate agency services; financial analysis; rental of apartments; rental of real estate; rental of offices [real estate]; lease-purchase financing; savings bank services; accommodation bureau services [apartments]; rent collection; issuance of travelers' checks; issuance of credit cards; issuance of tokens of value; capital investment; insurance information; financial information; clearing, financial; insurance consultancy; financial consultancy; stock exchange quotations; lending against security; business liquidation services, financial; brokerage; financial management; exchanging money; processing of debit card payments; processing of credit card payments; factoring; organization

of collections; antique appraisal; jewellery [jewelry (Am.)] appraisal; financial evaluation of standing timber; stamp appraisal; real estate appraisal; numismatic appraisal; art appraisal; financial evaluation of wool; financial evaluation [insurance, banking, real estate]; repair costs evaluation [financial appraisal]; electronic funds transfer; surety services; securities brokerage; real estate brokerage; brokerage of carbon credits; insurance brokerage; loans [financing]; pawnbrokerage; check [cheque] verification; charitable fund raising; financial sponsorship; mortgage banking; instalment loans; insurance underwriting; life insurance underwriting; health insurance underwriting; accident insurance underwriting; marine insurance underwriting; fire insurance underwriting; apartment house management; real estate management; actuarial services; banking; retirement payment services; trusteeship; customs brokerage services; mutual funds; financing services; safe deposit services; deposits of valuables; fiscal valuation; debt collection agency services; rental of farms; online banking; provident fund services.

38 – Information about telecommunication; providing user access to global computer networks; video-on-demand transmission; providing online forums; videoconferencing services; rental of access time to global computer networks; radio communications; transmission of electronic mail; streaming of data; news agency services; wireless broadcasting; television broadcasting; cable television broadcasting; electronic bulletin board services [telecommunications services]; providing access to databases; providing telecommunications connections to a global computer network; providing telecommunication channels for teleshopping services; message sending; computer aided transmission of messages and images; transmission of digital files; radio broadcasting; communications by fiber optic networks; communications by cellular phones; communications by computer terminals; satellite transmission; communications by telephone; paging services [radio, telephone or other means of electronic communication]; teleconferencing services; voice mail services; telephone services; telecommunications routing and junction services; providing internet chatrooms; transmission of greeting cards online.

41 – Videotaping; publication of books; recreation information; layout services, other than for advertising purposes; videotape editing; production of radio and television programmes; arranging and conducting of congresses; arranging and conducting of conferences; arranging and conducting of seminars; organization of lotteries; television entertainment; film production, other than advertising films; publication of texts, other than publicity texts; radio entertainment; photography; photographic reporting; providing on-line electronic publications, not down-

loadable; electronic desktop publishing; on-line publication of electronic books and journals.

42 – Computer system analysis; recovery of computer data; computer virus protection services; installation of computer software; research and development of new products for others; web site design consultancy; computer security consultancy; information technology [IT] consultancy; consultancy in the design and development of computer hardware; internet security consultancy; computer software consultancy; data security consultancy; technological consultancy; updating of computer software; monitoring of computer systems to detect breakdowns; monitoring of computer systems for detecting unauthorized access or data breach; monitoring of computer systems by remote access; maintenance of computer software; conversion of data or documents from physical to electronic media; providing information on computer technology and programming via a web site; providing search engines for the internet; computer system design; rental of computer software; computer software design; creating and designing website-based indexes of information for others [information technology services]; creating and maintaining web sites for others; hosting computer sites [web sites]; computer programming; technical writing; copying of computer programs; off-site data backup; computer technology consultancy; telecommunications technology consultancy; electronic data storage; electronic monitoring of credit card activity to detect fraud via the internet; electronic monitoring of personally identifying information to detect identity theft via the internet; software as a service [SaaS]; conversion of computer programs and data, other than physical conversion; server hosting.

45 – Rental of safes; legal research; security consultancy.

(260) AM 2019 97255 A

(800) 1396212

(151) 2017 12 08

(891) 2017 12 08

(731) CHANGLE CHENGXIN JEWELRY CO., LTD.

East of Economic Development Zone, Second

Second Road, Changle County, Shandong, China

(540)

V V S D
唯唯艾斯迪

(591) Black, white

(531) 27.05.01; 28.03

(511)

14 – Watch chains; ingots of precious metals; alloys of precious metal; jewellery boxes; necklaces [jewellery]; precious stones; rings [jewellery]; works of art of precious metal; jade; Jade jewelry.

35 – Sponsorship search; outdoor advertising; presentation of goods on communication media, for retail purposes; business management assistance; commercial administration of the licensing of the goods and services of others; marketing; personnel management consultancy; relocation services for businesses; compilation of information into computer databases; business auditing.

(260) AM 2019 97256 A
 (800) 1396302
 (151) 2017 12 12
 (891) 2017 12 12
 (731) W. L. GORE & ASSOCIATES, INC.
 555 Paper Mill Road; Newark DE 19711,
 USA
 (540)



(591) Black, white
 (531) 26.04.03; 26.04.07; 26.04.18; 27.05.01
 (511)
 9 – Protective clothing, namely, pants, coats, footwear, coveralls, jackets, gloves, mittens, parkas, vests, jumpsuits, rain suits, head wear, glove liners.
 22 – Bivy bags, tents, synthetic fibers for textile use, camouflage covers, nettings and tarpaulins.
 24 – Fabric for the manufacture of outerwear, fabric for the manufacture of protective clothing; fabric for the manufacture of sleeping bags; fabric for the manufacture of bullet proof vests; fabric for the manufacture of clothing; fabric for the manufacture of footwear; fabric for the manufacture of headwear; fabric for the manufacture of tents; sleeping bags.
 25 – Clothing, namely, shirts, singlets, crop tops, jerseys, pants, tights, shorts, knickers, bibs, coats, parkas, vests, footwear, head wear, gloves, mittens, glove inserts, coveralls, jumpsuits, rain suits, arm warmers, leg warmers, knee warmers, neck gaiters, fishing waders, athletic base layers, gaiters, balaclavas, scarfs, jackets, dresses, skirts, skorts, suits, socks, shoe covers, helmet covers, pullovers, uniforms.

(260) AM 2019 97257 A
 (800) 1396304
 (151) 2017 11 30
 (891) 2017 11 30
 (731) RIELLO S.P.A.
 Via Ing. P. Riello, 7; I-37045 Legnago (VR),
 Italy
 (540)

RIELLO

(591) Black, white
 (511)
 7 – Machines and machine tools; motors and engines (except for land vehicles); machine coupling and transmission components (except for land vehicles); agricultural implements other than hand-operated; incubators for eggs; automatic vending machines.
 9 – Temperature controlling apparatus, in particular temperature indicators and thermostats; electronic apparatus for the remote control of signals; electrical couplings; apparatus for regulating and controlling electricity; data processing equipment; remote control apparatus; solar panels for the production of electricity.
 11 – Apparatus for air conditioning; air-conditioning installations; cooking apparatus and installations; water distribution installations; drying apparatus; air dryers; refrigerators; refrigerating appliances and installations; humidifiers; heating apparatus; electric heating apparatus; heating installations; heating boilers; hot water boilers; burners; burners for liquid, gaseous or solid fuels and their metal, electric and pneumatic parts and accessories; kettles; heat exchangers (other than parts of machines); solar thermal collectors (heating); solar panels, panels for capturing solar energy.
 37 – Installation of burners and boilers; installation of apparatus for heating; installation of apparatus for air-conditioning; installation of steam generating apparatus; installation of cooking apparatus; installation of refrigerating apparatus; installation of drying installations; installation of ventilating apparatus for water pipes; installation of sanitary installations; installation of solar panels and collectors; maintenance of burners and boilers; maintenance of heating apparatus; installation of air-conditioning apparatus; maintenance of steam generating apparatus; maintenance of cooking apparatus; maintenance of refrigerating apparatus; maintenance of drying installations; maintenance of ventilating apparatus for water pipes; maintenance of sanitary installations; maintenance of solar panels and collectors; reparation services for others of burners and boilers; reparation services for others of heating apparatus; reparation services for others of air-conditioning apparatus; reparation services for others of steam generating apparatus; reparation services for others of cooking apparatus; reparation services for others of refrigerating apparatus;

reparation services for others of drying installations; reparation services for others of ventilating apparatus for water pipes; reparation services for others of sanitary installations; reparation services for others of solar panels and collectors.

(260) AM 2019 97258 A

(800) 1396326

(151) 2017 12 21

(891) 2017 12 21

(731) Public Joint Stock Company, "SIBUR Holding"

Eastern Industrial Area, building 30, Block 1, No.6, Tobolsk, RU-626150 Tyumen Region, Russian Federation

(540)

T V E R P E T

(591) Turquoise and black

(531) 26.01.01; 26.01.24; 26.07; 26.11.08; 27.05; 27.05.11; 29.01; 29.01.12

(511)

1 – Unprocessed plastics; polymer resins, unprocessed, namely thermoplastic polymers, polyethylene terephthalate, secondary and amorphous polyethylene terephthalate; synthetic resins, unprocessed, namely thermoplastic polymers, polyethylene terephthalate, secondary and amorphous polyethylene terephthalate; polyester-based chemicals.

(260) AM 2019 97259 A

(800) 1396347

(151) 2018 02 09

(891) 2018 02 09

(731) SANOFI

54 rue la Boetie, F-75008 PARIS, France

(540)

SARQLISTA

(591) Black, white

(511)

5 – Pharmaceutical products.

(260) AM 2019 97260 A

(800) 1396367

(151) 2017 09 22

(891) 2017 09 22

(731) LOKUM ATÖLYESİ ŞEKERLEME, GIDA TURİZM İNŞAAT HAYVANCILIK, SANAYİ VE TİCARET ANONİM ŞİRKETİ
Organize Sanayi Bölgesi 1. Cadde 1. Sokak
No:27 Merkez, Afyonkarahisar, Turkey

(540)



(591) Brown, light blue, white

(531) 25.01; 25.01.09; 25.01.10; 25.01.25; 27.05; 27.05.10; 29.01; 29.01.13

(511)

29 – Meat, dried, poultry and game, processed meat products, dried pulses, soups, bouillon, processed olives, olive paste, milks of animal origin, milks of herbal origin, milk products, butter, edible oils, dried, preserved, frozen, cooked, smoked or salted fruits and vegetables, tomato paste, prepared nuts and dried fruits as snacks, hazelnut spreads and peanut butter, tahini (sesame seed paste), eggs and powdered eggs, potato chips.

30 – Coffee, cocoa, coffee or cocoa based beverages, chocolate based beverages, pasta, stuffed dumplings, noodles, pastries and bakery products based on flour, desserts based on flour and chocolate, bread, simit [Turkish ring-shaped bagel covered with sesame seeds], poğaca [Turkish bagel], pita, sandwiches, katmer [Turkish pastry], pies, cakes, baklava [Turkish dessert based on dough coated with syrup], kadayıf [Turkish dessert based on dough], desserts based on dough coated with syrup, puddings, custard, kazandibi [Turkish pudding], rice pudding, keşkül [Turkish pudding], honey, bee glue for human consumption, propolis for food purposes, condiments for foodstuff, vanilla (flavoring), spices, sauces (condiments), tomato sauce, yeast, baking powder, flour, semolina, starch for food, sugar, cube sugar, powdered sugar, tea, ice tea, confectionery, chocolate, biscuits, crackers, wafers, chewing gums, ice-cream, edible ices, salt, cereal-based snack food, popcorn, crushed oats, corn chips, breakfast cereals, processed wheat for human consumption, crushed barley for human consumption, processed oats for human consumption, processed rye for human consumption, rice, molasses for food.

35 – Advertising, marketing and public relations; organization of exhibitions and trade fairs for commercial or advertising purposes, design for advertising, provision of an online marketplace for buyers and sellers of goods and services, office functions, secretarial services, arranging newspaper subscriptions for others, compilation of statistics, rental of office machines, systemization of information into computer databases, telephone answering for unavailable subscribers, business management, business administration and business consultancy, accounting, commercial consultancy services, personnel recruit-

ment, personnel placement, employment agencies, import-export agencies, temporary personnel placement services, auctioneering, the bringing together, for the benefit of others, of a variety of goods, namely, meat, fish, poultry and game, processed meat products, dried pulses, soups, bouillon, processed olives, olive paste, milks of animal origin, milks of herbal origin, milk products, butter, edible oils, dried, preserved, frozen, cooked, smoked or salted fruits and vegetables, tomato paste, prepared nuts and dried fruits as snacks, hazelnut spreads and peanut butter, tahini (sesame seed paste), eggs and powdered eggs, potato chips, coffee, cocoa, coffee or cocoa based beverages, chocolate based beverages, pasta, stuffed dumplings, noodles, pastries and bakery products based on flour, desserts based on flour and chocolate, bread, simit [Turkish ring-shaped bagel covered with sesame seeds], poğaca [Turkish bagel], pita, sandwiches, katmer [Turkish pastry], pies, cakes, baklava [Turkish dessert based on dough coated with syrup], kadayif [Turkish dessert based on dough], desserts based on dough coated with syrup, puddings, custard, kazandibi [Turkish pudding], rice pudding, keşkül [Turkish pudding], honey, bee glue for human consumption, propolis for food purposes, condiments for foodstuff, vanilla (flavoring), spices, sauces (condiments), tomato sauce, yeast, baking powder, flour, semolina, starch for food, sugar, cube sugar, powdered sugar, tea, ice tea, confectionery, chocolate, biscuits, crackers, wafers, chewing gums, ice-cream, edible ices, salt, cereal-based snack food, popcorn, crushed oats, corn chips, breakfast cereals, processed wheat for human consumption, crushed barley for human consumption, processed oats for human consumption, processed rye for human consumption, rice, molasses for food, agricultural and horticultural products, seeds, forestry products, live animals, fertilized eggs for hatching, plants, dried plants for decoration, fresh garden herbs, dried garden herbs for decoration, animal foodstuffs, malt not for human consumption, underlays for pets, cat litters, enabling customers to conveniently view and purchase those goods, such services may be provided by retail stores, wholesale outlets, by means of electronic media or through mail order catalogues.

(260) AM 2019 97261 A

(800) 1396447

(151) 2017 08 22

(891) 2017 08 22

(731) ROCKWOOL International A/S

Hovedgaden 584, DK-2640 Hedehusene,
Denmark

(540)



(591) The mark is in blue and white

(531) 26.04.01; 26.04.05; 26.04.10; 26.04.12;

26.05.04; 29.01.12

(511)

1 – Propagating and growing media for seeds and plants consisting wholly or partial of mineral fibres; fertilized preparations/bases of mineral wool for growing plants; boards of mineral wool for use in growing plants; growing substrates of stone wool fibres, namely, blocks and cubes for propagation; unprocessed artificial resins for use in composite rubber, thermoplastic and thermosetting plastic systems; unprocessed plastics; fire extinguishing compositions; preparations for tempering and soldering; adhesives used in industry; chemical fibres for use in the manufacture of paints, especially for strengthening of coatings and paints.

17 – Insulating materials of mineral wool; packing, stopping and insulating materials; insulants in the form of strips, felt, mats, boards, slatted mats, shaped parts for insulation and sealing against heat, cold, fire, sound, vibrations, air, light and humidity/moisture/damp/vapour, including sound absorbing materials for acoustic regulation; acoustic and thermal insulation products and articles; insulation and vapour barrier products and articles; insulation in the form of floor, wall and roof coverings; ceiling panels of mineral wool fibres, for sound absorbing insulation; mineral wool fibres in the form of matting for insulation; mineral wool/fibres [insulators]; processed mineral fibres for use in the manufacture of seals, sealants, fillers and gaskets; boards of extruded mineral wool, shells of mineral wool, blankets of mineral wool, mineral wool stucco and mineral wool felt, loose or semi-finished granulated mineral wool and loose or semi-finished mineral wool fibres for manufacture of reinforcing and/or filling materials for insulation; insulating mineral wool fibres for use in sealing and gasketing applications in the automotive and building industry; electrical insulating boards; processed mineral fibres for use in friction materials in the automotive industry; insulative mineral wool boards for ventilated constructions, for facade cladding, roofs, soffits and fascias; processed mineral fibres for use in the manufacture of cements and plaster for building purposes; processed mineral fibres for use in the manufacture of asphalt sealants and of sealants for road construction and roofing.

19 – Insulating building materials of mineral wool; wall, floor and ceiling panels, all made of mineral wool and fibres; building materials for road and track constructions and for fencing.

(260) AM 2019 97262 A

(800) 1396482

(151) 2017 12 14

(891) 2017 12 14

(731) TAKEDA PHARMACEUTICAL COMPANY LIMITED

1-1, Doshomachi 4-chome, Chuo-ku,
540-8645 Osaka, Japan

(540)

TAKEDA

(591) Black, white

(511)

5 – Pharmaceutical and veterinary preparations; sanitary preparations for medical purposes; vitamin preparations; food supplements; dietetic food and substances adapted for medical use, food for babies; plasters, materials for dressings; material for stopping teeth, dental wax; disinfectants; preparations for destroying vermin; fungicides, herbicides.

10 – Surgical, medical and veterinary apparatus and instruments; suture materials.

(260) AM 2019 97341 A

(800) 1397371

(151) 2017 03 01

(891) 2017 03 01

(731) MEGA ENDÜSTRİ KONTROL
SİSTEMLERİ, TİCARET LİMİTED
ŞİRKETİ

Yaşamkent Mahallesi, 3207. Cadde, 3204.
Sokak, No:8 Çayyolu Yenimahalle,
ANKARA, Turkey

(540)



(591) In color Torques written down part of the logo "Fuel Loading Automation System Akaryakit Dolum Otomasyon Sistemi", over it in the middle with bigger letters in color grey it is written "Flashtech", and on the right side there is a rectangular figure consist of turquaz, blue and grey

(531) 26.04.09; 27.05.10; 27.05.15; 29.01.13

(511)

9 – Measurement apparatus and equipment including those for scientific, nautical, topographic, meteorologic, industrial and laboratory purposes, thermometers, not for medical purposes, barometers, ammeters, voltmeters, hygrometers, testing apparatus not for medical purposes, telescopes, periscopes, directional compasses, speed indicators, laboratory apparatus, microscopes, magnifying glasses, stills, ovens and furnaces for laboratory experiments; apparatus for recording, transmission or reproduction of sound or images, cameras, photographic cameras, televisi-

on apparatus, video recorders, CD and DVD players and recorders, MP3 players, computers, desktop computers, tablet computers, microphones, loudspeakers, earphones, telecommunications apparatus, apparatus for the reproduction of sound or images, computer peripheral devices, cell phones, covers for cell phones, telephone apparatus, computer printers, scanners [data processing equipment], photocopiers; magnetic and optical data carriers and computer software and programmes recorded thereto, downloadable and recordable electronic publications, encoded magnetic and optical cards; antennas, satellite antennas, amplifiers for antennas, parts of the aforementioned goods; ticket dispensers, automatic teller machines (ATM); electronic components used in the electronic parts of machines and apparatus, semiconductors, electronic circuits, integrated circuits, chips [integrated circuits], diodes, transistors [electronic], magnetic heads for electronic apparatus, electronic locks, photocells, remote control apparatus for opening and closing doors, optical sensors; counters and quantity indicators for measuring the quantity of consumption, automatic time switches; clothing for protection against accidents, irradiation and fire, safety vests and life-saving apparatus and equipment; eyeglasses, sunglasses, optical lenses and cases, containers, parts and components thereof; apparatus and instruments for conducting, transforming, accumulating or controlling electricity, electric plugs, junction boxes [electricity], electric switches, circuit breakers, fuses, lighting ballasts, battery starter cables, electrical circuit boards, electric resistances, electric sockets, transformers [electricity], electrical adapters, battery chargers, electric door bells, electric and electronic cables, batteries, electric accumulators; alarms and anti-theft alarms, other than for vehicles, electric bells; signalling apparatus and instruments, luminous or mechanical signs for traffic use; fire extinguishing apparatus, fire engines, fire hose and fire hose nozzles; radar apparatus, sonars, night vision apparatus and instruments; decorative magnets; metronomes; computer software relating to fuel filling automation system, design services of fuel filling automation systems, maintenance services of fuel filling automation systems.

35 – Advertising, marketing and public relations; organization of exhibitions and trade fairs for commercial or advertising purposes; office functions; secretarial services; arranging newspaper subscriptions for others; compilation of statistics; rental of office machines; systemization of information into computer databases; telephone answering for unavailable subscribers; business management, business administration and business consultancy; accounting; commercial consultancy services; personnel recruitment, personnel placement, employment agencies, import-export agencies; temporary personnel placement services; auctioneering; bringing together, for the benefit of others, of a variety of goods, namely ,

measurement apparatus and equipment including those for scientific, nautical, topographic, meteorologic, industrial and laboratory purposes, thermometers, not for medical purposes, barometers, ammeters, voltmeters, hygrometers, testing apparatus not for medical purposes, telescopes, periscopes, directional compasses, speed indicators, laboratory apparatus, microscopes, magnifying glasses, stills, ovens and furnaces for laboratory experiments, apparatus for recording, transmission or reproduction of sound or images, cameras, photographic cameras, television apparatus, video recorders, CD and DVD players and recorders, mp3 players, computers, desktop computers, tablet computers, microphones, loudspeakers, earphones, telecommunications apparatus, apparatus for the reproduction of sound or images, computer peripheral devices, cell phones, covers for cell phones, telephone apparatus, computer printers, scanners [data processing equipment], photocopiers, magnetic and optic data carriers and computer software and programmes recorded thereto, downloadable and recordable electronic publications, encoded magnetic and optic cards, antennas, satellite antennas, amplifiers for antennas, parts of the aforementioned goods, ticket dispensers, automatic teller machines, electronic components used in the electronic parts of machines and apparatus, semi-conductors, electronic circuits, integrated circuits, chips [integrated circuits], diodes, transistors [electronic], magnetic heads for electronic apparatus, electronic locks, photocells, remote control apparatus for opening and closing doors, optical sensors, counters and quantity indicators for measuring the quantity of consumption, automatic time switches, clothing for protection against accidents, irradiation and fire, safety vests and life-saving apparatus and equipment, eyeglasses, sunglasses, optical lenses and cases, containers, parts and components thereof, apparatus and instruments for conducting, transforming, accumulating or controlling electricity, electric plugs, junction boxes [electricity], electric switches, circuit breakers, fuses, lighting ballasts, battery starter cables, electrical circuit boards, electric resistances, electric sockets, transformers [electricity], electrical adapters, battery chargers, electric door bells, electric and electronic cables, batteries, electric accumulators, alarms and anti-theft alarms, other than for vehicles, electric bells, signalling apparatus and instruments, luminous or mechanical signs for traffic use, fire extinguishing apparatus, fire engines, fire hose and fire hose nozzles, radar apparatus, sonars, night vision apparatus and instruments, decorative magnets, metronomes, fuel filling automation system, design services of fuel filling automation systems, maintenance services of fuel filling automation systems enabling customers to conveniently view and purchase those goods, such services may be provided by retail stores, wholesale outlets, by

means of electronic media or through mail order catalogues.

37 – Construction services, rental of construction machines and equipment; cleaning services for buildings (interior and exterior), public areas, industrial premises; disinfecting, vermin exterminating services, other than for agriculture, rental of cleaning machines and equipment; vehicles service stations for land vehicles, namely maintenance, repair and refueling of land vehicles; vehicles service stations for marine vehicles, namely maintenance, repair and refueling of marine vehicles; repair and maintenance of air vehicles; upholstery, repair and restoration of furniture; installation, maintenance and repair of heating, cooling and sanitary installations; cleaning, care and repair of clothing; installation, maintenance and repair of industrial machines and equipment, office machines and equipment, communication apparatus, electric and electronic appliances; repair and maintenance of lifts; clock and watch repair; mining services and mining extraction; repair of shoes, bags and belts.

(260) AM 2019 97354 A

(800) 341863

(151) 1968 01 12

(891) 2018 03 14

(731) GRUNDFOS HOLDING A/S

Poul Due Jensens Vej 7, DK-8850

Bjerringbro, Denmark

(540)

GRUNDFOS

(591) Black, white

(531) 27.05.17

(511)

7 – Pumps and their parts, including pumps and pump parts for the supply of water for industry, for the circulation of fuel oil, for hydraulic technology and for air compressors, as well as for groundwater pumps and pumps for waters of great depths; pumps for use in heating installations, for water supply and in the production of steam; electric motors and internal combustion engines for the control of pumps; motor pumps; pump accessories, namely, valves (parts of machines) for pumps, regulating, safety, and stopping devices, regulators; valves (parts of machines) responsive to changes in physical conditions for the modification of pressure; machines and machine tools for the aforesaid machines; motors and engines (except for land vehicles), machine couplings, transmission belts; agricultural machinery and utensils of high technology, foundry machine parts; valves (parts of machines), filters (parts of machines and engines) with gas and fuel, oil and dust; machines and auxiliary machines, apparatus

and devices for the cleaning of pipes; hydraulic and pneumatic apparatus for use in automatic control devices and devices; hydraulic self-regulating pumps; electromagnetically controlled valves.

9 – Life-saving apparatus and fire-extinguishing apparatus; non-electric weighing, measuring, signaling and checking apparatus and instruments (inspection); control devices and automatic control devices for use in combination with pumps and pumping systems; non-electric automatic control apparatus for machine tools, non-electric parts of control apparatus, non-electric automatic control apparatus.

10 – Pumps for medical purposes.

11 – Caloric apparatus, water circulation and evaporation apparatus, heating apparatus; machines, apparatus and auxiliary apparatus for the purification of boiler feed water.

(260) AM 2019 97356 A

(800) 1102515

(151) 2011 11 09

(891) 2018 03 05

(731) ROTOFLEX AG

Lebernstrasse 40, CH-2540 Grenchen,
Switzerland

(540)

ROTOFLEX

(591) Black, white

(511)

2 – Paints, ink, lacquers and semi-finished goods thereof (concentrated solutions) for industrial uses, particularly for printing of packaging and films in connection with the food and drinks industry and means of payment (especially banknotes) and other documents for meeting increased security demands; varnishes; colorants; mordants; raw natural resins; excluding metal powders and metal pigments.

42 – Scientific and technological services and research and design services related thereto, and industrial analysis and research services for others, all the above services relating to paints, lacquers and semi-finished goods thereof for industrial uses and for manufacturing of packaging especially in connection with the food and drinks industry and the production of means of payment (especially banknotes) and other documents for meeting increased security demands.

(260) AM 2019 97357 A

(800) 1194241

(151) 2014 01 31

(891) 2018 02 23

(731) TROPENBURG HOLDINGS B.V.

Jonkheer Sixhof 21, NL-1241 CR Kortenhoef,
Netherlands

(540)

BARKLEYS

(591) Black, white

(511)

30 – Coffee, tea, cocoa and artificial coffee; rice; tapioca and sago; flour and preparations made from cereals; bread, pastry and confectionery; ices; sugar; honey, treacle; yeast, baking-powder; salt; mustard; vinegar, sauces (condiments); spices; ice; chocolate; confectionery; sweetmeats [candy].

(260) AM 2019 97359 A

(800) 1234472

(151) 2014 12 18

(891) 2018 02 22

(731) ACINO PHARMA AG

Birsweg 2, CH-4253 Liesberg, Switzerland

(540)

Oxyler

(591) Black, white

(511)

5 – Pharmaceutical and veterinary products, excluding skin care products.

(260) AM 2019 97360 A

(800) 1251547

(151) 2015 04 07

(891) 2017 12 19

(731) ADMIXER LIMITED

Suite 319-3, Threadneedle Street, London
EC2R 8AY, United Kingdom

(540)

ADMIXER

(591) Black, white

(511)

35 – Commercial information agencies; administrative processing of purchase orders; cost price analysis; business auditing; auctioneering; accounting; marketing studies; opinion polling; organization of exhibitions for commercial or advertising purposes; organization of fashion shows for promotional purposes; organization of trade fairs for commercial or advertising purposes; payroll preparation; demonstration of goods; business research; business information; business appraisals; business investigations; business inquiries; business management assistance; commercial or industrial management assistance; advisory services for business management; marketing research; economic forecasting; business efficiency expert services; transcription of communications [office functions]; compilation of information into computer databases; compilation of statistics; import-export agencies; invoicing; on-line advertising on a computer network; computerized file management; business management of performing artists; business management of hotels; business management for

freelance service providers; business management of sports people; commercial information and advice for consumers [consumer advice shop]; commercial administration of the licensing of the goods and services of others; personnel recruitment; business management consultancy; business organization consultancy; personnel management consultancy; layout services for advertising purposes; marketing; typing; document reproduction; providing business information via a web site; provision of commercial and business contact information; rental of advertising space; office machines and equipment rental; publicity material rental; rental of vending machines; rental of sales stands; rental of photocopying machines; rental of advertising time on communication media; writing of publicity texts; word processing; updating and maintenance of data in computer databases; updating of advertising material; web site traffic optimization; shop window dressing; arranging newspaper subscriptions for others; arranging subscriptions to telecommunication services for others; business management and organization consultancy; price comparison services; procurement services for others [purchasing goods and services for other businesses]; outsourcing services [business assistance]; modelling for advertising or sales promotion; secretarial services; shorthand; telephone answering for unavailable subscribers; business project management services for construction projects; public relations; commercial intermediation services; news clipping services; relocation services for businesses; retail or wholesale services for pharmaceutical, veterinary and sanitary preparations and medical supplies; photocopying services; sponsorship search; search engine optimization; presentation of goods on communication media, for retail purposes; psychological testing for the selection of personnel; publication of publicity texts; radio advertising; advertising by mail order; advertising agencies; advertising; pay per click advertising; bill-posting; distribution of samples; dissemination of advertising matter; direct mail advertising; drawing up of statements of accounts; tax preparation; employment agencies; sales promotion for others; production of advertising films; television advertising; telemarketing services; negotiation and conclusion of commercial transactions for third parties; systemization of information into computer databases; professional business consultancy; data search in computer files for others.

42 – Analysis for oil-field exploitation; water analysis; computer system analysis; handwriting analysis [graphology]; architectural consultation; construction drafting; technical project studies; material testing; oil-well testing; textile testing; recovery of computer data; authenticating works of art; geological surveys; geological prospecting; design of interior decor; packaging design; off-site data backup; bacteriological research; biological research; geological research; cosmetic research; mechanical rese-

arch; technical research; physics [research]; chemical research; research in the field of environmental protection; duplication of computer programs; oil-field surveys; electronic data storage; energy auditing; cloud seeding; engineering; installation of computer software; calibration [measuring]; cartography services; clinical trials; computer programming; conversion of data or documents from physical to electronic media; data conversion of computer programs and data [not physical conversion]; web site design consultancy; consultancy in the field of energy-saving; information technology [IT] consultancy; computer software consultancy; consultancy in the design and development of computer hardware; meteorological information; dress designing; monitoring of computer systems by remote access; providing information on computer technology and programming via a web site; provision of scientific information, advice and consultancy in relation to carbon offsetting; providing search engines for the Internet; rental of web servers; computer rental; rental of computer software; scientific research; surveying; maintenance of computer software; updating of computer software; digitization of documents [scanning]; quality evaluation of wool; quality evaluation of standing timber; vehicle roadworthiness testing; quality control; underwater exploration; urban planning; computer virus protection services; scientific laboratory services; chemistry services; server hosting; architecture; research and development of new products for others; software as a service [SaaS]; computer system design; industrial design; oil prospecting; hosting computer sites [web sites]; computer software design; creating and maintaining web sites for others; land surveying; chemical analysis; cloud computing; styling [industrial design]; graphic arts design.

(260) AM 2019 97361 A

(800) 1370999

(151) 2017 04 21

(891) 2018 03 27

(731) CERAMICAS GALA, S. A.

Ctra. de Madrid-Irún, Km. 244, Apdo. 293,
E-09080 Burgos, Spain

(540)



(591) Light blue

(531) 27.05.17; 29.01.04

(511)

11 – Sanitary apparatus and installations; faucets; steam facial apparatus (saunas); bathtubs; whirlpools; portable Turkish bath cabinets; hand-drying apparatus for washrooms.

19 – Tiles, not of metal; non-metallic floors; wall tiles, not of metal, for covering walls; wall linings, not of metal, for building.

20 – Furniture exclusively for bathrooms.

21 – Soap holders; sponge holders; brush holders; coasters, not made of paper and other than table linen; soap dishes; soap dispensers; toilet brushes; toilet-paper-roll stands; towel holders (made of non-precious metals); ceramic products for household purposes.

(260) AM 2019 97362 A

(800) 1390083

(151) 2017 12 12

(891) 2018 03 28

(731) DAVIDOFF & CIE SA

Rue de Rive 2; CH-1200 Genève, Switzerland

(540)

DAVIDOFF REACH

(591) Black, white

(511)

34 – Tobacco, raw or manufactured; tobacco products; tobacco substitutes, for non-medicinal and non-curative use; cigarettes; electronic cigarettes; liquids for electronic cigarettes; smokers' articles, cigarette lighters; ashtrays; matches.

(260) AM 2019 97486 A

(800) 1397602

(151) 2018 01 09

(891) 2018 01 09

(731) Aktsionernoe obshchestvo Promyshlennaya

Gruppa "SPEKTR-AVTO"

Yaroslavskoe sh., 1A, g. Pushkino,

Pushkinskij r-n, RU-141200 Moskovskaya

oblast', Russian Federation

(540)



(591) Black, white

(531) 27.05.02

(511)

1 – Anti-knock substances for internal combustion engines; antifreeze; acetates [chemicals]; acetone; water-softening preparations; surface-active chemical agents; chemicals for the manufacture of paints; distilled water; acidulated water for recharging accumulators; glycerine for industrial purposes; oil dispersants; petroleum dispersants; detergent additives to gasoline [petrol]; chemical additives for oils; additives, chemical, to motor fuel; fluids for hydraulic circuits; liquids for removing sulfates from accumulators; power steering fluid; brake fluid; transmission

fluid; cement for pneumatic tires [tyres]; oil cement [putty]; filtering materials [unprocessed plastics]; filtering materials [mineral substances]; filtering materials [chemical preparations]; anti-boil preparations for engine coolants; solvents for varnishes; anti-frothing solutions for accumulators; water-purifying chemicals; oil-purifying chemicals; industrial chemicals; coolants for vehicle engines; fissionable chemical elements; glycol ether; ethers; benzene; benzol; xylene; xylol.

3 – Abrasives; descaling preparations for household purposes; polishing wax; windshield cleaning liquids; oils for cleaning purposes; soap; color-removing preparations; polishing preparations; refurbishing preparations; dry-cleaning preparations; paint stripping preparations; rust removing preparations; cleaning preparations; laundry preparations; shining preparations [polish]; ammonia [volatile alkali] [detergent]; detergents, other than for use in manufacturing operations and for medical purposes; cloths impregnated with a detergent for cleaning.

4 – Benzine; petroleum jelly for industrial purposes; cutting fluids; grease for leather; tallow; industrial grease; mazut; oils for paints; lubricating oil; industrial oil; motor oil; sunflower oil for industrial purposes; lubricants; naphtha; petroleum, raw or refined; dust removing preparations; non-slipping preparations for belts; lubricating grease; grease for belts; vaporized fuel mixtures; dust absorbing compositions; dust binding compositions for sweeping; dust laying compositions; alcohol [fuel]; diesel oil; mineral fuel; carburants; fuel with an alcoholic base; petrol; methylated spirit.

(260) AM 2019 97488 A

(800) 1397636

(151) 2017 10 05

(891) 2017 10 05

(731) KLAUS FABER AG

Lebacher Straße 152-156, 66113 Saarbrücken, Germany

(540)

FABER KABEL

(591) Black, white

(511)

6 – Unprocessed and semi-processed materials of metal; pipes, tubes and hoses, and fittings therefor, including valves, of metal; metal shafts for access to cables; metallic shafts for cable distribution; trunking [channels] of metal for electric cables; cable ducts made of metal [other than electricity]; clips of metal for cables and pipes; non-electric cables and wires of metal and chains of metal; reels of metal [non-mechanical] for storing cables; cable stretchers; cable supports made of metal; binding screws of metal for cables; cable straps of metal; metal hardware; ducts of metal for ventilating and air condi-

tioning installations; ducts made of metal for trunking conduits for gases.

9 – Cable harnesses; cable modems; cable connectors; cable adapters; cable detectors; cables for transmitting and receiving cable television signals; electric cables for the transmission of sounds and images; cable television converters; USB cables; luminous USB cables; telecommunications cables; data transmission cables; USB cables for cellphones; data synchronization cables; electric cables and wires; mobile High-Definition Link (MHL) cables; threaded electrical cable connectors; electric wiring harnesses; conductor bars; ducting for electric cables; cable channels (electric-); cable covers [conduits]; wire connectors [electricity]; electrical connecting cables; insulated electrical cables; heat resistant electric wires; thermocouple cables; cable junctions for electric cables; insulated cable for electrical installations; male connectors for electrical cables; connections for electric cables; threaded cable connectors of metal; identification threads for electric wires; cables for electrical signal transmission; joint boxes for housing cable joints; materials for electricity mains [wires, cables]; cable locators; power wires; current plugs; electricity conduits; power adapters; power distributors [electrical]; current-meters; apparatus and instruments for accumulating electricity; power line conditioners; power line protectors; apparatus and instruments for conducting electricity; ducts [electricity]; line drivers; electromagnetic conduits; ducts [electricity]; conduit couplings [electric]; metal ducts [electric]; cables, electric; wires, electric; interface cables [electric]; electrical power extension cords; mounting cords [electrical]; insulated electrical cables; rubber covered electrical wires; heat resistant electric wires; connections for electric cables; junction boxes for electric wires; sheaths for electrical wires; circuits for heavy current; aerial cables for heavy currents.

35 – Retail and wholesale services relating to cables, wires and other electrical goods, in particular copper ropes, including via the Internet; information on commercial matters, including via the Internet, cable network or other forms of data transmission; electronic processing of orders; advertising, marketing and sales promotion; business management; market research and market analyses; online advertising; online ordering services; compilation of online business directories.

39 – Electricity distribution via cables; supply of electricity; leasing the use of power lines to third parties for the transmission of electricity; electricity distribution via cables; storage of electrical equipment; packaging and storage of goods; transportation and storage; storage and delivery of goods; parcel receipt services; storage of packages; storage of cargo; distribution of oil and gas by pipeline and cable.

40 – Metal fabrication and finishing services; custom manufacture of metal hardware; custom manufacture of elastomeric components; custom manufacture of thermoplastic components; custom manufacture of semiconductor components, devices and circuits; coppersmithing; rental of assembly machine equipment; custom assembling of materials for others; heat treatment of pipes and tubes made of metal; exterior and interior plating of pipes and tubes made of metal; photogravure printing; custom manufacture of rubber stamps; processing of rubber.

(260) AM 2019 97500 A

(800) 1397996

(151) 2017 10 11

(891) 2017 10 11

(731) ELEKTA AB (PUBL)

Birger Jarlsgatan 53, SE-103 93 Stockholm, Sweden

(540)



(591) Blue and turquoise.

(531) 26.01.01; 26.01.05; 26.01.06; 26.01.24; 29.01.12

(511)

9 – Computer software for use with medical treatment as well as with planning or simulation of medical treatment; computer software for handling, displaying, transmitting and transfer of patient data, information and medical images; computer software for the generation, capture, analysis and display of medical images including X-rays, Magnetic Resonance (MR) images; Computed Tomography (CT) images, cone beam computed tomography (CBCT) images, ultrasound images, positron emission tomography images, single-photon emission computed tomography (SPECT) images; computer software for dose and fluence maps calculation and display for radiotherapy treatment; computer software for manipulation of medical systems and devices; imaging software; data analytics software; linear accelerator management and control software; MRI management and control software and analytics software; medical database software; treatment planning and workflow software; software for cloud based services, data analytics and informatics; software for remote access allowing wireless connectivity; software for measuring and analyzing radiation dose delivery in radiosurgery and radiotherapy equipment; quality assurance software; calibration software; software and computerized systems for management of clinical information and patient data, treatment delivery, patient record archiving and clinical charting; data and databases all recorded electronically, magnetically or optically; user, training and

instruction manuals for the aforesaid goods, all provided in electronic form or downloadable from a computer network or the Internet; electronic publications; remote software applications; software for quality assurance and calibration measurements in medical and surgical equipment; computer software and hardware for use with image guided radiation therapy device for use in medicine.

10 – Medical and surgical apparatus and instruments; apparatus and instruments for use with medical analysis for identification, planning as well as implementing of treatment against cancer, benign diseases or neurological disorders using radiation; radiosurgery and radiotherapy equipment, apparatus and instruments; image guided radiation therapy device for use in medicine; MRI diagnostic apparatus; instruments and image guidance systems for stereotactic surgery; stereotactic radio surgery equipment; fixtures and restraints for use in stereotactic surgery; medical equipment and instruments for non-invasive measurement of brain activity; test apparatus for medical purposes; radiology apparatus for medical purposes; apparatus for physiotherapy; collimators for medical purposes; fixation apparatus for fixing limbs during measuring and treatment; brachytherapy treatment delivery systems, after-loaders, applicators and seed delivery apparatus and fittings; magnetic resonance imaging equipment and apparatus; medical and radiographic linear accelerators; radiation beam collimation apparatus for radiotherapy; magnetoencephalography imaging equipment; radiographic and X-ray equipment; X-ray tubes; X-ray imaging tubes for radiation technology; radiation delivery devices; X-ray image intensifiers; accelerators for charged particles for therapeutic purposes; ultrasonic scanners; medical imaging apparatus for the creation or transmission of images, video or data relating to a medical treatment for diagnostic or clinical use; surgery, therapy, medical treatment and operating tables, beds and couches; special furniture for medical use; patient positioning systems, tools and manipulating apparatus and fixings; patient restraints; imaging and treatment simulation apparatus for treatment planning and simulation; medical imaging equipment; X-ray radiographic and fluoroscopic imaging systems, receivers and transmitter panels; parts and fittings for all the aforesaid goods.

41 – Medical education and user training; vocational guidance (non-business) in the field of medical, therapeutic, radiosurgical and radiotherapy techniques, appliances, apparatus and equipment; education and training on the use of image guided radiotherapy and image modulated radiation therapy, oncology, oncology information systems, stereotactic systems, brachytherapy equipment and solutions, software and planning tools; education and training on medical imaging techniques, apparatus and analysis; arranging and conducting of conferences, congresses and

seminars relating to the design, use, test of medical and surgical apparatus and software for the medical treatment of cancer; education and training services for radiotherapy apparatus use, dosimetry planning and dose delivery in radiotherapy equipment.

42 – Design and development of computer hardware and software; computer programming; updating of computer software; remote software and data hosting services; cloud computing; electronic data storage and off site data back-up; design and development of medical equipment; installation, maintenance and repair of software for computer systems; computer software technical support services; consultation services relating to computer software; medical software planning and installation services; treatment room design and planning services for medical and radiotherapy delivery systems; software as a service for use in medical treatment as well as with planning or simulation of medical treatment; software as a service for handling, displaying and transfer of patient data, information and images; software as service for collecting analyzing and displaying medical images; software as a service for medical analytics and infomatics.

(260) AM 2019 97509 A

(800) 1398138

(151) 2018 02 28

(891) 2018 02 28

(731) HAGLEITNER HYGIENE
INTERNATIONAL GMBH

Lunastr. 5, A-5751 Maishofen, Austria

(540)

ECOSOL

(591) Black, white

(511)

3 – Cosmetics; perfumery; cosmetics; hand and body cream; essential oils; scented oils; refurbishing preparations; refurbishing preparations; grease-removing preparations; dishwashing detergents; shining preparations [polish]; soaps; grinding preparations; abrasive soaps; soaps containing particles for mechanical cleaning; hand soaps; soaps in liquid form and foaming soaps; bubble bath; shower gels; household fragrances; room fragrancing preparations; scale-removing preparations, in particular for descaling of dishwashing, glass-washing and coffee machines; none of the aforesaid goods being for cleaning laundry.

(260) AM 2019 97510 A

(800) 1108183

(151) 2012 01 13

(891) 2018 02 27

(731) TÊXTIL CÃES DE PEDRA, S.A.

Rua Belmiro de Oliveria, S. Lourenço de
Selho, P-4800-134 GUIMARÃES, Portugal

(540)

LION OF PORCHES

(591) Black, white

(511)

25 – Clothing, footwear, headgear.

(260) AM 2019 97512 A

(800) 1260120

(151) 2015 06 08

(891) 2018 03 30

(731) FUJIREBIO INC.

1-1, Nishishinjuku 2-chome, Shinjuku-ku,

Tokyo 163-0410, Japan

(540)

FUJIREBIO

(591) Black, white

(531) 27.05.17

(511)

5 – Diagnostic reagents and preparations for clinical
and medical purposes.10 – Immunological diagnostic apparatus for medi-
cal purposes.

(260) AM 2019 97520 A

(800) 1398264

(151) 2017 11 08

(891) 2017 11 08

(731) CAMBRIDGE CHOCOLATE
TECHNOLOGIES POLSKA SPÓŁKA
AKCYJNASłomińskiego 15/509, PL-00-195 Warszawa,
Poland

(540)

**FOUNT**

(591) Brown, dark blue and claret

(531) 01.15.15; 01.15.23; 01.15.24; 27.05.01;
29.01.13

(511)

30 – Foods such as chocolate; chocolate-based beve-
rages; chocolate-based spreads; confectionery; cho-
colate sweets; non-medicated chocolate; mousse
confections; chocolate for toppings; candy; chocola-
te candies; sweets (non-medicated -) in the nature of
sugar confectionery; sugarless sweets; non-medica-
ted candy; non-medicated confectionery for use aspart of a calorie controlled diet; fondants; toffee;
chocolate bars; caramels [candy]; pralines; rice ca-
kes; high-protein cereal bars.

(260) AM 2019 97521 A

(800) 1398299

(151) 2017 11 15

(891) 2017 11 15

(731) "KONTI-RUS" JOINT STOCK COMPANY

ul. Zolotaia, 13, RU-305000 Kursk, Russian
Federation

(540)



(591) Black, white

(531) 05.03.14; 08.01.10; 26.11.13; 27.05.07; 28.05

(526) Picture of the pastry product

(511)

30 – Cakes; pastries; crackers; cookies; biscuits; pe-
tit-beurre biscuits.

(260) AM 2019 97523 A

(800) 1398376

(151) 2018 01 26

(891) 2018 01 26

(731) SOCIETE EUROPEENNE DE
CARDIOLOGIE2035 route des Colles, F-06903 SOPHIA
ANTIPOLIS, France

(540)

**ESC**European Society
of Cardiology

(591) Black and dark red

(531) 02.09.01; 27.05.23; 29.01.12

(511)

35 – Rental of advertising time on communication
media; design of advertising materials; rental of ad-
vertising material; presentation of goods on all co-
munication media, for retail sale; dissemination of
samples; public relations; document reproduction;
compilation of information into computer databases;
advertising; rental of advertising space; organization
of exhibitions for commercial or advertising purpo-
ses; publication of advertising texts; arranging news-
paper subscriptions for others; dissemination of
advertisements; arranging subscriptions to teleco-
munication services for others; rental of adverti-

sing panels; online advertising on a computer network.

38 – Videoconferencing services; communications by fiber-optic networks; information on telecommunications; cellular telephone communication services; communications by computer terminals; provision of user access to global computer networks; telephone communications; provision of access to databases; news or information agencies; connection by telecommunications to a global computer network; electronic messaging services; rental of telecommunication apparatus; television broadcasting; radio broadcasting; provision of on-line forums; rental of access time to global computer networks; electronic bulletin board services (telecommunication services); telecommunications; radio communications; teleconferencing services.

41 – Publication of books; organization of exhibitions for cultural or educational purposes; rental of videotapes; organization and conducting of seminars; organization and conducting of symposiums; videotape editing; rental of video cassette recorders; education; publication of texts other than advertising texts; organization and conducting of colloquiums, conferences or congresses; online publication of specialized electronic books and journals; training; rental of radio and television sets; videotape film production; electronic desktop publishing; rental of motion pictures; book lending; organization and conducting of non-virtual educational forums; organization and conducting of training workshops; sporting and cultural activities; organization of competitions (education or entertainment); vocational retraining; game services provided on-line from a computer network; information relating to education; rental of sound recordings; entertainment; electronic publication of books and journals online; editing of publications; publication of educational printed matter; editing of medical publications; editing of electronic publications; online publication services; provision of non-downloadable electronic publications; editing of periodical and non-periodical publications, other than advertising texts; publications accessible via a global computer network or the Internet.

42 – Technical project study; software development; software as a service (SaaS); rental of computer software; information technology (IT) consultancy; electronic data storage; digitization of documents; computer system design; scientific research; research and development of new products for others; maintenance of computer software; services provided by engineers and scientists conducting assessments, estimates, research and reports in the field of science and technology; scientific research services for medical purposes; programming for computers.

(260) AM 2019 97524 A

(800) 1398399

(151) 2017 09 08

(891) 2017 09 08

(731) JACOB COHEN COMPANY S.P.A.

Via Vittor Pisani, 20, Milano, Italy

(540)



(591) Black, white

(531) 27.05.12; 27.05.21

(511)

4 – Candles; perfumed candles; tealight candles; table candles; wicks for lighting; Christmas tree candles; Christmas tree decorations for illumination [candles]; candles for lighting; aromatherapy fragrance candles; nightlights [candles]; wicks for candles; candles for absorbing smoke; floating candles; beeswax; candles containing insect repellent; aromatic candles; scented candles; tallow; light oils; lamp wicks; illuminating grease; wood spills for lighting; illuminating wax; electrical energy; grease for shoes; moistening oil; dust removing preparations; biofuels; non-chemical additives for fuels; industrial grease; industrial wax; cutting fluids; oil for the preservation of masonry; oil for the preservation of leather; industrial oils and greases; lubricants; dust absorbing, wetting and binding compositions; fuels [including motor spirit] and illuminants; candles and wicks for lighting.

25 – Clothing for children; jeans; denims; denim clothing; denim jackets; denim coats; formal wear; suits; women's suits; men's suits; clothing of leather; clothing of imitations of leather; leisure wear; clothing for sports; combinations [clothing]; shirts; shirts for wear with suits; blouses; short-sleeve shirts; t-shirts; skirts; trousers; leggings [leg warmers]; shorts; hosiery; knitwear [clothing]; sports jerseys; maillots [hosiery]; sweaters; pullovers; sweatshirts; hooded sweatshirts; waistcoats; fleece vests; quilted vests; jackets [clothing]; suit jackets; wind-resistant jackets; coats; weatherproof clothing; underwear; bathing suits; underpants; panties, shorts and briefs; stockings; socks; neckties; ascots; neck scarfs [mufflers]; foulards [clothing articles]; belts [clothing]; leather belts [clothing]; textile belts [clothing]; money belts [clothing]; gloves and gloves made of skin, hide or fur [clothing]; footwear for men and women; leisure shoes; boots and shoes; dress shoes; leather shoes; beach shoes; sneakers; sports shoes; pumps [footwear]; sandals; fittings of metal for footwear; shoe uppers; insoles; tips for footwear; welts for footwear; hats; small hats; berets; visors [headwear]; cyclists' jerseys; golf shirts; athletic uni-

forms; furs [clothing]; overcoats; anoraks; raincoats; skiwear; tights; brassieres; singlets; corsets; petticoats; suspenders; nightgowns; pyjamas; dressing gowns; bath robes; bathing caps; gloves [clothing]; muffs [clothing]; cardigans; jerseys; neckerchiefs; scarves; jackets; jerkins; vests; jumpers; track suits; pants; panties; dresses; pareus; babies' pants [clothing]; dance costumes; balaclavas; headbands [clothing]; earbands [clothing]; ear muffs [clothing]; belts for clothing; sashes [clothing]; overshoes; soles for footwear; cycling shoes; shoes; gymnastic shoes; ski boots; boots; slippers; hoods [clothing]; caps; clothing, footwear, headgear.

(260) AM 2019 97530 A

(800) 1398657

(151) 2017 06 14

(891) 2017 06 14

(731) CODAN HOLDING GMBH

Stig Husted-Andersen Straße 11, 23738
Lensahn, Germany

(540)

CODAN

(591) Black, white

(511)

10 – Protective clothing for medical purposes; gloves for medical purposes; medical gowns; masks for use by medical personnel; protective clothing for medical purposes; suture and wound closing materials and products, except dressings for medical or surgical purposes; surgical tubing for wound drainage; surgical and wound treating equipment, except dressings for medical or surgical purposes; medical and veterinary apparatus and instruments, except dressings for medical or surgical purposes, especially apparatus and instruments for Infusion, transfusion, drawing blood, measuring blood pressure, providing enteral and oral nutrition, and for surgical procedures particularly in the fields of urology, incontinence, neonatology and pediatrics; medical apparatus and instruments, namely, infusion sets, transfusion sets, extension tube lines and manifold connectors for the delivery of fluids for medical purposes, intravenous (IV) filters and filter systems, catheters, medical valves, infusion spikes, infusion lines, drip chambers, special sets for preparation and administration of total intravenous anesthesia (TIVA), special sets for preparation and administration of cytotoxic drugs, cannulas, syringes [sold empty], invasive blood pressure monitoring systems, infusion pumps, syringe pumps, withdrawal sets for withdrawal of blood, manifold connectors for the delivery of fluids for medical purposes, intravenous (IV) filters and filter systems, preparation sets for preparation of drugs (terms too vague in the opinion of the International Bureau – Rule 13 (2) (b) of the Common Regulations), infusion needles, bags and containers for disposing of contaminated cleaning

materials and spilled hazardous drugs, workplace covers used on table and counter surfaces to absorb spills during the preparation of dangerous drugs, administration sets for administration of drugs and liquids (terms too vague in the opinion of the International Bureau – Rule 13 (2) (b) of the Common Regulations); protective sleeves for medical purposes, coveralls for medical purposes, workplace covers used on table and counter surfaces to absorb spills during the preparation of potentially dangerous drugs, spill sets for protection against accidents with spilled hazardous drugs such as cytotoxic drugs, containing for example caution tape, wipes, sponges, containers for disposing of cytostatic drugs, wipes, sponges, protective clothing and/or protective breathing masks for medical purposes.

(260) AM 2019 97531 A

(800) 1398729

(151) 2017 12 07

(891) 2017 12 07

(731) HALITLAR GIDA SAĞLIK ÜRÜNLERİ
SANAYİ VE TİCARET LİMİTED ŞİRKETİ
4. Organize Sanayi Bölgesi 83414 Nolu,
Cadde No:55 Şehitkamil, Gaziantep, Turkey

(540)

BUMBLE

(591) Blue

(531) 27.05.03; 29.01.04

(511)

3 – Perfumery; cosmetics; fragrances; deodorants for personal use and animals.

5 – Sanitary preparations for medical use; hygienic pads; hygienic tampons; plasters; materials for dressings; diapers, including those made of paper and textiles.

(260) AM 2019 97533 A

(800) 1398736

(151) 2017 12 26

(891) 2017 12 26

(731) S.L.E. Services aux Loteries en Europe,
Société coopérative à responsabilité limitée
Avenue Herrmann Debroux 44-46, B-1160
Bruxelles, Belgium

(540)



(591) Red and gold

(531) 01.13.01; 26.15.01; 27.05.02; 29.01; 29.01.13
(511)

41 – Teaching and training, education and entertainment services; sporting and cultural activities; correspondence courses; editing and publication of illustrations, books, reviews, newspapers, periodicals, magazines, publications of all kinds and in all forms (other than for advertising purposes), including electronic and digital publications (other than advertising) of sound and/or visual media, multimedia carriers, (interactive discs, digital-audio CD-ROMs), multimedia programs (computer formatting of text and/or images, still or animated), games; editing of radio and television programs, audiovisual and multimedia programs (computer editing of texts and/or images, still or animated, and/or of musical or non-musical sounds), for interactive use or non-interactive use; production of news programs, of radio and television entertainment, of audiovisual and multimedia programs (computer editing of texts and/or of still or animated images, and/or of musical or non-musical sounds) for interactive or non-interactive use; organization of shows; artistic production and rental of films and cassettes including video cassettes, and more generally all sound and/or visual media and multimedia carriers (interactive disks, digital-audio CD-ROMs); leisure services, namely arranging leisure events (entertainment); editing of videotapes, photographic reporting services; script-writing services; sound recording service (recording studio) and image recording service (filming); organization of competitions relating to education or entertainment; organization and conducting of colloquiums, conferences and congresses; organization of exhibitions for cultural or educational purposes; organization of lotteries and other games of chance, gambling and prediction games, raffles, prize draws, scratch card games, betting games, prediction games; book lending; film production; rental of films, phonographic recordings, cinema projection apparatus and accessories, theater sets.

(260) AM 2019 97534 A

(800) 1398749

(151) 2016 11 14

(891) 2016 11 14

(731) FUSHENG SHOES CO. LTD., SHISHI
FUJIAN
Changfu Gongyequ, Shishi, 362700 Fujian,
China

(540)

mulinsen
木林森

(591) Black, white

(531) 28.03

(511)

25 – Shoes; leather shoes; casual shoes; footwear; boots; clothing; neckties; belts (clothing); clothing of leather; hosiery.

(260) AM 2019 97535 A

(800) 1398788

(151) 2017 11 22

(891) 2017 11 22

(731) BUMFA GROUP LTD

Privokzal'naya st. 16, Cherkessk, RU-369000
Karachay-Cherkess Republic, Russian
Federation

(540)

Bumfa Group

(591) Black, white

(531) 27.05.17

(511)

3 – Bleaching preparations and other substances for laundry use; cleaning, polishing, scouring and abrasive preparations; soap; perfumery, essential oils, cosmetics, hair lotions; dentifrices; non-medicated toiletries; antiperspirants for personal use; body deodorants [perfumery]; abrasive cloth; cotton sticks for cosmetic purposes; feminine hygiene cleansing towelettes; decorative transfers for cosmetic purposes; beauty masks; adhesives for cosmetic purposes; cloths impregnated with a detergent for cleaning; cosmetic preparations for skin care; cosmetic hair dressing preparations; cosmetic nail care preparations; cosmetic preparations for the care of mouth and teeth; polishing paper; emery paper; abrasive paper.

5 – Sanitary preparations for medical purposes; dietetic substances adapted for medical use; food for babies; plasters, materials for dressings; material for dental fillings and dental impressions; herbicides; disinfectants; preparations for destroying noxious animals; fungicides; thermal water; medicated skin care preparations; medicated hair care preparations; nail care preparations for medical purposes; medicated mouth care and treatment preparations; mouthwashes for medical purposes; mothproofing paper; paper for mustard plasters; wadding for medical purposes; deodorants, other than for human beings or for animals; gauze for dressings; vulnerary sponges; bandages for dressings; pants, absorbent, for incontinents; sanitary pads; sanitary tampons; sanitary towels; tissues impregnated with pharmaceutical lotions; veterinary preparations; pharmaceutical preparations; surgical mesh comprised primarily of living tissue.

10 – Hernia bandages; bandages, elastic; maternity belts; belts for medical purposes; pads [pouches] for preventing pressure sores on patient bodies.

16 – Paper and cardboard; printed matter; bookbinding material; photographs [printed]; stationery; adhesives [glues] for stationery or household purposes; artists' materials; paintbrushes; typewriters and office requisites [except furniture]; instructional and teaching material [except apparatus]; plastic materials for packaging; printing type; printing blocks; stickers [stationery]; postcards; school supplies [stationery]; printed publications; newspapers; magazines [periodicals]; books; catalogues; booklets; posters; sewing patterns; paper pads for changing diapers; paper for wrapping and packaging; bags [envelopes, pouches] of paper or plastics, for packaging; cream containers of paper; table linen of paper; tissue paper; hand towels of paper; handkerchiefs of paper; labels of paper; flags of paper; toilet paper; tissues of paper for removing make-up; face towels of paper; lettering guides; stencils; paper coffee filters; coasters of paper.

21 – Household or kitchen utensils and containers of paper or cardboard; articles for cleaning purposes; cloths for cleaning.

24 – Fabric; bed linen; bath linen, except clothing; household linen; bed blankets; cloths for removing make-up; face towels of textile; place mats, not of paper; non-woven textile fabrics; bed throws; tablecloths of textile.

35 – Advertising; sales promotions at point of purchase or sale, for others; the bringing together, for the benefit of others, of a variety of goods (excluding the transport thereof), enabling customers to conveniently view and purchase those goods; procurement services for others [purchasing goods and services for other businesses]; organization of exhibitions for commercial or advertising purposes.

40 – Treatment of materials; textile treating; recycling of paper; treatment of cellulose.

(260) AM 2019 97536 A

(800) 1398794

(151) 2017 11 30

(891) 2017 11 30

(731) RHEINMETALL AUTOMOTIVE AG

Karl-Schmidt-Straße 2-8, 74172 Neckarsulm,
Germany

(540)



(591) Black, white

(531) 26.04.03; 26.04.04; 26.04.05; 26.04.18;

27.05.19; 27.05.22

(511)

7 – Motors and engines, in particular internal combustion engines, except for land vehicles; generic machine parts, included in this class; parts and accessories for all the aforesaid goods, included in this class; parts for motors and engines for vehicles, in particular for internal combustion engines, included in this class; engine blocks; cylinder heads, including parts therefor, cylinder liners, finned cylinders; pistons [parts of machines or engines]; piston pins; piston rings; piston ring segments, piston ring sets, piston pin retainer elements; connecting rods; connecting rod bearing elements; crank shafts; crank shaft bearing elements and crank shaft cases; cam shafts; camshaft bearing elements; rocker arms for motors and engines; pushrods; slide bearings; anti tappets; valve tappet guides; valve seats; valve seat rings; valve springs; suction pipes, discharge pipes; exhaust manifolds; carburettors; transmission cases; power train parts as generic machine parts included in this class; starter gears; pumps [machines]; centrifugal pumps; rotary pumps; hydraulic pumps; water pumps; fuel pumps; oil pumps; repair sets for pumps, consisting of replacement parts for pumps, included in this class; oil coolers; oil pressure relief valves; radiators [cooling] for motors and engines; fans for cooling vehicle engines; fly-wheels; blowing machines; bushings; adapted bolts (parts for motors and engines and machines); compressors as parts of machines, motors and engines; parts for compressors, included in this class.

12 – Automobile engines; parts and fittings for motor vehicles and for motor vehicle motors and engines, included in this class.

35 – Retailing services, wholesaling services and mail order trading services, including via the internet or online, in the field of motor vehicle fittings, motor vehicle parts, motor and engine parts.

(260) AM 2019 97537 A

(800) 1398797

(151) 2017 12 22

(891) 2017 12 22

(731) IVOCLAR VIVADENT AG

Bendererstrasse 2, FL-9494 Schaan,
Liechtenstein

(540)

ProBase Cold High Impact

(591) Black, white

(511)

5 – Materials for the manufacture of dental impressions, artificial teeth, artificial dental veneers, crowns and bridges, inlays, prostheses, protective coating for dental use, insulating agents, materials

for relining teeth, opaque materials for dental use, color stains for use in dentistry, synthetic materials for the manufacture of prostheses, crowns and bridges; materials for repairing damaged teeth; artificial dental veneers.

10 – Apparatus and devices for dental use; artificial teeth.

(260) AM 2019 97538 A

(800) 1398835

(151) 2018 01 15

(891) 2018 01 15

(731) Obshchestvo s ogranitshennoy otvetstvennost'yu "KOORDINIRUYUSHCHY RASPREDELITEL'NY TSENTR "EFKO-KASKAD"
ul. Frunze, 4, g. Alekseevka, RU-309850
Belgorodskaya obl., Russian Federation

(540)



(591) White, black, cherry, cream, green, sand, light green, dark green, light-beige, dark-vinous, gray, blue, pink

(531) 05.07.16; 19.03.01; 28.05; 29.01.15

(554) Three-dimensional

(511)

29 – Milk and milk products.

35 – Sales promotion for others; retail and wholesale services for milk and milk products.

(260) AM 2019 97540 A

(800) 1398875

(151) 2017 12 11

(891) 2017 12 11

(731) ZHEJIANG DONSEN ENVIRONMENTAL TECHNOLOGY CO., LTD.

No.1 Zhijiang Road, Lanjiang Street, Yuyao, Ningbo, China

(540)

Donsen

(591) Black, white

(531) 27.05.11; 27.05.17

(511)

19 – Penstock pipes, not of metal; drain pipes, not of metal; doors, not of metal; plastic pipes for construction; wooden floor; pipes, not of metal; water pipes, not of metal; architectural coating materials,

not of metal; windows, not of metal; refractory construction materials, not of metal.

(260) AM 2019 97541 A

(800) 1398915

(151) 2018 01 31

(891) 2018 01 31

(731) BIOFARMA

50 rue Carnot, F-92284 Suresnes Cedex,
France

(540)

PREXAMSA

(591) Black, white

(511)

5 – Pharmaceutical products, medical and veterinary preparations; sanitary products for medical purposes; dietetic food and substances for medical or veterinary use; implants for pharmaceutical use, namely implants (living tissues), biological implants or medical implants; implantable medicines; food for babies; food supplements for humans and animals; plasters, materials for dressings; material for dental fillings and dental impressions; disinfectants; products for destroying vermin; fungicides, herbicides.

(260) AM 2019 97542 A

(800) 1398991

(151) 2018 01 04

(891) 2018 01 04

(731) HUAWEI TECHNOLOGIES CO., LTD.

Administration Building, Huawei
Technologies Co., Ltd., Bantian, Longgang
District, Shenzhen, Guangdong, China

(540)

HUAWEI P20

(591) Black, white

(511)

9 – Smartphones; covers for smartphones; cases for smartphones; electric batteries for mobile phones; tablet computers; protective covers for tablet computers; stands for tablet computers; protective cases for tablet computers; headphones; earphones; television apparatus; set-top boxes; portable cabinets for loudspeakers; sound transmitting apparatus; camcorders; digital photo frames; routers; network communication apparatus; cell phone straps; screens for mobile phones; computer keyboards; mouse (computer peripheral); modems; covers for mobile phones; portable media players; magnetic encoded identification bracelets; pedometers; electric monitoring apparatus.

(260) AM 2019 97543 A

(800) 1398999

(151) 2017 10 30

(891) 2017 10 30

(731) HUAWEI TECHNOLOGIES CO., LTD.
Administration Building, Huawei
Technologies Co., Ltd. Bantian, Longgang
District, Shenzhen, China

(540)

HUAWEI P60

(591) Black, white

(511)

9 – Selfie sticks (hand-held monopods); digital photo frames; microphones; computer hardware; smart-glasses; smartwatches; wearable activity trackers; covers for smartphones; computer memories; integrated circuit cards (smart cards); cabinets for loudspeakers; modems; sleeves for laptops; smartphones; electric batteries; battery chargers; mobile power source (rechargeable batteries); tablet computers; laptop computers; notebook computers; bags adapted for laptops; headphones; loudspeakers; portable media players; sound transmitting apparatus; camcorders; cameras (photography); computer keyboards; mouse (computer peripheral); pedometers; electric monitoring apparatus; connected bracelets (measuring instruments); recorded computer programmes (programs); downloadable computer software applications; interactive touch screen terminals; humanoid robots with artificial intelligence; electronic sheet music, downloadable; smart rings; audio interfaces; virtual reality headsets; digital video recorders; set-top boxes.

(260) AM 2019 97544 A

(800) 1399000

(151) 2017 10 30

(891) 2017 10 30

(731) HUAWEI TECHNOLOGIES CO., LTD.
Administration Building, Huawei
Technologies Co., Ltd., Bantian, Longgang
District, Shenzhen, China

(540)

HUAWEI P50

(591) Black, white

(511)

9 – Smartglasses; smartwatches; wearable activity trackers; covers for smartphones; selfie sticks (hand-held monopods); digital photo frames; microphones; computer hardware; computer memories; integrated circuit cards (smart cards); cabinets for loudspeakers; modems; sleeves for laptops; smartphones; electric batteries; battery chargers; mobile power source (rechargeable batteries); tablet computers; laptop computers; notebook computers; bags adapted for laptops; headphones; loudspeakers; portable media players; sound transmitting apparatus; camcorders; cameras (photography); computer keyboards; mouse (computer peripheral); pedometers; electric monitoring apparatus; connected bracelets (measuring instruments); recorded computer progra-

mmes (programs); downloadable computer software applications; interactive touch screen terminals; humanoid robots with artificial intelligence; electronic sheet music, downloadable; smart rings; audio interfaces; virtual reality headsets; digital video recorders; set-top boxes.

(260) AM 2019 97545 A

(800) 1399004

(151) 2018 02 28

(891) 2018 02 28

(731) STADA Arzneimittel AG

Stadastr. 2-18, 61118 Bad Vilbel, Germany

(540)

BEVZIMLA

(591) Black, white

(511)

5 – Pharmaceutical preparations; veterinary preparations; medicine; sanitary preparations for medical purposes; dietary supplements and dietetic preparations; dietary supplements for humans; dietary supplements for animals; medical and veterinary preparations and articles; infant formula; diagnostic preparations; plasters, materials for dressings; dressings, medical; teeth filling material; dental impression materials; disinfectants; preparations for destroying vermin; fungicides; herbicides.

10 – Surgical instruments; medical and veterinary apparatus and instruments; dental apparatus and instruments; medical instruments for application on animal bodies; applicators for medications; medical apparatus for introducing pharmaceutical preparations into the human body; diagnostic apparatus for medical purposes; artificial limbs; artificial eyes; artificial teeth; orthopedic articles.

44 – Medical services; providing of medical information relating to diseases and health problems, including online and on the internet; dissemination of medical information via an interactive platform.

(260) AM 2019 97546 A

(800) 1399005

(151) 2018 02 28

(891) 2018 02 28

(731) STADA Arzneimittel AG

Stadastr. 2-18, 61118 Bad Vilbel, Germany

(540)

BIMAVA

(591) Black, white

(511)

5 – Pharmaceutical preparations; veterinary preparations; medicine; sanitary preparations for medical purposes; dietary supplements and dietetic preparations; dietary supplements for humans; dietary supplements for animals; medical and veterinary prepa-

rations and articles; infant formula; diagnostic preparations; plasters, materials for dressings; dressings, medical; teeth filling material; dental impression materials; disinfectants; preparations for destroying vermin; fungicides; herbicides.

10 – Surgical instruments; medical and veterinary apparatus and instruments; dental apparatus and instruments; medical instruments for application on animal bodies; applicators for medications; medical apparatus for introducing pharmaceutical preparations into the human body; diagnostic apparatus for medical purposes; artificial limbs; artificial eyes; artificial teeth; orthopedic articles.

44 – Medical services; providing of medical information relating to diseases and health problems, including online and on the internet; dissemination of medical information via an interactive platform.

(260) AM 2019 97547 A
(800) 1399006
(151) 2018 02 28
(891) 2018 02 28
(731) STADA Arzneimittel AG
Stadastr. 2-18, 61118 Bad Vilbel, Germany
(540)

CIZMILAR

(591) Black, white
(511)

5 – Pharmaceutical preparations; veterinary preparations; medicine; sanitary preparations for medical purposes; dietary supplements and dietetic preparations; dietary supplements for humans; dietary supplements for animals; medical and veterinary preparations and articles; infant formula; diagnostic preparations; plasters, materials for dressings; dressings, medical; teeth filling material; dental impression materials; disinfectants; preparations for destroying vermin; fungicides; herbicides.

10 – Surgical instruments; medical and veterinary apparatus and instruments; dental apparatus and instruments; medical instruments for application on animal bodies; applicators for medications; medical apparatus for introducing pharmaceutical preparations into the human body; diagnostic apparatus for medical purposes; artificial limbs; artificial eyes; artificial teeth; orthopedic articles.

44 – Medical services; providing of medical information relating to diseases and health problems, including online and on the internet; dissemination of medical information via an interactive platform.

(260) AM 2019 97553 A
(800) 1399168
(151) 2017 12 07
(891) 2017 12 07

(731) BACH TUONG PHAT HOLDINGS CORPORATION GROUP
12 Tran Kim Xuyen street, Yen Hoa urban areas, Yen Hoa ward, Cau Giay District, Hanoi, Viet Nam

(540)

(591) Black, white
(531) 27.05.01
(511)

11 – Cookers; infrared cookers; electromagnetic cookers.

(260) AM 2019 97554 A
(800) 1399171
(151) 2018 01 12
(891) 2018 01 12
(731) SOPHARMA AD
Iliensko shose Str. 16, BG-1220 SOFIA, Bulgaria
(540)

DEXPANTIN SOPHARMA

(591) Black, white
(531) 27.05.01
(511)

3 – Non-medicated cosmetics and toiletry preparations; non-medicated dentifrices; perfumery, essential oils.

(260) AM 2019 97569 A
(800) 1323664
(151) 2016 07 28
(891) 2018 03 19
(731) MEDPACK SWISS GROUP AG
c/o Zovag SRC GmbH, Unterlettenstrasse 14, CH-9443 Widnau, Switzerland
(540)



dentissimo

SWISS BIODENT

(591) Black, white
(531) 26.11.12; 27.05.10
(511)

3 – Dentifrices; all the aforesaid goods are of Swiss origin.

(260) AM 2019 97571 A
(800) 1336207
(151) 2016 02 26
(891) 2018 04 09
(731) COOPERATIVA CERAMICA D'IMOLA S.C.
Via Vittorio Veneto, 13, I-40026 IMOLA (BOLOGNA), Italy

(540)



(591) Black, white

(531) 26.01.04; 26.01.16; 26.01.24; 26.13.25;
27.05.09; 27.05.10

(511)

19 – Tiles, not of metal, for building; floor tiles, not of metal; parquet flooring and parquet slabs; floors, not of metal; building stone; mosaics for building; ceilings, not of metal; duckboards, not of metal; luminous paving blocks; partitions, not of metal; non-metal coverings; non-metal roof coverings; wood panelling; signalling panels, non-luminous and non-mechanical, not of metal; marble; stones; cement slabs; building materials and components, not of metal; tiles; fireproof tiles; translucent tiles (not of metal); ceramic tiles for flooring; ceramic tiles for paving; ceramic tiles for internal walls; ceramic tiles for external floors; ceiling tiles (non-metallic); tiles, not of metal, for building exteriors; building bricks, not of metal; facing bricks, not of metal; parquet flooring; parquet wood flooring; parquet floor boards; roofing tiles, not of metal; roof construction materials, not of metal; cladding panels, not of metal, for roofs; covering panels, not of metal, for roofs; non-metal roof coverings; non-metallic roofing plates; veneers; pavements; floorboards; flooring screeds; pavement screeds; flooring (non-metallic); paving cobblestones; paving blocks; paving stones; ceramic coverings for floor; non-metallic paving products; floors, not of metal; non-metallic flooring materials; paving blocks, not of metal; building panels, not of metal; wall panelling, not of metal; non-metallic cladding panels; non-metal floor panels; non-metallic interlocking panels for building; translucent building panels made from plastic materials; non-metallic waterproofing boards; non-luminous and non-mechanical signs, not of metal; non-metallic sidings; coatings (building materials); non-metallic facing bricks; cementitious waterproofing coatings; non-metallic wall claddings; wall panelling made of non-metallic materials; facing panels of non-metallic materials; non-metallic building slabs; fire burrs; non-metallic ceiling tiles; non-metallic ceiling panels; non-metallic cladding for ceilings; non-metal coverings for ceilings; signs made of plastic (non-luminous and non-mechanical); partitions, not of metal; screed coatings; building glass; figurines, statuettes of stone, concrete or marble included in this class; marble for building.

35 – Advertising; rental of advertising space; business research; conducting of marketing research; organization of trade fairs for commercial purposes; sponsorship search; business management; business administration; office functions; commercial or industrial management assistance; advertising agency

services; demonstration of goods for promotional and advertising purposes; sales promotion for others; dissemination of advertising matter; distribution of samples; presentation of goods on communication media, for retail purposes; production of promotional films; shop window dressing; shop window display arrangement services; business administration assistance; bill-posting (outdoor advertising); commercial information and advice for consumers (consumer advice shop); market research and surveys; conducting of marketing studies; negotiation and conclusion of commercial transactions for third parties; consultancy services related to human resources management; outsourcing services; business merchandising display services; products merchandising; public relations; import and export services; procurement services for others (purchasing goods and services for other businesses); arranging and conducting of events for promotional and advertising purposes; organizing and conducting trade fairs, events and exhibitions for commercial and advertising purposes; sponsorship [promotion and marketing services].

39 – Transport of goods; packaging and storage of goods; delivery of goods; warehousing of products; delivery of goods; packing of goods.

(260) AM 2019 97575 A

(800) 1368886

(151) 2017 06 20

(891) 2018 03 12

(731) LTD "BTC HOLDING"

ul. Leningradskaya, vladenie 39, zdanie 2,
str. 6, Pomeschenie OB02_11, Khimki,
RU-141402 Moscow region, Russian
Federation

(540)



(591) Black, white

(531) 03.01.04; 03.01.16

(511)

18 – Leather and imitations of leather, including pocket wallets; business card cases; goods for documents, not fitted, namely pocket wallets, card cases [notecases], attaché cases, purses, briefcases, credit card holders; purses; haversacks; rucksacks; travelling bags; net bags for shopping; bags for climbers; cases for travelling sets [leatherware]; baby carriers with handles; garment bags for travel; handbags; tool bags, empty; wheeled bags; beach bags; bags for sports; bags for campers; shopping bags; school

satchels; key cases [leatherware]; suitcases; cases of leather; cases of imitation leather.

25 – Clothing, footwear, headgear.

(260) AM 2019 97579 A

(800) 1399286

(151) 2018 01 12

(891) 2018 01 12

(731) YUNNAN TAETEA INDUSTRY GROUP CO., LTD.

Floor 12, Donghang Investment Building,
No.219 Chuncheng Road, Kunming City,
Yunnan Province, China

(540)

益友会

(591) Black, white

(531) 28.03

(511)

38 – Electronic bulletin board services [telecommunications services]; providing telecommunications connections to a global computer network; providing Internet chatrooms; providing access to databases; providing online forums; television broadcasting; wireless broadcasting; message sending; communications by computer terminals; teleconferencing services.

45 – On-line social networking services; clothing rental; funerary undertaking; opening of security locks; dating services; fire-fighting; organization of religious meetings; adoption agency services; lost property return; rental of safes; genealogical research; planning and arranging of wedding ceremonies; intellectual property consultancy.

(260) AM 2019 97580 A

(800) 1399308

(151) 2017 12 22

(891) 2017 12 22

(731) PEPSICO, INC., (a North Carolina corporation)

700 Anderson Hill Road, Purchase NY 10577,
USA

(540)

PEPSI BLACK

(591) Black, white

(531) 27.05.01

(511)

32 – Aperitifs, non-alcoholic; aerated water; mineral water [beverages]; waters [beverages]; table waters; kvass [non-alcoholic beverage]; cocktails, non-alcoholic; lemonades; non-alcoholic beverages; isotonic

beverages; non-alcoholic honey-based beverages; whey beverages; non-alcoholic beverages flavored with coffee; non-alcoholic beverages flavored with tea; non-alcoholic fruit juice beverages; fruit nectars, non-alcoholic; orgeat; sarsaparilla [non-alcoholic beverage]; powders for effervescing beverages; syrups for lemonade; syrups for beverages; smoothies; vegetable juices [beverages]; fruit juices; tomato juice [beverage]; cider, non-alcoholic; preparations for making aerated water; preparations for making mineral water; preparations for making beverages; pastilles for effervescing beverages; sherbets [beverages]; non-alcoholic fruit extracts; essences for making beverages.

(260) AM 2019 97581 A

(800) 1399314

(151) 2018 02 21

(891) 2018 02 21

(731) LONDON DOLLAR LTD

Kemp House, 160 City Road, London EC1V
2NX, United Kingdom

(540)

PALOMO

(591) Black, white

(511)

34 – Cigarettes; cigarettes containing tobacco substitutes, not for medical purposes; cigarillos; cigars; herbs for smoking; snuff; snuff boxes, tobacco, smokers' articles; matches.

(260) AM 2019 97582 A

(800) 1399344

(151) 2017 12 07

(891) 2017 12 07

(731) TOVARYSTVO Z OBMEZHENOYU
VIDPOVIDALNISTYU "SANDORA"

s. Mykolaiivske, Vitovskiyi rgn., Mykolaiivska
obl. 57262, Ukraine

(540)



(591) Beige, brown, black, grey, green, blue, red and pink

(531) 03.05.09; 03.05.24; 03.05.25; 16.01.04;
16.01.14; 18.01.05; 29.01.15

(511)
32 – Aperitifs, non-alcoholic; aerated water; waters (beverages); table waters; cocktails, non-alcoholic; lemonades; non-alcoholic beverages; whey beverages; soft drinks; non-alcoholic fruit juice beverages; fruit nectars, non-alcoholic; syrups for lemonade; syrups for beverages; smoothies; fruit juices; cider, non-alcoholic; preparations for making aerated water; preparations for making beverages; non-alcoholic fruit extracts; essences for making beverages.

(260) AM 2019 97583 A

(800) 1399347

(151) 2017 12 27

(891) 2017 12 27

(731) LIUHUI

No.71 Xinglong street, Huibei Village,
Xiuhui Town, Zhangqiu City, Shandong
Province, China

(540)



(591) Black, white

(531) 26.01.01; 26.01.03; 26.01.12; 26.15.01; 28.03

(511)

12 – Electric bicycle; mopeds; electric tricycle; motor tricycle; bicycles; electric vehicles; carrier tricycle; trolleys; automobiles.

(260) AM 2019 97584 A

(800) 1399368

(151) 2017 09 14

(891) 2017 09 14

(731) CARDIVA, S.L.

General Eguia, 48, E-48013 BILBAO, Spain

(540)



(591) Black, white

(531) 26.03.24; 26.04.24; 26.07.15

(511)

35 – Import-export agency services for surgical and medical apparatus and instruments; organization and assistance services regarding clinic management.

(260) AM 2019 97585 A

(800) 1399374

(151) 2018 01 12

(891) 2018 01 12

(731) GAOMI XINGJIA RUBBER FACTORY

Zhouyang Village, Juchenghe Community,
Mishui Street, Gaomi, Weifang City,
Shandong Province, China

(540)

HAPPYROAD

(591) Black, white

(531) 27.05.01

(511)

12 – Tires for land vehicles; casings for pneumatic ties [tyres]; pneumatic tires; solid tires for vehicle wheels; automobile tires [tyres]; inner tubes for vehicle tires; spikes for tires [tyres]; inner tubes for bicycle tires; bicycle tyres.

(260) AM 2019 97586 A

(800) 1399390

(151) 2018 02 28

(891) 2018 02 28

(731) STADA Arzneimittel AG

Stadastr. 2-18, 61118 Bad Vilbel, Germany

(540)

AVEQUAY

(591) Black, white

(511)

5 – Pharmaceutical preparations; veterinary preparations; medicine; sanitary preparations for medical purposes; dietary supplements and dietetic preparations; dietary supplements for humans; dietary supplements for animals; medical and veterinary preparations and articles; infant formula; diagnostic preparations; plasters, materials for dressings; dressings, medical; teeth filling material; dental impression materials; disinfectants; preparations for destroying vermin; fungicides; herbicides.

10 – Surgical instruments; medical and veterinary apparatus and instruments; dental apparatus and instruments; medical instruments for application on animal bodies; applicators for medications; medical apparatus for introducing pharmaceutical preparations into the human body; diagnostic apparatus for medical purposes; artificial limbs; artificial eyes; artificial teeth; orthopedic articles.

44 – Medical services; providing of medical information relating to diseases and health problems, including online and on the internet; dissemination of medical information via an interactive platform.

(260) AM 2019 97587 A

(800) 1399391

(151) 2018 02 28

(891) 2018 02 28
 (731) STADA Arzneimittel AG
 Stadastr. 2-18, 61118 Bad Vilbel, Germany
 (540)

NEARBEVA

(591) Black, white
 (511)

5 – Pharmaceutical preparations; veterinary preparations; medicine; sanitary preparations for medical purposes; dietary supplements and dietetic preparations; dietary supplements for humans; dietary supplements for animals; medical and veterinary preparations and articles; infant formula; diagnostic preparations; plasters, materials for dressings; dressings, medical; teeth filling material; dental impression materials; disinfectants; preparations for destroying vermin; fungicides; herbicides.

10 – Surgical instruments; medical and veterinary apparatus and instruments; dental apparatus and instruments; medical instruments for application on animal bodies; applicators for medications; medical apparatus for introducing pharmaceutical preparations into the human body; diagnostic apparatus for medical purposes; artificial limbs; artificial eyes; artificial teeth; orthopedic articles.

44 – Medical services; providing of medical information relating to diseases and health problems, including online and on the internet; dissemination of medical information via an interactive platform.

(260) AM 2019 97588 A
 (800) 1399392
 (151) 2018 02 28
 (891) 2018 02 28
 (731) STADA Arzneimittel AG
 Stadastr. 2-18, 61118 Bad Vilbel, Germany
 (540)

BEVLATRU

(591) Black, white
 (511)

5 – Pharmaceutical preparations; veterinary preparations; medicine; sanitary preparations for medical purposes; dietary supplements and dietetic preparations; dietary supplements for humans; dietary supplements for animals; medical and veterinary preparations and articles; infant formula; diagnostic preparations; plasters, materials for dressings; dressings, medical; teeth filling material; dental impression materials; disinfectants; preparations for destroying vermin; fungicides; herbicides.

10 – Surgical instruments; medical and veterinary apparatus and instruments; dental apparatus and instruments; medical instruments for application on animal bodies; applicators for medications; medical apparatus for introducing pharmaceutical preparations

into the human body; diagnostic apparatus for medical purposes; artificial limbs; artificial eyes; artificial teeth; orthopedic articles.

44 – Medical services; providing of medical information relating to diseases and health problems, including online and on the internet; dissemination of medical information via an interactive platform.

(260) AM 2019 97597 A
 (800) 1399761
 (151) 2018 03 19
 (891) 2018 03 19
 (731) ARNOLD & RICHTER CINE TECHNIK
 GMBH & CO. BETRIEBS KG
 Türkenstr. 89, 80799 München, Germany
 (540)

Signature Prime

(591) Black, white
 (511)

9 – Multifunctional remote controls for film and video recorders; camera lenses; objectives; anamorphic lenses; anamorphic objectives; adaptors; accessories for the aforementioned goods as well as spare parts as far as included in this class; adapted cases for carrying the aforementioned goods.

(260) AM 2019 97609 A
 (800) 1400090
 (151) 2017 12 27
 (891) 2017 12 27
 (731) RIANLON CORPORATION
 No.6 Huangshan Road, TEDA Hangu
 Modern Industrial Park, 300480 Tianjin,
 China
 (540)

 The logo for Rianlon features the brand name in a bold, black, sans-serif font. A thick, black, curved line arches over the letters, starting from the top of the 'R' and ending at the top of the 'n', creating a stylized, dynamic shape.

(591) Black, white
 (531) 26.11.01; 26.11.12; 27.05.08
 (511)

1 – Industrial chemicals, antioxidant, antistatic agent, accelerant, fire retardant, chemical additives for oils, chemical additives to motor fuel, surface-active chemical agents, dyestuff assister, brightener.

(260) AM 2019 97610 A
 (800) 1400151
 (151) 2018 01 08
 (891) 2018 01 08
 (731) AKTSIONERNO DROUJESTVO
 "MONBAT" AD
 Boulevard "Tcherni Vrah", No 32 A, Et. 4,
 Rayon "Lozenets", BG-1407 Sofia, Bulgaria

(540)

MONBAT

(591) Dark blue, red and white

(531) 27.05.17; 29.01.12

(511)

6 – Lead, unwrought or semi-wrought; lead alloys.

9 – Electric accumulators; electric accumulators for vehicles; lead acid batteries for starting motor vehicles for loading and for loading heavy equipment, as well as for machines intended for road construction; batteries for buses and coaches; batteries for automobile taxis and for vehicles for special use; batteries for farming equipment; batteries for railway engine equipment; batteries for starting tourist cars; stationary batteries intended for telecommunications for emergency power for telephone exchanges, for equipment for the transmission of messages and voice data, for mobile and fixed communication systems, for radio and television systems and for transmitters and relay stations; UPS system batteries intended for electrical power stations, industrial sites, production companies, data storage centers, hospitals, banks and shopping centers, signaling and navigation systems; stationary batteries intended for working in harsh conditions with high working temperatures, for hybrid and cyclic applications in remote sites and in areas of frequent power cuts; batteries for storing energy from renewable energy sources; cyclic application batteries intended for use in AGM technology; semi-traction batteries intended for sites requiring a constant and sustainable electricity supply; special batteries intended for tanks and armored machines, compliant with NATO standards; batteries intended for motor boats, river boats, camping vans, pleasure boats and caravans; accumulator boxes; battery jars; anode batteries; acidimeters for batteries; high voltage batteries; batteries for lighting; batteries for pocket lamps; electric accumulators for vehicles; electric cells (batteries); batteries for electronic cigarettes; galvanic batteries; plates for batteries, including, grids for batteries; solar batteries; solar panels for electricity production; charging stations for electric vehicles; battery chargers; apparatus for charging electric accumulators; chargers for electronic cigarettes.

40 – Information relating to equipment processing, especially relating to recycling and/or the destruction of used accumulators and batteries; waste processing (conversion), especially of used accumulators and batteries; incineration of waste; recycling of waste, especially the recycling of used accumulators and batteries; destruction of waste, especially technological waste produced by accumulators and batteries and used accumulators and batteries.

(260) AM 2019 97611 A

(800) 1400171

(151) 2018 03 07

(891) 2018 03 07

(731) FIIZY OÜ

Toom-Kooli 1, EE-10130 Tallinn, Estonia

(540)

FINZMO

(591) Black, white

(511)

35 – Advertising, marketing and promotional services; business analysis, research and information services; business intelligence services; business advisory and information services; business risk assessment services; competitive intelligence services; business risk management services; market reporting services; administrative data processing; business consultancy and advisory services.

36 – Financial and monetary services, and banking; valuation services; financial risk management; risk management [financial]; counterparty risk management; credit risk insurance; financial risk management services; financial risk assessment services; risk management consultancy [financial]; credit advice; credit rating; credit bureaus; credit brokerage; credit financing; credit services; credit assessment services; credit rating services; consumer credit services; credit scoring services; credit arranging services; credit counseling services; credit management services; credit card verification; instalment credit financing; credit and loan services; credit card payment processing; financial credit scoring services.

(260) AM 2019 97612 A

(800) 1400182

(151) 2018 01 12

(891) 2018 01 12

(731) LOTTE CORPORATION

(Sincheon-dong), 300, Olympic-ro, Songpa-gu, Seoul, Republic of Korea

(540)



(591) Red and white

(531) 26.04.03; 26.04.18; 27.05.21; 27.05.24; 29.01; 29.01.12

(511)

6 – Ores of metal; pot hooks of metal; baskets of metal; signboards of metal; memorial cups of metal;

traps for wild animals; stakes of metal for plants or trees; prefabricated animal houses of metal; ladders of metal; towel dispensers of metal; train and bus ticket holders of metal; casks of metal; boxes of metal; bungs of metal; fittings of metal for furniture; door scrapers of metal; letter boxes of metal; tombstone plaques of metal; shoe pegs of metal; ferrules of metal for canes and walking-sticks; furnace fireguards of metal; screws of metal; locks of metal; claws of metal for vice; filings of metal; steel, unwrought or semi-wrought; unwrought or semi-wrought non-ferrous metals; solder; materials of metal for exclusive use in building or construction; tiles of metal; buildings of metal; palings of metal; non-luminous and non-mechanical traffic signs of metal; wire stretchers [tension links]; loading pallets of metal; marine anchors; foundry molds [moulds] of metal; artificial fish reefs of metal; booths of metal for spraying paint; valves of metal (other than for machines); rocket launch-platforms of metal; diving boards of metal; tent pegs of metal; spurs; buckles of metal; ropes of metal; metal nets; works of art of metal (not of precious metal); metal pipes and tubes; metals and metal alloys; sleeves of metal for cable junction; monuments of metal.

7 – Aquarium pumps; electrically operated brushes [parts of machines]; stamping machines; automatic vending machines; gas pumps (gas station equipment); non-manual lawnmowers [machines]; electric door opening and closing apparatus; elevators [lifts]; automatic grapnels for marine purposes; excavators; cutters [machines]; mining machines; civil engineering machinery; agricultural machines; milking machines; incubators for eggs; fishing machines; chemical machines for industrial purposes; waste disposal machinery; textile machines; food and drink processing machines for industrial purposes; wood milling machines; pulp processing machines; printing machines; sewing machines; leather processing machines; tobacco processing machines; glass processing machines; painting machines; packing machines; motive power machines (other than for land vehicles); pumps and compressors as parts of machines, motors and engines; power transmissions and gearings (other than for land vehicles); shock absorbers for machine (other than for vehicles); braking devices for machine (other than for vehicles); engine bearings; windmills; electric machines and apparatus for cleaning; parking machines; rubber processing machines; 3D printers; motors (except for land vehicles); laundry washing machines for household use; robots; electrodes for welding machines; sericultural machines; sorting machines for industry; couplings for machines and transmission gear components (except for land vehicles); dairy machines; motors and engines [except for land vehicles]; taps (machine/engine or motor components); food peeling machines for commercial use; coffee grinders, other than hand-operated.

8 – Tableware [knives, forks and spoons]; fireplace tongs; flat irons; knives for processing; side arms, other than firearms; hammers [hand tools]; knife sharpeners; saws [hand tools]; money scoops; agricultural implements, hand-operated; hand-operated lasts for shoe-making; hand pumps; electric razors; scrapers for skis; ice axes; sand trap rakes; knives; shovels; razors; portable multi-function hand tools; manicure sets.

9 – Electric door bells; electric audio and visual apparatus and instruments; ear phones; telecommunication machines and implements; Bluetooth ear set; laboratory robots; computer software; computer hardware and computer peripheral devices; semi-conductors; electric plugs; video game cartridges and cassettes; sports whistles; protective gloves for industrial use; helmets; respiratory masks, other than for artificial respiration; clothing for protection against accidents, irradiation and fire; electronic media pre-recorded with music; metronomes; electronic media pre-recorded with non-music (excluding computer software); downloadable coupon; cinematographic films; downloadable electronic publication; calculating machines; goggles; CDs; control instruments for boiler; life-saving apparatus and equipment; audiovisual teaching apparatus; monitors; DNA chips; anti-glare glasses; slide-rules; protective shoes; electric locks; carpenters' rules; physical and chemical laboratory apparatus and instruments; optical apparatus and instruments except for glasses and photographic apparatus; photographic apparatus and instruments; precision measuring apparatus; eyeglasses; calculation instruments; mechanisms for coin-operated apparatus; lifesaving apparatus and equipment; automatic fire extinguishing apparatus; alarms; mechanical traffic signals; divers' apparatus, namely, diving gloves, diving suits and ear plugs for divers; life boats (rafts); satellites; fire engines; electric fences; egg-candlers; ionization apparatus not for the treatment of air or water; electrical controllers; neon signs; electric batteries; electricity measuring apparatus and instruments; electric wires; safety appliances for railway transportation; mounting devices for cameras and monitors; theft prevention apparatus; lenses; video conference system; home theater system; radio transceivers; smartphones; batteries and battery chargers; buzzers; downloadable multimedia file.

10 – Medical apparatus and instruments other than for dental purposes; medical thermometer; body fat measuring devices for medical use; body rehabilitation apparatus for medical purposes; blood glucose meters; portable arterial blood pressure measuring apparatus; dental apparatus and instruments; contraceptive apparatus; electric blankets for medical purposes; suture materials; baby bottles; bed pans; electric massage apparatus for household use; electric esthetic massage apparatus; clothing especially for

operating rooms; gloves for medical purposes; masks for medical purposes; massaging apparatus for personal use; orthopedic articles; medical and veterinary apparatus and instruments.

12 – Wheelchairs; parachutes; electric vehicles; parts and fittings for ships; parts and fittings for aircraft; parts and fittings for railway vehicles; parts and fittings for automobiles; parts and fittings for bicycles; carts; baby carriages; tyres for vehicle wheels; suspension systems for vehicles; braking devices for vehicles; tractors for agricultural purposes; engines for land vehicles; power transmissions and gearings for land vehicles; wheel bearings for land vehicles; motors for land vehicles; upholstery for vehicles; anti-theft devices for vehicles; vehicle wheels; tail-board lifts [parts of land vehicles]; engines and motors for land vehicles; rubber belts for land vehicle transmissions; brakes for land vehicles; air pumps for two-wheeled motor vehicles or bicycles; apparatus for locomotion by land, air or water; motors and engines for land vehicles; land vehicles.

13 – Tanks [weapons]; guns [weapons]; artillery guns [cannons]; tear gas rifles; air pistols [air guns]; rifles; pistols [arms]; side arms [firearms]; bullets; explosives; blasting agents; gunpowder; gas bombs [weapon]; rockets; missiles; sparklers [fireworks]; hand grenades; illuminating shells; firecrackers; guns and bullets.

19 – Tar and pitch; unprocessed non-metallic minerals for building or construction purposes; building glass; non-metallic advertisement columns; aquaria [structures]; lumber; agglomerated cork for building; tanks of masonry; outdoor blinds, not of metal and not of textile; gravestones; cement; stone; building materials, not of metal; tiles, not of metal; non-metallic modular building units; building blocks composed essentially of vegetable material for prevention of earth collapse or landslide; non-luminous and non-mechanical traffic signs (not of metal); floating docks, not of metal, for mooring boats; non-metal artificial fish reefs; non-metal paint spraying booths; valves (not of metal or plastic) for water supply and drainage; rocket launching platforms, not of metal; diving boards, not of metal; insect screens not of metal; works of art of stone, concrete or marble; monuments, not of metal; works of stonemasonry; pitch and bitumen; tiles and paving slabs (not of metal); logs.

(260) AM 2019 97614 A
(800) 1400270
(151) 2017 10 23
(891) 2017 10 23
(731) PEPSICO, INC., (a North Carolina corporation)
700 Anderson Hill Road, Purchase
New York 10577, USA

(540)



(591) White, black, red, blue and cherry-colored
(531) 05.07.16; 25.01.15; 25.01.19; 26.15.01;
29.01.15

(526) No calories

(511)

32 – Aperitifs, non-alcoholic; aerated water; mineral water [beverages]; waters [beverages]; table waters; kvass [non-alcoholic beverage]; cocktails, non-alcoholic; lemonades; non-alcoholic beverages; isotonic beverages; non-alcoholic honey-based beverages; whey beverages; non-alcoholic beverages flavored with coffee; non-alcoholic beverages flavored with tea; non-alcoholic fruit juice beverages; fruit nectars, non-alcoholic; orgeat; sarsaparilla [non-alcoholic beverage]; powders for effervescing beverages; syrups for lemonade; syrups for beverages; smoothies; vegetable juices [beverages]; fruit juices; tomato juice [beverage]; cider, non-alcoholic; preparations for making aerated water; preparations for making mineral water; preparations for making beverages; pastilles for effervescing beverages; sherbets [beverages]; non-alcoholic fruit extracts; essences for making beverages.

(260) AM 2019 97615 A

(800) 1400279

(151) 2017 12 27

(891) 2017 12 27

(731) RIANLON CORPORATION

No.6 Huangshan Road, TEDA Hangu
Modern Industrial Park, 300480 Tianjin,
China

(540)

利安隆

(591) Black, white

(531) 28.03

(511)

1 – Pentaerythrite, antioxidant, industrial chemicals, unprocessed plastics, unprocessed synthetic resins, unprocessed acrylic resins, unprocessed artificial synthetic resins, plasticizers, adhesives used in industry.

(260) AM 2019 97616 A

(800) 1400280

(151) 2017 12 27

(891) 2017 12 27

(731) RIANLON CORPORATION

No.6 Huangshan Road, TEDA Hangu
Modern Industrial Park, 300480 Tianjin,
China

(540)

U-pack

(591) Black, white

(531) 27.05.10

(511)

1 – Pentaerythrite, antioxidant, industrial chemicals, unprocessed plastics, unprocessed synthetic resins, unprocessed acrylic resins, unprocessed artificial synthetic resins, plasticizers.

(260) AM 2019 97622 A

(800) 1305576

(151) 2016 06 09

(891) 2018 03 30

(731) HANDMADE LOVE LLC

7147 E. Rancho Vista Dr., N2009,
Scottsdale AZ 85251, USA

(540)

Kypris

(591) Black, white

(511)

3 – Body and beauty care cosmetics; cosmetic preparations for bath and shower; cosmetic preparations for body care; cosmetic preparations for protecting the skin from the sun's rays; cosmetic preparations for skin care; aromatic skin care preparations for face and body, namely, cleansers, toners, serums, moisturizers, bath gels and salts using essential oils and natural extracts; non-medicated herbal body care products, namely, creme cleansers, toners, serums, moisturizers and after sun lotions and gels; non-medicated serums for use on face, body, hands, feet; non-medicated skin care creams and lotions; non-medicated sun care preparations for use on face and body; plant and herb extracts sold as components of cosmetics for face and body; private label cosmetics.

(260) AM 2019 97623 A

(800) 1338509

(151) 2016 11 10

(891) 2018 03 21

(731) AB ELECTROLUX

S:t Göransgatan 143, SE-105 45 Stockholm,
Sweden

(540)

AEG

(591) Black, white

(531) 27.05.17; 27.05.23

(511)

7 – Washing machines; combined washing and drying machines; ironing machines; ironing presses; spin driers; dishwashers; food processors; mixers; electronic food slicers; grinders for household purposes; coffee grinders; fruit juicers; milk foamers; electric tin openers; vacuum cleaners, battery driven vacuum cleaners and parts to vacuum cleaners namely hoses, nozzles, tubes, dust bags and filters; tools and implements, namely band saws, table saws, biscuit joiners, buffer/polishers, circular saws, cut-off machines, drill presses, drill drivers, grinders; rotary hammers; demolition hammers; scroll saws; specialty tools and accessories including twist drill bits, hammer drill bits, spade bits, self-feed bits, wood-boring bits, screw and nut driving bits; reciprocating blades; circular saw blades; cutting discs, grinding discs, router bits; router tables.

8 – Hand tools and implements, namely, jig saws; mitre saws; nailers; planers; reciprocating saws; sanders; electric irons.

9 – Telephones and portable phones and accessories; solar power equipment, including solar panels, solar batteries, solar collectors for electricity generation; and parts thereto; data processing devices; data storage media for domestic appliances; computer software; measuring devices, laser levels.

11 – Refrigerators; wine coolers, electric; freezers; cookers; grills; ovens; microwave ovens; air conditioning installations and apparatus; fans; cooker hoods; built-in hobs; water purifying apparatus; drying cabinets; electric coffee brewing machines; espresso machines; egg boilers; air cleaners for household use; humidifiers; toasters; electric waffle irons; hot plates; electrical water kettles; yoghurt preparing apparatus; electric cooking pans; hairdryers; tumble driers; filters for drinking water, filters for air conditions, reverse osmosis filters.

21 – Household and kitchen utensils, namely, manual grinders for household purposes; glassware; porcelain; earthenware; non-electric dusting and cleaning implements; dusting cloths; dusters; non-electric saucepans; ironing tables.

35 – Information to customers in connection with sales of all above mentioned goods; advertising in industry and commerce; shop window dressing.

37 – Maintenance and repair services of white goods and household products.

42 – Development of computer hardware and software.

(260) AM 2019 97624 A

(800) 1400331

(151) 2018 01 12

(891) 2018 01 12

(731) LOTTE Corporation

(Sincheon-dong), 300, Olympic-ro, Songpa-gu, Seoul, Republic of Korea

(540)



(591) Red and white

(531) 26.04.03; 26.04.18; 27.05.21; 27.05.24;
29.01.12

(511)

14 – Gemstones; memorial cups of precious metals; jewelry boxes; shoe jewellery; key rings of precious metals; watchstraps made of leather; watches; horological and chronometric instruments and parts thereof; precious stones; jewellery; paste jewelry [costume jewelry]; precious metals; imitation jewellery; ornaments of precious metal in the nature of jewelry; ornaments of precious metal in the nature of jewelry; cuff links; works of art of precious metal; jewellery and precious metals; watches incorporating mp3 players; watches incorporating cameras.

15 – Tuning apparatus for musical instruments; tuning hammers; tuners for musical instruments; musical instruments; auxiliary articles for musical instruments; electronic musical instruments; instruments for court music; guitars; drums [musical instruments]; digital pianos; recorders being musical instruments; violins; saxophones; western style musical instruments; electric and electronic musical instruments; electric guitars; cellos; pianos; percussion instruments; stringed musical instruments.

16 – Cigar bands; adhesives for household purposes (other than for stationery use); garbage bags of paper or of plastics; silver paper; signboards of paper or cardboard; flags of paper; flower-pot covers of paper; disposable litter pads for use in training puppies; embroidery designs [patterns]; printing paper; toilet paper; correcting ink [heliography]; stationery; plastic film for wrapping; money clips; cream containers of paper; boxes of paper; shopping bags of paper; paper covers for upholstery; paint brushes for coating, covering, or decorating purposes; histological sections for teaching purposes; typewriters, electric or non-electric; bookbinding material; sealing wax; bibs of paper; credit cards without magnetic coding;

printed matter (except books and periodicals); paintings and calligraphic works; figurines [statuettes] of papier mâché; photographic prints; modelling materials; books; industrial packaging containers of paper; adhesives [glues] for stationery or household purposes; stickers; printed matter; typewriters and office requisites [except furniture]; cardboard carriers for food and beverages; plastic materials for packaging; paper patterns; packing (cushioning/stuffing) materials of paper or cardboards.

18 – Portable cosmetic cases (sold empty); labels of leather; clothing for pets; leather; imitation leather; bags; boxes made of leather; bags [envelopes, pouches] of leather for packaging; coverings of leather; straps for skates; umbrellas; canes; feed bags for animals; valves of leather; harness for horses; leashes for guiding children; leather straps; umbrellas and parasols; walking sticks; packaging containers of leather.

21 – Toilet utensils; toothbrushes; cleaning tools and washing utensils (other than electric); decorative glass, not for building; non-electric pots; services [dishes]; apparatus for food and drink processing for household purposes (other than electric); buckets; signboards of porcelain or glass; coal scuttles; non-electronic apparatus for preventing vermin; mouse traps; flower pots; indoor aquaria; cages for household pets; clothes brushes; toilet paper holders; coin banks; ironing boards; rails and rings for towels; boxes of glass; glass caps; bottles (except vases); place mats, not of paper or textile; porcelain ware; dishes or utensils used in memorial services for the deceased; shoe horns; candlesticks; brushes for industrial use; cloths for cleaning spectacles; combs for animals; electric devices for attracting and killing insects; electric make-up removing appliances; portable pots and pans for camping; gloves for household purposes; buttonhooks; bath brushes; material for brush-making; fibreglass other than for insulation or textile use; fibreglass thread other than for insulation or textile use; works of art made of glass; nest eggs, artificial; kitchen utensils; cooking utensils, non-electric; combs and sponges; brushes; sponges; tableware, other than knives, forks and spoons; thermally insulated containers for food and beverages; drinking vessels; bottle openers, electric and non-electric; make-up removing appliances; lint removers, electric or non-electric.

22 – Seaweed for stuffing; snares [nets]; rope ladders; straw for stuffing; sawdust; bags [envelopes, pouches] of textile, for packaging; straw wrappers; tents [not for camping]; hammocks; sails for ship; floats being parts of fishing nets; tents; cocoons; raw cotton fibers; raw silk fibers; raw hemp fibers; raw wool fibers; chemical fibers for textile use; inorganic fibers for textile use; ropes; nets (not of metal or asbestos); textile fibers; padding materials, not of rubber, paper or plastic; tarpaulins.

23 – Yarn and thread for textile purposes; yarn; silk thread and yarn; synthetic microfiber thread; rayon thread and yarn; cotton thread and yarn; semi-synthetic fiber thread and yarn (chemically treated natural fiber yarn); colored threads; angora thread and yarn; synthetic thread and yarn; embroidery thread and yarn; thread for decoration; glass fiber thread and yarn; textile yarns; rubber thread for textile use; fibreglass thread for textile use; paper yarn for textile use; chemical-fiber threads and yarns for textile use; synthetic fiber thread and yarn; mixed thread and yarn.

24 – Tissues of textile for cosmetics; towels for drying dishes; labels of textile; flags of cloth; fitted toilet lid covers of fabric; traced cloths for embroidery; shower curtains; fabrics of imitation animal skins; upholstery of textile; wall hanging scrolls of textile; quilts; shrouds; towels of textile; fabric; knitted fabric; ribbonlike fabrics; fabric felts; draperies (thick drop curtains); bed and table covers; flannel.

25 – Money belts [clothing]; footwear; sportswear; climbing clothes; golfwear; clothes for fishing; overcoats (except for exclusive sportswear and Korean traditional dress); Korean traditional dress (hanbok); under garments; socks; gloves with conductive fingertips that may be worn while using handheld electronic touch screen devices; caps [headwear]; winter face masks (clothing); belts [clothing]; waterproof clothing; anoraks; leotards and tights; uniforms; clothing; panties, shorts and briefs; hosiery.

26 – Hair colouring caps; wigs; competitors' numbers; needle cushions; rug hooks; shoe laces; tapes for curtain headings; needles (not for sewing machines); needles for wool combing machines; sewing machine needles; hair curlers, electric, other than hand implements; cellular phone accessory charms; shoulder pads for clothing; expanding bands for holding sleeves; ribbons and braid; buttons; artificial flowers; embroidery for garments; artificial fruit; laces and embroidery; needles; haberdashery, except thread; hair curlers, other than hand implements.

27 – Pet feeding mats; bath mats; mats made of rush and/or straw; wallpaper; mats; non-slip mats; rugs; rubber mats; floor mats of textiles; floor mats for automobiles; mats for outdoor; play mats for children; floor mats of vinyl; carpets; door mats; non-textile wall hangings; artificial turf; sports mats.

28 – Butterfly nets; toys for pets; ornaments for Christmas trees (except illumination articles and confectionery); apparatus and devices for amusement parks; playthings; dolls; toys; games; sporting articles (other than golf articles/climbing articles); ascenders [mountaineering equipment]; golf clubs; golf balls; golf bags, with or without wheels; golf gloves; golf equipment; fishing tackle; twirling batons; decoys for hunting or fishing; gymnastic and sporting articles.

(260) AM 2019 97625 A

(800) 1400337

(151) 2017 12 01

(891) 2017 12 01

(731) MARLOW FOODS LIMITED

Station Road, Stokesley, North Yorkshire
TS9 7AB, United Kingdom

(540)



(591) Orange, white

(531) 25.03.01; 25.03.03; 26.11.01; 26.11.06;
27.05.03; 27.05.10; 27.05.24; 29.01.12

(511)

5 – Nutritional and dietetic food products for use in body maintenance and weight control for medical purposes, including meal replacement and nutritional drinks in powder mix and liquid form.

16 – Printed matter, books and periodicals concerning the use of protein, including mycoprotein, in food preparation.

29 – Formed textured vegetable protein for use as a meat substitute, including mycoprotein; savouries predominately consisting of vegetables and dairy products and containing protein, including mycoprotein; ready made meals consisting primarily of vegetables or meat substitutes; ready made meals consisting primarily of vegetables or meat substitutes and containing protein, including mycoprotein, including those with vegetables; dietetic and slimming foodstuffs and substances predominately containing vegetables or meat substitutes containing high quantity of protein, including mycoprotein; prepared meals and snacks for human consumption but not included in other classes; prepared frozen foods and meals consisting primarily of vegetables and meat substitutes containing protein, including mycoprotein; dairy products and substitutes therefor; cheese; cheese substitutes; pâtés; nut-based, dairy-based, vegetable-based spreads, margarine and vegetable oils; milk drinks; milk drink substitutes; milk shakes; shakes of milk substitutes; milk shake powder; powdered milk or milk substitutes; desserts made primarily from milk products and milk substitutes and dessert puddings of milk substitutes; desserts; yoghurts.

30 – Prepared meals and snacks for human consumption but not included in other classes; prepared rice dishes; prepared pasta dishes; pastry products; dry seasoning mixes; sandwiches; prepared frozen meals consisting primarily of paste, rice, and cereal; chocolate desserts; dessert puddings; dessert chocolate toppings and topping syrups; mousse confections;

chocolate-based spreads; prepared meals and snacks included in this class; mixes for cheese sauce, mixes for white sauce, mixes for sauces, mixes for cakes, mixes for bread and pizza dough, mixes for cookies, mixes for muffins, mixes for doughnuts; sauces; cooking sauces; prepared frozen meals consisting primarily of flour, rice, pasta, or noodles which include protein, including mycoprotein, and vegetables; dietetic foodstuffs and beverages, not for medical use, namely, bakery goods and chocolate or tea based beverages; dietetic foodstuffs and beverages, not for medical use, namely prepared meals and snacks for human consumption but not included in other classes, prepared rice dishes, prepared pasta dishes, prepared noodle dishes, pizzas, sauces, cooking sauces, processed grains, boxed lunches consisting of rice, boxed lunches consisting of pasta, boxed lunches consisting of noodles and rice crisps, beverages based on chocolate or tea; slimming foodstuffs, not for medical use, namely prepared meals and snacks for human consumption but not included in other classes, prepared rice dishes, prepared pasta dishes, prepared noodle dishes, pizzas, sauces, cooking sauces, processed grains, boxed lunches consisting of rice, boxed lunches consisting of pasta, boxed lunches consisting of noodles and rice crisps, beverages based on chocolate or tea; ice creams; frozen ices; ice deserts; frozen yoghurt; cereal bars; cereal based food bars; confectionery, sweets, toffees; chocolates; chocolate products; chocolate bars; flapjacks; muffins; cakes; cake bars; dessert puddings.

43 – Information and advice concerning cooking protein, including mycoprotein; providing recipe information over a global computer network.

44 – Information and advice concerning dietary and health aspects of using protein, including mycoprotein, for food.

(260) AM 2019 97627 A

(800) 1400376

(151) 2017 12 27

(891) 2017 12 27

(731) MENGHAI TEA FACTORY

(General Partnership)

No. 1 New Tea Road, Menghai Town,
Menghai County, Xishuangbanna Dai
Autonomous Prefecture, Yunnan Province,
China

(540)



(591) Black, white

(531) 01.15.05; 01.15.11; 11.03.14; 26.13.25

(511)

43 – Restaurant services; teahouse; café services; rental of meeting rooms; day-nursery [crèche] services; boarding for animals; rental of chairs, tables, table linen, glassware; rental of cooking apparatus; rental of drinking water dispensers; accommodation bureau services [hotels, boarding houses].

(260) AM 2019 97636 A

(800) 1400562

(151) 2017 11 21

(891) 2017 11 21

(731) OMP Trade GmbH

Ruthensteinstraße 6, A-4522 Sierning, Austria

(540)

FLEDBAG

(591) Black, white

(511)

8 – Agricultural, gardening and landscaping tools.

20 – Valves, not of metal, other than parts of machines.

(260) AM 2019 97637 A

(800) 1400563

(151) 2017 10 09

(891) 2017 10 09

(731) "INNOVATION GREASES

TECHNOLOGY" LIMITED LIABILITY
COMPANY

ul. 40 let VLKSM, 55, RU-400029 Volgograd,
Volgograd region, Russian Federation

(540)

ПОЛИФЛЕКС POLYFLEX

(591) Black, white

(531) 28.05

(511)

4 – Petroleum jelly for industrial purposes; lubricating graphite; cutting fluids; grease for leather; grease for footwear; industrial grease; oils for releasing form work [building]; textile oil; lubricating oil, namely motor oil, hydraulic oil, gear oil, industrial oil, turbine oil, compressor oil, marine oil, diesel oil; aircraft oil, gas-engine oil; industrial oil, namely hardening oil, flushing oil, slideway oil, softening oil for rubber industry, damping fluid; lubricants, namely antifriction grease; oleine; paraffin; grease for arms [weapons].

(260) AM 2019 97638 A
 (800) 1400576
 (151) 2017 12 14
 (891) 2017 12 14
 (731) KREKOTEN YEVHEN
 prospect Myru, 31, apt. 101, Dnipro 49130,
 Ukraine

(540)

MinoX

(591) Black, white
 (531) 27.05.10
 (511)
 3 – Bleaching preparations and other substances for laundry use; cleaning, polishing, scouring and abrasive preparations; non-medicated soaps; perfumery, essential oils, non-medicated cosmetics, non-medicated hair lotions; non-medicated dentifrices.

(260) AM 2019 97639 A
 (800) 1400585
 (151) 2018 02 20
 (891) 2018 02 20
 (731) ADP GAUSELMANN GMBH
 Merkur-Allee 1-15, 32339 Espelkamp,
 Germany

(540)

Joker's Cap

(591) Black, white
 (511)
 9 – Computer software; coin-operated mechanisms; computer and video games software; games software in particular for use on any computer platform, including electronic entertainment and games consoles; computer game programs; video games (software); computer games provided through a global computer network or supplied by means of multi-media electronic broadcast or through telecommunications or electronic transmission or via the internet; computer games, leisure and recreational software, video games and computer software, all being provided in the form of storage media; programs for operating electric and electronic apparatus for games, amusement and/or entertainment purposes; computer software for computer games on the internet; online games (software), in particular for online betting games, online prize games, online gambling games, online games of skill and online casino games; computer software in the form of an app for mobile devices and computers; calculating apparatus in coin-operated machines and parts for the aforesaid goods; electric, electronic, optical or automatic apparatus, for identifying data carriers, identity cards and credit cards, bank notes and coins; software in particular for casino and/or amusement arcade games, for gaming machines and/or slot machines each one with

or without prize payouts; gaming software that generates or displays wager outcomes of gaming machines; operational computer games software; computer software for managing of games (game collection); computer programs for video games; software for managing games (game collections).

28 – Games; toys; gaming apparatus (including coin-operated apparatus); coin-operated arcade games (machines); games for amusement arcades (included in this class); coin-operated video gaming apparatus; video games apparatus adapted for use with external screens or monitors only; casino fittings, namely roulette tables, roulette wheels; coin-operated automatic gaming machines and gaming machines, in particular for gaming arcades, with or without a prize payout; electronic or electrotechnical gaming apparatus, automatic gaming machines, gaming machines, slot machines operated by coins, tokens, banknotes, tickets or by means of electronic, magnetic or biometric storage media, in particular for commercial use in casinos and amusement arcades, with or without a prize payout; automatic gaming machines and gaming machines, in particular for commercial use in casinos and gaming arcades, with or without a prize payout; coin-operated gaming machines and/or electronic money-based gaming apparatus (machines), with or without prizes; housings adapted for gaming machines, gaming apparatus and automatic gaming machines, operated by means of coins, tokens, tickets or by means of electronic, magnetic or biometric storage media, in particular for commercial use in casinos and gaming arcades, with or without a prize payout; electronic games; electronic game entertainment apparatus and parts thereof; video output game machines; drawing apparatus for prize games and lotteries, draws or raffles; housings of metal, plastic and/or wood for coin-operated automatic machines; apparatus for games (including video games), other than adapted for use with external screens or monitors only; electropneumatic and electric slot machines with pulling handles (gaming machines); gaming tables, in particular for table football, billiards, sliding games; flying discs (toys) and darts; gaming machines, namely, electric, electronic or electromechanical apparatus for bingo games, lotteries or video lottery games and for betting offices, connected or unconnected to a computer network; LCD games consoles; automatic gaming machines; all the aforesaid automatic gaming machines operating in networks; apparatus and devices for accepting and storing money, being fittings for the aforesaid automatic machines, included in this class; automatic lottery machines.

(260) AM 2019 97640 A
 (800) 1400614
 (151) 2018 03 01
 (891) 2018 03 01

(731) LABORATORIOS NORMON, S.A.
Ronda de Valdecarrizo, 6, E-28760
Tres Cantos (Madrid), Spain

(540)

NORMOCARE

(591) Black, white

(511)

3 – Bleaching preparations and other substances for laundry use; cleaning, polishing, degreasing and abrasive preparations; non-medicinal soaps; perfumery products, essential oils, non-medicinal cosmetics, non-medicinal hair lotions; non-medicinal dentifrices.

5 – Pharmaceutical products, preparations for medical and veterinary use; sanitary products for medical use; dietetic food and substances for medical or veterinary use, food for babies; food supplements for humans or animals; plasters, material for dressings; teeth filling and dental impression materials; disinfectants; products for destroying vermin; fungicides, herbicides.

(260) AM 2019 97661 A

(800) 1401409

(151) 2018 01 26

(891) 2018 01 26

(731) SHANDONG HONGSHENG RUBBER
TECHNOLOGY CO., LTD.
East Of Shengli Road, West Of Xinggong
Road, Da Wang Town, Guangrao County,
Dongying City, 257336 Shandong Province,
China

(540)

SEULEMENT

(591) Black, white

(531) 27.05.01

(511)

12 – Tires for vehicle wheels; automobile tires; casings for pneumatic tires; spikes for tires; repair outfits for inner tubes; automobile wheels; automobiles; mopeds; trolleys; vehicle chassis.

(260) AM 2019 97665 A

(800) 1401494

(151) 2017 10 19

(891) 2017 10 19

(731) ARIANEGROUP HOLDING
7-11 Quai André Citroën, Tour Cristal,
F-75015 Paris, France

(540)

ARIANE

(591) Black, white

(511)

1 – Chemical products for use in industry and science; unprocessed artificial resins; unprocessed synt-

hetic resins; unprocessed artificial and synthetic mineral resins; unprocessed plastics; fire-extinguishing compositions; adhesives for use in industry; chemical reagents other than for medical or veterinary use.

4 – Fuels (including motor spirits); fuels (propellants); carburants; propellant compositions for rockets.

6 – Common metals and their alloys; building materials of metal; Structured composite materials, essentially with a metal matrix; carbonaceous composite materials, essentially with a metal matrix; laminated materials made of successive layers of elastomers and reinforcing materials of metal or composites; metals plated with explosives; space structures of metal.

7 – Motors and engines (other than for land vehicles); engines for air locomotion vehicles; airplane engines; aircraft engines; space vehicle engines; rocket engines; propulsion systems and mechanisms and their component parts for vehicles (except those for land vehicles); turbines other than for land vehicles; turbocompressors; air nozzles; mixers for aerospace propulsion; blowing machines for the compression, exhaustion and transport of gases; industrialization machines in the field of aeronautics and space; machines for the production of composite or non-composite parts in the field of aeronautics and space; machine tools; machines for producing and repairing parts for use in aeronautical and space propulsion systems; machines and machine tools for the dismantling of materials and equipment containing energetic materials; gas generators.

9 – Scientific apparatus and instruments; measuring apparatus and instruments; control apparatus and instruments; detection apparatus and instruments; apparatus for recording, transmission, reproduction or processing of sound or images; electric sensors; electronic sensors; magnetic sensors; electrical, electronic and magnetic pressure, velocity, displacement, temperature, position or vibration sensors; apparatus and instruments for measuring the mechanical properties of materials; apparatus and instruments for measuring and monitoring the aging of materials; measuring and detection apparatus and instruments for tracking and monitoring the aging of materials; data processing equipment; computers; software (recorded programs); software containing launch calculation codes for aerospace propulsion systems and mechanisms; software for designing, testing, planning and monitoring of installations for the dismantling of materials and equipment containing energetic materials; downloadable computer software applications for mobile telephones; downloadable electronic publications; telecommunication apparatus; satellites; satellites for transportation.

12 – Apparatus for locomotion by air; aircraft; space vehicles; air vehicles; launch vehicles; parts and fit-

tings for all the aforesaid products, except tires; braking devices for air vehicles; airbags for vehicles [airbags]; seat belts as protective devices.

13 – Pyrotechnic products; Pyrotechnic compounds; solid pyrotechnic products for rocket engines; propellant powders and solid propellants; explosive fuses; signal rockets; pyrotechnic transmission cords; pyrotechnic charges; pyrotechnic engines; pyrotechnic gas generators.

17 – Structured composite materials, essentially with a plastic matrix; carbonaceous composite materials, essentially with a plastic matrix; insulating refractory materials; thermal protection systems and heat protection devices in the form of super structures and coatings; heat shields; caulking materials; insulating materials; compositions for preventing the radiation of heat; insulating materials; insulating materials; erosion-resistant thermal protectors, namely, semi-finished products based on synthetic or artificial, mineral or organic resins, resistant to thermal or thermo-mechanical erosion, intended to coat and thermally protect (high temperatures) various structures such as doors, bulkheads, pipes or thruster nozzles.

19 – Non-metallic building materials; structured composite materials, essentially with a ceramic matrix; carbonaceous composite materials, essentially with a ceramic matrix; composite materials with a ceramic matrix; refractory materials.

37 – Construction; construction of buildings relating to the fields of aviation, aerospace and aeronautics; servicing, repair and maintenance of air locomotion vehicles; repair, maintenance and dismantling services in the field of air locomotion vehicles and apparatus, as well as their engines and component parts; servicing and repair of space vehicles; installation, maintenance and repair of data processing equipment; installation, maintenance and repair of telecommunication apparatus; installation, maintenance and repair of satellites; refueling services for air or space vehicles; air-to-air refueling services for air vehicles.

39 – Transport; air transport; travel organization; freighting; rental of space or air vehicles; traffic information; air traffic control services; airport services; GPS navigation services; storage of spacecraft, aircraft, helicopters and planes and their spare parts, for third-parties; satellite launches; launching and placing of third-party satellites in a predetermined orbit; emergency, recovery, towing and rescue services for air locomotion vehicles and apparatus.

42 – Engineering and technical consultancy services (services provided by engineers); analysis and expertise services (engineering works); scientific and industrial research in the fields of aerospace, aviation,

aeronautics, composite materials and energetic equipment; chemical research; technical project studies; testing of machines; testing of materials; flight tests of airplanes, helicopters and spacecraft; testing of aerospace vehicle systems, equipment and parts; technical inspection of systems, equipment and parts of aerospace vehicles; analysis, expertise and processing of the acquisition of technical data recorded during test campaign of systems, equipment and parts of aerospace vehicles (engineering works); design of spatial structures; design, installation, maintenance, update and rental of software; computer programming; design and maintenance of databases; research and development of new products for others.

(260) AM 2019 97671 A
 (800) 1340652
 (151) 2017 02 13
 (891) 2018 03 23
 (731) ACTELION PHARMACEUTICALS LTD
 Gewerbestrasse 16, CH-4123 Allschwil,
 Switzerland
 (540)

GOVANCI

(591) Black, white
 (511)
 5 – Pharmaceutical preparations.

(260) AM 2019 97672 A
 (800) 1365529
 (151) 2017 07 13
 (891) 2018 03 23
 (731) ACTELION PHARMACEUTICALS LTD
 Gewerbestrasse 16, CH-4123 Allschwil,
 Switzerland
 (540)

OPSYNVI

(591) Black, white
 (511)
 5 – Pharmaceutical preparations.

(260) AM 2019 97674 A
 (800) 1375898
 (151) 2017 05 04
 (891) 2018 04 25
 (731) CHRISTOPH GESKES
 Gustav-Heinemann-Ufer 74b, 50968 Köln,
 Germany
 (540)



(591) Black, white

(531) 26.11.12

(511)

35 – Advertising; business management; business administration; clerical services; writing of résumés for others; updating and maintenance of data in computer databases; updating and maintenance of information in registries; updating of advertising material; cost-price analysis; business information; business management and organisation consultancy; consultancy regarding public relations communications strategy; consultancy regarding advertising communications strategy; business management consultancy; personnel management consultancy; advisory services for business management; provision of an on-line marketplace for buyers and sellers of goods and services; providing business information via a web site; procurement services for others [purchasing goods and services for other businesses]; professional business consultancy; business project management services for construction projects; business research; business management of reimbursement programs for others; book-keeping; computerized file management; data search in computer files for others; shop window dressing; import-export agency services; advertising agency services; auctioneering; relocation services for businesses; tax filing services; retail or wholesale services for pharmaceutical, veterinary and sanitary preparations and medical supplies; design of advertising materials; business investigations; compilation of statistics; business efficiency expert services; drawing up of statements of accounts; tax preparation; economic forecasting; providing business information; commercial information and advice for consumers [consumer advice shop]; invoicing; television advertising; photocopying services; business management of performing artists; business management for freelance service providers; business management of sports people; business management of hotels for others; publication of publicity texts; commercial or industrial management assistance; web indexing for commercial or advertising purposes; business information; business intermediary services relating to the matching of potential private investors with entrepreneurs needing funding; commercial administration of the licensing of the goods and services of others; layout services for advertising purposes; payroll preparation; modeling for advertising or sales promotion; marketing; market research; market studies; opinion polling; public relations services; on-line advertising on a computer network; web site traffic optimization; search engine optimisation for sales promotion; arranging of exhibitions and trade fairs for commercial or advertising purposes; organization of fashion shows for promotional purposes; business organization consultancy; outsourced administrative management for companies; outsourcing services [business assistance]; pay per click advertising; emp-

loyment agency services; personnel recruitment; psychological testing for the selection of personnel; bill-posting; business management assistance; presentation of goods on communication media, for retail purposes; price comparison services; production of teleshopping programmes; production of advertising films; registration of written communications and data; radio advertising; news clipping services; word processing; typing; secretarial services; sponsorship search; shorthand; systemization of information into computer databases; telephone answering for unavailable subscribers; telemarketing services; appointment reminder services [office functions]; appointment scheduling services [office functions]; transcription of communications [office functions]; business appraisals; organisation of trade fairs for commercial or advertising purposes; dissemination of advertising matter; scriptwriting for advertising purposes; writing of publicity texts; negotiation of business contracts for others; sales promotion for others; rental of office machinery and equipment; rental of photocopying machines; rental of billboards [advertising boards]; rental of vending machines; rental of sales stands; rental of advertising space; rental of publicity material; rental of advertising time on communication media; negotiation and conclusion of commercial transactions for third parties; arranging subscriptions to telecommunication services for others; provision of commercial and business contact information; arranging newspaper subscriptions for others; commercial intermediation services; advertising by mail order; distribution of samples; dissemination of advertising material (leaflets, brochures, printed matter, samples); document reproduction; administration of consumer loyalty programs; administration of frequent flyer programs; administrative order processing; demonstration of goods; business auditing; compilation of information into computer databases; compiling indexes of information for commercial or advertising purposes.

36 – Insurance services; financial affairs; monetary affairs; real estate affairs; processing of debit card payments; processing of credit card payments; fund investment services; issuance of tokens of value; issuance of credit cards; issuance of travelers' checks; banking; pawnbrokerage; lending against security; providing financial information via a web site; stock exchange quotations; surety services; clearing, financial; brokerage of carbon credits; deposits of valuables; actuarial services; stock brokerage services; real estate brokerage; brokerage; stocks and bonds brokerage; real estate agency services; debt collection agencies; credit bureau services; retirement payment services; savings bank services; provident fund services; organization of collections; securities business; rent collection; electronic funds transfer; fiscal valuation; insurance information; financial information; factoring; fire insurance; financial analysis; financial customs brokerage services; financial con-

sultancy; financial sponsorship; financial evaluation of wool; financial evaluation of standing timber; financial evaluation [insurance, banking, real estate]; financial management of reimbursement payments for others; financing and funding services; currency trading and exchange services; business liquidation services, financial; providing rebates at participating establishments of others through use of a membership card; instalment loans; real estate management; financial investment; health insurance underwriting; hire-purchase financing; life insurance services; mortgage banking; numismatic appraisal; online banking; arranging finance for construction projects; charitable fund raising; stamp appraisal; jewellery appraisal; antique appraisal; real estate appraisal; art appraisal; repair costs evaluation [financial appraisal]; check [cheque] verification; debt advisory services; marine insurance underwriting; bail-bonding; accident insurance underwriting; loans [financing]; rental of offices for co-working; rental of offices; rental of real estate; rental of farms; rental of apartments; mutual funds; insurance brokerage; financial management; trusteeship; insurance consultancy; safe deposit services; apartment house management; accommodation bureau services [apartments].

44 – Medical services; veterinary services; hygienic and beauty care for human beings and animals; agriculture, horticulture and forestry services; aromatherapy services; reforestation services; tree surgery; pharmaceutical consultancy; alternative medicine services; blood bank services; human tissue bank services; midwife services; medical assistance; chiropractic; flower arranging; hair salon services; landscape gardening; hospital services; opticians' services; services of a psychologist; medical services; animal healthcare services; dentistry; aquaculture services; plant nursery services; rest home services; health centre services; health spa services; hospice services; medical clinic services; convalescent home services; public bath services for hygiene purposes; nursing home services; beauty salon services; solarium services; Turkish bath services; visagists' services; aerial and surface spreading of fertilisers and other agricultural chemicals; massage; rehabilitation for substance abuse patients; gardening; garden planning services; health counselling; depilatory waxing; hair implantation; in vitro fertilization services; orthodontic services; pet grooming; nursing, medical; wreath making; artificial insemination services; landscape design; manicuring; medical advice for individuals with disabilities; palliative care; tree planting for carbon offsetting purposes; physiotherapy; body piercing; cosmetic and plastic surgery; lawn care; sauna services; pest control services for agriculture, aquaculture, horticulture and forestry; speech therapy; tattooing; telemedicine services; therapy services; animal day-care services; livestock farming services; vermin exterminating for agriculture, aquaculture, horticulture and forestry; weed killing;

farming equipment rental; medical equipment rental; rental of sanitation facilities; preparation of prescriptions by pharmacists.

(260) AM 2019 97675 A

(800) 1380854

(151) 2017 09 11

(891) 2018 03 05

(731) ROGER KOCH

Mühlackerstrasse 80a, CH-9436 Balgach,
Switzerland

(540)

Heimat

(591) Black, white

(511)

34 – Tobacco; smokers' articles; matches.

(260) AM 2019 97716 A

(800) 1401628

(151) 2017 12 29

(891) 2017 12 29

(731) OMV Refining & Marketing GmbH

Trabrennstraße 6-8, A-1020 Wien, Austria

(540)

REOIL

(591) Black, white

(511)

4 – Fuels; carburants; lighting fuel; lubricants; industrial oils and greases.

37 – Installation, maintenance and repair of industrial machinery; rental, hire and leasing of objects in connection with the provision of the aforesaid services, Included in this class; advice, consultancy and information relating to the aforesaid services, included in this class.

40 – Treatment of materials using chemicals; treatment and processing of plastic materials; waste treatment [transformation]; refining services; rental, hire and leasing of objects in connection with the provision of the aforesaid services, included in this class; advice, consultancy and information relating to the aforesaid services, included in this class.

41 – Training relating to the treatment of plastic materials as well as the transformation of plastic materials into raw materials; arranging and conducting of conferences and seminars relating to the treatment of plastic materials as well as the transformation of plastic materials into raw materials.

42 – Scientific and technological services; engineering services; technical measuring and testing; quality checking and testing; providing information and data relating to scientific and technological research and development; rental, hire and leasing of objects in connection with the provision of the aforesaid

services, included in this class; advice, consultancy and information relating to the aforesaid services, included in this class.

45 – Licensing services; licensing of research and development [legal services]; licensing of technology; rental, hire and leasing of objects in connection with the provision of the aforesaid services, included in this class; advice, consultancy and information relating to the aforesaid services, included in this class.

(260) AM 2019 97717 A

(800) 1401634

(151) 2018 02 05

(891) 2018 02 05

(731) "SPAYKA" LLC

Nerkin Shengavit, 3rd str., 42, 0074 Yerevan, Armenia

(540)

SAMBIEL

(591) Black, white

(511)

29 – Fruit, preserved; charcuterie; jams; frozen fruits; vegetables, preserved; vegetables, cooked; vegetables, dried; oils for food; cream [dairy products]; cheese; butter; crystallized fruits; milk; fruit, stewed; fruit jellies; fruit pulp; meat; meat jellies; fat-containing mixtures for bread slices; ham; yogurt; vegetable juices for cooking; kephir [milk beverage]; milk beverages, milk predominating; whey; milk products; bacon; margarine; nuts, prepared; liver pâté; olives, preserved; sausages; tomato purée; vegetable salads; fruit salads; tomato juice for cooking; tripe; fruit peel; almonds, ground; peanuts, prepared; mushrooms, preserved; fruit chips; fruit preserved in alcohol; meat, preserved; whipped cream; pork; fruits, canned; meat, canned; vegetables, canned; apple purée; fruit-based snack food; curd; milk shakes; albumin milk; compotes; condensed milk; smetana [sour cream]; ryazhenka [fermented baked milk]; prostokvasha [soured milk]; tomato paste; aubergine paste; vegetable marrow paste; powdered milk; candied nuts; flavored nuts; hazelnuts, prepared; berries, preserved; vegetable-based cream; freeze-dried vegetables; hotdog sausages.

30 – Cocoa beverages with milk; coffee beverages with milk; chocolate beverages with milk; sauces [condiments]; coffee-based beverages; frozen yogurt [confectionery ices]; dressings for salad; fruit coulis [sauces]; pasta sauce.

31 – Raw and unprocessed agricultural, aquacultural, horticultural and forestry products; berries, fresh; nuts [fruits]; citrus fruit, fresh; mushrooms, fresh; lemons, fresh; cucumbers, fresh; vegetables, fresh; fruit, fresh; plants; oranges, fresh; grapes, fresh; almonds [fruits]; peanuts, fresh.

32 – Non-alcoholic fruit juice beverages; whey beverages; fruit juices; waters [beverages]; mineral water [beverages]; table waters; vegetable juices [beverages]; tomato juice [beverage]; non-alcoholic beverages; aerated water; cocktails, non-alcoholic; cider, non-alcoholic; fruit nectars, non-alcoholic; smoothies; protein-enriched sports beverages; non-alcoholic beverages flavored with coffee; non-alcoholic beverages flavored with tea; soft drinks.

(260) AM 2019 97718 A

(800) 1401676

(151) 2018 03 23

(891) 2018 03 23

(731) IRISH DISTILLERS LIMITED

Simmons Court House, Simmons Court Road – Ballsbridge, Dublin 4, Ireland

(540)

JAMESON

(591) Black, white

(511)

32 – Beers; flavored beers; aerated water; mineral water; non-alcoholic beverages; fruit beverages and fruit juices; syrups for making beverages; preparations for making beverages.

(260) AM 2019 97731 A

(800) 1402152

(151) 2018 02 19

(891) 2018 02 19

(731) AUGUST STORCK KG

Waldstraße 27, 13403 Berlin, Germany

(540)



(591) Green, pink, orange and white

(531) 05.01.05; 05.01.12; 05.01.16; 27.01.12; 27.03.11; 27.05.02; 27.05.08; 27.05.17; 29.01.14

(511)

30 – Confectionery; chocolate; chocolate products; pastries; ice-cream; preparations for making the aforementioned products, included in this class.

(260) AM 2019 97732 A

(800) 1402230

(151) 2018 01 12

(891) 2018 01 12

(731) LOTTE Corporation

(Sincheon-dong), 300, Olympic-ro, Songpa-gu, Seoul, Republic of Korea

(540)



(591) Red and white

(531) 26.04.03; 26.04.04; 26.04.18; 27.05.21;
27.05.24; 29.01.12

(511)

1 – Fertilizers; starch for industrial purposes; industrial chemicals; adhesives for industrial purposes; artificial sweeteners [chemical preparations]; microorganisms, other than for medical and veterinary use; plant nutrition preparations; ceramic glazings; graphite for industrial purposes; birdlime; chemical test paper; unprocessed plastics; paper pulp; silicones; chemical preparations for use in photography; hydraulic oils; antifreeze; compositions for the manufacture of technical ceramics; industrial by-products generated during the processing of cereals; chemicals for use in photography; chemicals for use in forestry; unprocessed artificial resins; preparations of microorganisms, other than for medical and veterinary use; scientific chemicals; horticultural chemicals, except fungicides, herbicides, insecticides and parasiticides; agricultural chemicals, except fungicides, herbicides, insecticides and parasiticides; metalloids.

2 – Natural resins, raw; protective preparations for metals; wood preservatives; anti-corrosive preparations; tattoo inks; dyes; pigments; coatings [paints]; colorants for use in the manufacture of paint; distempers; oil paints; synthesized resin paints; varnishes; lacquers; paper for dyeing Easter eggs; printers' pastes [ink]; colors for drawing pictures; anti-rust oils; colorants; paints.

3 – Food flavorings [essential oils]; bleaching preparations for laundry; starch for laundry; cosmetics; perfumery; beauty masks; adhesives for affixing wigs; cleaning preparations; beauty soap; dentifrices; shoe polish; refurbishing preparations; cosmetics for animals; pre-moistened cleansing tissues; abrasives; polishing preparations; laundry preparations; toiletry preparations; scouring preparations; essential oils; adhesive for artificial eyelashes, hair and nails.

4 – Industrial oils and fats; dust absorbing, wetting and binding compositions; grease for footwear; leather-preserving oils and greases; wicks for oil lamps; electrical energy; solid fuels; gaseous fuels; liquid fuels; industrial oil; wax [raw material]; nightlights [candles]; candles; industrial wax; tealights; scented candles; fuel for lighters; tinder; fuel; candles and wicks for lighting.

11 – Medical sterilizer; dental ovens; non-electric water purifiers for household purposes; ice boxes (except for portable); gas ranges; sinks; luminous house numbers; pocket warmers; aquarium filtration apparatus; toilet bowls; heaters for heating irons; showers; tanning apparatus [sun beds]; heating apparatus; refrigerating apparatus and installations (other than for vehicles); ventilators; non-electric lighting apparatus and devices; washers for water taps; water supply installations; toilets, portable; heating apparatus and devices for laboratory use; heating and cooling systems for ships; heating and cooling systems for aircrafts; heating and cooling systems for railway vehicles; heating and cooling systems for motor cars, not being parts of engines or motors; lighting apparatus and devices for bicycles; heat guns; drying apparatus for agricultural use; air purifying apparatus and machines; apparatus for dehydrating food waste; beverage cooling apparatus; industrial furnaces; cooling installations for tobacco; safety accessories for water or gas apparatus and pipes; electric lighting apparatus; electric heating and cooling systems for household purposes; hair dryers for household purposes; gas lighters; ice-cooling refrigerators for household purposes; heating apparatus for vehicles; lighting apparatus for vehicles; cooking apparatus and installations; cookers; footwarmers, electric or non-electric; coils (parts of distilling/heating or cooling installations); taps [faucets]; whirlpool-jet apparatus; heating and air conditioning apparatus; ventilating apparatus; apparatus for heating/ventilating and air conditioning; air washers; water purifiers for household purposes; freezers.

17 – Adhesive tapes (other than stationery and not for medical or household or electrical insulating purposes); mica, raw or partly processed; foam supports for flower arrangements [semi-finished products]; asbestos paper; plastic film, other than for wrapping; raw rubber; rubber pouches for packaging; rubber stoppers; washers of rubber; non-conducting materials for retaining heat; fire curtains of asbestos; shock-absorbing buffers of rubber; packing [cushioning, stuffing] materials of rubber or plastics; electrical insulating materials; electrical insulating tapes; insulating gloves; chemical fiber (not for textile use); inorganic fiber (not for textile use); chemical-fiber threads and yarns (not for textile use); asbestos fabrics; asbestos felt; cords of rubber; asbestos nets; statuettes of rubber; non-metallic flexible pipes; packing, stopping and insulating materials.

20 – Umbrella stands; unworked or semi-worked coral; baskets, not of metal; signboards of wood or plastics; poles, not of metal; memorial cups of plastic; stakes, not of metal, for plants or trees; kennels for household pets; steps [ladders], not of metal; embroidery frames; bathtub grab bars, not of metal; reeds [plaiting materials]; bamboo materials (not for

building); cane, unworked or semi-worked; Japanese food wrapping sheets of wood (kyogi); animal bone (unworked or partly worked material); casks, not of metal; wood boxes; plastic mailing tubes; plugs (dowels) not of metal; furniture; indoor blinds; picture frames; mail boxes, not of metal or masonry; bedding, except linen; coffin fittings; shoe dowels, not of metal; hand-held flat fans; non-metal fasteners, namely, nails; locks, other than electric, not of metal; saw horses; non-metal door fittings; mirror tiles; draughtsman's tables; hairdressers' chairs; loading gauge rods, not of metal, for railway waggons [wagons]; transport pallets, not of metal; mooring buoys, not of metal; fodder racks; beehives; valves, not of metal, other than parts of machines; gun racks; infant walkers; camping furniture; fishing chairs; works of art of wood, wax, plaster or plastic; mannequins; bed and mattress.

(260) AM 2019 97736 A

(800) 1402334

(151) 2017 10 03

(891) 2017 10 03

(731) WIZZ AIR HUNGARY KFT.

Kőér u. 2/A B. ép. II-V, H-1103 Budapest,
Hungary

(540)



(591) Black, white

(531) 27.05.02

(511)

10 – Ear plugs.

16 – Paper and paper products; pens; pencils; stationery; gift stationery; colouring books; colouring pencils; pastels [crayons]; printed gift vouchers, not encoded; magazines [periodicals]; inflight magazines; printed periodicals in the field of tourism; printed advertisements; brochures, printed matter.

18 – Baggage, travel baggage.

20 – Cushions; inflatable pillows; neck support cushions, not for medical purposes; inflatable neck support cushions.

24 – Lap blankets; travelling rugs [lap robes]; bed blankets.

25 – Clothing; footwear; headgear; sports headgear [other than helmets]; sports clothing; sports footwear; sleep masks.

28 – Toys; toy aircraft; inflatable toys resembling air vehicles; toy dolls; toys, games, playthings and novelties; sporting articles and equipment.

35 – Retail services in relation to toiletries; retail services relating to jewellery; retail services in relation to toys; retail services in relation to watches; retail services in relation to electronic devices; loyalty scheme services; management of customer loyalty, incentive or promotional schemes; advertising; magazine advertising; providing advertising space in periodicals, newspapers and magazines; online advertising; preparing advertisements for others; dissemination of advertising matter.

36 – Contributory benefit scheme services; bail bonding services; issuance of coupons of value; issuance of electronic payment cards in connection with bonus and reward schemes; issuance of vouchers; issuance of travel vouchers; issuance of tokens of value in the nature of gift vouchers; issuance of payment gift vouchers; provision of loans; instalment loans; financing of personal loans.

39 – Airline services; transport; transport of passengers; transport of goods; travel arrangements; travel booking agency services; organising of travel tours; operating of travel tours; airline transport; priority boarding, check-in, seating and reservation services for frequent air travellers; booking of air tickets; airline bookings; airline ticket services; booking of airport parking; booking and arranging of access to airport lounges; car parking; car parking [valet] services; vehicle parking and storage; car rental; rental of car parking spaces; providing information relating to car rental services.

41 – Entertainment; magazine publishing; publication of electronic magazines; training; pilot and cabin crew training; training services provided via simulators.

43 – Food and drink catering; temporary accommodation; hotel reservations; hotel information; hotel services; booking of hotel accommodation; hotels, hostels and boarding houses, holiday and tourist accommodation.

(260) AM 2019 97737 A

(800) 1402339

(151) 2017 10 03

(891) 2017 10 03

(731) WIZZ AIR HUNGARY KFT.

Kőér u. 2/A B. ép. II-V, H-1103 Budapest,
Hungary

(540)

WIZZAIR

(591) Black, white

(511)

10 – Ear plugs.

16 – Paper and paper products; pens; pencils; stationery; gift stationery; colouring books; colouring pencils; pastels [crayons]; printed gift vouchers, not en-

coded; magazines [periodicals]; inflight magazines; printed periodicals in the field of tourism; printed advertisements; brochures, printed matter.

18 – Baggage, travel baggage.

20 – Cushions; inflatable pillows; neck support cushions, not for medical purposes; inflatable neck support cushions.

24 – Lap blankets; travelling rugs [lap robes]; bed blankets.

25 – Clothing; footwear; headgear; sports headgear [other than helmets]; sports clothing; sports footwear; sleep masks.

28 – Toys; toy aircraft; inflatable toys resembling air vehicles; toy dolls; toys, games, playthings and novelties; sporting articles and equipment.

35 – Retail services in relation to toiletries; retail services relating to jewellery; retail services in relation to toys; retail services in relation to watches; retail services in relation to electronic devices; loyalty scheme services; management of customer loyalty, incentive or promotional schemes; advertising; magazine advertising; providing advertising space in periodicals, newspapers and magazines; online advertising; preparing advertisements for others; dissemination of advertising matter.

36 – Contributory benefit scheme services; bail bonding services; issuance of coupons of value; issuance of electronic payment cards in connection with bonus and reward schemes; issuance of vouchers; issuance of travel vouchers; issuance of tokens of value in the nature of gift vouchers; issuance of payment gift vouchers; provision of loans; instalment loans; financing of personal loans.

39 – Airline services; transport; transport of passengers; transport of goods; travel arrangements; travel booking agency services; organising of travel tours; operating of travel tours; airline transport; priority boarding, check-in, seating and reservation services for frequent air travellers; booking of air tickets; airline bookings; airline ticket services; booking of airport parking; booking and arranging of access to airport lounges; car parking; car parking [valet] services; vehicle parking and storage; car rental; rental of car parking spaces; providing information relating to car rental services.

41 – Entertainment; magazine publishing; publication of electronic magazines; training; pilot and cabin crew training; training services provided via simulators.

43 – Food and drink catering; temporary accommodation; hotel reservations; hotel information; hotel services; booking of hotel accommodation; hotels, hostels and boarding houses, holiday and tourist accommodation.

(260) AM 2019 97747 A

(800) 1402635

(151) 2017 12 05

(891) 2017 12 05

(731) Dochirnie pidpriemstvo "KONDYTERSKA KORPORATSIIA "ROSHEN"
Elektrykiv vul., 26/9, Kyiv 04176, Ukraine

(540)

ZOO-BOOM Roshen

(591) Black, white

(511)

30 – Peanut confectionery; pastries; waffles; cookies; cake frosting [icing]; frozen yoghurt [confectionery ices]; caramels [candy]; confectionery; crackers; liquorice [confectionery]; marzipan; almond confectionery; dessert mousses [confectionery]; chocolate mousses; peppermint sweets; stick liquorice [confectionery]; pastilles [confectionery]; petits fours [cakes]; pies; pralines; candy decorations for cakes; chocolate decorations for cakes; cakes; gingerbread; biscuit rolls; sweetmeats [candy]; sorbets [ices]; petit-beurre biscuits; fruit jellies [confectionery]; halvah; candy; chocolate.

(260) AM 2019 97816 A

(800) 1402690

(151) 2018 01 17

(891) 2018 01 17

(731) ER-MED MEDİKAL GEREÇLERİ SANAYİ
İÇ VE DIŞ TİCARET LİMİTED ŞİRKETİ
Kazımkarabekir Caddesi İsmail, Türk İş
Merkezi Kat: 2 No: 6-7, ERZURUM, Turkey

(540)



(591) Black, white blue

(531) 25.07.20; 27.05.11; 29.01.04

(511)

35 – Advertising; business management; business administration; office functions.

40 – Treatment of materials.

44 – Medical services; veterinary services; hygienic and beauty care for human beings or animals; agriculture, horticulture and forestry services.

(260) AM 2019 97820 A

(800) 1402711

(151) 2018 01 12

(891) 2018 01 12

(731) ALPEN PHARMA AG
Casinoplatz 2, CH-3011 Bern,
Switzerland

(540)



(591) Black, white
(531) 01.15.21; 24.17.02; 26.04.05; 26.04.06;
26.04.13; 26.04.24; 27.05.01

(511)

5 – Pharmaceutical products, medical and veterinary preparations; sanitary products for medical purposes; dietetic food and substances for medical or veterinary use, food for babies; food supplements for humans and animals; plasters, materials for dressings; material for dental fillings and dental impressions; disinfectants; products for destroying vermin; fungicides, herbicides.

(260) AM 2019 97834 A

(800) 1403051

(151) 2018 03 01

(891) 2018 03 01

(731) LABORATORIOS NORMON, S.A.
Ronda de Valdecarrizo, 6, E-28760 Tres
Cantos (Madrid), Spain

(540)

DERATIN

(591) Black, white

(511)

5 – Pharmaceutical products, preparations for medical and veterinary use; hygiene and sanitary products for medical use; dietetic food and substances for medical or veterinary use, food for babies; food supplements for humans or animals; plasters, material for dressings; teeth filling and dental impression materials; disinfectants; products for destroying vermin; fungicides, herbicides.

(260) AM 2019 97835 A

(800) 1403150

(151) 2017 11 30

(891) 2017 11 30

(731) Obschestvo s ogranichennoy
otvetstvennostyu "NATSIONALNYE
ALKOGOLNYE TRADITSII"
Schosseynaya ul., d. 1, corp. 1, pom. III, kab.
22, RU-109548 Moscow, Russian Federation

(540)

MOROZOFF

(591) Black, white

(531) 27.05.01; 27.05.17

(511)

33 – Aperitifs; arrack [arak]; baijiu [Chinese distilled alcoholic beverage]; brandy; wine; piquette; whisky; vodka; anisette [liqueur]; kirsch; gin; digesters [liqueurs and spirits]; cocktails; curacao; anise [liqueur]; liqueurs; pre-mixed alcoholic beverages, other than beer-based; alcoholic beverages, except beer; alcoholic beverages containing fruit; spirits [beverages]; distilled beverages; mead [hydromell]; peppermint liqueurs; bitters; rum; sake; perry; cider; rice alcohol; alcoholic extracts; fruit extracts, alcoholic; alcoholic essences.

(260) AM 2019 97843 A

(800) 1403357

(151) 2017 11 24

(891) 2017 11 24

(731) MATARACI BMB ULUSLARARASI
NAKLIYE İNŞAAT VE LOJİSTİK
HİZMETLERİ İÇ VE DIŞ TİCARET
LİMİTED ŞİRKETİ
Eminettin Mah. Menderes Bulv., Yavuz
Plaza K:9 No:804 Rize, Merkez, Turkey

(540)

MANAMO

(591) Black, white

(531) 27.05.17

(511)

24 – Woven or non-woven textile fabrics; textile goods for household use, not included in other classes: curtains, bed covers, sheets (textile), pillowcases, blankets, quilts, towels; flags, pennants, labels of textile; swaddling blankets; sleeping bags for camping.

35 – Advertising, marketing and public relations; organization of exhibitions and trade fairs for commercial or advertising purposes, design for advertising; provision of an online marketplace for buyers and sellers of goods and services; office functions, secretarial services, arranging newspaper subscriptions for others, compilation of statistics, rental of office machines, systemization of information into computer databases, telephone answering for unavailable subscribers; business management, business administration and business consultancy; accounting; commercial consultancy services, personnel recruitment, personnel placement, employment agencies, import-export agencies, temporary personnel placement services; auctioneering; the bringing together, for the benefit of others, of a variety of goods, namely woven or non-woven textile fabrics, textile goods

ods for household use, curtains, bed covers, sheets (textile), pillowcases, blankets, quilts, towels, flags, pennants, labels of textile, swaddling blankets, sleeping bags for camping enabling customers to conveniently view and purchase those goods, such services may be provided by retail stores, wholesale outlets, by means of electronic media or through mail order catalogues.

(260) AM 2019 97844 A

(800) 1403360

(151) 2017 12 29

(891) 2017 12 29

(731) LENZING AKTIENGESELLSCHAFT

Werkstr. 2, A-4860 Lenzing, Austria

(540)

VEOCEL

(591) Black, white

(511)

3 – Make-up removing preparations; anti-static dryer sheets; baby wipes; polish for furniture and flooring; skin cleansing cream [non-medicated]; personal deodorants; scented sachets; disposable wipes impregnated with cleansing compounds for use on the face; anti-wrinkle cream; grease-removing preparations; pre-moistened cosmetic wipes; non-medicated moisturisers; moist wipes impregnated with cleansing or cosmetic preparations for personal hygiene and cosmetic purposes; foot masks for skin care; facial masks; face scrubs (non-medicated -); cleaning masks for the face; facial cleansers [cosmetic]; facial wipes impregnated with cosmetics; facial washes [cosmetic]; hand masks for skin care; skin conditioners; skin masks [cosmetics]; skin conditioning creams for cosmetic purposes; skin care preparations; skin care creams, other than for medical use; wrinkle removing skin care preparations; skin cleansing cream; skin cleansing lotion; skin cleansers [non-medicated]; impregnated tissues for cleaning [non-medicated, for use on the person]; body masks; toiletry preparations; facial care preparations; skin cleansers [cosmetic]; nail varnish remover [cosmetics]; wrinkle-minimizing cosmetic preparations for topical facial use; patches containing sun screen and sun block for use on the skin; cologne impregnated disposable wipes; wiping cloth impregnated with a cleaning preparation for cleaning eye glasses; cloths impregnated with a detergent for cleaning; wipes impregnated with a skin cleanser; cloths impregnated with polishing preparations for cleaning; pre-moistened towelettes impregnated with a detergent for cleaning; cloths impregnated with a detergent for cleaning; wipes incorporating cleaning preparations; nail varnish removers; non-medicated body care preparations; perfumed tissues; exfoliating scrubs for the face; exfoliants for the care of the skin; exfoliants for the cleansing of the skin; exfoliating scrubs for cosmetic purposes; polishing preparations; pores

tightening mask packs used as cosmetics; fabric conditioning preparations; refurbishing preparations; cleaning and fragrancing preparations; cleansing masks; refurbishing preparations; feminine hygiene cleansing towelettes; grinding preparations; cosmetic masks; face packs; beauty care cosmetics; self-tanning preparations [cosmetics]; shampoo; tissues impregnated with essential oils, for cosmetic use; tissues impregnated with make-up removing preparations; cotton wool for cosmetic purposes; cotton sticks for cosmetic purposes; fabric softener for laundry.

5 – Dental impression materials; absorbent articles for personal hygiene; absorbent diapers of cellulose for pets; alcohol swabs for wound care; drug delivery agents in the form of edible wafers for wrapping powdered pharmaceuticals; drug delivery agents that facilitate the delivery of pharmaceutical preparations; medicinal creams for the protection of the skin; processed human donor skin for the replacement of soft tissue; dissolvable strips to stop bleeding from minor cuts and grazes; eyepatches for medical purposes; eye pads for medical use; eye bandages for medical use; surgical implants grown from stem cells [living tissues]; nappies for babies and incontinents; babies' diaper-pants; babies' diapers; babies' diapers of cellulose or paper; disposable babies' diapers of paper and cellulose; fibre (dietary -); bandages for dressings; cotton for medical use; bandages for making casts; surgical bandages; surgical implants comprised of living tissues; surgical plasters; medical and surgical dressings; sanitary towels; feminine hygiene products; dental materials for stopping the teeth; dental materials for making models of teeth; dental materials for duplicating models of teeth; deodorants for clothing and textiles; sanitizers for household use; disinfectants for hygiene purposes; disinfectants for medical apparatus and instruments; disinfectants for medical instruments; disinfectants for medical use; disinfectants for dental apparatus and instruments; sanitizing wipes; disinfectant swabs; shoe deodorizers; diagnostic preparations; diagnostic agents for pharmaceutical use; diagnostic substances for medical use; triangular-shaped napkins [paper] for babies; embedding material for dental use; nappy liners of paper for incontinents; nappy liners of cellulose for incontinents; disposable liners of cellulose for napkins; disposable liners for incontinence diapers; disposable pants of paper for holding a babies napkin in place; disposable pants of cellulose for holding a babies' napkin in place; disposable pads for incontinence; disposable nappies made of paper for incontinents; disposable swim diapers for babies; disposable swim diapers for children and infants; disposable training pants [diapers]; disposable napkins for incontinents; elastic bandages [dressings]; first aid kits for domestic use; first aid dressings; wipes for medical use; moist wipes impregnated with a pharmaceutical lotion; lining materials

for dental purposes; gauze; shaped napkins of paper for babies; shaped napkins of cellulose for babies; gels for dermatological use; odour absorbing materials; odour neutralizing preparations for clothing and textiles; tissues for surgical use; belts for sanitary napkins [towels]; haemostatic pencils; adhesive bandages; hemostatics for medical purposes; skin care creams for medical use; skin care preparations for medical use; skin grafts; adhesive plasters; adhesive bands for medical purposes; corn rings for the feet; sanitary wear; sanitary preparations for medical purposes; hygienic preparations for veterinary use; implants comprising living tissue; implants for guided tissue regeneration; implantable textile material to encourage the growth of tissue; impregnated medicated wipes; incontinence garments; incontinence pads; disposable nappies made of cellulose for incontinents; pants, absorbent, for incontinents; nappy pants for incontinents; tapes for strapping [medical]; adhesive bands for medical purposes; tapes for varicose veins; adhesive dressings; dental resin for temporary bridges, crowns and veneers; compresses; tisanes [medicated beverages]; materials for surgical casts; material for repairing teeth; implantable materials for use in guided tissue regeneration; materials for dressings; material for dental prostheses; materials for artificial teeth; material for dental bridges; material for dental crowns; materials for dressing wounds; medicated plasters; medical diagnostic test strips; diagnostic reagents for medical use; face scrubs (medicated -); skin care lotions [medicated]; medical adhesives for binding internal tissue; medical adhesives for binding wounds; medicated hand-wash; medicated swabs; sanitary pads; impregnated medicated pads; cleaning cloths impregnated with disinfectant for hygiene purposes; moist paper hand towels impregnated with a pharmaceutical lotion; impregnated pads containing medicated preparations; sanitary pads; sanitary pants; paper (mothproof -); gauze compresses; mediums (bacteriological culture -); nutritional supplements; ear bandages; oiled paper for medical purposes; paper for mustard poultices; paper liners for diapers; paper diapers; scrubs [preparations] for medical use; plasters, materials for dressings; bunion pads; plasters incorporating a magnet; pharmaceutical implants; pharmaceutical preparations for skin care; pharmaceutical preparations for dental use; pharmaceutical preparations for wounds; absorbent sanitary articles; absorbent diapers of paper for pets; cotton wool for medical use; sponge material for healing wounds; babies' swim diapers; mustard poultices; pantyliners; sanitary panty liners; pant liners for incontinents; sterilized dressing; breast-nursing pads; synthetic materials for dental use for fillings; synthetic material for use in setting bones; synthetic material for use in producing casts; tampons; tampons for medical purposes; test strips for measuring blood glucose levels; transdermal patches; transdermal patches for medical treat-

ment; wipes for medical use; tissues impregnated with antibacterial preparations; tissues impregnated with insect repellants; disinfectants impregnated into tissues; tissues impregnated with pharmaceutical lotions; swabs for medical use; sanitary wear; bandages for skin wounds; bandages for the prevention of blisters; gauze for dressings; first-aid boxes, filled; dressings, medical; dressing retention materials; medical dressings, coverings and applicators; surgical dressings; absorbent cotton; dental composite materials; cotton wool for surgical use; wadding for medical purposes; cotton wool for pharmaceutical purposes; cotton wool in the form of sticks for medical use; disposable training pants of paper for infants; disposable training pants of paper or cellulose; disposable training pants; disposable adult diapers; babies' disposable diaper pants of paper; babies' disposable diaper pants of cellulose; disposable diapers; disposable babies' diaper-pants; nappies of paper for incontinents; adult diapers; diapers for pets; incontinence diapers; vulnerary sponges; wound dressings; teeth filling material; dental mastics; dental preparations and articles; diapers made of cellulose; disposable training pants of cellulose for infants; alcohol swabs for medical purposes; antiseptic liquid bandages; antiseptic preparations for wound care; cleaning cloths for incontinents.

9 – Cases adapted for CD players; cases adapted for DVD players; cases adapted for photographic equipment; respirators for filtering air; battery separators; spectacle cases; camcorder cases; cases for digital media players; camera casings; cases for children's eye glasses; cases for contact lenses; cases adapted for mobile phones; lens cases; cases for PDAs; cases for pocket calculators; cases for telephones; cases fitted with dissecting instruments for scientific or research purposes; cases fitted with dissecting instruments, not for medical use; clothing for protection against fire; fire-resistant flying suits; fire resistant gloves; fireproof automobile racing suits for safety purposes; fire blankets; clothing for protection against fire; filters for respiratory masks; respiratory mask filters [non-medical]; helmets for motorcyclists; laboratory filters; advertising display signs [mechanical or luminous]; safety nets; footwear for protection against fire; protective and safety equipment; flame-retardant balaclavas; boots for protection against fire; clothing for protection against accidents, irradiation and fire.

10 – Breast shields; incontinence bed pads; medical drapes of non-woven textile materials; haemostats; surgical mesh comprised primarily of artificial materials; medical furniture and bedding, equipment for moving patients; blankets for medical purposes; cushions for medical purposes; incontinence mattress protectors; incontinence sheets; incontinence sheets for use with babies; incontinence sheets for use with infants; pillows (soporific -) filled with

down; pillows for orthopedic use; pillows for therapeutic use; sheets [drapes] for medical use; medical clothing; disposable protective gloves for medical purposes; gloves for medical purposes; gloves for use in hospitals; medical compression stockings; surgical mesh comprised primarily of artificial materials; knee supports for medical use.

16 – Tissues of paper for removing make-up; paper identification tags; stickers [stationery]; stickers [decalcomanias]; printed packaging materials of paper; printed advertising boards of paper; printed advertising boards of cardboard; containers of paper for packaging purposes; writing tablets; bags made of paper for packaging; pamphlets; decorative paper bows for wrapping; decorative wrapping paper; printed matter; pencil boxes; cases for stationery; flags of paper; humidity control sheets of paper or plastic for foodstuff packaging; filtering materials of paper; filter paper; sheets of reclaimed cellulose for wrapping; printed brochures; printed calendars; periodicals; printed promotional material; geographical maps; paper gift tags; gift wrap paper; coarse tissue [for toiletry use]; adhesive wall decorations of paper; envelopes [stationery]; annuals [printed publications]; filters (paper coffee -); calendars; cardboard packaging; small blackboards; crepe paper; crepe paper for domestic use; ball pens; plastic film for packaging; note pads; notebooks; paper impregnated with oil for wrapping purposes; cartons of cardboard for packaging; plastic materials for packaging; paper for use in the manufacture of tea bags; paper for wrapping and packaging; paper for use in the manufacture of wallpaper; paper wipes; labels of paper; paper banners; paper filters for coffee makers; paper handtowels; paper emblems; paper sacks; paper towels; facial tissues of paper; bags made of paper for packaging; paper pennants; posters; postcards; prospectuses; absorbent sheets of paper or plastic for foodstuff packaging; bows for decorating packaging; tissue paper for use as material of stencil paper (ganpishi); bags made of paper for packaging; bags and articles for packaging, wrapping and storage of paper, cardboard or plastics; paper tissues; tissue paper; hygienic paper; paper tissues for cosmetic use; book covers; industrial packaging containers of paper; containers of card for packaging; packaging containers of regenerated cellulose; bags [envelopes, pouches] of paper or plastics, for packaging; films for wrapping foodstuffs; packing cardboard; cartons of cardboard for packaging; adhesive packaging tapes; fiberboard boxes; plastic materials for packaging; wrapping materials made of paper; packaging materials made of cardboard; packaging materials made of recycled paper; packaging material made of starches; packaging materials; wrapping paper; cartons of cardboard for packaging; cartons of cardboard for packaging; bags made of paper for packaging; viscose sheets for wrapping; Christmas cards; promotional publications; promotional publications;

signboards of paper or cardboard; advertisement boards of card; advertisement boards of card; cellulose wipes; disposable pads for house-training pets; disposable housebreaking pads for use in training puppies.

17 – Acoustical insulation barrier panels; electrical insulation articles and materials; acoustic insulation articles and materials; thermal insulation articles and materials; treated papers for insulating; chemical fibres not for textile use; insulation sheets; barriers for protection against sound; sealing and insulating materials; electrical insulating tape; regenerated fiber thread not for textile use; fibres for insulating purposes; fibreboard for high temperature insulation; flame retardant fabrics [asbestos]; fire resistant insulated panels; insulating refractory materials; filtering materials [semi-processed foams or films of plastic]; insulating felt; foil of regenerated cellulose, other than for packing; sheets of regenerated cellulose for use in manufacture; foils of cellulose [other than for wrapping or packaging]; molded foam for packing; yarns of carbon fibres [other than for use in textiles]; fabrics of chemically produced fibres for use as insulation; fabrics of carbon fibre for use as insulation; fabrics made of mixed synthetic and natural fibres for use as insulation; fabrics of organic fibres for use as insulation; fabrics made from synthetic fibres [for insulation]; fibreglass for insulation; heat resistant fabrics [insulation]; insulation for electric conductors; insulation and barrier articles and materials; insulating materials produced from plastics; insulating fabrics; insulating materials; magnet wire (insulation for -); insulation material for use in the aircraft industry; insulating paper; insulation jackets for industrial pipes; insulation with sealing functions for heat protection; insulation with sealing functions for noise protection; carbon fibre; carbon fibres for use in industry; carbon fibers [fibres], other than for textile use; semi-worked plastic substances; plastic fibers for use in the manufacture of tire cord; structures (non-metallic -) for noise abatement [insulation]; fibres impregnated with synthetic resins for insulation; paper impregnated with oil for insulating; paper for electrical capacitors; raw fibres of carbon, other than for textile use; pipe insulation; acoustical tiles; acoustical insulation for buildings; foam rubber; quilted blankets for insulating; substrates for electrical insulation; synthetic fibres, other than for textile use; insulation of synthetic material for the thermic protection of pipes; pipe wrappings for insulation purposes; thermal insulation jackets for industrial plant; packaging tapes (adhesive -), other than for household or stationery use; viscose sheets, other than for packing; fleeces of crude fibres of glass [insulation]; fleeces of crude fibres of rock [insulation]; fleeces of crude fibres of carbon [insulation]; pre-formed insulation components; thermal insulating materials.

20 – Replacement seat covers [fitted] for furniture; bath pillows; animal housing and beds; children's beds made of cloth in the form of a bag; beds, bedding, mattresses, pillows and cushions; mattresses; bedding, except linen; bedding for cots [other than bed linen]; bedding for cots [other than bed linen]; futon mattresses [other than childbirth mattresses]; stuffed pillows; pet cushions; pillows; beds for pets; inflatable pillows; mattresses; mattresses [other than child birth mattresses]; mattress toppers; maternity pillows; neck-supporting pillows; scented pillows; soft furnishings [cushions]; nap mats [cushions or mattresses]; sleeping mats for camping [mattresses]; nursing pillows; support pillows for use in baby car safety seats; support pillows for use in baby seating; head supporting pillows; textile covers [shaped] for furniture; pet houses; advertising display boards; advertisement display boards of plastic [non-luminous].

21 – Anti-static polishing cloths for household use; applicators for applying eye make-up; chopstick cases; cases adapted for cosmetic utensils; toilet cases; oven mitts; towel rings; applicators for cosmetics; abrasive pads for kitchen [cleaning] purposes; abrasive discs for kitchen [cleaning] purposes; cleaning rags; eyeglass cleaning cloths; dusters; cleaning rags; cleaning rags.

22 – Tents for use in angling; sacks for the transport and storage of materials in bulk; strips for tying-up vines; wrapping or binding bands, not of metal; liber; raw cotton; treated wool; bags and sacks for packaging, storage and transport; binding thread, not of metal, for agricultural purposes; thread, not of metal, for wrapping or binding; string; twines made of polypropylene; twines made of sisal; non-metallic twines; strings for tying purposes; packaging string; tents for camping; chemical fibers for textile use; down feathers; elastic netting for meat products; vehicle covers, not fitted; fibres being partly prepared synthetic materials for textile use; fibres being raw synthetic materials for textile use; feathers for stuffing upholstery; wadding for filtering; silk flock; fillings of synthetic fibres for pillows; fillings for upholstered pillows; fillings of synthetic foam for pillows; fillings for duvets; fillings for pillows; fillings for quilts; yarn fibers; twisted cords [sash]; raw fibrous textile; scoured wool; semi-synthetic fibers [for textile use]; true hemp fiber [raw]; hemp nettings; hammocks; rabbit hair; wood shavings; jute; jute fiber [raw]; combed wool; kapok; Kashmir hair; storage bags for holding a body prior to cremation; liners; loose feathers; macrame rope; raw fibrous textile materials treated with flame retardants; mohair; natural fibers; mesh bags for washing lingerie; nets; netting [not of metal or asbestos]; nets for windbreak purposes; chemical fiber nettings; rockfall prevention nets of textile; commercial fishing nets; commercial nets; nets for use with floating structures; twine

for nets; net pens for fish farming; mesh bags for storage; unfitted covers for boats and marine vehicles; packaging bags [sacks] of textile for bulk transportation; packaging bags [sacks] of textile for bulk storage; plant hangers of rope; tarpaulins; tarpaulins, awnings, tents, and unfitted coverings for vehicles; padding and stuffing materials; padding and stuffing materials (except of paper, cardboard, rubber or plastics); materials for padding; padding materials, other than of rubber or plastic for pillows; padding materials, other than of rubber or plastic for sleeping bags; padding materials made of fibrous material; padding materials made of fibrous material; padding materials made of non-woven fabrics; padding materials, other than of rubber or plastic for beds; polyester stuffing fibers; polyester filament; polyester plastic netting for packaging goods; polyester batting; vitreous silica fibers for textile use; raffia fibers; ramie fibre; yarns for use in tyre cord construction; raw textile fibers and substitutes; raw textile fibers; raw fibres of carbon for textile use; raw fibres of plastics for textile use; linen (raw -) [flax]; canvas for sails; raw silk; raw wool; sacks; plastic-covered mesh fabric bags for growing plants; sacks made of textile materials; sacks for transporting waste; sacks for the transport of materials; sacks for the storage of materials in bulk; sacks for the storage of materials; sacks for the transport and storage of materials in bulk; non-textile bags for the transportation of materials in bulk; non-textile bags for the bulk storage of animal foodstuffs; non-textile bags for the bulk storage of materials; sawdust; silk waste; nets for shading; slings for loading and bands for wrapping or binding; shoe bags for storage; shorn wool; sails; canvas bags for storage; silk fibers; silk netting; silk polyester monofilaments; cordage; ropes and string; ropes and synthetic ropes; rope for use in toys for pets; sisal; sisal fibers; textile wine gift bags; carded wool; synthetic fibers for textile use; synthetic fibers for textile use; synthetic ropes; synthetic textile filaments; cordage; ropes, not of metal; protection pouches made of fabric for storing purses when not in use; textile filaments; textile fibers; non-woven textile fibres; fibres for making up into carpets; fibres for making up into carpet tiles; bags [envelopes, pouches] of textile, for packaging; industrial packaging containers of textile; bags [envelopes, pouches] of textile, for packaging; bags [envelopes, pouches] of textile, for packaging; baling twine; bags [envelopes, pouches] of textile, for packaging; packing rope; textile bags for merchandise packaging [envelopes, pouches]; viscose silica fibres; fleece wool for the upholstery industry; wadding for padding and stuffing upholstery; wadding fibres; raw or treated wool; wool (upholstery -) [stuffing]; wool flock; tents; tents [awnings] for vehicles; tents [awnings] for caravans; tents made of textile materials; tents for mountaineering or camping; fitted nets; stuffing, not of

rubber, plastics, paper or cardboard; spun polyester fibre for textile use.

23 – Angora yarn; spools of thread; spools of yarn; spun cotton; cotton yarn; chenille yarn; chenille yarn; douppioni silk yarn; elastic thread; elastic thread and yarn for textile use; elastic yarns of synthetic fibres for textile use; threads made of spun cotton; thread for textile use; textile filaments [threads]; yarns of flocked fibers; yarn; yarns made of angora for textile use; waste cotton yarn; polyester pre-oriented yarns; yarns made of carbon fibres for textile use; yarn of synthetic or mixed fibres for use in textiles; wild silk yarn; knitting yarns; yarns for domestic use; yarns for textile applications; yarns and threads; inorganic fiber base mixed thread and yarn; cotton base mixed thread and yarn; chemical fiber base mixed thread and yarn; chemical-fiber threads and yarns for textile use; degreased waste threads and yarns; hemp base mixed thread and yarn; regenerated fiber thread and yarn [for textile use]; silk base mixed thread and yarn; synthetic fiber thread and yarn; wool base mixed thread and yarn; yarns and threads for textile use; yarns for sale in kit form; twisted cotton thread and yarn; twisted threads and yarns; twisted hemp thread and yarn; twisted silk thread and yarn; twisted wool thread and yarn; yarns (combed -) made of natural fibres; twisted mixed thread and yarn; worsted yarn; spun silk yarn; semi-synthetic fiber thread and yarn [chemically treated natural fiber yarn]; hand knitting wools; true hemp thread and yarn; heat-stable yarns and threads; jute thread and yarn; camel hair yarn; wool yarn; carded threads in flax for textile use; carded yarns of hemp for textile use; carded threads in natural fibres for textile use; yarns (carded -) made of wool; carded threads in wool for textile use; cashmere yarns; ceramic fibre yarns for textile use; coir thread and yarn; rayon thread and yarn; linen thread and yarn; metal fiber thread for textile use; sewing thread for textile use; sewing thread and yarn; natural yarns; non-metallic yarns for textile use; silica threads; ramie thread and yarn; raw silk yarn; spun silk; silk yarn; embroidery thread and yarn; knitting yarns; knitting yarns made of acrylic materials; knitting yarns made of nylon; knitting yarns made of wool; polyester textured yarns; yarns made of synthetic material for textile use; synthetic threads; carpet yarns; textile yarns; textile yarns made of man-made fibres; textile yarns made of natural fibres; covered rubber thread and yarn [for textile use]; mixed spun threads and yarns; waxed thread; waxed yarn; yarns of weaved fibres for industrial use; spun thread and yarn; worsted; wool yarn.

24 – Hand towels of textile; receiving blankets; sleeping bags for babies; bath sheets; bath towels; bath linen, except clothing; bath linen; flocked fabrics; bed linen and table linen; bed pads; duvet covers; nightdress cases of textile; comforters; bed blankets

made of cotton; bed blankets made of man-made fibres; bed covers of paper; silk bed blankets; woolen blankets; duvet covers; bed sheets; bed skirts; bed throws; fabric bed valances; bed linen; bed linen made of non-woven textile material; infants' bed linen; bed linen; covers for eiderdown and duvets; comforters; blankets for household pets; quilts; blankets for outdoor use; fabrics being textile piece goods for use in tapestry; tick [linen]; printers' blankets of textile; disposable bedding of textile; disposable cloths; disposable wash cloths; knitted elastic fabrics for ladies underwear; knitted elastic fabrics for bodices; knitted elastic fabrics for sportswear; knitted elastic fabrics for gymnastic dresses; fibre fabrics for use in the manufacture of articles of clothing; fibre fabrics for the manufacture of the exterior coverings of furniture; fibre fabrics for use in the manufacture of linings of shoes; fibre fabrics for use in the manufacture of linings of bags; eiderdowns [down coverlets]; flame resistant fabrics; filtering materials of textile; felt; felt for use by papermakers; felt cloth; flame retardant fabrics [other than asbestos]; flannel [fabric]; towelling coverlets; towelling [textile]; towelling [textile]; face cloths of towelling; turkish towel; turkish towel; terry cloth; futon quilts; linings [textile]; linen lining fabric for shoes; inlay materials of non-woven fabrics; sleeping bags [sheeting]; tea cloths; dish towels for drying; chemical fiber fabrics; wall fabrics; fabrics for textile use; knit lace fabrics; knitted fabric; bath sheets; gummed waterproof cloth; bath sheets; towels of textile; towelling [textile] adapted for use in dispensers; hand towels; towelling [textile]; hand towels of textile; children's towels; towelling [textile]; household textile articles made from non-woven materials; linens; household linen, including face towels; nightdress cases of textile; impregnated bed linen; ticks [mattress covers]; jersey [fabric]; jersey [fabric]; cot blankets; cot sheets; children's blankets; shams; lap rugs; fabrics of carbon fibre, other than for insulation; fabrics [textile piece goods] made of carbon fibre; contoured mattress covers; pillowcases; kitchen and table linens; fabrics made from artificial fibres [other than for insulation]; coverings for furniture; ticks (mattress and pillow coverings); mattress covers; mattress covers; quilts filled with down; upholstery fabrics; furnishing fabrics; upholstery fabrics; furnishing fabrics in the piece; furnishing fabrics in the piece; coverings for furniture; furniture coverings (unfitted); loose covers made of textile materials for furniture; furniture coverings of textile; woven furnishing fabrics; mosquito nets; non-woven textile articles; non-woven felts; make-up removal cloths [textile], other than impregnated with cosmetics; duvets; place mats, not of paper; travelling rugs [lap robes]; sleeping bag liners; draperies [thick drop curtains]; silk blankets; silk fabrics for furniture; contour sheets; dust sheets; bed quilts; quilts of terry cloth; quilts of textile; quilts filled with feathers;

quilts filled with half down; quilts filled with stuffing materials; quilts filled with synthetic stuffing materials; quilts; quilt covers; semi-synthetic fiber fabrics; fabrics of chemically produced fibres, other than for insulation; fabrics of organic fibres, other than for insulation; regenerated fiber yarn fabrics; fabrics made from artificial fibres [other than for insulation]; fabrics for use in making jerseys; markers [labels] of cloth for textile fabrics; textile tissues; knitted fabric; knitted fabrics of cotton yarn; knitted fabrics of chemical-fiber yarn; knitted fabrics of wool yarn; make-up removal cloths [textile], other than impregnated with toilet preparations; textile covers for duvets; textile smallwares [table linen]; loose covers made of textile materials for furniture; towels of textile; fabrics made of mixed synthetic and natural fibres, other than for insulation; textile fabrics for use in the manufacture of beds; textile fabrics for making into linens; textile fabrics for use in the manufacture of bedding; textile fabrics for making into blankets; textile fabrics for use in the manufacture of furniture; textile fabrics for use in the manufacture of sheets; textile fabrics for use in the manufacture of towels; textile fabrics for use in the manufacture of pillowcases; textiles made of flannel; non-woven textile articles; textile goods, and substitutes for textile goods; textile piece goods for making bedding covers; textile piece goods for making-up into towels; textile goods for use as bedding; table covers; tablecloths not made of paper; tablemats of textile; table covers of non-woven textile fabrics; textile napkins; table linen, not of paper; napery of textile; table linen; cloth; bed sheets; tissues being textile piece goods; cloths of woven textile material for washing the body (other than for medical use); cloths of non-woven textile material for washing the body [other than for medical use]; bed throws; velours for furniture; non-woven fabrics; non-woven textile fabrics; non-woven textile fabrics for use as interlinings; non-woven fabrics of natural fibres; non-woven fabrics of synthetic fibres; non-woven fabrics in the form of sheeting for use in manufacture; valanced bed sheets; bed skirts; curtains; wall hangings of textile; bath mitts; washing gloves; mitts made of non-woven fabric for washing the body; wash cloths; cloths for washing the body [other than for medical use]; woven fabrics for furniture; woolen blankets; interlinings made of non-woven fabrics; resin impregnated carbon fibre fabrics.

25 – Evening wear; evening coats; detachable neckpieces for kimonos (haneri); detachable collars; heels; heelpieces for footwear; underarm gussets [parts of clothing]; aikido suits; albs; american football bibs; parkas; suits; evening suits; women's suits; bowties; dress pants; jumper suits; work clothes; coveralls; sleeveless jerseys; mantles; arm warmers [clothing]; gowns for doctors; warm-up pants; clothing made of fur; driving gloves; layettes [clothing];

layettes [clothing]; baby bodysuits; baby doll pyjamas; babies' pants [clothing]; plastic baby bibs; baby tops; sleeping bags for babies (clothing); bootees (woollen baby shoes); babies' pants [clothing]; baby bottoms; layettes [clothing]; pram suits; swimming costumes; bathing costumes for women; bathing suits for men; fitted swimming costumes with bra cups; swim wear for gentlemen and ladies; bathing drawers; swimming costumes; swimming costumes; bathrobes; swimming caps; bath slippers; swim shorts; swimming trunks; bathwraps; robes; ballet suits; ball gowns; bandanas [neckerchiefs]; bandeaux [clothing]; baseball caps; baseball uniforms; baselayer bottoms; baselayer tops; berets; crop tops; printed t-shirts; leg warmers; cashmere clothing; clothing of imitations of leather; woolen clothing; motorists' clothing; baby clothes; bridesmaids wear; figure skating clothing; christening robes; clothing for wear in judo practices; children's wear; infant wear; girls' clothing; motorcyclists' clothing of leather; clothing; leather clothing; linen clothing; paper clothing; plush clothing; silk clothing; clothing for martial arts; clothing for horse-riding [other than riding hats]; articles of clothing for theatrical use; clothing for fishermen; boys' clothing; clothing for wear in wrestling games; maternity clothing; lounge pants; bermuda shorts; bed jackets; bed socks; mail-lots; blazers; blousons; boas [necklets]; leotards; body stockings; teddies [underclothing]; boleros; bolo ties; bomber jackets; bobble hats; boxer shorts; wedding dresses; burnouses; brassieres; bustiers; pea coats; capes; pedal pushers; car coats; cargo pants; chaps (clothing); chasubles; chemisettes; cheongsams (chinese gowns); albs; choir robes; evening wear; corduroy trousers; coverups; ladies' clothing; lingerie; millinery; gowns; women's outerclothing; footwear for women; knickers; ladies' underwear; ladies' underwear; down jackets; down vests; denim jeans; ladies' underwear; topcoats; donkey jackets; three piece suits [clothing]; duffel coats; shower caps; insoles for footwear; pocket squares; one-piece suits; jumper suits; one-piece playsuits; disposable underwear; skating outfits; athletic tights; woollen tights; espadrilles; pleated skirts for formal kimonos (hakama); masquerade costumes; fascinator hats; fedoras; heel inserts; fezzes; women's ceremonial dresses; moisture-wicking sports bras; moisture-wicking sports shirts; moisture-wicking sports pants; fishing shirts; bucket caps; fishing vests; flat shoes; fleeces; fleece vests; bowties; flying suits; formal evening wear; formalwear; foulards [clothing articles]; morning coats; leisure suits; casual shirts; slacks; casualwear; tap pants; barber smocks; robes; replica football kits; football jerseys; soccer bibs; footmuffs, not electrically heated; gabardines [clothing]; goloshes; gaiters; morning coats; padded pants for athletic use; padded shirts for athletic use; padded shorts for athletic use; embossed heels of rubber or of plastic materials; embossed soles of rubber or of plastic ma-

terials; knitwear [clothing]; knitted gloves; knit jackets; knitted underwear; guernseys; woven clothing; woven shirts; gilets; non-slipping devices for footwear; polo shirts; golf trousers; golf pants, shirts and skirts; golf caps; golf skirts; unitards; clothing for gymnastics; ankle socks; halloween costumes; neckbands; neckwear; scarves; neck tubes; wrist warmers; gloves [clothing]; wetsuit gloves; gloves for cyclists; gloves with conductive fingertips that may be worn while using handheld electronic touch screen devices; gloves including those made of skin, hide or fur; handwarmers [clothing]; hats (headgear); bonnets [headwear]; tams; loungewear; slippers; slipper socks; aloha shirts; button-front aloha shirts; shirt yokes; shirts; shirts for suits; collared shirts; open-necked shirts; button down shirts; nighties; slips [underclothing]; shirt-jackets; shirt fronts; men's suits; menswear; outerclothing for men; men's socks; men's underwear; waistcoats; stiffeners for shoes; wedding dresses; lumberjackets; hooded pullovers; trousers; trousers of leather; trousers for children; trousers for children; nurse pants; sweatpants; snowboard trousers; pantsuits; culotte skirts; knee-high stockings; suspenders; suspenders (braces); suspender belts for men; girdles; girdles; hats; frames (hat -) [skeletons]; inner socks for footwear; jackets [clothing]; jackets being sports clothing; polar fleece jackets; fishermen's jackets; sleeved jackets; sleeveless jackets; snowboard jackets; rainproof jackets; men's and women's jackets, coats, trousers, vests; jacket liners; hunting pants; hunting jackets; hunting vests; hunting shirts; kimonos; denims [clothing]; denim jeans; denim jackets; jumpers; jodhpurs; shell suits; jogging sets [clothing]; sweatpants; jogging tops; running shoes; sweatpants; heavy jackets; stuff jackets [clothing]; judo uniforms; caftans; bodices [lingerie]; martial arts uniforms; combative sports uniforms; skull caps; waterpolo caps; hoods [clothing]; hooded sweatshirts; karate uniforms; cashmere scarves; kendo outfits; khakis; kilts; kilts; kimonos; infants' footwear; gowns; pinafores; gowns; nurse dresses; linings (ready-made -) [parts of clothing]; pockets for clothing; leisurewear; small hats; bloomers; walking breeches; trouser socks; knee warmers [clothing]; knot caps; chefs' hats; short sets [clothing]; ready-to-wear clothing; headgear; sports headgear [other than helmets]; children's headwear; head scarves; head scarves; head scarves; basic upper garment of korean traditional clothes [jeogori]; korean traditional women's waistcoats [baeja]; korean topcoats [durumagi]; body warmers; corselets; camisoles; corsets; corsets; corsets; costumes; skirt suits; costumes for use in children's dress up play; costumes for use in role-playing games; shoulder wraps; detachable collars; collars for dresses; neckties; ascots; crinolines; yashmaghs; cummerbunds; short-sleeved or long-sleeved t-shirts; short-sleeve shirts; short-sleeve shirts; short trousers; sweatpants; short petticoats; short overcoat for kimono (haori);

cowls [clothing]; laboratory coats; long sleeve pullovers; long sleeved vests; long jackets; japanese sleeping robes (nemaki); full-length kimonos (nagagi); long johns; bibs, not of paper; bib overalls for hunting; running suits; running vests; leather suits; leather clothing; leather jackets; leather jackets; leather slippers; leather shoes; casual trousers; leggings [trousers]; underwear; sweat-absorbent underwear; underclothing for women; canvas shoes; light-reflecting jackets; lingerie; liveries; bathing suit cover-ups; outerclothing for girls; maniples; athletic uniforms; cuffs; coats; pelisses; cotton coats; coats of denim; coats for women; coats for men; mantillas; sleep masks; eye masks; sailor suits; corselets; foundation garments; miniskirts; miters [hats]; fashion hats; deck shoes; monokinis; robes; lounging robes; motorcycle riding suits; motorcycle gloves; motorcycle jackets; muffs [clothing]; caps [headwear]; cap peaks; sun visors [headwear]; muumuu; nighties; nighties; nightcaps; nighties; nightwear; wet suits; negligees; pop socks; women's outerclothing; outerclothing; dress shirts; uppers of woven rattan for japanese style sandals; chemise tops; cycling tops; uppers for japanese style sandals; hooded tops; halter tops; earbands; ear muffs [clothing]; combinations [clothing]; coveralls; coveralls; nurse overalls; overshirts; slippers; hats (paper -) [clothing]; paper hats for wear by chefs; paper hats for wear by nurses; beach wraps; parkas; party hats [clothing]; pelerrines; furs [clothing]; pelisses; fur coats and jackets; fur muffs; fur hats; fur cloaks; petticoats; petti-pants; polo shirts; pirate pants; plastic aprons; pantaloons; polo shirts; polo knit tops; turtleneck sweaters; polo sweaters; ponchos; sweaters; crew neck sweaters; mock turtleneck sweaters; v-neck sweaters; slipovers [clothing]; bloomers; pumps [footwear]; pyjamas; pajama bottoms; cyclists' clothing; cycling shorts; welts for footwear; ramie shirts; rash guards; head scarves; rainproof clothing; rainwear; waterproof trousers; rain hats; mackintoshes; rain boots; rain ponchos; riding gloves; jodhpurs; riding jackets; riding shoes; riding shoes; shoe straps; skirts; turtlenecks; roll necks [clothing]; turtleneck shirts; turtleneck sweaters; rugby tops; rugby boots; rugby shorts; rugby tops; bushjackets; saris; sarongs; sheepskin jackets; sheepskin coats; neck scarves [mufflers]; mufflers [clothing]; shawls [from tricot only]; shawls and headscarves; shawls and stoles; sashes for wear; sash bands for kimono (obi); knitted caps; flat caps; referees uniforms; garrison caps; sedge hats (suge-gasa); tricot sleepsuits; nightwear; sleep masks; nighties; mules; tube tops; veils [clothing]; wimples; cravats; breeches; slip-on shoes; snow suits; snow pants; tam-o'-shanters; shoes; athletic shoes; leisure shoes; shoes for foot volleyball; shoes with hook and pile fastening tapes; high-heeled shoes; mountaineering shoes; shoe inserts for non-orthopedic purposes; shoe uppers; footwear soles; shoe covers, other than for medical purposes;

footwear uppers; footwear; shoulder scarves; shoulder wraps [clothing]; school uniforms; overalls; aprons [clothing]; paper aprons; maternity bands; maternity smocks; sweat-absorbent socks; sweat-absorbent stockings; sweatbands; sweat bands for the wrist; tennis sweatbands; headbands [clothing]; dress shields; anti-perspirant socks; head sweatbands; uniforms for nurses; swimming trunks; silk ties; silk scarves; adhesive bras; shampoo capes; shell jackets; shift dresses; mock turtleneck shirts; shirts and slippers; shortalls; shorts; fleece shorts; boy shorts [underwear]; snow suits; ski suits for competition; ski gloves; ski trousers; ski jackets; clothing for skiing; ski balaclavas; ski hats; sliding shorts; briefs; cummerbunds; dinner jackets; dinner suits; snow boarding suits; snowboard gloves; snowboard shoes; japanese style socks (tabi); socks and stockings; sock suspenders; bralettes; shoe soles; slipper soles; soles for japanese style sandals; sundresses; sunsuits; sun hats; playsuits [clothing]; camiknicker; gym suits; sports clothing [other than golf gloves]; sportswear; sports bras; casual shirts; sports shirts with short sleeves; sports pants; sports jackets; sports caps and hats; sports caps; sports socks; singlets; sports jerseys and breeches for sports; gym suits; athletics vests; dust coats; quilted jackets [clothing]; quilted vests; headbands [clothing]; head sweatbands; cloth bibs; cloth bibs for adult diners; espadrilles; tightening-up strings for kimonos (datejime); rompers; snap crotch shirts for infants and toddlers; beachwear; beach hats; beach robes; stretch pants; knitwear [clothing]; knit shirts; knitted caps; cardigans; thongs; garters; stockings; sweat-absorbent stockings; heelpieces for stockings; pantie-girdles; tights; maillots [hosiery]; footless tights; hosiery; footless socks; balaclavas; surfwear; jockstraps [underwear]; sweaters; tracksuit bottoms; sweatjackets; sweat shirts; sweat shorts; taekwondo suits; waist cinchers; tank tops; dance clothing; dance costumes; dance shoes; ballroom dancing shoes; tabards; camouflage gloves; camouflage shirts; camouflage pants; camouflage jackets; camouflage vests; trews; tennis wear; tennis shirts; tennis dresses; tennis pullovers; tennis skirts; tennis shoes; tennis shorts; tennis socks; fabric belts [clothing]; thobes; theatrical costumes; thermal headgear; thermal socks; thermal underwear; togas; tops [clothing]; toques [hats]; folk costumes; japanese traditional clothing; bra straps; bib tights; pinafore dresses; strapless bras; tank tops; clothing for gymnastics; sweatpants; training shoes; sweat shorts; tracksuit tops; trench coats; bib shorts; triathlon clothing; knitwear [clothing]; singlets; dry suits; tee-shirts; kerchiefs [clothing]; neckerchiefs; head scarves; tunics; turbans; clothing for gymnastics; gym shorts; tutus; twin sets; korean outer jackets worn over basic garment [magoja]; nappy pants [clothing]; topcoats; over-trousers; neck scarves; cloaks; shawls; maternity clothing; maternity sleepwear; maternity lingerie;

uniforms; uniforms for commercial use; uniforms for nurses; referees uniforms; union suits; underwear; babies' undergarments; sweat-absorbent underwear; vest tops; undershirts for kimonos (juban); undershirts for kimonos (koshimaki); bottoms [clothing]; pants; chemises; petticoats; bustles for obi-knots (obiage-shin); tracksuit bottoms; underwear; garments for protecting clothing; suit coats; volleyball jerseys; tips for footwear; thermally insulated clothing; warm-up jackets; warm-up tops; weatherproof clothing; waterproof suits for motorcyclists; waterproof capes; waterproof outerclothing; water socks; waterproof trousers; rainproof jackets; oilskins [clothing]; waterproof boots for fishing; wetsuits for water-skiing; aqua shoes; chefs' whites; white coats for hospital use; caftans; sweat shirts; reversible jackets; waistcoats; leather waistcoats; cagoules; weatherproof clothing; sailing wet weather clothing; puttees and gaiters; wrap belts for kimonos (datemaki); beach wraps; beach wraps; swaddling clothes; salopettes; windproof clothing; wind suits; wind pants; windshirts; wind vests; winter gloves; winter coats; winter boots; hosiery; weather resistant outer clothing; woolly hats; woollen socks; yoga pants; yoga shoes; yoga shirts; zoot suits; zori; tongues for shoes and boots; gussets [parts of clothing]; gussets for bathing suits [parts of clothing]; gussets for footlets [parts of clothing]; gussets for leotards [parts of clothing]; gussets for stockings [parts of clothing]; gussets for tights [parts of clothing]; gussets for underwear [parts of clothing]; intermediate soles; top hats.

27 – Bath mats; textile bath mats; bath mats; bath mats; vehicles mats and carpets; rugs (floor -); door mats; runners [mats]; oriental non-woven rugs (mosen); wallpaper; carpet tile backing; carpet backing; carpeting; carpets, rugs and mats; carpet tiles; primary carpet backing; textile bath mats; carpets [textile]; wall paper of vinyl; wall coverings of paper.

(260) AM 2019 97906 A

(800) 1403963

(151) 2018 01 12

(891) 2018 01 12

(731) LOTTE CORPORATION

(Sincheon-dong), 300, Olympic-ro, Songpa-gu, Seoul, Republic of Korea

(540)



(591) Red and white

(531) 26.04.03; 26.04.18; 27.05.21; 27.05.24;
29.01.12

(511)

35 – Retail services provided by duty free stores; management of duty free business; advertising and business management consultancy; business information and accounting advisory services; clerical services; business administration and office work; human resources management services; department store services; retail services provided by hypermarket; comprehensive shopping mall by internet; intermediary telemarketing services through electric communication; supermarkets; retail convenience stores; advertising; accounting; sales agency services for pharmaceutical and veterinary preparations; business management and organization consultancy; providing of job information; compilation of information into computer databases; import-export agency services; office functions; auctioneering; secretarial services; rental of vending machines; arranging subscriptions to internet services; sales agency services for fertilizers; sales agency services for processed cereals; sales agency services for spices; sales agency services for mineral water; sales agency services for beer; sales agency services for processed meat; sales agency services for fresh seaweeds; sales agency services for tobacco; sales agency services for laundry starch; sales agency services for medical apparatus and instruments other than for dental purposes; sales agency services for cosmetics; sales agency services for cleaning preparations; sales agency services for cleaning tools and washing utensils (other than electric); sales agency services for coatings [paints]; sales agency services for gemstones; sales agency services for building glass; sales agency services for services [dishes]; sales agency services for mattings; sales agency services for building timber; sales agency services for toilet paper; sales agency services for stationery; sales agency services for leather; sales agency services for pulp; sales agency services for bags; sales agency services for furniture; sales agency services for footwear; sales agency services for hot-water heating apparatus; sales agency services for non-electric lighting apparatus and devices; sales agency services for nails of metal; sales agency services for non-electric razors; sales agency services for steel; sales agency services for stone; sales agency services for photographic apparatus and instruments; sales agency services for clocks; sales agency services for alarms; sales agency services for bicycles; sales agency services for food and drink processing machines for industrial purposes; sales agency services for electric audio and visual apparatus and instruments; sales agency services for antifreeze; sales agency services for gas lighters; sales agency services for firearms; sales agency services for sporting articles (other than golf articles/climbing articles); sales agency services for jewelry; sales agency services for overcoats (ex-

cept wear for exclusive use for sports and Korean traditional dress); sales agency services for silkworm eggs; sales agency services for raw cotton fibers; sales agency services for yarn and thread for textile purposes; sales agency services for fabric; sales agency services for rubber cords and laces; sales agency services for musical instruments; sales agency services for books; sales agency services for compositions for the manufacture of technical ceramics.

36 – Financing services; financial trading; banking; securities brokerage; insurance underwriting; financial affairs; financial management; financial analysis; financial consultancy; management of buildings; real estate management; credit inquiries services relating to finance; credit inquiries services relating to insurance; financial customs brokerage services; customs brokerage; art appraisal; jewelry appraisal; charitable fund raising; consultancy relating to financial and monetary affairs; banking and insurance services.

37 – Construction; shipbuilding; repair of smokers' articles; repair of medical machines and apparatus; repair of non-electric dusting apparatus; kitchen equipment installation; fountain pen repair; fur care, cleaning and repair; repair of bags; installation of furniture; shoe repair; electric heating equipment installation and repair; repair of non-electric lighting apparatus and devices; repair of security locks; repair of hand-operated tools; photographic apparatus repair; clock and watch repair; office machines and equipment installation, maintenance and repair; vehicle breakdown assistance [repair]; installation/maintenance and repair of construction machines and apparatus; repair of computers; repair of lighters for smokers; repair of guns and bullets; repair of sporting articles (other than golf articles/climbing articles); repair of jewelry; renovation of clothing; repair or maintenance of sericultural machines and implements; repair of musical instruments; book repair; installation of doors and windows; pumicing; cleaning of furnishings; washing of motor vehicles; disinfecting for building; shoe cleaning; laundering; automobile decoration; artificial snow-making services; cleaning and repair of blocked drains; leather care, cleaning and repair; repair of brake devices; repair of razors; repair of lighting apparatus and devices.

38 – Communications by telephone; cellular telephone communication; radio communications; message sending; radio communications of data; information transmission via smart phone application; wire communications; television communications; communications by cellular phones; data transmission and telecommunication services; video communication services; providing user access to global computer networks; digital broadcasting; radio broadcasting; television broadcasting; television broadcasting services for mobile telephones; rental of broadcasting equ-

ipment; satellite transmission; Internet portal services; telecommunications.

39 – Transport; traffic information; storage of goods; hazardous materials warehousing; depot services for the storage of vehicles; rental of wheelchairs; travel guide services; travel reservation; provision of travel information; physical storage of electronically stored data or documents; packaging of goods; diving services (not for salvage); supply of electrical energy, gas, water and district heating; transport and storage of trash; transport of goods; delivery of goods; storage; packing/crating and warehousing services.

40 – Processing of rubber; processing of plastics; stone treating; processing of glasses; woodworking; paper treating; refining services; water treating; saddlery working; production of energy; metal treating; cloth treating; processing of cereals; processing of furniture; lumber logging services; printing; services of a dental technician; needleworking; photographic printing; waste treatment relating to environmental pollution control; rental of air-conditioning apparatus; rental of generators; duplication of tape recordings; framing of works of art; taxidermy; timber felling and processing; laminating; engraving; water treatment and purification.

41 – Planning services for movies, shows, plays or musical performances; rental of stage scenery; rental of audio recordings; instruction of agriculture skills; instruction of fishery skills; publication of books; nightclub services [entertainment]; operation of libraries; organization of events for cultural purposes; consultancy relating to education instruction; model academies; nursery schools; organization of exhibitions for educational purposes; beauty arts instruction; vocational education and training services; providing and operating of sports facilities; providing and operating of amusement facilities; operation of amusement parks; photography; photographic reporting; animal training; party planning [entertainment]; translation; arranging and conducting of competitions [education or entertainment]; entertainment and amusement information; arranging and conducting of seminars, conferences and exhibitions for cultural or educational purposes; providing facilities for movies/shows/plays/music or educational training; coaching [training]; education information; booking of seats for shows and sports events; ticket reservation and booking services for entertainment, sporting and cultural events; instruction of acting/singing/dancing; providing play facilities for children.

42 – Pharmaceutical research; architectural services; product design; visual design; dress design; software design and development services; design and development of computer hardware; environmental research; cosmetic research; meteorological research; agricultural research; research on construction technology; mechanical research; biotechnology rese-

arch; mining and mineral exploration; product safety testing; marine/aerial and land surveying; research and development of new products for others; testing/inspection or research of pharmaceuticals/cosmetics or foodstuff; testing/inspection or research on agriculture/livestock breeding or fisheries.

43 – Preparation of food and beverages; snack-bar services; restaurant services; chain restaurant services; provision of food and drink by bakeries; coffee shop services; pubs; tourist home services; hotel services; accommodation bureau services [hotels, boarding houses]; providing campground facilities; rental of transportable buildings; providing day-care centres for the elderly; day-nursery (creche) services; providing of accommodation for animal; rental of meeting rooms; rental of cooking apparatus; food stall services.

44 – Agriculture/horticulture and forestry services; fishery for others; pharmacy services; dentistry services; hospitals (other than dentistry); veterinary hospitals; beauty salon services; nail art services; beauty salons and hairdressing salons; skin beauty salons; public baths; massage services; flower arranging; landscape gardening; beauty shops for pets; psychological assessment services; medical and pharmaceutical consultancy; hygienic and beauty care; services for the care of the skin; home nursing aid services; nursing care services for mothers.

45 – Legal services; clothing rental; personal fashion consulting services; providing fashion information; funeral services; pet funeral services; personal services rendered by others to meet the needs of individuals at home; lost and found bureau services; body-guard services; guard services; security and protection services; marriage agency services; wedding chapel services; fortune telling; pet sitting; running errands for others; personal shopping for others; on-line social networking services.

(260) AM 2019 97908 A
 (800) 1403989
 (151) 2018 02 22
 (891) 2018 02 22
 (731) NOVARTIS AG
 CH-4002 Basel, Switzerland
 (540)



(591) Blue, orange and gray
 (531) 01.15.15; 29.01.13
 (511)
 5 – Pharmaceutical preparations for human use.

(260) AM 2019 97950 A
 (800) 1166412
 (151) 2013 05 30
 (891) 2018 04 18
 (731) OTKRYTOE AKTSIONERNOE
 OBSHCHESTVO
 "GRODNENSKAYA TABACHNAYA
 FABRIKA "NEMAN"
 18, ul. Ordzhonikidze, 230771 Grodno,
 Belarus

(540)

MATRIX

(591) Black, white
 (511)
 34 – Tobacco; smokers' articles; matches.

(260) AM 2019 98027 A
 (800) 1405455
 (151) 2018 03 03
 (891) 2018 03 03
 (731) INTERPRESTIGE
 14 rue Camille Desmoulins, F-95870
 BEZONS, France

(540)



(591) Black, white, gold
 (531) 05.05.20; 05.05.23; 27.05.10; 27.05.11;
 29.01.12

(526) PARIS
 (511)
 3 – Soaps; perfumes; essential oils; cosmetics; hair
 lotions; make-up removing products; lipstick; beauty
 masks; shaving products; all these goods are of
 French origin or made in France.

(260) AM 2019 98028 A
 (800) 1405467
 (151) 2017 12 21
 (891) 2017 12 21
 (731) HANERGY HOLDING GROUP LTD.
 Room 106, No. 17 of Fifth Street, Yanqi

Industrial Development District, Huairou
 District, Beijing, China

(540)

Hantile

(591) Black, white
 (531) 27.05.01; 27.05.17

(511)

9 – Distribution boxes [electricity]; plates for batte-
 ries; photovoltaic cells; computer hardware; electric
 apparatus for commutation; high voltage explosion
 protection device; solar batteries; collectors, electric;
 connections for electric lines; transformers [electrici-
 ty].

19 – Pantiles, not of metal; roofing, not of metal; ro-
 ofing tiles, not of metal; roofing, not of metal, incor-
 porating solar cells; building materials, not of metal;
 potters' clay; refractory construction materials, not of
 metal; flashing, not of metal, for building; tiles, not
 of metal, for building; refractory fiber.

(260) AM 2019 98030 A
 (800) 1405483
 (151) 2018 03 07
 (891) 2018 03 07
 (731) KAMEN ASENOV KAMENOV
 Strelbishte quarter bl. 93, entr. 2, floor 8,
 Sofia, Bulgaria

(540)

MARGO

(591) Black, white
 (511)

34 – Tobacco; lighters for smokers; ashtrays for
 smokers made of non-precious metals; smokers'
 articles, not of precious metal; smokers' articles of
 precious metal; cigarettes; cigarette boxes; ciga-
 rettes, cigars, cigarillos and other ready-for-use smo-
 king articles; cigars; cigar boxes of precious metal;
 cigar boxes not of precious metal; matches; match
 boxes; snuffboxes of precious metal.

(260) AM 2019 98032 A
 (800) 1405529
 (151) 2018 02 01
 (891) 2018 02 01
 (731) Limited liability company "ETOPET"
 Sokolovo-Mescherskaja str., House 31,
 flat 132, RU-125466 Moscow, Russian
 Federation

(540)

etopet

(591) Black, white
 (531) 27.05.01

(511)
35 – Advertising services for others; retail or wholesale services for live animals and animal foodstuffs.

(260) AM 2019 98036 A
(800) 1405630
(151) 2018 03 23
(891) 2018 03 23
(731) HARRY WINSTON INC.
718 Fifth Avenue, New York, NY 10019,
USA

(540)
**SECRET COLLECTION
BY HARRY WINSTON**

(591) Black, white
(511)
14 – Precious metals and their alloys and goods made of these materials or coated therewith included in this class; jewelry, jewelry products, jewelry caskets, jewelry cases, precious stones; timepieces and chronometric instruments, chronometers, chronographs, clocks, watches, wristwatches, wall clocks, alarm clocks, watch chains, presentation cases for timepieces, cases for timepieces.

(260) AM 2019 98146 A
(800) 1396587
(151) 2018 01 04
(891) 2018 05 14
(731) RADISSON HOTELS INTERNATIONAL,
INC.
Carlson Parkway P.O. Box 59159,
Minneapolis MN 55459, USA

(540)

**RADISSON
COLLECTION**

(591) Black, white
(531) 27.05.10; 27.05.22
(511)
43 – Hotel, bar and restaurant services; services for the reservation of rooms.

(260) AM 2019 98319 A
(800) 1409079
(151) 2018 03 22
(891) 2018 03 22

(731) SOCIÉTÉ DES PRODUITS NESTLÉ S.A.
CH-1800 Vevey, Switzerland

(540)
ФРУТТИФАН

(591) Black, white
(531) 28.05
(511)
30 – Cocoa and cocoa-based beverages and preparations; chocolate, chocolate products, chocolate paste, chocolate spread, chocolate-based preparations and beverages; confectionery, sugar confectionery, candy; sugar-based confectionery, including fruit jellies; marshmallows; biscuits, cookies; cakes, cookies, wafers, caramels; ice cream, water ices, sherbets, frozen confectionery, frozen cakes, frozen desserts, frozen yogurts.

(260) AM 2019 98369 A
(800) 1400643
(151) 2018 01 29
(891) 2018 06 07
(731) DD IP Holder LLC
P.O. Box 9141, Canton MA 02021, USA
(540)

DUNKIN'

(591) Black, white
(511)
29 – Fruit-based fillings for doughnuts, cookies, cakes and pies; edible oils and fats; fruit topping; nut topping; shortenings; hash brown potatoes; soups; vegetable and meat salads.

30 – Doughnuts and bakery products; cookies; cakes; pies; muffins; plain, glazed, coated and filled fried cakes; bagels; sandwiches; pizza; sugar; flour; flavoring extracts; confectionery chips for baking; honey; yeast; baking-powder; custard-based fillings for cakes and pies; chocolate-based fillings for cakes and pies; chocolate-based topping; coffee and coffee-based beverages; tea and tea-based beverages; cocoa and cocoa-based beverages; coffee-based iced beverages, namely, coffee-flavored slush-type drinks.

32 – Fruit drinks and fruit juices; fruit-flavored slush-type drinks; smoothies; coffee-flavored soft drinks; syrups and other preparations, concentrates, and powders for making soft drinks and fruit drinks.

43 – Restaurant services, cafe services, snack bar services, carry-out food services.

(260) AM 2019 98370 A
(800) 1403126
(151) 2018 01 30
(891) 2018 06 07

(731) DD IP Holder LLC

P.O. Box 9141, Canton MA 02021, USA

(540)

DUNKIN'

(591) Orange and pink

(531) 24.17.01; 27.05.17; 29.01.12

(511)

29 – Fruit-based fillings for doughnuts, cookies, cakes and pies; edible oils and fats; fruit topping; nut topping; shortenings; hash brown potatoes; soups; vegetable and meat salads.

30 – Doughnuts and bakery products; cookies; cakes; pies; muffins; plain, glazed, coated and filled fried cakes; bagels; sandwiches; pizza; sugar; flour; flavoring extracts; confectionery chips for baking; honey; yeast; baking-powder; custard-based fillings for cakes and pies; chocolate-based fillings for cakes and pies; chocolate-based topping; coffee and coffee-based beverages; tea and tea-based beverages; cocoa and cocoa-based beverages; coffee-based iced beverages, namely, coffee-flavored slush-type drinks.

32 – Fruit drinks and fruit juices; fruit-flavored slush-type drinks; smoothies; coffee-flavored soft drinks; syrups and other preparations, concentrates, and powders for making soft drinks.

43 – Restaurant services; cafe services; snack bar services; fast-food restaurant services.

INTERNATIONAL TRADEMARKS PROTECTED IN GEORGIA

(260) AM 2019 88284 A
(800) 1305243
(151) 2016 04 27
(181) 2026 04 27
(891) 2016 04 27
(511) 05, 42

(260) AM 2019 95465 A
(800) 1378931
(151) 2017 09 08
(181) 2027 09 08
(891) 2017 09 08
(511) 06, 09, 10, 12, 19, 28

(260) AM 2019 89623 A
(800) 1319636
(151) 2016 09 15
(181) 2026 09 15
(891) 2016 09 15
(511) 03

(260) AM 2019 95607 A
(800) 1378374
(151) 2017 07 03
(181) 2027 07 03
(891) 2017 07 03
(511) 03, 05, 35, 42

(260) AM 2019 90712 A
(800) 1329421
(151) 2016 08 11
(181) 2026 08 11
(891) 2016 08 11
(511) 29, 43

(260) AM 2019 95630 A
(800) 1378881
(151) 2017 07 10
(181) 2027 07 10
(891) 2017 07 10
(511) 29

(260) AM 2019 92694 A
(800) 1347148
(151) 2016 11 03
(181) 2026 11 03
(891) 2016 11 03
(511) 09, 28

(260) AM 2019 95693 A
(800) 1380709
(151) 2017 10 27
(181) 2027 10 27
(891) 2017 10 27
(511) 09

(260) AM 2019 93008 A
(800) 1350522
(151) 2016 11 03
(181) 2026 11 03
(891) 2016 11 03
(511) 09, 28

(260) AM 2019 95770 A
(800) 1380176
(151) 2017 09 08
(181) 2027 09 08
(891) 2017 09 08
(511) 32

(260) AM 2019 93493 A
(800) 1356404
(151) 2017 02 02
(181) 2027 02 02
(891) 2017 02 02
(511) 07

(260) AM 2019 95837 A
(800) 1381685
(151) 2017 07 06
(181) 2027 07 06
(891) 2017 07 06
(511) 05

(260) AM 2019 93745 A
(800) 1359234
(151) 2017 04 07
(181) 2027 04 07
(891) 2017 04 07
(511) 09, 28, 41

(260) AM 2019 95846 A
(800) 1381892
(151) 2017 09 04
(181) 2027 09 04
(891) 2017 09 04
(511) 04, 09, 12, 16, 18, 25, 26, 28, 32, 35, 36, 38,
39, 41, 43

(260) AM 2019 95848 A
(800) 1382353
(151) 2017 11 06
(181) 2027 11 06
(891) 2017 11 06
(511) 09

(260) AM 2019 95850 A
(800) 1381896
(151) 2017 09 06
(181) 2027 09 06
(891) 2017 09 06
(511) 30

(260) AM 2019 95853 A
(800) 725192
(151) 1999 11 30
(181) 2019 11 30
(891) 2017 11 20
(511) 35

(260) AM 2019 95897 A
(800) 1382402
(151) 2017 08 24
(181) 2027 08 24
(891) 2017 08 24
(511) 06, 07, 08, 12, 13, 14, 17, 29, 30, 31, 32, 33,
35, 36, 39, 40, 42, 45

(260) AM 2019 95907 A
(800) 1382764
(151) 2017 10 30
(181) 2027 10 30
(891) 2017 10 30
(511) 29, 30

(260) AM 2019 95917 A
(800) 1382837
(151) 2017 10 18
(181) 2027 10 18
(891) 2017 10 18
(511) 09, 35, 36, 38

(260) AM 2019 95918 A
(800) 1382859
(151) 2017 04 05
(181) 2027 04 05
(891) 2017 04 05
(511) 03, 05, 09, 10, 16, 20, 21, 24, 35, 38, 41, 42, 44

(260) AM 2019 95919 A
(800) 1382869
(151) 2017 02 22
(181) 2027 02 22
(891) 2017 02 22
(511) 09, 35, 36, 42, 45

(260) AM 2019 95921 A
(800) 1382871
(151) 2017 03 21
(181) 2027 03 21
(891) 2017 03 21
(511) 03, 04, 05, 16, 18, 20, 21, 24, 25, 27, 35

(260) AM 2019 95923 A
(800) 1382883
(151) 2017 06 27
(181) 2027 06 27
(891) 2017 06 27
(511) 09, 18, 25, 28, 41

(260) AM 2019 95924 A
(800) 1382885
(151) 2017 08 08
(181) 2027 08 08
(891) 2017 08 08
(511) 29, 30, 32

(260) AM 2019 95925 A
(800) 1382892
(151) 2017 07 14
(181) 2027 07 14
(891) 2017 07 14
(511) 03, 05

(260) AM 2019 95953 A
(800) 1383715
(151) 2017 04 05
(181) 2027 04 05
(891) 2017 04 05
(511) 44

(260) AM 2019 95954 A
(800) 1383749
(151) 2017 11 07
(181) 2027 11 07
(891) 2017 11 07
(511) 33

(260) AM 2019 95963 A
(800) 1384050
(151) 2017 07 11

(181) 2027 07 11
(891) 2017 07 11
(511) 03, 09, 14, 18, 25, 35

(260) AM 2019 95966 A
(800) 1213251
(151) 2014 03 04
(181) 2024 03 04
(891) 2017 05 22
(511) 43

(260) AM 2019 95968 A
(800) 1344883
(151) 2017 04 13
(181) 2027 04 13
(891) 2017 12 15
(511) 25

(260) AM 2019 95971 A
(800) 1365292
(151) 2017 06 08
(181) 2027 06 06
(891) 2017 12 18
(511) 05

(260) AM 2019 95979 A
(800) 1382950
(151) 2017 06 22
(181) 2027 06 22
(891) 2017 06 22
(511) 36

(260) AM 2019 96010 A
(800) 1383236
(151) 2017 06 06
(181) 2027 06 06
(891) 2017 06 06
(511) 05

(260) AM 2019 96011 A
(800) 1383255
(151) 2017 05 31
(181) 2027 05 31
(891) 2017 05 31
(511) 32

(260) AM 2019 96014 A
(800) 1383396
(151) 2017 06 05
(181) 2027 06 05
(891) 2017 06 05
(511) 07, 12, 17, 35

(260) AM 2019 96017 A
(800) 1383453
(151) 2017 10 17
(181) 2027 10 17
(891) 2017 10 17
(511) 08, 35

(260) AM 2019 96018 A
(800) 1383462
(151) 2017 11 09
(181) 2027 11 09
(891) 2017 11 09
(511) 09

(260) AM 2019 96019 A
(800) 1383504
(151) 2017 10 23
(181) 2027 10 23
(891) 2017 10 23
(511) 34

(260) AM 2019 96020 A
(800) 1383526
(151) 2017 09 04
(181) 2027 09 04
(891) 2017 09 04
(511) 01, 03, 04, 05, 06, 07, 08, 09, 10, 11, 12, 14, 16, 17, 18, 20, 21, 24, 25, 26, 27, 28, 34, 35, 36, 37, 38, 39, 40, 41, 42, 43, 44, 45

(260) AM 2019 96031 A
(800) 1384245
(151) 2017 10 17
(181) 2027 10 17
(891) 2017 10 17
(511) 03, 05

(260) AM 2019 96032 A
(800) 1384255
(151) 2017 11 11
(181) 2027 11 11
(891) 2017 11 11
(511) 44

(260) AM 2019 96033 A
(800) 1384261
(151) 2017 11 08
(181) 2027 11 08
(891) 2017 11 08
(511) 12

(260) AM 2019 96034 A
(800) 1384270
(151) 2017 11 15
(181) 2027 11 15
(891) 2017 11 15
(511) 03

(260) AM 2019 96035 A
(800) 1384362
(151) 2017 07 12
(181) 2027 07 12
(891) 2017 07 12
(511) 03

(260) AM 2019 96036 A
(800) 1384364
(151) 2017 08 03
(181) 2027 08 03
(891) 2017 08 03
(511) 03

(260) AM 2019 96037 A
(800) 1384367
(151) 2017 08 23
(181) 2027 08 23
(891) 2017 08 23
(511) 03

(260) AM 2019 96038 A
(800) 1384391
(151) 2017 06 14
(181) 2027 06 14
(891) 2017 06 14
(511) 29, 30, 32, 33

(260) AM 2019 96039 A
(800) 1384406
(151) 2017 07 31
(181) 2027 07 31
(891) 2017 07 31
(511) 03, 21

(260) AM 2019 96040 A
(800) 1384453
(151) 2017 08 22
(181) 2027 08 11
(891) 2017 08 22
(511) 06, 17, 19

(260) AM 2019 96043 A
(800) 1384467
(151) 2017 10 23

(181) 2027 10 23
(891) 2017 10 23
(511) 21

(260) AM 2019 96045 A
(800) 1384497
(151) 2017 11 19
(181) 2027 11 19
(891) 2017 11 19
(511) 09

(260) AM 2019 96090 A
(800) 1385088
(151) 2017 11 27
(181) 2027 11 27
(891) 2017 11 27
(511) 10

(260) AM 2019 96091 A
(800) 1385097
(151) 2017 07 06
(181) 2027 07 06
(891) 2017 07 06
(511) 38

(260) AM 2019 96092 A
(800) 375704B
(151) 1971 01 15
(181) 2021 01 15
(891) 2017 11 23
(511) 03, 05

(260) AM 2019 96095 A
(800) 770374
(151) 2001 10 30
(181) 2021 10 30
(891) 2018 01 02
(511) 09, 16, 35, 36, 41, 42

(260) AM 2019 96100 A
(800) 1098383
(151) 2011 05 16
(181) 2021 05 16
(891) 2017 12 11
(511) 03

(260) AM 2019 96109 A
(800) 1307914
(151) 2016 03 24
(181) 2026 03 24
(891) 2017 11 30
(511) 08, 14, 20, 21, 24, 26, 27

(260) AM 2019 96110 A
(800) 1318548
(151) 2016 08 01
(181) 2026 08 01
(891) 2017 12 18
(511) 05

(260) AM 2019 96111 A
(800) 1321420
(151) 2016 06 12
(181) 2026 06 12
(891) 2017 11 27
(511) 08

(260) AM 2019 96114 A
(800) 1340485
(151) 2017 01 04
(181) 2027 01 04
(891) 2017 11 28
(511) 05

(260) AM 2019 96125 A
(800) 1384794
(151) 2016 09 12
(181) 2026 09 12
(891) 2016 09 12
(511) 05

(260) AM 2019 96127 A
(800) 1384882
(151) 2017 09 18
(181) 2027 09 18
(891) 2017 09 18
(511) 33

(260) AM 2019 96128 A
(800) 1384903
(151) 2017 09 14
(181) 2027 09 14
(891) 2017 09 14
(511) 05

(260) AM 2019 96132 A
(800) 1385041
(151) 2017 11 07
(181) 2027 11 07
(891) 2017 11 07
(511) 05

(260) AM 2019 96133 A
(800) 1385042
(151) 2017 11 14

(181) 2027 11 14
(891) 2017 11 14
(511) 05

(260) AM 2019 96136 A
(800) 1385046
(151) 2017 11 07
(181) 2027 11 07
(891) 2017 11 07
(511) 05

(260) AM 2019 96137 A
(800) 1385047
(151) 2017 11 07
(181) 2027 11 07
(891) 2017 11 07
(511) 05

(260) AM 2019 96138 A
(800) 1385048
(151) 2017 11 08
(181) 2027 11 08
(891) 2017 11 08
(511) 05

(260) AM 2019 96142 A
(800) 1385051
(151) 2017 11 14
(181) 2027 11 14
(891) 2017 11 14
(511) 05

(260) AM 2019 96143 A
(800) 1385052
(151) 2017 11 14
(181) 2027 11 14
(891) 2017 11 14
(511) 05

(260) AM 2019 96145 A
(800) 1385053
(151) 2017 11 14
(181) 2027 11 14
(891) 2017 11 14
(511) 05

(260) AM 2019 96196 A
(800) 1385225
(151) 2017 01 18
(181) 2027 01 18
(891) 2017 01 18
(511) 05, 10

(260) AM 2019 96197 A
(800) 1385233
(151) 2017 11 21
(181) 2027 11 21
(891) 2017 11 21
(511) 12

(260) AM 2019 96198 A
(800) 1385342
(151) 2017 11 27
(181) 2027 11 27
(891) 2017 11 27
(511) 34

(260) AM 2019 96223 A
(800) 1385501
(151) 2017 11 08
(181) 2027 11 08
(891) 2017 11 08
(511) 01

(260) AM 2019 96224 A
(800) 1385504
(151) 2017 11 17
(181) 2027 11 17
(891) 2017 11 17
(511) 09

(260) AM 2019 96230 A
(800) 1385555
(151) 2017 11 03
(181) 2027 11 03
(891) 2017 11 03
(511) 34

(260) AM 2019 96232 A
(800) 1385570
(151) 2017 09 30
(181) 2027 09 30
(891) 2017 09 30
(511) 25

(260) AM 2019 96246 A
(800) 1385646
(151) 2017 11 08
(181) 2027 11 08
(891) 2017 11 08
(511) 05

(260) AM 2019 96248 A
(800) 1385648
(151) 2017 11 07

(181) 2027 11 07
(891) 2017 11 07
(511) 05

(260) AM 2019 96250 A
(800) 1385650
(151) 2017 11 08
(181) 2027 11 08
(891) 2017 11 08
(511) 05

(260) AM 2019 96251 A
(800) 1385651
(151) 2017 11 08
(181) 2027 11 08
(891) 2017 11 08
(511) 05

(260) AM 2019 96254 A
(800) 1385652
(151) 2017 11 07
(181) 2027 11 07
(891) 2017 11 07
(511) 05

(260) AM 2019 96256 A
(800) 1385653
(151) 2017 11 08
(181) 2027 11 08
(891) 2017 11 08
(511) 05

(260) AM 2019 96263 A
(800) 1385660
(151) 2017 11 07
(181) 2027 11 07
(891) 2017 11 07
(511) 05

(260) AM 2019 96264 A
(800) 1385794
(151) 2017 09 29
(181) 2027 09 29
(891) 2017 09 29
(511) 05

(260) AM 2019 96265 A
(800) 1385803
(151) 2017 07 28
(181) 2027 07 28
(891) 2017 07 28
(511) 32

(260) AM 2019 96266 A
(800) 1385824
(151) 2017 11 07
(181) 2027 11 07
(891) 2017 11 07
(511) 05

(260) AM 2019 96282 A
(800) 1093996
(151) 2011 07 11
(181) 2021 07 11
(891) 2017 11 23
(511) 03, 05

(260) AM 2019 96290 A
(800) 1278849
(151) 2015 10 15
(181) 2025 10 15
(891) 2017 12 15
(511) 01, 30

(260) AM 2019 96314 A
(800) 1386798
(151) 2017 12 05
(181) 2027 12 05
(891) 2017 12 05
(511) 03, 05

(260) AM 2019 96315 A
(800) 1386803
(151) 2017 11 14
(181) 2027 11 14
(891) 2017 11 14
(511) 05

(260) AM 2019 96316 A
(800) 1386804
(151) 2017 11 14
(181) 2027 11 14
(891) 2017 11 14
(511) 05

(260) AM 2019 96342 A
(800) 1386094
(151) 2017 11 22
(181) 2027 11 22
(891) 2017 11 22
(511) 17

(260) AM 2019 96344 A
(800) 1386128
(151) 2017 11 14

(181) 2027 11 14
(891) 2017 11 14
(511) 05

(260) AM 2019 96346 A
(800) 1386130
(151) 2017 11 14
(181) 2027 11 14
(891) 2017 11 14
(511) 05

(260) AM 2019 96347 A
(800) 1386131
(151) 2017 11 14
(181) 2027 11 14
(891) 2017 11 14
(511) 05

(260) AM 2019 96355 A
(800) 1386292
(151) 2017 12 11
(181) 2027 12 11
(891) 2017 12 11
(511) 03

(260) AM 2019 96357 A
(800) 1386314
(151) 2017 12 14
(181) 2027 12 14
(891) 2017 12 14
(511) 10

(260) AM 2019 96358 A
(800) 1386871
(151) 2016 06 02
(181) 2026 06 02
(891) 2016 06 02
(511) 12

(260) AM 2019 96359 A
(800) 1386350
(151) 2017 12 01
(181) 2027 12 01
(891) 2017 12 01
(511) 29, 30

(260) AM 2019 96361 A
(800) 1386921
(151) 2017 11 17
(181) 2027 11 17
(891) 2017 11 17
(511) 14

(260) AM 2019 96365 A
(800) 1386401
(151) 2017 11 07
(181) 2027 11 07
(891) 2017 11 07
(511) 05

(260) AM 2019 96366 A
(800) 1386402
(151) 2017 11 07
(181) 2027 11 07
(891) 2017 11 07
(511) 05

(260) AM 2019 96395 A
(800) 1386506
(151) 2017 09 29
(181) 2027 09 29
(891) 2017 09 29
(511) 05

(260) AM 2019 96399 A
(800) 1386542
(151) 2017 11 14
(181) 2027 11 14
(891) 2017 11 14
(511) 05

(260) AM 2019 96415 A
(800) 1268454
(151) 2013 07 11
(181) 2023 07 11
(891) 2017 09 28
(511) 36, 41

(260) AM 2019 96416 A
(800) 1291576
(151) 2015 09 21
(181) 2025 09 21
(891) 2017 06 19
(511) 30

(260) AM 2019 96418 A
(800) 1324332
(151) 2016 07 20
(181) 2026 07 20
(891) 2017 11 27
(511) 03

(260) AM 2019 96420 A
(800) 1365501
(151) 2017 03 27

(181) 2027 03 27
(891) 2016 12 08
(511) 25, 35

(260) AM 2019 96421 A
(800) 1387982
(151) 2017 11 14
(181) 2027 11 14
(891) 2017 11 14
(511) 05

(260) AM 2019 96423 A
(800) 1387983
(151) 2017 11 14
(181) 2027 11 14
(891) 2017 11 14
(511) 05

(260) AM 2019 96425 A
(800) 1387985
(151) 2017 11 14
(181) 2027 11 14
(891) 2017 11 14
(511) 05

(260) AM 2019 96466 A
(800) 1387628
(151) 2017 11 07
(181) 2027 11 07
(891) 2017 11 07
(511) 05

(260) AM 2019 96467 A
(800) 1387629
(151) 2017 11 14
(181) 2027 11 14
(891) 2017 11 14
(511) 05

(260) AM 2019 96468 A
(800) 1387637
(151) 2017 11 20
(181) 2027 11 20
(891) 2017 11 20
(511) 09

(260) AM 2019 96469 A
(800) 1387640
(151) 2017 12 06
(181) 2027 12 06
(891) 2017 12 06
(511) 12

(260) AM 2019 96470 A
(800) 1387665
(151) 2017 09 29
(181) 2027 09 29
(891) 2017 09 29
(511) 04, 36

(260) AM 2019 96471 A
(800) 1388365
(151) 2017 11 27
(181) 2027 11 27
(891) 2017 11 27
(511) 07

(260) AM 2019 96527 A
(800) 1387978
(151) 2017 11 14
(181) 2027 11 14
(891) 2017 11 14
(511) 05

(260) AM 2019 96528 A
(800) 1387979
(151) 2017 11 14
(181) 2027 11 14
(891) 2017 11 14
(511) 05

(260) AM 2019 96529 A
(800) 1387980
(151) 2017 11 14
(181) 2027 11 14
(891) 2017 11 14
(511) 05

(260) AM 2019 96541 A
(800) 1388529
(151) 2017 09 05
(181) 2027 09 05
(891) 2017 09 05
(511) 35

(260) AM 2019 96584 A
(800) 1389309
(151) 2017 07 19
(181) 2027 07 19
(891) 2017 07 19
(511) 21, 32, 33

(260) AM 2019 96585 A
(800) 1389363
(151) 2017 09 13

(181) 2027 09 13
(891) 2017 09 13
(511) 30

(260) AM 2019 96586 A
(800) 1389376
(151) 2017 10 13
(181) 2027 10 13
(891) 2017 10 13
(511) 07

(260) AM 2019 96587 A
(800) 1389388
(151) 2017 11 08
(181) 2027 11 08
(891) 2017 11 08
(511) 43

(260) AM 2019 96589 A
(800) 1389424
(151) 2017 12 22
(181) 2027 12 22
(891) 2017 12 22
(511) 12

(260) AM 2019 96590 A
(800) 1389449
(151) 2018 01 02
(181) 2018 01 02
(891) 2018 01 02
(511) 03, 05

(260) AM 2019 96591 A
(800) 1389479
(151) 2016 12 30
(181) 2026 12 30
(891) 2016 12 30
(511) 09, 16, 25, 28, 41

(260) AM 2019 96592 A
(800) 1389488
(151) 2017 06 30
(181) 2027 06 30
(891) 2017 06 30
(511) 01, 12, 17

(260) AM 2019 96593 A
(800) 1389496
(151) 2017 08 01
(181) 2027 08 01
(891) 2017 08 01
(511) 35, 41, 42

(260) AM 2019 96607 A
(800) 769193
(151) 2001 09 24
(181) 2021 09 24
(891) 2017 12 21
(511) 29

(260) AM 2019 96615 A
(800) 1388692
(151) 2017 08 15
(181) 2027 08 15
(891) 2017 08 15
(511) 30, 35, 39

(260) AM 2019 96616 A
(800) 1301165
(151) 2016 02 11
(181) 2026 02 11
(891) 2018 01 05
(511) 44

(260) AM 2019 96623 A
(800) 1388753
(151) 2017 11 08
(181) 2027 11 08
(891) 2017 11 08
(511) 03, 05

(260) AM 2019 96624 A
(800) 1388784
(151) 2017 09 01
(181) 2027 09 01
(891) 2017 09 01
(511) 32, 33

(260) AM 2019 96625 A
(800) 1388790
(151) 2017 09 13
(181) 2027 09 13
(891) 2017 09 13
(511) 30

(260) AM 2019 96638 A
(800) 1389130
(151) 2017 11 29
(181) 2027 11 29
(891) 2017 11 29
(511) 03

(260) AM 2019 96639 A
(800) 1389176
(151) 2017 12 11

(181) 2027 12 11
(891) 2017 12 11
(511) 05, 16

(260) AM 2019 96653 A
(800) 1390196
(151) 2017 10 31
(181) 2027 10 31
(891) 2017 10 31
(511) 05

(260) AM 2019 96655 A
(800) 1390241
(151) 2017 08 25
(181) 2027 08 25
(891) 2017 08 25
(511) 16, 20, 27, 35

(260) AM 2019 96660 A
(800) 1390358
(151) 2017 09 15
(181) 2027 09 15
(891) 2017 09 15
(511) 41

(260) AM 2019 96661 A
(800) 1390359
(151) 2017 09 15
(181) 2027 09 15
(891) 2017 09 15
(511) 41

(260) AM 2019 96666 A
(800) 1390458
(151) 2017 11 30
(181) 2027 11 30
(891) 2017 11 30
(511) 25

(260) AM 2019 96667 A
(800) 1390471
(151) 2017 12 20
(181) 2027 12 20
(891) 2017 12 20
(511) 05

(260) AM 2019 96668 A
(800) 1390167
(151) 2017 07 21
(181) 2027 07 21
(891) 2017 07 21
(511) 07, 09, 11, 42

(260) AM 2019 96689 A
(800) 1274453
(151) 2015 02 18
(181) 2025 02 18
(891) 2017 10 17
(511) 07, 09, 28, 35, 36

(260) AM 2019 96690 A
(800) 1369122
(151) 2017 06 08
(181) 2027 06 08
(891) 2018 01 15
(511) 05, 29, 30, 32

(260) AM 2019 96716 A
(800) 1389915
(151) 2017 12 22
(181) 2027 12 22
(891) 2017 12 22
(511) 05

(260) AM 2019 96717 A
(800) 1389916
(151) 2017 12 22
(181) 2027 12 22
(891) 2017 12 22
(511) 05

(260) AM 2019 96718 A
(800) 1389930
(151) 2017 12 07
(181) 2027 12 07
(891) 2017 12 07
(511) 34

(260) AM 2019 96724 A
(800) 1389948
(151) 2017 10 10
(181) 2027 10 10
(891) 2017 10 10
(511) 29

(260) AM 2019 96725 A
(800) 1390020
(151) 2017 06 02
(181) 2027 06 02
(891) 2017 06 02
(511) 08, 11

(260) AM 2019 96727 A
(800) 1390022
(151) 2017 08 03

(181) 2027 08 03
(891) 2017 08 03
(511) 35

(260) AM 2019 96728 A
(800) 1390027
(151) 2017 10 27
(181) 2027 10 27
(891) 2017 10 27
(511) 05, 10, 44

(260) AM 2019 96729 A
(800) 1390028
(151) 2017 10 27
(181) 2027 10 27
(891) 2017 10 27
(511) 41

OFFICIAL NOTIFICATION

INVENTIONS

RENEWAL OF PATENTS

(21) AP 2015 13701

(11) P 2015 6424 B

(73) LEPL I. Vekua named Institute of Physics and Technology of Sukhumi

(54) **MULTILAYER DIELECTRIC INTERFERENCE LASER MIRROR**

DATE OF CANCELLATION OF PATENT: 2019 01 22

DATE OF RESTORATION OF PATENT: 2019 02 25

(21) AP 2015 13702

(11) P 2015 6425 B

(73) LEPL I. Vekua named Institute of Physics and Technology of Sukhumi

(54) **METHOD AND EQUIPMENT FOR RECEIVING GIGANT LASER IMPULSES**

DATE OF CANCELLATION OF PATENT: 2019 01 22

DATE OF RESTORATION OF PATENT: 2019 02 25

(21) AP 2015 14239

(11) P 2018 6917 B

(73) SANTEN PHARMACEUTICAL CO., LTD

(54) **PHARMACEUTICAL PREPARATION INCLUDING PYRIDYLAMINO ACETIC ACID COMPOUND**

DATE OF CANCELLATION OF PATENT: 2019 01 08

DATE OF RESTORATION OF PATENT: 2019 02 25

CANCELLATION OF PATENTS

(21) AP 2011 12845

(11) P 2016 6441 B

(73) TAKEDA PHARMACEUTICAL COMPANY LIMITED

(54) **COMPOUNDS FOR SUPPRESSING A PERIPHERAL NERVE DISORDER INDUCED BY AN ANTI-CANCER AGENT**

DATE OF PATENT CANCELLATION: 2018 01 26

PATENT RESTORATION IS AVAILABLE: 2019 01 26

(21) AP 2010 12853

(11) P 2014 6193 B

(73) LLC "Corporation Stroj" Invest Project M"

(54) **METHOD AND DEVICE FOR DETERMINING SPEED OF TRAVEL AND COORDINATES OF VEHICLES AND SUBSEQUENTLY IDENTIFYING SAME AND AUTOMATICALLY RECORDING ROAD TRAFFIC OFFENCES**

DATE OF PATENT CANCELLATION: 2018 02 08

PATENT RESTORATION IS AVAILABLE: 2019 02 08

(21) AP 2012 13184
(11) P 2015 6351 B
(73) Pfaizer Inc.
(54) **GLUCAGON RECEPTOR MODULATOR**
DATE OF PATENT CANCELLATION: 2018 01 25
PATENT RESTORATION IS AVAILABLE: 2019 01 25

(21) AP 2012 13211
(11) P 2015 6333 B
(73) BOEHRINGER INGELHEIM INTERNATIONAL GMBH
(54) **(1,2,4)TRIAZOLO[4,3-A]QUINOXALINE DERIVATIVES AS INHIBITORS OF PHOSPHODIESTERASES**
DATE OF PATENT CANCELLATION: 2018 01 31
PATENT RESTORATION IS AVAILABLE: 2019 01 31

(21) AP 2013 13535
(11) P 2016 6438 B
(73) Novartis AG
(54) **IMIDAZOPYRROLIDINONE COMPOUNDS**
DATE OF PATENT CANCELLATION: 2018 01 25
PATENT RESTORATION IS AVAILABLE: 2019 01 25

(21) AP 2015 13719
(11) P 2016 6562 B
(73) Maria Silagadze;
Eliza Pruidze;
Giorgi Pkhakadze;
Nikoloz Pkhakadze;
Sophie Gachechiladze;
Khatia Khvadagiani
(54) **METHOD FOR BIOLOGICAL APPRECIATED VALUE GLUTEN-FREE BREAD PREPARATION FOR SICK PEOPLE WITH CELIAC DISEASE**
DATE OF PATENT CANCELLATION: 2018 02 05
PATENT RESTORATION IS AVAILABLE: 2019 02 05

(21) AP 2015 14236
(11) P 2017 6795 B
(73) H. Lundbeck A/S
(54) **HEXAHYDROFUROPYRROLES AS PDE1INHIBITORS**
DATE OF PATENT CANCELLATION: 2018 02 06
PATENT RESTORATION IS AVAILABLE: 2019 02 06

(21) AP 2003 8363
(11) P 2006 3898 B
(73) SOCIETE DES PRODUITS NESTLE S.A.
(54) **CLOSED CAPSULE WITH OPENING MEAN**
DATE OF PATENT CANCELLATION: 2018 01 13
PATENT RESTORATION IS AVAILABLE: 2019 01 13

(21) AP 2004 8964
(11) P 2008 4390 B
(73) Strakan International Limited
(54) **TRANSDERMAL GRANISETRON**
DATE OF PATENT CANCELLATION: 2018 02 05
PATENT RESTORATION IS AVAILABLE: 2019 02 05

(21) AP 2004 8983
(11) P 2007 4075 B
(73) Aziende Chimiche Riunite Angelini Francesco A.C.R.A.F. S.p.A.
(54) **INDAZOLAMIDES WITH ANALGESIC ACTIVITY**
DATE OF PATENT CANCELLATION: 2018 01 26
PATENT RESTORATION IS AVAILABLE: 2019 01 26

UTILITY MODELS

CANCELLATION OF PATENTS

(21) AU 2012 12565
(11) U 2013 1766 Y
(73) Saba Mamukashvili
(54) **UMBRELLA WITH DEVICE CONVERTING SOLAR ENERGY**
DATE OF PATENT CANCELLATION: 2018 02 07
PATENT RESTORATION IS AVAILABLE: 2019 02 07

(21) AU 2014 13380
(11) U 2015 1871 Y
(73) Ketevan Ebralidze;
Mzia Tsitsadze;
Mariam Chkhaidze;
Miranda Khachidze;
Badri Arziani;
Manana Buzariashvili
(54) **METHOD FOR QUERCETIN PREPARATION**
DATE OF PATENT CANCELLATION: 2018 02 06
PATENT RESTORATION IS AVAILABLE: 2019 02 06

(21) AU 2015 13726
(11) U 2016 1910 Y
(73) Nikoloz Jalabadze;
Givi Sharashenidze;
Otar Tserodze;
Levan Lortkipanidze
(54) **STEEP ALLOY RECEIVED BY SINTERING ON TITANIUM DIBORIDE AND TITANIUM CARBIDE BASE**
DATE OF PATENT CANCELLATION: 2018 02 06
PATENT RESTORATION IS AVAILABLE: 2019 02 06

DESIGNS

RENEWAL OF REGISTRATIONS

(11) D 2009 393 S

(73) Mars Incorporated (US)
Elm Stryt, Macklin, Virginia 22101-3883, USA (US)

(54) GRAPHIC SYMBOL

(28) 1
(24) 2009 02 19
(18) 2024 02 19
(58) 2019 02 05

(11) D 2010 442 S

(73) Mars Incorporated (US)
Elm Stryt, Macklin, Virginia 22101-3883, USA (US)

(54) GRAPHIC SYMBOL

(28) 1
(24) 2009 09 30
(18) 2024 09 30
(58) 2019 02 05

(11) D 2010 443 S

(73) Mars Incorporated (US)
Elm Stryt, Macklin, Virginia 22101-3883, USA (US)

(54) GRAPHIC SYMBOL

(28) 2
(24) 2009 12 21
(18) 2024 12 21
(58) 2019 02 05

(11) D 2014 589 S

(73) LTD "MITANA" (GE)
G. Tchcondidelis q. 26, 0180, Tbilisi, Georgia (GE)

**(54) LABELS: 1-4 – BOILED SAUSAGES, 5 – CERVELAT, 6 – SMOKED AND COOKED SAUSAGES,
7-8 – FRANKFURTERS**

(28) 8
(24) 2014 02 07
(18) 2024 02 07
(58) 2019 02 14

TRADEMARKS

RENEWAL OF REGISTRATIONS

(111) M 1998 11238 R2

(156) 09 12 1998

(186) 09 12 2028

(732) JOHNSON & JOHNSON (a corporation the state of New Jersey)
One Johnson & Johnson Plaza, New Brunswick, New Jersey, USA

(732) INTEL CORPORATION

2200 Mission College Boulevard,
Santa Clara, California 95052-8119, USA

(111) M 1998 11239 R2

(156) 09 12 1998

(186) 09 12 2028

(732) JOHNSON & JOHNSON (a corporation the state of New Jersey)
One Johnson & Johnson Plaza, New Brunswick, New Jersey, USA

(111) M 1998 11268 R2

(156) 11 12 1998

(186) 11 12 2028

(732) JOHNSON & JOHNSON
One Johnson & Johnson Plaza, New Brunswick, New Jersey 08933-7001, USA

(111) M 1999 11753 R2

(156) 18 03 1999

(186) 18 03 2029

(732) ORACLE AMERICA, INC.
500 Oracle Parkway, Redwood Shores, California 94065, USA

(111) M 1998 11269 R2

(156) 11 12 1998

(186) 11 12 2028

(732) PFIZER LIMITED
Ramsgate Road Sandwich Kent CT13 9NJ, INGLAND, United Kingdom

(111) M 1999 11779 R2

(156) 18 03 1999

(186) 18 03 2029

(732) UNILEVER N.V.
Weena 455, NL-3013 AL Rotterdam, Netherlands

(111) M 1998 11276 R2

(156) 14 12 1998

(186) 14 12 2028

(732) JOHNSON & JOHNSON
One Johnson & Johnson Plaza, New Brunswick, New Jersey 08933-7001, USA

(111) M 1998 10128 R2

(156) 31 07 1998

(186) 31 07 2028

(732) Jacobs Douwe Egberts BR Comercialização de Cafés Ltda.
Av. Dr. Marcos Penteado de Ulhôa Rodrigues 939, 2nd Floor, Tamboré, Barueri, 06460 040, São Paulo, Brazil

(111) M 1999 11383 R2

(156) 26 01 1999

(186) 26 01 2029

(732) IMAC S.P.A.
Via Menocchia 27, Montefiore Dell'Aso (Ascoli Piceno), 63010, Italy

(111) M 1998 11039 R2

(156) 29 10 1998

(186) 29 10 2028

(732) INTEL CORPORATION
2200 Mission College Boulevard, Santa Clara, California 95052-8119, USA

(111) M 1999 11566 R2

(156) 17 02 1999

(186) 17 02 2029

(732) MOLINOS RIO DE LA PLATA S.A.
Avenida Presidente Manuel Quintana 192, Piso 1, CP C1014ACO, Buenos-airesi, Argentina

(111) M 1998 11040 R2

(156) 29 10 1998

(186) 29 10 2028

(111) M 1999 11392 R2

(156) 26 01 1999

(186) 26 01 2029

(732) BOUCHARA RECORDATI
Immeuble "Le Wilson", 70, avenue du Général de Gaulle, 92800 Puteaux, France

(111) M 1999 11482 R2
(156) 11 02 1999
(186) 11 02 2029
(732) ZORLUTEKS TEKSTİL TİCARET VE
SANAYİ ANONİM ŞİRKETİ
Levent 199, Büyükdere Caddesi, No:199,
34394 Sisli, İstanbul, Turkey

(111) M 1999 11399 R2
(156) 26 01 1999
(186) 26 01 2029
(732) BIOLOGISCHE HEILMITTEL HEEL
GmbH
Dr.-Reckweg-Strasse 2-4, D-76532 Baden-
Baden, Germany

(111) M 1999 11569 R2
(156) 17 02 1999
(186) 17 02 2029
(732) CALZADOS PABLO, S.L.
Maestro Guerrero, 24 45510 Fuensalida
(Toledo), Spain

(111) M 1999 11570 R2
(156) 17 02 1999
(186) 17 02 2029
(732) PABLOSKY, S.L.
Maestro Guerrero, 24 45510 Fuensalida
(Toledo), Spain

(111) M 1999 11449 R2
(156) 09 02 1999
(186) 09 02 2029
(732) KIA MOTORS CORPORATION
231 Yangjae-dong, Seocho-gu, Seoul,
Republic of Korea

(111) M 1999 11494 R2
(156) 11 02 1999
(186) 11 02 2029
(732) INTEL CORPORATION
2200 Mission College Boulevard, Santa
Clara, California 95052-8119, USA

(111) M 1999 11466 R2
(156) 10 02 1999
(186) 10 02 2029
(732) GOLDEN LADY COMPANY S.P.A
Via Giacomo Leopardi 3/5, Castiglione
Delle Stiviere (MN), Italy

(111) M 1999 11872 R2
(156) 20 04 1999
(186) 20 04 2029
(732) BAYER CONSUMER CARE AG
Peter Merian-Str. 84, 4052 Basel, Switzerland

(111) M 1999 11692 R2
(156) 15 03 1999
(186) 15 03 2029
(732) JEAN PATOU
242 Rue Jean Goujon, Paris, 75008, France

(111) M 1999 11916 R2
(156) 30 04 1999
(186) 30 04 2029
(732) INTEL CORPORATION
a Delaware Corporation
2200 Mission College Boulevard, Santa
Clara, California 95052-8119, USA

(111) M 1999 12371 R2
(156) 15 06 1999
(186) 15 06 2029
(732) MARS Inc.
6885, Elm Street, McLean, Virginia, USA

(111) M 1999 12372 R2
(156) 15 06 1999
(186) 15 06 2029
(732) MARS Inc.
6885, Elm Street, McLean, Virginia, USA

(111) M 1999 11439 R2
(156) 29 01 1999
(186) 29 01 2029
(732) LTD "TURMANIDZE"
D. Uznadzis q. 117, b.12, Tbilisi, Georgia

(111) M 1999 12384 R2
(156) 15 06 1999
(186) 15 06 2029
(732) MARS Inc.
6885, Elm Street, McLean, Virginia, USA

(111) M 1999 12511 R2
(156) 12 07 1999
(186) 12 07 2029
(732) MARS Inc.
6885 Elm Street, McLean, Virginia
22101-3883, USA

(111) M 1999 12724 R2 (156) 31 08 1999 (186) 31 08 2029 (732) LRC PRODUCTS LIMITED 103-105 Bath Road, Slough, SL1 3UH, United Kingdom	Metekhis Aghmarti 22, 0103, Tbilisi, Georgia
(111) M 1999 12755 R2 (156) 23 09 1999 (186) 23 09 2029 (732) MARS Inc. 6885 Elm Street Mclean, Virginia 22101-3883, USA	(111) M 2009 19196 R1 (156) 21 04 2009 (186) 21 04 2029 (732) NOVARTIS AG 4002 Basel, Switzerland
(111) M 1999 12877 R2 (156) 25 10 1999 (186) 25 10 2029 (732) MARS Inc. 6885 Elm Street Mclean, Virginia 22101-3883, USA	(111) M 2009 19197 R1 (156) 21 04 2009 (186) 21 04 2029 (732) NOVARTIS AG 4002 Basel, Switzerland
(111) M 1999 13044 R2 (156) 15 12 1999 (186) 15 12 2029 (732) MARS Inc. 6885, Elm Street, McLean, Virginia, USA	(111) M 2008 18722 R1 (156) 26 09 2008 (186) 26 09 2028 (732) JSC "TechnoNIKOL" Ul. Giliarovskovo, Dom. 47, Stroenie 5, Et. 5, Pom. 1, Kom. 22, 129110, Moscow, Russian Federation
(111) M 1999 13051 R2 (156) 15 12 1999 (186) 15 12 2029 (732) MARS Inc. a Delaware Corporation 6885 Elm Street, McLean, Virginia 22101-3883, USA	(111) M 2008 18605 R1 (156) 11 07 2008 (186) 11 07 2028 (732) OOO "BAIKAL" 50, Kolcevaya St., 432044 Ulyanovsk, Russian Federation
(111) M 1999 13058 R2 (156) 15 12 1999 (186) 15 12 2029 (732) MARS Inc. 6885 Elm Street Mclean, Virginia 22101-3883, USA	(111) M 2008 18775 R1 (156) 16 10 2008 (186) 16 10 2028 (732) LTD "ASPHARMA" – Georgian Pharma- ceutical Company Shevchenkos q. 12, 0108, Tbilisi, Georgia
(111) M 2008 18517 R1 (156) 16 06 2008 (186) 16 06 2028 (732) Niaz Diasamidze Z. Paliashvilis q. 33a, 0179, Tbilisi, Georgia	(111) M 2008 18645 R1 (156) 31 07 2008 (186) 31 07 2028 (732) LTD "LUXLIGHT GEORGIA" Bakhtrionis q. 22/57, 0194, Tbilisi, Georgia
(111) M 2008 18821 R1 (156) 03 11 2008 (186) 03 11 2028 (732) LTD "GEORGIAN IVENTS"	(111) M 1999 12330 R2 (156) 08 06 1999 (186) 08 06 2029 (732) ROLEX SA Rue Francois-Dussaud 3-5-7, Geneva, Switzerland

(111) M 2008 18878 R1
(156) 17 11 2008
(186) 17 11 2028
(732) LTD "ASPHARMA" – Georgian Pharmaceutical Company
Shevchenkos q. 12, 0108, Tbilisi, Georgia

(111) M 2008 18879 R1
(156) 17 11 2008
(186) 17 11 2028
(732) LTD "ASPHARMA" – Georgian Pharmaceutical Company
Shevchenkos q. 12, 0108, Tbilisi, Georgia

(111) M 2008 18882 R1
(156) 17 11 2008
(186) 17 11 2028
(732) LTD "ASPHARMA" – Georgian Pharmaceutical Company
Shevchenkos q. 12, 0108, Tbilisi, Georgia

(111) M 2008 18796 R1
(156) 16 10 2008
(186) 16 10 2028
(732) LTD "ASPHARMA" – Georgian Pharmaceutical Company
Shevchenkos q. 12, 0108, Tbilisi, Georgia

(111) M 2009 19077 R1
(156) 13 02 2009
(186) 13 02 2029
(732) IMG Universe LLC
11 Madison Avenue, New York, New York
10010, USA

(111) M 2009 19078 R1
(156) 13 02 2009
(186) 13 02 2029
(732) IMG Universe LLC
11 Madison Avenue, New York, New York
10010, USA

(111) M 2009 19046 R1
(156) 16 01 2009
(186) 16 01 2029
(732) ITERNACIONAL OLIVARERA S.A.
Garcilaso de la Vega, 2, 41700 Dos
Hermanas, Sevilla, Spain

(111) M 1999 11802 R2
(156) 19 04 1999
(186) 19 04 2029

(732) MARS, INCORPORATED
6885, Elm Street, McLean, Virginia, USA

(111) M 1999 12132 R2
(156) 12 05 1999
(186) 12 05 2029
(732) MARS Inc.
6885 ELM Street, McLean, Virginia
22101-3883, USA

(111) M 1999 12133 R2
(156) 12 05 1999
(186) 12 05 2029
(732) MARS Inc.
6885 ELM Street, McLean, Virginia
22101-3883, USA

(111) M 1999 11611 R2
(156) 18 02 1999
(186) 18 02 2029
(732) MARS Inc.
6885 Elm Street Mclean, Virginia
22101-3883, USA

(111) M 1999 12095 R2
(156) 10 05 1999
(186) 10 05 2029
(732) MARS Inc.
6885 Elm Street Mclean, Virginia
22101-3883, USA

(111) M 1999 12096 R2
(156) 10 05 1999
(186) 10 05 2029
(732) MARS Inc.
6885 Elm Street Mclean, Virginia
22101-3883, USA

(111) M 2009 19207 R1
(156) 21 04 2009
(186) 21 04 2029
(732) Betek Boya Ve Kimya Sanayi Anonim
Şirketi
Kaynarca, Kavakpınar Mh. Tandogan Cad.
Kocamezarlık Karşisi, Pendik-ISTANBUL,
Turkey

(111) M 2009 19250 R1
(156) 29 04 2009
(186) 29 04 2029
(732) Diageo Ireland
St. James's Gate, Dublin 8, Ireland

(111) M 2009 19168 R1
(156) 30 03 2009
(186) 30 03 2029
(732) HEARST COMMUNICATIONS, INC.
a Delaware Corporation
300 West 57th Street, 40th Floor, New
York, New York 10019, USA

(111) M 2009 19141 R1
(156) 16 03 2009
(186) 16 03 2029
(732) PFIZER PRODUCTS INC.
a Connecticut Corporation
Eastern Point Road, Groton, Connecticut
06340, USA

(111) M 2009 19320 R1
(156) 15 05 2009
(186) 15 05 2029
(732) L'OREAL-SOCIETE ANONYME
14, rue Royal 75008, Paris, France

(111) M 2009 19321 R1
(156) 15 05 2009
(186) 15 05 2029
(732) L'OREAL-SOCIETE ANONYME
14, rue Royal, F-75008, Paris, France

(111) M 2009 19322 R1
(156) 15 05 2009
(186) 15 05 2029
(732) L'OREAL-SOCIETE ANONYME
14, rue Royal, F-75008, Paris, France

(111) M 2009 19329 R1
(156) 15 05 2009
(186) 15 05 2029
(732) L'OREAL-SOCIETE ANONYME
14, rue Royal, F-75008, Paris, France

(111) M 2009 19330 R1
(156) 15 05 2009
(186) 15 05 2029
(732) L'OREAL-SOCIETE ANONYME
14, rue Royal, F-75008, Paris, France

(111) M 2009 19179 R1
(156) 30 03 2009
(186) 30 03 2029
(732) LTD "GMP"
Sop. Ponitchala 65, 0165, Tbilisi, Georgia

(111) M 2009 19455 R1
(156) 29 06 2009
(186) 29 06 2029
(732) Wm. WRIGLEY Jr. Company
1132 West Blackhawk Street, Chicago,
Illinois 60642, USA

(111) M 2009 19182 R1
(156) 30 03 2009
(186) 30 03 2029
(732) GEORGE V ETERTAINMENT
(société anonyme)
21, PLACE DE LA MADELEINE, 75008
PARIS, France

(111) M 2009 19683 R1
(156) 08 09 2009
(186) 08 09 2029
(732) McDonald's International Property Company
Ltd., a corporation organized and existing
under the laws of the State of Delaware
110 North Carpenter Street, Chicago, Illinois
60607, USA

(111) M 2009 19578 R1
(156) 24 07 2009
(186) 24 07 2029
(732) WESTENHORST GMBH & CO. KG.
Paulsburg 1-3, 59302 Oelde, Germany

(111) M 2009 19579 R1
(156) 24 07 2009
(186) 24 07 2029
(732) WESTENHORST GMBH & CO. KG.
Paulsburg 1-3, 59302 Oelde, Germany

(111) M 2009 20068 R1
(156) 15 12 2009
(186) 15 12 2029
(732) DISNEY ENTERPRISES INC.
a Delaware corporation
500 South Buena Vista Street, Burbank,
California 91521, USA

(111) M 2009 19767 R1
(156) 11 09 2009
(186) 11 09 2029
(732) McDonald's International Property Company,
Ltd., a corporation organized and existing
under the laws of the State of Delaware
110 North Carpenter Street, Chicago, Illinois
60607, USA

(111) M 2010 20137 R1
(156) 11 01 2010
(186) 11 01 2030
(732) JSC "GEORGIAN BANK"
Gagarinis q. 29a, 0160, Tbilisi, Georgia

(111) M 2010 20138 R1
(156) 11 01 2010
(186) 11 01 2030
(732) JSC "GEORGIAN BANK"
Gagarinis q. 29a, 0160, Tbilisi, Georgia

(111) M 2009 20082 R1
(156) 15 12 2009
(186) 15 12 2029
(732) LTD "Gerogian Traditional Winemaking"
Ksnis q. 12, 0141, Tbilisi, Georgia

(111) M 2009 20083 R1
(156) 15 12 2009
(732) LTD "Gerogian Traditional Winemaking"
Ksnis q. 12, 0141, Tbilisi, Georgia

(111) M 2009 20112 R1
(156) 28 12 2009
(186) 28 12 2029
(732) LTD "Gerogian Traditional Winemaking"
Ksnis q. 12, 0141, Tbilisi, Georgia

(111) M 2009 20134 R1
(156) 28 12 2009
(186) 28 12 2029
(732) COORS BREWING COMPANY
1801 California Street, Suite 4600,
Denver, Colorado 80202, USA

(111) M 2009 20135 R1
(156) 28 12 2009
(186) 28 12 2029
(732) MARS Inc.
6885 Elm Street, McLean, Virginia
22101-3883, USA

(111) M 2009 20059 R1
(156) 27 11 2009
(186) 27 11 2029
(732) Marsel Benamu
Titsian Tabidzis q.41, b. 8, Tbilisi, 0162,
Georgia

(111) M 2010 20209 R1
(156) 26 01 2010
(186) 26 01 2030
(732) DEPO AUTO PARTS IND. CO., LTD.
N 20-3, NAN SHIN LANE, LU KONG
CHEN, CHUNGHUA SEIEN, Taiwan,
Province of China

(111) M 1998 10298 R2
(156) 19 08 1998
(186) 19 08 2028
(732) YVES SAINT LAURENT PARFUMS
284 Boulevard du Parc, 92521 Neuilly
Cedex, France

(111) M 1998 10299 R2
(156) 19 08 1998
(186) 19 08 2028
(732) YVES SAINT LAURENT PARFUMS
284 Boulevard du Parc, 92521 Neuilly
Cedex, France

(111) M 1998 10300 R2
(156) 19 08 1998
(186) 19 08 2028
(732) YVES SAINT LAURENT PARFUMS
284 Boulevard du Parc, 92521 Neuilly
Cedex, France

(111) M 1998 10301 R2
(156) 19 08 1998
(186) 19 08 2028
(732) YVES SAINT LAURENT PARFUMS
284 Boulevard du Parc, 92521 Neuilly
Cedex, France

(111) M 1998 10302 R2
(156) 19 08 1998
(186) 19 08 2028
(732) YVES SAINT LAURENT PARFUMS
284 Boulevard du Parc, 92521 Neuilly
Cedex, France

(111) M 1999 11531 R2
(156) 16 02 1999
(186) 16 02 2029
(732) MARS INC. (Corporatin of State Delaware)
6885 ELM Street, McLean, Virginia
22101-3883, USA

(111) M 1999 11533 R2
(156) 16 02 1999
(186) 16 02 2029

(732) MARS INC., (corp. State of Delaware)
6885 Elm Street, McLean, Virginia
22101-3883, USA

Schanzenstrase 84, 40549 Dusseldorf,
Germany

(111) M 1999 11705 R2
(156) 16 03 1999
(186) 16 03 2029
(732) MARS INC. (Corporatin of State Delaware)
6885 ELM Street, McLean, Virginia
22101-3883, USA

(111) M 1999 11724 R2
(156) 17 03 1999
(186) 17 03 2029
(732) SAINT GOBAIN WEBER GMBH
Schanzenstrase 84, 40549 Dusseldorf,
Germany

(111) M 1999 12134 R2
(156) 12 05 1999
(186) 12 05 2029
(732) MARS Inc.
6885 Elm Street Mclean, Virginia
22101-3883, USA

(111) M 1999 11537 R2
(156) 16 02 1999
(186) 16 02 2029
(732) BITBURGER BRAUGRUPPE GMBH
Romermauer 3, 54634 Bitburg, Germany

(111) M 1999 12054 R2
(156) 10 05 1999
(186) 10 05 2029
(732) MARS Inc.
a Delaware corporation
6885 ELM Street, McLEAN, VIRGINIA
22101-3883, USA

(111) M 1999 11538 R2
(156) 16 02 1999
(186) 16 02 2029
(732) BITBURGER BRAUGRUPPE GMBH
Romermauer 3, 54634 Bitburg, Germany

(111) M 1999 12055 R2
(156) 10 05 1999
(186) 10 05 2029
(732) MARS Inc.
a Delaware corporation
6885 ELM Street, McLEAN, VIRGINIA
22101-3883, USA

(111) M 1999 11726 R2
(156) 17 03 1999
(186) 17 03 2029
(732) SEIKO HOLDINGS KABUSHIKI
KAISHA (trading as SEIKO HOLDINGS
CORPORATION)
5-11, Ginza, 4-Chome, Chuo-ku, Tokyo,
Japan

(111) M 1998 11195 R2
(156) 02 12 1998
(186) 02 12 2028
(732) JOHNSON & JOHNSON
One Johnson & Johnson Plaza, New
Brunswick, New Jersey 08933, USA

(111) M 1999 11803 R2
(156) 19 04 1999
(186) 19 04 2029
(732) BEIERSDORF AG
Unnastrasse 48, D-20253 Hamburg, Germany

(111) M 1998 11196 R2
(156) 02 12 1998
(186) 02 12 2028
(732) JOHNSON & JOHNSON
One Johnson & Johnson Plaza, New
Brunswick, New Jersey 08933, USA

(111) M 1999 12167 R2
(156) 12 05 1999
(186) 12 05 2029
(732) MONTRES TUDOR S.A.
3, rue Francois-Dussaud, CH-Geneve,
Switzerland

(111) M 1999 11721 R2
(156) 17 03 1999
(186) 17 03 2029
(732) SAINT GOBAIN WEBER GMBH

(111) M 1999 12541 R2
(156) 12 07 1999
(186) 12 07 2029
(732) SOCIETE DES HOTELS MERIDIEN
TOUR MAINE MONTPARNASSE, 33,
avenue du Maine, 14è étage, 75015 Paris,
France

(111) M 1999 11735 R2
(156) 17 03 1999
(186) 17 03 2029
(732) COMPAGNE GENERALE DES
ESTABLISSEMENTS MICHELIN
23, Place des Carmes-dechaux, 63000
Klermont-Ferrand, France

(111) M 1999 11736 R2
(156) 17 03 1999
(186) 17 03 2029
(732) COMPAGNE GENERALE DES
ESTABLISSEMENTS MICHELIN
23, Place des Carmes-dechaux, 63000
Klermont-Ferrand, France

(111) M 1999 12073 R2
(156) 10 05 1999
(186) 10 05 2029
(732) PERFETTI VAN MELLE S.P.A.
7, Via XXV Aprile, 20020 Lainate (Milano),
Italy

(111) M 1999 11644 R2
(156) 18 02 1999
(186) 18 02 2029
(732) YVES SAINT LAURENT PARFUMS,
Societe anonyme
284, Boulevard du Parc, F-92521 Neuilly
Sedex, France

(111) M 1999 12556 R2
(156) 12 07 1999
(186) 12 07 2029
(732) MARS INC.
6885 Elm Street, McLean, Virginia, USA

(111) M 1999 11812 R2
(156) 19 04 1999
(186) 19 04 2029
(732) MARS, INC. (Corp. State Delaware)
6885 Elm Street, McLean, Virginia
22101-3883, USA

(111) M 1998 11148 R2
(156) 27 11 1998
(186) 27 11 2028
(732) MACDERMID AGRICULTURAL
SOLUTIONS HOLDINGS B.V.
245 Freight Street, Waterbury, Connecticut
06702, USA

(111) M 1999 11749 R2
(156) 18 03 1999
(186) 18 03 2029
(732) BAYER CONSUMER CARE AG
Peter Merian-Strasse 84, 4002 Basel,
Switzerland

(111) M 1999 11509 R2
(156) 16 02 1999
(186) 16 02 2029
(732) CALVIN KLEIN TRADEMARK TRUST
Rodney Square North, 1100 North
Market Street, Wilmington, DE 19890,
USA

(111) M 1999 11548 R2
(156) 16 02 1999
(186) 16 02 2029
(732) HERMES SUSSTOFF AG (HERMES
EDULCRANTS S.A., HERMES
SWEETENERS LTD.)
Ankerstrasse 53, CH-8026, Zurich,
Switzerland

(111) M 1999 11551 R2
(156) 16 02 1999
(186) 16 02 2029
(732) BEAM GLOBAL UK LIMITED
Prewetts Mill, Worthing Road, Horcham,
West Suisse RH12 1 ST, United Kingdom

COMPLETE TRANSFER OF RIGHTS

(111) M 2010 20454 R
(732) RB Health (US) LLC
399 Interpace Parkway, Parsippany,
New Jersey 07054, USA
(770) RECKITT BENCKISER LLC
399 Interpace Parkway, Parsippany, NJ
07454-1115, USA
(580) 28 01 2019

(111) M 2011 21971 R
(732) RB Health (US) LLC
399 Interpace Parkway, Parsippany, New
Jersey 07054, USA
(770) RECKITT BENCKISER LLC
Moris Corporqte Center IV, 399 Interpace
Parkway, Parsippany, NJ 07054-0225, USA
(580) 28 01 2019

(111) M 1997 5249 R
(732) ESCO Group LLC
2141 NW 25-th Avenue, Portland, Oregon,
97210, USA
(770) ESCO CORPORATION
2141 N.W. 25-th Avenue, P.O. Box
10123 Portland, Oregon 97210, USA
(580) 29 01 2019

(111) M 2017 28380 R
(732) Aleksandre Iamanidze
Al. Matchavarianis q. 5, Tbilisi, Georgia
(770) Nikoloz Iamanidze
Al. Matchavarianis q. 5, Tbilisi, Georgia
(580) 10 08 2018

CHANGES IN NAMES AND/OR ADDRESSES OF OWNERS

-
- (111) M 1998 9793 R
(732) LEVI STRAUSS & CO.
1155 Battery Street, San Francisco,
California 94111, USA
(770) LEVI STRAUSS & CO.
Levi's Plaza 7215, San Francisco, California
94120, USA
(580) 12 12 2018
-
- (111) M 1999 11466 R
(732) GOLDEN LADY COMPANY S.P.A
Via Giacomo Leopardi 3/5, Castiglione
Delle Stiviere (MN), Italy
(770) GOLDEN LADY COMPANY S.P.A
Viale Cavallotti 11, Jesi, Ancona, Italy
(580) 11 02 2019
-
- (111) M 1996 2365 R
(732) LEVI STRAUSS & CO.
1155 Battery Street, San Francisco,
California 94111, USA
(770) LEVI STRAUSS & CO
Levi's Plaza, P.O. Box 7215 SAN
FRANCISCO Cal. 94120, USA
(580) 12 12 2018
-
- (111) M 1996 2380 R
(732) LEVI STRAUSS & CO.
1155 Battery Street, San Francisco,
California 94111, USA
(770) LEVI STRAUSS & CO
Levi's Plaza, P.O. Box 7215 SAN
FRANCISCO Cal. 94120, USA
(580) 12 12 2018
-
- (111) M 1996 2366 R
(732) LEVI STRAUSS & Co.
1155 Battery Street, San Francisco, California
94111, USA
(770) LEVI STRAUSS & CO
Levi's Plaza, P.O. Box 7215, San Francisco
FRANCISCO Cal. 94120, USA
(580) 12 12 2018
-
- (111) M 1996 2381 R
(732) LEVI STRAUSS & CO.
1155 Battery Street, San Francisco, California
94111, USA
(770) LEVI STRAUSS & CO
- Levi's Plaza, P.O. Box 7215, San Francisco
Cal. 94120, USA
(580) 12 12 2018
-
- (111) M 1997 5340 R
(732) LEVI STRAUSS & CO.
1155 Battery Street, San Francisco,
California 94111, USA
(770) LEVI STRAUSS & CO
Levi's Plaza P.O. box 7215, San Francisco,
California 94120, USA
(580) 12 12 2018
-
- (111) M 1996 1351 R
(732) LEVI STRAUSS & CO.
1155 Battery Street, San Francisco,
California 94111, USA
(770) LEVI STRAUSS & CO
Levi's Plaza P.O. box 7215, San Francisco,
California 94120, USA
(580) 12 12 2018
-
- (111) M 1997 5312 R
(732) LEVI STRAUSS & CO.
1155 Battery Street, San Francisco,
California 94111, USA
(770) LEVI STRAUSS & CO.
Levi's Plaza 7215, San Francisco, California
94120, USA
(580) 12 12 2018
-
- (111) M 1996 3008 R
(732) LEVI STRAUSS & CO.
1155 Battery Street, San Francisco,
California 94111, USA
(770) LEVI STRAUSS & CO
Levi's Plaza, P.O. Box 7215, San Francisco,
California 94120, USA
(580) 12 12 2018
-
- (111) M 1996 2367 R
(732) LEVI STRAUSS & CO.
1155 Battery Street, San Francisco,
California 94111, USA
(770) LEVI STRAUSS & CO
Levi's Plaza, P.O. Box 7215, San Francisco
Cal. 94120, USA
(580) 12 12 2018
-

(111) M 1994 284 R
 (732) BRITISH AMERICAN TOBACCO
 (BRANDS) INC.
 251 Little Falls Drive, Suite 100,
 Wilmington, DE 19808-1674, USA
 (770) BRITISH AMERICAN TOBACCO
 (BRANDS) INC.
 2711 Centerville Road, Suite 300,
 Wilmington, Delaware 19808, USA
 (580) 21 01 2019

(111) M 2006 17012 R
 (732) BRITISH AMERICAN TOBACCO
 (BRANDS) INC. (a Delaware corporation)
 251 Little Falls Drive, Suite 100,
 Wilmington, DE 19808-1674, USA
 (770) BRITISH AMERICAN TOBACCO
 (BRANDS) INC. (a Delaware corporation)
 2711 Centerville Road, Suite 300,
 Wilmington, Delaware 19808, USA
 (580) 21 01 2019

(111) M 1997 7247 R
 (732) LEVI STRAUSS & CO.
 1155 Battery Street, San Francisco,
 California 94111, USA
 (770) LEVI STRAUSS & CO.
 Levis Plaza 7215, San Francisco,
 California 94120, USA
 (580) 12 12 2018

(111) M 1997 7248 R
 (732) LEVI STRAUSS & CO.
 1155 Battery Street, San Francisco,
 California 94111, USA
 (770) LEVI STRAUSS & CO.
 Levis Plaza 7215, San Francisco,
 California 94120, USA
 (580) 12 12 2018

(111) M 1994 214 R
 (732) BRITISH AMERICAN TOBACCO
 (BRANDS) INC.
 251 Little Falls Drive, Suite 100,
 Wilmington, DE 19808-1674, USA
 (770) BRITISH AMERICAN TOBACCO
 (BRANDS) INC.
 2711 Centerville Road, Suite 300,
 Wilmington, Delaware 19808, USA
 (580) 28 01 2019

(111) M 1995 792 R
 (732) ARLANXEO Netherland B.V.
 Urmonderbaan 24, 6167 RD Geleen,
 Netherlands

(770) LANXESS ELASTOMERS B.V.
 Mijnweg 1, 6167 AC Geleen, Netherlands
 (580) 10 12 2018

(111) M 2008 18722 R
 (732) JSC "TechnoNIKOL"
 Ul. Giliarovskovo, Dom. 47, Stroenie 5,
 Et. 5, Pom. 1, Kom. 22, 129110, Moscow,
 Russian Federation
 (770) Zakrytoe JSC "TechnoNIKOL"
 Krymskiy val, 8, 117049, Moscow, Russian
 Federation
 (580) 26 09 2018

(111) M 2009 19179 R
 (732) LTD "GMP"
 Sop. Ponitchala 65, Tbilisi, 0165, Georgia
 (770) LTD "GMP"
 Zemo Vedzsis q. 103, Tbilisi, 0160, Georgia
 (580) 12 02 2019

(111) M 2009 19182 R
 (732) GEORGE VETERTAINMENT (société
 anonyme)
 21, PLACE DE LA MADELEINE, 75008
 PARIS, France
 (770) GEORGE V ETERTAINMENT (société
 anonyme)
 23 rue d'anjou75008 Paris, France
 (580) 29 01 2019

(111) M 2009 19616 R
 (732) BRITISH AMERICAN TOBACCO
 (BRANDS) INC. (a Delaware corporation)
 251 Little Falls Drive, Suite 100,
 Wilmington, DE 19808-1674, USA
 (770) BRITISH AMERICAN TOBACCO
 (BRANDS) INC. (a Delaware corporation)
 2711 Centerville Road, Suite 300,
 Wilmington, Delaware 19808, USA
 (580) 18 01 2019

(111) M 2009 19683 R
 (732) MCDONALD'S INTERNATIONAL
 PROPERTY COMPANY, LTD.,
 a corporation organized and existing under
 the laws of the State of Delaware
 110 North Carpenter Street, Chicago, Illinois
 60607, USA
 (770) MCDONALD'S INTERNATIONAL
 PROPERTY COMPANY, LTD.,
 a corporation organized and existing under
 the laws of the State of Delaware

2711 Centerville Road, Suite 400,
Wilmington, DE 19808 Delaware, USA
(580) 28 09 2018

(111) M 2010 20454 R
(732) RECKITT BENCKISER LLC
399 Interpace Parkway, Parsippany, NJ
07454-1115, USA
(770) RECKITT BENCKISER INC.
399 Interpace Parkway, Parsippany, NJ
07454-1115, USA
(580) 28 01 2019

(111) M 2011 21245 R
(732) BRITISH AMERICAN TOBACCO
(BRANDS) INC. (a Delaware corporation)
251 Little Falls Drive, Suite 100,
Wilmington, DE 19808-1674, USA
(770) BRITISH AMERICAN TOBACCO
(BRANDS) INC. (a Delaware corporation)
2711 Centerville Road, Suite 300,
Wilmington, Delaware 19808, USA
(580) 18 01 2019

(111) M 2011 21315 R
(732) BRITISH AMERICAN TOBACCO
(BRANDS) INC. (a Delaware corporation)
251 Little Falls Drive, Suite 100,
Wilmington, DE 19808-1674, USA
(770) BRITISH AMERICAN TOBACCO
(BRANDS) INC. (a Delaware corporation)
2711 Centerville Road, Suite 300,
Wilmington, Delaware 19808, USA
(580) 18 01 2019

(111) M 2011 21477 R
(732) BRITISH AMERICAN TOBACCO
(BRANDS) INC. (a Delaware corporation)
251 Little Falls Drive, Suite 100,
Wilmington, DE 19808-1674, USA
(770) BRITISH AMERICAN TOBACCO
(BRANDS) INC. (a Delaware corporation)
2711 Centerville Road, Suite 300,
Wilmington, Delaware 19808, USA
(580) 18 01 2019

(111) M 2011 21971 R
(732) RECKITT BENCKISER LLC
Moris Corporqte Center IV, 399 Interpace
Parkway, Parsippany, NJ 07054-0225, USA
(770) RECKITT BENCKISER INC.
Moris Corporqte Center IV, 399 Interpace
Parkway, Parsippany, NJ 07054-0225, USA
(580) 28 01 2019

(111) M 2012 22647 R
(732) BRITISH AMERICAN TOBACCO
(BRANDS) INC. (a Delaware corporation)
251 Little Falls Drive, Suite 100,
Wilmington, DE 19808-1674, USA
(770) BRITISH AMERICAN TOBACCO
(BRANDS) INC. (a Delaware corporation)
2711 Centerville Road, Suite 300,
Wilmington, Delaware 19808, USA
(580) 18 01 2019

(111) M 2012 23170 R
(732) BRITISH AMERICAN TOBACCO
(BRANDS) INC. (a Delaware corporation)
251 Little Falls Drive, Suite 100,
Wilmington, DE 19808-1674, USA
(770) BRITISH AMERICAN TOBACCO
(BRANDS) INC. (a Delaware corporation)
2711 Centerville Road, Suite 300,
Wilmington, Delaware 19808, USA
(580) 18 01 2019

(111) M 2013 23342 R
(732) BRITISH AMERICAN TOBACCO
(BRANDS) INC. (a Delaware corporation)
251 Little Falls Drive, Suite 100,
Wilmington, DE 19808-1674, USA
(770) BRITISH AMERICAN TOBACCO
(BRANDS) INC. (a Delaware corporation)
2711 Centerville Road, Suite 300,
Wilmington, Delaware 19808, USA
(580) 18 01 2019

(111) M 2013 23343 R
(732) BRITISH AMERICAN TOBACCO
(BRANDS) INC. (a Delaware corporation)
251 Little Falls Drive, Suite 100,
Wilmington, DE 19808-1674, USA
(770) BRITISH AMERICAN TOBACCO
(BRANDS) INC. (a Delaware corporation)
2711 Centerville Road, Suite 300,
Wilmington, Delaware 19808, USA
(580) 18 01 2019

(111) M 2013 23344 R
(732) BRITISH AMERICAN TOBACCO
(BRANDS) INC. (a Delaware corporation)
251 Little Falls Drive, Suite 100,
Wilmington, DE 19808-1674, USA
(770) BRITISH AMERICAN TOBACCO
(BRANDS) INC. (a Delaware corporation)
2711 Centerville Road, Suite 300,
Wilmington, Delaware 19808, USA
(580) 18 01 2019

(111) M 2013 24385 R
(732) BRITISH AMERICAN TOBACCO
(BRANDS) INC. (a Delaware corporation)
251 Little Falls Drive, Suite 100,
Wilmington, DE 19808-1674, USA
(770) BRITISH AMERICAN TOBACCO
(BRANDS) INC. (a Delaware corporation)
2711 Centerville Road, Suite 300,
Wilmington, Delaware 19808, USA
(580) 18 01 2019

(111) M 2013 24039 R
(732) BRITISH AMERICAN TOBACCO
(BRANDS) INC. (a Delaware corporation)
251 Little Falls Drive, Suite 100,
Wilmington, DE 19808-1674, USA
(770) BRITISH AMERICAN TOBACCO
(BRANDS) INC. (a Delaware corporation)
2711 Centerville Road, Suite 300,
Wilmington, Delaware 19808, USA
(580) 18 01 2019

(111) M 2013 24391 R
(732) BRITISH AMERICAN TOBACCO
(BRANDS) INC. (a Delaware corporation)
251 Little Falls Drive, Suite 100,
Wilmington, DE 19808-1674, USA
(770) BRITISH AMERICAN TOBACCO
(BRANDS) INC. (a Delaware corporation)
2711 Centerville Road, Suite 300,
Wilmington, Delaware 19808, USA
(580) 18 01 2019

(111) M 2014 24547 R
(732) BRITISH AMERICAN TOBACCO
(BRANDS) INC. (a Delaware corporation)
251 Little Falls Drive, Suite 100,
Wilmington, DE 19808-1674, USA
(770) BRITISH AMERICAN TOBACCO
(BRANDS) INC. (a Delaware corporation)
2711 Centerville Road, Suite 300,
Wilmington, Delaware 19808, USA
(580) 18 01 2019

(111) M 1999 11721 R
(732) SAINT GOBAIN WEBER GMBH
Schanzenstrasse 84, 40549 Dusseldorf,
Germany
(770) MAXIT DEUTSCHLAND GMBH
Kupfertorstrasse 35, D-79206 Breisach,
Germany
(580) 04 02 2019

(111) M 1999 11724 R
(732) SAINT GOBAIN WEBER GMBH
Schanzenstrasse 84, 40549 Dusseldorf,
Germany
(770) MAXIT DEUTSCHLAND GMBH
Kupfertorstrasse 35, D-79206 Breisach,
Germany
(580) 04 02 2019

(111) M 2013 24404 R
(732) BRITISH AMERICAN TOBACCO
(BRANDS) INC. (a Delaware corporation)
251 Little Falls Drive, Suite 100,
Wilmington, DE 19808-1674, USA
(770) BRITISH AMERICAN TOBACCO
(BRANDS) INC. (a Delaware corporation)
2711 Centerville Road, Suite 300,
Wilmington, Delaware 19808, USA
(580) 18 01 2019

(111) M 2014 24889 R
(732) BRITISH AMERICAN TOBACCO
(BRANDS) INC. (a Delaware corporation)
251 Little Falls Drive, Suite 100,
Wilmington, DE 19808-1674, USA
(770) BRITISH AMERICAN TOBACCO
(BRANDS) INC. (a Delaware corporation)
2711 Centerville Road, Suite 300,
Wilmington, Delaware 19808, USA
(580) 18 01 2019

(111) M 2014 24751 R
(732) BRITISH AMERICAN TOBACCO
(BRANDS) INC. (a Delaware corporation)
251 Little Falls Drive, Suite 100,
Wilmington, DE 19808-1674, USA
(770) BRITISH AMERICAN TOBACCO
(BRANDS) INC. (a Delaware corporation)
2711 Centerville Road, Suite 300,
Wilmington, Delaware 19808, USA
(580) 18 01 2019

(111) M 1999 11735 R
(732) COMPAGNE GENERALE DES
ESTABLISSEMENTS MICHELIN
23, Place des Carmes-dechaux, 63000
Klermont-Ferrand, France
(770) COMPAGNE GENERALE DES
ESTABLISSEMENTS MICHELIN
12, cours Sablon, 63000, Clermont-Ferrand,
France
(580) 28 01 2019

(111) M 1999 11736 R
(732) COMPAGNE GENERALE DES
ESTABLISSEMENTS MICHELIN
23, Place des Carmes-dechaux, 63000
Klermont-Ferrand, France
(770) COMPAGNE GENERALE DES
ESTABLISSEMENTS MICHELIN
12, cours Sablon, 63000, Clermont-Ferrand,
France
(580) 28 01 2019

(111) M 2015 25689 R
(732) BRITISH AMERICAN TOBACCO
(BRANDS) INC. (a Delaware corporation)
251 Little Falls Drive, Suite 100,
Wilmington, DE 19808-1674, USA
(770) BRITISH AMERICAN TOBACCO
(BRANDS) INC. (a Delaware corporation)
2711 Centerville Road, Suite 300,
Wilmington, Delaware 19808, USA
(580) 21 01 2019

(111) M 2015 25809 R
(732) BRITISH AMERICAN TOBACCO
(BRANDS) INC. (a Delaware corporation)
251 Little Falls Drive, Suite 100,
Wilmington, DE 19808-1674, USA
(770) BRITISH AMERICAN TOBACCO
(BRANDS) INC. (a Delaware corporation)
2711 Centerville Road, Suite 300,
Wilmington, Delaware 19808, USA
(580) 21 01 2019

(111) M 2015 25898 R
(732) BRITISH AMERICAN TOBACCO
(BRANDS) INC. (a Delaware corporation)
251 Little Falls Drive, Suite 100,
Wilmington, DE 19808-1674, USA
(770) BRITISH AMERICAN TOBACCO
(BRANDS) INC. (a Delaware corporation)
2711 Centerville Road, Suite 300,
Wilmington, Delaware 19808, USA
(580) 21 01 2019

(111) M 1999 11646 R
(732) RHODIA CHIMIE, Societe par Actions
Simpliffee RHODIA CHIMIE, Societe par
ActionsSimpliffee
25 rue de Clichy - 75009 Paris, France
(770) RHODIA CHIMIE, Societe par Actions
Simpliffee
26 quai Alphonse Le Gallo - 92512
BOULOGNE-BILLANCOURT CEDEX,
France
(580) 08 02 2019

(111) M 2015 26262 R
(732) BRITISH AMERICAN TOBACCO
(BRANDS) INC. (a Delaware corporation)
251 Little Falls Drive, Suite 100,
Wilmington, DE 19808-1674, USA
(770) BRITISH AMERICAN TOBACCO
(BRANDS) INC. (a Delaware corporation)
2711 Centerville Road, Suite 300,
Wilmington, Delaware 19808, USA
(580) 21 01 2019

(111) M 2016 27887 R
(732) BRITISH AMERICAN TOBACCO
(BRANDS) INC. (a Delaware corporation)
251 Little Falls Drive, Suite 100,
Wilmington, DE 19808-1674, USA
(770) BRITISH AMERICAN TOBACCO
(BRANDS) INC. (a Delaware corporation)
2711 Centerville Road, Suite 300,
Wilmington, Delaware 19808, USA
(580) 21 01 2019

(111) M 2016 27217 R
(732) BRITISH AMERICAN TOBACCO
(BRANDS) INC. (a Delaware corporation)
251 Little Falls Drive, Suite 100,
Wilmington, DE 19808-1674, USA
(770) BRITISH AMERICAN TOBACCO
(BRANDS) INC. (a Delaware corporation)
2711 Centerville Road, Suite 300,
Wilmington, Delaware 19808, USA
(580) 21 01 2019

(111) M 2016 26976 R
(732) BRITISH AMERICAN TOBACCO
(BRANDS) INC. (a Delaware corporation)
251 Little Falls Drive, Suite 100,
Wilmington, DE 19808-1674, USA
(770) BRITISH AMERICAN TOBACCO
(BRANDS) INC. (a Delaware corporation)
2711 Centerville Road, Suite 300,
Wilmington, Delaware 19808, USA
(580) 21 01 2019

(111) M 2016 27055 R
(732) BRITISH AMERICAN TOBACCO
(BRANDS) INC. (a Delaware corporation)
251 Little Falls Drive, Suite 100,
Wilmington, DE 19808-1674, USA
(770) BRITISH AMERICAN TOBACCO
(BRANDS) INC. (a Delaware corporation)
2711 Centerville Road, Suite 300,
Wilmington, Delaware 19808, USA
(580) 21 01 2019

(111) M 2016 26829 R
(732) BRITISH AMERICAN TOBACCO
(BRANDS) INC. (a Delaware corporation)
251 Little Falls Drive, Suite 100,
Wilmington, DE 19808-1674, USA
(770) BRITISH AMERICAN TOBACCO
(BRANDS) INC. (a Delaware corporation)
2711 Centerville Road, Suite 300,
Wilmington, Delaware 19808, USA
(580) 21 01 2019

(111) M 2016 26831 R
(732) BRITISH AMERICAN TOBACCO
(BRANDS) INC. (a Delaware corporation)
251 Little Falls Drive, Suite 100,
Wilmington, DE 19808-1674, USA
(770) BRITISH AMERICAN TOBACCO
(BRANDS) INC. (a Delaware corporation)
2711 Centerville Road, Suite 300,
Wilmington, Delaware 19808, USA
(580) 21 01 2019

(111) M 2016 27142 R
(732) BRITISH AMERICAN TOBACCO
(BRANDS) INC. (a Delaware corporation)
251 Little Falls Drive, Suite 100,
Wilmington, DE 19808-1674, USA
(770) BRITISH AMERICAN TOBACCO
(BRANDS) INC. (a Delaware corporation)
2711 Centerville Road, Suite 300,
Wilmington, Delaware 19808, USA
(580) 21 01 2019

(111) M 2016 27078 R
(732) BRITISH AMERICAN TOBACCO
(BRANDS) INC. (a Delaware corporation)
251 Little Falls Drive, Suite 100,
Wilmington, DE 19808-1674, USA
(770) BRITISH AMERICAN TOBACCO
(BRANDS) INC. (a Delaware corporation)
2711 Centerville Road, Suite 300,
Wilmington, Delaware 19808, USA
(580) 21 01 2019

(111) M 2016 27342 R
(732) BRITISH AMERICAN TOBACCO
(BRANDS) INC. (a Delaware corporation)
251 Little Falls Drive, Suite 100,
Wilmington, DE 19808-1674, USA
(770) BRITISH AMERICAN TOBACCO
(BRANDS) INC. (a Delaware corporation)
2711 Centerville Road, Suite 300,
Wilmington, Delaware 19808, USA
(580) 21 01 2019

(111) M 2016 27348 R
(732) BRITISH AMERICAN TOBACCO
(BRANDS) INC. (a Delaware corporation)
251 Little Falls Drive, Suite 100,
Wilmington, DE 19808-1674, USA
(770) BRITISH AMERICAN TOBACCO
(BRANDS) INC. (a Delaware corporation)
2711 Sentervil Roud, Suit 300,
Uilmingtoni, Delaveri 19808, USA
(580) 21 01 2019

(111) M 2016 27100 R
(732) BRITISH AMERICAN TOBACCO
(BRANDS) INC
251 Little Falls Drive, Suite 100,
Wilmington, DE 19808-1674, USA
(770) BRITISH AMERICAN TOBACCO
(BRANDS) INC
2711 Centerville road, Suite 300,
Wilmington, Delaware 19808, USA
(580) 21 01 2019

(111) M 2016 27101 R
(732) BRITISH AMERICAN TOBACCO
(BRANDS) INC.
251 Little Falls Drive, Suite 100,
Wilmington, DE 19808-1674, USA
(770) BRITISH AMERICAN TOBACCO
(BRANDS) INC.
2711 Centerville Road, Suite 300,
Wilmington, Delaware 19808, USA
(580) 21 01 2019

(111) M 2016 27102 R
(732) BRITISH AMERICAN TOBACCO
(BRANDS) INC.
251 Little Falls Drive, Suite 100,
Wilmington, DE 19808-1674, USA
(770) BRITISH AMERICAN TOBACCO
(BRANDS) INC.
2711 Centerville Road, Suite 300,
Wilmington, Delaware 19808, USA
(580) 21 01 2019

(111) M 2016 27167 R
(732) BRITISH AMERICAN TOBACCO
(BRANDS) INC.
251 Litl Fols Draiv, Suit 100, Uilmingtoni,
DE 19808-1674, USA
(770) BRITISH AMERICAN TOBACCO
(BRANDS) INC.
2711 Centerville Road, Suite 300,
Wilmington, Delaware 19808, USA
(580) 21 01 2019

(111) M 2015 25865 R
(732) BRITISH AMERICAN TOBACCO
(BRANDS) INC. (a Delaware corporation)
251 Little Falls Drive, Suite 100,
Wilmington, DE 19808-1674, USA
(770) BRITISH AMERICAN TOBACCO
(BRANDS) INC. (a Delaware corporation)
2711 Centerville Road, Suite 300,
Wilmington, Delaware 19808, USA
(580) 21 01 2019

(111) M 2016 27641 R
(732) BRITISH AMERICAN TOBACCO
(BRANDS) INC. (a Delaware corporation)
251 Little Falls Drive, Suite 100,
Wilmington, DE 19808-1674, USA
(770) BRITISH AMERICAN TOBACCO
(BRANDS) INC. (a Delaware corporation)
2711 Centerville Road, Suite 300,
Wilmington, Delaware 19808, USA
(580) 21 01 2019

(111) M 2016 27806 R
(732) BRITISH AMERICAN TOBACCO
(BRANDS) INC. (a Delaware corporation)
251 Little Falls Drive, Suite 100,
Wilmington, DE 19808-1674, USA
(770) BRITISH AMERICAN TOBACCO
(BRANDS) INC. (a Delaware corporation)
2711 Centerville Road, Suite 300,
Wilmington, Delaware 19808, USA
(580) 21 01 2019

(111) M 2016 27670 R
(732) BRITISH AMERICAN TOBACCO
(BRANDS) INC. (a Delaware corporation)
251 Little Falls Drive, Suite 100,
Wilmington, DE 19808-1674, USA
(770) BRITISH AMERICAN TOBACCO
(BRANDS) INC. (a Delaware corporation)
2711 Centerville Road, Suite 300,
Wilmington, Delaware 19808, USA
(580) 21 01 2019

(111) M 2016 27307 R
(732) BRITISH AMERICAN TOBACCO
(BRANDS) INC. (a Delaware corporation)
251 Little Falls Drive, Suite 100,
Wilmington, DE 19808-1674, USA
(770) BRITISH AMERICAN TOBACCO
(BRANDS) INC. (a Delaware corporation)
2711 Centerville Road, Suite 300,
Wilmington, Delaware 19808, USA
(580) 18 01 2019

(111) M 2016 27813 R
(732) BRITISH AMERICAN TOBACCO
(BRANDS) INC. (a Delaware corporation)
251 Little Falls Drive, Suite 100,
Wilmington, DE 19808-1674, USA
(770) BRITISH AMERICAN TOBACCO
(BRANDS) INC. (a Delaware corporation)
2711 Centerville Road, Suite 300,
Wilmington, Delaware 19808, USA
(580) 18 01 2019

(111) M 2016 27678 R
(732) BRITISH AMERICAN TOBACCO
(BRANDS) INC. (a Delaware corporation)
251 Little Falls Drive, Suite 100,
Wilmington, DE 19808-1674, USA
(770) BRITISH AMERICAN TOBACCO
(BRANDS) INC. (a Delaware corporation)
2711 Centerville Road, Suite 300,
Wilmington, Delaware 19808, USA
(580) 18 01 2019

(111) M 2016 27679 R
(732) BRITISH AMERICAN TOBACCO
(BRANDS) INC. (a Delaware corporation)
251 Little Falls Drive, Suite 100,
Wilmington, DE 19808-1674, USA
(770) BRITISH AMERICAN TOBACCO
(BRANDS) INC. (a Delaware corporation)
2711 Centerville Road, Suite 300,
Wilmington, Delaware 19808, USA
(580) 18 01 2019

(111) M 1995 838 R
(732) BRITISH AMERICAN TOBACCO
(BRANDS) INC.
251 Little Falls Drive, Suite 100,
Wilmington, DE 19808-1674, USA
(770) BRITISH AMERICAN TOBACCO
(BRANDS) INC.
2711 Centerville Road, Suite 300,
Wilmington, Delaware 19808, USA
(580) 21 01 2019

(111) M 2016 27687 R
(732) BRITISH AMERICAN TOBACCO
(BRANDS) INC. (a Delaware corporation)
251 Little Falls Drive, Suite 100,
Wilmington, DE 19808-1674, USA
(770) BRITISH AMERICAN TOBACCO
(BRANDS) INC. (a Delaware corporation)
2711 Centerville Road, Suite 300,
Wilmington, Delaware 19808, USA
(580) 18 01 2019

(111) M 2016 27826 R
(732) BRITISH AMERICAN TOBACCO
(BRANDS) INC. (a Delaware corporation)
251 Little Falls Drive, Suite 100,
Wilmington, DE 19808-1674, USA
(770) BRITISH AMERICAN TOBACCO
(BRANDS) INC. (a Delaware corporation)
2711 Centerville Road, Suite 300,
Wilmington, Delaware 19808, USA
(580) 18 01 2019

(111) M 2016 27848 R
(732) BRITISH AMERICAN TOBACCO
(BRANDS) INC. (a Delaware corporation)
251 Little Falls Drive, Suite 100,
Wilmington, DE 19808-1674, USA
(770) BRITISH AMERICAN TOBACCO
(BRANDS) INC. (a Delaware corporation)
2711 Centerville Road, Suite 300,
Wilmington, Delaware 19808, USA
(580) 18 01 2019

(111) M 2017 28257 R
(732) BRITISH AMERICAN TOBACCO
(BRANDS) INC. (a Delaware corporation)
251 Little Falls Drive, Suite 100,
Wilmington, DE 19808-1674, USA
(770) BRITISH AMERICAN TOBACCO
(BRANDS) INC. (a Delaware corporation)
2711 Centerville Road, Suite 300,
Wilmington, Delaware 19808, USA
(580) 18 01 2019

(111) M 2017 28258 R
(732) BRITISH AMERICAN TOBACCO
(BRANDS) INC. (a Delaware corporation)
251 Little Falls Drive, Suite 100,
Wilmington, DE 19808-1674, USA
(770) BRITISH AMERICAN TOBACCO
(BRANDS) INC. (a Delaware corporation)
2711 Centerville Road, Suite 300,
Wilmington, Delaware 19808, USA
(580) 18 01 2019

(111) M 2017 28259 R
(732) BRITISH AMERICAN TOBACCO
(BRANDS) INC. (a Delaware corporation)
251 Little Falls Drive, Suite 100,
Wilmington, DE 19808-1674, USA
(770) BRITISH AMERICAN TOBACCO
(BRANDS) INC. (a Delaware corporation)
2711 Centerville Road, Suite 300,
Wilmington, Delaware 19808, USA
(580) 21 01 2019

(111) M 2017 28260 R
(732) BRITISH AMERICAN TOBACCO
(BRANDS) INC. (a Delaware corporation)
251 Little Falls Drive, Suite 100,
Wilmington, DE 19808-1674, USA
(770) BRITISH AMERICAN TOBACCO
(BRANDS) INC. (a Delaware corporation)
2711 Centerville Road, Suite 300,
Wilmington, Delaware 19808, USA
(580) 18 01 2019

(111) M 2017 28123 R
(732) BRITISH AMERICAN TOBACCO
(BRANDS) INC. (a Delaware corporation)
251 Little Falls Drive, Suite 100,
Wilmington, DE 19808-1674, USA
(770) BRITISH AMERICAN TOBACCO
(BRANDS) INC. (a Delaware corporation)
2711 Centerville Road, Suite 300,
Wilmington, Delaware 19808, USA
(580) 18 01 2019

(111) M 2016 28025 R
(732) BRITISH AMERICAN TOBACCO
(BRANDS) INC. (a Delaware corporation)
251 Little Falls Drive, Suite 100,
Wilmington, DE 19808-1674, USA
(770) BRITISH AMERICAN TOBACCO
(BRANDS) INC. (a Delaware corporation)
2711 Centerville Road, Suite 300,
Wilmington, Delaware 19808, USA
(580) 18 01 2019

(111) M 2017 28697 R
(732) BRITISH AMERICAN TOBACCO
(BRANDS) INC. (a Delaware corporation)
251 Little Falls Drive, Suite 100,
Wilmington, DE 19808-1674, USA
(770) BRITISH AMERICAN TOBACCO
(BRANDS) INC. (a Delaware corporation)
2711 Centerville Road, Suite 300,
Wilmington, Delaware 19808, USA
(580) 21 01 2019

(111) M 2017 28904 R
(732) BRITISH AMERICAN TOBACCO
(BRANDS) INC. (a Delaware corporation)
251 Little Falls Drive, Suite 100,
Wilmington, DE 19808-1674, USA
(770) BRITISH AMERICAN TOBACCO
(BRANDS) INC. (a Delaware corporation)
2711 Centerville Road, Suite 300,
Wilmington, Delaware 19808, USA
(580) 21 01 2019

(111) M 1998 9117 R
(732) ROHM AND HAAS COMPANY
400 Arcola Road, Collegeville, PA 19426,
USA
(770) ROHM AND HAAS COMPANY
Independence Mall West, City of
Philadelphia, State of Pennsylvania
19105, USA
(580) 24 01 2019

(111) M 2017 29166 R
(732) BRITISH AMERICAN TOBACCO
(BRANDS) INC. (a Delaware corporation)
251 Little Falls Drive, Suite 100,
Wilmington, DE 19808-1674, USA
(770) BRITISH AMERICAN TOBACCO
(BRANDS) INC. (a Delaware corporation)
2711 Centerville Road, Suite 300,
Wilmington, Delaware 19808, USA
(580) 21 01 2019

(111) M 2017 29167 R
(732) BRITISH AMERICAN TOBACCO
(BRANDS) INC. (a Delaware corporation)
251 Little Falls Drive, Suite 100,
Wilmington, DE 19808-1674, USA
(770) BRITISH AMERICAN TOBACCO
(BRANDS) INC. (a Delaware corporation)
2711 Centerville Road, Suite 300,
Wilmington, Delaware 19808, USA
(580) 21 01 2019

(111) M 1998 9613 R
(732) ROHM AND HAAS COMPANY
400 Arcola Road, Collegeville, PA 19426,
USA
(770) ROHM AND HAAS COMPANY
Independence Mall West, City of
Philadelphia, State of Pennsylvania
19105, USA
(580) 24 01 2019

(111) M 2018 29269 R
(732) BRITISH AMERICAN TOBACCO
(BRANDS) INC. (a Delaware corporation)
251 Little Falls Drive, Suite 100,
Wilmington, DE 19808-1674, USA
(770) BRITISH AMERICAN TOBACCO
(BRANDS) INC. (a Delaware corporation)
2711 Centerville Road, Suite 300,
Wilmington, Delaware 19808, USA
(580) 21 01 2019

(111) M 2018 29450 R
(732) BRITISH AMERICAN TOBACCO
(BRANDS) INC. (a Delaware corporation)
251 Little Falls Drive, Suite 100,
Wilmington, DE 19808-1674, USA
(770) BRITISH AMERICAN TOBACCO
(BRANDS) INC. (a Delaware corporation)
2711 Centerville Road, Suite 300,
Wilmington, Delaware 19808, USA
(580) 21 01 2019

(111) M 2018 29830 R
(732) BRITISH AMERICAN TOBACCO
(BRANDS) INC. (a Delaware corporation)
251 Little Falls Drive, Suite 100,
Wilmington, DE 19808-1674, USA
(770) BRITISH AMERICAN TOBACCO
(BRANDS) INC. (a Delaware corporation)
2711 Centerville Road, Suite 300,
Wilmington, Delaware 19808, USA
(580) 21 01 2019

(111) M 1997 5325 R
(732) LEVI STRAUSS & CO.
1155 Battery Street, San Francisco,
California 94111, USA
(770) LEVI STRAUSS & CO.
Levis Plaza 7215, San Francisco, California
94120, USA
(580) 12 12 2018

TERMINATION OF TRADEMARK REGISTRATIONS

(111) M 1998 9959 R

(151) 07 07 1998

(181) 2019 01 07

(732) ROLEX SA

rue Francois-Dussaud 3-5-7, Geneva,
Switzerland

(111) M 1998 10076 R

(151) 30 07 1998

(181) 2019 01 30

(732) HAYAT KIMYA SANAYI A.Ş.

Mahir Iz Caddesi No:25 Altunizade üsküdar,
Istanbul, Turkey

(111) M 1998 10219 R

(151) 06 08 1998

(181) 2019 02 06

(732) PARE B.V., Netherlands

Handelsweg 14-16, 9482 WE Tynaarlo,
Netherlands

(111) M 1998 10077 R

(151) 30 07 1998

(181) 2019 01 30

(732) HAYAT KIMYA SANAYI A.Ş.

Mahir Iz Caddesi No:25 Altunizade üsküdar,
Istanbul, Turkey

(111) M 1998 10220 R

(151) 06 08 1998

(181) 2019 02 06

(732) PARE B.V., Netherlands

Handelsweg 14-16, 9482 WE Tynaarlo,
Netherlands

(111) M 1998 10080 R

(151) 30 07 1998

(181) 2019 01 30

(732) THE JUICE PLUS+ COMPANY, LLC

140 Crescent Drive, Collierville, Shelby
Country, Tennessee 38017, USA

(111) M 1997 7895 R

(151) 18 12 1997

(181) 2018 06 18

(732) MERCK SHARP & DOHME CORP.

One Merck Drive, Whitehouse Station,
New Jersey 08889, USA

(111) M 1998 10083 R

(151) 30 07 1998

(181) 2019 01 30

(732) SIDERCA SOCIEDAD ANONIMA
INDUSTRIAL Y COMERCIAL

Carlos Maria della Paolera 297/299 piso 16,
C1001AAF-Ciudad Autonoma de Buenos
Aires, Argentina

(111) M 1998 10207 R

(151) 05 08 1998

(181) 2019 02 05

(732) GULOM TEXTILE AND JEWELRY
INDUSTRY COMMERCE LIMITED
COMPANY

Mithatpasa Caddesi Buyuk Haydar Efendi
Sokak 8, Beiazit-Istanbul, Turkey

(111) M 1998 10222 R

(151) 06 08 1998

(181) 2019 02 06

(732) ACER INC.

7F, No.137, Sec. 2, Chien Kuo North RD.,
Taipei City, Taiwan, Province of China

(111) M 1998 10210 R

(151) 05 08 1998

(181) 2019 02 05

(732) VALENTIN YUDASHKIN GROUP LIMITED

15 Agiou Pavlou Str. Ledra House, Agios
Andreas, 1105, Nicosia, Cyprus

(111) M 1998 10087 R

(151) 30 07 1998

(181) 2019 01 30

(732) LYSOFORM DESINFEKTION AG

Burgstrasse 28, CH-8750 Glarus,
Switzerland

(111) M 1998 10229 R

(151) 06 08 1998

(181) 2019 02 06

(732) MERCK SHARP & DOHME B.V

Waarderweg 39, 2013 BN Haarlem,
Netherlands

(111) M 1998 10088 R

(151) 30 07 1998

(181) 2019 01 30

(732) LYSOFORM DESINFEKTION AG

Burgstrasse 28, CH-8750 Glarus, Switzerland

(111) M 1998 10125 R (151) 31 07 1998 (181) 2019 01 31 (732) HAYAT KIMYA SANAYI A.Ş. Mahir Iz Caddesi No: 25 Altunizade üsküdar, Istanbul, Turkey	One Gillette Park, Boston, Massachusetts 0 2127, USA
(111) M 1998 10126 R (151) 31 07 1998 (181) 2019 01 31 (732) HAYAT KIMYA SANAYI A.Ş. Mahir Iz Caddesi No: 25 Altunizade üsküdar, Istanbul, Turkey	(111) M 1999 12743 R (151) 23 09 1999 (181) 2020 03 23 (732) INTERCONTINENTAL GREAT BRANDS LLC. 100 Deforest Ave, East Hanover, NJ, 07936, USA
(111) M 1998 10173 R (151) 05 08 1998 (181) 2019 02 05 (732) DALMINE S.P.A. Piazza Caduti 6 Luglio 1944, 1 DALMINE (Bergamo), Italy	(111) M 2002 14850 R (151) 12 12 2002 (181) 2023 06 12 (732) BENIHANA OF TOKYO, INC. 645 Fifth Avenue, Suite 905, New York, New York 10022, USA
(111) M 1998 10099 R (151) 31 07 1998 (181) 2019 01 31 (732) YVES SAINT LAURENT PARFUMS 284 Boulevard du Parc, 92521 Neuilly Cedex, France	(111) M 2002 14851 R (151) 12 12 2002 (181) 2023 06 12 (732) BENIHANA OF TOKYO, INC. 645 Fifth Avenue, Suite 905, New York, New York 10022, USA
(111) M 1998 10100 R (151) 31 07 1998 (181) 2019 01 31 (732) MERCK SHARP & DOHME CORP. One Merck Drive, Whitehouse Station, New Jersey 08889, USA	(111) M 2003 15185 R (151) 27 06 2003 (181) 2023 12 27 (732) BENIHANA OF TOKYO, INC. 645 Fifth Avenue, Suite 905, New York, New York 10022, USA
(111) M 1998 10176 R (151) 05 08 1998 (181) 2019 02 05 (732) ALTIRIS, INC. (a Utah Corporation) 588 West 400 South, Lindon, Utah 84042, USA	(111) M 2007 17410 R (151) 13 04 2007 (181) 2017 10 13 (732) LEVAN NIKOLISHVILI Aeroportis dasakhleba n46, b. 32, Tbilisi, 0158, Georgia
(111) M 1998 10102 R (151) 31 07 1998 (181) 2019 01 31 (732) L' OREAL 14 Rue Royale, 75008 Paris, France	(111) M 2007 17741 R (151) 18 09 2007 (181) 2018 03 18 (732) WIX FILTRON SP. Z O.O. ul. Wroclawska 145, 63-800 Gostyn, Poland
(111) M 1998 10103 R (151) 31 07 1998 (181) 2019 01 31 (732) THE GILLETTE COMPANY LLC	(111) M 2007 17911 R (151) 10 10 2007 (181) 2018 04 10 (732) LTD "ASPHARMA" - Saqartvelos pharmatsevtuli kompania Shevchenkos q., 12, Tbilisi, 0108, Georgia

(111) M 2007 17979 R
(151) 29 10 2007
(181) 2018 04 29
(732) LTD "Georgian Royal Water Company"
Stalinis q. 71, Borjomi, 1200, Georgia

(111) M 2008 18579 R
(151) 11 07 2008
(181) 2019 01 11
(732) LTD "ORI LULA"
Atenis q. 1, b. 6, Tbilisi, 0179, Georgia

(111) M 2008 18528 R
(151) 16 06 2008
(181) 2018 12 16
(732) LTD "GEOMEAL"
Chirnakhulis q. 4, 0151, Tbilisi, Georgia

(111) M 2008 18620 R
(151) 31 07 2008
(181) 2019 01 31
(732) LTD "Group Georgian Products"
K. Kekelidzis q. 14, b. 2, Tbilisi, 0179,
Georgia

(111) M 2008 18621 R
(151) 31 07 2008
(181) 2019 01 31
(732) LTD "Old Georgian Traditioanal"
Ilia Chavchavadzis gamz. 50a, 0179, Tbilisi,
Georgia

(111) M 2008 18531 R
(151) 16 06 2008
(181) 2018 12 16
(732) WM. WRIGLEY JR. COMPANY
a Delaware corporation
410 North Michigan Avenue, Chicago,
Illinois 60611, USA

(111) M 2008 18583 R
(151) 11 07 2008
(181) 2019 01 11
(732) TEQUILA CUERVO, S.A. DE C.V.
Avenida Periferico Sur N8500, Tlaquepaque,
Jalisco, CP 45601, Mexico

(111) M 2008 18682 R
(151) 17 09 2008
(181) 2019 03 17
(732) Vladimer Kvilitaia

Ilia chavchavadzis gamz., li shes. 31,
b. 24, Tbilisi, 0179, Georgia

(111) M 2008 18623 R
(151) 31 07 2008
(181) 2019 01 31
(732) LIFTED RESEARCH GROUP Inc.
a California corporation
1 Capital Drive, Lake Forest, California
92630, USA

(111) M 2008 18638 R
(151) 31 07 2008
(181) 2019 01 31
(732) P.T. KALBE FARMA TBK.
Kawasan Industri Delta Silicon, Jl.M.H
Thamrin Blok A3-1, Lippo Cikarang,
Bekasi 17550, Indonesia

(111) M 2008 18639 R
(151) 31 07 2008
(181) 2019 01 31
(732) UP "MINSKINTERKAPS"
Inzhenernaya Str. 26, 220075, Minsk, Belarus

(111) M 2008 18641 R
(151) 31 07 2008
(181) 2019 01 31
(732) UP "MINSKINTERKAPS"
Inzhenernaya Str. 26, 220075, Minsk, Belarus

(111) M 2008 18647 R
(151) 31 07 2008
(181) 2019 01 31
(732) REYNOLDS PRESTO PRODUCTS INC.
1900 West Field Court, Lake Forest,
Illinois 60045, USA

(111) M 2008 18651 R
(151) 31 07 2008
(181) 2019 01 31
(732) PJSC Comercial Bank "PRIVATBANK"
Ul. Nabehezhnaya Pobedi 50, 49094,
Dnepropetrovsk, Ukraine

(111) M 2008 18652 R
(151) 31 07 2008
(181) 2019 01 31
(732) PJSC Comercial Bank "PRIVATBANK"
Ul. Nabehezhnaya Pobedi 50, 49094,
Dnepropetrovsk, Ukraine

(111) M 1998 10065 R
(151) 30 07 1998
(181) 2019 01 30
(732) MARS Inc.
6885 Elm Street, McLean, Virginia, USA

(111) M 1998 10069 R
(151) 30 07 1998
(181) 2019 01 30
(732) BASF Agrochemical 1 Products B.V.
Kadestraat 1, 6811 CA Arnhem, Netherlands

(111) M 1998 10025 R
(151) 09 07 1998
(181) 2019 01 09
(732) MERCK SHARP & DOHME CORP.
One Merck Drive, Whitehouse Station,
New Jersey 08889, USA

(111) M 1998 10181 R
(151) 05 08 1998
(181) 2019 02 05
(732) McDERMOTT International Inc.
1450 Poydras st., P.O. Box 60035 New
Orlean LA 70160, USA

(111) M 1998 10187 R
(151) 05 08 1998
(181) 2019 02 05
(732) BP P.L.C.
1 St James's Square, London SW1Y 4PD,
United Kingdom

(111) M 1998 10575 R
(151) 26 08 1998
(181) 2029 02 26
(732) COTY FRANCE S.A.S.
14 rue du Quatre Septembre, 75002 Paris,
France

(111) M 1998 10576 R
(151) 26 08 1998
(181) 2019 02 26
(732) COTY FRANCE S.A.S.
14 rue du Quatre Septembre, 75002 Paris,
France

(111) M 2016 27793 R
(151) 10 11 2016
(181) 2027 05 10
(732) LTD "ALBATROS Company"

Ak.Tseretlis gamz. 141a, 0119, Tbilisi,
Georgia

(111) M 1998 10197 R
(151) 05 08 1998
(181) 2019 02 05
(732) CASTROL LIMITED
Technology Centre, Whitechurch Hill,
Pangbourne, Reading RG8 7QR, United
Kingdom

(111) M 1998 10070 R
(151) 30 07 1998
(181) 2019 01 30
(732) VITANA AKCIOVA SPOLECNOST
Bysice, Czech Republic

(111) M 1998 10202 R
(151) 05 08 1998
(181) 2019 02 05
(732) ABOIT SR.L.
Viale Giorgio Ribotta 9, 00144 Roma (RM),
Italy

(111) M 1998 10203 R
(151) 05 08 1998
(181) 2019 02 05
(732) ABOIT SR.L.
Viale Giorgio Ribotta 9, 00144 Roma (RM),
Italy

(111) M 1998 8612 R
(151) 10 03 1998
(181) 2018 09 10
(732) TATRA A.S.
Koprivnice, Czech Republic

(111) M 2018 30044 R
(151) 13 08 2018
(181) 2029 02 13
(732) LTD "ALBATROS Company"
Ak.Tseretlis gamz. 141a, 0119, Tbilisi,
Georgia

CLASSIFICATION INDEXES

INVENTIONS

CONCORDANCE TABLE OF INTERNATIONAL CLASSIFICATION INDEX AND PUBLICATION NUMBERS

INTERNATIONAL CLASSIFICATION INDEXES (51)	NUMBER OF PUBLISHED APPLICATION (10)
A 47 J 31/00; B 65 D 85/804; C 12 G 3/06	AP 2019 14581 A
A 61 K 31/44; C 07 D 213/22; C 07 D 401/04	AP 2019 14237 A
A 61 K 31/444; A 61 K 9/08; A 61 K 47/04; A 61 K 47/12; A 61 K 47/18; A 61 K 47/22; A 61 K 47/32; A 61 P 9/12; A 61 P 27/02; A 61 P 27/06	AP 2019 14215 A
A 61 K 31/501; A 61 P 25/00; A 61 P 25/14	AP 2019 14284 A
A 61 K 31/4439; A 61 P 25/28; A 61 P 25/00; A 61 P 25/16	AP 2019 14604 A
C 04 B 31/40	AP 2019 14403 A
C 22 B 3/10; C 01 F 5/00; C 01 F 5/30; C 22 B 26/22; C 22 B 3/22; C 22 B 3/44; C 25 C 3/04	AP 2019 14426 A
C 30 B 11/00, 30/04	AP 2019 14142 A

CONCORDANCE TABLE OF PUBLICATION NUMBERS AND INTERNATIONAL CLASSIFICATION INDEX

NUMBER OF PUBLISHED APPLICATION (10)	INTERNATIONAL CLASSIFICATION INDEXES (51)
AP 2019 14142 A	C 30 B 11/00, 30/04
AP 2019 14215 A	A 61 K 31/444; A 61 K 9/08; A 61 K 47/04; A 61 K 47/12; A 61 K 47/18; A 61 K 47/22; A 61 K 47/32; A 61 P 9/12; A 61 P 27/02; A 61 P 27/06
AP 2019 14237 A	A 61 K 31/44; C 07 D 213/22; C 07 D 401/04
AP 2019 14284 A	A 61 K 31/501; A 61 P 25/00; A 61 P 25/14
AP 2019 14403 A	C 04 B 31/40
AP 2019 14426 A	C 22 B 3/10; C 01 F 5/00; C 01 F 5/30; C 22 B 26/22; C 22 B 3/22; C 22 B 3/44; C 25 C 3/04
AP 2019 14581 A	A 47 J 31/00; B 65 D 85/804; C 12 G 3/06
AP 2019 14604 A	A 61 K 31/4439; A 61 P 25/28; A 61 P 25/00; A 61 P 25/16

CONCORDANCE TABLE OF INTERNATIONAL CLASSIFICATION INDEX, PATENT NUMBERS AND PUBLICATION NUMBERS

INTERNATIONAL CLASSIFICATION INDEX (51)	NUMBER OF PATENT (11)	NUMBER OF PUBLISHED APPLICATION (10)
A 61 K 31/444; A 61 K 31/506; A 61 K 31/4439; A 61 K 31/497; A 61 P 25/28; C 07 D 417/12; C 07 D 413/12; C 07 D 401/12	P 2019 6949 B	AP 2018 14485 A
B 26 B 21/24	P 2019 6951 B	AP 2018 14619 A
C 07 D 487/04; A 61 K 31/5025; A 61 K 9/00; A 61 P 11/00; A 61 P 25/00; A 61 P 27/02	P 2019 6950 B	AP 2018 14410 A

**CONCORDANCE TABLE OF PATENT NUMBERS,
PUBLICATION NUMBERS AND INTERNATIONAL CLASSIFICATION INDEX**

NUMBER OF PATENT (11)	NUMBER OF PUBLISHED APPLICATION (10)	INTERNATIONAL CLASSIFICATION INDEX (51)
P 2019 6949 B	AP 2018 14485 A	A 61 K 31/444; A 61 K 31/506; A 61 K 31/4439; A 61 K 31/497; A 61 P 25/28; C 07 D 417/12; C 07 D 413/12; C 07 D 401/12
P 2019 6950 B	AP 2018 14410 A	C 07 D 487/04; A 61 K 31/5025; A 61 K 9/00; A 61 P 11/00; A 61 P 25/00; A 61 P 27/02
P 2019 6951 B	AP 2018 14619 A	B 26 B 21/24

**CONCORDANCE TABLE OF APPLICATION NUMBERS, PUBLICATION NUMBERS
AND PATENTS**

NUMBER OF APPLICATION (21)	NUMBER OF PUBLISHED APPLICATION (10)	NUMBER OF PATENT (11)
AP 2015 14410	AP 2018 14410 A	P 2019 6950 B
AP 2015 14485	AP 2018 14485 A	P 2019 6949 B
AP 2017 14619	AP 2018 14619 A	P 2019 6951 B

UTILITY MODELS

**CONCORDANCE TABLE OF INTERNATIONAL CLASSIFICATION INDEX
AND PUBLICATION NUMBERS**

INTERNATIONAL CLASSIFICATION INDEXES (51)	NUMBER OF PUBLISHED APPLICATION (10)
A 61 K 35/78; A 61 K 8/04	AU 2019 14814

**CONCORDANCE TABLE OF PUBLICATION NUMBERS
AND INTERNATIONAL CLASSIFICATION INDEX**

NUMBER OF PUBLISHED APPLICATION (10)	INTERNATIONAL CLASSIFICATION INDEXES (51)
AU 2019 14814	A 61 K 35/78; A 61 K 8/04

**CONCORDANCE TABLE OF INTERNATIONAL CLASSIFICATION INDEX,
PATENT NUMBERS AND PUBLICATION NUMBERS**

INTERNATIONAL CLASSIFICATION INDEX (51)	NUMBER OF PATENT (11)	NUMBER OF PUBLISHED APPLICATION (10)
A 61 K 8/19; A 61 K 8/30; A 61 Q 15/00	U 2019 2002 Y	AU 2018 14607 U
A 61 K 33/36	U 2019 2003 Y	AU 2018 14383 U
F 24 D 19/00; F 24 H 9/00	U 2019 2001 Y	AU 2018 14602 U

**CONCORDANCE TABLE OF PATENT NUMBERS,
PUBLICATION NUMBERS AND INTERNATIONAL CLASSIFICATION INDEX**

NUMBER OF PATENT (11)	NUMBER OF PUBLISHED APPLICATION (10)	INTERNATIONAL CLASSIFICATION INDEX (51)
U 2019 2001 Y	AU 2018 14602 U	F 24 D 19/00; F 24 H 9/00
U 2019 2002 Y	AU 2018 14607 U	A 61 K 8/19; A 61 K 8/30; A 61 Q 15/00
U 2019 2003 Y	AU 2018 14383 U	A 61 K 33/36

**CONCORDANCE TABLE OF APPLICATION NUMBERS, PUBLICATION NUMBERS
AND PATENTS**

NUMBER OF APPLICATION (21)	NUMBER OF PUBLISHED APPLICATION (10)	NUMBER OF PATENT (11)
AU 2017 14383	AU 2018 14383 U	U 2019 2003 Y
AU 2017 14602	AU 2018 14602 U	U 2019 2001 Y
AU 2017 14607	AU 2018 14607 U	U 2019 2002 Y

TRADEMARKS

CONCORDANCE TABLE OF REGISTRATION NUMBERS, APPLICATION NUMBERS, PUBLICATION NUMBERS AND BULLETIN NUMBERS

NUMBER OF REGISTRATION (111)	NUMBER OF APPLICATIONS (210)	NUMBER OF PUBLISHED APPLICATIONS (260)	NUMBER OF BULLETIN
M 2019 30794 R	AM 101303	-	4(512)2019
M 2019 30795 R	AM 101494	-	4(512)2019
M 2019 30796 R	AM 101390	-	4(512)2019
M 2019 30797 R	AM 101379	-	4(512)2019
M 2019 30798 R	AM 101380	-	4(512)2019
M 2019 30799 R	AM 101391	-	4(512)2019
M 2019 30800 R	AM 101373	-	4(512)2019
M 2019 30801 R	AM 101388	-	4(512)2019
M 2019 30802 R	AM 101389	-	4(512)2019
M 2019 30803 R	AM 101528	-	4(512)2019
M 2019 30804 R	AM 101307	-	4(512)2019
M 2019 30805 R	AM 101405	-	4(512)2019
M 2019 30806 R	AM 101605	-	4(512)2019
M 2019 30807 R	AM 101529	-	4(512)2019
M 2019 30808 R	AM 92783	AM 2018 92783 A	15(499)2018
M 2019 30809 R	AM 92854	AM 2018 92854 A	4(488)2018
M 2019 30810 R	AM 92856	AM 2018 92856 A	4(488)2018
M 2019 30811 R	AM 93081	AM 2018 93081 A	16(500)2018
M 2019 30812 R	AM 93083	AM 2018 93083 A	16(500)2018
M 2019 30813 R	AM 93084	AM 2018 93084 A	16(500)2018
M 2019 30814 R	AM 93085	AM 2018 93085 A	16(500)2018
M 2019 30815 R	AM 93088	AM 2018 93088 A	16(500)2018
M 2019 30816 R	AM 93090	AM 2018 93090 A	16(500)2018
M 2019 30817 R	AM 93091	AM 2018 93091 A	16(500)2018
M 2019 30818 R	AM 95138	AM 2018 95138 A	14(498)2018
M 2019 30819 R	AM 95480	AM 2018 95480 A	15(499)2018
M 2019 30820 R	AM 95541	AM 2018 95541 A	14(498)2018
M 2019 30821 R	AM 95547	AM 2018 95547 A	14(498)2018
M 2019 30822 R	AM 95667	AM 2018 95667 A	14(498)2018
M 2019 30823 R	AM 95673	AM 2018 95673 A	14(498)2018
M 2019 30824 R	AM 95716	AM 2018 95716 A	14(498)2018
M 2019 30825 R	AM 95717	AM 2018 95717 A	14(498)2018
M 2019 30826 R	AM 95718	AM 2018 95718 A	14(498)2018
M 2019 30827 R	AM 95986	AM 2018 95986 A	15(499)2018
M 2019 30828 R	AM 96172	AM 2018 96172 A	16(500) 2018
M 2019 30829 R	AM 96176	AM 2018 96176 A	19(503)2018
M 2019 30830 R	AM 96178	AM 2018 96178 A	16(500)2018
M 2019 30831 R	AM 96305	AM 2018 96305 A	19(503)2018
M 2019 30832 R	AM 96407	AM 2018 96407 A	16(500)2018
M 2019 30833 R	AM 96706	AM 2018 96706 A	20(504)2018
M 2019 30834 R	AM 96711	AM 2018 96711 A	20(504)2018
M 2019 30835 R	AM 96735	AM 2018 96735 A	20(504)2018
M 2019 30836 R	AM 96738	AM 2018 96738 A	20(504)2018
M 2019 30837 R	AM 96782	AM 2018 96782 A	19(503)2018
M 2019 30838 R	AM 96807	AM 2018 96807 A	20(504)2018
M 2019 30839 R	AM 96842	AM 2018 96842 A	20(504)2018
M 2019 30840 R	AM 96852	AM 2018 96852 A	20(504)2018
M 2019 30841 R	AM 96864	AM 2018 96864 A	20(504)2018

1	2	3	4
M 2019 30842 R	AM 96977	AM 2018 96977 A	20(504)2018
M 2019 30843 R	AM 96981	AM 2018 96981 A	20(504)2018
M 2019 30844 R	AM 97032	AM 2018 97032 A	20(504)2018
M 2019 30845 R	AM 97090	AM 2018 97090 A	20(504)2018
M 2019 30846 R	AM 101516	-	4(512)2019

**CONCORDANCE TABLE OF PUBLICATION NUMBERS
AND APPLICATION NUMBERS**

NUMBER OF PUBLISHED APPLICATION (260)	NUMBER OF APPLICATION (210)	1	2
		1	2
AM 2019 78986 A*	AM 78986	AM 2019 98410 A	AM 98410
AM 2019 87174 A	AM 87174	AM 2019 98411 A	AM 98411
AM 2019 88279 A	AM 88279	AM 2019 98417 A	AM 98417
AM 2019 96309 A	AM 96309	AM 2019 98418 A	AM 98418
AM 2019 96310 A	AM 96310	AM 2019 98421 A	AM 98421
AM 2019 96312 A	AM 96312	AM 2019 98426 A	AM 98426
AM 2019 98186 A	AM 98186	AM 2019 98427 A	AM 98427
AM 2019 98187 A	AM 98187	AM 2019 98432 A	AM 98432
AM 2019 98188 A	AM 98188	AM 2019 98437 A	AM 98437
AM 2019 98189 A	AM 98189	AM 2019 98442 A	AM 98442
AM 2019 98209 A	AM 98209	AM 2019 98550 A	AM 98550
AM 2019 98244 A	AM 98244	AM 2019 98559 A	AM 98559
AM 2019 98246 A	AM 98246	AM 2019 98565 A	AM 98565
AM 2019 98247 A	AM 98247	AM 2019 98566 A	AM 98566
AM 2019 98249 A	AM 98249	AM 2019 98570 A	AM 98570
AM 2019 98371 A	AM 98371	AM 2019 98574 A	AM 98574
AM 2019 98376 A	AM 98376	AM 2019 98575 A	AM 98575
AM 2019 98390 A	AM 98390	AM 2019 98661 A	AM 98661
AM 2019 98395 A	AM 98395	AM 2019 98683 A	AM 98683
AM 2019 98405 A	AM 98405	AM 2019 98684 A	AM 98684
AM 2019 98409 A	AM 98409	AM 2019 98685 A	AM 98685
		AM 2019 98686 A	AM 98686
		AM 2019 98691 A	AM 98691
		AM 2019 98695 A	AM 98695
		AM 2019 98697 A	AM 98697

**CONCORDANCE TABLE OF INDEX OF GOODS AND/OR SERVICES
AND APPLICATION NUMBERS**

INDEX OF GOODS AND/OR SERVICES (511)	NUMBER OF PUBLISHED APPLICATIONS (26)	1	2
		1	2
1	AM 2019 98409 A	3	AM 2019 98437 A
1	AM 2019 98411 A	4	AM 2019 98187 A
3	AM 2019 98247 A	4	AM 2019 98188 A
3	AM 2019 98409 A	4	AM 2019 98189 A
3	AM 2019 98410 A	5	AM 2019 78986 A*
3	AM 2019 98411 A	5	AM 2019 98246 A
3	AM 2019 98432 A	5	AM 2019 98409 A
		5	AM 2019 98411 A
		5	AM 2019 98427 A
		5	AM 2019 98437 A
		5	AM 2019 98550 A
		5	AM 2019 98565 A

1	2
5	AM 2019 98566 A
5	AM 2019 98574 A
5	AM 2019 98683 A
9	AM 2019 98409 A
9	AM 2019 98411 A
9	AM 2019 98417 A
9	AM 2019 98697 A
11	AM 2019 98409 A
11	AM 2019 98411 A
16	AM 2019 96312 A
29	AM 2019 87174 A
29	AM 2019 88279 A
29	AM 2019 98186 A
29	AM 2019 98249 A
29	AM 2019 98661 A
30	AM 2019 87174 A
30	AM 2019 88279 A
30	AM 2019 98186 A
30	AM 2019 98249 A
30	AM 2019 98376 A
30	AM 2019 98421 A
30	AM 2019 98575 A
30	AM 2019 98661 A
31	AM 2019 87174 A
31	AM 2019 88279 A
31	AM 2019 98186 A
32	AM 2019 88279 A
32	AM 2019 98186 A
32	AM 2019 98249 A
33	AM 2019 87174 A
33	AM 2019 88279 A
33	AM 2019 96309 A
33	AM 2019 96310 A
33	AM 2019 98405 A
33	AM 2019 98684 A
33	AM 2019 98685 A
34	AM 2019 98418 A
35	AM 2019 87174 A
35	AM 2019 88279 A
35	AM 2019 98186 A
35	AM 2019 98187 A
35	AM 2019 98244 A

1	2
35	AM 2019 98247 A
35	AM 2019 98371 A
35	AM 2019 98405 A
35	AM 2019 98409 A
35	AM 2019 98410 A
35	AM 2019 98411 A
35	AM 2019 98421 A
35	AM 2019 98442 A
35	AM 2019 98570 A
35	AM 2019 98684 A
35	AM 2019 98685 A
35	AM 2019 98695 A
36	AM 2019 98695 A
37	AM 2019 98187 A
39	AM 2019 98426 A
39	AM 2019 98570 A
39	AM 2019 98697 A
40	AM 2019 98409 A
40	AM 2019 98411 A
41	AM 2019 98209 A
41	AM 2019 98390 A
41	AM 2019 98559 A
41	AM 2019 98684 A
41	AM 2019 98685 A
42	AM 2019 98209 A
42	AM 2019 98409 A
42	AM 2019 98411 A
42	AM 2019 98697 A
43	AM 2019 87174 A
43	AM 2019 88279 A
43	AM 2019 98186 A
43	AM 2019 98249 A
43	AM 2019 98395 A
43	AM 2019 98442 A
43	AM 2019 98559 A
43	AM 2019 98684 A
43	AM 2019 98685 A
43	AM 2019 98686 A
43	AM 2019 98691 A
44	AM 2019 98247 A
45	AM 2019 98695 A

CONCORDANCE TABLE OF INDEX OF GOODS AND/OR SERVICES
AND NUMBERS OF TRADEMARKS REGISTERED ACCORDING
TO THE ACCELERATED PROCEDURE

INDEX OF GOODS AND/OR SERVICES (511)	NUMBERS OF REGISTERED ACCORDING TO THE ACCELERATED PROCEDURE (111)
5	M 2019 30800 R
8	M 2019 30803 R
9	M 2019 30803 R
16	M 2019 30803 R
18	M 2019 30803 R
20	M 2019 30803 R
21	M 2019 30803 R
24	M 2019 30803 R
25	M 2019 30799 R
25	M 2019 30803 R
28	M 2019 30803 R
29	M 2019 30805 R
29	M 2019 30846 R
29	M 2019 30805 R
29	M 2019 30846 R
30	M 2019 30846 R
30	M 2019 30846 R
32	M 2019 30795 R
32	M 2019 30796 R
32	M 2019 30846 R
32	M 2019 30846 R
33	M 2019 30801 R
33	M 2019 30802 R
33	M 2019 30805 R
33	M 2019 30807 R
33	M 2019 30805 R
33	M 2019 30807 R
34	M 2019 30806 R
34	M 2019 30806 R
35	M 2019 30794 R
35	M 2019 30801 R
35	M 2019 30802 R
36	M 2019 30797 R
36	M 2019 30798 R
36	M 2019 30801 R
36	M 2019 30802 R
36	M 2019 30804 R
37	M 2019 30801 R
39	M 2019 30802 R
41	M 2019 30794 R
41	M 2019 30803 R
43	M 2019 30802 R
43	M 2019 30804 R
43	M 2019 30805 R

OFFICIAL BULLETIN OF THE INDUSTRIAL PROPERTY

INVENTIONS
UTILITY MODELS
TRADEMARKS

4(512)

EDITOR-IN-CHIEF: N. Bebrishvili

EDITOR-TRANSLATOR: E. Gabunia

PROOFREADER: A. Shikhashvili

COMPUTER LAYOUT: M. Ordenidze
K. Svanidze

www.sakpatenti.gov.ge

E-mail: info@sakpatenti.org.ge