



**NATIONAL INTELLECTUAL PROPERTY CENTER OF GEORGIA  
SAKPATENTI**

**OFFICIAL BULLETIN  
OF THE INDUSTRIAL PROPERTY**

**5(417)**

**2015  
TBILISI**

# INID CODES FOR IDENTIFICATION OF BIBLIOGRAPHIC DATA

## INVENTIONS, UTILITY MODELS

- (10) Number of publication for application, which has been examined
- (11) Number of patent and kind of document
- (21) Serial number of application
- (22) Date of filing of the application
- (23) Date of exhibition or the date of the earlier filing and the number of application, if any
- (24) Date from which patent may have effect
- (31) Number of priority application
- (32) Date of filing of priority application
- (33) Code of the country or regional organization allotting priority application number
- (44) Date of publication of application not granted, but examined and number of bulletin
- (45) Date of publication of registered document
- (51) International Patent Classification Index
- (54) Title of the invention
- (57) Abstract
- (60) Number of examined patent document granted by foreign patent office, date from which patent has effect and country code
- (62) Number of the earlier application and in case of divided application, date of filing an application
- (71) Name, surname and address of applicant (country code)
- (72) Name, surname of inventor (country code)
- (73) Name, surname and address of patent owner (country code)
- (74) Name, surname of representative or patent attorney
- (85) Date of commencement of the national phase of International Application
- (86) Number and date of filing of international application
- (87) Number and date of publication of international application

## DESIGNS

- (10) Number of publication for application
- (11) Number of patent and kind of document or number of registration
- (15) Date of registration/Date of patent renewal
- (18) Expected expiration date of patent or registration
- (21) Serial number of application
- (22) Date of filing of the application
- (23) Date of exhibition or the date of the earlier filing and the number of application, if any
- (24) Date from which patent may have effect
- (28) Number of designs included in the application
- (30) Data relating to priority (number of application, date of filing of application, two-letter code identifying the authority with whom the priority application was made)
- (31) Number of priority application
- (32) Date of filing of priority application
- (33) Code of the country or regional organization allotting priority application number
- (34) Two-letter code according to WIPO St.3 identifying the authority with which the priority application was made
- (44) Date of publication of design and number of bulletin (the first publication)
- (45) Date of publication of design registered by WIPO and number of bulletin
- (51) International Classification for designs (class and subclass of the Locarno Classification)
- (54) Title of the invention
- (55) Reproduction of the design
- (57) Description of characteristic features of the design including indication of colors
- (58) Date of recording of any kind of amendment in the Register
- (62) Number of the earlier application, registration and document number and if available the date of filing an application in case of divided application
- (71) Name, surname and address of applicant (country code)
- (72) Name, surname of creator (country code)
- (73) Name, surname and address of patent owner (country code)
- (74) Name, surname of representative or patent attorney
- (81) Contracting states concerned
  - II designated contracting states according to the 1960 Act
  - III designated contracting states according to the 1999 Act
- (85) Owner's permanent address
- (86) Owner's nationality
- (87) Owner's residence
- (88) State in which the owner has a real and effective industrial or commercial establishment

## TRADEMARKS

- (111) – Number of registration
- (151) – Date of registration
- (156) – Date of the renewal
- (181) – Expected expiration date of registration
- (186) – Renewal expiration date of registration
- (141) – Date of cancel of duration of the mark
- (210) – Serial number of application
- (220) – Date of filing of the application
- (230) – Date concerning exhibition
- (260) – Number of application, for which favorable decision of examination about registration has been taken (publication number)
- (310) – Number of the first application
- (320) – Date of filing of the first application
- (330) – Code, identifying national or regional Office where the first application was made
- (511) – International Classification of Goods and Services for the purposes of registration of trade marks and/or list of goods and/or services classified according thereto
- (531) – Description of figurative elements of Trade Marks according to the International Classification of the Figurative Elements of Marks
- (540) – Reproduction of Trade Mark
- (550) – Nature and kind of Trade Mark
- (580) – Date of recording of any kind changes in respect of applications or registrations
- (591) – Information concerning colors claimed
- (731) – Name and address of the applicant
- (732) – Name and address of the holder of the registration
- (740) – Name and address of the representative
- (750) – Address for correspondence
- (770) – Name and address of the previous applicant or holder in case of change in ownership
- (771) – Previous name and address of the applicant or holder in case of change in ownership
- (791) – Name and address of the licensee
- (793) – Indication of conditions and/or restrictions under the license (Type of license, number of license agreement, data of license, data of validity of license)
- (800) – Certain data relating to the international registration of Trade Marks under the Protocol Relating to Madrid Agreement (International registration number)

## CODES FOR PUBLICATION IN BULLETIN

- (21) AP 0000 000000 – serial number of application for invention
- (10) AP 0000 0000 A – number of published application for invention (first publication)
- (11) P 0000 0000 B – number of patent for invention (second publication)
- (21) API 0000 000000 – number of application for imported patent
- (11) PI 0000 0000 A – number of imported patent (first publication)
- (21) AU 0000 000000 – serial number of application for utility model
- (10) AU 0000 000 U – number of published application for utility model (first publication)
- (11) U 0000 000 Y – number of patent for utility model (second publication)
- (21) AD 0000 000000 – serial number of application for design
- (10) AD 0000 000 S – number of published application for design (first publication)
- (11) D 0000 000 S – number of patent for design (second publication)

## INTERNATIONAL PATENT CLASSIFICATION FOR INVENTIONS AND UTILITY MODELS

- SECTION A – HUMAN NECESSITIES
- SECTION B – PERFORMING OPERATIONS; TRANSPORTING
- SECTION C – CHEMISTRY; METALLURGY
- SECTION D – TEXTILES; PAPER
- SECTION E – FIXED CONSTRUCTIONS
- SECTION F – MECHANICAL ENGINEERING; LIGHTING; HEATING; WEAPONS; BLASTING
- SECTION G – PHYSICS
- SECTION H – ELECTRICITY

- 
- M – Trade Mark
  - (210) AM 0000 000000 – Serial number of application;
  - (260) AAM 0000 00000 A – Publication number of application;
  - (111) M 0000 00000 R – Number of registration;
  - (111) MMM0000 00000 Rn – Number of renewals, in which n=1,2,3;
  - (111) M 0000 00000 R(P) – Number of registration under partial assignment of rights
-

**LIST OF CODES, IN ALPHABETIC SEQUENCE, AND THE CORRESPONDING (SHORT) NAMES OF STATES, OTHER ENTITIES AND INTERGOVERNMENTAL ORGANIZATIONS**  
(WIPO STANDARD ST.3)

AD	Andorra				
AE	United Arab Emirates				
AF	Afghanistan				
AG	Antigua and Barbuda				
AI	Anguilla				
AL	Albania				
AM	Armenia				
AN	Netherlands Antilles				
AO	Angola				
AP	African Regional Intellectual Property Organization (ARIPO)				
AR	Argentina				
AT	Austria				
AU	Australia				
AW	Aruba				
AZ	Azerbaijan				
BA	Bosnia and Herzegovina				
BB	Barbados				
BD	Bangladesh				
BE	Belgium				
BF	Burkina Faso				
BG	Bulgaria				
BH	Bahrain				
BI	Burundi				
BJ	Benin				
BM	Bermuda				
BN	Brunei Darussalam				
BO	Bolivia				
BR	Brazil				
BS	Bahamas				
BT	Bhutan				
BV	Bouvet Island				
BW	Botswana				
BX	Benelux Office for Intellectual Property (BOIP)				
BY	Belarus				
BZ	Belize				
CA	Canada				
CD	Democratic Republic of the Congo				
CF	Central African Republic				
CG	Congo				
CH	Switzerland				
CI	Cote d'Ivoire				
CK	Cook Islands				
CL	Chile				
CM	Cameroon				
CN	China				
CO	Colombia				
CR	Costa Rica				
CU	Cuba				
CV	Cape Verde				
CY	Cyprus				
CZ	Czech Republic				
DE	Germany				
DJ	Djibouti				
DM	Dominica				
DO	Dominican Republic				
DZ	Algeria				
EA	Eurasian Patent Organization (EAPO)				
EC	Ecuador				
EE	Estonia				
EG	Egypt				
EH	Western Sahara				
EM	Office for Harmonization in the Internal Market (Trademarks and Designs)(OHIM)				
EP	European Patent Office (EPO)				
ER	Eritrea				
ES	Spain				
ET	Ethiopia				
FI	Finland				
FJ	Fiji				
FK	Falkland Islands (Malvinas)				
FO	Faroe Islands				
FR	France				
GA	Gabon				
GB	United Kingdom				
GC	Patent Office of the Cooperation Council for the Arab States of the Gulf (GCC)				
GD	Grenada				
GG	Guernsey				
GH	Ghana				
GI	Gibraltar				
GT	Guatemala				
GW	Guinea- Bissau				
GY	Guyana				
HK	The Hong Kong Special Administrative Region of the People's Republic of China				
HN	Honduras				
HR	Croatia				
HT	Haiti				
HU	Hungary				
IB	International Bureau of the World Intellectual Property Organization (WIPO)				
ID	Indonesia				
IE	Ireland				
IL	Israel				
IM	Isle of Man				
IN	India				
IQ	Iraq				
ID	Indonesia				
IE	Ireland				
IL	Israel				
IM	Isle of Man				
IN	India				
IQ	Iraq				
IR	Iran (Islamic Republic of)				
IS	Iceland				
IT	Italy				
JE	Jersey				
JM	Jamaica				
JO	Jordan				
JP	Japan				
KE	Kenya				
KG	Kyrgyzstan				
KH	Cambodia				
KI	Kiribati				
KM	Saint Kitts and Nevis				
KP	Democratic People's Republic of Korea				
KR	Republic of Korea				
KW	Kuwait				
KY	Cayman Islands				
KZ	Kazakhstan				
LA	Lao People's Democratic Republic				
LB	Lebanon				
LC	Saint Lucia				
LI	Liechtenstein				
LK	Sri Lanka				
LR	Liberia				
LS	Lesotho				
LT	Lithuania				
LU	Luxembourg				
LV	Latvia				
LY	Libyan Arab Jamahiriya				
MA	Morocco				
MC	Monaco				
MD	Republic of Moldova				
ME	Montenegro				
MG	Madagascar				
MK	The former Yugoslav Republic of Macedonia				
ML	Mali				
MM	Myanmar				
MN	Mongolia				
MO	Macao				
MP	Northern Mariana Islands				
MR	Mauritania				
MS	Montserrat				
MT	Malta				
MU	Mauritius				
MV	Maldives				
MW	Malawi				
MX	Mexico				
MY	Malaysia				
MZ	Mozambique				
NA	Namibia				
NE	Niger				
NG	Nigeria				
NI	Nicaragua				
NL	Netherlands				
NO	Norway				
NP	Nepal				
NR	Nauru				
NZ	New Zealand				
OA	African Intellectual Property Organization (OAPI)				
OM	Oman				
PA	Panama				
PE	Peru				
PG	Papua New Guinea				
PH	Philippines				
PK	Pakistan				
PL	Poland				
PT	Portugal				
PW	Palau				
PY	Paraguay				
QA	Qatar				
QZ	Community Plant Variety Office (European Community) (CPVO)				
RO	Romania				
RS	Serbia				
RU	Russian Federation				
RW	Rwanda				
SA	Saudi Arabia				
SB	Solomon Islands				
SC	Seychelles				
SD	Sudan				
SG	Singapore				
SH	Saint Helena				
SI	Slovenia				
SK	Slovakia				
SL	Sierra Leone				
SM	San Marino				
SN	Senegal				
SO	Somalia				
SR	Suriname				
ST	Sao Tome and Principe				
SV	El Salvador				
SY	Syrian Arab Republic				
SZ	Swaziland				
TC	Turks and Caicos Islands				
TD	Chad				
TG	Togo				
TH	Thailand				
TJ	Tajikistan				
TL	Timor-Leste				
TM	Turkmenistan				
TN	Tunisia				
TO	Tonga				
TR	Turkey				
SE	Sweden				
TT	Trinidad and Tobago				
TV	Tuvalu				
TW	Taiwan, Province of China				
TZ	United Republic of Tanzania				
UA	Ukraine				
UG	Uganda				
US	United States of America				
UY	Uruguay				
UZ	Uzbekistan				
VA	Holy See				
VC	Saint Vincent and the Grenadines				
VE	Venezuela				
VG	Virgin Islands (British)				
VN	Viet Nam				
VU	Vanuatu				
WO	World Intellectual Property Organization (WIPO)				
WS	Samoa				
XN	Nordic Patent Institute (NPI)				
YE	Yemen				
ZA	South Africa				
ZM	Zambia				
ZW	Zimbabwe				

**NATIONAL INTELLECTUAL PROPERTY CENTER OF GEORGIA  
SAKPATENTI**

**OFFICIAL BULLETIN  
OF THE INDUSTRIAL PROPERTY**

**ОФИЦИАЛЬНЫЙ БЮЛЛЕТЕНЬ  
ПРОМЫШЛЕННОЙ СОБСТВЕННОСТИ**

**5(417)**

**INVENTIONS  
UTILITY MODELS  
DESIGNS  
TRADEMARKS**

**DATE OF PUBLICATION  
2015 03 10**

# CONTENTS

<b>PUBLISHED TITLES OF PROTECTION</b> .....	3
<b>INVENTIONS</b>	
▪ APPLICATIONS APPROVED FOR GRANTING PATENTS .....	4
▪ PATENTED INVENTIONS .....	8
<b>UTILITY MODELS</b>	
▪ PATENTED UTILITY MODEL .....	10
<b>DESIGNS</b>	
▪ REGISTERED DESIGNS .....	11
▪ DESIGN REGISTERED ACCORDING TO THE ACCELERATED PROCEDURE .....	12
▪ DESIGNS REGISTERED WITH THE INTERNATIONAL BUREAU CLAIMING PRIORITY ON THE TERRITORY OF GEORGIA .....	13
<b>TRADEMARKS</b>	
▪ APPLICATIONS FILED UNDER THE NATIONAL PROCEDURE APPROVED FOR REGISTRATION .....	37
▪ TRADEMARKS REGISTERED ACCORDING TO THE ACCELERATED PROCEDURE .....	49
▪ INTERNATIONAL TRADEMARKS FOR WHICH A DECISION ON GANTING PROTECTION IS TAKEN .....	50
▪ INTERNATIONAL TRADEMARKS PROTECTED IN GEORGIA .....	150
<b>CLASSIFICATION INDEXES</b>	
INVENTIONS .....	158
UTILITY MODELS .....	159
DESIGNS .....	160
TRADEMARKS .....	162

## **PUBLISHED TITLES OF PROTECTION**

### **INVENTIONS**

- **APPLICATIONS APPROVED FOR GRANTING PATENTS:**  
13270; 13130; 13243; 13092; 12810; 13282; 12040; 13023; 13373
- **PATENTED INVENTIONS:**  
6253-6259

### **UTILITY MODELS**

- **PATENTED UTILITY MODEL:**  
1852

### **DESIGNS**

- **REGISTERED DESIGNS:**  
618, 619
- **DESIGN REGISTERED ACCORDING TO THE ACCELERATED PROCEDURE:**  
620
- **DESIGNS REGISTERED WITH THE INTERNATIONAL BUREAU CLAIMING PRIORITY ON THE TERRITORY OF GEORGIA :**  
84150; 84999; 84122; 85068; 85166; 83893; 85197

### **TRADEMARKS**

- **APPLICATIONS FILED UNDER THE NATIONAL PROCEDURE APPROVED FOR REGISTRATION:**  
68212; 69810\*; 73488; 74591; 74713; 75191; 75221; 75234-75242; 75736; 75759; 75763, 75764; 75766; 75860; 75891; 75932; 75990; 76177; 76191; 76216; 76522; 76529; 76569; 76601; 76700; 76720; 76814; 76818; 76822; 76845; 77021; 77244; 77255; 77263; 77420; 77482; 77523, 77524; 77574; 77582; 77620, 77621; 77623; 77654; 77720; 77782; 77814, 77815; 77849; 77872-77874; 77890-77892; 77907; 77988; 77998; 78005; 78009; 78017; 78027; 78052; 78174; 78247-78250
- **TRADEMARKS REGISTERED ACCORDING TO THE ACCELERATED PROCEDURE:**  
25701-25705
- **INTERNATIONAL TRADEMARKS FOR WHICH A DECISION ON GRANTING PROTECTIONS IS TAKEN:**  
68653\*\*; 74428\*; 74677\*; 75562; 75605; 75901; 75905, 75906; 75913; 75928; 75930, 75931; 75953-75955; 75957-75961; 75968; 75970-75974; 75978-75982; 75988, 75989; 75992-75994; 75996; 75998; 76055; 76057; 76059; 76061, 76062; 76064-76070; 76073; 76076; 76079; 76081; 76090; 76140-76142; 76145-76147; 76162; 76220; 76237; 76241, 76242; 76245; 76248; 76252, 76253; 76255-76257; 76259; 76265; 76270; 76277; 76323-76327; 76420; 76509; 76535; 76538; 76558, 76559; 76606; 76623; 76631-76633; 76681; 76722; 76724; 76727-76729; 76784; 76799; 76800; 76807, 76808; 76811-76813; 76878; 76880-76882; 76896; 77028; 77030; 77032-77034; 77088-77095; 77253; 77267; 77299, 77300; 77495; 77504; 77512, 77513; 77515, 77516; 77519-77521; 77527-77529; 77532; 77595; 77597; 77605; 77610; 77628; 77942, 77943; 77953; 77957; 77959; 77961, 77962; 80056
- **INTERNATIONAL TRADEMARKS PROTECTED IN GEORGIA:**  
73649; 73828-73842; 74080; 74082; 74125, 74126; 74140, 74141; 74144; 74310-74316; 74320-74323; 74335-74337; 74339; 74348; 74369; 74512-74519; 74521, 74522; 74525; 74527; 74689-74691; 74695; 74697-74700; 74702-74705; 74737; 74747; 74921-74926; 74928, 74929; 74932; 74934-74936; 74941; 74952-74958; 74961-74974; 74976-74978; 74984-74987; 74991-74993; 95106-75108; 75122-75124; 75126, 75127; 75130; 75132, 75133; 75135, 75136

---

# INVENTIONS

## APPLICATIONS APPROVED FOR GRANTING PATENTS

The decision can be appealed at the Chamber of Appeal of Sakpatenti within 3 months from the publication or at the Mtskheta District Court Administrative Cases Board (Address: №17, Samkhedro str., Mtskheta), within 1 month following the publication.

### PART A

#### A 61

**(10) AP 2015 13270 A**    **(51) Int. Cl. (2006)**  
**A 61 K 9/20**  
**A 61 K 31/4188**

(21) AP 2012 013270    (22) 2012 03 29  
(31) 2011-082301  
(32) 2011 04 01  
(33) JP

(71) TAKEDA PHARMACEUTICAL  
COMPANY LIMITED (JP)  
1-1, Doshomachi 4-chome, Chuo-ku,  
Osaka-shi, Osaka 5410045 (JP)

(72) HOSHINA, Wataru (JP);  
MISAKI, Masafumi (JP)

(74) Shalva Gvaramadze  
(85) 2013 10 28

(86) PCT/JP2012/059276, 2012 03 29

**(54) SOLID PREPARATION**

(57) There is represented solid preparation containing 6-((7S)-6,7-dihydro-5H-pyrrolo[1,2-c]imidazole-7-yl)-N-methyl-2-naphthamide or salt thereof and stabilization method.

Claims: 2 independent  
4 dependent

---

**(10) AP 2015 13130 A**    **(51) Int. Cl. (2006)**  
**A 61 K 31/4411**  
**A 61 K 31/41**  
**A 61 K 9/16**  
**A 61 P 9/00**

(21) AP 2011 013130    (22) 2011 12 07  
(31) 10-2010-0125804  
(32) 2010 12 09  
(33) KR

(71) LG LIFE SCIENCES LTD. (KR)  
LG Gwanghwamun Bldg., 92, Sinmunno 2-ga,  
Jongno-gu, Seoul 110-062 (KR)

(72) CHUNG, Young Sik (KR);  
PARK, Soo Ah (KR);  
KIM, Ree Sun (KR);  
KIM, Sung Il (KR);  
JUHN, Jae Hyeon (KR);  
KIM, Dong Kyu (US);  
KIM, Yoo Rin (KR);  
PARK, Hee Dong (KR);

PARK, Seong Jae (KR);  
LEE, Sung Hack (KR);  
KIM, Ju Hyun (KR);  
JUNG, Min Young (KR)

(74) Shalva Gvaramadze

(85) 2013 06 21

(86) PCT/KR2011/009413, 2011 12 07

**(54) COMPLEX FORMULATION  
COMPRISING LERCANIDIPINE  
HYDROCHLORIDE AND VALSARTAN  
AND METHOD FOR THE PREPARA-  
TION THEREOF**

(57) There is represented formulation containing lercanidipine hydrochloride and valsartan; at that those substances are included therein separately.

Claims: 2 independent  
10 dependent

Fig.: 9

---

**(10) AP 2015 13243 A**    **(51) Int. Cl. (2006)**  
**A 61 K 35/60**  
**A 61 K 36/00**  
**A 61 P 1/10**

(21) AP 2013 013243    (22) 2013 09 26

(71) Eter Kemertelidze (GE)

Pekinis Gamz. 33a, b. 40, 0160, Tbilisi (GE);  
Pavel Javich (GE)  
Machablis q. 16, 0105, Tbilisi (GE);  
Luiza Churadze (GE)

Vazha-Pshavelas VII kvart., korp. 19, b. 17,  
0186, Tbilisi (GE)

(72) Eter Kemertelidze (GE);

Pavel Javich (GE);

Luiza Churadze (GE)

**(54) DRUG FOR PATIENT  
PREPARATION FOR PROCTOSCOPY**

(57) There is represented a drug containing shark liver oil, horse gowan *Matricaria chamomilla* dense extract, xylite, and tartaric acid sodium-potassium salt.

Claims: 1 independent

## PART C

## C 04

(10) AP 2015 13092 A (51) Int. Cl. (2006)  
C 04 B 14/38  
C 04 B 16/06  
C 04 B 32/02  
E 04 C 5/07

(21) AP 2011 013092 (22) 2011 10 21  
(31) 20101485  
(32) 2010 10 21  
(33) NO

(71) REFORCETECH LTD. (IE)  
Palmdohlen House Dooradoyle Road  
Limerick (IE)

(72) STANDAL, Per, Cato (NO);  
MILLER, Leonard, W. (NO)

(74) Liliana Darakhvelidze  
(85) 2013 05 20

(86) PCT/NO2011/000300, 2011 10 21

(54) **REINFORCEMENT BAR AND  
METHOD FOR MANUFACTURING  
SAME**

(57) There is represented reinforcement bar for concrete structures, comprising a large number of continuous, parallel fibers, preferably made of basalt, carbon, glass fiber, or the like, embedded in a cured matrix, the bars having an average length of 20 mm to 200 mm, and an average diameter of 2 mm to 10 mm. Each bar is made of at least one fiber bundles comprising a number of parallel, preferably straight fibers having a cylindrical cross section. At least a part of surface of each bar is deformed prior to or during the curing stage of the matrix by means of: a) one or more strings of an elastic or inelastic, but tensioned material being helically wound around said at least one bundle of parallel, straight fibers prior to curing of the matrix in which the fibers are embedded, maintaining the fibers in an parallel state during curing and providing an uneven external surface in a longitudinal direction of the reinforcement bars, and/or b) at least one deformed section and/or at least one end of each reinforcement bar; thereby producing a roughened surface. The invention also relates to a method for manufacturing reinforcement bars and for use of such short fibers.

Claims: 2 independent  
6 dependent

Fig.: 10

Table: 3

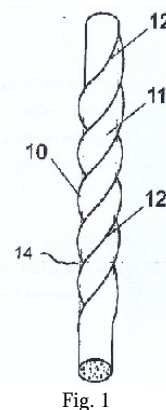

Fig. 1

## C 07

(10) AP 2015 12810 A (51) Int. Cl. (2006)  
C 07 D 215/48  
C 07 D 401/12  
C 07 D 407/12  
C 07 D 409/12  
C 07 D 413/12  
C 07 D 417/12  
A 61 K 31/4709  
A 61 P 31/10

(21) AP 2010 012810 (22) 2010 12 28

(31) 09180899.8

(32) 2009 12 29

(33) EP

(71) POLICHEM S.A. (LU)  
50, Val Fleuri, L-1526 Luxembourg (LU)

(72) GAGLIARDI, Stefania (IT);  
DEL SORDO, Simone (IT);  
MAILLAND, Federico (IT);  
LEGORA, Michela (IT)

(74) Aleksandre Gegechkori

(85) 2012 07 27

(86) PCT/EP2010/070791, 2010 12 28

(54) **SECONDARY 8-HYDROXYQUINO-  
LINE-7-CARBOXAMIDE DERIVATIVES  
FOR USE AS ANTIFUNGAL AGENTS**

(57) The present invention provides secondary 8-hydroxyquinoiine-7-carboxamide derivatives of general formula (I')

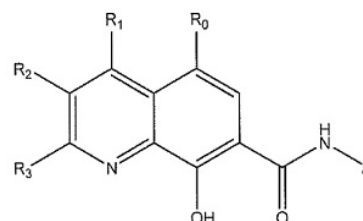

(I)

and pharmaceutically acceptable salts thereof. These compounds are useful as antifungal agents. Specifically, these compounds are applied for fungus disease caused by *Trichophyton Rubrum*,



Tricophyton Mentagrophytes, Aspergillus Niger and Scopulohopsis Brevicaulis, Candida Albicans and Candida Glabrata.

Claims: 2 independent  
16 dependent

Fig.: 3

**(10) AP 2015 13282 A** (51) **Int. Cl. (2006)**  
**C 07 D 405/12**  
**C 07 D 223/16**  
**A 61 P 9/10**  
**A 61 P 9/08**  
**A 61 P 9/06**  
**A 61 K 31/55**

(21) AP 2012 013282 (22) 2012 11 08

(31) 12.60576

(32) 2012 11 08

(33) FR

(71) LES LABORATOIRES SERVIER (FR)

35, rue de Verdun, 92284 Suresnes

Cedex (FR)

(72) CARRANZA, Maria del Pilar (ES);

GARCIA ARANDA, Maria Isabel (ES);

GONZALEZ, Jose Lorenzo (ES);

SANCHEZ, Frederic (ES)

(74) Tamaz Shilakadze

**(54) NEW PROCESS FOR SYNTHESIS OF (2E)-3-(3,4-DIMETHOXYPHENYL) PROP-2-ENENITRILE, AND APPLICATION IN SYNTHESIS OF IVABRADINE AND ADDITION SALTS THEREWITH PHARMACEUTICALLY ACCEPTABLE ACID**

(57) There are represented (2E)-3-(3,4-dimethoxyphenyl)prop-2-enenitrile of formula (I),

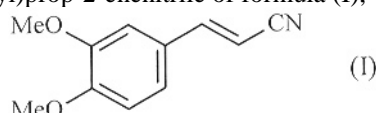

new method of synthesis thereof, and application therefor synthesis of ivabradine and pharmaceutically acceptable salts thereof.

Claims: 2 independent  
12 dependent

## C 12

**(10) AP 2015 12040 A** (51) **Int. Cl. (2006)**  
**C 12 N 5/06**

(21) AP 2009 012040 (22) 2009 05 20

(31) 61/054,785; 61/102,913; 61/179,674

(32) 2008 05 20; 2008 10 06; 2009 05 19

(33) US; US; US

(71) INCURON, LLC (RU)

6 Stolovyi Pereulok, Moscow 121069 (RU);

HEALTH RESEARCH INC. (US)

Elm Carlton streets, buffalo, NY 14263 (US)

(72) GUDKOV, Andrei, V. (US);  
GUROVA, Katerina (RU);  
NEZNANOV, Nickolay (US)

(74) Tamaz Shilakadze

(85) 2010 12 17

(86) PCT/US2009/044736, 2009 05 20

**(54) INDUCING CELL DEATH BY INHIBITING ADAPTIVE HEAT SHOCK RESPONSE**

(57) There is represented adaptive heat shock response inhibitor, particularly carbazole applied to cause death of cell wherein temperature shock response is induced.

Claims: 1 independent  
11 dependent

Fig.: 17

## PART E

### E 01

**(10) AP 2015 13023 A** (51) **Int. Cl. (2006)**  
**E 01 F 8/00**  
**E 04 B 1/24**

(21) AP 2010 013023 (22) 2010 08 06

(71) URBANTECH S.R.L. (IT)

Via Lombardia n. 26, Zona Industriale  
Gello I-56025 Pontedera (PI) (IT)

(72) TIZZONI, Giampaolo (IT)

(74) Aleksandre Gegechkori

(85) 2013 03 05

(86) PCT/IT2010/000359, 2010 08 06

**(54) ANTI-NOISE BARRIER AND ASSEMBLY METHOD THEREOF**

(57) An invention concerns an anti-noise barrier 20, 21 and assembly method thereof. The foundation and the structural post of the barrier are a single continuous piece in the shape of a sheet pile 2. The sheet pile comprises a first part 2' and a second part 2'' of such a length that, in use, the second part 2'' results insertable on the ground 50 to realize the foundation, while, contextually, the first part 2' results emerging from the ground upwards. The first part of the sheet pile 2', besides, is provided with connection means 4, 5 through which to be able to connect the sound-absorbent panels 6, and with a plate 3 on which to lean the panels themselves in such a way that the arrangement on the ground of the foundation and of the structural post results realizable in a single phase to then proceed with the second phase of application of the panels.

Claims: 2 independent  
10 dependent

Fig.: 4

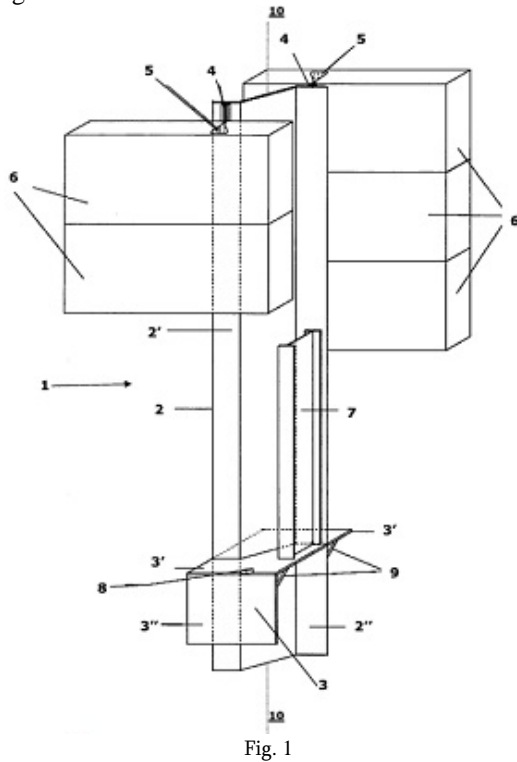

Fig. 1

## PART G

### G 05

(10) AP 2015 13373 A (51) Int. Cl. (2006)

G 05 F 3/16

H 05 B 33/08

(21) AP 2012 013373 (22) 2012 06 22

(31) 1111359.4; 1210561.5

(32) 2011 07 04; 2012 06 14

(33) GB; GB

(71) ACCURIC LTD (GB)

1 Conference Grove Crowle Worcester  
Worcestershire WR7 4SF (GB)

(72) BANNISTER, Dave (GB)

(74) Aleksandre Gegechkori

(85) 2014 02 03

(86) PCT/GB2012/051448, 2012 06 22

(54) **CURRENT REGULATOR**

(57) There is represented current regulator for providing regulated current from an input voltage. The current regulator comprises a voltage regulator circuit, operable to provide regulated voltage, which comprises a plurality of Zener diodes connected in parallel.

Claims: 2 independent

12 dependent

Fig.: 8

## PATENTED INVENTIONS

### PART A

#### A 23

- (11) P 2015 6256 B**      **(51) Int. Cl. (2006)**  
**A 23 L 1/30**  
**C 12 G 3/00**  
**C 12 G 3/04**  
**C 12 G 3/06**  
**A 61 K 36/28**
- (10) AP 2014 12937 A      (44) 22(410)/2014  
(21) AP 2011 012937  
(22) 2011 06 28  
(24) 2011 06 28  
(31) 12/825,568  
(32) 2010 06 29  
(33) US  
(86) PCT/GE2011/000003, 2011 06 28  
(73) Nodar Chigogidze (GE)  
Al. Kazbegis Gamz. 4a, b. 47,  
0160, Tbilisi (GE);  
Aleksandre Kakhaberi (GE)  
Ketevan Tsamebulis q. 29, 0144, Tbilisi (GE)  
(72) Nodar Chigogidze (GE);  
Aleksandre Kakhaberi (GE)  
(54) **DIABETIC ALCOHOLIC BEVERAGE  
AND PREPARATION METHOD  
THEREOF**

#### A 61

- (11) P 2015 6254 B**      **(51) Int. Cl. (2006)**  
**A 61 K 36/899**  
**A 61 K 8/97**  
**A 61 P 37/08**
- (10) AP 2014 12262 A      (44) 22(410)/2014  
(21) AP 2009 012262  
(22) 2009 09 15  
(24) 2009 09 15  
(31) 0857755  
(32) 2008 11 14  
(33) FR  
(86) PCT/EP2009/061971, 2009 09 15  
(73) PIERRE FABRE DERMO-COSMETIQUE (FR)  
45, place Abel Gance F-92100 Boulogne-  
Billancourt (FR)  
(72) MANDEAU, Anne (FR);  
FABRE, Bernard (FR);  
TEYSSEYRE, Valérie (FR);  
BOE, Jean-François (FR)  
(74) Giorgi Meipariani  
(54) **HYPOALLERGENIC  
DERMATOLOGICAL COMPOSITION**

- (11) P 2015 6253 B**      **(51) Int. Cl. (2006)**  
**A 61 K 39/395**  
**A 61 K 39/00**

- (10) AP 2014 10981 A      (44) 22(410)/2014  
(21) AP 2007 010981  
(22) 2007 04 20  
(24) 2007 04 20  
(31) 60/793,997; 11/788,697  
(32) 2006 04 21; 2007 04 19  
(33) US; US  
(86) PCT/US2007/009712, 2007 04 20  
(73) AMGEN INC. (US)  
Patent Operations M/S 28-2- C, One Amgen  
Center Drive, Thousand Oaks,  
CA 91320-1799 (US)  
(72) CALLAHAN, William, J. (US);  
REMMELE, Jr., Richard, L. (US);  
RATNASWAMY, Gayathri; (IN);  
LATYPOV, Ramil, F. (RU);  
LIU, Dingjiang (CN)  
(74) Tamaz Shilakadze  
(54) **LYOPHILIZED THERAPEUTIC  
PEPTIBODY FORMULATIONS**

### PART B

#### B 03

- (11) P 2015 6255 B**      **(51) Int. Cl. (2006)**  
**B 03 B 7/00**
- (10) AP 2014 12852 A      (44) 22(410)/2014  
(21) AP 2012 012852  
(22) 2012 09 05  
(24) 2012 09 05  
(73) Nugzar Tsereteli (GE)  
Varketilis Mas., Zemo Plato, II mkr.,  
21 korp., b. 62, 0163, Tbilisi (GE)  
(72) Nugzar Tsereteli (GE)  
(54) **METHOD OF CARBONATE-OXIDE  
MANGANESE ORE CONCENTRATION**

**PART C****C 10**

- (11) P 2015 6257 B (51) Int. Cl. (2006)  
C 10 G 45/00  
C 10 G 65/00  
C 07 C 5/00
- (10) AP 2014 13170 A (44) 22(410)/2014  
(21) AP 2012 013170  
(22) 2012 01 18  
(24) 2012 01 18  
(31) 61/434,427  
(32) 2011 01 19  
(33) US  
(86) PCT/RU2012/000038, 2012 01 18  
(73) LIMITED COMPANY "REACTIVE  
RECTIFICATION TECHNOLOGY" (RU)  
Ul. Serpukhovskaya, 10, lit. A St. Petersburg,  
190013 (RU)  
(72) GIYAZOV, Oleg (RU);  
PARPUTS, Oleg (RU)  
(74) Tamaz Shilakadze  
(54) **NAPHTHA ISOMERISATION ON  
THREE CATALYTIC REACTION  
ZONES INSIDE DISTILLATION  
COLUMN**

**PART E****E 01**

- (11) P 2015 6259 B (51) Int. Cl. (2006)  
E 01 F 8/00
- (10) AP 2014 13214 A (44) 21(409)/2014  
(21) AP 2012 013214  
(22) 2012 02 06  
(24) 2012 02 06  
(31) PI2011A000011  
(32) 2011 02 07  
(33) IT  
(86) PCT/IB2012/050533, 2012 02 06  
(73) URBANTECH S.p.A. (IT)  
Via Lombardia, 34 Z.I. Gello, I-56025  
Pontedera (Pisa) (IT)  
(72) TIZZONI, Giampaolo (IT)  
(74) Alexander Gegechkori  
(54) **NOISE BARRIER STRUCTURE WITH  
SOUND-ABSORBING AND SOUND-  
REDIRECTING PROPERTIES AND  
HIGH PERFORMANCE SOUND  
ABSORBER FOR USE IN SUCH  
STRUCTURE**

**PART F****F 26**

- (11) P 2015 6258 B (51) Int. Cl. (2006)  
F 26 B 15/04
- (10) AP 2014 13314 A (44) 22(410)/2014  
(21) AP 2013 013314  
(22) 2013 12 06  
(24) 2013 12 06  
(73) Marine Tepnadze (GE)  
Vazisubani, IV mkr., I kvart., korp. 19,  
b. 37, 0152, Tbilisi (GE);  
Zaur Balamtsarashvili (GE)  
Saburtalos q. 37/4, b. 12, 0102, Tbilisi (GE);  
Petre Dundua (GE)  
Shio Mghvimelis q. 6A, b. 8, 0179, Tbilisi (GE);  
Lasha Mirotadze (GE)  
Sop. Tsirkvali, 5500, Tchiaturis R-ni (GE);  
Davit Litkini (GE)  
Ush. Chkheidzis I Chikhi 2, 2000, Zestaponi (GE);  
Zaur Korkia (GE)  
Arakishvilis q. 7, 0179, Tbilisi (GE)  
(72) Marine Tepnadze (GE);  
Zaur Balamtsarashvili (GE);  
Petre Dundua (GE);  
Lasha Mirotadze (GE);  
Davit Litkini (GE);  
Zaur Korkia (GE)  
(54) **CONVECTIONAL DRYER OF PANEL  
MATERIALS HAVING LACQUERED  
SURFACES**



---

# DESIGNS

## REGISTERED DESIGNS

**(11) D 2015 618 S**      **(51) 17-01**  
(10) AD 2014 811 S      (44) 22(410)/2014  
(21) AD 2014 000811  
(22) 2014 07 23  
(24) 2014 07 23  
(18) 2019 07 23  
(73) Omar Kvinikadze (GE)  
Dighmis Mas., III kvart., korp. 39, b. 61, 0159,  
Tbilisi (GE)  
(72) Omar Kvinikadze (GE)  
(54) **FINGERBOARD FOR MUSICAL  
INSTRUMENT**

---

**(11) D 2015 619 S**      **(51) 19-08**  
(10) AD 2014 812 S      (44) 22(410)/2014  
(21) AD 2014 000812  
(22) 2014 07 28  
(24) 2014 07 28  
(18) 2019 07 28  
(73) Morozov Viktor Aleksandrovich (SU)  
Kosmonavtebis Gamz., 5, korp., b. 40,  
344092, Russia, Rostov-on-Don (SU)  
(72) Morozov Viktor Aleksandrovich (SU)  
(74) Alexander Gegechkori  
(54) **LABEL**

---

## DESIGN REGISTERED ACCORDING TO THE ACCELERATED PROCEDURE

The decision can be appealed at the Chamber of Appeal of Sakpatenti within 3 months from the publication.

- (11) **D 2015 620 S**      (51) **09-01**  
(21) AD 2015 000835    (22) 2015 02 09  
(24) 2015 02 09  
(28) 2  
(18) 2020 02 09  
(73) Bondo Kalandadze (GE)  
      Larsis Shes. 5, b.12, 0179, Tbilisi (GE)  
(72) Bondo Kalandadze (GE)  
(74) Merab Kvimsadze  
(54) **BOTTLE**  
(55)



## DESIGNS, WHICH HAVE BEEN REGISTERED WITH THE INTERNATIONAL BUREAU CLAIMING PRIORITY ON THE TERRITORY OF GEORGIA

The decision can be appealed at the Chamber of Appeal of Sakpatenti within 3 months from the publication or at the Mtskheta District Court Administrative Cases Board (Address: №17, Samkhedro Str., Mtskheta), within 1 month following the publication.

(11) DM/084150

(51) 11-01

(15) 2014 06 12

(45) 2014/49 (2014 12 12)

(22) 2014 06 12

(28) 11

(73) HARRY WINSTON SA

Chemin du Tourbillon 8, CH-1228 Plan-les-Ouates (CH)

(85) CH

(86) CH

(87) CH

(88) CH

(89) CH

(81) II. BZ, MA, III. AL, AM, AZ, BA, CH, EM, GE, KG, LI, MC, MD, ME, MK, MN, NO, OM, SG, TJ, TN, TR, UA

(72) 1-11: Rie YATSUGI-KANG

272 Highland St., 07626 Cresskill N.J., États-Unis d'Amérique

(54) 1.-6. Necklaces; 7. Jewelry article; 8.-11. Necklaces

(55)



1.1



1.2



1.3



1.4



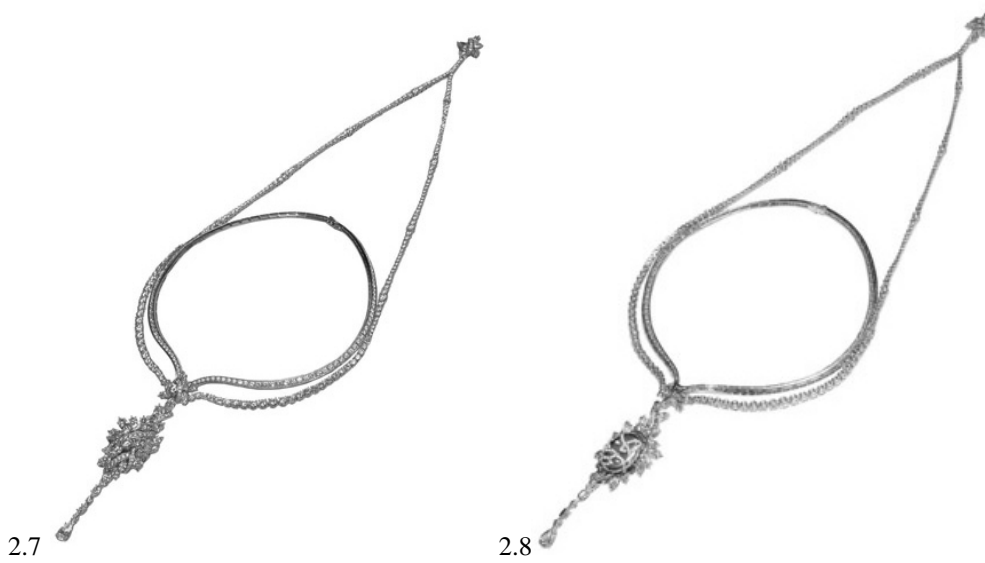
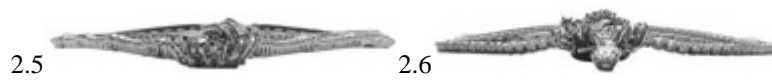
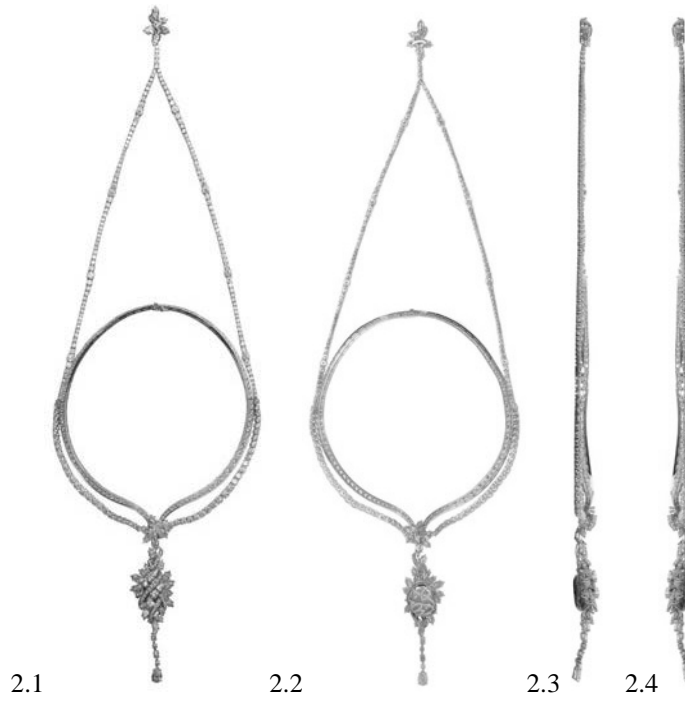
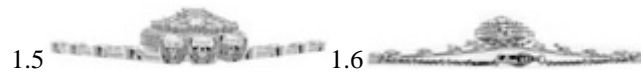



2.9



3



4



5



6



7.1



7.2



7.3



8.1



8.2



8.3



8.4



8.5



8.6



8.7



8.8



9.1



9.2



9.3



9.4

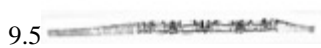

9.5



9.6

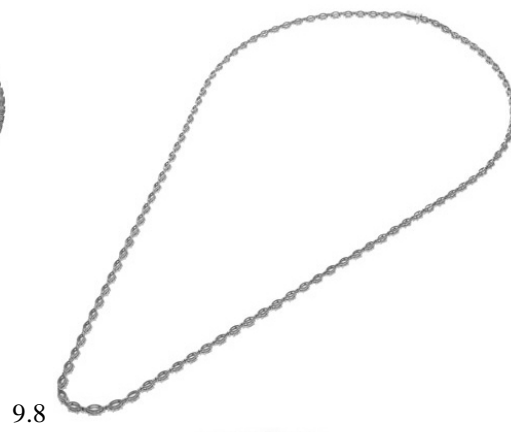
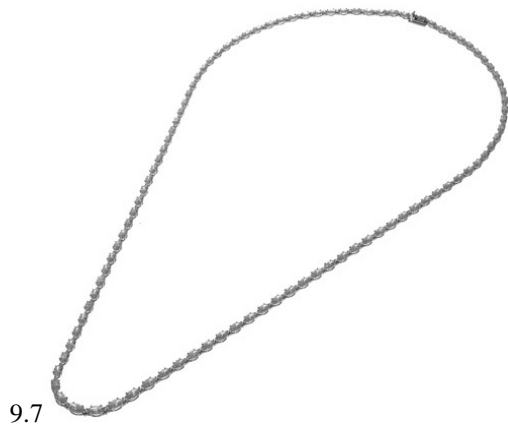

10.6

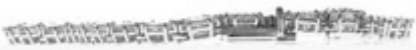

10.7



10.8



11.1



11.2



11.3



11.4



11.5

11.6



11.7

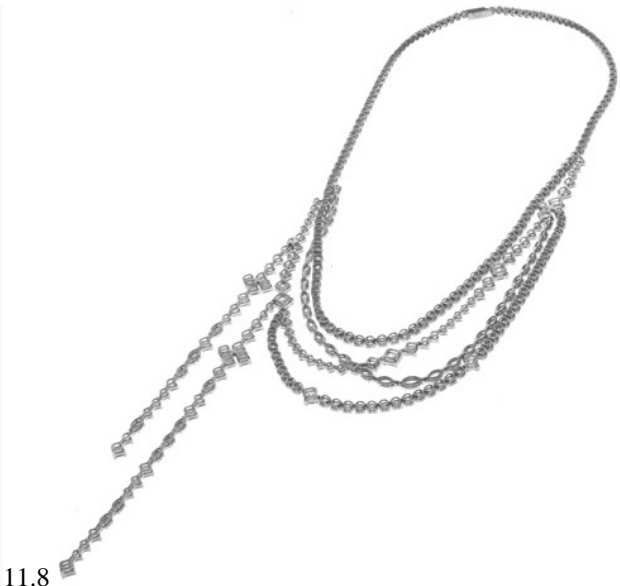

11.8

**(11) DM/084999**

(15) 2014 08 14

(22) 2014 08 14

(28) 4

(73) IMAGO TECHMEDIA LIMITED

The Malt House, 25/29 High Street, Kingston upon Thames, KT1 1LL (GB)

(85) EM

(86) EM

(87) EM

(88) EM

(89) EM

(81) III. AL, AM, AZ, BA, BN, BW, CH, EG, EM, GE, GH, IS, KG, LI, MC, MD, ME, MK, MN, NA, NO, OA, OM, RS, RW, SG, ST, TJ, TN, TR, UA

(72) 1-4: Vivid Associates

Mulgrave Chambers 26-28 Mulgrave Rd, SM2 6LE Sutton, United Kingdom

(54) 1.-4. Logos

(55)

**DATA  
CENTRE  
EXPO**8-9 October 2014  
ExCeL London

1

**CYBER  
SECURITY  
EXPO**8-9 October 2014  
ExCeL London

2

**IPEXPO  
EUROPE**8-9 October 2014  
ExCeL London

3

**UC EXPO**  
CONNECTED BUSINESS

21-22 April 2015 Olympia, London

4



(11) DM/084122

(51) 10-02, 07

(15) 2014 06 20

(45) 2014/51 (2014 12 26)

(22) 2014 06 20

(28) 14

(30) 20.12.2013; 140343; CH

(73) ROLEX SA

3-5-7 rue François-Dussaud, CH-1211 Genève 26 (CH)

(85) CH

(86) CH

(87) CH

(88) CH

(89) CH

(81) II. BZ, KP, MA, SR. III. AL, AM, AZ, BA, BN, BW, EG, EM, GE, GH, IS, KG, LI, MC, MD, ME, MK, MN, NA, NO, OA, OM, RS, RW, SG, ST, SY, TJ, TN, TR, UA

(72) 1, 2, 3, 4, 5, 6, 7, 9, 10, 11, 12, 13, 14: GUEIT Emmanuel

23, rue de la Terrassiere, 1207 Genève, Suisse

(54) 1.-3. Wristwatches; 4.-5. Watch cases; 6.-9. Watch dials; 10. Watch winding crown; 11. Watch rim; 12.-13. Watch hand sets; 14. Watch clasp

(55)







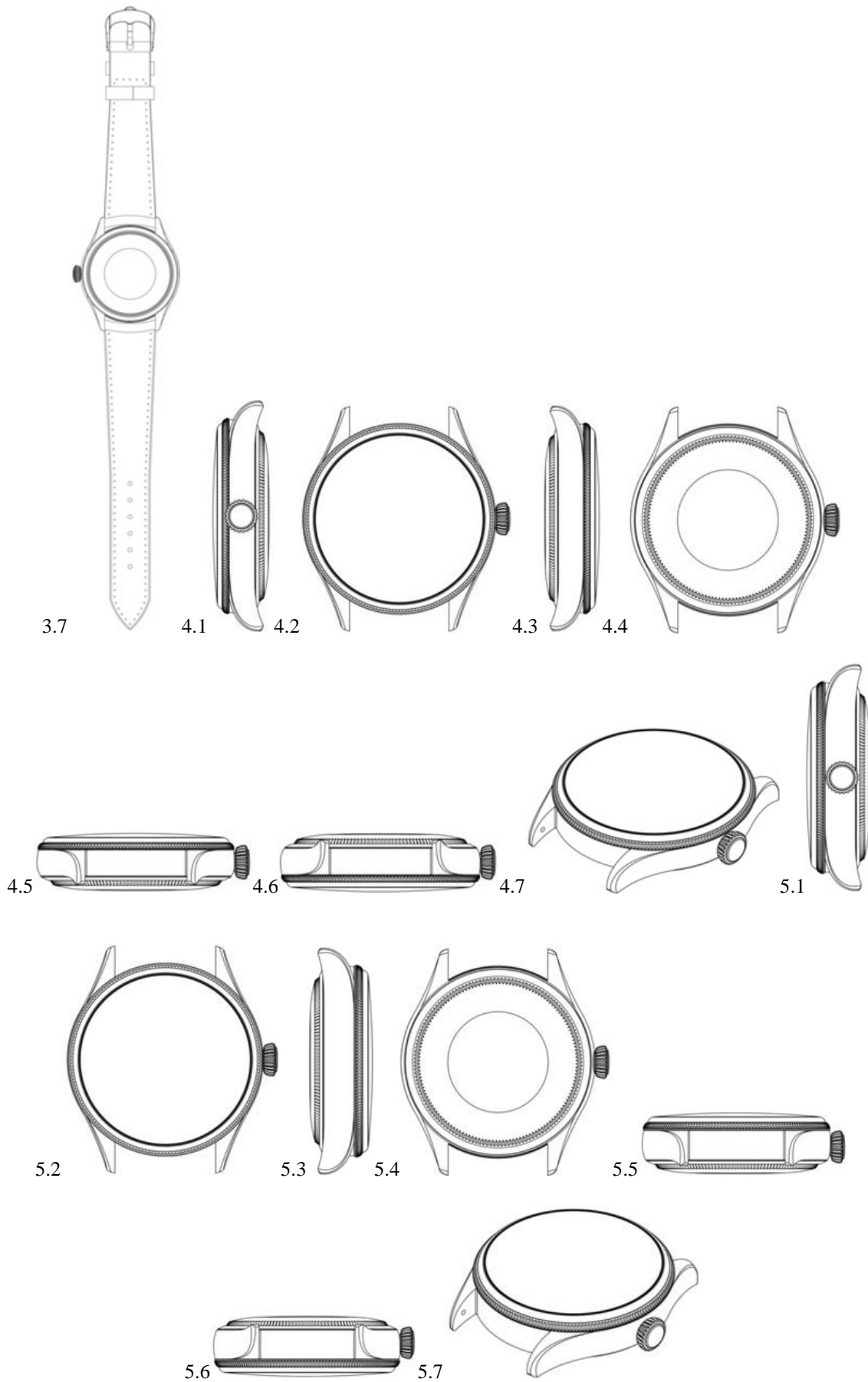

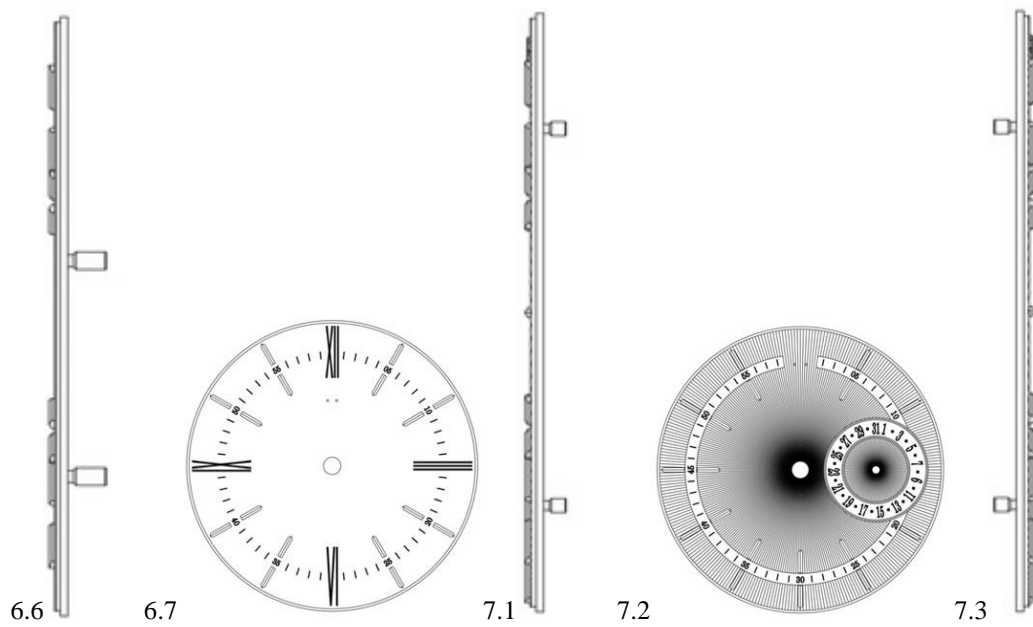
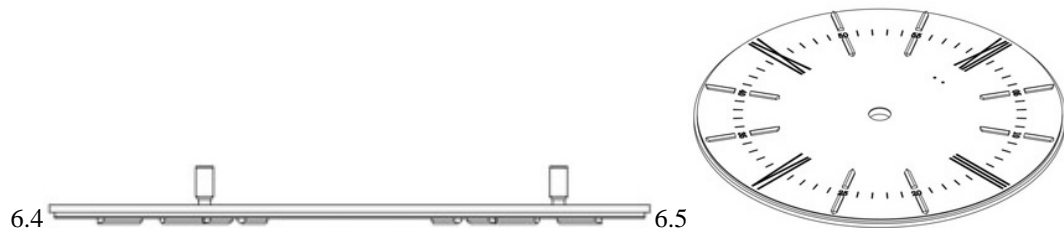
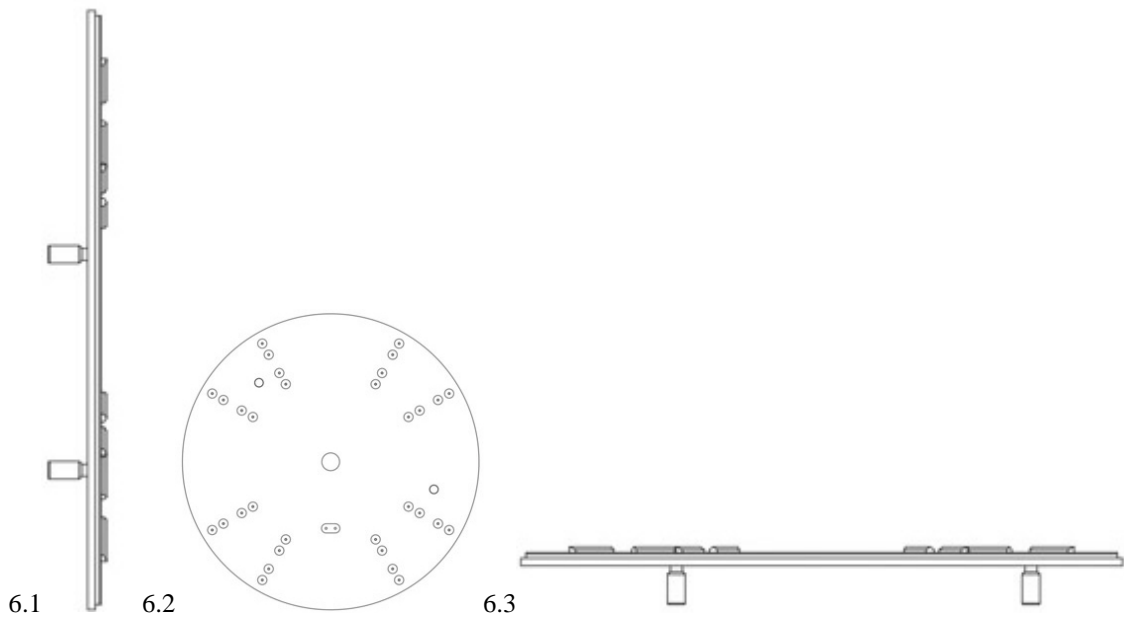

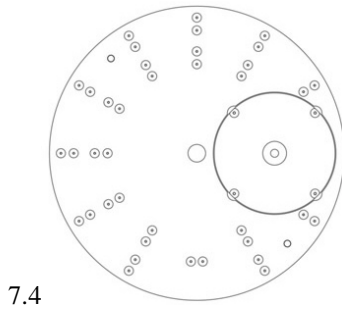

7.4



7.5



7.6

7.7

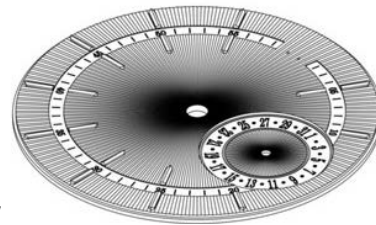

8.1

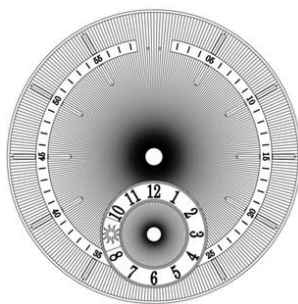

8.2



8.3

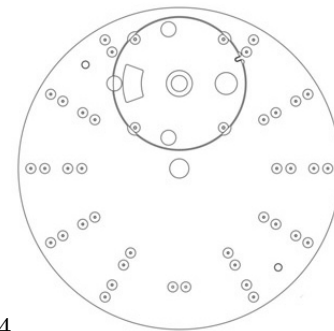

8.4



8.5



8.6

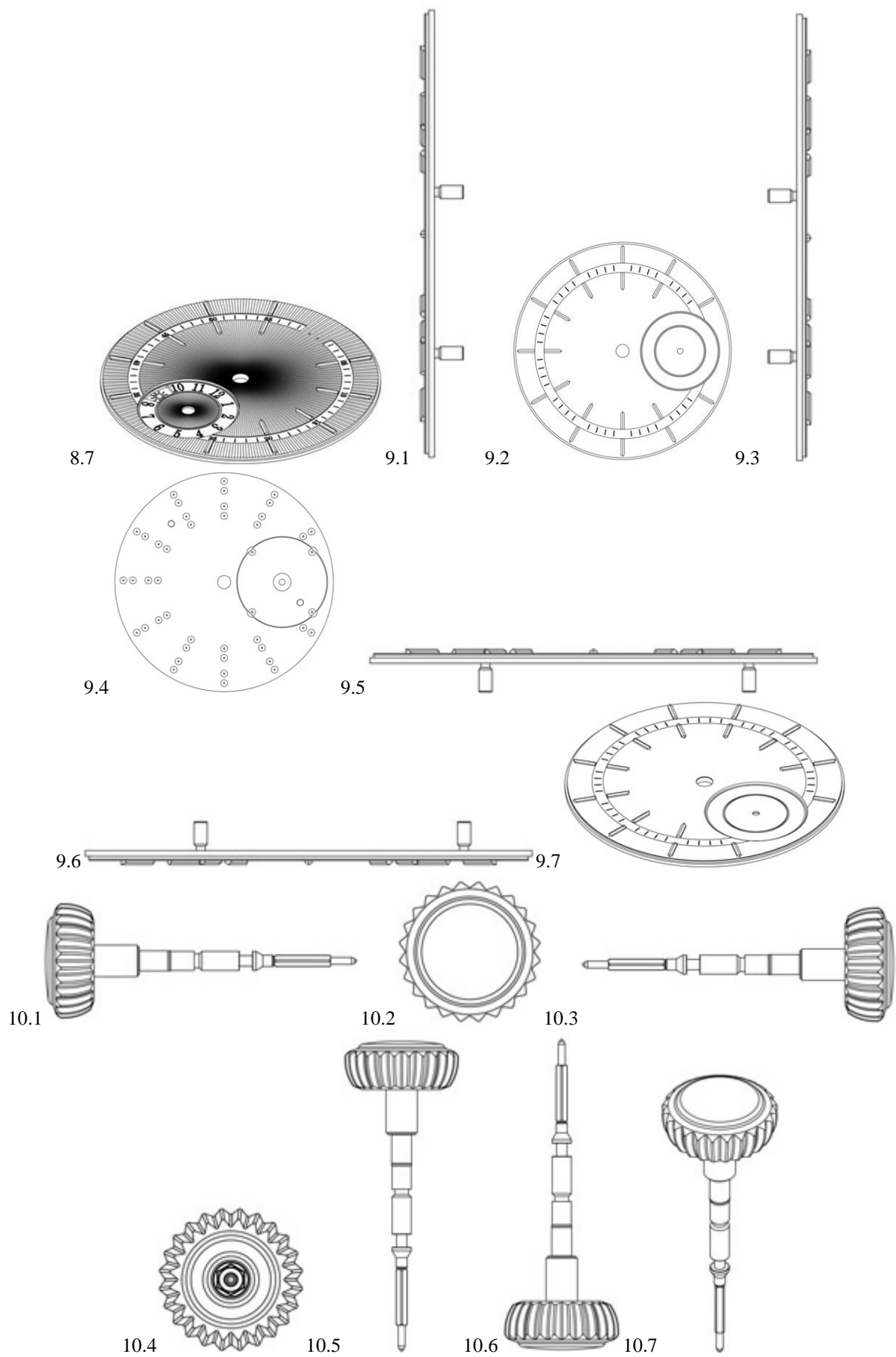

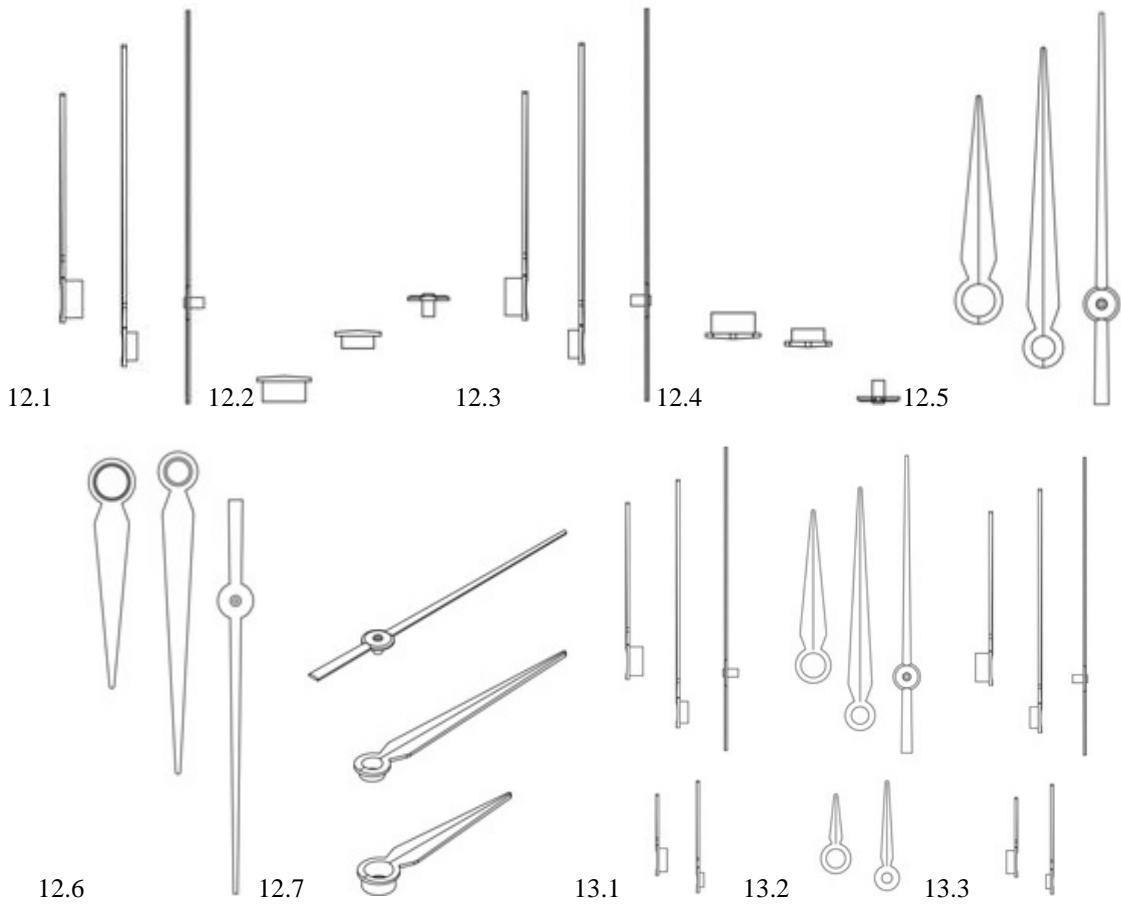
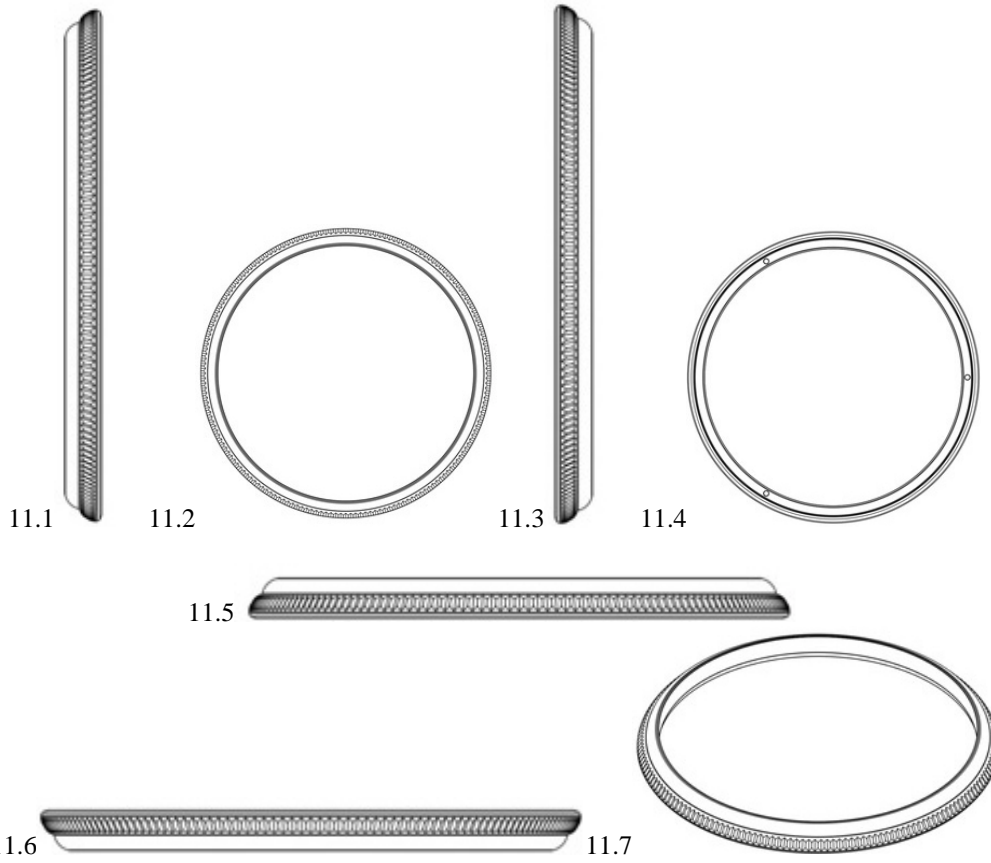



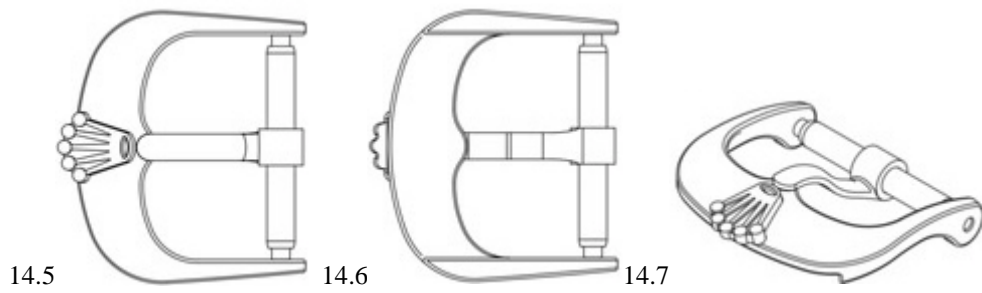
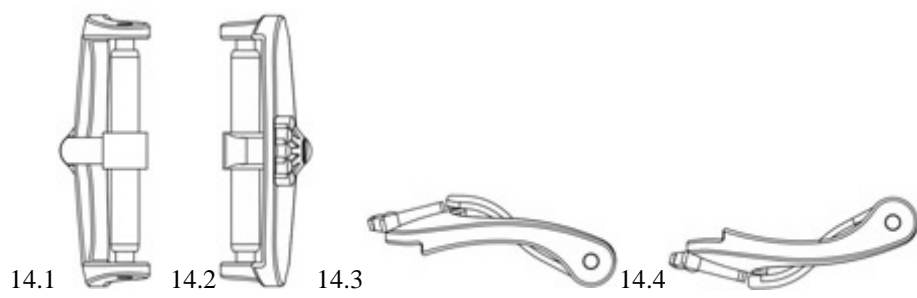
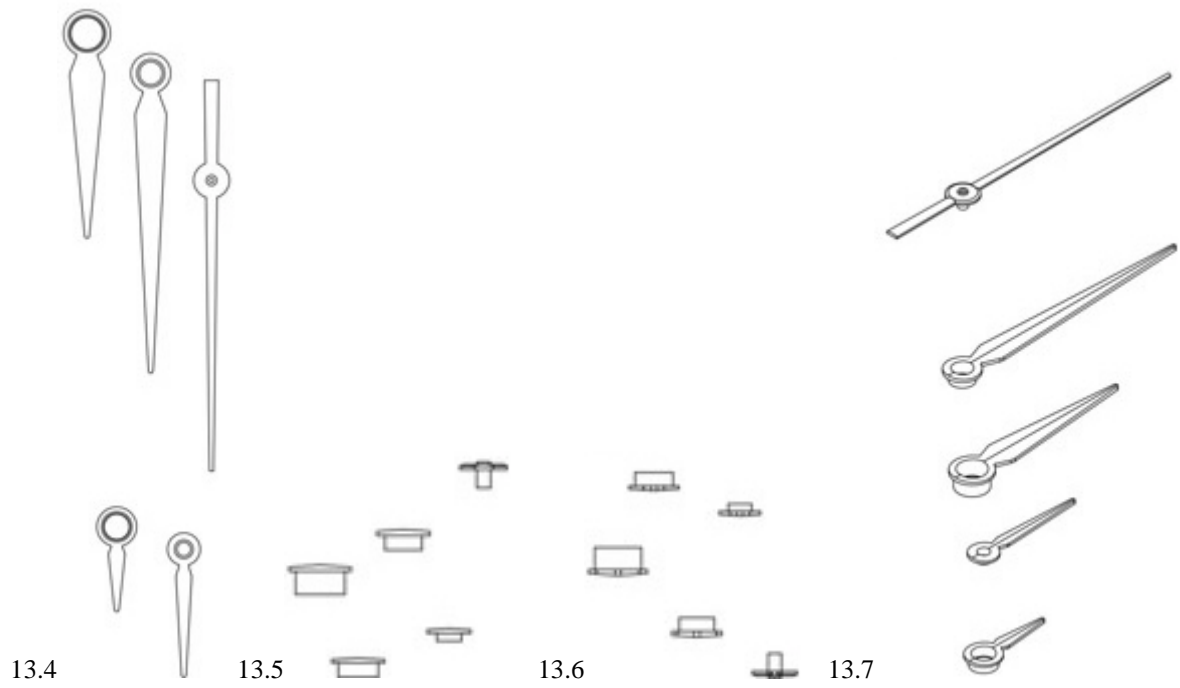

**(11) DM/085068**

(15) 2014 12 10

(22) 2014 12 10

(28) 2

(73) FRIESLAND BRANDS B.V.

Stationsplein 4, NL-3818 LE Amersfoort (NL)

(85) EM

(86) BX, EM

(87) BX, EM

(88) BX, EM

(89) EM

(81) III. CH, EG, EM, GE, KG, MD, MN, OA, UA

(54) 1.-2. Bottles

(55)

**(51) 09-01**

(45) 2014/51 (2014 12 26)

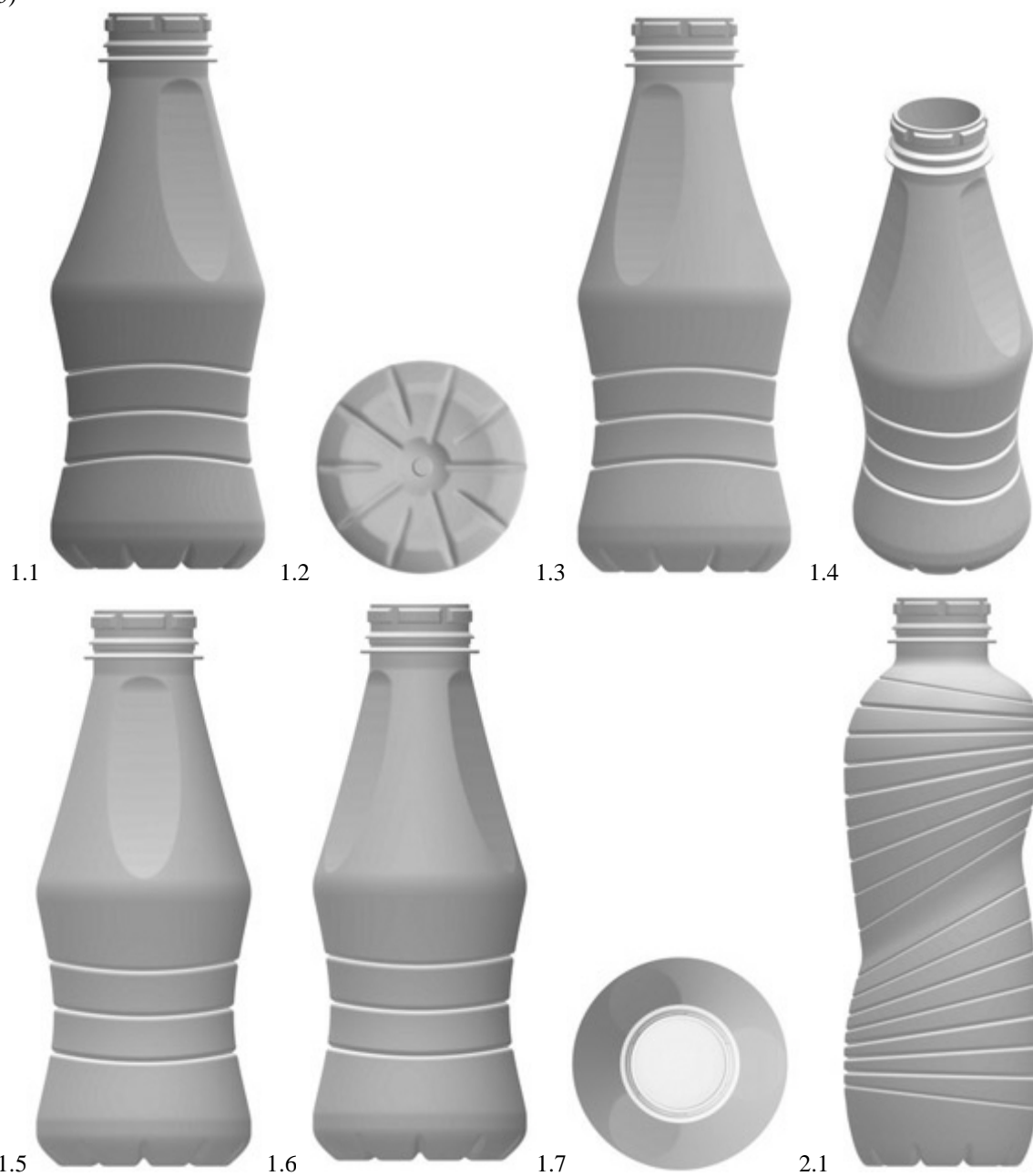

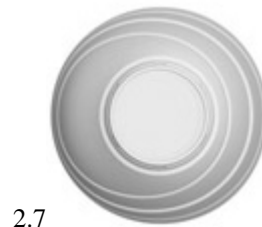
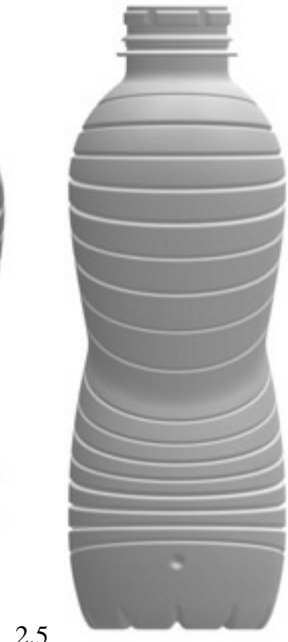

**(11) DM/085166****(51) 02-04**

(15) 2014 12 17

(45) 2014/51 (2014 12 26)

(22) 2014 12 17

(28) 2

(73) VALENTINO S.P.A.

Via Turati, 16/18, I-20121 Milano (IT)

(85) –

(86) EM, IT

(87) EM, IT

(88) EM, IT

(89) EM

(81) III. AZ, EM, GE, KG, KR, TJ, TR, UA

(72) 1-2: SASSI Stefano

c/o VALENTINO S.p.A. Via Turati, 16/18, I-20121 MILANO, Italy

(54) 1.-2. Shoes

(55)



1.1

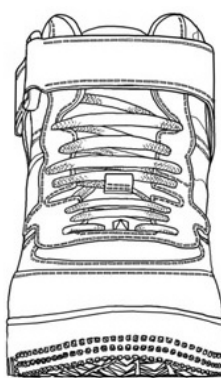

1.2

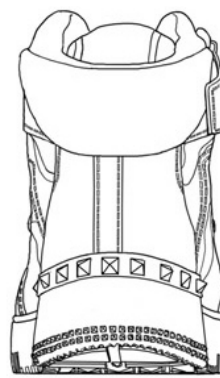

1.3



1.4

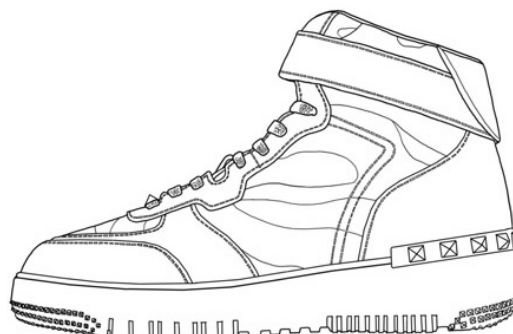

1.5

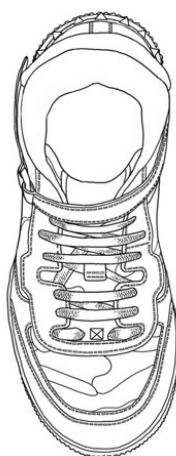

1.6

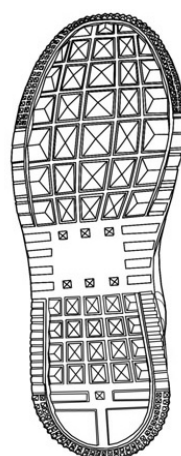

1.7



2.1



2.2



2.3



2.4



2.5



2.6



2.7

**(11) DM/083893**

(15) 2014 06 27

(22) 2014 06 27

(28) 1

(73) SWATCH AG (SWATCH SA) (SWATCH LTD.)

Jakob-Stämpfli-Strasse 94, CH-2502 Biel/Bienne (CH)

(85) CH

(86) CH

(87) CH

(88) CH

(89) CH

(81) II. BZ, MA. III. AL, AM, AZ, BA, CH, EM, GE, KG, LI, MC, MD, ME, MK, MN, NO, OM, SG, TJ, TN, TR, UA

(72) 1: Alexander Gorlizki

128 Coffey St. Apt. 3, 11231 Brooklyn N.Y., États-Unis d'Amérique

(54) 1. Wristwatch

(55)

**(51) 10-02**

(45) 2014/52 (2015 01 02)



1.1



1.2

(11) DM/085197

(51) 25-03

(15) 2014 03 07

(45) 2014/52 (2015 01 02)

(22) 2014 03 07

(28) 1

(73) YORULMAZER, RAFET EREN

Askerocagi Caddesi No:15 Suzer Plaza Kat:30/31, Sisli Istanbul (TR)

(85) –

(86) TR

(87) –

(88) –

(89) TR

(81) III. AL, AM, AZ, BA, BW, CH, EG, EM, GE, GH, IS, KG, LI, MC, MD, ME, MK, MN, NA, NO, OA, OM, RS, RW, SG, ST, TJ, TN, UA

(72) YORULMAZER, Rafet Eren

Askerocagi Caddesi No:15 Suzer Plaza Kat:30/31 Sisli ISTANBUL TURKEY, ISTANBUL, Turkey

(54) 1. Building complex

(55)

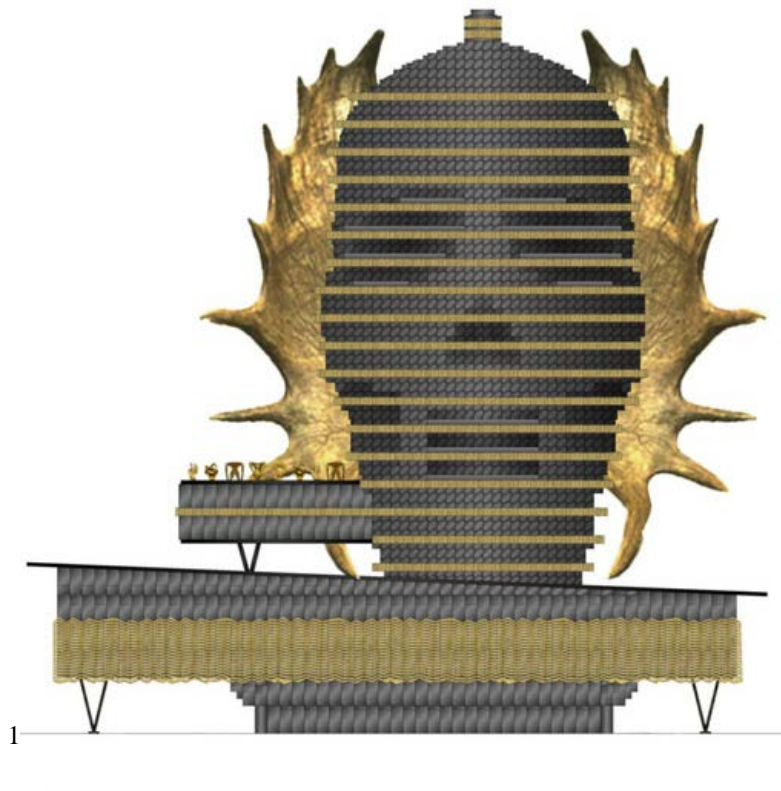



# TRADEMARKS

## APPLICATIONS FILED UNDER THE NATIONAL PROCEDURE APPROVED FOR REGISTRATION

The decision can be appealed at the Chamber of Appeal of Sakpatenti within 3 months from the publication or at the Mtskheta District Court Administrative Cases Board (Address: №17, Samkhedro str., Mtskheta), within 1 month following the publication.

(260) AM 2015 68212 A

(210) AM 68212

(220) 2013 10 10

(731) LTD "KURORTI SAIRME"

Kurorti Sairme, 1000, Baghdatis R-ni,  
Georgia

(540)



(591) Orange, white

(531) 03.06.25-25.01.01-26.03.23-26.11.07-  
26.11.08-26.11.09-27.05.05-28.19.00-  
29.01.12-03.06.25-

(526) The trademark is protected as a whole. The words „საირმის საცხობი“, "SAIRME BAKERY" included therein shall not be subject to independent legal protection.

(511) 30, 35, 39

(260) AM 2105 69810 A\*

(210) AM 69810

(220) 2013 06 25

(731) PT. MULTISTRADA ARAH SARANA, TBK

Jalan Raya Lemahabang Km 58.3, Desa  
Karangsari, Kecamatan Cikarang Timiur,  
Kabupaten Bekasi 17550, Indonesia

(740) Giorgi Taktakishvili

(540)



(591) Black, white

(531) 27.05.08-27.05.24-

(511) 12

(260) AM 2015 73488 A

(210) AM 73488

(220) 2013 08 12

(731) KRAFT FOODS SCHWEIZ HOLDING  
GMBH

Chollerstrasse 4, 6301 Zug, Switzerland

(740) Tamar Kochlamazashvili

(540)



(591) Blue, white, red, golden

(531) 01.01.10-26.11.06-26.11.12-28.05.00-  
29.01.14-

(511) 29

(260) AM 2015 74591 A

(210) AM 74591

(220) 2013 11 04

(731) JSC "IERIA"

Gudautis q. 7, Didubis R-ni, 0119, Tbilisi,  
Georgia

(540)



(591) Black, white

(531) 01.15.21-05.03.14-27.05.01-28.05.00-  
28.19.00-

(526) The trademark is protected as a whole. The words „ნუნისი“, "Нуниси", "Nunisi" included therein shall not be subject to independent legal protection.

(511) 3, 5

(260) AM 2015 74713 A

(210) AM 74713

(220) 2013 11 11

(731) LTD "GRAND CANDY"

Peikrebis q. 12, 0141, Tbilisi, Georgia

(740) Davit Zurabishvili

(540)

ავლაბარი  
Авлабар



(591) Black, white  
(511) 30

(260) AM 2015 75191 A  
(210) AM 75191  
(220) 2013 12 18  
(310) 2013 720749  
(320) 2013 06 20  
(330) RU  
(731) NEMIROFF INTELLECTUAL PROPERTY  
ESTABLISHMENT  
Staedtle 31, 9490 Vaduz, Liechtenstein  
(740) Givi Sibashvili  
(540)



(591) Black, white  
(531) 19.07.17, 19.07.23, 05.03.15  
(511) 21, 32, 33

(260) AM 2015 75221 A  
(210) AM 75221  
(220) 2013 12 20  
(731) WM. WRIGLEY JR. COMPANY  
1132 West Blackhawk Street, Chicago, Illinois  
60642, USA  
(740) Tamaz Shilakadze  
(540)



(591) Black, white  
(531) 26.01.04, 26.02.01, 27.05.02, 26.01.18  
(511) 3, 21, 30

(260) AM 2015 75234 A  
(210) AM 75234  
(220) 2013 12 24  
(731) FERERO S.P.A.  
Piazzale Pietro Ferrero 1, 12051 Alba,  
Cuneo, Italy

(740) Giorgi Sarajishvili  
(540)

## ქინდერი

(511) 30

(260) AM 2015 75235 A  
(210) AM 75235  
(220) 2013 12 24  
(731) FERERO S.P.A.  
Piazzale Pietro Ferrero 1, 12051 Alba,  
Cuneo, Italy  
(740) Giorgi Sarajishvili  
(540)

## ქინდერ შოკოლადი

(511) 30

(260) AM 2015 75236 A  
(210) AM 75236  
(220) 2013 12 24  
(731) FERERO S.P.A.  
Piazzale Pietro Ferrero 1, 12051 Alba,  
Cuneo, Italy  
(740) Giorgi Sarajishvili  
(540)

## ქინდერ დელისი

(511) 30

(260) AM 2015 75237 A  
(210) AM 75237  
(220) 2013 12 24  
(731) FERERO S.P.A.  
Piazzale Pietro Ferrero 1, 12051 Alba,  
Cuneo, Italy  
(740) Giorgi Sarajishvili  
(540)

## ქინდერ სიურპრიზი

(511) 30

(260) AM 2015 75238 A  
(210) AM 75238  
(220) 2013 12 24  
(731) FERERO S.P.A.  
Piazzale Pietro Ferrero 1, 12051 Alba,  
Cuneo, Italy  
(740) Giorgi Sarajishvili  
(540)

## ქინდერ ბუენო

(511) 30

(260) AM 2015 75239 A  
 (210) AM 75239  
 (220) 2013 12 24  
 (731) FERRERO S.P.A.  
 Piazzale Pietro Ferrero 1, 12051 Alba,  
 Cuneo, Italy  
 (740) Giorgi Sarajishvili  
 (540)

## ნუთელა

(511) 30

(260) AM 2015 75240 A  
 (210) AM 75240  
 (220) 2013 12 24  
 (731) FERRERO S.P.A.  
 Piazzale Pietro Ferrero 1, 12051 Alba,  
 Cuneo, Italy  
 (740) Giorgi Sarajishvili  
 (540)

## ფერერო რაშე

(511) 30

(260) AM 2015 75241 A  
 (210) AM 75241  
 (220) 2013 12 24  
 (731) FERRERO S.P.A.  
 Piazzale Pietro Ferrero 1, 12051 Alba,  
 Cuneo, Italy  
 (740) Giorgi Sarajishvili  
 (540)

## ფერერო

(511) 30

(260) AM 2015 75242 A  
 (210) AM 75242  
 (220) 2013 12 24  
 (731) FERRERO S.P.A.  
 Piazzale Pietro Ferrero 1, 12051 Alba,  
 Cuneo, Italy  
 (740) Giorgi Sarajishvili  
 (540)

## ტიკ ტაკო

(511) 30

(260) AM 2015 75736 A  
 (210) AM 75736  
 (220) 2014 01 30  
 (310) 12027066  
 (320) 2013 07 30  
 (330) EM  
 (731) BRITISH AMERICAN TOBACCO  
 (BRANDS) INC.

(a Delaware corporation)  
 2711 Centerville Road, Suite 300,  
 Wilmington, Delaware 19808, USA  
 (740) Tamar Kochlamazashvili  
 (540)



(591) Light violet, dark violet, violet, white-grey  
 (531) 24.01.25, 25.01.01, 25.05.02, 26.04.24,  
 27.05.24, 29.01.05  
 (511) 34

(260) AM 2015 75759 A  
 (210) AM 75759  
 (220) 2014 02 03  
 (310) 86/039384; 86/038915  
 (320) 2013 08 15  
 (330) US  
 (731) GENERAL MOTORS LLC  
 300 Renaissance Center, City of Detroit, State  
 of Michigan 48265-3000, USA  
 (740) Giorgi Taktakishvili  
 (540)

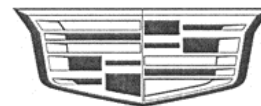

(591) Black, white  
 (531) 24.01.03, 24.11.25  
 (511) 12, 37

(260) AM 2015 75763 A  
 (210) AM 75763  
 (220) 2014 02 03  
 (310) 86174517  
 (320) 2014 01 24  
 (330) US  
 (731) AMGEN INC  
 One Amgen Center Drive, Thousand Oaks,  
 California 91320-1799, USA  
 (740) Shalva Gvaramadze  
 (540)

## ELUCIAM

(511) 5

(260) AM 2015 75764 A  
 (210) AM 75764  
 (220) 2014 02 03  
 (731) AMGEN INC  
 One Amgen Center Drive, Thousand Oaks,  
 California 91320-1799, USA  
 (740) Shalva Gvaramadze  
 (540)

**REPATHA**

(511) 5

(260) AM 2015 75766 A  
 (210) AM 75766  
 (220) 2014 02 03  
 (731) THE GILLETTE COMPANY  
 One Gillette Park, Boston Massachusetts  
 02127, USA  
 (740) Shalva Gvaramadze  
 (540)

**DURACOMFORT**

(511) 8

(260) AM 2015 75860 A  
 (210) AM 75860  
 (220) 2014 02 11  
 (731) LTD "SAAMO"  
 Dzveli Tbilisis R-ni, Leselidzis q. 5/7, 0105  
 Tbilisi, Georgia  
 (540)

**კახური ხაოცრება**

(526) The trademark is protected as a whole. The word „კახური“ included therein shall not be subject to independent legal protection.  
 (511) 33

(260) AM 2015 75891 A  
 (210) AM 75891  
 (220) 2014 02 13  
 (731) LTD "MITANA"  
 G. Chkondideli Str. 26,0180 Tbilisi,  
 Georgia  
 (740) Giorgi Taktakishvili  
 (540)



(591) Brown  
 (531) 29.01.07, 28.19  
 (511) 30, 35

(260) AM 2015 75932 A  
 (210) AM 75932  
 (220) 2014 02 17  
 (731) Eleonora Archaia

Mtskhethis q. korp. 8, b.73, 0179, Tbilisi  
 Georgia  
 (740) Eleonora Archaia  
 (540)



(591) White, red  
 (531) 28.19, 29.01.01, 26.01.18  
 (511) 43

(260) AM 2015 75990 A  
 (210) AM 75990  
 (220) 2014 02 19  
 (731) LTD "CHATEAU ZEGAANI"  
 1514 Gurjaanis r-ni, sop. Zegaani, Georgia  
 (740) Zurab Tatulashvili  
 (540)

**Grand Vine Zegaani**

(526) The trademark is protected as a whole. The word "Zegaani" included therein shall not be subject to independent legal protection  
 (511) 33

(260) AM 2015 76177 A  
 (210) AM 76177  
 (220) 2014 03 06  
 (731) LTD "SEACRET SPA"  
 Arlozerov 128, Tel Aviv, 62097, Israel  
 (740) Liliana Darakhvelidze  
 (540)

**SEACRET MINERALS FROM THE DEAD SEA**

(526) The trademark is protected as a whole. The phrase "MINERALS FROM THE DEAD SEA" included therein shall not be subject to independent legal protection.  
 (511) 3

(260) AM 2015 76191 A  
 (210) AM 76191  
 (220) 2014 03 10  
 (731) AKTSIONERNO DROUJESTVO  
 BULGARTABAC HOLDING  
 1000 Sofia, 62 Graf Ignatiev Str., Bulgaria  
 (740) Liliana Darakhvelidze  
 (540)



(591) Black, white

(531) 26.04.12, 26.04.22, 26.04.03, 26.04.24,  
26.11.08, 27.05.21, 27.05.24  
(511) 16, 32, 34, 35

(260) AM 2015 76216 A  
(210) AM 76216  
(220) 2014 03 11  
(731) LTD "GEORGIAN WINE HOUSE"  
Sop. Zegaani, Gurjaani, Georgia  
(740) Zaza Kikabidze  
(540)

**რაცხული მარანი**  
**RACHULI MARANI**  
**РАЧУЛИ МАРАНИ**

(511) 33

(260) AM 2015 76522 A  
(210) AM 76522  
(220) 2014 04 01  
(731) LTD "GEORGIAN WINE HOUSE"  
Sop. Zegaani, Gurjaani, Georgia  
(740) Zaza Kikabidze  
(540)

**ქართული სუპრა**  
**KARTULI SUPRA**  
**КАРТУЛИ СУПРА**

(511) 33

(260) AM 2015 76529 A  
(210) AM 76529  
(220) 2014 04 01  
(731) LTD "GEORGIAN WINE HOUSE"  
Sop. Zegaani, Gurjaani, Georgia  
(740) Zaza Kikabidze  
(540)

**მწირი**  
**MTSIRI**  
**МЦЫРИ**

(511) 33

(260) AM 2015 76569 A  
(210) AM 76569  
(220) 2014 04 04  
(731) JSC "FOODMART"  
Kindzmaraulis q. 5, 0145 Tbilisi, Georgia  
(540)



(591) Yellow, black

(531) 29.01.13, 02.09.15, 11.01.01, 28.19, 29.01.02  
(511) 35

(260) AM 2015 76601 A  
(210) AM 76601  
(220) 2014 04 07  
(731) VISA INTERNATIONAL SERVICE  
ASSOCIATION  
900 Metro Center Boulevard, Foster City,  
California 94404, USA  
(740) Giorgi Meipariani  
(540)

**VISA DIRECT**

(511) 36

(260) AM 2015 76700 A  
(210) AM 76700  
(220) 2014 04 14  
(731) LTD "MITANA"  
G. Chkondideli Str. 26, 0180, Tbilisi,  
Georgia  
(540)



(591) Red, brownish-green  
(531) 03.04.13, 03.07.16, 25.01.18, 03.04.11,  
26.01.18, 28.19, 29.01.15  
(526) The trademark is protected as a whole, the  
words „მეხვი, მთიული, პრემიუმი“ included  
therein, and all the words defining kind of product,  
its quality, amount, specification, value, appro-  
priation and other characteristics, as well, shall not  
be subject of independent legal protection.  
(511) 29, 35

(260) AM 2015 76720 A  
(210) AM 76720  
(220) 2014 04 16  
(731) LTD "GEORGIAN WINE CORPORATION"  
Simon Chikovanis q. 35, 0171 Tbilisi,  
Georgia  
(540)



(591) Golden, faded wine, black, white  
 (531) 02.01.20, 06.01.02, 06.19.07, 25.01.19,  
 27.05.01, 27.05.21, 29.01.14  
 (526) The trademark is protected as a whole. The  
 word "QARTULI" included therein shall not be sub-  
 ject to independent legal protection.  
 (511) 33

(260) AM 2015 76814 A  
 (210) AM 76814  
 (220) 2014 04 25  
 (731) LTD "PSP"  
 Aghmasheneblis gamz. 148, Tbilisi, Georgia  
 (740) Nugzar Ksovreli  
 (540)



(591) Black, white  
 (531) 26.04.22, 27.05.02, 27.05.23, 18.01.19  
 (511) 35

(260) AM 2015 76818 A  
 (210) AM 76818  
 (220) 2014 04 25  
 (731) MATTEL, INC  
 333 Continental Boulevard, El Segundo,  
 California 90245-5012, USA  
 (740) Giorgi Meipariani  
 (540)

**MATTEL**

(511) 28

(260) AM 2015 76822 A  
 (210) AM 76822  
 (220) 2014 04 25  
 (731) CJSC "PHARMFIRM "COTEKC"  
 141345, Moskovis olqi, Sergievo-Posadski  
 municepalni r-n, selskoe poselenie  
 Bereznyakovskoe, pos. Belikovo, d. 11,  
 Russian Federation  
 (740) Khatuna Imnadze  
 (540)

**Диклотекс**

(511) 5

(260) AM 2015 76845 A  
 (210) AM 76845  
 (220) 2014 04 28  
 (731) LTD "IDS BORJOMI BEVERAGES  
 COMPANY"  
 Toris q. 39, Borjomi, Georgia

(540)



(591) Green, light green boue  
 (531) 19.07.12, 19.07.16, 19.07.23, 29.01.03  
 (511) 32, 35

(260) AM 2015 77021 A  
 (210) AM 77021  
 (220) 2014 05 06  
 (731) INTERSUN HOLDING FZCO  
 Po/Box 61051, Jebel Ali Fri Zoun,  
 United Arab Emirates  
 (740) Vakhtang Torotadze  
 (540)



(591) Green, white  
 (531) 26.01.22, 28.19, 29.01.12  
 (511) 16, 29, 30, 35

(260) AM 2015 77244 A  
 (210) AM 77244  
 (220) 2014 05 22  
 (731) LEPL "NATIONAL FOOD AGENCY"  
 M. Gelovanis q. 6, Tbilisi, Georgia  
 (540)



(591) Green, yellow, blue  
 (531) 26.03.07, 26.03.18, 26.11.12, 26.03.23,  
 28.19, 26.11.07, 29.01.14  
 (511) 44

(260) AM 2015 77255 A  
 (210) AM 77255  
 (220) 2014 05 22  
 (731) Mikheil Kvatashidze  
 Dimitri Tavdadebulis q. 10, b. 96, 0131,  
 Tbilisi, Georgia

(740) Mikheil Kvatashidze  
(540)

**Prince Matchabelli**  
პრინცი მაჩაბელი

(511) 14

(260) AM 2015 77263 A

(210) AM 77263

(220) 2014 05 23

(731) KOPPERT B.V.

Veilingweg 14, 2651 BE Berkel en Rodenrijs,  
The Netherlands

(740) Shalva Gvaramadze

(540)

**KOPPERT**

(511) 1, 5, 20, 31, 44

(260) AM 2015 77420 A

(210) AM 77420

(220) 2014 06 04

(731) LTD "MOGO"

Gudiashvilis moedani 4, 0103 Tbilisi,  
Georgia

(740) Irakli Gvilia

(540)



(591) Green, blue, white

(531) 01.15.11, 26.11.13, 27.05.17, 27.05.12,  
29.01.13

(511) 36

(260) AM 2015 77482 A

(210) AM 77482

(220) 2014 06 10

(731) LTD "WINE COMPANY OF KVARELI"

Lermontovis q. 3, 4800, Kvareli,  
Georgia

(540)

**ბერმუხა**  
**BERMUKHA**  
**БЕРМУХА**

(511) 29, 30, 31, 32, 33, 34, 35, 43

(260) AM 2015 77523 A

(210) AM 77523

(220) 2014 06 11

(731) EMIRATES NATIONAL OIL COMPANY  
LIMITED (ENOC) LLC

P.O. Box: 6442, Dubai, United Arab Emirates,

United Arab Emirates

(740) Larisa Amirkhanyan

(540)



اينوك  
**ENOC**

(591) Black, white

(531) 27.05.01, 28.01, 01.15.05

(511) 4

(260) AM 2015 77524 A

(210) AM 77524

(220) 2014 06 12

(731) QURAMAX LIMITED

Artisans House, 7 Queensbridge Northampton  
NN4 7BF, United Kingdom

(740) Givi Akopashvili

(540)

**COMCOLD**

(511) 5

(260) AM 2015 77574 A

(210) AM 77574

(220) 2014 06 17

(731) LTD "METRA DEVELOPMENT"

Ilia Chavchavadzis gamz. 80, 0162 Tbilisi,  
Georgia

(740) Mariam Zaldastanishvili

(540)



(591) Dark red, black, white

(531) 27.05.15, 26.03.23, 29.01.12, 28.19

(511) 36, 37

(260) AM 2015 77582 A

(210) AM 77582

(220) 2014 06 17

(731) LTD "PUSHKINI"

Bochormis q. 3, Tbilisi, Georgia

(740) Ana Jikia

(540)



(591) Black, white

(531) 25.01.10, 26.01.02, 26.01.20, 28.05

(511) 43

(260) AM 2015 77620 A  
 (210) AM 77620  
 (220) 2014 06 19  
 (731) Karen Vardanyan  
 Bairon Str. 3, Ap. 36, Yerevan, Armenia  
 (740) Davit Zurabishvili  
 (540)



(591) White, violet, red, bordeaux, blue  
 (531) 08.01.11, 08.01.18, 28.05, 29.01.15  
 (511) 30

(260) AM 2015 77621 A  
 (210) AM 77621  
 (220) 2014 06 19  
 (731) Karen Vardanyan  
 Bairon Str. 3, Ap. 36, Yerevan, Armenia  
 (740) Davit Zurabishvili  
 (540)



(591) White, yellow, violet, red, bordeaux, green  
 (531) 08.01.18, 26.01.06, 26.11.12, 27.05.02,  
 29.01.15  
 (511) 30

(260) AM 2015 77623 A  
 (210) AM 77623  
 (220) 2014 06 19  
 (731) Karen Vardanyan  
 Bairon Str. 3, Ap. 36, Yerevan, Armenia  
 (740) Davit Zurabishvili  
 (540)



(591) White, brown, yellow, violet, red, bordeaux  
 (531) 08.01.23, 19.03.05, 27.05.02, 29.01.15,  
 04.05.02  
 (511) 30

(260) AM 2015 77654 A  
 (210) AM 77654  
 (220) 2014 06 23  
 (731) N(n)LE Agriculture Project Management  
 Agency  
 Marshal Gelovanis gamz. 6, 0159 Tbilisi,  
 Georgia  
 (740) Shalva Jokharidze  
 (540)



(591) Green, white and grey  
 (531) 26.04.03, 26.04.12, 26.11.09, 29.01.12  
 (511) 35, 36, 44

(260) AM 2015 77720 A  
 (210) AM 77720  
 (220) 2014 06 26  
 (731) SOCIETE NATIONALE D'EXPLOITATION  
 INDUSTRIAL DE TOBA E ALAMUT  
 SASU  
 143 boulevard Romen Rolan, France  
 (740) Giorgi Gvinjilia  
 (540)



(591) Black, grey, dark grey, light grey  
 (531) 23.05.05, 25.01.01, 25.07.15, 27.05.10  
 (511) 34

(260) AM 2015 77782 A  
 (210) AM 77782  
 (220) 2014 07 02  
 (731) LTD "CHIATURMANGANUM GEORGIA"  
 Sop. Nakhshirghele, Georgia  
 (540)



(591) White, blue  
 (531) 26.04.22, 01.15.11, 27.05.08, 29.01.04  
 (526) The trademark is protected as a whole. The  
 words "CHIATURMANGANUM", "GEORGIA"  
 and "Georgian" included therein shall not be subject  
 to independent legal protection.



(511) 6, 35

(260) AM 2015 77814 A  
 (210) AM 77814  
 (220) 2014 07 04  
 (731) LTD "MARNISKARI"  
 Sh. Askuravas q. 17, 0119, Tbilisi, Georgia  
 (740) Davit Lortkipanidze  
 (540)

**მონისტო**  
**MONISTO**  
**МОНИСТО**

(511) 33

(260) AM 2015 77815 A  
 (210) AM 77815  
 (220) 2014 07 04  
 (731) LTD "MARNISKARI"  
 Sh. Askuravas q. 17, 0119, Tbilisi, Georgia  
 (740) Davit Lortkipanidze  
 (540)

**ოქროს ველი**  
**OKROS VELI**  
**ОКРОС ВЕЛИ**

(511) 33

(260) AM 2015 77849 A  
 (210) AM 77849  
 (220) 2014 07 07  
 (731) DAEWOONG PHARMACEUTICAL CO.,  
 LTD  
 244, Galmachi-ro, Jungwon-gu, Seongnam-si,  
 Gyeonggi-do, Republic of Korea  
 (740) Tamaz Shilakadze  
 (540)

**GEMRON GOLD-1**

(511) 5

(260) AM 2015 77872 A  
 (210) AM 77872  
 (220) 2014 07 08  
 (731) LTD "EKOMETRI"  
 Besikis q. 4 (mimdebare), Tbilisi, Georgia  
 (740) Ana Gelovani  
 (540)

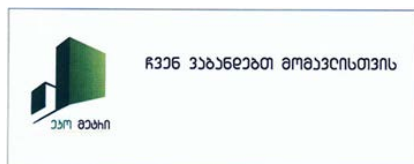

(511) Green, yellow, black

(531) 07.01.08, 26.04.09, 26.15.11, 28.19, 29.01.13  
 (511) 37

(260) AM 2015 77873 A  
 (210) AM 77873  
 (220) 2014 07 08  
 (731) LTD "PARAPHARM"  
 Ul. Sverdlova, d. 4, 440026, g. Penza,  
 Russian Federation  
 (740) Davit Zurabishvili  
 (540)



(591) Black, white, green, light lettuce green, red  
 (531) 28.05, 29.01.15, 26.02.08, 26.04.10  
 (526) The trademark is protected as a whole. The words "ВАЛЕРИАНА+ХМЕЛЬ+МЯТА" included therein shall not be subject to independent legal protection.  
 (511) 5

(260) AM 2015 77874 A  
 (210) AM 77874  
 (220) 2014 07 08  
 (731) LTD "IVERIA"  
 S. Chikovanis q. 31, 0171, Tbilisi, Georgia  
 (740) Nugzar Ksovreli  
 (540)

**გროსმაისტერი**  
**Гроссмейстер**  
**Grossmeister**

(511) 29

(260) AM 2015 77890 A  
 (210) AM 77890  
 (220) 2014 07 10  
 (731) LTD "AGRO TRADING GEORGIA"  
 Rustavis gzatk. 68a, 0165, Tbilisi, Georgia  
 (740) Giorgi Kartvelishvili  
 (540)



(591) White, pink, cornelian red, blue, grey



(531) 03.04.18, 25.01.05, 27.05.03  
 (526) The trademark is protected as a whole. The word "Pig" included therein shall not be subject to independent legal protection.  
 (511) 31

(260) AM 2015 77891 A  
 (210) AM 77891  
 (220) 2014 07 10  
 (731) LTD "AGRO TRADING GEORGIA"  
 Rustavis gzatk. 68a, 0165 Tbilisi, Georgia  
 (740) Giorgi Kartvelishvili  
 (540)



**Layer Max**

(591) White, red  
 (531) 08.07.11, 27.05.01, 29.01.01, 03.07.03  
 (526) The trademark is protected as a whole. The word "Layer" included therein shall not be subject to independent legal protection.  
 (511) 31

(260) AM 2015 77892 A  
 (210) AM 77892  
 (220) 2014 07 10  
 (731) LTD "AGRO TRADING GEORGIA"  
 Rustavis gzatk.i 68a, 0165 Tbilisi, Georgia  
 (740) Giorgi Kartvelishvili  
 (540)



(591) Yellow, green  
 (531) 03.07.03, 26.04.15, 27.05.10, 29.01.12  
 (526) The trademark is protected as a whole. The word "BROILER" included therein shall not be subject to independent legal protection.  
 (511) 31

(260) AM 2015 77907 A  
 (210) AM 77907  
 (220) 2014 07 11  
 (731) ROCKTAPE, INC., A CALIFORNIA CORPORATION  
 1610 Dell Avenue, Suite S, Campbell, California 95008, USA

(740) Tamaz Shilakadze  
 (540)

**ROCKTAPE**

(511) 5

(260) AM 2015 77988 A  
 (210) AM 77988  
 (220) 2014 07 16  
 (731) QUALCOMM INCORPORATED  
 5775 Morehouse Drive, San Diego, CA 92121-1714, USA  
 (740) Tamaz Shilakadze  
 (540)



Qualcomm  
**snapdragon**

(591) Black, white  
 (531) 01.15.05, 26.01.16, 27.05.05  
 (511) 9

(260) AM 2015 77998 A  
 (210) AM 77998  
 (220) 2014 07 18  
 (731) LTD "GU FRUIT"  
 Sop. Parizi, 1105, Bolnisi, Georgia  
 (540)



**GU FRUIT**  
apple company

(591) Red, green, white  
 (531) 06.01.01, 01.03.15, 05.07.13, 27.05.10, 29.01.13  
 (526) The trademark is protected as a whole. The words "FRUIT" and "company" included therein shall not be subject to independent legal protection.  
 (511) 29, 32, 44

(260) AM 2015 78005 A  
 (210) AM 78005  
 (220) 2014 07 18  
 (731) Gela Mikadze  
 Lalionis shes. 5, 0101, Tbilisi, Georgia  
 (740) Gela Mikadze  
 (540)

**KHACHAPURI INN**

(526) The trademark is protected as a whole. The word "KHACHAPURI" included therein shall not be subject to independent legal protection.

(511) 30, 35, 43

(260) AM 2015 78009 A  
 (210) AM 78009  
 (220) 2014 07 18  
 (731) LTD "SANIMA GROUP"  
 Ip. Khvichias q. 16, b. 9, 0160,  
 Tbilisi, Georgia  
 (540)



(591) White, golden  
 (531) 24.09.01, 29.01.02  
 (511) 25, 35

(260) AM 2015 78017 A  
 (210) AM 78017  
 (220) 2014 07 21  
 (731) "NOBEL ILAC SANAYII VE TICARET  
 ANONIM SIKRETI" representation in  
 Georgia  
 Tavisuplebis moedani 4, Tbilisi, Georgia  
 (740) Tinatin Tskhvediani  
 (540)

**TİYOZİD**  
**თიოზიდი**

(511) 5, 35

(260) AM 2015 78027 A  
 (210) AM 78027  
 (220) 2014 07 21  
 (310) 2014/06255  
 (320) 2014 01 24  
 (330) TR  
 (731) SOCIETE NATIONALE D'EXPLOITATION  
 INDUSTRIAL DE TOBA E ALAMUT  
 SASU  
 143 boulevard Romen Rolan, France  
 (740) Giorgi Gvinjilia  
 (540)



(591) Light grey, white, grey, turquoise, light and  
 dark turquoise  
 (531) 25.01.01, 26.11.12, 27.05.10, 29.01.13,  
 23.05.05  
 (511) 34

(260) AM 2015 78052 A  
 (210) AM 78052  
 (220) 2014 07 23  
 (731) NGK SPARK PLUG CO., LTD  
 14-18, Takatsuji-cho, Mizuho-ku, Nagoya  
 City, 467-8525, Japan  
 (740) Giorgi Meipariani  
 (540)

**NTK**

(591) Black, white  
 (531) 27.05.23, 27.05.17  
 (511) 7

(260) AM 2015 78174 A  
 (210) AM 78174  
 (220) 2014 07 31  
 (731) HANKOOK TIRE CO., LTD  
 133, Teheran-ro (Yeoksam-dong), Gangnam-  
 gu, Seoul, 135-723, Republic of Korea  
 (740) Larisa Amirkhanyan  
 (540)

**SEALGUARD**

(591) Black, white  
 (531) 27.03.15, 14.03.01  
 (511) 12

(260) AM 2015 78247 A  
 (210) AM 78247  
 (220) 2014 08 08  
 (731) P.P.U.H. WOSEBA SPOLKA Z OGRANIC-  
 ZONA ODPOWIEDZIALNOSCIA  
 Ul. Kroszynska 150, 63 – 430 Odolanow,  
 Poland  
 (740) Pavle Meipariani  
 (540)



(591) Golden, dark brown, dark red  
 (531) 25.01.01, 27.03.11, 29.01.12, 05.07.01,  
 11.03.04

(526) The trademark is protected as a whole. The  
 words "COFFEE BEANS", "GOLD", "GUARAN-  
 TEED QUALITY" included therein shall not be sub-  
 ject to independent legal protection.  
 (511) 30, 43

(260) AM 2015 78248 A  
 (210) AM 78248  
 (220) 2014 08 08  
 (731) P.P.U.H. WOSEBA SPOLKA Z OGRANIC-  
 ZONA ODPOWIEDZIALNOSCIA  
 Ul. Kroszynska 150, 63 – 430 Odolanow,  
 Poland

(740) Pavle Meipariani  
 (540)



(591) Golden, dark brown, brown, green, white, red  
 (531) 11.03.04, 25.01.01, 27.03.11, 29.01.15,  
 05.07.01  
 (526) The trademark is protected as a whole. The  
 words "COFFEE BEANS", "ESPRESSO", "GUA-  
 RANTEED QUALITY" included therein shall not  
 be subject to independent legal protection.  
 (511) 30, 43

(260) AM 2015 78249 A  
 (210) AM 78249  
 (220) 2014 08 08  
 (731) P.P.U.H. WOSEBA SPOLKA Z OGRANIC-  
 ZONA ODPOWIEDZIALNOSCIA  
 Ul. Kroszynska 150, 63 – 430 Odolanow,  
 Poland

(740) Pavle Meipariani  
 (540)



(591) Golden, brown, dark blue, yellow, blue, red  
 (531) 11.03.04, 25.01.01, 27.03.11, 29.01.15,  
 05.07.01

(526) The trademark is protected as a whole. The  
 words "COFFEE BEANS", "ARABICA", "GUA-  
 RANTEED QUALITY" included therein shall not  
 be subject to independent legal protection.  
 (511) 30, 43

(260) AM 2015 78250 A  
 (210) AM 78250  
 (220) 2014 08 08  
 (731) P.P.U.H. WOSEBA SPOLKA Z OGRANIC-  
 ZONA ODPOWIEDZIALNOSCIA  
 Ul. Kroszynska 150, 63 – 430 Odolanow,  
 Poland

(740) Pavle Meipariani  
 (540)



(591) Golden, brown  
 (531) 25.01.01, 05.07.01, 27.03.11, 29.01.12  
 (526) The trademark is protected as a whole. The  
 word "WOSEBA" included therein shall not be sub-  
 ject to independent legal protection  
 (511) 30, 43

## TRADEMARKS REGISTERED ACCORDING TO THE ACCELERATED PROCEDURE

The decision can be appealed at the Chamber of Appeal of Sakpatenti within 3 months from the publication.

(111) M 2015 25701 R  
(151) 2015 02 24  
(181) 2025 02 24  
(210) AM 78237  
(220) 2014 08 07

(732) LABORATORIOS LIOMONT ES EI DE SI  
Mateos 68, kuahimalpas tsentri, Mexico  
Adolfo López Mateos 68, Cuajimalpa,  
Cuajimalpa de Morelos, 05000 Ciudad de  
México, D.F., Mexico  
(740) Tamar Kharazishvili  
(540)

Facidex

ფაზიდექსი

Фасидекс

(591) Black, white  
(531) 27.05.05-28.05.00-28.19.00-  
(511) 5

(111) M 2015 25702 R  
(151) 2015 02 24  
(181) 2025 02 24  
(210) AM 79622  
(220) 2014 11 24

(732) JSC "TBC BANK"  
Marjanishvilis q. 7, 0102, Tbilisi, Georgia  
(740) Giorgi Gogshelidze  
(540)



(591) White, blue  
(531) 26.03.03-27.05.05-28.19.00-29.01.04-  
(511) 36

(111) M 2015 25703 R  
(151) 2015 02 26  
(181) 2025 02 26  
(210) AM 80656  
(220) 2015 02 09

(732) LTD "ICONIA CAPITAL"  
Vake-Saburtalos raioni, S. Tsintsadzis q. 79,  
Tbilisi, Georgia  
(740) Giorgi Gogshelidze  
(540)



(591) White, black, grey, light black  
(531) 01.03.15-07.01.24-26.04.09-27.05.05-  
(511) 36, 37

(111) M 2015 25704 R  
(151) 2015 02 27  
(181) 2025 02 27  
(210) AM 80743  
(220) 2015 02 12

(732) BERGLAHD INVEST S.A.  
P.O.Box 3321, Drake Chambers, Road Town,  
Tortola, British Virgin Islands

(740) Davit Zurabishvili  
(540)

**СОЛНЕЧНОЕ ДИВНОЕ**

(591) Black, white  
(511) 29

(111) M 2015 25705 R  
(151) 2015 02 27  
(181) 2025 02 27  
(210) AM 80905  
(220) 2015 02 19

(732) LTD "MIXORI"  
Khandztelis q. 1, 0117, Tbilisi, Georgia  
(540)

მიქსორი

MIXORI

(591) Black, white  
(511) 19, 37

## INTERNATIONAL TRADEMARKS FOR WHICH A DECISION ON GRANTING PROTECTIONS IS TAKEN

The decision can be appealed at the Chamber of Appeal of Sakpatenti within 3 months from the publication or at the Mtskheta District Court Administrative Cases Board (Address: №17, Samkhedro str., Mtskheta), within 1 month following the publication.

(260) AM 2015 68653 A\*\*

(800) 925317

(731) COMPAGNIE GENERALE DES  
ETABLISSEMENTS MICHELIN  
Société en Commandite par Actions  
12, cours Sablon, F-63040 CLERMONT-  
FERRAND Cedex 09, France

(540)

### TYREPLUS

(591) Black, white

(511)

12 – Pneumatic tyres and inner tubes for vehicle wheels; treads for retreading tyres; tracks for track vehicles.

16 – Printed matter and publications; technical manuals and guides; printed educational and teaching materials; technical drawings and diagrams; photographs; stationery; calendars; dairies; paperweights; clipboards; packaging materials of cardboard or plastics, namely bags, pouches, films and sheets.

35 – Pneumatic tyre, tyre inner tube retailing and/or wholesaling services; business information services and business advisory services, business management services, all relating to the tyre trade; advertising; sales promotion support services relating to the tyre trade, namely sales promotion services.

37 – Pneumatic tyre and tyre inner tube repair services; tyre and tyre inner tube replacing, fitting, installation and inflation services; tyre retreading and tyre regrooving services; wheel balancing services; services for installation of machines for use in the tyre trade; vehicle repair and maintenance services.

41 – Technical training services relating to the tyre trade; training services in the field of repair and replacement of tyres; training services in the use of machines for mounting, repairing and inflating tyres.

42 – Technical advice services relating to the use, the inspection, the monitoring and the analysis of tyres; services for the design of business premises for the tyre trade; testing and quality control services for tyres and inner tubes.

(260) AM 2015 74428 A\*

(800) 1131351

(731) INDUSTRIA CHIMICA ADRIATICA– S.P.A.

Via Sandro Pertini 52, I-62012

CIVITANOVA MARCHE (MC), Italy

(540)



(591) Red and light blue

(511)

1 – Chemicals used in industry, science and photography, as well as in agriculture, horticulture and forestry; unprocessed artificial resins, unprocessed plastics; tempering and soldering preparations; adhesives used in industry.

2 – Paints, varnishes, lacquers; preservatives against rust and against deterioration of wood; colorants; mordants; raw natural resins; metals in foil and powder form for painters, decorators, printers and artists; colorants; thinners for paints; thinners for lacquers; fixatives (varnishes); binding preparations for paints; anti-rust oils; oils for the preservation of wood; enamels for painting; anti-corrosive preparations; anti-rust preparations for preservation.

(260) AM 2015 74677 A\*

(800) 1180255

(731) ECOLAB USA INC.

370 Wabasha Street North Saint Paul,  
Minnesota 55102, USA

(540)

### ECOLAB

(591) Black, white

(511)

1 – Chemicals used in industry, science and photography, as well as in agriculture, horticulture and forestry; unprocessed artificial resins, unprocessed plastics; manures; fire extinguishing compositions; tempering and soldering preparations; chemical substances for preserving foodstuffs; tanning substances; adhesives used in industry; chemically-treated non-medical test strips to improve food safety and prevent waste in the food service industry; chemical preparations for testing swimming pool water; chemical composition applied to the hands for use in the detection, enumeration and identification of microorganisms; chemical composition for solidification of fluids and for absorbing spills; chemical stone sealers that penetrate the stone to provide sealing protection; chemical test paper; chemicals for treating hazardous waste; defoaming agents; textile-im-

pregnating chemicals, textile-waterproofing chemicals; stain repellents and protectants for carpets; stain repellents for textiles; fabric protectant for textiles; waste water treatment chemicals for industrial use; chemicals for industrial purposes; chemical water conditioner for commercial, industrial and institutional laundry use; water softening chemicals; water treatment and purifying chemicals for use in swimming pools and spas; water treatment chemicals for use in cooling towers and boilers; wetting agents; anti-static preparation for electronic equipment; granular absorbent organic mineral-based compositions used to absorb liquid spills.

2 – Paints, varnishes, lacquers; preservatives against rust and against deterioration of wood; colorants; mordants; raw natural resins; metals in foil and powder form for painters, decorators, printers and artists; weatherproofing coatings and paint sealers; concrete sealers in the form of a coating; floor coatings; rust preventatives in the nature of a coating; stone sealer coatings.

3 – Bleaching preparations and other substances for laundry use; cleaning, polishing, scouring and abrasive preparations; soaps; perfumery, essential oils, cosmetics, hair lotions; dentifrices; adhesive remover; all-purpose cleaners; antibacterial soaps; anti-static preparation and fabric softener for laundry use; automatic dishwashing detergents; automobile carpet and upholstery cleaning preparations; automobile glass cleaner; automobile polish; automobile tire cleaning and polishing preparations; automobile wax; bathroom cleaning preparations; buffing compound for automotive use; carpet cleaner and shampoo; chemical cleaners directed to the food and beverage industry; chemical cleaners directed to the medical industry; chemical cleaners directed to the pharmaceutical industry; chrome polish; cleaning preparations; cleaning kits for restrooms comprised primarily of liquid cleaning preparations, a restroom brush, debris tool, odor neutralizer, glass and multi-surface cleaner, sanitizer, and use instructions; concentrated laundry sour; crème cleansers, namely, mild abrasive cream cleaning preparations for commercial and institutional use; de-liming agents, namely, chemical decalcifying and descaling preparations for commercial use; detergent for pots, pans, and other kitchen utensils; degreasing preparations not used in manufacturing processes for industrial and institutional use; detergents for automobiles; detergents for machine dishwashing; dish detergent; dishwashing detergents; disinfectant soaps; disposable wipes impregnated with cleaning chemicals or compounds for industrial and commercial use; disposable wipes impregnated with cleansing compounds for use on hard surfaces; drain cleaners; drain cleaning preparations; fabric wrinkle control compositions for laundry use; fabric softener; floor stripping/cleaning preparation; floor wash; floor waxes;

fruit and vegetable wash; furniture polish; germicidal detergents; glass cleaners; grease and lipstick remover for bar glassware; grill cleaners; grout cleaners; gum removing preparations; hand cleaning preparations; hand lotions and hand creams, hand soaps; hand scrubs; laundry bleach; laundry brightening preparations; laundry detergent booster; laundry detergent; laundry fabric conditioners; laundry starch; leather cleaning preparations; leather polishes; liquid solution visible when illuminated by a black-light and used to determine whether a surface has been cleaned; oven cleaners; laundry bleach, namely oxidizers; pipeline cleaners; pot and pan detergent for industrial and institutional uses; presoaks, detergents and rinse agents for use in manual and automatic car wash facilities; rinse additives for use in dishwashing machines; cleaning preparations for rubber goods and tires; rust removing preparations; shampoos; scouring liquids and powders; soaps for body care; spot removers; stain removing preparations; stainless steel cleaner; stainless steel polish; stone polishes; tile cleaners; tile polish; toilet bowl detergents; upholstery cleaners; spot removers for carpets; stain removing preparations for carpets; fragrances.

4 – Industrial oils and greases; lubricants; dust absorbing, wetting and binding compositions; fuels (including motor spirit) and illuminants; candles and wicks for lighting; conveyor lubricants; lubricants for food processing equipment; industrial lubricants; lubricant for surgical instruments; lubricants for rails, shackles and trolleys.

5 – Pharmaceutical and veterinary preparations; sanitary preparations for medical purposes; dietetic food and substances adapted for medical or veterinary use, food for babies; dietary supplements for humans and animals; plasters, materials for dressings; material for stopping teeth, dental wax; disinfectants; preparations for destroying vermin; fungicides, herbicides; air deodorising preparations and air deodorizers; algacides for swimming pools and spas; all purpose disinfectants; antibacterial alcohol skin sanitizer gel; antibacterial handwash; antimicrobial adjuvants, antimicrobial water additives, and antimicrobial food additives to reduce spoilage and aging of fruits and vegetables and to eliminate odors; bactericides; bandages for skin wounds; biocides; burn kits consisting primarily of burn dressings and burn-relief medications; car deodorizers; carpet and rug deodorizer and sanitizer; chemical preparations for deodorizing, disinfecting, and sanitizing preparations for swimming pool and spa use; chemical preparations for textiles for inhibiting the growth of bacteria; disinfectant bathroom cleaners; disinfectants for sanitary purposes; drain sanitizer; eye washes; first aid kits; gauze; fungicides, germicidal udder wash for dairy cows; germicides; hand-sanitizing preparations; insecticides; irrigating solu-

tions for eye use; laundry sanitizer; liquid sanitizer for use in commercial and institutional dish washing machines; mildewstats; odor neutralizing preparations for general use on various surfaces; odor neutralizing preparations for use in waste and waste water storage facilities, waste water treatment facilities, and food processing facilities; outdoor air deodorizers; refills for air deodorizers; preparations for destroying parasites; sanitizing hoof bath bactericidal treatment for livestock; sanitizing preparation, namely, a teat dip, used for livestock; sanitizing preparations for commercial, healthcare, hospital, industrial, and institutional use; sanitizing wipes; skin care products, namely, antibacterial skin cleanser and waterless antimicrobial hand rinse, for use in health care facilities; disinfecting preparations for use in medical environments; medicated balms for treatment of udders of dairy cows; toilet deodorizing blocks; virucides; disinfectant bathroom cleaner; mold inhibitors for preventing growth of mold.

6 – Common metals and their alloys; metal building materials; transportable buildings of metal; materials of metal for railway tracks; non-electric cables and wires of common metal; ironmongery, small items of metal hardware; pipes and tubes of metal; safes; goods of common metal not included in other classes; ores; metal hooks; metal hose reel; metal ladders; metal pre-rinse and washdown spray nozzles for commercial and industrial use; towel dispensers of metal; metal mop handles.

7 – Machines and machine tools; motors and engines (except for land vehicles); machine coupling and transmission components (except for land vehicles); agricultural implements other than hand-operated; incubators for eggs; automatic vending machines; automatic floor scrubber; dishwashing machines; electric pumps; mobile foam generating, sanitizing, and cleaning machine for floors and carpets; multi-purpose high pressure washers; pads and brushes for floor polishing machines; power operated blowers; power-operated floor polishers; power-operated sprayers for insecticide; vacuum cleaners; vacuum cleaner bags; commercial automotive car wash systems, namely, car washing machines consisting primarily of water tanks, dispensers, controller, hoses, brushes, and nozzles; washing machine having water treatment device installed in the rinse modules of the tunnel washer to clean and reduce water consumption and the volume of discharged wastewater by recirculating wastewater.

8 – Hand tools and implements (hand-operated); cutlery; side arms; razors; blades for utility knives; hand tools, namely, hand operated pumps; knife sharpeners; knife sheaths; knives, namely, paring, boning, carving, chef, kitchen, serrated, scalloped, utility and vegetable; magnetic hand-operated operated retriever tool, namely, a magnetic flatware retriever for preventing inadvertent disposal of flatware;

non-electric can opener; scissors; shears; tweezers; screwdrivers; handtools being multifunction pocket-knives; kitchen tongs.

9 – Scientific, nautical, surveying, photographic, cinematographic, optical, weighing, measuring, signaling, checking (supervision), life-saving and teaching apparatus and instruments; apparatus and instruments for conducting, switching, transforming, accumulating, regulating or controlling electricity; apparatus for recording, transmission or reproduction of sound or images; magnetic data carriers, recording discs; compact discs, DVDs and other digital recording media; mechanisms for coin-operated apparatus; cash registers, calculating machines, data processing equipment, computers; computer software; fire-extinguishing apparatus; briefcases specially adapted for holding laptop computers; calculators; cases for mobile phones; computer carrying cases; computerized equipment, namely, computer hardware, for monitoring and controlling product dispensers; computer network information system comprising computer hardware, computer software, network hardware and network software all for use in allowing users to remotely access company documents and information; computer software for collecting and reporting data in the field of hygiene management; computer software for use in controlling, monitoring, and testing water treatment systems; computer storage devices, namely, blank flash drives; digital pH meter; digital photo frames for displaying digital pictures, video clips, and music; dosage dispensers and automated dispensers for laundry detergents, cleaning preparations, dish washing detergents, rinsing agents, sanitation chemicals, vehicle care products and water treatment chemicals; dosage dispensers and automated dispensers for automatic dish washing detergents, rinse additives, hand soaps, hand lotions, and shampoos; doorway sanitation system to prevent the flow of contaminants from entering and spreading within a facility, comprised primarily of infrared motion sensors, automated dispensing equipment, and sanitizing preparations; downloadable asset management software that tracks commercial kitchen equipment inventory and service history; downloadable electronic newsletters in the field of food safety; downloadable electronic newsletters in the field of pest control and elimination; downloadable podcasts in the field of food safety; downloadable software for monitoring and reporting cleaning and sanitation systems; downloadable software for monitoring the performance of and collecting data from clean-in-place sanitation systems, downloadable software for recording and analyzing compliance with pest control programs and tracking pest inspection and elimination services; downloadable software for tracking and generating reports regarding the maintenance and service history, equipment maintenance expenditures, condition and performance of commercial kitchen equip-



ment; egg timers; electrical integrated control and dispensing systems for use in the field of automated cleaning and sanitizing equipment; electronic controllers for dish washing detergents and rinse additives, pool and spa chemical additives, laundry chemical additives, automotive cleaning chemicals; electronic indicator, namely, a device with a fluorescent light source under which hands and fingers are placed for measuring the effectiveness of antimicrobial handwash; electronic insect traps; electronic timers; face protection shields other than for medical purposes; hydrometers; laboratory equipment and supplies, namely, test tubes, beakers, laboratory glassware, burettes, flasks, pipettes, stoppers for laboratory bottles and syringes; laundry dryer monitoring equipment in the nature of computer hardware and software for monitoring laundry dryer cycle data and reporting the information; dosage dispensers; pre-recorded CDs, DVDs, and video tapes featuring commercial cleaning, disinfecting, personal hygiene and food safety; protective and respiratory face masks not for medical purposes; protective work gloves; safety goggles; software for creating customized food labels; sterile personal radiation protection shields; temperature sensors; thermal printers; thermometer; thermocouple; pre-recorded CDs, video tapes, and DVDs featuring commercial car wash training modules and marketing information; backlit signs; highway safety cones, pre-recorded CDs, video tapes, and DVDs featuring information regarding pest control and elimination; pre-recorded CDs, video tapes, and DVDs featuring training and instructions for use of cleaning and sanitation products; weighing scales; smoke evacuation systems to capture and filter surgical smoke to remove odor.

10 – Surgical, medical, dental and veterinary apparatus and instruments, artificial limbs, eyes and teeth; orthopedic articles; suture materials; disposable medical utility drapes for covering medical equipment to prevent contamination; disposable patient sheets for medical use in hospitals; disposable plastic medical devices, namely, bags for medical waste, mouth guards, supports for arms, orthopedic cushions, ice bags, and internal administrative apparatus, namely, bags and pumps for fluids control in patients; electric blankets for medical purposes; medical devices, namely, inflatable surgical boots and sleeves; medical goods, namely, absorbent pads used as surgical sponges for fluid absorption during medical procedures, absorbent surgical instrument table pads used for fluid absorption during medical procedures, absorbent pads used for fluid absorption during preparation of patient for medical procedures; medical products, namely, containers especially made for medical waste, namely containment devices to be attached to suction canisters for treating and solidifying medical waste for point of generation encapsulation and antimicrobial treatment of medical waste; disposable headrest covers for medical and dental

examination chairs; surgical arm rest covers; surgical shoe covers; human face protectors, namely, transparent face shields for use in the medical and dental fields; orthopedic cushions, radiology drapes, surgical drapes, surgical gowns and gloves, containers for medical waste; medical products, namely, infection control kits for surgical use comprised of disposable packs containing disposable mop heads, disposable non-sterile linens, and drapes for the surgical table; bags for containing biohazardous medical waste; medical goods, namely, non-woven wraps to sterilize medical instruments and supplies, medical goods, namely, pneumatic compression controller for cyclically inflatable surgical devices; medical radiation shields sold as an integral component of surgical patient drapes; resuscitation apparatus; surgical instruments for use in orthopedic surgery, namely, trays, orthopedic brushes, orthopedic suction wands, implantable cement restrictors, cement sculpts, sponges and rods for cement restrictors; surgical kits consisting primarily of laryngopharyngeal tube, tube clamp, securing strap and tongue depressor; surgical lamp handles and disposable sterile covers for surgical lamp handles; surgical microscope drapes and adapter rings for attachment to the drapes; vacuum splints for medical purposes; wound suction apparatus.

11 – Apparatus for lighting, heating, steam generating, cooking, refrigerating, drying, ventilating, water supply and sanitary purposes; dispensing units for air fresheners and room deodorants; swimming pool and spa chlorinating units; water treatment equipment, namely, dispensing units for delivering water treatment chemicals to treat scale and corrosion in boilers and cooling tower steam and water systems; apparatus for purifying tap water and oxygen generators for processing water by increasing oxygen content in the water; flashlights; portable electric fans; air filtering installations for use in operating clean rooms; chemically activated light sticks; incandescent light sticks; LED luminaires; light bulbs; water filtration and purification units; ultraviolet lamps not for medical purposes; bioreactors for use in the treatment of wastewater; water filtering units for commercial, institutional or industrial use; water filtering apparatus; water purification tanks; water filters; sterilization units for medical purposes; air filters and purifiers for medical purposes.

12 – Vehicles; apparatus for locomotion by land, air or water; carts; dollies; fitted vinyl covers for carts designed to carry dishwashers and laundry.

14 – Lanyards (keycords).

16 – Paper, cardboard and goods made from these materials, not included in other classes; printed matter; bookbinding material; photographs; stationery; adhesives for stationery or household purposes; artists' materials; paint brushes; typewriters and of-



rice requisites (except furniture); instructional and teaching material (except apparatus); plastic materials for packaging (not included in other classes); printers' type; printing blocks; label printers being addressing machines; adhesive and non-adhesive labels for use in the food service industry; adhesive labels; blank or partially printed paper labels; educational publications, namely, training manuals and printed graphs in the field of proper hygiene and sanitation in a food safe environment, sanitation practices, cleaning product use and application and operation of laundry equipment and food safety; freezer bags; hand-held labeling devices; ink pens; pencils; instructional and educational printed cardboard and paper signs for displaying data featuring information regarding proper surgical scrub techniques, hand hygiene, medical instrument reprocessing, and cleaning standards and use of cleaning and sanitizing products; instructional and educational printed cardboard, paper, vinyl, and plastic wall charts for displaying data featuring information regarding proper surgical scrub techniques, hand hygiene, medical instrument reprocessing, and cleaning standards and use of cleaning and sanitizing products; magazines in the field of food safety; markers; newsletters in the field of pest control and elimination, hand care, food safety, cleaning and sanitation training; notebooks; notepads; plastic wrap; printed instructional, educational, and teaching materials for the restaurant and food services industry; printed materials, namely, advertising signs of paper or cardboard, brochures, handouts, decals, menu boards, pamphlets, posters, paper banners, vinyl static window cling sheets, and training materials, all in the field of automotive care; paper signs, vinyl static window cling sheets, and training materials, all in the field of automotive care; molded plastic document markers; trash can liners; stationery, non-thermally insulated plastic bags for holding defined portions of food for use in storing, freezing, and cooking foods in the food service industry; cardboard containers.

17 – Rubber, gutta-percha, gum, asbestos, mica and goods made from these materials and not included in other classes; plastics in extruded form for use in manufacture; packing, stopping and insulating materials; flexible pipes, not of metal; grout sealant; non-metal hoses for use in the food service industry; adhesive tape for industrial and commercial use.

18 – Leather and imitations of leather, and goods made of these materials and not included in other classes; animal skins, hides; trunks and travelling bags; umbrellas and parasols; walking sticks; whips, harness and saddlery; duffel bags; tote bags; briefcases; wallets; umbrellas.

20 – Furniture, mirrors, picture frames; goods (not included in other classes) of wood, cork, reed, cane, wicker, horn, bone, ivory, whalebone, shell, amber, mother-of-pearl, meerschaum and substitutes for all

these materials, or of plastics; adjustable plastic clamps for attaching hand sanitizer dispenser to cylindrical surfaces, namely, hospital iv poles and bed rails; clear plastic holders for badges; display stands; fixed towel dispensers not of metal; hampers; non-metal fluid storage tanks; non-metal hooks; non-metal mirror hangers; picture frames; plastic boxes; plastic clips for sealing bags; plastic containers and covers for the food industry; container closures of plastic used for chemicals for commercial use; plastic hang tags; plastic holders for signboards; plastic inserts for use as container liners; plastic lids; plate racks; plastic storage racks and container closures of plastic for storing dishware, glassware, and silverware; plastic soak tanks, namely, plastic tubs for pre-soaking pots, pans, and kitchen utensils; plastic storage containers for commercial or industrial use; shelves; furniture, namely, stainless steel side tables and shelves; wall-mounted tool racks; non-metal mop handles; soak tank for use in soaking cookware, flatware, and dishware used in commercial and institutional kitchens.

21 – Household or kitchen utensils and containers; combs and sponges; brushes (except paint brushes); brush-making materials; articles for cleaning purposes; steelwool; unworked or semi-worked glass (except glass used in building); glassware, porcelain and earthenware not included in other classes; adhesive lint rollers; insect traps; bottles, sold empty; brooms; brushes used for cleaning medical instruments; buckets; cleaning tools, namely, pads, sponges and steel wool for cleaning; cleaning, dusting and polishing cloths; concession dispensing equipment, namely, condiment pump dispensers; cups and mugs; cutting boards; disposable rubber, vinyl, and plastic gloves for use in the food service industry; dust pans; foam drink holders; garbage cans; hand and nail brushes; household utensils, namely, serving spoons, scoops, pot and pan scrapers, spatulas, strainers, turners and whisks; ice buckets; knife blocks; microfiber cleaning cloths, mops, and sweep set comprised of a squeegee-type sweeper and a dust collecting bag holder sold together as a unit; mitts of fabric for cleaning; mobile dispensers for floor cleaning preparations for industrial, commercial, and institutional use; mops; mouse traps; insect traps with a pheromone-monitoring badge for luring moths; plastic spray nozzles; plungers for clearing blocked drains; portable beverage coolers; rat traps; scouring sponges; manually actuated pump dispensers for attachment to containers for use in dispensing liquids; scrubbing brushes; soap dispensers; squeegees for windows, floors, and tables for industrial, commercial, and institutional use; thermal insulated containers for food; tooth brushes; waste baskets; dish drying racks; flatware dispensers; oven mitts.

22 – Ropes, string, nets, tents, awnings, tarpaulins, sails, sacks and bags (not included in other classes);

padding and stuffing materials (except of rubber or plastics); raw fibrous textile materials; laundry bags.

24 – Textiles and textile goods, not included in other classes; bed covers; table covers; dish machine curtains, namely, splash curtains for dish washing and ware washing machines for commercial, institutional, and industrial use; hand towels; woven water soluble fabrics, namely, a water-soluble bi-laminate material having a layer of water-soluble nonwoven fabric formed of polyvinyl alcohol fibers bonded to a layer of water-soluble polyvinyl alcohol film, for use in further manufacturing of industrial or nuclear products, namely, equipment covers, machinery covers, and building structure covers; woven and non-woven fabrics, and woven fabric and film composites composed primarily of fabric for use in further manufacturing of industrial or nuclear products, namely, equipment covers, machinery covers, and building structure covers; woven and non-woven fabrics, films, and fabric and film composites composed primarily of fabric for use in covering and protecting sensitive equipment and packaging from contaminants; woven and non-woven hand towels; woven and non-woven fabrics, films, and fabric and film composites for use in the manufacture of clothing, namely, gloves and glove liners, woven and non-woven industrial gowns, coveralls, head covers, hard hat covers, hoods, lab coats, T-shirts, degradable plastic undergarments, pennants.

25 – Clothing, footwear, headgear; aprons; boots; caps; caps with visors; shirts; sweat shirts; coats; jackets; hats; cap visors.

26 – Lace and embroidery, ribbons and braid; buttons, hooks and eyes, pins and needles; artificial flowers; boxes for needles; cloth patches for clothing; embroidered patches for clothing; hair nets.

27 – Carpets, rugs, mats and matting, linoleum and other materials for covering existing floors; wall hangings (non-textile); floor mats.

28 – Games and playthings; gymnastic and sporting articles not included in other classes; decorations for Christmas trees; divot repair tools for golfers; golf tees; golf balls; plush toys; toy cars; stress relief toys for hand exercise.

30 – Coffee, tea, cocoa and artificial coffee; rice; tapioca and sago; flour and preparations made from cereals; bread, pastry and confectionery; ices; sugar, honey, treacle; yeast, baking-powder; salt; mustard; vinegar, sauces (condiments); spices; ice; candy; chewing gum.

35 – Advertising; business management; business administration; office functions; business administration and management of a hand hygiene compliance program for others; business consulting and information services; business data analysis; business information management; providing business

information; business auditing; business consultation services in the field of energy usage management and energy efficiency; business consulting services in the field of water usage efficiency and water usage management; business consulting services in the field of selection of preparations for cleaning and sanitizing for commercial, industrial, and institutional use; consulting services in the field of sustainable business solutions; business consulting services in the field of the operation of water treatment systems for industrial, commercial, and institutional uses; business consulting services in the field of car washing systems; business consulting services in the field of the operation of water filtration and conditioning systems for industrial, commercial, and institutional uses; business and organization consultancy in the field of commercial kitchen equipment; online retail store services and mail order catalog services for the restaurant and food services industries featuring goods in the food preparation, food handling, food labeling, cleaning, personal safety, personal hygiene, emergency response, protective apparel, material handling, shelving, and office supplies fields; business consulting and business strategy development services that provide strategies to companies wishing to move toward sustainability and socially responsible business practices through the use of effective products and controlled dispensing and monitoring technology, provided mainly to the beverage industry, dairy industry, food industry, food processing industry, food retail industry, food services industry, restaurant industry, healthcare industry, medical industry, pharmaceutical industry, industrial laundry industry, institutional laundry industry, vehicle care industry, and water care industry.

37 – Building construction; repair; installation services; boiler cleaning and repair; consulting services in the field of comprehensive cleaning, disinfecting, sanitizing and pest elimination for the food service, lodging, and healthcare industries; consulting services provided to supermarkets regarding cleaning, sanitation, pest elimination and fumigating; installation of air freshener and odor neutralizer dispensers; installation of renewable energy generation equipment; installation, maintenance, and repair of clean-in-place equipment and automated cleaning systems in the food and beverage industry; installation, maintenance, and repair of commercial kitchen equipment; installation, maintenance, and repair of dish machines, laundry equipment, dispensers for cleaning, disinfecting, and sanitizing preparations, water filtration systems, and pool and spa water treatment systems; installation, maintenance, and repair of equipment and apparatus for the vehicle care industry; installation, maintenance, and repair of insect and rodent traps and bait stations; installation, maintenance, and repair of water treatment and filtration equipment and control systems to analyze water

usage and treatment; leasing of floor maintenance equipment; leasing of pool and spa equipment for pool and spa cleaning; leasing of water softening equipment for pool and spa cleaning; termite and pest control other than for agricultural purposes and consultancy thereof; swimming pool and spa maintenance and cleaning services; technical support services, namely, technical advice related to the installation and repair of vehicle wash equipment and apparatus; pool and spa maintenance consultation services; consulting services in the field of institutional and janitorial cleaning and sanitation; installation, maintenance and repair of computer hardware.

38 – Providing access to database on the Internet where documents and images can be viewed, copied and printed for purposes of conducting corporate transactions; providing access to a website with non-downloadable video recordings featuring information regarding training for use of cleaning and sanitation products.

40 – Treatment of materials; leasing of equipment for use in textile care; custom manufacture of equipment and custom manufacture of pharmaceuticals; printing; printing of advertising matter; energy generation services; water treatment services.

41 – Education; providing of training; entertainment; sporting and cultural activities; educational services, namely, classes, seminars, and workshops, in the field of pool operation; educational services, namely, classes, seminars, and workshops, in the field of automobile care, automobile detailing, use of vehicle care products and equipment, and the sustainable operation of vehicle care facilities; educational services, namely, classes, seminars, and workshops, in the field of operating water treatment equipment and testing and analyzing water; educational services, namely, classes, seminars, and workshops, regarding efficient dishwashing practices and procedures; educational services, namely, classes, seminars, and workshops, in the field of prevention and treatment of pest infestation; educational services, namely, classes, seminars, and workshops, in the field of medical room turnover; educational services, namely, classes, seminars, and workshops, regarding medical instrument cleaning and reprocessing, hand hygiene and surgical scrub techniques, and cleaning and sanitizing product use and processes; educational services, namely, classes, seminars, and workshops, regarding efficient dishwashing practices and procedures; training services in the field of pool operation; training services in the field of automobile care, automobile detailing, use of vehicle care products and equipment, the sustainable operation of vehicle care facilities and distribution of training material in connection therewith; training services in the field of operating water treatment equipment and testing and analyzing water; training services regarding efficient dishwashing practices and procedures; training ser-

vices in the field of prevention and treatment of pest infestation; training services in the field of medical room turnover, training services regarding medical instrument cleaning and reprocessing, hand hygiene and surgical scrub techniques, and cleaning and sanitizing product use and processes; training services regarding efficient dishwashing practices and procedures; educational services, namely, conducting conferences and workshops in the field of car wash operations; educational services, namely, providing and/or conducting classes, seminars and workshops in the field of proper selection and use of laundry products and the proper handling of linen to commercial, institutional and industrial laundry business; educational services, namely, conducting classes, conferences, workshops, certification courses, seminars and training about food safety, hygiene, sanitation, and customer safety for the restaurant and food services industry and distribution of training materials in connection therewith; educational services, namely, conducting classes, seminars, and training in the field of cleaning, disinfection, sanitation, hygiene and infection control, proper selection and use of cleaning products, equipment and services; providing online publications in the nature of articles and podcasts in the field of food safety; business training services, namely, training which assists companies wishing to move toward sustainability and socially responsible business practices through the use of effective products and controlled dispensing and monitoring technology, provided mainly to the beverage industry, dairy industry, food industry, food processing industry, food retail industry, food services industry, restaurant industry, healthcare industry, medical industry, pharmaceutical industry, industrial laundry industry, institutional laundry industry, vehicle care industry, and water care industry.

42 – Scientific and technological services and research and design relating thereto; industrial analysis and research services; design and development of computer hardware and software; bacteriological research and testing; environmental testing and inspection services; food safety testing and consultation related thereof; inspection of cleaning and sanitation systems for quality control; calibration in the field of commercial kitchen equipment; custom design and engineering of clean-in-place systems and equipment, automated cleaning systems, and control systems for cleaning systems; inspections of commercial kitchen equipment for quality control; testing services for the certification of quality or standards in the field of water care, water usage, energy usage and waste reduction; testing, analysis, and evaluation of water quality; providing temporary use of online, non-downloadable software for monitoring and analyzing water usage and conditions data remote monitoring services of pool and spa water quality apparatus; providing quality assurance services in

the field of cleaning, disinfecting, sanitizing, personal hygiene and pest elimination for the beverage, dairy and food processing industry; food safety testing and consultation related thereto; providing information in the field of food safety testing and consultation; design of advertising materials for others.

43 – Services for providing food and drink; temporary accommodation; leasing of kitchen appliances.

44 – Consultancy in the field of personal hygiene.

45 – Legal services; security services for the protection of property and individuals; personal and social services rendered by others to meet the needs of individuals; reviewing standards and practices to assure compliance with laws and regulations in the fields of food safety, food sanitation, food preparation, food handling, and food service management in the food service and food retail industries; reviewing standards and practices to assure compliance with laws and regulations in the vehicle care field, namely, vehicle care products, equipment, and facilities of others, and preparing reports for regulatory compliance for the vehicle care industry; reviewing standards and practices to assure compliance with laws and regulations in the water treatment field, namely, water treatment products, equipment, and facilities of others, and preparing reports for regulatory compliance for the industrial, commercial, and institutional industries.

(260) AM 2015 75562 A

(800) 1187930

(891) 2013 07 16

(731) "SPORTLIFE" LTD

Aptekarsky pr. 16, RU-197022 Saint-Petersburg, Russian Federation

(540)

## **SPORT life club**

(511)

5 – Dietetic foods adapted for medical purposes; dietetic beverages adapted for medical purposes; dietetic substances adapted for medical use; pharmaceutical preparations; medical preparations for slimming purposes; tonics [medicines].

10 – Esthetic massage apparatus; massage apparatus; physical exercise apparatus, for medical purposes.

16 – Booklets; newspapers; printed periodicals; printed publications; advertising pamphlets; photographs [printed].

27 – Gymnasium exercise mats; mats.

35 – Dissemination of advertising matter; organization of exhibitions for commercial or advertising purposes; arranging newspaper subscriptions for others; publication of publicity texts; advertising; radio advertising; advertising in newspapers; tele-

vision advertising; direct mail advertising; sales promotion for others.

41 – Educational services; physical education; party planning [entertainment]; organization of exhibitions for cultural or educational purposes; gymnastic trainer services; providing golf facilities, namely, development of sports grounds for golf; providing amusement arcade services; publication of books; education information; recreation information; entertainment information; health club services [health and fitness training]; sport camp services; providing of training; gymnastic instruction; practical training [demonstration]; organization of sports competitions; sports competition scheduling services; timing of sports competitions.

43 – Bar services; cafés; cafeterias; restaurants.

44 – Medical assistance; sanatoriums; massage; hair-dressing salons.

(260) AM 2015 75605 A

(800) 1188749

(891) 2013 12 03

(731) SENTISS AG

c/o Pfister Treuhand AG, Bankstrasse 4  
CH-8610 Uster, Switzerland

(540)



(591) Grey, white

(511)

5 – Pharmaceutical and veterinary products; sanitary products for medicine; dietetic food and substances for medical or veterinary use, food for babies; food supplements for humans and animals; plasters, materials for dressings; material for dental fillings and dental impressions; disinfectants; products for destroying vermin; fungicides, herbicides.

9 – Scientific, nautical, surveying, photographic, cinematographic, optical, weighing, measuring, signaling, checking (supervision), life-saving and teaching apparatus and instruments; apparatus and instruments for conducting, switching, transforming, accumulating, regulating or controlling electricity; apparatus for recording, transmission or reproduction of sound or images; magnetic recording media, sound recording disks; compact disks, DVDs and other digital recording media; mechanisms for coin-operated apparatus; cash registers, calculating machines, data processing equipment, computers; software; fire extinguishers.

10 – Surgical, medical, dental and veterinary apparatus and instruments, artificial limbs, eyes and teeth; orthopedic articles; suture material.

16 – Paper, cardboard and goods made from these materials, not included in other classes; printed matter (printing products); bookbinding material; photographs; stationery; adhesives (glues) for stationery or household purposes; artists' materials; paintbrushes; typewriters and office requisites (except furniture); instructional or teaching material (except apparatus); plastic materials for packaging (not included in other classes); printing type; printing blocks.

44 – Medical services; veterinary services; hygienic and beauty care for human beings or animals; agriculture, horticulture and forestry services.

(260) AM 2015 75901 A

(800) 1190993

(891) 2013 07 30

(731) OBCHTCHESTVO S OGRANITCHENNOI OTVETSTVENNOSTYOU "PEGAS TOURISTIK"

etazh 5, dom 53, Leningradsky prospect,  
RU-125993 MOSKVA, Russian Federation

(540)



(591) Dark blue and green

(526) The trademark is protected as a whole. The words "TOURISTIK" included therein shall not be subject to independent legal protection.

(511)

41 – Sporting and cultural activities; club services (entertainment or education); health club services; boarding schools; bowling alleys; providing billiard rooms; entertainer services in particular singers and dancers.

43 – Restaurant services; temporary accommodation; hotel reservations, rental of temporary accommodation; temporary accommodation reservations.

(260) AM 2015 75905 A

(800) 1191038

(891) 2013 11 21

(731) INVESTTORG LLC

Aviamotornaya ulitsa, dom 50, Stroenie 2,  
cherdak, Pomeshenie XIV, komnata 35,  
RU-111024 Moscow, Russian Federation

(540)



(591) Grey, white and red

(511)

29 – Ajvar [preserved peppers]; albumen for culinary purposes; albumin milk; alginates for culinary purposes; almonds, ground; aloe vera prepared for human consumption; anchovy; animal marrow for

food; apple purée; bacon; beans, preserved; black pudding [blood sausage]; blood sausage; bone oil, edible; bouillon; bouillon concentrates; broth; broth concentrates; butter; buttercream; caviar; charcuterie; cheese; chocolate nut butter; clams [not live]; cocoa butter; coconut butter; coconut fat; coconut oil; coconut, desiccated; colza oil for food; corn oil; cranberry sauce [compote]; crayfish, not live; cream [dairy products]; croquettes; crustaceans, not live; crystallized fruits; curd; dates; edible birds' nests; edible fats; edible oils; eggs; fat-containing mixtures for bread slices; fatty substances for the manufacture of edible fats; kimchi [fermented vegetable dish]; fish fillets; fish meal for human consumption; fish mousses; fish, not live; fish, preserved; fish, tinned [canned (am.)]; flaxseed oil for culinary purposes; food products made from fish; foods prepared from fish; frosted fruits; frozen fruits; fruit chips; fruit jellies; fruit peel; fruit preserved in alcohol; fruit pulp; fruit salads; fruit, preserved; fruit, stewed; fruit-based snack food; fruits, tinned [canned (am.)]; game, not live; gelatine; gherkins; ginger jam; ham; herrings; hummus [chickpea paste]; isinglass for food; jams; jellies for food; kefir [milk beverage]; kefir [milk beverage]; koumiss [kumiss] [milk beverage]; kumys [kumyss] [milk beverage]; lard for food; lecithin for culinary purposes; lentils, preserved; linseed oil for culinary purposes; liver; liver pastes; liver pâté; lobsters, not live; low-fat potato chips; maize oil; margarine; marmalade; meat; meat extracts; meat jellies; meat, preserved; meat, tinned [canned (am.)]; milk; milk beverages, milk predominating; milk ferments for culinary purposes; milk products; milk shakes; mushrooms, preserved; mussels, not live; non-alcoholic egg nog; nuts, prepared; olive oil for food; olives, preserved; onions, preserved; oysters, not live; palm kernel oil for food; palm oil for food; peanut butter; peanuts, processed; peas, preserved; pectin for culinary purposes; piccalilli; pickles; pollen prepared as foodstuff; pork; potato chips; potato crisps; potato flakes; potato fritters; poultry, not live; powdered eggs; prawns, not live; preparations for making bouillon; preparations for making soup; preserved garlic; processed fish spawn; processed seeds; processed sunflower seeds; protein milk; raisins; rape oil for food; rennet; salmon; salted fish; salted meats; sardines; sauerkraut; sausages; sausages in batter; sea-cucumbers, not live; sesame oil; shellfish, not live; shrimps, not live; silkworm chrysalis, for human consumption; snail eggs for consumption; soups; soya beans, preserved, for food; soya milk [milk substitute]; spiny lobsters, not live; suet for food; sunflower oil for food; tahini [sesame seed paste]; toasted laver; tofu; tomato juice for cooking; tomato purée; tripe; truffles, preserved; tuna fish; vegetable juices for cooking; vegetable mousses; vegetable salads; vegetable soup preparations; vegetables, cooked; vegetables, dried; vegetables, preserved; vegetables, tinned [canned (am.)];

seaweed extracts for food; whey; whipped cream; white of eggs; yoghurt; yogurt; yolk of eggs.

30 – Allspice; almond confectionery; aniseed; aromatic preparations for food; baking powder; baking soda [bicarbonate of soda for cooking purposes]; barley meal; husked barley; crushed barley; bean meal; beer vinegar; flavorings [flavourings], other than essential oils, for beverages; coffee-based beverages; cocoa-based beverages; chocolate-based beverages; tea-based beverages; binding agents for ice cream [edible ices]; cookies; bread; breadcrumb; buns; cakes; flavorings [flavourings], other than essential oils, for cakes; rice cakes; candy; capers; caramels [candy]; celery salt; cereal preparations; cereal bars; cheeseburgers [sandwiches]; chewing gum; chicory [coffee substitute]; chips [cereal products]; chocolate; chocolate beverages with milk; chow-chow [condiment]; confectionery for decorating Christmas trees; chutneys [condiments]; cinnamon [spice]; cloves [spice]; cocoa; cocoa beverages with milk; coffee flavorings [flavourings]; coffee; unroasted coffee; vegetal preparations for use as coffee substitutes; coffee beverages with milk; artificial coffee; condiments; confectionery; corn flour; corn, milled; corn, roasted; fruit coulis [sauces]; couscous [semolina]; crackers; ice cream; cream of tartar for culinary purposes; curry [spice]; custard; dough; ferments for pastes; corn flakes; oat flakes; flavourings, other than essential oils; flour-milling products; fondants [confectionery]; farinaceous foods; essences for foodstuffs, except etheric essences and essential oils; cake frosting [icing]; garden herbs, preserved [seasonings]; ginger [spice]; gingerbread; glucose for culinary purposes; gluten prepared as foodstuff; gluten additives for culinary purposes; golden syrup; meat gravies; groats for human food; gruel, with a milk base, for food; halvah; ham glaze; high-protein cereal bars; hominy; hominy grits; honey; ice, natural or artificial; ice for refreshment; edible ices; infusions, not medicinal; fruit jellies [confectionery]; ketchup [sauce]; leaven; linseed for human consumption; liquorice [confectionery]; lozenges [confectionery]; macaroni; macarons [pastry]; malt biscuits; malt extract for food; malt for human consumption; maltose; marinades; marzipan; mayonnaise; meal; meat tenderizers, for household purposes; mint for confectionery; molasses for food; chocolate mousses; dessert mousses [confectionery]; muesli; mustard meal; mustard; noodle-based prepared meals; noodles; nutmegs; oat-based food; oatmeal; crushed oats; husked oats; palm sugar; pancakes; pasta; pasta sauce; almond paste; cake paste; soya bean paste [condiment]; pasties; pastries; peanut confectionery; pepper; peppers [seasonings]; pesto [sauce]; petit-beurre biscuits; petits fours [cakes]; pies; meat pies; pizzas; popcorn; potato flour for food; cake powder; powders for ice cream; pralines; salt for preserving foodstuffs; propolis; puddings; quiches; ravioli; relish [condiment]; rice; bread rolls; royal jelly; rusks;

saffron [seasoning]; sago; dressings for salad; cooking salt; sandwiches; tomato sauce; sauces [condiments]; sausage binding materials; seasonings; seaweed [condiment]; semolina; sherbets [ices]; cereal-based snack food; rice-based snack food; soya flour; soya sauce; spaghetti; spices; spring rolls; star aniseed; starch for food; stick liquorice [confectionery]; preparations for stiffening whipped cream; sugar; sushi; natural sweeteners; sweetmeats [candy]; peppermint sweets; tabbouleh; tacos; tapioca; tapioca flour for food; tarts; tea; iced tea; thickening agents for cooking foodstuffs; tortillas; turmeric for food; unleavened bread; vanilla [flavoring] [flavouring]; vanillin [vanilla substitute]; vermicelli [noodles]; vinegar; waffles; sea water for cooking; wheat flour; wheat germ for human consumption; yeast; frozen yoghurt [confectionery ices].

32 – Preparations for making aerated water; aerated water; milk of almonds [beverage]; aloe vera drinks, non-alcoholic; aperitifs, non-alcoholic; beer; beer wort; whey beverages; preparations for making beverages; non-alcoholic beverages; cider, non-alcoholic; cocktails, non-alcoholic; pastilles for effervescing beverages; powders for effervescing beverages; essences for making beverages; non-alcoholic fruit extracts; non-alcoholic fruit juice beverages; fruit juices; ginger beer; grape must, unfermented; non-alcoholic honey-based beverages; extracts of hops for making beer; isotonic beverages; kvass [non-alcoholic beverage]; lemonades; preparations for making liqueurs; malt beer; malt wort; peanut milk [non-alcoholic beverage]; mineral water [beverages]; preparations for making mineral water; must; fruit nectars, non-alcoholic; orgeat; sarsaparilla [non-alcoholic beverage]; sherbets [beverages]; smoothies; soda water; syrups for beverages; syrups for lemonade; tomato juice [beverage]; vegetable juices [beverages]; lithia water; seltzer water; waters [beverages]; table waters.

35 – Accounting; administrative processing of purchase orders; advertising; advertising agencies; advertising by mail order; arranging newspaper subscriptions for others; auctioneering; business auditing; bill-posting; book-keeping; business appraisals; business information; business inquiries; business investigations; business management and organization consultancy; business management assistance; business management consultancy; business management of hotels; business management of performing artists; business management of sports people; business organization consultancy; business research; commercial administration of the licensing of the goods and services of others; commercial information agencies; commercial information and advice for consumers [consumer advice shop]; commercial or industrial management assistance; compilation of information into computer databases; compilation of statistics; professional business consultancy; cost

price analysis; data search in computer files for others; demonstration of goods; direct mail advertising; dissemination of advertising matter; distribution of samples; document reproduction; economic forecasting; business efficiency expert services; employment agencies; organization of fashion shows for promotional purposes; import-export agencies; invoicing; layout services for advertising purposes; advisory services for business management; computerized file management; marketing; marketing research; marketing studies; modeling for advertising or sales promotion; news clipping services; office machines and equipment rental; on-line advertising on a computer network; opinion polling; organization of exhibitions for commercial or advertising purposes; organization of trade fairs for commercial or advertising purposes; outdoor advertising; outsourcing services [business assistance]; payroll preparation; personnel management consultancy; personnel recruitment; photocopying services; presentation of goods on communication media, for retail purposes; price comparison services; procurement services for others [purchasing goods and services for other businesses]; production of advertising films; psychological testing for the selection of personnel; public relations; publication of publicity texts; publicity; publicity agencies; publicity columns preparation; publicity material rental; radio advertising; radio commercials; relocation services for businesses; rental of advertising space; rental of advertising time on communication media; rental of photocopying machines; rental of vending machines; sales promotion for others; secretarial services; shop window dressing; shorthand; sponsorship search; drawing up of statements of accounts; arranging subscriptions to telecommunication services for others; systemization of information into computer databases; tax preparation; telemarketing services; telephone answering for unavailable subscribers; television advertising; television commercials; transcription; typing; updating of advertising material; word processing; writing of publicity texts.

41 – Academies [education]; providing amusement arcade services; arranging of beauty contests; booking of seats for shows; publication of books; calligraphy services; holiday camp services [entertainment]; sport camp services; providing casino facilities [gambling]; rental of cine-films; cinema presentations; circuses; club services [entertainment or education]; coaching [training]; arranging and conducting of colloquiums; organization of competitions [education or entertainment]; organization of sports competitions; arranging and conducting of concerts; conducting fitness classes; arranging and conducting of conferences; arranging and conducting of congresses; correspondence courses; disc jockey services; discotheque services; rental of skin diving equipment; dubbing; videotape editing; religious education; educational examination; electronic desktop

publishing; entertainer services; entertainment; organization of exhibitions for cultural or educational purposes; organization of fashion shows for entertainment purposes; film production, other than advertising films; gambling; game services provided on-line from a computer network; games equipment rental; providing golf facilities; vocational guidance [education or training advice]; gymnastic instruction; health club services [health and fitness training]; education information; entertainment information; recreation information; sign language interpretation; language interpreter services; layout services, other than for advertising purposes; lending libraries; mobile library services; presentation of live performances; operating lotteries; microfilming; modelling for artists; rental of movie projectors and accessories; providing museum facilities [presentation, exhibitions]; music composition services; music-halls; night clubs; orchestra services; organization of balls; organization of shows [impresario services]; amusement parks; personal trainer services [fitness training]; photographic reporting; photography; physical education; party planning [entertainment]; videotape film production; production of music; providing sports facilities; providing karaoke services; providing on-line electronic publications, not downloadable; publication of electronic books and journals on-line; radio entertainment; rental of radio and television sets; production of radio and television programmes; rental of video cassette recorders; recording studio services; providing recreation facilities; rental of audio equipment; rental of lighting apparatus for theatrical sets or television studios; rental of tennis courts; rental of video cameras; rental of sports grounds; news reporters services; nursery schools; boarding schools; scriptwriting services; arranging and conducting of seminars; rental of show scenery; production of shows; rental of sound recordings; rental of sports equipment, except vehicles; timing of sports events; rental of stadium facilities; rental of stage scenery; movie studios; subtitling; arranging and conducting of symposiums; teaching; television entertainment; publication of texts, other than publicity texts; writing of texts, other than publicity texts; theatre productions; ticket agency services [entertainment]; toy rental; animal training; practical training [demonstration]; translation; rental of videotapes; videotaping; vocational retraining; arranging and conducting of workshops [training]; zoological garden services.

43 – Accommodation bureaux [hotels, boarding houses]; rental of temporary accommodation; temporary accommodation reservations; boarding for animals; bar services; boarding house bookings; rental of transportable buildings; cafés; cafeterias; holiday camp services [lodging]; providing campground facilities; canteens; food and drink catering; rental of cooking apparatus; day-nurseries [crèches]; retirement homes; tourist homes; hotel reservations; ho-



tels; boarding houses; motels; rental of chairs, tables, table linen, glassware; rental of meeting rooms; rental of tents; rental of drinking water dispensers; rental of lighting apparatus other than for theatrical sets or television studios; restaurants; self-service restaurants; snack-bars.

(260) AM 2015 75906 A  
(800) 1191039  
(891) 2013 11 15  
(731) SWATCH AG (SWATCH SA)  
(SWATCH LTD)  
Jakob-Stämpfli-Strasse 94, CH-2502  
Biel/Bienne, Switzerland

(540)

## SISTEM51

(511)  
14 – Precious metals and their alloys and goods made of these materials or coated therewith included in this class, namely figurines, trophies, jewelry, namely rings, earrings, cuff links, bracelets, charms, brooches, chains, necklaces, tie pins, tie clips, jewelry cases [caskets], cases [caskets]; precious stones, semi-precious stones; timepieces and chronometric instruments, namely chronometers, chronographs, clocks, watches, bracelets, wall clocks, alarm clocks, as well as parts and accessories for the aforesaid goods namely hands, anchors, pendulums, barrels, watch cases, watch straps, watch dials, clockworks, watch chains, movements for timepieces.

(260) AM 2015 75913 A  
(800) 1191051  
(891) 2013 11 18  
(731) FERRERO S.P.A.  
Piazzale Pietro Ferrero, 1, I-12051 Alba,  
Cuneo (Italy), Italy

(540)



(591) White, brown, red, black, grey, green, yellow and beige

(511)  
29 – Preserved, dried and cooked fruits; jellies, jams, compotes; milk and milk based products; cocoa butter; hazelnuts butter of chocolate; spread melted cheese; fruit-based spread cream; hazelnuts-based spread cream; milk-based spread cream; vegetable-based spread cream.

30 – Pastry and confectionery; chocolate and chocolate-based products; cocoa and cocoa-based pro-

ducts; cocoa-based spread cream; chocolate-based spread cream; cocoa and hazelnuts-based spread cream; ices; sugar; honey.

(260) AM 2015 75928 A  
(800) 1191054  
(891) 2013 11 11  
(731) ASLAN YILMAZ  
Mehmet Nezih Özmen Mahallesi, Zakkum  
Sokak, Timaş İşhamı No:6 Kat:3, Güngören-  
İstanbul, Turkey

(540)



(591) Black, white  
(526) The trademark is protected as a whole. The word "L&S" included therein shall not be subject to independent legal protection.

(511)  
25 – Clothing, namely, trousers, jackets, overcoats, coats, skirts, suits, jerseys, waistcoats, shirts, ready-made leather linings (parts of clothing), T-shirts, sweatshirts, dresses, bermuda shorts, shorts, pajamas, pullovers, jeans, tracksuits, rainwear, beachwear, bathing suits, swimming suits; clothing for sports (for exclusive use for sports), clothing for babies, namely, shirts, pants, coats, dresses; underclothing, namely, boxer shorts, brassieres, briefs, pants, socks; footwear, namely, shoes excluding orthopedic shoes, sandals, waterproof boots, walking boots, booties, sporting shoes, slippers; shoe parts, namely, heelpieces, insoles for footwear, footwear uppers; headgear, namely, caps, skull caps, sports caps, hats, berets; gloves (clothing), stockings, belts (clothing), camisoles, sarongs, scarves, neck scarves, shawls, collars, neckties, ties, suspender belts.

(260) AM 2015 75930 A  
(800) 1191100  
(891) 2013 10 03  
(731) JT INTERNATIONAL S.A.  
1, Rue de la Gabelle, CH-1211 Genève 26,  
Switzerland

(540)

## CHOOZIT

(511)  
34 – Tobacco, raw or manufactured; smoking tobacco, pipe tobacco, rolling tobacco, chewing tobacco, moist tobacco powder called "snus"; cigarettes, cigars, cigarillos; substances for smoking sold separately or mixed with tobacco for non-medical and non-therapeutic purposes; snuff; smokers' articles included in this class; cigarette paper, cigarette tubes and matches.



(260) AM 2015 75931 A  
 (800) 1191107  
 (891) 2013 11 26  
 (731) JAPAN TOBACCO INC.  
 2-2-1 Toranomom, Minato-ku, Tokyo, Japan  
 (540)

## SMOOV

(511)  
 34 – Tobacco, raw or manufactured; smoking tobacco, pipe tobacco, rolling tobacco, chewing tobacco, moist tobacco powder called "snus"; cigarettes, cigars, cigarillos; snuff; smokers' articles included in this class; cigarette paper, cigarette tubes and matches.

(260) AM 2015 75953 A  
 (800) 1191518  
 (891) 2013 11 25  
 (731) ECOPA  
 10 rue Luce de Casabianca, F-20200 Bastia, France  
 (540)



(591) Orange, black, red  
 (511)  
 9 – Software, particularly calculation software for performing tax audits.

(260) AM 2015 75954 A  
 (800) 1191528  
 (891) 2013 08 06  
 (731) WORLD MEDICINE İLAÇ SANAYİ VE TİCARET LİMİTED ŞİRKETİ  
 Evren Mah. Camiyolu Cad. No:50 K:1 B, Zemin 4-5-6, Güneşli Bağcılar İstanbul, Turkey  
 (540)

## NEBIWORLD

(511)  
 5 – Medicines for human purposes, medicines for veterinary purposes, vitamin preparations, chemical preparations for medical purposes, dietetic substances adapted for medical use; dietetic foods adapted for medical purposes; baby foods, medicinal herbs, herbal beverages adapted for medical purposes, nutritional supplements, pollen dietary supplements, mineral food supplements, protein dietary supplements; medicines for dental purposes, hygienic products for medical purposes including pads, waddings for medical purposes, plasters for medical purposes, dressings for medical purposes, babies' napkins, preparations for destroying noxious plants, preparations for destroying noxious animals, fungicides, deodorants other than for human beings or for animals, air

deodorising preparations, disinfectants for hygiene purposes, antiseptics, detergents for medical purposes.

(260) AM 2015 75955 A  
 (800) 1191529  
 (891) 2013 09 04  
 (731) DR.SERTUS İLAÇ SANAYİ VE TİCARET LİMİTED ŞİRKETİ  
 Evren Mah. Camiyolu Cad. No:50 K:2, Güneşli/Bağcılar/İstanbul, Turkey  
 (540)

## MIGLAN МИГЛАН

(591) Black, white  
 (511)  
 5 – Medicines for human purposes, medicines for veterinary purposes, vitamin preparations, chemical preparations for medical purposes, dietetic substances adapted for medical use; dietetic foods adapted for medical purposes; baby foods, medicinal herbs, herbal beverages adapted for medical purposes, nutritional supplements, pollen dietary supplements, mineral food supplements, protein dietary supplements; medicines for dental purposes, hygienic products for medical purposes including pads, waddings for medical purposes, plasters for medical purposes, dressings for medical purposes, babies' napkins, preparations for destroying noxious plants, preparations for destroying noxious animals, fungicides, deodorants other than for human beings or for animals, air deodorising preparations, disinfectants for hygiene purposes, antiseptics, detergents for medical purposes.

(260) AM 2015 75957 A  
 (800) 1191547  
 (891) 2013 11 18  
 (731) LUISA SPAGNOLI S.P.A.  
 Strada Santa Lucia, 71, I-06125 PERUGIA, Italy  
 (540)



(591) Black, white  
 (511)  
 3 – Perfumes, perfumes in solid form; cosmetics in general, including deodorants for personal use; soaps, liquid soaps; cakes of toilet soap; bath foams; dentifrices; shampoos; essential oils; hair lotions; preparations for permanent hair waves and for setting hair; gels; hair dyes; facial creams; mascara;

eyeliners; eye shadows; make-up pencils; face powder; lipsticks; foundations; body creams; nail polish; nail hardeners; sun-tanning oils and creams; detergents; bleaching products; fabric softeners; soaps; bleaching preparations and other substances for laundry use; cleaning, polishing, degreasing, scouring and abrasive preparations.

(260) AM 2015 75958 A  
(800) 738478  
(891) 2014 01 06  
(731) LANDEWYCK TOBACCO S.A.  
31 rue de Hollerich, L-1741 Luxembourg,  
Luxembourg  
(540)

## Che

(511)  
34 – Tobacco; tobacco products, cigarettes, cigars, cigarillos, smoker's articles, matches.

(260) AM 2015 75959 A  
(800) 796825  
(891) 2013 10 18  
(731) TISSOT SA  
Chemin des Tourelles 17, CH-2400 Le Locle,  
Switzerland  
(540)

## INNOVATORS BY TRADITION

(511)  
14 – Precious metals and their alloys and goods made of or coated with these materials not included in other classes; jewellery, precious stones; horological and chronometric instruments.

(260) AM 2015 75960 A  
(800) 833165  
(891) 2013 07 08  
(731) Zakrytoe aktsionernoe obchtchestvo  
"ELECTRONNYE SISTEMY "ALKOTEL"  
ulitsa Marshala Govorova 8-A, RU-198188  
St.-Petersbourg, Russian federation  
(540)

## TEXET

(511)  
9 – Telephone answering machines; electric accumulators; antennas, remote control apparatus; electric monitoring apparatus; sound recording apparatus; intercommunication apparatus; sound transmitting apparatus; electric apparatus for commutation; magic lanterns; telegraphs (apparatus); telephone apparatus; telephone transmitters; facsimile machines; phototelegraphy apparatus; acidimeters for batteries; electric batteries; computer memory devices; video

cameras; video cassettes; video telephones; video screens; sights, plugs, sockets and other contacts; optical goods; detectors; floppy disks; sound recording disks; magnetic disks; optical disks; disk drives (for computers); dictating machines; electronic notice boards; interfaces (for computers); calculating machines; pocket calculators; video game cartridges; magnetic cards; mouse pads, electronic agendas; magnetic encoders; commutators (switches); comparators; notebook computers; correcting lenses (optics); optical lenses; lens hoods; optical condensers; microprocessors; microphones; modems; monitors (hardware); sound recording media; magnetic data media; optical data media; electronic pocket translators; transmitters (telecommunication); transmitters of electronic signals; telephone wires; electric wires; recorded computer programs; game software; radiotelephony sets; word processing machines, television apparatus; teleprinters; portable telephones; telephone receivers; video recorders; sound reproduction apparatus; tape recorders; data processing apparatus; computer peripheral devices; acoustic couplers.

38 – Electronic bulletin board services (telecommunication services); telecommunication information; telecommunications routing and junction services; provision of access to a global computer network; providing telecommunication connections to a global computer network; message sending; computer-aided transmission of messages and images; sending of telegrams; electronic messaging; rental of message sending apparatus; rental of modems; rental of telecommunication apparatus; rental of telephones; rental of facsimile apparatus; radio communications; communications by fiber optic networks; radio telephony; communications by computer terminals; satellite transmission; communications by telegrams; communications by telephone; facsimile transmission; paging services (radio, telephone or other means of electronic communication); teleconferencing services; telex services; telegraph services; telephone services.

(260) AM 2015 75961 A  
(800) 875351  
(891) 2013 11 06  
(731) BORA CREATIONS S.L.  
Calle Rey Sancho, 7, Local 3 E-07180 Santa  
Ponsa, Mallorca, Spain  
(540)

## Catrice

(511)  
4 – Candles, scented candles, scented oil (included in this class).

8 – Hand-operated tools and instruments for cosmetic purposes and for decorating the nails of hands and feet, particularly nail files, scissors and tweezers; nail clippers for shaping nails.

16 – Office material, paper, cardboard and goods made from these materials, not included in other classes; nail stickers.

21 – Hair combs and brushes (except paint brushes), cosmetic sponges, cosmetic brushes; small wooden or plastic sticks for decorative purposes.

26 – Hair ornaments, particularly clips, hair-bands, hair garlands.

35 – Retail outlet services for cosmetic goods and perfumery.

(260) AM 2015 75968 A

(800) 1142694

(891) 2013 11 18

(731) FORTUNATO O. FREDERICO & CA., LDA  
Rua 24 de Junho, nº 453-Penselo, P-4800-128  
Guimarães, Portugal

(540)



(591) Black, white

(511)

18 – Leather and imitations of leather, and goods made of these materials and not included in other classes; animal skins, hides; trunks and travelling bags; umbrellas, parasols and walking sticks.

25 – Clothing, footwear, headgear.

(260) AM 2015 75970 A

(800) 1191595

(891) 2013 12 02

(731) LABORATOIRES DE BIOLOGIE  
VEGETALE YVES ROCHER  
La Croix des Archers, F-56200 LA  
GACILLY, France

(540)

**CAMOMILLE CHERIE**

(511)

3 – Cosmetic products for face and body care; cosmetic products for bathing and showering; cosmetics for foot and hand care.

(260) AM 2015 75971 A

(800) 1191615

(891) 2013 09 20

(731) LUCIANO TESSARIOL  
Via Barbaro F. 23 I-31044 Montebelluna  
(TV), Italy

(540)

**J JOG DOG**

(511)

9 – Shoes for protection against accidents, irradiation and fire; boots (protective footwear); safety

boots for use in industry (other than for protection against accident or injury); protective footwear for the prevention of accident or injury; protective shoes; gloves for protection against accidents.

18 – Leather for shoes; shoe bags; travelling sets (leatherware); purses; leisure bags; bags with wheels; cloth bags; leather bags; bags made of imitation leather; sling bags; handbags; small bags; umbrella sticks; umbrella covers; umbrella handles; umbrella; bags for umbrellas; pocket wallets; pocket wallets with card holders; leather pouches; pocket wallets with pockets for cards; wallets for attachment to belts; key cases; briefcases (leatherware); luggage tags (leatherware); key wallets.

25 – Footwear; boots for sports; casual footwear; men's footwear; women's footwear; riding shoes; training shoes; articles of footwear for athletics; footwear for golf sport purposes; footwear for children; baby footwear; inner socks for footwear; pumps (footwear); trekking footwear; leisure footwear; bath slippers; football boots; beach shoes; sports shoes; esparto shoes or sandals; studs for football boots; formal shoes; gymnastic shoes; heels for shoes; shoe soles; canvas shoes; shoes of rubber; gym shoes; athletic shoes; shoes for casual wear; high-heeled shoes; anglers' shoes; baseball shoes; basketball shoes; bowling shoes; boxing shoes; deck shoes; women's shoes; golf shoes; handball shoes; hockey shoes; leather shoes; rugby boots; tennis shoes; volleyball shoes; dance shoes; walking shoes; hiking boots; infants' shoes; running shoes; jogging shoes; rain shoes; slip-on shoes; track and field shoes; ballet shoes; sandals; shoe soles for repair; rope sole canvas shoes; ski and snowboard shoes and parts thereof; sneakers; boots; winter boots; army boots; biker boots; boots for motorcycling; wellies; fishing boots; hunting boots; polo boots; stiffeners for boots; half-boots; ladies' boots; bath sandals; loafers; wooden shoes; slippers; leather slippers; slipper soles; socks; shoes with a wooden sole; boot uppers; protectors for footwear; non-slipping devices for footwear; fittings of metal for footwear; welts for boots; heelpieces for footwear; inner soles for footwear; gloves (clothing); gloves including those made of skin, hide or fur; money belts (clothing); fabric belts; belts of leather; sashes for wear; cashmere scarves; shawls and headscarves; stoles; babushkas; silk scarves; berets; hats; inner socks for footwear; sports caps; cap visors; bonnets, caps; baseball-caps; golf caps; bobble hats; ski caps; knitted berets; top hats; leather hats; woolly hats; beach hats; sun hats; visor hats; nightcaps; rain hats; clothing, footwear, headgear.

(260) AM 2015 75972 A

(800) 1191658

(891) 2013 11 15

(731) SOREMARTEC S.A.

Findel Business Center, Complexe B, Rue  
de Trèves, L-2632 Findel, Luxembourg  
(540)

## FERRERO FARMING VALUES

(511)

30 – Coffee, tea, cocoa and coffee substitutes; rice; tapioca and sago; flour and preparations made from cereals; bread, pastry and confectionery; edible ices; sugar, honey, treacle; yeast, baking powder; salt; mustard; vinegar, sauces (condiments); spices; ice for refreshment; chocolate and chocolate-based products, cocoa-based spread, filled wafers, pralines, filled Genoese cakes; beverages based on tea or coffee or cocoa or chocolate.

31 – Grains and agricultural, horticultural and forestry products, not included in other classes; fresh fruits and vegetables; seeds; natural plants and flowers; foodstuffs for animals; malt; fresh hazelnuts, walnuts, coconuts, peanuts and almonds.

35 – Advertising; business management; business administration; commercial or industrial management assistance; import-export agency services; promotion services with a view to exporting (advertising); consultancy services relating to commercial business in the field of agriculture; administrative management of inventory and supply chains; presentation of goods on communication media, for retail purposes; commercial information and advice for consumers [consumer advice shop]; sales promotion.

(260) AM 2015 75973 A

(800) 1191660

(891) 2013 11 28

(731) CHIAUS (FUJIAN) INDUSTRIAL

DEVELOPMENT CO., LTD.

HuiDong Industrial Area, HuiAn, Quanzhou,  
Fujian, China

(540)

(591) Black, white

(511)

3 – Bath foam; hair lotions; detergents for household use; shoe cream; make-up; aromatics [essential oils]; toilet water; talcum powder, for toilet use; bath powder; dentifrices.

5 – Babies' diapers of paper and cellulose, disposable; babies' diaper-pants of paper and cellulose, disposable; sanitary towels; napkins for incontinents; pants, absorbent, for incontinents; antiseptic wipes; incontinence garments; medicines for human purposes; food for babies; air purifying preparations; cattle washes; mosquito-repellent incense.

16 – Paper; towels of paper; aquarelles; stationery; drawing materials; children's books incorporating an audio component; writing chalk; architects' models.

(260) AM 2015 75974 A

(800) 1191664

(891) 2013 10 30

(731) JAPANPARTS S.R.L.

Via Della Meccanica, 1/A, I-37139 Fraz.

Bassona, VERONA (VR), Italy

(540)

## JAPKO

(511)

7 – Machines and machine tools; motors and engines (except for land vehicles); machine coupling and transmission components (except for land vehicles); agricultural implements other than hand-operated; incubators for eggs; automatic vending machines.

9 – Scientific, nautical, surveying, photographic, cinematographic, optical, weighing, measuring, signalling, checking (supervision), life-saving and teaching apparatus and instruments; apparatus and instruments for conducting, switching, transforming, accumulating, regulating or controlling electricity; apparatus for recording, transmission or reproduction of sound or images; magnetic data carriers, recording discs; compact discs, DVDs and other digital recording media; automatic vending machines and mechanisms for coin-operated apparatus; cash registers, calculating machines, data processing equipment and computers; computer software; fire-extinguishing apparatus.

12 – Vehicles; apparatus for locomotion by land, air or water.

(260) AM 2015 75978 A

(800) 1191687

(891) 2013 11 01

(731) LIMITED LIABILITY COMPANY

"24/7 DELIVERY"

vul. Kniazhyi Zaton, bud. 9-A, of. 369, Kyiv  
02095, Ukraine

(540)

(591) Black and red

(526) The trademark is protected as a whole. The word "24/7" included therein shall not be subject to independent legal protection.

(511)

35 – Advertising; business management; business administration; office functions.

(260) AM 2015 75979 A  
 (800) 1191781  
 (891) 2013 11 28  
 (731) PAKSHOO MANUFACTURING &  
 CHEMICAL CO  
 No:29, The 2nd Alley, Pakistan St., Beheshti  
 Ave, Tehran, Tehran (Islamic Republic of Iran)  
 (540)

مریدنت

**Merident**

(591) Black, white  
 (511)  
 3 – Cosmetics, cleaning preparations for laundry use, washing liquids, shampoo, hand washing liquids, toothpastes, mouthwashes, mouth fresheners, air fragrancing preparations.  
 21 – Toothbrushes, toothpicks.  
 35 – Advertising agencies, business management for all aforementioned goods.

(260) AM 2015 75980 A  
 (800) 1191782  
 (891) 2013 11 13  
 (731) SYSTENE LIMITED  
 P.O. Box 3321, Drake Chambers, Road Town,  
 Tortola, British Virgin Islands  
 (540)

**Sky Lark**

(591) Black, white  
 (511)  
 11 – Apparatus for lighting, heating, steam generating, cooking, refrigerating, drying, ventilating, water supply and sanitary purposes; lamp shades; steam accumulators; heat accumulators; defrosters for vehicles; distillation apparatus; desiccating apparatus; hydromassage bath apparatus; disinfectant apparatus; air deodorising apparatus; tanning apparatus [sun beds]; ionization apparatus for the treatment of air or water; coffee roasters; beverage cooling apparatus; hand drying apparatus for washrooms; fruit roasters; water purifying apparatus and machines; refrigerating apparatus and machines; drying apparatus and installations; freezers; drying apparatus; structural plates for ovens; coolers for furnaces; expansion tanks for central heating installations; flushing tanks; refining towers for distillation; bidets; boilers, other than parts of machines; bath tubs; spa baths [vessels]; bath tubs for sitz baths; waffle irons, electric; fans [air-conditioning]; fans [parts of air-conditioning installations]; electric fans for personal use; roasting spits; refrigerating display cabinets [display cases]; water heaters; water heaters [apparatus]; water flushing installations; air reheaters; extractor hoods for kitchens; gas condensers, other

than parts of machines; acetylene generators; hydrants; burners; acetylene burners; petrol burners; gas burners; burners for lamps; germicidal burners; incandescent burners; oxhydrogen burners; laboratory burners; oil burners; alcohol burners; hot water bottles; footwarmers, electric or non-electric; bedwarmers; pocket warmers; warming pans; grills [cooking appliances]; lampshade holders; stills; showers; refrigerating containers; gas lighters; lighters; friction lighters for igniting gas; chimney blowers; coils [parts of distilling, heating or cooling installations]; furnace ash boxes; evaporators; torches for lighting; shower cubicles [enclosures (Am.)]; Turkish bath cabinets, portable; heating apparatus; refrigerating chambers; fireplaces, domestic; chimney flues; pressure cooking saucepans, electric; air valves for steam heating installations; level controlling valves in tanks; thermostatic valves [parts of heating installations]; electrically heated carpets; light bulbs; light bulbs, electric; solar thermal collectors [heating]; distillation columns; furnace grates; ventilation hoods; ventilation hoods for laboratories; lamp globes; air conditioning apparatus; air conditioners for vehicles; gas boilers; laundry room boilers; heating boilers; coffee machines, electric; taps [cocks, spigots] [faucets (Am.)] for pipes; taps [faucets]; mixer taps for water pipes; forges, portable; lava rocks for use in barbecue grills; electric lights for Christmas trees; acetylene flares; safety lamps; gas lamps; curling lamps; germicidal lamps for purifying air; projector lamps; lamps for directional signals of automobiles; light bulbs for directional signals for vehicles; arc lamps; laboratory lamps; oil lamps; ultraviolet ray lamps, not for medical purposes; miners' lamps; electric lamps; chandeliers; barbecues; bread baking machines; watering machines for agricultural purposes; disposable sterilization pouches; footmuffs, electrically heated; heaters for baths; heaters for heating irons; immersion heaters; brackets for gas burners; anti-splash tap nozzles; heat pumps; filaments for electric lamps; magnesium filaments for lighting; heating filaments, electric; luminous house numbers; bath linings; stoves; heating apparatus for defrosting windows of vehicles; hot air bath fittings; bath fittings; loading apparatus for furnaces; kiln furniture [supports]; sauna bath installations; refrigerating appliances and installations; blankets, electric, not for medical purposes; fabric steamers; lamp reflectors; vehicle reflectors; hearths; steam boilers, other than parts of machines; pasteurisers; lamp mantles; sockets for electric lights; coffee percolators, electric; stoves [heating apparatus]; bakers' ovens; hot air ovens; kitchen ranges [ovens]; microwave ovens [cooking apparatus]; microwave ovens for industrial purposes; incinerators; kilns; solar furnaces; dental ovens; furnaces, other than for laboratory use; urinals [sanitary fixtures]; feeding apparatus for heating boilers; heating plates; cookers; hot plates; heaters, electric, for feeding bottles; aquari-

um heaters; aquarium lights; heating cushions [pads], electric, not for medical purposes; clean chambers [sanitary installations]; water intake apparatus; deodorising apparatus, not for personal use; apparatus for dehydrating food waste; fumigation apparatus, not for medical purposes; gas scrubbing apparatus; oil-scrubbing apparatus; glue-heating appliances; drying apparatus for fodder and forage; water filtering apparatus; air purifying apparatus and machines; ice machines and apparatus; cooling appliances and installations; cooking apparatus and installations; lighting apparatus and installations; sanitary apparatus and installations; cooking rings; lighting apparatus for vehicles; light-emitting diodes [LED] lighting apparatus; heating apparatus for solid, liquid or gaseous fuels; heating apparatus, electric; hot air apparatus; steam facial apparatus [saunas]; safety accessories for water or gas apparatus and pipes; regulating and safety accessories for gas apparatus; regulating accessories for water or gas apparatus and pipes; regulating and safety accessories for water apparatus; regulating and safety accessories for gas pipes; roasting jacks; plate warmers; electric appliances for making yogurt; anti-dazzle devices for automobiles [lamp fittings]; anti-glare devices for vehicles [lamp fittings]; rotisseries; radiator caps; diving lights; washers for water taps; radiators [heating]; central heating radiators; radiators, electric; sinks; disinfectant dispensers for toilets; drip irrigation emitters [irrigation fittings]; light diffusers; nuclear reactors; heat regenerators; pressure water tanks; roasters; lamps; street lamps; ceiling lights; toilet seats; lighting installations for air vehicles; pressure cookers [autoclaves], electric; gas scrubbers [parts of gas installations]; lamp glasses; sterilizers; water sterilizers; air sterilisers; air dryers; laundry dryers, electric; hair dryers; malt roasters; tobacco roasters; heat exchangers, not parts of machines; bread toasters; discharge tubes, electric, for lighting; lamp chimneys; luminous tubes for lighting; pipes [parts of sanitary installations]; flues for heating boilers; boiler pipes [tubes] for heating installations; toilets [water-closets]; toilets, portable; humidifiers for central heating radiators; wash-hand basins [parts of sanitary installations]; toilet bowls; water conduits installations; bath installations; air conditioning installations; desalination plants; installations for processing nuclear fuel and nuclear moderating material; watering installations, automatic; cooling installations for water; cooling installations for liquids; milk cooling installations; cooling installations for tobacco; water purification installations; purification installations for sewage; steam generating installations; water distribution installations; air filtering installations; swimming pool chlorinating apparatus; ventilation [air-conditioning] installations and apparatus; ventilation [air-conditioning] installations for vehicles; water softening apparatus and installations; cooling installations and

machines; heating installations; heaters for vehicles; hot water heating installations; polymerisation installations; water supply installations; flare stacks for use in the oil industry; ash conveyor installations, automatic; whirlpool-jet apparatus; air cooling apparatus; aquarium filtration apparatus; cooking utensils, electric; flares; headlights for automobiles; vehicle headlights; filters [parts of household or industrial installations]; filters for air conditioning; coffee filters, electric; filters for drinking water; lights for automobiles; bicycle lights; cycle lights; lights for vehicles; pocket torches, electric; lanterns for lighting; Chinese lanterns; fountains; ornamental fountains; deep fryers, electric; fittings, shaped, for ovens; oven fittings made of fireclay; bread-making machines; refrigerators; chromatography apparatus for industrial purposes; kettles, electric; dampers [heating]; refrigerating cabinets; ice boxes; fuel economizers; carbon for arc lamps; heating elements.

(260) AM 2015 75981 A

(800) 1191786

(891) 2013 12 05

(731) ROLEX SA

3-5-7 rue François-Dussaud, CH-1211 Genève  
26, Switzerland

(540)

## CHRONERGY

(511)

14 – Jewelry, timepieces, namely watches, wristwatches, components of timepieces and accessories for timepieces not included in other classes, clocks and other chronometric instruments, chronometers, chronographs (timepieces), apparatus for timing sports events, time measuring and marking apparatus and instruments not included in other classes; dials (for timepieces), hands (for timepieces), boxes, cases and presentation cases for timepieces and jewelry.

(260) AM 2015 75982 A

(800) 1191845

(891) 2013 11 14

(731) EDENRED

166-180 boulevard Gabriel Péri, F-92240  
MALAKOFF, France

(540)



(591) Blue Pantone 276C and red Pantone 485

(511)

9 – Magnetic, optical, memory or electronic microchip cards with or without contact (radio frequency, infrared or other), disposable or rechargeable, for pre-paid or post-paid use, capable of containing one or several electronic purses, used for all types of applications and especially physical access control,



control of access to computer systems, checking loyalty cards; payment cards, credit cards and debit cards, encoded and magnetic, prepaid magnetic cards.

16 – Printed matter, prospectuses, pamphlets, coupons of paper, payment orders of paper, payment cards of paper or plastic.

36 – Issue, compensation and refund of vouchers, coupons, counterfoils, prepaid or debit or credit cards or any other means of payment, namely via a computer network, enabling the organization of payment for the provision of meals and food items and any other good or service; insurance underwriting, financial and monetary services; financial services for the payment for the provision of meals and food items and any other good or service using electronic cards, vouchers, coupons or control tickets, or any other means of payment.

(260) AM 2015 75988 A

(800) 1191886

(891) 2013 05 29

(731) GUANDONG ALPHA ANIMATION AND CULTURE CO., LTD

Auldey Industrial Area, Wenguan Rd.,  
Chenghai, Shantou Guangdong, China

(540)



(591) Black, white

(511) 28 – Apparatus for games; mobiles [toys]; playing cards; chess or any board games; toys; toy vehicles; games other than those adapted for use with an external display screen or monitor; plastic racetrack; spinning tops [toys]; jigsaw puzzles; toy watches.

(260) AM 2015 75989 A

(800) 1191934

(891) 2013 09 02

(731) OBSHCHESTVO S OGRANICHENNOY OTVETSTVENNOSTYU "RIA "PANDA"

lit. D, 17/5, Zheleznovodskaya ul.,  
RU-199155 Saint-Petersburg, Russian Federation

(540)

**НЕЗУДИН**

(511)

3 – Deodorants for personal use; perfumery; hair lotions; lotions for cosmetic purposes; beauty masks; oils for cosmetic purposes; cleansing milk for toilet purposes; soap; liquid soap; cosmetic kits; lipsticks;

non-medicated lip protectors; shaving preparations; cosmetic preparations for baths; toiletries; nail care preparations; tissues impregnated with cosmetic lotions; bath salts, not for medical purposes; cosmetic preparations for skin care; lip care preparations, including lip balms [non-medicated]; cosmetic after-sun preparations; depilatories; exfoliant preparations for cosmetic use; bleaching preparations [decolorants] for cosmetic purposes; detergents other than for use in manufacturing operations and for medical purposes; shampoos.

5 – Dietetic substances adapted for medical use; mineral food supplements; nutritional supplements for medical purposes; dietetic beverages adapted for medical purposes; medicinal infusions; biological preparations for medical purposes; vitamin preparations; dermatological preparations; pharmaceutical preparations for skin care; pharmaceutical preparations for hair care; medical preparations for slimming purposes; pharmaceutical preparations; sunburn preparations for pharmaceutical purposes; pharmaceutical preparations for skin improvement after insect bites; food for babies; dietetic foods adapted for medical purposes; syrups for pharmaceutical purposes; sanitary preparations for medical purposes; herbal teas for medicinal purposes; plant extracts for medical purposes.

(260) AM 2015 75992 A

(800) 1191954

(891) 2013 09 20

(731) OPEN JOINT STOCK COMPANY  
"SIBUR HOLDING"

ul. Galernaya, liter A, d.5, RU-190000  
Saint-Petersburg, Russian Federation

(540)

**PURPET**

(511)

1 – Plastics, unprocessed, namely polyethylene terephthalate in powder, pellet, liquid or paste form.

17 – Plastic substances, semi-processed for use in manufacture.

(260) AM 2015 75993 A

(800) 1191964

(891) 2013 11 25

(731) REPSOL, S.A.

C/Méndez Álvaro 44, E-28045 Madrid,  
Spain

(540)



(591) White, black, gray, green and yellow

(526) The trademark is protected as a whole. The words "Fuel Grade" included therein shall not be subject to independent legal protection.

(511)

1 – Chemical products for use in industry, science and photography, as well as in agriculture, horticulture and forestry; unprocessed artificial resins, unprocessed plastics; soil fertilizers; fire extinguishing compositions; tempering and soldering preparations; tanning substances; adhesives for use in industry; chemical additives; chemical additives for fuels and motor fuels; detergent additives for lubricants and fuels; synthetic materials for absorbing oil; acids and acid-resistant chemical compounds; activated carbon; coolants for vehicle engines; chemical preparations for facilitating the alloying of metals; fuel-saving agents.

4 – Oils and greases for industrial use; lubricants; dust absorbing, wetting and binding compositions; coal; fuels (including gasoline for engines) and illuminating materials; candles and wicks for lighting; fuel oils; additives, non-chemical, to motor fuel; methylated spirits; combustible briquettes; greases and greasing oils; fuel gas; electrical energy; petroleum, including petroleum ether and petroleum jelly for industrial use; petrochemical additives for gasoline.

(260) AM 2015 75994 A

(800) 1192017

(891) 2013 12 18

(731) RADISSON HOTELS INTERNATIONAL, INC.

Carlson Parkway, P.O. Box 59159,  
Minneapolis MN 554598249, USA

(540)



(591) Red, black and white

(511)

43 – hotel, bar and restaurant services; services for the reservation of rooms.

(260) AM 2015 75996 A

(800) 1192095

(891) 2013 10 07

(731) ARA AG

Zur Schlenkhecke 4, 40764 Langenfeld,  
Germany

(540)

**Jenny**

(511)

10 – Orthopedic articles, particularly shoes and insoles.

18 – Leather and imitations of leather, and goods made of these materials and not included in other

classes; hides; trunks, travelling bags; umbrellas, parasols and walking sticks; whips, harness and saddlery.

25 – Clothing, footwear and headgear.

(260) AM 2015 75998 A

(800) 1192112

(891) 2013 09 20

(731) ADYLJAN MAMUDJANOVICH  
IBRAGIMOV

Magadanskaia street, 16, Bishkek c.,  
Kyrgyzstan

(540)

**OLIMP**

(511)

7 – Construction machines and apparatus; vulcanisation apparatus; compressed air machines; expansion tanks [parts of machines]; drums [parts of machines]; reels [parts of machines]; journal boxes [parts of machines]; crank shafts; valves [parts of machines]; bearings [parts of machines]; water heaters [parts of machines]; bushings [parts of machines]; exhausts for motors and engines; generators of electricity; silencers for motors and engines; hydraulic controls for machines, motors and engines; cylinder heads for engines; mud catchers and collectors [machines]; tarring machines; hydraulic engines and motors; motors, other than for land vehicles; compressed air engines; engines for boats; rack and pinion jacks; jacks [machines]; injectors for engines; air condensers; carburettors; crankcases for machines, motors and engines; pressure valves [parts of machines]; clack valves [parts of machines]; pressure reducers [parts of machines]; shoe lasts [parts of machines]; cowlings [parts of machines]; machine wheels; compressors [machines]; condensers [steam] [parts of machines]; grease boxes [parts of machines]; housings [parts of machines]; cranks [parts of machines]; machine fly-wheels; hammers [parts of machines]; superchargers; vacuum pumps [machines]; compressed air pumps; lubricating pumps; self-regulating fuel pumps; pumps [parts of machines, engines or motors]; axles for machines; chucks [parts of machines]; exhaust manifold for engines; carburettor feeders; hangers [parts of machines]; anti-friction bearings for machines; roller bearings; self-oiling bearings; bearings for transmission shafts; ball-bearings; shock absorber plungers [parts of machines]; pistons for engines; pistons [parts of machines or engines]; pistons for cylinders; fuel conversion apparatus for internal combustion engines; springs [parts of machines]; radiators [cooling] for motors and engines; pressure regulators [parts of machines]; speed governors for machines, engines and motors; regulators [parts of machines]; stuffing boxes [parts of machines]; sparking plugs for internal combustion engines; glow plugs for diesel engi-



nes; heat exchangers [parts of machines]; transmissions for machines; hydraulic turbines; connecting rods for machines, motors and engines; joints [parts of engines]; igniting devices for internal combustion engines; door closers, electric; pneumatic door openers and closers [parts of machines]; hydraulic door openers and closers [parts of machines]; door openers, electric; control mechanisms for machines, engines or motors; filters for cleaning cooling air, for engines; filters [parts of machines or engines]; brushes [parts of machines]; speed governors for machines, engines and motors.

12 – Automobiles; motor cars; refrigerated vehicles; sports cars; caravans; bumpers for automobiles; luggage carriers for vehicles; tires for vehicle wheels; brakes for vehicles; brake shoes for vehicles; fenders for land vehicles; automobile engines; valves for vehicle tires [tyres]; lug nuts for vehicle wheels; hoods for vehicles; trucks; treads for vehicles [tractor type]; doors for vehicles; engines for land vehicles; driving motors for land vehicles; spare wheel holders for automobiles; brake discs for vehicles; anti-theft devices for vehicles; adhesive rubber patches for repairing inner tubes; inner tubes for pneumatic tires [tyres]; hoods for vehicle engines; crankcases for land vehicle components, other than for engines; vehicle wheels; brake pads for automobiles; hub caps; brake linings for vehicles; gear boxes for land vehicles; bands for wheel hubs; caps for vehicle petrol [gas] tanks; automobile bodies; tipping bodies for lorries [trucks]; clutches for land vehicles; driving belts and chains for land vehicles; freewheels for land vehicles; clutches for land vehicles; repair outfits for inner tubes; air pumps [vehicle accessories]; upholstery for vehicles; rims for wheels of bicycles, cycles; axles for vehicles; headlight wipers; gearing for land vehicles; suspension shock absorbers for vehicles; air bags [safety devices for automobiles]; casings for pneumatic tires [tyres]; torque converters for land vehicles; cigar lighters for automobiles; non-skid devices for vehicle tires [tyres]; anti-glare devices for vehicles; anti-theft devices for vehicles; sun-blinds adapted for automobiles; balance weights for vehicle wheels; shock absorbing springs for vehicles; reduction gears for land vehicles; safety belts for vehicle seats; vehicle suspension springs; luggage carriers for vehicles; steering wheels for vehicles; brake segments for vehicles; luggage nets for vehicles; anti-theft alarms for vehicles; reversing alarms for vehicles; safety seats for children, for vehicles; vehicle seats; hydraulic circuits for vehicles; spoilers for vehicles; windscreens; windshield wipers; hubs for vehicle wheels; trailer hitches for vehicles; couplings for land vehicles; undercarriages for vehicles; driving chains for land vehicles; transmission chains for land vehicles; automobile chassis; connecting rods for land vehicles, other than parts of motors and engines; vehicle wheel tires

[tyres]; mudguards; motors, electric, for land vehicles; suspension shock absorbers for vehicles.

(260) AM 2015 76055 A  
(800) 1192345  
(891) 2013 08 30  
(731) ZENTIVA GROUP, A.S.  
U Kabelovny 130, CZ-102 37 Praha  
10 – Dolní Měcholupy, Czech Republic  
(540)

## TELFORT

(511)  
5 – Pharmaceuticals, pharmaceutical preparations for human use.

(260) AM 2015 76057 A  
(800) 1192353  
(891) 2013 11 06  
(731) GLENCORE INTERNATIONAL AG  
Baarerstattstrasse 3, CH-6340 Baar,  
Switzerland  
(540)

## GLENCORE

(511)  
14 – Precious metals and their alloys and goods in precious metals or coated therewith not included in other classes; jewelry; precious stones; timepieces and chronometric instruments; Gold; platinum; platinum (metal); palladium; rhodium; silver; coins; gemstones; pearls (jewelry); component parts and accessories for the aforementioned goods, included in this class.

37 – Construction; repair; installation services; industrial mining services; extraction of oil; gas extraction; mining extraction; quarrying; exploitation of oil deposits; mining extraction; construction of buildings; drilling of wells; drilling of deep oil or gaswells; wrecking services; rental of tools, equipment and materials for construction and demolition; cleaning services; maintenance services; extermination services, namely extermination of vermin except in agriculture; disinfecting; pest control except for agricultural purposes; information, consultancy and advice services for the aforesaid services.

(260) AM 2015 76059 A  
(800) 1192404  
(891) 2013 09 02  
(731) SWARCO AG  
Blattenwaldweg 8, A-6112 Wattens,  
Austria  
(540)



(591) blue, orange, black

(511)

7 – Automatic vending machines.

9 – Scientific, nautical, surveying, photographic, cinematographic, optical, weighing, measuring, signalling, checking (supervision), life-saving and teaching apparatus and instruments; apparatus and instruments for conducting, switching, transforming, accumulating, regulating or controlling electricity; apparatus for recording, transmission or reproduction of sound or images; magnetic data carriers, recording discs; mechanisms for coin-operated apparatus; cash registers, calculating machines, data processing equipment and computers; fire-extinguishing apparatus.

11 – Apparatus for lighting, heating, steam generating, cooking, refrigerating, drying, ventilating, water supply and sanitary purposes.

38 – Telecommunications.

39 – Transport; packaging and storage of goods; travel arrangement.

42 – Scientific and technological services and research and design relating thereto; industrial analysis and research services; design and development of computer hardware and software.

(260) AM 2015 76061 A

(800) 1192414

(891) 2013 10 04

(731) SOVMESTNOE OBCHTCHESTVO S  
OGRANITCHENNOY OTVETSTVEN-  
NOSTIYU "CONTE SPA"  
d. 30, Pobedy Street, 230026 Grodno, Belarus

(540)

## TRINITI

(511)

3 – Bleaching preparations and other substances for laundry use; cleaning, polishing, scouring and abrasive preparations; soaps; perfumery, essential oils, cosmetics, hair lotions; styling mousse; dentifrices; deodorants for human beings or for animals; shampoos; antistatic preparations for household purposes; scale removing preparations for household purposes; stain removers; cleaning preparations and substances, detergents other than for use in manufacturing operations or for medical purposes; cleaning preparations for irons to facilitate smooth ironing; rust removing preparations; baby powder not for medical purposes; baby oils, not for medical purposes; toiletries; adhesives for cosmetic purposes; false nails; cosmetic preparations for baths; tissues impregnated with cosmetic lotions; potpourris (fragrances); bath salts, not for medical purposes; decorative transfers for cosmetic purposes; creams for leather; sunscreen creams for cosmetic use; suntan creams; cosmetic

creams; creams for cellulite reduction for cosmetic use; anti-aging creams for cosmetic use.

25 – Headgear except headgear for sport; underclothing; brassieres; teddies (undergarments); hosiery; layettes (clothing); neckties; knitwear; beach clothes; masquerade costumes; ear muffs (clothing); headbands (clothing); bath slippers; sashes for wear; scarfs; gaiter straps; women's stockings, tights, leggings; children's stockings, tights, leggings.

35 – Retail services relating to the abovementioned goods of classes 3, 18 and 25; sales promotion of the abovementioned goods of classes 3, 18 and 25 for others.

(260) AM 2015 76062 A

(800) 1192418

(891) 2013 10 21

(731) DEEP, SIA

Ūnijas iela 38-14, LV-1084 Rīga, Latvia

(540)

## LOC-WATCH

(511)

9 – Global positioning system (GPS) apparatus; receivers, transmitters, computer hardware, computer software and sensors for determining precise geographic locations of movable objects; global positioning sensors; computer programs; communication software.

38 – Communications services, namely, transmission of information pertaining to navigation, location, tracking, mapping, and timing of objectives by means of global position systems (GPS); transmission of digital information; providing user access to computer programs in a data networks.

42 – Computer software development; computer programming.

(260) AM 2015 76064 A

(800) 1192434

(891) 2013 10 02

(731) SPIESS-URANIA CHEMICALS GMBH  
Frankenstraße 18 b, 22097 Hamburg,  
Germany

(540)

## CUPROZIN

(511)

3 – Bleaching preparations and other substances for laundry use; cleaning, polishing, scouring and abrasive preparations; soaps; perfumery, essential oils, cosmetics, hair lotions; dentifrices; leaf shine compositions; cleaning preparations for gardens and containers; chemicals, namely preparations for cleaning gardens and containers.

(260) AM 2015 76065 A  
 (800) 1192435  
 (891) 2013 10 29  
 (731) AKTSIONERNOE OBSHCHESTVO  
 "EURASIAN FOODS CORPORATION"  
 ul. Baizakova, d. 69, 050026 g. Almaty,  
 Kazakstan

(540)



(591) Blue, white and gold

(511)

29 – Meat, fish, poultry and game; meat extracts; preserved, dried and cooked fruits and vegetables including tomato puree, canned beans, canned peas, canned mushrooms, gherkins; piccalilli, pickles; jellies, jams, compotes; eggs, milk, condensed milk, milk products; edible oils and fats, including vegetable oils, blend of vegetable oils, oils for deep-fry, butter, margarines, spreads, edible creams and pastes based on vegetable fats and suet for food, edible creams and pastes based on vegetable oils; fat-containing mixtures for bread slices; sunflower seeds prepared, prepared nuts; potato chips; cutlets.

30 – Coffee, tea, cocoa, sugar, rice, tapioca (manioc); sago; artificial coffee; flour and preparations made from cereals, groats for human food (including buckwheat), bread, pastry and confectionary, ices; honey, treacle; yeast, baking-powder; salt, mustard, vinegar, sauces (condiments), including horseradish sauce, prepared mustard, sauces including soya sauces, tomato sauces, pepper sauces, vegetable sauces, sauces based on vegetable puree, fruit sauces, fruit coulis (sauces), fat and milk based sauces, mayonnaise sauce, vegetable oils based sauces, dressings for salad; mayonnaise, ketchup; spices, edible ice; popcorn; semi-finished products included in this class, particularly ravioli, manty (dumplings), vareniki (dumplings).

43 – Services for providing food and drink including snack-bars, cafes, cafeterias, restaurants, self-service restaurants, canteens, bar services; food and drink catering; temporary accommodation.

(260) AM 2015 76066 A  
 (800) 1192462  
 (891) 2013 12 16  
 (731) SUAREZ H, S.A.  
 Gran Via, 40 Bis – 3º, E-48009 Bilbao,  
 Vizcaya, Spain

(540)

**ARISTOCRAZY**

(511)  
 25 – Clothing, footwear, headgear, expressly excluding stockings, leotards, pantyhose and socks for women.

(260) AM 2015 76067 A  
 (800) 1192470  
 (891) 2013 11 27  
 (731) PREMIER BEVERAGES P.B. LIMITED  
 Arch. Makariou III, 2-4, Capital Center, 9-th  
 floor, CY-1065 Nicosia, Cyprus

(540)

**ЗОЛОТАЯ КРУЖКА**

(511)

32 – Beers; mineral and aerated waters and other non-alcoholic beverages; fruit beverages and fruit juices; syrups and other preparations for making beverages.

33 – Alcoholic beverages (except beers).

(260) AM 2015 76068 A  
 (800) 1192478  
 (891) 2013 11 28  
 (731) BAHLSEN GMBH & CO. KG  
 Podbielskistrasse 11 30163 Hannover, Germany

(540)

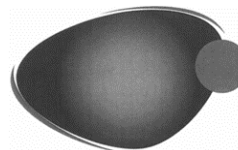

(591) Black, white

(511)

29 – Meat, fish, poultry and game; meat extracts; frozen, preserved, dried and cooked fruits and vegetables; jellies, jams, compotes; eggs, milk and milk products; edible oils and fats; foodstuffs made from extruded potato products; potato crisps, potato sticks, raisins, hazelnut, peanut and cashew nut kernels, pistachio nut kernels and almonds, dried, roasted, salted and/or spiced; dried fruit.

30 – Coffee, tea, cocoa, sugar, rice, tapioca, sago j coffee substitutes; flour and preparations made from cereals; bread, pastry and confectionery, ices; honey, treacles; yeast, baking powder, salt, mustard, vinegar, sauces (condiments), spices, ice; cookies, cakes, chocolate, chocolate goods, pralines, sugar confectionery, sweets, marzipan; extruded wheat, rice and maize products for food, puffed corn.

(260) AM 2015 76069 A  
 (800) 1192481  
 (891) 2013 11 22  
 (731) YIGIT AYDOGAR  
 Jägerstrasse 73, 47166 Duisburg, Germany

(540)

**VERSAGE**

(511)

32 – Beers; mineral and aerated waters and other non-alcoholic drinks; fruit drinks and fruit juices; syrups and other preparations for making beverages.

33 – Alcoholic beverages (except beers).

(260) AM 2015 76070 A

(800) 1192483

(891) 2013 11 12

(731) TOVARYSTVO Z OBMEZHENOIU  
VIDPOVIDALNISTIU "INVERT"

vul. Vuzka 19, Poltava, 36022, Ukraine

(540)

(591) Blue

(511)

30 – Peanut confectionery; meal; flour for food; farinaceous foods; pastries; bread rolls; buns; waffles; vermicelli (noodles); oatmeal; oat-based food; biscuits; fruit jellies (confectionery); cereal preparations; sandwiches; caramels (candy); lozenges (confectionery); confectionery; corn meal; confectionery for decorating Christmas trees; liquorice (confectionery); macaroni; farinaceous food pastes; semolina; peppermint sweets; marzipan; macaroons (pastry); almond confectionery; flour-milling products; pancakes; cookies; pies; pies (confectionery); meat pies; quiches; fondants (confectionery); gingerbread; wheat flour; malt biscuits; spaghetti; rusks; petit-beurre biscuits; cakes; petits fours (cakes); crackers; tarts; rice cakes; bread; sweetmeats (candy); fondants (confectionery); barley meal.

35 – Demonstration of goods; business information; business inquiries; distribution of samples; shop window dressing; dissemination of advertising matter; advertising; sales promotion for others.

(260) AM 2015 76073 A

(800) 1192546

(891) 2013 09 11

(731) CHEMO IBERICA, S.A.

Gran Vía Carlos III, №98-7ª, E-08028

Barcelona, Spain

(540)

(591) Various shades of blue. Dark blue, lighter blue

(511)

5 – Pharmaceutical preparations for use in the treatment of ophthalmic diseases and disorders, dermatological diseases and disorders, digestive diseases and disorders, gynecological diseases and disorders; reagents for use in pregnancy tests; reagents for use in ovulation tests; reagents for use in testing for diabetes; contraceptives; pharmaceutical preparations for use in the treatment of hormonal diseases and disorders, blood disorders, cancer, cardiovascular diseases, vascular diseases, gastro-intestinal diseases, genitourinary diseases, immunological diseases, infectious diseases, inflammatory diseases, metabolic diseases and disorders; pharmaceutical preparations for use in the treatment of neurological diseases and disorders, psychiatric diseases, diseases of the central nervous system, diseases of the musculoskeletal system, diseases of the respiratory system, diseases of the circulatory system, viral diseases, glaucoma, dental and mouth diseases, headaches, migraines, obesity, cholesterol, in liver treatment; nutraceutical preparations; blood pressure treatment; treatments for rheumatism; veterinary preparations for the treatment of digestive diseases and disorders, gynecological diseases and disorders, blood disorders, cancer, the treatment of cardiovascular diseases, vascular diseases, gastrointestinal diseases, genitourinary diseases, immunological diseases, infectious diseases, inflammatory diseases, metabolic diseases and disorders, the treatment of neurological diseases, the central nervous system, the musculoskeletal system, the circulatory system and the respiratory system, the treatment of viral diseases, glaucoma, dental and oral diseases, headaches, migraines, obesity, liver treatment, cholesterol; nutraceutical veterinary preparations; veterinary preparations for the treatment of blood pressure and for rheumatism; and dietetic foods for medical use.

10 – Surgical apparatus and instruments, medical instruments for use in gynecological disorders; in ophthalmological disorders, in dermatological disorders, in respiratory and metabolic disorders; pregnancy tests; ovulation tests; diabetes tests; orthopedic devices for diagnostic and therapeutic use; suture materials.

35 – Sales promotion for third parties, business management assistance; consulting on business management and marketing studies; presentation of goods on any kind of communication media for retail sale; commercial administration of licenses for the goods and services of others; organization of exhibitions, trade fairs or congresses for business or advertising purposes, all relating to pharmaceutical, veterinary and biotechnological companies and for pharmaceutical, veterinary and biotechnological products.

42 – Chemical, biological and pharmaceutical research services.

(260) AM 2015 76076 A  
 (800) 1192563  
 (891) 2013 08 29  
 (731) SHENZHEN SONGMATAI  
 TECHNOLOGY PLASTIC ELECTRONIC  
 FACTORY  
 4/F, Building A7, No:1 Laodong Industrial  
 Zone, Xixiang Street, Baoan District,  
 SHENZHEN, China

(540)  

(591) Black, white  
 (511)  
 9 – Mouses [data processing equipment]; computer  
 peripheral devices; computer keyboards; laptop co-  
 mputers; notebook computers; video telephones; na-  
 vigation apparatus for vehicles [on-board compu-  
 ters]; learning machines; cabinets for loudspeakers.

(260) AM 2015 76079 A  
 (800) 1192604  
 (891) 2013 11 25  
 (731) JAPAN TOBACCO INC.  
 2-2-1 Toranomom, Minato-ku, Tokyo, Japan

(540)  

(591) Black, orange, blue and white  
 (511)  
 34 – Tobacco, raw or manufactured; smoking tobac-  
 co, pipe tobacco, rolling tobacco, chewing tobacco,  
 moist tobacco powder called "snus"; cigarettes, ci-  
 gars, cigarillos; snuff; smokers' articles included in  
 this class; cigarette paper, cigarette tubes and mat-  
 ches.

(260) AM 2015 76081 A  
 (800) 1192628  
 (891) 2013 11 28  
 (731) BAHLSSEN GMBH & CO. KG  
 Podbielski-Str. 11, 30163 Hannover, Germany

(540)  

(591) Blue, white, red and brown  
 (511)  
 29 – Meat, fish, poultry and game; meat extracts;  
 frozen, preserved, dried and cooked fruits and vege-  
 tables; jellies, jams, compotes; eggs, milk and milk  
 products; edible oils and fats; foodstuffs made from

extruded potato products; potato crisps, potato  
 sticks, raisins, hazelnut, peanut and cashew nut  
 kernels, pistachio nut kernels and almonds, dried,  
 roasted, salted and/or spiced; dried fruit.

30 – Coffee, tea, cocoa, sugar, rice, tapioca, sago,  
 coffee substitutes; flour and preparations made from  
 cereals; bread, pastry and confectionery, ices; honey,  
 treacles; yeast, baking powder, salt, mustard, vine-  
 gar, sauces (condiments), spices, ice; cookies, cakes,  
 chocolate, chocolate goods, pralines, sugar confec-  
 tionery, sweets, marzipan; extruded wheat, rice and  
 maize products for food, puffed corn.

(260) AM 2015 76090 A  
 (800) 1192662  
 (891) 2013 12 18  
 (731) OBSHESTVO S OGRANICHENNOY  
 OTVETSTVENNOSTYU "FISSMAN  
 BIOECOLISTIK"  
 str. 1, d. 11, 1-y Magistralny tupik,  
 RU-123290 Moscow, Russian Federation

(540)  

(591) Black, white  
 (511)  
 8 – Table forks; sharpening instruments; ladles for  
 wine; spoons; cheese slicers, non-electric; egg slic-  
 ers, non-electric; pizza cutters, non-electric; scaling  
 knives; can openers, non-electric; knives; scissors;  
 vegetable slicers; table cutlery [knives, forks and  
 spoons]; silver plate [knives, forks and spoons].

35 – Import-export agencies; commercial informa-  
 tion agencies; demonstration of goods; marketing  
 studies; business investigations; marketing research;  
 organization of exhibitions for commercial or adver-  
 tising purposes; organization of trade fairs for com-  
 mercial or advertising purposes; shop window dres-  
 sing; data search in computer files for others; com-  
 mercial or industrial management assistance; presen-  
 tation of goods on communication media, for retail  
 purposes; auctioneering; sales promotion for others;  
 rental of vending machines; distribution of samples;  
 compilation of information into computer databases;  
 administrative processing of purchase orders; mode-  
 lling for advertising or sales promotion; procurement  
 services for others [purchasing goods and services  
 for other businesses].

(260) AM 2015 76140 A  
 (800) 861383  
 (891) 2013 11 21  
 (731) LISTANO LIMITED  
 37 Greenhill Street, Stratford upon Avon  
 CV37 6LE, United Kingdom

(540)  



(511)

16 – Paper and cardboard (unprocessed, semi-processed or for stationery or printing); printed matter; bookbinding material; photographs; stationery; adhesives for stationery and household purposes; artists' materials; paintbrushes; typewriters and office requisites (except furniture); instructional and teaching material (except apparatus); printers' type; printing blocks.

35 – Advertising; business management; business administration; office functions, distribution of prospectuses and samples, business consultancy and information, document reproduction, computerized file management, organization of exhibitions for commercial or advertising purposes.

45 – Astrology, parapsychology, radiesthesia, cartomancy, fortune telling, futurology.

(260) AM 2015 76141 A

(800) 910024

(891) 2014 01 14

(731) MONTENAPO 79 S.R.L.

Via Montenapoleone 5, I-20121 MILANO,  
Italy

(540)



(591) Black, white

(511)

25 – Shirts; blouses; brassieres; corsets; singlets; petticoats; nightgowns; pyjamas; dressing gowns; pullovers; bath robes; bathing suits; gloves [clothing]; cardigans; jerseys; neckties; neckerchiefs; scarves; sweaters; socks; stockings; tights; trousers; leggings [leg warmers]; leggings [trousers]; skirts; jackets; jerkins; vests; waistcoats; jumpers; track suits; jeans; panties; pants; bermuda shorts; T-shirts; sweat shirts; suits; dresses; overcoats; coats; anoraks; raincoats; belts [clothing]; suspenders; shoes; boots; slippers; sandals; hats; caps.

35 – Franchising, namely services rendered by a franchisor, that is transfer of business and organisational know-how, assistance in the development and management of a commercial enterprise; the bringing together, for the benefit of others, of clothing articles, footwear, headgear [excluding the transport thereof], enabling customers to conveniently view and purchase those goods; on-line and non-online retail and wholesale services of clothing articles, footwear, headgear; commercial administration of the licensing of the goods and services of others; administrative processing of purchase orders; advertising; advertising by mail order; dissemination of advertising material; commercial information and advice for consumers [consumer advice shop]; cost price analysis; business management assistance; professional business consultancy; business information; bu-

ness management and organization consultancy; business research; demonstration of goods; distribution of samples; organization of exhibitions for commercial or advertising purposes; organization of trade fairs for commercial or advertising purposes; import-export agencies; marketing research; marketing studies; modelling for advertising or sales promotion; on-line advertising on a computer network; presentation of goods on communication media, for retail purposes; procurement services for others [purchasing goods and services for other businesses]; publicity; sales promotion for others; shop window dressing.

42 – Franchising, namely services rendered by a franchisor, that is transfer of technical know-how; consultancy relating to the planning and layout design of shops, the interior decor of shops and related signs; architectural consultation; architecture; cosmetic research; design of interior decor; dress designing; quality control; styling [industrial design]; technical research.

(260) AM 2015 76142 A

(800) 942429

(891) 2013 11 22

(731) WIZZ Air Hungary Kft.

BUD Nemzetközi Repulotér, (BUD  
International Airport) 221. ép., H-1185  
Budapest, Hungary

(540)

## Wizz air

(526) The trademark is protected as a whole. The word "air" included therein shall not be subject to independent legal protection.

(511)

12 – Vehicles; apparatus for locomotion by land, air or water.

39 – Transport of passengers; transport of goods; travel arrangement.

43 – Catering services; temporary accommodation.

(260) AM 2015 76145 A

(800) 962018

(891) 2013 11 13

(731) LB BULGARICUM Plc.

9, Saborna Str., BG-1000 SOFIA, Bulgaria

(540)



(591) Black, white

(511)

1 – Bacterial cultures for production of dairy products.

5 – Dietetic substances adapted for medical use, dietetic beverages adapted for medical purposes, dietetic foods adapted for medical purposes, nutritional additives for medical purposes, dietetic food preparations adapted for medical purposes.

29 – Milk and milk products.

(260) AM 2015 76146 A

(800) 1039305

(891) 2013 05 23

(731) PHARMATON SA

Via Mulini, CH-6934 BIOGGIO, Switzerland

(540)



(591) White, grey

(511)

5 – Pharmaceutical preparations; sanitary preparations for medical use; dietetic substances adapted for medical use, food for babies; plasters, materials for dressings; disinfectants.

29 – Food supplements and health foods, either not for medical use, based on proteins, with added vitamins, mineral substances, trace elements, or singly or combined (all the aforesaid goods included in this class).

30 – Food supplements, health foods and additives for foodstuffs not for medical use, novel food included in this class; all the above goods made with plant extracts either singly or combined with vitamins, minerals and trace elements.

(260) AM 2015 76147 A

(800) 1046904

(891) 2013 12 18

(731) DREW BRADY & CO. LIMITED

Kearsley Mill, Stoneclough, Radcliffe,  
Manchester M26 1RH, United Kingdom

(540)

## HEAT HOLDERS

(511)

25 – Clothing, footwear, headgear.

(260) AM 2015 76162 A

(800) 1177646

(891) 2013 12 27

(731) MYKOLA GRYGOROVYCH LYAPKO

m-n Sonyachny, 8-21, Krasnogorivka,  
Marjinsky rajon, Donetsk obl. 85630,  
Ukraine

(540)



(591) Black, white

(511)

10 – Abdominal pads; abdominal corsets; acupuncture needles; anaesthetic apparatus; arch supports for footwear; apparatus for artificial respiration; bandages for joints, bandages, elastic; beds, specially made for medical purposes; belts, electric, for medical purposes; belts for medical purposes; orthopaedic [orthopedic] belts; blankets, electric, for medical purposes; boots for medical purposes; childbirth mattresses; corsets for medical purposes; diagnostic apparatus for medical purposes; draw-sheets for sick beds; electric acupuncture instruments; electrodes for medical use; furniture especially made for medical purposes; galvanic therapeutic appliances; galvanic belts for medical purposes; gloves for massage; heating cushions [pads], electric, for medical purposes; heating pads, electric, for medical purposes; inhalers; knee bandages, orthopedic; lamps for medical purposes; massage apparatus; maternity belts; medical apparatus and instruments; needles for medical purposes; orthopaedic footwear; orthopaedic articles; orthopaedic soles; pads [pouches] for preventing pressure sores on patient bodies; physical exercise apparatus, for medical purposes; physiotherapy apparatus; resuscitation apparatus; splints, surgical; supportive bandages; supports for flat feet; suspensory bandages; traction apparatus for medical purposes; water bags for medical purposes.

35 – Advertising; advertising by mail order; bill-posting; business management assistance; demonstration of goods; direct mail advertising; dissemination of advertising matter; distribution of samples; marketing studies; marketing research; organization of exhibitions for commercial or advertising purposes; presentation of goods on communication media, for retail purposes; radio advertising; sales promotion for others; television advertising.

(260) AM 2015 76220 A

(800) 1193445

(891) 2013 12 18

(731) BAYER INTELLECTUAL PROPERTY

GMBH

Alfred-Nobel-Straße 10, 40789 Monheim am  
Rhein, Germany

(540)

## LATYVAR

(511)  
5 – Pharmaceutical preparations.

(260) AM 2015 76237 A

(800) 1193546

(891) 2013 09 27

(731) "ASKONA HOLDING COMPANY" LLC  
Vatutina St., 90, Vladimir region, RU-601900  
Kovrov, Russian Federation

(540)



(591) White, Blue, Green and Yellow

(511)

20 – Furniture, mirrors, picture frames; goods [not included in other classes] of wood, cork, reed, cane, wicker, horn, bone, ivory, whalebone, shell, amber, mother-of-pearl, meerschaum and substitutes for all these materials, or of plastics.

24 – Textiles and textile goods, not included in other classes; bed covers; table covers.

35 – Advertising; business management; business administration; office functions.

(260) AM 2015 76241 A

(800) 1193549

(891) 2013 10 17

(731) GESELLSCHAFT MIT BESCHRÄNKTER  
HAFTUNG "EHRMANN"  
pos. RAOS, 15, Ramenskiy r-n, RU-140025  
Moscow Region, Russian Federation

(540)



(591) Orange, light orange, dark orange, yellow, dark yellow, light yellow, white, blue, brown, dark brown and beige

(511)

29 – Milk products, namely yoghurt, drinking yogurt, dessert quark, quark products with fruit, milk-based and cream-based desserts, milk-based and cream-based desserts with addition of fruit filling, milk-based and cream-based buttercream.

(260) AM 2015 76242 A

(800) 1193550

(891) 2013 10 17

(731) GESELLSCHAFT MIT BESCHRÄNKTER  
HAFTUNG "EHRMANN"  
pos. RAOS, 15, Ramenskiy r-n, RU-140025  
Moscow Region, Russian Federation

(540)



(591) Brown, light brown, dark brown, yellow, blue, white, orange, light orange, dark orange, beige, deep red, maroon and red

(511)

29 – Milk products, namely yoghurt, drinking yogurt, dessert quark, quark products with fruit, milk-based and cream-based desserts, milk-based and cream-based desserts with addition of fruit filling, milk-based and cream-based buttercream.

(260) AM 2015 76245 A

(800) 1193598

(891) 2013 11 29

(731) COMPAGNIE GENERALE DES  
ETABLISSEMENTS MICHELIN  
12 Cours Sablon, F-63000 CLERMONT  
FERRAND, France

(540)

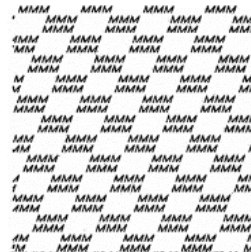

(591) Black, white

(511)

12 – Pneumatic tires and inner tubes for vehicle wheels; treads for retreading tires; tracks for track vehicles.

(260) AM 2015 76248 A

(800) 1193610

(891) 2013 12 05

(731) LIMITED LIABILITY COMPANY  
"VIKTORIYA"  
Pobedy Street, 102, RU-352630 Belorechensk,  
Krasnodarskiy Krai, Russian Federation

(540)





(591) Black, grey

(511)

30 – Sponge dough products, namely, sponge cake roll, sponge layer cake, sponge plum cake, sponge pie, sponge dough discs; waffles; pastries; candy; crackers; fruit jellies [confectionery]; marzipan; muesli; cookies; condiments; ketchup [sauce]; popcorn; confectionery; cereal preparations; flour-milling products; oat-based food; gingerbread; sweetmeats [candy]; rusks; tarts; cereal-based snack food; chocolate.

(260) AM 2015 76252 A

(800) 1193653

(891) 2013 07 02

(731) DAF Trucks N.V.

Hugo van der Goeslaan 1, NL-5643 TW  
Eindhoven, Netherlands

(540)



(591) Red, white and blue

(511)

1 – Antifreeze; brake fluid; liquids and solutions for batteries; protective gases for welding; welding chemicals; soldering fluxes; chemical cleaning additives to gasoline and other motor fuels; coolants for vehicle engines; combusting preparations being chemical additives to motor fuel; glues, adhesives and sealants for the maintenance and repair of vehicles; fuel-saving preparations; transmission fluid; fluids for power steering.

6 – Sheet metal for vehicles.

9 – Coupling amplifiers for land vehicles; control mechanisms for cabins and windows of vehicles (parts of vehicles), non-electric.

11 – Apparatus for lighting; drying, air conditioning, heating, cooling and ventilation equipment including filters and cabin filters being parts of the aforementioned devices, whether or not for vehicles; electric lamps; lamps; vehicle reflectors; LED luminaries to be used with reflection bands for vehicles; lighting apparatus for vehicles; interior lighting for vehicles; lamps for vehicles, including lamps for directional signals; vehicle tail lights and headlights; high beam headlamps for vehicles; fog lamps for vehicles; pocket torches, electric; vehicle breakdown warning light; marker lamps; safety lamps; work lamps; light bulbs; microwave ovens (cooking apparatus); electrical water heaters; electric coffee percolators; cold boxes, electric, for use in trucks; blankets, electric, not for medical purposes; air driers; cartridges as components of air driers; filters for air conditioning; air filtering installations; air purifying apparatus and machines; cooling installations and machines; refrigerating cabinets and chambers with their parts;

radiator caps; air conditioning and heaters for vehicles; lamp brackets for trailer lights; anti-glare devices for vehicles (lamp fittings); parts for refrigeration equipment and machines.

12 – Vehicles; parts for vehicles, not included in other classes; trucks, buses, trailers, semi-trailers; engines for land vehicles; vehicle cabs; cab, chassis and body parts for vehicles, trailers and semi-trailers; cargo lift parts and shaft parts for vehicles, trailers and semi-trailers; spoilers, grills, bumpers, side skirts, fenders, seats, doors and steps for vehicles; foot boards for trucks; door extensions and door windshields being parts of vehicles; hoods and sunblinds specially adapted for vehicles; belts for land vehicles; transmission shafts and transmission chains for land vehicles; windscreen wipers; blades for windscreen wipers; windows for vehicles; pneumatic spring bellows for vehicles; brake shoes, brake drums, brake calipers, brake hoses, brake discs, brake couplers, brake cylinders, brake pads, brake linings, brake segments for vehicles; brakes for vehicles; air brake valves for vehicle tires; brake levers and ABS sensor cables being parts of brakes for vehicles; valves for vehicle tires; caps for vehicle petrol (gas) tanks; fuel tanks, coolant tanks, wiper fluid tanks, fluid tanks, antifreeze liquid tanks and other such tanks specially for vehicles; suspension shock absorbers for vehicles; shock absorbing springs for vehicles; splash guards and mud flaps for vehicles; anti-skid chains; vehicle wheel tires; air pumps for vehicles; headlight wipers; clutches for land vehicles and heads therefor; gear boxes for land vehicles; couplings for land vehicles and trailers; steering parts for vehicles; covers for steering wheels; steering wheels for vehicles; vehicle covers (shaped); covers for vehicle seats; horns and air horns for vehicles; refrigerated vehicles and load carrying trailers; outriggers for vehicles; interior and outside mirrors for vehicles; safety belts for vehicle seats; wheel hubs, sockets, rings, rims, bearings and bolts for vehicle wheels for land vehicles; hydraulic cylinders for tilting truck cabins; drawbar couplings for land vehicles; hydraulic circuits for vehicles; transmission belts for land vehicles; anti-theft alarms for vehicles; lockable fuel caps for vehicles.

(260) AM 2015 76253 A

(800) 1193656

(891) 2013 08 12

(731) CONTINENTAL REIFEN DEUTSCHLAND  
GMBH

Vahrenwalder Str. 9, 30165 Hannover, Germany

(540)



(591) Black, white

(511)

1 – Chemicals used in industry, science, photography, agriculture, horticulture and forestry; unprocessed artificial resins, unprocessed plastics; manures; fire-extinguishing compositions; tempering and soldering preparations; tanning substances; adhesives used in industry; rubber solvents; synthetic materials for absorbing oils; vulcanization accelerators; vulcanizing preparations; photosensitive plates for printing purposes; sensitised offset-printing plates; brake fluid.

4 – Industrial oil and grease; lubricants; dust absorbing, wetting and binding compositions; fuels (including engine fuel) and illuminants; grease for motor vehicles; brake paste.

6 – Common metals and their alloys; metal building materials; transportable constructions of metal; metal building materials for railway tracks; metal cables and wires (not for electrical purposes); ironmongery and small items of metal hardware; metal pipes and flexible tubings; metal hose and pipe connectors; metal manifolds, couplings and adapters; metal hose and pipe couplings, fittings as far as included in this class; metal pipes and tubes for ventilation and air-conditioning systems; metal molds; metal goods as far as included in this class.

7 – Metal, wood, rubber and plastics working machines, for the manufacture, repair and disassembly of land and sea vehicles, for the chemical industry, agriculture, mining, textile, food and beverage, construction and packaging industry; machine tools; printing machines; printing frames, printing plates; machines used in the manufacture of printing plates; printing plates [not light-sensitive]; pressure casting molds [machine; components]; lithographic printing plates for printing machines; motors and engines (except for land vehicles and aerospace vehicles); components for motors and engines of all types, including electric motors and their components (except for land vehicles and aerospace vehicles); control units for motors and engines (except for aerospace vehicles); electric starters for motors and engines (except for aerospace vehicles); motor driven electric generators (except for aerospace vehicles); main cylinders; electric motors (except for land vehicles and aerospace vehicles) and pumps (machines); engine actuators (throttle valves, idle governors, linear actuators, air control valves, air flap actuators, exhaust gas recirculation valves) (except for aerospace vehicles); injection valves, injection nozzles for engines (except for aerospace vehicle engines); fuel pumps; fuel injection systems; spark plugs for combustion engines (except for aerospace vehicle engines); glow plugs for diesel engines (except for aerospace vehicle engines); ignition coils; air filters for engines; catalytic converters; chargers [turbochargers]; turbocompressors; control units for

machines; controlled adjusting devices for vehicle parts such as vehicle seats, windows, mirrors, sliding roofs, throttle valves, camshafts; machine coupling and transmission components, including shift clutches (except for land vehicles); drive belts, transmission belts, V-belts, V-ribbed belts, variator belts, timing belts, synchronous belts, nubbed belts, double-sided timing belts, flat belts, lift belts (machine components), conveyor belts; machine components, such as springs, shock absorber pistons, vibration dampers; molded parts made from rubber and rubber-metal bondings for vibration control as far as included in this class; engine mounts; hydraulic mounts, torsional vibration dampers; actuators; all of the aforementioned goods exclusive of aerospace vehicle power plants, aerospace vehicle piston engines, aerospace vehicle turbine engines and parts and controls therefor; valves (machine components); conveyor belts, belt conveyors, parts and accessories for conveyor belts and belt conveyors; passenger conveyors not included in other classes; (compressed air) spray guns for water, oil, gas, paint and other gaseous or liquid substances; metal fittings (accessories for spray guns or sprayers); mechanical vehicle jacks; lawn mowers (machines); agricultural implements, other than hand operated; automatic distribution machines.

8 – Hand tools for installing, repairing and mounting drive belts; cutlery, forks and spoons; side arms; razors; repair hand tools for motor vehicles; hand tools for installing, testing and checking vehicle brake, fuel feed and injection systems; hand-operated syringes for water, oil, paint, gas and other gaseous or liquid substances; hand-operated spray guns; sprayers; metal fittings (accessories for spray guns or sprayers).

9 – Scientific, nautical, surveying, electric, photographic, cinematographic, optical, weighing, measuring, signaling, checking (supervision), life-saving and teaching apparatus and instruments as far as included in this class; measuring devices and instruments (except for aerospace vehicles); electric control and regulating systems (except for aerospace vehicles) including their processors and sensors for the steering and controlling of vehicles, for improved driving safety, driving stability, suspension quality and noise reduction; electric control and regulating systems (except for aerospace vehicles) including their processors and sensors for regulation and control of brakes, accelerator pedals, transmissions, chassis and exhaust gases; voltage regulators for vehicles; automatic control systems for vehicles (except for aerospace vehicles); electrical and electrohydraulic power steering (except for aerospace vehicles); ammeters, voltmeters, ohmmeters, manometers, thermometers, tachometers (except for aerospace vehicles); compasses, acidimeters, spirit levels, scales; thermostats (except for aerospace vehicles); engine management and/or idle speed control devi-

ces (except for aerospace vehicles), data management devices, data processing devices; measuring, warning and display devices and instruments for distance, axle load monitoring, acceleration, speed, engine speed, torque, turn rate, pressure, fill level, fluid supply (particularly fuel and washer fluid supply), altitude, coolant temperature, charge pressure, power, air quality, air mass, oil level, oil pressure, position, rudder position, temperature, travel, travel distance, wind and water depth (all of the aforesaid except for aerospace vehicles); distance warning and controlling devices and display instruments (except for aerospace vehicles); radar devices (except for aerospace vehicles); rearview monitoring equipment; automatic parking assistant systems; optical, acoustic and haptic drowsiness and speed warning devices and display instruments; tire pressure gauge, tire inflating equipment; service indicator, wear indicator, consumption measurement device, maintenance indicator, workshop testing equipment; time recording unit; accident data recorder, apparatus and instruments for conducting, switching, converting, storing, regulating and monitoring electricity (except for aerospace vehicles); electrical fuses, electrical relays, transponders, sensors, electric actuators (as far as included in this class); detectors (except for aerospace vehicles); pressure switches; controllers; brake fluid testers; diagnostic apparatus (not for medical purposes); monitoring and diagnostic apparatus and devices and systems made thereof for vehicle engines and power trains (except for aerospace vehicles); warning lamps for vehicles; magnetic valves; lasers, not for medical purposes; electric batteries and their components, rechargeable batteries and their components, solar batteries; fuel cells and their components, chargers for electric batteries; alarm equipment; burglar alarms, burglary detection equipment; electrical opening and closing devices for motor vehicles, including control units, controls and electric motors; central locking systems; electronic immobilizers for motor vehicles; remote control devices; remote operation systems for central locking systems; position finding, course tracking and traffic routing devices (except for aerospace vehicles); navigation instruments; navigation devices for vehicles; GPS devices (except for aerospace vehicles); electric/electronic controllers for convertible soft tops, sliding roofs and sun protection devices; data processing devices, computers including electronic calendars, fax machines, monitors, computer peripheral devices, calculators, computer programs and software, recorded; electrical, electronic, opto-electronic and mechanical analog and digital display devices and instruments (except for aerospace vehicles); image transmission and reproduction devices; electrical or electronic display devices; display equipment, display modules, display elements, display panels, displays, monitors, screens, LCDs, devices with LCDs, flat screens, video scre-

ens and monitors; touch screens; devices for recording, receiving, transmitting and reproducing analog and/or digital signals, as well as images and sound, antennae, radios, television apparatus, telephones including video telephones; hands-free equipment for telephones; rescue equipment, namely life-saving rafts, fire escapes, safety nets, safety tarpaulins, life belts, life buoys, life jackets, fire extinguishing equipment; contact lenses, spectacles, spectacle cases, binoculars, magnifying glasses, sunglasses, vehicle breakdown warning triangles for vehicles; projectors; film cameras; cameras [photography]; photocopiers; electronic translators; electronic pocket translators; exposed film, magnetic, electronic and optical recording media, with the exception of non-exposed film; recording disks including magnetic cards; cards with integrated circuitry (smart cards); telephone cards; mechanisms for coin-operated apparatus including cash machines; cash registers, computing machines; photovoltaic elements; photo cells; presence monitoring devices.

11 – Apparatus for lighting, heating, steam generating, cooking, refrigerating, drying, blowing, ventilation, air-conditioning and water supply and sanitary purposes; attachments for water supply equipment for adjusting and changing the water flow volume; end pieces for water supply equipment; heating and air-conditioning systems for vehicles; fans and ventilation modules for vehicles; vehicle headlights; bicycle lights; vehicle tail lamps; heating, cooling, air-conditioning and ventilation systems in vehicles.

12 – Vehicles for transportation on land and/or on water; parts and accessories for vehicles for transportation on land and/or on water as far as included in this class; combination display instruments, land vehicle cockpits, instrument panels, center consoles; tires, inner tubes for tires, wheels, wheel rims, treads for the retreading of tires, hub caps, rim strips, repair outfits for tires, treads and kits for repairing tires and inner tubes not included in other classes; valves for vehicle tires; chassis and parts thereof included in this class; controlled and non-controlled chassis and suspensions; electronic, hydraulic, electromechanical, electrohydraulic and mechanical brakes for vehicles; parts and accessories for electronic, hydraulic, electromechanical, electrohydraulic and mechanical brakes for vehicles; brake cylinders, brake pads, brake calipers, brake disks, brake linings, brake hoses; mechanical and hydraulic controllers and regulators not included in other classes; regulated and unregulated electromechanical and electrohydraulic steering systems and their components; hydraulic power steering, steering columns, steering gear; electrical, electronic and mechanical actuators, drive shafts and electric motors (except for aerospace vehicles); safety equipment for motor vehicles as far as included in this class; airbags, belt tensioners and their parts and accessories as far as

included in this class; shaft couplings and transmission mechanism, including shift clutches for land vehicles; active and passive, regulated and unregulated dampers and springs for vehicles, wheels and their parts, particularly air pressure springs and gas springs; air supply units for air spring systems; shock absorbers and suspension struts for vehicles; shock absorber springs for vehicles, suspension springs for vehicles; vibration dampers and torsional vibration dampers (except as components of land vehicle engines) for vehicles; vehicle engines, steering apparatus; vehicle cabins and driver seats; hydromounts as vehicle components as far as included in this class; axles and axle modules, axle boots, diaphragms, drive belts, transmission belts not included in other classes; cooling, heating, brake, fuel, charge air, oil, hydraulic hoses being parts of and accessories for vehicles as far as included in this class; vehicle interiors lining; airbag covers; paneling for dashboards; interior upholstery for vehicles; motor vehicle seats; cigarette lighters for automobiles; cockpit cross beams; driver workstations, driver cabins; ventilation nozzles, air deflector elements and air lines; window and headlight cleaning systems for motor vehicles as well as the associated containers, nozzles, hoses, hose couplings, pumps, heaters and valves; windshield and headlight cleaning systems; window lift and window positioning systems for vehicles; electric/electronic drives for convertible soft tops, sliding roofs and sun protection devices; rubber or plastic concertina walls for trains and articulated buses; fuel lines; fuel tank systems for motor vehicles.

16 – Printed matter, printers' type, printing blocks, non-textile printing blankets, components and accessories therefor, not included in other classes; atlases, calendars, geographic maps, publications (written); ball pens and pencils, bookbinding articles; photographs; stationery except stationary made out of paper; adhesives for stationery or household purposes; artists' materials; typewriters and office requisites (except furniture); instructional and teaching material (except apparatus), including textbooks, specialist books, magazines, repair and/or user instructions on automotive parts; plastic materials for packaging as far as included in this class; forms, printed forms, print rolls and diagram plates made out of paper for use in tachographs.

17 – Rubber, gutta-percha, gum, asbestos, mica and goods made from these materials and not included in other classes; plastic goods (semi-finished products); sealing, packing and insulating materials; flexible pipes (not made from metal); flexible pipe connections (not made from metal); armoring for tubes (not made from metal); rubber compensators; line seals; sealing gaiters, sealing rings, diaphragms (not included in other classes); natural rubber (liquid); sub-ballast mats made from rubber and rubber substitutes for vibration and shock damping in track const-

ruktion; oil absorbent mats made of rubber and rubber substitutes; rubber valves; soft top, door, window, engine compartment seals; rubber or plastic upholstery materials; plastic sheeting (except for packaging purposes), including sheeting for sealing and insulating purposes, roof and pond liners made out of plastic; bellows, concertina walls made from rubber or plastic for airport passenger bridges; parts and accessories for all aforementioned goods not included in other classes; rubber for retreading tires; rubber solutions.

18 – Goods of leather and imitations of leather, as far as included in this class; animal skins, hides; trunks and traveling bags; umbrellas, parasols and walking sticks; whips, harness and saddlery including suitcases and bags as far as included in this class, in particular travelling bags, briefcases and handbags, document holders, wallets, key pouches made of leather.

19 – Building materials [non metallic]; non-metallic rigid pipes for building; asphalt, pitch and bitumen; non-metallic transportable buildings; ducts, not of metal, for ventilating and air conditioning installations; water pipes, not of metal [components]; water pipe valves, not made of metal or plastic.

20 – Furniture including beds (furniture), shelves, cupboards, tables, desks, chairs, armchairs, sofas, head-rests, upholstered furniture; mirrors, picture frames and mattresses; goods (not included in other classes) of wood, cork, reed, cane, wicker, horn, bone, ivory, whalebone, shell, amber, mother-of-pearl, meerschaum and substitutes for all these materials, or of plastics, including steeping bags for camping purposes, barrels, casks not of metal, packaging containers made from plastic; flexible containers of rubber or plastic for the storage and transport of solids, liquids, gases and fuels; containers, not of metal, for liquid fuel; inflatable publicity objects as far as included in this class.

22 – Ropes, string, nets, tents, awnings, tarpaulins, sails, sacks and bags (not included in other classes); padding and stuffing materials (except of rubber or plastics); raw fibrous textile materials; hammocks, bags (envelopes, pouches) of textile, for packaging; car towing ropes; vehicle covers, not fitted.

24 – Textiles and textile goods, elastomer-coated textile fabrics as far as included in this class; printers' blankets of textile; fabric, impervious to gases, for aeronautical balloons; bed and table covers including bed linen, towels, (textile) border edging, bed covers, table napkins of textile, mosquito nets, pennants and flags (not of paper).

25 – Clothing, footwear, headgear including trousers, T-shirts, polo shirts, coats, jackets, overalls, caps, gloves (clothing), shoes, cloth for clothing purposes, ties, scarves.

28 – Games and playthings, gymnastic and sporting articles (as far as included in this class); parts and accessories for the aforementioned goods as far as included in this class, including rollers and wheels for roller skates, inline skates and skateboards, scale model vehicles, in particular model cars; playing cards, balls, plush toy animals and other plush toy articles, kaleidoscopes; electronic games (including video games).

35 – Advertising, business management, business administration; office functions; personnel recruitment, personnel management consultancy, business consultancy services, public relations, radio and television advertising, organization of exhibitions and fairs for commercial and advertising purposes, marketing, sales research, market research; retail (including online retail) services in the following areas: vehicles and vehicle accessories, tires, brakes, rubber end plastic goods, chemical products, fuels and propellants, machines, tools and metal goods, building articles, electrical and electronic goods, sound and data media, printed matter, stationery, office equipment, articles of clothing, shoes and textile goods, toys, sports equipment; wholesale services (including online wholesale services) in the following areas: vehicles and vehicle accessories, tires, brakes, rubber and plastic goods, chemical products, fuels and propellants, machines, tools and metal goods, building articles, electrical and electronic goods, sound and data media, print shop products, stationery, office equipment, articles of clothing, shoes and textile goods, toys, sports equipment; organizational advice on the granting of usage rights for mobility systems.

37 – Building construction, installation services, car workshop services, conversion, repair, servicing, assembly, dismantling, maintenance, care, cleaning and paint work for vehicles (except for aerospace vehicles), engines (except for aerospace vehicles engines), brakes, tires and their parts; repair of vehicles (except for aerospace vehicles) as part of vehicle breakdown assistance; retreading of tires; maintenance, assembly, repair of evaluation instruments for diagram plates, tachographs, accident data recorder, electronic vehicle logs, test and diagnostic apparatus and instruments; installation, maintenance and repair of machines and machine components; installation, maintenance and repair of conveyor belts and systems; installation, maintenance and repair of EDP systems.

40 – Treatment of materials including the treatment (conversion) of waste; recycling of tires; metal treating.

41 – Education; entertainment; provision of training for third parties in the fields of electronics, electrical engineering and in tire development and manufacturing; sporting and cultural activities including the

organization and management of colloquiums, conferences, congresses, symposiums, seminars and workshops; organization of fairs for cultural and educational purposes, compilation of television and radio programs, radio and television entertainment, operation of movie theaters, organization of live events; operation of museums, musical performances, in particular orchestra performances, organization of lotteries and other gambling activities.

42 – Scientific and technological services and the associated research and drafts; industrial experiments and R& services; technical project development; design and development of computer hardware and software; updating of software; maintenance of computer software; technical consultancy relating to franchise; technical advice on the granting of usage rights for mobility systems; engineering surveying for the automotive and rubber industry; technical consultation of evaluation instruments for tachograph disks, tachographs, accident data recorder, electronic vehicle logs, test and diagnostic apparatus and instruments.

(260) AM 2015 76255 A

(800) 1193707

(891) 2013 07 05

(731) OBSHCHESTVO S OGRANICHENNOY OTVETSTVENNOSTYU "VARTON"  
ul. Dorogobuzhskaya, 14, stroenie 6,  
RU-121354 g. Moskva, Russian Federation

(540)



(591) Black, white

(511)

9 – Optical lenses; lens hoods; circuit breakers; fuses; converters, electric; telerupters; transistors [electronic]; transformers [electricity].

11 – Lamp globes; lights, electric, for christmas trees; acetylene flares; safety lamps; gas lamps; curling lamps; germicidal lamps for purifying air; projector lamps; lamps for directional signals of automobiles; light bulbs for directional signals for vehicles; arc lamps; laboratory lamps; oil lamps; ultraviolet ray lamps, not for medical purposes; miners' lamps; electric lamps; chandeliers; luminous house numbers; lamp reflectors; lighting apparatus and installations; light diffusers; lamps; standard lamps; ceiling lights; discharge tubes, electric, for lighting; lamp chimneys; luminous tubes for lighting; cycle lights; lights for vehicles; pocket searchlights; lanterns for lighting; light-emitting diodes [led] lighting apparatus.

35 – Advertising agencies; cost price analysis; personnel recruitment; updating of advertising material; word processing; organization of exhibitions for commercial or advertising purposes; arranging newspaper subscriptions for others; shop window dressing; bill-posting; outdoor advertising; distribution of samples; dissemination of advertising matter; direct mail advertising; writing of publicity texts; advertising; on-line advertising on a computer network; advertising by mail order; television advertising; television commercials; document reproduction; compilation of statistics; compilation of information into computer databases; business inquiries.

(260) AM 2015 76256 A

(800) 1193710

(891) 2013 10 09

(731) ROTTAPHARM S.P.A.

Galleria Unione 5, I-20122 MILANO, Italy

(540)

## SAUGELLA

(511)

3 – Cosmetics, cosmetic creams, cosmetic preparations for the bath, cosmetic preparations for skin care, pomades for cosmetic purposes, cleansing milk, deodorants for human beings, cakes of soap, medicated soap, deodorant soaps, disinfectant soap, shampoos, dry shampoos, make-up removing preparations, lotions for cosmetic purposes, wipes impregnated with cosmetic lotions, cotton wool for cosmetic purposes, cosmetic preparations relating to health or hygiene, including for intimate hygiene and health, personal deodorants, toiletries, balms, not for medical purposes, perfumes, antiperspirants (toiletries), essential oils, depilatory preparations, preparations for shaving, cosmetic preparations for slimming purposes, massage gels, not for medical purposes.

5 – Pharmaceutical preparations for use with urogenital apparatus, food supplements for use with urogenital apparatus, pharmaceutical preparations for use with integumentary apparatus, food supplements for use with integumentary apparatus, chemical preparations for medical purposes, antiseptic cotton, compresses, gauze for dressings, absorbent cotton, napkins for incontinents, oils for medical purposes, slimming pills, bath salts for medical purposes, sanitary towels, sanitary pads, menstruation compresses, panty liners, vaginal washes, pharmaceutical preparations for skincare, detergents for medical purposes, disinfectants for hygiene purposes, tissues impregnated with pharmaceutical lotions, personal sexual lubricants, douching preparations for medical purposes.

10 – Medical devices for use with urogenital apparatus, medical instruments for use with urogenital apparatus, medical devices for use with integumen-

tary apparatus, medical instruments for use with integumentary apparatus, uterine syringes, syringes for medical purposes, enema apparatus for medical purposes, receptacles for applying medicines, condoms, babies' pacifiers.

(260) AM 2015 76257 A

(800) 1193736

(891) 2013 07 05

(731) TOVARYSTVO Z OBMEZHENOIU  
VIDPOVIDALNISTIU "PROPER AVTO"  
prospekt Vyzvolyteliv, 13, Kyiv 02660,  
Ukraine

(540)

## PROPER

(591) Black, white

(511)

4 – Industrial oils and greases.

6 – Bottles (metal containers) for compressed gas or liquid air; connecting rod bearing of metal; hardware of metal, small; loading pallets, of metal; main bearing of metal; stabilizer bushing of metal; stud; radiator air pipe of metal; rivets of metal; torque rod bush of metal.

7 – Alternators; belts for machines; belts for motors and engines; control cables for machines, engines or motors; compressed air pumps; compressors (machines); current generators; dynamos; filters (parts of machines or engines); generators of electricity; impeller (parts of machines); king pin kit seti (parts of machines, engines or motors); levelling valve (parts of machines), radiators (cooling) for motors and engines; stuffing boxes (parts of machines); tie rod end (parts of machines); turbo compressors; water pump (parts of machines); bearing.

9 – Accumulators, electric, for vehicles; apparatus and instruments for conducting, switching, transforming, accumulating, regulating or controlling electricity; automatic indicators of low pressure in vehicle tires; kilometer recorders for vehicles; navigation apparatus for vehicles (on-board computers); steering apparatus, automatic, for vehicles speed indicators; speed checking apparatus for vehicles; thermostats for vehicles; vehicle breakdown warning triangles; vehicle radios; voltage regulators for vehicles.

11 – Automobile lights; anti-glare devices for vehicles (lamp fittings); anti-dazzle devices for automobiles (lamp fittings); air conditioners for vehicles; heaters for vehicles; headlights for automobiles; heating apparatus for defrosting windows of vehicles; lamps for directional signals of automobiles; light bulbs for directional signals for vehicles; lights for vehicles; lighting apparatus for vehicles; vehicle headlights; ventilation (air-conditioning) installations for vehicles; vehicle reflectors.

12 – Air pumps (vehicle accessories); aerial conveyors; automobile chassis; automobile tires (tyres); automobile hoods; automobile bodies; automobile chains; axles for vehicles; anti-dazzle devices for vehicles; anti-theft devices for vehicles; anti-theft alarms for vehicles; air bags (safety devices for automobiles); balance weights for vehicle wheels; bodies for vehicles; bumpers for automobiles; brake drums; brakes for vehicles; brake pads for vehicles; brake linings for vehicles; brake shoes for vehicles; cigar lighters for automobiles; crankcases for land vehicle components, other than for engines; clutches for land vehicles; connecting rods for land vehicles, other than parts of motors and engines; caps for vehicle petrol (gas) tanks; direction signals for vehicles; dining cars (carriages); doors for vehicles; driving motors for land vehicles; driving chains for land vehicles; engines for land vehicles; freewheels for land vehicles; gear boxes for land vehicles; gearing for land vehicles; hoods for vehicle engines; head-rests for vehicle seats; horns for vehicles; hydraulic circuits for vehicles; hubs for vehicle wheels; luggage carriers for vehicles; luggage nets for vehicles; motors for land vehicles; motors, electric, for land vehicles; non-skid devices for vehicle tires (tyres); propulsion mechanisms for land vehicles; steering wheels for vehicles; rims for vehicle wheels; reduction gears for land vehicles; reversing alarms for vehicles; security harness for vehicle seats; safety seats for children, for vehicles; shock absorbers for automobiles; suspension shock absorbers for vehicles; shock absorbing springs for vehicles; sun-blinds adapted for automobiles; safety belts for vehicle seats; sleeping berths for vehicles; seat covers for vehicles; ski carriers for cars; tail-board lifts (parts of land vehicles); torque converters for land vehicles; trailer hitches for vehicles; trailer hitches for land vehicles; tires for vehicle wheels; transmission shafts for land vehicles; transmission chains for land vehicles; torsion bars for vehicles; transmissions, for land vehicles; tires, solid, for vehicle wheels; upholstery for vehicles; undercarriages for vehicles; vehicle running boards; vehicle chassis; vehicle wheel spokes; vehicle bumpers; valves for vehicle tires (tyres); vehicle wheels; vehicle seats; vehicle suspension springs; windows for vehicles; windscreens.

17 – Washers of rubber or vulcanized fiber (fibre).

35 – Sales promotion for others of auto parts and accessories for motor vehicles.

(260) AM 2015 76259 A

(800) 1193744

(891) 2013 09 04

(731) DR. SERTUS İLAÇ SANAYİ VE TİCARET LİMİTED ŞİRKETİ  
Evren Mah. Camiyolu Cad. No:50 K:2,  
Güneşli, Bağcılar, İstanbul, Turkey

(540)

**SERTOΓAMMA**

**CEPTOΓAMMA**

(591) Black, white

(511)

5 – Medicines for human purposes, medicines for veterinary purposes, vitamin preparations, chemical preparations for medical purposes, dietetic substances adapted for medical use; dietetic foods adapted for medical purposes; baby foods, medicinal herbs, herbal beverages adapted for medical purposes, nutritional supplements, pollen dietary supplements, mineral food supplements, protein dietary supplements; medicines for dental purposes, hygienic products for medical purposes including pads, waddings for medical purposes, plasters for medical purposes, dressings for medical purposes, babies' napkins, preparations for destroying noxious plants, preparations for destroying noxious animals, fungicides, deodorants other than for human beings or for animals, air deodorising preparations, disinfectants for hygiene purposes, antiseptics, detergents for medical purposes.

(260) AM 2015 76265 A

(800) 1193774

(891) 2013 10 17

(731) GESELLSCHAFT MIT BESCHRÄNKTER HAFTUNG "EHRMANN"  
pos. RAOS, 15, Ramenskiy r-n, RU-140025  
Moscow Region, Russian Federation

(540)



(591) Lilac, light lilac, dark lilac, yellow, light yellow, red, light red, pink, green, light green, dark green, blue, white, light gray and beige

(511)

29 – Milk products, namely yoghurt, drinking yogurt, dessert quark, quark products with fruit, milk-based and cream-based desserts, milk-based and cream-based desserts with addition of fruit filling, milk-based and cream-based buttercream.

(260) AM 2015 76270 A

(800) 1193834

(891) 2013 12 20

(731) NEMIROFF INTELLECTUAL PROPERTY ESTABLISHMENT  
Staedtle 31, FL-9490 Vaduz, Liechtenstein



(540)



(591) White, black, violet, light yellow, dark yellow, light green, green, light brown and brown

(511)

33 – Aperitifs; arrack; vodka; digestives (liqueurs and alcoholic beverages); cocktails; alcoholic beverages, except beers; spirits; distilled beverages; honey drink (mead); bitters; alcohol extracts; spirits essences.

(260) AM 2015 76277 A

(800) 488547

(891) 2013 11 25

(731) VOSSLOH COGIFER

21 avenue de Colmar, F-92500 RUEIL  
MALMAISON, France

(540)

## COGIFER

(511)

6 – Unwrought and semi-wrought common metals and their alloys; anchors, anvils, bells, rolled and cast building materials; rails and other materials of metal for railway tracks; chains (excluding transmission chains for vehicles); non-electric cables and wires of metal; ironmongery; pipes of metal; safes and strongboxes; balls of steel; horseshoes; nails and screws; other goods of metal (non-precious) not included in other classes; ores; products relating to fixed railway equipment, such as equipment for running tracks.

9 – Scientific, nautical, surveying, electric (including wireless), photographic, cinematographic, optical, weighing, measuring, signaling, checking (supervision), life-saving and teaching apparatus and instruments; automatic coin or token-operated apparatus; talking machines; cash registers, calculating machines; extinguishers; products relating to fixed railway equipment, such as apparatus for tracks and signaling apparatus.

42 – Engineering (not for building); prospecting services; drilling services; testing of materials; laboratories; services relating to fixed railway equipment,

namely engineering work, professional consultancy and drawing up of plans in connection with railway tracks.

(260) AM 2015 76323 A

(800) 1193936

(891) 2013 10 17

(731) GESELLSCHAFT MIT BESCHRÄNKTER  
HAFTUNG "EHRMANN"

pos. RAOS, 15, Ramenskiy r-n, RU-140025  
Moscow Region, Russian Federation

(540)



(591) Azure, dark azure, light azure, blue, yellow, light yellow, light orange, red, light red, purple, dark green, light green, white and beige

(511)

29 – Milk products, namely yoghurt, drinking yogurt, dessert quark, quark products with fruit, milk-based and cream-based desserts, milk-based and cream-based desserts with addition of fruit filling, milk-based and cream-based buttercream.

(260) AM 2015 76324 A

(800) 1193943

(891) 2013 12 16

(731) CARLSON HOTELS WORLDWIDE AB

c/o Advokatfirman Vinge KB PO Box 1703  
SE-111 87 Stockholm, Sweden

(540)

## QUORVUS COLLECTION

(511)

43 – Hotel, bar and restaurant services; services for the reservation of rooms.

(260) AM 2015 76325 A

(800) 1193961

(891) 2013 12 12

(731) BRUPHARMEXPORT SPRL

Rue de la Grotte 14, B-1020 Bruxelles,  
Belgium

(540)

## PROTON



(511)

5 – Pharmaceutical and veterinary products; sanitary products for medicine; dietetic food and substances for medical or veterinary use; food for babies; food supplements for humans and animals; plasters; materials for dressings; material for dental fillings and dental impressions; disinfectants; products for destroying vermin; fungicides; herbicides.

(260) AM 2015 76326 A

(800) 1193966

(891) 2013 11 22

(731) HENKEL AG &amp; CO. KGAA

Henkelstraße 67, 40589 Düsseldorf, Germany

(540)

*blonde*  
ULTIME

(591) Black, white

(511)

3 – Preparations for caring, cleaning, tinting, coloring, bleaching, fixing, styling and waving of hair.

(260) AM 2015 76327 A

(800) 1193999

(891) 2013 10 17

(731) GESELLSCHAFT MIT BESCHRÄNKTER HAFTUNG "EHRMANN"

pos. RAOS, 15, Ramenskiy r-n, RU-140025

Moscow Region, Russian Federation

(540)



(591) Blue, dark blue, white, light gray, yellow, light yellow, dark yellow, light brown, beige, green, light green, red, light red and pink

(511)

29 – Milk products, namely yoghurt, drinking yogurt, dessert quark, quark products with fruit, milk-based and cream-based desserts, milk-based and cream-based desserts with addition of fruit filling, milk-based and cream-based buttercream.

(260) AM 2015 76420 A

(800) 1194843

(891) 2012 03 29

(731) SONY CORPORATION

1-7-1 Konan, Minato-ku Tokyo, Japan

(540)

**SONY**

(511)

1 – Chemical products used in industry, science and photography, as well as in agriculture; horticulture and forestry; unprocessed artificial resins, unprocessed plastics; fertilizers; fire extinguishing compositions; tempering and soldering preparations; chemical products for preserving foodstuffs; adhesives for industrial purposes; unprocessed acetate of cellulose; acetates; acetic anhydride; acetone; acetylene; acetylene tetrachloride; acid-proof chemical compositions; acids; acidulated water for recharging batteries; unprocessed acrylic resins; actinium; activated carbon; chemical additives to drilling muds; chemical additives for fungicides; chemical additives to insecticides; chemical additives to motor fuel; adhesives (other than for stationery or household purposes); adhesive preparations for surgical bandages; adhesives for billposting; adhesives (adhesive materials) for use in industry; adhesives for wallpaper; adhesives for wall tiles; agar-agar; agglutinants for concrete; chemical products for repelling aggressors; agricultural chemicals excluding fungicides, herbicides, insecticides and parasiticides; albuminized paper; alcohol; aldehydes; algarobilla (tanning substance); alginates (gelling and inflating products), not for food; alkalies; alkaline iodides for industrial use; alkaline metals; alkaline-earth metals; alkaloids; alum; alumina; aluminum acetate; aluminum alum; aluminum chloride; aluminum hydrate; aluminum iodide; aluminum silicate; americium; ammonia; ammonia alum; ammonia volatile alkali for industrial use; ammoniacal salts; aminoethanol; ammonium salts; amyl acetate; amyl alcohol; anhydrides; anhydrous ammonia; animal albumen (raw material); animal carbon; animal carbon preparations; animal charcoal; anti-boil preparations for engine coolants; anti-freeze; anti-frothing solutions for accumulators; anti-incrustants; anti-knock substances for internal combustion engines; antimony; antimony oxide; antimony sulphide; anti-sprouting preparations for vegetables; antistatic preparations not for household use; anti-tarnishing chemicals for windows; antranilic acid; argon; arsenic; arsenious acid; unprocessed artificial resins; artificial sweeteners (chemical preparations); astatine; artificial sweeteners; auxiliary fluids for abrasives; bacterial preparations other than for medical and veterinary use; bacteriological preparations for acetification; bacteriological preparations other than for medical and veterinary use; balm of gurjun (gurjon, gurjan) for making varnish; barium; barium compounds; barium sulphate; baryta; baryta paper; barytes; bases (chemical products); basic gallate of bismuth; bauxite; beer-preserving agents; beer-clarifying and preserving agents; bentonite; benzene derivatives; benzene-based acids; benzoic acid; benzoic sulphinide; berkelium; bicarbonate of soda for chemical use; bichloride of tin; bichromate of potassium; bichromate of soda; biochemical catalysts; biological preparations other than

for medical or veterinary use; birdlime; bismuth; bismuth nitrite for chemical use; blood charcoal; blueprint cloth; blueprint paper; bone charcoal; borax; boric acid for industrial use; brake fluids; brazing fluxes; brazing products; brickwork preservatives, except paints and oils; bromine for chemical use; by-products of the processing of cereals for industrial use; caesium; calcined soda; calcium carbide; calcium salts; californium; camphor for industrial use; carbide; carbolineum for the protection of plants; carbon; carbon black for industrial use; carbon for filters; carbon sulphide; carbon tetrachloride; carbonates; carbonic acid; carbohydrates; casein for industrial use; cassiopium (lutetium); catalysts; catechu; caustic alkali; caustic soda for industrial use; caustics for industrial use; cellulose; chemical cellulose derivatives; cellulose esters for industrial use; cellulose ethers for industrial use; glue for shoes and boots; cement for mending broken articles; cement for pneumatic tires; cement [metallurgy]; cement preservatives, except paints and oils; cement-waterproofing preparations, except paints; ceramic compositions for sintering (granules and powders); ceramic glazings; ceramic materials in particulate form for use as filtering media; cerium; chemical products; chemical intensifiers for paper; chemical intensifiers for rubber; chemical products for facilitating the alloying of metals; chemical preparations for scientific use other than for medical or veterinary use; chemical reagents (except for medical and veterinary use); chemical preparations for analyses in laboratories other than for medical or veterinary purposes; chemicals for forestry, except fungicides, herbicides, insecticides and parasiticides; chemical chimney cleaners; chlorates; chlorides; chlorine; cholic acid; chromates; chrome alum; chrome salts; chromic acid; chromic salts; chromium oxide; cinematographic films, sensitized but not exposed; citric acid for industrial use; coal saving products; cobalt oxide for industrial use; collodion; color brightening chemicals for industrial use; combusting preparations (chemical additives to motor fuel); compositions for the manufacture of phonograph records; compost; concrete preservatives, except paints and oils; concrete-aeration chemicals; condensation-preventing chemicals; coolants for vehicle engines; vitriol; corrosive products; cream of tartar, other than for pharmaceutical use; creosote for chemical use; crotonic aldehyde; cryogenic products; cultures of microorganisms other than for medical and veterinary use; curium; currying preparations for leather; currying preparations for skins; cyanides (prussiates); cymene; damp proofing products except paints for masonry; decolorants for industrial use; defoliant; dehydrating preparations for industrial use; detergent additives to gasoline; detergents for use in manufacturing processes; dextrine (size); diagnostic preparations other than for medical or veterinary use; diastase for industrial use; diatomaceous earth;

diazo paper; hydrogen peroxide; disincrustants; dispersions of plastics; distilled water; dolomite for industrial use; bate for dressing skins; drilling muds; dry ice (carbon dioxide); dysprosium; earth for growing; emollients for industrial use; emulsifiers; enamel-staining chemicals; engine-decarbonizing chemicals; enzyme preparations for industrial use; enzymes for industrial use; unprocessed epoxy resins; erbium; esters; ethane; ethyl alcohol; ethyl ether; europium; fat-bleaching chemicals; fatty acids; ferments for chemical use; fermium; ferrocyanides; ferrotype plates (photography); fertilizers; filtering materials (chemical products); filtering materials (mineral substances); filtering materials (unprocessed plastics); filtering materials (vegetable substances); filtering preparations for the beverages industry; steel finishing preparations; fireproofing preparations; fissionable chemical elements; fissionable material for nuclear energy; fixing baths (photography); fixing solutions (photography); flashlight products; flocculants; flours for industrial use; flower preservatives; flowers of sulphur for chemical use; fluids for hydraulic circuits; fluorine; fluorspar compounds; flour and starch for industrial use; formic acid; formic aldehyde for chemical use; foundry molding products; foundry sand; francium; fuel for atomic piles; fuel-saving products; fuller's earth for use in textile industry; fulling preparations; fulling preparations for use in textile industry; gadolinium; gallic acid for the manufacture of ink; gallium; gallnuts; gallotannic acid; galvanizing baths; galvanizing products; gambier; gas propellents for aerosols; gas purifying products; gelatine for industrial use; getters (active substances); glass-frosting chemicals; chemicals for preventing the tarnishing of glass; glucose for industrial use; glucosides; glue for industrial purposes; gluten (glue), other than for stationery or household purposes; glutinous tree-grafting products; glycerides; glycerine for industrial use; glycol; glycol ether; gold salts; grafting mastic for trees; grafting wax for trees; graphite for industrial use; degreasing preparations for use in manufacturing processes; guano; gum arabic for industrial purposes; degumming products; gums (adhesives) other than for stationery or household purposes; heavy water; helium; holmium; hormones for hastening the ripening of fruit; horticulture chemicals, except fungicides, herbicides, insecticides and parasiticides; humus top dressing; hydrates; hydrazine; hydrochlorates; hydrochloric acid; hydrofluoric acid; hydrogen; hypochlorite of soda; hyposulphites; industrial chemicals; iodic acid; iodine for chemical use; iodine for industrial use; iodized albumen; iodized salts; ion exchangers (chemicals); iron salts; isinglass other than for stationery, household or alimentary purposes; isotopes for industrial use; kainite; kaolin; ketones; kieselgur; krypton; lactic acid; lamp black for industrial use; lanthanum; lead acetate; lead arsenate; lead oxide; leather glues; leather-

dressing chemicals; leather-impregnating chemicals; leather-renovating chemicals; leather-waterproofing chemicals; lecithin (raw material); lime acetate; lime carbonate; lime chloride; limestone hardening substances; liquids for removing sulphates from accumulators; lithia [lithium oxide]; lithium; litmus paper; loam; cassiopium (lutetium); magnesite; magnesium carbonate; magnesium chloride; magnetic fluid for industrial use; malt albumen; manganate; manganese dioxide; mangrove bark for industrial use; manure for agriculture; masonry preservatives, except paints and oils; mastic for leather; cement for pneumatic tires; meat tenderizers for industrial use; mercuric oxide; mercury; mercury salts; metal earths; metal hardening products; metal annealing products; metalloids; methane; methyl benzene; methyl benzol; methyl ether; milk ferments for chemical use; mineral acids; moderating materials for nuclear reactors; moistening (wetting) preparations for use in bleaching; wetting preparations for use in dyeing; moistening [wetting] preparations for use in the textile industry; mordants for metals; mold-release products; must-finishing products; naphthalene; neodymium; neon; neptunium; nitrate of uranium; nitrate paper; nitrates; nitric acid; nitrous oxide; nitrogen; nitrogenous fertilizers; calcium cyanamide (fertilizer); nitrous oxide; non-ferrous metals; non-metallic minerals; oenological bactericides (chemical preparations used in wine making); oil dispersants; oil-bleaching chemicals; oil-purifying chemicals; oils for currying leather; oils for preparing leather in the course of manufacture; oils for tanning leather; oils for the preservation of food; oil-separating chemicals; oleic acid; olivine (chemical product); opacifiers for enamel or glass; organic-bleaching chemicals; oxalates; oxalic acid; oxygen; palladium chlorides; paper pulp; peat (fertilizer); peat pots for horticulture; pectin [photography]; perborate of soda; percarbonates; perchlorates; persulphates; persulphuric acid; petroleum dispersants; phenol for industrial use; phosphates (fertilizers); phosphatides; phosphoric acid; phosphorus; photographic developers; photographic emulsions; photographic paper; photographic sensitizers; photographic supplies, namely chemical products for use in photography, photographic paper, photographic sensitizers, unexposed photographic films, photographic plates; photosensitive plates; chemical products for use in photographic work; photographic developers for use in photography and electrophotography, particularly toner salts in the form of powders and liquids; gelatine for photographic use; sensitized photographic plates; potash; potassic water; potassium; potassium dioxalate; potato flour for industrial use; potting soil; power steering fluids; praseodymium; preservatives for pharmaceutical products; preservatives for tiles, except paints and oils; oil cement [putty]; promethium; protactinium; protective gases for welding; protein (raw material); prussiates; purification preparations;

paper pulp and wood pulp; pyrogallol acid; pyro-ligneous acid (wood vinegar); quebracho for industrial use; radiator flushing chemicals; radioactive elements for scientific use; radium for scientific use; radon; rare earths; reagent paper; reducing agents for use in photography; refrigerating products; renovating products for phonograph records; rhenium; rock salt; sensitized but not exposed X-ray films; rubber preservatives; rubidium; saccharin; sal ammoniac; sal ammoniac spirits; salicylic acid; salt for preserving, other than for foodstuffs; raw salt; saltpeter; salts (chemical products); salts (fertilizers); salts for coloring metal; salts for galvanic cells; salts for industrial use; salts from rare earth metals; salts of alkaline metals; salts of precious metals for industrial use; samarium; sauce for preparing tobacco; scale removing preparations, other than for household use; scandium; sea water for industrial use; algae (fertilizers); sebacic acid; seed preserving products; selenium; self-toning paper (photography); sensitized cloth for photography; unexposed sensitized films; sensitized paper; sensitized plates for offset printing; silicates; silicon; silicones; silver nitrate; silver salt solutions for silvering; glues (size for finishing and priming); sizing products; slag (fertilizers); metallic soaps for industrial use; soda ash; sodium; sodium salts (chemical products); soil conditioning chemicals; welding chemicals; soldering fluxes; solidified gases for industrial use; solvents for varnishes; soot for industrial or agricultural use; sorrel salt; spinels (chemical products); spirits of salt; spirits of vinegar (dilute acetic acid); stain-preventing chemicals for use on fabrics; industrial starch; starch paste (glue) other than for stationery or household use, primers; starch-liquifying chemicals (ungluing agents); stearic acid; strontium; substrates for soil-free cultivation (agriculture); sulphates; sulphides; sulphonic acids; sulphur; sulfuric acid, sulfuric ether, sulfurous acid; sumac for use in tanning; superphosphates (fertilizers); unprocessed synthetic resins; talc (magnesium silicate); tan; tannic acid; tannin; tanning materials; tan-wood; tapioca flour for industrial use; tartar other than for pharmaceutical use; tartaric acid; technetium; tellurium; surface-active chemical agents; terbium; chemical test paper; tetrachlorides; textile-brightening chemicals; textile-impregnating chemicals; textile-waterproofing chemicals; thallium; thiocarbanilide; thorium; thulium; tire-repairing compounds; titanite; titanium dioxide for industrial use; toluene; toluol; toning baths (photography); toning salts (photography); toxic gas neutralizers; tragacanth gum for use in manufacture; automatic transmission fluids; tree cavity fillers (forestry); tungstic acid; compositions for repairing tires; chemicals agents or products for protection against vulcanization diseases; vulcanizing products; moistening products for use in the textile industry; laundry products; wine finings; witherite; wood alcohol, wood pulp; wood vinegar (pyro-ligneous acid); xe-

non; X-ray films, sensitized but not exposed; ytterbium; yttrium; zirconia; wood pulp.

2 – Paints, varnishes, lacquers; preservatives against rust and against deterioration of wood; colorants, mordants; raw natural resins, metals in foil and powder form for painters, decorators, printers and artists; alizarine dyes; aluminum paints; aluminum powder for painting; aniline dyes; annatto [dyestuff]; anti-corrosive bands; anti-corrosive products; anti-fouling paints; anti-rust greases; anti-rust oils; anti-rust preparations for preservation; preparations for preventing the tarnishing of metals, asbestos paints; auramine; bactericidal paints; badigeon; binding preparations for paints; bitumen varnish; black japan; blacks (colorants or paints); bronze powder; bronzing lacquers; Canada balsam; caramel (food colorant); carbon black color; carbonyl [wood preservative]; ceramic paints; coatings (paints); coatings for roofing felt (paints); cobalt oxide (colorant); cochineal carmine; colophony; colorants for beer; colorants for beverages; colorants for butter; colorants for liqueurs; paints for drawing images; copal varnish; copal; creosote for wood preservation; dammar; distempers; dyes; colorants; dyewood extracts; coloring wood; enamels (varnishes); enamels for painting; engraving inks; fireproof paints; fixatives (varnishes); fixatives for watercolors; food dyes; gamboge for painting; gildings; glazes (coatings); gum resins, gum-lac; indigo; inks for leather; ink for skin-dressing; lacquers; lamp black (pigment); lime wash; litharge; malt caramel (food colorant); malt colorants; marking ink for animals; mastics; metal foil for painters, decorators, printers and artists; inks for photocopying, non-ferrous metals in foil or powder form for painters, decorators, printers and artists; paints; paper for dyeing Easter eggs; pigments; gum resins; rosin for stringed musical instruments; precious metals in foil or powder form for painters, decorators, printers and artists; wood preserving oils; printing inks; minium; sandarac; gum-lac; Sienna earth; silver emulsions (pigments); silver foil [leaf]; mordants for leather; sumac for varnishes; thickeners for colorants; thinners for lacquers; thinners for paints; titanium dioxide (pigment); ink (toner) cartridges for printers and photocopiers; inks (toner) for photocopiers; turmeric (colorant); turpentine (paint thinner); undercoating for vehicle chassis; varnishes; white lead; whites (colorants or paints); whitewash; wood coatings (paints); wood mordants; wood preservatives; wood stains; yellowwood (colorant); zinc oxide (pigment).

3 – Bleaching preparations and other substances for laundry use; cleaning, polishing, degreasing and abrasive preparations; soaps; perfumes; essential oils; cosmetics, hair lotions; dentifrices; abrasive papers; abrasive sand, abrasives, adhesives for affixing false eyelashes; adhesives for affixing false hair; adhesives for cosmetic use; after-shave lotions; air freshe-

ners, almond milks for cosmetic use; almond oil; almond soap; aloe vera preparations for cosmetic use, alum stones (astringents); amber (perfumery); anti-perspirant soap; antiperspirants [toiletries]; antistatic products for household use; aromatics (essential oils); artificial pumice stone; astringents for cosmetic use; badian essence; balms other than for medical use; bases for flower perfumes; bath salts, not for medical use; beard dyes; beauty masks; bergamot oil; bleaching preparations [decolorants] for cosmetic use; bleaching salts; bleaching soda; breath freshening sprays; breath freshening strips; flavorings for cakes (essential oils); cakes of toilet soap; canned pressurized air for cleaning and dusting purposes; carbides of metal (abrasives); cleaning chalk; cleaning products; cleansing milk for toilet purposes; cloths impregnated with a detergent for cleaning; cobblers' wax; colorants for toilet purposes; color-brightening chemicals for household purposes (laundry); color-removing products; corundum (abrasive); cosmetic creams; cosmetic dyes; cosmetic kits; cosmetic pencils; cosmetic preparations for baths; cosmetic preparations for eyelashes; cosmetic skin care preparations; cosmetic preparations for slimming; toiletries and cosmetic products; cosmetics for animals; cosmetic products; cotton sticks for cosmetic use; cotton wool for cosmetic use; creams for leather; decorative transfers for cosmetic use; degreasers other than for use in manufacturing processes; degreasing products for household use; dental bleaching gels; denture polishes; deodorant soaps; deodorants for humans or for animals; deodorants for pets; depilatories; detergents other than for use in manufacturing operations and for medical use; diamantine (abrasive); disinfectant soaps; douching preparations for personal sanitary or deodorant purposes [toiletries]; dry shampoos; dry-cleaning products; drying agents for dishwashing machines; eau de Cologne; emery cloth; emery paper; emery; essential oils of cedarwood; essential oils of lemon; ethereal essences; extracts of flowers (perfumery products); eyebrow cosmetics, eyebrow pencils; fabric softeners for laundry use; false eyelashes; false nails; flavorings for beverages (essential oils); floor wax removers (scouring preparations); parquet floor wax; fumigation products (perfumes); refurbishing preparations; gaultheria oil; starch gelatin (chemical preparations); geraniol; glass cloth; greases for cosmetic use; grinding products; hair dyes; hair lotions; hair spray; hair waving preparations; heliotropine; hydrogen peroxide for cosmetic use; incense; ionone (perfumery); jasmine oil; Javelle water; polishing rouge; incense sticks; lacquer-removing products; laundry bleach; laundry blueing; laundry glaze; laundry detergents; laundry soaking preparations; starch for laundry purposes; laundry wax; lavender oil; lavender water; leather bleaching products; preservatives for leather (polishes); lip glosses; lipstick; lotions for cosmetic use; make-up powder; make-up

products; make-up removing products; make-up; mascara, massage gels other than for medical use; medicated soaps; mint essence [essential oil]; mint for perfumery; mustache wax; mouth washes not for medical use; musk (perfumery); nail art stickers; nail care products; nail polish; neutralizers for permanent waving; non-slipping liquids for floors; non-slip wax for floors; oil of turpentine (degreasing product); oils for cleaning purposes; oils for cosmetic use; oils for perfumes and scents; oils for toilet use; paint stripping products; pastes for razor strops; perfumery products, fragrances and incenses (other than perfumes used as cosmetic or toiletry products); petroleum jelly for cosmetic use; polish for furniture and flooring; abrasive cloth; polishing creams; polishing paper; polishing preparations; polishing stone; polishing wax; ointments for cosmetic use; potpourris [fragrances]; preparations for unblocking drain pipes; preparations to make the leaves of plants shiny; preparations for cleaning dentures; pumice stone; quillaia bark for washing; rose oil; rust removing products; sachets for perfuming linen; safrol; sandpaper; scale removing preparations for household use; scented water; scented wood; scouring solutions; seaweed gelatin for laundry use (funori); shampoos for pets; shampoos; shaving products; shaving soap; shaving stones (astringents); shining products [polish]; polish for footwear; shoe wax; shoemakers' wax; abrasive silicon carbide; skin whitening cream; smoothing products [starching]; smoothing stones; soap for brightening textile; soaps for foot perspiration; detergents; soda lye; stain removers; starch glaze for laundry purposes; sunscreen preparations; sun-tanning preparations [cosmetics]; tailors' wax; talcum powder, for toilet use; terpenes [essential oils]; tissues impregnated with cosmetic lotions; toilet water; toiletries; tripoli stone for polishing; turpentine (degreasing product); varnish-removing products; volcanic ash for cleaning; wallpaper cleaning products; washing soda, for cleaning; whiting; windshield cleaning liquids.

4 – Industrial oils and greases; dust absorbing, wetting and binding compositions; fuels (including motor spirit) and lighting fuel; candles and wicks for lighting; non-chemical additives to motor fuel; alcohol used as fuel; anthracite; beeswax; belting wax; benzene; benzine; benzol; bone oil for industrial purposes; candles; carnauba wax, castor oil for technical purposes; ceresine; coal (fuel); Christmas tree candles; coal briquettes; coal dust (fuel); coal naphtha; coal tar oil; coal; coke; combustible briquettes; cutting fluids; diesel oil; dust binding compositions for sweeping; dust laying compositions; dust removers; electrical energy; ethanol (fuel); firelighters; firewood; fish oil, not edible; fuel gas; combustible oils (fuel oil); fuel with an alcoholic base; carburants; gas for lighting; gasoline; grease for belts; grease for leather; grease for shoes and boots; grease for arms (weapons); illuminating grease; illumina-

ting wax; industrial grease; industrial oils; industrial wax; kerosene; lamp wicks; leather preservative oils and greases; lighting fuel; lignite; ligroin; lubricants; lubricating graphite; lubricating grease; lubricating oil; mazut; methylated spirit; mineral fuel; mineral oils and greases for industrial purposes (not for fuel); moistening oil; fuels, motor oils; naphtha; nightlights; non-mineral oils and greases for industrial purposes (not for fuel); non-slipping preparations for belts; oil for the preservation of leather; oils for the preservation of masonry; oil-gas; oils for paints, oils for releasing form work [building]; oleine; ozocerite; paper spills for lighting; paraffin, peat (fuels); blocks of peat (fuel); perfumed candles; petroleum ether; petroleum jelly for industrial purposes; raw or refined petroleum; leather preservatives (oils and greases); producer gas; rape oil for industrial purposes; solid lubricants; solidified fuel gases; soya bean oil preparations for non-stick treatment of cooking utensils; stearine; sunflower oil for industrial purposes; tallow; oils for fabrics; tinder; fuel mixtures in gas form; wax (raw material); wicks for candles; wood briquettes; wood spills for lighting; woody biomass fuel; wool grease; xylene; xylo.

5 – Pharmaceutical and veterinary preparation; sanitary preparations for medical use; dietetic foodstuffs and substances for medical or veterinary use, food for babies; dietary supplements for humans and animals; plasters, materials for dressings; material for stopping teeth, dental wax; disinfectants; preparations for destroying vermin; absorbent cotton; acaricides; acetates for pharmaceutical purposes; acids for pharmaceutical use; aconitine; adhesive plaster, adhesive tapes for medical use; adhesives for dentures; adjuvants for medical purposes; air fresheners; air purifying products; albumin dietary supplements; albuminous foodstuffs for medical use; albuminous preparations for medical use; alcohol for pharmaceutical use; aldehydes for pharmaceutical use; algicides; alginate dietary supplements; alginates for pharmaceutical use; alkaline iodides for pharmaceutical purposes; alkaloids for medical use; alloys of precious metals for dental use; aloe vera preparations for pharmaceutical use; aluminum acetate for pharmaceutical use; amino acids for medical use; amino acids for veterinary use; anesthetics; analgesics; angostura bark for medical use; animal washes; antibiotics; anticryptogamic preparations; antioxidant pills; antiparasitic collars for animals; anti-parasitic products; anti-rheumatism bracelets; anti-rheumatism rings; antiseptic cotton; antiseptics; anti-uric preparations; appetite suppressant pills; appetite suppressants for medical use; migraine treatment articles; aseptic cotton; asthmatic tea; babies' diaper-pants; bacterial poisons; bacterial preparations for medical or veterinary use; bacteriological preparations for medical or veterinary use; balms for medical use; balsamic preparations for medical use; bandages for dressings; barks for pharmaceutical

use; medicated baths; bath salts for medical use; belts for sanitary towels; bicarbonate of soda for pharmaceutical use; biocides; biological preparations for medical use; biological preparations for veterinary use; biological tissue cultures for medical use; biological tissue cultures for veterinary use; bismuth preparations for pharmaceutical use; bismuth subnitrate for pharmaceutical use; blood for medical use; blood plasma; bone cement for surgical and orthopedic purposes; bracelets for medical use; breast-nursing pads; bromine for pharmaceutical use; bronchodilating preparations; bunion pads; by-products of the processing of cereals for dietetic or medical use; cachou for pharmaceutical use; calomel; camphor for medical use; camphor oil for medical use; candy for medical use; capsules for medicines; capsules for pharmaceutical use; carbolineum (parasiticide); casein dietary supplements; castor oil for medical use; cattle washes; caustic pencils; caustics for pharmaceutical use; cedar wood for use as an insect repellent; cellulose esters for pharmaceutical use; cellulose ethers for pharmaceutical use; cement for animal hooves; charcoal for pharmaceutical use; chemical conductors for electrocardiograph electrodes; chemical contraceptives, chemical preparations for medical use; chemical preparations for pharmaceutical use; chemical preparations for the diagnosis of pregnancy; chemical preparations for treating phylloxera; chemical preparations for veterinary use; chemical preparations to treat mildew; chemical preparations to treat wheat blight [smut]; chemical reagents for medical or veterinary use; chemico-pharmaceutical products; chewing gum for medical use; chilblain products; chinoline for medical use; chloroform; quinquina for medical use; cocaine; cod liver oil; collodion for pharmaceutical use; collyrium; compresses; condurango bark for medical use; contact lens cleaning preparations; cooling sprays for medical use; corn remedies; corn rings for the feet; cotton for medical use; cream of tartar for pharmaceutical use; creosote for pharmaceutical use; croton bark; cultures of microorganisms for medical or veterinary use; curare; decoctions for pharmaceutical use; abrasives for dental use; dental amalgams of gold; dental amalgams; dental cements; dental impression materials; dental lacquers; dental mastics; deodorants for clothing or textiles; deodorants other than for human beings or animals; depuratives; detergents for medical use; bread for medical use in diabetics; diagnostic products for medical use; diapers; diastase for medical use; dietary fibers; food supplements for animals; dietetic beverages adapted for medical use; dietary foodstuffs for medical use; dietetic substances for medical use; digestives for pharmaceutical use; digitalin; dill oil for medical use; disinfectants for chemical toilets; disinfectants for hygienic use; dog lotions; dog washes; vaginal douching preparations for medical use; medical dressings; drugs for medical use; elixirs (pharma-

ceuticals); enzyme dietary supplements; enzyme preparations for medical use; enzyme preparations for veterinary use; enzymes for medical use; enzymes for veterinary use; ergot for pharmaceutical use; esters for pharmaceutical use; ethers for pharmaceutical use; eucalyptol for pharmaceutical use; eucalyptus for pharmaceutical use; purgatives; hop extracts for pharmaceutical use; eyepatches for medical use; eye-washes; febrifuges; fennel for medical use; ferments for pharmaceutical use; filled first-aid boxes; fish meal for pharmaceutical use; linseed dietary supplements; linseed for pharmaceutical use; linseed meal for pharmaceutical use; linseed oil dietary supplements; flowers of sulphur for pharmaceutical use; fly glue; fly catching paper; fly destroying preparations; food for babies; formic aldehyde for pharmaceutical use; frostbite salve for pharmaceutical use; fumigating sticks; fumigation preparations for medical use; fungicides; gallic acid for pharmaceutical use; gamboge for medical use; gases for medical use; gauze for dressings; gelatine for medical use; gentian for pharmaceutical use; germicides; glucose food supplements; glucose for medical use; glycerine for medical use; glycerophosphates, lead water; fats for medical use; greases for veterinary use; guaiacol for pharmaceutical use; gum for medical use; gurjun balm for medical use; migraine treatment pencils; hematogen; hemoglobin; hemorrhoid products; hemostatic pencils; herb teas for medicinal use; herbicides; hormones for medical use; hydrastine; hydrastinine; hydrated chloral for pharmaceutical use; hydrogen peroxide for medical use; hygienic bandages; insect repellent incense; insect repellents; insecticides; iodides for pharmaceutical use; iodine for pharmaceutical use; iodoform; Irish moss for medical use; isotopes for medical use; jalap; jujube, medicated; lacteal flour for babies; lactose for pharmaceutical use; larvae exterminating preparations; laxatives; lecithin dietary supplements; lecithin for medical use; leeches for medical use; liniments; lint for medical use; liquorice for pharmaceutical use; lotions for pharmaceutical use; lotions for veterinary use; lupulin for pharmaceutical use; magnesia for pharmaceutical use; malt for pharmaceutical use; malted milk beverages for medical use; mangrove bark for pharmaceutical use; flour for pharmaceutical use; culture media for bacteriology; medical preparations for slimming; medicinal mud; candy for pharmaceutical use; medicinal drinks; medicinal hair growth preparations; medicinal herbs; medicinal infusions; medicinal oils; medicinal roots, medicinal tea; filled portable medicine cases; constipation remedies; medicines for dental use; medicines for human medicine; medicines for veterinary use; melissa water for pharmaceutical use; menthol; mercurial ointments; milk ferments for pharmaceutical use; milk of almonds for pharmaceutical use; milking grease; mineral food supplements; mineral water salts; mineral

waters for medical use; mint for pharmaceutical use; molding wax for dentists; moleskin for medical use; mothproofing paper; mothproofing products; mouth-washes for medical use; mud for baths; mustard for pharmaceutical use; mustard oil for medical use; mustard plasters; myrobalan bark for pharmaceutical use; sanitary napkins for incontinence; narcotics; nervines; nutritional supplements; nutritive substances for microorganisms; oil of turpentine for pharmaceutical purposes; ointments for pharmaceutical use; opiates; opium; opodeldoc; ophotherapy preparations; oxygen baths; oxygen for medical use; absorbent underpants for incontinence; panty liners (sanitary articles); paper for mustard plasters; parasitocides; pastilles for pharmaceutical use; pearl powder for medical use; pectin for pharmaceutical use; pepsins for pharmaceutical use; peptones for pharmaceutical use; personal sexual lubricants; pesticides; petroleum jelly for medical use; pharmaceutical products for skin care; pharmaceutical products for treating dandruff; pharmaceuticals; phenol for pharmaceutical use; phosphates for pharmaceutical use; plasters; poisons; pollen dietary supplements; pomades for medical use; porcelain for dental prostheses; potassium salts for medical use; poultices; powder of cantharides; products for calluses; preparations for destroying dry rot fungus; products for destroying mice; preparations for reducing sexual activity; products for the treatment of burns; preparations of trace elements for human and animal consumption; lime-base products for pharmaceutical use; preparations to facilitate teething; propolis dietary supplements; propolis for pharmaceutical use; protein dietary supplements; protein supplements for animals; pyrethrum powder; quassia for medical use; quebracho for medical use; quinine for medical use; radioactive substances for medical use; radiological contrast substances for medical use; radium for medical use; rat poison; remedies for foot perspiration; remedies for perspiration; repellents for dogs; rhubarb roots for pharmaceutical use; royal jelly dietary supplements; royal jelly for pharmaceutical use; rubber for dental use; salts for medical use; salts for mineral water baths; sanitary pads; sanitary panties; sarsaparilla for medical use; scapulars for surgical use; sea water for medicinal bathing; semen for artificial insemination; serotherapeutic medicines; sera; siccatives [drying agents] for medical use; slimming pills; slug exterminating products; smelling salts; smoking herbs for medical use; sodium salts for medical use; floor-sterilizing products, solutions for contact lenses; solvents for removing adhesive plasters; soporifics; starch for dietetic or pharmaceutical use; stem cells for medical use; stem cells for veterinary use; sterilizing products; steroids; stick liquorice for pharmaceutical use; strychnine; styptic preparations; sugar for medical use; sulfonamides (medicines); sulphur sticks [disinfectants]; sunburn ointments; sunburn products for pharmaceutical use;

suppositories; surgical dressings; surgical implants (living tissues); surgical cloth [tissues]; syrups for pharmaceutical use; tanning pills; tartar for pharmaceutical use; teeth filling material; therapeutic preparations for the bath; thermal water; thymol for pharmaceutical use; tincture of iodine; tinctures for medical use; tissues impregnated with pharmaceutical lotions; tobacco extracts (insecticides); tobacco-free cigarettes for medical use; tonics (medicines); tranquillizers; turpentine for pharmaceutical use; vaccines; vaginal washes; vermifuges; vermin destroying products; vesicants; veterinary products; vine disease treating chemicals; vitamin preparations; vulnery sponges; wadding for medical use; wart pencils; wheat germ dietary supplements; yeast dietary supplements; yeast for pharmaceutical use; lactose (milk sugar); liquid bandages; sanitary pads; sanitary tampons; oiled paper for packaging purposes for doses of medicines; reagents for medical or veterinary use; hygienic napkins of paper for buttocks; paper diaper pants.

6 – Common metals and their alloys; building materials of metal; transportable buildings of metal; railway material of metal; cables and wires of metal, non-electric; ironmongery and small items of metal hardware; pipes and tubes of metal; safes [strong boxes]; goods of common metal not included in other classes; ores; advertisement columns of metal; alloys of common metals; aluminum foil; aluminum wires; aluminum; anchor plates; anchors; firedogs [andirons]; angle irons; valves of metal other than parts of machines; anti-friction metal; anvils (portable); anvils; arbors (structures of metal); armour plate; armor plating; artificial fish reefs of metal; metal valves other than for parts of machines; badges of metal for vehicles; balls of steel; wrapping or binding bands of metal; barbed wire; barrel hoops of metal; large barrels of metal; bars for metal railings; baskets of metal; beacons of metal, non-luminous; beak-irons [bick-irons]; bed casters of metal; bells for animals; bells; belt stretchers of metal; straps of metal for handling loads; beryllium; bicycle parking installations of metal; binding screws of metal for cables; binding thread of metal for agricultural purposes; bindings of metal; bird baths (metal constructions); blooms (metallurgy); movable metal boarding stairs for passengers; bolts of metal; flat bolts; bottle caps of metal; bottle closures of metal; box fasteners of metal; boxes of common metal; braces of metal for handling loads; metal brackets (building); nails; branching pipes of metal; unwrought or semi-wrought brass; brazing alloys; bronzes (works of art); bronze; bronzes for tombstones; broom handles of metal; buckles of common metal (hardware); building panels of metal; building or furniture fittings of nickel-silver; buildings of metal; busts of common metal; cabanas of metal; non-electric cable joints of metal; cables of metal, non-electric; cadmium; snap hooks; casement windows of metal; cash boxes of

metal; casings of metal for oilwells; casks of metal; unwrought or semi-wrought cast iron; cast steel; cattle chains; ceilings of metal; hafnium; cermets; chains for dogs; chains of metal; chests of metal for food; chests of metal; chicken-houses, of metal; chill-molds (foundry); chimney cowls of metal; chimney pots of metal; chimney shafts of metal; chimneys of metal; chrome iron; chrome ores; chromium; linings of metal (building); clips of metal for cables or pipes; closures of metal for containers; clothes hooks of metal; cobalt (raw) (metal); common metals, unwrought or semi-wrought; containers of metal (storage, transport); containers of metal for compressed gas or liquid air; containers of metal for liquid fuel; containers of metal for storing acids; transport containers of metal; copper rings; copper wires, not insulated; copper, unwrought or semi-wrought; cornices of metal; cotter pins; cotter pins of metal; couplings of metal for chains; ice spikes; crampons of metal; guard rails of metal for roads; diving boards of metal; platforms of metal; door bells, non-electric; flat bolts of metal; door closers, non-electric; door fittings, of metal; door cases of metal; door handles of metal; door knockers; door-mats of metal; non-electric door openers; door panels of metal; foot scrapers; door stops of metal; doors of metal; drain pipes of metal; drain traps (valves) of metal; duckboards of metal; ducts of metal for ventilating and air conditioning facilities; ducts of metal for central heating installations; metal pipe bends; enclosures of metal for tombs; eye bolts; fences of metal; titanium iron; ferrules of metal for handles; ferrules of metal for walking sticks; ferrules of metal; figurines statuettes of common metal; filings of metal; fish plates (rails); fittings of metal for beds; fittings of metal for building; fittings of metal for coffins; fittings of metal for compressed air ducts; fittings of metal for furniture; fittings of metal for windows; flanges of metal; flashes of metal, for building; floating containers of metal; floating docks of metal, for mooring boats; floor tiles, of metal; floors of metal; foils of metal for wrapping and packaging; foundry molds of metal; frames of metal (for building); framework of metal for building; furnace screens; furnace fireguards; furniture casters of metal; galena (ore); gates of metal; nickel-silver alloys; germanium; girders of metal; gold solder; grilles of metal; grease nipples; greenhouse frames of metal; transportable conservatories of metal; guard rails of metal; gutter pipes of metal; gutters of metal; handcuffs; handling pallets of metal; small hardware of metal; hat hanging hooks of metal; hinges of metal; hooks (metal hardware); hooks for slate (metal hardware); hooks of metal for clothes rails; iron strip; hoppers of metal, non-mechanical; horseshoe nails; binding thread of metal for agricultural purposes; ice molds of metal; identification bracelets of metal, for hospitals; identity plates of metal; indium; industrial packaging containers of metal not inc-

luding stoppers, lids and caps of metal; industrial water storage tanks of metal; ingots of common metal; insect screens (frames of metal); internal floating lids of aluminum for use with storage tanks for liquefied gas or gas; iron ores; iron slabs; iron wires; iron, unwrought or semi-wrought; iron and steel; ironwork for doors; ironwork for windows; jalousies of metal; jets of metal; joists of metal; keys (mechanical element); keys; knife handles of metal; knobs of metal; leaf springs of metal, not machine elements; latch bars of metal; latches of metal; laths of metal; latticework of metal; lead seals; lead, unwrought or semi-wrought; letter boxes of metal; letters and numerals of common metal, except type; limonite; lintels of metal; storage tanks of metal for liquefied gas; storage tanks or reservoirs of metal for storing liquids; loading and unloading pallets of metal; loading gauge rods, of metal, for railway waggons; loading pallets, of metal; locking bolts; closures of metal for bags; locks of metal for vehicles; locks of metal, other than electric; machine belt fasteners of metal; magnesium; manganese; manhole covers of metal; manifolds of metal for pipelines; masts of metal; fixed equipment for funicular railways; paving blocks of metal; metal cages for wild animals; containers of metal for compressed gas or liquid air; metal ironmongery; joinery connectors of metal; metal pipe couplings; metal lids and caps for industrial packaging containers; metal materials for building or construction; metal molds for forming cement products; metal nameplates and door nameplates; metal stepladders and ladders; metal stoppers for industrial packaging containers; metal tombs and tomb plates of metal; metals in powder form; moldings of metal for cornices; molybdenum iron; molybdenum; metal monuments for tombs; monuments of metal; mooring bitts of metal; mooring bollards of metal; mooring buoys of metal; nails; nickel; nickel-silver; niobium; non-ferrous metals and their alloys; metal nozzles; registration plates, of metal; nuts of metal; ores of metal; outdoor blinds of metal; packaging containers of metal; padlocks; booths of metal for spraying paint; palings of metal; partitions of metal; paving blocks of metal; metal pegs; penstock pipes of metal; sheet piles of metal; metal columns (parts of constructions); pins (hardware); pipe muffs of metal; pipes of metal; pipework of metal; pitons of metal (mountaineering equipment); prefabricated platforms of metal; bungs of metal; metal posts, for electric lines; poles of metal; porches of metal (building); posts of metal; pot hooks of metal; poultry cages of metal; prefabricated building assembly kits of metal; metal cans; props of metal; pulleys of metal, other than for machines; pyrophoric metals; railroad ties of metal; rails of metal; materials, of metal, for railway tracks; lane change; non-mechanical reels of metal for flexible hoses; refractory construction materials of metal; reinforcing materials of metal for building; reinforcing



materials of metal for machine belts; reinforcing materials for pipes (of metal); reinforcing materials, of metal, for concrete; rings of common metal for keys; rings of metal; rivets of metal; signage panels, non-luminous and non-mechanical, of metal; rocket launching platforms of metal; rods of metal for brazing and welding; rods of metal for brazing; rods of metal for welding; roller blinds of steel; roof coverings of metal; roof flashing of metal; roofing of metal; rope thimbles of metal; wire rope; runners of metal for sliding doors; safety cashboxes; safety chains of metal; window pulleys; scaffolding of metal; screws of metal; sculptures of metal; scythe handles of metal; sealing caps of metal; sheaf binders, of metal; metal sheets; shims; metal formwork for concrete; shutters of metal; signs, non-luminous and non-mechanical, of metal; signboards of metal; road signs, non-luminous and non-mechanical, of metal, for roads, signs, non-luminous and non-mechanical, of metal; silicon iron; sills of metal; silos of metal; silver plated tin alloy; silver solder; skating rinks (metal structures); muffs; slings, of metal, for handling loads; soldering wire of metal; spiral springs, of metal, not elements of machines; spring locks; springs (metal hardware); spurs; metal steps; metal staircases; statues of common metal; steel alloys; steel structure; steel masts; steel tubes; steel sheets; steel strips; steel wires; unwrought or semi-unwrought steel; steps [ladders] of metal; stops of metal; belt joints of metal; iron band stretchers; stretchers for metal bands; metal load beams; swage blocks; reels of metal, non-mechanical, for flexible hoses; reservoirs of metals; tantalum (metal); taps for casks, of metal; telegraph posts of metal; telephone booths of metal; telpher cables; tension links; tent pegs of metal; thread of metal for tying-up purposes; tiles of metal; tiles, of metal, for construction; tiles of metal; tin; tinfoil; tinplate packings; tinplate; titanium; tombac; tombs of metal; tombstone plaques of metal; tombstone stelae of metal; gravestones of metal; toolboxes of metal, empty; tool chests of metal, empty; tool handles of metal; towel dispensers of metal; towel dispensers, fixed, of metal; transport pallets of metal; transportable greenhouses of metal for household use; traps for wild animals; straps of metal for handling loads; tree protectors of metal; troughs of metal for mixing mortar; casings of metal; tungsten iron; tungsten; turnstiles non-automatic; turntables (railways); turn-tables for load handling; upright signboards of metal; valves (of metal, not machine elements); vanadium; vats of metal; vaults of metal [burial]; vice benches of metal; metal vice claws; wainscoting of metal; wall claddings of metal (building); collars of metal for fastening pipes; wall claddings of metal (building); metal pins; washers of metal; water tanks, of metal, for household use; water-pipe valves of metal; water pipes of metal; weather-or wind-vanes of metal; wheel clamps [boots]; white metal; wind-driven

bird-repelling devices made of metal; winding spools, of metal, non-mechanical, for flexible hoses; window casement bolts; window fasteners of metal; window frames of metal, window stops of metal; wires of common metal alloys, of metal; wire stretchers (packaging stirrups for dose of medicines); industrial packaging containers of metal, not including metal stoppers, lids and caps.

7 – Machines and machine tools; motors and engines (other for land vehicles); machine coupling and transmission components (except for land vehicles); agricultural implements other than hand-operated; incubators for eggs; automatic distribution machines; acetylene cleaning apparatus; adhesive bands for pulleys; adhesive tape dispensers (machines); aerated beverage-making machines; aerated water making apparatus; aerated water production apparatus; aerating pumps for aquariums; aerocondensers; aeronautical engines; airplane engines; agitators; agricultural elevators; agricultural implements other than hand-operated; agricultural machines; air brushes for applying color; air condensers; air cushion devices for moving loads; air pumps (garage installations); air suction machines; air turbines, not for land vehicles; alternators; angle valve, machine elements, and not for land vehicles; anti-friction bearings for machines; anti-pollution devices for engines; apparatus for drawing up beer under pressure; atomisers (machines); automatic control valves, machine elements, not for land vehicles; automatic grapnels for marine purposes; axial flow fans; axial flow compressors; axial flow pumps; shafts for machines; ball rings for bearings; ball valves, machine elements not for land vehicles; ball-bearings; band brakes, machine elements not for land vehicles; wine presses; bearing brackets for machines; bearings (parts of machines); bearings for transmission shafts; electric beaters; beating machines; beer pumps; belt conveyors; belt pulleys, machine elements, not for land vehicles; belts for conveyors; belts for machines; belts for motors and engines; bending machines; electromechanical machines for preparing drinks; bicycle assembling machines; bicycle dynamos; binding apparatus for hay; bitumen making machines; blade holders (parts of machines); blade sharpening [stropping] machines; iron elements (parts of machines); electric blenders for household use; shoe brakes, machine elements, not for land vehicles; bellows [machines]; blowing machines for the compression, exhaustion and transport of gases; blowing machines or fans for the compression, sucking and carrying of grain; bellows [machines]; bobbins for weaving looms; boiler tubes (parts of machines); bookbinding apparatus and machines for industrial use; bottle capping machines; filling machines; bottle sealing machines; bottle stoppering machines; bottle washing machines; boxes for matrices (printing); braiding machines; brake linings other than for vehicles; brake pads other than for vehicles; brake

segments other than for vehicles; brake shoes other than for vehicles; bread cutting machines; brewing machines; brushes (parts of machines); electric brushes; bulldozers; butter machines; calenders; cams, machine elements, not for land vehicles; capstans; carbon brushes (electricity); carburetor feeders; carburetors; carding machine fittings (parts of carding machines); carding machines; aprons [parts of machines]; carriages for knitting machines; cartridges for filtering machines; catalytic converters; central vacuum cleaning installations; centrifugal fans; centrifugal compressors; centrifugal machines; centrifugal mills; centrifugal pumps; chaff cutter blades; straw chaff cutters; chisels for machines; chucks (parts of machines); churns; cigarette machines for industrial use; cinder sifters (machines); clack valves (parts of machines); cleaning appliances utilizing steam; clippers (machines); clutches other than for land vehicles; coal-cutting machines; taps, machine elements not for land vehicles; coffee grinders, other than hand-operated; coin-operated washing machines; compressed air engines; compressed air guns for the extrusion of mastics; compressed air machines; compressed air pumps; compressors (machines); compressors for refrigerators; concrete mixers (machines); condensing installations; cone brakes, machine elements not for land vehicles; connecting rods for machines and engines; control cables for machines, engines or motors; control mechanisms for machines, motors and engines; converters for steelworks; conveyors; radiators [cooling] for motors and engines; cord making machines; grain husking machines; couplings other than for land vehicles; cranes (lifting and hoisting apparatus); crank shafts; crankcases for machines, motors and engines; cranks (parts of machines); cream/milk separators; cultivators (machines); current generators; electrically-operated curtain-drawing devices; cutters (machines); gas-operated cutting blow pipes; cutting machines; cylinder heads for engines; cylinders for machines; cylinders for motors and engines; dairy machines; darning machines; feed-water deaerators; degreasers (machines); derricks; die-cutting and tapping machines; diesel engines, not for land vehicles; die-stamping machines; diffusion pumps; diggers (machines); disk brakes, machine elements not for land vehicles; dishwashers; disintegrators; dividing machines; electric door closers; electric door openers; water separators; drainage machines; drill chucks (parts of machines); drilling bits (parts of machines); drilling heads (parts of machines); drilling machines; floating or non-floating drilling rigs; driving chains other than for land vehicles; driving motors other than for land vehicles; drums [parts of machines]; dust exhausting installations for cleaning purposes; dust removing installations for cleaning purposes; dyeing machines; dynamo belts; dynamo brushes; dynamos; earth-moving machines; ejectors; electric arc cutting apparatus; electric arc welding

apparatus; electric can openers; electric hammers; electric hand drills; electric machines for shampooing carpets; electric machines and apparatus for cleaning; electric machines and apparatus for polishing; electric machines and apparatus for wax-polishing; electric welding apparatus; electrical apparatus for sealing plastics [packaging]; electrodes for welding machines; electromechanical machines for the chemical industry; electroplating machines; elevating apparatus; elevator belts; elevator chains (parts of machines); lift operating apparatus; lifts, other than ski-lifts; embossing machines; emergency power generators; engines for air cushion vehicles; boat engines; motors and engines, other than for land vehicles; engraving machines; moving staircases [escalators]; excavators; exhaust manifolds for engines; exhausts for electric motors and thermal engines; expansion tanks (parts of machines); extractors for mines; fan belts for electric motors and thermal engines; fans for electric motors, and thermal engines; feeders (parts of machines); supply apparatus for engine boilers; feedwater regulators; filling machines; filter presses; filtering machines; filters (parts of machines or engines); filters for cleaning cooling air, for motors and engines; finishing machines; fittings for engine boilers; fleshing machines; flour mill machines; flues for boilers, for engines; hydraulic couplings, machine elements, not for land vehicles; fodder presses; electromechanical machines for food preparation; electric food processors; forge bellows; foundry machines; freewheels, other than for land vehicles; friezing machines; electric fruit presses for household use; fuel conversion apparatus for internal combustion engines; fuel dispensing pumps for service stations; fuel economizers for electric motors and thermal engines; galvanizing machines; garbage [waste] disposals; gas turbines, not for land vehicles; aerators; gasoline engines, not for land vehicles; gas-operated blow torches; gearboxes, other than for land vehicles; gears for weaving looms; gears, other than for land vehicles; electricity generators; glass-working machines; glaziers' diamonds (parts of machines); glow plugs for diesel engines; electric glue guns; grain separators; grating machines for vegetables; grease boxes as parts of machines; grease rings (parts of machines); electric grinders/crushers for household purposes; crusher; grindstones (parts of machines); guides for machines; guides for machines; hair clipping machines for animals; hammers (parts of machines); hand printing machines; hand-held tools, other than hand-operated; handling apparatus (for loading and unloading); automatic handling machines (manipulators); hangers [parts of machines]; harrows; harvesting machines; heat exchangers (parts of machines); heel-making machines; hemming machines; high pressure washers; hoists; tool holders (parts of machines); cowlings (parts of machines); hoppers [for mechanical discharging]; hosiery looms; housings [parts of machi-

nes]; hydraulic accumulators, elements for machines, not for land vehicles; hydraulic controls for machines, electric motors and thermal engines; hydraulic devices for opening and closing doors (machine parts); hydraulic engines and motors; hydraulic intensifiers, elements for machines, not for land vehicles; hydraulic torque converters, elements for machines, not for land vehicles; hydraulic turbines; idle speed pulleys, elements for machines, not for land vehicles; igniting devices for internal combustion engines; igniting magnetos; incubators for eggs; injection molding machines; injectors for motor and engines; inking apparatus for printing machines; internal combustion engines, elements for machine, not for land vehicles; ironing machines; jacks (machines); jet engines other than for land vehicles; journal boxes (parts of machines); journals (parts of machines); kerosene engines, elements for machines, not for land vehicles; kick starters for motorcycles; electric food processors; kneading machines; knitting machines; knives (parts of machines); knives for mowing machines; electric knives; labelers (machines); lace making machines; laminated blade springs, elements for machines, not for land vehicles; lathes; lawnmowers (machines); leather paring machines; leather-working machines; lifting apparatus; lifts, other than ski-lifts; connections, elements for machines, not for land vehicles; loading ramps; loom shafts; weaving looms; lubricating pumps; lubricators (parts of machines); machine boiler scale collectors; machine fly-wheels; machine tools; machine wheels; machine wheelwork; machines for making edible pastes; machines for the textile industry; brand printing machine; matrices for use in printing; meat choppers (machines); mechanized livestock feeders; metal drawing machines; metalworking machines; milking machines; milling machines; mills (machines); mills for household use other than hand-operated; millstones; mine borers; machines for the manufacture of mineral waters; mineworking machines; mixed flow pumps; mixers (machines); mixing machines; molding machines; molds (parts of machines); mortizing machines; motorized cultivators; motors for boats; electric parts for motors, other than for land vehicles; electric motors, other than for land vehicles; mud catchers and collectors (machines); silencers for electric motors and for thermal engines; net hauling machines [fishing]; notchers (machine tools); nuclear engines; oil refining machines; machines for processing minerals; packaging machines; packing machines; painting machines; devices for feeding paper (printing); paper machines; papermaking machines; electric parquet wax-polishers; parts of air turbines, other than for land vehicles; parts of diesel engines, other than for land vehicles; parts of gas turbines, other than for land vehicles; parts of gasoline engines, other than for land vehicles; parts of hydraulic turbines, other than for land vehicles; parts of internal combustion

engines, other than for land vehicles; parts of jet engines, other than for land vehicles; parts of kerosene motors, other than for land vehicles; parts of ramjets, other than for land vehicles; parts of steam engines, other than for automobiles; parts of steam engines, other than for land vehicles; parts of steam turbines, other than for land vehicles; parts of turbojet engines, other than for land vehicles; parts of turbo prop engines, other than for land vehicles; pedal drives for sewing machines; sifting machines; pepper mills other than hand-operated; piston rings; pistons (parts of machines or engines); pistons for cylinders; pistons for engines; planing machines; plows; plowshares; pneumatic controls for machines, electric motors and thermal engines; pneumatic door openers and closers (parts of machines); pneumatic hammers; pneumatic shock absorbers (air cushions, machine elements not for land vehicles); pneumatic transporters; pneumatic tube conveyors; potters' wheels; power hammers; power transmission belts, elements for machines, not for land vehicles; leather power transmission belts, elements for machines, not for land vehicles; rubber power transmission belts, elements for machines, not for land vehicles; textile power transmission belts, elements for machines, not for land vehicles; presses (machines for industrial use); pressure reducers (parts of machines); pressure regulators (parts of machines); pressure valves (parts of machines); printing cylinders; printing machines for use on sheet metal; machines for printing; printing plates; printing presses; printing rollers for machines; propulsion mechanisms other than for land vehicles; puddling machines; pulleys (parts of machines); pulleys being parts of machines; pump diaphragms; pumps (machines); pumps (parts of machines, of electric motors or of thermal engines); pumps for heating installations; punches for punching machines; punching machines; rack and pinion jacks; racket stringing machines; rail-laying machines; railroad constructing machines; rakes for raking machines; raking machines; ramjet engines, not for land vehicles; rams (machines); reapers and binders; reapers and threshers; reapers; reciprocating compressors; reciprocating compressors; piston pumps; shock absorber plungers; reduction gears other than for land vehicles; mechanical reeling apparatus; reels (parts of machines); mechanical reels for flexible hoses; regulators (machine parts); inverter mechanisms, elements for machines, not for land vehicles; rinsing machines; riveting machines; road making machines; steamrollers; self-propelled road sweeping machines; robots (machines); rocket engines, not for land vehicles; roller bearings; roller bridges; roller chains, elements for machines, not for land vehicles; rolling mill cylinders; rolling mills; rotary blowers; rotary printing presses; rotary pumps; portable rotary steam presses for fabrics; rotary vacuum pumps; satinizing machines; sausage machines; saw benches (machine

parts); saw blades (parts of machines); saws (machines); electric scissors; joints (parts of engines); sealing machines for industrial purposes; self-oiling bearings; self-regulating fuel pumps; separators; sewage pulverizers; sewing machines; shaft couplings (machines); sharpening machines; sheaf-binding machines; electric shears; lasts for shoes (parts of machines); electric shoe polishers; mechanical shovels; shredders (machines) for industrial use; shuttles (machine parts); moving pavements [sidewalks]; sieves (machines or parts of machines); sifters; sifting installations; sizing machines; slide rests (machine parts); smoothing presses; snow plows; gas-operated welding apparatus; gas-operated soldering blow pipes; electric soldering irons; gas-operated soldering irons; soldering lamps; sorting machines for industry; sowers (machines); spark plugs other than for land vehicles; sparking plugs for internal combustion engines; speed regulators for machines, electric motors and thermal engines; spin driers (not heated); spinning frames; spinning machines; spinning wheels; coil springs, elements for machines, not for land vehicles; spray guns for paint; spring shock absorbers, elements for machines, not for land vehicles; spring-assisted hydraulic shock absorbers, elements for machines, not for land vehicles; springs (parts of machines); stalk separators (machines); stamping machines; stands for machines; starters for electric motors and thermal engines; stators (parts of machines); condensers (steam parts of machines); boilers for steam machines; steam engines; steam marine engines, not for land vehicles; steam traps; steam turbines, not for land vehicles; steam/oil separators; stereotype machines; stitching machines; stone working machines; stuffing boxes (parts of machines); teat cups [suction cups] for milking machines; suction machines for industrial use; sugar making machines; superchargers; superheaters; swaging machines; tables for machines; tambours for embroidery machines; faucets (parts of machines, of electric motors or of thermal engines); tarring machines; tending machines; thermic lances (machines); threading machines; threshing machines; tilt hammers; tobacco processing machines; tools (parts of machines); toothed wheels or gears, elements for machines, not for land vehicles; torque converters other than for land vehicles; transmission chains other than for land vehicles; drive shafts, excluding for land vehicles; power transmissions for machines; transmissions, other than for land vehicles; trimming machines; truck lifts; trueing machines; turbines other than for land vehicles; turbo blowers; turbocompressors; turbojet engines, not for land vehicles; turboprop engines, not for land vehicles; turf removing plows; tympan (parts of printing presses); typecasting machines; type-setting machines [photocomposition]; type-setting machines (printing); typographic machines; typographic presses; universal joints [Cardan joints]; dust suction accessories for washing appara-

tus; washing machines [laundry]; water heaters (parts of machines); weeding machines; electric welding machines; electric whisks for household use; wind turbines; wine presses; winnowers; woodworking machines; wrapping machines; wringing machines for laundry; automatic distribution machines (automatic vending machines); motor reducers; composting machines; rotary printing presses; stepper motors.

8 – Hand-operated hand tools and implements (hand-operated); side arms, other than firearms; razors; abrading instruments (hand instruments); adzes (tools); hand-operated agricultural tools; annular screw plates; skinning apparatus and instruments for butchers' animals; apparatus and instruments for slaughtering butchers' animals; apparatus for tattooing; earth augers (hand tools); awls; axes; bayonets; beard clippers; bill-hooks; bits (hand tools); bits (parts of hand tools); blade sharpening instruments; bladed or pointed hand tools, other than swords; blades (hand tools); blades (weapons); blades for planes; truncheons; border shears; borers; saw bows; braiders (hand tools); branding irons; breast drills; budding knives; pickhammers; can openers, non-electric; carpenters' inkwells and their accessories; cattle shearers; cattle stunning appliances; caulking irons; center punches (hand tools); non-electric cheese slicers; chisels; choppers (knives); clamps for carpenters or coopers; cleavers; crimping irons; crow bars; curling tongs; cuticle tweezers; cutlery; cutter bars; cutting devices; cutting bars; cutting tools (hand tools); daggers; electric or non-electric depilation apparatus; plant parasite killing apparatus; dies (hand tools); diggers (hand tools); digging forks (spading forks); ditchers (hand tools); diving knife holders; diving knives; drawing knives; tailors' chalk sharpeners; drill holders (hand tools); gimlets; ear-piercing apparatus; earth rammers (hand tools); edge tools (hand tools); non-electric egg slicers; electric clippers for cutting human hair; embossers (hand tools); emery cuticle pushers; emery grinding wheels; engraving needles; expanders (hand tools); extension pieces for braces for screw taps; eyelash curlers; farriers' knives; files (tools); cuticle pushers, electric or non-electric; fire irons; shovels for transporting coal from living wood; fire tongs; fireplace bellows (hand instruments); fish tapes (hand tools); flat irons; mincing knives (hand tools); forks; instruments for transporting cast iron (hand tools); frames for handsaws; fruit pickers (hand tools); fullers (hand tools); fulling tools (hand tools); hand-operated garden tools; gimlets (hand tools); glazier's diamonds (parts of hand tools); polishing irons; gofering irons; gouges (hand tools); grafting tools (hand tools); chisels (hand tools); grindstones (hand tools); guns (tools); guns, hand-operated, for the extrusion of mastics; hackles (hand tools); hainault scythes; clippers for cutting animal hair (hand instruments); electric and non-electric clippers for cutting

human hair, for personal use; hair-removing tweezers; hammers (tools); hand drills; hand implements for hair curling; hand pumps; hand tools, hand-operated; harpoons for fishing; harpoons; hatchets; hoes (hand tools); holing axes; hollowing bits (parts of tools); hoop cutters (tools); hunting knives; ice picks; implements for decanting liquids (hand tools); insecticide atomizers (tools); instruments and tools for skinning animals; instruments for punching tickets; irons (non-electric hand tools); jig-saws; knives; punch rings [knuckle dusters]; ladles (tools); ladles for wine; lasts for shoes (shoemakers' tools); lawn clippers (hand instruments); lawn rakes (hand-held rakes only); leather strops; levers; lifting jacks, hand-operated; livestock marking tools; machetes; mallets (hand instruments); manicure sets, electric; manicure sets; marline spikes; masons hammers; mattocks; stretchers for wire and metal bands (hand tools); milling cutters (tools); miter boxes (tools); molding irons; money scoops; mortars for pounding; mortise chisels; nail clippers, electric or non-electric; crowbars (tools); nail extractors; nail files, electric nail files; nail nippers; nail punches; needle files; needle-threaders; tongs; non-electric planes for crumbling dried bonitos; numbering punches; nutcrackers; oyster openers; palette knives; paring irons (hand tools); paring knives; pedicure sets; penknives; perforating tools; pestles; pickaxes; picks (tools); pin punches; pizza cutters, non-electric; plane irons; planes; clamps; priming irons (hand tools); pruning knives; secateurs; pruning shears (tools); punch pliers (tools); punches (tools); rabbeting planes; rakes (tools); rams (hand tools); rasps (tools); ratchets (hand tools); razor blades; razor cases; razor strops; razors, electric or non-electric; reamer sockets; reamers; riveting hammers (tools); riveting hammers (tools); sabers; sand trap rakes; saw blades (parts of tools); saw holders; saws (tools); pruning knives, namely knives for cutting branches and bushes; scissors; scrapers (tools), scraping tools (hand instruments); screwdrivers; scythe rings; scythes; sharpening instruments; sharpening steels; sharpening stones; shaving cases; scissor blades; shearers (hand instruments); shears; shovels (tools); sickles; handguns, other than firearms; silver plate (knives, forks and spoons); sledgehammers; spades (hand tools); wrenches (tools); spatulas (tools); spoons; squares (tools); stamps (hand tools); stone hammers; stropping instruments; sugar tongs; sword scabbards; swords; syringes for spraying insecticides; tableware (knives, forks and spoons); table forks; tap wrenches; carriage keys; thistle extirpators (tools); tool belts [holders]; tree pruners; trowels (gardening); trowels; pipe cutters (tools); tube cutting instruments; tweezers; whetstone holders; scythe stone; wick trimmers (scissors); stripping pliers (hand tools); electric flat irons for household use; electric hair crimpers for household use.

9 – Scientific, nautical, surveying, photographic, cinematographic, optical, weighing, measuring, signaling, checking (supervision), life-saving and teaching apparatus and instruments; apparatus and instruments for conducting, switching, transforming, accumulating, regulating or controlling electricity; apparatus for recording, transmission or reproduction of sound or images; magnetic data media, recording disks; compact disks, DVDs and other digital recording media; mechanisms for coin-operated apparatus; cash registers, calculating machines; data processing equipment, computers; software; extinguishers; electronic apparatus; electronic apparatus and their parts and accessories; video and/or audio electronic apparatus; electronic communication apparatus; computer program for downloading, managing, converting and playing audio files, cinematographic films, texts and data regarding tray photo images; downloadable audio, video and image music file; downloadable software for wireless transmission and synchronization of audio, video, text, multimedia and film files and data flows, as well as music files to and between computers, television adapted to a computer, other devices for displaying video and playing audio content compatible with computers, mobile telephones, laptop computers, or other mobile devices; downloadable video game software; computer peripherals; laptop computers, tablet computers; personal digital assistants, computer terminals, electronic reading devices, electronic publications; network media players, helmet-mounted displays; wireless and wired remote controls for portable digital electronic devices, telephones, mobile telephones; smart phones, audio and video recorders and/or players for the home; portable and personal audio and video recorders and/or players; players and/or recorders for MP3 and other digital audio and video formats; earphones, helmets, cameras, video cameras, television apparatus, mobile television sets, electronic circuits, magnetic disks, optical discs, magnetic and optical disks, CD-Roms, (ROM compact discs), magnetic tapes and encoded DVD-ROMs, encoded, containing video game programs for personal use; electronic circuits, magnetic disks, optical disks, optical and magnetic disks, CD-ROMs (ROM compact discs), magnetic tapes and encoded DVD-ROMs containing video game programs for professional use; control modules, apparatus and instruments for remote control for television sets and video systems, memory cards, volume controllers, discs, computer mice, optical discs, magnetic and optical disks, CD-ROMs, (ROM compact discs), magnetic tapes and encoded DVDs with magazines, books, newspapers, Cards, photographs, literal information and images; cell analyzers; cell sorters; flow cytometers, laboratory apparatus and instruments (other than for medical use); apparatus and instruments for scientific research in laboratories; apparatus for measurement by standard measuring units;

apparatus for measurement by derived measuring units, precision measuring machines and instruments, material testing machines and instruments; surveying machines and instruments; astronomic measurement machines and instruments; heat-sensitive plastic film sheets for temperature display; electricity control and/or distribution apparatus; converters; phase modifiers; dry cells; wet cells; accumulators and batteries; photovoltaic cells; electric or magnetic meters and testers; electric wires; electric cables; telescopes; microscopes, spectacles and goggles; parts and accessories for spectacles and goggles; safety nets; life belts; life jackets; life buoys; electron microscopes; electronic desk calculators; word processing software; X-rays tubes (not for medical use); photo-sensitive tubes; vacuum tubes; rectifier tubes; cathode-ray tubes; discharge tubes; thermistors; diodes; transistors; electron tubes; semiconductor elements (semiconductor devices); integrated circuits; large-scale integrated circuits; electric buzzers for household use; exposed cinematographic films; exposed filmstrips; filmstrip mounts; pre-recorded videodisks and videotapes; lenses (glasses) and sunglasses; drainers for use in photography; Japanese charcoal extinguishers (hikeshi-tsubo); plotter; wall sockets and plugs; navigational instruments; music and cassette players (toys); portable electronic games and apparatus (different from those adapted for use with a television set only); diving suits (wet suits).

10 – Surgical, medical, dental and veterinary apparatus and instruments; prostheses, artificial eyes and teeth; suture material; cell analyzers for medical or clinical use; cell sorters for medical or clinical use; diagnostic apparatus for medical use; medical apparatus and instruments; testing apparatus for medical use; apparatus used for medical analysis; apparatus for artificial respiration; beds, specially designed for medical use; blankets electric for medical use; blood testing apparatus; boots for medical use; catheters; clothing especially for operating rooms; crutches; cushions for medical use; dental apparatus; esthetic massage apparatus; ultraviolet ray filters, for medical use; gastroscopes; hearing aids for the deaf; hearing protection apparatus; heart pacemakers; hematometers; hot air therapeutic apparatus; inhalers; lamps for medical use; lasers for medical use; massage apparatus; orthopedic articles; physical exercise apparatus for medical purposes; pulse meters; radiological apparatus for medical use; radiotherapy apparatus; respirators for artificial respiration; sphygmotensimeters; orthopedic bandages for hygiene purposes.

11 – Apparatus for lighting, heating, steam generating, cooking, refrigerating, drying, supplying water, ventilation, and for sanitary use; accumulators; air conditioning apparatus; air filtering installations; lights for automobiles; bath fittings; bath tubs; elect-

ric blankets, not for medical use; brackets for gas burners; burners; electrically heated carpets; ceiling lights; electronic coffeemakers; cooking apparatus and installations; cycle lights; deodorizing apparatus not for personal use; desiccating apparatus; disinfectant apparatus; distillation apparatus; hair driers; air driers; electric lamps; fans; filaments for electric lamps; filters for air conditioning; filters for drinking water; chimneys; flares; flashlights (torches); foot muffs, electrically heated; gas boilers; gas burners; gas lamps; heat accumulators; heaters for baths; hot plates; electric kettles; kitchen ranges (ovens); lamps; lighting apparatus for vehicles; lighting apparatus for air vehicles; microwave ovens; flashlights for lighting; electric pressure cookers (autoclaves); electric radiators; refrigerators; roasters; sanitary apparatus and installations; sockets for electric lamps; cookers; stoves; washbasins; machines and apparatus for water purification, water supply installations; automatic control plumbing fittings of metal, excluding machine elements; aviaries of metal (structures); ball valves of metal, excluding machine elements; metal valves, excluding parts of machines; food cooling devices, containing heat exchange fluids, for household purposes; smoke absorbers for household purposes.

12 – Vehicles; apparatus for locomotion by land, air or water; AC or DC motors for land vehicles (their parts not included); electric motors; electric gear motors; electric motors for automobiles; adhesive patches for repairing inner tubes or tires; aerial conveyors; aeronautical apparatus, machines and devices; airplanes; inflatable air bags (safety devices for automobiles); air balloons; air cushion vehicles; aircraft and their parts and fittings; air pumps (vehicle accessories), air vehicles; aircraft; dirigible balloons [airships]; ambulances; amphibious airplanes; anti-dazzle devices for vehicles; anti-skid chains; anti-theft alarms for vehicles; anti-theft devices for vehicles; automobiles and their parts and fittings; automobile bodies; automobile chains; automobile chassis; automobile hoods; automobile tires; automobiles; axles; baby carriage; bands for wheel hubs; bicycle bells; bearings (for land vehicles); bicycle chains; rims for wheels of bicycles; spokes for bicycles; stands for bicycles; bicycles; bicycle trailers; boat hooks; boats, vehicle bodies; bogies for railway cars; brake linings for vehicles; brakes (for land vehicles); brake pads for automobiles; brake segments for vehicles; brake shoes for vehicles; bicycle brakes; brakes for vehicles; buffers for railway rolling stock; bumpers for automobiles; telfer railways [cable cars]; cable transport apparatus and installations; caissons (vehicle); caps for vehicle petrol [gas] tanks; caravans; carriages (railways); motor cars; carts; cars for cable transport installations; casing for pneumatic tires; casters for carts (vehicles); chairlifts; cleaning carts; concrete mixing vehicles; couplings for land vehicles; covers

for vehicle steering wheels; crankcases for land vehicle components; other than for motors and engines; cranks for cycles; bells for bicycles, cycles; bicycle brakes; cycle cars; chains for bicycles, cycles; frames for cycles; handle bars for bicycles, cycles; cycle hubs; cycle mudguards; pumps for bicycles; bicycle rims; bicycle saddles; bicycle spokes; cycle stands; bicycle tires; cycles; davits for boats; delivery tricycles; dining cars; dining cars; direction indicators for bicycles; dirigible balloons (airships); disengaging gear for boats; doors for vehicles; dredgers (boats); dress guards for bicycles, cycles; driving chains for land vehicles; driving motors for land vehicles; ejector seats for aircraft; vehicles, fenders for ships; ferry boats; railway wheel tires; frames for cycles; freewheels for land vehicles; funiculars; funnels for locomotives; funnels for ships; gear boxes for land vehicles; gearing for land vehicles; gears for cycles; golf carts; handle bars for bicycles, cycles; handling carts; headlight wipers; head-rests for vehicle seats; hoods for vehicle engines; hoods for vehicles; horns for vehicles; hose carts; horse drawn carriages; hub caps; hubs for vehicle wheels; hydraulic circuits for vehicles; hydroplanes; inclined ways for boats; inner tubes for bicycles, cycles; inner tubes for pneumatic tires; jet engines for land vehicles; kick sledges; casting carriages; launches; lifting cars [lift cars]; locomotives; luggage carriers for vehicles; luggage nets for vehicles; two-wheeled trolleys; masts for boats; military vehicles for transport; mine cart wheels; mopeds, motor buses; motor cars; motor coaches; motor homes; motorcycles; electric motors for land vehicles; motors for cycles; motors and engines for land vehicles; mudguards; non-skid devices for vehicle tires; non-electric primary engines for land vehicles (not including parts); oars; omnibuses; paddles for canoes; special baskets for cycles and bicycles; parachutes; pedals for cycles; pontoons; portholes; tailboard lifts (parts of land vehicles); transmissions and clutches (for land vehicles); propulsion mechanisms for land vehicles; pumps for bicycles, cycles; stroller covers; stroller hoods; strollers (pushchairs); cars for mining extraction; railway couplings; railway rolling stock and their parts and accessories; rearview mirrors; reduction gears for land vehicles; refrigerated vehicles; remote control vehicles, other than toys; repair outfits for inner tubes; reversing alarms for vehicles; rickshaws; rims for vehicle wheels; rims for wheels of bicycles, cycles; rolling stock for funicular railways; rolling stock for railways; cable cars for cargo or freight handling; oarlocks; rudders; two-wheeled trolleys; saddle covers for bicycles or motorcycles; saddles for bicycles, cycles or motorcycles; safety belts for vehicle seats; children's safety seats, for vehicles; scooters (vehicles); screw-propellers; screw-propellers for boats; screws [propellers] for ships; seaplanes; seat covers for vehicles; security harness for vehicle seats; shafts, axles or

spindles (for land vehicles); shaft couplings or connectors (for land vehicles); ships; boat hulls; automotive absorbers; shock absorbers (for land vehicles); shock absorbing springs for vehicles; shopping carts; side cars; ski lifts; sleeping berths for vehicles; sleeping cars; sleighs; sleighs and sleds (vehicles); snowmobiles; space vehicles; covers for spare tires; pneumatic tire cover for spare tires; spare wheel covers; spars for ships; spoilers for vehicles; spoke clips for wheels; spokes for bicycles, cycles; sports cars; sprinkling trucks; shock absorbing springs (for land vehicles); stands for bicycles, cycles (parts for bicycles, cycles); steering gear for ships; steering wheels for vehicles; sculls; stroller covers; strollers (pushchairs); spikes for tires; sun-blinds adapted for automobiles; suspension shock absorbers for vehicles; tailboard lifts (parts of land vehicles); cable cars (funicular railways); tilt trucks; tilting-carts; timbers [frames] for ships; tipping apparatus, parts of trucks and carriages; tipping bodies for trucks; tires for bicycles, cycles; tires for vehicle wheels; tires (pneumatic tires); torque converters for land vehicles; torsion bars for vehicles; traction engines; tractors; traction engine; trailer hitches for vehicles; trailers (vehicles); tramcars; transmission chains for land vehicles; transmission shafts for land vehicles; transmissions, for land vehicles; treads for retreading tires; treads for vehicles [tractor type]; treads for vehicles (tractors); tricycles; trolleys; trucks; tubeless tires for bicycles, cycles; turbines for land vehicles; direction signals for vehicles; two-wheeled trolleys; two-wheeled motor vehicles, bicycles and their parts and accessories; tires for vehicle wheels; tires (pneumatic tires); undercarriages for vehicles; unloading tippers (to tilt railway freight cars); upholstery for vehicles; valves for vehicle tires; vans (vehicles); vehicle bumpers; vehicle chassis; fitted covers for vehicles; vehicle running boards; vehicle seats; vehicle suspension springs; rims for vehicle wheels; vehicle wheel spokes; tires for vehicle wheels (tires); vehicle wheels; vehicles for transportation by land, air, water or rail; ships and their parts and rolling parts.

13 – Firearms; ammunition and projectiles; acetyl nitrocellulose; air pistols (weapons); ammonium nitrate explosives; ammunition for firearms; ammunition; apparatus for recharging cartridge pouches; artillery pieces; automatic firearm ammunition belts; ballistic missiles; special belts for ammunition; Bengal lights; breeches of firearms; cannons; cartridge cases; cartridge loading apparatus; cartridge pouches; cartridges; cleaning brushes for firearms; detonating caps other than toys; detonating fuses for explosives; detonating plugs; detonators; dynamite; explosive cartridges; explosive powders; explosives; firearm sights; firecrackers; fireworks; firing platforms; explosive fog signals; fuses for lighting explosives (for use in mines); fuses for explosives; rifle barrel; gun carriages (artillery); gun cases; gun

cotton; barrel powder; guns (weapons); gunstocks; hammers for guns and rifles; hand grenades; guns harpoon (weapons); hunting firearms; lead shot (for hunting); machine guns; mines (explosives); mortars (firearms); self-propelled weapons; noise-suppressors for guns; pistols (weapons); powder horns; primings; projectiles (weapons); pyrophoric substances; pyrotechnic products and their peripherals; pyrotechnic products; revolvers; rifles; rocket launchers; rockets; shells (projectiles); shoulder straps for weapons; side arms (firearms); sighting mirrors for guns and rifles; sights, other than telescopic sights, for guns; sights, other than telescopic sights, for guns [artillery]; signal rockets; sprays for personal defense; battle tanks; protective weapons, guns; trunnions for heavy weapons.

14 – Precious metals and their alloys and goods in precious metals or coated therewith not included in other classes; jewelry, precious stones; timepieces and chronometric instruments; agates; alarm clocks; alloys of precious metal; amulets (jewelry); anchors (clock and watch making); atomic clocks; badges of precious metal; barrels (clock and watch making); beads for making jewelry; boxes of precious metal; bracelets (jewelry); brooches (jewelry); busts of precious metal; cases for timepieces; cases for watches [presentation]; chains (jewelry); trinkets (jewelry); stopwatches (watches); chronometers; chronometric instruments; chronoscopes; clock cases; clock hands (clock and watch making); clocks and watches; clocks and watches, electric; clocks; clockworks; cloisonné jewelry; coins; commemorative shields; copper tokens; fashion jewelry; cuff links; dials (clock and watch making); diamonds; earrings; gold thread (jewelry); gold, unwrought or beaten; hat ornaments of precious metal; ingots of precious metals; iridium; ivory ornament (jewelry); unwrought or semi-wrought jet; jewelry cases (caskets); jewelry of yellow amber; jewelry; novelty key rings; control clocks; medallions (jewelry); medals; movements for timepieces; necklaces (jewelry); olivine (gems); ornamental pins; ornaments (jewelry); ornaments of jet; osmium; palladium; parts and accessories for timepieces; pearls (jewelry); pearls made of ambroid [pressed amber]; pendulums (clock and watch making); ornaments (other than cuff links); pins (jewelry); platinum (metal); precious metals; precious metals, unwrought or semi-wrought; precious stones; rhodium; rings (jewelry); ruthenium; semi-precious stones; semi-wrought precious stones and their imitations; shoe ornaments of precious metal; silver thread; silver, unwrought or beaten; spinel (precious stones); spun silver; statues of precious metal; statuettes of precious metal; stopwatches; watch straps; sundials; wire of precious metal (jewelry); tie clips; tie pins; trophies (prize cups); uncut precious stones; watch cases; watch chains; watch glasses; watch springs; watches; works of art of precious metal; wristwatches; leather bracelets.

15 – Musical instruments; accordions; bagpipes (musical instruments); bamboo flutes; bandonions; barrel organs; basses (musical instruments); bellows for musical instruments; bow nuts for musical instruments; bows for musical instruments; bridges for musical instruments; buccins (trumpets); carillons (musical instruments); cases for musical instruments; castanets; catgut for musical instruments; chin rests for violins; clarionets; clarions; cocertinas; conductors' batons; cornets (musical instruments); cymbals; dampers for musical instruments; double basses; drumheads; drums (musical instruments); drumsticks; electronic musical instruments; flutes; gongs; guitars; handbells (musical instruments); harmonicas; harmoniums; strings for harps; harps; hats with bells (musical instruments); French horns (musical instruments); horsehair for bows for musical instruments; huqin (Chinese violins); intensity regulators for mechanical pianos; Jews' harps (musical instruments); kettledrum frames; kettledrums; keyboards for musical instruments; keys for musical instruments; lyres; mandolins; mouthpieces for musical instruments; music rolls (piano); music stands; music synthesizers; musical boxes; oboes; ocarinas; organs; pedals for musical instruments; pegs for musical instruments; perforated music rolls; piano keyboards; piano keys; piano strings; pianos; plectrums; pipa (Chinese guitars); reeds; saxophones; sheng (Chinese musical wind instruments); stands for musical instruments; sticks for bows for musical instruments; stringed musical instruments; strings for musical instruments; suona (Chinese trumpets); tambourines; tom-toms; triangles (musical instruments); trombones (musical instruments); trumpets; apparatus for tuning musical instruments; tuning forks; tuning hammers; apparatus for turning pages of sheet music; valves for instruments of xylophones; zithers; music box.

16 – Paper, cardboard and goods made from these materials, not included in other classes; printed matter; bookbinding material; photographs; adhesives for stationery or for the home (sticky materials); artists' materials; typewriters and office requisites (except furniture); instructional and teaching material (except apparatus); plastic materials for packaging (not included in other classes); printing blocks; absorbent sheets of paper or plastic for foodstuff packaging; address plates for addressing machines; address stamps; address printing machines; adhesive bands for stationery or household purposes; adhesive tape dispensers (office requisites); adhesive tapes for stationery or household purposes; adhesives for plastics for stationery or the home; adhesives for stationery or household purposes; advertisement boards of paper or cardboard; almanacs; announcement cards (stationery); apparatus for mounting photographs; architects' models; arithmetical tables; watercolor [watercolour] saucers for artists; atlases; automatic stamp affixing machines; luggage tags; bags (enve-



lopes, pouches), of paper or plastic, for packaging; bags for microwave cooking; balls for ball-point pens; paper banners; bibs of paper; biological samples for use in microscopy; blackboards; blotters; blueprints; bookbinding apparatus and machines (items of stationery); bookbinding cloth; thread for bookbinding; bookbinding materials; bookbindings; bookends; booklets; bookmarkers; books; bottle envelopes of cardboard or paper; bottle wrappers of cardboard or paper; boxes of cardboard or paper; cabinets for stationery (office requisites); calendars; canvas for painting; carbon paper; cardboard articles; cardboard tubes; cardboard; cards; cases for stamps (or seals); catalogs; chalk for lithography; chalk holders; crayons (pencils); non-electronic chart pointers; chromolithographs; cigar bands; clipboards (office requisites); staples for offices; coasters of paper; comics (comic books); compasses for drawing; composing frames (printing); obliterating stamps; conical paper bags; copying paper (stationery); correcting fluids (stationery); correcting ink (heliography); correcting tapes (office items); cream containers of paper; credit card imprinters, non-electric; transfers [decalcomanias]; decorators' paintbrushes; diagrams; document holders (stationery); document laminators for office use; paper drawer liners, perfumed or not; drawing boards; drawing instruments; drawing materials; drawing pads; ruling pens; drawing rulers; drawing sets; drawing squares; drawing T-squares; duplicators; elastic bands for offices; electric staplers for offices; electrocardiograph paper; electrotypes; embroidery patterns; engraving plates; engravings; envelope sealing machines, for offices; envelopes (stationery); erasers for offices; erasing products; erasing shields; etching needles; etching; fabrics for bookbinding; face towels of paper; figurines of papier mâché; folder; document files (stationery); filter paper; filtering materials (paper); finger-stalls (stationery); flags of paper; covers of paper for flower pots; flyers; folders for documents (stationery); paper folders; food wrapping plastic film for household use; printed forms; fountain pens; mail franking machines; French curves; galley racks (printing); garbage bags, of paper, for household use; garbage bags of paper or of plastics; garbage bags, of plastic, for household use; geographical maps; glue for stationery or household purposes; graining combs; graphic prints; graphic representations; graphic reproductions; greeting cards; gummed cloth for stationery purposes; gummed tape (stationery); gums (adhesives) for stationery or household purposes; hand labeling appliances; hand towels, of paper; handkerchiefs of paper; hand support units for painters; handwriting specimens for copying; hat boxes, of cardboard; hectographs; histological sections for teaching purposes; holders for checkbooks [cheque books]; stamp holder or seals; hooks for writing instruments; house painters' rollers; humidity control sheets, of

paper or plastic, for foodstuff packaging; videocassette files; index cards (stationery); repositionable index; Indian inks; industrial packaging containers, of paper; ink containers; inking ribbons; inking ribbons for holograms; ink sticks (Sumi); ink sticks; ink; inking pads; inking ribbons for computer printers; inking sticks; inking sheets for reproduction machines; inking sheets for duplicators; inkstands; ink stone (ink containers); inkwells; isinglass for stationery or household purposes; label for videocassette; labels, not of textile; ledgers (books); letter trays; characters (numbers and letters); lithographic stones; lithographic works of art; lithographs; loose-leaf binders; luminous paper; periodical magazines; magazines (publication); manifolds (stationery); manuals [handbooks]; marking chalk; marking pens (stationery); marking templates; equipment for seals; mats for beer glasses; duplicators; modeling clay; modeling materials; modeling paste; modeling wax, not for dental use; moisteners [office requisites]; moisteners for gummed surfaces (stationery); bank-note clips; molds for modeling clays; musical greeting cards; newsletters; newspapers; nibs of gold; nibs; notebooks; numbering apparatus; numbers (printing type); office perforators; office requisites, except furniture; oleographs; packaging material made of starch; memo blocks (stationery); paint boxes (articles for use in school); paint trays; paintbrushes; painters' brushes; easels for painters; paintings and calligraphic works; framed or non-framed paintings; palettes for painters; pamphlets; pantographs (drawing instruments); paper and cardboard; paper bows; paper clasps; paper coffee filters; paper for radiograms; paper for recording machines; hologram paper; paper cutters (stationery); paper on which a hologram is formed; paper patterns; paper ribbons; paper sheets (stationery); paper shredders for office use; punched paper tapes or cards for recording computer programs; paper; paper clips; paperweights; papier mâché; parchment paper; passport holders; pastels; pastes and other adhesives for stationery or household purposes; patterns for making clothes; patterns for making clothes; pen cases; pen clips; pen wipers; pencil holder; pencil lead holders; pencil leads; pencil sharpener, electric or non-electric; pencil sharpening machines, electric or non-electric; pencils; pen holders; pens (office requisites); perforated cards for jacquard looms; periodicals; photo engravings; photograph stands; photographs (printed); pictures; placards of paper or cardboard; packaging films, of plastic, for wrapping or packaging; adhesive plastic film, extensible, for palletization; plastic film for wrapping; plastics for modeling; portraits; franking machines for office use; postage stamps; postcards; posters; printed lottery tickets (other than toys); printed sheets on which a hologram is formed; printed matter; printed publications; printed timetables; printers' blankets, not of textile; printers' reglets; printing blocks; portable

printing sets (office requisites); printing type; prints (engravings); processed paper in the form of a sheet on which a hologram is formed; prospectuses; cutter (office items); relief duplicators; rollers for typewriters; rosaries; rotary duplicators; rubber erasers; school supplies (stationery); albums; stamps for ink pads; sealing compounds for stationery purposes; sealing machines for offices; sealing stamps; sealing wafers; sealing wax; seals on which a hologram is formed; seals; self-adhesive tapes for stationery or household purposes; blankets; sheets of reclaimed cellulose for wrapping; shields (paper seals); signboards of paper or cardboard; silver paper; slate pencils; song books; spools for inking ribbons; square rulers; stamp cancelling machines; stamp pads; stamp stands; stamps; stands for pens and pencils; staples for offices; staplers (stationery); starch paste (adhesive) for stationery or household use; stationery and study materials; stationery; steatite (tailor's chalk); steel letters; steel pens; stencil cases; stencil; stencils (stationery); stencils; stickers for holograms; stickers (stationery); tablecloths of paper; table linen of paper; table napkins, of paper; place mats of paper; tags for index cards; tailors' chalk; teaching materials (except apparatus); terrestrial globes; thumbtacks; tickets; tissues of paper for removing makeup; toilet paper; paper napkins; tracing cloth; tracing needles for drawing purposes; tracing paper; tracing patterns; trading cards on which a hologram is formed; trading cards other than for games; transparencies (stationery); trays for sorting and counting money; typewriter keys; typewriter ribbons; typewriters, electric or non-electric; vignette-making equipment; (paints); waxed paper; cover (stationery); wrapping paper; wristbands for the retention of writing instruments; writing board erasers; writing brushes; writing set (writing case); writing set (stationery); writing chalk; writing ink; writing instruments; writing materials; writing or drawing books; notepads; writing paper; writing slates; Xuan paper for Chinese painting and calligraphy; transfer film with holograms on the surface; bed throws, of paper; ornamental stickers for jackets; sheets with a hologram formed on the surface, namely sheets consisting of a carrier material, mainly of paper or of plastic, with a hologram formed on the surface.

17 – Rubber, guttapercha, gum, asbestos, mica and goods made from these materials, not included in other classes; plastics in extruded form for use in manufacture; packing, stopping and insulating materials; flexible pipes, not of metal; acrylic resins (semi-finished products); adhesive bands other than for stationery and other than for medical or household purposes; anti-dazzle films for windows (tinted films); synthetic resins (semi-finished products); asbestos boards; asbestos cloth; asbestos tarps; asbestos fabrics; asbestos felt; asbestos fibers; asbestos mill boards; asbestos packing; asbestos packing; asbestos paper; asbestos powder; asbestos

safety curtains; asbestos sheets; asbestos slate; asbestos sole; asbestos; bags, envelopes and pouches, of rubber, for packaging; balata; bands of rubber for unscrewing jar lids; bark for sound insulation; material for preventing the radiation of heat in boilers; brake lining materials, partly semi-processed; canvas hose pipes; carbon fibers, other than for textile use; caulking materials; cellulose acetate, semi-processed; chemical compositions for repairing leaks; clack valves of rubber; clutch linings; compositions to prevent the radiation of heat; compressed air pipe fittings, not of metal; condensation paper; connecting hose for vehicle radiators; cords of rubber; cotton wool for packing; cylinder connectors; dielectrics (insulators); weatherstripping; ebonite [vulcanite] molds [moulds]; ebonite (vulcanite); elastic thread, not for textile use; electric insulating board; electric insulating canvas; electric insulating compound; electric insulating paper; electric insulating products of rubber; electrical insulators; expansion joint fillers; fiberglass fabrics for insulation purposes; glass fibers for insulation; filtering materials (semi-processed foams or plastic films); flexible tubes, not of metal; floating anti-pollution barriers; floral foam (semi-finished products); foil of regenerated cellulose, other than for packing; metal foil for insulation; gaskets; glass wool for insulation; gutta-percha; reinforcing materials, not of metal, for pipes; junctions, not of metal, for pipes; pipe gaskets; compressed air pipe fittings, not of metal; canvas hose pipe; pipe muffers, not of metal; pipes, of textile material; insulating cloths; insulating felt; insulating gloves; insulators; insulating oil for transformers; insulating oils; insulating paints; insulating paper; insulating plaster; insulating refractory materials; insulating tape; insulating varnish; insulators for cables; insulators for electric mains; insulators for railway tracks; insulators; connectors for non-metal tubes; latex (rubber); lute; mica, raw or partly processed; mineral wool (insulator); non-conducting materials for maintaining heat; packing (cushioning, stuffing) materials of rubber or plastics; stuffing materials, of rubber or plastic; paper for electrical capacitors; joints for pipes; pipe jackets, not of metal; plastic fibers, not for textile use; plastic film on which a hologram is formed; plastic film, other than for wrapping; plastic semi-processed products as supplies; plastic sheet on which a hologram is formed; plastic sheet with a function to prevent counterfeiting of goods when a hologram is produced by irradiation with a laser beam; plastic sheets for agricultural use; plastic substances, semi-processed; reinforcing materials for pipes, not of metal; rings of rubber; pipes of rubber; rubber material for recapping tires; rubber fittings; shell casings of rubber for protecting parts of machines; rubber solutions; gum, raw or partly processed; sealant compounds for joints; gaskets; adhesive tapes, other than stationery and not for medical or household purposes; shock absorbing buffers of rub-

ber; slag wool (insulator); threads of plastic for soldering; soundproofing materials of rock wool (not for building); soundproofing materials; rubber stoppers; substances for insulating buildings against moisture; synthetic rubber; threads made of plastic materials, not for textile use; rubber thread, not for textile use; valves of rubber or vulcanized fiber; viscose sheets, other than for wrapping; vulcanized fiber [fire]; washers of rubber or vulcanized fiber; garden hose; waterproof packings; water-tight rings; weatherstripping compositions; liquid rubber; rubber solutions.

18 – Leather and imitation leather, goods made from these materials and not included in other classes; animal skins; trunks and suitcases; umbrellas and parasols; walking sticks; whips, harness and saddlery; alpenstocks; attaché cases; backpacks; bags, namely sports bags, shoulder bags, Gladstone bags, hand luggage, Boston bags, leather shopping bags, net bags for shopping, shopping bags, rope bags, textile shopping bags, school book bags, backpacks, handbags, purses, wallets, key cases, credit card cases, business card cases, cases for suburban train tickets, folding briefcases and attache cases, trunks and suitcases; bags for campers; bags for climbers; sports bags; bands of leather; beach bags; bits (harness); blinders (harness); boxes made of leather or leather boards; boxes of vulcanized fiber; bridles (harness); bridoons; briefcases; butts [parts of hides]; card cases; cases, of leather or leather board; casings, of leather, for springs; cat o' nine tails (whips); cattle skins; chain mesh purses; skins of chamois, other than for cleaning; leather straps (chin straps); clothing for pets; clothing for animals; collars for animals; coverings of skins (furs); covers for horse saddles; curried skins; bags (envelopes, pouches), of leather, for packaging; fastenings for saddles; frames for umbrellas or parasols; furs; furniture coverings of leather; game bags [hunting accessories]; garment bags for travel; gold beaters' skin; gut for making sausages; halters; handbag frames; handbags; walking stick handles and walking sticks; harness fittings; harnesses for animals; harness straps; hat boxes, of leather; haversacks; horse blankets; horse collars; horseshoes; imitations of leather; industrial packaging containers, of leather; key cases; kid; knee-pads for horses; leather laces; dog leashes; leather shoulder straps; thongs [straps] of leather; leather, not worked or semi-worked; leather board; metal parts of canes; moleskin (imitation leather); music cases; muzzles; net bags for shopping; nose bags; card cases (wallets); pads for horseback riding saddles; parasols; parts of rubber for stirrups; pocket books; pouch baby carriers; bags and the like; purse frames; purses; rawhides; unworked leathers; reins; riding saddles; saddle trees; saddlery; school bags; shopping bags; saddlebags for carrying infants; slings for carrying infants; stirrup leathers; stirrups; straps for soldiers' equipment; straps of leather

(saddlery); suitcase handles; suitcases; tanned leather; tool bags, of leather, empty; straps (harnesses); travel bags; travel sets (leather goods); travel cases; leather fittings for furniture; trunks (luggage); umbrella covers; umbrella handles; umbrella or parasol ribs; umbrella rings; umbrella sticks; wheels; whips; alpenstocks (ice axes); imitation leather.

19 – Building materials (not of metal); non-metallic rigid pipes for building; asphalt, pitch and bitumen; transportable buildings, not of metal; monuments, not of metal; advertisement columns, not of metal; agglomerated bagasses of cane (building material); alabaster glass; alabaster; angle irons, not of metal; aquaria (structures); aquarium gravel; aquarium sand; arbors (structures, not of metal); artificial reef (not of metal); artificial stone; asbestos cement; asbestos mortar; asphalt paving; asphalt; aviaries, not of metal (structures); balustrades; beacons, not of metal, non-luminous; beams, non-metal; bicycle parking installations, not of metal; binding agents for making briquettes; binder for road repairs; bird baths (structures, not of metal); bitumen; bituminous coatings for roofing; bituminous products for building; blinds (outdoor), not of metal and not of textile; spray coating booths using air jets (not of metal); branching pipes, not of metal; bricks; building cardboard (asphalted); building glass; building panels, not of metal; building paper; building stone; building timber; buildings, not of metal; transportable buildings, not of metal; busts of stone, concrete or marble; cabins, not of metal; chicken houses (not of metal); caissons for construction work under water; calcareous marl; casement windows not of metal; cask wood; ceiling, not of metal; cement for blast furnaces; cement for furnaces; cement posts; cement slabs; cement; chicken-houses, not of metal; chimney cowls, not of metal; chimney pots, not of metal; chimney shafts, not of metal; chimneys not of metal; facings, not metal for building; clay; clinker ballast; slag stone; coal tar; coatings (building materials); concrete building elements; sculptures of concrete; concrete; non-metal building materials; cork (compressed); cornices, not of metal; crash barriers, not of metal, for roads; diving boards, not of metal; door cases, not of metal; door panels, not of metal; doors not of metal; drain traps (valves), not of metal or plastic; non-metal drainage pipes; duckboards not of metal; ducts, not of metal, for ventilation, and air conditioning installations; earth for bricks; fair huts; felt for building; fences, not of metal; fire burrs; grog [fired refractory material]; refractory cement coatings; valley rafters, not of metal, for building; floating docks, not of metal, for mooring boats; tile floorings, not of metal; floors, not of metal; folding doors, not of metal; casings for forming cement products (not of metal); plaster (baked); framework, not of metal, for building; furrings of wood; gates, not of metal; geotextiles; granules for road marking, of glass; granite; gravel; gravestone slabs, not of me-

tal; greenhouse frames, not of metal; transportable greenhouses, not of metal; mortar; gutter pipes, not of metal; gypsum; platforms; hips for roofing; huts; insect screens (not of metal); insulating glass (building); jalousies not of metal; joists, not of metal; laths, not of metal; latticework, not of metal; extensions for chimneys, not of metal; letter boxes, of masonry; luminous paving; lime; limestone; lintels, not of metal; macadam; magnesia cement; manhole covers not of metal; mantlepieces; manufactured lumber; sculptures of marble; marble; masts (poles), not of metal; materials for roads and coverings for roads; memorial plaques, not of metal; moldable wood; moldings, not of metal, for building; moldings, not of metal, for cornices; monuments, not of metal; mooring bollards, not of metal; mosaics for building; road signs, non-luminous and non-mechanical, not of metal; minerals for building or construction, not of metal; olivine for building; non-metallic paint spraying booths; palings, not of metal; pantiles; paperboard for building; floor boards; parquet flooring; dividing screens not of metal; paving blocks, not of metal; penstock pipes, not of metal; petroleum pitch; pigsties; sheet piles, not of metal; pitch; planks (wood for building); plaster; plate glass (windows), for building; platforms, prefabricated, not of metal; plywood; posts, not of metal, for electric lines; porches, not of metal, for building; porphyry (stone); posts, not of metal; clay for potters (raw material); clay for potters; prefabricated houses (kits); props, not of metal; quartz; railway sleepers, not of metal; raw chalk; reeds, for building; refractory construction materials, not of metal; reinforcing materials, not of metal, for construction; rigid pipes, not of metal (building); coating for roads; road marking sheets and strips of synthetic material; rocket launching platforms, not of metal; roof coverings, not of metal; roof flashing not of metal; roof gutters, not of metal; roofing shingles; roofing slates; roofing, not of metal, incorporating photovoltaic cells; roofing, not of metal; rubble; safety glass; sand, except foundry sand; sandstone for building; sandstone tubes; squared timber; scaffolding not of metal; scantlings [carpentry]; schists; shuttering, not of metal, for concrete; shutters, not of metal; signaling panels, non-luminous and non-mechanical, not of metal; market posts, non-luminous and non-mechanical, not of metal, for roads; silica (quartz); sills, not of metal; silos, not of metal; silvered sand; skating rinks (structures, not of metal); paving slabs not of metal; slag (building material); slate powder; slate; stables; stained-glass windows; staircases not of metal; stair-treads [steps] not of metal; statues of stone, concrete or marble; statuettes of stone, concrete or marble; stone sculptures; stone; street gutters, not of metal; stringers (parts of staircases), not of metal; swimming pools (structures, not of metal); tanks of masonry; tar; tarred strips, for building; telegraph posts, not of metal; telephone booths, not

of metal; terra cotta; tiles, not of metal, for building; tomb or grave enclosures, not of metal; tombs (monuments), not of metal; tombs, not of metal; tombstone stelae, not of metal; tombstones; tufa; vaults, not of metal (burial); veneer wood; vinyl siding; wainscoting not of metal; wall linings, not of metal, for building; non-metallic wall linings for building; water tanks, of masonry (for industrial use); water tanks, of masonry, for household purposes; water-pipe valves, not of metal or plastic; water pipes, not of metal; window cases not of metal; window glass, except glass for vehicle windows; window glass, for building; windows not of metal; wood for making household utensils; wood paneling; wood paving; wood pulp board (construction); wood tar; wood veneers; wood, semi-worked; works of art of stone, concrete or marble; works of stonemasonry; xylo-lith; carpet underlay.

20 – Furniture, mirrors, picture frames; products (not included in other classes) of wood, cork, reed, cane, wicker, horn, bone, ivory, whalebone, sea shell, amber, mother-of-pearl, meerschaum, substitutes for all these materials, or of plastic; air cushions, not for medical use; air mattresses, not for medical use; air pillows, not for medical purposes; amber bars; amber plates; animal claws; animal hooves; animal horns; armchairs; artificial honeycombs; baby changing mats; baby-changing platforms; bakers' bread baskets; curtains of bamboo; bamboo; barbers' chairs; barrel hoops, not of metal; casks, not of metal; trays, not of metal; bead curtains for decoration; bed castors, not made of metal; hook fittings, not of metal; bedding, except bed linen; beds for household pets; beds; bedsteads of wood; frills for clothing; benches (furniture); pressure screws, not of metal, for cables; boarding stairs, not of metal, mobile, for passengers; bolsters; bolts, non-metal; book stands (furniture); bottle caps, not of metal; bottle racks, of wood; corks for bottles, not of metal; bottle racks; broom handles, not of metal; brush mountings; busts made of wood, wax, plaster or plastic; cabinet work; pipe or cable clips, of plastic; trolleys for computers (furniture); barrel holders, not of metal; casks, of wood, for decanting wine; barrels, not of metal; chairs (seats); toy chests; chests of drawers; chopping blocks (tables); closing devices, not of metal, for containers; coat hooks, not of metal; cloth hangers; coat hooks, not of metal; coat hangers; accessories for coffins, not of metal; coffins; containers, not of metal (storage, transport); containers, not of metal, for liquid fuel; coral; cork bands; corks for bottles; corks; corozo; suit display stands; display stands for suits; counters (tables); covers for clothing (wardrobe); cradles; boxes; cabinets; accessories for curtains; curtain holders, not of textile; curtain hooks; curtain rods; curtain rings; curtain rods; curtain rollers; curtain tie-backs; cushions; easy chairs; decoration of plastic for foodstuffs; desks; display panels; display stands; divans; dog kennels; bayonet

bolts, not of metal; door accessories, not of metal; door handles, not of metal; doors for furniture; stud bolts, not of metal; traps of plastic; draughtsman's tables; beauty cabinet (furniture); mannequins; easy chairs (recliners); edgings, of plastic, for an item of furniture; embroidery frames and hoops; embroidery frames; folding fans for personal use, non-electric; filing cabinets; fireplace screens, domestic; fishing baskets; flagstaves; floating containers, not of metal; stands for flower pots; plant stands (furniture); hayracks; stools; foundations for beehives; funerary urns; furniture casters, not of metal; furniture accessories, not of metal; furniture, of metal; furniture partitions, of wood; racks (furniture); piece of furniture; garment covers (storage); gas storage tanks (not of metal or brick); hairdressers' chairs; baskets; portable mirrors (toilet mirrors); pallets, not of metal; hanging boards (Japanese style pegboards using positional hooks); hat hooks (not of metal); hat stands; head rests (furniture); high chairs for babies; hinges, non-metal; honeycombs; horns, non-worked or semi-worked; hospital beds; house numbers, not of metal, non-luminous; identification bracelets, not of metal, for hospital purposes; name plates, not of metal; filing cabinets (furniture); interior window blinds (blinds) (furniture); industrial water tanks (not of metal or brick); walkers; inflatable publicity objects; interior textile window blinds; ivory, not-machined or partly machined; Japanese floor cushions (zabuton); kennels for household pets; keyboards for hanging keys; knife handles, not of metal; knobs, not of metal; ladders, of wood or plastic; bolts, not of metal; mail boxes, not of metal or brick; library shelves; gas storage tanks, not of metal or brick; liquid storage tanks or reservoirs, not of metal or brick; loading gauge rods, not of metal, for railway waggons [wagons]; loading pallets, non-metal; filing cabinets; bolts, not of metal, for vehicles; bolts, non-electric, not of metal; magazine racks; mannequins; massage tables; mats for playpens; removable mats for sinks; mattresses; meat chests, not of metal; medicine cabinets; meerscham; plastic fasteners, of metal substitute; mirror tiles; mirrors; wind chimes (decoration); mooring buoys, not of metal; mother-of-pearl, non-machined or partly machined; moldings for picture frames; nails, wedges, nuts, screws, tacks, bolts, rivets and casters [not of metal]; plates and door plates [not of metal]; nests for domestic animals; nesting boxes for small birds; nesting boxes; newspaper display stands; registration plates, not of metal; nuts, not made of metal; office furniture; oyster shells; packaging containers made of plastic; paper blinds; cushions for pets; frame supports; frames; pillows; signboards, of wood or plastic; straw mats, except matting; plaster sculptures; plastic key cards, not encoded; dish drainers; playpens for babies; stoppers, not of metal; piles, non-metallic; pulleys, of plastic, for blinds; racks (furniture); rattan; reeds (plating materials); reels of

wood for yarn, silk, cord; spools, not of metal, non-mechanical, for flexible hoses; containers, not of metal or brick; rivets, not of metal; saw horses; school furniture; playing posts for cats; screens (furniture); screws, not made of metal; scythe handles, not of metal; sealing cowls, not of metal; seats of metal; sections of wood for beehives; settees; hulls; shelves for filing-cabinets (furniture); storage shelves; shelves for typewriters; shopping baskets; showcases (furniture); sideboards; poster boards, of wood or plastic; silvered glass (mirrors); slatted indoor blinds; sleeping bags for camping; sofas; bed springs; horns (antlers); stair rods; stakes for plants or trees; standing desks; stands for calculating machines; statues of wood, wax, plaster or plastic; statuettes of wood, wax, plaster or plastic; staves of wood; ladder rungs (ladders), not of metal; edgings of straw; straw mattresses; mats of straw; stuffed animals; stuffed birds; table tops; tables of metal; tables; taps for casks, not of metal; tea trolleys; tent pegs, not of metal; non-metal tool boxes; tool handles, not of metal; imitation tortoiseshell; tortoise shells; towel cupboards (furniture); towel dispensers, not of metal; transport pallets, not made of metal; tray (bon), not of metal; trestles (furniture); trolleys (furniture); feeding troughs, not of metal, for mixing mortar; umbrella stands; valves of plastic, other than parts of machines; valves not of metal, other than parts of machines; vats, not of metal; vices, not of metal; washers, not of metal, of rubber or vulcanized fiber; hand basins (furniture); water beds, not for medical use; water tanks for household purposes, not of metal or brick; water pipe valves of plastic; wax figures; whalebone, not machined or semi-machined; willow; winding spools, not of metal, non-mechanical, for flexible hoses; window fittings, not of metal; wood ribbon; sculpture of wood; work benches; works of art, of wood, wax, plaster or plastic; woven wood blinds (furniture); standing desks; wind chimes (decoration); shoulder poles [yokes].

21 – Household or kitchen utensils and containers; combs and sponges; brushes (except paintbrushes); brush-making materials; brooms of synthetic fibers or natural animal fibers; glass, non-machined or semi-machined (except glass used in building); glassware, porcelain and tableware, not included in other classes; abrasive pads for the kitchen; abrasive sponges for scraping the skin; aerosol dispensers, not for medical purposes; animal hair brushes (equipment for brushes); apparatus for polishing, non-electric; aquarium hoods; baby baths, portable; basins (bowls); basins (receptacles); baskets for domestic use; sprinkling spoons, for culinary use; whisks, not electrically powered; beer tankards; bird baths; birdcages; mixers, non-electric, for household use; boot jacks; drinking flasks for travelers; bottle openers; bottles; boxes of glass; metal boxes for dispensing paper towels; bread baskets, domestic; bread boards; brooms; brush goods; brushes for

cleaning tanks and containers; brush for shoes; brushes; buckets made of woven fabrics; buckets; chamois leathers for cleaning; busts of china terracotta or glass; butter dishes; button hooks; cabaret (trays); cages for domestic animals; cake molds; candle extinguishers; candelabra (candlesticks); candlesticks; candy boxes; demijohns; beaters (hand instruments); carpet sweepers; cauldrons; ceramics for household purposes; chamber pots; cheese cutlery; porcelain ornaments; chopsticks; ash sieves (household utensils); cleaning instruments, hand-operated; tow; lids for pans; cloths for washing floors; laundry driers; clothes pegs; clothing stretchers; rags cloth for cleaning; coasters, not of paper and other than tablecloths; cocktail stirrers; coffee filters, non-electric; coffee grinders, hand-operated; percolators, non-electric; coffee services (tableware); coffeepots, non-electric; comb cases; combs for animals; combs; confectioners' decorating bags; containers for household or kitchen use; cookery molds (molds); cookie cutters; cookie jars; cooking pot sets; skewers, of metal; cooking utensils, not electric; corkscrews; cosmetic utensils; cotton waste for cleaning; dish covers; covers, not of paper, for flower pots; condiment set; cruets; crumb trays; crystal (glassware); cups of paper or plastic; cups; currycombs; cutting boards for the kitchen; wine decanters; deep-fryers, non-electric; dental floss for children; dental floss holder; cotton dental floss; deodorising apparatus for personal use; soap holders; dishes; dishwashing brushes; disposable table plates; glasses; drinking horns; straws; drinking trough; drinking vessels; drying apparatus; dusting apparatus, non-electric; dusting cloths (rags); earthenware pans; egg cups; electric brushes, except parts of machines; electric combs; electric devices for attracting and killing insects; electric toothbrushes; electric toothbrushes and brush heads for children; electric toothbrushes and their parts and accessories; enameled glass; centerpiece; eyebrow brushes; feather dusters; feeding troughs; fiberglass, not for insulation or textile use; fiberglass thread, not for textile use; figurines (statuettes), of porcelain, ceramic, earthenware or glass; equipped picnic baskets, including crockery; hip flasks; holders for straightening irons; floss for dental use; flower boxes; fly catchers (fly traps or catchers); fruit cups; citrus presses, non-electric, for household purposes; frying pans; funnels; furniture dusters; fused silica (semi-finished product), other than the one used for construction; trash cans; gardening gloves; garlic press (kitchen utensils); glasses (receptacles); glass bowls; ampules (receptacles); glass caps; glass covers and lids for industrial packaging containers; glass flasks (containers); glass for vehicle windows (semi-finished product); glass incorporating fine electrical conductors; glass jars; glass stoppers for industrial packaging containers; glass wool other than for insulation; glass, not processed or semi-processed glass, except

for building glass; glove stretchers; gloves for household use; glue-pots; goblets; graters (household utensils); grills and grill supports (kitchen utensils); hair for brushes; thermally insulated containers for beverages; heaters for feeding bottles; thermally insulated containers; holders for flowers and plants (flower arrangement); horse brushes; hot plates, not electrically heated; ice pails [coolers]; ice cube molds (molds); indoor aquariums; mini-indoor greenhouses (plant growing); indoor terrariums (vivariums); insect traps; insulating flasks; ironing board covers, shaped; ironing boards; isothermal bags; decanters; kettles, not electrically powered; kitchen vessels; kitchen mixers, non-electric; kitchen utensils; knife rests for the table; lamp glass brushes; wide-toothed haircombs; lazy Susans; liqueur sets; litter trays for animals; lunch boxes; majolica; make-up removing appliances; mangers for animals; manual mixers (cocktail shakers); material for brush making; menu holders; mess-tins; hand-operated grinder for household use; mixing spoons (kitchen utensils); molds (kitchen utensils); floor mop wringers; floor mops; mosaics of glass, not for construction; nail brush; napkin holders; napkin rings; nest eggs, artificial; isothermic boxes, non-electric; spaghetti pots, hand-operated; nozzles for perforated garden hose; nozzles for watering cans; opal glass; opaline glass; cleaning pads; painted glassware; paper plates; pasta cutters; pepper mills, hand-operated; pepper pots; perfume burners; perfume diffusers; pie servers; pig bristles; piggy banks; ice glasses (raw material); overflow prevention plates for milk; pipe cleaners (for unblocking pipes); polishing machines and apparatus, non-electric, for household use; gloves for polishing; polishing leathers; polishing materials for shining paper and stone, except preparations; porcelain service; non-electric cooking utensils; pan lids; stew-pans; pottery; poultry rings; powder compacts; powder puffs; powdered glass for decoration; pressure cookers (autoclaves), non-electric; rails and rings for towels; refrigerating bottles; rings for birds; rolling pins, domestic; salad bowls; salt cellars; saucepan scourers of metal; saucers; spoons (tableware); scrubbing brushes; services (plates); shaving brush stands; shaving brushes; shoe horns; stretchers (shapes); Chinese strainers (household utensils); sieves (household utensils); signboards of porcelain or glass; siphons for carbonated water; smoke absorbers for household purposes; soap boxes; soap dispensers; soup bowls; spatulas (kitchen utensils); spice sets; sponge holders; sponges for household purposes; spouts; syringes for watering flowers and plants; sprinklers; devices for watering; statues of porcelain, earthenware, ceramic or glass; strainers for household purposes; strainers; sugar bowls; table plates; tableware other than knives, forks and spoons; beer mugs; tar brushes, with long handles; tea caddies; tea cosies; tea infusers; tea services (tableware); tea strainers; teapots; thermally

insulated containers for food; tie presses; closet brushes; toiletry sets; toilet paper holders; toilet tissue holder; toilet sponge; toilet utensils; tooth brushes, electric; toothbrushes; toothpick holders; toothpicks; trays for domestic purposes, of paper; trays for domestic use; table mats (utensils); trouser press; urns; utensils for household use; vases; vegetable dishes; containers, of metal, for making ices and iced drinks; vitreous silica fibers, not for textile use; waffle maker, non-electric; washing boards; tub; waste paper baskets; water apparatus for cleaning teeth and gums; watering cans; non-electric wax-polishing appliances for footwear; non-electric whisks for household use; precious objects of porcelain, earthenware, not of metal; steel wool; steel wool for cleaning; mouse traps; rattraps; water apparatus for cleaning teeth and gums; bread boxes; window-boxes.

22 – Ropes, string, nets, tents, awnings, tarpaulins, sails, sacks and bags (not included in other classes); padding and stuffing materials (except those of rubber or plastic); raw fibrous textile materials; animal hair; blinds of synthetic materials; bags (envelopes, small bags) of textile, for packaging; bags in the nature of sacks for the transport and storage of materials in bulk; bags for washing hosiery; bands, not of metal, for wrapping or binding; straps, not of metal, for handling loads; binding wire, not of metal, for agricultural purposes; body bags; straw wrappers for bottles; braces, not of metal, for handling loads; cables, not of metal; camel hair; car towing ropes; carbon fibers [fibres] for textile use; carded wool; coconut fiber; cocoons; combed wool; cordage; ropes for hanging frames; cotton felt for futon; combing tow; cotton wadding for clothing; cotton waste (flock) for padding and stuffing; covers for camouflage; down (feathers); eiderdown; esparto grass; feathers for bedding; feathers for stuffing; fibrous joints for boats; fishing nets; fleece wool; flock (stuffing); futon bags; glass fibers for textile use; grasses for upholstering; hammocks for babies; hammocks; hemp bands; hemp; horse hair; jute; kapok; knitted cordage; tapes for venetian blinds; liber; linters; mail bags; mountaineering ropes; nets for camouflage; nets; network; packing materials (cushioning, stuffing), not of rubber or plastic; packaging cable; packaging rope; cushioning, not of rubber or plastic, for stuffing; plastic fibers (fibers) for textile use; raffia; ramie fiber; raw cotton; raw fibrous textile; raw linen (cut); raw or treated wool; raw silk; rope ladders; ropes, not of metal; ropes; sails for ski sailing; sails for board sailing; veils; window sash cords; sawdust; seaweed for stuffing; bundled wires; shaved wool; silk flock; silk waste; sisal; slings, not of metal, for handling loads; snares (nets); hammock feet; straw for stuffing; strings; tapes for tying-up vines; tarpaulins; tarred brattice cloth; tents; tents for mountaineering or camping; textile fibers; wire, not of metal, for wrapping or binding; packings; twine

for nets; twine made of paper; upholstery wool (stuffing); vehicle covers, not fitted; silica fibers (vitrified) for textile use; filtering wadding; cotton wadding; wax ends; whipcord; wood shavings; wood wool; wool flock; bands, not of metal, for wrapping or binding.

23 – Yarns and threads, for textile use; chenille threads; coir thread and yarn; cotton thread and yarn; darning thread and yarn; degreased waste threads; elastic thread and yarn for textile use; embroidery threads; glass fiber thread for textile use; hemp thread and yarn; jute thread and yarn; linen thread and yarn; rayon thread and yarn; rubber thread for textile use; sewing thread and yarn; silk thread and yarn; cotton thread and yarn; spun silk, spun thread; spun wool; wire, of common metal, for embroidery; threads; threads of plastic materials for textile use; woolen thread and yarn.

24 – Fabrics and textile goods, not included in other classes; bed throws; tablecloths; adhesive fabric for thermal application; banners; bath linen, except clothing; bed blankets; sheets [textile]; bed linen; bed sheets; billiard coating, of wool; billiard table covering; blankets; bunting; brocades; buckram; gauze; calico; heavy canvas for tapestry or embroidery; cheese cloth; chenille fabric; cheviots (fabrics); cloth for tatami mat edging ribbons; fabrics; coasters (table linen); cotton fabrics; covers for furniture; covers for cushions; crepe (fabric); crepon; curtain holders, of textile material; curtains of textile or plastic; damask; honeycomb fabrics; cross fustian; dish cloths; curtains for doors; drugget; eiderdowns (bed covers); elastic woven material; esparto fabrics; fabrics for footwear; fabrics of imitation leather; fabric, impermeable to gas, for hot air balloons; fabrics for textile use; textile face towels; felt; fiberglass fabrics for textile use; filtering materials of textile; covers for toilet lids of fabric; flags, not of paper; flannel (fabric); ratine (fabric); furniture covers of textile; fustian; futon and quilt covers; eiderdowns (duvet foot covers); futon covers (untrimmed futon); gauze (cloth); glass cloths (towels); gummed cloth, other than for stationery; waterproof water-gummed cloth; horsehair cloth (packaging cloth); handkerchiefs of textile; hat linings, of textile, in pieces; hemp fabric; hemp cloth; household linen; jersey (fabric); jute fabric; knitted fabric; woven textile label; textile labels; linen sheet; lingerie fabric; lining fabric for shoes; linings (textile); marabout (fabric); mattress covers; moleskin (fabric); mosquito nets; make-up removing tissues; curtains; non-woven textile fabrics; oilcloth, for use as tablecloth; oil cloths; personal articles of woven textile, not for wear; pillow cases; table mats, not of paper; plastic (fabric substitute); printed calico cloth; blankets of textile, for printing; ramie fabrics; rayon fabrics; rubberized cloth; sheets (textile); shower curtains of textile or plastic; shrouds; Silk (fabric);



silk fabrics for printing patterns; sleeping bags (sheeting); table cloths (not of paper); table napkins of textile; table runners; table cloths (not of paper); table sets not of paper; taffeta (fabric); tapestry (wall hangings), of textile; textile materials; ticking (linen); covers (mattress covers); towels of textile; traced cloths for embroidery; lap robes; trellis (cloth); tulle; upholstery fabrics; velvet; coated fabrics; washing mitts; wool fabrics; woven fabrics; zephyr (cloth).

25 – Clothing, footwear, headgear; aprons for wear; scarves for men; baby underpants (clothing); bandanas (neckerchiefs); bath robes; bath sandals; bath slippers; bathing suits; beach clothes; beach shoes; belts (clothing); berets; bibs, not of paper; boas (neckwear); corsets (underwear); waders; sports shoes; boots; suspenders for clothing; brassieres; breeches for wear; smock tops; caps [headwear]; bonnets (hats); chasubles; sports clothing; gymnasts' clothing; imitation leather clothing; clothing of leather; clothing; coats; collar protectors; overalls (clothing); handsets; corsets (underwear); cyclists' clothing; detachable collars; underarm clothing shields; dresses; dressing gowns (robes); ear warmers (clothing); Roman sandals or sandals; fisher vests (angler vests); metal fittings for footwear; football boots; foot muffs, not electrically heated; boots; fur stoles; furs (clothing); gabardines (for clothing); stocking suspenders; girdles; gloves (clothing); gym boots; calf-height boots; hat frames (skeletons); hats; headbands (clothing); headgear for wear; heel inserts for footwear; heel pieces for stockings; heels; hoods (clothing); riding boots; hosiery; inner soles; fishing vests; Japanese style socks (tabi); covers for Japanese style socks (tabi covers); Japanese traditional clothing; jerseys; jumper dresses; pullovers; knitwear (clothing); lace-up boots; baby layettes for clothing; leggings (leg warmers); leggings (pants); liveries; priest's stoles; mantillas; disguises; miters (hats); mittens; wallet belts (clothing); clothing for motorcyclists; muffs (clothing); scarves; neckties; night-caps; pyjamas; anti-slip devices for footwear; outdoor clothing; bib overalls; overcoats; pajamas; breeches for wear; clothing of paper; hats (paper) (clothing); parkas; pelerines; pelisses; petticoats; pocket squares; pockets for clothing; ponchos; puttees and gaiters; prêt-à-porter clothing; prêt-à-porter clothing linings (parts of clothing); sandals; saris; sarongs; belts of cloth; sashes for wear; dickies; shirt inserts; shirts; footwear; short-sleeved shirts; shawls; shower caps; ski boots; ski gloves; skirts; culottes; yarmulke; masks worn over the eyes to shield off lights; slippers; petticoats (underwear); sock suspenders; socks; soles for footwear; spats; sports singlets; boots for sports; garters; stockings; cleats for football shoes; woolen jackets (clothing); suits; sweat-absorbing socks; sweat-absorbing underclothing (underwear); sweaters; bathing caps; bathing suits; teddies (undergarments); tee-shirts; tights; shoe dowels;

togas; top hat; trouser suspenders; trousers; turbans; underpants; underwear; uniforms; veils (clothing); vests; isothermal combination suit; waterproof clothing; welts for footwear; wimples; wooden shoes; Cuffs (clothing); item of clothing of hemp; wet suits for water skiing.

26 – Lace and embroidery; ribbons and braid; buttons, hooks and eyes, pins and needles; armbands (clothing accessories); artificial flowers; artificial fruit; artificial garlands; badges, not of precious metal (embroidery); barrettes (hair slides); beads different from those for making jewelry; belt buckles [for clothing]; needles for braiding; bird feathers (clothing accessories); blouse buttons; coil for retaining embroidery yarn or wool (that are not part of machines); hat pins, not of precious metal; bows for the hair; braids; brassards; brooches (clothing accessories); brooches for clothing; buckles (clothing accessories); buttons; chenille (trimmings); collar supports; competitors' numbers; cords for clothing; edge cords, for clothing; corset hooks; darning lasts; darning needles; edgings for clothing; elastic ribbons; hooks for embroidery; embroidery; elastic bands for holding sleeves; eyelets for clothing; false beards; false hems; false moustaches; buttons for clothing; buttons for garters; feathers (clothing accessories); festoons (embroidery); flounces (lace-making); flounces for clothing; fringes; gold embroidery; haberdashery, except yarn; bands; coloring caps; hair curlers, non-electric; hair curlers, different from hand-operated utensils; hair-setting papers; hair-setting pins; hair-curling papers (curlers), pins for crimping hair; hair extensions; hair grips (barrettes); hair nets; hair ornaments; hair pins; hat ornaments, not of precious metal; thermo-adhesive patches for repairing textile articles; thermo-adhesive patches for decorating textile articles (haberdashery); hook and pile fastening tapes; hooks (haberdashery); hooks for corsets; human hair; coat of arms to be worn, not of precious metal; knitting needles; lace for edgings; lace trimmings; letters for marking linen; buckles, of metal, for shoes and boots; mica spangles; numerals or letters for marking linen; boxes for needles; needle cushions; needles for combing machines; needles; numbers for marking linen; fancy badges (buttons); ostrich feathers (clothing accessories); picot (lace); pin cushions; pins, different from those used in jewelry; braided hair; medal ribbons; ribbons (haberdashery); rosettes (haberdashery); lockstitches for carpets; saddlers' needles; sewing boxes; sewing needles; thimbles; buckles for footwear; shoe eyelets; buckles and laces for footwear; shoe hooks; shoe laces; footwear ornaments, not of precious metal; cobblers' needles; shoulder pads for clothing; shuttles for making fishing nets; silver embroidery; skirt flounces; slide locks for bags; snap fasteners; spangles for clothing; special belt clips for obi (Japanese belt); tapes for curtain headings; tassels (haberdashery); garlands (trimmings for clothing); top-knots

(pompoms); toupees; trimmings for clothing; pants clips for cyclists; wigs; zippers; japanese style braids (sanada-himo); knitted braids; starched braids; twist braids; reins for guiding children.

27 – Carpets, rugs, mats and matting, linoleum and other materials for covering existing floors; wall hangings (non-textile); artificial turf; car mats; bath mats for wash places; bath mats; carpeting; door mats; floor coverings; gymnastic mats; linoleum; mats of woven rope for ski slopes; rugs; non-slip mats; reed mats; carpets; tapestry (wall hangings), non-textile; wallpaper of textile; vinyl floor coverings; wallpaper with textile covering; wallpaper.

28 – Games and toys; gymnastic and sporting articles not included in other classes; decorations for Christmas trees; playing cards; portable electronic game units; apparatus for games adapted for use with an external display screen or monitor; game controllers for video game consoles for use with an external display screen or monitor; toys, games and musical games; audio equipment (game); music box (game); musical instruments (games); players for listening to music and cassettes (games); musical games; battery operated action toys; electronic toys; electric computer games, different from those adapted for use with television sets; electric and electronic entertainment apparatus (automatic, without coins/tokens); automatic electronic games, without coins or tokens (different from those used with television sets); portable electronic game apparatus (different from those adapted for use with television sets only); video games different from those adapted for use with television sets only; automatic and coin-operated amusement machines; computer game apparatus, different from those operated with coins or for use with television sets; video games and toys; toys; interactive computer game apparatus; stand-alone video game machines incorporating a means of display; portable electronic devices (games); toy computers (not working); toy mobile telephones (not working); parts and accessories for all of the aforementioned goods; straps for skates; accessories for video game machines with television set for personal use.

29 – Meat, fish, poultry and game; meat extracts; preserved, deep-frozen, dried and cooked fruit and vegetables; jellies, jams, compotes; eggs; milk and dairy products; edible oils and fats; ajvar (preserved peppers); albumen for culinary purposes; albumin milk; alginates for culinary purposes; almonds, crushed; aloe vera prepared for human consumption; anchovy; animal marrow for food; apple sauce; bacon; beans, preserved; black pudding; bone oil, edible; concentrates (broth); stock; butter; butter cream; canned fish; fruits canned; canned meat; caviar; charcuterie; cheese; clams (not live); cocoa butter; coconut butter; coconut fat; coconut oil; coconut, desiccated; colza oil for food; corn oil; cranberry

sauce (compote); crayfish (not live); cream (dairy products); croquettes; crustaceans, not live; frosted fruits; curd; dates; edible birds' nests; edible fats; edible oils; eggs; fat-containing mixtures for bread slices; fatty substances for the manufacture of edible fats; fermented vegetable-based foods (kimchi); fillets of fish; fish meal for human consumption; fish mousses; fish, not alive; fish, preserved; linseed oil for food; foods prepared from fish; glazed fruit; frozen fruits; fruit chips; fruit jellies; fruit peel; fruit preserved in alcohol; fruit pulp; fruit salads; fruits, stewed; fruit-based snack; game, not live; gelatine; gherkins; ginger jam; ham; herring; hummus (chickpea puree); gelatine for food; jams; jellies for food; kephir (milk beverage); kumys (milk beverage); lard for food; lecithin for culinary purposes; lentils, preserved; liver pâté; liver; lobsters, not live; low-calorie chips; margarine; marmalade; meat extracts; meat jellies; meat, preserved; meat; milk beverages, milk predominating; milk ferments for culinary purposes; products of milk; milkshakes; milk; mushrooms, preserved; mussels, not live; non-alcoholic eggnog; walnuts, prepared; olive oil for food; olive, preserved; onions, preserved; oysters, not live; palm kernel oil for food; palm oil for food; peanut butter; peanuts, processed; peas, preserved; pectin for food; piccalilli; pickles; pollen prepared as foodstuff; pork; chips; potato flakes; potato fritters; poultry, not live; powdered eggs; prawns (not live); preparations for making bouillon; preparations for making soup; preserved garlic; processed fish spawn; processed grains; sunflower seeds processed; protein for human consumption; raisins; raw pulses; rennet; salmon; fish, salty; slated meats; sardines; sauerkraut; sausages in batter; sausages; sea cucumbers, not live; sesame oil; shellfish, not alive; shrimps, not live; silkworm chrysalis, for human consumption; snail eggs for consumption; soups; soya beans, preserved, for food; soya milk (milk substitute); spiny lobsters, not live; suet for food; sunflower oil for food; tahini (cream based on sesame seeds); toasted seaweed; tofu; tomato juice for cooking; tomato purée; tripe; truffles, preserved; tuna fish; vegetable juices for cooking; whipped cream.

30 – Coffee, tea, chocolate and coffee substitute; rice; tapioca and sago; flour and preparations made from cereals; bread, pastry and confectionery; ices; sugar, honey, treacle; yeast, baking powder; salt; vinegar, sauces (condiments); allspice; almond confectionery; almond paste; aniseed; aromatic preparations for food; coffee substitute; baking-powder; sodium bicarbonate; barley meal; bean meal; propolis; beer vinegar; binding agents for ice cream (edible ices); biscuits, cookies; bread rolls; bread; breadcrumbs; buns; icing for cakes; cake powder; cakes; candy; capers; caramels (sweet); celery salt; cereal preparations; cereal based snack foods; cheeseburgers (sandwiches); bubble gum; chicory (coffee substitute); Chinese steamed ravioli (shumai, cooked);

Chinese stuffed ravioli (gyoza, cooked); chips (cereal products); chocolate-type beverages with milk; chocolate mousses; chocolate beverages; chowchow (condiment); chutneys (condiments); cinnamon (spice); cloves (spice); chocolate goods; cocoa; cocoa-based beverages; coffee-type beverages with milk; coffee flavorings; coffee; coffee-based beverages; confectionery for decorating christmas trees; confectionery products; cookies; cooking salt; corn flour; corn, milled; corn, roasted; couscous (semolina); crackers; cream of tartar for cooking; crushed barley; crushed oats; icing sugar (different from confectionery); cube sugar; curry (condiment); custard; mousses (pastry); edible ices; essences for foodstuffs, except ethereal essences and essential oils; farinaceous foods; ferments for pastes; flavorings, other than essential oils, for beverages; flavouring, other than essential oils, for cakes; flavorings, other than essential oils; linseed for human consumption; flour; flour-milling products; fondants (confectionery); toasted octopus fritters (takoyaki); frozen yogurt (edible ices); fructose (for food); fruit coulis (sauces); fruit jellies (confectionery); aromatic herbs, preserved (seasoning); ginger (spice); gingerbread; glucose for culinary use; additives containing gluten for food; gluten prepared as foodstuff; table syrup; oatmeal for human consumption; milk-based gruel, for food; halvah; glaze for ham; hamburgers; high-protein cereal bars; crushed and boiled corn; hominy grits; honey; hot dog sausages; husked barley; husked oats; husked rice; ice; ice for refreshment; ice, natural or artificial; iced tea; infusions, not medicinal; ketchup (sauce); leaven; licorice (confectionery); macaroni; macaroons (pastry); malt-based cookies; malt extract for food; malt for human consumption; maltose; marinades; marzipan; mayonnaise; flour; meat gravies; potpies; meat tenderizers, for household purposes; mint for confectionery; molasses for food; muesli; mustard meal; mustard; natural sweeteners; prepared noodle-based meals; noodles; nutmegs; oat flakes; oat-based foodstuff; oatmeal; pancakes; pasta; pasties; pastilles (confectionery); pastry; peanut confectionery; pepper; peppermint sweets; peppers (seasonings); pesto (sauce); petit-beurre biscuits; petits fours (cakes); pies; pizzas; popcorn; potato flour for food; powdered starch syrup (for food); ice powders; pralines; preparations for stiffening whipped cream; propolis; puddings; quiches; ravioli; condiments; rice cakes; rice; rice-based snack food; royal jelly; rusks; saffron (seasoning); sago; salad dressings for salads; salt for preserving foodstuffs; sandwiches; sauces (condiments); sauces for barbecued meat; binding agents for sausages; sea water for cooking; soy sauce (sobatsuyu); seasonings; semolina; sherbets (ices); soya bean paste (condiment); soya flour; soy sauce (soya sauce); spaghetti; spices; spring rolls; star aniseed; starch for food; Chinese-style bread stuffed with minced meat (Chinese manjuh); licorice stick (con-

fectionery); sugar; sushi; sweets (candy); tabbouleh; tacos; tapioca flour for food; tapioca; tarts; tea; tea-based beverages; thickening agents for cooking foodstuffs; tomato sauce; tortillas; turmeric for food; unleavened bread; unroasted coffee; vanilla (flavoring); vanillin (vanilla substitute); plant-based preparations for use as coffee substitutes; vermicelli (noodles); vinegar mixes; vinegar; waffles; weeds (condiment); wheat flour; wheatgerm for human consumption; white sauce; worcester sauce; yeast.

31 – Grains and agricultural, horticultural and forestry products, not included in other classes; fresh fruits and vegetables; grains; natural plants and flowers; food products for animals; malt; algarovilla for animal consumption; almonds (fruit); aloe vera (plants); animal foodstuffs; aromatic sand for pets (litter); bagasses of cane [raw material]; fresh barley beans; beet; berries (fruits); beverages for pets; preserved bird food (food for animals); bran; bred stock; unprocessed buckwheat; shrubs; by-products of the processing of cereals for animal consumption; unprocessed cereal seeds; fresh chestnuts; chicory (salad); chicory roots; Christmas trees; citrus fruit; cocoa beans, raw; coconut shell; coconuts; kola nuts; copra; unprocessed corn; crayfish, live; live crustaceans; fresh cucumbers; cuttle bone for birds; distillery waste for animal consumption (animal foodstuffs); dog biscuits; draff; edible chews for animals; eggs for hatching, fertilised; fish meal for animal consumption; fish spawn; fish, live; live bait for fishing; fishing bait; flax meal (fodder); linseed for animal consumption; flaxseed meal for animal consumption; onions (flower bulbs); flowers, dried, for decoration; natural flowers; fodder; bird millet, unprocessed; fruit residue (marc); fresh fruits; fresh garden herbs; grains (cereals); grains for animal consumption; fresh grapes; groats for poultry; hay; hazelnuts; hop cones; hops; Japanese millet, unprocessed; juniper berries; leeks, fresh; fresh lemons; lentils fresh; lettuce, fresh; lime for animal forage; litter peat; live animals; animal fattening products; locust beans; maize cake for cattle; corn; malt for brewing and distilling; squashes; mash for fattening livestock; meal for animals; menagerie animals; mushroom spawn for propagation; fresh mushrooms; mussels live; nettles; nuts; oats; oil cake; fresh olives; fresh onions (vegetables); oranges; oysters, live; palm tree leaves, unprocessed; palm trees; palms (leaves of the palm tree); peanut cake for animals; peanut meal for animals; fresh peanuts; peas, fresh; chili peppers (plants); pet food; pine cones; grains (seeds); dried plants for decoration; plants; pollen, raw material; potatoes, fresh; fowl (live animals); preparations for egg laying poultry; products for animal litter; proso millet, unprocessed; rape cake for cattle; raw barks; residue in a still after distillation; rhubarb; flax meal (fodder); rice, unprocessed; roots for food; rose bushes; rye; salt for cattle; p sanded paper for pets (litter); sea-cucumbers live; germ seed

for botanical purposes; seedlings; sesame; live shellfish; silkworm eggs; silkworms; natural turf; sorghum, unprocessed; spinach, fresh; spiny lobsters, live; stall food for animals; straw (forage); straw litter (cereal stalks); mulch (humus layer); strengthening animal forage; sugarcane; trees (plants); truffles, fresh; trunks of trees; undressed timber; unsawn timber; lacquer tree seeds, rough cork; fresh vegetables; vine plants; algae for human or animal consumption; wheat germ for animal consumption; wheat; wood chips for the manufacture of wood pulp; wreaths of natural flowers; yeast for animal consumption.

32 – Beers; mineral and aerated waters and other non-alcoholic drinks; beverages based on fruit and fruit juices; syrups and other preparations for making beverages; aerated water; ale; non-alcoholic aloe vera-based beverages; aperitifs non-alcoholic; beer wort; black beer (roasted malt-based beer); carbonated beverages (refreshing beverages); apple juices; non-alcoholic cocktails; de-alcoholized beer; essences for making beverages; extracts of hops for making beer; flavored beers; fruit juices; fruit juices; fruit nectars; ginger ale; ginger beer; grape must; imitation beer; isotonic beverages; kvass (non-alcoholic beverages); lager; lemonades; lithia waters; malt beer; malt wort; milk of almonds (beverage); mineral water (beverages); must; non-alcoholic beverages; non-alcoholic fruit extracts; non-alcoholic fruit beverages; non-alcoholic honey-based beverages; orgeat; pastilles for effervescing beverages; peanut milk (soft drink); dark beer; powders for effervescing beverages; preparations for making carbonated water; preparations for making beverages; preparations for making liqueurs; preparations for making mineral water; sarsaparilla (non-alcoholic beverage); seltzer water; smoothies; soda water; sherbets (beverages); black beer [roasted malt beer]; syrups for beverages; syrups for lemonade; table waters.

33 – Alcoholic beverages except beers; alcoholic beverages containing fruit; alcoholic beverages of fruit; alcoholic essences; alcoholic extracts; anise (liqueur); anisette (liqueur); aperitifs; arrack; bitters; eaux-de-vie (brandy); chinese liquors; cider; cocktails; curaçao; digesters (liqueurs and spirits); distilled beverages; flavored tonic liquors; alcoholic fruit extracts; gin; mead [hydromel]; Japanese liquors; Japanese distilled spirits; kirsch; liqueurs; peppermint liqueur; perry; piquette; pre-mixed alcoholic beverages, other than beer-based; rice alcohol; rum; sake; spirits (beverages); vodka; whisky; wines.

34 – Tobacco; smokers' articles; matches; absorbent paper for tobacco pipes; ashtrays for smokers; books of cigarette papers; chewing tobacco; cigar cases; cigar cutters; cigar holders for smoking; cigarette cases; cigarette filters; cigarette holders for smoking; cigarette paper; cigarette tips; cigarettes containing tobacco substitutes, not for medical use; cigarettes; cigarillos; cigars; flintstones; gas containers for cigar

lighters; herbs for smoking; humidors; lighters for smokers; match boxes; match holders; mouthpieces for cigarette holders; pipe cleaners for tobacco pipes; pipe racks for tobacco pipes; machines for hand-rolling cigarettes; snuff boxes; snuff; spittoons for tobacco users; tips of yellow amber for cigar and cigarette holders; tobacco jars; tobacco pipes; tobacco pouches.

35 – Advertising; business management; business administration; office functions; retail sale; retail services in the field of electronic apparatus, computer software and of game machines and apparatus; retail or wholesale services for musical instruments and recordings; retail services in the field of entertainment, namely musical and audiovisual works and merchandise in the field of consumer electronic devices and entertainment equipment, provided via the Internet and via other computer and electronic communication networks; administration of the business affairs of retail stores; computerized point-of-sale data collection for retailers; management of a retail company for others; gathering, for the benefit of others, of electrical household appliances, enabling customers to conveniently view and purchase such goods in a retail store; retail sale of computer hardware on the Internet; retail sale of home video game machines; automatic data processing; computer data processing; computerized services for processing commercial information; computerized data processing; data processing; data processing for companies; data processing for the collection of data for commercial purposes; checking of data processing; EDP; information services in connection with data processing; online data processing services; advice, consultancy and information in this class for all the above-mentioned services; accounting; mail advertising; auctions; checking of accounts; bill-posting; book-keeping; company appraisals; business inquiries; business inquiries; business investigations; business management of hotels; business management of performing artists; business research; commercial information agencies; commercial or industrial management assistance; compilation of information in computer databases; computerized online ordering services in the field of video game apparatus for use with television sets only and with the software thereof; cost price analysis; demonstration of goods; mail advertising; dissemination of advertising matter; distribution of samples; document reproduction; economic forecasting; efficiency experts; employment agencies; import-export agencies; market research; market studies; modelling for advertising or sales promotion; office machines and equipment rental; opinion polling; organization of exhibitions for commercial or advertising purposes; organization of trade fairs for commercial or advertising purposes; bill-posting; wage payroll preparation; personnel management consultancy; personnel recruitment; photocopying service; supply of commercial statis-

tics about new goods, namely magazines, video games and videos; public relations; publication of publicity texts; advertising agencies; advertising mail; publicity material rental; radio advertising; radio commercials; relocation services for businesses; rental of advertising space; rental of photocopying machines; retail sale of video game machines and software thereof, including on the Internet; secretarial services; shop window dressing; shorthand services; statistics on the sale of new products; systematization of information within computer databases; tax preparation; television advertising; television commercials; transcription of communications and typing services; updating of advertising material; evaluation of standing timber; word processing; data search in computer files for others, particularly press articles; administrative processing of purchase orders; commercial and advertising services, namely the preparation and distribution of printed advertising, according to the orders and/or instructions of others; advertising agencies; advertising via public communication means; arranging newspaper subscriptions for others; arranging subscriptions to telecommunication services for others; business management assistance; business management consultancy; business management consultancy, namely practical strategies for innovative management; business management for athletes; business management and organization consultancy; business management services and administration services relating to the use of a global computer network; business organization consultancy; business administration of the licensing of the goods and services of others; commercial information and advice for consumers; compilation of statistics; data search in computer files on behalf of third parties; invoicing; layout design services for advertising purposes; marketing; news clipping service; on-line advertising on a computer network; outsourcing services [assistance to companies]; photocopying services; presentation of goods on communication media, for retail sale; price comparison services; procurement services for third parties [purchasing goods and services for other companies]; production of advertising films; psychological testing for the selection of personnel; rental of advertising time on communication media; rental of vending machines; sales promotion for others; advertising order search; telemarketing services; telephone answering for unavailable subscribers; writing of advertising texts.

36 – Insurance; financial affairs; monetary affairs; real estate affairs; accident insurance underwriting; housing agencies [real estate]; actuarial services; financial analysis; antique appraisal; apartment house management; art appraisal; sureties; banking; capital investment; charitable fund raising; check verification; deposit and clearing agencies for the exchange of money, for accounting and debt collection via computer systems; clearing operations; credit bure-

aux; credit card services; customs brokerage; debit card services; debt collection agencies; deposits of valuables; electronic funds transfer; electronic payment of road tolls; payment services for electronic commerce, namely opening of accounts supplied and used for purchasing goods and services on the Internet; exchanging money; factoring; financial consultancy; financial appraisals relating to insurance, banking and real estate services; financial information; financial management; financial guarantee; financing services; fire insurance underwriting; fiscal valuations; capital investments; surety services; health insurance underwriting; hire-purchase financing; home banking; real estate brokers; insurance regarding fees for goods and services on the Internet; installment loans; insurance brokerage; insurance consultancy; insurance information; issuance of credit cards; issue of tokens of value; issuing of travelers' checks; leasing of farms; leasing of real estate; pawnbrokerage; life insurance underwriting; financing loans; marine insurance underwriting; lending against security; mutual fund bodies; numismatic appraisal; organization of collections; real estate agencies; real estate appraisals; real estate brokers; real estate management; rent collection; rental of offices; renting of apartments; retirement pension payment services; safe deposit services; saving banks; stock exchange brokerage; stamp appraisal; stock exchange quotations; security and bond brokerage; guarantees and sureties; trusteeship; brokerage; brokerage of carbon credits; financial company liquidation services; clearing operations; jewelry appraisal; lending services for companies; loans [financing]; provident fund services; repair cost evaluation [financial valuation]; financial evaluation of standing timber; financial evaluation of wool; hire-purchase financing of encoded magnetic tapes with programs for video game consoles on televisions for computer system security.

37 – Building construction; repair; installation services; installation and repair of air conditioning systems; airplane maintenance and repair; anti-corrosive treatment for vehicles; artificial snow-making services; asphaltting; boiler cleaning and repair; building construction supervision; insulation of buildings; construction of trade fair stands and shops; building sealing; burglar alarm installation and repair; maintenance and repair of burners; cabinet making (repair) relating to caissons; motor vehicle wash; carpentry services; chimney sweeping; cleaning of buildings [exterior surfaces]; cleaning of buildings [interior]; cleaning of clothing; clothing repair; construction; construction consultation; construction information; protection against damp [buildings]; demolition of buildings; diaper cleaning; disinfecting; drilling of deep oil or gas wells; drilling of wells; dry cleaning; installation and repair of electric apparatus; factory construction; projector repair and maintenance; installation and repair of fire

alarms; freezing equipment installation and repair; care, cleaning and repair of furs; furnace installation and repair; furniture care; restoration of furniture; harbor construction; installation and heating equipment repair; information on installation, maintenance and repair of computer hardware, components and peripherals; installation of doors and windows; installation and repair of surgical and medical apparatus and instruments, including surgical drills, scalpels, blades, staplers, anatomical couplers and cardiac stabilizers, auto-transfusion equipment and disposable devices used for handling and monitoring blood; installation of water supply systems and of waste water and sludge processing systems; installation, maintenance and repair of telecommunication devices; interference suppression in electric apparatus; irrigation devices installation and repair; kitchen equipment installation; knife sharpening, laundering; care, cleaning and repair of leather; elevator installation and repair; installation, maintenance and repair of machines for ironing; masonry; clothing repair (mending clothing); mining extraction; motor vehicle maintenance and repair; motor vehicle washing, installation, maintenance and repair of office machines and equipment; painting of interiors and exteriors; wallpapering; parasol repair; repair of cameras, breakwater construction; construction and maintenance of pipes; plastering; plumbing; pressing, sanding; pump repair; extraction services; rat exterminating; rebuilding engines that have been worn or partially destroyed; rebuilding machines that have been worn or partially destroyed; filling of toner cartridges; renovation of clothing; rental of bulldozers; rental of cranes [construction equipment]; rental of excavators; rental of road-sweeping machines; information on repair services; electric apparatus installation and repair, and installation, maintenance and repair of kitchen equipment; installation, maintenance and repair of office machines; repair and maintenance of electronic printers; repair of locks; restoration of musical instruments; restoration of works of art; re-tinning; retreading of tires; riveting; road paving; covering services; protection against rust; secure maintenance and repair; sanding; scaffolding; service stations [vehicles] [refueling and maintenance], shipbuilding; shoe repair; street cleaning; maintenance and repair of vaults; maintenance of swimming pools; telephone installation and repair; umbrella repair; under-water constructions; repair, underwater; packing; upholstery repair; varnishing; vehicle breakdown [repair]; vehicle cleaning; vehicle lubrication [greasing]; vehicle maintenance; vehicle polishing; service stations [refueling and maintenance]; vehicle washing; vermin exterminating, except for agriculture; vulcanization of pneumatic tires [repair]; wallpaper application; warehouse constructions and repair; washing; washing of linen; window cleaning; repair or maintenance of aircraft; cleaning of bathtubs and boilers; cleaning of carpets

and rugs; repair or maintenance of clocks and watches; building consultancy; disinfecting of telephone handsets; floor polishing; fluffing of cotton felt for futons; concierge services, namely maintenance and cleaning of buildings; rental of vehicle washing equipment; rental of construction equipment, machines and equipment; rental of electric washing machines; rental of floor cleaning machines; rental of laundry dryers; rental of mining machines and equipment; rental of mops; rental of spin dryers for clothes; repair of bags; repair of bicycles; billiard table repair services; repair of fishing tackle; repair of game machines; repair of personal ornaments; repair of radio or television sets; repair of spectacles; repair of sports equipment; repair of tatami mats; repair of toilet seats with water jets; repair of toys or dolls; repair or maintenance of air conditioning [industrial] systems; repair or maintenance of arcade machines; repair or maintenance of automobiles; repair or maintenance of sanitary valves and fittings; repair or maintenance of bicycle parking systems; repair or maintenance of boilers; burner maintenance and repair; repair or maintenance of fodder machines; repair or maintenance of chemical units; repair or maintenance of machines and systems for chemical treatment; repair or maintenance of chick brooders; repair or maintenance of cinematographic machines and systems; repair or maintenance of construction machines and equipment; repair or maintenance of consumer electric appliances; repair or maintenance of industrial cooking equipment; repair or maintenance of cultivation machines and accessories; repair or maintenance of industrial dish washing machines; repair or maintenance of various systems; repair or maintenance of egg incubators; repair or maintenance of electric lighting; repair or maintenance of electric motors; repair or maintenance of industrial electric washing machines; repair or maintenance of electronic machines and systems; repair or maintenance of fire alarms; repair or maintenance of firearms; repair or maintenance of fishing machines and instruments; repair or maintenance of fodder cutting machines; repair or maintenance of fodder mixing machines; repair or maintenance of fodder presses; repair or maintenance of freezing machines and systems; repair or maintenance of gas water heaters; repair or maintenance of service station equipment; repair or maintenance of machines and systems for manufacturing glassware; repair or maintenance of harvesting machines and systems; repair or maintenance of industrial furnaces; repair or maintenance of integrated circuit manufacturing machines and systems; repair or maintenance of laboratory systems and instruments; repair or maintenance of machines and systems for loading and unloading; repair or maintenance of machines and apparatus for lumbering, woodworking, or veneer or plywood making; repair or maintenance of machines and systems for

processing food and beverages; repair or maintenance of machines and systems for use in beauty salons or hairdressing salons; repair or maintenance of machines and systems for making paper pulp, paper or treating paper; repair or maintenance of machines and instruments for measuring and testing; repair or maintenance of mechanical parking systems; repair or maintenance of medical apparatus and instruments; repair or maintenance of metal-working machines and tools; repair or maintenance of milk filtering machines; repair or maintenance of dairy machines; repair or maintenance of machines and systems for mining extraction; repair or maintenance of musical instruments; repair or maintenance of non-electric cooking apparatus; repair or maintenance of nuclear power plants; repair or maintenance of office machines and equipment; repair or maintenance of optical machines and instruments; repair or maintenance of machines and systems for packaging; repair or maintenance of painting machines and systems; repair or maintenance of photographic machines and systems; repair or maintenance of plant fiber treatment machines and systems; repair or maintenance of machines and systems for plastic processing; repair or maintenance of plowing machines and systems [except "portable tools"]; repair or maintenance of machines and systems for energy distribution or control; repair or maintenance of power generators; repair or maintenance of mechanically controlled floor-cleaning machines; repair or maintenance of machines and systems for book printing or bookbinding; pump repair or maintenance; repair or maintenance of railway rolling stock; repair or maintenance of tanks; repair or maintenance of machines and systems for manufacturing rubber products; repair or maintenance of machines and systems for manufacturing semi-conductors; repair or maintenance of machines and systems for silk farming; repair or maintenance of sewing machines; repair or maintenance of footwear-making machines; repair or maintenance of signboards; repair or maintenance of telecommunication systems [except telephones, radios and television sets]; repair or maintenance of telephone apparatus; repair or maintenance of textile machines and systems; repair or maintenance of tobacco processing; repair or maintenance of two-wheeled motor vehicles; repair or maintenance of vehicle washing installations, repair or maintenance of automatic distribution machines; repair or maintenance of vessels; repair or maintenance of machines and systems for waste compacting; repair and maintenance of waste crushing machines; repair or maintenance of water pollution control systems; repair or maintenance of water purification systems; tank cleaning; septic tank cleaning; installation or repair of locks; sharpening of kitchen knives and scissors; sterilization of horticulture or forestry machines and apparatus; sanding [saw mill].

38 – Telecommunications; telecommunications (other than broadcasting); electronic transmission of audio and video files by streaming and downloadable via computer and other communication networks; webcasting services; provision of connectivity services and access to electronic communication networks, for transmission or reception of audio, video or multimedia content; provision of connectivity services and access to electronic communication networks, for the transmission or reception of digital photographs, video files and other digital multimedia, broadcasting services and provision of telecommunication access to films and video programs provided via a video-on-demand service; telecommunication services including provision of access to online communities in which users create, view, edit, share, store and upload and download digital photos, video files and other multimedia content; cable television broadcasting; cellular telephone communications; communications by computer terminals; communications via telegrams; communications by telephone; computer aided transmission of messages and images; electronic mail; electronic display services (telecommunications); transmission via facsimile; information about telecommunications; message sending; press agencies; telecommunication connection services to a global computer network; provision of user access to global computer networks; radio broadcasting; rental of facsimile devices; rental of message sending devices; rental of modems; rental of telecommunication equipment; rental of telephones; satellite transmission; sending of telegrams; routing and connection services for telecommunication networks; teleconferencing services; telegraph services; telephone services; television broadcasting; online distribution of games from a computer network; telex services; transmission of telegrams; transmission of videos on demand; news agency services; provision of access points to electronic news bulletins; communication by fiber-optic networks; paging services [radio, telephone or other means of electronic communication]; database access services; provision of chat rooms on the Internet; provision of telecommunication channels for teleshopping services; telecommunication connection services to a global computer network; rental of access time to global computer networks; transmission of digital files; transmission of greeting cards online; voice mail services; wireless broadcasting; online access to photograph catalogs by means of a sharing portal; provision of access to electronic communication networks, namely social networks for facilitating social interaction between individuals, social meetings and searches for people with specific leisure pursuits, interests and origins; providing access to electronic communications networks, namely social and personal services provided by others.



39 – Transport; packaging and storage of goods; arranging of tours; air transport; ambulance transport; armored-car transport; arranging of cruises; organization of tours; lighterage; boat rental; storage of ships; boat transport; booking of seats for travel; bottling services; bus transport; vehicle parking; coach rental; grouping, transport of vehicles; chauffeur services; courier services [messages or merchandise]; delivery of goods by mail order; delivery of newspapers; distribution of energy; electricity distribution; transport by ferry-boat; flower delivery; franking of mail; freight brokerage [forwarding]; freight forwarding; freight [shipping of goods]; freighting; frozen food locker rental; garage rental; transportation of valuables; hauling; horse rental; ice-breaking; launching of satellites for others; barge transportation services; marine transport; message delivery; operating canal locks; packaging of merchandise; parcel delivery; rental of parking spaces; passenger transport; piloting; pleasure boat service; portage; provision of travel information, via a global computer network; provision of navigation and information services, namely information relating to traffic and traffic jams; railway transport; re-floating services for boats; refrigerator rental; removal services; rental of diving bells; rental of diving suits; rental of freezers; rental of motor racing cars; hire storage containers; rental of vehicle roof racks; rental of warehouses; rental of wheelchairs; salvaging and rescue operations [transport]; river transport; salvage of ships; rescue services; shipbrokerage; sightseeing [tourism]; stowage and unloading; storage; storage information; goods storage; tram services; taxi transport; towing; traffic information; tramway services; transport and disposal of waste; transport and storage of waste; transport brokerage; pipeline transport; transport of travelers; booking of transport; transport information; transport logistics; transport of furniture; booking for travel; travel agency services, namely transportation bookings; underwater salvage; unloading cargo; vehicle breakdown assistance [towing]; vehicle rental; storage; water distribution; water supply; packing of merchandise; airport services; brokerage relating to rental or chartering of ships; mail supply service; gas supplying [distribution]; heat supplying [distribution]; management of parking spaces; parking services; provision of road and traffic information; providing toll roads; provision of mooring equipment for boats; airplane rental; rental of bicycles; rental of freezers for household purposes; rental of freezing machines and apparatus; rental of loading-unloading machines and apparatus; rental of mechanical parking systems; rental of machines and apparatus for wrapping or packaging; rental of refrigerator-freezers for household use; rental of ships; rental of warehouses; boat steering; temporary safekeeping of personal belongings; temporary storage of deliveries; tour escorting; circuit accompanying or escort-

ing; travel agencies; vehicle driving services; warehousing services; supply of water; food and beverage delivery services; escorting of travelers.

40 – Treatment of materials; development, processing, printing, reproduction, duplication, resizing, engraving, retouching, photo-composition and finishing of digital photographs and video files; enlarging of photographic prints; developing photographic film; printing of photographic film; processing of photographic and digital images, printing and reproduction; digital printing, namely printing of digital photographs and images on disks or other electronic media, printing of photographic and digital images from photographic negatives and digital images downloaded on printable surfaces, photographic printing, namely printing of photographic and digital images from photographic negatives and digital images downloaded on printable surfaces; photographic printing, namely printing of digital and photographic images from photographic negatives and digital images downloaded on printable surfaces, editing and retouching of photographic images, enlargement of photographs, reprinting, development and modification of images; online processing and development of digital images; online printing of digital images on photographic paper, photographic books or goods, advisory, consultancy and information services on processing photographic film and printing of photographs; abrasion; air freshening; air freshening; air purification; applying finishes to textiles; blacksmithing; Coppersmithing; bookbinding; burnishing by abrasion; cadmium-plating; chromium plating; cloth cutting; dyeing of fabrics; cloth edging; cloth fireproofing; cloth pre-shrinking; cloth treating; fabric waterproofing; alteration of clothing; color separation services; coppersmithing; crease-resistant treatment for clothing; cryopreservation services; customized assembly of materials for others; custom fashioning of fur; decontamination of hazardous materials; dressmaking; electroplating; embroidery; engraving; fabric bleaching; textile fireproofing; fabric waterproofing; flour milling; food and drink preservation; food smoking; framing of works of art; freezing of foods; fruit crushing; fulling of cloth; fur conditioning; fur dyeing; fur glossing; moth-proofing of fur; fur coloring; galvanization; gilding; glassblowing; gold-plating; grinding; laser scribing; leather staining; leather processing; lithographic printing; magnetization; information on treatment of materials; metal casting; metal plating; metal tempering; metal treating; milling; nickel plating; offset printing; optical glass grinding; paper finishing; pattern printing; permanent-press treatment of fabrics; photocomposition services; development of photographic films; photographic printing; photogravure; pottery firing; printing; processing of petroleum; production of energy; quilting; recycling of waste and trash; refining services; rental of air conditioning apparatus; rental of generators; rental of he-

ating apparatus; saddlery work; sanding services; sawing [saw mill]; shoe staining; silkscreen printing; silvering; skin dressing; slaughtering of animals; soldering; sorting of waste and recyclable material [transformation]; washing finishes; tailoring services; tanning; taxidermy; fabric fireproofing; mothproofing of textiles; textile treating; timber felling and processing; tin plating; vulcanization [material processing]; window tinting treatment, being surface coating; woodworking; wool treatment; rental of decontamination equipment.

41 – Education; training services; entertainment; sporting and cultural activities; teaching; provision of non-downloadable films and television programs via a video-on-demand service; provision of prerecorded music online via a global computer network; amusement parks; entertainment; animal training; preparation and organization of colloquiums; preparation and organization of conferences; preparation and organization of congresses; preparation and organization of seminars; preparation and organization of symposiums; organization of beauty contests; boarding schools; booking of seats for shows; mobile library services; circuses; correspondence courses; discotheque services; dubbing; information on education; school examinations; hosting services; information on entertainment; production of films other than advertising films; providing games online from a computer network; gymnastic lessons; fitness club services; instruction services; lending libraries; mobile library services; modeling services for artists; movie studios; show halls; nursery schools; operating lotteries; orchestra services; organization of balls; organization of exhibitions for cultural or educational purposes; organization of sports competitions; physical education; production of radio and television broadcasts; show production; amusement arcade game services; providing sports facilities; publication of books; publication of online electronic books and newspapers from a computer network; radio entertainment; recording studio services; recreation information; religious education; rental of audio equipment; rental of video cameras; rental of motion pictures; rental of lighting devices for scenery for theaters or television studios; rental of animated films; rental of movie projectors and accessories; rental of radio and television sets; rental of show scenery; rental of skin diving equipment; rental of sound recordings; rental of stadium equipment; rental of stage scenery; rental of tennis courts; rental of video cameras; rental of video cassette recording devices; script writing services; sports camp services; television entertainment; theater production services; preparation of sporting events; education; editing of video cassettes; videotape film production; zoological gardens; provision of online information about video games on computers and computer game programs as described in magazines, manuals and publications; publication of manuals for

programs for video game consoles on television for personal use; rental of encoded magnetic tapes with programs for video game consoles on television for the security of the computer system; digital publishing services; provision of online downloadable computer software to enable users to program digital photographs, video files and other multimedia content; academies [education]; preparation and organization of concerts; calligraphy services; movie presentations; club services [entertainment or education]; coaching [training]; computer-assisted electronic publishing; entertainment in the form of interactive games played via a global communication network; games involving gambling; rental of equipment for games; provision of golfing equipment; guidance [professional] [advice relating to education or training]; holiday camp services [entertainment]; language interpreter services; layout services, other than for advertising purposes; reproduction on micro film; rental of movie projectors and accessories; cinematographic film projection; music composition services; services of a journalist; nightclubs; organization of contests [education or entertainment]; organization of shows [impresario services]; personal training services [fitness training]; photographic reporting; photography; practical training [demonstration]; music production services; karaoke services; provision of non-downloadable online electronic publications; publication of online electronic books and newspapers; publication of texts, other than advertising texts; rental of sports equipment, except vehicles; rental of sports grounds; sign language interpretation; subtitling; teaching; ticket agency services [entertainment]; forecasting of sports events; toy rental; translation; rental of video cassettes; videotaping; professional guidance [advice for education or training]; vocational retraining; preparation and organization of workshops [training]; writing texts, other than advertising texts; zoo services; musical performances; publishing of computer programs; writing of instruction manuals for others in the field of video game consoles on television for personal use; health clubs (health and fitness training).

42 – Scientific and technological services, research and design relating to these services; industrial analysis and research services; design and development of computer hardware and software; provision of computer programs; provision of online non-downloadable software for wireless transmission and synchronization of audio, video, text, multimedia files, films, music, and data flows to and between a computer, television via a computer, another audio and video display device via a computer, a mobile telephone, a laptop computer or other mobile device; ASP application service provider services including computer software; ASP application service provider services including computer software for creation, downloading, transmission, reception, publishing, extraction, encoding, decoding, display, storage and

organization of texts, graphics, images and electronic publications; ASP application service provider, namely hosting of third-party computer software programs in the field of online sales on a computer server to make them accessible to others; provision of a website with technology that enables users to upload, store, view and download digital photos and video files; computer services, namely Cloud hosting services; advice for Cloud computer networks and applications; encryption of information available on a computer; planning, production and maintenance of computer system programs for securing data available on a computer; encryption of computer data relating to electronic communication; computer graphics design; design and production of computer graphics programs; creation and management of websites on a proprietary domain name; creation and management of a page for Internet communication; conversion of data or documents from physical support to an electronic support; conversion of program data and computer data (not physical conversion); professional consultancy services relating to computer systems; professional consultancy services relating to the design of computer systems; development of computer systems; development of software for video game consoles; computer security services; Computer access, authorization, authentication, encryption, identification and digital certificate services for users of Internet pages in connection with online sales; design of programs for video game consoles on television sets for personal use; provision of information relating to computers and computer programs; professional consulting services in connection with data creation and processing by a computer; design and management of systems for information processing by a computer; creation and processing of computer programs; design of computer networks; professional consulting in connection with the study and design of computer networks; rental of encoded magnetic tapes with computer programs for the security of computer systems; rental of memory space on servers for Internet pages; rental of computers and computer programs; rental by the hour of computers via an on-line network; private authentication services by means of Internet communication; provision of search engines for obtaining data via a global computer network; rental of computer access time; hosting on an online Website community so that registered users can share information, photographs, audio and video content and use social networks; analysis for the exploitation of oil sites; consultancy in the field of architecture; architecture; authentication of works of art; bacteriology research; biological research; grading [measuring]; chemical analysis; chemical research; chemistry services; cloud seeding; computer programming; computer rental; consultancy on computer software; computer software design; computer system analysis; computer system design; computer virus protection servi-

ces; construction drafting; consultancy in the field of design and development of computer hardware; consultancy in the field of energy saving; cosmetic research; creation and management of third-party websites; design of interior decoration; digitization of documents [scanning]; clothing design; duplication of computer programs; engineering; geological prospecting; geological research; geological surveys; graphic arts designing; writing analysis [graphology]; hosting computer sites [websites]; industrial design; installation of computer software; land surveying; maintenance of computer software; equipment testing; mechanical research; meteorological information; remote monitoring of computer systems; oil exploration; studies of oil sites; oil well testing; packaging design; physics [research]; providing searching engines for the Internet; provision of scientific information, advice and consultancy in relation to carbon offsetting; quality control; recovery of computer data; rental of software; rental of web servers; research and development for others; research in the field of environmental protection; design [industrial design]; topography; technical research; textile monitoring; underwater exploration; town and city planning; technical inspection of vehicles; water analysis; weather forecast; provision or rental of electronic memory space (Web space) on messaging servers for recipients of electronic mail; writing of technical manuals for computer programs and computers.

43 – Temporary accommodation services; provision of temporary accommodation; bookings of hotels, boarding houses and other temporary accommodation; accommodation for animals; preschooler and infant care at daycare centers; rental of meeting rooms; provision of centers for holding exhibitions; rental of futons and duvets; rental of cooking equipment for industrial use; rental of non-electric cookers; rental of kitchen worktops; rental of sinks; rental of curtains for hotels; furniture rental; rental of wall hangings for hotels; rental of floor coverings for hotels; bar services; boarding house bookings; boarding houses; cafes; cafeterias; canteens; daycare centers [crèches]; holiday camp services [lodging]; hotel reservations; hotels; motels; provision of camping equipment; rental of chairs, tables, table linen, glassware; rental of cooking apparatus; rental of drinking water dispensers; temporary rental of accommodation; rental of tents; rental of transportable buildings; restaurants; retirement homes; self-service restaurants; snack bars; tourist homes; retirement homes; self-service restaurants; snack bars; tourist homes.

44 – Medical services; veterinary services; hygienic and beauty care for human beings or animals; agriculture; horticulture and forestry services; provision of medical, veterinary, sanitary, cosmetic and beauty care services; massage, sun tanning and sauna ser-

vices; beauty salon services; hairdressing salons; information, help and consultancy services relating to beauty, health care, beauty care, cosmetics and slimming; professional consultancy in the field of surgical and medical equipment, apparatus, devices and instruments, medical care, medical treatments and surgery; surface and air distribution of fertilizers and other agricultural chemicals; animal breeding; animal grooming; aquaculture services; aromatherapy services; artificial insemination services; blood bank services; chiropractic services; dental care; rental of farming equipment; flower arrangements; gardening; hair implants; health care; health centers; health and spa services; horticulture; hospices; hospitals; in-vitro fertilization services; landscaping; landscape design services; lawn maintenance; manicure services; massage; medical assistance; medical clinic services; leasing of medical equipment; midwife services; nursing homes; nursing and medical services; opticians' services; pet grooming; pharmacy services for the delivery of prescriptions; pharmaceutical advice; physical therapy; physical therapy; plant nurseries; plastic surgery; public baths for hygiene purposes; rehabilitation for drug abuse patients; rest homes; sanatoriums; sun bed services; tattooing; telemedicine services; therapy services; tree planting to offset carbon emissions; tree surgery; Turkish baths; vermin extermination for agriculture, horticulture and forestry; veterinary assistance; for crowns.

45 – Legal services; security services for the protection of property; presentation, networking and dating agencies; personal information to meet the needs of individuals, namely information on personal development; provision of websites on the Internet for the purpose of social networking; licensing of computer software [legal services]; consultancy relating to intellectual property; on-line social networking services; presentation and social networking services on the Internet; adoption agency services; alternative services for settling disputes; arbitration services; baby sitting; inspection of luggage for security purposes; chaperoning; clothing rental; copyright management; crematorium services; dating services; detective agencies; escorting in society [chaperoning]; suit rental; firefighting; burial; genealogical research; civil protection (guards); horoscope casting; house-sitting; inspection of factories for security purposes; intellectual property monitoring services; legal research; intellectual property licensing; litigation management services; lost and found property; marriage agencies; mediation; missing person searches; monitoring of alarms to prevent burglary and for security purposes; night guards; opening of security locks; organization of religious meetings; personal background checks; body guarding; care of animals; planning and organizing wedding ceremonies; registration of domain names [legal services]; rental of fire alarms; rental of fire extinguishers; ren-

tal of safes; security consultancy; undertaking; providing user authentication services in e-commerce transactions.

(260) AM 2015 76509 A

(800) 1195641

(891) 2013 09 17

(731) BAXTER INTERNATIONAL INC.

One Baxter Parkway, Deerfield, IL 60015,  
USA

(540)

## SHARESOURCE

(511)

9 – Computer software for monitoring, collecting and transmitting patient data; computer software allowing medical professionals to access data for the monitoring, analyzing and diagnosing of medical conditions and treatment; computer software allowing medical professionals to prescribe and update prescriptions; computer software allowing patients to access and view their medical data, treatments and history and order prescribed medication and product.

42 – Providing a cloud computing network featuring software for use in monitoring, collecting and transmitting patient data; providing a cloud computing network featuring software allowing medical professionals to access data for the monitoring, analyzing and diagnosing of medical conditions and treatment; providing a cloud computing network featuring software allowing medical professionals to prescribe and update prescriptions, and allowing patients to access and view their medical data, treatments, and history and order prescribed medication and product; providing temporary use of online non-downloadable operating software for accessing and using a cloud computing network; consultancy in the field of cloud computing networks and applications; design and development of operating software for accessing and using a cloud computer network; computer software technical support services, namely, services for monitoring, administration, updating and management of software, including remote medical device resident application software and remote medical device resident firmware software.

44 – Providing information for medical professionals and medical patients from a website featuring medical information from remote locations via electronic patient monitoring devices that feed information to the website that can be accessed in real-time by medical professionals for purposes of monitoring, analyzing and diagnosing medical conditions and treatment, prescribing and updating patient prescriptions and by medical patients for the purpose of viewing their medical data, treatments and history and ordering prescribed medication and product.

(260) AM 2015 76535 A

(800) 1195847

(891) 2013 10 31

(731) OPEN JOINT-STOCK "RUSSIAN HELICOPTERS"

Vereyskaya str., 29, 141, RU-121357  
Moscow, Russian Federation

(540)



(591) burgundy and grey

(526) The trademark is protected as a whole. The word "RUSSIAN HELICOPTERS" included therein shall not be subject to independent legal protection.

(511)

12 – Aircraft; aeronautical apparatus, machines and appliances; hoods for vehicle engines; hub caps; ships' hulls; ejector seats for aircraft; caps for vehicle petrol [gas] tanks; propulsion mechanisms for land vehicles; upholstery for vehicles; windows for vehicles; parachutes; head-rests for vehicle seats; vehicle running boards; chairlifts; sleeping berths for vehicles; anti-theft devices for vehicles; shock absorbing springs for vehicles; reduction gears for land vehicles; safety belts for vehicle seats; vehicle suspension springs; rudders; anti-theft alarms for vehicles; reversing alarms for vehicles; vehicle seats; safety seats for children, for vehicles; hydraulic circuits for vehicles; military vehicles for transport; air vehicles; electric vehicles; ambulances; remote control vehicles, other than toys; windscreens; windscreen wipers; hubs for vehicle wheels; brakes for vehicles; torsion bars for vehicles; aerial conveyors; seat covers for vehicles; vehicle chassis; tires; vehicle wheel tires; timbers [frames] for ships.

35 – Import-export agencies; cost price analysis; business auditing; computerized file management; business efficiency expert services; demonstration of goods; marketing studies; business information; statistics information; business investigations; business management and organization consultancy; professional business consultancy; organization of exhibitions for commercial or advertising purposes; organization of trade fairs for commercial or advertising purposes; business appraisals; business management assistance; commercial or industrial management assistance; economic forecasting; auctioneering; sales promotion for others; publicity material rental; publication of publicity texts; distribution of samples; dissemination of advertising matter; advertising; business inquiries; systemization of information into computer databases; psychological testing for the selection of personnel; business management of hotels; relocation services for businesses.

37 – Motor vehicle maintenance and repair; vehicle service stations.

42 – Computer system analysis; technical project studies; engineering; material testing; mechanical research; research and development of new products for others; technical research; quality control; design of interior decor; construction drafting; industrial design; surveying.

45 – Intellectual property consultancy; intellectual property watching services; licensing of intellectual property.

(260) AM 2015 76538 A

(800) 1195860

(891) 2013 08 05

(731) NG KÜTAHYA SERAMİK PORSELEN TURİZM ANONİM ŞİRKETİ

Atatürk Bulvarı, Çalca Mahallesi Merkez-Kutahya, Turkey

(540)

**TAU**  
PORCELANA

(591) Black, white

(526) The trademark is protected as a whole. The word "PORCELANA" included therein shall not be subject to independent legal protection.

(511)

21 – Cleaning tools and equipment (non-electric); brushes (other than painting brushes), brushes for cleaning purposes, materials used in brush-making, namely, sponges, steel wools and wool wastes; dusting and cleaning cloths, gloves for washing dishes, non-electric polishing machines, carpet beaters, carpet sweepers, pads for cleaning, electric brushes, except parts of machines; toothbrushes, electric toothbrushes, dental floss, shaving brushes, hairbrushes, combs; non-electrical small hand tools for home and kitchen use, namely, mixers, blenders, coffee and spice mills, fruit and vegetable presses, grinders, graters; household and kitchen utensils and containers made of glass, porcelain, ceramics, ordinary metal, plastic and synthetic and other materials, included in this class; metal money boxes, buckets, waste baskets, sauce pots, plates, paper plates and drinking glasses, trays, coffee pots, non-electric, strainers, basting spoon (ladles) for kitchen use, mixing spoons (kitchen utensils), spatulas, washtubs, bowls, egg cups, cake molds, pitchers, food keeping boxes, coasters, not of paper and other than table linen, toilet paper holders, baby baths, ice molds and ice buckets; heat insulated containers for beverages, flasks, fitted picnic baskets (including dishes), bread boxes, bread baskets, bread cutting boards; that all aforementioned goods are not of precious metal or coated therewith (including of synthetic materials); clothes pegs, vases; non-electric cooking utensils, namely, grills, griddles (cooking utensils), non-electric autoclaves, hot pots, not electrically heated,

grills; bottles, jars, demijohns; corkscrews, shoe-horns, toothpicks, drinking straws; ironing boards, ironing board covers, laundry drying racks; cages for pets, litter boxes (trays) for pets, drinking and feeding troughs for animals, bird baths, perches for bird cages; aquariums; indoor terrariums for animal and plant cultivation; ornaments made of glass, porcelain, ceramics or terra-cotta; sculptures, works of art of porcelain, terra-cotta or glass; mouse traps, insect traps, fly catchers, fly swatters, toilet utensils, electric devices for attracting and killing insects; perfume burners, perfume atomizers, perfume sprayers and vaporizers, sold empty, cosmetic utensils (non-electric), make-up removing appliances, powder puffs, toilet cases; nozzles for sprinkler hose, nozzles for watering cans, watering devices, roses for watering cans; glass, unworked or semi-worked [except building glass], mosaics of powdered glass for decoration, not for building; glass wool other than for insulation and textile; non-metallic cups given at the sport contests made of glass, porcelain, ceramics, plastic and synthetic and other materials, included in this class.

(260) AM 2015 76558 A  
(800) 1129804  
(891) 2014 01 21  
(731) NOVARTIS AG  
CH-4002 Basel, Switzerland

(540)

**OMBEO**

(511)  
5 – Vaccines for human use. not for diabetes.

(260) AM 2015 76559 A  
(800) 1175619  
(891) 2014 01 21  
(731) NOVARTIS AG  
CH-4002 Basel, Switzerland

(540)

**VIXALTO**

(511)  
5 – Vaccines for human use.

(260) AM 2015 76606 A  
(800) 1196484  
(891) 2013 12 23  
(731) MASTER EXPLOTACIONES, S.L.  
P.I. Finestrat – Calle Calpe nº 1, 3º-C,  
E-03509 Finestrat, Spain

(540)

  
**ENERGY SISTEM**

(591) black, white

(511)

9 – Apparatus, instruments, devices and media for recording, registering, transmission, reproduction and playing of sound, voice, images and texts; data processing equipment and computers; software for computers; scientific, nautical, surveying, photographic, cinematographic, optical, weighing, measuring, signaling, checking (supervision), life-saving, teaching apparatus and instruments; apparatus and instruments for conducting, switching, transforming, accumulating, regulating or controlling electricity, electronic computation apparatus and devices; cash registers.

35 – Sale services in stores and via global computer networks for apparatus, instruments, devices and media for recording, registering, transmission, reproduction and playing of sound, voice, images and texts, data processing equipment and computers, computer software, scientific, nautical, surveying, photographic, cinematographic, optical, weighing, measuring, signaling, checking, supervision, life-saving, teaching apparatus and instruments, apparatus and instruments for conducting, switching, transforming, accumulating, regulating or controlling electricity, electronic computation apparatus and devices; advertising services; business management services; organization of exhibitions for commercial or advertising purposes; sales promotion for others; market research and study.

38 – Telecommunication services; provision of user access to global computer networks; rental of telecommunication apparatus; rental of access time to global computer and telecommunication networks; voice mail services; electronic mail services; radio and television program broadcasting; provision of access to databases; information about telecommunications; provision of telecommunication channels for teleshopping services; mobile radiotelephony services; wireless broadcasting services; video conferencing and teleconferencing services; telephone services; telegraph services; transmission of messages, images and voice via computer.

(260) AM 2015 76623 A  
(800) 1196568  
(891) 2013 12 18  
(731) HOMA PUMPENFABRIK GMBH  
1, Industriestrasse, 53819 NEUNKIRCHEN-  
SEELSCHEID, Germany

(540)

**HOMA**

(511)  
7 – Machines for drainage, watering, water supply, pressure increase, waste water treatment technique, construction dewatering and surface drainage and for the municipal and industrial disposal of water and water treatment; motors and engines; pumps;

submerged pumps; waste water pumps; sump pumps; dirty water lifting systems; cutting unit dirty water pumps; pump shafts (pits); recirculation pumps; stirring devices; flow accelerators; aerator; cleaning systems for rain storage reservoirs; excrement pumps; excrement lifting station; irrigation pumps and systems; pure water submerged pumps; self-priming pumps; domestic water supply plant; condensate pumps; parts of pumps, included in this class; flush valves.

9 – Measuring, signalling, checking (supervision) apparatus and instruments, for machines for drainage, watering, water supply, pressure increase, waste water treatment technique, construction dewatering and surface drainage and for the municipal and industrial disposal of water and water treatment, as well as for motors and engines, pumps and pump stations; apparatus and instruments for measurement and diagnosis of vibrations or accelerations; computer programs for machines for drainage, watering, water supply, pressure increase, waste water treatment technique, construction dewatering and surface drainage and for the municipal and industrial disposal of water and water treatment, as well as for motors and engines, pumps and pump stations; hardware and software for processing of sensor, vibration or acceleration data; control apparatus; control units; sensors and diagnostic apparatus for pumps.

42 – Scientific and technological services; industrial analysis and research services; technical project planning in connection with pumping and lifting stations; technical advice with regard to development and realisation of specific maintenance and repair concepts in connection with pumping and lifting stations; technical configuration and design of pumping and lifting stations; development of design, operational and maintenance concepts in connection with pumping and lifting stations; technical analysis of sensor, vibration or acceleration data; design and development of computer hardware and software for the processing of sensor, vibration or acceleration data.

(260) AM 2015 76631 A  
(800) 1196643  
(891) 2013 12 19  
(731) BC CONSULTING SP. Z O.O.  
ul. Sianowska 4a, PL-60-431 Poznan, Poland  
(540)



(591) Blue, grey, white  
(511)  
9 – Scientific, nautical, surveying, photographic, cinematographic, optical, weighing, measuring, signalling, checking (supervision), life-saving and tea-

ching apparatus and instruments; apparatus and instruments for conducting, switching, transforming, accumulating, regulating or controlling electricity; apparatus for recording, transmission or reproduction of sound or images; magnetic data carriers, recording discs; automatic vending machines and mechanisms for coin-operated apparatus; cash registers, calculating machines, data processing equipment and computers; fire-extinguishing apparatus.

35 – Sale in retail and wholesale outlets, and via the Internet of telecommunications apparatus, telephones, telephone cards, smartphones, computers, palmtops, PDAs, PNDs and PNY computers, computer parts, data storage devices, computer accessories, computer peripheral devices, multimedia players, computer software, GPS maps, digital maps, measuring, signalling, locating and navigational apparatus, data sending apparatus.

(260) AM 2015 76632 A  
(800) 1196662  
(891) 2013 12 20  
(731) VEPSFORD LTD  
Spyrou Kyprianou, 61, SK HOUSE 4003,  
Limassol, Cyprus  
(540)

## BONTEL

(511)  
1 – Fire extinguishing compositions; compositions for fire extinguisher; fireproofing preparations; mixtures for fire extinguisher.

9 – Fire extinguishers; fire-extinguishing apparatus; device for extinguishing fire; other products for extinguishing fire.

35 – Marketing studies; business management; procurement services for others, namely, procurement of goods and services to enterprises, including the sale of goods; the sale of goods on-line; the sale of goods by an agent; advertising.

(260) AM 2015 76633 A  
(800) 1196680  
(891) 2013 12 10  
(731) VIENNA INSURANCE GROUP AG Wiener  
Versicherung Gruppe  
Schottenring 30, A-1010 Vienna, Austria  
(540)



(591) Green  
(511)  
36 – Insurance, financial affairs.



(260) AM 2015 76681 A  
 (800) 1197027  
 (891) 2014 01 29  
 (731) LOLLY TOGS, LTD.  
 100 West 33rd Street, Suite 1012, New York  
 NY 10001, USA  
 (540)

## FRENCH TOAST

(511)  
 25 – Clothing for boys and girls and infants, namely, woven shirts, knitted shirts, sweaters, sweatshirts, sweat pants, sweat jackets, jogging suits, pants, overalls, slacks, shorts, jackets, coats and vests; girls' clothing, namely, blouses, skirts and jumpers.

(260) AM 2015 76722 A  
 (800) 1197317  
 (891) 2013 11 21  
 (731) ACTAVIS GROUP PTC EHF  
 Reykjavikurvegi 76-78, IS-220 Hafnarfjordur,  
 Iceland  
 (540)

## PINECHIN

(511)  
 5 – Pharmaceutical preparations and substances.

(260) AM 2015 76724 A  
 (800) 1197335  
 (891) 2013 12 30  
 (731) THE BRITISH COUNCIL  
 10 Spring Gardens, London SW1A 2BN,  
 United Kingdom  
 (540)



(591) Black, white  
 (511)  
 9 – Downloadable electronic publications.

16 – Books and printed publications; calendars, diaries, posters, pens and pencils; instructional and teaching material (except apparatus).

35 – Services for the promotion of educational opportunities and cultural relations.

41 – Educational services; provision of instructional, training, teaching, testing, examination and student assessment services; provision of interactive and distance learning courses; publication of instructional, training, teaching, testing, examination and student assessment materials, including examination papers and syllabuses and materials for the testing of English language skills; testing of English language skills; information, advisory and consultancy services relating to all the aforesaid services; services for

the development of educational opportunities and cultural relations; arranging conferences, exhibitions and competitions relating to education, the arts, science and sports; library services; theatre productions; entertainment services in the form of radio and television programmes; production and distribution of television programmes; organisation of educational exchange schemes; awarding of scholarships; information and advisory services relating to education, the arts and sports; administering educational and professional examinations for other institutions and organisations.

(260) AM 2015 76727 A  
 (800) 1197371  
 (891) 2014 01 10  
 (731) ALMIRALL, S.A.  
 Ronda General Mitre, 151, E-08022  
 Barcelona, Spain  
 (540)



(591) Green  
 (511)  
 10 – Inhalers.

(260) AM 2015 76728 A  
 (800) 1197390  
 (891) 2013 12 23  
 (731) COMEDY CLUB PRODUCTION IP  
 (Cyprus) LIMITED  
 Theklas Lysioty, 29, Cassandra Centre, 3rd  
 floor, CY-3030 Limassol, Cyprus  
 (540)



(591) Red, white, black  
 (511)  
 9 – Abacuses; accumulator boxes; accumulator jars; accumulators, electric; accumulators, electric, for vehicles; acid hydrometers; acidimeters for batteries; acoustic conduits; acoustic couplers; acoustic [sound] alarms; actinometers; adding machines; aerials; aerometers; electronic agendas; air analysis apparatus; alarm bells, electric; alarms; fire alarms; alcoholmeters; alidades; altimeters; ammeters; amplifiers; amplifying tubes; amplifying valves; anemometers; animated cartoons; anode batteries; anodes; answering machines; antennas; anticathodes; anti-dazzle shades; anti-glare glasses; anti-glare visors; anti-interference devices [electricity]; anti-theft war-



ning apparatus; apertometers [optics]; armatures [electricity]; asbestos clothing for protection against fire; asbestos gloves for protection against accidents; asbestos screens for firemen; apparatus and instruments for astronomy; lenses for astrophotography; audiovisual teaching apparatus; automated teller machines [atm]; protective suits for aviators; azimuth instruments; precision balances; balances [steelyards]; balancing apparatus; meteorological balloons; bar code readers; barometers; batteries, electric; batteries, electric, for vehicles; batteries for lighting; battery boxes; battery chargers; battery jars; beacons, luminous; signal bells; bells [warning devices]; betatrons; binoculars; blinkers [signalling lights]; blueprint apparatus; fire boats; boiler control instruments; encoded identification bracelets, magnetic; branch boxes [electricity]; breathing apparatus, except for artificial respiration; breathing apparatus for underwater swimming; bullet-proof waistcoats; marking buoys; signalling buoys; buzzers; cabinets for loudspeakers; coaxial cables; cables, electric; junction sleeves for electric cables; calculating disks; calculating machines; calibrating rings; calipers; camcorders; cinematographic cameras; cameras [photography]; capacitors; capillary tubes; encoded magnetic cards; carpenters' rules; carriers for dark plates [photography]; cases especially made for photographic apparatus and instruments; eyeglass cases; cases fitted with dissecting instruments [microscopy]; pince-nez cases; cash registers; cassette players; cathodes; cathodic anti-corrosion apparatus; cell phone straps; cell switches [electricity]; centering apparatus for photographic transparencies; central processing units [processors]; eyeglass chains; chargers for electric batteries; chemistry apparatus and instruments; dna chips; chips [integrated circuits]; choking coils [impedance]; megaphones; mercury levels; wires of metal alloys [fuse wire]; metal detectors for industrial or military purposes; meteorological instruments; meters; metronomes; micrometer gauges; micrometer screws for optical instruments; micrometers; microprocessors; containers for microscope slides; microscopes; microtomes; milage recorders for vehicles; mirrors for inspecting work; mirrors [optics]; modems; money counting and sorting machines; monitoring apparatus, electric; monitors [computer hardware]; monitors [computer programs]; mouse [data processing equipment]; mouse pads; coin-operated musical automata [juke boxes]; nautical apparatus and instruments; naval signalling apparatus; navigation apparatus for vehicles [on-board computers]; navigational instruments; needles for record players; neon signs; nets for protection against accidents; safety nets; nose clips for divers and swimmers; notebook computers; electronic notice boards; fire hose nozzles; objectives [lenses] [optics]; observation instruments; octants; ohmmeters; optical apparatus and instruments; optical character readers; optical condensers; optical da-

ta media; optical discs; optical fibers [fibres] [light conducting filaments]; optical glass; optical goods; optical lamps; optical lanterns; optical lenses; oscillographs; ovens for laboratory use; oxygen transva-sing apparatus; ozonisers [ozonators]; parking meters; particle accelerators; pedometers; peepholes [magnifying lenses] for doors; electronic pens [visual display units]; computer peripheral devices; periscopes; personal stereos; petrol gauges; phonograph records; photocopiers [photographic, electrostatic, thermic]; drying apparatus for photographic prints; glazing apparatus for photographic prints; frames for photographic transparencies; photometers; phototelegraphy apparatus; photovoltaic cells; apparatus and instruments for physics; pince-nez; pince-nez chains; pince-nez cords; pince-nez mountings; pipettes; plane tables [surveying instruments]; planimeters; plates for batteries; DVD players; plotters; plugs, sockets and other contacts [electric connections]; plumb bobs; plumb lines; pocket calculators; light-emitting electronic pointers; polarimeters; precision measuring apparatus; pressure gauges; automatic indicators of low pressure in vehicle tires [tyres]; pressure indicator plugs for valves; pressure indicators; pressure measuring apparatus; printed circuits; printers for use with computers; prisms [optics]; probes for scientific purposes; processors [central processing units]; computer programs [downloadable software]; computer game programs; projection apparatus; projection screens; protection devices against x-rays, not for medical purposes; protection devices for personal use against accidents; protective helmets; protective helmets for sports; protective masks; voltage surge protectors; protractors [measuring instruments]; electronic publications, downloadable; punched card machines for offices; push buttons for bells; pyrometers; quantity indicators; photographic racks; radar apparatus; radio pagers; radiological apparatus for industrial purposes; radiology screens for industrial purposes; radios; vehicle radios; radiotelegraphy sets; radiotelephony sets; railway traffic safety appliances; range finders; readers [data processing equipment]; telephone receivers; apparatus for changing record player needles; record players; apparatus for recording distance; reducers [electricity]; reflecting discs for wear, for the prevention of traffic accidents; refractometers; refractors; regulating apparatus, electric; light regulators [dimmers], electric; relays, electric; shutter releases [photography]; remote control apparatus; electric installations for the remote control of industrial operations; electro-dynamic apparatus for the remote control of railway points; electro-dynamic apparatus for the remote control of signals; resistances, electric; respirators for filtering air; respirators, other than for artificial respiration; respiratory masks, other than for artificial respiration; resuscitation mannequins [teaching apparatus]; retorts; retorts' stands; revolution counters; rheostats; riding helmets; road signs,

luminous or mechanical; rods for water diviners; rods [surveying instruments]; rulers [measuring instruments]; rules [measuring instruments]; saccharometers; safety tarpaulins; salinometers; satellite navigational apparatus; satellites for scientific purposes; scales; lever scales [steelyards]; scanners [data processing equipment]; screens for photoengraving; screens [photography]; screw-tapping gauges; semi-conductors; sextants; sheaths for electric cables; shoes for protection against accidents, irradiation and fire; shutters [photography]; sighting telescopes for firearms; signal lanterns; signalling panels, luminous or mechanical; signalling whistles; signals, luminous or mechanical; transmitters of electronic signals; signs, luminous; simulators for the steering and control of vehicles; sirens; apparatus for measuring the thickness of skins; slide calipers; slide projectors; slide-rules; slides [photography]; slope indicators; smart cards [integrated circuit cards]; smoke detectors; sockets, plugs and other contacts [electric connections]; socks, electrically heated; computer software, recorded; solar batteries; solderers' helmets; solenoid valves [electromagnetic switches]; sonars; sound alarms; sound locating instruments; sound recording apparatus; sound recording carriers; sound recording discs; sound recording strips; sound reproduction apparatus; sound transmitting apparatus; sounding apparatus and machines; sounding leads; sounding lines; spark-guards; speaking tubes; spectacle cases; spectacle frames; spectacles [optics]; spectrograph apparatus; spectroscopes; speed checking apparatus for vehicles; speed indicators; speed measuring apparatus [photography]; speed regulators for record players; spherometers; spirit levels; spools [photography]; goggles for sports; sprinkler systems for fire protection; stage lighting regulators; apparatus to check stamping mail; stands for photographic apparatus; starter cables for motors; steelyards [lever scales]; steering apparatus, automatic, for vehicles; step-up transformers; stereoscopes; stereoscopic apparatus; stills for laboratory experiments; styli for record players; sulphitometers; sunglasses; surveying apparatus and instruments; surveying chains; surveying instruments; surveyors' levels; switchboards; switchboxes [electricity]; switches, electric; tachometers; tape recorders; magnetic tape units for computers; demagnetizing apparatus for magnetic tapes; taximeters; teaching apparatus; teeth protectors; telegraph wires; telemeters; telephone apparatus; telephone wires; portable telephones; teleprinters; teleprompters; telerupters; telescopes; teletypewriters; television apparatus; automated teller machines; temperature indicators; terminals [electricity]; test tubes; testing apparatus not for medical purposes; theft prevention installations, electric; theodolites; thermionic tubes; thermionic valves; thermometers, not for medical purposes; thermostats; thermostats for vehicles; thread counters; identification threads for

electric wires; ticket dispensers; time clocks [time recording devices]; time recording apparatus; time switches, automatic; automatic indicators of low pressure in vehicle tires; tone arms for record players; totalizers; traffic-light apparatus [signalling devices]; transformers [electricity]; transistors [electronic]; transmitters [telecommunication]; transmitting sets [telecommunication]; transparencies [photography]; transparency projection apparatus; transponders; triodes; tripods for cameras; electric discharge tubes, other than for lighting; automatic indicators of low pressure in vehicle tyres; urinometers; vacuum gauges; vacuum tubes [radio]; variometers; vehicle breakdown warning triangles; verniers; bullet-proof vests (am.); video cassettes; video game cartridges; video recorders; video screens; video telephones; videotapes; viewfinders, photographic; viscosimeters; voltage regulators for vehicles; voltmeters; voting machines; waling glasses; walkie-talkies; washing trays [photography]; water level indicators; wavemeters; weighbridges; weighing apparatus and instruments; weighing machines; weights; whistle alarms; wind socks for indicating wind direction; wire connectors [electricity]; masts for wireless aerials; wires, electric; workmen's protective face-shields; wrist rests for use with computers; x-ray apparatus not for medical purposes; x-ray films, exposed; x-ray photographs, other than for medical purposes; x-ray tubes not for medical purposes; chronographs [time recording apparatus]; apparatus for editing cinematographic film; cinematographic film, exposed; circuit breakers; circuit closers; cleaning apparatus for phonograph records; cleaning apparatus for sound recording discs; clinometers; clothing especially made for laboratories; clothing for protection against accidents, irradiation and fire; clothing for protection against fire; coils, electric; electromagnetic coils; holders for electric coils; mechanisms for coin-operated apparatus; coin-operated mechanisms for television sets; collectors, electric; electric apparatus for commutation; commutators; compact disc players; compact discs [audio-video]; compact discs [read-only memory]; comparators; directional compasses; compasses [measuring instruments]; computer keyboards; computer memory devices; computer operating programs, recorded; computer programmes [programs], recorded; computers; condensers [capacitors]; conductors, electric; lightning conductors; electricity conduits; connections, electric; connections for electric lines; connectors [electricity]; contact lenses; containers for contact lenses; contacts, electric; control panels [electricity]; converters, electric; copper wire, insulated; correcting lenses [optics]; cosmographic instruments; counterfeit [false] coin detectors; mechanisms for counter-operated apparatus; counters; couplers [data processing equipment]; couplings, electric; covers for electric outlets; crash test dummies; crucibles [laboratory]; cupels [laboratory]; current rectifiers;

cyclotrons; darkroom lamps [photography]; dark-rooms [photography]; magnetic data media; data processing apparatus; decompression chambers; densimeters; densitometers; detectors; diagnostic apparatus, not for medical purposes; diaphragms [acoustics]; diaphragms for scientific apparatus; diaphragms [photography]; dictating machines; diffraction apparatus [microscopy]; light dimmers [regulators], electric; discharge tubes, electric, other than for lighting; disk drives for computers; disks, magnetic; distance measuring apparatus; distance recording apparatus; distillation apparatus for scientific purposes; distribution boards [electricity]; distribution boxes [electricity]; distribution consoles [electricity]; divers' masks; diving suits; dog whistles; dosage dispensers; dosimeters; drainers for use in photography; dressmakers' measures; drying racks [photography]; ducts [electricity]; dynamometers; ear plugs for divers; editing appliances for cinematographic films; egg timers [sandglasses]; egg-candlers; electric door bells; electric loss indicators; materials for electricity mains [wires, cables]; electrified fences; electrified rails for mounting spot lights; electrolyzers; electronic pocket translators; electronic tags for goods; magnetic encoders; enlarging apparatus [photography]; epidiascopes; ergometers; exposure meters [light meters]; eyeglass cords; eyeglass frames; eyeglasses; eyepieces; instruments containing eyepieces; facsimile machines; false coin detectors; apparatus for fermentation [laboratory apparatus]; fibre optic cables; film cutting apparatus; films, exposed; filters for respiratory masks; filters for ultraviolet rays, for photography; filters [photography]; fire beaters; fire blankets; fire engines; fire escapes; fire extinguishing apparatus; fire hose; flash-bulbs [photography]; flashing lights [luminous signals]; flashlights [photography]; floppy disks; fluorescent screens; fog signals, non-explosive; food analysis apparatus; apparatus to check franking; frequency meters; furnaces for laboratory use; furniture especially made for laboratories; fuse wire; fuses; galena crystals [detectors]; galvanic batteries; galvanic cells; galvanometers; garments for protection against fire; gas testing instruments; gasoline gauges; gasometers [measuring instruments]; gauges; glass covered with an electrical conductor; graduated glassware; global positioning system [gps] apparatus; gloves for divers; gloves for protection against accidents; gloves for protection against x-rays for industrial purposes; gradient indicators; grids for batteries; hands free kits for phones; head cleaning tapes [recording]; headphones; heat regulating apparatus; heliographic apparatus; hemline markers; high tension batteries; high-frequency apparatus; holograms; horns for loudspeakers; hourglasses; hydrometers; hygrometers; identification sheaths for electric wires; identity cards, magnetic; igniting apparatus, electric, for igniting at a distance; electric apparatus for remote ignition; inclinometers; incubators for bacteria culture;

inductors [electricity]; integrated circuit cards [smart cards]; integrated circuits; intercommunication apparatus; interfaces for computers; inverters [electricity]; invoicing machines; ionization apparatus not for the treatment of air or water; juke boxes for computers; juke boxes, musical; junction boxes [electricity]; kilometer recorders for vehicles; kneepads for workers; laboratory trays; lactodensimeters; lactometers; magic lanterns; lasers, not for medical purposes; appliances for measuring the thickness of leather; lens hoods; letter scales; levelling instruments; levelling staffs [surveying instruments]; levels [instruments for determining the horizontal]; life belts; life buoys; life jackets; life nets; life saving apparatus and equipment; life-saving rafts; light-emitting diodes [led]; lighting ballasts; lightning arresters; lightning conductors [rods]; limiters [electricity]; locks, electric; logs [measuring instruments]; loudspeakers; magnetic tapes; magnetic wires; magnets; decorative magnets; magnifying glasses [optics]; manometers; marine compasses; marine depth finders; marking gauges [joinery]; material testing instruments and machines; mathematical instruments; measures; measuring apparatus; measuring devices, electric; measuring glassware; measuring instruments; measuring spoons.

16 – Absorbent sheets of paper or plastic for foodstuff packaging; address plates for addressing machines; address stamps; addressing machines; adhesive bands for stationery or household purposes; adhesive tape dispensers [office requisites]; adhesive tapes for stationery or household purposes; adhesives [glues] for stationery or household purposes; advertisement boards of paper or cardboard; albums; almanacs; announcement cards [stationery]; aquarelles; architects' models; arithmetical tables; artists' watercolor [watercolour] saucers; atlases; conical paper bags; bags [envelopes, pouches] of paper or plastics, for packaging; bags for microwave cooking; garbage bags of paper or of plastics; balls for ball-point pens; bibs of paper; loose-leaf binders; binding strips [bookbinding]; biological samples for use in microscopy [teaching materials]; blackboards; blotters; blueprints; bookbinding apparatus and machines [office equipment]; bookbinding cloth; bookbinding cords; bookbinding material; bookbindings; bookends; booklets; bookmarkers; books; bottle envelopes of cardboard or paper; bottle wrappers of cardboard or paper; paper bows; boxes for pens; boxes of cardboard or paper; plastic bubble packs for wrapping or packaging; cabinets for stationery [office requisites]; calculating tables; calendars; canvas for painting; carbon paper; cardboard; cardboard articles; cardboard tubes; cards; cases for stamps [seals]; catalogues; chalk for lithography; chalk holders; marking chalk; chaplets; charcoal pencils; chart pointers, non-electronic; charts; holders for check-books [cheque books]; chromolithographs [chromos]; chromos; cigar bands; clipboards; clips for

offices; money clips; cloth for bookbinding; coasters of paper; paper coffee filters; comic books; compasses for drawing; composing frames [printing]; composing sticks; inking ribbons for computer printers; paper tapes and cards for the recordal of computer programmes; copying paper [stationery]; cords for bookbinding; correcting fluids [office requisites]; correcting ink [heliography]; correcting tapes [office requisites]; covers of paper for flower pots; covers [stationery]; cream containers of paper; credit card imprinters, non-electric; paper cutters [office requisites]; decalcomanias; diagrams; document files [stationery]; document holders [stationery]; document laminators for office use; drawer liners of paper, perfumed or not; drawing boards; drawing instruments; drawing materials; drawing pads; drawing pens; drawing pins; drawing sets; drawing squares; drawing t-squares; duplicators; inking sheets for duplicators; painters' easels; elastic bands for offices; electrocardiograph paper; electrotypes; embroidery designs [patterns]; engraving plates; engravings; envelope sealing machines, for offices; envelopes [stationery]; writing board erasers; erasing products; erasing shields; etching needles; etchings; fabrics for bookbinding; face towels of paper; files [office requisites]; filter paper; filtering materials [paper]; finger-stalls [office requisites]; flags of paper; flower-pot covers of paper; flyers; folders for papers; folders [stationery]; forms, printed; fountain pens; franking machines for office use; french curves; galley racks [printing]; geographical maps; terrestrial globes; glue for stationery or household purposes; gluten [glue] for stationery or household purposes; graining combs; graphic prints; graphic representations; graphic reproductions; greeting cards; gummed cloth for stationery purposes; gummed tape [stationery]; gums [adhesives] for stationery or household purposes; hand labelling appliances; handbooks [manuals]; handkerchiefs of paper; hand-rests for painters; handwriting specimens for copying; hat boxes of cardboard; hectographs; histological sections for teaching purposes; holders for stamps [seals]; passport holders; house painters' rollers; humidity control sheets of paper or plastic for foodstuff packaging; hygienic paper; index cards [stationery]; indexes; indian inks; ink; ink sticks; ink stones [ink reservoirs]; inking pads; inking ribbons; inking sheets for document reproducing machines; inkstands; inkwells; isinglass for stationery or household purposes; jackets for papers; perforated cards for jacquard looms; paper knives [office requisites]; labels, not of textile; ledgers [books]; letter trays; letters [type]; lithographic stones; lithographic works of art; lithographs; luminous paper; magazines [periodicals]; manifolds [stationery]; manuals [handbooks]; marking pens [stationery]; mats for beer glasses; modelling clay; molds for modelling clays [artists' materials]; moulds for modelling clays [artists' materials]; modelling materials; modelling paste; modelling wax, not for dental pur-

poses; moisteners for gummed surfaces [office requisites]; moisteners [office requisites]; apparatus for mounting photographs; musical greeting cards; napkins of paper for removing make-up; table napkins of paper; newsletters; newspapers; nibs; nibs of gold; note books; numbering apparatus; numbers [type]; obliterating stamps; office perforators; office requisites, except furniture; oleographs; packaging material made of starches; packing paper; pads [stationery]; writing pads; paint boxes [articles for use in school]; paint trays; paintbrushes; painters' brushes; paintings [pictures], framed or unframed; palettes for painters; pamphlets; pantographs [drawing instruments]; paper; paper clasps; electro-cardiograph paper; paper for recording machines; paper knives [cutters] [office requisites]; paper ribbons; paper sheets [stationery]; paper shredders for office use; waxed paper; paper-clips; paperweights; parchment paper; pastels [crayons]; pastes for stationery or household purposes; patterns for dressmaking; patterns for making clothes; pen cases; pen clips; pen wipers; pencil holders; pencil lead holders; pencil leads; pencil sharpeners, electric or non-electric; pencil sharpening machines, electric or non-electric; pencils; penholders; pens [office requisites]; periodicals; photo-engravings; photograph stands; photographs [printed]; pictures; placards of paper or cardboard; place mats of paper; plans; plastic cling film, extensible, for palletization; plastic film for wrapping; plastics for modelling; portraits; postage meters for office use; postage stamps; postcards; posters; printed matter; printed publications; printed timetables; printers' blankets, not of textile; printers' reglets; printing blocks; printing sets, portable [office requisites]; printing type; prints [engravings]; prospectuses; punches [office requisites]; paper for radiograms; rollers for typewriters; rosaries; rubber erasers; drawing rulers; square rulers; watercolor [watercolour] saucers for artists; school supplies [stationery]; scrapbooks; scrapers [erasers] for offices; sealing compounds for stationery purposes; sealing machines for offices; sealing stamps; sealing wafers; sealing wax; seals [stamps]; self-adhesive tapes for stationery or household purposes; sheets of reclaimed cellulose for wrapping; shields [paper seals]; signboards of paper or cardboard; silver paper; slate pencils; song books; spools for inking ribbons; stamp pads; stamp stands; stamps [seals]; stands for pens and pencils; staples for offices; stapling presses [office requisites]; stationery; steatite [tailor's chalk]; steel letters; steel pens; stencil cases; stencil plates; stencils; stencils [stationery]; stickers [stationery]; table linen of paper; tablecloths of paper; tablemats of paper; tags for index cards; tailors' chalk; teaching materials [except apparatus]; thumb-tacks; tickets; tissues of paper for removing make-up; toilet paper; towels of paper; tracing cloth; tracing needles for drawing purposes; tracing paper; tracing patterns; trading cards other than for games;

transfers [decalcomanias]; transparencies [stationery]; trays for sorting and counting money; type [numerals and letters]; typewriter keys; typewriter ribbons; typewriters, electric or non-electric; vignetting apparatus; viscose sheets for wrapping; artists' watercolor saucers; watercolors [paintings]; artists' watercolour saucers; watercolours [paintings]; wood pulp board [stationery]; wood pulp paper; wrappers [stationery]; wrapping paper; wristbands for the retention of writing instruments; writing brushes; writing cases [sets]; writing cases [stationery]; writing chalk; writing instruments; writing materials; writing or drawing books; writing paper; writing slates; writing tablets.

35 – Commercial administration of the licensing of the goods and services of others; administrative processing of purchase orders; advertising; advertising agencies; advertising by mail order; updating of advertising material; dissemination of advertising matter; rental of advertising space; commercial information and advice for consumers [consumer advice shop]; cost price analysis; telephone answering for unavailable subscribers; business appraisals; arranging newspaper subscriptions for others; arranging subscriptions to telecommunication services for others; business management of performing artists; business management assistance; auctioneering; bill-posting; book-keeping; professional business consultancy; business information; business inquiries; business investigations; business management and organization consultancy; business management consultancy; business management of hotels; business management of sports people; business organization consultancy; commercial or industrial management assistance; presentation of goods on communication media, for retail purposes; price comparison services; compilation of statistics; compilation of information into computer databases; systemization of information into computer databases; data search in computer files for others; demonstration of goods; direct mail advertising; distribution of samples; document reproduction; economic forecasting; employment agencies; organization of exhibitions for commercial or advertising purposes; organization of fashion shows for promotional purposes; computerized file management; import-export agencies; commercial information agencies; invoicing; personnel management consultancy; marketing; marketing research; marketing studies; modelling for advertising or sales promotion; news clipping services; office machines and equipment rental; on-line advertising on a computer network; opinion polling; organization of trade fairs for commercial or advertising purposes; outdoor advertising; outsourcing services [business assistance]; payroll preparation; personnel recruitment; photocopying services; word processing; procurement services for others [purchasing goods and services for other businesses]; production of advertising films; psychological testing for the se-

lection of personnel; public relations; publication of publicity texts; publicity; publicity agencies; publicity columns preparation; publicity material rental; writing of publicity texts; radio advertising; radio commercials; relocation services for businesses; rental of advertising time on communication media; rental of photocopying machines; rental of vending machines; business research; sales promotion for others; secretarial services; shop window dressing; shorthand; sponsorship search; drawing up of statements of accounts; tax preparation; telemarketing services; television advertising; television commercials; transcription; typing.

36 – Accident insurance underwriting; accommodation bureaux [apartments]; actuarial services; financial analysis; antique appraisal; apartment house management; renting of apartments; art appraisal; jewellery appraisal; numismatic appraisal; real estate appraisal; stamp appraisal; bail-bonding; banking; home banking; brokerage; brokerage of carbon credits; business liquidation services, financial; capital investments; charitable fund raising; check [cheque] verification; clearing, financial; clearing-houses, financial; rent collection; organization of collections; financial consultancy; insurance consultancy; credit bureaux; credit card services; issuance of credit cards; customs brokerage; debit card services; debt collection agencies; deposits of valuables; real estate agencies; real estate management; financial evaluation [insurance, banking, real estate]; financial evaluation of standing timber; financial evaluation of wool; repair costs evaluation [financial appraisal]; exchanging money; factoring; fiduciary; financial information; financial management; financial sponsorship; financing services; fire insurance underwriting; fiscal assessments; fund investments; electronic funds transfer; guarantees; health insurance underwriting; hire-purchase financing; housing agents; insurance information; instalment loans; insurance brokerage; insurance underwriting; capital investment; issue of tokens of value; issuing of travellers' checks [cheques]; jewelry appraisal; lease-purchase financing; leasing of farms; leasing of real estate; lending against security; life insurance underwriting; loans [financing]; marine insurance underwriting; mortgage banking; mutual funds; pawn-brokerage; provident fund services; real estate brokers; rental of offices [real estate]; renting of flats; retirement payment services; safe deposit services; savings bank services; securities brokerage; stock exchange quotations; stocks and bonds brokerage; surety services; trusteeship; financial valuation of standing timber; fiscal valuations.

38 – Rental of access time to global computer networks; cable television broadcasting; radio broadcasting; television broadcasting; cellular telephone communication; providing internet chatrooms; communications by computer terminals; communica-

tions by fiber [fibre] optic networks; communications by telegrams; communications by telephone; computer aided transmission of messages and images; electronic bulletin board services [telecommunications services]; electronic mail; facsimile transmission; transmission of greeting cards online; information about telecommunication; message sending; news agencies; paging services [radio, telephone or other means of electronic communication]; providing access to databases; providing telecommunication channels for teleshopping services; providing telecommunications connections to a global computer network; providing user access to global computer networks; rental of facsimile apparatus; rental of message sending apparatus; rental of modems; rental of telecommunication equipment; rental of telephones; satellite transmission; telecommunications routing and junction services; teleconferencing services; transmission of telegrams; telegraph services; telephone services; telex services; transmission of digital files; voice mail services; wire service; wireless broadcasting.

41 – Academies [education]; providing amusement arcade services; amusement parks; amusements; animal training; arranging and conducting of colloquiums; arranging and conducting of concerts; arranging and conducting of conferences; arranging and conducting of congresses; arranging and conducting of seminars; arranging and conducting of symposiums; arranging and conducting of workshops [training]; arranging of beauty contests; boarding schools; booking of seats for shows; bookmobile services; publication of books; calligraphy services; holiday camp services [entertainment]; sport camp services; providing casino facilities [gambling]; rental of cine-films; cinema presentations; circuses; club services [entertainment or education]; coaching [training]; organization of competitions [education or entertainment]; organization of sports competitions; conducting fitness classes; correspondence courses; disc jockey services; discoteque services; rental of skin diving equipment; dubbing; videotape editing; education information; religious education; educational examination; educational services; electronic desktop publishing; entertainer services; entertainment; entertainment information; organization of exhibitions for cultural or educational purposes; organization of fashion shows for entertainment purposes; film production, other than advertising films; gambling; game services provided on-line from a computer network; games equipment rental; providing golf facilities; vocational guidance [education or training advice]; gymnastic instruction; health club services [health and fitness training]; recreation information; instruction services; sign language interpretation; language interpreter services; layout services, other than for advertising purposes; lending libraries; mobile library services; presentation of live performances; opera-

ting lotteries; microfilming; modelling for artists; rental of motion pictures; rental of movie projectors and accessories; movie studios; movie theatre presentations; providing museum facilities [presentation, exhibitions]; music composition services; music-halls; news reporters services; night clubs; nursery schools; orchestra services; organization of balls; organization of shows [impresario services]; party planning [entertainment]; personal trainer services [fitness training]; photographic reporting; photography; physical education; practical training [demonstration]; production of music; production of radio and television programmes; production of shows; videotape film production; providing karaoke services; providing on-line electronic publications, not downloadable; providing sports facilities; publication of electronic books and journals on-line; publication of texts, other than publicity texts; rental of radio and television sets; radio entertainment; rental of video cassette recorders; recording studio services; providing recreation facilities; rental of audio equipment; rental of camcorders; rental of lighting apparatus for theatrical sets or television studios; rental of show scenery; rental of sound recordings; rental of sports equipment, except vehicles; rental of sports grounds; rental of stadium facilities; rental of stage scenery; rental of tennis courts; rental of video cameras; rental of videotapes; scriptwriting services; timing of sports events; subtitling; teaching; television entertainment; writing of texts, other than publicity texts; theatre productions; ticket agency services [entertainment]; toy rental; translation; tuition; videotaping; vocational retraining; zoological garden services.

42 – Analysis for oil-field exploitation; architectural consultation; architecture; authenticating works of art; bacteriological research; biological research; calibration [measuring]; chemical analysis; chemical research; chemistry services; cloud seeding; consultancy in the design and development of computer hardware; computer programming; duplication of computer programs; computer rental; computer software consultancy; computer software design; installation of computer software; maintenance of computer software; updating of computer software; computer system analysis; computer system design; computer virus protection services; construction drafting; consultancy in the field of energy-saving; conversion of data or documents from physical to electronic media; cosmetic research; creating and maintaining web sites for others; data conversion of computer programs and data [not physical conversion]; design of interior decor; industrial design; packaging design services; dress designing; digitization of documents [scanning]; engineering; research in the field of environmental protection; quality evaluation of standing timber; quality evaluation of wool; underwater exploration; weather forecasting; geological prospecting; geological research; geologi-

cal surveys; handwriting analysis [graphology]; hosting computer sites [web sites]; scientific laboratory services; land surveying; material testing; mechanical research; meteorological information; monitoring of computer systems by remote access; oil prospecting; oil-field surveys; oil-well testing; packaging design; physics [research]; technical project studies; providing search engines for the internet; provision of scientific information, advice and consultancy in relation to carbon offsetting; quality control; recovery of computer data; rental of computer software; rental of web servers; research and development of new products for others; styling [industrial design]; surveying; land surveys; technical research; textile testing; urban planning; quality valuation of standing timber; vehicle roadworthiness testing; water analysis.

(260) AM 2015 76729 A  
 (800) 1197393  
 (891) 2014 02 24  
 (731) MAGDA ROSE GMBH & CO KG  
 Modecenterstrasse 22/A4, A-1030 Wien,  
 Austria  
 (540)

## Jones

(511)  
 4 – Perfumed candles, candles.  
 20 – Picture frames, cushions.  
 24 – Pillow shams, towels, table napkins, bed covers, table linen, bed linen.

(260) AM 2015 76784 A  
 (800) 1197970  
 (891) 2014 02 05  
 (731) ROBERT BOSCH GMBH  
 70469 Stuttgart, Germany  
 (540)

## ZAMO

(511)  
 9 – Laser rangefinders.

(260) AM 2015 76799 A  
 (800) 1198001  
 (891) 2014 02 18  
 (731) BECTON, DICKINSON AND COMPANY  
 1 Becton Drive, MC 090, Franklin Lakes NJ  
 07417, USA  
 (540)

## BD ONEFLOW

(511)  
 1 – Chemicals for flow cytometry for non-medical purposes.

(260) AM 2015 76800 A  
 (800) 1198038  
 (891) 2013 10 10  
 (731) PRIVATE JOINT STOCK COMPANY  
 "INDUSTRIAL ASSOCIATION "KONTI"  
 Bul. Shevchenko, 6-b, Donetsk 83015,  
 Ukraine  
 (540)

## Воздушное наслаждение

(511)  
 30 – Coffee, tea, cocoa, sugar, rice, tapioca, sago, artificial coffee; flour and preparations made from cereals, bread, pastry and confectionery, ices; honey, treacle; yeast, baking-powder; salt, mustard; vinegar, sauces (condiments); spices; edible ice; peanut confectionery; biscuits; farinaceous foods; pastries; bread rolls stuffed (confectionery); waffles; waffle cakes; products of puff pastry stuffed; glazed and not glazed candies; candied roasted nuts (confectionery); desserts (confectionery); dragee (confectionery); yeast and not yeast baking; fruit and berry jellies (confectionery); jelly confectionery; jelly candies; chewing gum; frozen kefir; frozen yogurt; baking semi-frozen; marshmallow; marshmallow covered with chocolate; cocoa and coffee beverages; coffee beverages with milk; cocoa with milk; cocoa based ingredients for confectionery products; caramels (candy); lozenges (confectionery); cakes; brittle; crackers; starch foods; croissant; confectionery for decorating Christmas trees; liquorice (confectionery); candy for food; marzipan; marzipan candies; almond cookies; almond confectionery; mousses; chocolate beverages; candy sets; paskha (Easter cake); paste; cookies; cookies glazed with chocolate; quiches (confectionery); pies; fondants (confectionery); pralines; gingerbread; gingerbread covered with chocolate; puddings; Turkish delight; rice cakes; bagel; dessert sauces; soufflé (whipped chocolate confectionery); chocolate soufflé (whipped chocolate confectionery); candies stuffed with whipped confectionery (soufflé); candies stuffed with whipped confectionery (soufflé) and fruit jellies confectioneries; soufflé-jelly candies; tartlets; petit-beurre biscuits; petits fours (cakes); chocolate cakes; halvah; candy decorations for cakes; chocolate decorations for cakes; bakery; sweetmeats (candy); candies with fillings; sugar confectionery; waffle candies; toffee candies; chocolate; chocolate desserts; chocolate cream; chocolate dragee with raisins or nuts; chocolate paste; chocolate cakes; chocolate candies; chocolate bars; chocolate beverages with milk; chocolate figurines.

(260) AM 2015 76807 A  
 (800) 1198062  
 (891) 2013 11 11  
 (731) CHENGDU AIMINER LEATHER  
 PRODUCTS CO., LTD.

No:16, Wenchangzhonglu, Cuqiao, Wuhou  
District, Chengdu City, 610043 Sichuan  
Province, China

(540)



(591) Black, grey

(511)

18 – Briefcases; backpacks; travelling bags; pocket  
wallets; bags for campers; travelling sets [leather-  
ware]; umbrellas; animal skins; fur-skins.

(260) AM 2015 76808 A

(800) 1198070

(891) 2014 01 13

(731) CHINA TOBACCO HUNAN INDUSTRIAL  
CO., LTD.

No:188, Section 3, Wanjiali Zhong Road,  
Yuhua District, Changsha City, Hunan, China

(540)

# WHITE SAND

(591) Black, white

(511)

34 – Tobacco; cigars; cigarettes containing tobacco  
substitutes, not for medical purposes; cigarettes;  
tobacco pipes; cigarette cases; ashtrays for smokers;  
match boxes; lighters for smokers; cigarette filters.

(260) AM 2015 76811 A

(800) 1198083

(891) 2013 12 20

(731) CITIZEN HOLDINGS KABUSHIKI  
KAISHA ALSO TRADING AS CITIZEN  
HOLDINGS CO., LTD.

1-12, 6-chome, Tanashi-cho, Nishi-tokyo-shi,  
Tokyo 188-8511, Japan

(540)



(591) Black, white

(511)

14 – Watches, clocks and parts and fittings thereof.

(260) AM 2015 76812 A

(800) 1198110

(891) 2013 12 10

(731) VIENNA INSURANCE GROUP AG

Wiener Versicherung Gruppe  
Schottenring 30, A-1010 Vienna, Austria

(540)



(591) Green, black and white

(526) The trademark is protected as a whole. The  
word "VERSICHERUNGEN" included therein shall  
not be subject to independent legal protection.

(511)

36 – Insurance, financial affairs.

(260) AM 2015 76813 A

(800) 1198119

(891) 2013 12 24

(731) CARLO POLETTI S.r.l.

Via Tancognino, 134, I-28024 GOZZANO  
(NO), Italy

(540)

## CARLO POLETTI

(511)

11 – Manual and thermostatic decorative valves for  
design radiators; decorative fittings for plastic, cop-  
per and iron pipe connections; elements for decora-  
tive valves; sanitary mixers; sanitary and heating  
manifolds; thermostatic and manual valves for radi-  
ators; fittings for plastic, copper and iron pipes con-  
nections; valves and fittings for solar systems; safe-  
ty, mixing and regulating valves for thermic sanitary  
and solar systems; radiant heating and air condition-  
ing systems.

(260) AM 2015 76878 A

(800) 1198671

(891) 2013 09 14

(731) SERCO INTERNATIONAL GENERAL  
TRADING L.L.C.

No:1702, almoosa Tower 1, Shikh Zaved  
Road, Dubai, United Arab Emirates

(540)

نانسى

## NANCY

(591) Black, white

(511)

5 – Sanitary napkins, babies diaper of paper and cel-  
lulose; cotton for medical purposes.

16 – Napkin of paper, handkerchiefs of paper, toilet  
paper, towels of paper, cellulose wipes.

(260) AM 2015 76880 A

(800) 1198723

(891) 2013 12 23

(731) UAB "TUTUTIS"

Raudondvario pl. 101, LT-47184 Kaunas,  
Lithuania



(540)



(591) Black, white

(511)

5 – Babies' napkins; babies' diaper-pants; sanitary towels (disposable); babies' napkin-pants (diaper-pants).

12 – Casters for trolleys (vehicles); safety seats for children, for vehicles; stroller covers (pushchairs); prams; pushchairs; covers for baby carriages.

20 – High chairs for babies; babies' furniture; chests for toys; mats for infant playpens; babies' cradles; babies' woven cradles; babies' bedding, except linen; beds for children (furniture); babies' benches (furniture); infant walkers; cots; trolleys for babies' (furniture).

21 – Baby baths, portable.

25 – Bibs, not of paper; babies' clothing; babies' pants (clothing); babies' headgear for wear.

28 – Babies' games; babies' toys.

(260) AM 2015 76881 A

(800) 1198743

(891) 2013 12 24

(731) PRIVATE BUSINESS "GOLDEN-FARM"  
vul. Akademika Filatova, bud. 10-A, of. 3/7,  
Kyiv, 01042, Ukraine

(540)



(591) Black, white

(511)

3 – Anti cellulite serum other than for medical purposes; balms other than for medical purposes; skin lightening creams; shower gel; beauty gels; cosmetics; cosmetic kits; cosmetics for use on the skin; sun-tanning preparations (cosmetics); cosmetic preparations for slimming purposes; cosmetic preparations for bath; cosmetic creams; medicated soap; lotions for cosmetic purposes; massage gels other than for medical purposes; soap; cleansing milk for toilet purposes; tissues impregnated with cosmetic lotions.

5 – Anti cellulite serum for medical purposes; appetite suppressants for medical purposes; tonics [medicines]; balms for medical purposes; albumin dietary supplements; albuminous preparations for medical purposes; albuminous foodstuffs for medical purposes; biological preparations for medical purposes; decoctions for pharmaceutical purposes; vitamin

preparations; dietetic beverages adapted for medical purposes; dietetic foods adapted for medical purposes; elixirs [pharmaceutical preparations]; gels for medical purposes; compresses; medical preparations for slimming purposes; drugs for medical purposes; medicines for human purposes; medicinal tea; medicinal herbs; medicinal infusions; liniments; lotions for pharmaceutical purposes; sunburn ointments; ointments for pharmaceutical purposes; frostbite salve for pharmaceutical purposes; mineral food supplements; tinctures for medical purposes; appetite suppressant pills; slimming pills; nutritional supplements; digestives for pharmaceutical purposes; tissues impregnated with pharmaceutical lotions; therapeutic preparations for the bath; herbal teas for medicinal purposes; pharmaceutical preparations for skin care.

(260) AM 2015 76882 A

(800) 1198774

(891) 2014 02 14

(731) LIMITED LIABILITY COMPANY  
"SOVITER"

komn.25, pom.1, str.3, d.3, Rubtsovskaya  
nab., RU-105082 Moscow, Russian  
Federation

(540)



(591) Brown, dark-brown, beige, white

(511)

32 – Aperitifs, non-alcoholic; waters [beverages]; kvass [non-alcoholic beverage]; cocktails non-alcoholic; lemonades; peanut milk [non-alcoholic beverage]; non-alcoholic beverages; isotonic beverages; whey beverages; non-alcoholic fruit juice beverages; milk of almonds [beverage]; fruit nectars, non-alcoholic; orgeat; beer; powders for effervescing beverages; sarsaparilla [non-alcoholic beverage]; syrups for lemonade; syrups for beverages; tomato juice [beverage]; cider, non-alcoholic; vegetable juices [beverages]; fruit juices; preparations for making aerated water; preparations for making liqueurs; preparations for making mineral water; preparations for making beverages; must; grape must, unfermented; beer wort; malt wort; pastilles for effervescing beverages; sherbets [beverages]; non-alcoholic fruit extracts; extracts of hops for making beer; essences for making beverages.

33 – Aperitifs; arak [arrack]; brandy; wine; piquette; whisky; vodka; gin; digesters [liqueurs and spirits]; cocktails; liqueurs; alcoholic beverages, except beer; alcoholic beverages containing fruit; spirits [beverages]; distilled beverages; hydromel [mead]; peppermint liqueurs; bitters; Rum; sake; cider; rice alcohol;

alcoholic extracts; fruit extracts, alcoholic; alcoholic essences.

(260) AM 2015 76896 A

(800) 1198999

(891) 2013 11 11

(731) CHENGDU AIMINER LEATHER

PRODUCTS CO., LTD.

No:16, Wenchangzhonglu, Cuqiao, Wuhou

District, Chengdu City, 610043 Sichuan

Province, China

(540)

**annastar**

(511)

25 – Clothing, (namely shirts and pants); boots; footwear; boots for climbing; sports shoes; sandals; headgear for wear; hosiery; neckties; belts [clothing].

(260) AM 2015 77028 A

(800) 1200131

(891) 2014 01 26

(731) X.T. TECH LTD

1 Hamenofim St., 4672552 Herzliya, Israel

(540)

**ISABEL GARCIA**

(591) Black, white

(511)

18 – Pocket wallets; card cases [notecases]; umbrellas; parasols; valves of leather; imitation leather; leather, unworked or semi-worked; leatherboard; hat boxes of leather; boxes of vulcanised fibre; chain mesh purses; purses; leather straps; straps of leather [saddlery]; chin straps, of leather; umbrella handles; suitcase handles; rucksacks; travelling bags; garment bags for travel; valises; handbags; beach bags; bags for sports; bags for campers; school bags; umbrella sticks; walking sticks; suitcases; attaché cases; umbrella covers.

25 – Bandanas [neckerchiefs]; underwear; berets; overalls; boas [necklets]; teddies [undergarments]; half-boots; boots for sports; breeches for wear; pants; football shoes; brassieres; detachable collars; collars [clothing]; shirt yokes; veils [clothing]; gabardines [clothing]; neckties; ascots; leggings [leg warmers]; spats; boot uppers; corselets; jerseys [clothing]; vests; hosiery; heels; hoods [clothing]; hat frames [skeletons]; pockets for clothing; collar protectors; visors [headwear]; cap peaks; tights; slips [undergarments]; combinations [clothing]; wet suits for water-skiing; bodices [lingerie]; corsets [underclothing]; suits; bathing suits; masquerade costumes; beach clothes; jackets [clothing]; leggings [trousers]; liveries; camisoles; cuffs; short-sleeve shirts; mantillas; coats; sleep masks; furs [clothing]; mittens; muffs [clothing]; footmuffs, not electrically heated;

bibs, not of paper; fur stoles; ear muffs [clothing]; socks; beach shoes; sports shoes; footwear; paper clothing; outerclothing; ready-made clothing; motorists' clothing; cyclists' clothing; clothing for gymnastics; clothing of leather; clothing; fittings of metal for footwear; overcoats; parkas; pelerines; gloves [clothing]; ski gloves; pajamas (Am.); bathing trunks; shirt fronts; pocket squares; dresses; water-proof clothing; headbands [clothing]; garters; sock suspenders; stocking suspenders; ready-made linings [parts of clothing]; dress shields; soles for footwear; braces for clothing [suspenders]; lace boots; ponchos; girdles; belts [clothing]; money belts [clothing]; jumpers [pullover]; shirts; wooden shoes; sandals; bath sandals; boots; sarongs; jumper dresses; saris; sweaters; footwear uppers; inner soles; bath slippers; togas; knitwear [clothing]; underpants; gymnastic shoes; slippers; shoes; turbans; headgear for wear; aprons [clothing]; tee-shirts; dressing gowns; bathrobes; top hats; tips for footwear; stockings; sweat-absorbent stockings; shawls; caps [headwear]; paper hats [clothing]; shower caps; bathing caps; sashes for wear; studs for football boots; hats; babies' pants [clothing]; trouser straps; pelisses; esparto shoes or sandals; skirts; skorts.

(260) AM 2015 77030 A

(800) 1200133

(891) 2014 01 26

(731) X.T. TECH LTD

1 Hamenofim St., 4672552 Herzliya, Israel

(540)

**ISABEL GARCIA**

(591) Black, white

(511)

18 – Pocket wallets; card cases [notecases]; umbrellas; parasols; valves of leather; imitation leather; leather, unworked or semi-worked; leatherboard; hat boxes of leather; boxes of vulcanised fibre; chain mesh purses; purses; leather straps; straps of leather [saddlery]; chin straps, of leather; umbrella handles; suitcase handles; rucksacks; travelling bags; garment bags for travel; valises; handbags; beach bags; bags for sports; bags for campers; school bags; umbrella sticks; walking sticks; suitcases; attaché cases; umbrella covers.

25 – Bandanas [neckerchiefs]; underwear; berets; overalls; boas [necklets]; teddies [undergarments]; half-boots; boots for sports; breeches for wear; pants; football shoes; brassieres; detachable collars; collars [clothing]; shirt yokes; veils [clothing]; gabardines [clothing]; neckties; ascots; leggings [leg warmers]; spats; boot uppers; corselets; jerseys [clothing]; vests; hosiery; heels; hoods [clothing]; hat frames [skeletons]; pockets for clothing; collar protectors; visors [headwear]; cap peaks; tights; slips [undergarments]; combinations [clothing]; wet suits

for water-skiing; bodices [lingerie]; corsets [under-clothing]; suits; bathing suits; masquerade costumes; beach clothes; jackets [clothing]; leggings [trousers]; liveries; camisoles; cuffs; short-sleeve shirts; mantillas; coats; sleep masks; furs [clothing]; mittens; muffs [clothing]; footmuffs, not electrically heated; bibs, not of paper; fur stoles; ear muffs [clothing]; socks; beach shoes; sports shoes; footwear; paper clothing; outer-clothing; ready-made clothing; motorists' clothing; cyclists' clothing; clothing for gymnastics; clothing of leather; clothing; fittings of metal for footwear; overcoats; parkas; pelerines; gloves [clothing]; ski gloves; pajamas (Am.); bathing trunks; shirt fronts; pocket squares; dresses; waterproof clothing; headbands [clothing]; garters; sock suspenders; stocking suspenders; ready-made linings [parts of clothing]; dress shields; soles for footwear; braces for clothing [suspenders]; lace boots; ponchos; girdles; belts [clothing]; money belts [clothing]; jumpers [pullover]; shirts; wooden shoes; sandals; bath sandals; boots; sarongs; jumper dresses; saris; sweaters; footwear uppers; inner soles; bath slippers; togas; knitwear [clothing]; underpants; gymnastic shoes; slippers; shoes; turbans; headgear for wear; aprons [clothing]; tee-shirts; dressing gowns; bath robes; top hats; tips for footwear; stockings; sweat-absorbent stockings; shawls; caps [headwear]; paper hats [clothing]; shower caps; bathing caps; sashes for wear; studs for football boots; hats; babies' pants [clothing]; trouser straps; pelisses; esparto shoes or sandals; skirts; skorts.

(260) AM 2015 77032 A  
(800) 1200135  
(891) 2014 01 27  
(731) CHENGDU AIMINER LEATHER PRODUCTS CO., LTD.  
No:16, Wenchangzhonglu, Cuqiao, Wuhou District, Chengdu City, 610043 Sichuan Province, China

(540)

**annastar**

(591) Black, white  
(511)  
18 – Briefcases; handbags; backpacks; travelling bags; pocket wallets; handbags; travelling sets [leatherware]; animal skins; fur-skins; trimmings of leather for furniture.

(260) AM 2015 77033 A  
(800) 1200137  
(891) 2014 01 27  
(731) XTEP (CHINA) CO., LTD.  
Qingmeng Park, Economic & Technological Development Zone, Quanzhou, Fujian Province, China

(540)

**XTOP**

(591) Black, white  
(511)  
18 – Imitation leather; pocket wallets; travelling bags; haversacks; leather decorations, fur; umbrella; walking sticks; harness straps; gut for making sausages.

(260) AM 2015 77034 A  
(800) 1200144  
(891) 2013 12 04  
(731) SHANGDONG WANDA BOTO TYRE CO., LTD.  
No:68 Yongshen Road, Dongying City, Shandong, China

(540)

**WANDA**

(591) Black, white  
(511)  
12 – Traction engines; bands for wheel hubs; vehicle wheels; bicycles; funiculars; goods handling carts; sleighs [vehicles]; tyres for vehicle wheels; inner tubes for pneumatic tires [tyres]; treads for vehicles [roller belts].

(260) AM 2015 77088 A  
(800) 1200806  
(891) 2014 01 31  
(731) JOHNSON MATTHEY PUBLIC LIMITED COMPANY  
5th Floor, 25 Farringdon Street, London EC4A 4AB, United Kingdom

(540)

**Pro-Lok**

(511)  
1 – Precious metal gauze catalysts.

(260) AM 2015 77089 A  
(800) 1200821  
(891) 2014 02 26  
(731) MPEX PHARMACEUTICALS, INC.  
100 Somerset Corporate Boulevard, Bridgewater NJ 08807, USA

(540)

**ZYLUSO**

(591) Black, white  
(511)  
5 – Pharmaceutical preparations, namely, antibiotics.

(260) AM 2015 77090 A  
(800) 1200832  
(891) 2014 01 21

(731) LIMITED LIABILITY COMPANY  
 "INTERNET COMPANY MAIL.RU"  
 Leningradsky pr-kt, d. 39, str. 79,  
 RU-125167 Moscow, Russian Federation

(540)



(591) Black, white

(511)

9 – Video cassettes; video game cartridges; compact discs [audio-video]; compact discs [read-only memory]; magnetic data media; optical data media; computer software, recorded; computer programmes [programs], recorded; computer game software; computer programs [downloadable software]; computer operating programs, recorded; downloadable image files; downloadable music files; animated cartoons; USB flash drives.

16 – Almanacs; atlases; posters; pamphlets; booklets; newsletters; newspapers; engravings; magazines [periodicals]; periodicals; printed publications; graphic representations; calendars; geographical maps; catalogues; books; comic books; lithographs; graphic prints; greeting cards; postcards; printed matter; prospectuses; manuals [handbooks]; photographs [printed].

28 – Arcade video game machines; video game machines; gaming machines for gambling; amusement machines, automatic and coin-operated; jigsaw puzzles; toys; mobiles [toys]; parlor games; board games; games; building games; playing cards; scale model kits [toys]; portable games with liquid crystal displays; apparatus for games.

35 – Rental of advertising space; computerized file management; demonstration of goods; opinion polling; marketing studies; business investigations; marketing research; news clipping services; updating of advertising material; organization of exhibitions for commercial or advertising purposes; organization of trade fairs for commercial or advertising purposes; shop window dressing; data search in computer files for others; commercial or industrial management assistance; presentation of goods on communication media, for retail purposes; auctioneering; sales promotion for others; production of advertising films; rental of advertising time on communication media; publicity material rental; publication of publicity texts; radio advertising; bill-posting; dissemination of advertising matter; direct mail advertising; advertising; on-line advertising on a computer network; advertising by mail order; television advertising; compilation of information into computer databases; systemization of information into computer databases; publicity columns preparation; administrative processing of purchase orders; public relations.

38 – News agencies; television broadcasting; cable television broadcasting; electronic bulletin board services [telecommunications services]; information about telecommunication; providing user access to global computer networks; providing access to databases; providing internet chatrooms; providing telecommunications connections to a global computer network; providing telecommunication channels for teleshopping services; transmission of greeting cards online; message sending; computer aided transmission of messages and images; transmission of digital files; electronic mail; providing online forums; rental of access time to global computer networks; radio broadcasting; communications by fiber [fibre] optic networks; cellular telephone communication; communications by computer terminals; communications by telephone; paging services [radio, telephone or other means of electronic communication]; teleconferencing services; voice mail services; telephone services.

41 – Booking of seats for shows; videotaping; gambling; publication of books; education information; recreation information; entertainment information; health club services [health and fitness training]; night clubs; layout services, other than for advertising purposes; videotape editing; game services provided on-line from a computer network; providing on-line electronic publications, not downloadable; practical training [demonstration]; organization of exhibitions for cultural or educational purposes; providing recreation facilities; arranging and conducting of colloquiums; arranging and conducting of conferences; arranging and conducting of workshops [training]; arranging and conducting of seminars; organization of competitions [education or entertainment]; operating lotteries; television entertainment; videotape film production; rental of videotapes; rental of sound recordings; publication of electronic books and journals online; publication of texts, other than publicity texts; radio entertainment; entertainer services; entertainment; writing of texts, other than publicity texts; news reporters services; party planning [entertainment]; providing casino facilities [gambling]; club services [entertainment or education]; teaching; recording studio services; photography; production of shows.

42 – Computer system analysis; recovery of computer data; computer virus protection services; installation of computer software; information technology [IT] consultancy; consultancy in the design and development of computer hardware; computer software consultancy; updating of computer software; maintenance of computer software; providing search engines for the internet; data conversion of computer programs and data [not physical conversion]; computer system design; computer rental; rental of computer software; hosting computer sites [web sites]; server hosting; duplication of computer programs;

computer software design; creating and maintaining web sites for others; computer programming.  
45 – Missing person investigations; personal background investigations; dating services.

(260) AM 2015 77091 A

(800) 1200833

(891) 2014 01 21

(731) LIMITED LIABILITY COMPANY

"INTERNET COMPANY MAIL.RU"

Leningradsky pr-kt, d. 39, str. 79, RU-125167  
Moscow, Russian Federation

(540)

**my.com**

(591) Black, white

(511)

16 – Almanacs; atlases; posters; pamphlets; booklets; newsletters; newspapers; engravings; magazines [periodicals]; periodicals; printed publications; graphic representations; calendars; geographical maps; catalogues; books; comic books; lithographs; graphic prints; greeting cards; postcards; printed matter; prospectuses; manuals [handbooks]; photographs [printed].

28 – Arcade video game machines; video game machines; gaming machines for gambling; amusement machines, automatic and coin-operated; jigsaw puzzles; toys; mobiles [toys]; parlor games; board games; games; building games; playing cards; scale model kits [toys]; portable games with liquid crystal displays; apparatus for games.

45 – Missing person investigations; personal background investigations; dating services.

(260) AM 2015 77092 A

(800) 1200834

(891) 2014 01 23

(731) OBSHESTVO S OGRANICHENNOY  
OTVETSTVENNOSTYU "LABORATO-  
RIYA SOVREMENNOGO ZDOROVYA"

ul. Khimzavodskaya, 11/20, Berdsk,  
RU-633004 Novosibirskaya oblast',  
Russian Federation

(540)

**AGEVITALS**

(511)

5 – Albumin dietary supplements; alginate dietary supplements; albuminous foodstuffs for medical purposes; albuminous preparations for medical purposes; aloe vera preparations for pharmaceutical purposes; antioxidant pills; appetite suppressant pills; balms for medical purposes; bath preparations, medicated; biocides; biological preparations for medical purposes; by-products of the processing of cereals for dietetic or medical purposes; casein dietary

supplements; decoctions for pharmaceutical purposes; diabetic bread adapted for medical use; dietary fiber; dietetic beverages adapted for medical purposes; dietetic foods adapted for medical purposes; dietetic substances adapted for medical use; digestives for pharmaceutical purposes; enzyme dietary supplements; enzyme preparations for medical purposes; flaxseed dietary supplements; flaxseed oil dietary supplements; flour for pharmaceutical purposes; food for babies; glucose dietary supplements; hematogen; herbal teas for medicinal purposes; lacteal flour for babies; lecithin dietary supplements; liniments; lotions for pharmaceutical purposes; malted milk beverages for medical purposes; medicinal infusions; medicinal herbs; medicinal oils; medicinal roots; medicinal tea; milk ferments for pharmaceutical purposes; mineral food supplements; nervines; nutritional supplements; pharmaceutical preparations for skin care; pollen dietary supplements; preparations of trace elements for human and animal use; propolis dietary supplements; protein dietary supplements; royal jelly dietary supplements; royal jelly for pharmaceutical purposes; slimming pills; syrups for pharmaceutical purposes; vitamin preparations; wheat germ dietary supplements; yeast dietary supplements; yeast for pharmaceutical purposes.

(260) AM 2015 77093 A

(800) 1200840

(891) 2014 02 18

(731) MIROGLIO TEXTILE S.R.L.

Via Santa Margherita, 23, I-12051 ALBA  
(CN), Italy

(540)

**twinfabs**  
MiroglioTEXTILE

(591) Black, white

(511)

24 – Textiles and textile goods, not included in other classes; textile material; cloth; hemp cloth, printed calico cloth; fabric; non-woven textile fabrics; fabrics for textile use; furnishing fabrics; apparel fabrics.

(260) AM 2015 77094 A

(800) 1200879

(891) 2014 03 20

(731) QUANU FURNITURE CO., LTD.

Chongzhou Industrial Zone Sichuan Province,  
China

(540)



(591) Black, white  
(511)  
35 – Advertising; outdoor advertising; presentation of goods on communication media, for retail purposes; advertising planning; marketing; organization of exhibitions for commercial or advertising purposes; systemization of information into computer databases; sponsorship search; commercial administration of the licensing of the goods and services of others; relocation services for businesses.

(260) AM 2015 77095 A  
(800) 1200887  
(891) 2014 03 26  
(731) HUAWEI TECHNOLOGIES CO., LTD.  
Administration Building, Huawei  
Technologies Co., Ltd., Bantian, Longgang  
District, Shenzhen China

(540)

**PhoPad**

(591) Black, white  
(511)  
9 – Computers; tablet computers; mobile phones; protective covers for tablet computers; protective covers for mobile phones; protective cases for mobile phones; protective cases for tablet computers.

(260) AM 2015 77253 A  
(800) 1202350  
(891) 2014 03 03  
(731) Tovarystvo z obmezheniou vidpovidalnistiu  
"NOVA POSHTA"  
vul. Frunze, 57, Poltava 36039, Ukraine

(540)



(591) Red, black and white  
(511)  
35 – Arranging newspaper subscriptions for others; demonstration of goods; business information; distribution of samples; updating of advertising material; procurement services for others (purchasing goods and services for other businesses); advertising by mail order; distribution of samples; advertising; direct mail advertising; sales promotion for others.

39 – Car transport; freight (shipping of goods); delivery of newspapers; message delivery; parcel delivery; delivery of goods; delivery of goods by mail order; freight forwarding; storage (warehousing); storage of goods; transportation information; courier services (messages or merchandise); wrapping of

goods; packaging of goods; transport; transport brokerage; hauling; handling of goods, unloading cargo.

(260) AM 2015 77267 A  
(800) 1202442  
(891) 2013 10 16  
(731) NICOVENTURES HOLDINGS LIMITED  
Globe House, 4 Temple Place, London WC2R  
2PG, United Kingdom

(540)

**VYPE**

(511)  
5 – Tobacco-free cigarettes, all for medical use.

9 – Electronic cigarette batteries and battery chargers; electronic devices for charging electronic cigarettes and electronic cigarette cases.

10 – Medical devices, namely medical devices for human use including, but not limited to, mouth sprays, nasal sprays.

34 – Electronic cigarettes; cartridges for electronic cigarettes; liquids for electronic cigarettes; cigarettes containing tobacco substitutes; tobacco substitutes; cigarettes; tobacco; tobacco products; cigarette cases; cigarette boxes.

(260) AM 2015 77299 A  
(800) 1202851  
(891) 2014 02 27  
(731) CHROME HEARTS LLC  
915 N. Mansfield, Hollywood CA 90038, USA

(540)



(591) Black, white  
(511)  
9 – Eyewear, namely, eyeglasses, sunglasses, their parts and cases.

(260) AM 2015 77300 A  
(800) 1202857  
(891) 2013 12 20  
(731) DAW SE  
Roßdörfer Str. 50, 64372 Ober-Ramstadt,  
Germany

(540)

**CAPASILBER**

(511)

2 – Paints; varnishes; lacquers; glazes; preservatives against rust; primers; dyes, dye stuffs, dye paste; mordants; thickeners for paints; fixatives, siccatives (drying agents) for paints; natural resins (included in this class); thinners and binding agents for paints, lacquers and coatings; wood preservatives, wood mordants and oils for the preservation of wood; coatings (included in this class), including those that are structurable; bactericidal and fungicidal paints; anti-corrosive preparations; protective preparations for metals; metals in powder form and metal foil for painters, decorators, printers and artists.

19 – Building materials (not of metal); profile rails (not of metal) and corner rails (not of metal) for building purposes, especially edging profiles; adjusting and levelling parts (not of metal) for building purposes; spacer (not of metal) for building purposes; window sills (not of metal); natural and artificial stones; mortar and quartz (building material); plaster (included in this class); coatings (building materials); wall and ceiling panels (not of metal for building purposes); fabric embedding compounds for building purposes; fillers as building materials.

27 – Wall hangings not of textile, including textured fabrics combined with coatings; wallpaper (non-textile).

(260) AM 2015 77495 A

(800) 1204791

(891) 2013 12 30

(731) Obshchestvo s ogranichennoj otvetstvennost'yu "KHIT LAJF"  
ul. Gogolya, 42, RU-630005 Novosibirsk,  
Russian Federation

(540)

**Ondolia**

(511)

11 – Desiccating apparatus; drying apparatus and installations; drying apparatus; fruit roasters; footmuffs, electrically heated; heaters for baths; heaters for baths; immersion heaters; heating filaments, electric; sauna bath installations; blankets, electric, not for medical purposes; heating plates; aquarium heaters; heating cushions [pads], electric, not for medical purposes; drying apparatus for fodder and forage; cooking apparatus and installations; hot air apparatus; radiators [heating]; central heating radiators; radiators, electric; heat regenerators; air driers [dryers]; malt roasters; tobacco roasters; heat exchangers, not parts of machines; heating installations; heaters for vehicles; polymerisation installations; heating elements.

(260) AM 2015 77504 A

(800) 1204864

(891) 2014 05 07

(731) MERCK KGAA

Frankfurter Str. 250, 64293 Darmstadt,  
Germany

(540)

**AXTUMIO**

(511)

5 – Pharmaceutical preparations for human use in the field of oncology.

(260) AM 2015 77512 A

(800) 1205023

(891) 2014 03 27

(731) COMITÉ INTERNATIONAL OLYMPIQUE

Château de Vidy, CH-1007 Lausanne,  
Switzerland

(540)



**LAUSANNE**  
**2020**

(591) Black, white

(511)

35 – Advertising; dissemination of advertising matter via all media, in particular in the form of thematic messages centered on human values; advertising by sponsoring; business management; business administration; office functions; promoting the goods and services of others, by means of contractual agreements, in particular sponsoring and licensing agreements, enabling them to gain additional notoriety and/or enhanced image and/or a surge of sympathy derived from the notoriety and/or enhanced image resulting from cultural and sporting events, in particular international events, and/or a surge of sympathy generated by the above; promoting the goods and services of others by means of what is referred to as the initial interest factor leading the public to consider, among a multitude of competitors, goods or services presented to the public bearing signs, emblems or messages able to capture its attention; promoting the goods and services of others by means of the so-called image transfer; rental of advertising space of all type and on all media, whether digital or not; business administration of the participation of national teams to an international athletic competition, and promoting the support to said teams with the public and the concerned circles; inventory management services; consultation relating to stock monitoring services; advertising by means of direct marketing for others consisting in marketing of databases; consultation for advertising by means of direct marketing for others consisting in marketing of databases; advisory services in connection with business reorganization; truck and automobile fleet management services,

namely billing and consulting in connection with the administrative management of truck and automobile fleets; business administration consultancy; administrative management of power plants of others; business consultation in connection with the management of power plants, commercial services, namely administration of contracts for repair and servicing, supply chain management services and consulting services relating to the purchase and supply of chemical services and products, supply management and product inventory, limitation of costs; consulting, marketing, analysis of prices and costs concerning devices for electrochemical purification of liquids for industrial use; administrative, commercial and technical management of computer files; data input and processing services; retail sale of electric and electronic machines and apparatus (the bringing together, for the benefit of others, of a range of goods so as to enable customers to view and purchase said goods at their convenience in a retail store carrying electrical goods), information concerning the sale of raw materials, commercial information, commercial information agencies, rental of photocopiers; promoting the sale of goods and services of others including by means of advertisements, promotional competitions, awarding of prizes and bonuses in the form of promotional lotteries, discounts, reduction tokens and value-added offers in connection with the use of payment cards; promotion of sporting events and competitions for use by others; promoting concerts and cultural events for others, organization of exhibitions for commercial or advertising purposes; provision of documentation, namely direct mail advertising, distribution of advertising material, distribution of samples, reproduction of documents; advertising concerning the promotion of commercial sales of goods and services for retail sale purposes; provision of information in connection with e-commerce and electronic retail sale; provision of information concerning the purchase of goods and services on line via the Internet and other computer networks; tourist documentation services, namely advertising concerning transport, travel, hotels, accommodation, food and meals, sports, entertainment and sightseeing tours, tourist agency services; maintenance of computerized databases.

41 – Education; training; entertainment; sporting and cultural activities, televised sporting and cultural entertainment; organization of exhibitions for cultural and educational purposes; organization of lotteries and competitions; betting and gambling services in connection with or relating to sports; entertainment services provided during sporting events or concerning sporting events; organization of sporting and cultural events and activities; organization of real or virtual sporting competitions; operation of sports facilities; rental of audio and video equipment, production of films, other than advertising

films; production of sound and video recordings; presentation and distribution of films and of sound and video recordings; rental of sound and video recordings; rental and/or provision via a computer network of interactive education and entertainment products, namely interactive compact discs, CD-ROMs, computer games; entertainment, namely presentation of interactive education and entertainment products, namely interactive compact discs, CD-ROMs, computer games; radio and television coverage of sporting events; production of television and radio programs and of videotapes; production of cartoons; production of animated programs for television; reservation of tickets for sporting events and shows; timing of sports events; organization of beauty contests; interactive entertainment; on-line betting services; provision of games on the Internet; provision of raffle services; information concerning entertainment or education, provided on line from a data bank or the Internet; electronic game services provided by means of the Internet; provision of electronic publications on line; publication of books, magazines, texts (other than publicity texts) and periodicals; on line publication of electronic books, magazines, texts (other than publicity texts) and periodicals; provision of digital music from the Internet; provision of digital music from MP3 web sites; provision of sporting results; information services concerning sports and sporting events; rental of recorded sounds and images; audio production services; information services concerning sporting events provided on line from a computer database or the Internet; editing and publishing services; provision of digital music (non-downloadable); offering digital music by means of telecommunications; publication of statistics regarding sporting results and audience ratings for sporting competitions; training in the use and operation of systems for signaling and notification of crossings for the railway and transit industries; education services in the field of medical imaging and diagnosis, namely conducting of seminars, conferences, symposiums or workshops concerning the pharmaceutical industry, intended for medical practitioners and employees of pharmaceutical companies; education services, namely conducting of seminars, conferences, symposiums or workshops in the field of life sciences and biotechnology for scientists and researchers; conducting of seminars on problems in connection with industrial water treatment; training services in all the aforesaid fields; training services in the field of management and medicine by means of the use of instructions and demonstrations provided on line, via the Internet, intranets and extranets; education services, namely conducting of practical training workshops, courses and seminars including demonstrations in the field of medicine and management; design, conducting and hosting of courses, seminars and all training activities in the field of information technology;



organization and performance of concerts; booking of seats for shows; movie presentations; entertainment information; production of films; show production; theater production services; operation of golf facilities; health club services (fitness training); sports camp services; presentation of live performances; film projection; organization of shows (impresario services); holiday camp services [entertainment]; movie studios; news reporters services; provision of on-line electronic publications, not downloadable; music hall services; education services, namely conducting of courses, seminars, presentations, video presentations; provision of educational material, namely dissemination of material in the field of financial knowledge; education services in the field of tourism; information services in the field of tourism, namely information services regarding reservation of tickets for recreational events; information services in the field of tourism, namely information services regarding entertainment; information services in the field of tourism, namely information services regarding planned sporting, cultural and recreational activities; services in connection with entertainment for tourist assistance; tourist reservation services, namely activity and entertainment reservation services; assistance services for tourists concerning reservation of tickets for recreational events; assistance services for tourists concerning planned sporting, cultural and recreational activities.

(260) AM 2015 77513 A

(800) 1205032

(891) 2014 03 27

(731) COMITÉ INTERNATIONAL OLYMPIQUE  
Château de Vidy, CH-1007 Lausanne,  
Switzerland

(540)



(591) Black, white

(511)

35 – Advertising; dissemination of advertising matter via all media, in particular in the form of thematic messages centered on human values; advertising by sponsoring; business management; business administration; office functions; promoting the goods and services of others, by means of contractual agreements, in particular sponsoring and licensing agreements, enabling them to gain additional notoriety and/or enhanced image and/or a surge of sympathy derived from the notoriety and/or enhanced image resulting from cultural and sporting events, in particular international events, and/or a surge of sympathy generated by the above; promoting the goods and services of others by means of

what is referred to as the initial interest factor leading the public to consider, among a multitude of competitors, goods or services presented to the public bearing signs, emblems or messages able to capture its attention; promoting the goods and services of others by means of the so-called image transfer; rental of advertising space of all type and on all media, whether digital or not; business administration of the participation of national teams to an international athletic competition, and promoting the support to said teams with the public and the concerned circles; inventory management services; consultation relating to stock monitoring services; advertising by means of direct marketing for others consisting in marketing of databases; consultation for advertising by means of direct marketing for others consisting in marketing of databases; advisory services in connection with business reorganization; truck and automobile fleet management services, namely billing and consulting in connection with the administrative management of truck and automobile fleets; business administration consultancy; administrative management of power plants of others; business consultation in connection with the management of power plants, commercial services, namely administration of contracts for repair and servicing, supply chain management services and consulting services relating to the purchase and supply of chemical services and products, supply management and product inventory, limitation of costs; consulting, marketing, analysis of prices and costs concerning devices for electrochemical purification of liquids for industrial use; administrative, commercial and technical management of computer files; data input and processing services; retail sale of electric and electronic machines and apparatus (the bringing together, for the benefit of others, of a range of goods so as to enable customers to view and purchase said goods at their convenience in a retail store carrying electrical goods), information concerning the sale of raw materials, commercial information, commercial information agencies, rental of photocopiers; promoting the sale of goods and services of others including by means of advertisements, promotional competitions, awarding of prizes and bonuses in the form of promotional lotteries, discounts, reduction tokens and value-added offers in connection with the use of payment cards; promotion of sporting events and competitions for use by others; promoting concerts and cultural events for others, organization of exhibitions for commercial or advertising purposes; provision of documentation, namely direct mail advertising, distribution of advertising material, distribution of samples, reproduction of documents; advertising concerning the promotion of commercial sales of goods and services for retail sale purposes; provision of information in connection with e-commerce and electronic retail sale; provision of information concerning the purchase of

goods and services on line via the Internet and other computer networks; tourist documentation services, namely advertising concerning transport, travel, hotels, accommodation, food and meals, sports, entertainment and sightseeing tours, tourist agency services; maintenance of computerized databases.

41 – Education; training; entertainment; sporting and cultural activities, televised sporting and cultural entertainment; organization of exhibitions for cultural and educational purposes; organization of lotteries and competitions; betting and gambling services in connection with or relating to sports; entertainment services provided during sporting events or concerning sporting events; organization of sporting and cultural events and activities; organization of real or virtual sporting competitions; operation of sports facilities; rental of audio and video equipment, production of films, other than advertising films; production of sound and video recordings; presentation and distribution of films and of sound and video recordings; rental of sound and video recordings; rental and/or provision via a computer network of interactive education and entertainment products, namely interactive compact discs, CD-ROMs, computer games; entertainment, namely presentation of interactive education and entertainment products, namely interactive compact discs, CD-ROMs, computer games; radio and television coverage of sporting events; production of television and radio programs and of videotapes; production of cartoons; production of animated programs for television; reservation of tickets for sporting events and shows; timing of sports events; organization of beauty contests; interactive entertainment; on-line betting services; provision of games on the Internet; provision of raffle services; information concerning entertainment or education, provided on line from a data bank or the Internet; electronic game services provided by means of the Internet; provision of electronic publications on line; publication of books, magazines, texts (other than publicity texts) and periodicals; on line publication of electronic books, magazines, texts (other than publicity texts) and periodicals; provision of digital music from the Internet; provision of digital music from MP3 web sites; provision of sporting results; information services concerning sports and sporting events; rental of recorded sounds and images; audio production services; information services concerning sporting events provided on line from a computer database or the Internet; editing and publishing services; provision of digital music (non-downloadable); offering digital music by means of telecommunications; publication of statistics regarding sporting results and audience ratings for sporting competitions; training in the use and operation of systems for signaling and notification of crossings for the railway and transit industries; education services in the field of medical imaging and diagnosis, namely conducting of semi-

nars, conferences, symposiums or workshops concerning the pharmaceutical industry, intended for medical practitioners and employees of pharmaceutical companies; education services, namely conducting of seminars, conferences, symposiums or workshops in the field of life sciences and biotechnology for scientists and researchers; conducting of seminars on problems in connection with industrial water treatment; training services in all the aforesaid fields; training services in the field of management and medicine by means of the use of instructions and demonstrations provided on line, via the Internet, intranets and extranets; education services, namely conducting of practical training workshops, courses and seminars including demonstrations in the field of medicine and management; design, conducting and hosting of courses, seminars and all training activities in the field of information technology; organization and performance of concerts; booking of seats for shows; movie presentations; entertainment information; production of films; show production; theater production services; operation of golf facilities; health club services (fitness training); sports camp services; presentation of live performances; film projection; organization of shows (impresario services); holiday camp services [entertainment]; movie studios; news reporters services; provision of on-line electronic publications, not downloadable; music hall services; education services, namely conducting of courses, seminars, presentations, video presentations; provision of educational material, namely dissemination of material in the field of financial knowledge; education services in the field of tourism; information services in the field of tourism, namely information services regarding reservation of tickets for recreational events; information services in the field of tourism, namely information services regarding entertainment; information services in the field of tourism, namely information services regarding planned sporting, cultural and recreational activities; services in connection with entertainment for tourist assistance; tourist reservation services, namely activity and entertainment reservation services; assistance services for tourists concerning reservation of tickets for recreational events; assistance services for tourists concerning planned sporting, cultural and recreational activities.

(260) AM 2015 77515 A

(800) 1205034

(891) 2014 04 02

(731) COMITÉ INTERNATIONAL OLYMPIQUE

Château de Vidy, CH-1007 Lausanne,

Switzerland

(540)

 BEIJING 2022

(591) Black, white

(511)

35 – Advertising; dissemination of advertising matter via all media, in particular in the form of thematic messages centered on human values; advertising by sponsoring; business management; business administration; office functions; promoting the goods and services of others, by means of contractual agreements, in particular sponsoring and licensing agreements, enabling them to gain additional notoriety and/or enhanced image and/or a surge of sympathy derived from the notoriety and/or enhanced image resulting from cultural and sporting events, in particular international events, and/or a surge of sympathy generated by the above; promoting the goods and services of others by means of what is referred to as the initial interest factor leading the public to consider, among a multitude of competitors, goods or services presented to the public bearing signs, emblems or messages able to capture its attention; promoting the goods and services of others by means of the so-called image transfer; rental of advertising space of all type and on all media, whether digital or not; business administration of the participation of national teams to an international athletic competition, and promoting the support to said teams with the public and the concerned circles; inventory management services; consultation relating to stock monitoring services; advertising by means of direct marketing for others consisting in marketing of databases; consultation for advertising by means of direct marketing for others consisting in marketing of databases; advisory services in connection with business reorganization; truck and automobile fleet management services, namely billing and consulting in connection with the administrative management of truck and automobile fleets; business administration consultancy; administrative management of power plants of others; business consultation in connection with the management of power plants, commercial services, namely administration of contracts for repair and servicing, supply chain management services and consulting services relating to the purchase and supply of chemical services and products, supply management and product inventory, limitation of costs; consulting, marketing, analysis of prices and costs concerning devices for electrochemical purification of liquids for industrial use; administrative, commercial and technical management of computer files; data input and processing services; retail sale of electric and electronic machines and apparatus (the bringing together, for the benefit of others, of a range of goods so as to enable customers to view and purchase said goods at their convenience in a retail store carrying electrical goods), information concerning the sale of raw materials, commercial information, commercial information agencies, rental of photocopiers; promoting the sale of goods and services of ot-

hers including by means of advertisements, promotional competitions, awarding of prizes and bonuses in the form of promotional lotteries, discounts, reduction tokens and value-added offers in connection with the use of payment cards; promotion of sporting events and competitions for use by others; promoting concerts and cultural events for others, organization of exhibitions for commercial or advertising purposes; provision of documentation, namely direct mail advertising, distribution of advertising material, distribution of samples, reproduction of documents; advertising concerning the promotion of commercial sales of goods and services for retail sale purposes; provision of information in connection with e-commerce and electronic retail sale; provision of information concerning the purchase of goods and services on line via the Internet and other computer networks; tourist documentation services, namely advertising concerning transport, travel, hotels, accommodation, food and meals, sports, entertainment and sightseeing tours, tourist agency services; maintenance of computerized databases.

41 – Education; training; entertainment; sporting and cultural activities, televised sporting and cultural entertainment; organization of exhibitions for cultural and educational purposes; organization of lotteries and competitions; betting and gambling services in connection with or relating to sports; entertainment services provided during sporting events or concerning sporting events; organization of sporting and cultural events and activities; organization of real or virtual sporting competitions; operation of sports facilities; rental of audio and video equipment, production of films, other than advertising films; production of sound and video recordings; presentation and distribution of films and of sound and video recordings; rental of sound and video recordings; rental and/or provision via a computer network of interactive education and entertainment products, namely interactive compact discs, CD-ROMs, computer games; entertainment, namely presentation of interactive education and entertainment products, namely interactive compact discs, CD-ROMs, computer games; radio and television coverage of sporting events; production of television and radio programs and of videotapes; production of cartoons; production of animated programs for television; reservation of tickets for sporting events and shows; timing of sports events; organization of beauty contests; interactive entertainment; on-line betting services; provision of games on the Internet; provision of raffle services; information concerning entertainment or education, provided on line from a data bank or the Internet; electronic game services provided by means of the Internet; provision of electronic publications on line; publication of books, magazines, texts (other than publicity texts) and periodicals; on line publication of electronic books, magazines, texts (other than publicity texts) and periodicals;

provision of digital music from the Internet; provision of digital music from MP3 web sites; provision of sporting results; information services concerning sports and sporting events; rental of recorded sounds and images; audio production services; information services concerning sporting events provided on line from a computer database or the Internet; editing and publishing services; provision of digital music (non-downloadable); offering digital music by means of telecommunications; publication of statistics regarding sporting results and audience ratings for sporting competitions; training in the use and operation of systems for signaling and notification of crossings for the railway and transit industries; education services in the field of medical imaging and diagnosis, namely conducting of seminars, conferences, symposiums or workshops concerning the pharmaceutical industry, intended for medical practitioners and employees of pharmaceutical companies; education services, namely conducting of seminars, conferences, symposiums or workshops in the field of life sciences and biotechnology for scientists and researchers; conducting of seminars on problems in connection with industrial water treatment; training services in all the aforesaid fields; training services in the field of management and medicine by means of the use of instructions and demonstrations provided on line, via the Internet, intranets and extranets; education services, namely conducting of practical training workshops, courses and seminars including demonstrations in the field of medicine and management; design, conducting and hosting of courses, seminars and all training activities in the field of information technology; organization and performance of concerts; booking of seats for shows; movie presentations; entertainment information; production of films; show production; theater production services; operation of golf facilities; health club services (fitness training); sports camp services; presentation of live performances; film projection; organization of shows (impresario services); holiday camp services [entertainment]; movie studios; news reporters services; provision of on-line electronic publications, not downloadable; music hall services; education services, namely conducting of courses, seminars, presentations, video presentations; provision of educational material, namely dissemination of material in the field of financial knowledge; education services in the field of tourism; information services in the field of tourism, namely information services regarding reservation of tickets for recreational events; information services in the field of tourism, namely information services regarding entertainment; information services in the field of tourism, namely information services regarding planned sporting, cultural and recreational activities; services in connection with entertainment for tourist assistance; tourist reservation services, namely activity and entertainment reservation services; assistance servi-

ces for tourists concerning reservation of tickets for recreational events; assistance services for tourists concerning planned sporting, cultural and recreational activities.

(260) AM 2015 77516 A

(800) 1205035

(891) 2014 04 02

(731) COMITÉ INTERNATIONAL OLYMPIQUE  
Château de Vidy, CH-1007 Lausanne,  
Switzerland

(540)

 **ALMATY 2022**

(591) Black, white

(511)

35 – Advertising; dissemination of advertising matter via all media, in particular in the form of thematic messages centered on human values; advertising by sponsoring; business management; business administration; office functions; promoting the goods and services of others, by means of contractual agreements, in particular sponsoring and licensing agreements, enabling them to gain additional notoriety and/or enhanced image and/or a surge of sympathy derived from the notoriety and/or enhanced image resulting from cultural and sporting events, in particular international events, and/or a surge of sympathy generated by the above; promoting the goods and services of others by means of what is referred to as the initial interest factor leading the public to consider, among a multitude of competitors, goods or services presented to the public bearing signs, emblems or messages able to capture its attention; promoting the goods and services of others by means of the so-called image transfer; rental of advertising space of all type and on all media, whether digital or not; business administration of the participation of national teams to an international athletic competition, and promoting the support to said teams with the public and the concerned circles; inventory management services; consultation relating to stock monitoring services; advertising by means of direct marketing for others consisting in marketing of databases; consultation for advertising by means of direct marketing for others consisting in marketing of databases; advisory services in connection with business reorganization; truck and automobile fleet management services, namely billing and consulting in connection with the administrative management of truck and automobile fleets; business administration consultancy; administrative management of power plants of others; business consultation in connection with the management of power plants, commercial services, namely administration of contracts for repair and servicing, supply chain management services and consulting services relating to the purchase and supply of chemical

services and products, supply management and product inventory, limitation of costs; consulting, marketing, analysis of prices and costs concerning devices for electrochemical purification of liquids for industrial use; administrative, commercial and technical management of computer files; data input and processing services; retail sale of electric and electronic machines and apparatus (the bringing together, for the benefit of others, of a range of goods so as to enable customers to view and purchase said goods at their convenience in a retail store carrying electrical goods), information concerning the sale of raw materials, commercial information, commercial information agencies, rental of photocopiers; promoting the sale of goods and services of others including by means of advertisements, promotional competitions, awarding of prizes and bonuses in the form of promotional lotteries, discounts, reduction tokens and value-added offers in connection with the use of payment cards; promotion of sporting events and competitions for use by others; promoting concerts and cultural events for others, organization of exhibitions for commercial or advertising purposes; provision of documentation, namely direct mail advertising, distribution of advertising material, distribution of samples, reproduction of documents; advertising concerning the promotion of commercial sales of goods and services for retail sale purposes; provision of information in connection with e-commerce and electronic retail sale; provision of information concerning the purchase of goods and services on line via the Internet and other computer networks; tourist documentation services, namely advertising concerning transport, travel, hotels, accommodation, food and meals, sports, entertainment and sightseeing tours, tourist agency services; maintenance of computerized databases.

41 – Education; training; entertainment; sporting and cultural activities, televised sporting and cultural entertainment; organization of exhibitions for cultural and educational purposes; organization of lotteries and competitions; betting and gambling services in connection with or relating to sports; entertainment services provided during sporting events or concerning sporting events; organization of sporting and cultural events and activities; organization of real or virtual sporting competitions; operation of sports facilities; rental of audio and video equipment, production of films, other than advertising films; production of sound and video recordings; presentation and distribution of films and of sound and video recordings; rental of sound and video recordings; rental and/or provision via a computer network of interactive education and entertainment products, namely interactive compact discs, CD-ROMs, computer games; entertainment, namely presentation of interactive education and entertainment products, namely interactive compact discs, CD-ROMs, computer games; radio and television coverage of spor-

ting events; production of television and radio programs and of videotapes; production of cartoons; production of animated programs for television; reservation of tickets for sporting events and shows; timing of sports events; organization of beauty contests; interactive entertainment; on-line betting services; provision of games on the Internet; provision of raffle services; information concerning entertainment or education, provided on line from a data bank or the Internet; electronic game services provided by means of the Internet; provision of electronic publications on line; publication of books, magazines, texts (other than publicity texts) and periodicals; on line publication of electronic books, magazines, texts (other than publicity texts) and periodicals; provision of digital music from the Internet; provision of digital music from MP3 web sites; provision of sporting results; information services concerning sports and sporting events; rental of recorded sounds and images; audio production services; information services concerning sporting events provided on line from a computer database or the Internet; editing and publishing services; provision of digital music (non-downloadable); offering digital music by means of telecommunications; publication of statistics regarding sporting results and audience ratings for sporting competitions; training in the use and operation of systems for signaling and notification of crossings for the railway and transit industries; education services in the field of medical imaging and diagnosis, namely conducting of seminars, conferences, symposiums or workshops concerning the pharmaceutical industry, intended for medical practitioners and employees of pharmaceutical companies; education services, namely conducting of seminars, conferences, symposiums or workshops in the field of life sciences and biotechnology for scientists and researchers; conducting of seminars on problems in connection with industrial water treatment; training services in all the aforesaid fields; training services in the field of management and medicine by means of the use of instructions and demonstrations provided on line, via the Internet, intranets and extranets; education services, namely conducting of practical training workshops, courses and seminars including demonstrations in the field of medicine and management; design, conducting and hosting of courses, seminars and all training activities in the field of information technology; organization and performance of concerts; booking of seats for shows; movie presentations; entertainment information; production of films; show production; theater production services; operation of golf facilities; health club services (fitness training); sports camp services; presentation of live performances; film projection; organization of shows (impresario services); holiday camp services [entertainment]; movie studios; news reporters services; provision of on-line electronic publications, not downloadable; music hall services; education

services, namely conducting of courses, seminars, presentations, video presentations; provision of educational material, namely dissemination of material in the field of financial knowledge; education services in the field of tourism; information services in the field of tourism, namely information services regarding reservation of tickets for recreational events; information services in the field of tourism, namely information services regarding entertainment; information services in the field of tourism, namely information services regarding planned sporting, cultural and recreational activities; services in connection with entertainment for tourist assistance; tourist reservation services, namely activity and entertainment reservation services; assistance services for tourists concerning reservation of tickets for recreational events; assistance services for tourists concerning planned sporting, cultural and recreational activities.

(260) AM 2015 77519 A  
(800) 1205046  
(891) 2014 03 07  
(731) CARTIER INTERNATIONAL AG  
Hinterbergstrasse 22, Postfach 61, CH-6312  
Steinhausen, Switzerland

(540)

## CLE DE CARTIER

(511)

14 – Jewelry; jewelry products; precious stones; precious metals and their alloys; pearls; cuff links; tie clips; rings; bracelets; earrings; necklaces; broaches; charms; key rings of precious metal; works of art of precious metal; jewelry cases [caskets]; boxes of precious metal; timepieces and chronometric instruments; watches; chronometers; watch and clock movements, wall clocks; small clocks; cases; watch straps; watch chains and springs or glasses; key rings [trinkets or fobs]; statues or figurines (statuettes) of precious metals; cases or presentation cases for timepieces; medals; jewelry for computers; jewelry for bags; coins.

(260) AM 2015 77520 A  
(800) 1205053  
(891) 2014 05 05  
(731) JAPAN TOBACCO INC.  
2-2-1 Toranomon, Minato-ku, Tokyo,  
Japan

(540)

## DUAL

(511)

34 – Tobacco, raw or manufactured; smoking tobacco, pipe tobacco, rolling tobacco, chewing tobacco, moist tobacco powder called snus; cigarettes, electronic cigarettes, cigars, cigarillos; snuff; smokers'

articles included in this class; cigarette paper, cigarette tubes and matches.

(260) AM 2015 77521 A  
(800) 1205058  
(891) 2014 05 07  
(731) MERCK KGaA  
Frankfurter Str. 250, 64293 Darmstadt,  
Germany

(540)

## KELSPRIG

(511)

5 – Pharmaceutical preparations for human use in the field of oncology.

(260) AM 2015 77527 A  
(800) 1205074  
(891) 2013 12 31  
(731) GMG GRAND MEDICAL İLAÇLARI  
LİMİTED ŞİRKETİ  
Oruç Reis Mah. Tekstilent, Cad. Koza Plaza  
B, Blok K.17 D.60, ESENLER / ISTANBUL,  
Turkey

(540)

## KEPLERON

## КЕПЛЕРОН

(591) Black, white

(511)

5 – Medicines for human purposes, medicines for veterinary purposes, vitamin preparations, chemical preparations for medical purposes, dietetic substances adapted for medical use; dietetic foods adapted for medical purposes; baby foods, medicinal herbs, herbal beverages adapted for medical purposes, nutritional supplements, pollen dietary supplements, mineral food supplements, protein dietary supplements; dietary supplements for animals; fodder supplements for veterinary purposes; medicines for dental purposes, hygienic products for medical purposes including sanitary pads, breast-nursing pads and bunion pads, waddings for medical purposes, plasters for medical purposes, dressings for medical purposes, babies' napkins, preparations for destroying noxious plants, preparations for destroying noxious animals, fungicides, deodorants other than for human beings or for animals, air deodorising preparations, disinfectants for hygiene purposes, antiseptics, detergents for medical purposes.

(260) AM 2015 77528 A  
(800) 1205075  
(891) 2014 02 18  
(731) PIRELLI TYRE S.P.A.  
Viale Piero e Alberto Pirelli, 25, I-20126  
MILANO, Italy

(540)

**NORDMASTER**

(511)

12 – Tires, solid, for vehicle wheels; pneumatic, semi-pneumatic and/or solid tyres; vehicle wheels; wheel rims inner tubes.

(260) AM 2015 77529 A

(800) 1205076

(891) 2014 02 06

(731) FERRERO S.P.A.

Piazza Pietro Ferrero, 1, I-12051 ALBA (CN), Italy

(540)



(591) Black, red-orange and blue

(511)

16 – Paper and paper articles, cardboard and cardboard articles; printed matter, newspapers and periodicals, books; bookbinding material; photographs, stationery, stationery objects, adhesives for stationery or household purposes; artists' materials; paint brushes, office requisites (except furniture); instructional and teaching material (except apparatus); printers' type, printing blocks.

25 – Clothing, footwear, headgear, clothing for sports.

28 – Games and playthings; gymnastic and sporting articles not included in other classes.

(260) AM 2015 77532 A

(800) 1205078

(891) 2013 12 31

(731) GMG GRAND MEDICAL İLAÇLARI LİMİTED ŞİRKETİ

Oruç Reis Mah. Tekstil Kent, Cad. Koza Plaza B, Blok K.17 D.60, ESENLER / İSTANBUL, Turkey

(540)

**GRAMELL  
ГРАМЕЛЛ**

(591) Black, white

(511)

5 – Medicines for human purposes, medicines for veterinary purposes, vitamin preparations, chemical preparations for medical purposes, dietetic substances adapted for medical use; dietetic foods adapted for medical purposes; baby foods, medicinal herbs, herbal beverages adapted for medical purposes, nutritional supplements, pollen dietary supplements, mineral food supplements, protein dietary supplements; dietary supplements for animals; fodder sup-

plements for veterinary purposes; medicines for dental purposes, hygienic products for medical purposes including sanitary pads, breast-nursing pads and union pads, waddings for medical purposes, plasters for medical purposes, dressings for medical purposes, babies' napkins, preparations for destroying noxious plants, preparations for destroying noxious animals, fungicides, deodorants other than for human beings or for animals, air deodorising preparations, disinfectants for hygiene purposes, antiseptics, detergents for medical purposes.

(260) AM 2015 77595 A

(800) 1205693

(891) 2014 03 07

(731) TANFOGLIO S.R.L.

Via Valtrompia, 45, I-25063 GARDONE VAL TROMPIA (BS), Italy

(540)

**TANFOGLIO**

(511)

13 – Firearms; pistols [arms]; ammunition; weapon cases for firearms.

25 – Clothing for men, women and children, namely polos, shirts, T-shirts, shorts, pants, jackets, coats, chemises, underwear, gloves; clothing for hunting, namely jackets, pants, shirts, trousers, vests, gloves; clothing for sports, namely shirts, jackets, jerseys, pants, gloves; footwear, boots, shoes, sport boots, sport shoes; headgear, hats.

(260) AM 2015 77597 A

(800) 1205758

(891) 2014 03 18

(731) PepsiCo, Inc. (a North Carolina corporation)  
700 Anderson Hill Road, Purchase NY 10577, USA

(540)



(591) White, blue and red

(511)

16 – Albums; scrapbook albums; sketch books; banners of paper; forms, printed; announcement cards [stationery]; note books; pads [stationery]; booklets; paper stationery; writing paper; day planners; calendars; writing materials; printed matter; writing or drawing books; stationery.

18 – Bags [envelopes, pouches] of leather, for packaging; travelling sets [leatherware]; souvenir bags; briefcases; haversacks; rucksacks; bags; valises; handbags.

21 – Mugs; containers for household or kitchen use; works of art of porcelain, ceramic, earthenware or

glass; beer mugs; crystal [glassware]; drinking glasses; glasses [spectacles].

25 – Clothing; outer-clothing; water-resistant clothing; ready-made clothing; denim clothing; motorists' clothing; cyclists' clothing; clothing for children; loungewear; outdoor clothing; clothing for sports; leisure wear; clothing, footwear, headgear.

(260) AM 2015 77605 A  
(800) 725666  
(891) 2014 03 14  
(731) AKZO NOBEL CHEMICALS B.V.  
Stationsstraat 77, NL-3811 MH  
AMERSFOORT, Netherlands

(540)

## BOLIKEL

(511)

1 – Chelates; chemicals for use in agriculture, such as micronutrients and fertilizers.

(260) AM 2015 77610 A  
(800) 827520  
(891) 2014 04 16  
(731) KIMBO S.P.A.  
Galleria Vanvitelli, 2, I-80100 NAPOLI, Italy

(540)

## KIMBO

(511)

11 – Electric coffee makers, electric coffee percolators, electric coffee pots, their parts and accessories.

30 – Coffee, tea, cocoa, sugar, rice, tapioca, sago, artificial coffee; flour and preparations made from cereals, bread, pastry and confectionery, ices; honey, treacle; yeast, baking-powder; salt, mustard; vinegar, sauces (condiments); spices; ice.

43 – Services for providing food and drink; temporary accommodation.

(260) AM 2015 77628 A  
(800) 983376  
(891) 2014 05 13  
(731) FUYAO GLASS INDUSTRY GROUP CO., LTD.  
Fuyao Industry Village, 350300 Fuqing City, Fujian Province, China

(540)

## FUYAO

(591) Black, white

(511)

12 – Windshields; windows for vehicles.

19 – Building glass; insulating glass; safety glass; window glass except glass for vehicle windows; coated glass; window glass, for building; glass granules for road marking.

21 – Opaline glass; semi-finished glass for vehicle windows; plate glass; crystal; unworked or semi-worked glass; shatterproof glass; toughened glass; enamelled glass; mosaics of glass, not for building.

(260) AM 2015 77942 A  
(800) 1186292  
(891) 2013 06 02  
(731) AGILENT TECHNOLOGIES, INC.  
5301 Stevens Creek Blvd., Santa Clara, CA  
95051, USA

(540)

## AGILENT

(591) Black, white

(511)

1 – Reagents for scientific or medical research use; chemicals for scientific purposes used in spectroscopy, mass spectrometry, chromatography and electrophoresis and for sample preparation for spectroscopy, mass spectrometry, chromatography and electrophoresis; chemicals used in industry and science, namely, for use in spectroscopy, mass spectrometry, chromatography, or electrophoresis or in sample preparation for spectroscopy, mass spectrometry, chromatography, or electrophoresis including standards all for scientific, clinical and scientific research use; reagents for scientific and research use; aqueous and organic solvents in the nature of chemical preparations for scientific and research use; cleaning detergents for industrial use, namely, for scientific and research use; chemicals for scientific purposes, namely, calibrants for performance verification of scientific instrumentation; ampholytes, namely, chemical products in the nature of preparations for scientific use for use in the separation and purification of any charge carrying molecule such as proteins and other molecules of biological origin as well as synthetic chemicals, these products being carrier ampholytes designed for use in isoelectric focusing, isotachopheresis and iso exchange chromatograph; chemicals, namely, buffer and standard solutions used in analytical chemistry; catalysts for chemical and biochemical processes; reagents, namely, matrices for scientific or medical research use; electrophoresis gels other than for medical or veterinary purposes; chromatography chemicals, namely, silica gel, polymers and solvents all for use in chromatography; purifying filtering and absorbing chemicals for use in industry, including for scientific and research use; solid phase extraction chemicals for use in the chromatography industry; chemical and biological standards, namely, chemical reagents for scientific and research use used in DNA, RNA and protein analysis; reagents for research purposes for scientific or medical research use; DNA labeling reagents for research purposes; DNA hybridization buffers, namely, reagents for research purposes for use in DNA hybridization; DNA cloning vectors, namely, reagents for scientific and research use; ge-



nomic cloning vectors, namely, reagents for scientific and research use; eukaryotic expression vectors, namely, reagents for scientific and research use; prokaryotic expression vectors, namely, reagents for scientific and research use; yeast shuttle vectors, namely, reagents for scientific and research use; competent cells, namely, reagents for scientific and research use; host cells, namely, reagents for scientific and research use; scientific and research laboratory reagents for molecular biological use, namely, packaging extracts used for inserting DNA into phages; polymerase chain reaction or PCR related products, namely, reagents for scientific and research use; nucleic acid markers, namely, reagents for scientific and research use; reagents used as protein standards for scientific, medical and research use; reagents used as synthetic peptide and protein digest standards for scientific and research use; reagents, namely, DNA primers and DNA vectors for scientific and research use; modifying enzymes not for medical use, namely, polymerase, nucleases, reverse transcriptases, ligases, kinases, phosphatases, glycosylases and transferases for scientific and research use; restriction enzymes for scientific and research use; media supplements, namely, reagents for scientific and research use; lymphokines, namely, reagents for scientific and research use; cytokines, namely, reagents for scientific and research use; enzymes, reagents, and vectors for molecular biological research namely, DNA scientific research; enzymes, reagents, and vectors for molecular biological research namely, genomic cloning scientific research; enzymes, reagents, and vectors for molecular biological research namely, transfection scientific research; enzymes, reagents, and vectors for molecular biological research namely, purification scientific research; enzymes, reagents, and vectors for molecular biological research namely, polymerase chain reaction (PCR) related scientific research; enzymes, reagents, and vectors for molecular biological research namely, library construction scientific research; enzymes, reagents, and vectors for molecular biological research namely, labeling kits for scientific research; enzymes, reagents, and vectors for molecular biological research namely, sequencing scientific research; enzymes, reagents, and vectors for molecular biological research namely, mutagenesis scientific research; enzymes, reagents, and vectors for molecular biological research namely, protein analysis scientific research; enzymes, reagents, and vectors for molecular biological research namely, transcription scientific research; enzymes, reagents, and vectors for molecular biological research namely, translation scientific research; enzymes, reagents, and vectors for molecular biological research namely, in situ hybridization scientific research.

(260) AM 2015 77943 A  
 (800) 1189326  
 (891) 2014 06 04  
 (731) ACINO PHARMA AG  
 Birsweg 2, CH-4253 Liesberg, Switzerland  
 (540)

## Clopacin

(511)  
 5 – Pharmaceutical products for inhibiting platelet aggregation; veterinary products.

(260) AM 2015 77953 A  
 (800) 1207919  
 (891) 2014 02 28  
 (731) JAPAN TOBACCO INC.  
 2-2-1 Toranomom, Minato-ku, Tokyo, Japan  
 (540)

## LEAD BY YOUR CHOICE

(511)  
 34 – Tobacco, raw or manufactured; smoking tobacco, pipe tobacco, rolling tobacco, chewing tobacco, moist tobacco powder called "snus"; cigarettes, cigars, cigarillos; substances for smoking sold separately or mixed with tobacco for non-medical and non-therapeutic purposes; snuff; smokers' articles included in this class, cigarette paper, cigarette tubes and matches.

(260) AM 2015 77957 A  
 (800) 1208012  
 (891) 2014 01 30  
 (731) APPLE INC.  
 1 Infinite Loop, Cupertino CA 95014, USA  
 (540)

## TOUCH ID

(591) Black, white  
 (511)  
 9 – Computers; computer peripheral devices; computer hardware; handheld computers; tablet computers; handheld digital electronic devices and software related thereto; handheld mobile digital electronic devices capable of providing access to the Internet and for the sending, receiving, and storing of telephone calls, electronic mail, and other digital data; car audio apparatus; audio components and accessories; telecommunications apparatus and instruments; global positioning system (GPS) devices; telephones; wireless communication devices for voice, data or image transmission; cables; apparatus for data storage; global positioning system (GPS) computer software; computer software for use in recording, organizing, transmitting, manipulating, and reviewing text, data, audio files, video files and electronic games in connection with computers, televisions, television set-top boxes, audio players, video players, media players, telephones, and handheld digital electronic devices; computer software for use

on handheld mobile digital electronic devices and other consumer electronics; cables, chargers, docks, docking stations, interfaces, and adapters for use with all of the aforesaid goods; computer equipment for use with all of the aforesaid goods; accessories, parts, fittings, and testing apparatus for all of the aforesaid goods; and covers, bags and cases adapted or shaped to contain all of the aforesaid goods.

(260) AM 2015 77959 A  
 (800) 1208122  
 (891) 2014 06 04  
 (731) ACINO PHARMA AG  
 Birsweg 2, CH-4253 Liesberg, Switzerland  
 (540)

## Amlocim

(511)  
 5 – Pharmaceutical and veterinary products.

(260) AM 2015 77961 A  
 (800) 1208161  
 (891) 2014 01 14  
 (731) TELA BIO, Inc.  
 1 Great Valley Parkway, Suite 24, Malvern  
 PA 19355, USA  
 (540)

## TELAMAX

(591) Black, white  
 (511)  
 10 – Natural and biocompatible materials comprised of non-living tissue for implantation or application in a surgical site to restore, repair, or treat organ, tissue, and body structures.

(260) AM 2015 77962 A  
 (800) 1208162  
 (891) 2014 01 14  
 (731) TELA BIO, Inc.  
 1 Great Valley Parkway, Suite 24, Malvern  
 PA 19355, USA  
 (540)

## TELAFIX

(591) Black, white  
 (511)  
 10 – Natural and biocompatible materials comprised of non-living tissue for implantation or application in a surgical site to restore, repair, or treat organ, tissue, and body structures.

(260) AM 2015 80056 A  
 (800) 639702  
 (891) 2014 09 24  
 (731) MOTUL

119 boulevard Félix Faure F-93300  
 AUBERVILLIERS, France

(540)



(591) White and red.

(511)  
 1 – Chemicals used in industry, science, photography as well as in agriculture, horticulture and silviculture; unprocessed artificial resins, unprocessed plastics; soil fertilizers; fire extinguishing compositions; tempering and soldering preparations; chemical substances for preserving foodstuffs; tanning substances; adhesives used in industry.

4 – Industrial oils and greases; lubricants; dust absorbing, wetting and binding compositions; fuels (including petrol) and illuminants; candles, wicks.

**INTERNATIONAL TRADEMARKS PROTECTED IN GEORGIA**

(260) AM 2014 73649 A  
(800) 1170844  
(151) 2013 04 09  
(181) 2023 04 09  
(511) 25, 35

---

(260) AM 2014 73835 A  
(800) 1172696  
(151) 2013 06 11  
(181) 2023 06 11  
(511) 05

---

(260) AM 2014 73828 A  
(800) 1172688  
(151) 2013 06 11  
(181) 2023 06 11  
(511) 05

---

(260) AM 2014 73836 A  
(800) 1172697  
(151) 2013 06 11  
(181) 2023 06 11  
(511) 05

---

(260) AM 2014 73829 A  
(800) 1172689  
(151) 2013 06 11  
(181) 2023 06 11  
(511) 05

---

(260) AM 2014 73837 A  
(800) 1172698  
(151) 2013 06 11  
(181) 2023 06 11  
(511) 05

---

(260) AM 2014 73830 A  
(800) 1172690  
(151) 2013 07 09  
(181) 2023 07 09  
(511) 05

---

(260) AM 2014 73838 A  
(800) 1172699  
(151) 2013 06 11  
(181) 2023 06 11  
(511) 05

---

(260) AM 2014 73831 A  
(800) 1172691  
(151) 2013 06 11  
(181) 2023 06 11  
(511) 05

---

(260) AM 2014 73839 A  
(800) 1172700  
(151) 2013 06 11  
(181) 2023 06 11  
(511) 05

---

(260) AM 2014 73832 A  
(800) 1172693  
(151) 2013 06 11  
(181) 2023 06 11  
(511) 05

---

(260) AM 2014 73840 A  
(800) 1172701  
(151) 2013 06 11  
(181) 2023 06 11  
(511) 05

---

(260) AM 2014 73833 A  
(800) 1172694  
(151) 2013 06 11  
(181) 2023 06 11  
(511) 05

---

(260) AM 2014 73841 A  
(800) 1172702  
(151) 2013 06 11  
(181) 2023 06 11  
(511) 05

---

(260) AM 2014 73834 A  
(800) 1172695  
(151) 2013 06 11  
(181) 2023 06 11  
(511) 05

---

(260) AM 2014 73842 A  
(800) 1172703  
(151) 2013 07 24  
(181) 2023 07 24  
(511) 29, 30, 31, 32, 33

---

(260) AM 2014 74080 A  
(800) 1174566  
(151) 2013 02 26  
(181) 2023 02 26  
(511) 18, 25, 35

---

(260) AM 2014 74082 A  
(800) 1174568  
(151) 2013 08 07  
(181) 2023 08 07  
(511) 36

---

(260) AM 2014 74125 A  
(800) 869150  
(151) 2004 07 19  
(891) 2013 08 07  
(181) 2014 07 19  
(511) 05

---

(260) AM 2014 74126 A  
(800) 903340  
(151) 2006 08 07  
(891) 2013 08 13  
(181) 2016 08 07  
(511) 09

---

(260) AM 2014 74140 A  
(800) 1175069  
(151) 2013 06 21  
(181) 2023 06 21  
(511) 30

---

(260) AM 2014 74141 A  
(800) 1175097  
(151) 2012 11 16  
(181) 2022 11 16  
(511) 09, 38, 42

---

(260) AM 2014 74144 A  
(800) 1175181  
(151) 2013 06 24  
(181) 2023 06 24  
(511) 18, 25, 35

---

(260) AM 2014 74310 A  
(800) 1176753  
(151) 2013 07 24  
(181) 2023 07 24  
(511) 39, 42

---

(260) AM 2014 74311 A  
(800) 1176761  
(151) 2013 07 30  
(181) 2023 07 30  
(511) 01, 09, 16

---

(260) AM 2014 74312 A  
(800) 1176773  
(151) 2013 07 26  
(181) 2023 07 26  
(511) 07

---

(260) AM 2014 74313 A  
(800) 1176806  
(151) 2013 09 02  
(181) 2023 09 02  
(511) 05

---

(260) AM 2014 74314 A  
(800) 1176807  
(151) 2013 07 09  
(181) 2023 07 09  
(511) 05

---

(260) AM 2014 74315 A  
(800) 1176808  
(151) 2013 09 02  
  
(181) 2023 09 02  
(511) 05

---

(260) AM 2014 74316 A  
(800) 1176809  
(151) 2013 09 02  
(181) 2023 09 02  
(511) 05

---

(260) AM 2014 74320 A  
(800) 1176810  
(151) 2013 09 02  
(891)  
(181) 2023 09 02  
(511) 05

---

(260) AM 2014 74321 A  
(800) 1176811  
(151) 2013 09 02  
(181) 2023 09 02  
(511) 05

---

(260) AM 2014 74322 A  
(800) 1176825  
(151) 2013 07 11  
(181) 2023 07 11  
(511) 03, 05, 07

---

(260) AM 2014 74323 A  
(800) 923263  
(151) 2007 04 09  
(891) 2013 09 02  
(181) 2017 04 09  
(511) 30

---

(260) AM 2014 74335 A  
(800) 1049563  
(151) 2010 03 24  
(891) 2013 08 20  
(181) 2020 03 24  
(511) 09, 16, 18, 20

---

(260) AM 2014 74336 A  
(800) 1115209  
(151) 2012 03 27  
(891) 2013 07 04  
(181) 2022 03 27  
(511) 03, 14, 18, 25

---

(260) AM 2014 74337 A  
(800) 1121732  
(151) 2012 03 27  
(891) 2013 07 04  
(181) 2022 03 27  
(511) 03, 14, 18, 25

---

(260) AM 2014 74339 A  
(800) 1160311  
(151) 2012 10 23  
(891) 2013 08 28  
(181) 2022 10 23  
(511) 16, 35, 41, 42

---

(260) AM 2014 74348 A  
(800) 1147125  
(151) 2012 09 19  
(891) 2013 06 06  
  
(181) 2022 09 19  
(511) 05

---

(260) AM 2014 74369 A  
(800) 1177100  
(151) 2013 07 09

(181) 2023 07 09  
(511) 33

---

(260) AM 2014 74512 A  
(800) 1178644  
(151) 2013 09 09  
(181) 2023 09 09  
(511) 25

---

(260) AM 2014 74513 A  
(800) 1178650  
(151) 2013 09 02  
(181) 2023 09 02  
(511) 09, 37

---

(260) AM 2014 74514 A  
(800) 1178667  
(151) 2013 08 06  
(181) 2023 08 06  
(511) 18, 25

---

(260) AM 2014 74515 A  
(800) 1114003  
(151) 2011 11 16  
(891) 2013 09 06  
(181) 2021 11 16  
(511) 05, 29, 32, 35

---

(260) AM 2014 74516 A  
(800) 1154464  
(151) 2012 09 18  
(891) 2013 07 29  
(181) 2022 09 18  
(511) 25, 35

---

(260) AM 2014 74517 A  
(800) 631961  
(151) 1995 01 14  
(891) 2013 09 04  
(181) 2015 01 14  
(511) 05

---

(260) AM 2014 74518 A  
(800) 865887  
(151) 2004 12 20  
(891) 2013 09 09  
(181) 2014 12 20  
(511) 05

---

(260) AM 2014 74519 A  
(800) 919005

(151) 2007 02 15  
(891) 2013 08 02  
(181) 2017 02 15  
(511) 03, 25, 35

---

(260) AM 2014 74521 A  
(800) 1010374  
(151) 2009 03 24  
(891) 2013 06 11  
(181) 2019 03 24  
(511) 25, 35

---

(260) AM 2014 74522 A  
(800) 1094916  
(151) 2011 06 29  
(891) 2013 08 27  
(181) 2021 06 29  
(511) 12, 20

---

(260) AM 2014 74525 A  
(800) 1126520  
(151) 2012 07 06  
(891) 2013 08 01  
(181) 2022 07 06  
(511) 05

---

(260) AM 2014 74527 A  
(800) 1159657  
(151) 2013 04 12  
(891) 2013 09 06  
(181) 2023 04 12  
(511) 05

---

(260) AM 2014 74689 A  
(800) 1180350  
(151) 2013 07 10  
(181) 2023 07 10  
(511) 03

---

(260) AM 2014 74690 A  
(800) 1180363  
(151) 2013 09 06  
(181) 2023 09 06  
(511) 09, 10

---

(260) AM 2014 74691 A  
(800) 1180385  
(151) 2013 09 03  
(181) 2023 09 03  
(511) 05

---

(260) AM 2014 74695 A  
(800) 1180398  
(151) 2013 09 20  
(181) 2023 09 20  
(511) 09

---

(260) AM 2014 74697 A  
(800) 1180409  
(151) 2013 08 28  
(181) 2023 08 28  
(511) 03, 06, 08, 09, 10, 14, 15, 16, 18, 20, 21, 24,  
25, 26, 27, 28, 35

---

(260) AM 2014 74698 A  
(800) 508682  
(151) 1986 12 08  
(891) 2013 08 28  
(181) 2016 12 08  
(511) 34

---

(260) AM 2014 74699 A  
(800) 603354  
(151) 1993 07 07  
(891) 2013 08 22  
(181) 2023 07 07  
(511) 03, 05

---

(260) AM 2014 74700 A  
(800) 804406  
(151) 2003 05 19  
(891) 2013 06 06  
(181) 2023 05 19  
(511) 08, 21

---

(260) AM 2014 74702 A  
(800) 1018565  
(151) 2009 09 14  
(891) 2013 09 24  
(181) 2019 09 14  
(511) 29

---

(260) AM 2014 74703 A  
(800) 1083230  
(151) 2011 03 30  
(891) 2013 09 16

---

(181) 2021 03 30  
(511) 29, 30

---

(260) AM 2014 74704 A  
(800) 1098038  
(151) 2011 10 05

---

(891) 2013 06 25  
(181) 2021 10 05  
(511) 03, 04, 18, 20, 21, 24, 25, 28

---

(260) AM 2014 74705 A  
(800) 1158359  
(151) 2013 01 24  
(891) 2013 05 17  
(181) 2023 01 24  
(511) 30

---

(260) AM 2014 74737 A  
(800) 1180683  
(151) 2013 05 20  
(181) 2023 05 20  
(511) 05

---

(260) AM 2014 74747 A  
(800) 1180715  
(151) 2013 07 26  
(181) 2023 07 26  
(511) 05

---

(260) AM 2014 74921 A  
(800) 1182040  
(151) 2013 06 12  
(181) 2023 06 12  
(511) 05

---

(260) AM 2014 74922 A  
(800) 1182053  
(151) 2013 09 04  
(181) 2023 09 04  
(511) 07

---

(260) AM 2014 74923 A  
(800) 1182065  
(151) 2013 07 23  
(181) 2023 07 23  
(511) 09, 28, 38, 42

---

(260) AM 2014 74924 A  
(800) 1182085  
(151) 2013 08 23  
(181) 2023 08 23  
(511) 32

---

(260) AM 2014 74925 A  
(800) 1182095  
(151) 2013 09 30  
(181) 2023 09 30  
(511) 16, 25, 41

---

(260) AM 2014 74926 A  
(800) 1182107  
(151) 2013 04 05  
(181) 2023 04 05  
(511) 03, 05, 10

---

(260) AM 2014 74928 A  
(800) 1182145  
(151) 2013 08 19  
(181) 2023 08 19  
(511) 25, 35

---

(260) AM 2014 74929 A  
(800) 1182164  
(151) 2013 09 26  
(181) 2023 09 26  
(511) 30

---

(260) AM 2014 74932 A  
(800) 1182224  
(151) 2013 09 09  
(181) 2023 09 09  
(511) 13

---

(260) AM 2014 74934 A  
(800) 1182232  
(151) 2013 07 12  
(181) 2023 07 12  
(511) 17, 19

---

(260) AM 2014 74935 A  
(800) 1182247  
(151) 2013 09 09  
(181) 2023 09 09  
(511) 13

---

(260) AM 2014 74936 A  
(800) 1182270  
(151) 2013 06 14  
(181) 2023 06 14  
(511) 16, 29, 30, 32, 33, 35, 43

---

(260) AM 2014 74941 A  
(800) 1182326  
(151) 2013 08 06  
(181) 2023 08 06  
(511) 02, 17, 19

---

(260) AM 2014 74952 A  
(800) 1182534  
(151) 2013 06 21

---

---

(181) 2023 06 21  
(511) 16, 36, 41, 42

---

(260) AM 2014 74953 A  
(800) 1182574  
(151) 2013 08 26  
(181) 2023 08 26  
(511) 25

---

(260) AM 2014 74954 A  
(800) 1182581  
(151) 2013 08 23  
(181) 2023 08 23  
(511) 05

---

(260) AM 2014 74955 A  
(800) 1182582  
(151) 2013 08 23  
(181) 2023 08 23  
(511) 05

---

(260) AM 2014 74956 A  
(800) 1182583  
(151) 2013 08 23  
(181) 2023 08 23  
(511) 05

---

(260) AM 2014 74957 A  
(800) 1182584  
(151) 2013 08 23  
(181) 2023 08 23  
(511) 05

---

(260) AM 2014 74958 A  
(800) 1182585  
(151) 2013 08 23  
(181) 2023 08 23  
(511) 05

---

(260) AM 2014 74961 A  
(800) 1182586  
(151) 2013 08 23  
(181) 2023 08 23  
(511) 05

---

(260) AM 2014 74962 A  
(800) 1182587  
(151) 2013 08 23  
(181) 2023 08 23  
(511) 05

---

(260) AM 2014 74963 A  
(800) 1182588  
(151) 2013 08 23  
(181) 2023 08 23  
(511) 05

---

(260) AM 2014 74964 A  
(800) 1182590  
(151) 2013 06 12  
(181) 2023 06 12  
(511) 05

---

(260) AM 2014 74965 A  
(800) 1182591  
(151) 2013 06 12  
(181) 2023 06 12  
(511) 05

---

(260) AM 2014 74966 A  
(800) 1182618  
(151) 2013 02 14  
(181) 2023 02 14

---

(511) 01, 02, 03, 04, 05, 06, 07, 08, 09, 10, 11, 12,  
13, 14, 15, 16, 17, 18, 19, 20, 21, 22, 23, 24,  
25, 26, 27, 28, 29, 30, 31, 32, 33, 34, 35, 36,  
37, 38, 39, 40, 41, 42, 43, 44, 45

---

(260) AM 2014 74967 A  
(800) 1182648  
(151) 2013 06 12  
(181) 2023 06 12  
(511) 05

---

(260) AM 2014 74968 A  
(800) 1182652  
(151) 2013 06 18  
(181) 2023 06 18  
(511) 03

---

(260) AM 2014 74969 A  
(800) 1182673  
(151) 2013 09 12  
(181) 2023 09 12  
(511) 03

---

(260) AM 2014 74970 A  
(800) 1182679  
(151) 2013 09 04  
(181) 2023 09 04  
(511) 12

---



(260) AM 2014 74971 A  
(800) 1182691  
(151) 2013 09 12  
(181) 2023 09 12  
(511) 03, 05, 44

---

(260) AM 2014 74972 A  
(800) 1182716  
(151) 2013 09 25  
(181) 2023 09 25  
(511) 10

---

(260) AM 2014 74973 A  
(800) 358449  
(151) 1969 07 18  
(891) 2013 07 18  
(181) 2019 07 18  
(511) 05, 30

---

(260) AM 2014 74974 A  
(800) 392557  
(151) 1972 10 24  
(891) 2013 10 22  
(181) 2022 10 24  
(511) 34

---

(260) AM 2014 74976 A  
(800) 990235  
(151) 2008 12 11  
(891) 2013 10 09  
(181) 2018 12 11  
(511) 32

---

(260) AM 2014 74977 A  
(800) 1172150  
(151) 2012 10 17  
(891) 2013 09 13  
(181) 2022 10 17  
(511) 09

---

(260) AM 2014 74978 A  
(800) 946501  
(151) 2007 10 02  
(891) 2013 10 17  
(181) 2017 10 02  
(511) 09

---

(260) AM 2014 74984 A  
(800) 1182777  
(151) 2013 07 25  
(181) 2023 07 25  
(511) 09, 42

---

(260) AM 2014 74985 A  
(800) 1182791  
(151) 2013 01 24  
(181) 2023 01 24  
(511) 07, 09, 11, 37, 42

---

(260) AM 2014 74986 A  
(800) 1182811  
(151) 2013 06 12  
(181) 2023 06 12  
(511) 05

---

(260) AM 2014 74987 A  
(800) 1182813  
(151) 2013 05 14  
(181) 2023 05 14  
(511) 05

---

(260) AM 2014 74991 A  
(800) 1182835  
(151) 2013 09 09  
(181) 2023 09 09  
(511) 13

---

(260) AM 2014 74992 A  
(800) 1182889  
(151) 2013 08 29  
(181) 2023 08 29  
(511) 33

---

(260) AM 2014 74993 A  
(800) 1182892  
(151) 2013 09 25  
(181) 2023 09 25  
(511) 10

---

(260) AM 2014 75106 A  
(800) 1183570  
(151) 2013 09 27  
(181) 2023 09 27  
(511) 29

---

(260) AM 2014 75107 A  
(800) 1183597  
(151) 2013 10 08  
(181) 2023 10 08  
(511) 12, 37

---

(260) AM 2014 75108 A  
(800) 1183604  
(151) 2013 10 28

---

---

(181) 2023 10 28  
(511) 43

---

(260) AM 2014 75122 A  
(800) 1183648  
(151) 2013 08 20  
(181) 2023 08 20  
(511) 25

---

(260) AM 2014 75123 A  
(800) 1183654  
(151) 2013 09 16  
(181) 2023 09 16  
(511) 39, 43

---

(260) AM 2014 75124 A  
(800) 1183656  
(151) 2013 09 03  
(181) 2023 09 03  
(511) 30, 35, 39

---

(260) AM 2014 75126 A  
(800) 1183785  
(151) 2013 10 31  
(181) 2023 10 31  
(511) 09, 38

---

(260) AM 2014 75127 A  
(800) 1183725  
(151) 2013 10 21  
(181) 2023 10 21  
(511) 05

---

(260) AM 2014 75130 A  
(800) 1183804  
(151) 2013 08 15  
(181) 2023 08 15  
(511) 09, 16, 35, 41, 42

---

(260) AM 2014 75132 A  
(800) 1183947  
(151) 2013 10 22  
(181) 2023 10 22  
(511) 35, 41, 45

---

(260) AM 2014 75133 A  
(800) 1183950  
(151) 2012 12 07  
(181) 2022 12 07  
(511) 01, 03, 05, 42, 44

---

(260) AM 2014 75135 A  
(800) 1183973  
(151) 2013 09 19  
(181) 2023 09 19  
(511) 09, 42

---

(260) AM 2014 75136 A  
(800) 1184004  
(151) 2013 05 06  
(181) 2023 05 06  
(511) 35

---

# CLASSIFICATION INDEXES

## INVENTIONS

### CONCORDANCE TABLE OF INTERNATIONAL CLASSIFICATION INDEX AND PUBLICATION NUMBERS

INTERNATIONAL CLASSIFICATION INDEXES (51)	NUMBER OF PUBLISHED APPLICATION (10)
A 61 K 9/20; A 61 K 31/4188	AP 2015 13270 A
A 61 K 31/4411; A 61 K 31/41; A 61 K 9/16; A 61 P 9/00	AP 2015 13130 A
A 61 K 35/60, 36/00; A 61 P 1/10	AP 2015 13243 A
C 04 B 14/38; C 04 B 16/06; C 04 B 32/02; E 04 C 5/07	AP 2015 13092 A
C 07 D 215/48; C 07 D 401/12; C 07 D 407/12; C 07 D 409/12; C 07 D 413/12; C 07 D 417/12; A 61 K 31/4709; A 61 P 31/10	AP 2015 12810 A
C 07 D 405/12; C 07 D 223/16; A 61 P 9/10; A 61 P 9/08; A 61 P 9/06; A 61 K 31/55	AP 2015 13282 A
C 12 N 5/06	AP 2015 12040 A
E 01 F 8/00; E 04 B 1/24	AP 2015 13023 A
G 05 F 3/16; H 05 B 33/08	AP 2015 13373 A

### CONCORDANCE TABLE OF PUBLICATION NUMBERS AND INTERNATIONAL CLASSIFICATION INDEX

NUMBER OF PUBLISHED APPLICATION (10)	INTERNATIONAL CLASSIFICATION INDEXES (51)
AP 2015 12040 A	C 12 N 5/06
AP 2015 12810 A	C 07 D 215/48; C 07 D 401/12; C 07 D 407/12; C 07 D 409/12; C 07 D 413/12; C 07 D 417/12; A 61 K 31/4709; A 61 P 31/10
AP 2015 13023 A	E 01 F 8/00; E 04 B 1/24
AP 2015 13092 A	C 04 B 14/38; C 04 B 16/06; C 04 B 32/02; E 04 C 5/07
AP 2015 13130 A	A 61 K 31/4411; A 61 K 31/41; A 61 K 9/16; A 61 P 9/00
AP 2015 13243 A	A 61 K 35/60, 36/00; A 61 P 1/10
AP 2015 13270 A	A 61 K 9/20; A 61 K 31/4188
AP 2015 13282 A	C 07 D 405/12; C 07 D 223/16; A 61 P 9/10; A 61 P 9/08; A 61 P 9/06; A 61 K 31/55
AP 2015 13373 A	G 05 F 3/16; H 05 B 33/08

### CONCORDANCE TABLE OF INTERNATIONAL CLASSIFICATION INDEX, PATENT NUMBERS AND PUBLICATION NUMBERS

INTERNATIONAL CLASSIFICATION INDEX (51)	NUMBER OF PATENT (11)	NUMBER OF PUBLISHED APPLICATION (10)
A 23 L 1/30; C 12 G 3/00; C 12 G 3/04; C 12 G 3/06; A 61 K 36/28	P 2015 6256 B	AP 2014 12937 A
A 61 K 36/899; A 61 K 8/97; A 61 P 37/08	P 2015 6254 B	AP 2014 12262 A
A 61 K 39/395, 39/00	P 2015 6253 B	AP 2014 10981 A
B 03 B 7/00	P 2015 6255 B	AP 2014 12852 A
C 10 G 45/00; C 10 G 65/00; C 07 C 5/00	P 2015 6257 B	AP 2014 13170 A
E 01 F 8/00	P 2015 6259 B	AP 2014 13214 A
F 26 B 15/04	P 2015 6258 B	AP 2014 13314 A

**CONCORDANCE TABLE OF PATENT NUMBERS,  
PUBLICATION NUMBERS AND INTERNATIONAL CLASSIFICATION INDEX**

NUMBER OF PATENT (11)	NUMBER OF PUBLISHED APPLICATION (10)	INTERNATIONAL CLASSIFICATION INDEX (51)
P 2015 6253 B	AP 2014 10981 A	A 61 K 39/395, 39/00
P 2015 6254 B	AP 2014 12262 A	A 61 K 36/899; A 61 K 8/97; A 61 P 37/08
P 2015 6255 B	AP 2014 12852 A	B 03 B 7/00
P 2015 6256 B	AP 2014 12937 A	A 23 L 1/30; C 12 G 3/00; C 12 G 3/04; C 12 G 3/06; A 61 K 36/28
P 2015 6257 B	AP 2014 13170 A	C 10 G 45/00; C 10 G 65/00; C 07 C 5/00
P 2015 6258 B	AP 2014 13314 A	F 26 B 15/04
P 2015 6259 B	AP 2014 13214 A	E 01 F 8/00

**CONCORDANCE TABLE OF APPLICATION NUMBERS, PUBLICATION NUMBERS  
AND PATENTS**

NUMBER OF APPLICATION (21)	NUMBER OF PUBLISHED APPLICATION (10)	NUMBER OF PATENT (11)
AP 2007 010981	AP 2014 10981 A	P 2015 6253 B
AP 2009 012262	AP 2014 12262 A	P 2015 6254 B
AP 2012 012852	AP 2014 12852 A	P 2015 6255 B
AP 2011 012937	AP 2014 12937 A	P 2015 6256 B
AP 2012 013170	AP 2014 13170 A	P 2015 6257 B
AP 2012 013214	AP 2014 13214 A	P 2015 6259 B
AP 2013 013314	AP 2014 13314 A	P 2015 6258 B

## UTILITY MODELS

**CONCORDANCE TABLE OF INTERNATIONAL CLASSIFICATION INDEX,  
PATENT NUMBERS AND PUBLICATION NUMBERS**

INTERNATIONAL CLASSIFICATION INDEX (51)	NUMBER OF PATENT (11)	NUMBER OF PUBLISHED APPLICATION (10)
A 47 B 9/00	U 2015 1852 Y	AU 2014 13473 U

**CONCORDANCE TABLE OF PATENT NUMBERS,  
PUBLICATION NUMBERS AND INTERNATIONAL CLASSIFICATION INDEX**

NUMBER OF PATENT (11)	NUMBER OF PUBLISHED APPLICATION (10)	INTERNATIONAL CLASSIFICATION INDEX (51)
U 2015 1852 Y	AU 2014 13473 U	A 47 B 9/00

**CONCORDANCE TABLE OF APPLICATION NUMBERS, PUBLICATION NUMBERS  
AND PATENTS**

NUMBER OF APPLICATION (21)	NUMBER OF PUBLISHED APPLICATION (10)	NUMBER OF PATENT (11)
AU 2014 013473	AU 2014 13473 U	U 2014 1852 Y

**DESIGNS**

**PATENT NUMBERS AND PUBLICATION NUMBERS**

INTERNATIONAL CLASSIFICATION INDEX (51)	NUMBER OF PATENT (11)	NUMBER OF PUBLISHED APPLICATION (10)
17-01	D 2015 618 S	AD 2014 811 S
19-08	D 2015 619 S	AD 2014 812 S

**CONCORDANCE TABLE OF PATENT NUMBERS,  
PUBLICATION NUMBERS AND INTERNATIONAL CLASSIFICATION INDEX**

NUMBER OF PATENT (11)	NUMBER OF PUBLISHED APPLICATION (10)	INTERNATIONAL CLASSIFICATION INDEX (51)
D 2015 618 S	AD 2014 811 S	17-01
D 2015 619 S	AD 2014 812 S	19-08

**CONCORDANCE TABLE OF APPLICATION NUMBERS, PUBLICATION NUMBERS  
AND PATENTS**

NUMBER OF APPLICATION (21)	NUMBER OF PUBLISHED APPLICATION (10)	NUMBER OF PATENT (11)
AD 2014 000811	AD 2014 811 S	D 2015 618 S
AD 2014 000812	AD 2014 812 S	D 2015 619 S

**DESIGN REGISTERED ACCORDING TO THE  
ACCELERATED PROCEDURE**

**CONCORDANCE TABLE OF INTERNATIONAL CLASSIFICATION INDEX  
AND PATENTS NUMBERS**

INTERNATIONAL CLASSIFICATION INDEX (51)	NUMBER OF PATENT (11)
09-01	D 2015 620 S

---

CONCORDANCE TABLE OF PATENT NUMBERS AND INTERNATIONAL  
CLASSIFICATION INDEX

NUMBER OF PATENT (11)	INTERNATIONAL CLASSIFICATION INDEX (51)
D 2015 620 S	09-01

CONCORDANCE TABLE OF APPLICATION NUMBERS  
AND PATENT NUMBERS

NUMBER OF APPLICATION (21)	NUMBER OF PATENT (11)
AD 2015 000835	D 2015 620 S

## TRADEMARKS

### CONCORDANCE TABLE OF REGISTRATION NUMBERS, APPLICATION NUMBERS, PUBLICATION NUMBERS AND BULLETIN NUMBERS

NUMBER OF REGISTRATION (111)	NUMBER OF APPLICATIONS (210)	NUMBER OF PUBLISHED APPLICATIONS (260)	NUMBER OF BULLETIN
M 2015 25701 R	AM 2015 78237	-	
M 2015 25702 R	AM 2015 79622	-	
M 2015 25703 R	AM 2015 80656	-	
M 2015 25704 R	AM 2015 80743	-	
M 2015 25705 R	AM 2015 80905	-	

### CONCORDANCE TABLE OF PUBLICATION NUMBERS AND APPLICATION NUMBERS

NUMBER OF PUBLISHED APPLICATION (260)	NUMBER OF APPLICATION (210)	1	2
1	2		
AM 2015 68212 A	AM 2012 68212	AM 2015 76522 A	AM 2014 76522
AM 2015 69810 A*	AM 2013 69810	AM 2015 76529 A	AM 2014 76529
AM 2015 73488 A	AM 2013 73488	AM 2015 76569 A	AM 2014 76569
AM 2015 74591 A	AM 2013 74591	AM 2015 76601 A	AM 2014 76601
AM 2015 74713 A	AM 2013 74713	AM 2015 76700 A	AM 2014 76 700
AM 2015 75191 A	AM 2013 75191	AM 2015 76720 A	AM 2014 76720
AM 2015 75221 A	AM 2013 75221	AM 2015 76814 A	AM 2014 76814
AM 2015 75234 A	AM 2013 75234	AM 2015 76818 A	AM 2014 76818
AM 2015 75235 A	AM 2013 75235	AM 2015 76822 A	AM 2014 76822
AM 2015 75236 A	AM 2013 75236	AM 2015 76845 A	AM 2014 76845
AM 2015 75237 A	AM 2013 75237	AM 2015 77021 A	AM 2014 77021
AM 2015 75238 A	AM 2013 75238	AM 2015 77244 A	AM 2014 77244
AM 2015 75239 A	AM 2013 75239	AM 2015 77255 A	AM 2014 77255
AM 2015 75240 A	AM 2013 75240	AM 2015 77263 A	AM 2014 77263
AM 2015 75241 A	AM 2013 75241	AM 2015 77420 A	AM 2014 77420
AM 2015 75242 A	AM 2013 75242	AM 2015 77482 A	AM 2014 77482
AM 2015 75736 A	AM 2014 75736	AM 2015 77523 A	AM 2014 77523
AM 2015 75759 A	AM 2014 75759	AM 2015 77524 A	AM 2014 77524
AM 2015 75763 A	AM 2014 75763	AM 2015 77574 A	AM 2014 77574
AM 2015 75764 A	AM 2014 75764	AM 2015 77582 A	AM 2014 77582
AM 2015 75766 A	AM 2014 75766	AM 2015 77620 A	AM 2014 77620
AM 2015 75860 A	AM 2014 75860	AM 2015 77621 A	AM 2014 77621
AM 2015 75891 A	AM 2014 75891	AM 2015 77623 A	AM 2014 77623
AM 2015 75932 A	AM 2014 75932	AM 2015 77654 A	AM 2014 77654
AM 2015 75990 A	AM 2014 75990	AM 2015 77720 A	AM 2014 77720
AM 2015 76177 A	AM 2014 76177	AM 2015 77782 A	AM 2014 77782
AM 2015 76191 A	AM 2014 76191	AM 2015 77782 A	AM 2014 77782
AM 2015 76216 A	AM 2014 76216	AM 2015 77814 A	AM 2014 77814
		AM 2015 77815 A	AM 2014 77815
		AM 2015 77849 A	AM 2014 77849
		AM 2015 77872 A	AM 2014 77872
		AM 2015 77873 A	AM 2014 77873
		AM 2015 77874 A	AM 2014 77874
		AM 2015 77890 A	AM 2014 77890

1	2
AM 2015 77891 A	AM 2014 77891
AM 2015 77892 A	AM 2014 77892
AM 2015 77907 A	AM 2014 77907
AM 2015 77988 A	AM 2014 77988
AM 2015 77998 A	AM 2014 77998
AM 2015 78005 A	AM 2014 78005
AM 2015 78009 A	AM 2014 78009
AM 2015 78017 A	AM 2014 78017

1	2
AM 2015 78027 A	AM 2014 78027
AM 2015 78052 A	AM 2014 78052
AM 2015 78174 A	AM 2014 78174
AM 2015 78247 A	AM 2014 78247
AM 2015 78248 A	AM 2014 78248
AM 2015 78249 A	AM 2014 78249
AM 2015 78250 A	AM 2014 78250

**CONCORDANCE TABLE OF INDEX OF GOODS AND/OR SERVICES  
AND APPLICATION NUMBERS**

INDEX OF GOODS AND/OR SERVICES (511)	NUMBER OF PUBLISHED APPLICATIONS (260)
1	2
1	AM 2015 776263 A
3	AM 2015 74591 A
3	AM 2015 75221A
3	AM 2015 76177 A
4	AM 2015 77523 A
5	AM 2015 74591 A
5	AM 2015 75763 A
5	AM 2015 75764 A
5	AM 2015 76822 A
5	AM 2015 77263 A
5	AM 2015 77524 A
5	AM 2015 77849 A
5	AM 2015 77873 A
5	AM 2015 77907 A
5	AM 2015 78017 A
6	AM 2015 77782 A
7	AM 2015 78052 A
8	AM 2015 75766 A
9	AM 2015 77988 A
12	AM 2015 69810 A*
12	AM 2015 75759 A
12	AM 2015 78174 A
14	AM 2015 77255 A
16	AM 2015 76191 A
16	AM 2015 77021 A
20	AM 2015 77263 A
21	AM 2015 75191 A
21	AM 2015 75221 A
25	AM 2015 78009 A
28	AM 2015 76818 A
29	AM 2015 73488 A
29	AM 2015 76700 A
29	AM 2015 77021 A
29	AM 2015 77482 A
29	AM 2015 77874 A

1	2
29	AM 2015 77998 A
30	AM 2015 68212 A
30	AM 2015 74713 A
30	AM 2015 75221 A
30	AM 2015 75234 A
30	AM 2015 75235 A
30	AM 2015 75236 A
30	AM 2015 75237 A
30	AM 2015 75238 A
30	AM 2015 75239 A
30	AM 2015 75240 A
30	AM 2015 75241 A
30	AM 2015 75242 A
30	AM 2015 75891 A
30	AM 2015 77021 A
30	AM 2015 77482 A
30	AM 2015 77620A
30	AM 2015 77621A
30	AM 2015 77623A
30	AM 2015 78005 A
30	AM 2015 78247 A
30	AM 2015 78248 A
30	AM 2015 78249 A
30	AM 2015 78250 A
31	AM 2015 77263 A
31	AM 2015 77482 A
31	AM 2015 77890 A
31	AM 2015 77891 A
31	AM 2015 77892 A
32	AM 2015 75191 A
32	AM 2015 76191 A
32	AM 2015 76845 A
32	AM 2015 77482 A
32	AM 2015 77998 A
33	AM 2015 75191 A
33	AM 2015 75860A
33	AM 2015 75990 A
33	AM 2015 76216 A
33	AM 2015 76522 A
33	AM 2015 76529 A



1	2	1	2
33	AM 2015 76720 A	35	AM 2015 78017 A
33	AM 2015 77482 A	36	AM 2015 76601 A
33	AM 2015 77814 A	36	AM 2015 77420 A
33	AM 2015 77815 A	36	AM 2015 77574 A
34	AM 2015 75736 A	36	AM 2015 77654 A
34	AM 2015 76191 A	37	AM 2015 75759 A
34	AM 2015 77482 A	37	AM 2015 77574 A
34	AM 2015 77720 A	37	AM 2015 77872 A
34	AM 2015 78027 A	39	AM 2015 68212 A
35	AM 2015 68212 A	43	AM 2015 75932 A
35	AM 2015 75891 A	43	AM 2015 77482 A
35	AM 2015 76191 A	43	AM 2015 77582 A
35	AM 2015 76569 A	43	AM 2015 78005 A
35	AM 2015 76700 A	43	AM 2015 78247 A
35	AM 2015 76814 A	43	AM 2015 78248 A
35	AM 2015 76845 A	43	AM 2015 78249 A
35	AM 2015 77021 A	43	AM 2015 78250 A
35	AM 2015 77482 A	44	AM 2015 77244A
35	AM 2015 77654A	44	AM 2015 77263 A
35	AM 2015 77782 A	44	AM 2015 77654 A
35	AM 2015 78005 A	44	AM 2015 77998 A
35	AM 2015 78009 A		

**CONCORDANCE TABLE OF INDEX OF GOODS AND/OR SERVICES  
AND NUMBERS OF TRADEMARKS REGISTERED ACCORDING  
TO THE ACCELERATED PROCEDURE**

INDEX OF GOODS AND/OR SERVICES (511)	NUMBERS OF REGISTERED ACCORDING TO THE ACCELERATED PROCEDURE (111)
5	M 2015 25701 R
19	M 2015 25705 R
29	M 2015 25704 R
36	M 2015 25702 R
36	M 2015 25703 R
37	M 2015 25703 R
37	M 2015 25705 R

# OFFICIAL BULLETIN OF THE INDUSTRIAL PROPERTY

## 5(417)

EDITOR-IN-CHIEF: N. Bebrishvili

EDITORS-TRANSLATORS: E. Gabunia  
G. Nadareishvili

PROOFREADER: L. Chanturia

COMPUTER LAYOUT: M. Ordenidze  
K. Svanidze

[www.sakpatenti.org.ge](http://www.sakpatenti.org.ge)

E-mail: [info@sakpatenti.org.ge](mailto:info@sakpatenti.org.ge)