



**NATIONAL INTELLECTUAL PROPERTY CENTER OF GEORGIA  
SAKPATENTI**

**OFFICIAL BULLETIN  
OF THE INDUSTRIAL PROPERTY**

**8(420)**

**2015  
TBILISI**

# INID CODES FOR IDENTIFICATION OF BIBLIOGRAPHIC DATA

## INVENTIONS, UTILITY MODELS

- (10) Number of publication for application, which has been examined
- (11) Number of patent and kind of document
- (21) Serial number of application
- (22) Date of filing of the application
- (23) Date of exhibition or the date of the earlier filing and the number of application, if any
- (24) Date from which patent may have effect
- (31) Number of priority application
- (32) Date of filing of priority application
- (33) Code of the country or regional organization allotting priority application number
- (44) Date of publication of application not granted, but examined and number of bulletin
- (45) Date of publication of registered document
- (51) International Patent Classification Index
- (54) Title of the invention
- (57) Abstract
- (60) Number of examined patent document granted by foreign patent office, date from which patent has effect and country code
- (62) Number of the earlier application and in case of divided application, date of filing an application
- (71) Name, surname and address of applicant (country code)
- (72) Name, surname of inventor (country code)
- (73) Name, surname and address of patent owner (country code)
- (74) Name, surname of representative or patent attorney
- (85) Date of commencement of the national phase of International Application
- (86) Number and date of filing of international application
- (87) Number and date of publication of international application

## DESIGNS

- (10) Number of publication for application
- (11) Number of patent and kind of document or number of registration
- (15) Date of registration/Date of patent renewal
- (18) Expected expiration date of patent or registration
- (21) Serial number of application
- (22) Date of filing of the application
- (23) Date of exhibition or the date of the earlier filing and the number of application, if any
- (24) Date from which patent may have effect
- (28) Number of designs included in the application
- (30) Data relating to priority (number of application, date of filing of application, two-letter code identifying the authority with whom the priority application was made)
- (31) Number of priority application
- (32) Date of filing of priority application
- (33) Code of the country or regional organization allotting priority application number
- (34) Two-letter code according to WIPO St.3 identifying the authority with which the priority application was made
- (44) Date of publication of design and number of bulletin (the first publication)
- (45) Date of publication of design registered by WIPO and number of bulletin
- (51) International Classification for designs (class and subclass of the Locarno Classification)
- (54) Title of the invention
- (55) Reproduction of the design
- (57) Description of characteristic features of the design including indication of colors
- (58) Date of recording of any kind of amendment in the Register
- (62) Number of the earlier application, registration and document number and if available the date of filing an application in case of divided application
- (71) Name, surname and address of applicant (country code)
- (72) Name, surname of creator (country code)
- (73) Name, surname and address of patent owner (country code)
- (74) Name, surname of representative or patent attorney
- (81) Contracting states concerned
  - II designated contracting states according to the 1960 Act
  - III designated contracting states according to the 1999 Act
- (85) Owner's permanent address
- (86) Owner's nationality
- (87) Owner's residence
- (88) State in which the owner has a real and effective industrial or commercial establishment

## TRADEMARKS

- (111) – Number of registration
- (151) – Date of registration
- (156) – Date of the renewal
- (181) – Expected expiration date of registration
- (186) – Renewal expiration date of registration
- (141) – Date of cancel of duration of the mark
- (210) – Serial number of application
- (220) – Date of filing of the application
- (230) – Date concerning exhibition
- (260) – Number of application, for which favorable decision of examination about registration has been taken (publication number)
- (310) – Number of the first application
- (320) – Date of filing of the first application
- (330) – Code, identifying national or regional Office where the first application was made
- (511) – International Classification of Goods and Services for the purposes of registration of trade marks and/or list of goods and/or services classified according thereto
- (531) – Description of figurative elements of Trade Marks according to the International Classification of the Figurative Elements of Marks
- (540) – Reproduction of Trade Mark
- (550) – Nature and kind of Trade Mark
- (580) – Date of recording of any kind changes in respect of applications or registrations
- (591) – Information concerning colors claimed
- (731) – Name and address of the applicant
- (732) – Name and address of the holder of the registration
- (740) – Name and address of the representative
- (750) – Address for correspondence
- (770) – Name and address of the previous applicant or holder in case of change in ownership
- (771) – Previous name and address of the applicant or holder in case of change in ownership
- (791) – Name and address of the licensee
- (793) – Indication of conditions and/or restrictions under the license (Type of license, number of license agreement, data of license, data of validity of license)
- (800) – Certain data relating to the international registration of Trade Marks under the Protocol Relating to Madrid Agreement (International registration number)

## CODES FOR PUBLICATION IN BULLETIN

- (21) AP 0000 000000 – serial number of application for invention
- (10) AP 0000 0000 A – number of published application for invention (first publication)
- (11) P 0000 0000 B – number of patent for invention (second publication)
- (21) API 0000 000000 – number of application for imported patent
- (11) PI 0000 0000 A – number of imported patent (first publication)
- (21) AU 0000 000000 – serial number of application for utility model
- (10) AU 0000 000 U – number of published application for utility model (first publication)
- (11) U 0000 000 Y – number of patent for utility model (second publication)
- (21) AD 0000 000000 – serial number of application for design
- (10) AD 0000 000 S – number of published application for design (first publication)
- (11) D 0000 000 S – number of patent for design (second publication)

## INTERNATIONAL PATENT CLASSIFICATION FOR INVENTIONS AND UTILITY MODELS

- SECTION A – HUMAN NECESSITIES
- SECTION B – PERFORMING OPERATIONS; TRANSPORTING
- SECTION C – CHEMISTRY; METALLURGY
- SECTION D – TEXTILES; PAPER
- SECTION E – FIXED CONSTRUCTIONS
- SECTION F – MECHANICAL ENGINEERING; LIGHTING; HEATING; WEAPONS; BLASTING
- SECTION G – PHYSICS
- SECTION H – ELECTRICITY

- 
- M – Trade Mark
  - (210) AM 0000 000000 – Serial number of application;
  - (260) AAM 0000 00000 A – Publication number of application;
  - (111) M 0000 00000 R – Number of registration;
  - (111) MMM0000 00000 Rn – Number of renewals, in which n=1,2,3;
  - (111) M 0000 00000 R(P) – Number of registration under partial assignment of rights
-

**LIST OF CODES, IN ALPHABETIC SEQUENCE, AND THE CORRESPONDING (SHORT) NAMES OF STATES, OTHER ENTITIES AND INTERGOVERNMENTAL ORGANIZATIONS**  
(WIPO STANDARD ST.3)

AD	Andorra				
AE	United Arab Emirates				
AF	Afghanistan				
AG	Antigua and Barbuda				
AI	Anguilla				
AL	Albania				
AM	Armenia				
AN	Netherlands Antilles				
AO	Angola				
AP	African Regional Intellectual Property Organization (ARIPO)				
AR	Argentina				
AT	Austria				
AU	Australia				
AW	Aruba				
AZ	Azerbaijan				
BA	Bosnia and Herzegovina				
BB	Barbados				
BD	Bangladesh				
BE	Belgium				
BF	Burkina Faso				
BG	Bulgaria				
BH	Bahrain				
BI	Burundi				
BJ	Benin				
BM	Bermuda				
BN	Brunei Darussalam				
BO	Bolivia				
BR	Brazil				
BS	Bahamas				
BT	Bhutan				
BV	Bouvet Island				
BW	Botswana				
BX	Benelux Office for Intellectual Property (BOIP)				
BY	Belarus				
BZ	Belize				
CA	Canada				
CD	Democratic Republic of the Congo				
CF	Central African Republic				
CG	Congo				
CH	Switzerland				
CI	Cote d'Ivoire				
CK	Cook Islands				
CL	Chile				
CM	Cameroon				
CN	China				
CO	Colombia				
CR	Costa Rica				
CU	Cuba				
CV	Cape Verde				
CY	Cyprus				
CZ	Czech Republic				
DE	Germany				
DJ	Djibouti				
DM	Dominica				
DO	Dominican Republic				
DZ	Algeria				
EA	Eurasian Patent Organization (EAPO)				
EC	Ecuador				
EE	Estonia				
EG	Egypt				
EH	Western Sahara				
EM	Office for Harmonization in the Internal Market (Trademarks and Designs)(OHIM)				
EP	European Patent Office (EPO)				
ER	Eritrea				
ES	Spain				
ET	Ethiopia				
FI	Finland				
FJ	Fiji				
FK	Falkland Islands (Malvinas)				
FO	Faroe Islands				
FR	France				
GA	Gabon				
GB	United Kingdom				
GC	Patent Office of the Cooperation Council				
			for the Arab States of the Gulf (GCC)		
		GD	Grenada		
		GG	Guernsey		
		GH	Ghana		
		GI	Gibraltar		
		GT	Guatemala		
		GW	Guinea- Bissau		
		GY	Guyana		
		HK	The Hong Kong Special Administrative Region of the People's Republic of China		
		HN	Honduras		
		HR	Croatia		
		HT	Haiti		
		HU	Hungary		
		IB	International Bureau of the World Intellectual Property Organization (WIPO)		
		ID	Indonesia		
		IE	Ireland		
		IL	Israel		
		IM	Isle of Man		
		IN	India		
		IQ	Iraq		
		ID	Indonesia		
		IE	Ireland		
		IL	Israel		
		IM	Isle of Man		
		IN	India		
		IQ	Iraq		
		IR	Iran (Islamic Republic of)		
		IS	Iceland		
		IT	Italy		
		JE	Jersey		
		JM	Jamaica		
		JO	Jordan		
		JP	Japan		
		KE	Kenya		
		KG	Kyrgyzstan		
		KH	Cambodia		
		KI	Kiribati		
		KM	Saint Kitts and Nevis		
		KP	Democratic People's Republic of Korea		
		KR	Republic of Korea		
		KW	Kuwait		
		KY	Cayman Islands		
		KZ	Kazakhstan		
		LA	Lao People's Democratic Republic		
		LB	Lebanon		
		LC	Saint Lucia		
		LI	Liechtenstein		
		LK	Sri Lanka		
		LR	Liberia		
		LS	Lesotho		
		LT	Lithuania		
		LU	Luxembourg		
		LV	Latvia		
		LY	Libyan Arab Jamahiriya		
		MA	Morocco		
		MC	Monaco		
		MD	Republic of Moldova		
		ME	Montenegro		
		MG	Madagascar		
		MK	The former Yugoslav Republic of Macedonia		
		ML	Mali		
		MM	Myanmar		
		MN	Mongolia		
		MO	Macao		
		MP	Northern Mariana Islands		
		MR	Mauritania		
		MS	Montserrat		
		MT	Malta		
		MU	Mauritius		
		MV	Maldives		
		MW	Malawi		
		MX	Mexico		
		MY	Malaysia		
		MZ	Mozambique		
		NA	Namibia		
		NE	Niger		
		NG	Nigeria		
		NI	Nicaragua		
		NL	Netherlands		
		NO	Norway		
		NP	Nepal		
		NR	Nauru		
		NZ	New Zealand		
		OA	African Intellectual Property Organization (OAPI)		
		OM	Oman		
		PA	Panama		
		PE	Peru		
		PG	Papua New Guinea		
		PH	Philippines		
		PK	Pakistan		
		PL	Poland		
		PT	Portugal		
		PW	Palau		
		PY	Paraguay		
		QA	Qatar		
		QZ	Community Plant Variety Office (European Community) (CPVO)		
		RO	Romania		
		RS	Serbia		
		RU	Russian Federation		
		RW	Rwanda		
		SA	Saudi Arabia		
		SB	Solomon Islands		
		SC	Seychelles		
		SD	Sudan		
		SG	Singapore		
		SH	Saint Helena		
		SI	Slovenia		
		SK	Slovakia		
		SL	Sierra Leone		
		SM	San Marino		
		SN	Senegal		
		SO	Somalia		
		SR	Suriname		
		ST	Sao Tome and Principe		
		SV	El Salvador		
		SY	Syrian Arab Republic		
		SZ	Swaziland		
		TC	Turks and Caicos Islands		
		TD	Chad		
		TG	Togo		
		TH	Thailand		
		TJ	Tajikistan		
		TL	Timor-Leste		
		TM	Turkmenistan		
		TN	Tunisia		
		TO	Tonga		
		TR	Turkey		
		SE	Sweden		
		TT	Trinidad and Tobago		
		TV	Tuvalu		
		TW	Taiwan, Province of China		
		TZ	United Republic of Tanzania		
		UA	Ukraine		
		UG	Uganda		
		US	United States of America		
		UY	Uruguay		
		UZ	Uzbekistan		
		VA	Holy See		
		VC	Saint Vincent and the Grenadines		
		VE	Venezuela		
		VG	Virgin Islands (British)		
		VN	Viet Nam		
		VU	Vanuatu		
		WO	World Intellectual Property Organization (WIPO)		
		WS	Samoa		
		XN	Nordic Patent Institute (NPI)		
		YE	Yemen		
		ZA	South Africa		
		ZM	Zambia		
		ZW	Zimbabwe		

**NATIONAL INTELLECTUAL PROPERTY CENTER OF GEORGIA  
SAKPATENTI**

**OFFICIAL BULLETIN  
OF THE INDUSTRIAL PROPERTY**

**8(420)**

**INVENTIONS  
UTILITY MODELS  
DESIGNS  
TRADEMARKS**

DATE OF PUBLICATION  
2015 04 27

# CONTENTS

<b>PUBLISHED TITLES OF PROTECTION</b> .....	3
<b>INVENTIONS</b>	
▪ APPLICATIONS APPROVED FOR GRANTING PATENTS .....	4
▪ PATENTED INVENTIONS .....	8
<b>UTILITY MODELS</b>	
▪ APPLICATIONS APPROVED FOR GRANTING PATENT .....	10
▪ PATENTED UTILITY MODEL .....	11
<b>DESIGNS</b>	
▪ APPLICATION APPROVED FOR REGISTRATION .....	12
<b>TRADEMARKS</b>	
▪ APPLICATIONS FILED UNDER THE NATIONAL PROCEDURE APPROVED FOR REGISTRATION .....	13
▪ REGISTERED TRADEMARKS .....	22
▪ TRADEMARKS REGISTERED ACCORDING TO THE ACCELERATED PROCEDURE .....	23
▪ INTERNATIONAL TRADEMARKS FOR WHICH A DECISION ON GRANTING PROTECTION IS TAKEN .....	24
▪ INTERNATIONAL TRADEMARKS PROTECTED IN GEORGIA .....	74
<b>OFFICIAL NOTIFICATIONS</b>	
<b>TRADEMARKS</b>	
▪ RENEWAL OF REGISTRATIONS .....	94
▪ COMPLETE TRANSFER OF RIGHTS .....	95
▪ CHANGES IN NAMES AND/OR ADDRESSES OF OWNERS .....	96
▪ LICENSE AGREEMENTS .....	98
<b>CLASSIFICATION INDEXES</b>	
INVENTIONS .....	103
UTILITY MODELS .....	104
DESIGNS .....	105
TRADEMARKS .....	107

## PUBLISHED TITLES OF PROTECTION

### INVENTIONS

- **APPLICATIONS APPROVED FOR GRANTING PATENTS:**  
12988; 12984; 12836; 12776; 12736; 13259; 13177; 13075, 13076
- **PATENTED INVENTIONS:**  
6277-6280

### UTILITY MODELS

- **APPLICATIONS APPROVED FOR GRANTING PATENTS:**  
12920; 13452
- **PATENTED UTILITY MODEL:**  
1857

### DESIGNS

- **APPLICATION APPROVED FOR REGISTRATION:**  
843

### TRADEMARKS

- **APPLICATIONS FILED UNDER THE NATIONAL PROCEDURE APPROVED FOR REGISTRATION:**  
74294\*\*; 76190; 76843; 77586; 77609; 77612; 77726; 77728; 77848; 77898; 77909; 78016; 78023, 78024; 78035; 78040, 78041; 78080, 78081; 78175; 78204; 78206; 78209, 78210; 78213-78215; 78221, 78222; 78224; 78252, 78253; 78255-78258; 78264; 78267; 78269-78273; 78275; 78290; 78300; 78315; 78382, 78383; 78406; 78408-78411; 78728; 78754; 78849, 78850; 78899; 79030, 79031
- **REGISTERED TRADEMARKS:**  
25779-25786; 25788
- **TRADEMARKS REGISTERED ACCORDING TO THE ACCELERATED PROCEDURE:**  
25778; 25787; 25789
- **INTERNATIONAL TRADEMARKS FOR WHICH A DECISION ON GRANTING PROTECTIONS IS TAKEN:**  
73494\*; 74632\*; 76359; 76361-76363; 76372; 76374; 76487; 76816; 76836; 76839; 76854; 76856-76859; 76864; 76963; 77153; 77160; 77173, 77174; 77176; 77219; 77239; 77241; 77247; 77250-77252; 77301; 77303; 77332; 77335; 77363; 77366; 77375; 77377, 77378; 77383; 77385; 77387, 77388; 77390, 77391; 77407; 77409; 77411-77419; 77421; 77423-77427; 77499, 77500; 77502; 77509, 77510; 77567; 77588; 77590-77592; 77594; 77603, 77604; 77607; 77611; 77613; 77638; 77642, 77643; 77716-77719; 77729-77732; 77735-77739; 77748, 77749; 77751; 77753-77756; 77758, 77759; 77762, 77763; 77838; 78043-78045; 78054-78064; 78067, 78068; 78075; 78324, 78325; 78327; 78329, 78330; 78337-78339; 78341, 78342; 78344
- **INTERNATIONAL TRADEMARKS PROTECTED IN GEORGIA:**  
75045-75050; 75052, 75053; 75055; 75057; 75061, 75062; 75064; 75180, 75181; 75186-75190; 75192-75195; 75337-75344; 75349-75354; 75360-75362; 75364-75371; 75378, 75379; 75381-75385; 75388, 75389; 75391-75395; 75397; 75400, 75401; 75403; 75404; 75406; 75410-75412; 75423-75425; 75430, 75431; 75437, 75438; 75440-75450; 75466, 75467; 75473-75475; 75490; 75502-75504; 75506; 75509, 75510; 75529-75534; 75537-75539; 75543-75547; 75557-75559; 75563; 75568, 75569; 75578; 75580-75585; 75613-75620; 75623-75626; 75628-75634; 75637-75639; 75738; 75740; 75743; 75744; 75879; 75884; 75888; 75944; 76049; 76052, 76053; 76094; 76096-76100; 76112-76114; 76117; 76119-76121; 76123; 76125; 76132, 76133; 76137-76139; 76149, 76150; 76152, 76153; 76155-76159; 76164; 76169; 76172; 76176; 76178, 76179; 76205; 76218, 76219; 76221; 76224; 76226, 76227; 76229-76233; 76265; 76282-76285; 76287, 76288; 76290; 76294, 76295; 76298; 76303-76305; 76309; 76315-76317; 76319-76321; 76336; 76381-76384; 76386-76393; 76396-76398; 76400; 76407; 76410; 76434; 76436; 76439; 76441; 76444-76448; 76450, 76451; 76458; 76463-76466; 76478-76484; 76488, 76489; 77108; 77110; 77113-77115; 77117-77120; 77122-77124; 77126; 77130-77137; 77260; 77264, 77265

# INVENTIONS

## APPLICATIONS APPROVED FOR GRANTING PATENTS

The decision can be appealed at the Chamber of Appeal of Sakpatenti within 3 months from the publication or at the Mtskheta District Court Administrative Cases Board (Address: №17, Samkhedro str., Mtskheta), within 1 month following the publication.

### PART A

#### A 61

(10) AP 2015 12988 A (51) Int. Cl. (2006)

A 61 K 9/00

A 61 K 31/44

A 61 P 11/06

(21) AP 2011 012988 (22) 2011 07 27

(31) 10171748.6

(32) 2010 08 03

(33) EP

(71) CHIESI FARMACEUTICI S.p.A. (IT)

Via Palermo, 26/A I-43100 Parma (IT)

(72) COCCONI, Daniela (IT);

SCHIARETTI, Francesca (IT);

BILZI, Roberto (IT)

(74) Tamaz Shilakadze

(85) 2013 02 01

(86) PCT/EP2011/062872, 2011 07 27

(54) **DRY POWDER FORMULATION  
COMPRISING A PHOSPHODIESTE-  
RASE INHIBITOR**

(57) There are represented preparation containing micronized binding particles of formula (I),

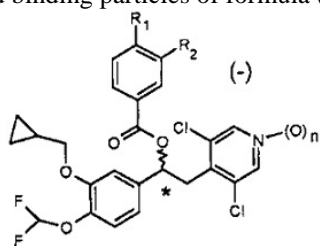

(I)

and pharmaceutically acceptable coarse particle of inert carrier.

Claims: 4 independent

14 dependent

(10) AP 2015 12984 A (51) Int. Cl. (2006)

A 61 K 9/50

A 61 K 31/495

(21) AP 2013 012984 (22) 2013 01 29

(31) 12.00322

(32) 2012 02 03

(33) FR

(71) LES LABORATOIRES SERVIER (FR)

35, rue de Verdun, 92284 Suresnes

Cedex (FR)

(72) GENTY, Patric (FR);

HERMELIN, Christophe (FR);

PEAN, Jean-Manuel (FR)

(74) Tamaz Shilakadze

(54) **PHARMACEUTICAL COMPOSI-  
TION FOR TRIMETAZIDINE RELEASE  
PROLONGATION**

(57) There is represented pharmaceutical composition, which inner phase contains neutral core covered with trimetazidine and astringent and outer layer contains inhibitor and antiagglomerant.

Claims: 3 independent

15 dependent

Fig.: 5

(10) AP 2015 12836 A (51) Int. Cl. (2006)

A 61 K 39/00

C 07 K 16/44

(21) AP 2011 012836 (22) 2011 01 20

(31) 10151239.0; 61/383,914

(32) 2010 01 20; 2010 09 17

(33) EP; US

(71) BOEHRINGER INGELHEIM  
INTERNATIONAL GMBH (DE)  
Binger Str. 173, 55216 Ingelheim  
am Rhein (DE)

(72) VAN RYN, Joanne (CA);  
PARK, John Edward (DE);

HAUEL, Norbert (DE);

KUNZ, Ulrich (DE);

LITZENBURGER, Tobias (DE);

CANADA, Keith (US);

SINGH, Sanjaya (US);

WATERMAN, Alisa (US)

(74) Tamar Kochlamazashvili

(85) 2012 08 20

(86) PCT/EP2011/050749, 2011 01 20

(54) **ANTICOAGULANT ANTIDOTES**

(57) Present invention relates to antibodies acting as antidotes against primary inhibitor of thrombin dabigatran. Said antibodies are applied for by-effect prevention at anticoagulant therapy, and bleeding, as well.

Claims: 11 independent

22 dependent

Fig.: 14

**PART B****B 01**

(10) AP 2015 12776 A (51) Int. Cl. (2006)  
B 01 D 24/10  
B 01 D 53/02

(21) AP 2010 012776 (22) 2010 12 03  
(31) 61/266,423  
(32) 2009 12 03  
(33) US  
(71) RED LEAF RESOURCES, INC. (US)  
200 West Civic Center Drive, Suite 190,  
Sandy, UT 84070 (US)  
(72) PATTEN, James, W. (US)  
(74) Shalva Gvaramadze  
(85) 2012 07 03

(86) PCT/US2010/058948, 2010 12 03  
(54) **METHODS AND SYSTEMS FOR  
REMOVING FINES FROM HYDRO-  
CARBON-CONTAINING FLUIDS**

(57) A method and system of small particles removing from hydrocarbon-containing fluid provides layered medium preparation from clay fine material by passing with certain speed through thereof the flow containing fine-grained coal to provide filtered fluid containing hydrocarbon and fine-grained coal separation, at the same time.

Claims: 2 independent  
24 dependent

Fig.: 2

**PART C****C 07**

(10) AP 2015 12736 A (51) Int. Cl. (2006)  
C 07 C 231/12  
C 07 C 233/18  
A 61 K 31/165  
A 61 P 25/16  
A 61 P 25/18  
A 61 P 25/28  
A 61 P 3/00

(21) AP 2012 012736 (22) 2012 06 05  
(31) 11.01766; 201110245039.6  
(32) 2011 06 09; 2011 08 25  
(33) FR; CN  
(71) LES LABORATOIRES SERVIER (FR)  
35, rue de Verdun, 92284 Suresnes  
Cedex (FR)  
(72) LETELLIER, Philippe (FR);  
LYNCH, Michael (GB);  
PEAN, Jean-Manuel (FR)  
(74) Tamaz Shilakadze

(54) **NEW CO-CRYSTALS OF  
AGOMELATINE, PROCESS FOR THEIR  
PREPARATION AND PHARMACEUTI-  
CAL COMPOSITIONS CONTAINING  
THEM**

(57) There are represented co-crystal of agomelatine, preparation method thereof, pharmaceutical composition on basis thereof, and application thereof for the treatment of melatonergic system disorders.

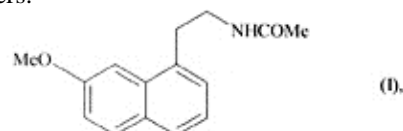

Claims: 7 independent  
3 dependent

(10) AP 2015 13259 A (51) Int. Cl. (2006)  
C 07 D 319/20  
C 07 D 405/10  
C 07 D 487/10  
C 07 D 405/12  
C 07 D 405/14  
A 61 K 31/357  
A 61 P 29/00  
A 61 P 19/00

(21) AP 2012 013259 (22) 2012 03 13  
(31) 61/452,329  
(32) 2011 03 14  
(33) US

(71) BOEHRINGER INGELHEIM  
INTERNATIONAL GMBH (DE)  
Binger Strasse 173, 55216 Ingelheim am  
Rhein (DE)

(72) ABEYWARDANE, Asitha (LK);  
BURKE, Michael J. (CA);  
KIRRANE, Thomas Martin, Jr. (US);  
NETHERTON, Matthew Russell (CA);  
PADYANA, Anil Kumar (IN);  
SMITH KEENAN, Lana Louise (CA);  
TAKAHASHI, Hidenori (JP);  
TURNER, Michael Robert (US);  
ZHANG, Qiang (CA);  
ZHANG, Qing (CN)

(74) Tamar Kochlamazashvili

(85) 2013 10 11

(86) PCT/US2012/028843, 2012 03 13

(54) **BENZODIOXANE INHIBITORS OF  
LEUKOTRIENE PRODUCTION**

(57) There are represented benzodioxanes of common formula (I),

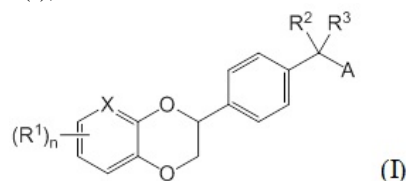



pharmaceutical compositions containing them, which are inhibitors LTA4H and are applied for the treatment of various diseases stipulated with leukotrienes activity.

Claims: 5 independent  
24 dependent

(10) AP 2015 13117 A (51) Int. Cl. (2006)  
C 07 D 519/00  
A 61 K 31/519  
A 61 P 25/00  
A 61 P 25/18  
A 61 P 25/24

(21) AP 2011 013117 (22) 2011 11 18

(31) PA2010 01045; 61/415,356

(32) 2010 11 19; 2010 11 19

(33) DK; US

(71) H. LUNDBECK A/S (DK)  
Ottliavej 9, DK-2500 Valby (DK)

(72) KEHLER, Jan (DK);  
NIELSEN, Jacob (DK);  
MARIGO, Mauro (IT);  
KILBURN, John, Paul (GB);  
LANGGÅRD, Morten (DK)

(74) Shalva Gvaramadze

(85) 2013 06 17

(86) PCT/DK2011/000136, 2011 11 18

(54) **IMIDAZOLE DERIVATIVES  
AS PDE10A ENZYME INHIBITORS**

(57) There are represented compound of formula (I),

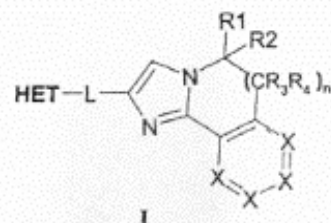

pharmaceutical composition on basis thereof and application therefor the treatment of neurodegenerative mental insanity.

Claims: 5 independent  
7 dependent

Table: 1

## PART F

### F 01

(10) AP 2015 13075 A (51) Int. Cl. (2006)  
F 01 B 17/02  
F 02 G 1/02  
F 24 J 2/42

(21) AP 2011 013075 (22) 2011 10 03

(31) 1058005

(32) 2010 10 04

(33) FR

(71) MOTOR DEVELOPMENT  
INTERNATIONAL S.A. (LU)

17 rue des Bains L-1212 Luxembourg (LU)

(72) NEGRE, Guy (FR);  
NEGRE, Cyril (FR)

(74) Shalva Gvaramadze

(85) 2013 05 01

(86) PCT/EP2011/067211, 2011 10 03

(54) **METHOD OF WORKING OF  
MONO-ENERGY AND/OR DUAL-  
ENERGY ENGINE WITH COMPRESSED  
AIR AND/OR ADDITIONAL ENERGY,  
COMPRISED AN ACTIVE CHAMBER  
INCLUDED IN THE CYLINDER**

(57) There is represented working method of engine with an active chamber provides installation of at least one movable piston 2 in a cylinder 1 and driving a crankshaft 5 by means of a slider-crank device 3 and 4 and operating according to a four-phase thermodynamic cycle comprising: an isothermal expansion without work; a transfer - slight so-called quasi-isothermal expansion with work; a polytropic expansion with work; and an exhaust at ambient pressure, preferentially supplied by compressed air or any gas contained in a high-pressure storage tank 12, through a buffer capacity, called a working capacity 11, which is expanded at an average pressure, called a working pressure, in a working capacity 11, preferentially through a dynamic pressure-reducing device 13, furthermore, the piston is established so, that the cylinder volume 1 being swept by the piston and divided into two separate parts, a first part forming the active chamber CA, and a second part forming the expansion chamber CD.

Claims: 1 independent  
10 dependent

Fig.: 8

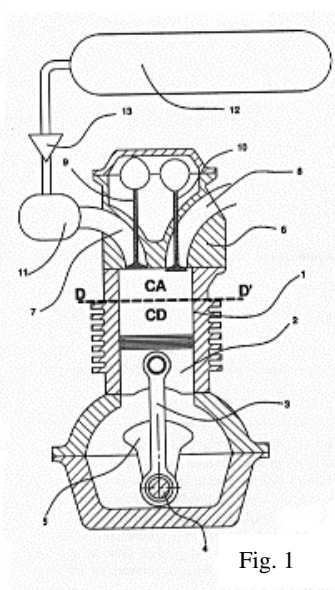

Fig. 1

**F 02****(10) AP 2015 13076 A (51) Int. Cl. (2006)**

**F 02 B 21/00**  
**F 02 M 31/04**  
**F 02 M 31/16**  
**F 01 B 17/02**  
**F 01 D 13/02**

(21) AP 2011 013076 (22) 2011 10 03

(31) 1058037

(32) 2010 10 05

(33) FR

(71) MOTOR DEVELOPMENT

INTERNATIONAL S.A. (LU)

17 rue des Bains L-1212 Luxembourg (LU)

(72) NEGRE, Guy (FR);

NEGRE, Cyril (FR)

(74) Shalva Gvaramadze

(85) 2013 05 01

(86) PCT/EP2011/067212, 2011 10 03

**(54) METHOD OF WORKING OF SELF-  
 PRESSURE-REGULATING  
 COMPRESSED AIR ENGINE  
 COMPRISING AN INTEGRATED  
 ACTIVE CHAMBER**

(57) There is represented working method of engine having active chamber, which provides at least one movable piston 2 installation in a cylinder 1 by dividing it into an active chamber CA and an expansion chamber CD, and in which: compressed air contained in a tank 12 directly feeds the intake of the engine cylinder 1; included active chamber CA is filled at a constant admission pressure at each engine revolution, said admission pressure decreasing as the pressure in the tank decreases; the volume of the included active chamber CA increases progressively as the pressure in the tank 12, volume of included therein active chamber CA is gradually increased respectively pressure decreasing in the tank. The method also provides not only to open inlet hole and channel 7, opened essentially at the top dead center of the stroke of the piston, but also the modification of the duration and/or the angular sector of the admission, in addition to the opening passage section; and the volume of the included active chamber CA is dimensioned for maximum storage pressure, and is then progressively increased, resulting in a self-pressure regulating engine.

Claims: 1 independent

12 dependent

Fig.: 7

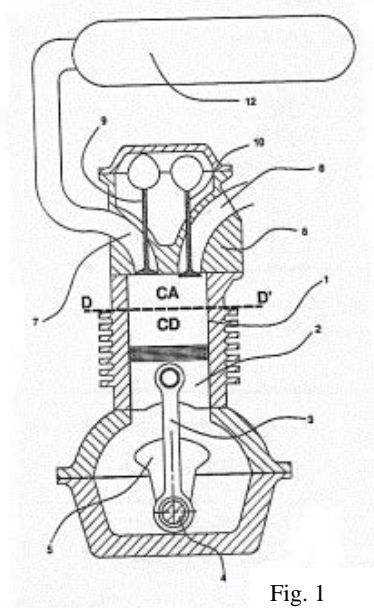

Fig. 1

## PATENTED INVENTIONS

### PART A

#### A 61

- (11) P 2015 6277 B**      **(51) Int. Cl. (2006)**  
**A 61 M 15/00**  
 (10) AP 2015 12434 A    (44) 1(413)/2015  
 (21) AP 2010 012434  
 (22) 2010 03 30  
 (24) 2010 03 30  
 (31) TR2009/02446  
 (32) 2009 03 30  
 (33) TR  
 (86) PCT/TR2010/000068, 2010 03 30  
 (73) ILAC SANAYI VE TICARET ANONIM  
 SIRKETI (TR)  
 Istinye Mah. Balabandere Cad. No. 14 34460  
 Sariyer, Istanbul (TR)  
 (72) TOKSOZ, Ahmet (TR);  
 TOKSOZ, Zafer (TR);  
 CIFTER, Musa Umit (TR)  
 (74) Shalva Gvaramadze  
 (54) **DRY POWDER INHALER DEVICE**
- 

### PART B

#### B 03

- (11) P 2015 6279 B**      **(51) Int. Cl. (2006)**  
**B 03 C 3/014**  
**B 03 C 3/16**  
**B 01 D 47/06**  
**B 01 D 50/00**  
 (10) AP 2015 13190 A    (44) 1(413)/2015  
 (21) AP 2011 013190  
 (22) 2011 07 14  
 (24) 2011 07 14  
 (31) 20110007  
 (32) 2011 01 12  
 (33) FI  
 (86) PCT/FI2011/000037, 2011 07 14  
 (73) AAVI TECHNOLOGIES LTD (FI)  
 Kirkonkyläntie 37A, FI-00700 Helsinki (FI)  
 (72) ILMASTI, Veikko Ilmari (FI)  
 (74) Shalva Gvaramadze  
 (54) **DEVICE AND METHOD FOR  
 PURIFYING AIR FROM NON-DESIRED  
 COMPONENTS AND FOR  
 ELIMINATING SUCH COMPONENTS**
- 

### PART F

#### F 02

- (11) P 2015 6278 B**      **(51) Int. Cl. (2006)**  
**F 02 B 75/32**  
 (10) AP 2014 13030 A    (44) 24(412)/2014  
 (21) AP 2013 013030  
 (22) 2013 03 18  
 (24) 2013 03 18  
 (73) Revaz Varsimashvili (GE)  
 Vazha-Pshavelas Gamz., V kvart., korp. 4,  
 b. 82, 0186, Tbilisi (GE);  
 Mariam Varsimashvili (GE)  
 Vazha-Pshavelas Gamz., V kvart., korp. 4,  
 b. 82, 0186, Tbilisi (GE);  
 Zaza Varsimashvili (GE)  
 Vazha-Pshavelas Gamz., V kvart., korp. 4,  
 b. 82, 0186, Tbilisi (GE);  
 Mertsia Tchirakadze (GE);  
 Vazha-Pshavelas Gamz., V kvart., korp. 4,  
 b. 82, 0186, Tbilisi (GE);  
 Luka Varsimashvili (GE)  
 Mtskhetyis q. 20, b. 34, 0179, Tbilisi (GE);  
 Zurab Varsimashvili (GE)  
 Mtskhetyis q. 20, b. 34, 0179, Tbilisi (GE);  
 Tsiala Varsimashvili (GE)  
 T. Tabidzis q. 39, 4600, Kutaisi (GE)  
 (72) Revaz Varsimashvili (GE);  
 Mariam Varsimashvili (GE);  
 Zaza Varsimashvili (GE);  
 Mertsia Tchirakadze (GE);  
 Luka Varsimashvili (GE);  
 Zurab Varsimashvili (GE);  
 Tsiala Varsimashvili (GE)  
 (54) **INTERNAL COMBUSTION ENGINE**
-



# UTILITY MODELS

## APPLICATION APPROVED FOR GRANTING PATENT

The decision can be appealed at the Chamber of Appeal of Sakpatenti within 3 months from the publication or at the Mtskheta District Court Administrative Cases Board (Address: №17, Samkhedro str., Mtskheta), within 1 month following the publication.

### PART C

#### C 04

(10) AU 2015 12920 U (51) Int. Cl. (2006)  
C 04 B 35/01  
H 01 L 39/12

(21) AU 2012 012920 (22) 2012 12 11

(71) Nikoloz Chikhradze (GE)

I. Petritsis Gamz. 9a, b. 9, 0131,

Tbilisi (GE);

Leri Kurdadze (GE)

Sanzona 10b, b. 40, 0192, Tbilisi (GE);

Guram Abashidze (GE)

Kurdianis q. 4. b. 12, 0112, Tbilisi (GE)

(72) Nikoloz Chikhradze (GE);

Leri Kurdadze (GE);

Guram Abashidze (GE)

(54) **COMPOSITE, ABSORBING  
THERMAL NEUTRONS**

(57) There is represented composite containing metal (iron/nickel/tungsten) and gadolinium with specified correlation of components; is obtained by means of explosive compaction of initial mixture of powdered components; and is characterized with high coefficient of thermal neutrons steam abatement.

Claims: 1 independent  
2 dependent

Fig.: 1

(57) There is represented form panel 1, which is plastic rectangular parallelepiped shaped hollow case 2. On case upper surface the plug-like projections 3 are executed to connect panels together, and for strengthen the connection, in panel cavity, corresponding form height, and outgoing from lower part of case upper surface, the plug-like projections 4; partitions 5 connecting thereto couple of longitudinal parallel sides; and the projections 6 outgoing from case parallel sides are executed, as well.

Claims: 1 independent

1 dependent

Fig.: 4

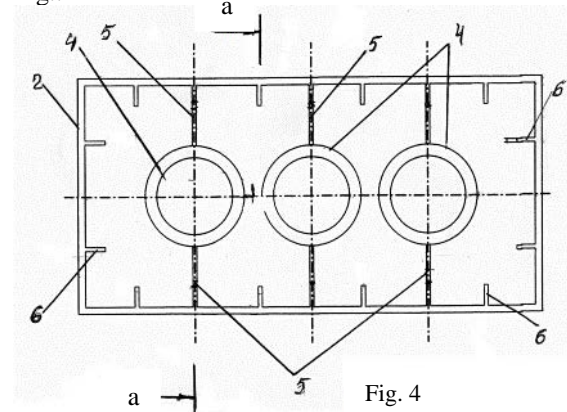

Fig. 4

### PART E

#### E 04

(10) AU 2015 13452 U (51) Int. Cl. (2006)  
E 04 G 9/00

(21) AU 2014 013452 (22) 2014 04 29

(71) LTD "SBC" (GE)

Tetrikhevis Das., Samgoris II Shes.,

0109, Tbilisi (GE)

(72) Erik Ovakimov (GE);

Zaur Tughushi (GE)

(74) Tamaz Shilakadze

(54) **FORM PANEL**



---

# DESIGNS

## APPLICATION APPROVED FOR REGISTRATION

The decision can be appealed at the Chamber of Appeal of Sakpatenti within 3 months from the publication or at the Mtskheta District Court Administrative Cases Board (Address: №17, Samkhedro str., Mtskheta), within 1 month following the publication.

- (10) **AD 2015 843 S**      (51) **32-00**
- (21) AD 2015 000843
- (22) 2015 03 02
- (28) 1
- (71) Eldar Mamaladze (GE)  
Aghmasheneblis q. 101, 3300, Mtskheta (GE)
- (72) Eldar Mamaladze (GE)
- (54) **RAISED FINISH FOR POTTERY WORKS**
- (55)

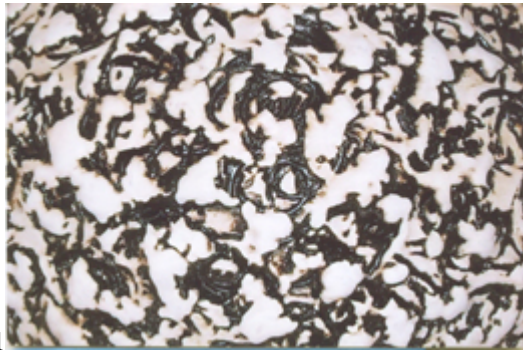

---

# TRADEMARKS

## APPLICATIONS FILED UNDER THE NATIONAL PROCEDURE APPROVED FOR REGISTRATION

The decision can be appealed at the Chamber of Appeal of Sakpatenti within 3 months from the publication or at the Mtskheta District Court Administrative Cases Board (Address: №17, Samkhedro str., Mtskheta), within 1 month following the publication.

(260) AM 2015 74294 A\*\*  
(210) AM 74294  
(220) 2013 10 10  
(732) LTD "ALIGATORI I.S."  
Imedashvilis shes. 16, Batumi, Georgia  
(740) Giorgi Taktakishvili  
(540)

**ROYAL ALIGATOR**

(511) 7

---

(260) AM 2015 76190 A  
(210) AM 76190  
(220) 2014 03 09  
(731) APPLE INC  
1 Infinite Loop, Cupertino, California 95014,  
USA  
(740) Tamar Kochlamazashvili  
(540)

**APPLE**

(511) 12, 14, 16, 25, 28, 35, 36, 37, 38

---

(260) AM 2015 76843 A  
(210) AM 76843  
(220) 2014 04 28  
(731) LTD "IDEAS BORJOMI BEVERAGES  
COMPANY"  
Toris q. 39, 1200 Borjomi, Georgia  
(540)



(591) White, blue, red, light green  
(531) 06.01.01, 27.05.10, 28.19, 29.01.14  
(526) The trademark is protected as a whole. The words "BORJOMI" and „ბორჯომის“ included therein shall not be subject to independent legal protection.  
(511) 32, 35

---

(260) AM 2015 77586 A  
(210) AM 77586  
(220) 2014 06 17

(731) Kakhaber Onashvili  
Zedazenis q. 16, 0180, Tbilisi, Georgia  
(740) Giorgi Ghvinjilia  
(540)

**მძღვეარი  
MDZLEVARI**

(511) 9, 41

---

(260) AM 2015 77609 A  
(210) AM 77609  
(220) 2014 06 18  
(731) LTD "ASPHARMA GEORGIA  
PHARMACEUTICAL COMPANY"  
Mtskhetis q. 8, 0179, Tbilisi, Georgia  
(740) Maia Samadashvili  
(540)

**Vedira  
ვედირა  
Ведира**

(511) 5

---

(260) AM 2015 77612 A  
(210) AM 77612  
(220) 2014 06 18  
(731) LTD "ASPHARMA GEORGIA  
PHARMACEUTICAL COMPANY"  
Mtskhetis q. 8, 0179, Tbilisi, Georgia  
(740) Maia Samadashvili  
(540)

**Cardiva  
კარდივა  
Кардива**

(511) 5

---

(260) AM 2015 77726 A  
(210) AM 77726  
(220) 2014 06 27  
(731) SHENZHEN ITZR TECHNOLOGY  
CO., LTD  
ITZR industrial Park, TangQian, GuanLan  
Town, Shenzhen City, China.



(740) Khatuna Imnadze  
(540)

**Esonic** 

(591) Black, white, red  
(531) 25.07.06, 25.07.07, 26.01.06, 27.05.05,  
29.01.12  
(511) 9

(260) AM 2015 77728 A  
(210) AM 77728  
(220) 2014 06 27  
(731) Shenzhen Bilian Electronic Limited  
268 FuQian Rd., Jutang Community, Guanlan  
Town, Longhua new District, Shenzhen city,  
518110, China  
(740) Khatuna Imnadze  
(540)

**EB-LINK**

(591) Black-white  
(531) 26.11.09, 27.05.17  
(511) 9

(260) AM 2015 77848 A  
(210) AM 77848  
(220) 2014 07 07  
(731) DAEWOONG PHARMACEUTICAL CO.,  
LTD  
244, Galmachi-ro, Jungwon-gu, Seongnam-si,  
Gyeonggi-do, Republic of Korea  
(740) Tamaz Shilakadze  
(540)

**STOPHELMIN-1**

(511) 5

(260) AM 2015 77898 A  
(210) AM 77898  
(220) 2014 07 11  
(731) Societe Nationale d'Exploitation  
Industrielle des Tabacs et Allumettes, SASU  
143 Blvd. Romain Rolland, Paris 75014,  
France  
(740) Giorgi Ghvinjilia  
(540)

**LIBERTE TOUJOURS**

(511) 34

(260) AM 2015 77909 A  
(210) AM 77909  
(220) 2014 07 11  
(731) GEORGIAN DISTRIBUTION  
MARKETING COMPANY  
Moskow Ave. 31a, 0120, Tbilisi, Georgia

(740) Vakhtang Torotadze  
(540)



(591) Light green, white  
(531) 26.04.22, 26.04.24, 27.05.24, 05.03.14  
(511) 29

(260) AM 2015 78016 A  
(210) AM 78016  
(220) 2014 07 21  
(731) NOBEL ILAC SANAYII VE  
TICARET ANONIM SIKRETI  
Representation in Georgia  
Tavisuplebis moedani 4, Tbilisi, Georgia  
(740) Tinatin Tskhvediani  
(540)

**DEXTANOL**  
**დექსტანოლი**

(511) 5, 35

(260) AM 2015 78023 A  
(210) AM 78023  
(220) 2014 07 21  
(731) LTD "LARKI"  
Umashev str. 8, 0151, Tbilisi, Georgia  
(740) Davit Khinveli  
(540)

**რუმეფოსი**

(511) 31

(260) AM 2015 78024 A  
(210) AM 78024  
(220) 2014 07 21  
(731) LTD "LARKI"  
Iumashevis q. 8, 0151, Tbilisi, Georgia  
(740) Davit Khinveli  
(540)

**ლიაკრისი**

(511) 5

(260) AM 2015 78035 A  
(210) AM 78035  
(220) 2014 07 22  
(731) Nodar Esiava  
Simon Chikovani str. 4/10, b. 51, 0171 Tbilisi,  
Georgia  
Besarion Surmava  
Ghrmaghelis dasakh..., Sanzona, korp. 7, b. 4,  
Tbilisi, Georgia  
(740) Besarion Surmava

(540)



(591) Cornelian red, golden, light cornelian red  
 (531) 05.07.10, 24.03.13, 26.01.21, 27.05.24, 28.19,  
 29.01.12  
 (511) 33

(260) AM 2015 78040 A  
 (210) AM 78040  
 (220) 2014 07 22  
 (731) ARAMEX INTERNATIONAL LLC  
 Business Central Towers, A2302, Dubai  
 Media City (TECOM), Sheikh Zayed Road,  
 P.O.Box 95946, United Arab Emirates  
 (740) Tamaz Shilakadze  
 (540)

**SnS/ SHOP AND SHIP**

(511) 35, 39

(260) AM 2015 78041 A  
 (210) AM 78041  
 (220) 2014 07 22  
 (731) ARAMEX INTERNATIONAL LLC  
 Business Central Towers, A2302, Dubai  
 Media City (TECOM), Sheikh Zayed Road,  
 P.O.Box 95946, United Arab Emirates  
 (740) Tamaz Shilakadze  
 (540)

**GET IT  
 ANYWHERE  
 SHOP  
 AND  
 SHIP  
 .COM**

(591) Black-white  
 (531) 27.05.25  
 (511) 35, 39

(260) AM 2015 78080 A  
 (210) AM 78080  
 (220) 2014 07 28  
 (731) LTD "SHUKHMAN WINE GEORGIA"  
 Sop. Kisiskhevi, 2200, Telavis raioni, Georgia  
 (740) Shalva Gvaramadze  
 (540)

**URMULI  
 УРМУЛИ**

(511) 33

(260) AM 2015 78081 A  
 (210) AM 78081  
 (220) 2014 07 28  
 (731) LTD "SHUKHMAN WINE GEORGIA"  
 Sop. Kisiskhevi, 2200, Telavis raioni, Georgia  
 (740) Shalva Gvaramadze  
 (540)



(591) Black-white  
 (531) 26.01.21, 25.01.19, 07.01.01  
 (511) 33

(260) AM 2015 78175 A  
 (210) AM 78175  
 (220) 2014 07 31  
 (731) LTD "COMPANY BESINI"  
 Vake-Saburtalos raioni, Gamrekelis q. 19,  
 0160, Tbilisi, Georgia  
 (740) Maia Chachibaia  
 (540)



(591) Black-white  
 (531) 26.04.12, 26.11.13, 26.11.09, 27.05.19  
 (511) 33

(260) AM 2015 78204 A  
 (210) AM 78204  
 (220) 2014 08 01  
 (731) DD IP Holder LLC  
 Royall Street, Canton, Massachusetts 02021,  
 USA  
 (740) Pavle Meipariani  
 (540)

**MUNCHKINS**

(511) 30

(260) AM 2015 78206 A  
 (210) AM 78206  
 (220) 2014 08 01  
 (731) HANKOOK TIRE WORLDWIDE CO., LTD.  
 647-15, Yoksam-dong, Kangnam-gu, Seoul,  
 Republic of Korea

(740) Larisa Amirkhanyan  
(540)

**Hankook  absorber**

(591) Black-white  
(531) 21.03.21, 27.01.06, 27.05.10  
(511) 12

(260) AM 2015 78209 A  
(210) AM 78209  
(220) 2014 08 01  
(731) LTD "DIO"  
Saburtalos q. 55, 0160 Tbilisi, Georgia  
(740) Irma Daushvili  
(540)

**საბურთალოსი**

(511) 6, 17, 19, 24, 37

(260) AM 2015 78210 A  
(210) AM 78210  
(220) 2014 08 01  
(731) LTD "DIO"  
Saburtalos q. 55, 0160, Tbilisi, Georgia  
(740) Irma Daushvili  
(540)



(591) Silver, red, blue  
(531) 04.05.04, 26.11.09, 28.19, 29.01.13  
(511) 6, 17, 19, 24, 37

(260) AM 2015 78213 A  
(210) AM 78213  
(220) 2014 08 03  
(731) GLOBAL GURAYSH FZCO  
P.O. Box 119640, Dubai, United Arab  
Emirates  
(740) Larisa Amirkhanyan  
(540)



(591) Black-white  
(531) 01.15.11, 11.03.04, 25.01.05, 27.01.12  
(511) 21, 30

(260) AM 2015 78214 A  
(210) AM 78214  
(220) 2014 08 04  
(731) GENERAL MOTORS LLC  
300 Renaissance Center, City of Detroit, State  
of Michigan 48265-3000, USA  
(740) Giorgi Taktakishvili  
(540)

**CADILLAC CT5**

(511) 12

(260) AM 2015 78215 A  
(210) AM 78215  
(220) 2014 08 04  
(731) GENERAL MOTORS LLC  
300 Renaissance Center, City of Detroit, State  
of Michigan 48265-3000, USA  
(740) Giorgi Taktakishvili  
(540)

**CADILLAC CT6**

(511)12

(260) AM 2015 78221 A  
(210) AM 78221  
(220) 2014 08 06  
(310) 52586/2014  
(320) 2014 03 03  
(330) CH  
(731) ROTHMANS OF PALL MALL LIMITED  
Zaehlerweg 4, Zug, CH 6300, Switzerlan  
(740) Tamar Kochlamazashvili  
(540)

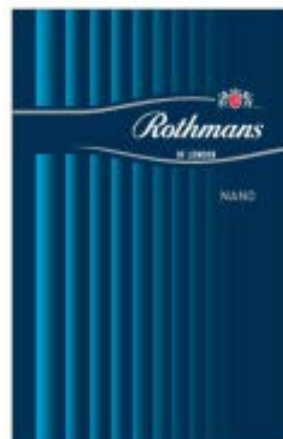

(591) Dark blue, light blue, white, red, silver  
(531) 25.01.01, 26.11.07, 26.11.12, 27.05.19,  
27.05.24, 29.01.15, 24.01.15  
(511) 34

(260) AM 2015 78222 A  
 (210) AM 78222  
 (220) 2014 08 06  
 (310) 52585/2014  
 (320) 2014 03 03  
 (330) CH  
 (731) ROTHMANS OF PALL MALL LIMITED  
 Zaehlerweg 4, Zug, CH 6300, Switzerland  
 (740) Tamar Kochlamazashvili  
 (540)

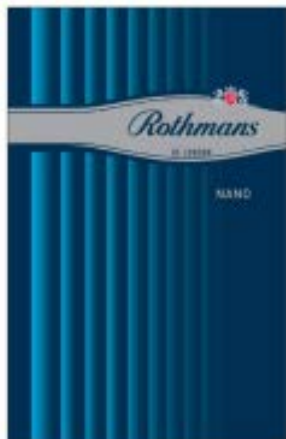

(591) Dark blue, light blue, white, red, silver  
 (531) 24.01.15, 25.01.01, 26.11.07, 26.11.12,  
 27.05.19, 27.05.24, 29.01.15  
 (511) 34

(260) AM 2015 78224 A  
 (210) AM 78224  
 (220) 2014 08 06  
 (731) INTEL CORPORATION  
 2200 Mission College Blvd.  
 Santa Clara, CA 95054-1549, USA  
 (740) Tamaz Shilakadze  
 (540)

**INTEL**

(511) 45

(260) AM 2015 78252 A  
 (210) AM 78252  
 (220) 2014 08 08  
 (731) LTD "ALMAZ-M"  
 RUSSIA, 119034, Moskow, First Obidenskiy  
 pereulok, Build. 10, Russian Federation  
 (740) Shalva Gvaramadze  
 (540)



(591) White, yellow, brown  
 (531) 25.01.01, 27.05.01, 29.01.12, 26.11.12  
 (511) 3

(260) AM 2015 78253 A  
 (210) AM 78253  
 (220) 2014 08 08  
 (731) SHANTHA BIOTECHICS LIMITED  
 3rd & 4th Floor. Vasanta Chimberz,  
 Fateh Maidan Road, Basheerbagh, India  
 (740) Shalva Gvaramadze  
 (540)

**ShanIPV**

(511) 5

(260) AM 2015 78255 A  
 (210) AM 78255  
 (220) 2014 08 09  
 (731) HANKOOK TIRE WORLDWIDE CO., LTD.  
 133, Teheran-ro (Yeoksam-dong), Gangnam-gu,  
 Seoul, 135-723, Republic of Korea  
 (740) Larisa Amirkhanyan  
 (540)

**LAUFENN S FIT**

(591) Black-white  
 (531) 27.05.17, 27.05.19  
 (511) 12

(260) AM 2015 78256 A  
 (210) AM 78256  
 (220) 2014 08 09  
 (731) HANKOOK TIRE WORLDWIDE CO., LTD.  
 133, Teheran-ro (Yeoksam-dong), Gangnam-gu,  
 Seoul, 135-723, Republic of Korea  
 (740) Larisa Amirkhanyan  
 (540)

**LAUFENN G FIT**

(591) Black-white  
 (531) 27.05.19, 27.05.17  
 (511) 12

(260) AM 2015 78257 A  
 (210) AM 78257  
 (220) 2014 08 09  
 (731) HANKOOK TIRE WORLDWIDE CO., LTD.  
 133, Teheran-ro (Yeoksam-dong), Gangnam-gu,  
 Seoul, 135-723, Republic of Korea  
 (740) Larisa Amirkhanyan  
 (540)

**LAUFENN X FIT**

(591) Black-white

(531) 27.05.17, 27.05.19  
(511) 12

(260) AM 78258 A  
(210) AM 78258  
(220) 2014 08 09  
(731) HANKOOK TIRE WORLDWIDE CO., LTD.  
133, Teheran-ro (Yeoksam-dong), Gangnam-gu,  
Seoul, 135-723, Republic of Korea  
(740) Larisa Amirkhanyan  
(540)

**LAUFENN i FIT**

(591) Black-white  
(531) 27.05.17, 27.05.19  
(511) 12

(260) AM 2015 78264 A  
(210) AM 78264  
(220) 2014 08 11  
(731) MASTERCARD INTERNATIONAL  
INCORPORATED  
a Delaware corporation  
2000 Purchase Street, Purchase, New York  
10577, USA  
(740) Tamar Kochlamazashvili  
(540)



(591) Dark blue, blue-white  
(531) 26.01.06, 26.01.24, 27.05.24, 29.01.12  
(511) 9, 16, 35, 36, 38, 39, 42

(260) AM 2015 78267 A  
(210) AM 78267  
(220) 2014 08 12  
(731) DAEWOONG PHARMACEUTICAL  
CO., LTD  
244, Galmachi-ro, Jungwon-gu, Seongnam-si,  
Gyeonggi-do, Republic of Korea  
(740) Tamaz Shilakadze  
(540)

**PROFIDEX-1**

(511) 5

(260) AM 2015 78269 A  
(210) AM 78269  
(220) 2014 08 12  
(731) DAEWOONG PHARMACEUTICAL  
CO., LTD  
244, Galmachi-ro, Jungwon-gu, Seongnam-si,  
Gyeonggi-do, Republic of Korea

(740) Tamaz Shilakadze  
(540)

**ONECEPHINE-1**

(511) 5

(260) AM 2015 78270 A  
(210) AM 78270  
(220) 2014 08 12  
(731) ARVEN ILAC SANAYI VE TICARET  
ANONIM SIRKETI  
Istinye Mahallesi, Balabandere Caddesi No:14  
TR-34460 SARIYER/ISTANBUL, Turkey  
(740) Larisa Amirkhanyan  
(540)

**messina-arven**

(591) Black-white  
(531) 27.05.17  
(511) 5

(260) AM 2015 78271 A  
(210) AM 78271  
(220) 2014 08 12  
(731) ARVEN ILAC SANAYI VE TICARET  
ANONIM SIRKETI  
Istinye Mahallesi, Balabandere Caddesi No:14  
TR-34460 SARIYER/ISTANBUL, Turkey  
(740) Larisa Amirkhanyan  
(540)

**budarol-arven**

(591) Black-white  
(531) 27.05.05  
(511) 5

(260) AM 2015 78272 A  
(210) AM 78272  
(220) 2014 08 12  
(310) UK00003043003  
(320) 2014 02 18  
(330) GB  
(731) BRITISH AMERICAN TOBACCO  
(BRANDS) INC (a Delaware corporation)  
2711 Centerville Road, Suite 300,  
Wilmington, Delaware 19808, USA  
(740) Tamar Kochlamazashvili  
(540)



(591) Black, white, grey, violet, silver  
 (531) 25.01.01, 25.05.02, 25.07.15, 27.05.23,  
 29.01.15  
 (511) 34

(260) AM 2015 78273 A  
 (210) AM 78273  
 (220) 2014 08 12  
 (731) NISSAN JIDOSHA KABUSHIKI KAISHA  
 (also trading as NISSAN MOTOR CO., LTD.)  
 No:2, Takara-cho, Kanagawa-ku, Yokohama-shi,  
 Kanagawa-ken, Japan  
 (740) Shalva Gvaramadze  
 (540)

## DATSUN

(511) 4, 7, 9, 25, 28, 36

(260) AM 2015 78275 A  
 (210) AM 78275  
 (220) 2014 08 12  
 (731) LTD "KANO INVEST"  
 Vashlijvari, korp. 6, b. 27, 0159,  
 Tbilisi, Georgia  
 (740) Nugzar Ksovreli  
 (540)



(591) Blue, light blue, yellow, light yellow, golden,  
 brown, light brown, green  
 (531) 01.03.17, 05.05.04, 25.01.01, 28.19, 29.01.15  
 (526) The trademark is protected as a whole. The  
 words "ჰერეთი, HERETI" included therein shall  
 not be subject to independent legal protection.  
 (511) 29

(260) AM 2015 78290 A  
 (210) AM 78290  
 (220) 2014 08 15  
 (731) ELEMENTOS TRADE LIMITED  
 Avlonos, 1 Maria House 1075, Nicosia,  
 Cyprus, Cyprus  
 (740) Vakhtang Torotadze  
 (540)



(591) Black-white  
 (531) 05.05.04, 28.05  
 (511) 29

(260) AM 2015 78300 A  
 (210) AM 78300  
 (220) 2014 08 18  
 (731) LTD "KAKHA 66"  
 Sh. Tsintsadzis I shes., 64, Tbilisi, Georgia  
 (740) Giorgi Taktakishvili  
 (540)



(591) Yellow, green, bordeaux, brown, beige  
 (531) 05.07.02, 07.01.13, 25.01.05, 29.01.15  
 (511) 30

(260) AM 2015 78315 A  
 (210) AM 78315  
 (220) 2014 08 19  
 (731) PERRY ELLIS INTERNATIONAL GROUP  
 HOLDINGS LIMITED  
 Montague Sterling Center, 5th Floor, East Bay  
 Street, Nassau, Bahamas  
 (740) Tamaz Shilakadze  
 (540)

## THE HAVANERA CO.

(511) 25

(260) AM 2015 78382 A  
 (210) AM 78382  
 (220) 2014 08 25  
 (731) SHULTON, INC.  
 One Procter & Gamble Plaza, Cincinnati OH  
 45202, USA  
 (740) Shalva Gvaramadze  
 (540)

## HARDEST WORKING COLLECTION

(511) 3

(260) AM 2015 78383 A  
 (210) AM 78383  
 (220) 2014 08 25  
 (310) 86278143  
 (320) 2014 05 12  
 (330) US  
 (731) THE GILLETTE COMPANY  
 One Gillette Park, Boston, Massachusetts  
 02127, USA  
 (740) Shalva Gvaramadze  
 (540)

## PROSHIELD

(511) 8



(260) AM 2015 78406 A  
 (210) AM 78406  
 (220) 2014 08 29  
 (731) ABBOTT LABORATORIES  
 100 Abbott Park Road, Abbott Park, Illinois  
 60064, USA  
 (740) Tamar Kochlamazashvili  
 (540)

**PEDIASURE**

(511) 5, 29

(260) AM 2015 78408 A  
 (210) AM 78408  
 (220) 2014 08 29  
 (731) ATTERBURY IP COMPANY  
 (PROPRIETARY) LIMITED  
 The Atterbury Building, Lynnwood Bridge,  
 4 Daventry Street, Lynnwood Manor,  
 0081, Gauteng, South Africa  
 (740) Pavle Meipariani  
 (540)



(591) Black-white  
 (531) 26.03.04, 27.05.10, 26.03.03  
 (511) 35, 36, 37

(260) AM 2015 78409 A  
 (210) AM 78409  
 (220) 2014 08 29  
 (731) NOVARTIS AG  
 4002 Basel, Switzerland  
 (740) Shalva Gvaramadze  
 (540)

**ORTANOL**

(511) 5

(260) AM 2015 78410 A  
 (210) AM 78410  
 (220) 2014 08 29  
 (731) NOVARTIS AG  
 4002 Basel, Switzerland  
 (740) Shalva Gvaramadze  
 (540)

**ОПТАНОЛ**

(511) 5

(260) AM 2015 78411 A  
 (210) AM 78411  
 (220) 2014 08 29

(731) LG HAUSYS, LTD  
 One IFC Building, 10 Gukjegeumyung-ro,  
 Yeongdeungpo-gu, Seoul 150-876, Republic  
 of Korea  
 (740) Larisa Amirkhanyan  
 (540)

**HI-MACS**

(591) Black-white  
 (531) 27.05.17  
 (511) 19

(260) AM 2015 78728 A  
 (210) AM 78728  
 (220) 2014 09 18  
 (310) 86345422  
 (320) 2014 07 23  
 (330) US  
 (731) THE GILLETTE COMPANY  
 One Gillete Park, Boston, Massachusetts  
 02127, USA  
 (740) Shalva Gvaramadze  
 (540)

**FLEXIBALL**

(511) 8

(260) AM 2015 78754 A  
 (210) AM 78754  
 (220) 2014 09 19  
 (731) DIAGEO NORTH AMERICA, INC.  
 a Connecticut corporation. 801 Main Avenue,  
 Norwalk CT 06851, USA  
 (740) Tamar Kochlamazashvili  
 (540)



(591) Black-white  
 (531) 24.01.09, 24.09.01, 24.01.01, 24.01.03  
 (511) 33

(260) AM 2015 78849 A  
 (210) AM 78849  
 (220) 2014 09 29  
 (731) KENTUCKY FRIED CHICKEN  
 INTERNATIONAL HOLDINGS, INC.  
 1441 Gardiner Lane, Louisville, Kentucky  
 40213, USA  
 (740) Tamar Kochlamazashvili  
 (540)

**ICE DREAM**

(511) 30

(260) AM 2015 78850 A

(210) AM 78850

(220) 2014 09 29

(731) KENTUCKY FRIED CHICKEN  
INTERNATIONAL HOLDINGS, INC.  
1441 Gardiner Lane, Louisville, Kentucky  
40213, USA

(740) Tamar Kochlamazashvili

(540)

**სის ღრობი**

(511) 30

(540)

**Super Star**

(511) 2

(260) AM 2015 78899 A

(210) AM 78899

(220) 2014 09 30

(731) Ketevan Salakaia  
Abashidzis 32, Tbilisi, Georgia

(740) Ketevan Salakaia

(540)



(591) Pink, white

(531) 25.01.01, 25.01.13, 26.01.20, 26.04.09,  
26.04.10, 29.01.14, 19.03.24, 27.05.24,

(526) The trademark is protected as a whole. The word "PATISSERIE" included therein shall not be subject to independent legal protection.

(511) 30, 32

(260) AM 2015 79030 A

(210) AM 79030

(220) 2014 10 09

(731) LTD "ZIP

Ul. Shirokaya, 107 A, Dneprodzerzhinsk,  
Dnepropetrovskaya obl., 51901, Ukraine

(740) Davit Dзамukashvili

(540)

**Супер Стар**

(511) 2

(260) AM 2015 79031 A

(210) AM 79031

(220) 2014 10 09

(731) LTD "ZIP

Ul. Shirokaya, 107 A, Dneprodzerzhinsk,  
Dnepropetrovskaya obl., 51901, Ukraine

(740) Davit Dзамukashvili



---

**REGISTERED TRADEMARKS**

(111) M 2015 025779 R  
(151) 2015 04 15  
(181) 2025 04 15  
(260) AM 2014 70882 A  
(220) 2013 08 07  
(732) LTD "Gudauri SQI RESORT"  
Makashvilis q. 31, Dzveli Tbilisis raioni,  
0105, Tbilisi, Georgia

---

(111) M 2015 025780 R  
(151) 2015 04 15  
(181) 2025 04 15  
(260) AM 2015 73130 A  
(220) 2013 07 18  
(732) LTD "A-B-C PHARMACIA"  
Sanapiros q. 10, 0108, Tbilisi, Georgia

---

(111) M 2015 025781 R  
(151) 2015 04 15  
(181) 2025 04 15  
(260) AM 2014 73927 A  
(220) 2013 09 13  
(732) PJSC "KIEVMEDPREPARATI"  
Ul. Saksaganskogo, 139, Kiyiv, 01032,  
Ukraine

---

(111) M 2015 025782 R  
(151) 2015 04 15  
(181) 2025 04 15  
(260) AM 2014 74104 A  
(220) 2013 09 30  
(732) WANG JIANHUA  
ChengJiaCun, Shangshu Village, An'Ji  
County, Zhejiang Province, China

---

(111) M 2015 025783 R  
(151) 2015 04 15  
(181) 2025 04 15  
(260) AM 2014 74105 A  
(220) 2013 09 30  
(732) WANG JIANHUA  
ChengJiaCun, Shangshu Village, An'Ji  
County, Zhejiang Province, China

---

(111) M 2015 025784 R  
(151) 2015 04 15  
(181) 2025 04 15  
(260) AM 2014 74772 A  
(220) 2013 11 18  
(732) LTD "WORLD MEDICINE"  
Berbutis q. 10/Almasianis q. 19/21 (bloki II),  
b. 26 bloki II, 0171, Tbilisi, Georgia

---

(111) M 2015 025785 R  
(151) 2015 04 15  
(181) 2025 04 15  
(260) AM 2014 74800 A  
(220) 2013 11 20  
(732) MEADWESTVACO CORPORATION  
501 South 5th Street, Richmond, Virginia  
23219-0501, USA

---

(111) M 2015 025786 R  
(151) 2015 04 15  
(181) 2025 04 15  
(260) AM 2014 74801 A  
(220) 2013 11 20  
(732) MEADWESTVACO CORPORATION  
501 South 5th Street, Richmond, Virginia  
23219-0501, USA

---

(111) M 2015 025788 R  
(151) 2015 04 16  
(181) 2025 04 16  
(260) AM 2014 74778 A  
(220) 2013 11 19  
(732) LTD "BARAMBO"  
Sop. Nataktari, 3308, Mtskheta, Georgia

---

## TRADEMARKS REGISTERED ACCORDING TO THE ACCELERATED PROCEDURE

The decision can be appealed at the Chamber of Appeal of Sakpatenti within 3 months from the publication.

(111) M 2015 25778 R

(151) 2015 04 14

(181) 2025 04 14

(210) AM 081488

(220) 2015 03 31

(732) LTD "MAKNATUNA"

Gugunavas q. 13 (nakv. 4-3/2), 4600, Kutaisi,  
Georgia

(740) Emzar Sokhadze

(540)

(540)

**მამისტრო-24**

**MAESTRO-24**

**МАЭСТРО-24**

(591) Black, white

(531) 27.05.05-28.05.00-28.19.00-

(511) 38



(591) White, black, blue, red, yellow

(531) 01.03.20-16.03.13-28.19.00-29.01.15-

(511) 30, 31

(111) M 2015 25787 R

(151) 2015 04 15

(181) 2025 04 15

(210) AM 081037

(220) 2015 03 02

(732) SMITHKLINE BEECHAM LIMITED

980 Great West Road, Brentford, Middlesex  
TW8 9GS, United Kingdom

(740) Shalva Gvaramadze

(540)

**ავოდარტი**

(591) Black, white

(531) 28.19.00-

(511) 5

(111) M 2015 25789 R

(151) 2015 04 17

(181) 2025 04 17

(210) AM 081350

(220) 2015 03 23

(732) LTD "TELECOMPANY MAESTRO"

Erekle Tatishvilis q. 19, 0179, Tbilisi, Georgia

(740) Giorgi Meipariani

## INTERNATIONAL TRADEMARKS FOR WHICH A DECISION ON GRANTING PROTECTIONS IS TAKEN

The decision can be appealed at the Chamber of Appeal of Sakpatenti within 3 months from the publication or at the Mtskheta District Court Administrative Cases Board (Address: №17, Samkhedro str., Mtskheta), within 1 month following the publication.

(260) AM 73494 A\*  
(800) 1169531  
(731) GLUTOLIN RENOVIERUNGSPRODUKTE  
GMBH  
Im Schedetal 1, 34346 Hann. Münden,  
Germany

(540)

### GLUTOLIN

(591) Black, white

(511)

1 – adhesives used in industry; adhesives for do-it-yourself supplies; adhesives for wall coverings, ceiling coverings and floor coverings; adhesives for insulating plates; wallpaper pastes; fixations for floor coverings (as far as included in this class); fillers for mineral-based foundations or resin-based foundations; wallpaper removing preparations; facade impregnating preparations.

2 – Paints; varnishes; lacquers; dispersion paints; full tone paints and tinting paints; ceiling paints and wall paints; effect paints; color concentrates; primers; preservatives against rust; preservatives against deterioration of wood.

19 – Building materials (non-metallic); plaster, cement; mortar; leveling floor compounds; fillers for filling cracks, joints or holes in walls, ceilings and facades; fillers for smoothing, leveling and repairing uneven surfaces, especially on a plaster basis or a cement basis.

(260) AM 74632 A\*  
(800) 1179759  
(731) FARMAK INTERNATIONAL HOLDING  
GMBH  
Mariahilferstrasse 136, A-1150 Wien, Austria

(540)

Би-сепТ-Фармак 

(591) Black, white

(511)

5 – Medicines for human purposes; pharmaceutical, veterinary, diagnostic preparations for medical purposes; medicinal infusions; ointments for pharmaceutical purposes.

(260) AM 2015 76359 A  
(800) 1194291  
(891) 2013 09 04  
(731) DR. SERTUS İLAÇ SANAYİ VE TİCARET  
LİMİTED ŞİRKETİ  
vren Mah. Camiyolu Cad. No:50 K.2 Güneşli,  
Bağcılar İstanbul, TR

(540)

### GEMBAG

### ГЕМБАГ

(591) Black, white

(511)

5 – Medicines for human purposes, medicines for veterinary purposes, vitamin preparations, chemical preparations for medical purposes, dietetic substances adapted for medical use; dietetic foods adapted for medical purposes; baby foods, medicinal herbs, herbal beverages adapted for medical purposes, nutritional supplements, pollen dietary supplements, mineral food supplements, protein dietary supplements; medicines for dental purposes, hygienic products for medical purposes including pads, waddings for medical purposes, plasters for medical purposes, dressings for medical purposes, babies' napkins, preparations for destroying noxious plants, preparations for destroying noxious animals, fungicides, deodorants other than for human beings or for animals, air deodorising preparations, disinfectants for hygiene purposes, antiseptics, detergents for medical purposes.

(260) AM 2015 76361 A  
(800) 1194339  
(891) 2013 12 19  
(731) PIERRE FABRE DERMO-COSMETIQUE  
45 place Abel Gance, F-92100 BOULOGNE,  
FR

(540)

### SENSINOL

(511)

3 – Cosmetic products.

5 – Dermatological products; dermo-cosmetic products for skin hygiene and care.

(260) AM 2015 76362 A  
 (800) 1194388  
 (891) 2013 09 05  
 (731) PRIVATE JOINT STOCK COMPANY  
 "INDUSTRIAL ASSOCIATION "KONTI"  
 Bul. Shevchenko, 6-b Donetsk 83015, UA

(540)  
**Фруктовая радуга**

(511)  
 30 – Coffee; tea; cocoa; sugar; rice; tapioca; sago; artificial coffee; flour and preparations made from cereals; bread; pastry and confectionery; ices; honey; golden syrup; yeast; baking-powder; salt; mustard; vinegar; sauces (condiments); spices; edible ices; peanut confectionery; biscuits; farinaceous foods; pastries; bagels; bread rolls; buns; sandwiches; dumplings; waffles; waffle cakes; products of puff pastry with fillings; oat cakes; oat flakes; oat-based food; desserts (confectionery); dragée (confectionery); yeast and non-yeast pastries; essences for foodstuffs, except etheric essences and essential oils; fruit and berries jellies (confectionery); jelly candy; chewing gums, not medical; custard; frozen kefir and yogurt (frozen confectionery); marshmallow; marshmallow covered with chocolate; cocoa and coffee beverages; coffee beverages with milk; cocoa with milk; cocoa products; paskha (Easter cake); caramels (candy); lozenges (confectionery); cakes; ketchup (sauce); royal jelly; peanut brittle; crackers; starch products for food; croissants; corn (roasted); corn bagels; corn flakes; pita; pita with various fillings; confectionery for decorating Christmas trees; liquorice (confectionery); candies; mayonnaise; farinaceous food pastes; marzipan; almond cookies; almond confectionery; flour-milling products; pancakes; spring rolls; dessert mousses (confectionery); muesli; peppermint sweets; pancakes with fillings; tea-based beverages; chocolate-based beverages; infusions, not medical; donuts; paste; ravioli; cookies; glazed chocolate cookies; pies (confectionery); pizza; natural sweeteners; chips (cereal products); fondants (confectionery); popcorn; praline; gingerbread; gingerbread with various fillings; puddings; Turkish delight; rice cakes; puddings (confectionery); chocolate puddings (confectionery); petit-beurre biscuits; sushi; cakes; petits fours (cakes); almond paste; cake paste; puff pastry; fruit, citrus and berry ice; halvah; vanilla halvah; halvah made of sesame; chocolate halvah; pistachio halvah; halva with various additives including nuts, raisins, peanuts, dried apricots; candy cake decorations; chocolate cake decorations; bakery; sweetmeats (candy); sugar confectionery; waffle candies; charlotte; chocolate; chocolate-based desserts; chocolate cream; chocolate dragée with raisins or nuts; chocolate paste; chocolate brownies; chocolate candies; chocolate bars; chocolate sweets in the form of figurines; chocolate beverages with milk; iced tea; iced tea.

(260) AM 2015 76363 A  
 (800) 1194389  
 (891) 2013 09 04  
 (731) WORLD MEDICINE İLAÇ SANAYİ VE  
 TİCARET LİMİTED ŞİRKETİ  
 Evren Mah. Camiyolu Cad. No:50 K:1 B,  
 Zemin 4-5-6, Güneşli Bağcılar İstanbul, TR

(540)

**DERYLIFE**  
**ДЕРИЛАЙФ**

(591) Black, white

(511)

5 – Medicines for human purposes, medicines for veterinary purposes, vitamin preparations, chemical preparations for medical purposes, dietetic substances adapted for medical use; dietetic foods adapted for medical purposes; baby foods, medicinal herbs, herbal beverages adapted for medical purposes, nutritional supplements, pollen dietary supplements, mineral food supplements, protein dietary supplements; medicines for dental purposes, hygienic products for medical purposes including pads, waddings for medical purposes, plasters for medical purposes, dressings for medical purposes, babies' napkins, preparations for destroying noxious plants, preparations for destroying noxious animals, fungicides, deodorants other than for human beings or for animals, air deodorising preparations, disinfectants for hygiene purposes, antiseptics, detergents for medical purposes.

(260) AM 2015 76372 A  
 (800) 1194394  
 (891) 2013 10 10  
 (731) ZUCAMI POULTRY EQUIPMENT, S.L.U.  
 Polig. Ind. Morea Norte, C/C No:2, E-31191  
 BERIAIN (NAVARRA), ES

(540)

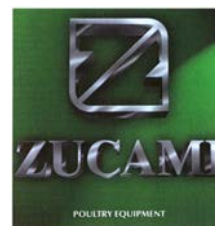

(591) Green, silver, black

(526) The trademark is protected as a whole. The words "POULTRY" and "EQUIPMENT" included therein shall not be subject to independent legal protection.

(511)

6 – Poultry cages of metal.

7 – Incubators for poultry; incubators for eggs; nesting boxes for domestic fowl.

37 – Maintenance of poultry cages of metal, incubators for poultry, incubators for eggs and nesting boxes for domestic fowl.

(260) AM 2015 76374 A

(800) 1194398

(891) 2013 09 14

(731) MARINASUN CELLULOSE INDUSTRIES CO.

Unit:1, T floor, 3rd Building, Eskan Complex,  
Mirdamad Blvd., Valie Asr Ave. Tehran, IR

(540)



(591) Dark blue, gray and light blue

(511)

5 – Sanitary napkins, menstruation tampons, babies' diapers.

16 – Napkins of paper, handkerchiefs of paper, toilet paper, towels of paper, scented paper, cellulose wipes, tissues of paper for removing make-up.

(260) AM 2015 76487 A

(800) 1166887

(891) 2013 07 12

(731) Fbm Lazer Estetik Plastik Cerrahi Kliniği

Sanayi Ticaret Limited Şirketi  
Kale Mah., Şükrüefendi Sokak No:2/2,  
İlkadim/Samsun, TR

(540)



(591) Blue

(511)

44 – Medical services; veterinary services; hygienic and beauty care for human beings or animals, agriculture, horticulture and forestry services.

(260) AM 2015 76816 A

(800) 1198189

(891) 2014 02 19

(731) Zakrytoe aktsionernoe obshchestvo Firma

"BERTELSMANN MEDIA MOSCOW"  
Zvyozdny bulvar, d. 21, str. 3, pom. 1, komn.  
5, RU-129085 Moscow, RU

(540)



(591) Black, white

(511)

16 – Newspapers; calendars; maps; geographical maps; posters; newsletters; catalogues; books; graphic prints; greeting cards; postcards; periodicals; printed publications; printed matter; prospectuses; photographs [printed].

41 – Publication of books; organization of exhibitions for cultural or educational purposes; arranging and conducting of conferences; arranging and conducting of congresses; arranging and conducting of seminars; arranging and conducting of symposiums; publication of texts, other than publicity texts; publication of electronic books and journals on-line; providing on-line electronic publications, not downloadable; videotaping; photography; news reporters services; electronic desktop publishing.

(260) AM 2015 76836 A

(800) 1198247

(891) 2013 12 10

(731) VIENNA INSURANCE GROUP AG Wiener

Versicherung Gruppe  
Schottenring 30, A-1010 Vienna, AT

(540)



(591) Green, black and grey

(511)

36 – Insurance, financial affairs.

(260) AM 2015 76839 A

(800) 1198288

(891) 2014 02 07

(731) "TM Navigator" Limited

Dmitrovskoe shosse, d. 107, str. 1, RU-127247  
Moscow, RU

(540)



(591) Black, white and red

(511)

9 – Apparatus and instruments for conducting, switching, transforming, accumulating, regulating or controlling electricity; electric accumulators; remote control apparatus; galvanic batteries; solar batteries; electric batteries; anode batteries; plugs, sockets and other contacts [electric connections]; current rectifiers; light-emitting diodes; electric door bells; electric cables; wire connectors [electricity]; distribution boxes [electricity]; junction boxes [electricity]; elec-

tric converters; electric wires; light dimmers [regulators], electric; electric couplings; transformers; chargers for electric batteries; battery chargers; optical lamps; galvanic cells.

11 – Apparatus for lighting; light bulbs; electric light bulbs; safety lamps; gas lamps; germicidal lamps for purifying air; projector lamps; arc lamps; electric lights for Christmas trees; electric lamps; chandeliers; sockets for electric lights; lamp reflectors; lamp mantles; lighting apparatus and installations; light-emitting diodes [LED] lighting apparatus; diving lights; ceiling lights; lamps; standard lamps; electric discharge tubes for lighting; luminous tubes for lighting; bicycle lights; electric pocket torches; lanterns for lighting.

(260) AM 2015 76854 A

(800) 1198417

(891) 2014 02 06

(731) HUIZHOU OIWAS SPORTS EQUIPMENT CO., LTD.

Huabianling Industry Zone, XinXuTown,  
Huiyang District, Huizhou City, Guangdong,  
CN

(540)



(591) Black, grey, white

(511)

18 – Animal pelts; handbags; attaché cases; shoulder straps; umbrellas; canes; harness straps; school bags; travelling bags; rucksacks; backpacks; bags for sports; valises; trunks.

(260) AM 2015 76856 A

(800) 1198428

(891) 2013 12 20

(731) ARCHROMA IP GMBH

Neuhofstrasse 11, CH-4153 Reinach, CH

(540)



(591) Black, white, grey

(511)

1 – Chemicals for use in the textile, paper and emulsions industries; chemicals used in the manufacture of fabric, textiles, paper and emulsions; emulsions resulting from the polymerization of one or more monomers; synthetic resin compositions for use in the manufacture and processing of leather; chemicals for use in industry; unprocessed artificial resins;

synthetic resins; chemicals used as dispersing agents; chemical products for use in the manufacture of paints; chemical products for use in the manufacture of varnishes and enamels; solutions for the treatment of textiles and fabrics, clothing, apparel, home textiles, carpets, sterilized materials and technical textiles for use in the medical, construction and transportation industries; chemical flame retardants that are applied to finished products.

2 – Pigments, colorants, dyestuffs, dyes, colors, paints, enamel paints, varnishes, lacquers.

38 – Telecommunication and communication services by electronic means, transfer of data and information; electronic transmission of requests, offers and orders.

42 – Technical and scientific consulting, research, development, engineering and testing services concerning textiles and textile goods, cellulose, paper, paperboard, non-woven paper substitutes, laminate paper, pressurized wood, emulsions, emulsion formulations, resins, pigments, colorants, dyestuffs, dyes, colors, paints, enamel paints, varnishes and lacquers; laboratory services, namely pigment and color analysis; development and design services in the field of textiles, paper and emulsions.

(260) AM 2015 76857 A

(800) 1198455

(891) 2013 11 18

(731) SİNTAŞ BOYA VE KİMYA SANAYİİ LİMİTED ŞİRKETİ

Çerkezköy Organize Sanayi, Bölgesi Hızır  
Sokak No:27, Çerkezköy, Tekirdağ, TR

(540)



(591) Red, white

(511)

2 – Raw natural resins, paints, (for motor vehicle and industrial purposes) varnishes, lacquers, anti-rust preparations for preservation; preservatives against rust and against deterioration of wood; thinners for lacquers; paints; primers; ink [toner] for photocopiers, ink for leather; metals in foil and powder form for painters, decorators, printers and artists.

(260) AM 2015 76858 A

(800) 1198459

(891) 2013 11 18

(731) SİNTAŞ BOYA VE KİMYA SANAYİİ LİMİTED ŞİRKETİ

Çerkezköy Organize Sanayi, Bölgesi Hızır  
Sokak No:27, Çerkezköy, Tekirdağ, TR



(540)



(591) Black, white

(511)

2 – Raw natural resins, paints, (for motor vehicle and industrial purposes) varnishes, lacquers, anti-rust preparations for preservation; preservatives against rust and against deterioration of wood; thinners for lacquers; paints; primers; ink (toner) for photocopiers, ink for leather; metals in foil and powder form for painters, decorators, printers and artists.

(260) AM 2015 76859 A

(800) 1198474

(891) 2014 02 07

(731) KRAFT FOODS DEUTSCHLAND  
HOLDING GMBH

4-20, Langemarckstraße, 28199 Bremen, DE

(540)

**JACOBS SWITCH ON**

(511)

30 – Coffee, coffee extracts, coffee substitutes, coffee beverages and preparations for such beverages, tea.

(260) AM 2015 76864 A

(800) 1198551

(891) 2014 01 14

(731) ADRIATIC SLOVENICA d.d.

Ljubljanska cesta 3A, SI-6000 KOPER, SI

(540)



(591) Black and orange

(511)

36 – Insurance; financial affairs; real estate affairs; pension fund services; pension insurance, retirement insurance, private pension insurances; income insurance, annuity insurance underwriting; life insurance; health insurance; accident insurance; insurance of possessions and persons; fire insurance; earthquake insurance; insurance underwriting; vehicle, air vehicle and water vehicle insurance; home insurance; real estate insurance; insurance for shows and events; liability insurance; insurance of animals; goods in transit insurance; insurance information; insurance consultancy; insurance brokerage; financial evaluation (insurance); credit protection insurance and surety insurance; financial loss insurance; life insurance with risk investments; insurance representation services and insurance intermediary services; all the aforesaid services also supplied online via a computer network and/or the Internet.

(260) AM 2015 76963 A

(800) 1199491

(891) 2013 12 18

(731) PAKSHOO MANUFACTURING &  
CHEMICAL CONo:29, The 2nd Alley, Pakistan St., Beheshti  
Ave, Tehran, IR

(540)

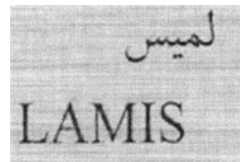

(591) Black, white

(511)

3 – Cosmetics, detergents for household use and laundry preparations, shampoos, baby shampoo, body shampoo, soap and soap powder, hair masks, air freshener, hand washing liquid, water free hand sanitizer and toothpastes, dish washing liquids, hair conditioner, fabric softeners for laundry use, bleaching preparations, window and glass cleaners, oven cleaners, bathroom and faucet cleaner, car cleaners, washing machine and detergent powders, laundry and dish washer detergent tablets, dishwasher salt and powder and liquid supplements, laundry liquids, surface cleaners – cream and liquid, carpet shampoos-liquid and foam, all purpose liquid cleaner, pipe and drain opener, mouth wash not for medical purposes, mouth freshener pills, lime & stain removers; antiseptic and hand cleaning gels.

35 – Advertising, publicity, business management, office functions export services of all aforementioned goods.

(260) AM 2015 77153 A

(800) 1180630

(891) 2014 03 10

(731) PHILIP MORRIS PRODUCTS S.A.

Quai Jeanrenaud 3, CH-2000 Neuchâtel, CH

(540)



(591) Black, white

(511)

34 – Tobacco, raw or manufactured; tobacco products, including cigars, cigarettes, cigarillos, tobacco for roll-your-own cigarettes, pipe tobacco, chewing tobacco, snuff tobacco, kretek; snus; tobacco substitutes (not for medical purposes); smokers' articles, including cigarette paper and tubes, cigarette filters, tobacco tins, cigarette cases and ashtrays, pipes, pocket apparatus for rolling cigarettes, lighters; matches.

(260) AM 2015 77160 A  
 (800) 1193954  
 (891) 2014 03 20  
 (731) NOKIAN TYRES PLC.  
 Pirkkalaistie 7, Nokia, FI  
 (540)



(591) Black, white  
 (511)  
 12 – Vehicle tyres and inner tubes; parts, fittings and spare parts for vehicles.  
 35 – Retail and franchising services of vehicles, their parts, fittings and spare parts.  
 37 – Maintenance, repair and installation services of vehicles, tyres, their parts, fittings and spare parts.

(260) AM 2015 77173 A  
 (800) 1201360  
 (891) 2013 08 22  
 (731) THE CORPORATE EXECUTIVE BOARD  
 COMPANY  
 1919 North Lynn Street, Arlington VA 22209,  
 US  
 (540)



(591) Blue  
 (511)  
 16 – Printed matter; instructional and teaching material; books; periodical publications; leaflets, forms and printed questionnaires; articles of stationery; office requisites, other than furniture.  
 35 – Business management advice and assistance; consultancy and expert services all relating to business; personnel management advice; data processing, data verification and data management; commercial and personnel information services; employment and personnel consultancy and management services; arranging and conducting business and commercial conferences and seminars; statistical studies and provision of statistical information, all relating to personnel and recruitment; testing of individuals to determine employment skills; consultancy services relating to the assessment, development and application of human resource; business information and advisory services; preparations of reports, all relating to the foregoing; analysis of market research data and statistics; business advisory services in the field of corporate best practices, sales professional development, support and management; business advisory services, consultancy and information; business data analysis; conducting business and market research surveys.

41 – Educational, instructional and training services, all relating to business, personnel, vocational testing and guidance, personality testing, psychological examination and career advice; arranging and conducting educational and training conferences and seminars; production of sound and video recordings; lease, hire and rental of instructional and teaching materials; information services and preparation of reports, all relating to the foregoing; educational services, namely, conducting classes, seminars, lectures, workshops, in the field of corporate best practices, sales professional development, support and management and distribution of course material in connection therewith; educational services, namely, developing curriculum for others in the field of corporate best practices, sales professional development, support and management; educational services, namely, developing, arranging, and conducting educational conferences and programs and providing courses of instruction in the field of corporate best practices, sales professional development, support and management; educational services, namely, providing on-line classes, seminars, lectures, workshops in the field of corporate best practices, sales professional development, support and management career advice; career and vocational counselling.

42 – Providing temporary use of online non-downloadable software in the field of personnel, vocational testing and guidance, personality testing and psychological examination.

(260) AM 2015 77174 A  
 (800) 1201480  
 (891) 2014 03 10  
 (731) FORMULA ONE LICENSING B.V.  
 Beursplein 37, NL-3011 AA Rotterdam, NL  
 (540)

**HISTORIC FORMULA ONE**

(511)  
 41 – Education; training; entertainment; sporting and cultural activities.

(260) AM 2015 77176 A  
 (800) 1201508  
 (891) 2014 01 24  
 (731) Limited Liability Company  
 "INTERNET COMPANY MAIL.RU"  
 Leningradsky pr-kt, d. 39, str. 79, RU-125167  
 Moscow, RU  
 (540)



(591) Black, white



(511)

9 – Video cassettes; video game cartridges; compact discs [audio-video]; compact discs [read-only memory]; magnetic data media; optical data media; computer software, recorded; computer programmes [programs], recorded; computer game software; computer programs [downloadable software]; computer operating programs, recorded; downloadable image files; downloadable music files; animated cartoons; USB flash drives.

16 – Almanacs; atlases; posters; pamphlets; booklets; newsletters; newspapers; engravings; magazines [periodicals]; periodicals; printed publications; graphic representations; calendars; geographical maps; catalogues; books; comic books; lithographs; graphic prints; greeting cards; postcards; printed matter; prospectuses; manuals [handbooks]; photographs [printed].

28 – Arcade video game machines; video game machines; gaming machines for gambling; amusement machines, automatic and coin-operated; jigsaw puzzles; toys; mobiles [toys]; parlor games; board games; games; building games; playing cards; scale model kits [toys]; portable games with liquid crystal displays; apparatus for games.

35 – Rental of advertising space; computerized file management; demonstration of goods; opinion polling; marketing studies; business investigations; marketing research; news clipping services; updating of advertising material; organization of exhibitions for commercial or advertising purposes; organization of trade fairs for commercial or advertising purposes; shop window dressing; data search in computer files for others; commercial or industrial management assistance; presentation of goods on communication media, for retail purposes; auctioneering; sales promotion for others; production of advertising films; rental of advertising time on communication media; publicity material rental; publication of publicity texts; radio advertising; bill-posting; dissemination of advertising matter; direct mail advertising; advertising; on-line advertising on a computer network; advertising by mail order; television advertising; compilation of information into computer databases; systemization of information into computer databases; publicity columns preparation; administrative processing of purchase orders; public relations.

38 – News agencies; television broadcasting; cable television broadcasting; electronic bulletin board services [telecommunications services]; information about telecommunication; providing user access to global computer networks; providing access to databases; providing internet chatrooms; providing telecommunications connections to a global computer network; providing telecommunication channels for teleshopping services; transmission of greeting cards

online; message sending; computer aided transmission of messages and images; transmission of digital files; electronic mail; providing online forums; rental of access time to global computer networks; radio broadcasting; communications by fiber [fibre] optic networks; cellular telephone communication; communications by computer terminals; communications by telephone; paging services [radio, telephone or other means of electronic communication]; teleconferencing services; voice mail services; telephone services.

41 – Booking of seats for shows; videotaping; gambling; publication of books; education information; recreation information; entertainment information; health club services [health and fitness training]; night clubs; layout services, other than for advertising purposes; videotape editing; game services provided on-line from a computer network; providing on-line electronic publications, not downloadable; practical training [demonstration]; organization of exhibitions for cultural or educational purposes; providing recreation facilities; arranging and conducting of colloquiums; arranging and conducting of conferences; arranging and conducting of workshops [training]; arranging and conducting of seminars; organization of competitions [education or entertainment]; operating lotteries; television entertainment; videotape film production; rental of videotapes; rental of sound recordings; publication of electronic books and journals online; publication of texts, other than publicity texts; radio entertainment; entertainer services; entertainment; writing of texts, other than publicity texts; news reporters services; party planning [entertainment]; providing casino facilities [gambling]; club services [entertainment or education]; teaching; recording studio services; photography; production of shows.

42 – Computer system analysis; recovery of computer data; computer virus protection services; installation of computer software; information technology [IT] consultancy; consultancy in the design and development of computer hardware; computer software consultancy; updating of computer software; maintenance of computer software; providing search engines for the internet; data conversion of computer programs and data [not physical conversion]; computer system design; computer rental; rental of computer software; hosting computer sites [web sites]; server hosting; duplication of computer programs; computer software design; creating and maintaining web sites for others; computer programming.

45 – Missing person investigations; personal background investigations; dating services.

---

(260) AM 2015 77219 A  
(800) 1201883  
(891) 2014 02 13

(731) HAITEC Aircraft Maintenance GmbH  
Maintenance Hangar 900, 55483 Hahn-  
Flughafen, DE

(540)



(591) Black, white

(511)

37 – Servicing, maintenance and repair of planes, aircrafts and flying machines.

(260) AM 2015 77239 A

(800) 1202047

(891) 2013 12 06

(731) BYSTRONIC LASER AG

Industriestrasse 21, CH-3362 Niederönz, CH

(540)

## BYSTRONIC XCITE

(511)

7 – Bending machines; bending presses; stamping machines; presses (machines for industrial use); straighteners; deep-drawing presses; molding machines; drills; drilling heads (parts of machines); chisels for machines; engraving machines; milling machines; punching machines; stamping machines; saws (machines); cutting machines; cutting machines (cutters); lathes; electric generators; coils for machines; control apparatus for machines, motors or engines; controllers (parts of machines); filtering machines; filters (parts of machines, motors or engines); pumps (machines); pumps (parts of machines, motors or engines); pump diaphragms; sludge collectors (machines); vacuum pumps (machines); guides for machines; bearings (machine parts); machine housings; machine wheels; machine stands; tables for machines; axles for machines; tools (parts of machines); tool holders (parts of machines); roller bearings; chucks (parts of machines); machine bearings; gas-operated cutting torches; plasma cutting and welding machines; gas-operated welding apparatus; gas-operated welding machines; glass-working machines; machine tools for glass processing, namely for the manufacture of structural glazing and glazing and glass plates for land vehicles and aircraft; glass cutting machines; lifting platform; lifting apparatus; elevating apparatus; loading equipment, namely for installations for transport and storage of raw materials and semi-finished and finished parts; automatic magazines; mechanical storage installations; hydraulic motors and engines; hydraulic drives for machines, motors and engines; pneumatic drives for machines, motors and engines; cylinders for machines; cylinder pistons; electric arc cutting apparatus; electric arc welding apparatus; welding apparatus (electric); welding machines (electric); automatic welding machines (electric); machines for the textile indus-

try; sugar making machines; machines for making pasta; machines for the food industry; metal processing machines; machine tools; robots (machines); machine tools for beam machining of workpieces; water jet cutting machines; laser cutting machines; laser welding machines; accessories and auxiliary equipment (machines and machine parts) for beam machining of workpieces, spare parts for these items; parts and accessories of the above machines and tools, insofar as included in this class, in particular machine tools, handling equipment; spare parts for machines.

40 – Information about material processing; milling; engraving; cutting; water jet cutting; laser cutting; laser engraving; metal machining; sawing; sanding; welding; water jet machining; water treatment; custom assembling of materials (for others); identifying and marking; rental of machines for material machining; providing information in the field of material processing, especially of machine-specific information, on the Internet and on screen.

(260) AM 2015 77241 A

(800) 1202153

(891) 2013 11 07

(731) BIERJET GMBH

Pummerinplatz 3, A-4490 St. Florian, AT

(540)

## BIERJET

(511)

7 – Dispensing system, filling machines, automatic dispensers, beer pumps, vending machines.

20 – Sideboards (furniture), furniture, counters, bars, pub furniture.

32 – Beers.

(260) AM 2015 77247 A

(800) 1201402

(891) 2013 12 05

(731) WHIRLPOOL POLSKA S.A.

Gen.T.Bora – Komorowskiego 6, PL-51-210  
Wrocław, PL

(540)

## POLAR

(511)

7 – Motors including electric motors (except for land vehicles); electrically driven pumps included in this class excluding pump equipment for steam; compressors for refrigeration and air conditioning; appliances and installations for washing food, linen and textiles, namely clothes washing machines, dishwashers, machines for washing glasses, machine for washing vegetables, dry cleaning machines, spin dryer, ironing machines, pressing and ironing machines; components and accessories for washing

machines and for dishwashers; installations for preparing and processing food; components and accessories for machines and installations for preparing and cooking food and beverages; components food waste disposals; food waste and trash compactors; small portable appliances namely blenders, mixers, food grinders, juicers, parts and fitting relative to these products.

11 – Appliances and apparatus for heating, steam generating, cooking, refrigerating, freezing, drying, air conditioning, air purifying, ventilating, water supply, including electric toaster ovens, electric toasters, electric hot beverage making machines, electric coffee makers, electric waffle makers, electric ice cream makers, electric food warming units, food warming drawers, clothes drying machines; washbasins and sinks; electric cooking ranges and ovens, gas cooking ranges and ovens, range and microwave hoods; cook-tops; hot plates; microwave ovens; refrigerators; freezers; combination refrigerator-freezers; refrigerator ice cube making machines; temperature controlled wine cellars, hot water dispensers, water supply units for dispensing cold water and ice from refrigerators and filtered water from domestic water filtration units; parts and attachments for all of the above goods; whereby appliances and apparatus for refrigerating and/or freezing excluding cryocoolers, stirring coolers other than for installation in refrigerating equipment for food and drinks and excluding cryocoolers, stirring coolers for cooling telecommunications components and high-temperature superconductors.

37 – Installation, repair and maintenance of motors including electric motors (except for land vehicles), electrically driven pumps, compressors for refrigeration and air conditioning, electromechanical appliances, clothes washing machines, clothes drying machines, dishwashers, food waste disposals, food waste and trash compactors, appliances and apparatuses for heating, cooking, drying, refrigerating, freezing, microwave ovens, cooker hoods, air purifying, ventilating and water supply installations.

(260) AM 2015 77250 A  
(800) 1202303  
(891) 2014 02 11  
(731) OCEANIC S.A.  
ul. Łokietka 58, PL-81-736 Sopot, PL  
(540)



(591) Blue, white and yellow  
(511)  
3 – Cosmetics.

5 – Pharmaceutical preparations.

(260) AM 2015 77251 A  
(800) 1202331  
(891) 2013 11 07  
(731) BIERJET GMBH  
Pummerinplatz 3, A-4490 St. Florian, AT  
(540)

## BEERJET

(511)  
7 – Dispensing system, filling machines, automatic dispensers, beer pumps, vending machines.

20 – Sideboards (furniture), furniture, counters, bars, pub furniture.

32 – Beers.

(260) AM 2015 77252 A  
(800) 1202332  
(891) 2013 11 27  
(731) WEBZEN INC.  
242, Pangyo-ro, Bundang-gu, Seongnam-si,  
(Sampyeong-Dong, Pangyo Digital, Contents  
Park B Dong), Gyeonggi-do, KR  
(540)



(591) Black, white  
(511)

9 – Downloadable computer game software; computer software, recorded; game software, recorded; downloadable electronic books; animated cartoons; exposed slide films; exposed cinematographic film.

41 – Production of DVD (Digital Versatile Disk) animated cartoons; distribution of animated films; game services provided on-line from a computer network; providing amusement arcade services; holiday camp services [entertainment]; provision of play facilities for children.

(260) AM 2015 77301 A  
(800) 1202878  
(891) 2013 11 27  
(731) ETI GIDA SANAYI VE TICARET  
ANONIM SİRKETİ  
Organize Sanayi Bolgesi 11 Cadde,  
ESKİSEHIR, TR  
(540)



(591) Brown, red and white

(511)  
30 – Biscuits, chocolates, pastries, crackers, wafers, cakes, pastry and bakery products, chocolate bars, tarts, pies, breakfast cereals, bread, popcorn and rice crisp.

(260) AM 2015 77303 A

(800) 1202935

(891) 2013 12 13

(731) INSTITUT FRANCAIS DE LA VIGNE ET DU VIN  
Domaine de l'Espiguette, F-30240 LE GRAU DU ROI;  
INSTITUT NATIONAL DE LA RECHERCHE AGRONOMIQUE  
147, rue de l'Université, F-75007 PARIS, FR

(540)

ENTAV  INRA

(591) Brown, green

(511)

44 – Agricultural, horticultural and forestry services; tree surgery; landscape design; plant nurseries; selection, propagation and production of plants namely agricultural, horticultural and forestry services.

(260) AM 2015 77332 A

(800) 1203113

(891) 2014 02 27

(731) AVON PRODUCTS, INC.  
World Headquarters, 777 Third Avenue,  
New York NY 10017, US

(540)

**AVON ULTRA SEXY PINK**

(511)

3 – Non-medicated toilet preparations; toiletries; skin care preparations; skin moisturizers; body and beauty care preparations; powders, creams and lotions, all for the face, hands and body; cosmetic suntan preparations; soaps; shower and bath preparations; beauty masks; talcum powder, nail polish; nail polish remover; enamel for nails; false nails; adhesives for cosmetic purposes; cosmetics; eye makeup remover, eye shadow, eye liner, mascara, lipstick, lip liner, lipgloss; make-up foundation; blusher; tissues impregnated with cosmetic lotions; cotton sticks for cosmetic purposes; cotton wool for cosmetic purposes; preparations for cleaning, moisturising, colouring and styling the hair; preparations for cleaning the teeth; shaving and aftershave preparations; perfumes, fragrances, toilet waters, eau de cologne; deodorants and anti-perspirants for personal use; essential oils (cosmetic).

(260) AM 2015 77335 A

(800) 1203163

(891) 2014 02 27

(731) ARNOLD & RICHTER CINE TECHNIK  
GMBH & CO. BETRIEBS KG  
Türkenstrasse 89, 80799 München, DE

(540)

**AMIRA**

(511)

9 – Film, photo and cinematographic apparatus and cameras; camera equipment, namely light shades, flashlights, filters, tripods, suspensions and mountings, lenses, objectives, object filters, light filters, self timers, photographic shutters, blimps, panorama heads, viewfinders; film and video recorders; film and video editing devices; apparatus for analyzing film and video shots; accessories for the aforementioned goods as far as included in class 9; adapted cases for carrying the aforementioned goods.

(260) AM 2015 77363 A

(800) 1203514

(891) 2013 11 22

(731) Zakrytoe aktsionernoe obshchestvo  
"STARODVORSKIE KOLBASY"  
ul. Poliny Osipenko, 41, RU-600009 Vladimir,  
RU

(540)

**Вязанка**

(511)

29 – Meat, fish, poultry and game; meat extracts; preserved, frozen, dried and cooked fruits and vegetables; jellies, jams, compotes; eggs; milk and milk products; edible oils and fats; ajvar [preserved peppers]; aloe vera prepared for human consumption; alginates for culinary purposes; anchovy; peanuts, processed; albumen for culinary purposes; white of eggs; beans, preserved; soya beans, preserved, for food; bouillon; ginger jam; ham; fatty substances for the manufacture of edible fats; toasted laver; edible birds' nests; peas, preserved; mushrooms, preserved; gelatine; meat jellies; jellies for food; fruit jellies; yolk of eggs; coconut fat; bone oil, edible; lard for food; suet for food; fruit-based snack food; charcuterie; raisins; caviar; processed fish spawn; yoghurt; sauerkraut; kefir [milk beverage]; isinglass for food; clams, not live; milk shakes; black pudding; meat, tinned; vegetables, tinned; fish, tinned; fruits, tinned; bouillon concentrates; gherkins; shrimps, not live; prawns, not live; buttercream; croquettes; silkworm chrysalis, for human consumption; kumys [kumyss] [milk beverage]; spiny lobsters, not live; lecithin for culinary purposes; salmon; onions, preserved; margarine; piccalilli; marmalade; peanut butter; chocolate nut butter; colza oil for food; coconut butter; corn oil; sesame oil; flaxseed oil for culinary purposes; palm oil for food; palm kernel oil for food; sunflower oil for food; coconut oil; butter; shellfish, not live; almonds, ground; animal marrow for food; mussels, not live; albumin milk; soya milk [milk

substitute]; fishmeal for human consumption; vegetable mousses; fish mousses; fruit pulp; meat, preserved; milk beverages, milk predominating; potato fritters; olives, preserved; lobsters, not live; coconut, desiccated; nuts, prepared; tomato purée; liver pâté; pectin for culinary purposes; liver; pickles; jams; powdered eggs; kimchi [fermented vegetable dish]; food products made from fish; prostokvasha [soured milk]; poultry, not live; pollen prepared as foodstuff; cranberry sauce [compote]; apple purée; crayfish, not live; crustaceans, not live; fish, preserved; salted fish; vegetable salads; fruit salads; bacon; sardines; pork; herrings; processed seeds; processed sunflower seeds; cream [dairy products]; whipped cream; fat-containing mixtures for bread slices; tomato juice for cooking; vegetable juices for cooking; salted meats; sausages; sausages in batter; preparations for making bouillon; preparations for making soup; tripe; soups; vegetable soup preparations; whey; cheese; tahini [sesame seed paste]; tofu; sea-cucumbers, not live; truffles, preserved; tuna fish; oysters, not live; milk ferments for culinary purposes; rennet; fish fillets; dates; crystallized fruits; frozen fruits; fruit preserved in alcohol; fruit, stewed; potato flakes; hummus [chickpea paste]; fruit peel; preserved garlic; lentils, preserved; potato chips; low-fat potato chips; fruit chips; non-alcoholic eggnog; seaweed extracts for food; snail eggs for consumption.

- (260) AM 2015 77366 A  
 (800) 1203550  
 (891) 2014 01 24  
 (731) Otkrytoe akcionernoe obshchestvo  
 "RUSSKIY PRODUKT"  
 1, Permskaya str., RU-107143 Moscow, RU  
 (540)



- (591) Red, yellow, white, blue, green, brown and pale blue  
 (526) The trademark is protected as a whole. The words ®, "РУССКИЙ ПРОДУКТ", "ГЕРКУЛЕС" included therein shall not be subject to independent legal protection.  
 (511)  
 30 – Gruel, namely gruel from oatmeal flakes; oat flakes.

- (260) AM 2015 77375 A  
 (800) 1203638

- (891) 2013 12 17  
 (731) S.I.T. SORDINA IORT TECHNOLOGIES  
 SPA  
 Galleria del Pozzo Rosso, 13, I-36100  
 Vicenza, IT

(540)

**LIAC**

- (511)  
 10 – Surgical and medical apparatus and instruments, in particular operating tables, surgical and medical apparatus and instruments; orthopedic articles; suture materials.  
 11 – Apparatus for lighting, heating, steam generating, cooking, refrigerating, drying, ventilating, water supply; sterilizers, sanitary apparatus and installations.  
 37 – Installation services, maintenance, servicing and repair of operating tables, surgical and medical apparatus and instruments, sterilizers, installation of sanitary apparatus.

- (260) AM 2015 77377 A  
 (800) 1203650  
 (891) 2013 11 22  
 (731) Zakrytoe aktsionernoe obshchestvo  
 "STARODVORSKIE KOLBASY"  
 ul. Poliny Osipenko, 41, RU-600009  
 Vladimir, RU

(540)



- (591) White, dark-brown, yellow and red-wine coloured  
 (526) The trademark is protected as a whole. The word "Мясной Продукт В Лучших ДЕРЕВЕНСКИХ ТРАДИЦИЯХ" included therein shall not be subject to independent legal protection.  
 (511)  
 29 – Charcuterie; black pudding.

- (260) AM 2015 77378 A  
 (800) 1203656  
 (891) 2014 01 16  
 (731) TORREFAZIONE POLI S.R.L.  
 Via Galvani, 2, Curnasco, I-24048  
 TREVIOLO (BG), IT  
 (540)

**NERO  
 AROMA**

(591) White, black and red  
(511)  
30 – Coffee, coffee capsules, coffee beans and powder, coffee blends, decaffeinated coffee, coffee extracts; waffles.

(260) AM 2015 77383 A  
(800) 824195  
(891) 2014 03 17  
(731) IMI International Management Institute  
Switzerland Ltd.  
Seeacherweg 1, CH-6047 Kastanienbaum, CH  
(540)



(591) Black, white,  
(511)  
35 – Advertising; business management; business administration; office functions.  
41 – Education; training; entertainment; sporting and cultural activities.

(260) AM 2015 77385 A  
(800) 972704  
(891) 2013 12 20  
(731) DSM IP Assets B.V.  
Het Overloon 1, NL-6411 TE Heerlen, NL  
(540)

**Quali**

(591) Black, white  
(511)  
5 – Veterinary products; food supplements and food ingredients for medical purposes; vitamins and vitamin preparations; food for babies.

(260) AM 2015 77387 A  
(800) 1166496  
(891) 2014 03 05  
(731) MERIAL  
29, avenue Tony Garnier, F-69007 LYON, FR  
(540)

**NEXGARD**

(511)  
5 – Veterinary products; veterinary preparations.

(260) AM 2015 77388 A  
(800) 1168724  
(891) 2014 04 24  
(731) RODELER LIMITED  
Samos Business Center, 2nd floor,  
67 Spyrou Kyprianou Street, Potamos  
Yermasoyla, CY-4043 Limassol, CY

(540)  
**24OPTION.COM**

(511)  
36 – Financial affairs.

(260) AM 2015 77390 A  
(800) 1180932  
(891) 2014 03 11  
(731) PHILIP MORRIS PRODUCTS S.A.  
Quai Jeanrenaud 3, CH-2000 Neuchâtel, CH  
(540)



(591) Black, white  
(511)  
34 – Tobacco, raw or manufactured; tobacco products, including cigars, cigarettes, cigarillos, tobacco for roll-your-own cigarettes, pipe tobacco, chewing tobacco, snuff tobacco, kretek; snus; tobacco substitutes (not for medical purposes); smokers' articles, including cigarette paper and tubes, cigarette filters, tobacco tins, cigarette cases and ashtrays, pipes, pocket apparatus for rolling cigarettes, lighters; matches.

(260) AM 2015 77391 A  
(800) 1184215  
(891) 2014 01 21  
(731) CROSSFIT, INC.  
1500 Green Hills Road, Suite 201, Scotts  
Valley CA 95066, US  
(540)

**CROSSFIT**

(511)  
16 – Paper goods and printed matter, namely, a series of books, written articles, handouts and worksheets in the fields of fitness, nutrition, sports and exercise; printed instructional, educational, and teaching materials in the fields of fitness, nutrition, sports and exercise; magazines in the fields of fitness, nutrition, sports and exercise; general feature magazines; exercise books; posters; bumper stickers.  
28 – Exercising equipment, namely, weight lifting bars, dumbbells, medicine balls, climbing ropes, nets for sports, exercise bars; fitness machines and equipment, namely, rowing machines; exercise weights; gymnastic apparatus.

(260) AM 2015 77407 A  
(800) 1203873  
(891) 2014 03 19  
(731) ENTREMATIC GROUP AB  
Gamla Flygplatsvägen 2, SE-423 37  
Torslanda, SE



(540)

**DITEC**

(511)

9 – Electronic sensors for opening, closing and stopping of doors for entry and exit.

(260) AM 2015 77409 A

(800) 1203887

(891) 2014 04 10

(731) JANSSEN PHARMACEUTICA NV  
Turnhoutseweg 30 B-2340 Beerse, BE

(540)



(591) Black, white

(511)

3 – Facial care products, namely, facial wash, facial scrub, facial moisturizer, pre-moistened cosmetic wipes; body wash.

5 – Medicated skin care preparations for the treatment of acne.

(260) AM 2015 77411 A

(800) 1203914

(891) 2014 04 03

(731) LODESTAR ANSTALT  
(a Liechtenstein company)  
Lova-Center, PO Box 1150, FL-9490 Vaduz,  
LI

(540)

**TARTAN ARMY**

(511)

33 – Alcoholic beverages (except beer); rum; whiskey; vodka; gin; distilled beverages; distilled spirits; liqueurs; cocktails.

(260) AM 2015 77412 A

(800) 1203934

(891) 2014 03 24

(731) MOZILLA FOUNDATION  
313 East Evelyn Avenue, Mountain View CA  
94041, US

(540)

**FIREFOX**

(511)

9 – Mobile phones; handheld mobile digital electronic devices for the sending and receiving of telephone calls, electronic mail, and other digital data, for use as a digital format audio player, and for use as a handheld computer, personal digital assistant, electronic organizer, electronic notepad, and camera;

operating system software; software for use in developing, executing, and running other software on mobile communication devices, computers, computer networks, and global communication networks; graphical user interface software; application development tool software; software for accessing, organizing, and managing multiple software applications, sold as an integral component of computer operating system and graphical user interface software.

(260) AM 2015 77413 A

(800) 1203937

(891) 2014 03 25

(731) APPLE INC.  
1 Infinite Loop, Cupertino CA 95014, US

(540)



(591) Green and white

(511)

9 – Computer software for creating spreadsheets, tables, graphs, and charts, and for organizing, analyzing, and transmitting data, for home, education, business, and developer use.

(260) AM 2015 77414 A

(800) 1203947

(891) 2013 11 13

(731) Anton & Völkl Patente UG  
(haftungsbeschränkt) & Co. KG  
Salzhub 16 (Gewerbegebiet), 83737  
Irschenberg, DE

(540)

**TVI**

(511)

7 – Machines for the food industry; meat processing machines; cutters (machines); portioning machines; inserting machines; tray dispensers.

11 – Freezers.

(260) AM 2015 77415 A

(800) 1203967

(891) 2013 10 22

(731) MERKUR GAMING GMBH  
Borsigstraße 26, 32312 Lübbecke, DE

(540)

**Gemblitz**

(511)

9 – Scientific, nautical, surveying, photographic, cinematographic, optical, weighing, measuring, signalling, checking (supervision), life-saving and teac-

hing apparatus and instruments; apparatus and instruments for conducting, switching, transforming, accumulating, regulating or controlling electricity; apparatus for recording, transmission or reproduction of sound or images; magnetic data carriers, recording discs; compact discs, DVDs and other digital recording media; cash registers, calculating machines, data processing equipment, computers; computer software; fire-extinguishing apparatus; musical juke boxes and parts for the aforesaid automatic machines; automatic cash dispensers, automatic money counting and money changing machines; mechanisms for coin-operated apparatus; computer and video games software; games software for use on any computer platform, including electronic entertainment and games consoles; programs for computer games; computer games; video games (software); computer games provided through a global computer network or supplied by means of multi-media electronic broadcast or through telecommunications or electronic transmission or via the internet; computer games, electronic game programs, electronic entertainment, leisure and recreational software, computer and video game software, all provided in the form of storage media; programs for operating electric and electronic apparatus for games, amusement and/or entertainment purposes; automatic lottery machines; computer software for computer games on the internet; online games (software); computer software in the form of an app for mobile devices and computers; calculating apparatus in coin-operated machines and parts for the aforesaid goods; apparatus for recording, transmission, processing or reproduction of data, including sound or images, including parts for all the aforesaid goods, except radio sets, television receivers, hi-fi systems, video recorders, telephone apparatus, fax machines and telephone answering machines; computer hardware and software for casino and amusement arcade games, for gaming machines, slot machines or video lottery gaming machines or games of chance via the internet; electric, electronic, optical or automatic apparatus, for identifying data carriers, identity cards and credit cards, bank notes and coins; electric, electronic or optical alarm and monitoring installations, including video cameras and apparatus for image transmission and image processing; data processing equipment and computers, including data processing apparatus and computers being components for data networks and parts facilitating data network communications; electric wiring harnesses; circuit boards, printed circuit boards (electronic components) and combinations thereof, being assemblies and parts for apparatus, included in this class.

28 – Games; toys; gymnastic and sporting articles not included in other classes; decorations for Christmas trees; gaming apparatus (including coin-operated apparatus); coin-operated arcade games (machines); games for amusement arcades (included in

this class); coin-operated video gaming apparatus; video games adapted for use with external screens or monitors only; casino fittings, namely roulette tables, roulette wheels; coin-operated automatic gaming machines and gaming machines, in particular for gaming arcades, with or without a prize payout; electronic or electrotechnical gaming apparatus, automatic gaming machines, gaming machines, slot machines operated by coins, tokens, banknotes, tickets or by means of electronic, magnetic or biometric storage media, in particular for commercial use in casinos and amusement arcades, with or without a prize payout; automatic gaming machines and gaming machines, in particular for commercial use in casinos and gaming arcades, with or without a prize payout; coin-operated gaming machines and/or electronic money-based gaming apparatus (machines), with or without prizes; housings adapted for gaming machines, gaming apparatus and automatic gaming machines, operated by means of coins, tokens, tickets or by means of electronic, magnetic or biometric storage media, in particular for commercial use in casinos and gaming arcades, with or without a prize payout; electronic games; electronic game entertainment apparatus and accessories; video output game machines; drawing apparatus for prize games and lotteries, draws or raffles; housings of metal, plastic and/or wood for coin-operated automatic machines; apparatus for games (including video games), other than adapted for use with external screens or monitors only; electropneumatic and electric pulling machines (gaming machines); gaming tables, in particular for table football, billiards, sliding games; quoits (playthings) and darts; electric, electronic or electromechanical apparatus for bingo games, lotteries or video lottery games and for betting offices, networked or unnetworked; LCD games consoles; automatic gaming machines; including all the aforesaid automatic machines, machines and apparatus operating in networks; apparatus and devices for accepting and storing money, being fittings for the aforesaid automatic machines, included in this class.

41 – Education; providing of training; entertainment; sporting and cultural activities; rental of automatic slot machines and entertainment machines for casinos; arranging and conducting games; gambling; operating lotteries; electronic games services provided by means of the Internet, including via smartphone applications; online game services provided via a computer network; provision of entertainment and/or educational content for apps for mobile devices and computers; conducting quizzes by means of smartphone applications; providing casino facilities (gambling), betting offices; operating gaming establishments, arcades and/or online internet casinos and betting platforms; gambling services via the internet.



(260) AM 2015 77416 A  
 (800) 1203971  
 (891) 2013 12 04  
 (731) NEXI ENTERTAINMENT B.V  
 Barnsteenstraat 80, NL-2403 CA Alphen aan  
 den Rijn, NL  
 (540)

**NEXI**

(511)  
 9 – Computer games, computer programs and computer software; computer discs; computers, computer hardware and firmware, all for use in the gaming industry; diskettes, semiconductor data memories; data carriers for computer programs; keyboards and computer joysticks and play apparatus; games software and video games software recorded and encoded on CD-ROMs or DVD-ROMs; computer game cartridges.

28 – Games and playthings, video games; video game amusement apparatus; television games; electronic games and apparatus for electronic games adapted for use with television receivers or video reproduction apparatus; amusement machines.

42 – Scientific and technological services and research and design relating thereto; industrial analysis and research services; design and development of computer hardware and software; none of the aforesaid services in relation to retail services or franchise services relating to the retail of consumer goods and not in connection with apparatus and instruments for conduction, switching, transforming, accumulating, regulation or controlling electricity.

(260) AM 2015 77417 A  
 (800) 1203981  
 (891) 2013 11 19  
 (731) ZBOM CABINETS CO., LTD  
 No:19, Lianshui Road, Luyang Industry  
 District, Hefei, Anhui, CN  
 (540)

**zbom**

(591) Black, white  
 (511)  
 20 – Cupboards; sideboards; furniture; chests of drawers; containers, not of metal [storage, transport]; work benches; picture frames; works of art of wood and bamboo; works of art of lacquer; registration plates, not of metal; doors for furniture; indoor window blinds [shades] [furniture]; washstands [furniture].

(260) AM 2015 77418 A  
 (800) 1203990  
 (891) 2013 12 24  
 (731) Obschestvo s ogranichennoy otvetstvennosty

"Nauchno-proizvodstvennaya kompaniya  
 "PHARMASOFT"  
 ul. Avtozavodskaya, 22, RU-115280 Moscow,  
 RU

(540)

**ΦΑΡΜΑCΟΦΤ**

(511)  
 3 – Cosmetic creams; shampoos; shampoos for pets; dentifrices; mouth washes, not for medical purposes; denture polishes; preparations for cleaning dentures; floss for dental care.

5 – Balms for medical purposes; aseptic cotton; anti-septic cotton; wart pencils; lotions for veterinary purposes; lotions for pharmaceutical purposes; ointments for pharmaceutical purposes; dressings, medical; surgical dressings; drugs for medical purposes; medicines for veterinary purposes; sticking plasters for medical purposes; eyepatches for medical purposes; bacterial preparations for medical and veterinary use; bacteriological preparations for medical and veterinary use; veterinary preparations; preparations for the treatment of burns; pharmaceutical preparations; sanitary napkins; tissues impregnated with pharmaceutical lotions; suppositories; vulnery sponges; chemico-pharmaceutical preparations; chemical preparations for pharmaceutical purposes; adhesives for dentures; dental mastics; teeth filling material; medicines for dental purposes; preparations to facilitate teething; mouthwashes for medical purposes; dental cements; medical plate for gum treatment (terms too vague in the opinion of the International Bureau – Rule 13(2)(b) of the Common Regulations).

21 – Toothbrushes.

35 – Sales promotion for others; procurement services for others [purchasing goods and services for other businesses]; advertising.

(260) AM 2015 77419 A  
 (800) 1204020  
 (891) 2014 03 12  
 (731) SHENZHEN MOTOMA POWER CO., LTD.  
 12/F, Shenmao Building, Xinwen Road,  
 Futian, Shenzhen, 518000 Guangdong, CN  
 (540)

**MOTOMA**

(591) Black, white  
 (511)  
 9 – Accumulators, electric, for vehicles; batteries, electric, for vehicles; accumulator jars; battery jars; batteries for lighting; anode batteries; high tension batteries; galvanic batteries; photovoltaic cells; solar batteries; batteries, electric; galvanic cells; accumulators, electric; battery chargers.

(260) AM 2015 77421 A  
 (800) 1204052  
 (891) 2014 04 01  
 (731) GREY GLOBAL GROUP LLC  
 a Delaware Limited Liability Company  
 200 Fifth Avenue, New York NY 10010 (US),  
 US

(540)

## GREY FAMOUSLY EFFECTIVE SINCE 1917

(511)

35 – Advertising agency services; marketing services; marketing communication services; market research services; public relations services; direct mail advertising services; direct marketing services; business marketing services; development of marketing strategies and concepts for others; creating corporate and brand identities for others; brand strategy consultation services in the field of brand creation and development; business research services, namely, providing analysis of data in the field of brand strategy; sales promotion services, namely, promoting the goods and services of others, arranging and conducting promotional marketing events for others; media planning, namely, media planning, namely, advising clients on times, venues, and media in which to advertise their products and services based on media analysis of the market for that media and securing of advertising media space and airtime for others; conducting market and media research services for others for marketing and advertising purposes; internet advertising services.

(260) AM 2015 77423 A

(800) 1204084

(891) 2013 05 15

(731) PEKER YÜZEY TASARIMLARI SANAYI  
VE TICARET ANONİM ŞİRKETİ  
Organize Sanayi Bölgesi, 4 Kisim, Emlakdere  
Mahallesi, Ahmet Nazif Zorlu Bulvarı, No:22,  
Manisa, TR

(540)



(591) Purple

(526) The trademark is protected as a whole. The word "Quartz surfaces" included therein shall not be subject to independent legal protection.

(511)

19 – Materials for constructing, coating, repairing roads, namely, asphalt, pitch and tar, bitumen asphalt, sand, gravel, slag stone, mixtures of sand and sand stones, non-agricultural lime for use in construction, slag-lime cement, gypsum; blocks of concrete, plaster and colored plaster for building

purposes, articles of artificial stone for building purposes; natural stone and stone tile; rock materials used in building flooring, roofing, countertops, vanity tops, tabletops, desktops, walls, cladding and fireplaces; non-metal partitions for building, namely, toilet compartment partitions; non-metal fireplace surrounds, fireplace mantels; shaped building, construction and road construction building, construction materials made of concrete, gypsum, earthen, clay, sand, natural stone, artificial stone, wooden, plastic or synthetic materials; poles, barriers; non-luminous, non-mechanical signs not of metal; monuments of stone, concrete or marble; statues of stone, concrete or marble; natural or synthetic non-metallic surface coatings for building purposes in the form of plates or strips (heat-adhesive); glass blocks for building, glass bricks, glass tiles, glass panes, glass panels for building construction purposes; prefabricated swimming pools not of metal; aquarium sand.

20 – Furniture, display stands and boards, index cabinets, medicine cabinets, writing and drawing desks, service carts, deck chairs, counters (tables) not of metal, work benches, vice benches, furniture chests, mailboxes, fixed towel dispensers (not of metal), coat hangers, coat stands; mirrors; beehives, comb foundations for beehives, sections of wood for beehives; playpens for babies, high chairs for babies, bassinets, infant walkers; vehicle plates not of metal, signs, signboards of wood or plastics, display boards, picture frames, picture frame brackets, moldings (moldings) for picture frames, identity plates, not of metal; nameplates, not of metal; registration plates, not of metal; number plates, not of metal; wooden barrels, casks, kegs, liquid containers, wood boxes, boxes for transportation purposes, chests, transport palettes, packaging containers of plastic, plastic barrels, reservoirs, neither of metal nor of masonry; boxes, non-metal valves for containers, taps for casks (not of metal); handles, stalks, stems, buttons for tools and instruments, of wood, wood substitute materials or synthetic materials, latches not of metal, bottle closures, not of metal; bottle caps, not of metal; corks for bottles, cork bands, window fittings, not of metal; door fittings, not of metal; locks, not of metal; racks, door handles, not of metal; drawer rails; casters, not of metal; bolts, not of metal; screws, not of metal; dowels, not of metal; pipe or cable clips, plugs (dowels) not of metal; works of art in this class, of wood, wax, plaster or plastic; sculptures, busts; mannequins, mobiles (decoration), wall plaques made of plastic or wood (furniture), stuffed animals; baskets, bakers' bread baskets, hamper baskets, reed baskets, fishing baskets; kennels, nesting boxes, cushions, beds for household pets; portable steps (ladders), not of metal, of wood or plastic; mobile boarding stairs not of metal for passengers; curtain holders, not of textile material; curtain hooks, curtain rails, curtain rings, curtain rods, curtain rollers, curtain tie-backs, bamboo

curtains, indoor window blinds (shades), slatted indoor blinds, bead curtains for decoration.

35 – Advertising agencies services, marketing and publicity bureaus services including commercial or advertisement exhibition and trade fair organization services; providing office functions; business management; business administration; import and export agencies; business investigations, evaluations, expert appraisals, information and research of industrial and commercial goods, auctioneering; the bringing together, for the benefit of others, of articles of artificial stone for building purposes; natural stone and stone tile; rock materials used in building flooring, roofing, countertops, vanity tops, tabletops, desktops, walls, cladding and fireplaces; non-metal partitions for building, namely, toilet compartment partitions; non-metal fireplace surrounds, fireplace mantels; building materials (non-metallic), non-metallic rigid pipes for building, asphalt, pitch and bitumen, non-metallic transportable buildings, monuments, not of metal, furniture, mirrors, picture frames, goods (not included in other classes) of wood, cork, reed, cane, wicker, horn, bone, ivory, whalebone, shell, amber, mother-of-pearl, meerschaum and substitutes for all these materials, or of plastics (excluding the transport thereof), enabling customers to conveniently view and purchase those goods; such services may be provided by retail stores, wholesale outlets, through mail order catalogues or by means of electronic media, for example, through web sites or television shopping programmes.

(260) AM 2015 77424 A

(800) 1204087

(891) 2014 01 22

(731) EGIS Gyógyszergyár Zrt.

Keresztúri út 30-38, H-1106 Budapest, HU

(540)

## SARTEG

(511)

5 – Pharmaceutical preparations for human use.

(260) AM 2015 77425 A

(800) 1204088

(891) 2014 01 22

(731) EGIS Gyógyszergyár Zrt.

Keresztúri út 30-38, H-1106 Budapest, HU

(540)

## RAMZUVA

(511)

5 – Pharmaceutical preparations for human use.

(260) AM 2015 77426 A

(800) 1204089

(891) 2014 01 22

(731) EGIS Gyógyszergyár Zrt.

Keresztúri út 30-38, H-1106 Budapest, HU

(540)

## RAMROS

(511)

5 – Pharmaceutical preparations for human use.

(260) AM 2015 77427 A

(800) 1204090

(891) 2014 01 22

(731) EGIS Gyógyszergyár Zrt.

Keresztúri út 30-38, H-1106 Budapest, HU

(540)

## RASUREL

(511)

5 – Pharmaceutical preparations for human use, not including respiratory products or pharmaceuticals for the treatment of respiratory illnesses.

(260) AM 2015 77499 A

(800) 1204823

(891) 2014 03 12

(731) SAMUEL BAGDASAROV

9 rue Barbes F-92130 Issy-Les-Moulineaux, FR;

HASAN YEŞİL

78 rue de Loigny la Bataille, F-28150 Voves,

FR;

ÖZGÜR YEŞİL

19 rue de la Libération, F-28300 Mainvilliers, FR

(540)



(591) Black, white

(511)

25 – Clothing, namely jackets [clothing]; dresses; gloves [clothing]; shirts; stuff jackets [clothing]; short-sleeve shirts; trousers; overcoats; ponchos; parkas; mittens; pelerines; suits; tee-shirts; jumper dresses; overalls; vests; coats; denim jackets; denims, jeans; footwear, namely lace boots; boots; socks; football shoes; studs for football boots; sports shoes; boots for sports; slippers; half-boots; footwear; shoes; headgear, namely skull caps; berets; scarfs; bandanas [neckerchiefs]; hats; caps [headwear].

(260) AM 2015 77500 A

(800) 1204826

(891) 2014 02 04

(731) ORIFLAME COSMETICS S.A.

24, Avenue Emile Reuter, L-2420

LUXEMBOURG, LU

(540)

## ORIFLAME IMAGINATION

(511)  
3 – Perfumes for women.

(260) AM 2015 77502 A  
(800) 1204852  
(891) 2014 02 28  
(731) ASTEOS EOOD.  
15 Trakia Str., BG-1527 Sofia, BG  
(540)

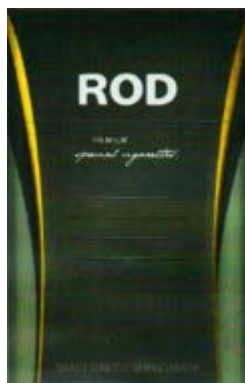

(591) Gray, black, yellow and white  
(526) The trademark is protected as a whole. The words PREMIUM; SPECIAL CIGARETTES; TOBACCO SERIOUSLY DAMAGES HEALTH. Included therein shall not be subject to independent legal protection.

(511)  
34 – Tobacco; cigarettes; cigars; cigarillos.

(260) AM 2015 77509 A  
(800) 1204936  
(891) 2013 08 23  
(731) SMITHKLINE BEECHAM LIMITED  
980 Great West Road, Brentford, Middlesex  
TW8 9GS, GB  
(540)



(591) Black, white  
(511)

1 – Chemicals used in pharmaceutical industry; protein for food.

3 – Cleaning, polishing, scouring and abrasive preparations; soaps; perfumery; essential oils; cosmetics; shampoos for the scalp and hair; non-medicated skincare and cleansing preparations; skin creams, skin and hair lotions, gels, ointments, cold cream; skin preparations; preparations for sun protection; dentifrices and mouthwashes not for medical purposes; breath fresheners; dental gels; toothpaste; tooth bleaching preparations, tooth polishing preparations, tooth whitening preparations and accelerators, cos-

metic tooth stain removal preparations; non-medicated toilet preparations; oral care preparations; medicated bleaching preparations; preparations for cleaning, washing, polishing, deodorizing and sterilizing dentures.

5 – Pharmaceutical and medicinal preparations and substances; therapeutic agents (medical); adhesive patches for medical purposes; adhesive patches for surgical purposes; adhesive patches incorporating a pharmaceutical preparation; vaccines; vitamins, minerals and food supplements; dietary preparations; dietetic substances including foods and drinks adapted for medical use; foods for infants and invalids; weight loss preparations; medicated oral care preparations; medicated chewing gum and lozenges for dental hygiene; denture adhesives, denture fixatives; smoking cessation preparations.

9 – Scientific apparatus and instruments; computer software to enable healthcare professionals to access information on new products and services.

10 – Surgical and medical apparatus and instruments; dental care apparatus; dental trays; nasal dilators.

16 – Printed matter; periodicals, books, stationery; instructional and teaching materials (except apparatus); printed educational materials, namely, brochures, leaflets; booklets featuring information concerning pharmaceutical products, vaccines, medical diseases and disorders and related treatments; printed publications, magazines, newsletters, catalogues, instructional and teaching materials, advertising and promotional material for use in relation to fitness, athletes, sports and body building.

21 – Toothbrushes, electric toothbrushes, floss for dental purposes, toothpicks, toothpick holders (not of precious metal) and plastic containers for holding toothbrushes; drinking vessels, cups, food and drink shakers, food and drink containers and bottles.

29 – Preserved, frozen, dried and cooked fruits and vegetables and fruit and vegetable based products; jellies, jams, compotes; milk and milk products (including food preparations prepared from milk); edible oils and fats; soya and whey based products.

35 – Promotional and advertising services; provision of the aforementioned services on-line, via cable and/or the Internet; the provision of customer information on pharmaceutical, medical, healthcare and fitness products through an on-line computer network.

41 – Educational services relating to pharmaceutical, diagnostic, vaccines, proprietary medicines, health, medical, food, drink, toiletries and cosmetic industries; education, providing of training, entertainment, sporting and cultural activities relating to sporting events and personal sports training; educational ser-

vices and providing of training in relation to smoking control and smoking cessation; educational services relating to weight loss, diet, nutrition and fitness; sporting and cultural activities.

42 – Scientific research for medical purposes.

44 – Medical, hygienic and beauty care; healthcare services; provision of medical information and services; information provided to patients and healthcare professionals concerning pharmaceutical products, vaccines, medical diseases and disorders and related treatments via the Internet; gene and cell therapy; medical counselling services; medical and health care services.

(260) AM 2015 77510 A

(800) 1204966

(891) 2014 01 24

(731) WINE & SPIRIT EDUCATION TRUST  
International House, 39-45 Bermondsey  
Street, London SE1 3XF, GB

(540)

## Wine & Spirit Education Trust

(511)

9 – Pre-recorded magnetic data carriers featuring information about alcoholic beverages; compact discs featuring information about alcoholic beverages; downloadable electronic publications in the nature of manuals, newsletters, magazine articles, presentation packs and books in the field of alcoholic beverages; electronic publications (downloadable), namely books, magazines and manuals featuring information about alcoholic beverages recorded on computer media; photographic slide transparencies featuring information about alcoholic beverages, and pre-recorded video tapes featuring alcoholic beverages.

16 – Printed matter and publications, namely newsletters featuring the promotion of wine and spirits and the wine and spirit trade, wards, charts, emblems, forms guides for wine and spirit appreciation, invitations, seminar notes, and survey answer sheets; printed instructional and teaching materials, namely, lesson plans, plastic overhead transparencies, paper and plastic overhead transparencies, course books, reference and text books and manuals, assessment material, examination papers, paper awards, certificates, diplomas, scholarships certificates and paper badges, all for the promotion of wine and spirit appreciation and the wine and spirit trade.

36 – Provision of scholarships and bursaries.

41 – Provision of teaching and instructional services relating to the wine and spirit trade both direct and through interactive electronic media; the publication of course material therefor; publication and issuing

of printed matter; organisation of lectures, classes, seminars and tutorials for education purposes; arranging congresses and meetings; provision of awards, certificates, diplomas.

(260) AM 2015 77567 A

(800) 1205486

(891) 2014 03 27

(731) Otkrytoe aktsionernoe obchtchestvo  
"PIVZAVOD OLIVARIA"  
30, oul. Kisseleva, 220002 Minsk, BY

(540)



(591) Red, yellow, white, light blue, blue, black, green  
(511)

32 – Beer.

(260) AM 2015 77588 A

(800) 1205581

(891) 2014 02 18

(731) BAYER INTELLECTUAL PROPERTY  
GMBH  
Alfred-Nobel-Straße 10, 40789 Monheim am  
Rhein, DE

(540)

## GIALARN

(511)

5 – Pharmaceutical preparations; dietetic food and substances adapted for medical use; dietary supplements for humans.

(260) AM 2015 77590 A

(800) 1205594

(891) 2014 04 01

(731) BESINS HEALTHCARE LUXEMBOURG  
S.A.R.L.  
Société de droit luxembourgeois 67,  
boulevard Grande-Duchesse Charlotte,  
L-1331 Luxembourg, LU

(540)

## ВИТАЖИНАЛЬ

(511)

5 – Pharmaceutical products, sanitary products for medical purposes, dietetic substances for medical use, nutritional supplements for medical use, vitamin preparations for medical use.

(260) AM 2015 77591 A  
 (800) 1205625  
 (891) 2014 04 16  
 (731) ACTELION PHARMACEUTICALS LTD  
 Gewerbestrasse 16, CH-4123 Allschwil, CH  
 (540)

## PAHUMAN

(511)  
 16 – Printed matter (printing products); pamphlets; printed publications; instructional and teaching material (except apparatus).

41 – Education; training; entertainment; sporting and cultural activities.

44 – Medical consultation; medical services.

(260) AM 2015 77592 A  
 (800) 1205628  
 (891) 2014 03 21  
 (731) Otkrytoe aktsionernoe obshchestvo  
 "NIZHEGORODSKY MASLO-ZHIROVOY  
 KOMBINAT"  
 11, sh. Zhirkombinata, RU-603950 g. Nizhny  
 Novgorod, RU

(540)

## Stepanovna

(591) Black, white

(511)

29 – Fish fillets; preparations for making soup; her-rings; onions, preserved; mussels, not live; game, not live; albumin milk; kefir [milk beverage]; coconut butter; piccalilli; smetana [sour cream]; pork; edible oils; poultry, not live; seaweed extracts for food; hummus [chickpea paste]; tofu; buttercream; milk shakes; fatty substances for the manufacture of edible fats; sunflower oil for food; ham; sauerkraut; fruit peel; fruit pulp; potato chips; pickles; tuna fish; seeds, prepared; tomato paste; corn oil; lecithin for culinary purposes; vegetable salads; preparations for making bouillon; ryazhenka [fermented baked milk]; prostokvasha [soured milk]; fruit salads; margarine; croquettes; alginates for culinary purposes; dates; food products made from fish; fish mousses; potato flakes; milk; snail eggs for consumption; ginger jam; aloe vera prepared for human consumption; vegetables, cooked; butter; truffles, preserved; crystallized fruits; fish roe, prepared; salmon; meat, tinned [canned (Am.)]; peas, preserved; albumen for culinary purposes; sausages in batter; cream [dairy products]; sea-cucumbers, not live; bouillon; soya beans, preserved, for food; soya milk [milk substitute]; eggs; vegetables, preserved; beans, preserved; sesame oil; koumiss [kumiss] [milk beverage]; rennet; olive oil for food; sausages; lobsters, not live; salted fish; fish, not live; cheese; processed sunflower seeds; compotes; fruits, tinned [canned (Am.)]; vegetable mousses; coconut oil; prawns, not live; vegetables, dried; meat jellies; almonds, ground; liver

pâté; meat; bouillon concentrates; milk ferments for culinary purposes; palm kernel oil for food; jams; fruit-based snack food; colza oil for food; marmalade; yoghurt; edible fats; whey; fruit jellies; bone oil, edible; flaxseed oil for culinary purposes; ajvar [preserved peppers]; spiny lobsters, not live; white of eggs; fish, preserved; vegetables, tinned [canned (Am.)]; tomato purée; coconut fat; mushrooms, preserved; raisins; crustaceans, not live; jellies for food; powdered eggs; bacon; lentils, preserved; fish, tinned [canned (Am.)]; caviar; tahini [sesame seed paste]; meat extracts; fruit, stewed; apple purée; chocolate nut butter; shellfish, not live; vegetable soup preparations; oysters, not live; salted meats; tomato juice for cooking; vegetable juices for cooking; anchovy; shrimps, not live; suet for food; lard; non-alcoholic egg nog mixes; soups; gelatine; fat-containing mixtures for bread slices; toasted laver; liver; animal marrow for food; curd; meat, preserved; peanut butter; yolk of eggs; pectin for culinary purposes; gherkins; palm oil for food; nuts, prepared; black pudding; charcuterie; tripe; clams, not live; milk products; fruit preserved in alcohol; peanuts, processed; cranberry sauce [compote]; fish meal for human consumption; coconut, desiccated; whipped cream; fruit chips; kimchi [fermented vegetable dish]; low-fat potato chips; olives, preserved; potato fritters; pollen prepared as foodstuff; isinglass for food; condensed milk; sardines; edible birds' nests; milk beverages, milk predominating; fruit, preserved; crayfish, not live; trepangs, not live; preserved garlic; silkworm chrysalis, for human consumption; frozen fruits.

(260) AM 2015 77594 A  
 (800) 1205637  
 (891) 2014 03 17  
 (731) ROCHE DIAGNOSTICS GMBH  
 Sandhofer Str. 116 68305 Mannheim, DE  
 (540)

## ACCU-CHEK SUPRA

(511)

5 – Pharmaceutical and veterinary products; in-vitro diagnostics for medical purposes; test strips for determining levels of blood glucose.

10 – Medical and surgical instruments, devices and apparatus including accessories included in this class; blood glucose meters including accessories included in this class; lancets devices and lancets for medical purposes; insulin pumps and infusion sets including accessories included in this class.

(260) AM 2015 77603 A  
 (800) 383302  
 (891) 2014 03 14  
 (731) Akzo Nobel Chemicals B.V.  
 Stationsstraat 77, NL-3811 MH  
 AMERSFOORT, NL



(540)

**DISSOLVINE**

(511)

1 – Chemical products for industrial use, namely descaling agents.

(260) AM 2015 77604 A

(800) 545599

(891) 2014 05 23

(731) AZIENDE CHIMICHE RIUNITE  
ANGELINI FRANCESCO A.C.R.A.F. S.P.A.  
Viale Amelia 70, I-00181 ROMA, IT

(540)

**MOMENT**

(511)

5 – Analgesic products.

(260) AM 2015 77607 A

(800) 815129

(891) 2014 05 21

(731) AZIENDE CHIMICHE RIUNITE ANGELINI  
FRANCESCO A.C.R.A.F. S.P.A.  
Viale Amelia, 70, I-00181 ROMA, IT

(540)

**MOMENTACT**

(511)

5 – Pharmaceutical, veterinary and sanitary products; dietetic substances for medical use, food for babies; plasters, materials for dressings; material for dental fillings and dental impressions; disinfectants; products for destroying vermin; fungicides, herbicides.

(260) AM 2015 77611 A

(800) 881066

(891) 2014 05 21

(731) AZIENDE CHIMICHE RIUNITE  
ANGELINI FRANCESCO A.C.R.A.F. S.p.A.  
Viale Amelia, 70, I-00181 ROMA, IT

(540)

**MOMENTINO**

(511)

5 – Pharmaceutical and veterinary products; sanitary products for medical purposes; dietetic substances for medical use, food for babies; plasters, materials for dressings; material for dental fillings and dental impressions; disinfectants; products for destroying vermin; fungicides, herbicides.

(260) AM 2015 77613 A

(800) 927327

(891) 2014 05 05

(731) FLINEX HOLDING AG  
Neuhofstrasse 5A, CH-6340 Baar, CH

(540)

**MEMO**

(511)

3 – Soaps; perfumery, essential oils, cosmetics, hair lotions; depilatories, shaving products, dentifrices; lipstick, cosmetic creams, lotions for cosmetic use, hair sprays, sprays for cosmetic use; balsamic preparations for cosmetic use, oils for perfumes and scents, oils for toilet purposes, ethereal essences, flower extracts (perfumery), sunscreens (cosmetic preparations for skin tanning); dentifrices and non-medicated mouth care products; cleaning products for cosmetic use, cosmetic bath preparations, bath salts, not for medical purposes, cosmetics, cosmetic sets, make-up removing products, scented water, shampoos, nail care products, make-up, beauty masks, cosmetic preparations for slimming purposes, tissues impregnated with cosmetic lotions.

14 – Precious metals and their alloys and goods made of or coated with these materials not included in other classes; jewellery, precious stones; horological and chronometric instruments; amulets (jewellery), fancy key rings, medals, pins (jewellery), bracelets (jewellery), boxes of precious metal, unwrought or beaten gold, necklaces (jewellery), coins, pins for ties and ornaments, pearls (jewellery), watches, cases for watches, alarm clocks.

(260) AM 2015 77638 A

(800) 1203748

(891) 2014 05 22

(731) KONINKLIJKE PHILIPS N.V.  
High Tech Campus 5, NL-5656 AE  
Eindhoven, NL

(540)

**ИННОВАЦИИ**  **ВЫ**

(591) Black, white

(511)

7 – Appliances for household purposes not included in other classes, electric blenders, can openers, food processors, fruit presses, mills and mixers (machines); electric knives; kitchen appliances for food not included in other classes; electric dust removing apparatus for cleaning purposes, including vacuum cleaners; vacuum cleaner hoses, vacuum cleaner bags and other parts of vacuum cleaners; ironing machines and ironing presses; parts of the aforesaid goods.

8 – Hand tools and implements (hand-operated); razors; electric and non-electric hair clippers and hair trimmers; scissors to trim hair; nail clippers; depilation appliances, also serving as nose cleaners; electric or non-electric hair-removing tweezers; electric or non-electric nail files; electric or non-electric manicure and pedicure sets; punches for making holes in teats (hand tools); tongs for picking up teats



and other objects from a sterilizer; electric irons and steam irons; electric hair stylers; parts of the aforesaid goods.

9 – Scientific, nautical, surveying, photographic, cinematographic, optical, weighing, measuring, signalling, checking (supervision), life-saving and teaching apparatus and instruments; apparatus and instruments for conducting, switching, transforming, accumulating, regulating or controlling electricity; television apparatus; control apparatus and computer software programs for lighting systems, not included in other classes; light-emitting diodes (LEDs), LED modules fully or partially consisting of integrated LEDs, oleds, polymer light-emitting diodes; optical control apparatus, thermal control apparatus; apparatus for recording, transmission or reproduction of sound or images; magnetic data carriers, recording discs; compact discs, DVDs and other digital recording media; data processing equipment, computers; computer software; computer mice, data entry apparatus, trackballs, touch pads and joysticks; remote controls and peripheral control devices for personal computers, for media center PC, pointing devices and electronic, infrared and laser pointers, laser sensors, as well as apparatus combining aforesaid functionalities; detectors, chips; operating software for the aforesaid goods; alarms; scales for babies; DECT monitors, thermometers and electronic thermometers, other than for medical purposes, included soother thermometers; anti-radiation garment; downloadable electronic publications, provided online from databases or on the internet, storage media, interactive compact discs and cd-roms; records, tapes, discs, cassettes, cartridges, cards and other similar carriers, all containing or for recording sound, video, data, images, games, text, programs or information; all the aforesaid goods for or relating to babies, young children, pregnant women, breast-feeding mothers and young mothers; computer software programs and software applications for mobile phones and other handheld mobile digital electronic devices, mobile apps; computer programs for accessing, browsing and searching online databases, computer software and firmware, namely operating system programs, data synchronization programs, and application development computer software programs for personal and handheld computers; spectacle frames, eyeglasses, sunglasses; fridge magnets; monitoring apparatus, electric; baby monitors; audio monitors; digital video monitors; monitors (hardware); chargers for electric batteries; battery chargers; batteries and rechargeable batteries; rechargeable battery pack; central processing unit for baby monitor; electric connections for baby monitor; electrical power extension cords; charger stand for parent unit; parts of baby monitors; bath and room thermometers; digital photograph frames; stress meters not for medical use; parts of the aforesaid goods.

10 – Surgical, medical, dental and veterinary instruments and apparatus; clothes especially for operating rooms; lights and lamps for medical, curative, surgical, dental and veterinary use; artificial limbs, eyes and teeth; electric blankets for medical use; ultraviolet and infrared irradiation apparatus, devices and instruments for medical use; x-ray apparatus, tubes, installations and instruments for medical use; hearing instruments; feeding bottles; teats and soothers, including pacifiers, also chains, clips and other similar holders therefor; teething rings; spoons and medical feeders for administering medicines; incubators for medical purposes; breast pumps; nursing appliances for use in breast feeding, namely, breast shields and nipple protectors; thermometers for medical use; condoms; incubators for babies; commode chairs for babies and children; massage apparatus, electric or non-electric, body and breast massage apparatus; gloves for massage; vibration generating apparatus for massage; pregnancy support belt; babies bottles; disposable feeding bottles; disposable babies bottles; nipple shields; icepack for medical purposes; breast milk storage bottles, pouches and other similar containers, that also can be frozen or heated; dummies for babies; ear and forehead thermometers for medical use; medical apparatus for removing nasal mucous, namely, external nasal dilators, nasal aspirators, nasal irrigation vessels and nasal lavage vessels; lasers for medical and cosmetic treatment of the face and the skin; skin rejuvenating apparatus, namely, portable laser systems, consisting of a handheld laser for use in cosmetic, medical and dermatological treatment of the face and the skin; dental instruments and tools for dental bleaching, or whitening, namely dental curing lights, curing dental bite trays, intra-oral dental lights, and polymerization apparatus for dental purposes; parts of the aforesaid goods.

11 – Installations, apparatus and instruments for lighting, heating, steam generating, cooking, refrigerating, freezing, drying, ventilating, water supply and sanitary purposes; electric lamps; humidifying and dehumidifying installations, apparatus and instruments; apparatus and instruments for air conditioning; toasters and hot water tanks; installations for liquefying gases; apparatus and instruments for sterilizing; heaters and warmers for feeding bottles, foodstuffs, liquids and solids; steam generating apparatus to generate steam for ironing purposes, for domestic use; air purifiers and humidifiers; hot water bottles; electric fryers and low-fat fryers; electric hair dryers; electric coffee makers; garment steamers; coolers for breast milk; parts of the aforesaid goods.

21 – Household or kitchen utensils and containers; combs and sponges; brushes (except paint brushes); toothbrushes, finger toothbrush; apparatus for cleaning teeth and gums, for home use; flossing instru-

ments for dental care; apparatus which use water and air for dental care, for home use; brush-making materials; articles for cleaning purposes; glassware, porcelain and earthenware not included in other classes, including figurines and statuettes; cups and vessels adapted for feeding babies and children; spouts for cups, adapted for feeding babies and children; cups for food; containers for use in the sterilization of babies' feeding bottles and closures for such containers; milk powder dispensers; heat insulated containers for household use, including heat insulated containers for baby feeding bottles; baby food containers; non-spill covers or caps for use with cups; baths and potties for babies; bowls and buckets; drinking vessels; boxes, money boxes; boxes and holders for household use, including for storing, freezing, preserving, transporting and heating of breast milk; thermal and isothermic household containers to keep bottles and cups warm or cool, including insulated containers; insulated and vacuum flasks and vacuum bottles; parts of the aforesaid goods.

(260) AM 2015 77642 A

(800) 1205812

(891) 2014 02 18

(731) Oleksandr Stanislavovych BOZHKO  
prov. Novyi, 12, s. Potash, Mankivskii r-n,  
Cherkaska obl. 20100, UA

(540)

# DIVA

(591) Black, white

(511)

11 – Heat accumulators; hot air apparatus; heating elements; hot plates; radiator caps; stoves [heating apparatus]; heating installations; heating installations [water]; heating apparatus; heating apparatus, electric; radiators [heating]; radiators, electric; central heating radiators.

(260) AM 2015 77643 A

(800) 1205816

(891) 2014 02 19

(731) KOTON MAĞAZACILIK TEKSTİL  
SANAYİ VE TİCARET ANONİM ŞİRKETİ  
Ayazağa Mahallesi, Ayazağa Yolu, No:3/A-B,  
Maslak Şişli İstanbul, TR

(540)

# KOTON

(591) Black, white

(511)

3 – Bleaching and cleaning preparations, perfumery; cosmetics; fragrances; deodorants for human beings or for animals, soaps, dental care products, abrasive

preparations; emery cloth; sandpaper; pumice stone; abrasive pastes, polishing preparations for leather, vinyl, metal and wood.

(260) AM 2015 77716 A

(800) 1177474

(891) 2014 05 21

(731) APPLE INC.

1 Infinite Loop, Cupertino CA 95014, US

(540)



(591) Red, orange, yellow, green, blue, purple and pink

(511)

9 – Computer software for organizing, storing, sharing, and viewing images, sold as a feature of computers and handheld mobile digital electronic devices comprised of mobile phones, digital audio and video players, handheld computers, personal digital assistants, and electronic personal organizers.

(260) AM 2015 77717 A

(800) 1177889

(891) 2014 05 22

(731) APPLE INC.

1 Infinite Loop, Cupertino, CA 95014, US

(540)

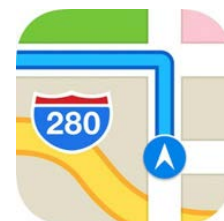

(591) Yellow, blue, red, gray, pink, green, and white

(511)

9 – Computer software for use in searching, transmitting, storing, accessing, finding, organizing and viewing geographic locations, and for providing traffic information, travel route planning, driving and walking directions, customized mapping of locations, electronic map display, and destination information.

(260) AM 2015 77718 A

(800) 1184265

(891) 2014 03 03

(731) BIOFARMA

50 rue Carnot, F-92284 SURESNES CEDEX,  
FR

(540)

**STATRIAM**

(511)

5 – Pharmaceutical and veterinary products; sanitary products for medicine; dietetic food and substances for medical or veterinary use; food for babies; food supplements for humans and animals; materials for dressings; material for dental fillings and dental impressions; disinfectants; products for destroying vermin; fungicides, herbicides.

(260) AM 2015 77719 A

(800) 1202906

(891) 2014 05 19

(731) MACHINE ZONE, INC.

555 Hamilton Avenue, Palo Alto CA 94301,  
US

(540)



(591) Black, white

(511)

9 – Downloadable video game software for use on wireless devices; computer game software downloadable from a global computer network.

41 – Entertainment services, namely, providing temporary use of non-downloadable video games; entertainment services, namely, providing online, non-downloadable virtual items in the nature of characters, heroes, legions, troops, weapons, tools, buildings, land, vehicles, clothing, currency, gifts, and prizes, for use in virtual environments created for entertainment purposes; providing an internet website portal in the field of computer games and gaming; entertainment services, namely, providing virtual environments in which users can interact through social games for recreational, leisure, or entertainment purposes.

42 – Computer services, namely, creating an online community for registered users to participate in competitions, showcase their skills, get feedback from their peers, form virtual communities, engage in social networking, and improve their talent; providing a website featuring non-downloadable software tools for use in tracking performance of computer games.

(260) AM 2015 77729 A

(800) 1206527

(891) 2013 12 23

(731) COMEDY CLUB PRODUCTION IP

(Cyprus) LIMITED

Theklas Lysioty, 29, Cassandra Centre, 3rd  
floor, CY-3030 Limassol, CY

(540)



(591) Red, white

(511)

9 – Abacuses; accumulator boxes; accumulator jars; accumulators, electric; accumulators, electric, for vehicles; acid hydrometers; acidimeters for batteries; acoustic conduits; acoustic couplers; acoustic [sound] alarms; actinometers; adding machines; aerials; aerometers; electronic agendas; air analysis apparatus; alarm bells, electric; alarms; fire alarms; alcoholmeters; alidades; altimeters; ammeters; amplifiers; amplifying tubes; amplifying valves; anemometers; animated cartoons; anode batteries; anodes; answering machines; antennas; anticathodes; anti-dazzle shades; anti-glare glasses; anti-glare visors; anti-interference devices [electricity]; anti-theft warning apparatus; apertometers [optics]; armatures [electricity]; asbestos clothing for protection against fire; asbestos gloves for protection against accidents; asbestos screens for firemen; apparatus and instruments for astronomy; lenses for astrophotography; audiovisual teaching apparatus; automated teller machines [atm]; protective suits for aviators; azimuth instruments; precision balances; balances [steelyards]; balancing apparatus; meteorological balloons; bar code readers; barometers; batteries, electric; batteries, electric, for vehicles; batteries for lighting; battery boxes; battery chargers; battery jars; beacons, luminous; signal bells; bells [warning devices]; betatrons; binoculars; blinkers [signalling lights]; blueprint apparatus; fire boats; boiler control instruments; encoded identification bracelets, magnetic; branch boxes [electricity]; breathing apparatus, except for artificial respiration; breathing apparatus for underwater swimming; bullet-proof waistcoats; marking buoys; signalling buoys; buzzers; cabinets for loudspeakers; coaxial cables; cables, electric; junction sleeves for electric cables; calculating disks; calculating machines; calibrating rings; calipers; camcorders; cinematographic cameras; cameras [photography]; capacitors; capillary tubes; encoded magnetic cards; carpenters' rules; carriers for dark plates [photography]; cases especially made for photographic apparatus and instruments; eyeglass cases; cases fitted with dissecting instruments [microscopy]; pince-nez cases; cash registers; cassette players; cathodes; cathodic anti-corrosion apparatus; cell phone straps; cell switches [electricity]; centering apparatus for photographic transparencies; central processing units [processors]; eyeglass chains; chargers for electric batteries; chemistry apparatus and instruments; dna chips; chips [integrated circuits]; choking coils [impedance]; megaphones; mercury levels; wires of metal alloys [fuse wire]; metal detectors for industrial or military purposes; meteorological instruments; meters; metronomes; micro-

meter gauges; micrometer screws for optical instruments; micrometers; microprocessors; containers for microscope slides; microscopes; microtomes; milage recorders for vehicles; mirrors for inspecting work; mirrors [optics]; modems; money counting and sorting machines; monitoring apparatus, electric; monitors [computer hardware]; monitors [computer programs]; mouse [data processing equipment]; mouse pads; coin-operated musical automata [juke boxes]; nautical apparatus and instruments; naval signalling apparatus; navigation apparatus for vehicles [on-board computers]; navigational instruments; needles for record players; neon signs; nets for protection against accidents; safety nets; nose clips for divers and swimmers; notebook computers; electronic notice boards; fire hose nozzles; objectives [lenses] [optics]; observation instruments; octants; ohmmeters; optical apparatus and instruments; optical character readers; optical condensers; optical data media; optical discs; optical fibers [fibres] [light conducting filaments]; optical glass; optical goods; optical lamps; optical lanterns; optical lenses; oscillographs; ovens for laboratory use; oxygen transvasing apparatus; ozonisers [ozonators]; parking meters; particle accelerators; pedometers; peepholes [magnifying lenses] for doors; electronic pens [visual display units]; computer peripheral devices; periscopes; personal stereos; petrol gauges; phonograph records; photocopiers [photographic, electrostatic, thermic]; drying apparatus for photographic prints; glazing apparatus for photographic prints; frames for photographic transparencies; photometers; phototelegraphy apparatus; photovoltaic cells; apparatus and instruments for physics; pince-nez; pince-nez chains; pince-nez cords; pince-nez mountings; pipettes; plane tables [surveying instruments]; planimeters; plates for batteries; DVD players; plotters; plugs, sockets and other contacts [electric connections]; plumb bobs; plumb lines; pocket calculators; light-emitting electronic pointers; polarimeters; precision measuring apparatus; pressure gauges; automatic indicators of low pressure in vehicle tires [tyres]; pressure indicator plugs for valves; pressure indicators; pressure measuring apparatus; printed circuits; printers for use with computers; prisms [optics]; probes for scientific purposes; processors [central processing units]; computer programs [downloadable software]; computer game programs; projection apparatus; projection screens; protection devices against x-rays, not for medical purposes; protection devices for personal use against accidents; protective helmets; protective helmets for sports; protective masks; voltage surge protectors; protractors [measuring instruments]; electronic publications, downloadable; punched card machines for offices; push buttons for bells; pyrometers; quantity indicators; photographic racks; radar apparatus; radio pagers; radiological apparatus for industrial purposes; radiology screens for industrial purposes; radios; vehicle

radios; radiotelegraphy sets; radiotelephony sets; railway traffic safety appliances; range finders; readers [data processing equipment]; telephone receivers; apparatus for changing record player needles; record players; apparatus for recording distance; reducers [electricity]; reflecting discs for wear, for the prevention of traffic accidents; refractometers; refractors; regulating apparatus, electric; light regulators [dimmers], electric; relays, electric; shutter releases [photography]; remote control apparatus; electric installations for the remote control of industrial operations; electro-dynamic apparatus for the remote control of railway points; electro-dynamic apparatus for the remote control of signals; resistances, electric; respirators for filtering air; respirators, other than for artificial respiration; respiratory masks, other than for artificial respiration; resuscitation mannequins [teaching apparatus]; retorts; retorts' stands; revolution counters; rheostats; riding helmets; road signs, luminous or mechanical; rods for water diviners; rods [surveying instruments]; rulers [measuring instruments]; rules [measuring instruments]; saccharometers; safety tarpaulins; salinometers; satellite navigational apparatus; satellites for scientific purposes; scales; lever scales [steelyards]; scanners [data processing equipment]; screens for photoengraving; screens [photography]; screw-tapping gauges; semi-conductors; sextants; sheaths for electric cables; shoes for protection against accidents, irradiation and fire; shutters [photography]; sighting telescopes for firearms; signal lanterns; signalling panels, luminous or mechanical; signalling whistles; signals, luminous or mechanical; transmitters of electronic signals; signs, luminous; simulators for the steering and control of vehicles; sirens; apparatus for measuring the thickness of skins; slide calipers; slide projectors; slide-rules; slides [photography]; slope indicators; smart cards [integrated circuit cards]; smoke detectors; sockets, plugs and other contacts [electric connections]; socks, electrically heated; computer software, recorded; solar batteries; solderers' helmets; solenoid valves [electromagnetic switches]; sonars; sound alarms; sound locating instruments; sound recording apparatus; sound recording carriers; sound recording discs; sound recording strips; sound reproduction apparatus; sound transmitting apparatus; sounding apparatus and machines; sounding leads; sounding lines; spark-guards; speaking tubes; spectacle cases; spectacle frames; spectacles [optics]; spectrograph apparatus; spectroscopes; speed checking apparatus for vehicles; speed indicators; speed measuring apparatus [photography]; speed regulators for record players; spherometers; spirit levels; spools [photography]; goggles for sports; sprinkler systems for fire protection; stage lighting regulators; apparatus to check stamping mail; stands for photographic apparatus; starter cables for motors; steelyards [lever scales]; steering apparatus, automatic, for vehicles;

step-up transformers; stereoscopes; stereoscopic apparatus; stills for laboratory experiments; styli for record players; sulphitometers; sunglasses; surveying apparatus and instruments; surveying chains; surveying instruments; surveyors' levels; switchboards; switchboxes [electricity]; switches, electric; tachometers; tape recorders; magnetic tape units for computers; demagnetizing apparatus for magnetic tapes; taximeters; teaching apparatus; teeth protectors; telegraph wires; telemeters; telephone apparatus; telephone wires; portable telephones; teleprinters; teleprompters; telerupters; telescopes; teletypewriters; television apparatus; automated teller machines; temperature indicators; terminals [electricity]; test tubes; testing apparatus not for medical purposes; theft prevention installations, electric; theodolites; thermionic tubes; thermionic valves; thermometers, not for medical purposes; thermostats; thermostats for vehicles; thread counters; identification threads for electric wires; ticket dispensers; time clocks [time recording devices]; time recording apparatus; time switches, automatic; automatic indicators of low pressure in vehicle tires; tone arms for record players; totalizers; traffic-light apparatus [signalling devices]; transformers [electricity]; transistors [electronic]; transmitters [telecommunication]; transmitting sets [telecommunication]; transparencies [photography]; transparency projection apparatus; transponders; triodes; tripods for cameras; electric discharge tubes, other than for lighting; automatic indicators of low pressure in vehicle tyres; urinometers; vacuum gauges; vacuum tubes [radio]; variometers; vehicle breakdown warning triangles; verniers; bullet-proof vests (am.); video cassettes; video game cartridges; video recorders; video screens; video telephones; videotapes; viewfinders, photographic; viscosimeters; voltage regulators for vehicles; voltmeters; voting machines; waling glasses; walkie-talkies; washing trays [photography]; water level indicators; wavemeters; weighbridges; weighing apparatus and instruments; weighing machines; weights; whistle alarms; wind socks for indicating wind direction; wire connectors [electricity]; masts for wireless aerials; wires, electric; workmen's protective face-shields; wrist rests for use with computers; x-ray apparatus not for medical purposes; x-ray films, exposed; x-ray photographs, other than for medical purposes; x-ray tubes not for medical purposes; chronographs [time recording apparatus]; apparatus for editing cinematographic film; cinematographic film, exposed; circuit breakers; circuit closers; cleaning apparatus for phonograph records; cleaning apparatus for sound recording discs; clinometers; clothing especially made for laboratories; clothing for protection against accidents, irradiation and fire; clothing for protection against fire; coils, electric; electromagnetic coils; holders for electric coils; mechanisms for coin-operated apparatus; coin-operated mechanisms for television sets;

collectors, electric; electric apparatus for commutation; commutators; compact disc players; compact discs [audio-video]; compact discs [read-only memory]; comparators; directional compasses; compasses [measuring instruments]; computer keyboards; computer memory devices; computer operating programs, recorded; computer programmes [programs], recorded; computers; condensers [capacitors]; conductors, electric; lightning conductors; electricity conduits; connections, electric; connections for electric lines; connectors [electricity]; contact lenses; containers for contact lenses; contacts, electric; control panels [electricity]; converters, electric; copper wire, insulated; correcting lenses [optics]; cosmographic instruments; counterfeit [false] coin detectors; mechanisms for counter-operated apparatus; counters; couplers [data processing equipment]; couplings, electric; covers for electric outlets; crash test dummies; crucibles [laboratory]; cupels [laboratory]; current rectifiers; cyclotrons; darkroom lamps [photography]; darkrooms [photography]; magnetic data media; data processing apparatus; decompression chambers; densimeters; densitometers; detectors; diagnostic apparatus, not for medical purposes; diaphragms [acoustics]; diaphragms for scientific apparatus; diaphragms [photography]; dictating machines; diffraction apparatus [microscopy]; light dimmers [regulators], electric; discharge tubes, electric, other than for lighting; disk drives for computers; disks, magnetic; distance measuring apparatus; distance recording apparatus; distillation apparatus for scientific purposes; distribution boards [electricity]; distribution boxes [electricity]; distribution consoles [electricity]; divers' masks; diving suits; dog whistles; dosage dispensers; dosimeters; drainers for use in photography; dressmakers' measures; drying racks [photography]; ducts [electricity]; dynamometers; ear plugs for divers; editing appliances for cinematographic films; egg timers [sandglasses]; egg-candlers; electric door bells; electric loss indicators; materials for electricity mains [wires, cables]; electrified fences; electrified rails for mounting spot lights; electrolyzers; electronic pocket translators; electronic tags for goods; magnetic encoders; enlarging apparatus [photography]; epidiascopes; ergometers; exposure meters [light meters]; eyeglass cords; eyeglass frames; eyeglasses; eyepieces; instruments containing eyepieces; facsimile machines; false coin detectors; apparatus for fermentation [laboratory apparatus]; fibre optic cables; film cutting apparatus; films, exposed; filters for respiratory masks; filters for ultraviolet rays, for photography; filters [photography]; fire beaters; fire blankets; fire engines; fire escapes; fire extinguishing apparatus; fire hose; flash-bulbs [photography]; flashing lights [luminous signals]; flashlights [photography]; floppy disks; fluorescent screens; fog signals, non-explosive; food analysis apparatus; apparatus to check franking; frequency meters; furnaces for laboratory

use; furniture especially made for laboratories; fuse wire; fuses; galena crystals [detectors]; galvanic batteries; galvanic cells; galvanometers; garments for protection against fire; gas testing instruments; gasoline gauges; gasometers [measuring instruments]; gauges; glass covered with an electrical conductor; graduated glassware; global positioning system [gps] apparatus; gloves for divers; gloves for protection against accidents; gloves for protection against x-rays for industrial purposes; gradient indicators; grids for batteries; hands free kits for phones; head cleaning tapes [recording]; headphones; heat regulating apparatus; heliographic apparatus; hemline markers; high tension batteries; high-frequency apparatus; holograms; horns for loudspeakers; hourglasses; hydrometers; hygrometers; identification sheaths for electric wires; identity cards, magnetic; igniting apparatus, electric, for igniting at a distance; electric apparatus for remote ignition; inclinometers; incubators for bacteria culture; inductors [electricity]; integrated circuit cards [smart cards]; integrated circuits; intercommunication apparatus; interfaces for computers; inverters [electricity]; invoicing machines; ionization apparatus not for the treatment of air or water; juke boxes for computers; juke boxes, musical; junction boxes [electricity]; kilometer recorders for vehicles; knee-pads for workers; laboratory trays; lactodensimeters; lactometers; magic lanterns; lasers, not for medical purposes; appliances for measuring the thickness of leather; lens hoods; letter scales; levelling instruments; levelling staffs [surveying instruments]; levels [instruments for determining the horizontal]; life belts; life buoys; life jackets; life nets; life saving apparatus and equipment; life-saving rafts; light-emitting diodes [led]; lighting ballasts; lightning arresters; lightning conductors [rods]; limiters [electricity]; locks, electric; logs [measuring instruments]; loudspeakers; magnetic tapes; magnetic wires; magnets; decorative magnets; magnifying glasses [optics]; manometers; marine compasses; marine depth finders; marking gauges [joinery]; material testing instruments and machines; mathematical instruments; measures; measuring apparatus; measuring devices, electric; measuring glassware; measuring instruments; measuring spoons.

16 – Absorbent sheets of paper or plastic for food-stuff packaging; address plates for addressing machines; address stamps; addressing machines; adhesive bands for stationery or household purposes; adhesive tape dispensers [office requisites]; adhesive tapes for stationery or household purposes; adhesives [glues] for stationery or household purposes; advertisement boards of paper or cardboard; albums; almanacs; announcement cards [stationery]; aquarelles; architects' models; arithmetical tables; artists' watercolor [watercolour] saucers; atlases; conical paper bags; bags [envelopes, pouches] of paper or plastics, for packaging; bags for microwave cooking; garbage bags of paper or of plastics; balls for ball-

point pens; bibs of paper; loose-leaf binders; binding strips [bookbinding]; biological samples for use in microscopy [teaching materials]; blackboards; blot- ters; blueprints; bookbinding apparatus and machines [office equipment]; bookbinding cloth; bookbinding cords; bookbinding material; bookbindings; bookends; booklets; bookmarkers; books; bottle envelopes of cardboard or paper; bottle wrappers of cardboard or paper; paper bows; boxes for pens; boxes of cardboard or paper; plastic bubble packs for wrapping or packaging; cabinets for stationery [office requisites]; calculating tables; calendars; canvas for painting; carbon paper; cardboard; cardboard articles; cardboard tubes; cards; cases for stamps [seals]; catalogues; chalk for lithography; chalk holders; marking chalk; chaplets; charcoal pencils; chart pointers, non-electronic; charts; holders for checkbooks [cheque books]; chromolithographs [chromos]; chromos; cigar bands; clipboards; clips for offices; money clips; cloth for bookbinding; coasters of paper; paper coffee filters; comic books; compasses for drawing; composing frames [printing]; composing sticks; inking ribbons for computer printers; paper tapes and cards for the recordal of computer programmes; copying paper [stationery]; cords for bookbinding; correcting fluids [office requisites]; correcting ink [heliography]; correcting tapes [office requisites]; covers of paper for flower pots; covers [stationery]; cream containers of paper; credit card imprinters, non-electric; paper cutters [office requisites]; decalcomanias; diagrams; document files [stationery]; document holders [stationery]; document laminators for office use; drawer liners of paper, perfumed or not; drawing boards; drawing instruments; drawing materials; drawing pads; drawing pens; drawing pins; drawing sets; drawing squares; drawing t-squares; duplicators; inking sheets for duplicators; painters' easels; elastic bands for offices; electrocardiograph paper; electrotypes; embroidery designs [patterns]; engraving plates; engravings; envelope sealing machines, for offices; envelopes [stationery]; writing board erasers; erasing products; erasing shields; etching needles; etchings; fabrics for bookbinding; face towels of paper; files [office requisites]; filter paper; filtering materials [paper]; finger-stalls [office requisites]; flags of paper; flower-pot covers of paper; flyers; folders for papers; folders [stationery]; forms, printed; fountain pens; franking machines for office use; french curves; galley racks [printing]; geographical maps; terrestrial globes; glue for stationery or household purposes; gluten [glue] for stationery or household purposes; graining combs; graphic prints; graphic representations; graphic reproductions; greeting cards; gummed cloth for stationery purposes; gummed tape [stationery]; gums [adhesives] for stationery or household purposes; hand labelling appliances; handbooks [manuals]; handkerchiefs of paper; hand-rests for painters; handwriting specimens for co-

pying; hat boxes of cardboard; hectographs; histological sections for teaching purposes; holders for stamps [seals]; passport holders; house painters' rollers; humidity control sheets of paper or plastic for foodstuff packaging; hygienic paper; index cards [stationery]; indexes; indian inks; ink; ink sticks; ink stones [ink reservoirs]; inking pads; inking ribbons; inking sheets for document reproducing machines; inkstands; inkwells; isinglass for stationery or household purposes; jackets for papers; perforated cards for jacquard looms; paper knives [office requisites]; labels, not of textile; ledgers [books]; letter trays; letters [type]; lithographic stones; lithographic works of art; lithographs; luminous paper; magazines [periodicals]; manifolds [stationery]; manuals [handbooks]; marking pens [stationery]; mats for beer glasses; modelling clay; molds for modelling clays [artists' materials]; moulds for modelling clays [artists' materials]; modelling materials; modelling paste; modelling wax, not for dental purposes; moistureners for gummed surfaces [office requisites]; moistureners [office requisites]; apparatus for mounting photographs; musical greeting cards; napkins of paper for removing make-up; table napkins of paper; newsletters; newspapers; nibs; nibs of gold; note books; numbering apparatus; numbers [type]; obliterating stamps; office perforators; office requisites, except furniture; oleographs; packaging material made of starches; packing paper; pads [stationery]; writing pads; paint boxes [articles for use in school]; paint trays; paintbrushes; painters' brushes; paintings [pictures], framed or unframed; palettes for painters; pamphlets; pantographs [drawing instruments]; paper; paper clasps; electro-cardiograph paper; paper for recording machines; paper knives [cutters] [office requisites]; paper ribbons; paper sheets [stationery]; paper shredders for office use; waxed paper; paper-clips; paperweights; parchment paper; pastels [crayons]; pastes for stationery or household purposes; patterns for dressmaking; patterns for making clothes; pen cases; pen clips; pen wipers; pencil holders; pencil lead holders; pencil leads; pencil sharpeners, electric or non-electric; pencil sharpening machines, electric or non-electric; pencils; penholders; pens [office requisites]; periodicals; photoengravings; photograph stands; photographs [printed]; pictures; placards of paper or cardboard; place mats of paper; plans; plastic cling film, extensible, for palletization; plastic film for wrapping; plastics for modelling; portraits; postage meters for office use; postage stamps; postcards; posters; printed matter; printed publications; printed timetables; printers' blankets, not of textile; printers' galleys; printing blocks; printing sets, portable [office requisites]; printing type; prints [engravings]; prospectuses; punches [office requisites]; paper for radiograms; rollers for typewriters; rosaries; rubber erasers; drawing rulers; square rulers; watercolor [watercolour] saucers for artists; school supplies [stationery]; scrap-

books; scrapers [erasers] for offices; sealing compounds for stationery purposes; sealing machines for offices; sealing stamps; sealing wafers; sealing wax; seals [stamps]; self-adhesive tapes for stationery or household purposes; sheets of reclaimed cellulose for wrapping; shields [paper seals]; signboards of paper or cardboard; silver paper; slate pencils; song books; spools for inking ribbons; stamp pads; stamp stands; stamps [seals]; stands for pens and pencils; staples for offices; stapling presses [office requisites]; stationery; steatite [tailor's chalk]; steel letters; steel pens; stencil cases; stencil plates; stencils; stencils [stationery]; stickers [stationery]; table linen of paper; tablecloths of paper; tablemats of paper; tags for index cards; tailors' chalk; teaching materials [except apparatus]; thumbtacks; tickets; tissues of paper for removing make-up; toilet paper; towels of paper; tracing cloth; tracing needles for drawing purposes; tracing paper; tracing patterns; trading cards other than for games; transfers [decalcomanias]; transparencies [stationery]; trays for sorting and counting money; type [numerals and letters]; typewriter keys; typewriter ribbons; typewriters, electric or non-electric; vignetting apparatus; viscose sheets for wrapping; artists' watercolor saucers; watercolors [paintings]; artists' watercolour saucers; watercolours [paintings]; wood pulp board [stationery]; wood pulp paper; wrappers [stationery]; wrapping paper; wristbands for the retention of writing instruments; writing brushes; writing cases [sets]; writing cases [stationery]; writing chalk; writing instruments; writing materials; writing or drawing books; writing paper; writing slates; writing tablets.

35 – Commercial administration of the licensing of the goods and services of others; administrative processing of purchase orders; advertising; advertising agencies; advertising by mail order; updating of advertising material; dissemination of advertising matter; rental of advertising space; commercial information and advice for consumers [consumer advice shop]; cost price analysis; telephone answering for unavailable subscribers; business appraisals; arranging newspaper subscriptions for others; arranging subscriptions to telecommunication services for others; business management of performing artists; business management assistance; auctioneering; billposting; book-keeping; professional business consultancy; business information; business inquiries; business investigations; business management and organization consultancy; business management consultancy; business management of hotels; business management of sports people; business organization consultancy; commercial or industrial management assistance; presentation of goods on communication media, for retail purposes; price comparison services; compilation of statistics; compilation of information into computer databases; systemization of information into computer databases; data search in computer files for others; demonstration of goods;



direct mail advertising; distribution of samples; document reproduction; economic forecasting; employment agencies; organization of exhibitions for commercial or advertising purposes; organization of fashion shows for promotional purposes; computerized file management; import-export agencies; commercial information agencies; invoicing; personnel management consultancy; marketing; marketing research; marketing studies; modelling for advertising or sales promotion; news clipping services; office machines and equipment rental; on-line advertising on a computer network; opinion polling; organization of trade fairs for commercial or advertising purposes; outdoor advertising; outsourcing services [business assistance]; payroll preparation; personnel recruitment; photocopying services; word processing; procurement services for others [purchasing goods and services for other businesses]; production of advertising films; psychological testing for the selection of personnel; public relations; publication of publicity texts; publicity; publicity agencies; publicity columns preparation; publicity material rental; writing of publicity texts; radio advertising; radio commercials; relocation services for businesses; rental of advertising time on communication media; rental of photocopying machines; rental of vending machines; business research; sales promotion for others; secretarial services; shop window dressing; shorthand; sponsorship search; drawing up of statements of accounts; tax preparation; telemarketing services; television advertising; television commercials; transcription; typing.

36 – Accident insurance underwriting; accommodation bureaux [apartments]; actuarial services; financial analysis; antique appraisal; apartment house management; renting of apartments; art appraisal; jewellery appraisal; numismatic appraisal; real estate appraisal; stamp appraisal; bail-bonding; banking; home banking; brokerage; brokerage of carbon credits; business liquidation services, financial; capital investments; charitable fund raising; check [cheque] verification; clearing, financial; clearing-houses, financial; rent collection; organization of collections; financial consultancy; insurance consultancy; credit bureaux; credit card services; issuance of credit cards; customs brokerage; debit card services; debt collection agencies; deposits of valuables; real estate agencies; real estate management; financial evaluation [insurance, banking, real estate]; financial evaluation of standing timber; financial evaluation of wool; repair costs evaluation [financial appraisal]; exchanging money; factoring; fiduciary; financial information; financial management; financial sponsorship; financing services; fire insurance underwriting; fiscal assessments; fund investments; electronic funds transfer; guarantees; health insurance underwriting; hire-purchase financing; housing agents; insurance information; instalment loans; insurance brokerage; insurance underwriting; capital

investment; issue of tokens of value; issuing of travellers' checks [cheques]; jewelry appraisal; lease-purchase financing; leasing of farms; leasing of real estate; lending against security; life insurance underwriting; loans [financing]; marine insurance underwriting; mortgage banking; mutual funds; pawnbrokerage; provident fund services; real estate brokers; rental of offices [real estate]; renting of flats; retirement payment services; safe deposit services; savings bank services; securities brokerage; stock exchange quotations; stocks and bonds brokerage; surety services; trusteeship; financial valuation of standing timber; fiscal valuations.

38 – Rental of access time to global computer networks; cable television broadcasting; radio broadcasting; television broadcasting; cellular telephone communication; providing internet chatrooms; communications by computer terminals; communications by fiber [fibre] optic networks; communications by telegrams; communications by telephone; computer aided transmission of messages and images; electronic bulletin board services [telecommunications services]; electronic mail; facsimile transmission; transmission of greeting cards online; information about telecommunication; message sending; news agencies; paging services [radio, telephone or other means of electronic communication]; providing access to databases; providing telecommunication channels for teleshopping services; providing telecommunications connections to a global computer network; providing user access to global computer networks; rental of facsimile apparatus; rental of message sending apparatus; rental of modems; rental of telecommunication equipment; rental of telephones; satellite transmission; telecommunications routing and junction services; teleconferencing services; transmission of telegrams; telegraph services; telephone services; telex services; transmission of digital files; voice mail services; wire service; wireless broadcasting.

41 – Academies [education]; providing amusement arcade services; amusement parks; amusements; animal training; arranging and conducting of colloquiums; arranging and conducting of concerts; arranging and conducting of conferences; arranging and conducting of congresses; arranging and conducting of seminars; arranging and conducting of symposiums; arranging and conducting of workshops [training]; arranging of beauty contests; boarding schools; booking of seats for shows; bookmobile services; publication of books; calligraphy services; holiday camp services [entertainment]; sport camp services; providing casino facilities [gambling]; rental of cine-films; cinema presentations; circuses; club services [entertainment or education]; coaching [training]; organization of competitions [education or entertainment]; organization of sports competitions; conducting fitness classes; correspondence co-

urses; disc jockey services; discotheque services; rental of skin diving equipment; dubbing; videotape editing; education information; religious education; educational examination; educational services; electronic desktop publishing; entertainer services; entertainment; entertainment information; organization of exhibitions for cultural or educational purposes; organization of fashion shows for entertainment purposes; film production, other than advertising films; gambling; game services provided on-line from a computer network; games equipment rental; providing golf facilities; vocational guidance [education or training advice]; gymnastic instruction; health club services [health and fitness training]; recreation information; instruction services; sign language interpretation; language interpreter services; layout services, other than for advertising purposes; lending libraries; mobile library services; presentation of live performances; operating lotteries; microfilming; modelling for artists; rental of motion pictures; rental of movie projectors and accessories; movie studios; movie theatre presentations; providing museum facilities [presentation, exhibitions]; music composition services; music-halls; news reporters services; night clubs; nursery schools; orchestra services; organization of balls; organization of shows [impresario services]; party planning [entertainment]; personal trainer services [fitness training]; photographic reporting; photography; physical education; practical training [demonstration]; production of music; production of radio and television programmes; production of shows; videotape film production; providing karaoke services; providing on-line electronic publications, not downloadable; providing sports facilities; publication of electronic books and journals on-line; publication of texts, other than publicity texts; rental of radio and television sets; radio entertainment; rental of video cassette recorders; recording studio services; providing recreation facilities; rental of audio equipment; rental of camcorders; rental of lighting apparatus for theatrical sets or television studios; rental of show scenery; rental of sound recordings; rental of sports equipment, except vehicles; rental of sports grounds; rental of stadium facilities; rental of stage scenery; rental of tennis courts; rental of video cameras; rental of videotapes; scriptwriting services; timing of sports events; subtitling; teaching; television entertainment; writing of texts, other than publicity texts; theatre productions; ticket agency services [entertainment]; toy rental; translation; tuition; videotaping; vocational retraining; zoological garden services.

42 – Analysis for oil-field exploitation; architectural consultation; architecture; authenticating works of art; bacteriological research; biological research; calibration [measuring]; chemical analysis; chemical research; chemistry services; cloud seeding; consultancy in the design and development of computer hardware; computer programming; duplication of

computer programs; computer rental; computer software consultancy; computer software design; installation of computer software; maintenance of computer software; updating of computer software; computer system analysis; computer system design; computer virus protection services; construction drafting; consultancy in the field of energy-saving; conversion of data or documents from physical to electronic media; cosmetic research; creating and maintaining web sites for others; data conversion of computer programs and data [not physical conversion]; design of interior decor; industrial design; packaging design services; dress designing; digitization of documents [scanning]; engineering; research in the field of environmental protection; quality evaluation of standing timber; quality evaluation of wool; underwater exploration; weather forecasting; geological prospecting; geological research; geological surveys; handwriting analysis [graphology]; hosting computer sites [web sites]; scientific laboratory services; land surveying; material testing; mechanical research; meteorological information; monitoring of computer systems by remote access; oil prospecting; oil-field surveys; oil-well testing; packaging design; physics [research]; technical project studies; providing search engines for the internet; provision of scientific information, advice and consultancy in relation to carbon offsetting; quality control; recovery of computer data; rental of computer software; rental of web servers; research and development of new products for others; styling [industrial design]; surveying; land surveys; technical research; textile testing; urban planning; quality valuation of standing timber; vehicle roadworthiness testing; water analysis.

(260) AM 2015 77730 A

(800) 1206544

(891) 2014 04 01

(731) INFOSEC COMMUNICATION

4 rue de la Rigotière, F-44700 ORVAULT, FR

(540)



(591) Black, silver, green

(511)

9 – Inverter units.

(260) AM 2015 77731 A

(800) 1206580

(891) 2013 09 14

(731) MARINASUN CELLULOSE INDUSTRIES CO.

No:1, T floor, 3rd Building, Eskan Complex, Mirdamad Blvd., Valie Asr Ave., Tehran, IR

(540)



(591) Blue, light blue, white

(511)

5 – Sanitary napkins, babies' diapers of paper and cellulose.

16 – Napkins of paper, handkerchiefs of paper, toilet paper, towels of paper, scented paper; all the aforementioned goods of cellulose and paper.

(260) AM 2015 77732 A

(800) 1206583

(891) 2013 12 03

(731) DEEPAK MITTAL

6, Industrial Estate, Jalandhar Road,  
Hoshiarpur (Punjab) – 146001, IN

(540)



(591) Black, white

(511)

12 – Tractors, motor land vehicles parts and fittings thereof, included in this class.

(260) AM 2015 77735 A

(800) 1206629

(891) 2014 03 18

(731) OLIVE LINE INTERNATIONAL, S.L.

C/Manuel Pombo Angulo, n°24, Planta 2,  
Ofic. 13, E-28050 Madrid, ES

(540)



(591) White, black, red, orange, yellow and silver

(511)

29 – Edible oils.

(260) AM 2015 77736 A

(800) 1206640

(891) 2014 03 18

(731) KIA MOTORS CORPORATION

(Yangjae-dong), 12, Heolleung-ro, Seocho-gu,  
Seoul 137-938, KR

(540)



(591) Green

(511)

12 – Passenger cars [automobiles]; lorries; buses; vans.

(260) AM 2015 77737 A

(800) 1206646

(891) 2014 04 22

(731) SHANDONG HENGYU TECHNOLOGY  
GROUP

Economic Development Zone, Guangrao  
Town, Dongying City, 257335 Shandong  
Province, CN

(540)



(591) Black, white

(511)

12 – Motorcycle wheels; automobile tires; tires, solid, for vehicle wheels; pneumatic tires; bicycles; inner tubes for vehicles.

(260) AM 2015 77738 A

(800) 1206647

(891) 2014 04 22

(731) HEFEI JINGHONG ELECTRICAL CO., LTD

No:4288 Tiandu Road, Economic and Technology  
Zone, Hefei, Anhui, CN

(540)



(591) Black, white

(511)

11 – Germicidal lamps for purifying air; gas lamps; microwave ovens [cooking apparatus]; refrigerators; desiccating apparatus; heat accumulators; taps [cocks, spigots] [faucets (Am.)] for pipes; hot air bath fittings; disinfectant apparatus; radiators, electric.

(260) AM 2015 77739 A  
 (800) 1206660  
 (891) 2014 04 30  
 (731) BROOKSBURNETT INVESTMENTS LTD  
 SOFIAS TSIROU, 9 TOULLA, COURT 3,  
 2ND FL., FLAT OFFICE 22, CY-3021  
 LIMASSOL, CY

(540)

## ARGENTOVIVO

(511)

25 – Clothing, footwear and headgear for men, women and children, namely, belts, coats, raincoats, waistcoats, blouses and pullovers, jackets, trousers, dresses, suits, swimsuits, shirts and chemises, t-shirts, sweaters, underwear, hosiery, socks and stockings, tights, gloves, ties, scarves, hats and caps, leather shoes, rubber shoes, low shoes, sandals, straw shoes, slippers, sport shoes, shoe soles, shoe liner, bath sandals, bath slippers, boots, lace shoes, half boots, outsole, shoe upper.

(260) AM 2015 77748 A  
 (800) 1206732  
 (891) 2013 12 31  
 (731) HYUNDAI MOTOR COMPANY  
 12 Heolleung-ro, Seocho-Gu, Seoul 137-938,  
 KR

(540)



(591) Blue, black, red

(511)

28 – Toys [playthings]; ornaments for Christmas trees except illumination articles and confectionery; fairground ride apparatus; dolls; rattles [playthings]; mobiles (toys); building blocks [toys]; toy sets; puppets; model vehicles for children; rocking horses; theatrical masks; toy clocks and watches; toy musical instruments; toy furniture; playing balls; scooters (toys); toy houses; slides (playthings); toy vehicles; paper toys; carnival masks; spinning tops (toys); plastic toys; scale model kits (toys); apparatus for games; games; parlor games; puzzles; play balloons; computer games apparatus; sporting articles other than golf articles and climbing articles; swings; knee guards (sports articles).

(260) AM 2015 77749 A  
 (800) 1206737  
 (891) 2013 11 27  
 (731) ETI GIDA SANAYI VE TICARET  
 ANONIM SIRKETI  
 Organize Sanayi Bolgesi 11. Cad., Eskisehir,  
 TR

(540)



(591) Black, blue, white and red

(511)

30 – Biscuits, chocolates, pastries, crackers, wafers, cakes, pastry and bakery products, chocolate bars, tarts, pies, breakfast cereals, bread, popcorn and rice crisps.

(260) AM 2015 77751 A

(800) 1206783

(891) 2014 03 18

(731) KIA MOTORS CORPORATION  
 (Yangjae-dong), 12, Heolleung-ro, Seocho-gu,  
 Seoul 137-938, KR

(540)



(591) Green

(511)

12 – Passenger cars [automobiles]; lorries; buses; vans.

(260) AM 2015 77753 A

(800) 1206826

(891) 2014 04 10

(731) Fyfe Co. LLC  
 8380 Miralani Drive, San Diego CA 92126,  
 US

(540)

## FYFE

(511)

37 – Reinforcement of buildings, and other commercial or public building structures of masonry, concrete, steel and wood, namely, planning of installation, laying out of installation, and supervising of installation of reinforcement materials on buildings, pipes, bridges, structural columns, structural beams, structural slabs, structural walls, pipes, tanks, chimneys, structural connections, transportation infrastructure, water transmission facilities, waterfront structures, water storage facilities, and water treatment facilities.

(260) AM 2015 77754 A

(800) 1206836

(891) 2014 02 13

(731) ENT SOG AISBL EUROPEAN NETWORK  
 OF TRANSMISSION SYSTEM

OPERATORS FOR GAS  
Avenue de Cortenbergh 100, Second Floor,  
B-1000 Brussels, BE

(540)



(591) Green, Grey and Blue

(511)

35 – Assistance and consultancy services in the field of business management of companies in the energy sector; commercial lobbying services; assistance and consultancy relating to international business representation services.

36 – Consultancy concerning financing of energy projects; financial consultancy in the energy sector.

40 – Production of energy.

41 – Education and training services, all relating to the energy sector; organising and conducting international conventions, congresses, conferences and seminars; publication of books and printed matter; provision of advice and information relating to the aforementioned services provided by an association towards its members in the field of energy; educational events organised and conducted by an international association towards its members.

42 – Technological advisory services relating to the use of energy; developing of integrated energy concepts; energy auditing; research in the field of energy; technological consulting services in the field of alternative energy generation; geophysical exploration for the gas industry; provision of technological consultancy to the gas industry.

45 – Political lobbying services; advisory services relating to legal regulations; compilation of legal regulatory information; provision of legal information and advisory services provided by an international association towards its members, the public, governmental and non-governmental bodies, administration bodies and other interested parties in the field of energy.

(260) AM 2015 77755 A

(800) 1206855

(891) 2014 03 19

(731) FIDIA FARMACEUTICI S.p.A.

Via Ponte della Fabbrica, 3/A, I-35031  
ABANO TERME (PD), IT

(540)

**IAL-SYSTEM ACP**

(511)

3 – Bleaching preparations and other substances for laundry use; cleaning, polishing, scouring and abra-

sive preparations; soaps; perfumery, essential oils, cosmetics, hair lotions; dentifrices.

5 – Pharmaceutical and veterinary preparations; sanitary preparations for medical purposes; dietetic food and substances adapted for medical or veterinary use, food for babies; dietary supplements for humans and animals; plasters, materials for dressings; material for stopping teeth, dental wax; disinfectants; preparations for destroying vermin; fungicides, herbicides.

10 – Surgical, medical, dental and veterinary apparatus and instruments, artificial limbs, eyes and teeth; orthopaedic articles; suture materials.

(260) AM 2015 77756 A

(800) 1206858

(891) 2013 10 09

(731) SOFAR SPA

Via Firenze, 40, I-20060 TREZZANO ROSA  
(MI), IT

(540)



(591) Black, white

(511)

5 – Food supplements.

35 – Advertising, on-line sale; customer care services; Internet advertising and business information services; organization of online sales to the public via the Internet, on-line or via Internet sale services and retail and whole sales services of goods for others; business management for sales via the Internet; providing information to consumers via the Internet.

(260) AM 2015 77758 A

(800) 1206864

(891) 2013 12 31

(731) HYUNDAI MOTOR COMPANY

12 Heolleung-ro, Seocho-Gu, Seoul 137-938,  
KR

(540)



(591) Blue, red, black

(511)

35 – Commercial intermediary services in the field of automobiles; commercial intermediary services in the field of parts and accessories for automobiles; retail and wholesale of automobiles, and related sales administration; retail and wholesale of parts and accessories for automobiles, and related sales administration; marketing services; rental of advertisement space and advertising material; bill-posting;



organization of trade fairs for commercial or advertising purposes; organization of exhibitions for commercial or advertising purposes; demonstration of goods; sales promotion for others; advertising services by means of mobile telephones; on-line advertising on a computer network: compilation of statistics; compilation of information into computer databases; import-export agencies; rental of office machines and equipment; online auction services.

(260) AM 2015 77759 A  
(800) 1206866  
(891) 2013 12 31  
(731) HYUNDAI MOTOR COMPANY  
12 Heolleung-ro, Seocho-Gu, Seoul 137-938, KR  
(540)



(591) Black, blue, red  
(511)  
25 – Clothing; footwear; caps (headwear); sportswear; sport shirts; sports overcoats; outerclothing; overcoats excluding clothing used exclusively for sports and Korean traditional clothes; children's clothing; underwear; sleeping garments; winter gloves; ear muffs (clothing); masks for the protection against the cold (clothing); socks; sashes for wear; waterproof clothing; belts for clothing; athletic uniforms.

(260) AM 2015 77762 A  
(800) 1206909  
(891) 2014 03 17  
(731) ASH-D ICECEK GIDA OTOMOTIV  
TEMIZLIK SANAYI VE TICARET  
ANONIM SIRKETI  
Halaskargazi Cad. No:364/1 Sisli,  
ISTANBUL, TR  
(540)



(591) Black, white  
(511)  
32 – Beers; mineral and aerated waters and other non-alcoholic beverages; fruit beverages and fruit juices; syrups and other preparations for making beverages.

(260) AM 2015 77763 A  
(800) 1206949  
(891) 2014 05 30

(731) BEIERSDORF AG  
Unnastrasse 48, 20253 Hamburg, DE  
(540) NIVEA ORIGINAL CARE  
(511)  
3 – Soaps, perfumery, essential oils, cosmetics, cosmetic lip care preparations.

(260) AM 2015 77838 A  
(800) 1152997  
(891) 2014 06 10  
(731) S. TOUS, S.L.  
Carretera de Vic, El Guix, 3, E-08243  
MANRESA (Barcelona), ES  
(540)



(591) Black, white  
(511)  
3 – Perfumes, soaps and creams for the body.

(260) AM 2015 78043 A  
(800) 1209052  
(891) 2014 04 22  
(731) ANDRII ZDESENKO  
kv. 23, bud. 1, vul. Novokrims'ka, m.  
Dnipropetrovs'k 49055, UA  
(540)



(591) Black, white  
(511)  
3 – Cotton sticks for cosmetic use; deodorants [perfumery]; stain removers; detergents other than those used in manufacturing operations and for medical use; eau de Cologne; laundry detergents; lotions for cosmetic use; laundry soaking preparations; cotton wool for cosmetic use; soaps; deodorant soaps; tissues impregnated with cosmetic lotions; cloths impregnated with a detergent for cleaning.

16 – Hand towels of paper; absorbent sheets of paper or plastic for foodstuff packaging; sheets of reclaimed cellulose for wrapping; humidity control sheets of paper or plastic for foodstuff packaging; table linen of paper; handkerchiefs of paper; toilet paper; parchment paper; extensible plastic cling film for palletization; plastic film for wrapping; bags for microwave cooking; bags [envelopes, pouches] of

paper or plastics, for packaging; garbage bags of paper or of plastics; tissues of paper for removing make-up; table napkins of paper; face towels of paper; tablecloths of paper.

(260) AM 2015 78044 A

(800) 1209072

(891) 2014 05 13

(731) SHIYAN CHITIAN MOTOR CO., LTD.  
No:2 Heilongjiang Road, Shiyang Hubei, CN

(540)



(591) Black, white

(511)

12 – Lifting cars (lift cars); sprinkling trucks; motor buses; trailers (vehicles); hose carts; military vehicles for transport; tilting-carts; automobiles; vehicle chassis; hydraulic system for vehicles.

(260) AM 2015 78045 A

(800) 1209077

(891) 2014 03 05

(731) SANOFI  
54 rue La Boétie, F-75008 Paris, FR

(540)

**GLYROGO**

(511)

5 – Pharmaceutical preparations for the treatment of cardiovascular diseases, diseases of the central and peripheral nervous system, respiratory, gynecological, rheumatic, urological, gastro-enterological, infectious, ophthalmological, dermatological, autoimmune, genital, endocrine and intestinal diseases, diseases of the blood, internal medicine diseases, diabetes, cancer and allergies; vitamins; hormones; vaccines; food supplements.

10 – Medical apparatus, syringes, injection pens for pharmaceutical substances.

(260) AM 2015 78054 A

(800) 1209090

(891) 2014 05 23

(731) Open-Type Joint Stock Company  
"CONFECTIONARY CONCERN  
BABAYEVSKY"  
d. 7, ul. Malaya Krasnoselskaya, RU-107140  
Moscow, RU

(540)

**WHITE SWAN**

(511)

30 – Confectionery made of sugar, namely Turkish delight, pastilles [confectionery], marshmallows, chocolate paste, chocolate paste with milk, caramels [candy], candy, halvah, sweets, chocolate, pralines, waffles; cocoa; sugar; ice cream; honey; flour and preparations made from cereals; pastries.

(260) AM 2015 78055 A

(800) 1209102

(891) 2013 04 22

(731) MEHTAP MUTFAK EŞYALARI SANAYİ  
VE TİCARET ANONİM ŞİRKETİ  
Akpınar Mahallesi, Kanuni Caddesi, No:2,  
Samandıra, Kartal-İstanbul, TR

(540)

**ALARA**

(591) Black, white

(511)

8 – Table cutlery made of precious or non-precious metals or coated therewith, namely, knives, spoons and forks; non-electric egg and cheese slicers, non-electric pizza cutters, non-electric vegetable and fruit peelers; side arms, not including firearms, namely swords, daggers, hunting knives; hand tools for personal use, namely, electric and non-electric razors, razor blades, electric hair removing devices, scissors, eyelash curlers; pedicure and manicure implements, namely, nail scissors, nail files, cuticle pushers, tweezers; cases for manicure instruments; electric hair curling irons, electric hair straightening irons; manually operated hand tools, namely, adzes, saws, planes, gardening shears and scissors, pipe wrenches, spanners, spatulas, scythes, hatchets, hammers, mauls, hand operated pumps, hand operated tools for applying paint to surfaces, chisels, screwdrivers, drills, sharpening stones, shovels, sharpening wheels for knives and blades, socket sets, socket wrenches, pliers, pincers, hand jacks, crowbar, non electric soldering irons; irons, namely, electric and steam irons.

21 – Cleaning tools and equipments (non-electric); brushes (other than painting brushes), brushes with cleaning purposes, materials used in brush-making, namely, sponges, steelwool and wool wastes; dusting and cleaning clothes, gloves for washing dishes, non-electric polishing machines, carpet beaters, carpet sweepers, pads for cleaning, electric brushes, except parts of machines; toothbrushes, electric toothbrushes, dental floss, shaving brushes, hairbrushes, combs; non-electrical small hand tools for home and kitchen use, namely, mixers, blenders, coffee and spice mills, fruit and vegetable presses, grinders, graters; household and kitchen utensils and containers made of glass, porcelain, ceramics, ordinary metal, plastic and synthetic and other materials, included in this class; metal money boxes, buckets, waste baskets, sauce pots, plates, paper plates and



drinking glasses, trays, coffee pots, non-electric, strainers, basting spoon (ladles) for kitchen use, mixing spoons (kitchen utensils), spatulas, washtubs, bowls, egg cups, cake molds, pitchers, food keeping boxes, coasters, not of paper and other than table linen, toilet paper holders, baby baths, ice molds and ice buckets; heat insulated containers for beverages, flasks, fitted picnic baskets (including dishes), bread boxes, bread baskets, bread cutting boards, all aforementioned goods are not of precious metal or coated therewith (including of synthetic materials); clothes pegs, vases; non-electric cooking utensils, namely, grills, griddles (cooking utensils), non-electric autoclaves, hot pots, not electrically heated, grills; bottles, jars, demijohns; corkscrews, shoehorns, toothpicks, drinking straws; ironing boards, ironing board covers, laundry drying racks; cages for pets, litter boxes (trays) for pets, drinking and feeding troughs for animals, bird baths, perches for bird cages; aquariums; indoor terrariums for animal and plant cultivation; ornaments made of glass, porcelain, ceramics or terra-cotta; sculptures, works of art of porcelain, terra-cotta or glass; mouse traps, insect traps, fly catchers, fly swatters, toilet utensils, electric devices for attracting and killing insects; perfume burners, perfume atomizers, perfume sprayers and vaporizers, sold empty, cosmetic utensils (non-electric), make-up removing appliances, powder puffs, toilet cases; nozzles for sprinkler hose, nozzles for watering cans, watering devices, roses for watering cans; glass, unworked or semi-worked (except building glass), mosaics of powdered glass for decoration, not for building; glass wool other than for insulation and textile; non-metallic cups given at the sport contests made of glass, porcelain, ceramics, ordinary metal, plastic and synthetic and other materials, included in this class.

35 – Advertising; business management; business administration; the bringing together, for the benefit of others, of hand tools and implements (hand-operated), cutlery, side arms, razors, household or kitchen utensils and containers, combs and sponges, brushes (except paint brushes), brush-making materials, articles for cleaning purposes, steelwool, unworked or semi worked glass (except glass used in building), glassware, porcelain and earthenware not included in other classes (excluding the transport thereof), enabling customers to conveniently view and purchase those goods; all the aforementioned retail services may be provided by retail stores, wholesale outlets, through mail order catalogues or by means of electronic media, including, through web sites or television shopping programmes.

(260) AM 2015 78056 A

(800) 1209104

(891) 2013 08 19

(731) PIPEDREAM PRODUCTS, INC.

21350 Lassen St., Chatsworth, CA 91311, US

(540)

## PIPEDREAM

(511)

3 – Perfume, soaps, body lotions, massage oil, massage lotions, shower gel, massage cream, dusting powder, bubble bath and kits comprised of one or more of each of the aforementioned goods.

5 – Water-based personal lubricants, water based non-medicated personal lubricant jellies, jams, butter and puddings all for use on the skin (terms considered too vague by the International Bureau – rule 13.2.b of the Common Regulations).

10 – Electric and non-electric massage devices, namely, devices for massaging or vibrating portions of the face and body and pacifiers for massaging the lips; devices for aiding in copulation and masturbation, namely, reproduction of parts of the male and female anatomy, penises, vaginas, pumps, rings, clamps, stimulators, vibrators, dildos, dongs, butt plugs, sleeves on vibrators sold together with the massaging devices, harnesses, masturbators, nipple clippers, body prostheses, electrical appliances for massaging the body, kits comprised of two or more of these products; love dolls and condoms and miniature condoms; pacifiers for use by adults.

28 – Toy trinkets, namely, squirt guns, toy pacifiers, plastic fruit, plastic vegetables, pacifiers, false nose and glasses, and windup toys (terms considered too vague by the International Bureau – rule 13.2.b of the Common Regulations); dolls and action figures, play figures; party favors in the nature of small toys; sexually humorous novelties, namely, action figures, play figures, mechanical action toys, water squirting toys, and ring toss games; playing cards; playing cards consisting of a custom deck adult playing card game; dice, consisting of a custom adult dice game; board games; lottery cards and lottery tickets, consisting of a custom adult lottery game; adult party game consisting of a poster and paper game pieces.

(260) AM 2015 78057 A

(800) 1209122

(891) 2013 12 25

(731) LAARA INTERPRAISEZ LIMITED

Sheikh Zayed Road, Suite 1003, P.O. Box

No:712241, Khalid Al Attar Tower, Dubai, AE

(540)

## DR. CLEAN

(511)

21 – Toothbrushes; toothbrushes, electric; floss for dental purposes; toothpicks; gloves for household purposes; gardening gloves; rubber gloves.

(260) AM 2015 78058 A

(800) 1209126

(891) 2013 12 11

(731) Limited Liability Company  
 "GEKSA-NETKANIE MATERIALI"  
 3, Tsentralnaya Street, Goljovo, Krasnogorsk  
 region, RU-143405 Moscow, RU

(540)

**IZOSPAN**

(591) Black, white

(511)

17 – Shock-absorbing buffers of rubber; compressed air pipe fittings, not of metal; asbestos; cellulose acetate, semi-processed; balata; asbestos paper; paper for electrical capacitors; insulating paper; insulating paper, including paper with a layer of metallized polymer film; cotton wool for packing [caulking]; mineral wool [insulator]; insulating felt; plastic fibers [fibres], not for textile use; carbon fibers [fibres], other than for textile use; asbestos fibers [fibres]; guttapercha; foam supports for flower arrangements [semi-finished products]; dielectrics [insulators]; floating anti-pollution barriers; lute; insulators; insulators for railway tracks; insulators for electric mains; insulators for cables; asbestos mill boards; liquid rubber; synthetic rubber; gum, raw or partly processed; valves of india-rubber or vulcanized fiber [fibre]; clack valves of rubber; rings of rubber; water-tight rings; insulating paints; insulating varnish; latex [rubber]; insulating tape and band; adhesive bands, other than stationery and not for medical or household purposes; adhesive bands, other than stationery and not for medical or household purposes, including adhesive bands on tissue basis, adhesive bands on the aluminum base with silicone paper, adhesive polypropylene metallized bands; adhesive polyethylene bands, mesh reinforced; self-adhesive tapes, other than stationery and not for medical or household purposes; asbestos sheets; viscose sheets, other than for wrapping; foil of regenerated cellulose, other than for wrapping; insulating oils; insulating oil for transformers; reinforcing materials, not of metal, for pipes; weatherstripping compositions; caulking materials; brake lining materials, partly processed; soundproofing materials; insulating materials; insulating refractory materials; padding materials of rubber or plastics; rubber material for recapping tires [tyres]; non-conducting materials for retaining heat; boiler composition to prevent the radiation of heat; packing [cushioning, stuffing] materials of rubber or plastics; sealant compounds for joints; sealant compounds for joints including butyl rubber tape for joints; filtering materials [semi-processed foams or films of plastic]; compositions to prevent the radiation of heat; bags [envelopes, pouches] of rubber, for packaging; pipe muffs, not of metal; rubber sleeves for protecting parts of machines; asbestos packing; clutch linings; soldering threads of plastic; threads of plastic materials, not for textile use; threads of rubber, not for use in textiles; elastic threads, not for use in textiles; stops of rubber; insulating gloves; plastic substances,

semi-processed; insulating plaster; plastic sheeting for agricultural purposes; plastic film other than for wrapping; anti-dazzle films for windows [tinted films]; asbestos coverings; bark coverings for sound insulation; asbestos cloth; rubber stoppers; expansion joint fillers; cylinder jointings; washers of rubber or vulcanized fiber [fibre]; pipe gaskets; draught excluder strips; joint packings; rubber solutions; mica, raw or partly processed; acrylic resins [semi-finished products]; artificial resins [semi-finished products]; junctions, not of metal, for pipes; substances for insulating buildings against moisture; chemical compositions for repairing leaks; glass wool for insulation; fiberglass for insulation; asbestos fabrics; fiberglass fabrics for insulation; insulating fabrics; flexible tubes, not of metal; hoses of textile material; connecting hose for vehicle radiators; waterproof packings; bands of rubber for unscrewing jar lids; foils of metal for insulating; ebonite [vulcanite] molds [moulds]; asbestos slate; slag wool [insulator]; watering hose; canvas hose pipes; cords of rubber; asbestos safety curtains; ebonite [vulcanite].

19 – Asbestos cement; asphalt; concrete; bitumen; building paper; busts of stone, concrete or marble; binding agents for making briquettes; binding material for road repair; stained-glass windows; felt for building; geotextiles; gypsum; clay; gravel; granite; coal tar; parquet floor boards; memorial plaques, not of metal; roofing shingles; wood for making household utensils; veneer wood; moldable wood; jalousies, not of metal; roof gutters, not of metal; street gutters, not of metal; agglomerated bagasses of cane [building material]; calcareous stone; lime; fences, not of metal; works of stonemasonry; works of art of stone, concrete or marble; stone; artificial stone; building stone; gravestones; reeds, for building; greenhouse frames, not of metal; framework, not of metal, for building; building cardboard [asphalted]; wood pulp board, for building; paperboard for building; quartz; caissons for construction work under water; bricks; fire burrs; water-pipe valves, not of metal or plastic; cement posts; cask wood; mooring bollards, not of metal; drain traps [valves], not of metal or plastic; buildings, not of metal; buildings, transportable, not of metal; door casings, not of metal; door frames, not of metal; stringers [parts of staircases], not of metal; silica [quartz]; roofing, not of metal; manhole covers, not of metal; xylolith; chicken-houses, not of metal; building timber; manufactured timber; sawn timber; wood, semi-worked; staircases, not of metal; road marking sheets and strips of synthetic material; reinforcing materials, not of metal, for building; bituminous products for building; tar; road coating materials; materials for making and coating roads; fireclay; pitch; building materials, not of metal; building materials, not of metal, including materials in the form of non-woven laminated linen for protection against mois-

ture and condensate; building materials, not of metal, in the form of woven polypropylene linen, including laminated linen, for protection against moisture and condensate; building materials, not of metal, in the form of woven, non-woven or foamed polyethylene canvas with a layer of metallized polypropylene film, reflecting thermal radiation, for protection against moisture and condensate; refractory construction materials, not of metal; masts [poles], not of metal; raw chalk; calcareous marl; mosaics for building; marble; slate powder; porches, not of metal, for building; tombs, not of metal; flashing, not of metal, for building; roof flashing, not of metal; perches; duckboards, not of metal; wall claddings, not of metal, for building; moldings, not of metal, for cornices; coatings [building materials]; grave or tomb enclosures, not of metal; tomb or grave enclosures, not of metal; laths, not of metal; wood paneling; wall linings, not of metal, for building; palings, not of metal; crash barriers, not of metal, for roads; latticework, not of metal; trellises, not of metal; windows, not of metal; olivine for building; shuttering, not of metal, for concrete; poles, not of metal, for electric power lines; props, not of metal; branching pipes, not of metal; fair huts; tombs [monuments], not of metal; monuments, not of metal; wainscotting, not of metal; signalling panels, non-luminous and non-mechanical, not of metal; building panels, not of metal; parquet flooring; partitions, not of metal; lintels, not of metal; casement windows, not of metal; aquarium sand; silver sand; sand, except foundry sand; sandstone for building; planks [wood for building]; tarred strips, for building; platforms, prefabricated, not of metal; floor tiles, not of metal; tiles, not of metal, for building; paving slabs, not of metal; cement slabs; grave slabs, not of metal; scaffolding, not of metal; asphalt paving; wood paving; paving blocks, not of metal; luminous paving; macadam; fireproof cement coatings; bituminous coatings for roofing; roof coverings, not of metal; roofing, not of metal, incorporating solar cells; wooden floor boards; cladding, not of metal, for building; mantelpieces; door panels, not of metal; floors, not of metal; sills, not of metal; porphyry [stone]; ceilings, not of metal; floating docks, not of metal, for mooring boats; cork [compressed]; grout; asbestos mortar; tanks of masonry; scantlings [carpentry]; furrings of wood; vinyl siding; pilings, not of metal; pigsties, not of metal; insect screens, not of metal; vaults, not of metal [burial]; schists; blinds [outdoor], not of metal and not of textile; shutters, not of metal; safety glass; glass granules for road marking; insulating glass [building]; window glass, for building; window glass, except glass for vehicle windows; building glass; plate glass [windows], for building; tombstone stelae, not of metal; stables, not of metal; advertisement columns, not of metal; posts, not of metal; hips for roofing; stair-treads [steps], not of metal; tombstone plaques, not of metal; greenhouses, trans-

portable, not of metal; terra cotta; penstock pipes, not of metal; water-pipes, not of metal; gutter pipes, not of metal; ducts, not of metal, for ventilating and air-conditioning installations; drain pipes, not of metal; chimneys, not of metal; rigid pipes, not of metal [building]; sandstone tubes; turnstiles, not of metal; tufa; angle irons, not of metal; lengthening pieces, not of metal, for chimneys; bicycle parking installations, not of metal; plywood; foundry molds [moulds], not of metal; cement for blast furnaces; cement for furnaces; magnesia cement; cement; pantiles; slate; roofing slates; slag [building material]; clinker stone; railroad ties, not of metal; veneers; clinker ballast; concrete building elements; letter boxes of masonry.

24 – Velvet; household linen; diapered linen; bath linen, except clothing; bed linen; bed linen, including disposable bed linen; table linen, not of paper; buckram; dimity; felt; damask; table runners; drugget; shower curtains of textile or plastic; curtains of textile or plastic; net curtains; banners; canvas for tapestry or embroidery; bolting cloth; crepon; furniture coverings of textile; fabrics for textile use; filtering materials of textile; wall hangings of textile; non-woven textile fabrics; plastic material [substitute for fabrics]; textile material; sleeping bags [sheeting]; pillowcases; mattress covers; bed blankets; handkerchiefs of textile; travelling rugs [lap robes]; coasters [table linen]; linings [textile]; hat linings, of textile, in the piece; curtain holders of textile material; bed covers; bed covers of paper; coverings of plastic for furniture; towels of textile; hemp cloth; gummed cloth, other than for stationery; printers' blankets of textile; cloth; door curtains; bed clothes; sheets [textile]; eiderdowns [down coverlets]; washing mitts; shrouds; glass cloths [towels]; napkins, of cloth, for removing make-up; face towels of textile; tablemats, not of paper; place mats, not of paper; table napkins of textile; mosquito nets; calico; oilcloth for use as tablecloths; tablecloths, not of paper; billiard cloth; ticks [mattress covers]; tick [linen]; lingerie fabric; fabric, impervious to gases, for aeronautical balloons; jute fabric; fabric for footwear; ramie fabric; rayon fabric; esparto fabric; fiberglass fabrics, for textile use; adhesive fabric for application by heat; linen cloth; upholstery fabrics; hemp fabric; lining fabric for shoes; traced cloths for embroidery; chenille fabric; printed calico cloth; bunting; knitted fabric; cotton fabrics; silk fabrics for printing patterns; woollen cloth; elastic woven material; fabric; fabric of imitation animal skins; haircloth [sackcloth]; cheese cloth; tulle; flags, not of paper; flannel [fabric]; sanitary flannel; trellis [cloth]; covers for cushions; fitted toilet lid covers of fabric; covers [loose] for furniture; pillow shams; labels of cloth.

(260) AM 2015 78059 A  
 (800) 1209214  
 (891) 2014 01 20  
 (731) VELVET CARE SP. Z O.O.  
 Klucze-Osada 3 PL-32-310 Klucze, PL  
 (540)



(591) Dark blue, white and light blue  
 (511)

3 – Impregnated cosmetic cloths; moist cosmetic cloths; cloth impregnated with a detergent; impregnated cosmetic wipes; moist cosmetic wipes for personal hygiene; cosmetic wipes for sanitary purposes; tissues impregnated with cosmetic lotions; swabs (toiletries); cleaning and polishing preparations; cosmetic wipes; baby wipes.

5 – Sanitary towels, panty liners; sanitary tampons; wipes for sanitary purposes other than toiletries; paper pant diapers; disposable nappies; disposable napkins for babies.

16 – Paper articles including: filter paper; table linen of paper; handkerchief of paper; paper filters for coffee; envelopes (stationery); stationery paper; tablecloths of paper; toilet paper; towels of paper; table napkins of paper; napkins of paper for removing make-up; table napkins of paper; tablemats of paper; bibs of paper; adhesive tapes for stationery and household purposes; toilet tissues; table napkins of paper; tissues of paper; kitchen paper towels; cleaning tissues; sanitary paper products being hand towels of paper; facial tissues of paper; facial towels of paper; moisture absorbent paper tissues especially facial tissues of paper; toilet tissues; refuse bags for used babies napkins; disposable paper towels for babies.

21 – Disposable cleaning cloths of non-woven fabrics; rags for cleaning; scouring pads; containers for household or kitchen use; boxes for dispensing paper towels.

35 – Wholesale and retail sales of: impregnated cloths, moist cloths, cloth impregnated with a detergent, impregnated wipes, moist wipes for personal hygiene, wipes for sanitary purposes, tissues impregnated with cosmetic lotions, swabs (toiletries), cleaning and polishing preparations, sanitary, towels, panty, liners, sanitary paper articles including, filter paper, table linen of paper, handkerchief of paper, paper filters for coffee, confetti, envelopes (stationery), stationery paper, tablecloths of paper, toilet paper, paper pant diapers, disposable nappies, towels of paper, table napkins of paper, napkins of paper for removing make-up, table napkins of paper, tablemats of paper, bibs of paper, adhesive tapes for stationery and household purposes, toilet tissues, cos-

metic wipes, table napkins of paper, tissues of paper, kitchen paper towels, cleaning tissues, baby wipes, sanitary paper products, facial tissues of paper, facial towels of paper, moisture absorbent paper tissues especially facial tissues, toilet tissues, disposable napkins for babies, refuse bags for used babies napkins, disposable towels for babies, disposable cloths of non-woven fabrics, rags for cleaning, scouring pads, containers for household or kitchen use, boxes for dispensing paper towels.

(260) AM 2015 78060 A  
 (800) 1209217  
 (891) 2014 02 24  
 (731) VELVET CARE SP. Z O.O.  
 Klucze-Osada 3, PL-32-310 Klucze, PL  
 (540)



(591) Black, grey and white  
 (511)

3 – Impregnated cosmetic cloths; moist cosmetic cloths, cloth impregnated with a detergent except cleaning cloths and dusters, impregnated cosmetic wipes, moist cosmetic wipes for personal hygiene, cosmetic wipes for sanitary purposes, tissues impregnated with cosmetics lotion, swabs (toiletries), cleaning and polishing preparations; cosmetic wipes, baby wipes.

5 – Sanitary towels, panty liners, sanitary tampons, wipes for sanitary purposes other than toiletries; paper pant diapers, disposable nappies, disposable napkin for babies.

16 – Paper articles including: filter paper, table linen of paper, handkerchief of paper, paper filters for coffee, envelopes (stationery), stationery paper, tablecloths of paper, toilet paper, towels of paper, table napkins of paper, napkins of paper for removing make-up, tablemats of paper, serviettes of paper, bibs of paper, adhesive tapes for stationery and household purposes, toilet tissues, paper towels, paper tissues, kitchen towels of paper, paper cloths, sanitary paper products being hand towels of paper, facial tissues of paper, toilet towels of paper, facial tissues of paper, hygienic toilet tissues, refuse bags for used babies napkins, disposable paper towels for babies.

21 – Disposable cleaning cloths of non-woven fabrics, rags for cleaning, scouring pads, containers for household or kitchen use, boxes for dispensing paper towels.

(260) AM 2015 78061 A  
 (800) 1209231  
 (891) 2014 04 18  
 (731) SOCIÉTÉ JAS HENNESSY & CO  
 1 rue de la Richonne, F-16100 COGNAC, FR  
 (540)

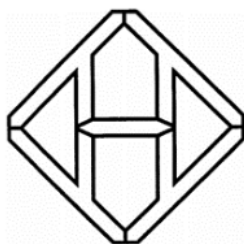

(591) Black, white  
 (511)  
 33 – Alcoholic beverages (except beers); alcoholic cocktails.

(260) AM 2015 78062 A  
 (800) 1209236  
 (891) 2014 02 14  
 (731) IVOCLAR VIVADENT AG  
 Bendererstrasse 2, FL-9494 Schaan, LI  
 (540)

## IPS E.MAX CAD FOR ZENOTEC

(511)  
 5 – Dental materials for use in dentistry, namely materials and preparations for the manufacture of models, crowns and bridges, inlays, prostheses, artificial teeth, characterization of teeth; dental alloys; tooth filling materials; dental adhesive agents; materials for the cavity treatment; dental cements; dental ceramic layering; colour stains for use in dentistry; core build-up materials for use in dentistry; opaque materials for dental use; materials for metal-resin bonding systems for dental purposes; prefabricated parts for dental crowns, bridges and pontics.

7 – Milling and grinding machines, in particular for the treatment of ceramics, plastics and metal; milling and grinding tools as parts of machines; tool holders and workpiece holders for the aforementioned goods (as far as contained in this class).

9 – Electric and electronic apparatus for dental use as far as included in this class, in particular scanners, devices for digital imaging and devices for computer aided design (CAD) processing.

(260) AM 2015 78063 A  
 (800) 1209246  
 (891) 2014 05 26  
 (731) NEMIROFF INTELLECTUAL PROPERTY  
 ESTABLISHMENT  
 Städtle 31, FL-9490 Vaduz, LI

(540)



(591) Brown, bordeaux, red, beige, white and grey  
 (511)  
 33 – Alcoholic beverages (except beers).

35 – Advertising; business management; business administration; office functions; importation and exportation of alcoholic beverages; retail and wholesale services with alcoholic beverages.

(260) AM 2015 78064 A  
 (800) 1209247  
 (891) 2014 05 26  
 (731) NEMIROFF INTELLECTUAL PROPERTY  
 ESTABLISHMENT  
 Städtle 31, FL-9490 Vaduz, LI  
 (540)



(591) Grey, blue, white, black, beige and brown  
 (511)  
 33 – Alcoholic beverages (except beers).

35 – Advertising; business management; business administration; office functions; importation and exportation of alcoholic beverages; retail and wholesale services with alcoholic beverages.

(260) AM 2015 78067 A  
 (800) 1209268  
 (891) 2014 04 30  
 (731) VIZIO, INC.  
 39 Tesla, Irvine CA 92618, US

(540)

**VIZIO**

(511)

9 – Mobile phones; smart phones; desk or car mounted units incorporating a loudspeaker to allow a telephone handset to be used hands-free; wireless communication devices, namely smart phones, telephone handsets, and telephone headsets.

11 – LED light bulbs; LED luminaires; LED lighting fixtures; household appliances; kitchen appliances; ventilation hoods; wine coolers, namely, refrigerated cabinets containing racks for wine bottles and storage shelves.

(260) AM 2015 78068 A

(800) 1209295

(891) 2013 04 08

(731) GENERAL ELECTRIC COMPANY

1 River Road, Schenectady, NY 12345, US

(540)



(591) Black, white

(511)

7 – Machines for domestic and household use, namely, electronic power operated coffee grinders; mechanical mixing machines; electric food blenders for domestic use; electric juice extractors; electric food processors, and electric food preparation machines, vegetable grinders and slicers; electric motors other than for land vehicles, steam and gas turbines and parts thereof; electric generators and their parts; aircraft engines; gas compressors, air-conditioning compressors; washing machines; gas and electric clothes drying machines; dishwashers; garbage disposers and compactors; electric knives; electric can openers; axial and centrifugal compressors; reciprocating compressors; screw and vane compressors; rotary, vacuum, electric, submersible and centrifugal pumps; turbo expanders, namely, air and electric compressors; CNG refueling machines for land vehicles and industrial equipment and accessories and parts for all the foregoing, namely, pumps, valves, fuel filters, filter casings, distributor rotors, blades, bearings, and mechanical seals; steam condensers; pumps, namely, centrifugal pumps, diaphragm pumps, bellows pumps and process and transfer pumps for water and wastewater treatment systems; regulators being parts of machines; filter cartridges for various industrial machines for filtration applications, namely, for the filtration of beer in the brewing industry, and other specialty chemicals; machines for the feeding and application of chemicals for

industrial uses; boat engines, turbochargers for engines, and fuel injectors; vehicle engine parts, namely, high frequency motor spindles with high frequency electric converters and power supply units, rocker arms, push rods, oil coolers, crankcase breathers, oil tanks, ignition parts for internal combustion engines, namely, points, radiators, water pumps, starter motors, pumps for cooling engines, engine bearings, engine camshafts, engine rods and engine mufflers; apparatus, equipment and instruments for the generation of power, namely, electric generators and wind powered electricity generators; turbines; turbines for power generation; wind turbines for power generation; engines for the generation of electricity, and parts and fittings for all the aforesaid; electrical power generation products.

9 – Navigation apparatus for vehicles in the nature of on-board computers; optical inspection apparatus for railway system use; railway signals, namely, crossing warning systems; high-frequency switching power supplies; electrical engine controllers; global positioning system (GPS) consisting of computers, computer software, transmitters, receivers, and network interface devices for the rail and transit industries; electrical devices and electrical power distribution products, namely, capacitors, circuit breakers, circuit breaker load centers, circuit closers, circuit interrupters, commutators, contactors, current rectifiers, current limiters, electric contacts, electric collectors, electric conductors, electric connectors, electric controllers, electric inductors, electric power supplies, electricity distribution boards and boxes, electricity distribution consoles, electricity switchboards, and switchboxes; computer software for persons who troubleshoot and maintain programmable controllers; computer software for analyzing blood vessels including cardiac vessels which also provides calculation functions with respect to blood vessels; computer software for use with medical patient monitoring equipment; computer software for receiving, processing, transmitting and displaying data, for use in developing personalized asset allocation programs; computer software for collecting data involving vital medical signs; computer software for use in electrical power systems analyses; computer software for regulating and managing vehicle fleet maintenance services; computer software for use by customers to obtain lease portfolio information; computer software for a radiology information system for use by radiologists and radiology departments in the database management of employee and patient information; computer software for graphical user interface; computer software for underground navigation, namely, for navigation of down-hole probe assembly for oil drilling and drilling assemblies for routing underground utilities; telephones; telephone answering machines; cordless telephones, cordless headset telephones; digital messaging systems; televisions; television remote controls; DVD

players; DVD remote controls; batteries; electrical power distribution products and electrical voltage and overvoltage surge products, namely, arresters, busways, lighting contactors, controllers, and input/output devices; fuses; lighting controllers; switch boxes; LEDs, namely, light emitting diodes; voltage regulators for electric power; voltage surge protectors; voltage surge suppressors; voltmeters; relays and timers; solenoids and limit switches; full-voltage manual starters; reduced voltage starters; electrical switches and disconnects; circuit board terminal blocks and pumping panels; transformers; electrical lighting and power circuit boards; electrical wires; cables and conductors; electrical wiring and fixtures; lightning arrestors; electricity meters; power meters; grounding resistors; humidity and temperature sensors; industrial calibration sensors; motor control centers; electrical resistance heating wires; electrical controllers; apparatus for electrophoresis not for medical purposes; chromatography columns and pumps; apparatus for conformations systems, namely, computer hardware and software for processing biological information; scintillation counter to measure beta-emitting nuclides; imaging apparatus for radioactive and luminescent emissions, namely, CCD cameras and scanners; synthesis and purification integrated systems, namely, chromatography columns, cartridges, fraction collectors, mixers, monitors, pumps, recorders, and analysis software; apparatus for microarrays, namely, probes, slides, buffers, bacterial controls, racks, and trays; laboratory glassware; computer software for hospital operating room management; computer software for critical care information management; industrial process control software; computer software programs and program manuals sold as a unit for use in factory management; software for creating graphics displays and editing dynamic data interfaces for real time graphics applications for industrial and business applications; communications software for connecting computer network users; factory automation software for control, monitoring, simulation, communications, data logging and collection, and factory automation; software to integrate manufacturing machine operations, control processes, to provide data for visualization, to track problems and generate production reports; packaged software for use in the operation and programming of grinding machines in the manufacturing industry; industrial process control hardware, namely, computer monitors, laptop computers, ethernet cards and cables; computer networking hardware; memory cards; microchips; microprocessors; computer network hubs, switches and routers; computer displays and terminals; computer whiteboards; system boards and processors; industrial process controller featuring call control, operator interface, gage interfaces, and data collectors; manufacturing execution systems and document management software; digital signal processing products

and systems, namely, industrial automation controls and programmable logic controllers; controllers of machine tools, namely, an adaptive control product in the nature of an external controller to optimize machine tool cutting performance of rough and semi-rough cuts; power supplies and mounting hardware; intrusion and burglar alarm systems; security devices, namely, programming logic computers, control panels, electronic intrusion detectors, electronic glass-break sensors, electronic vibration sensors, magnetic contacts for use in security systems, electronic switch plates, electronic motion sensors for alarm systems, electronic motion sensitive switches, hardwire sirens, audio speakers, electronic speaker drivers, access control and alarm monitoring systems; fire, heat, and smoke detecting and alarm units; computer card operated access control systems; card readers, card encoders, and encoded cards for use with card operated access control systems; video cameras; video object recognizers; video object trackers; video license plate readers; video alarm verifiers; video face recognizers; video vehicle recognizers; video traffic detectors; video access door controllers; video intrusion detectors; processing hardware and software that analyzes digital video images to automatically extract, record, and report intelligence; remote video monitoring systems for security and surveillance applications; central video monitors; cameras; short range wireless radio frequency transceivers; power line transceivers; communication control hardware, namely, keypad controllers, matrix switchers, multiplexes, digital video recorders, integrated pan-tilt-zoom domes, remote video controllers, electronic alarms, and management controls and triggers; video transmission devices in the nature of video transmitters sold separately or as part of a system for operating closed circuit cameras; fiber-optic transmission systems, namely, fiber optic transmitters, receivers, and transceivers used in the transmission of video, audio, and data signals over optical fiber; electro-mechanical locks; magnetic locks; electric keys; handheld electronic hardware, namely, handheld programmable units and handheld computers for receiving, controlling, storing, manipulating, displaying, transmitting data and for operating electronic locks; electronic key fobs and readers and encoders therefor; access keypads; radio frequency tracking tags; tracking and control system comprising one or more radio frequency tags, transceivers, and sensors used to determine and monitor the location and movement of tangible assets, of inventory, and of individuals; infrared sensors; computer hardware and software for facilities management and controlling facility access systems and components therefor, namely, control panels, access card readers, and equipment and systems for video imaging, video monitoring, digital hard drive recording, network transmission and remote access; networked digital video storage servers



for access control and surveillance applications, for alarm monitoring applications, and for security applications; computer software and hardware for controlling and operating security and access system comprising locks, doors, and access and identification; devices and security enclosures in the nature of electronic boxes, namely, safes for securing keys; surveillance equipment sold individually as components or together as a system comprising one or more surveillance cameras, covert cameras, close circuit television cameras, camera housings, camera mounts, camera lenses, video monitors, video recorders, digital recorders, video storage media, video switches, control panels, keypad controllers, joystick controllers, transceivers, receivers, transmitters, signal processors, multiplexers, matrix switches, controllers, control panel housing, switch housing, transformer switches, splitters, coaxial cables, connectors, motion detectors, microphones, and speakers; computer user interface software and control software for managing security, fire, and access systems; hand-held electronic computer and communication hardware for receiving, controlling, storing, manipulating, displaying and transmitting data for operating electronic locks; pre-recorded magnetic data carriers featuring identification and security information; data processing software and computer hardware; siren speakers and electronic siren drivers, namely, tone generators and amplifiers adapted to be used for sirens; switch units incorporating magnetically actuated reed switches for use in burglary and fire sensing alarm systems, in industrial position sensing apparatus, in revolution counters, in equipment cabinet safety interlock systems, in industrial position controlling apparatus, in electrical cables and in pump and valve controlling apparatus and in home security alarm systems; time or condition sensing apparatus for initiating and controlling regeneration or backwash cycles for water treatment equipment; bioreactors for culturing cells; portable analytical instruments, namely, probes with a microprocessor based data conversion logger for measurement of organic and inorganic chemicals in water; filters and filter housings for laboratory use; fluid separation apparatus for laboratory use; membrane filters for laboratory use; silt density measuring device; deionization units for laboratory use; fluid flow control devices, namely, pumps, valves, flow meters, and regulators for laboratory use; ozone monitors; laboratory equipment, namely, porous microtiter plates for use in cell biology and other life science applications; electronic water and process treatment controls, namely, apparatus for use in the treatment of commercial and industrial water systems, boiler water systems, cooling water systems, closed water systems, fuel processing systems, and metal processing systems to analyze the chemistry of the system, determine the proper treatment program, apply the desired treatment, and monitor the effec-

tiveness of the treatment; computer software for data management in the water treatment field; electronic controllers used for processing information in the water treatment field; apparatus for use in industrial water systems to measure and control ph and conductivity; electronic apparatus for feeding chemicals to an industrial, commercial, or municipal water system in measured amounts; laboratory testing equipment, namely, deposition and corrosion rate testers; mobile laboratory equipped with equipment and instrumentation to monitor and measure ph, conductivity, and chromatic concentration of industrial and domestic waters, to conduct inorganic and microbiological analysis of water; avionic sensor systems, namely, navigation systems; battery chargers; computer hardware and software for use with medical patient monitoring equipment, and for receiving, processing, transmitting and displaying data; computer software for accessing information directories that may be downloaded from the global computer network; computer software for controlling and managing patient medical information; electric control devices for heating and energy management; electrical apparatus, namely, charging stations for charging electric vehicles; electronic signaling mechanism, namely, a train control system used in the railway industry for detecting and controlling trains, ground faults, broken rails, power failures, track switches and lights; electronic sensors for monitoring energy utilization, temperature, position, distance, speed, and acceleration; electrical substations comprised of transformers, circuit breakers, circuit switchers, voltage regulators, fuses, capacitors, relays, rectifiers, and electric power converters; power inverters; electronic control devices for energy management; electronic automation products, namely, electrical routers and electrical hubs; computer software and hardware for the management, distribution, monitoring, and control of energy; automation systems, namely, computer software and hardware and communications devices for planning, scheduling, controlling, monitoring, and providing information on transportation assets and parts thereof; automation systems, namely, computer hardware for embedded operating systems and pc based computer software, for monitoring specified conditions and controlling respective innovative devices within a designated area; computer hardware and software systems for automated train control and traffic supervision, namely, location tracking, vehicle monitoring, vehicle controlling, dispatching, signaling, communication, and data transmission; computer software for management of railway networks; wireless communication devices for voice, data, or image transmission; traffic management equipment, namely, display monitors, computers, auto compasses, and software to manage traffic; computer software for interfacing and interacting with remote control locomotives and locomotive hardware; led traffic and rail signals;

electronic fuel level gauges; automated fuel station management systems comprising of computer operating software, metered fuel pumps, rate control panels, fuel lines, and dispensing nozzles for fueling land, marine or aircraft vehicles; gas meters; electrical and scientific apparatus, namely, general-purpose high-precision electric computer-controlled valves for use in high-precision flow applications; optical imaging apparatus; microscopes and high accuracy electro-mechanical actuators; automated dna optical scanners; automated microscopy systems comprising microscopes, computer hardware, and software; electromechanical hardware and software systems comprising of computers, computer software, electromechanical positioners for micro-positioning control, all for use in the field of photonics, digital flow control, analysis of biological samples, semiconductor testing and inspection, microscopy, optical scanning, and in the field of scanning systems for lasers; computer software for microscopy, imaging, and informatics in the field of clinical and diagnostic testing; electric actuators; electric valve actuators; precision positioning systems comprised of optical indexers, namely, an optical train with a camera and a filter wheel that enables image data to be digitized, microscopy stages, electronic control circuitry, motion control chassis, linear actuators, screw actuators, linear sliders, electric motors, and tunable lasers for digitizing images in the fields of photonics, bio-medical imaging, fluidics, mass flow valves, life sciences, semiconductor manufacturing, and clinical diagnostics; modular biologics manufacturing system used for growing, purifying, concentrating, isolating, and packaging biological materials in chemical, of a bioreactor used to grow cell cultures and biological products, a separation machine used for isolating, purifying, and concentrating biological materials, and connecting computer hardware and software; computer hardware and software for use in industrial processing plants and refineries in the chemical, petrochemical, and processing industries.

10 – Medical specimen collection vials; medical cannulas; medical syringes; injection devices for pharmaceuticals; disposable cartridges for holding and transferring encapsulated radioisotope brachytherapy sources for use in treating prostate and other cancers; pre-filled cartridges containing contrast media for medical imaging; infusion pumps for intravenous administration of fluids; implantable radiation therapy devices consisting of encapsulated radioisotope brachytherapy sources for use in treating prostate and other cancers; radiation therapy delivery system consisting of radioactive seeds and a bio-absorbable carrier assembly; cardiac output monitors; bacteria filters for medical use; gas analyzers for medical purposes; anesthesia record keeping and data management systems; patient monitoring systems, namely, gas monitors, pulse oximeters, multi-parameter

monitors, ECG monitors, invasive and non-invasive blood pressure monitors, neuromuscular transmission monitors, metabolic monitors, and spirometers for anesthesia, intensive care, and diagnostic applications; anesthesia machines and ventilators; intensive care and anesthesia accessories for single patient use, namely, gas sampling lines, airway adapters, breathing circuits, spirometry sensors, tubes, water traps, pulse oximetry sensors, non-invasive blood pressure cuffs, intravenous flushing sets, anesthesia masks, carbon dioxide absorbers, temperature probes, and nebulizers; central nervous system monitors; gastrointestinal tonometers; gradient coils, namely, magnetic gradient coils used in magnetic resonance imaging; medical diagnostic devices, namely, bone densitometers; fetal monitoring apparatus, namely, fetal pulse and vital signs monitor; patient monitoring apparatus, namely, heart and vital signs monitor; medical imaging systems, namely, ultrasounds, medical diagnostic imaging machines, imaging devices for screening and diagnostic applications for use in planning intervention and surgery, and parts thereof and attachments thereto; blood glucose monitors, analyzers, and meters; blood glucose monitoring combination kits comprised of lancets, control solution, and test strips all sold as a unit; medical diagnostic apparatus for displaying diagnostic images, namely, spot film apparatus, x-ray fluoroscopes, mobile x-ray units, computerized tomography scanners, nuclear resonance scanners, ultra sound scanners, magnetic resonance scanners, positron emission tomography (PET)scanners, and parts thereof and attachments thereto including tables and pads; incubators for babies; warming device for stabilizing infant body temperature for medical purposes; medical devices, namely pressure regulating valves; medical apparatus and instruments, namely, medical respiratory apparatus to enhance breathing; sleep screening apparatus and accessories thereto for use with medical respiratory apparatus and with sleep monitoring devices, namely remote controls, remote alarms, and nasal masks; medical apparatus for intravenous administration of fluids namely fluid warmers; medical apparatus and surgical devices, namely face masks, breathing circuits, manual resuscitators, pressure infusers, laryngoscopes, anesthesia systems comprised of hoses, breathing bags, and Y-elbow fittings.

11 – Heat exchangers not being parts of machines; chemical heavy wall reactors, nuclear reactors, and accessories and component parts thereof, namely, heat pumps, steam valves and valves for regulating the flow of gases and liquids; electric lamps of all kinds and their parts; electric lighting fixtures and their parts; electric refrigerators, freezers, air conditioning apparatus, dehumidifiers; electric ovens, and ranges; microwave ovens for cooking; wall cooking ovens for domestic use; food warming drawers; electric and gas cook tops; gas cooking ovens

and ranges; ventilation hoods for stoves; ventilating exhaust fans; water filters; water softening units; clothes dryers; electric fans; ceiling fans; flashlights; lamps and lights for vehicles; electric lights for christmas trees; fluid separation units for industrial use in a wide variety of industries; fluid concentration units for industrial use in a wide variety of industries; fluid recycling units for industrial use in a wide variety of industries; filter apparatus used for filtering solids from gases and liquids or filtering liquids from gases, or for filtering one immiscible liquid from another for industrial use in a wide variety of industries; spirally-wound elements or cartridges contained within a tubular plastic sleeve for concentrating products and removing impurities in fluid treatment systems for industrial use in a wide variety of industries; water conditioning units for residential purposes; reverse osmosis modules and membranes therefore for industrial use in a wide variety of industries; water purification units and systems consisting of clarifiers, electro-deionization systems, condensate polishers, vacuum degasification units, ultra filtration units, ultraviolet sterilizers, ion exchangers, caustic regeneration systems, reverse osmosis systems, forced draft decarbonator units, filters, chemical feed systems, and bulk storage units, sold with automatic controls and instruments to monitor operating parameters of the units and systems electrochemical liquid purification units for use in the industrial, commercial, and municipal sectors; domestic electric and gas cooking appliances, namely, cooking rings, gas and electric stoves; gas and electric ovens and cooktops; electric coffee makers for domestic use; electric coffee percolators; electric tea makers and component parts; electric toasters; electric toaster ovens; electric cooking crockery cookers and casserole dishes; electric hot plates; electric deep fryers; domestic electric frying pans; domestic electric rotisserie ovens; electric hot air cooking ovens for domestic use; electric roaster ovens; electric waffle irons; electric kettles; electric radiant heaters; humidifiers; LED and HID light fixtures; led luminaires; water heaters; filter cartridges for the filtration of potable water; control valves for water conditioning and water filtration equipment.

12 – Electric motors and diesel engines for land vehicles; locomotives and engines for land vehicles; airplane propellers; railway bogies; railway cars; railway couplings; screw propellers for vehicles; torque converters for land vehicles; vehicle propellers.

17 – Silicone sealants for a variety of uses such as for bath tub caulking, sealing boats and automobiles; silicone silicone rubber roof coating; plastic glazing compounds.

35 – Inventory control services; consultation in the field of inventory control services; acquisition integration services; business reorganization consulting

services; truck and automobile fleet management services, namely, voyage reporting and invoicing via a global computer network; consultation in the field of truck and automobile fleet management services; business administration consulting services; consultation in the field of operation and management of power plants; supply chain management and consulting services in the areas of chemical product and service sourcing, and procurement, product inventory and supply management and cost containment; consulting, marketing, cost and pricing analysis relating to electrochemical liquid purification units for use in the industrial sector; business consulting and information services.

36 – Asset based and private label financing services; financial analysis and consultation; credit card financial services; credit card services, namely, extension of credit to others; financial asset management for others; equity investment services; personal loan financing; mortgage banking services; acquisition financing services; commercial financing services; commercial real estate agency services; mutual fund investment; private equity and debt investment; consultancy, advisory and information services relating to all the forgoing services.

37 – Consulting in the field of building construction; construction, installation, repair, replacement, overhaul, and maintenance of power plants, engines, turbines, wind turbines, motors, and apparatus, equipment and instruments for the generation of power and electricity and their component parts and fittings and accessories; remote monitoring and diagnostic repair and maintenance services rendered in the repair and maintenance of aircraft engines including accessories and component parts, turbines including accessories and component parts, electrical equipment, medical equipment, and locomotives including accessories and component parts; services rendered in the repair and maintenance of machinery, instruments, electrical equipment, and appliances; chemical cleaning services for glass-lined reactor vessels used in the chemical and pharmaceutical processing industries; maintenance services for heat transfer systems and condensers; maintenance and repair services in the field of computerized cooling system equipment; installation, maintenance, and repair of equipment and systems in the field transportation and traffic control; maintenance and/or repair of traffic control equipment; technical support services, namely, technical advice related to the installation and repair of advanced train control and traffic supervision systems and subsystems.

40 – Water and wastewater treatment services; water treatment services, namely, desalination, purification, conditioning, cleaning of ion exchange resins, identifying and controlling of microbiological organisms; membrane regeneration services; chemical control system services relating to the feeding of

treatment chemicals to industrial water systems; consulting services in the fields of water treatment for aqueous systems, cooling water systems, industrial boiler water systems, industrial water and process systems; consulting services in the fields of industrial fuel processing system treatment, and metal and plastic processing system treatment; providing information to others, over a global computer network, relating to industrial water purification systems; custom manufacture in the field of biotechnology and pharmaceuticals.

41 – Educational services in the field of medical imaging and diagnostics, namely, holding seminars, conferences, symposiums or workshops relating to the pharmaceutical industry for medical practitioners and employees of pharmaceutical companies; educational services, namely, holding seminars, conferences, symposiums or workshops in the field of life science and biotechnology for scientists and researchers; conducting seminars related to industrial water treatment problems; providing training services for all the aforesaid; training in the use and operation of signaling and crossing-warning systems for the rail and transit industries; providing training services in management and the medical field through the use of instructions and demonstrations provided online, through the internet, intranet, or extranets; education services, namely, conducting practical training workshops, classes, and seminars, featuring demonstrations in the fields of management and medicine.

42 – Services relating to wind and wind power, namely, engineering services and professional technology consulting services; design services for others in the field of wind power; industrial design services; design of power, wind power and electric power generating equipment and installations; information technology services in the field of global railroad and transit industries; remote monitoring of aircraft engines, turbines, electrical equipment, medical equipment, locomotives, and accessories and component parts of all the foregoing; research services, consultation services, and advisory services relating to engineering, design, and development problems encountered by utility companies, industrial companies, commercial companies, governments, or individuals; computer consultation services; maintenance and updating of computer software and computer systems for others; installation of computer software; computer systems analysis and design services; engineering services; technical consultation and research services in the oil and gas industries; oil and gas exploration services; geophysical exploration for the oil and gas industries; analysis of oil and gas fields; oil and gas prospecting, namely, well logging and testing; oil and gas well testing; oil and gas pipeline inspection; remote monitoring and diagnostic services for compressors, pumps, turboexpanders, fuel pumps, and fuel distribution equipment, CNG

refueling equipment, gas turbines, steam turbines, air cooled heat exchangers, steam condensers, heavy wall reactors and tubular reactors; consulting services relating to chemical research; research and testing on high throughput screening assays for drug development services; biotechnological services in the nature of development of new technology for others in the field of biotechnology; technical support services for factory automation software, namely, providing maintenance of computer software and providing periodic upgrades of the software; custom design and consulting services in connection with the configuration of computer systems used in applications supporting fiber optic technology; technical support services, namely, troubleshooting of problems with computer hardware, video, and electronic communication hardware and software; technical consultation services for hardware and software used in connection with security and access systems; technical consultation services for surveillance cameras; custom design services for others in the fields of security systems, access systems, and tangible asset and inventory monitoring systems; laboratory research and testing services for fluid separation and membrane testing; engineering services in the fields of aqueous systems, cooling water systems, industrial boiler water systems, industrial water and process systems, and industrial fuel processing system treatment; engineering services and technical support services in the nature of troubleshooting problems and monitoring network systems related to the design and configuration of computer software and hardware systems to be used in the treatment of aqueous systems and in the treatment of petroleum and petrochemical processing systems; technology supervision and inspection in the field of energy distribution networks; metering and monitoring electric power consumption for electric power providers; scientific research in the fields of energy transfer, energy distribution, energy generation, and energy storage; monitoring, diagnostic, and control services for operation failure detection of electricity generation, transmission field of biotechnology and pharmaceuticals; consultancy in the field of energy efficiency; consultancy in the field of energy-saving; technological consultancy in the field of energy use.

44 – Consultancy services relating to medical and diagnostic imaging; consultancy services relating to diagnostic, prophylactic and therapeutic properties of pharmaceuticals; medical information services; medical imaging services; medical diagnostic services; advisory services related to all the aforesaid; medical testing for diagnostic or treatment purposes; providing medical information via a web site; providing medical information; rental of medical equipment.

(260) AM 2015 78075 A  
 (800) 1209518  
 (891) 2014 03 28  
 (731) TAIZHOU ANTEBAO SHOES CO., LTD.  
 Bafen Village, Zeguo Town, Wenling City,  
 317521 Zhejiang Province, CN  
 (540)



(591) Red, blue, green, yellow and purple

(511)

18 – Purses; school bags, school satchels; garment bags for travel; rucksacks, backpacks; handbags; briefcases; suitcases; boxes of leather or leather board; bags for sports; umbrellas.

25 – Clothing; babies' pants; babies' clothes; bathing suits; bathing trunks; clothing for gymnastics; waterproof clothing; footwear; football shoes; football boots; boots; slippers; sandals; sports shoes; boots for sports; footwear uppers; soles for footwear; headgear; socks; gloves (clothing); neckties; scarves, scarfs; girdles; belts (clothing).

28 – Apparatus for games; puppets, marionettes; toys; building blocks (toys); dolls; toy vehicles; balls for games; ornaments for Christmas trees, except illumination articles and confectionery; radio-controlled toy vehicles.

(260) AM 2015 78324 A  
 (800) 1210960  
 (891) 2013 12 16  
 (731) KALAYCIOĞLU GIDA PAZARLAMA  
 SANAYI VE TICARET ANONİM ŞİRKETİ  
 Ankara Yolu 16.Km., CORUM, TR

(540)

**YAKAMOZ**

(591) Black, white

(511)

29 – Dried, cooked, preserved, frozen vegetables, vegetable juices for cooking, beans, peas, chickpeas, lentils, soya beans, olives, pickles, milk and milk products namely, any kind of milk, white cheese, "kasar" namely a mild and pale yellow cheese made of sheep's milk, yoghurt, "ayran" namely a drink made of yoghurt and water, whipped cream, cream, creme chantilly, powdered milk, kephir, milk beverages (milk predominating), fruit milk, fruit yoghurt, koumiss, desserts made of milk and milk products (milk predominating), edible oils and fats, margarines, butters, preserved, frozen, cooked fruits; jams, marmalades, fruit pulp, compote, puree of hazelnut and peanut, eggs, powdered eggs, jellies for food, pollen preparations as foodstuff, potato crisps, potato chips.

30 – Coffee, cocoa, artificial coffee, mocha (coffee), coffee substitutes, coffee or cocoa-based beverages, tapioca, sago, macaroni, meat pies, vermicelli, breads, pitas, pizzas, biscuits, crackers, wafers, pastries, tarts, cakes, desserts made of flour, puddings, namely rice puddings, black puddings, noah's pudding, honey, propolis, yeast, baking-powder, vanillas, sugar, powdered sugar, herbal teas, ice teas, sage tea, lime tea, confectioneries, Turkish delight, frozen yoghurt (confectionary), chocolates, chocolate products, coconut bars covered with chocolate, caramel bars covered with chocolate, milky bars covered with chocolate, cakes covered with chocolate, confectionary for decorating Christmas trees, chocolate-based beverages, chewing-gum, ice creams, edible ices, salt, rice, bulgur (boiled and pounded wheat), malt for food, "pekmez" namely a thick syrup made by boiling down grape juice; appetizers made of cereal and flour, roasted corn and wheat, crisps, corn flakes, crushed oats, cereal for breakfast.

32 – Beers, preparations for making beer (barley yeast, extract of hops for making beer), yeast for beer, aerated waters, namely mineral waters, spring waters, soda waters, tonics, gaseous beverages, namely fizzy drinks, colas, isotonic beverages, "boza" (beverage made of slightly fermented millet), "sahlep" (drink made from sahlep root in hot milk and cinnamon).

(260) AM 2015 78325 A  
 (800) 1210964  
 (891) 2014 04 07  
 (731) PHILIP MORRIS BRANDS SÀRL  
 Quai Jeanrenaud 3, CH-2000 Neuchâtel,  
 CH

(540)

**FLIP-TOP POUCH**

(511)

34 – Tobacco, raw or manufactured; tobacco products, including cigars, cigarettes, cigarillos, tobacco for roll-your-own cigarettes, pipe tobacco, chewing tobacco, snuff tobacco, kretek; snus; tobacco substitutes (not for medical purposes); smokers' articles, including cigarette paper and tubes, cigarette filters, tobacco tins, cigarette cases and ashtrays, pipes, pocket apparatus for rolling cigarettes, lighters; matches.

(260) AM 2015 78327 A  
 (800) 1210966  
 (891) 2014 04 08  
 (731) PHILIP MORRIS GLOBAL BRANDS INC.  
 9711 Farrar Court, 23236 Richmond,  
 Virginia, US

(540)

**MARLBORO  
CLASSICS**

(591) Black, white

(511)

28 – Games and toys; playing cards; gymnastic and sporting articles; Christmas tree decorations; miniature bicycles for children.

(260) AM 2015 78329 A

(800) 1211000

(891) 2014 04 25

(731) EGIS GYÓGYSZERGYÁR ZRT.

Keresztúri út 30-38, H-1106 Budapest, HU

(540)

**PLANOS**

(511)

5 – Human pharmaceutical preparations for oncologic and immunotherapeutic use.

(260) AM 2015 78330 A

(800) 1211040

(891) 2014 03 31

(731) WORLD MEDICINE İLAÇ SANAYİ VE TİCARET ANONİM ŞİRKETİ

Evren Mah. Camiyolu Cad. No:50, Kat 1 B  
Zemin 4-5-6, Güneşli/Bağcılar/İstanbul, TR

(540)

**LEVOSETİL  
ЛЕВОСЕТИЛ**

(591) Black, white

(511)

5 – Medicines for human purposes, medicines for veterinary purposes, vitamin preparations, chemical preparations for medical purposes, dietetic substances adapted for medical use; dietetic foods adapted for medical purposes; baby foods, medicinal herbs, herbal beverages adapted for medical purposes, nutritional supplements, pollen dietary supplements, mineral food supplements, protein dietary supplements; dietary supplements for animals; fodder supplements for veterinary purposes; medicines for dental purposes, hygienic products for medical purposes including sanitary pads, breast-nursing pads and bunion pads, waddings for medical purposes, plasters for medical purposes, dressings for medical purposes, babies' napkins, preparations for destroying noxious plants, preparations for destroying noxious animals, fungicides, deodorants other than for human beings or for animals, air deodorising preparations, disinfectants for hygiene purposes, antiseptics, detergents for medical purposes.

(260) AM 2015 78337 A

(800) 1211079

(891) 2013 10 16

(731) ALLIANT TECHSYSTEMS INC.

7480 Flying Cloud Drive, Minneapolis  
MN 55344, US

(540)



(591) Black, white

(511)

9 – Tactical gear and tactical equipment for military, law enforcement, and defense applications, namely, protective clothing with or without built in armor for protection against accident or injury, protective eye-wear, protective sunglasses, protective goggles and masks, protective helmets, protective work gloves; protective gloves, namely, assault gloves, rescue gloves, rappelling gloves; protective clothing, namely, flame retardant balaclavas, slash resistant balaclavas, thermal balaclavas, protective load bearing vests reinforced with or without ballistic armor for holding tactical equipment, armor bearing vests, combination ballistic/flotation vests, load-bearing vests.

13 – Firearms accessories, namely: holsters, pistol holsters, holster belts, duty belts, shoulder holster harnesses, leg-mounted harnesses, leg-mounted holsters, slings for firearms, straps for firearms, covers for firearms, cartridge pouches packs and carriers, ammunition magazine pouches packs and carriers, ammunition pouches packs and carriers, cases for guns and weapons, pouches, carriers, and keepers for firearms for affixation to belts, vests, and backpacks.

18 – Backpacks; small backpacks; backpack pouches; rucksacks; waist packs; hip packs; lumbar packs; all purpose carrying bags for tactical equipment, duffel bags, harnesses, chest harnesses; all purpose carrying pouches and bags sold empty for attachment to backpacks, vests, belts, and carriers; garment bags for travel; satchels; travel bags; all-purpose sport bags; drawstring pouches and luggage.

(260) AM 2015 78338 A

(800) 1211088

(891) 2013 12 05

(731) SIGNUM INTERNATIONAL S.À.R.L.

Luxembourg, Luzern Branch, Haldenstrasse 4,  
CH-6006 Luzern, CH

(540)

**EF**

(511)

39 – Transport of passengers; travel agency services; travel and tour guide services, arranging of tours and excursions, arranging of cruises, travel reservations, information of journeys and travel destinations; services for the arranging of the transportation of travellers.

41 – Provision of language education and training, examination for language proficiency; providing information concerning language education via a global network; computer assisted language education, teaching and training services, providing on-line educational material; educational services concerning provision of educational experiences relating to cultural, historic and social subjects, places and events through educational travel tours and student and teacher exchange programs.

(260) AM 2015 78339 A

(800) 1211094

(891) 2013 12 02

(731) Zakrytoe aktsionerное obshchestvo

"MYASNAYA GALEREYA"

ul. Poliny Osipenko, 41, RU-600009 Vladimir, RU

(540)

## Чебуница

(511)

29 – Meat, fish, poultry and game; meat extracts; preserved, frozen, dried and cooked fruits and vegetables; jellies, jams, compotes; eggs; milk and milk products; edible oils and fats; ajvar [preserved peppers]; aloe vera prepared for human consumption; alginates for culinary purposes; anchovy; peanuts, processed; albumen for culinary purposes; white of eggs; beans, preserved; soya beans, preserved, for food; bouillon; ginger jam; ham; fatty substances for the manufacture of edible fats; toasted laver; edible birds' nests; peas, preserved; mushrooms, preserved; gelatine; meat jellies; jellies for food; fruit jellies; yolk of eggs; coconut fat; bone oil, edible; lard for food; suet for food; fruit-based snack food; charcuterie; raisins; caviar; processed fish spawn; yoghurt; sauerkraut; kefir [milk beverage]; isinglass for food; clams, not live; milk shakes; black pudding; meat, tinned; vegetables, tinned; fish, tinned; fruits, tinned; bouillon concentrates; gherkins; shrimps, not live; prawns, not live; buttercream; croquettes; silkworm chrysalis, for human consumption; kumys [kumyss] [milk beverage]; spiny lobsters, not live; lecithin for culinary purposes; salmon; onions, preserved; margarine; piccalilli; marmalade; peanut butter; chocolate nut butter; colza oil for food; coconut butter; corn oil; sesame oil; flaxseed oil for culinary purposes; palm oil for food; palm kernel oil for food; sunflower oil for food; coconut oil; butter; shellfish, not live; almonds, gro-

und; animal marrow for food; mussels, not live; albumin milk; soya milk [milk substitute]; fishmeal for human consumption; vegetable mousses; fish mousses; fruit pulp; meat, preserved; milk beverages, milk predominating; potato fritters; olives, preserved; lobsters, not live; coconut, desiccated; nuts, prepared; tomato purée; liver pâté; pectin for culinary purposes; liver; pickles; jams; powdered eggs; kimchi [fermented vegetable dish]; food products made from fish; prostokvasha [soured milk]; poultry, not live; pollen prepared as foodstuff; cranberry sauce [compote]; apple purée; crayfish, not live; crustaceans, not live; fish, preserved; salted fish; vegetable salads; fruit salads; bacon; sardines; pork; herrings; processed seeds; processed sunflower seeds; cream [dairy products]; whipped cream; fat-containing mixtures for bread slices; tomato juice for cooking; vegetable juices for cooking; salted meats; sausages; sausages in batter; preparations for making bouillon; preparations for making soup; tripe; soups; vegetable soup preparations; whey; cheese; tahini [sesame seed paste]; tofu; sea-cucumbers, not live; truffles, preserved; tuna fish; oysters, not live; milk ferments for culinary purposes; rennet; fish fillets; dates; crystallized fruits; frozen fruits; fruit preserved in alcohol; fruit, stewed; potato flakes; hummus [chickpea paste]; fruit peel; preserved garlic; lentils, preserved; potato chips; low-fat potato chips; fruit chips; non-alcoholic eggnog; seaweed extracts for food; snail eggs for consumption.

30 – Coffee; tea; cocoa; sugar; rice; tapioca; sago; artificial coffee; flour and preparations made from cereals; bread, pastry and confectionery; edible ices; sugar, honey, treacle; yeast, baking-powder; salt; mustard; vinegar, sauces [condiments]; spices; ice; aromatic preparations for food; flavorings [flavourings], other than essential oils, for cakes; flavorings [flavourings], other than essential oils, for beverages; coffee flavorings; flavoring, other than essential oils; star aniseed; high-protein cereal bars; pancakes; noodle-based prepared meals; buns; bread rolls; vanillin [vanilla substitute]; vanilla [flavoring]; waffles; vermicelli [noodles]; natural sweeteners; sausage binding materials; binding agents for edible ices; sea water for cooking; seaweed [condiment]; malt biscuits; cloves [spice]; cake frosting [icing]; glucose for culinary purposes; gluten additives for culinary purposes; yeast; thickening agents for cooking foodstuffs; leaven; rice-based snack food; cereal-based snack food; vegetal preparations for use as coffee substitutes; dressings for salad; fruit jellies [confectionery]; confectionery for decorating Christmas trees; cakes; pastries; peanut confectionery; almond confectionery; farinaceous food pastes; pasties; ginger [spice]; frozen yoghurt [confectionery ices]; capers; caramels [candy]; curry [spice]; gruel, with a milk base, for food; quiches; gluten prepared as foodstuff; sweetmeats [candy]; liquorice [confectionery]; peppermint sweets; cinnamon [spi-



ce]; unroasted coffee; starch for food; crackers; custard; hominy grits; semolina; oatmeal; crushed barley; groats for human food; corn, milled; corn, roasted; meat pies; turmeric for food; couscous [semolina]; farinaceous foods; noodles; ice for refreshment; ice, natural or artificial; edible ices; candy; rice cakes; mayonnaise; macaroons [pastry]; macaroni; maltose; hominy; marinades; marzipan; honey; royal jelly; ice cream; bean meal; tapioca flour for food; potato flour for food; corn flour; wheat flour; soya flour; barley meal; dessert mousses [confectionery]; chocolate mousses; muesli; mint for confectionery; cocoa beverages with milk; coffee beverages with milk; coffee-based beverages; tea-based beverages; chocolate beverages with milk; chocolate-based beverages; cocoa-based beverages; infusions, not medicinal; crushed oats; husked oats; nutmegs; stick liquorice [confectionery]; soya bean paste [condiment]; lozenges [confectionery]; molasses for food; pepper; allspice; peppers [seasonings]; pesto; biscuits; petit-beurre biscuits; pies; pizzas; meat gravies; fondants [confectionery]; pop corn; powder for edible ices; mustard meal; pralines; condiments; meat tenderizers, for household purposes; cereal preparations; flour-milling products; oat-based food; bee glue; gingerbread; petits fours [cakes]; puddings; cake powder; fruit coulis [sauces]; ravioli; chewing gum; relish [condiment]; wheat germ for human consumption; spring rolls; aniseed; flaxseed for human consumption; golden syrup; cake paste; baking soda [bicarbonate of soda for cooking purposes]; malt for human consumption; salt for preserving foodstuffs; cooking salt; celery salt; sherbets [ices]; ham glaze; soya sauce; tomato sauce; spaghetti; seasonings; preparations for stiffening whipped cream; rusks; breadcrumbs; sushi; sandwiches; tabbouleh; tacos; cream of tartar for culinary purposes; tarts; almond paste; tortillas; garden herbs, preserved [seasonings]; vinegar; beer vinegar; ferments for pastes; halvah; bread; unleavened bread; chips [cereal products]; corn flakes; oat flakes; chicory [coffee substitute]; iced tea; chutneys.

43 – Services for providing food and drink; temporary accommodation; accommodation bureaux [hotels, boarding houses]; rental of temporary accommodation; rental of meeting rooms; tourist homes; hotel reservations; boarding house bookings; temporary accommodation reservations; hotels; retirement homes; snack-bars; cafés; cafeterias; motels; boarding houses; boarding for animals; rental of cooking apparatus; rental of chairs, tables, table linen, glassware; rental of tents; rental of transportable buildings; rental of drinking water dispensers; restaurants; self-service restaurants; canteens; holiday camp services [lodging]; bar services; providing campground facilities; food and drink catering; day-nurseries [crèches].

(260) AM 2015 78341 A  
(800) 1211137  
(891) 2014 03 07  
(731) MW Handel GmbH  
Lyonerstraße 14, 60528 Frankfurt am Main,  
DE

(540)



(591) Black, white  
(511)  
11 – Chandeliers; street lamps; ceiling lights; lamps; wall lights; standard lamps.  
14 – Jewelry; jewelry cases of rock crystal [caskets].  
19 – Rock crystal.

(260) AM 2015 78342 A  
(800) 1211146  
(891) 2014 03 21  
(731) EGIS Gyógyszergyár Zrt.  
Keresztúri út 30-38, H-1106 Budapest, HU  
(540)

## TACRUS

(511)  
5 – Human pharmaceutical preparations for use in the oncological and immunotherapeutic fields.

(260) AM 2015 78344 A  
(800) 1211151  
(891) 2014 04 29  
(731) SOREMARTEC SA  
Findel Business Center, Complexe B, Rue  
De Trèves, L-2632 Findel, LU  
(540)



(591) Light green, dark green, gray, white, black and bronze  
(511)  
29 – Milk and milk-based products.  
30 – Confectionery; candy and chewing gum; chocolate-based products; sugar-free candy and chewing gum.

**INTERNATIONAL TRADEMARKS PROTECTED IN GEORGIA**

(260) AM 2015 75045 A  
(800) 1183352  
(151) 2013 09 24  
(181) 2023 09 24  
(511) 12, 20

---

(260) AM 2015 75046 A  
(800) 1183387  
(151) 2013 09 09  
(181) 2023 09 09  
(511) 05

---

(260) AM 2015 75047 A  
(800) 1183388  
(151) 2013 09 09  
(181) 2023 09 09  
(511) 05

---

(260) AM 2015 75048 A  
(800) 1183393  
(151) 2013 09 06  
(181) 2023 09 06  
(511) 38, 41

---

(260) AM 2015 75049 A  
(800) 1183405  
(151) 2013 09 19  
(181) 2023 09 19  
(511) 03

---

(260) AM 2015 75050 A  
(800) 1183406  
(151) 2013 09 19  
(181) 2023 09 19  
(511) 03

---

(260) AM 2015 75052 A  
(800) 1183440  
(151) 2013 05 01  
(181) 2023 05 01  
(511) 07, 11, 17

---

(260) AM 2015 75053 A  
(800) 1183443  
(151) 2013 05 07

(181) 2023 05 07  
(511) 09, 16, 35, 41, 42

---

(260) AM 2015 75055 A  
(800) 1183508  
(151) 2013 09 02  
(181) 2023 09 02  
(511) 14, 18, 25, 26

---

(260) AM 2015 75057 A  
(800) 1183514  
(151) 2013 08 15  
(181) 2023 08 15  
(511) 32, 33

---

(260) AM 2015 75061 A  
(800) 1183544  
(151) 2013 09 25  
(181) 2023 09 25  
(511) 05

---

(260) AM 2015 75062 A  
(800) 1183545  
(151) 2013 10 30  
(181) 2023 10 30  
(511) 03

---

(260) AM 2015 75064 A  
(800) 1047896  
(151) 2010 03 24  
(891) 2013 10 11  
(181) 2020 03 24  
(511) 09, 16, 18, 20

---

(260) AM 2014 75180 A  
(800) 1184456  
(151) 2013 10 01  
(181) 2023 10 01  
(891) 2013 10 01  
(511) 05

---

(260) AM 2014 75181 A  
(800) 1184479  
(151) 2013 10 30  
(181) 2023 10 30

---

(891) 2013 10 30  
(511) 33

---

(260) AM 2014 75186 A  
(800) 1184495  
(151) 2013 11 14  
(181) 2023 11 14  
(891) 2013 11 14  
(511) 05

---

(260) AM 2014 75187 A  
(800) 1184520  
(151) 2013 08 09  
(181) 2023 08 09  
(891) 2013 08 09  
(511) 35, 41

---

(260) AM 2014 75188 A  
(800) 1184521  
(151) 2013 11 07  
(181) 2023 11 07  
(891) 2013 11 07  
(511) 01

---

(260) AM 2014 75189 A  
(800) 1184522  
(151) 2013 06 24  
(181) 2023 06 24  
(891) 2013 06 24  
(511) 07

---

(260) AM 2014 75190 A  
(800) 1184528  
(151) 2013 06 19  
(181) 2023 06 19  
(891) 2013 06 19  
(511) 09, 16, 35, 41, 42

---

(260) AM 2014 75192 A  
(800) 1184531  
(151) 2013 11 14  
(181) 2023 11 14  
(891) 2013 11 14  
(511) 05

---

(260) AM 2014 75193 A  
(800) 1184532  
(151) 2013 11 14  
(181) 2023 11 14  
(891) 2013 11 14  
(511) 05

---

(260) AM 2014 75194 A  
(800) 1184545  
(151) 2013 04 26  
(181) 2023 04 26  
(891) 2013 04 26  
(511) 41

---

(260) AM 2014 75195 A  
(800) 1184546  
(151) 2013 04 18  
(181) 2023 04 18  
(891) 2013 04 18  
(511) 20, 21, 11, 19

---

(260) AM 2014 75337 A  
(800) 1185792  
(151) 2013 09 27  
(181) 2023 09 27  
(891) 2013 09 27  
(511) 03, 05, 10, 16, 21, 22, 24, 44

---

(260) AM 2014 75338 A  
(800) 1185794  
(151) 2013 10 17  
(181) 2023 10 17  
(891) 2013 10 17  
(511) 29

---

(260) AM 2014 75339 A  
(800) 1185800  
(151) 2013 10 16  
(181) 2023 10 16  
(891) 2013 10 16  
(511) 05

---

(260) AM 2014 75340 A  
(800) 1185816  
(151) 2013 11 20  
(181) 2023 11 20  
(891) 2013 11 20  
(511) 09

---

(260) AM 2014 75341 A  
(800) 1185829  
(151) 2013 11 21  
(181) 2023 11 21  
(891) 2013 11 21  
(511) 34

---

(260) AM 2014 75342 A  
(800) 1185847  
(151) 2013 03 25

---

(181) 2023 03 25  
(891) 2013 03 25  
(511) 09, 38

---

(260) AM 2014 75343 A  
(800) 1185848  
(151) 2013 04 26  
(181) 2023 04 26  
(891) 2013 04 26  
(511) 01, 06, 42

---

(260) AM 2014 75344 A  
(800) 1185865  
(151) 2012 12 13  
(181) 2022 12 13  
(891) 2012 12 13  
(511) 40, 11, 35, 07, 36, 37, 39, 43, 09

---

(260) AM 2014 75349 A  
(800) 1185895  
(151) 2013 06 12  
(181) 2023 06 12  
(891) 2013 06 12  
(511) 05

---

(260) AM 2014 75350 A  
(800) 1185938  
(151) 2013 07 30  
(181) 2023 07 30  
(891) 2013 07 30  
(511) 07, 11, 21

---

(260) AM 2014 75351 A  
(800) 1185954  
(151) 2013 09 18  
(181) 2023 09 18  
(891) 2013 09 18  
(511) 14

---

(260) AM 2014 75352 A  
(800) 1185987  
(151) 2013 10 24  
(181) 2023 10 24  
(891) 2013 10 24  
(511) 30

---

(260) AM 2014 75353 A  
(800) 1186026  
(151) 2013 09 24  
(181) 2023 09 24  
(891) 2013 09 24  
(511) 32

---

(260) AM 2014 75354 A  
(800) 1186027  
(151) 2013 09 20  
(181) 2023 09 20  
(891) 2013 09 20  
(511) 05

---

(260) AM 2014 75360 A  
(800) 1186061  
(151) 2013 09 20  
(181) 2023 09 20  
(891) 2013 09 20  
(511) 05

---

(260) AM 2014 75361 A  
(800) 1186064  
(151) 2013 10 31  
(181) 2023 10 31  
(891) 2013 10 31  
(511) 05

---

(260) AM 2014 75362 A  
(800) 1186071  
(151) 2013 11 01  
(181) 2023 11 01  
(891) 2013 11 01  
(511) 32, 33

---

(260) AM 2014 75364 A  
(800) 1186082  
(151) 2013 09 20  
(181) 2023 09 20  
(891) 2013 09 20  
(511) 05

---

(260) AM 2014 75365 A  
(800) 1186108  
(151) 2013 10 17  
(181) 2023 10 17  
(891) 2013 10 17  
(511) 34

---

(260) AM 2014 75366 A  
(800) 1186113  
(151) 2013 11 15  
(181) 2023 11 15  
(891) 2013 11 15  
(511) 43

---

(260) AM 2014 75367 A  
(800) 1186125  
(151) 2013 10 15

---

(181) 2023 10 15  
(891) 2013 10 15  
(511) 03

---

(260) AM 2014 75368 A  
(800) 1186133  
(151) 2013 07 29  
(181) 2023 07 29  
(891) 2013 07 29  
(511) 07, 11

---

(260) AM 2014 75369 A  
(800) 1186136  
(151) 2013 10 08  
(181) 2023 10 08  
(891) 2013 10 08  
(511) 30

---

(260) AM 2014 75370 A  
(800) 1186158  
(151) 2013 07 25  
(181) 2023 07 25  
(891) 2013 07 25  
(511) 03, 04, 05, 11, 21

---

(260) AM 2014 75371 A  
(800) 1186176  
(151) 2013 09 18  
(181) 2023 09 18  
(891) 2013 09 18  
(511) 09, 14

---

(260) AM 2014 75378 A  
(800) 1186203  
(151) 2013 09 24  
(181) 2023 09 24  
(891) 2013 09 24  
(511) 32, 33

---

(260) AM 2014 75379 A  
(800) 1186204  
(151) 2013 09 24  
(181) 2023 09 24  
(891) 2013 09 24  
(511) 33

---

(260) AM 2014 75381 A  
(800) 1186205  
(151) 2013 09 24  
(181) 2023 09 24  
(891) 2013 09 24  
(511) 32, 33

---

(260) AM 2014 75382 A  
(800) 1186220  
(151) 2013 09 20  
(181) 2023 09 20  
(891) 2013 09 20  
(511) 05

---

(260) AM 2014 75383 A  
(800) 1186223  
(151) 2013 10 28  
(181) 2023 10 28  
(891) 2013 10 28  
(511) 01, 02

---

(260) AM 2014 75384 A  
(800) 1186236  
(151) 2013 11 05  
(181) 2023 11 05  
(891) 2013 11 05  
(511) 29, 05, 30, 32

---

(260) AM 2014 75385 A  
(800) 1186238  
(151) 2013 11 01  
(181) 2023 11 01  
(891) 2013 11 01  
(511) 32, 33

---

(260) AM 2014 75388 A  
(800) 591517  
(151) 1992 08 25  
(891) 2013 01 07  
(511) 41

---

(260) AM 2014 75389 A  
(800) 599418  
(151) 1993 03 09  
(891) 2013 08 19  
(511) 30

---

(260) AM 2014 75391 A  
(800) 610399  
(151) 1993 11 10  
(891) 2013 11 11  
(511) 05

---

(260) AM 2014 75392 A  
(800) 1028190  
(151) 2009 10 02  
(891) 2013 10 16  
(511) 09

---

(260) AM 2014 75393 A  
(800) 1116769  
(151) 2012 03 30  
(891) 2013 09 11  
(511) 05, 30

---

(260) AM 2014 75394 A  
(800) 1186250  
(151) 2013 10 22  
(181) 2023 10 22  
(891) 2013 10 22  
(511) 34

---

(260) AM 2014 75395 A  
(800) 1186258  
(151) 2013 10 16  
(181) 2023 10 16  
(891) 2013 10 16  
(511) 25

---

(260) AM 2014 75397 A  
(800) 1186282  
(151) 2013 09 13  
(181) 2023 09 13  
(891) 2013 09 13  
(511) 07, 11, 12

---

(260) AM 2014 75400 A  
(800) 1186381  
(151) 2013 11 14  
(181) 2023 11 14  
(891) 2013 11 14  
(511) 05

---

(260) AM 2014 75401 A  
(800) 1186382  
(151) 2013 11 14  
(181) 2023 11 14  
(891) 2013 11 14  
(511) 05

---

(260) AM 2014 75403 A  
(800) 1186383  
(151) 2013 11 14  
(181) 2023 11 14  
(891) 2013 11 14  
(511) 05

---

(260) AM 2014 75404 A  
(800) 1186384  
(151) 2013 11 14  
(181) 2023 11 14

(891) 2013 11 14  
(511) 05

---

(260) AM 2014 75406 A  
(800) 1186387  
(151) 2013 11 14  
(181) 2023 11 14  
(891) 2013 11 14  
(511) 05

---

(260) AM 2014 75410 A  
(800) 1186399  
(151) 2013 09 20  
(181) 2023 09 20  
(891) 2013 09 20  
(511) 05

---

(260) AM 2014 75411 A  
(800) 1186400  
(151) 2013 09 20  
(181) 2023 09 20  
(891) 2013 09 20  
(511) 05

---

(260) AM 2014 75412 A  
(800) 1186433  
(151) 2013 10 29  
(181) 2023 10 29  
(891) 2013 10 29  
(511) 05

---

(260) AM 2014 75423 A  
(800) 1186484  
(151) 2013 10 21  
(181) 2023 10 21  
(891) 2013 10 21  
(511) 30

---

(260) AM 2014 75424 A  
(800) 1186494  
(151) 2013 10 29  
(181) 2023 10 29  
(891) 2013 10 29  
(511) 28

---

(260) AM 2014 75425 A  
(800) 1186509  
(151) 2013 05 24  
(181) 2023 05 24  
(891) 2013 05 24  
(511) 25

---

(260) AM 2014 75430 A  
(800) 1186526  
(151) 2013 07 01  
(181) 2023 07 01  
(891) 2013 07 01  
(511) 05, 09, 14, 16, 18, 20, 21, 24, 25, 28, 35, 36,  
37, 38, 39, 41, 42, 43, 44, 45

---

(260) AM 2014 75431 A  
(800) 1186530  
(151) 2013 06 22  
(181) 2023 06 22  
(891) 2013 06 22  
(511) 06, 07, 09, 17, 19, 20, 21, 35

---

(260) AM 2014 75437 A  
(800) 1186672  
(151) 2013 10 17  
(181) 2023 10 17  
(891) 2013 10 17  
(511) 01

---

(260) AM 2014 75438 A  
(800) 1186715  
(151) 2013 11 20  
(181) 2023 11 20  
(891) 2013 11 20  
(511) 06

---

(260) AM 2015 75440 A  
(800) 1186725  
(151) 2013 09 24  
(181) 2023 09 24  
(891) 2013 09 24  
(511) 30

---

(260) AM 2014 75441 A  
(800) 1186726  
(151) 2013 09 24  
(181) 2023 09 24  
(891) 2013 09 24  
(511) 30

---

(260) AM 2014 75442 A  
(800) 1186734  
(151) 2013 10 02  
(181) 2023 10 02  
(891) 2013 10 02  
(511) 30

---

(260) AM 2014 75443 A  
(800) 1186747  
(151) 2013 11 22

(181) 2023 11 22  
(891) 2013 11 22  
(511) 39, 36, 43

---

(260) AM 2014 75444 A  
(800) 1186748  
(151) 2013 11 26  
(181) 2023 11 26  
(891) 2013 11 26  
(511) 34

---

(260) AM 2014 75445 A  
(800) 1186758  
(151) 2013 11 20  
(181) 2023 11 20  
(891) 2013 11 20  
(511) 03, 05, 44

---

(260) AM 2014 75446 A  
(800) 1186760  
(151) 2013 11 27  
(181) 2023 11 27  
(891) 2013 11 27  
(511) 03, 05

---

(260) AM 2014 75447 A  
(800) 1186765  
(151) 2013 10 03  
(181) 2023 10 03  
(891) 2013 10 03  
(511) 34

---

(260) AM 2014 75448 A  
(800) 1186766  
(151) 2013 10 03  
(181) 2023 10 03  
(891) 2013 10 03  
(511) 34

---

(260) AM 2014 75449 A  
(800) 1186775  
(151) 2013 10 21  
(181) 2023 10 21  
(891) 2013 10 21  
(511) 03, 16

---

(260) AM 2014 75450 A  
(800) 1186774  
(151) 2013 10 10  
(181) 2023 10 10  
(891) 2013 10 10  
(511) 18, 25

---



(260) AM 2014 75466 A  
(800) 1186857  
(151) 2013 08 29  
(181) 2023 08 29  
(891) 2013 08 29  
(511) 05

---

(260) AM 2014 75467 A  
(800) 1186858  
(151) 2013 08 29  
(181) 2023 08 29  
(891) 2013 08 29  
(511) 05

---

(260) AM 2014 75473 A  
(800) 1186859  
(151) 2013 08 29  
(181) 2023 08 29  
(891) 2013 08 29  
(511) 05

---

(260) AM 2014 75474 A  
(800) 1186860  
(151) 2013 08 30  
(181) 2023 08 30  
(891) 2013 08 30  
(511) 05

---

(260) AM 2014 75475 A  
(800) 1186861  
(151) 2013 08 30  
(181) 2023 08 30  
(891) 2013 08 30  
(511) 05

---

(260) AM 2014 75490 A  
(800) 1186980  
(151) 2013 09 30  
(181) 2023 09 30  
(891) 2013 09 30  
(511) 30

---

(260) AM 2014 75502 A  
(800) 1187041  
(151) 2013 11 29  
(181) 2023 11 29  
(891) 2013 11 29  
(511) 14

---

(260) AM 2014 75503 A  
(800) 1187073  
(151) 2013 11 06  
(181) 2023 11 06

(891) 2013 11 06  
(511) 05

---

(260) AM 2014 75504 A  
(800) 1187074  
(151) 2013 11 06  
(181) 2023 11 06  
(891) 2013 11 06  
(511) 05

---

(260) AM 2014 75506 A  
(800) 1187179  
(151) 2013 11 12  
(181) 2023 11 12  
(891) 2013 11 12  
(511) 11

---

(260) AM 2014 75509 A  
(800) 1187245  
(151) 2013 11 12  
(181) 2023 11 12  
(891) 2013 11 12  
(511) 32

---

(260) AM 2014 75510 A  
(800) 1187246  
(151) 2013 11 12  
(181) 2023 11 12  
(891) 2013 11 12  
(511) 32

---

(260) AM 2014 75529 A  
(800) 1187534  
(151) 2012 07 13  
(181) 2022 07 13  
(891) 2012 07 13  
(511) 01, 02, 07, 09, 11, 37, 42

---

(260) AM 2014 75530 A  
(800) 1187540  
(151) 2012 10 12  
(181) 2022 10 12  
(891) 2012 10 12  
(511) 03, 05, 10, 16, 29, 35, 36, 39, 41, 42, 44

---

(260) AM 2014 75531 A  
(800) 1187555  
(151) 2013 03 22  
(181) 2023 03 22  
(891) 2013 03 22  
(511) 03

---

(260) AM 2014 75532 A  
(800) 1187558  
(151) 2013 03 29  
(181) 2023 03 29  
(891) 2013 03 29  
(511) 01, 04, 19

---

(260) AM 2014 75533 A  
(800) 1187573  
(151) 2013 04 01  
(181) 2023 04 01  
(891) 2013 04 01  
(511) 30, 35

---

(260) AM 2014 75534 A  
(800) 1187578  
(151) 2013 04 03  
(181) 2023 04 03  
(891) 2013 04 03  
(511) 05

---

(260) AM 2014 75537 A  
(800) 1187587  
(151) 2013 05 27  
(181) 2023 05 27  
(891) 2013 05 27  
(511) 11

---

(260) AM 2014 75538 A  
(800) 1187590  
(151) 2013 05 27  
(181) 2023 05 27  
(891) 2013 05 27  
(511) 12, 35, 41

---

(260) AM 2014 75539 A  
(800) 1187627  
(151) 2013 08 02  
(181) 2023 08 02  
(891) 2013 08 02  
(511) 35

---

(260) AM 2014 75543 A  
(800) 1187694  
(151) 2013 09 20  
(181) 2023 09 20  
(891) 2013 09 20  
(511) 05

---

(260) AM 2014 75544 A  
(800) 1187695  
(151) 2013 09 20

(181) 2023 09 20  
(891) 2013 09 20  
(511) 05

---

(260) AM 2014 75545 A  
(800) 1187696  
(151) 2013 09 20  
(181) 2023 09 20  
(891) 2013 09 20  
(511) 05

---

(260) AM 2014 75546 A  
(800) 1187697  
(151) 2013 09 20  
(181) 2023 09 20  
(891) 2013 09 20  
(511) 05

---

(260) AM 2014 75547 A  
(800) 1187698  
(151) 2013 09 20  
(181) 2023 09 20  
(891) 2013 09 20  
(511) 05

---

(260) AM 2014 75557 A  
(800) 1187894  
(151) 2013 11 06  
(181) 2023 11 06  
(891) 2013 11 06  
(511) 05

---

(260) AM 2014 75558 A  
(800) 1187895  
(151) 2013 11 06  
(181) 2023 11 06  
(891) 2013 11 06  
(511) 05

---

(260) AM 2014 75559 A  
(800) 1187897  
(151) 2013 04 30  
(181) 2023 04 30  
(891) 2013 04 30  
(511) 05

---

(260) AM 2014 75563 A  
(800) 1187958  
(151) 2013 08 21  
(181) 2023 08 21  
(891) 2013 08 21  
(511) 01

---

(260) AM 2014 75568 A  
(800) 1188054  
(151) 2013 07 19  
(181) 2023 07 19  
(891) 2013 07 19  
(511) 05

---

(260) AM 2014 75569 A  
(800) 1188065  
(151) 2013 12 04  
(181) 2023 12 04  
(891) 2013 12 04  
(511) 05

---

(260) AM 2014 75578 A  
(800) 1188169  
(151) 2013 08 20  
(181) 2023 08 20  
(891) 2013 08 20  
(511) 41

---

(260) AM 2014 75580 A  
(800) 1188209  
(151) 2013 10 09  
(181) 2023 10 09  
(891) 2013 10 09  
(511) 08

---

(260) AM 2014 75581 A  
(800) 1188267  
(151) 2013 11 11  
(181) 2023 11 11  
(891) 2013 11 11  
(511) 33

---

(260) AM 2014 75582 A  
(800) 1188271  
(151) 2013 10 10  
(181) 2023 10 10  
(891) 2013 10 10  
(511) 33

---

(260) AM 2014 75583 A  
(800) 1188303  
(151) 2013 10 02  
(181) 2023 10 02  
(891) 2013 10 02  
(511) 33

---

(260) AM 2014 75584 A  
(800) 1188310  
(151) 2013 10 15

(181) 2023 10 15  
(891) 2013 10 15  
(511) 30

---

(260) AM 2014 75585 A  
(800) 1188320  
(151) 2013 11 26  
(181) 2023 11 26  
(891) 2013 11 26  
(511) 19

---

(260) AM 2014 75613 A  
(800) 1133053  
(151) 2012 08 22  
(181) 2022 08 22  
(891) 2012 08 22  
(511) 05

---

(260) AM 2014 75614 A  
(800) 1188668  
(151) 2013 11 05  
(181) 2023 11 05  
(891) 2013 11 05  
(511) 05

---

(260) AM 2014 75615 A  
(800) 1188782  
(151) 2013 08 06  
(181) 2023 08 06  
(891) 2013 08 06  
(511) 05

---

(260) AM 2014 75616 A  
(800) 1188816  
(151) 2013 07 23  
(181) 2023 07 23  
(891) 2013 07 23  
(511) 03, 14, 18, 25

---

(260) AM 2014 75617 A  
(800) 1188817  
(151) 2013 08 02  
(181) 2023 08 02  
(891) 2013 08 02  
(511) 09, 16, 20, 35, 36, 37, 38, 39, 41, 42, 45

---

(260) AM 2014 75618 A  
(800) 1188821  
(151) 2013 08 26  
(181) 2023 08 26  
(891) 2013 08 26  
(511) 05

---

(260) AM 2014 75619 A  
(800) 1188825  
(151) 2013 08 06  
(181) 2023 08 06  
(891) 2013 08 06  
(511) 05

---

(260) AM 2014 75620 A  
(800) 1188826  
(151) 2013 08 06  
(181) 2023 08 06  
(891) 2013 08 06  
(511) 05

---

(260) AM 2014 75623 A  
(800) 1188912  
(151) 2013 03 27  
(181) 2023 03 27  
(891) 2013 03 27  
(511) 16, 17, 12

---

(260) AM 2014 75624 A  
(800) 1188950  
(151) 2013 07 24  
(181) 2023 07 24  
(891) 2013 07 24  
(511) 11

---

(260) AM 2014 75625 A  
(800) 1188952  
(151) 2013 07 08  
(181) 2023 07 08  
(891) 2013 07 08  
(511) 07, 17

---

(260) AM 2014 75626 A  
(800) 1188953  
(151) 2013 08 26  
(181) 2023 08 26  
(891) 2013 08 26  
(511) 05

---

(260) AM 2014 75628 A  
(800) 1188963  
(151) 2013 08 09  
(181) 2023 08 09  
(891) 2013 08 09  
(511) 12

---

(260) AM 2014 75629 A  
(800) 1188997  
(151) 2013 11 07

(181) 2023 11 07  
(891) 2013 11 07  
(511) 03, 05

---

(260) AM 2014 75630 A  
(800) 1189011  
(151) 2013 11 07  
(181) 2023 11 07  
(891) 2013 11 07  
(511) 07, 08, 12

---

(260) AM 2014 75631 A  
(800) 1189016  
(151) 2013 09 26  
(181) 2023 09 26  
(891) 2013 09 26  
(511) 39

---

(260) AM 2014 75632 A  
(800) 1189017  
(151) 2013 11 28  
(181) 2023 11 28  
(891) 2013 11 28  
(511) 03, 21, 35

---

(260) AM 2014 75633 A  
(800) 1189041  
(151) 2013 10 14  
(181) 2023 10 14  
(891) 2013 10 14  
(511) 06, 11

---

(260) AM 2014 75634 A  
(800) 1189063  
(151) 2013 12 06  
(181) 2023 12 06  
(891) 2013 12 06  
(511) 09

---

(260) AM 2014 75637 A  
(800) 1189065  
(151) 2013 12 06  
(181) 2023 12 06  
(891) 2013 12 06  
(511) 09

---

(260) AM 2014 75638 A  
(800) 1189067  
(151) 2013 12 06  
(181) 2023 12 06  
(891) 2013 12 06  
(511) 09

---

(260) AM 2014 75639 A  
(800) 1189068  
(151) 2013 12 06  
(181) 2023 12 06  
(891) 2013 12 06  
(511) 09

---

(260) AM 2014 75738 A  
(800) 768753  
(151) 2001 10 25  
(891) 2013 11 27  
(511) 03, 05, 16

---

(260) AM 2014 75740 A  
(800) 906353  
(151) 2006 11 13  
(891) 2013 10 31  
(511) 11, 30, 43

---

(260) AM 2014 75743 A  
(800) 1145520  
(151) 2012 11 13  
(891) 2013 12 11  
(511) 29, 30

---

(260) AM 2014 75744 A  
(800) 1182298  
(151) 2013 10 15  
(181) 2023 10 15  
(891) 2013 12 17  
(511) 09

---

(260) AM 2014 75879 A  
(800) 1039984  
(151) 2010 03 31  
(891) 2013 11 25  
(511) 03

---

(260) AM 2014 75884 A  
(800) 1159949  
(151) 2012 11 20  
(891) 2013 06 20  
(511) 03, 05, 10

---

(260) AM 2014 75888 A  
(800) 1177809  
(151) 2013 05 17  
(181) 2023 05 17  
(891) 2013 10 30  
(511) 06, 32, 33, 35, 43

---

(260) AM 2014 75944 A  
(800) 1191310  
(151) 2013 08 06  
(181) 2023 08 06  
(891) 2013 08 06  
(511) 05

---

(260) AM 2014 76049 A  
(800) 1098893  
(151) 2011 11 09  
(891) 2013 11 20  
(511) 05

---

(260) AM 2014 76052 A  
(800) 1179863  
(151) 2013 03 27  
(181) 2023 03 27  
(891) 2013 11 28  
(511) 26, 25

---

(260) AM 2014 76053 A  
(800) 1182568  
(151) 2013 09 18  
(891) 2014 01 07  
(511) 22, 23, 24, 25, 27

---

(260) AM 2014 76094 A  
(800) 1192720  
(151) 2013 12 26  
(181) 2023 12 26  
(891) 2013 12 26  
(511) 07

---

(260) AM 2014 76096 A  
(800) 1192730  
(151) 2013 05 21  
(181) 2023 05 21  
(891) 2013 05 21  
(511) 35, 41, 42

---

(260) AM 2014 76097 A  
(800) 1192751  
(151) 2013 08 23  
(181) 2023 08 23  
(891) 2013 08 23  
(511) 20, 35

---

(260) AM 2014 76098 A  
(800) 1192752  
(151) 2013 08 30  
(181) 2023 08 30

---

---

(891) 2013 08 30  
(511) 05

---

(260) AM 2014 76099 A  
(800) 1192754  
(151) 2013 07 17  
(181) 2023 07 17  
(891) 2013 07 17  
(511) 03, 05

---

(260) AM 2014 76100 A  
(800) 1192759  
(151) 2013 08 28  
(181) 2023 08 28  
(891) 2013 08 28  
(511) 19, 20, 35

---

(260) AM 2014 76112 A  
(800) 1192840  
(151) 2013 12 04  
(181) 2023 12 04  
(891) 2013 12 04  
(511) 07, 08

---

(260) AM 2014 76113 A  
(800) 1192889  
(151) 2013 12 24  
(181) 2023 12 24  
(891) 2013 12 24  
(511) 09

---

(260) AM 2014 76114 A  
(800) 1192901  
(151) 2013 09 16  
(181) 2023 09 16  
(891) 2013 09 16  
(511) 31

---

(260) AM 2014 76117 A  
(800) 1192947  
(151) 2013 08 06  
(181) 2023 08 06  
(891) 2013 08 06  
(511) 05

---

(260) AM 2014 76119 A  
(800) 1192965  
(151) 2013 11 02  
(181) 2023 11 02  
(891) 2013 11 02  
(511) 09, 16, 35, 38, 41

---

(260) AM 2014 76120 A  
(800) 1192968  
(151) 2013 10 25  
(181) 2023 10 25  
(891) 2013 10 25  
(511) 05, 16, 31, 42, 41, 44

---

(260) AM 2014 76121 A  
(800) 1192994  
(151) 2013 12 03  
(181) 2023 12 03  
(891) 2013 12 03  
(511) 30, 35, 43

---

(260) AM 2014 76123 A  
(800) 1193017  
(151) 2013 10 23  
(181) 2023 10 23  
(891) 2013 10 23  
(511) 16

---

(260) AM 2014 76125 A  
(800) 1193088  
(151) 2013 10 24  
(181) 2023 10 24  
(891) 2013 10 24  
(511) 05

---

(260) AM 2014 76132 A  
(800) 654362  
(151) 1996 03 12  
(891) 2013 10 03  
(511) 14

---

(260) AM 2014 76133 A  
(800) 798776  
(151) 2003 02 21  
(891) 2013 11 04  
(511) 03, 05, 30

---

(260) AM 2014 76137 A  
(800) 855176  
(151) 2005 03 24  
(891) 2014 01 21  
(511) 07

---

(260) AM 2014 76138 A  
(800) 857135  
(151) 2005 01 25  
(891) 2013 11 29  
(511) 38

---

(260) AM 2014 76139 A  
(800) 857136  
(151) 2005 01 25  
(891) 2013 11 22  
(511) 38

---

(260) AM 2014 76149 A  
(800) 1069951  
(151) 2010 12 17  
(891) 2013 12 30  
(511) 18, 25, 09

---

(260) AM 2014 76150 A  
(800) 1079055  
(151) 2011 02 28  
(891) 2013 12 17  
(511) 12, 37, 39

---

(260) AM 2014 76152 A  
(800) 1084036  
(151) 2011 06 27  
(891) 2014 01 13  
(511) 05

---

(260) AM 2014 76153 A  
(800) 1085758  
(151) 2011 02 23  
(891) 2013 12 19  
(511) 12, 37, 39

---

(260) AM 2014 76155 A  
(800) 1129800  
(151) 2012 08 31  
(891) 2013 12 20  
(511) 05

---

(260) AM 2014 76156 A  
(800) 1141126  
(151) 2012 11 16  
(891) 2013 12 20  
(511) 05

---

(260) AM 2014 76157 A  
(800) 1142645  
(151) 2012 11 09  
(891) 2013 10 21  
(511) 03

---

(260) AM 2014 76158 A  
(800) 1159617  
(151) 2013 05 02  
(181) 2023 05 02

(891) 2013 11 21  
(511) 05

---

(260) AM 2014 76159 A  
(800) 1175514  
(151) 2013 06 27  
(181) 2023 06 27  
(891) 2013 12 04  
(511) 07, 04, 12

---

(260) AM 2014 76164 A  
(800) 1179972  
(151) 2013 09 11  
(181) 2023 09 11  
(891) 2013 11 07  
(511) 30

---

(260) AM 2014 76169 A  
(800) 1193185  
(151) 2014 01 27  
(181) 2024 01 27  
(891) 2014 01 27  
(511) 34

---

(260) AM 2014 76172 A  
(800) 1193250  
(151) 2013 09 30  
(181) 2023 09 30  
(891) 2013 09 30  
(511) 16, 25, 35, 41

---

(260) AM 2014 76176 A  
(800) 1193260  
(151) 2013 09 03  
(181) 2023 09 03  
(891) 2013 09 03  
(511) 05, 29, 30, 35, 39

---

(260) AM 2014 76178 A  
(800) 1193281  
(151) 2013 10 08  
(181) 2023 10 08  
(891) 2013 10 08  
(511) 25

---

(260) AM 2014 76179 A  
(800) 1193287  
(151) 2013 10 18  
(181) 2023 10 18  
(891) 2013 10 18  
(511) 03, 05, 35

---



(260) AM 2014 76205 A  
(800) 1193394  
(151) 2013 09 30  
(181) 2023 09 30  
(891) 2013 09 30  
(511) 25, 35, 16, 41

---

(260) AM 2014 76218 A  
(800) 1193440  
(151) 2013 11 29  
(181) 2023 11 29  
(891) 2013 11 29  
(511) 12

---

(260) AM 2014 76219 A  
(800) 1193444  
(151) 2013 12 18  
(181) 2023 12 18  
(891) 2013 12 18  
(511) 05

---

(260) AM 2014 76221 A  
(800) 1193451  
(151) 2013 11 29  
(181) 2023 11 29  
(891) 2013 11 29  
(511) 33

---

(260) AM 2014 76224 A  
(800) 1193453  
(151) 2014 02 03  
(181) 2024 02 03  
(891) 2014 02 03  
(511) 03

---

(260) AM 2014 76226 A  
(800) 1193455  
(151) 2013 08 23  
(181) 2023 08 23  
(891) 2013 08 23  
(511) 05

---

(260) AM 2014 76227 A  
(800) 1193468  
(151) 2013 07 26  
(181) 2023 07 26  
(891) 2013 07 26  
(511) 05, 31

---

(260) AM 2014 76229 A  
(800) 1193494  
(151) 2013 07 26

(181) 2023 07 26  
(891) 2013 07 26  
(511) 31, 05

---

(260) AM 2014 76230 A  
(800) 1193503  
(151) 2013 12 26  
(181) 2023 12 26  
(891) 2013 12 26  
(511) 07

---

(260) AM 2014 76231 A  
(800) 1193528  
(151) 2013 09 04  
(181) 2023 09 04  
(891) 2013 09 04  
(511) 05

---

(260) AM 2014 76232 A  
(800) 1193529  
(151) 2013 09 04  
(181) 2023 09 04  
(891) 2013 09 04  
(511) 05

---

(260) AM 2014 76233 A  
(800) 1193535  
(151) 2013 08 30  
(181) 2023 08 30  
(891) 2013 08 30  
(511) 05

---

(260) AM 2015 76265 A  
(800) 1193774  
(151) 2013 10 17  
(181) 2023 10 17  
(891) 2013 10 17  
(511) 29

---

(260) AM 2014 76282 A  
(800) 857134  
(151) 2005 01 25  
(891) 2013 11 22  
(511) 38

---

(260) AM 2014 76283 A  
(800) 892895  
(151) 2005 10 28  
(891) 2013 12 23  
(511) 07, 09, 11, 12, 25, 35, 41, 42

---

(260) AM 2014 76284 A  
(800) 923290  
(151) 2007 04 30  
(891) 2014 01 28  
(511) 03

---

(260) AM 2014 76285 A  
(800) 947762  
(151) 2007 11 26  
(891) 2013 12 18  
(511) 05, 42, 44

---

(260) AM 2014 76287 A  
(800) 1087371  
(151) 2011 04 29  
(891) 2013 12 10  
(511) 29

---

(260) AM 2014 76288 A  
(800) 1144069  
(151) 2012 08 03  
(891) 2013 12 06  
(511) 05

---

(260) AM 2014 76290 A  
(800) 1163281  
(151) 2013 03 15  
(891) 2014 01 21  
(511) 03

---

(260) AM 2014 76294 A  
(800) 1175910  
(151) 2013 08 15  
(181) 2023 08 15  
(891) 2013 11 25  
(511) 34

---

(260) AM 2014 76295 A  
(800) 1193855  
(151) 2013 09 04  
(181) 2023 09 04  
(891) 2013 09 04  
(511) 07, 09, 42, 11, 37, 45

---

(260) AM 2014 76298 A  
(800) 1193864  
(151) 2013 08 07  
(181) 2023 08 07  
(891) 2013 08 07  
(511) 09

---

(260) AM 2014 76303 A  
(800) 1193866  
(151) 2013 08 09  
(181) 2023 08 09  
(891) 2013 08 09  
(511) 07, 09, 11, 12, 19, 37

---

(260) AM 2014 76304 A  
(800) 1193873  
(151) 2013 12 18  
(181) 2023 12 18  
(891) 2013 12 18  
(511) 05

---

(260) AM 2014 76305 A  
(800) 1193879  
(151) 2013 09 25  
(181) 2023 09 25  
(891) 2013 09 25  
(511) 18, 25

---

(260) AM 2014 76309 A  
(800) 1193880  
(151) 2013 07 26  
(181) 2023 07 26  
(891) 2013 07 26  
(511) 31, 05

---

(260) AM 2014 76315 A  
(800) 1193883  
(151) 2013 12 20  
(181) 2023 12 20  
(891) 2013 12 20  
(511) 33

---

(260) AM 2014 76316 A  
(800) 1193920  
(151) 2013 09 04  
(181) 2023 09 04  
(891) 2013 09 04  
(511) 05

---

(260) AM 2014 76317 A  
(800) 1193921  
(151) 2013 09 30  
(181) 2023 09 30  
(891) 2013 09 30  
(511) 25, 16, 35, 41

---

(260) AM 2014 76319 A  
(800) 1193933  
(151) 2013 10 17

(181) 2023 10 17  
(891) 2013 10 17  
(511) 29

---

(260) AM 2014 76320 A  
(800) 1193934  
(151) 2013 10 17  
(181) 2023 10 17  
(891) 2013 10 17  
(511) 29

---

(260) AM 2014 76321 A  
(800) 1193935  
(151) 2013 10 17  
(181) 2023 10 17  
(891) 2013 10 17  
(511) 29

---

(260) AM 2014 76336 A  
(800) 1194063  
(151) 2013 12 12  
(181) 2023 12 12  
(891) 2013 12 12  
(511) 05

---

(260) AM 2014 76381 A  
(800) 1194474  
(151) 2014 01 24  
(181) 2024 01 24  
(891) 2014 01 24  
(511) 33

---

(260) AM 2014 76382 A  
(800) 1194479  
(151) 2014 02 05  
(181) 2024 02 05  
(891) 2014 02 05  
(511) 05

---

(260) AM 2014 76383 A  
(800) 1194480  
(151) 2013 12 30  
(181) 2023 12 30  
(891) 2013 12 30  
(511) 09, 16, 28, 35, 41, 42, 45, 38

---

(260) AM 2014 76384 A  
(800) 169218  
(151) 1953 05 11  
(891) 2014 01 17  
(511) 05

---

(260) AM 2014 76386 A  
(800) 400587  
(151) 1973 08 17  
(891) 2013 12 10  
(511) 05

---

(260) AM 2014 76387 A  
(800) 713557  
(151) 1999 05 03  
(891) 2013 12 23  
(511) 03

---

(260) AM 2014 76388 A  
(800) 737339  
(151) 2000 06 08  
(891) 2014 01 17  
(511) 32

---

(260) AM 2014 76389 A  
(800) 821167  
(151) 2003 10 08  
(891) 2013 12 09  
(511) 09

---

(260) AM 2014 76390 A  
(800) 901778  
(151) 2006 08 01  
(891) 2014 01 01  
(511) 07

---

(260) AM 2014 76391 A  
(800) 1073346  
(151) 2011 03 01  
(891) 2013 11 15  
(511) 14

---

(260) AM 2014 76392 A  
(800) 1119284  
(151) 2012 04 13  
(891) 2013 12 12  
(511) 14, 18, 25

---

(260) AM 2014 76393 A  
(800) 1159501  
(151) 2013 04 26  
(181) 2023 04 26  
(891) 2013 12 27  
(511) 14, 35

---

(260) AM 2014 76396 A  
(800) 1194483  
(151) 2013 11 18  
(181) 2023 11 18  
(891) 2013 11 18  
(511) 34

---

(260) AM 2014 76397 A  
(800) 1194487  
(151) 2013 10 04  
(181) 2023 10 04  
(891) 2013 10 04  
(511) 05

---

(260) AM 2014 76398 A  
(800) 1194504  
(151) 2014 01 17  
(181) 2024 01 17  
(891) 2014 01 17  
(511) 05

---

(260) AM 2014 76400 A  
(800) 1194598  
(151) 2013 08 06  
(181) 2023 08 06  
(891) 2013 08 06  
(511) 05

---

(260) AM 2014 76407 A  
(800) 1194605  
(151) 2013 09 30  
(181) 2023 09 30  
(891) 2013 09 30  
(511) 33

---

(260) AM 2014 76410 A  
(800) 1194654  
(151) 2013 11 21  
(181) 2023 11 21  
(891) 2013 11 21  
(511) 29, 30

---

(260) AM 2014 76434 A  
(800) 1195000  
(151) 2014 01 13  
(181) 2024 01 13  
(891) 2014 01 13  
(511) 30

---

(260) AM 2014 76436 A  
(800) 1195003  
(151) 2014 01 09  
(181) 2024 01 09

(891) 2014 01 09  
(511) 05

---

(260) AM 2014 76439 A  
(800) 1195021  
(151) 2014 01 27  
(181) 2024 01 27  
(891) 2014 01 27  
(511) 05

---

(260) AM 2014 76441 A  
(800) 1195026  
(151) 2013 11 18  
(181) 2023 11 18  
(891) 2013 11 18  
(511) 34

---

(260) AM 2014 76444 A  
(800) 1195061  
(151) 2013 09 24  
(181) 2023 09 24  
(891) 2013 09 24  
(511) 30

---

(260) AM 2014 76445 A  
(800) 1195062  
(151) 2013 09 30  
(181) 2023 09 30  
(891) 2013 09 30  
(511) 30

---

(260) AM 2014 76446 A  
(800) 1195063  
(151) 2013 09 30  
(181) 2023 09 30  
(891) 2013 09 30  
(511) 30

---

(260) AM 2014 76447 A  
(800) 1195065  
(151) 2013 12 20  
(181) 2023 12 20  
(891) 2013 12 20  
(511) 18, 03, 21

---

(260) AM 2014 76448 A  
(800) 1195067  
(151) 2014 01 06  
(181) 2024 01 06  
(891) 2014 01 06  
(511) 09, 18, 25, 35

---

(260) AM 2014 76450 A  
(800) 1195117  
(151) 2013 10 24  
(181) 2023 10 24  
(891) 2013 10 24  
(511) 13

---

(260) AM 2014 76451 A  
(800) 1195141  
(151) 2014 01 23  
(181) 2024 01 23  
(891) 2014 01 23  
(511) 21

---

(260) AM 2014 76458 A  
(800) 1195158  
(151) 2013 11 29  
(181) 2023 11 29  
(891) 2013 11 29  
(511) 36

---

(260) AM 2014 76463 A  
(800) 1195184  
(151) 2014 01 09  
(181) 2024 01 09  
(891) 2014 01 09  
(511) 05

---

(260) AM 2014 76464 A  
(800) 1195189  
(151) 2013 10 01  
(181) 2023 10 01  
(891) 2013 10 01  
(511) 05

---

(260) AM 2014 76465 A  
(800) 1195190  
(151) 2013 10 01  
(181) 2023 10 01  
(891) 2013 10 01  
(511) 05

---

(260) AM 2014 76466 A  
(800) 1195191  
(151) 2013 10 01  
(181) 2023 10 01  
(891) 2013 10 01  
(511) 05

---

(260) AM 2014 76478 A  
(800) 1195317  
(151) 2013 12 20

(181) 2023 12 20  
(891) 2013 12 20  
(511) 05

---

(260) AM 2014 76479 A  
(800) 203631  
(151) 1957 09 28  
(891) 2014 01 17  
(511) 32

---

(260) AM 2014 76480 A  
(800) 248122  
(151) 1961 10 05  
(891) 2013 12 19  
(511) 05

---

(260) AM 2014 76481 A  
(800) 411562  
(151) 1974 12 09  
(891) 2013 12 30  
(511) 03

---

(260) AM 2014 76482 A  
(800) 631439  
(151) 1995 02 23  
(891) 2013 12 19  
(511) 05

---

(260) AM 2014 76483 A  
(800) 772490  
(151) 2001 06 20  
(891) 2013 12 19  
(511) 30

---

(260) AM 2014 76484 A  
(800) 797171  
(151) 2002 12 12  
(891) 2013 12 24  
(511) 29, 30, 35

---

(260) AM 2014 76488 A  
(800) 1167728  
(151) 2013 02 12  
(891) 2014 01 14  
(511) 14, 25, 26

---

(260) AM 2014 76489 A  
(800) 1178512  
(151) 2013 09 09  
(181) 2023 09 09

(891) 2013 12 02  
(511) 09

---

(260) AM 2014 77108 A  
(800) 1200973  
(151) 2013 11 01  
(181) 2023 11 01  
(891) 2013 11 01  
(511) 05

---

(260) AM 2014 77110 A  
(800) 1200987  
(151) 2013 12 20  
(181) 2023 12 20  
(891) 2013 12 20  
(511) 35, 34, 04, 11

---

(260) AM 2014 77113 A  
(800) 1200998  
(151) 2014 02 11  
(181) 2024 02 11  
(891) 2014 02 11  
(511) 12

---

(260) AM 2014 77114 A  
(800) 1201010  
(151) 2014 01 14  
(181) 2024 01 14  
(891) 2014 01 14  
(511) 18, 25

---

(260) AM 2014 77115 A  
(800) 1201044  
(151) 2014 02 04  
(181) 2024 02 04  
(891) 2014 02 04  
(511) 05

---

(260) AM 2014 77117 A  
(800) 1201077  
(151) 2014 02 03  
(181) 2024 02 03  
(891) 2014 02 03  
(511) 44

---

(260) AM 2014 77118 A  
(800) 1201082  
(151) 2014 03 25  
(181) 2024 03 25  
(891) 2014 03 25  
(511) 25

---

(260) AM 2014 77119 A  
(800) 1201084  
(151) 2014 03 10  
(181) 2024 03 10  
(891) 2014 03 10  
(511) 09, 10

---

(260) AM 2014 77120 A  
(800) 1201113  
(151) 2014 02 13  
(181) 2024 02 13  
(891) 2014 02 13  
(511) 37

---

(260) AM 2014 77122 A  
(800) 1201137  
(151) 2013 12 05  
(181) 2023 12 05  
(891) 2013 12 05  
(511) 44

---

(260) AM 2014 77123 A  
(800) 1201155  
(151) 2013 11 18  
(181) 2023 11 18  
(891) 2013 11 18  
(511) 09, 41, 42

---

(260) AM 2014 77124 A  
(800) 1201157  
(151) 2013 11 26  
(181) 2023 11 26  
(891) 2013 11 26  
(511) 25

---

(260) AM 2014 77126 A  
(800) 1201162  
(151) 2014 03 20  
(181) 2024 03 20  
(891) 2014 03 20  
(511) 35

---

(260) AM 2014 77130 A  
(800) 1201180  
(151) 2013 10 04  
(181) 2023 10 04  
(891) 2013 10 04  
(511) 43

---

(260) AM 2014 77131 A  
(800) 1201185  
(151) 2013 10 04

(181) 2023 10 04  
(891) 2013 10 04  
(511) 05

---

(260) AM 2014 77132 A  
(800) 1201186  
(151) 2013 12 09  
(181) 2023 12 09  
(891) 2013 12 09  
(511) 10, 20, 06

---

(260) AM 2014 77133 A  
(800) 1201208  
(151) 2014 02 12  
(181) 2024 02 12  
(891) 2014 02 12  
(511) 35

---

(260) AM 2014 77134 A  
(800) 1201214  
(151) 2014 01 27  
(181) 2024 01 27  
(891) 2014 01 27  
(511) 25

---

(260) AM 2014 77135 A  
(800) 1201234  
(151) 2014 01 21  
(181) 2024 01 21  
(891) 2014 01 21  
(511) 35, 41, 25

---

(260) AM 2014 77136 A  
(800) 1201262  
(151) 2014 03 12  
(181) 2024 03 12  
(891) 2014 03 12  
(511) 01

---

(260) AM 2014 77137 A  
(800) 1201283  
(151) 2014 03 25  
(181) 2024 03 25  
(891) 2014 03 25  
(511) 41

---

(260) AM 2014 77260 A  
(800) 1202427  
(151) 2014 03 12  
(181) 2024 03 12  
(891) 2014 03 12  
(511) 38

---

(260) AM 2014 77264 A  
(800) 1202429  
(151) 2013 08 28  
(181) 2023 08 28  
(891) 2013 08 28  
(511) 05, 35, 41, 42, 44

---

(260) AM 2014 77265 A  
(800) 1202432  
(151) 2013 08 28  
(181) 2023 08 28  
(891) 2013 08 28  
(511) 05, 35, 41, 42, 44

---



---

# OFFICIAL NOTIFICATIONS

## TRADEMARKS

### RENEWAL OF REGISTRATIONS

(111) M 2005 15879 R1

(156) 2015 03 01

(186) 2025 03 01

(732) BRF S.A.

Rua Jorge Tzachel, 475 Fazenda, City of  
Itajai, State of Santa Catarina, Brazil

---

(111) M 1995 628 R2

(156) 2015 05 03

(186) 2025 05 03

(732) KRAFT FOODS GROUP BRANDS LLC

Three Lakes Drive, Northfield,  
Illinois 60093, USA

---

(111) M 2005 15890 R1

(156) 2015 03 16

(186) 2025 03 15

(732) JSC "PHARMAK"

Vul. Frunze N63, UA-04080, Kiyiv, Ukraine

---

(111) M 1995 602 R2

(156) 2015 05 02

(186) 2025 05 02

(732) KRAFT FOODS GROUP BRANDS LLC

Three Lakes Drive, Northfield, Illinois  
60093, USA

---

(111) M 1995 603 R2

(156) 2015 05 02

(186) 2025 05 02

(732) KRAFT FOODS GROUP BRANDS LLC

Three Lakes Drive, Northfield, Illinois  
60093, USA

---

(11) M 1995 608 R2

(156) 2015 05 02

(186) 2025 05 02

(732) INTERCONTINENTAL GREAT BRANDS

LLC.  
100 Deforest Ave, East Hanover,  
NJ, 07936, USA

---

(111) M 1995 609 R2

(156) 2015 05 02

(186) 2025 05 02

(732) INTERCONTINENTAL GREAT BRANDS

LLC.  
100 Deforest Ave, East Hanover,  
NJ, 07936, USA

---

## COMPLETE TRANSFER OF RIGHTS

(111) M 2005 015879 R1  
(732) PERDIGÃO S.A.  
Rua Jorge Tzachel, 475 Fazenda, City of  
Itajai,  
State of Santa Catarina, Brazil  
(770) PERDIGAO AGROINDUSTRIAL S/A,  
Avenida Escola Politecnica, n 760,  
05350-901 Sao Paulo, Sao Paulo, Brazil  
(580) 2015 02 26

---

(111) M 2012 023160 R  
(732) ABG Juicy Couture, LLC  
100 W 33rd St. Suite 1007, New York, NY,  
10001, USA  
(770) JIUCY COUTURE, INC. (a California corp.)  
12720 Wentworth Street, Pacoima, California  
91331, USA  
(580) 2015 04 15

---

(111) M 2013 023674 R  
(732) BAYER CONSUMER CARE AG,  
a Swiss company  
Peter Merian-Str. 84, CH-4052 Basel,  
Switzerland  
(770) STEIGERWALD ARZNEIMITTELWERK  
GMBH  
Havelstrasse 5, 64295 Darmstadt, Germany  
(580) 2015 04 07

---

(111) M 2014 024723 R  
(732) CREAM FINANCE HOLDING LTD  
28 Nikodimou Mylona, 3095 Limassol,  
Cyprus  
(770) LTD "KREDITON"  
A. Kazbegis gamz. 24, 0160, Tbilisi, Georgia  
(580) 2015 04 15

---

## CHANGES IN NAMES AND/OR ADDRESSES OF OWNERS

(111) M 1998 010080 R1  
(732) THE JUICE PLUS+COMPANY, LLC  
140 Crescent Drive, Collierville, Shelby  
Country, Tennessee 38017, USA  
(770) NSA, LLC  
140 Crescent Drive, Collierville, Shelby  
Country, Tennessee 38017, USA  
(580) 2015 03 25

---

(111) M 1999 012291 R1  
(732) HLT International IP LLC  
7930 Jones Branch Drive, Suite 1100  
McLean, VA 22102, USA  
(770) HLT INTERNATIONAL IP LLC  
9336 Civil Center Drive, Beverley Hills,  
California 90210, USA  
(580) 2015 03 31

---

(111) M 2005 015879 R1  
(732) BRF-BRAZIL FOODS S.A.  
Rua Jorge Tzachel, 475 Fazenda, City of  
Itajai, State of Santa Catarina, Brazil  
(770) Perdigão S.A.  
Rua Jorge Tzachel, 475 Fazenda, City of  
Itajai, State of Santa Catarina, Brazil  
(580) 2015 02 26

---

(111) M 2005 015879 R1  
(732) BRF  
Rua Jorge Tzachel, 475 Fazenda, City of  
Itajai, State of Santa Catarina, Brazil  
(770) BRF-BRAZIL FOODS S.A.  
Rua Jorge Tzachel, 475 Fazenda, City of  
Itajai, State of Santa Catarina, Brazil  
(580) 2015 02 26

---

(111) M 2005 015890 R1  
(732) JOINT STOCK COMPANY "FARMAK"  
vul. Frunze N63, UA-04080, KYIV, Ukraine  
(770) VIDKRITIE AKTSIONERNE  
TOVARISTVO "FARMAK"  
vul. Frunze N63, UA-04080, KYIV, Ukraine  
(580) 2015 03 25

---

(111) M 2006 016814 R  
(732) LTD "TM "ELISEEVSKIE"  
Ul. Krylatskaya, d. 5, kom. 21, 121552  
Moscow, Russian Federation  
(770) CJSC "TM "ELISEEVSKIE"  
Ul. Krylatskaya, d. 5, 121552 Moscow,  
Russian Federation  
(580) 2015 04 15

---

(111) M 2006 016815 R  
(732) LTD "TM "ELISEEVSKIE"  
Ul. Krylatskaya, d. 5, kom. 21, 121552  
Moscow, Russian Federation  
(770) CJSC "TM "ELISEEVSKIE"  
Ul. Krylatskaya, d. 5, 121552 Moscow,  
Russian Federation  
(580) 2015 04 15

---

(111) M 2011 021154 R  
(732) HAMID SHARIATI  
Kipshidzis q. 3b, I sadarbazo, b. 19, 0162,  
Tbilisi, Georgia  
(770) HAMID SHARIATI  
Marjvena sanapiro 2a, b. 53, 0105, Tbilisi,  
Georgia  
(580) 2015 03 31

---

(111) M 2012 022992 R  
(732) LTD "SAAMO"  
G. Skhvitardzis q. 35, 0160, Tbilisi, Georgia  
(770) LTD "SAAMO"  
Zovretis q. 35, 0160, Tbilisi, Georgia  
(580) 2015 03 24

---

(111) M 2013 023810 R  
(732) FRHI Hotels & Resorts S.a.r.l.  
8-10 Avenue de la Gare, L-1610  
Luxembourg, Grand-Duchy of Luxembourg,  
Luxembourg  
(770) FRS Hotel Group (Lux) S.à r.l.  
37, rue d'Anvers, L-1130 Luxembourg,  
Grand-Duchy of Luxembourg, Luxembourg  
(580) 2015 03 31

---

(111) M 2013 023811 R  
(732) FRHI Hotels & Resorts S.a.r.l.  
8-10 Avenue de la Gare, L-1610  
Luxembourg, Grand-Duchy of Luxembourg,  
Luxembourg  
(770) FRS Hotel Group (Lux) S.à r.l.  
37, rue d'Anvers, L-1130 Luxembourg,  
Grand-Duchy of Luxembourg, Luxembourg  
(580) 2015 03 31

---

(111) M 2013 023812 R  
(732) FRHI Hotels & Resorts S.a.r.l.  
8-10 Avenue de la Gare, L-1610  
Luxembourg, Grand-Duchy of Luxembourg,  
Luxembourg  
(770) FRS Hotel Group (Lux) S.à r.l.

37, rue d'Anvers, L-1130 Luxembourg,  
Grand-Duchy of Luxembourg, Luxembourg  
(580) 2015 03 31

---

(111) M 2013 023942 R  
(732) THE CHILDREN'S PLACE, INC.  
500 Plaza Drive, Secaucus, New Jersey, USA  
(770) THE CHILDREN'S PLACE RETAIL  
STORES, INC.  
500 Plaza Drive, Secaucus, New Jersey, USA  
(580) 2015 03 24

---

(111) M 2013 024111 R  
(732) THE CHILDREN'S PLACE, INC.  
500 Plaza Drive, Secaucus, New Jersey, USA  
(770) THE CHILDREN'S PLACE RETAIL  
STORES, INC.  
500 Plaza Drive, Secaucus, New Jersey, USA  
(580) 2015 03 24

---

(111) M 2014 024624 R  
(732) THE CHILDREN'S PLACE, INC.  
500 Plaza Drive, Secaucus, New Jersey, USA  
(770) THE CHILDREN'S PLACE RETAIL  
STORES, INC.  
500 Plaza Drive, Secaucus, New Jersey, USA  
(580) 2015 03 24

---

## LICENSE AGREEMENTS

(111) 11510  
(732) B.S.A.  
33 Avenue du Main Tour Maine  
Montparnasse 75015 Paris, France  
(791) LTD "LACTALIS GEORGIA"  
Vazha-Pshavela Ave. 71, 4-th floor,  
office 24, 0186, Tbilisi, Georgia  
(580) 2015 03 25  
(793) Kind of License: Simple  
(793) 1246  
(793) 2014 11 01  
(793) 2024 10 31  
(511) 29

---

(111) 11683  
(732) LTD "LUKOIL GEORGIA"  
Right River Bank Mtkvari, Adjacent  
Territory of Gotua str., Tbilisi, Georgia  
(791) LTD "L & M"  
Vazisubani. m/r 4, kvart. I, korp. 19, b. 40,  
0152, Tbilisi, Georgia  
(580) 2015 02 26  
(793) Kind of License: Simple  
(793) 1238  
(793) 2014 07 01  
(793) 2015 12 31  
(511) 35, 37, 39, 42

---

(111) 11683  
(732) LTD "LUKOIL GEORGIA"  
Right River Bank Mtkvari, Adjacent  
Territory of Gotua str., Tbilisi, Georgia  
(791) LTD "L OIL"  
Gudauta str. 7, 0119, Tbilisi, Georgia  
(580) 2014 09 25  
(793) Kind of License: Simple  
(793) 1192  
(793) 2014 01 07  
(793) 2015 12 31  
(511) 35, 37, 39, 42

---

(111) 11683  
(732) LTD "LUKOIL GEORGIA"  
Right River Bank Mtkvari, Adjacent  
Territory of Gotua str., Tbilisi, Georgia  
(791) LTD "GIGO"  
Kipshidze str. 2, Tbilisi, Georgia  
(580) 2014 09 25  
(793) Kind of License: Simple  
(793) 1197  
(793) 2014 07 01  
(793) 2015 12 31  
(511) 35, 37, 39, 42

---

(111) 11683  
(732) LTD "LUKOIL GEORGIA"  
Right River Bank Mtkvari, Adjacent  
Territory of Gotua str., Tbilisi, Georgia  
(791) LTD "ST OIL"  
Kandelaki str. 1, Tbilisi, Georgia  
(580) 2014 09 25  
(793) Kind of License: Simple  
(793) 1202  
(793) 2014 07 01  
(793) 2015 12 31  
(511) 35, 37, 39, 42

---

(111) 11683  
(732) LTD "LUKOIL GEORGIA"  
Right River Bank Mtkvari, Adjacent  
Territory of Gotua str., Tbilisi, Georgia  
(791) LTD "IBERCOMPANY PETROLIUM"  
Vazha-Pshavela str. 8, Ambrolauri, Georgia  
(580) 2015 04 15  
(793) Kind of License: Simple  
(793) 1249  
(793) 2015 07 01  
(793) 2015 12 31  
(511) 35, 37, 39, 42

---

(111) 11683  
(732) LTD "LUKOIL GEORGIA"  
Right River Bank Mtkvari, Adjacent  
Territory of Gotua str., Tbilisi, Georgia  
(791) LTD "GEO-SERVICE"  
Besiki str. 82, Poti, Georgia  
(580) 2015 04 15  
(793) Kind of License: Simple  
(793) 1256  
(793) 2015 07 01  
(793) 2015 12 31  
(511) 35, 37, 39, 42

---

(111) 11683  
(732) LTD "LUKOIL GEORGIA"  
Right River Bank Mtkvari, Adjacent  
Territory of Gotua str., Tbilisi, Georgia  
(791) LTD "NOREKS"  
Guramishvili Ave. 8, Tbilisi, Georgia  
(580) 2015 04 17  
(793) Kind of License: Simple  
(793) 1259  
(793) 2015 07 01  
(793) 2015 12 31  
(511) 35, 37, 39, 42

---

(111) 11683  
 (732) LTD "LUKOIL GEORGIA"  
 Right River Bank Mtkvari, Adjacent  
 Territory of Gotua str., Tbilisi, Georgia  
 (791) LTD "BRAND OIL"  
 Digmis masivi, kvart. VI, Korp. 11, b. 19  
 Tbilisi, Georgia  
 (580) 2015 01 26  
 (793) Kind of License: Simple  
 (793) 1222  
 (793) 2014 07 01  
 (793) 2015 12 31  
 (511) 35, 37, 39, 42

---

(111) 11683  
 (732) LTD "LUKOIL GEORGIA"  
 Right River Bank Mtkvari, Adjacent  
 Territory of Gotua str., Tbilisi, Georgia  
 (791) LTD "KSILIS"  
 O. Taktakishvili str. 4, 0179, Tbilisi,  
 Georgia  
 (580) 2015 01 26  
 (793) Kind of License: Simple  
 (793) 1227  
 (793) 2014 07 01  
 (793) 2015 12 31  
 (511) 35, 37, 39, 42

---

(111) 11683  
 (732) LTD "LUKOIL GEORGIA"  
 Right River Bank Mtkvari, Adjacent  
 Territory of Gotua str., Tbilisi, Georgia  
 (791) LTD "SUBPETROL"  
 Nutsubidze str. 17, b. 16, 0177, Tbilisi,  
 Georgia  
 (580) 2015 01 26  
 (793) Kind of License: Simple  
 (793) 1232  
 (793) 2014 07 01  
 (793) 2015 12 31  
 (511) 35, 37, 39, 42

---

(111) 11684  
 (732) LTD "LUKOIL GEORGIA"  
 Right River Bank Mtkvari, Adjacent  
 Territory of Gotua str., Tbilisi, Georgia  
 (791) LTD "SUBPETROL"  
 Nutsubidze str. 17, b. 16, 0177, Tbilisi,  
 Georgia  
 (580) 2015 01 26  
 (793) Kind of License: Simple  
 (793) 1233  
 (793) 2014 07 01  
 (793) 2015 12 31  
 (511) 35, 37, 39, 42

---

(111) 11684  
 (732) LTD "LUKOIL GEORGIA"  
 Right River Bank Mtkvari, Adjacent  
 Territory of Gotua str., Tbilisi, Georgia  
 (732) LTD "LUKOIL GEORGIA"  
 Right River Bank Mtkvari, Adjacent  
 Territory of Gotua str., Tbilisi, Georgia  
 (791) LTD "L & M"  
 Vazisubani. m/r 4, kvart. I, korp. 19, b. 40,  
 0152, Tbilisi, Georgia  
 (580) 2015 02 26  
 (793) Kind of License: Simple  
 (793) 1239  
 (793) 2014 07 01  
 (793) 2015 12 31  
 (511) 35, 37, 39, 42

---

(111) 11684  
 (732) LTD "LUKOIL GEORGIA"  
 Right River Bank Mtkvari, Adjacent  
 Territory of Gotua str., Tbilisi, Georgia  
 (791) LTD "L OIL"  
 Gudauta str. 7, 0119, Tbilisi, Georgia  
 (580) 2014 09 25  
 (793) Kind of License: Simple  
 (793) 1193  
 (793) 2014 07 01  
 (793) 2015 12 31  
 (511) 35, 37, 39, 42

---

(111) 11684  
 (732) LTD "LUKOIL GEORGIA"  
 Right River Bank Mtkvari, Adjacent  
 Territory of Gotua str., Tbilisi, Georgia  
 (791) LTD "GIGO"  
 Kipshidze str. 2, Tbilisi, Georgia  
 (580) 2014 09 25  
 (793) Kind of License: Simple  
 (793) 1198  
 (793) 2014 07 01  
 (793) 2015 12 31  
 (511) 35, 37, 39, 42

---

(111) 11684  
 (732) LTD "LUKOIL GEORGIA"  
 Right River Bank Mtkvari, Adjacent  
 Territory of Gotua str., Tbilisi, Georgia  
 (791) LTD "ST OIL"  
 Kandelaki str. 1, Tbilisi, Georgia  
 (580) 2014 09 25  
 (793) Kind of License: Simple  
 (793) 1203  
 (793) 2014 07 01  
 (793) 2015 12 31  
 (511) 35, 37, 39, 42

---

(111) 11684  
(732) LTD "LUKOIL GEORGIA"  
Right River Bank Mtkvari, Adjacent  
Territory of Gotua str., Tbilisi, Georgia  
(791) LTD "IBERCOMPANY PETROLIUM"  
Vazha-Pshavel str. 8, Ambrolauri, Georgia  
(580) 2015 04 15  
(793) Kind of License: Simple  
(793) 1250  
(793) 2015 07 01  
(793) 2015 12 31  
(511) 35, 37, 39, 42

---

(111) 11684  
(732) LTD "LUKOIL GEORGIA"  
Right River Bank Mtkvari, Adjacent  
Territory of Gotua str., Tbilisi, Georgia  
(791) LTD "GEO-SERVICE"  
Besiki str. 82, Poti, Georgia  
(580) 2015 04 15  
(793) Kind of License: Simple  
(793) 1255  
(793) 2015 07 01  
(793) 2015 12 31  
(511) 35, 37, 39, 42

---

(111) 11684  
(732) LTD "LUKOIL GEORGIA"  
Right River Bank Mtkvari, Adjacent  
Territory of Gotua str., Tbilisi, Georgia  
(791) LTD "NOREKS"  
Guramishvili Ave. 8, Tbilisi, Georgia  
(580) 2015 04 17  
(793) Kind of License: Simple  
(793) 1260  
(793) 2015 07 01  
(793) 2015 12 31  
(511) 35, 37, 39, 42

---

(111) 11684  
(732) LTD "LUKOIL GEORGIA"  
Right River Bank Mtkvari, Adjacent  
Territory of Gotua str., Tbilisi, Georgia  
(791) LTD "BRAND OIL"  
Digmis masivi, kvart. VI, Korp. 11, b. 19  
Tbilisi, Georgia  
(580) 2015 01 26  
(793) Kind of License: Simple  
(793) 1223  
(793) 2014 07 01  
(793) 2015 12 31  
(511) 35, 37, 39, 42

---

(111) 11684  
(732) LTD "LUKOIL GEORGIA"  
Right River Bank Mtkvari, Adjacent  
Territory of Gotua str., Tbilisi, Georgia  
(791) LTD "KSILIS"  
O. Taktakishvili str. 4, 0179, Tbilisi,  
Georgia  
(580) 2015 01 26  
(793) Kind of License: Simple  
(793) 1228  
(793) 2014 07 01  
(793) 2015 12 31  
(511) 35, 37, 39, 42

---

(111) 11685  
(732) LTD "LUKOIL GEORGIA"  
Right River Bank Mtkvari, Adjacent  
Territory of Gotua str., Tbilisi, Georgia  
(791) LTD "SUBPETROL"  
Nutsbidze str. 17, b. 16, 0177, Tbilisi,  
Georgia  
(580) 2015 01 26  
(793) Kind of License: Simple  
(793) 1234  
(793) 2014 07 01  
(793) 2015 12 31  
(511) 35, 37, 39, 42

---

(111) 11685  
(732) LTD "LUKOIL GEORGIA"  
Right River Bank Mtkvari, Adjacent  
Territory of Gotua str., Tbilisi, Georgia  
(791) LTD "L & M"  
Vazisubani. m/r 4, kvart. I, korp. 19, b. 40,  
0152, Tbilisi, Georgia  
(580) 2015 02 26  
(793) Kind of License: Simple  
(793) 1240  
(793) 2014 07 01  
(793) 2015 12 31  
(511) 35, 37, 39, 42

---

(111) 11685  
(732) LTD "LUKOIL GEORGIA"  
Right River Bank Mtkvari, Adjacent  
Territory of Gotua str., Tbilisi, Georgia  
(791) LTD "L OIL"  
Gudauta str. 7, 0119, Tbilisi, Georgia  
(580) 2014 09 25  
(793) Kind of License: Simple  
(793) 1194  
(793) 2014 07 01  
(793) 2015 12 31  
(511) 35, 37, 39, 42

---

(111) 11685  
(732) LTD "LUKOIL GEORGIA"  
Right River Bank Mtkvari, Adjacent  
Territory of Gotua str., Tbilisi, Georgia  
(791) LTD "GIGO"  
Kipshidze str. 2, Tbilisi, Georgia  
(580) 2014 09 25  
(793) Kind of License: Simple  
(793) 1199  
(793) 2014 07 01  
(793) 2015 12 31  
(511) 35, 37, 39, 42

---

(111) 11685  
(732) LTD "LUKOIL GEORGIA"  
Right River Bank Mtkvari, Adjacent  
Territory of Gotua str., Tbilisi, Georgia  
(791) LTD "ST OIL"  
Kandelaki str. 1, Tbilisi, Georgia  
(580) 2014 09 25  
(793) Kind of License: Simple  
(793) 1204  
(793) 2014 07 01  
(793) 2015 12 31  
(511) 35, 37, 39, 42

---

(111) 11685  
(732) LTD "LUKOIL GEORGIA"  
Right River Bank Mtkvari, Adjacent  
Territory of Gotua str., Tbilisi, Georgia  
(791) LTD "IBERCOMPANY PETROLIUM"  
Vazha-Pshavel str. 8, Ambrolauri, Georgia  
(580) 2015 04 15  
(793) Kind of License: Simple  
(793) 1251  
(793) 2015 07 01  
(793) 2015 12 31  
(511) 35, 37, 39, 42

---

(111) 11685  
(732) LTD "LUKOIL GEORGIA"  
Right River Bank Mtkvari, Adjacent  
Territory of Gotua str., Tbilisi, Georgia  
(791) LTD "GEO-SERVICE"  
Besiki str. 82, Poti, Georgia  
(580) 2015 04 15  
(793) Kind of License: Simple  
(793) 1254  
(793) 2015 07 01  
(793) 2015 12 31  
(511) 35, 37, 39, 42

---

(111) 11685  
(732) LTD "LUKOIL GEORGIA"  
Right River Bank Mtkvari, Adjacent  
Territory of Gotua str., Tbilisi, Georgia  
(791) LTD "NOREKS"  
Guramishvili Ave. 8, Tbilisi, Georgia  
(580) 2015 04 17  
(793) Kind of License: Simple  
(793) 1261  
(793) 2015 07 01  
(793) 2015 12 31  
(511) 35, 37, 39, 42

---

(111) 11685  
(732) LTD "LUKOIL GEORGIA"  
Right River Bank Mtkvari, Adjacent  
Territory of Gotua str., Tbilisi, Georgia  
(791) LTD "BRAND OIL"  
Digmis masivi, kvart. VI, Korp. 11, b. 19  
Tbilisi, Georgia  
(580) 2015 01 26  
(793) Kind of License: Simple  
(793) 1224  
(793) 2014 07 01  
(793) 2015 12 31  
(511) 35, 37, 39, 42

---

(111) 11685  
(732) LTD "LUKOIL GEORGIA"  
Right River Bank Mtkvari, Adjacent  
Territory of Gotua str., Tbilisi, Georgia  
(791) LTD "KSILIS"  
O. Taktakishvili str. 4, 0179, Tbilisi,  
Georgia  
(580) 2015 01 26  
(793) Kind of License: Simple  
(793) 1229  
(793) 2014 07 01  
(793) 2015 12 31  
(511) 35, 37, 39, 42

---

(111) 13620  
(732) LTD "AVERSI-PHARMA"  
Davit Agmashenebeli Ave. 148/2, 0112,  
Tbilisi, Georgia  
(791) LTD "AVERSI-RATIONAL"  
Chirnakhuli str. 14, 0198, Tbilisi,  
Georgia  
(580) 2014 09 30  
(793) Kind of License: Simple  
(793) 1213  
(793) 2014 09 08  
(793) 2019 09 08  
(511) 42

---



(111) 13620  
(732) LTD "AVERSI-PHARMA"  
Davit Agmashenebeli Ave. 148/2, 0112,  
Tbilisi, Georgia  
(791) N(N)LE "CHARITABLE FUND AVERSI"  
Davit Agmashenebeli Ave. 148a, 0112,  
Tbilisi,  
Georgia  
(580) 2014 12 15  
(793) Kind of License: Simple  
(793) 1218  
(793) 2014 11 02  
(793) 2019 11 02  
(511) 42

---

(111) 17474  
(732) JSC "NIKORA"  
M. Kavtaradze str. 11, 0180, Tbilisi, Georgia  
(791) LTD "NIKORA"  
M. Kavtaradze str. 11, 0180, Tbilisi, Georgia  
(580) 2015 01 23  
(793) Kind of License: Simple  
(793) 1219  
(793) 2014 01 01  
(793) Before Expiration  
(511) 29, 30

---

(111) 17478  
(732) JSC "NIKORA"  
M. Kavtaradze str. 11, 0180, Tbilisi, Georgia  
(791) LTD "NIKORA"  
M. Kavtaradze str. 11, 0180, Tbilisi, Georgia  
(580) 2015 01 23  
(793) Kind of License: Simple  
(793) 1220  
(793) 2015 01 01  
(793) Before Expiration  
(511) 29, 30, 32, 35

---

(111) 20970  
(732) JSC "NIKORA"  
M. Kavtaradze str. 11, 0180, Tbilisi, Georgia  
(791) LTD "NIKORA"  
M. Kavtaradze str. 11, 0180, Tbilisi, Georgia  
(580) 2015 01 23  
(793) Kind of License: Simple  
(793) 1221  
(793) 2015 01 01  
(793) Before Expiration  
(511) 29

---

---

# CLASSIFICATION INDEXES

## INVENTIONS

### CONCORDANCE TABLE OF INTERNATIONAL CLASSIFICATION INDEX AND PUBLICATION NUMBERS

INTERNATIONAL CLASSIFICATION INDEXES (51)	NUMBER OF PUBLISHED APPLICATION (10)
A 61 K 9/00; A 61 K 31/44; A 61 P 11/06	AP 2015 12988 A
A 61 K 9/50; A 61 K 31/495	AP 2015 12984 A
A 61 K 39/00; C 07 K 16/44	AP 2015 12836 A
B 01 D 24/10; B 01 D 53/02	AP 2015 12776 A
C 07 C 231/12; C 07 C 233/18; A 61 K 31/165; A 61 P 25/16; A 61 P 25/18; A 61 P 25/28; A 61 P 3/00	AP 2015 12736 A
C 07 D 319/20; C 07 D 405/10; C 07 D 487/10; C 07 D 405/12; C 07 D 405/14; A 61 K 31/357; A 61 P 29/00; A 61 P 19/00	AP 2015 13259 A
C 07 D 519/00; A 61 K 31/519; A 61 P 25/00; A 61 P 25/18; A 61 P 25/24	AP 2015 13117 A
F 01 B 17/02; F 02 G 1/02; F 24 J 2/42	AP 2015 13075 A
F 02 B 21/00; F 02 M 31/04; F 02 M 31/16; F 01 B 17/02; F 01 D 13/02	AP 2015 13076 A

### CONCORDANCE TABLE OF PUBLICATION NUMBERS AND INTERNATIONAL CLASSIFICATION INDEX

NUMBER OF PUBLISHED APPLICATION (10)	INTERNATIONAL CLASSIFICATION INDEXES (51)
AP 2015 12736 A	C 07 C 231/12; C 07 C 233/18; A 61 K 31/165; A 61 P 25/16; A 61 P 25/18; A 61 P 25/28; A 61 P 3/00
AP 2015 12776 A	B 01 D 24/10; B 01 D 53/02
AP 2015 12836 A	A 61 K 39/00; C 07 K 16/44
AP 2015 12984 A	A 61 K 9/50; A 61 K 31/495
AP 2015 12988 A	A 61 K 9/00; A 61 K 31/44; A 61 P 11/06
AP 2015 13075 A	F 01 B 17/02; F 02 G 1/02; F 24 J 2/42
AP 2015 13076 A	F 02 B 21/00; F 02 M 31/04; F 02 M 31/16; F 01 B 17/02; F 01 D 13/02
AP 2015 13117 A	C 07 D 519/00; A 61 K 31/519; A 61 P 25/00; A 61 P 25/18; A 61 P 25/24
AP 2015 13259 A	C 07 D 319/20; C 07 D 405/10; C 07 D 487/10; C 07 D 405/12; C 07 D 405/14; A 61 K 31/357; A 61 P 29/00; A 61 P 19/00

**CONCORDANCE TABLE OF INTERNATIONAL CLASSIFICATION INDEX,  
PATENT NUMBERS AND PUBLICATION NUMBERS**

INTERNATIONAL CLASSIFICATION INDEX (51)	NUMBER OF PATENT (11)	NUMBER OF PUBLISHED APPLICATION (10)
A 61 M 15/00	P 2015 6277 B	AP 2015 12434 A
B 03 C 3/014; B 03 C 3/16; B 01 D 47/06; B 01 D 50/00	P 2015 6279 B	AP 2015 13190 A
F 02 B 75/32	P 2015 6278 B	AP 2014 13030 A
H 02 K 19/00; G 01 M 1/38	P 2015 6280 B	AP 2015 13268 A

**CONCORDANCE TABLE OF PATENT NUMBERS,  
PUBLICATION NUMBERS AND INTERNATIONAL CLASSIFICATION INDEX**

NUMBER OF PATENT (11)	NUMBER OF PUBLISHED APPLICATION (10)	INTERNATIONAL CLASSIFICATION INDEX (51)
P 2015 6277 B	AP 2015 12434 A	A 61 M 15/00
P 2015 6278 B	AP 2014 13030 A	F 02 B 75/32
P 2015 6279 B	AP 2015 13190 A	B 03 C 3/014; B 03 C 3/16; B 01 D 47/06; B 01 D 50/00
P 2015 6280 B	AP 2015 13268 A	H 02 K 19/00; G 01 M 1/38

**CONCORDANCE TABLE OF APPLICATION NUMBERS, PUBLICATION NUMBERS  
AND PATENTS**

NUMBER OF APPLICATION (21)	NUMBER OF PUBLISHED APPLICATION (10)	NUMBER OF PATENT (11)
AP 2010 012434	AP 2015 12434 A	P 2015 6277 B
AP 2013 013030	AP 2014 13030 A	P 2015 6278 B
AP 2011 013190	AP 2015 13190 A	P 2015 6279 B
AP 2013 013268	AP 2015 13268 A	P 2015 6280 B

## UTILITY MODELS

**CONCORDANCE TABLE OF INTERNATIONAL CLASSIFICATION INDEX  
AND PUBLICATION NUMBERS**

INTERNATIONAL CLASSIFICATION INDEXES (51)	NUMBER OF PUBLISHED APPLICATION (10)
C 04 B 35/01; H 01 L 39/12	AU 2015 12920 U
E 04 G 9/00	AU 2015 13452 U

**CONCORDANCE TABLE OF PUBLICATION NUMBERS  
AND INTERNATIONAL CLASSIFICATION INDEX**

NUMBER OF PUBLISHED APPLICATION (10)	INTERNATIONAL CLASSIFICATION INDEXES (51)
AU 2015 12920 U	C 04 B 35/01; H 01 L 39/12
AU 2015 13452 U	E 04 G 9/00

**CONCORDANCE TABLE OF INTERNATIONAL CLASSIFICATION INDEX,  
PATENT NUMBERS AND PUBLICATION NUMBERS**

INTERNATIONAL CLASSIFICATION INDEX (51)	NUMBER OF PATENT (11)	NUMBER OF PUBLISHED APPLICATION (10)
A 47 C 23/04	U 2015 1857 Y	AU 2015 13182 U

**CONCORDANCE TABLE OF PATENT NUMBERS,  
PUBLICATION NUMBERS AND INTERNATIONAL CLASSIFICATION INDEX**

NUMBER OF PATENT (11)	NUMBER OF PUBLISHED APPLICATION (10)	INTERNATIONAL CLASSIFICATION INDEX (51)
U 2015 1857 Y	AU 2015 13182 U	A 47 C 23/04

**CONCORDANCE TABLE OF APPLICATION NUMBERS, PUBLICATION NUMBERS  
AND PATENTS**

NUMBER OF APPLICATION (21)	NUMBER OF PUBLISHED APPLICATION (10)	NUMBER OF PATENT (11)
AU 2013 013182	AU 2015 13182 U	U 2015 1857 Y

## DESIGNS

**CONCORDANCE TABLE OF INTERNATIONAL CLASSIFICATION INDEX  
AND PUBLICATION NUMBERS**

INTERNATIONAL CLASSIFICATION INDEXES (51)	NUMBER OF PUBLISHED APPLICATION (10)
32-00	AD 2015 843 S

CONCORDANCE TABLE OF PUBLICATION NUMBERS  
AND INTERNATIONAL CLASSIFICATION INDEX

NUMBER OF PUBLISHED APPLICATION (10)	INTERNATIONAL CLASSIFICATION INDEXES (51)
AD 2015 843 S	32-00

## TRADEMARKS

### CONCORDANCE TABLE OF REGISTRATION NUMBERS, APPLICATION NUMBERS, PUBLICATION NUMBERS AND BULLETIN NUMBERS

NUMBER OF REGISTRATION (111)	NUMBER OF APPLICATIONS (210)	NUMBER OF PUBLISHED APPLICATIONS (260)	NUMBER OF BULLETIN
1	2	3	4
M 2015 25778 R	AM 2015 81488	-	8(420) 2015
M 2015 25779 R	AM 2013 70882	AM 2014 70882 A	24(412) 2014
M 2015 25780 R	AM 2013 73130	AM 2015 73130 A	4(416) 2015
M 2015 25781 R	AM 2013 73927	AM 2014 73927 A	24(412) 2014
M 2015 25782 R	AM 2013 74104	AM 2014 74104 A	15(403) 2014
M 2015 25783 R	AM 2013 74105	AM 2014 74105 A	17(405) 2014
M 2015 25784 R	AM 2013 74772	AM 2014 74772 A	24(412) 2014
M 2015 25785 R	AM 2013 74800	AM 2014 74800 A	23(411) 2014
M 2015 25786 R	AM 2013 74801	AM 2014 74801 A	23(411) 2014
M 2015 25787 R	AM 2015 81037	-	8(420) 2015
M 2015 25788 R	AM 2013 74778	AM 2014 74778 A	24(412) 2014
M 2015 25798 R	AM 2015 81350	-	8(420) 2015

### CONCORDANCE TABLE OF PUBLICATION NUMBERS AND APPLICATION NUMBERS

NUMBER OF PUBLISHED APPLICATION (260)	NUMBER OF APPLICATION (210)	1	2
1	2		
AM 2015 74294 A**	AM 74294	AM 2015 78209 A	AM 78209
AM 2015 76190 A	AM 76190	AM 2015 78210 A	AM 78210
AM 2015 76843 A	AM 76843	AM 2015 78213 A	AM 78213
AM 2015 77586 A	AM 77586	AM 2015 78214 A	AM 78214
AM 2015 77609 A	AM 77609	AM 2015 78215 A	AM 78215
AM 2015 77612 A	AM 77612	AM 2015 78221 A	AM 78221
AM 2015 77726 A	AM 77726	AM 2015 78222 A	AM 78222
AM 2015 77728 A	AM 77728	AM 2015 78224 A	AM 78224
AM 2015 77848 A	AM 77848	AM 2015 78252 A	AM 78252
AM 2015 77898 A	AM 77898	AM 2015 78253 A	AM 78253
AM 2015 77909 A	AM 77909	AM 2015 78255 A	AM 78255
AM 2015 78016 A	AM 78016	AM 2015 78256 A	AM 78256
AM 2015 78023 A	AM 78023	AM 2015 78257 A	AM 78257
AM 2015 78024 A	AM 78024	AM 2015 78258 A	AM 78258
AM 2015 78035 A	AM 78035	AM 2015 78264 A	AM 78264
AM 2015 78040 A	AM 78040	AM 2015 78267 A	AM 78267
AM 2015 78041 A	AM 78041	AM 2015 78269 A	AM 78269
AM 2015 78080 A	AM 78080	AM 2015 78270 A	AM 78270
AM 2015 78081 A	AM 78081	AM 2015 78271 A	AM 78271
AM 2015 78175 A	AM 78175	AM 2015 78272 A	AM 78272
AM 2015 78204 A	AM 78204	AM 2015 78273 A	AM 78273
AM 2015 78206 A	AM 78206	AM 2015 78275 A	AM 78275
		AM 2015 78290 A	AM 78290
		AM 2015 78300 A	AM 78300
		AM 2015 78315 A	AM 78315
		AM 2015 78382 A	AM 78382
		AM 2015 78383 A	AM 78383

1	2
AM 2015 78406 A	AM 78406
AM 2015 78408 A	AM 78408
AM 2015 78409 A	AM 78409
AM 2015 78410 A	AM 78410
AM 2015 78411 A	AM 78411
AM 2015 78728 A	AM 78728

1	2
AM 2015 78754 A	AM 78754
AM 2015 78849 A	AM 78849
AM 2015 78850 A	AM 78850
AM 2015 78899 A	AM 78899
AM 2015 79030 A	AM 79030
AM 2015 79031 A	AM 79031

CONCORDANCE TABLE OF INDEX OF GOODS AND/OR SERVICES  
AND APPLICATION NUMBERS

INDEX OF GOODS AND/OR SERVICES (511)	NUMBER OF PUBLISHED APPLICATIONS (260)
1	2
2	AM 2015 79030 A
2	AM 2015 79091 A
3	AM 2015 78252 A
3	AM 2015 78382 A
4	AM 2015 78273 A
5	AM 2015 77609 A
5	AM 2015 77612 A
5	AM 2015 77848 A
5	AM 2015 78016 A
5	AM 2015 78024 A
5	AM 2015 78253 A
5	AM 2015 78267 A
5	AM 2015 78269 A
5	AM 2015 78270 A
5	AM 2015 78271 A
5	AM 2015 78406 A
5	AM 2015 78409 A
5	AM 2015 78410 A
6	AM 2015 78209 A
6	AM 2015 78210 A
7	AM 2015 74294 A**
7	AM 2015 78273 A
8	AM 2015 78383 A
8	AM 2015 78728 A
9	AM 2015 77586 A
9	AM 2015 77726 A
9	AM 2015 77728 A
9	AM 2015 78264 A
9	AM 2015 78273 A
12	AM 2015 76190 A
12	AM 2015 78206 A
12	AM 2015 78214 A
12	AM 2015 78215 A
12	AM 2015 78255 A
12	AM 2015 78256 A
12	AM 2015 78257 A
12	AM 2015 78258 A

1	2
14	AM 2015 76190 A
16	AM 2015 76190 A
16	AM 2015 78264 A
17	AM 2015 78209 A
17	AM 2015 78210 A
19	AM 2015 78209 A
19	AM 2015 78210 A
19	AM 2015 78411 A
21	AM 2015 78413 A
24	AM 2015 78209 A
24	AM 2015 78210 A
25	AM 2015 76190 A
25	AM 2015 78273 A
25	AM 2015 78315 A
28	AM 2015 76190 A
28	AM 2015 78273 A
29	AM 2015 77909 A
29	AM 2015 78275 A
29	AM 2015 78290 A
29	AM 2015 78406 A
30	AM 2015 78204 A
30	AM 2015 78213 A
30	AM 2015 78300 A
30	AM 2015 78849 A
30	AM 2015 78850 A
30	AM 2015 78899 A
31	AM 2015 78023 A
32	AM 2015 76843 A
32	AM 2015 78899 A
33	AM 2015 78035 A
33	AM 2015 78080 A
33	AM 2015 78081 A
33	AM 2015 78175 A
33	AM 2015 78754 A
34	AM 2015 77898 A
34	AM 2015 78221 A
34	AM 2015 78222 A
34	AM 2015 78272 A
35	AM 2015 76190 A
35	AM 2015 76843 A
35	AM 2015 78016 A
35	AM 2015 78040 A

1	2
35	AM 2015 78041 A
35	AM 2015 78264 A
35	AM 2015 78408 A
36	AM 2015 76190 A
36	AM 2015 78264 A
36	AM 2015 78273 A
36	AM 2015 78408 A
37	AM 2015 76190 A
37	AM 2015 78209 A
37	AM 2015 78210 A

1	2
37	AM 2015 78408 A
38	AM 2015 76190 A
38	AM 2015 76264 A
39	AM 2015 78040 A
39	AM 2015 78041 A
39	AM 2015 76264 A
41	AM 2015 77586 A
42	AM 2015 76264 A
45	AM 2015 78224 A

**CONCORDANCE TABLE OF INDEX OF GOODS AND/OR SERVICES  
AND NUMBERS OF TRADEMARKS REGISTERED ACCORDING  
TO THE ACCELERATED PROCEDURE**

INDEX OF GOODS AND/OR SERVICES (511)	NUMBERS OF REGISTERED ACCORDING TO THE ACCELERATED PROCEDURE (111)
5	M 2015 25787 R
30	M 2015 25778 R
31	M 2015 25778 R
38	M 2015 25789 R



# OFFICIAL BULLETIN OF THE INDUSTRIAL PROPERTY

## 8(420)

EDITOR-IN-CHIEF: N. Bebrishvili

EDITORS-TRANSLATORS: E. Gabunia

COMPUTER LAYOUT: M. Ordenidze  
K. Svanidze

[www.sakpatenti.org.ge](http://www.sakpatenti.org.ge)

E-mail: [info@sakpatenti.org.ge](mailto:info@sakpatenti.org.ge)