



Official Bulletin of the Industrial Property

Invention

Utility Model

Validation Of European Patent

Design

Trademark



საქართველოს ინტელექტუალური
საკუთრების ეროვნული ცენტრი
საქპატენტი
SAKPATENTI
NATIONAL INTELLECTUAL PROPERTY
CENTER OF GEORGIA

INID CODES FOR IDENTIFICATION OF BIBLIOGRAPHIC DATA

INVENTIONS, UTILITY MODELS

- (10) Number of publication of examined application/
Application publication number***
- (11) Patent number/ Patent number***
Registered utility model number***
- (21) Application number (domestic number)
- (22) Date of filing of the application
- (23) Date of exhibition priority
- (24) Date from which patent may have effect
- (30) Priority data
- (31) Number of priority application
- (32) Date of filing of priority application
- (33) Code of the country or regional organization allotting priority application number
- (43) Date of publication of application, number of bulletin***
- (44) Date of publication of examined application, on which no grant has taken place and number of bulletin
- (45) Date of publication of patent/ Date of publication of patent***
Date of publication of registered utility model***
- (51) IPC
- (54) Title of invention
- (57) Abstract
- (60) Number of examined patent document granted by foreign patent office, date from which patent has effect and country code
- (62) Number and filing date of the earlier application from which the present patent document has been divided up
- (71) Applicant
- (72) Inventor
- (73) Name and address of patent owner/patent owner***/ registered utility model owner***
(country code)
- (74) Representative
- (82) Date of publication of request of validation
- (85) Date of commencement of the national phase
- (86) PCT filing date, PCT application number
- (87) Number and date of publication of international application (PCT)
- (94) Calculated date of expiry of the SPC or the duration of the SPC
- (100) EP application publication number
- (210) EP application number
- (220) EP filing date
- (430) EP application publication date

DESIGNS

- (10) Number of publication for application
- (11) Number of patent and kind of document or number of registration
- (15) Date of registration/Date of patent renewal
- (18) Expected expiration date of patent or registration
- (21) Serial number of application
- (22) Date of filing of the application
- (23) Date of exhibition or the date of the earlier filing and the number of application, if any
- (24) Date from which patent may have effect
- (28) Number of designs included in the application
- (30) Data relating to priority (number of application, date of filing of application, two-letter code identifying the authority with whom the priority application was made)
- (31) Number of priority application
- (32) Date of filing of priority application
- (33) Code of the country or regional organization allotting priority application number
- (34) Two-letter code according to WIPO St.3 identifying the authority with which the priority application was made
- (44) Date of publication of design and number of bulletin (the first publication)
- (45) Date of publication of design registered by WIPO and number of bulletin
- (51) International Classification for designs (class and subclass of the Locarno Classification)
- (54) Title of the invention
- (55) Reproduction of the design
- (57) Description of characteristic features of the design including indication of colors
- (58) Date of recording of any kind of amendment in the Register
- (62) Number of the earlier application, registration and document number and if available the date of filing an application in case of divided application
- (71) Name, surname and address of applicant (country code)
- (72) Name, surname of creator (country code)
- (73) Name, surname and address of patent owner (country code)
- (74) Name, surname of representative or patent attorney
- (81) Contracting states concerned
II designated contracting states according to the 1960 Act
III designated contracting states according to the 1999 Act
- (85) Owner's permanent address
- (86) Owner's nationality
- (87) Owner's residence
- (88) State in which the owner has a real and effective industrial or commercial establishment

TRADEMARKS

- (111) – Number of registration
- (151) – Date of registration
- (156) – Date of the renewal
- (181) – Expected expiration date of registration
- (186) – Renewal expiration date of registration
- (141) – Date of cancel of duration of the mark
- (210) – Serial number of application
- (220) – Date of filing of the application
- (230) – Date concerning exhibition
- (260) – Number of application, for which favorable decision of examination about registration has been taken (publication number)
- (310) – Number of the first application
- (320) – Date of filing of the first application
- (330) – Code, identifying national or regional Office where the first application was made
- (511) – International Classification of Goods and Services for the purposes of registration of trade marks and/or list of goods and/or services classified according thereto
- (526) – Disclaimer
- (531) – Description of figurative elements of Trade Marks according to the International Classification of the Figurative Elements of Marks
- (540) – Reproduction of Trade Mark
- (550) – Nature and kind of Trade Mark
- (551) – Indication to the effect that the mark is a collective mark, a certification mark or a guarantee mark
- (554) – Three-dimensional mark
- (580) – Date of recording of any kind changes in respect of applications or registrations
- (591) – Information concerning colors claimed
- (731) – Name and address of the applicant
- (732) – Name and address of the holder of the registration
- (740) – Name and address of the representative
- (750) – Addreses for correspondence
- (770) – Name and address of the previous applicant or holder in case of change in ownership
- (771) – Previous name and address of the applicant or holder in case of change in ownership
- (791) – Name and address of the licensee
- (793) – Indication of conditions and/or restrictions under the license (Type of license, number of license agreement, data of license, data of validity of license)
- (800) – Certain data relating to the international registration of Trade Marks under the Protocol Relating to Madrid Agreement (International registration number)
- (852) – Partial cancellation of the list of goods and services
- (891) – Date of subsequent designation

CODES FOR PUBLICATION IN BULLETIN

- (21) AP 0000 000000 – number of application for invention
- (10) AP 0000 0000 A – number of publication of application for invention
- (11) P 0000 0000 B – number of patent for invention/ patent number***
- (21) API 0000 000000 – number of application for imported patent
- (11) PI 0000 0000 A – number of imported patent
- (21) AU 0000 000000 – number of application for utility model
- (10) AU 0000 000 U – number of publication of application for utility model
- (11) U 0000 000 Y – number of patent for utility model/ registered utility model number***
- (21) AD 0000 000000 – serial number of application for design
- (10) AD 0000 000 S – number of published application for design (first publication)
- (11) D 0000 000 S – registered design

INTERNATIONAL PATENT CLASSIFICATION FOR INVENTIONS AND UTILITY MODELS

- SECTION A – HUMAN NECESSITIES
- SECTION B – PERFORMING OPERATIONS; TRANSPORTING
- SECTION C – CHEMISTRY; METALLURGY
- SECTION D – TEXTILES; PAPER
- SECTION E – FIXED CONSTRUCTIONS
- SECTION F – MECHANICAL ENGINEERING; LIGHTING; HEATING; WEAPONS;
BLASTING
- SECTION G – PHYSICS
- SECTION H – ELECTRICITY

* Number of application published after the decision of Appellation Chamber of SAKPATENTI

** Number of application published after Court decision

*** Materials published according to the amendments of May 16, 2023 (No. 2883-XI0b-X03) to the Patent Law of Georgia

- M – Trade Mark
- (210) AM 0000 000000 – Serial number of application;
- (260) AAM 0000 00000 A – Publication number of application;
- (111) M 0000 00000 R – Number of registration;
- (111) MMM0000 00000 Rn – Number of renewals, in which n=1,2,3;
- (111) M 0000 00000 R(P) – Number of registration under partial assignment of rights

Official Bulletin of the Industrial Property

Invention

Utility Model

Validation Of European Patent

Design

Trademark

CONTENT

PUBLISHED TITLES OF PROTECTION	2
INVENTION	
▪ APPLICATION APPROVED FOR GRANTING PATENT	4
▪ APPLICATION***	5
▪ PATENT***	8
UTILITY MODEL	
APPLICATION***	10
VALIDATION OF EUROPEAN PATENT	
EUROPEAN PATENT APPLICATION FOR WHICH THE VALIDATION IS REQUESTED IN GEORGIA	11
DESIGN	
▪ REGISTERED DESIGN	22
▪ DESIGN, WHICH HAS BEEN REGISTERED WITH THE INTERNATIONAL BUREAU CLAIMING PRIORITY ON THE TERRITORY OF GEORGIA	23
TRADEMARK	
▪ APPLICATION FILED UNDER THE NATIONAL PROCEDURE APPROVED FOR REGISTRATION	35
▪ REGISTERED TRADEMARK	42
▪ TRADEMARK REGISTERED ACCORDING TO THE ACCELERATED PROCEDURE	49
▪ INTERNATIONAL TRADEMARK FOR WHICH A DECISION ON GRANTING PROTECTION IS TAKEN	53
▪ INTERNATIONAL TRADEMARK PROTECTED IN GEORGIA	197
OFFICIAL NOTIFICATIONS	
INVENTION	
▪ RESTORATION OF PATENT	208
▪ LAPSE OF PATENT WITH THE RIGHT TO RESTORE	209
▪ EXPIRATION OF PATENT RESTORATION TERM	209
UTILITY MODEL	
LAPSE OF PATENT WITH THE RIGHT TO RESTORE	211
DESIGN	
▪ CANCELLATION OF DESIGN REGISTRATION	212
▪ EXTENSION OF TERM OF INTERNATIONAL DESIGN REGISTRATION	212
TRADEMARK	
▪ EXTENSION OF TERM OF TRADEMARK REGISTRATION	215
▪ COMPETE TRANSFER OF RIGHT	221
▪ CHANGE OF NAME AND/OR ADDRESS OF TRADEMARK OWNER	225
▪ CANCELLATION OF TRADEMARK REGISTRATION	229
▪ INTERNATIONAL LICENSE AGREEMENT	230
CLASSIFICATION INDEXES	
INVENTION	231
UTILITY MODEL	233
DESIGN	234
TRADEMARK	235

PUBLISHED TITLES OF PROTECTION

INVENTION

- **APPLICATION APPROVED FOR GRANTING PATENT**
16026
- **APPLICATION:*****
16917; 16925; 16950; 16909; 16965; 16842
- **PATENT:*****
7899-7902

UTILITY MODEL

APPLICATION***

16635

VALIDATION OF EUROPEAN PATENT

EUROPEAN PATENT APPLICATION FOR WHICH THE VALIDATION IS REQUESTED IN GEORGIA:

363-391

DESIGN

- **REGISTERED DESIGN:**
1119, 1120
- **DESIGN, WHICH HAS BEEN REGISTERED WITH THE INTERNATIONAL BUREAU CLAIMING
PRIORITY ON THE TERRITORY OF GEORGIA:**
250322; 250924; 250497; 255570

TRADEMARK

- **APPLICATION FILED UNDER THE NATIONAL PROCEDURE APPROVED FOR REGISTRATION:**
135708; 135731; 135761; 135763; 135801; 135928; 136064; 136132; 136137; 136138; 136151-136153; 136158-
-136161; 136252, 136253; 136261; 136271; 136274; 136279-136282; 136284, 136285; 136293; 136353; 136355;
136360, 136361; 136365; 136374; 136441; 136444; 136451-136453; 136485, 136486
- **REGISTERED TRADEMARK:**
41293-41330; 41334-41362
- **TRADEMARK REGISTERED ACCORDING TO THE ACCELERATED PROCEDURE:**
41331-41333; 41363-41376
- **INTERNATIONAL TRADEMARK FOR WHICH A DECISION ON GRANTING PROTECTION IS
TAKEN:**
113646*; 131041; 131124, 131125; 131136, 131137; 131139, 131140; 131206-131209; 131217; 131416-131422;
131550-131554; 131635-131644; 131651-131654; 131660, 131661; 131664; 131696; 131784; 131803; 131805;
131807; 131869; 132301; 132720; 132826; 132828; 132853; 132868; 132876*; 132953-132956; 132958-132961;
132964; 132968; 132972; 132974; 133080, 133081; 133083, 133084; 133091, 133092; 133101; 133189-133194;
133207-133209; 133211, 133212; 133296-133302; 133323; 133419; 133422; 133432; 133513; 133516, 133610;
133714; 133730; 133735; 133752; 133755; 133791; 134281; 134587; 134589; 134591; 134850-134852; 134854,
134855; 134898-134900; 135027, 135028; 135030-135033; 135136-135144; 135163-135168; 135179; 135182;
135184; 135243; 135252-135256; 135273; 135275, 135276; 135278, 135279; 135318-135334; 135336-135341;
135358; 135413; 135415-135420; 135423-135431; 135438-135446; 135509; 135511-135513; 135529-135532;
135779; 135975; 135978, 135979; 135981; 136020; 136071, 136072; 136075; 136168, 136169; 136174; 136182;
136211-136213; 136244; 136246
- **INTERNATIONAL TRADEMARK PROTECTED IN GEORGIA:**
129513; 129563-129568; 129619; 129681, 129682; 129712; 129714-129716; 129804; 129806-129808; 129888-
-129901; 129969-129977; 129984, 129985; 130023-130031; 130085, 130086; 130090-130092; 130161-130164;
130173, 130174; 130298-130301; 130303; 130380-130383; 130462-130466; 130468; 130478, 130479; 130599;
130613; 130615; 130618, 130619; 132006; 132009, 132057; 132059; 132061; 132182, 132183; 132460; 132892;
133115-133119; 133195, 133196; 133198, 133199; 133310; 133446; 133492; 133628-133630; 133632-133638;
133709; 133718; 133722; 133728; 133736; 133738; 133753; 133807; 133832; 133906-133909; 133930-133934;
134002; 134009; 134011; 134013-134015; 134044; 134046-134049; 134107, 134108; 134110-134113; 134222-
-134225

APPLICATION***

PART A

A 61

- (10) AP 2026 16917 A (51) Int. Cl. (2006)
 A 61 K 31/4709
 A 61 K 31/437
 A 61 P 3/10
 A 61 P 1/16
 A 61 P 3/04
 C 07 D 471/04
 C 07 D 498/22
- (43) 2026 06 10 №11
 (21) AP 2024 16917
 (22) 2024 07 29
 (31) 202311372605.9; 202311546779.2;
 202410882329.9; 202410385768.9;
 202410241733.8; 202311110642.2;
 202311269491.5; 202311087184.5;
 202310946477.8; 202311690443.3;
 202311866263.6; 202410140555.X;
 202410587643.4
- (32) 2023 10 20; 2023 11 17; 2024 07 02; 2024 03 29;
 2024 03 01; 2023 08 30; 2023 09 27; 2023 08 25;
 2023 07 28; 2023 12 08; 2023 12 29; 2024 01 31;
 2024 05 11
- (33) CN; CN; CN; CN; CN; CN; CN; CN; CN;
 CN; CN; CN; CN
- (71) Shanghai Hansoh Biomedical Co., Ltd. (CN)
 Bldg. 11, №3728 Jinke Road, China (Shanghai)
 Pilot Free Trade Zone, Pudong New Area,
 Shanghai 201203, People's Republic
 of China (CN);
 Jiangsu Hansoh Pharmaceutical Group
 Co., Ltd. (CN)
 Economic and Technological Development Zone,
 Lianyungang, Jiangsu 222047, People's Republic
 of China (CN)
- (72) MAO, Xiaofeng (CN);
 WANG, Jun (CN);
 SU, Yidong (CN);
 YU, Wensheng (CN)
- (74) Shalva Gvaramadze
 (85) 2026 02 27
 (86) PCT/CN2024/108192, 2024 07 29
 (54) BENZO NITROGEN-CONTAINING HETERO-
 CYCLIC DERIVATIVE REGULATOR,
 PREPARATION METHOD THEREFOR
 AND USE THEREOF
 (57) Present invention relates to the field of medicine
 and biology and, in particular, to a regulator based on
 benzo nitrogen-containing heterocyclic derivative, a
 method for its preparation, and its use. Specifically, the
 invention relates to compound represented with general

formula (XIX), a method for preparing the same,
 pharmaceutical composition comprising the compound,
 and the use of compound as a regulator in the
 preparation of medicaments for treating metabolic
 diseases and related diseases, wherein each substituent
 in general formula (XIX) has the meaning defined in
 the description.

- (10) AP 2026 16925 A (51) Int. Cl. (2006)
 A 61 K 31/4184
 A 61 K 31/437
 A 61 K 31/444
 A 61 K 31/439
 A 61 K 31/496
 A 61 P 3/00
 C 07 D 401/14
 C 07 D 487/04
 C 07 D 403/14
 C 07 D 413/14
 C 07 D 487/08
 C 07 D 31/439
 C 07 D 405/14

- (43) 2026 06 10 №11
 (21) AP 2022 16925
 (22) 2022 01 27
 (62) AP 2022 16333 2023 08 25
 (31) 63/274,893; 63/183,612; 63/143,025
 (32) 2021 11 02; 2021 05 03; 2021 01 28
 (33) US; US; US
 (71) Carmot Therapeutics, Inc. (US)
 1 DNA Way, South San Francisco, CA 94080,
 USA (US)
 (72) ZHANG, Xiu (US);
 HANSEN, Stig (US);
 LLOYD, David (US);
 LEE, Craig (US);
 KAWAI, Hiroyuki (US);
 WANG, Xiaofang (US);
 SAKYA, Subas Man (US);
 LIU, Li (US);
 JEONG, Joon Won (US);
 GAO, Rui (US);
 ZHOU, Xiang (US);
 YEY, Chien-Hung (US);
 DU, Xiaohui (US);
 FUCINI, Ray (US)
 (74) Shalva Gvaramadze
 (85) 2026 03 12
 (86) PCT/US2022/014156, 2022 01 27
 (54) GPCR RECEPTOR AGONISTS, PHARMACEU-
 TICAL COMPOSITIONS COMPRISING THE
 SAME, AND METHODS FOR THEIR USE
 (57) Provided herein are GLP-1 receptor modulator
 compounds, pharmaceutical compositions, methods of

their preparation, and methods of their use in treatment, and/or diagnosis.

- (10) AP 2026 16950 A (51) Int. Cl. (2006)
A 61 K 39/00
A 61 K 39/395
A 61 K 38/17
C 07 K 16/28
- (43) 2026 06 10 №11
(21) AP 2021 16950
(22) 2021 09 06
(62) AP 2021 16662 2024 12 24
(31) 202011624826.7; 202010972365.6
(32) 2020 12 31; 2020 09 16
(33) CN; CN
(71) Sichuan Kelun-Biotech Biopharmaceutical Co., Ltd. (CN)
№6666, Xinhua Avenue (Section 2), Haixia Industrial Park, Wenjiang District, Chengdu, Sichuan 611138, People's Republic of China (CN)
- (72) REN, Qi (CN);
LIU, Le (CN);
WANG, Jingyi (CN);
XUE, Tongtong (CN);
XIAO, Liang (CN);
LI, Fen (CN);
WANG, Cheng (CN);
LIU, Dengnian (CN);
GE, Junyou (CN)
- (74) Shalva Gvaramadze
(85) 2026 04 15
(86) PCT/CN2021/116651, 2021 09 06
(54) ANTI-NECTIN-4 ANTIBODY, CONJUGATE INCLUDING SAME, AND APPLICATION THEREOF
(57) Provided are an anti-Nectin-4 antibody or an antigen-binding fragment thereof, an antibody conjugate including same, and a use thereof in the preparation of a medicament, particularly in the preparation of a medicament for preventing and/or treating cancer.

PART B

B 01

- (10) AP 2026 16909 A (51) Int. Cl. (2006)
B 01 D 23/30
B 01 J 35/39
B 01 J 37/03
B 01 J 21/06
B 01 J 23/06
C 09 D 5/00
C 09 D 1/00
C 09 D 5/14
C 23 C 18/12

- (43) 2026 06 10 №11
(21) AP 2024 16909
(22) 2024 07 17
(31) 23186148.5
(32) 2023 07 18
(33) EP
(71) Ze Blue Planet S.p.A. (IT)
Via C. G. Merlo, 3, I-20122 Milan (MI), Italy (IT)
- (72) CIANCI, Antonio (IT);
BERNARDONI, Massimo (IT)
- (74) Nikoloz Gogilidze
(85) 2026 02 13
(86) PCT/EP2024/070305, 2024 07 17
(54) SOL-GEL PHOTOCATALYTIC TRANSPARENT WATER- BASED COATING
(57) Sol-gel photocatalytic transparent coating composition comprising:
a) at least one water solvent;
b) at least one photocatalyst precursor (TTIP);
c) at least one non-ionic surfactant
d) at least one epoxy silane;
e) at least one chelating agent
f) at least one inorganic acid;
g) at least one an inorganic salt.
- Such composition can be used with conventional means, such as spray coating and ensures a highly transparent photocatalytic coating with very low thickness that can be applied on several substrates which is stable over time with good resistance also to weathering agents and with relative low quantities of photocatalyst, generally lower than 10% by weight.

B 65

- (10) AP 2026 16965 A (51) Int. Cl. (2006)
B 65 G 1/04
B 65 G 1/137
B 66 F 9/06
- (43) 2026 06 10 №11
(21) AP 2024 16965
(22) 2024 11 09
(31) U2300183
(32) 2023 11 09
(33) HU
(71) ZOMBORI, Antal (HU)
Remete köz 43, 1037 Budapest, Hungary (HU)
- (72) ZOMBORI, Antal (HU)
(74) Shalva Gvaramadze
(85) 2026 04 29
(86) PCT/HU2024/050092, 2024 11 09
(54) WAREHOUSE LOADING MACHINE
(57) Warehouse loading machine (1) for moving suspended goods in automated goods handling warehouse, comprising a motor-driven rolling frame (2) having wheels (3, 4) and lifting columns (5). The lifting columns (5) are mounted on the rolling frame (2), and on the lifting columns (5) are arranged movable, motor-operated lifting blocks (6) which are raised and

lowered, which support a lifting frame (7). The lifting frame (7) comprises a motor-driven pull-out unit (8) and a motor-driven fork lift unit (9).

PART H

H 02

(10) AP 2026 16842 A (51) Int. Cl. (2006)
H 02 J 7/00
H 02 M 3/00

(10) AP 2026 16842 A

(43) 2026 06 10 №11

(21) AP 2025 16842

(22) 2025 09 21

(71) Levan Kapanadze (GE)

University St. 2, 0102, Tbilisi, Georgia (GE);

Ilo Labadze (GE)

8th Street, IV Lane 1, Vill. Zeda Sakara, 2000,

Zestaponi, Georgia (GE)

(72) Levan Kapanadze (GE);

Ilo Labadze (GE)

(54) REGULATOR OF INFORMATION
PARAMETERS OF A PROTECTIVE-
CONTROL LOGICAL UNIT USED IN
BATTERY CHARGING DEVICES FOR
HYBRID VEHICLES

(57) An invention relates to the regulation of information parameters of protective-control logical unit incorporated in battery charging devices for hybrid vehicles.

PATENT***

PART A

A 01

- (11) P 2026 7902 B (51) Int. Cl. (2006)
A 01 N 1/02
- (10) AP 2025 16862 A (43) 2025 12 25 №24
(45) 2026 06 10 №11
(21) AP 2024 16862
(22) 2024 03 28
(31) 18/136,419
(32) 2023 04 19
(33) US
(85) 2025 10 31
(86) PCT/US2024/021859, 2024 03 28
(73) Biotech, Inc. (US)
5975 Shiloh Road, Suite 101, Alpharetta,
GA 30005, USA (US)
- (72) PARRA-ALMANZA, Jorge, E. (US)
(74) Shalva Gvaramadze
(54) CRYOPRESERVATION DEVICE WITH
INTEGRATED TRACKING DEVICE
CHAMBER
(57) The present invention provides a cryopreserva-
tion device with an integrated tracking device cham-
ber. The tracking device can be an RFID tag which
can be placed in the cryopreservation device as part
of the procedure for vitrification of a biological
specimen. The cryopreservation device maintains its
integrity and keeps the RFID tag securely in the
chamber at both ambient conditions when the spe-
cimen is collected and under liquid nitrogen where
the specimen is stored. The cryopreservation device
with an integrated tracking device chamber allows
for each individual biological sample to have its own
tracking device for monitoring during cryogenic sto-
rage.

A 61

- (11) P 2026 7901 B (51) Int. Cl. (2006)
A 61 K 31/4184
A 61 K 31/496
A 61 K 31/444
A 61 K 31/439
A 61 K 31/437
A 61 P 3/00
C 07 D 487/04
C 07 D 413/14
C 07 D 405/14
C 07 D 403/14
C 07 D 401/14
C 07 D 487/08

- (10) AP 2023 16333 A (43) 2023 12 11 №23
(45) 2026 06 10 №11
(21) AP 2022 16333
(22) 2022 01 27
(31) 63/143,025; 63/183,612; 63/274,893
(32) 2021 01 28; 2021 05 03; 2021 11 02
(33) US; US; US
(85) 2023 08 25
(86) PCT/US2022/014156, 2022 01 27
(73) Carmot Therapeutics, Inc. (US)
1 DNA Way, South San Francisco, CA 94080,
USA (US)
- (72) DU, Xiaohui (US);
FUCINI, Ray (US)
YEH, Chien-Hung (US);
ZHOU, Xiang (US);
GAO, Rui (US);
JEONG, Joon Won (US);
LIU, Li (US);
SAKYA, Subas Man (US);
WANG, Xiaofang (US);
KAWAI, Hiroyuki (US);
LEE, Craig (US);
LLOYD, David (US);
HANSEN, Stig (US);
ZHANG, Xiu (US)
- (74) Shalva Gvaramadze
(54) GPCR RECEPTOR AGONISTS, PHARMA-
CEUTICAL COMPOSITIONS COMPRI-
SING THE SAME, AND METHODS FOR
THEIR USE
(57) Benzimidazole-piperazine compounds having
GPCR receptor agonist activity. Said compounds are
used for the treatment of metabolic diseases and
disorders, including obesity and type 2 diabetes
mellitus.

- (11) P 2026 7899 B (51) Int. Cl. (2006)
A 61 K 38/00
A 61 K 45/06
A 61 P 27/02
C 07 K 14/71
- (10) AP 2024 16461 A (43) 2024 04 25 №8
(45) 2026 06 10 №11
(21) AP 2022 16461
(22) 2022 07 18
(31) 63/223,265
(32) 2021 07 19
(33) US
(73) Acceleron Pharma Inc. (US)
128 Sidney Street, Cambridge, MA 02139,
USA (US)
- (72) DE OLIVEIRA PENA, Janethe (US)
(74) Tamaz Shilakadze
(85) 2024 02 16

(86) PCT/US2022/037479, 2022 07 18
 (54) ACTRII PROTEINS AND USES THEREOF
 (57) The present disclosure relates to the use of the-
 reapeutically effective amount of ActRIIA fusion pro-
 tein in a method for reducing the risk of telangie-
 ctasia, wherein the treatment provides specific dos-
 ing regimen.

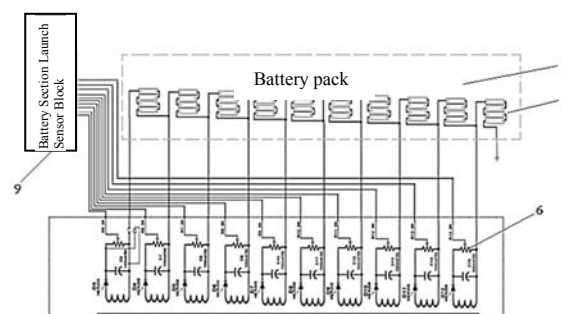

Fig. 4

PART H

H 02

- (11) P 2026 7900 B (51) Int. Cl. (2006)
 H 02 J 7/00
 H 02 M 3/00
- (10) AP 2026 16842 A (43) 2026 06 10 №11
 (45) 2026 06 10 №11
 (21) AP 2025 16842
 (22) 2025 09 21
 (73) Ilo Labadze (GE)
 8th Street, IV Lane 1, Vill. Zeda Sakara, 2000,
 Zestaponi, Georgia (GE);
 Levan Kapanadze (GE)
 University St. 2, 0102, Tbilisi, Georgia (GE)
- (72) Ilo Labadze (GE);
 Levan Kapanadze (GE)
- (54) REGULATOR OF INFORMATION
 PARAMETERS OF A PROTECTIVE-
 CONTROL LOGICAL UNIT USED IN
 BATTERY CHARGING DEVICES FOR
 HYBRID VEHICLES

(57) Interface device for integrating non-original battery pack into hybrid vehicle comprises pulse voltage converter with pulse-width modulation control, voltage transformer (1), primary winding of which is connected to the output of said pulse voltage converter, and galvanically isolated multi-channel DC voltage source implemented as a plurality of secondary windings (2) of transformer. Rectifier circuit (3) together with voltage-smoothing filter is connected to the terminals of each secondary winding. The output of each rectifier circuit is connected to voltage divider implemented as a potentiometer or resistive voltage divider. One output terminal of each rectifier circuit is intended for connection to corresponding section terminal of non-original battery pack, while another output terminal is intended for connection, through voltage divider implemented as a potentiometer or resistive voltage divider, to corresponding input of vehicle's sensor unit.

UTILITY MODEL

APPLICATION***

PART A

A 23

(10) AU 2026 16635 U (51) Int. Cl. (2006)
A 23 L 2/00

(43) 2026 06 10 №11

(21) AU 2024 16635

(22) 2024 11 21

(71) Nanuli Oragvelidze (GE)

Universitatis St. 12, ap. 39, Anaseuli, Ozurgeti,
Georgia (GE)

(72) Nanuli Oragvelidze (GE)

(54) METHOD FOR PRODUCTION OF NON-
ALCOHOLIC BEVERAGE

(57) Utility model relates to food industry and may
be used in the production of non-alcoholic beverages.

Technical result of utility model is the improvement
of organoleptic and tonic characteristics of beverage
and the expansion of beverage assortment.

Plant raw materials are used in fresh or dried form to
produce non-alcoholic beverage. Crushed blueberry
and/or kiwi and/or feijoa leaves and/or fruits, lemon
fruits and/or lemon peel, and/or rosehip fruits, tea
leaves or green or black tea, and stevia leaves are
employed. Liquid phase is obtained by extraction
with water at the temperature of 70-95°C, at water-
to-raw-material ratio of (3-10):1, by double extra-
ction with holding for 25-30 minutes, or by diffusion
extraction, or by boiling in water bath for 15-20
minutes, or in continuous extractor to obtain 5-10%
solution, followed by concentration to dry matter
content of 10-30%. Fruit juice is obtained by pre-
ssing or by using juice extractor. When leaves and
fruits are used jointly in beverage production, the
fruits are blended with the leaves of corresponding
plant and extraction is carried out in diffusion
extractor equipped with stirring device. The ingre-
dients for beverage preparation are used in the
following ratio (wt.%): Blueberry fruits and/or leaves
and/or kiwi fruits and/or leaves and/or feijoa fruits
and/or leaves and/or rosehip fruits 5-10; Lemon juice
and/or lemon peel 0.3-3; Stevia concentrate contain-
ing 10-30% solids, or a mixture of sugar and stevia
concentrate 3-10; Tea extract containing 5-10%
solids, or tea concentrate containing 15-20% solids
5-10; Food-grade acid 0.5-2.5; Natural flavoring
0.05-1.

Proposed beverage possesses pleasant aroma and
taste, effectively quenches thirst, and exhibits tonic
properties. Its consumption does not cause dental
caries or other adverse side effects.

VALIDATION OF EUROPEAN PATENT

EUROPEAN PATENT APPLICATION FOR WHICH THE VALIDATION IS REQUESTED IN GEORGIA

(21) AE 2026 363
(82) 2026 06 10 (51) Int. Cl. (2006)
A 42 B 1/008
A 42 B 1/012
A 42 B 1/0195
A 42 B 1/046
(71) Vandorpe, Dries (BE)
Kasteelstraat 18 bus 0201, 9070 Destelbergen, Belgium (BE)
(72) Vandorpe, Dries (BE)
(54) DISPOSABLE VR COMFORT MASK
(210) 24198030.9
(220) 2024 09 02
(100) EP 4702865 A1
(430) 2026 03 04

(21) AE 2026 364
(82) 2026 06 10 (51) Int. Cl. (2006)
C 22 B 1/00
C 22 B 7/00
C 22 B 7/04
C 22 B 11/00
C 22 B 3/00
(30) GR 20240100035 01.22.2024
(71) Argyropoulos, Sokratis (GR)
K. Kristalli 2, 54630 Thessaloniki, Greece (GR)
(72) Argyropoulos, Sokratis (GR)
(54) HYDROMETALLURGICAL METHOD OF PRODUCTION OF IRON, LEAD AND
SILVER, FROM RESIDUES OF PYROMETALLURGICAL AND HYDROMETAL-
LURGICAL METAL PRODUCTION PROCESSES, USING NEW, ORGANIC AND
INORGANIC, SYNTHETIC AQUEOUS SOLUTIONS
(210) 24386127.5
(220) 2024 11 12
(100) EP 4589032 A1
(430) 2025 07 23

(21) AE 2026 365
(82) 2026 06 10 (51) Int. Cl. (2006)
A 61 K 31/405
A 61 P 25/22
A 61 P 25/24
C 07 B 59/00
C 07 D 403/04
(30) US 202363513158 P 07.12.2023; EP 23185135 07.12.2023
(86) EP2024069911, 2024 07 12
(71) HMNC Holding GmbH (DE)
Wilhelm-Wagenfeld-Straße 20, 80807 München, Germany (DE)
(72) STÜBER, Werner (DE);
ERIKSSON, Hans (DE)

(54) DEUTERATED 1,3 DIHYDRO -2H-INDOLE-2-ONE DERIVATIVES

(210) 24739621.1
 (220) 2024 07 12
 (100) EP 4743176 A1
 (430) 2026 05 20

(21) AE 2026 366

(82) 2026 06 10 (51) Int. Cl. (2006)
 A 61 F 11/20
 A 61 M 31/00

(30) EP 23306222 07.13.2023

(86) EP2024069940, 2024 07 12

(71) Sensorion (FR)

375 rue du Professeur Joseph Blayac, 34080 Montpellier, France (FR)

(72) NEVOUX, Jérôme (FR);

MBANGA, Yacobina-Laura (FR);

LOUNDON, Natalie (FR);

LAHLOU, Ghizlene (FR);

GIESE, Arnaud (FR);

COQUET, Bertrand (FR)

(54) INTRA COCHLEAR ADMINISTRATION DEVICE

(210) 24739626.0

(220) 2024 07 12

(100) EP 4743042 A1

(430) 2026 05 20

(21) AE 2026 367

(82) 2026 06 10 (51) Int. Cl. (2006)
 C 01 B 3/02
 C 01 B 3/38
 C 01 B 3/48
 C 01 B 3/50
 C 01 B 13/02

(30) EP 23185367 07.13.2023

(86) EP2024069385, 2024 07 09

(71) CASALE SA (CH)

Via Giulio Pocobelli 6, 6900 Lugano, Switzerland (CH)

(72) CORBETTA, Michele (IT);

OSTUNI, Raffaele (CH);

FILIPPI, Ermanno (CH)

(54) REFORMING PROCESS WITH POST-TREATMENT OF A HYDROGEN-CONTAINING GAS

(210) 24742888.1

(220) 2024 07 09

(100) EP 4743390 A1

(430) 2026 05 20

(21) AE 2026 368

(82) 2026 06 10 (51) Int. Cl. (2006)
 A 47 J 31/36
 A 47 J 31/44
 A 47 J 31/54

(30) IT 202300014463 07.11.2023

(86) EP2024000040, 2024 07 09

(71) Del Giudice, Biagio (IT)

Via dei Pini, 11, 80040 Terzigno (NA), Italy (IT);

Macripò, Giuliano (IT)
 Via Molin Nuovo, 7b, 33100 Udine (UD), Italy (IT)
 (72) MACRIPÒ Giuliano (IT)
 (54) HOT BEVERAGE PREPARATION MACHINE AND METHOD OF OPERATION
 THEREOF
 (210) 24743263.6
 (220) 2024 07 09
 (100) EP 4742955 A1
 (430) 2026 05 20

(21) AE 2026 369
 (82) 2026 06 10 (51) Int. Cl. (2006)
 A 61 K 48/00
 A 61 K 35/761
 C 07 K 14/005
 C 07 K 14/00
 C 12 N 7/00
 C 12 N 15/86
 (30) GB 202401712 02.08.2024; GB 202319182 12.14.2023; GB 202310617 07.11.2023
 (86) GB2024051792, 2024 07 10
 (71) Theolytics Ltd. (GB)
 The Sherard Building Edmund Halley Road Oxford Science Park Oxford, Oxfordshire
 OX4 4DQ, United Kingdom (GB)
 (72) FISHER, Kerry David (GB);
 DUFFY, Margaret R. (GB);
 TAVERNER, William Keith (GB)
 (54) ADENOVIRUSES
 (210) 24745494.5
 (220) 2024 07 10
 (100) EP 4743478 A1
 (430) 2026 05 20

(21) AE 2026 370
 (82) 2026 06 10 (51) Int. Cl. (2006)
 A 61 K 45/06
 A 61 K 35/761
 A 61 P 35/00
 C 07 K 14/005
 C 12 N 15/86
 C 12 N 7/00
 C 12 N 9/12
 (30) GB 202401729 02.08.2024; GB 202310618 07.11.2023
 (86) GB2024051794, 2024 07 10
 (71) Theolytics Ltd. (GB)
 The Sherard Building Edmund Halley Road Oxford Science Park Oxford, Oxfordshire OX4 4DQ,
 United Kingdom (GB)
 (72) TAVERNER, William Keith (GB);
 FISHER, Kerry David (GB);
 DUFFY, Margaret R. (GB)
 (54) MUTATED ADENOVIRUSES WITH IMPROVED REPLICATION AND THEIR USE
 FOR TREATING CANCER
 (210) 24745496.0
 (220) 2024 07 10
 (100) EP 4743101 A1
 (430) 2026 05 20

(21) AE 2026 371
 (82) 2026 06 10 (51) Int. Cl. (2006)
 A 61 K 48/00
 C 07 K 14/005
 C 07 K 14/00
 C 12 N 7/00
 C 12 N 15/86
 (30) GB 202405058 04.09.2024; GB 202401729 02.08.2024; GB 202401715 02.08.2024;
 GB 202401712 02.08.2024; GB 202401719 02.08.2024; GB 202319693 12.20.2023;
 GB 202319182 12.14.2023; GB 202310618 07.11.2023; GB 202310617 07 11 2023
 (86) GB2024051795, 2024 07 10
 (71) Theolytics Ltd. (GB)
 The Sherard Building Edmund Halley Road Oxford Science Park Oxford, Oxfordshire OX4 4DQ,
 United Kingdom (GB)
 (72) FISHER, Kerry David (GB);
 TAVERNER, William Keith (GB);
 DUFFY, Margaret R. (GB)
 (54) ADENOVIRUSES
 (210) 24745497.8
 (220) 2024 07 10
 (100) EP 4743479 A1
 (430) 2026 05 20

(21) AE 2026 372
 (82) 2026 06 10 (51) Int. Cl. (2006)
 C 07 K 16/28
 (30) US 202463645552 P 05.10.2024; US 202363512718 P 07.10.2023
 (86) US2024037132, 2024 07 09
 (71) Regeneron Pharmaceuticals, Inc. (US)
 777 Old Saw Mill River Road, Tarrytown, NY 10591, USA (US)
 (72) ULLMAN, Erica (US);
 CANOVA-KLEINMAN, Lauren (US);
 KIRSHNER, Jessica R. (US);
 HABER, Lauric (US);
 DADI-MEHMETAJ, Saida (US)
 (54) BISPECIFIC PD-L1XCD28 ANTIBODIES AND METHODS OF USE THEREOF
 (210) 24748208.6
 (220) 2024 07 09
 (100) EP 4743492 A1
 (430) 2026 05 20

(21) AE 2026 373
 (82) 2026 06 10 (51) Int. Cl. (2006)
 A 61 K 39/395
 C 07 K 16/28
 C 07 K 16/30
 (30) US 202463645718 P 05.10.2024; US 202363512719 P 07.10.2023
 (86) US2024037133, 2024 07 09
 (71) Regeneron Pharmaceuticals, Inc. (US)
 777 Old Saw Mill River Road, Tarrytown, NY 10591, USA (US)
 (72) CANOVA-KLEINMAN, Lauren (US);
 ULLMAN, Erica (US);
 KIRSCHNER, Jessica R. (US);
 HABER, Lauric (US);
 DADI-MEHMETAJ, Saida (US)
 (54) BISPECIFIC PD-L1X4-1BB ANTIBODIES AND METHODS OF USE THEREOF
 (210) 24748209.4

(220) 2024 07 09
 (100) EP 4743493 A1
 (430) 2026 05 20

(21) AE 2026 374
 (82) 2026 06 10

(51) Int. Cl. (2006)
 A 61 K 39/395
 A 61 P 21/00
 A 61 P 25/02
 A 61 P 37/00
 C 07 K 16/28

(30) GB 202310890 07.16.2023; US 202463662098 P 06.20.2024; US 202463617702 P 01.04.2024
 (86) IB2024000374, 2024 07 16

(71) argenx BV (BE)
 Industriepark-Zwijnaarde 7, 9052 Gent, Belgium (BE)

(72) TRUYEN, Luc (BE);
 BEAUCHAMP, Jon (BE);
 GUPTILL, Jeffrey (BE);
 JIANG, Ming (BE);
 ISTAS, Geoffrey (BE);
 VAN HOORICK, Benjamin (BE);
 DE PAEPE, Els (BE);
 SEGHERS, Katarina (BE);
 DINCQ, Stephanie (BE);
 PARYS, Wim (BE);
 HOFMAN, Erik (BE);
 BEELKE, Manolo (DE);
 LOWE, Murray (GB)

(54) METHODS FOR TREATING CHRONIC INFLAMMATORY DEMYELINATING POLYNEUROPATHY

(210) 24765204.3
 (220) 2024 07 16
 (100) EP 4743114 A1
 (430) 2026 05 20

(21) AE 2026 375
 (82) 2026 06 10

(51) Int. Cl. (2006)
 G 06 Q 50/06
 H 02 J 3/46
 H 02 J 3/32
 H 02 J 3/38;
 H 02 J 13/00

(30) JP 2023113029 07.10.2023
 (86) JP2024024588, 2024 07 08

(71) Share-ENA Inc. (JP)
 SP873, 5-15-1, Ginza Chuo-ku, Tokyo 104-0061, Japan (JP)

(72) MORITA, Hiroyuki (JP)

(54) POWER MANAGEMENT DEVICE AND POWER MANAGEMENT SYSTEM

(210) 24839710.1
 (220) 2024 07 08
 (100) EP 4746236 A1
 (430) 2026 05 20

(21) AE 2026 376
 (82) 2026 06 10

(51) Int. Cl. (2006)
 B 01 J 20/02
 B 01 J 20/28

B 01 J 20/32
 B 22 F 9/24
 C 10 G 29/02
 C 10 G 25/06
 (30) RS P20240427 04.09.2024; RS P20230532 07.12.2023
 (86) RS2024000010, 2024 07 04
 (71) Electrical Engineering Institute Nikola Tesla Joint Stock Company Belgrade (RS)
 Koste Glavinica 8a, 11040 Belgrade, Serbia (RS)
 (72) JANKOVIC, Jelena (RS);
 LUKIC, Jelena (RS);
 KOLARSKI, Dejan (RS)
 (54) DESULPHURISATION PROCESS
 (210) 24840168.9
 (220) 2024 07 04
 (100) EP 4743549 A1
 (430) 2026 05 20

(21) AE 2026 377
 (82) 2026 06 10 (51) Int. Cl. (2006)
 A 24 F 40/05
 A 24 F 1/30
 A 24 F 40/10
 A 24 F 40/42
 A 61 M 11/00
 A 61 M 15/00
 B 05 B 17/06
 (30) US 202463678870 P 08.02.2024
 (86) GB2025051659, 2025 07 24
 (71) Shaheen Innovations Holding Limited (AE)
 Unit 2, Level 7, Al Sila Tower Abu Dhabi Global Market Square Al Maryah Island, Abu Dhabi,
 United Arab Emirates (AE)
 (72) LOMAS, Peter (AE);
 CHAUDHARYM, Nveed (AE);
 LAMOUREUX, Clement (AE);
 DIVAKARAN, Dinil (AE);
 ALSHAIBA SALEH GHANNAM ALMAZROUEI, Mohammed (AE)
 (54) ATOMISATION MODULE AND LIQUID CONTAINER FOR A HOOKAH
 (210) 25749942.6
 (220) 2025 07 24
 (100) EP 4742929 A1
 (430) 2026 05 20

(21) AE 2026 378
 (82) 2026 06 10 (51) Int. Cl. (2006)
 C 01 B 3/02
 C 01 B 3/32
 C 10 B 57/02
 C 10 J 3/72
 (30) US 202318445321 07.10.2023
 (86) US2024000020, 2024 07 01
 (71) Greyrock Technology LLC (US)
 2020 L Street, Suite 120, Sacramento, CA 95811-4260, USA (US)
 (72) WRIGHT, Benjamin (US);
 SCHUETZLE, Robert (US);
 McGINNIS, Glenn (US)
 (54) PROCESS FOR THE PRODUCTION OF LIQUID FUELS USING BIOMASS GASIFICATION
 INTEGRATED WITH AN ELECTROLYZER

(210) 24840208.3
 (220) 2024 07 01
 (100) EP 4743552 A2
 (430) 2026 05 20

(21) AE 2026 379
 (82) 2026 06 10

(51) Int. Cl. (2006)
 B 01 J 19/08
 B 01 J 37/34
 F 01 M 57/06
 F 02 P 9/00
 H 01 T 13/52
 H 01 T 13/54
 H 01 T 13/50
 H 05 H 1/34
 H 05 H 1/48

(30) US 202318222252 07.14.2023; US 202318222220 07.14.2023; US 202318222176 07.14.2023;
 US 202318222135 07.14.2023; US 202318222103 07.14.2023; US 202318222080 07.14.2023;
 US 202318222053 07.14.2023; US 202318222027 07.14.2023

(86) US2024037957, 2024 07 14

(71) Green Lightning Solutions LLC (US)
 1805 Fortune Drive, Winchester, KY 40391, USA (US)

(72) LEWIS, Joseph, III (US)

(54) APPARATUS, SYSTEM AND METHOD FOR PRODUCING AN IONIZED GAS DISCHARGE FOR
 TREATMENT OF A MEDIUM

(210) 24843790.7
 (220) 2024 07 14
 (100) EP 4744443 A2
 (430) 2026 05 20

(21) AE 2026 380
 (82) 2026 06 10

(51) Int. Cl. (2006)
 E 06 B 9/52

(30) PT 2024119417 04.19.2024

(71) BBG S.A. (PT)
 Zona Industrial de Esposende Rua Dr. Francisco Sá Carneiro 475C, 4740 - 473 Esposende,
 Portugal (PT)

(72) Araújo, Miguel (PT);
 Duarte, Paulo (PT)

(54) PROTECTIVE FRAME FOR LARGE FRAMES

(210) 24175373.0
 (220) 2024 05 13
 (100) EP 4636219 A1
 (430) 2025 10 22

(21) AE 2026 381
 (82) 2026 06 10

(51) Int. Cl. (2006)
 A 61 K 31/454
 A 61 K 31/47
 A 61 K 31/5365
 A 61 K 45/06
 A 61 P 31/04
 A 61 P 31/06

(30) EP 23185975 07.18.2023
 (86) EP2024070206, 2024 07 17

- (71) Janssen Pharmaceutica NV (BE)
Turnhoutseweg 30, 2340 Beerse, Belgium (BE)
- (72) LOUNIS, Nacer (BE);
AGUILAR PÉREZ, Clara (BE);
LAMPRECHT, Dirk Antonie (BE);
PYM, Alexander Stephen (GB)
- (54) COMBINATION PRODUCTS OF AT LEAST THREE ANTIBIOTICS COMPRISING BEDAQUILINE,
PRETOMANID OR DELAMANID, AND A CYTOCHROME BC1 INHIBITOR, AND THEIR USE IN
THE TREATMENT OF MYCOBACTERIAL INFECTIONS
- (210) 24745425.9
(220) 2024 07 17
(100) EP 4746883 A1
(430) 2026 05 27

-
- (21) AE 2026 382
(82) 2026 06 10 (51) Int. Cl. (2006)
 A 61 K 31/519
 A 61 P 25/28
 C 07 D 471/04
 C 07 D 487/04
- (30) EP 24164145 03.18.2024; EP 23185890 07.17.2023
(86) EP2024070237, 2024 07 17
(71) Muna Therapeutics ApS (DK)
 Nordre Fasanvej 215, 2000 Frederiksberg, Denmark (DK)
- (72) BUSCH-PETERSEN, Jakob (DK);
 WHITLOCK, Gavin (GB)
- (54) TREM2 MODULATORS
- (210) 24745433.3
(220) 2024 07 17
(100) EP 4747249 A1
(430) 2026 05 27

-
- (21) AE 2026 383
(82) 2026 06 10
(51) Int. Cl. (2006)
A 61 P 37/06; C 07 K 16/28;
- (30) US 202363607809 P 12.08.2023; US 202363528398 P 07.23.2023
(86) US2024038738, 2024 07 19
(71) Incyte Corporation (US)
 1801 Augustine Cut-Off, Wilmington, DE 19803, USA (US)
- (72) LOU, Shuyuan (US);
 TIAN, Chuan (US);
 YANG, Yan-ou (US)
- (54) METHODS OF TREATING CHRONIC GRAFT-VERSUS-HOST DISEASE USING AN ANTI-COLONY
 STIMULATING FACTOR 1 RECEPTOR ANTIBODY
- (210) 24754486.9
(220) 2024 07 19
(100) EP 4746973 A1
(430) 2026 05 27

-
- (21) AE 2026 384
(82) 2026 06 10 (51) Int. Cl. (2006)
 A 61 P 7/02
 C 07 K 16/36
- (30) US 202363514392 P 07.19.2023
(86) US2024038781, 2024 07 19

(71) Regeneron Pharmaceuticals Inc. (US)
777 Old Saw Mill River Road, Tarrytown, NY 10591, USA (US)

(72) YANCOPOULOS, George, D. (US);
LAI, KehDih (US);
MITNAUL, Lyndon (US);
MORTON, Lori, C. (US);
CHALOTHORN, Dan (US)

(54) ANTI-FACTOR XII/XIIIA ANTIBODIES AND USES THEREOF

(210) 24755113.8
(220) 2024 07 19
(100) EP 4746967 A1
(430) 2026 05 27

(21) AE 2026 385

(82) 2026 06 10 (51) Int. Cl. (2006)
B 28 C 7/00
B 65 D 88/08
B 65 D 88/30
E 04 H 7/22

(30) CH 12202023 11.03.2023

(86) EP2024081045, 2024 11 04

(71) HEID AG (CH)

Hauptstrasse 57, 6045 Meggen, Switzerland (CH)

(72) HEID, Yves (CH)

(54) SILOS AND PLANTS FOR THE PRODUCTION OF CONCRETE

(210) 24801221.3
(220) 2024 11 04
(100) EP 4713182 A1
(430) 2026 03 25

(21) AE 2026 386

(82) 2026 06 10 (51) Int. Cl. (2006)
A 61 K 47/68
A 61 P 35/00
C 07 K 16/28

(30) US 202363514783 P 07.20.2023

(86) US2024038764, 2024 07 19

(71) Exelixis Inc. (US)

1851 Harbor Bay Parkway, Alameda, CA 94502, USA (US)

(72) SAMUEL, Dharmaraj (US);

MENDELSON, Brian, Alan (US);

KANTAK, Seema (US);

GOGAS, Kathleen (US);

BAUZON, Maxine (US)

(54) ACTIVATABLE TYROSINE-PROTEIN KINASE MEMBRANE RECEPTOR (ROR) ANTIBODY- DRUG CONJUGATES AND USES THEREOF

(210) 24844022.4
(220) 2024 07 19
(100) EP 4747282 A1
(430) 2026 05 27

(21) AE 2026 387

(82) 2026 06 10 (51) Int. Cl. (2006)
A 61 K 47/68
A 61 P 35/00
C 07 K 16/28

(30) US 202363514782 P 07.20.2023
 (86) US2024038788, 2024 07 19
 (71) Exelixis Inc. (US)
 1851 Harbor Bay Parkway, Alameda, CA 94502, USA (US)
 (72) DU, Fangyong (US);
 XU, Jiangchun (US);
 LUO, Peter, Peizhi (US);
 LI, Yan (US);
 KANTAK, Seema (US);
 HIGAKI, Jeffrey, N. (US);
 GOGAS, Kathleen (US)
 (54) ACTIVATABLE ROR BINDING AGENTS AND USES THEREOF
 (210) 24844027.3
 (220) 2024 07 19
 (100) EP 4747284 A1
 (430) 2026 05 27

(21) AE 2026 388
 (82) 2026 06 10 (51) Int. Cl. (2006)
 C 05 D 1/00
 C 05 D 3/00
 C 05 D 5/00
 C 05 D 9/02
 C 05 F 9/04
 C 05 F 11/00
 C 05 F 11/02
 C 05 G 5/35

(30) PL 45033624 11.22.2024
 (71) EVERGREEN SOLUTIONS SPOLKA Z OGRANICZONA ODPOWIEDZIALNOSCIA (PL)
 ul. W. B. Glowackiego 10, 74-200 Pырzyce, Poland (PL)
 (72) Zakrzewski, Janusz (PL)
 (54) A FERTILIZER COMPRISING BIOMASS AND A METHOD OF ITS MANUFACTURING
 (210) 25196515.8
 (220) 2025 08 18
 (100) EP 4748816 A1
 (430) 2026 05 27

(21) AE 2026 389
 (82) 2026 06 10 (51) Int. Cl. (2006)
 B 25 B 11/00
 (30) CN 202511639157 11.10.2025; CN 202422836043 U 11.20.2024; CN 202422837405 U 11.20.2024;
 CN 202411661508 11.20.2024
 (71) Zhejiang Shijing Tools Co., Ltd (CN)
 №1, Weiwu West Road Tongqin Hardware Machinery Industrial Park Tongqin Town Wuyi County,
 Jinhua, Zhejiang 321200, People's Republic of China (CN)
 (72) XU, Shuaijie (CN);
 XU, Min (CN)
 (54) VACUUM SUCTION CUP BASED ON SNAP-ON TYPE GASKET STRUCTURE
 (210) 25216626.9
 (220) 2025 11 18
 (100) EP 4748531 A1
 (430) 2026 05 27

(21) AE 2026 390
(82) 2026 06 10 (51) Int. Cl. (2006)
B 65 D 43/02
(30) IT 202400025725 11.14.2024; IT 202400018448 08.06.2024
(86) IB2025055694, 2025 06 03
(71) Tontarelli, Sergio (IT)
Via Verdi 123, 60022 Castelfidardo (AN), Italy (IT)
(72) Tontarelli, Sergio (IT)
(54) STORAGE UNIT COMPRISING A BOX AND A LID PROVIDED WITH INNOVATIVE MEANS
FOR COUPLING TO SAID BOX
(210) 25730389.1
(220) 2025 06 03
(100) EP 4747167 A1
(430) 2026 05 27

(21) AE 2026 391
(82) 2026 06 10 (51) Int. Cl. (2006)
A 61 K 31/519
A 61 K 31/495
A 61 P 43/00
C 07 D 487/04
C 07 D 221/20
C 07 D 487/10
C 07 D 241/02
(30) US 202363515017 P 07.21.2023
(86) US2024038888, 2024 07 19
(71) Tenvie Therapeutics, Inc. (US)
1400 Sierra Point Parkway, Suite 300, Brisbane, CA 94005, USA (US)
(72) WIDEN, John C. (US);
OSIPOV, Maksim (US);
LEXA, Katrina W. (US);
HUFFMAN, Benjamin J. (US);
FOX, Brian M. (US);
ESTRADA, Anthony A. (US);
DE VICENTE FIDALGO, Javier (US);
BUCHER, Cyril (US);
BAGDASARIAN, Alex L. (US)
(54) COMPOUNDS, COMPOSITIONS, AND METHODS
(210) 24846301.0
(220) 2024 07 19
(100) EP 4747258 A2
(430) 2026 05 27

DESIGN

REGISTERED DESIGN

(11) D 2026 1120 S (51) 09-01
(10) AD 2026 1475 S (44) 2026 02 25 №4
(21) AD 2025 1475
(22) 2025 10 16
(24) 2025 10 16
(28) 1
(18) 2030 10 16
(73) LLC "Duty Free International" (GE)
Besiki St. 4, nearby (plot 46/10), 3rd floor, office 311-312, 0108, Mtatsminda District, Tbilisi, Georgia
(72) Faruk Yilmaz (GE)
(74) Levan Nikoladze (GE)
(54) GLASS BOTTLE

(11) D 2026 1119 S (51) 11-01
(10) AD 2026 1469 S (44) 2026 02 25 №4
(21) AD 2025 1469
(22) 2025 09 03
(24) 2025 09 03
(28) 1
(18) 2030 09 03
(73) Vasil Maruashvili (GE)
Petre Kavtaradze St., III Lane 3, 0186, Tbilisi, Georgia (GE)
(72) Vasil Maruashvili (GE)
(54) RING

DESIGN, WHICH HAS BEEN REGISTERED WITH THE INTERNATIONAL BUREAU CLAIMING PRIORITY ON THE TERRITORY OF GEORGIA

The decision can be appealed at the Chamber of Appeal of Sakpatenti within 3 months from the publication or at the Mtskheta District Court Administrative Cases Board (Address: №17, Samkhedro St., Mtskheta), within 1 month following the publication.

- (11) DM/250 322 (51) 10-02
 (15) 2025 09 23 (44) 13/2026 (2026 03 27)
 (22) 2025 09 23
 (28) 5
 (73) Omega SA (Omega AG) (Omega LTD.)
 Jakob-Stämpfli-Strasse 96, 2502 Biel/Bienne (CH)
 (85) CH
 (86) CH
 (87) CH
 (88) CH
 (89) CH
 (81) III. AL, AM, AZ, BA, BZ, CA, CH, EM, GB, GE, IL, KH, KR, LI, MA, MC, MD, ME, MK, MN, NO, OM, SG, TN, TR, UA
 (72) Valère Despond
 C/o OMEGA SA (OMEGA AG) (OMEGA LTD.), Jakob-Stämpfli-Strasse 96, 2502, Biel/Bienne (CH)
 (74) The Swatch Group AG (The Swatch Group SA) (The Swatch Group Ltd.)
 6, Faubourg Du Lac, 2501 BIEL/BIENNE (CH)
 (46) 2026 03 27
 (54) 1. WATCH, 2. WATCH CASING, 3. WATCH DIAL, 4. WATCH BRACELET, 5. WATCH BRACELET
 (55)

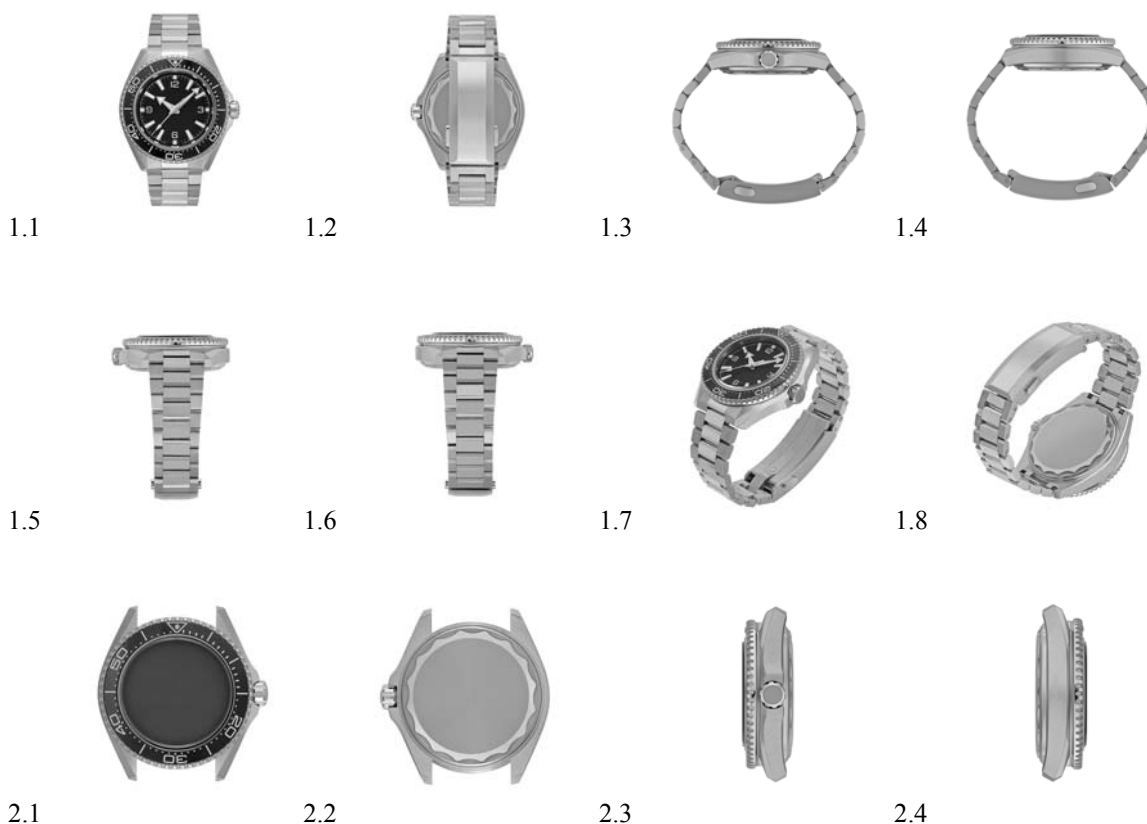



2.5



2.6



2.7



2.8



3.1



3.2



3.3



3.4



3.5



3.6



3.7



3.8



4.1



4.2



4.3



4.4



4.5

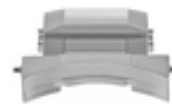

4.6

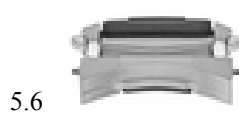
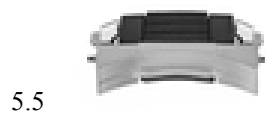

- (11) DM/250 924 (51) 10-02
 (15) 2025 09 26 (44) 13/2026 (2026 03 27)
 (22) 2025 09 26
 (28) 6
 (73) Montres Breguet SA (Montres Breguet AG) (Montres Breguet Ltd)
 Place De La Tour 23, 1344 L'Abbaye (CH)
 (85) CH
 (86) CH
 (87) CH
 (88) CH
 (89) CH
 (81) III. AL, AM, AZ, BA, BZ, CA, CH, EM, GB, GE, KG, LI, MA, MC, MD, ME, MK, MN, NO, OM, SG, TN, TR, UA
 (72) Lubna Driouech
 Alfred Lugin 2, 1341, L'Orient (CH);
 Grégory Kissling
 Place De La Tour 23, 1344, L'Abbaye (CH)
 (74) The Swatch Group SA (The Swatch Group AG) (The Swatch Group Ltd.)
 Faubourg Du Lac 6, 2501 Biel / Bienne (CH)
 (46) 2026 03 27
 (54) 1. WATCH, 2. WATCH BRACELET, 3. WATCH, 4. WATCH BRACELET, 5. WATCH, 6. WATCH BRACELET
 (55)

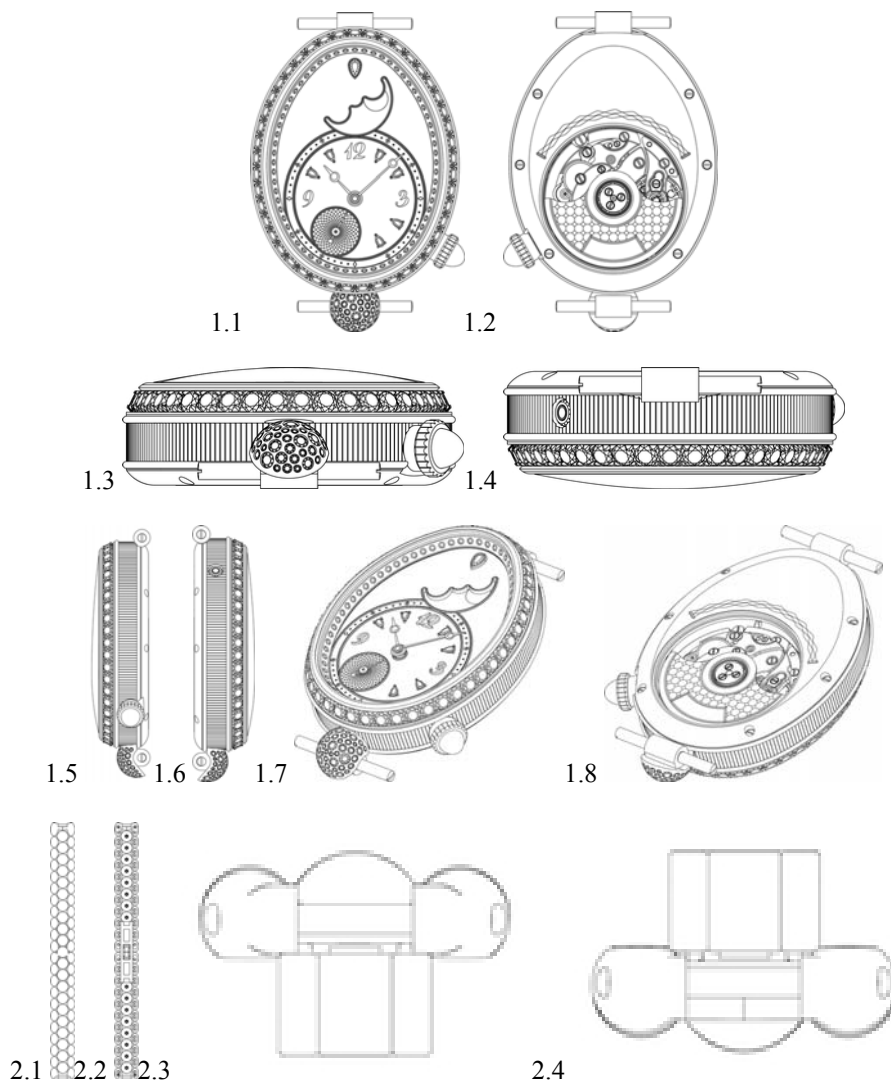

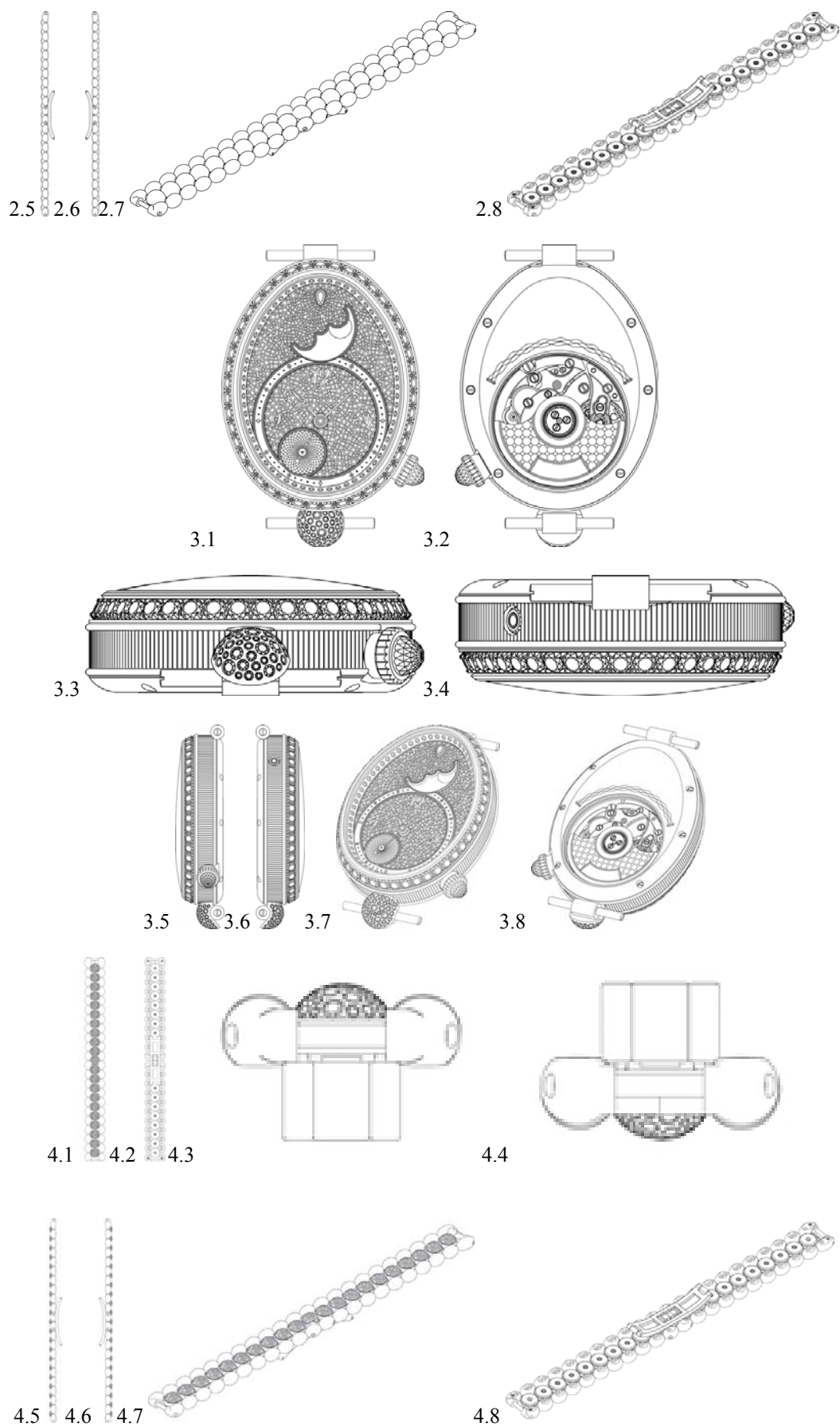

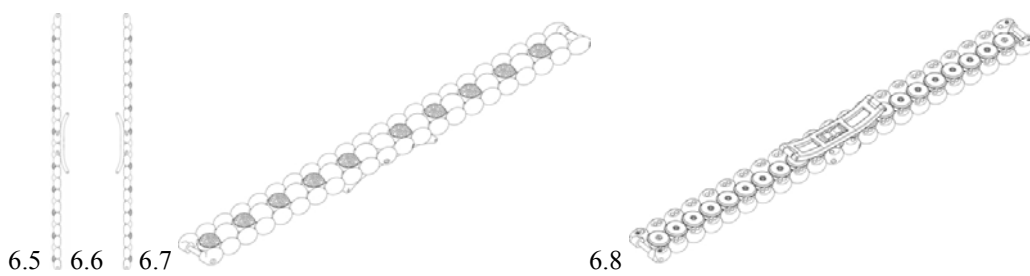
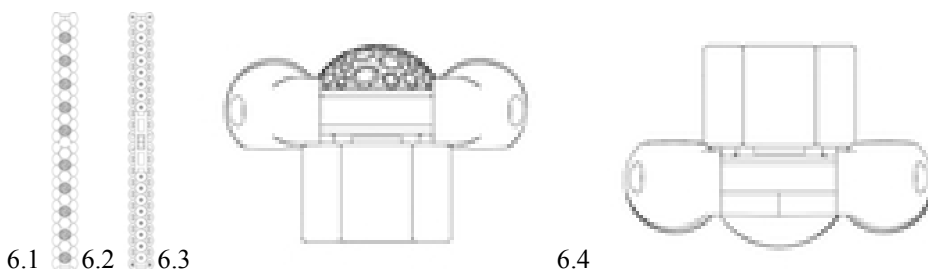
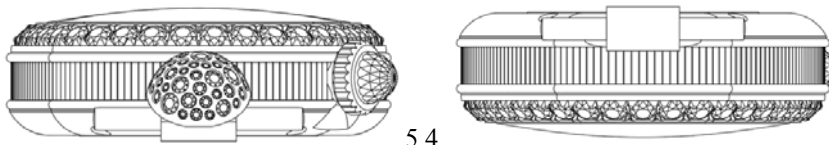
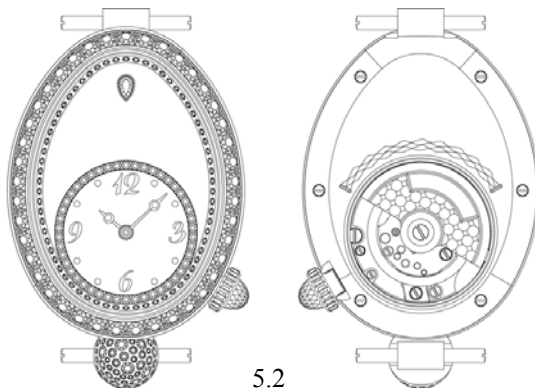

- (11) DM/250 497 (51) 11-01
 (15) 2025 09 24 (44) 13/2026 (2026 03 27)
 (22) 2025 09 24
 (28) 6
 (73) Harry Winston SA
 Chemin Du Tourbillon 8, 1228 Plan-les-Ouates (CH)
 (85) CH
 (86) CH
 (87) CH
 (88) CH
 (89) CH
 (81) III. AL, AM, AZ, BA, BZ, CA, CH, EM, GB, GE, IL, KG, KH, KR, LI, MA, MC, MD, ME, MK, MN, NO,
 OM, SG, TN, TR, UA
 (72) 1-2 Tobias WUEST
 C/o Harry Winston Inc. 718 Fifth Avenue, 10019, New York (US);
 3-6 Rie YATSUGI-KANG
 C/o Harry Winston Inc. 718 Fifth Avenue, 10019, New York (US)
 (74) The Swatch Group AG (The Swatch Group SA) (The Swatch Group Ltd.)
 Faubourg Du Lac 6, 2501 Biel/Bienne (CH)
 (46) 2026 03 27
 (54) 1. FINGER RING, 2. FINGER RING, 3. FINGER RING, 4. NECKLACE WITH PENDANT,
 5. NECKLACE, 6. PAIR OF EARRINGS
 (55)

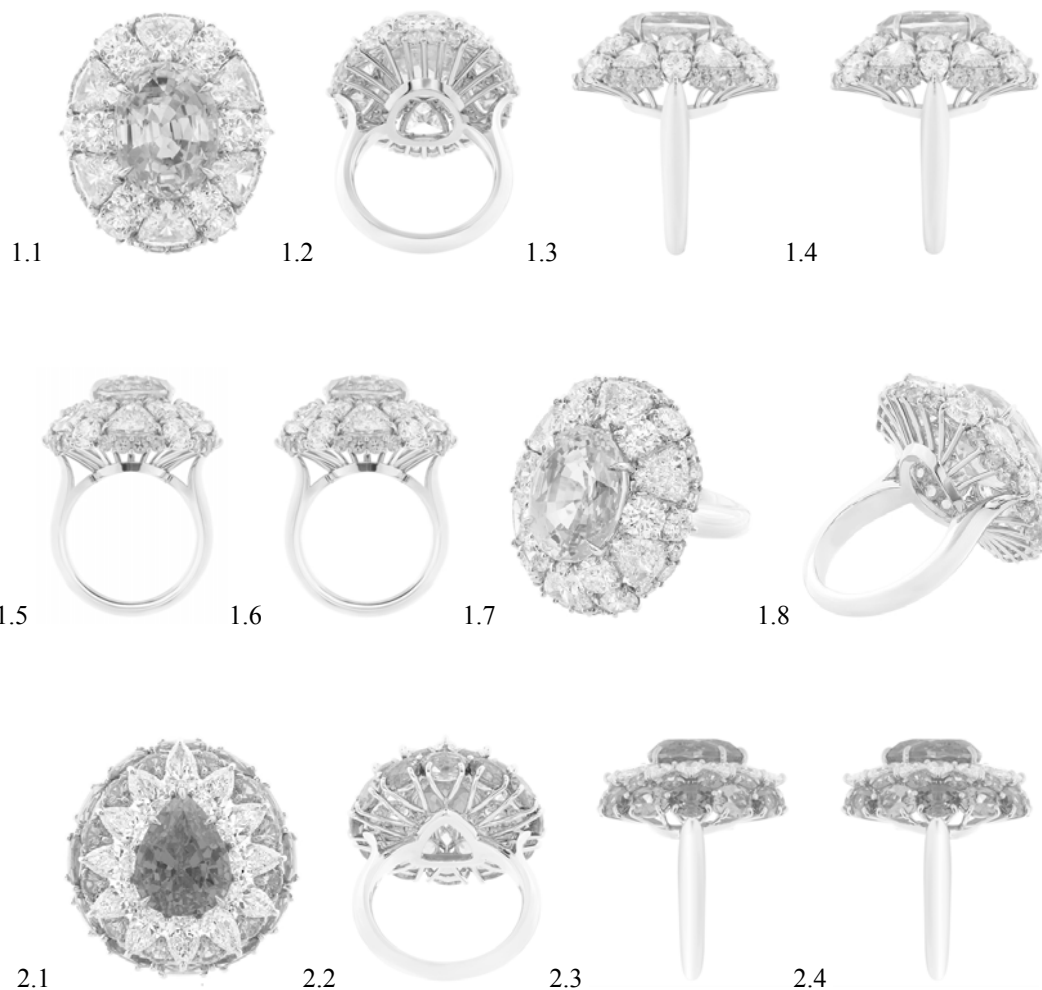

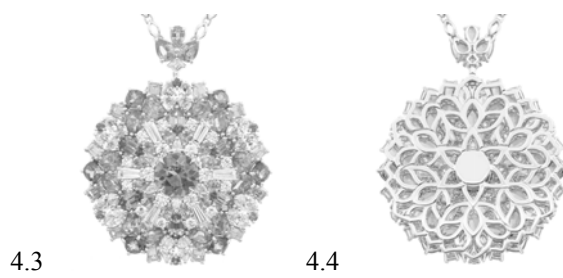
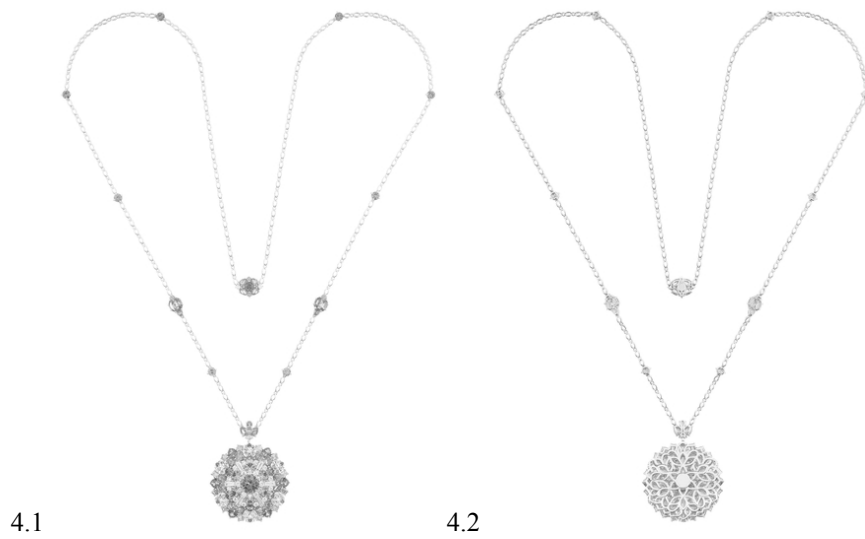





5.4



5.5



5.6



5.7



5.8



6.1



6.2



6.3



6.4



6.5



6.6



6.7



6.8



- (11) DM/255 570 (51) 20-99
 (15) 2026 02 13 (44) 15/2026 (2026 04 10)
 (22) 2026 02 13
 (28) 2
 (30) №1: 03.02.2026; D-2026/0011; RS; №2: 03.02.2026; D-2026/0011; RS
 (73) EXPO 2027 D.O.O. BEOGRAD
 Kralja Milana 5, 11000 Belgrade (RS)
 (85) RS
 (86) RS
 (87) RS
 (88) RS
 (89) RS
 (81) III. AL, AM, AZ, BA, BG, BN, BR, BW, BX, BY, BZ, CA, CH, CN, DE, DK, EE, EG, EM, ES, FI, FR, GB, GE, GH, GR, HR, HU, IL, IS, IT, JM, JP, KG, KH, KN, KP, KR, LI, LT, LV, MA, MC, MD, ME, MK, MN, MU, MX, NA, NO, OA, OM, PL, RO, RU, RW, SA, SG, SI, SM, SR, ST, SY, TJ, TM, TN, TR, UA, US, UZ, VN, WS
 (72) Stanislav Drča
 Jevrejska 26, 21000, Novi Sad, RS; Dorijan Kolundžija, Dalmatinska 27, 11000, Belgrade (RS)
 (54) 1. MASCOT, 2. MASCOT
 (55)

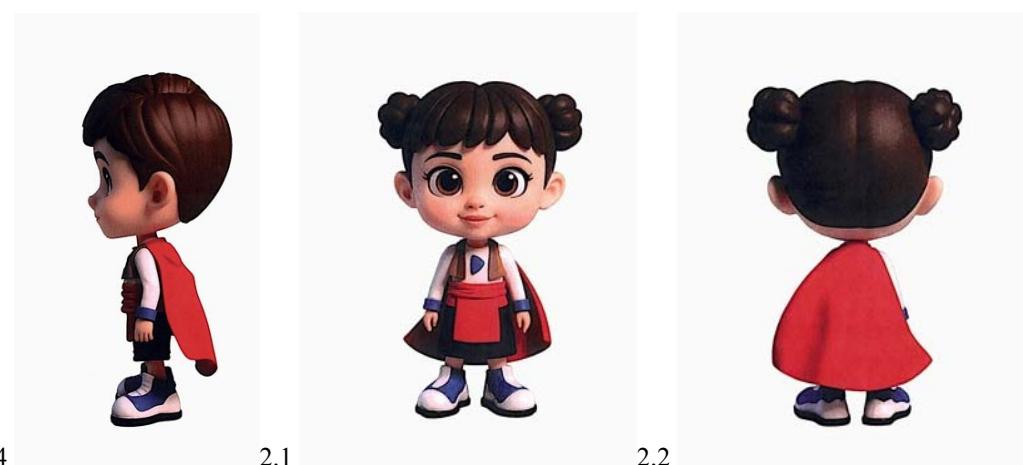



2.3



2.4

TRADEMARK

APPLICATION FILED UNDER THE NATIONAL PROCEDURE APPROVED FOR REGISTRATION

The decision can be appealed at the Chamber of Appeal of Sakpatenti within 3 months from the publication or at the Mtskheta District Court Administrative Cases Board (Address: №17, Samkhedro St., Mtskheta), within 1 month following the publication.

(260) AM 2026 135708 A

(210) AM 135708

(220) 2025 09 26

(310) 86502238

(320) 2025 07 15

(330) CH

(731) BYD Company Limited

№1, Yan'an Road, Kuichong Street, Dapeng
New District, Shenzhen, People's Republic
of China

(740) Giorgi Kartvelishvili

(540)

B3

(591) Black-white

(511) 12

(260) AM 2026 135731 A

(210) AM 135731

(220) 2025 09 29

(731) LLC "Football Club Meshakhte"

Takaishvili St. 3, Tkibuli, Georgia

(540)



(591) Black, green, yellow, white

(531) 14.07.03; 24.01.03; 24.01.05; 24.01.12;
24.01.13; 24.01.15; 24.01.25; 27.05.01;
29.01.13

(511) 35, 41

(260) AM 2026 135761 A

(210) AM 135761

(220) 2025 10 02

(731) LLC "Football Club Wit Georgia"

Al. Kazbegi Av. 24g, Non-residential
Area A8-1, Vake District, Tbilisi, Georgia

(540)



(591) Green, white

(531) 26.01.02; 26.01.03; 26.01.04; 26.01.21;
27.05.01; 27.05.04; 27.05.07; 27.05.09;
27.05.17; 27.05.19; 29.01.12

(526) GEORGIA

(511) 41

(260) AM 2026 135763 A

(210) AM 135763

(220) 2025 10 02

(731) LLC "Football Club Gardabani"

Village Dighomi, Vepkhistaosani St. 86,
ap. 28, Saburtalo District, Tbilisi, Georgia

(540)



(591) Blue, sky-blue, white, black

(531) 01.01.03; 03.01.01; 03.01.02; 07.05.25;
26.01.02; 26.01.04; 26.01.12; 26.01.15;
26.01.16; 26.01.18; 26.01.21; 27.05.01;
29.01.13

(526) GARDABANI

(511) 41

(260) AM 2026 135801 A

(210) AM 135801

(220) 2025 10 03

(731) LLC "Football Club Tbilisi Lokomotiv"

Ilia Chavchavadze Av. 74, Vake District,
Tbilisi, Georgia

(540)



(591) White, blue, yellow, red
 (531) 21.03.01; 24.01.03; 24.01.05; 24.01.17;
 27.05.01; 29.01.13
 (526) TBILISI
 (511) 35, 41

(260) AM 2026 135928 A
 (210) AM 135928
 (220) 2025 10 15
 (731) Ameed Food Industries W.L.L.
 P.O. Box 1557 Amman 11953, Jordan
 (740) Merab Kvimsadze
 (540)

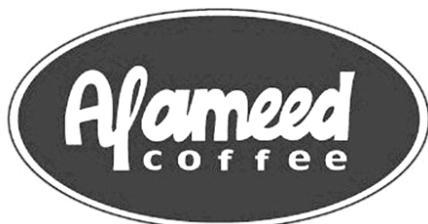

(591) Black-white
 (531) 26.01.02; 26.01.20; 26.01.24; 27.05.01;
 27.05.10; 27.05.24; 28.19; 29.01.12
 (511) 35, 43

(260) AM 2026 136064 A
 (210) AM 136064
 (220) 2025 10 23
 (731) Aram Mnatsakanov
 3-4093879-4, Berlin, Germany
 (540)

BOTEGA LOUI
 TRATTORIA-TBILISI

(591) Beige, light brown, dark brown
 (526) TBILISI
 (511) 28, 43

(260) AM 2026 136132 A
 (210) AM 136132
 (220) 2025 10 27
 (731) ROHTO Pharmaceutical Co., Ltd.

8-1, Tatsuminishi 1 Chome, Ikuno-ku,
 Osaka-shi, Osaka 544-8666, Japan

(740) Irakli Gvilia
 (540)

DRY AID

(591) Black-white
 (531) 27.05.01
 (511) 5

(260) AM 2026 136137 A
 (210) AM 136137
 (220) 2025 10 27
 (731) LLC "GIG Energy"
 Pekin Av. 34 / Al. Kazbegi Av. 2a, 0160,
 Tbilisi, Georgia
 (540)



(591) F90B0B ruby red
 (531) 01.15.05; 26.11.13; 26.15.25; 29.01.01;
 29.01.11
 (511) 35, 36, 37, 38, 39, 40, 41, 42, 43, 44, 45

(260) AM 2026 136138 A
 (210) AM 136138
 (220) 2025 10 28
 (731) LLC "GIG Energy"
 Pekin Av. 34 / Al. Kazbegi Av. 2a, 0160,
 Tbilisi, Georgia
 (540)

პოტენციალი მოქმედებაში
Potential in Action

(591) Black-white
 (511) 35, 36, 37, 38, 39, 40, 41, 42, 43, 44, 45

(260) AM 2026 136151 A
 (210) AM 136151
 (220) 2025 10 29
 (731) "Luding-Trade" Limited Liability Company
 Ryabinovaya St. 55, Stroenie 2, Pomeshe-
 nie 4-1, Floor/Room 1/3, Municipal District
 Ochakovo-Matveevskoe Vn.Ter.G., 121471,
 Moscow, Russian Federation
 (740) Giorgi Taktakishvili

(540)

ZAGORAMI(591) Black-white
(511) 33, 35

(260) AM 2026 136152 A

(210) AM 136152

(220) 2025 10 29

(731) FCA US LLC

1000 Chrysler Drive, City of Auburn Hills,
State of Michigan 48326, USA

(740) Giorgi Taktakishvili

(540)

LAREDO(591) Black-white
(511) 12

(260) AM 2026 136153 A

(210) AM 136153

(220) 2025 10 30

(731) Sichuan Yibin Wuliangye Group Co., Ltd
№150, Minjiang West Road, Yibin, Sichuan,
People's Republic Of China

(740) Giorgi Giorgi Kartvelishvili

(540)

JIAN ZHUANG(591) Black-white
(511) 33

(260) AM 2026 136158 A

(210) AM 136158

(220) 2025 10 30

(731) LLC "Aversi-Pharma"

Davit Aghmashenebeli Av. 148, 0112,
Tbilisi, Georgia

(540)

ლერონი**Лерон****Leron**(591) Black-white
(511) 5

(260) AM 2026 136159 A

(210) AM 136159

(220) 2025 10 30

(731) LLC "Aversi-Pharma"

Davit Aghmashenebeli Av. 148, 0112,
Tbilisi, Georgia

(540)

ლემუდორი**Лемудор****Lemudor**(591) Black-white
(511) 5

(260) AM 2026 136160 A

(210) AM 136160

(220) 2025 10 30

(731) Mikheil Papukashvili

Kartli St. 13, Tbilisi, Georgia

(540)



(591) Red, yellow and brown

(531) 26.04.02; 26.04.05; 26.04.18; 26.04.22;
29.01.13

(511) 43

(260) AM 2026 136161 A

(210) AM 136161

(220) 2025 10 30

(731) LLC "Aversi-Pharma"

Davit Aghmashenebeli Av. 148, 0112,
Tbilisi, Georgia

(540)

კვადიმაქსი**Квадимакс****Quadimax**(591) Black-white
(511) 5

(260) AM 2026 136252 A

(210) AM 136252

(220) 2025 11 02

(731) LLC "Gamarjoba Group"

Vazha-Pshavela Av. 13, ap. 28, 0160,
Saburtalo District, Tbilisi, Georgia

(540)



(591) 466984 blue, FEFCFF white
 (531) 09.01.13; 26.04.02; 26.04.04; 26.04.07;
 26.04.22; 26.11.01; 26.11.06; 26.11.12;
 26.11.25; 27.05.01; 27.05.17
 (511) 9, 45

(260) AM 2026 136253 A
 (210) AM 136253
 (220) 2025 11 03
 (731) Yıldız Holding Anonim Şirketi
 Kısıklı Mahallesi Çeşme Çıkmağı,
 Sokak № 6/1, Üsküdar İstanbul, Türkiye
 (740) Tamaz Shilakadze
 (540)



(591) Red, green, brown
 (531) 01.01.02; 27.05.01; 27.05.08; 27.05.10;
 27.05.17; 29.01.13
 (511) 30

(260) AM 2026 136261 A
 (210) AM 136261
 (220) 2025 11 03
 (731) LLC "ტიფლისიდისტილერი Tiflisidistillery"
 Nino Zjvania St. 10, ent. 2, fl. 11, ap. 31,
 Tbilisi, Georgia
 (740) Khatuna Imnadze
 (540)

შემოგევლე
Shemogevle
 Шемогевле

(591) Black-white
 (511) 33

(260) AM 2026 136271 A
 (210) AM 136271
 (220) 2025 11 04
 (731) LLC "Epic Development"
 Tskneti Highway 65, Office Space 2,
 0192, Tbilisi, Georgia
 (540)



(591) 9E1111 cornelian-red, red, white
 (531) 07.01.24; 07.01.25; 07.03.02; 07.03.11;
 27.05.01; 27.05.10; 29.01.13
 (511) 37

(260) AM 2026 136274 A
 (210) AM 136274
 (220) 2025 11 04
 (731) BTGT Group Holdings Limited
 Craigmuir Chambers, Road Town, Tortola,
 VG 1110, Virgin Islands (British)
 (740) Giorgi Giorgi Kartvelishvili
 (540)



(591) Black-white
 (531) 26.03.23; 26.11.02; 26.11.06; 26.11.11;
 27.05.01; 27.05.17
 (511) 9, 42

(260) AM 2026 136279 A
 (210) AM 136279
 (220) 2025 11 05
 (731) LLC "Silk Road Business Center"
 Shota Rustaveli Av. 31, 0108, Mtatsminda
 District, Tbilisi, Georgia
 (540)



(591) Black-white
 (531) 27.05.10; 27.05.17
 (511) 43

(260) AM 2026 136280 A
 (210) AM 136280
 (220) 2025 11 05
 (731) LLC "Silk Road Business Center"
 Shota Rustaveli Av. 31, 0108, Mtatsminda
 District, Tbilisi, Georgia
 (540)



(591) Black-white
 (531) 27.05.01; 27.05.10
 (511) 43

(260) AM 2026 136281 A
 (210) AM 136281
 (220) 2025 11 05
 (731) LLC "Silk Road Business Center"
 Shota Rustaveli Av. 31, 0108, Mtatsminda
 District, Tbilisi, Georgia
 (540)

BELL & GRAY
 TELEGRAPH

(591) Black-white
 (531) 24.17.25; 27.05.01; 27.05.08; 27.05.10;
 27.05.17
 (511) 43

(260) AM 2026 136282 A
 (210) AM 136282
 (220) 2025 11 05
 (731) LLC "Silk Road Business Center"
 Shota Rustaveli Av. 31, 0108, Mtatsminda
 District, Tbilisi, Georgia
 (540)

LAAN THAI
 TELEGRAPH

(591) Black-white
 (531) 27.05.01; 27.05.10; 27.05.17
 (511) 43

(260) AM 2026 136284 A
 (210) AM 136284
 (220) 2025 11 06
 (731) LLC "Silk Road Business Center"
 Shota Rustaveli Av. 31, 0108, Mtatsminda
 District, Tbilisi, Georgia
 (540)

WELLNESS STUDIO
 TELEGRAPH

(591) Black-white
 (531) 27.05.01; 27.05.10
 (511) 44

(260) AM 2026 136285 A
 (210) AM 136285
 (220) 2025 11 06
 (731) ShenZhen Lingyi Innovation Technology
 Co., Ltd
 12 F, Block C, Central Avenue Building,
 Xixiang BLVD West, Baoan District,
 Shenzhen, Guangdong, People's Republic of
 China
 (740) Shalva Gvaramadze

(540)

PITAKA

(591) Black-white
 (511) 9

(260) AM 2026 136293 A
 (210) AM 136293
 (220) 2025 11 06
 (731) CFL Flooring (China) Co., Ltd.
 №111 Changjiang Rd., Jiashan Development
 Area, 314100 Jiaxing, People's Republic
 of China
 (740) Merab Kvimsadze
 (540)

Lamett

(591) Black-white
 (531) 27.05.01
 (511) 20

(260) AM 2026 136353 A
 (210) AM 136353
 (220) 2025 11 07
 (731) Harvey Nichols and Company Limited
 Harvey Nichols Harriet Walk, Knightsbridge,
 SW1X 7RJ, London, England, United Kingdom
 (740) Vasil Bibilashvili
 (540)

BEYOND BEAUTY

(591) Black
 (511) 44

(260) AM 2026 136355 A
 (210) AM 136355
 (220) 2025 11 10
 (731) The Lebanese Company For Cigarette
 Paper Sobhi Shourbaji and Partners SARL
 Ghandour Galleria – Avenue des Francais –
 Beirut, Lebanon
 (740) Merab Kvimsadze
 (540)



(591) Light blue, dark blue, golden, orange
 (531) 05.05.16; 25.01.01; 25.01.19; 25.07.20;
 25.07.25; 25.12.25; 26.04.02; 26.04.09;
 26.04.12; 26.04.16; 26.04.22; 28.01; 29.01.14
 (511) 34

(260) AM 2026 136360 A
 (210) AM 136360
 (220) 2025 11 10
 (731) LLC "Camex International"
 Tskneti Village, Iliko Sukhishvili St. 11,
 ap. 3, 0190, Tbilisi, Georgia
 (540)



(591) Blue, red, white
 (531) 06.01.04; 26.11.02; 26.11.13; 27.05.11;
 27.05.17; 29.01.01; 29.01.04; 29.01.12
 (511) 32

(260) AM 2026 136361 A
 (210) AM 136361
 (220) 2025 11 10
 (731) Magnum IP Holdings B.V.
 Reguliersdwarstraat 63, Amsterdam 1017BK,
 Netherlands
 (740) Giorgi Taktakishvili
 (540)



(591) Cream, brown
 (531) 08.01.18; 25.03.01; 25.03.25; 27.03.15;
 27.05.01; 27.05.02; 27.05.08; 27.05.09;
 27.05.17; 29.01.12
 (511) 30

(260) AM 2026 136365 A
 (210) AM 136365
 (220) 2025 11 11
 (731) Magnum IP Holdings B.V.
 Reguliersdwarstraat 63, Amsterdam 1017BK,
 Netherlands
 (740) Giorgi Taktakishvili
 (540)



(591) Sky-blue

(531) 01.15.07; 01.15.15; 27.05.01; 27.05.02;
 27.05.04; 27.05.07; 27.05.08; 27.05.17;
 27.05.25; 29.01.04; 29.01.11
 (511) 30

(260) AM 2026 136374 A
 (210) AM 136374
 (220) 2025 11 13
 (731) Inpha LLP Representative Office in Georgia
 Near Besiki St. 4, Plot 46/10, 0108,
 Tbilisi, Georgia
 (540)

Ezevastin
ЭЗЕВАСТИН
ეზევასტინი

(591) Black-white
 (511) 5

(260) AM 2026 136441 A
 (210) AM 136441
 (220) 2025 11 14
 (731) LLC "Silk Road Business Center"
 Shota Rustaveli Av. 31, 0108, Mtatsminda
 District, Tbilisi, Georgia
 (540)

Telegraph

(591) Black-white
 (531) 26.11.14; 26.11.25; 27.05.01; 27.05.17
 (511) 43, 44

(260) AM 2026 136444 A
 (210) AM 136444
 (220) 2025 11 14
 (731) LLC "Dougladze Wine Company"
 Orkhevi, Tengiz Chantladze ST., Lane 8, 0109,
 Tbilisi, Georgia
 (540)



(591) Dark green, white, black, red
 (531) 05.03.13; 05.03.14; 26.04.02; 26.04.08;
 27.05.01
 (511) 33

(260) AM 2026 136451 A
 (210) AM 136451
 (220) 2025 11 14
 (731) Paving The Way PTE. LTD
 160 Robinson Road, N14-04, Singapore,
 068914, Singapore
 (740) Ketevan Rukhadze
 (540)



(591) FFFFFFF white, 000000 black, 2FB560 green
 (531) 26.04.02; 26.04.05; 26.04.26; 27.05.01;
 27.05.09; 29.01.12
 (511) 9, 35, 36, 42

(260) AM 2026 136452 A
 (210) AM 136452
 (220) 2025 11 14
 (731) Paving The Way PTE. LTD
 160 Robinson Road, N14-04, Singapore,
 068914, Singapore
 (740) Ketevan Rukhadze
 (540)



(591) 000000 black, FFFFFFF white
 (531) 26.15.09; 27.05.01
 (511) 9, 35, 36, 42

(260) AM 2026 136453 A
 (210) AM 136453
 (220) 2025 11 14
 (731) Paving The Way PTE. LTD
 160 Robinson Road, N14-04, Singapore,
 068914, Singapore
 (740) Ketevan Rukhadze
 (540)



(591) FFFFFFF white, 4C4848 grey
 (531) 26.04.02; 26.04.05; 26.04.12; 26.04.22;
 26.04.24; 26.15.09; 27.05.01; 27.05.24
 (511) 9, 35, 36, 42

(260) AM 2026 136485 A
 (210) AM 136485
 (220) 2025 11 20
 (731) LLC "Impuls"
 Leningradskoe Shosse, ap. 16a, bld. 1,
 125171, Moscow, Russian Federation

(740) Ketevan Rukhadze
 (540)

OPTICELL

(591) 000000 black, FFFFFFF white
 (531) 27.05.01; 27.05.17
 (511) 9

(260) AM 2026 136486 A
 (210) AM 136486
 (220) 2025 11 20
 (731) LLC "Impuls"
 Leningradskoe Shosse, ap. 16a, bld. 1,
 125171, Moscow, Russian Federation
 (740) Ketevan Rukhadze
 (540)

ОПТИСЕЛЛ

(591) FFFFFFF white, 000000 black
 (531) 28.05
 (511) 9

REGISTERED TRADEMARK

(111) M 2026 41293 R
(151) 2026 05 21
(181) 2036 05 21
(260) AM 2025 134352 A
(220) 2025 06 23
(732) Valgrana S.P.A.
Via Moretta, 7, 12030 Scarnafigi (CN), Italy
(511) 29

(111) M 2026 41294 R
(151) 2026 05 21
(181) 2036 05 21
(260) AM 2025 134353 A
(220) 2025 06 23
(732) Valgrana S.P.A.
Via Moretta, 7, 12030 Scarnafigi (CN), Italy
(511) 29

(111) M 2026 41295 R
(151) 2026 05 21
(181) 2036 05 21
(260) AM 2025 134685 A
(220) 2025 07 18
(732) LTD "HMC Georgia"
Nutsbidze Slope, II m/r, IV qu., bld. 2,
ap. 76, Vake District, Tbilisi, Georgia
(511) 43

(111) M 2026 41296 R
(151) 2026 05 21
(181) 2036 05 21
(260) AM 2025 133054 A
(220) 2025 03 27
(732) RC Global Beverages Inc.
c/o 11th Floor Dah Sing Life Building,
99 Des Voeux Road Central, Hong Kong
(511) 32

(111) M 2026 41297 R
(151) 2026 05 21
(181) 2036 05 21
(260) AM 2025 133657 A
(220) 2025 05 06
(732) JSC "Gomi Spirit and Vodka Company"
Village of Gomi, Khashuri Region, Georgia
(511) 33

(111) M 2026 41298 R
(151) 2026 05 21
(181) 2036 05 21
(260) AM 2025 132255 A
(220) 2025 02 13
(732) NIO Co., Ltd.
Room 521, 5th Floor, №388, Lane 1555,
Jinshajiang West
Road, Jiading District, Shanghai, People's
Republic of China
(511) 12

(111) M 2026 41299 R
(151) 2026 05 21
(181) 2036 05 21
(260) AM 2025 134749 A
(220) 2025 07 22
(732) LLC "Winery Graneli"
Meurneoba Settlement, 4800, Kvareli, Georgia
(511) 33

(111) M 2026 41300 R
(151) 2026 05 21
(181) 2036 05 21
(260) AM 2025 133035 A
(220) 2025 03 25
(732) Hangzhou Hikvision Digital Technology
Co., Ltd.
№555 Qianmo Road, Binjiang District,
Hangzhou, Zhejiang Province, People's
Republic of China
(511) 9, 42

(111) M 2026 41301 R
(151) 2026 05 21
(181) 2036 05 21
(260) AM 2025 133052 A
(220) 2025 03 27
(732) RC Global Beverages Inc.
c/o 11th Floor Dah Sing Life Building,
99 Des Voeux Road Central, Hong Kong
(511) 32

(111) M 2026 41302 R
(151) 2026 05 21
(181) 2036 05 21
(260) AM 2025 133053 A
(220) 2025 03 27
(732) RC Global Beverages Inc.

c/o 11th Floor Dah Sing Life Building,
99 Des Voeux Road Central, Hong Kong
(511) 32

(111) M 2026 41303 R
(151) 2026 05 21
(181) 2036 05 21
(260) AM 2024 130755 A
(220) 2024 11 07
(732) Inkism International Co., Ltd.
20F-1, №88, Sec. 1, Huizhong Rd., Xitun Dist.,
Taichung City 40756, Taiwan, Province of
China
(511) 30, 32, 35

(111) M 2026 41304 R
(151) 2026 05 21
(181) 2036 05 21
(260) AM 2025 134584 A
(220) 2025 07 10
(732) LTD "Astorios"
Sairme St. 55, ap. 132, Saburtalo District,
Tbilisi, Georgia
(511) 9

(111) M 2026 41305 R
(151) 2026 05 21
(181) 2036 05 21
(260) AM 2025 134576 A
(220) 2025 07 09
(732) LTD "GM Pharmaceuticals"
Rustavi Highway 52, 0114, Tbilisi, Georgia
(511) 5

(111) M 2026 41306 R
(151) 2026 05 21
(181) 2036 05 21
(260) AM 2025 134660 A
(220) 2025 07 14
(732) Vladimir Okhotnikov
JBR, Marsa Dubai, Shams-1, unit 3305,
Dubai, United Arab Emirates
(511) 41

(111) M 2026 41307 R
(151) 2026 05 21
(181) 2036 05 21
(260) AM 2025 134201 A
(220) 2025 06 13
(732) Hongkong Vanliew Technology Co., Limited
Room 9042, 9th Floor, Block B, Chung Mei
Centre, 15-17 Hing Yip Street., Kwun Tong,
Kowloon, Hong Kong

(511) 34

(111) M 2026 41308 R
(151) 2026 05 21
(181) 2036 05 21
(260) AM 2025 133863 A
(220) 2025 05 16
(732) Little Things Trading LLC
Street №48 Plot 597-398, Dubai Investment
Park 2, Dubai, United Arab Emirates
(511) 28

(111) M 2026 41309 R
(151) 2026 05 21
(181) 2036 05 21
(260) AM 2025 133966 A
(220) 2025 05 27
(732) LTD "GGS.Tech"
Petre and Ioseb Otskheli's St. 30, ap. 17,
Samgori District, Tbilisi, Georgia
(511) 4, 7

(111) M 2026 41310 R
(151) 2026 05 21
(181) 2036 05 21
(260) AM 2025 133978 A
(220) 2025 05 28
(732) Nicoventures Holdings Limited
Globe House 1 Water Street London WC2R
3LA, United Kingdom
(511) 34

(111) M 2026 41311 R
(151) 2026 05 21
(181) 2036 05 21
(260) AM 2024 130408 A
(220) 2024 10 11
(732) Miniso Hong Kong Limited
Room 32, 11/F, Lee Ka Industrial Building,
8 Ng Fong Street, San Po Kong, KI, Hong
Kong, China
(511) 3, 4, 5, 8, 9, 10, 11, 14, 16, 18, 20, 21, 24, 25,
26, 27, 28, 32

(111) M 2026 41312 R
(151) 2026 05 21
(181) 2036 05 21
(260) AM 2025 134672 A
(220) 2025 07 15
(732) LTD "Tiko Estate"
Polikarpe Zeragia St. 29, 4400, Poti, Georgia
(511) 33

(111) M 2026 41313 R
(151) 2026 05 21
(181) 2036 05 21
(260) AM 2025 134648 A
(220) 2025 07 11
(732) Starbucks Corporation
2401 Utah Avenue South, Seattle, Washington,
98134, USA
(511) 30

(111) M 2026 41314 R
(151) 2026 05 21
(181) 2036 05 21
(260) AM 2025 134248 A
(220) 2025 06 15
(732) Shenzhen Sunlong Technology Co., Ltd.
501, Bohua Technology Park, № 25,
Huohuiluo Rd., Zhangkengjing Community,
Guanhu Street, Longhua District, Shenzhen,
Guangdong Province, China
(511) 9

(111) M 2026 41315 R
(151) 2026 05 21
(181) 2036 05 21
(260) AM 2025 134762 A
(220) 2025 07 23
(732) Biofa GmbH
Rudolf-Diesel-Str. 2, Münsingen, 72525,
Germany
(511) 1, 5

(111) M 2026 41316 R
(151) 2026 05 21
(181) 2036 05 21
(260) AM 2025 134447 A
(220) 2025 06 30
(732) LTD "Nuga Development"
I. Abashidze St. 34, Commercial Area NA-3,
Ent. 1, Floor 1, Block I, Tbilisi, Georgia
(511) 9, 42

(111) M 2026 41317 R
(151) 2026 05 21
(181) 2036 05 21
(260) AM 2025 133892 A
(220) 2025 05 21
(732) Guanron Holdings Limited
Unit A 8/F Chinaweal Ctr, 414-424
Jaffe Rd Causeway Bay, Hong Kong
(511) 20

(111) M 2026 41318 R
(151) 2026 5 21
(181) 2036 05 21
(260) AM 2025 134452 A
(220) 2025 06 30
(732) HP Hewlett Packard Group LLC
10300 Energy Drive, Spring, Texas, 77389,
USA
(511) 9, 35, 36, 37, 38, 41, 42

(111) M 2026 41319 R
(151) 2026 05 21
(181) 2036 05 21
(260) AM 2025 134647 A
(220) 2025 07 11
(732) Obchestvo s Ogranichennoy Otvetstvennostiu
"Mon'delez Rus" (Mon'delez Rus LLC.).
Franz Stollwerka St. 10, Vladimirskaia Oblast,
Petushinskiy District, Pokrov, 601123, Russian
Federation
(511) 30

(111) M 2026 41320 R
(151) 2026 05 21
(181) 2036 05 21
(260) AM 2025 134541 A
(220) 2025 07 04
(732) Georgian International Association
of Aesthetics – "Gaia"
Vakhtang Gorgasali St. 63, ap. 54, 0114,
Tbilisi, Georgia
(511) 44

(111) M 2026 41321 R
(151) 2026 05 21
(181) 2036 05 21
(260) AM 2025 134661 A
(220) 2025 07 14
(732) LTD "Tradeline"
Gamrekeli St. 19, Office 29, Tbilisi, Georgia
(511) 25, 35

(111) M 2026 41322 R
(151) 2026 05 21
(181) 2036 05 21
(260) AM 2025 134474 A
(220) 2025 07 02
(732) LTD "Mtis Ludi"
Tevdore St. 4, Kaspi, Georgia
(511) 32

(111) M 2026 41323 R
(151) 2026 05 21
(181) 2036 05 21
(260) AM 2025 134659 A

(220) 2025 07 14
 (732) LTD "Tradeline"
 Gamrekeli St. 19, Office 29, Tbilisi, Georgia
 (511) 35

(111) M 2026 41324 R
 (151) 2026 05 21
 (181) 2036 05 21
 (260) AM 2025 134194 A
 (220) 2025 06 12
 (732) Euroklimat (Asia Pacific) Limited
 19/F Kam Fung Commercial Building 2-4
 Tin Lok Lane Wan Chai, Hong Kong
 (511) 11

(111) M 2026 41325 R
 (151) 2026 05 21
 (181) 2036 05 21
 (260) AM 2025 134247 A
 (220) 2025 06 15
 (732) Shenzhen Sunlong Technology Co., Ltd.
 501, Bohua Technology Park, No. 25,
 Huohuiluo Rd., Zhangkengjing Community,
 Guanhu Street, Longhua District, Shenzhen,
 Guangdong Province, China
 (511) 9

(111) M 2026 41326 R
 (151) 2026 05 21
 (181) 2036 05 21
 (260) AM 2025 134089 A
 (220) 2025 06 04
 (732) Zhejiang Ushas Cosmetics Co., LTD.
 №1329, Yin Hai Road, Yidong Industrial
 Park, Yiwu City, Zhejiang Province 322000,
 People's Republic of China
 (511) 21

(111) M 2026 41327 R
 (151) 2026 05 21
 (181) 2036 05 21
 (260) AM 2025 134246 A
 (220) 2025 06 15
 (732) Shenzhen Weofly Innovation Technology
 Co., LTD
 Rum 1001, Biding T2, Lijincheng Sintr,
 Iusong Komuniti, Longhua Strit, Longhua
 Distrikt, Shenjeni, Guangdongi, People's
 Republic of China
 (511) 9

(111) M 2026 41328 R
 (151) 2026 05 21
 (181) 2036 05 21
 (260) AM 2025 134550 A

(220) 2025 07 05
 (732) Guangzhou Umorsea Investment
 Holding Co., Ltd.
 Room 1622, №395 Jianpeng Road,
 Baiyun District, Guangzhou, Guangdong
 Province, People's Republic of China
 (511) 3

(111) M 2026 41329 R
 (151) 2026 05 21
 (181) 2036 05 21
 (260) AM 2025 134548 A
 (220) 2025 07 05
 (732) Guangzhou Umorsea Investment Holding
 Co., Ltd.
 Room 1622, №395 Jianpeng Road,
 Baiyun District, Guangzhou, Guangdong
 Province, People's Republic of China
 (511) 3

(111) M 2026 41330 R
 (151) 2026 05 21
 (181) 2036 05 21
 (260) AM 2025 134869 A
 (220) 2025 07 28
 (732) The H.D. Lee Company Inc.
 3411 Silverside Road, Wilmington, Delaware,
 19810, USA
 (511) 25

(111) M 2026 41334 R
 (151) 2026 05 25
 (181) 2036 05 25
 (260) AM 2025 134549 A
 (220) 2025 07 05
 (732) Guangzhou Umorsea Investment
 Holding Co., Ltd.
 Room 1622, №395 Jianpeng Road,
 Baiyun District, Guangzhou, Guangdong
 Province, People's Republic of China
 (511) 3

(111) M 2026 41335 R
 (151) 2026 05 25
 (181) 2036 05 25
 (260) AM 2025 134170 A
 (220) 2025 06 07
 (732) JSC "Credo Bank"
 Rezo Tabukashvili St. 27, bld. 5, 0108,
 Mtatsminda District, Tbilisi, Georgia
 (511) 36

(111) M 2026 41336 R
 (151) 2026 05 25
 (181) 2036 05 25
 (260) AM 2025 134539 A
 (220) 2025 07 04
 (732) LTD "Elvare"
 Kvemo Alekseevka Settlement, 0190, Tbilisi,
 Georgia
 (511) 6, 9

(111) M 2026 41337 R
 (151) 2026 05 25
 (181) 2036 05 25
 (260) AM 2025 134680 A
 (220) 2025 07 17
 (732) LTD "Bolero & Company"
 Kuchishvili St. 12-14-16, fl. 6, 0179,
 Mtatsminda District, Tbilisi, Georgia
 (511) 33

(111) M 2026 41338 R
 (151) 2026 05 25
 (181) 2036 05 25
 (260) AM 2025 134681 A
 (220) 2025 07 17
 (732) LTD "Bolero & Company"
 Kuchishvili St. 12-14-16, fl. 6, 0179,
 Mtatsminda District, Tbilisi, Georgia
 (511) 33

(111) M 2026 41339 R
 (151) 2026 05 25
 (181) 2036 05 25
 (260) AM 2025 134264 A
 (220) 2025 06 19
 (732) LTD "Company Jaokeni"
 Davit Aghmashenebeli Alley, Saburtalo
 District, Tbilisi, Vill. Dighomi; Tbilisi, former
 Georgian Polit. University of Tbilisi, in the
 Eastern from Maquette Base; Tbilisi, Along the
 highway leading to Tbilisi, in the West; Tbilisi,
 along former highway, in the West, 0159,
 Tbilisi, Georgia
 (511) 35

(111) M 2026 41340 R
 (151) 2026 05 25
 (181) 2036 05 25
 (260) AM 2025 134172 A
 (220) 2025 06 09
 (732) JSC "Credo Bank"
 Rezo Tabukashvili St. 27, bld. 5, 0108,
 Mtatsminda District, Tbilisi, Georgia
 (511) 36

(111) M 2026 41341 R
 (151) 2026 05 25
 (181) 2036 05 25
 (260) AM 2025 134674 A
 (220) 2025 07 16
 (732) LTD "Glavspirtprom"
 Lilo Settlement 51, 0198, Tbilisi, Georgia
 (511) 33

(111) M 2026 41342 R
 (151) 2026 05 25
 (181) 2036 05 25
 (260) AM 2025 133584 A
 (220) 2025 04 30
 (732) LLC "Proline Georgia"
 Mazniashvili St. 6, 3700, Tbilisi, Georgia
 (511) 3

(111) M 2026 41343 R
 (151) 2026 05 25
 (181) 2036 05 25
 (260) AM 2025 134336 A
 (220) 2025 06 20
 (732) Chevron Intellectual Property LLC
 1400 Smith Street, Houston, Texas 77002, USA
 (511) 4

(111) M 2026 41344 R
 (151) 2026 05 25
 (181) 2036 05 25
 (260) AM 2025 134335 A
 (220) 2025 06 20
 (732) Chevron Intellectual Property LLC
 1400 Smith Street, Houston, Texas 77002, USA
 (511) 4

(111) M 2026 41345 R
 (151) 2026 05 25
 (181) 2036 05 25
 (260) AM 2025 134334 A
 (220) 2025 06 20
 (732) Chevron Intellectual Property LLC
 1400 Smith Street, Houston, Texas 77002, USA
 (511) 4

(111) M 2026 41346 R
 (151) 2026 05 25
 (181) 2036 05 25
 (260) AM 2025 134650 A
 (220) 2025 07 11
 (732) Wenzhou Rockgrand Trade Co., Ltd.
 №A1501, Xinyi Building, Shifu Road,

Wenzhou, Zhejiang, People's Republic of China (511) 9	(511) 2
(111) M 2026 41347 R (151) 2026 05 25 (181) 2036 05 25 (260) AM 2025 134333 A (220) 2025 06 20 (732) Chevron Intellectual Property LLC 1400 Smith Street, Houston, Texas 77002, USA (511) 1, 4	(111) M 2026 41352 R (151) 2026 05 25 (181) 2036 05 25 (260) AM 2025 134440 A (220) 2025 06 27 (732) Yiwu Anxing Hardware Tools Co., Ltd. Room 1106, Unit 1, No. 125 Wangdao Road, Beiyuan Street, Yiwu City, Jinhua City, China (Zhejiang) Pilot Free Trade Zone, People's Republic of China (511) 7, 8
(111) M 2026 41348 R (151) 2026 05 25 (181) 2036 05 25 (260) AM 2025 134567 A (220) 2025 07 08 (732) Sichuan Egoint Technology Co., Ltd Room 502, Maihong Building, No.1599, Auxiliary Road, Second Section of Cheng- shuang Avenue, Shuangliu District, Chengdu City, 610000, Sichuan Province, People's Republic of China (511) 30	(111) M 2026 41353 R (151) 2026 05 25 (181) 2036 05 25 (260) AM 2025 134437 A (220) 2025 06 27 (732) Tsitsino Iashvili Sulkhan Saba St. 5, 0105, Tabakhmela, Georgia (511) 3, 41, 43
(111) M 2026 41349 R (151) 2026 05 25 (181) 2036 05 25 (260) AM 2025 134332 A (220) 2025 06 20 (732) Chevron Intellectual Property LLC 1400 Smith Street, Houston, Texas 77002, USA (511) 4	(111) M 2026 41354 R (151) 2026 05 25 (181) 2036 05 25 (260) AM 2025 133673 A (220) 2025 05 07 (732) The Procter & Gamble Company One Procter & Gamble Plaza, Cincinnati, Ohio 45202, USA (511) 5
(111) M 2026 41350 R (151) 2026 05 25 (181) 2036 05 25 (260) AM 2025 134331 A (220) 2025 06 20 (732) Chevron Intellectual Property LLC 1400 Smith Street, Houston, Texas 77002, USA (511) 1, 4	(111) M 2026 41355 R (151) 2026 05 25 (181) 2036 05 25 (260) AM 2025 134664 A (220) 2025 07 14 (732) LTD "Golden Suneli" Gldani, VI m/r, bld. 24, ap. 41, Tbilisi, Georgia (511) 29, 30
(111) M 2026 41351 R (151) 2026 05 25 (181) 2036 05 25 (260) AM 2025 134271 A (220) 2025 06 19 (732) Zhuhai ZhongKai Imaging Products Co., Ltd. 1st, 2ND&4TH Floor B Building №2 ShengLi Road, SanZao Town, ZhuHai, Guangdong, People's Republic of China	(111) M 2026 41356 R (151) 2026 05 25 (181) 2036 05 25 (260) AM 2025 134374 A (220) 2025 06 25 (732) Qingdao New Keter Tyre Co., LTD. Room 099, 1st Floor, East Office Building, №45, Beijing Road, Bonded Port District, Qingdao, Shandong, People's Republic of China (511) 12

(111) M 2026 41357 R
(151) 2026 05 25
(181) 2036 05 25
(260) AM 2025 134337 A
(220) 2025 06 20
(732) Chevron Intellectual Property LLC
1400 Smith Street, Houston, Texas 77002, USA
(511) 4

City, Zhejiang Province, People's Republic of
China
(511) 35

(111) M 2026 41358 R
(151) 2026 05 25
(181) 2036 05 25
(260) AM 2025 134341 A
(220) 2025 06 20
(732) TP-Link Systems Inc.
10 Mauchly, Irvine, CA 92618, USA
(511) 9, 42

(111) M 2026 41359 R
(151) 2026 05 25
(181) 2036 05 25
(260) AM 2025 134338 A
(220) 2025 06 20
(732) Chevron Intellectual Property LLC
1400 Smith Street, Houston, Texas 77002, USA
(511) 4

(111) M 2026 41360 R
(151) 2026 05 25
(181) 2036 05 25
(260) AM 2025 134339 A
(220) 2025 06 20
(732) Chevron Intellectual Property LLC
1400 Smith Street, Houston, Texas 77002, USA
(511) 1, 4

(111) M 2026 41361 R
(151) 2026 05 25
(181) 2036 05 25
(260) AM 2025 133273 A
(220) 2025 04 08
(732) LLC "Mysun Technologies"
Nutsbidze Plateau, IV m/r, bld. 21, ap. 103,
Tbilisi, Georgia
(511) 43

(111) M 2026 41362 R
(151) 2026 05 25
(181) 2036 05 25
(260) AM 2025 133580 A
(220) 2025 04 29
(732) Hangzhou Babycare Industrial Co., Ltd.
Room 202, Building 1, №611 Jianghong Road,
Changhe Street, Binjiang District, Hangzhou

TRADEMARK REGISTERED ACCORDING TO THE ACCELERATED PROCEDURE

The decision can be appealed at the Chamber of Appeal of Sakpatenti within 3 months from the publication.

(111) M 2026 41331 R
(151) 2026 05 25
(181) 2036 05 25
(210) AM 139307
(220) 2026 05 18
(732) Natalia Evdokimova
Kubanskaya Embankment St., Building 37,
ap. 239, Krasnodar, 350063, Russian
Federation
(740) Karen Akhnazarov
(540)



LEVDO

(591) 411319 Reddish brown
(531) 03.01.01; 03.01.16; 05.03.04; 05.03.13;
05.07.10; 24.09.02; 24.09.03; 24.09.05;
24.09.12; 24.09.22; 27.05.17
(511) 33

(111) M 2026 41332 R
(151) 2026 05 25
(181) 2036 05 25
(210) AM 139196
(220) 2026 05 08
(732) LLC "Daxil Georgia"
Tamarashvili St. 1, ap. 16, 0179, Vake
District, Tbilisi, Georgia
(540)



(591) FFFFFFF white, 070000 black
(531) 26.04.05; 26.04.24; 27.05.01; 27.05.10;
27.05.21; 27.05.24
(511) 36

(111) M 2026 41333 R
(151) 2026 05 25
(181) 2036 05 25
(210) AM 139218
(220) 2026 05 14
(732) LLC "GM Pharmaceuticals"
Rustavi Highway 52, 0114, Tbilisi,
Georgia
(740) Nugzar Ksovreli
(540)

აკნედუო
Акнедуо
Acneduo

(591) Black-white
(511) 5

(111) M 2026 41363 R
(151) 2026 05 25
(181) 2036 05 25
(210) AM 139124
(220) 2026 05 07
(732) Afrah Asam Alshamri
Dasma, Bld. 5, House 68, Kuwait
(740) Nino Mgaloblishvili
(540)



CELEBQUE

(591) White, light sky-blue
(531) 26.13.25; 27.05.01; 27.05.17; 27.05.22;
29.01.04
(511) 35, 41

(111) M 2026 41364 R
(151) 2026 05 25
(181) 2036 05 25
(210) AM 139131
(220) 2026 05 07
(732) Zurab Tsikhishvili
Shota Mikatadze St. 7, 0167, Tbilisi,
Georgia

(540)



(591) Black, yellow, white

(531) 21.03.13; 26.04.05; 26.04.16; 26.04.17;
26.04.22; 26.04.24; 26.11.01; 26.11.08;
27.05.01; 27.05.10; 27.05.17; 27.05.24;
27.07.01; 27.07.21; 29.01.13

(511) 41, 44

(111) M 2026 41365 R

(151) 2026 05 27

(181) 2036 05 27

(210) AM 139207

(220) 2026 05 13

(732) LLC "Starke"

Evgeni Kharadze St. 11a, 2nd floor, Gldani
District, Tbilisi, Georgia

(540)



(591) 000000 black, C90D0D red

(531) 15.01.19; 27.03.15; 27.05.01; 29.01.12

(511) 19

(111) M 2026 41366 R

(151) 2026 05 27

(181) 2036 05 27

(210) AM 139305

(220) 2026 05 15

(732) Almofa Limited

Agias Filaqseos 36, 3025, Limassoli, 3025,
Cyprus

(740) Mirian Bichikashvili

(540)



(591) 09111A black, F4C430 yellow, FBFCFD
white

(531) 26.04.04; 26.04.05; 27.05.01; 27.05.17;
29.01.13

(511) 9, 41, 42

(111) M 2026 41367 R

(151) 2026 05 27

(181) 2036 05 27

(210) AM 139322

(220) 2026 05 20

(732) LLC "Daxil Georgia"

Tamarashvili St. 1, ap. 16, 0179, Vake District,
Tbilisi, Georgia

(540)



(591) 0A0000 black, F9F7F7 white, A46EB7
lilac, 5B6EE5 blue

(531) 27.01.06; 27.05.01; 27.05.10; 27.05.25;
29.01.14

(511) 36, 42

(111) M 2026 41368 R

(151) 2026 06 01

(181) 2036 06 01

(210) AM 139238

(220) 2026 05 14

(732) LLC "New Pharm Group"

Irodion Evdoshvili St. 18, Office Area 2, 0119,
Tbilisi, Georgia

(540)

ტენზიდინი
Tenzidine
Тензидин

(591) Black-white

(511) 5

(111) M 2026 41369 R

(151) 2026 06 03

(181) 2036 06 03

(210) AM 139324

(220) 2026 05 20

(732) LLC "ToriGeorgia"

Tskaro St. 19a, Gldani, Gldani District, Tbilisi,
Georgia

(540)



(591) Blue, white

(531) 03.07.22; 03.07.24; 26.11.12; 27.05.01;
27.05.10; 29.01.12

(511) 5

(111) M 2026 41370 R

(151) 2026 06 03

(181) 2036 06 03

(210) AM 139308

(220) 2026 05 18

(732) LLC "Kvelaze Strapebi"

Vill. Ghebi, Oni Region, Georgia

(540)



(591) White, burgundy, brown

(531) 02.01.25; 02.03.30; 11.01.03; 11.01.04;
18.01.08; 26.01.01; 26.01.04; 26.01.14;
26.01.16; 26.01.21

(511) 43

(111) M 2026 41371 R

(151) 2026 06 03

(181) 2036 06 03

(210) AM 139389

(220) 2026 05 22

(732) Artem Kulesha

Vakhtanf Gorgasali St. 128/134, ap. 81a,
6010, Batumi, Georgia

(540)



(591) 000000 black

(531) 26.03.23; 26.11.06; 26.11.09; 27.05.17;
27.05.21

(511) 35, 43

(111) M 2026 41372 R

(151) 2026 06 03

(181) 2036 06 03

(210) AM 139316

(220) 2026 05 19

(732) LLC "Ehi Car Rental Service"

Nino and Ilia Nakashidze St. 1 (former
Avlev), ap. 3, bld. 3, Krtsanisi District, Tbilisi,
Georgia

(540)



(591) Black, yellow

(531) 26.04.07; 26.04.18; 27.05.01; 27.05.09;
27.05.10; 27.05.19; 27.05.22; 28.03; 29.01.02;
29.01.08

(511) 39

(111) M 2026 41373 R

(151) 2026 06 03

(181) 2036 06 03

(210) AM 139315

(220) 2026 05 19

(732) LLC "Ehi Car Rental Service"

Nino and Ilia Nakashidze St. 1 (former
Avlev), ap. 3, bld. 3, Krtsanisi District, Tbilisi,
Georgia

(540)



(591) Orange, white

(531) 24.15.02; 27.05.01; 27.05.17; 28.03; 28.19;
29.01.02

(511) 39

(111) M 2026 41374 R

(151) 2026 06 05

(181) 2036 06 05

(210) AM 139385

(220) 2026 05 22

(732) Nino Supatashvili

Didi Dighomi, Shalva Akhaltsikheli St. 17,
Tbilisi, Georgia

(540)



(591) Black, golden

(531) 01.03.02; 05.03.04; 05.03.19; 05.07.10;
06.01.04; 26.04.04; 26.04.06; 26.13.25;
27.05.01; 27.05.05; 27.05.24; 29.01.02;
29.01.08

(511) 33

(111) M 2026 41375 R

(151) 2026 06 05

(181) 2036 06 05

(210) AM 139386

(220) 2026 05 22

(732) LLC "Homer Group"

Chkheidze St. 3, Square Iv. Javakhishvili 1,
0102, Chughureti District, Tbilisi, Georgia

(540)

ახალი ცხოვრების გასაღები

(591) Black

(511) 35, 36, 37

(111) M 2026 41376 R

(151) 2026 06 05

(181) 2036 06 05

(210) AM 139387

(220) 2026 05 22

(732) LLC "Homer Group"

Chkheidze St. 3, Square Iv. Javakhishvili 1,
0102, Chughureti District, Tbilisi, Georgia

(540)

**გამორჩეული ცხოვრების
მისამართი**

(591) Black

(511) 35, 36, 37

INTERNATIONAL TRADEMARK FOR WHICH A DECISION ON GRANTING PROTECTION IS TAKEN

The decision may be appealed to the Chamber of Appeals of Sakpatenti within 3 months of its publication or to the Administrative Cases Bench of Mtskheta District Court within 1 month, while the decisions of the Chamber of Appeals may be appealed only to the Administrative Cases Bench of Mtskheta District Court within 1 month (Address: 17 Samkhedro St., Mtskheta).

(260) AM 2026 113646 A*

(800) 1598275

(151) 2021 04 26

(891) 2021 04 26

(731) Fall Creek Farm and Nursery, Inc.
39318 Jasper-Lowell Road, Lowell OR 97452,
USA

(540)

LORETOBLUE

(591) Black, white

(511)

31 – Fresh Blueberries.

(260) AM 2026 131041 A

(800) 1823860

(151) 2024 10 17

(891) 2024 10 17

(731) Elekta AB (publ)
PO Box 7593; SE-103 93 Stockholm, Sweden

(540)

IRIS

(591) Black, white

(511)

42 – Software as a service, for use in the following fields: medicated treatments and planning and simulation of medical treatment; software as a service for handling, displaying and transfer of patient data, information and images; software as a service [SaaS] for the creation, collection, analysis, processing and display of medical images; software as a service for medical analytics and informatics; all the aforesaid relating to the field of oncology.

(260) AM 2026 131124 A

(800) 1824673

(151) 2024 09 11

(891) 2024 09 11

(731) Amusnet Interactive
Garitage Park, Building No. 4, Floor 2, Donka
Ushlinova Str. 2, BG-1766 Sofia, Bulgaria

(540)



(591) Red, yellow, orange and white

(531) 01.15.09; 05.07.13; 05.07.23; 24.17.25;
27.03.11; 29.01.13

(511)

9 – Computer software for the administration of on-line games and gaming; computer application software featuring games and gaming; betting software; gaming software that generates or displays wager outcomes of gaming machines.

28 – Slot machines [gaming machines]; gaming machines for gambling.

41 – Providing of casino and gaming facilities; gambling services.

(260) AM 2026 131125 A

(800) 1824710

(151) 2023 10 23

(891) 2023 10 23

(731) Flowserve Pte Ltd
10 Tuas Loop, Tuas Connection, Singapore
637345, Singapore

(540)

MOGAS

(591) Black, white

(511)

6 – Common metals and their alloys, ores; metal materials for building and construction; transportable buildings of metal; non-electric cables and wires of common metal; small items of metal hardware; metal containers for storage or transport; safes; safes (metal or non-metal); ironmongery; metal hardware; metal fittings for industrial apparatus; fittings of metal for building; building materials of metal; railway material of metal; loading pallets of metal; anchors; metal cages for wild animals; traps for wild animals; tree protectors of metal; weather- or wind-vanes of metal; monuments of metal; works of art of common metal; identification bracelets of metal; signs, non-luminous and non-mechanical, of metal; locks of metal, other than electric; split rings of common metal for keys; fittings of metal for furniture; fittings of metal for compressed air lines; seals of metal for the reduction of friction in metals; anti-friction metal; common metals, unwrought or semi-wrought; ores of metal; unprocessed and semi-processed non-precious metals and their alloys; welding and soldering materials; soldering wire of metal; wire of common metal; cable joints of metal,

non-electric; bindings of metal; bolts of metal; flanges of metal [collars]; nuts of metal; screws of metal; sealing caps of metal; closures of metal for containers; containers of metal (storage, transport); containers of metal for compressed gas or liquid air; containers of metal for liquid fuel; pipework of metal; rivets of metal; modular shelters of metal; sheets and plates of metal; sleeves [metal hardware]; pins [metal hardware]; springs [metal hardware]; drain valves of metal; metal valves not being parts of machines; metal valves, not being parts of machines, and their parts, namely stems, seats, packing, springs, flow control elements, bushings, bearings, anti-extrusion rings, gaskets, position indicators, nuts, studs, bolts, live loading systems, indicator rods, stem adaptors, gland flanges, sleeves, rings, seals, pins, plates, soft goods kits, trim change kits; valves of metal other than parts of machines; valves of metal other than parts of machines including those from alloy steel, nickel, tantalum, and titanium; manually operated metal valves; manually operated metal valves, and their parts, namely stems, seats, packing, springs, flow control elements, bushings, bearings, anti-extrusion rings, gaskets, position indicators, nuts, studs, bolts, live loading systems, indicator rods, stem adaptors, gland flanges, sleeves, rings, seals, pins, plates, soft goods kits, trim change kits; metal valves not being parts of machines, namely vent and drain valves, isolation valves, oxygen valves, trunnion valves, ball valves, general service valves, inline repairable valves; metal pipe fittings; parts, fittings and accessories for all the aforesaid goods.

7 – Machine tools, power-operated tools; motors and engines, except for land vehicles; machine coupling and transmission components, except for land vehicles; agricultural implements, other than hand-operated hand tools; incubators for eggs; automatic vending machines; tools [parts of machines]; machine tools; hand-held tools, other than hand-operated; hand-held tools, other than hand-operated machines for the electronic industry; wire drawing machines; holding devices for machine tools; handling machines, automatic [manipulators]; machines for handling materials; machines and machine tools for treatment of materials and for manufacturing; machines for processing plastics; leather-working machines; glass-working machines; optical cold working machines; enamel making machinery; engraving machines; packing machines; painting machines; printing machines; sizing machines; converters for steelworks; foundry machines; machines for battery industry; machines for the petrochemical industry; machines for the petroleum exploration and refining industry; agricultural, earthmoving, construction, oil and gas extraction and mining equipment; agricultural machines; fertilizer manufacturing machines; fodder presses; milking machines; shearing machines for animals; aerating pumps for aquaria; geological exploration, mining, mineral processing machines; salt pond smashing machines; steamrollers;

oil extraction, oil refining equipment; gas separating installations; aerocondensers; filter presses; electromechanical machines for chemical industry; machines for pharmaceutical processing industry; machines for the industrial preparation and processing of foodstuffs; food preparation machines, electromechanical; beverage preparation machines, electromechanical; tea manufacturing machines; vending machines; kitchen machines, electric; washing machines (laundry); washing apparatus; fittings for engine boilers; light bulb making machines; curtain drawing devices, electrically operated; cord making machines; zipper making machines; needle making machines; stitching machines; spinning wheels; potters' wheels; machines for use in aerospace applications; pulp and paper pulp processing machines; woodworking machines; papermaking machines; paper diaper making machines; honeycomb-shaped briquet making machines; cigarette machines for industrial purposes; elevators (lifts); bicycle assembling machines; welding and soldering machines and devices; welding machines, electric; sealing machines for industrial purposes; metalworking machines; electroplating machines; drainage machines; turbines other than for land vehicles; motors, other than for land vehicles; carburetter feeders; dynamos; pumps [machines]; opening and closing mechanisms; mechanical control apparatus for machines; control mechanisms for machines, engines or motors; control mechanisms for machinery; regulators being parts of machines; valves; valves (parts of machines); ball valves being parts of machines; check valves of metal [parts of machines]; clack valves [parts of machines]; control valves [parts of machines]; pressure control valves [parts of machines]; regulators [parts of machines]; pressure regulators [parts of machines]; safety valves [parts of machines]; ventilation valves [parts of machines]; actuators for valves; drives for valves; mechanical seals [parts of machines]; industrial cleaning machines; industrial process controllers [hydraulic]; hydraulic controls for machines, motors and engines; hydraulic couplers; industrial process controllers [pneumatic]; pneumatic controls for machines, motors and engines; pneumatic hammers; bearings (parts of machines); self-oiling bearings; anti-friction bearings for machines; housings [parts of machines]; parts for machines, namely adapted covers for machine parts; axles for machines; belts for machines; valves as machine components; valves as machine components and their parts, namely stems, seats, packing, springs, flow control elements, bushings, bearings, anti-extrusion rings, gaskets, position indicators, nuts, studs, bolts, live loading systems, indicator rods, stem adaptors, gland flanges, sleeves, rings, seals, pins, plates, soft goods kits, trim change kits; valve actuators; pneumatic valve actuators; pneumatic valve actuators and their parts and accessories, namely position indicators, mounting pads, gears, pinions, end caps, pistons, springs, bearings and guides, O-rings, switches, solenoids, pilots, quick exhausts, vo-

lume boosters, flow control valves, speed controls, bug screens, mufflers, manual blocks and vents; components especially designed for severe service applications in industrial chemical processing equipment in the field of chemical, petrochemical, metals, minerals, oil and gas, power, refining, food, aerospace, and pulp and paper industries; chemical processing machines; industrial chemical processing machines; modular industrial chemical processing machines; chemical processing machines including dual process control valves, actuated isolation valves, redundant pathway piping, fittings, controls, instrumentation, and purging and flushing equipment; valve purging and flushing equipment and systems; valves for pumps; valves being parts of machines; valves being parts of machines, and their parts, namely stems, seats, packing, springs, flow control elements, bushings, bearings, anti-extrusion rings, gaskets, position indicators, nuts, studs, bolts, live loading systems, indicator rods, stem adaptors, gland flanges, sleeves, rings, seals, pins, plates, soft goods kits, trim change kits; pump control valves; ball valves being parts of machines; ball valves being parts of machines and their parts, namely stems, seats, packing, springs, flow control elements, bushings, bearings, anti-extrusion rings, gaskets, position indicators, nuts, studs, bolts, live loading systems, indicator rods, stem adaptors, gland flanges, sleeves, rings, seals, pins, plates, soft goods kits, trim change kits; valves being parts of machines, namely, vent and drain valves, isolation valves, switching valves, oxygen valves, trunnion valves, ball valves, general service valves, inline repairable valves; pressure reducers [parts of machines]; pressure relief valves for power, chemical and petrochemical plants; chemical processing equipment; filtering machines for chemical processing, pressure reducers for chemical processing; pumps [machines] for chemical processing; parts, fittings and accessories for all the aforesaid goods.

9 – Scientific, research, navigation, surveying, photographic, cinematographic, audiovisual, optical, weighing, measuring, signalling, detecting, testing, inspecting, life-saving and teaching apparatus and instruments; apparatus and instruments for conducting, switching, transforming, accumulating, regulating or controlling the distribution or use of electricity; apparatus and instruments for recording, transmitting, reproducing or processing sound, images or data; recorded and downloadable media, computer software, blank digital or analogue recording and storage media; mechanisms for coin-operated apparatus; cash registers, calculating devices; computers and computer peripheral devices; diving suits, divers' masks, ear plugs for divers, nose clips for divers and swimmers, gloves for divers, breathing apparatus for underwater swimming; fire-extinguishing apparatus; fire extinguishers; monitoring apparatus, other than for medical purposes; monitoring apparatus and instruments; apparatus for monitoring and recording the performance of machinery; apparatus to remotely monitor and con-

trol the function and status of mechanical devices or systems; portable remote retarder; remote control apparatus; electric installations for the remote control of industrial operations; surveying instruments; material testing instruments and machines; chemistry apparatus and instruments; instruments and measuring devices for physical/chemical experiments and composition analysis; air analysis apparatus; chromatography apparatus for laboratory use; anodes; barometers; cathodic anti-corrosion apparatus; ionization apparatus not for the treatment of air or water; radiological apparatus for industrial purposes; detectors; egg-candlers; probes for scientific purposes; diagnostic apparatus, not for medical purposes; testing apparatus not for medical purposes; time recording apparatus; time switches, automatic; weighing apparatus and instruments; weighing machines; money counting and sorting machines; apparatus to check franking; measuring apparatus; measures; distance measuring apparatus; theodolites; measuring instruments; measuring devices, electric; pressure measuring apparatus; precision measuring apparatus; precision balances; gauges; counters; meters; hydrometers; hygrometers; thermohygrometers; thermometers, not for medical purposes; variometers; viscosimeters; flowmeters; frequency meters; micrometers; microprocessors; central processing units [processors]; calculating machines; data processing apparatus; batteries; coils, electric; transformers (electricity); materials for electricity mains (wires, cables); printed circuits; wafers for integrated circuits; data processing equipment and accessories (electrical and mechanical); data processing software for graphic representations; recordings; digital recordings; animated cartoons; recordings of sounds, music, images, audio, visual and audio-visual content; video recordings provided from the Internet; computer software for cryptocurrency; computer software for fungible tokens; downloadable software for non-fungible tokens; digital artworks and digital cultural works; decorative magnets; ticket dispensing terminals, electronic; punched card machines for offices; computer hardware, firmware and software; computer games; software applications (apps), including apps for installation on mobile telephones and communications devices; communications devices and cases therefor; intercommunication apparatus; transmitters [telecommunication]; transponders; portable hand held digital electronic devices and computers and other electronic devices for reading and viewing text, images and audio-visual content; portable media players; radios; dictating machines; cameras [photography]; video screens; face recognition device; computers; cameras; memory cards; data cards; mouse mats; bags adapted for laptops, cameras and video apparatus; spectacles (optics); protective clothing, footwear and headgear; protective and safety equipment; protection devices for personal use against accidents; sports whistles; dog whistles; alarms; electrified fences; lightning conductors (rods); safety, security, protection

and signalling devices; signals, luminous or mechanical; signal lanterns; automatic indicators of low pressure in vehicle tires (tyres); electronic control apparatus for valves; pressure indicator plugs for valves; remote controls for automatically operating valves; industrial automation controls; industrial controls incorporating software; industrial software; product engineering software; mechanical engineering software; inventory software; computer software to enable searching and retrieval of data; hardware reliability software; maintenance software; predictive maintenance software; scheduling software; software for diagnostics and troubleshooting; computer software, recorded; computer programs, downloadable; computer programs, recorded; monitors [computer programs]; interfaces for computers; humanoid robots with artificial intelligence for preparing beverages; non-printed, electronic, optical and digital publications; downloadable electronic publications provided on-line from databases or the Internet; electronic publications in any media; teaching apparatus; audiovisual teaching apparatus; instructional apparatus and instruments; instruction manuals in electronic format; downloadable electronic manuals; downloadable electronic reports; downloadable image files; optical apparatus and instruments; optical fibers (fibres) (light conducting filaments); optical inspection apparatus for industrial use; temperature monitors for industrial use; heat detectors; heat regulators; heat regulating apparatus; regulating apparatus, electric; sheaths for electric cables; impact sensors; pressure indicators; pressure gauges; electronic apparatus for controlling the pressure and flow of gases; flow measuring apparatus; flow control installations [electric]; control valves for regulating the flow of gases and liquids and their parts and accessories; valves for controlling and regulating the flow of gases or liquids not being parts of plumbing, heating, cooling installations or machines; fitted noise reduction holed plates for control valves used in regulating the flow of gases and liquids; electromagnetic valves; valve position indicators; metal hardness testing machines; parts, fittings and accessories for all the aforesaid goods.

11 – Apparatus and installations for lighting, heating, cooling, steam generating, cooking, drying, ventilating, water supply and sanitary purposes; sanitary apparatus and installations; distillation apparatus for chemical processing; evaporators for chemical processing; heat exchangers for chemical processing; polymerisation installations; ball valves; level control valves; regulating and safety accessories for gas apparatus; regulating and safety accessories for water apparatus; safety valves for gas apparatus and for water apparatus; stop valves for regulating gas and water; air purgers for use with water supply installations; water distribution installations; water filtering apparatus; water purifying apparatus and machines; fog machines for theatre; ornamental fountains; cooling appliances and installations; refrigerating appliances and ins-

tallations; air conditioning apparatus; drying apparatus and installations; hair driers (dryers); lighting apparatus and installations; lights for vehicles; ultraviolet ray lamps, not for medical purposes; curing lamps, not for medical purposes; oil lamps; heating apparatus; heating installations; electrically heated blankets, not for medical purposes; pocket warmers; cooking apparatus and installations; lava rocks for use in barbecue grills; gas lighters; steam valves; plumbing fittings, namely valves; manually operated plumbing valves; parts, fittings and accessories for all the aforesaid goods.

(260) AM 2026 131136 A

(800) 1825160

(151) 2024 10 18

(891) 2024 10 18

(731) IsarCare Holding GmbH

Augustenstr. 68A, 80333 Munich, Germany

(540)



(591) Red and white

(531) 27.05.24; 29.01.12

(511)

3 – Non-medicated cosmetics; preparations for body and beauty care; non-medicated dentifrices; perfume; essential oils; laundry preparations; bleaching preparations; cleaning preparations; polishing preparations; grease-removing preparations; abrasive preparations.

(260) AM 2026 131137 A

(800) 1825217

(151) 2024 09 19

(891) 2024 09 19

(731) Obschestvo s ogranichennoy otvetstvennostyu
MIRROLLA

ul. Zavodskaya, d. 3, 361 A, 1-N, g. p.

Kuzmolovskiy, r-n Vsevolozhskiy, RU-188663
obl. Leningradskaya, Russian Federation

(540)



(591) Yellow, dark yellow, brown, light brown,
orange and dark orange

(531) 03.06.03; 28.05; 29.01.13

(511)

5 – Dietary supplements; biological preparations for medical purposes; food for babies.

(260) AM 2026 131139 A

(800) 1825269

(151) 2024 09 12

(891) 2024 09 12

(731) Limited Liability Company "Kazachiy Khutor"
zd. 2, s.p. Arkhonskoye, m.r-n Prigorodny,
RU-363120 Republic of North Ossetia-Alania,
Russian Federation

(540)



(591) Green, light green, dark green, white and red

(531) 05.07.13; 07.01.09; 25.01.19; 28.05; 29.01.15

(526) North Ossetia-Alania stanitsa Arkhonskaya

(511)

20 – Hampers [baskets] not of metal for the transport of items; bakers' bread baskets; baskets, not of metal; casks of wood for decanting wine; casks, not of metal; barrels, not of metal; staves of wood; taps, not of metal, for casks; cask hoops, not of metal; recycling bins, not of metal; bottles [containers], not of metal, for compressed gas or liquid air; containers, not of metal, for liquid fuel; troughs, not of metal, for mixing mortar; oil drainage containers, not of metal; packaging containers of plastic; jerrycans, not of metal; waste dumpsters, not of metal, other than for medical use; containers, not of metal [storage, transport]; floating containers, not of metal; bottle casings of wood; tool boxes, not of metal, empty; containers, not of metal, for compressed gas or liquid air; reservoirs, not of metal nor of masonry; vats, not of metal; crates; covers specially made for handling and transport of bottles, not of metal, for compressed gas; tool chests, not of metal, empty; bottle caps, not of metal; plugs, not of metal; boxes of wood or plastic.

21 – Dripping pans.

31 – Algarovilla for animal consumption; anchovy, live; oranges, fresh; peanuts, fresh; artichokes, fresh; draff; beans, fresh; locust beans, raw; wreaths of natural flowers; grapes, fresh; algae, unprocessed, for human or animal consumption; fruit residue [marc]; dog biscuits; sea-cucumbers, live; peas, fresh; mushroom spawn for propagation; mushrooms, fresh; trees; palm trees; turf, natural; unsawn timber; undressed timber; yeast for animal consumption; Christmas trees; edible chews for animals; live animals; menagerie animals; peanut cake for animals; oil cake; maize cake for cattle; rape cake for cattle; bagasses of cane [raw material]; cereal seeds, unprocessed; grains [cereals]; grains for animal consumption; lime for animal forage; fish spawn; zucchini, raw; cocoa beans, unprocessed; po-

tatoes, fresh; chestnuts, fresh; arrangements of fresh fruit; copra; raw barks; rough cork; animal foodstuffs; pet food; stall food for animals; bird food; strengthening animal forage; chicory roots; roots for animal consumption; nettles; groats for poultry; maize; edible sesame, unprocessed; shrubs; rose bushes; spiny lobsters, live; lemons, fresh; vine plants; salmon, live; onions, fresh; flower bulbs; leeks, fresh; olives, fresh; bran mash for animal consumption; mussels, live; almonds [fruits]; molluscs, live; peanut meal for animals; linseed meal for animal consumption; meal for animals; flax meal [fodder]; rice meal for forage; fish meal for animal consumption; straw mulch; beverages for pets; edible insects, live; oats; vegetables, fresh; cucumbers, fresh; lobsters, live; nuts [fruits]; coconuts; kola nuts; bran; distillery waste for animal consumption; residue in a still after distillation; palms [leaves of the palm tree]; cuttle bone for birds; peppers [plants]; aromatic sand [litter] for pets; citrus fruit, fresh; litter for animals; mash for fattening livestock; unprocessed sweet corn ears [husked or unhusked]; animal fattening preparations; preparations for egg laying poultry; fishing bait, live; by-products of the processing of cereals, for animal consumption; seed germ for botanical purposes; poultry, live; wheat; pollen [raw material]; crayfish, live; crustaceans, live; seedlings; plants; aloe vera plants; plants, dried, for decoration; rhubarb, fresh; rice, unprocessed; rye; wheat germ for animal consumption; fish, live; lettuce, fresh; sardines, live; beet, fresh; herrings, live; seeds for planting; linseed for animal consumption; edible linseed, unprocessed; hay; coconut shell; bred stock; sanded paper [litter] for pets; malt for brewing and distilling; straw [forage]; straw litter; salt for cattle; trunks of trees; wood chips for the manufacture of wood pulp; litter peat; garden herbs, fresh; sugarcane; truffles, fresh; tuna, live; pumpkins, fresh; oysters, live; fruit, fresh; hazelnuts, fresh; fodder; hops; flowers, natural; flowers, dried, for decoration; chicory, fresh; silkworms; garlic, fresh; lentils, fresh; pine cones; hop cones; spinach, fresh; juniper berries; berries, fresh; eggs for hatching, fertilized; silkworm eggs; barley.

(260) AM 2026 131140 A

(800) 1825311

(151) 2024 06 10

(891) 2024 06 10

(731) Rohto Pharmaceutical Co., Ltd.
8-1, Tatsuminishi 1 Chome, Ikuno-ku,
Osaka-shi, Osaka 544-8666, Japan

(540)

(591) Black, white

(531) 26.11.01; 26.11.12; 27.05.08; 27.05.11;
27.05.17

(511)

3 – Antistatic preparations for household purposes; de-greasing preparations for household purposes; rust removing preparations; stain removing benzine; fabric softeners for laundry use; laundry bleach; adhesives for affixing false hair; laundry starch; seaweed gelatine for laundry use [funori]; adhesives for affixing false eyelashes; breath freshening preparations; deodorants for animals; paint stripping preparations; shoe cream; shoe black [shoe polish]; polishing preparations; soaps and detergents; dentifrices; cosmetics; perfumes and flavourings for beverages [essential oils]; perfumes and food flavourings [essential oils]; incense; abrasive paper [sandpaper]; abrasive cloth; abrasive sand; artificial pumice stone; polishing paper; false nails; false eyelashes.

5 – Pharmaceutical preparations; reagent paper for medical purposes; oiled paper for medical purposes; adhesive tapes for medical purposes; drug delivery agents in the form of edible wafers for wrapping powdered pharmaceuticals; gauze for dressings; empty capsules for pharmaceuticals; eyepatches for medical purposes; ear bandages; menstruation bandages; menstruation tampons; sanitary napkins; sanitary panties; absorbent cotton; adhesive plasters; bandages for dressings; liquid bandages; breast-nursing pads; cotton swabs for medical use; dental materials; diapers; diaper covers; fly catching paper; mothproofing paper; lacteal flour for babies; dietary supplements for human beings; dietetic beverages adapted for medical purposes; dietetic foods adapted for medical purposes; beverages for babies; food for babies; dietary supplements for animals; semen for artificial insemination; stem cells for medical, pharmaceutical or veterinary use; stem cells for regenerative medicine, medicine or veterinary use; stem cells (only for medical and veterinary use); diagnostic reagents for clinical or medical laboratory use; diagnostic media for bacteriological cultures; microorganism culture media for medical use; cell culture media for medical or veterinary use; serums; serotherapeutic medicines; fumigants [only for agricultural purposes]; fungicides [only for agricultural purposes]; rodenticides [only for agricultural purposes]; insecticides [only for agricultural purposes]; herbicides [weedkillers]; insect-repellents [only for agricultural purposes]; antiseptics [only for agricultural purposes].

(260) AM 2026 131206 A

(800) 1826153

(151) 2024 05 27

(891) 2024 05 27

(731) MAKİNİST TEKSTİL TURİZM OTOMOTİV
İNŞAAT SANAYİ DIŞ TİCARET LİMİTED
ŞİRKETİ

Mehmet Nesih Özmen Mahallesi, Yüksek
Sokak 6 3, Güngören, İstanbul, Türkiye

(540)

Machinist

(591) Black, white

(511)

25 – Clothing, namely, trousers, jackets, overcoats, coats, skirts, suits, jerseys, waistcoats, shirts, ready-made leather linings (parts of clothing), T-shirts, sweatshirts, dresses, bermuda shorts, shorts, pajamas, pullovers, jeans, tracksuits, rainwear, beachwear, bathing suits, swimming suits; clothing for sports (for exclusive use for sports), clothing for babies, namely, shirts, pants, coats, dresses; underclothing, namely, boxer shorts, brassieres, briefs, pants; socks; footwear, namely shoes excluding orthopedic shoes, sandals, waterproof boots, walking boots, booties, sporting shoes, slippers; shoe parts namely heelpieces, insoles for footwear, footwear uppers; headgear, namely caps, skull caps, sports caps, hats, berets; gloves (clothing), stockings, belts (clothing), camisoles, sarongs, scarves, neck scarves, shawls, collars, neckties, ties, suspender belts.

35 – Advertising, marketing and public relations; organization of exhibitions and trade fairs for commercial or advertising purposes; development of advertising concepts; office functions; secretarial services; arranging newspaper subscriptions for others; compilation of statistics; rental of office machines; systemization of information into computer databases; telephone answering for unavailable subscribers; business management, business administration and business consultancy; accounting; commercial consultancy services; personnel recruitment, personnel placement, employment agencies, import-export agencies; temporary personnel placement services; auctioneering; the bringing together, for the benefit of others, of a variety of goods, namely, clothing, namely, trousers, jackets, overcoats, coats, skirts, suits, jerseys, waistcoats, shirts, ready-made leather linings (parts of clothing), t-shirts, sweatshirts, dresses, bermuda shorts, shorts, pajamas, pullovers, jeans, tracksuits, rainwear, beachwear, bathing suits, swimming suits, clothing for sports (for exclusive use for sports), clothing for babies, namely, shirts, pants, coats, dresses, underclothing, namely, boxer shorts, brassieres, briefs, pants, socks, footwear, namely shoes excluding orthopedic shoes, sandals, waterproof boots, walking boots, booties, sporting shoes, slippers, shoe parts namely heelpieces, insoles for footwear, footwear uppers, headgear, namely caps, skull caps, sports caps, hats, berets, gloves (clothing), stockings, belts (clothing), camisoles, sarongs, scarves, neck scarves, shawls, collars, neckties, ties, suspender belts enabling customers to conveniently view and purchase those goods, such services may be provided by retail stores, wholesale outlets, by means of electronic media or through mail order catalogues.

(260) AM 2026 131207 A
 (800) 1826187
 (151) 2024 06 28
 (891) 2024 06 28
 (731) LALIT MITTAL TECHNOLOGIES PRIVATE LIMITED
 1825, Industrial Area, Phase – 1, 160002
 Chandigarh 160002, India

(540)



(591) Black, white
 (531) 24.17.10; 24.17.12; 26.03.04; 26.03.06;
 26.03.07; 26.03.24; 27.03.01; 27.03.15;
 27.05.01; 27.05.08

(511)

9 – Downloadable mobile applications, application software for mobile phones, computer application software for mobile phones, computer application software, downloadable computer software applications, computer application software for mobile phones, computer software.

(260) AM 2026 131208 A
 (800) 1826239
 (151) 2024 08 07
 (891) 2024 08 07
 (731) SANER SERDAR MECIT
 Via Della Chiesa, 28, I-42016 GUASTALLA
 (Reggio Emilia), Italy

(540)



(591) Black, white
 (531) 27.05.07; 27.05.11; 27.05.15; 27.05.17

(511)

7 – Dishwashers; laundry machines; washing machines [laundry]; vacuum packing machines; laundry washing machines incorporating a drying tumbler; food processing machines, namely, graters, mixers and whisks, beaters, mixers, meat grinders, grinders, food grinders and separators, coffee grinders, presses, fruit and vegetable extractors, vegetable peeling tools, slicers, vegetable cutters, electric knives; kitchen appliances and machines with built-in cooking devices, for chopping, grating, grinding, mincing, pressing, cutting, mixing, kneading, emulsifying, liquefying and beating food, namely, electric mixers and blenders, electric food processors; electric kitchen appliances and

machines with built-in cooking appliances, for chopping, grating, shredding, pressing, cutting, mixing, kneading, emulsifying, liquefying and beating food, namely, electric food processors; electric cooking appliances and machines with a built-in cooking device for shredding, grating, grinding, pressing, cutting, mixing, kneading, emulsifying, passing, and beating food, namely, electric food processors; knife-sharpening machines; household vacuum cleaners, with their parts and accessories.

8 – Hand tools and implements, all intended for the preparation of food and drink, namely hand operated food processors; hand-operated food slicers; hand-operated choppers; chopping knives; molding irons; scrapers; shears (scissors); hand-operated cutting tools; kitchen knives; blades; scrapers; kitchen knives; knife handles; knife handles; bits [parts of hand tools]; table cutlery; electric irons; electric steam irons.

9 – Smartphones; smartwatches; computers; portable computers; programs for computers; software; television apparatus; monitors; tablet computers; scales; electronic scales; solar panels for the production of electricity; rechargeable batteries; power banks; headset; wireless headphones; virtual reality software; virtual reality software for simulation; virtual classroom software; virtual reality models; virtual server software; virtual assistant software; apparatus for generating virtual images; virtual reality [vr] motion simulators; software for generating virtual images; virtual and augmented reality software; security tokens [encryption devices]; downloadable digital files authenticated by non-fungible tokens; downloadable virtual products, namely, software in connection with the online retail of virtual products, namely, home appliances, cookers, refrigerators, ovens, washing machines, dishwashers, air conditioners, cooling and heating systems, kitchen utensils, smartphones, smart watches [smartwatches], computers, laptops, televisions, monitors, tablets, scales, electronic scales, solar panels for power generation; downloadable software to provide access to online virtual environments; downloadable software for creating, producing, and editing animated and non-animated digital drawings and characters, avatars, digital overlays, and skins for access and use in online environments, online virtual environments, and extended reality virtual environments; downloadable computer software for managing, displaying, monetizing, buying, selling, trading, transferring, clearing, confirming, and authenticating virtual products, blockchain tokens, digital tokens, non-fungible tokens, digital media, digital files, and digital assets; downloadable software for use as digital token wallets; downloadable software to enable users to create, store, send, receive, accept, exchange and transmit digital goods electronically.

11 – Cooking stoves; gas and/or electric cookers; gas and electric stoves; cooktops; refrigerating cabinets; combined refrigerators and freezers; domestic refrige-

rators; combinations of refrigerators and freezers; gas ovens; electric ovens; microwave ovens [cooking apparatus]; food cooking appliances; extractor hoods for kitchens; clothes dryers; industrial dishdrying machines; electric cooking utensils, namely, pressure cookers, multi-baking appliances, pressure cooking systems, rice cookers, deep fryers, grills [cooking appliances], griddles, toasters, waffle makers, pancake and crepe making machines, egg cooking appliances, rotisseries, warmers, heaters, yogurt makers, ice cream makers; appliances for making hamburgers, fondue, raclette, tajine; electric machines for making beverages; electric appliances for making yoghurt; electric kettles; electric coffee makers; coffee machines; electric cooking appliances; programmable kitchen cooking appliances; heating, ventilation and water supply appliances and systems; home heating appliances and systems; solar heating equipment and appliances; boilers; heating boilers; combination boilers; combined thermoelectric boilers; water heaters; gas boilers; solar heating panels; solar thermal collectors [heating]; solar thermal panels; air-conditioning appliances; solar thermal collectors [heating]; fans [air-conditioning]; mobile air conditioning apparatus; combined heating and air conditioning apparatus; humidification apparatus for use with air conditioning apparatus.

(260) AM 2026 131209 A

(800) 1826341

(151) 2024 11 06

(891) 2024 11 06

(731) Noscat Pharma GmbH

Wallnerstrasse 4/WA21a, A-1010 Vienna,
Austria

(540)

Slamiry

(591) Black, white

(511)

5 – Pharmaceutical preparations and substances for treatment of diseases in the field of paediatrics, gynaecology, urology, pain, respiratory, central nervous system [CNS], ophthalmology; food supplements for use in the field of paediatrics, gynaecology, urology, pain treatment, respiratory, central nervous system [CNS], ophthalmology; dietetic food and substances adapted for medical use; dietary supplements for human beings; vitamins and vitamin preparations.

10 – Surgical and medical apparatus and instruments for use in the field of paediatrics, gynaecology, urology, pain treatment, respiratory, central nervous system [CNS], ophthalmology.

(260) AM 2026 131217 A

(800) 1826661

(151) 2024 10 11

(891) 2024 10 11

(731) Ehrmann SE

A.-Ehrmann-Straße 2, 87770 Oberschöneck,
Germany

(540)

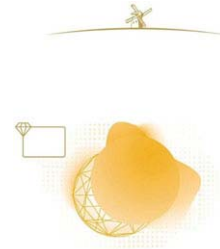

(591) White, beige, yellow, light-yellow, dark-yellow and light-orange

(531) 01.05.23; 07.01.13; 17.02.02; 25.07.01;
26.15.01; 29.01.13

(511)

5 – Powdered milk for babies; products based on powdered milk for babies; breast-milk substitutes; food for babies; lacteal flour for babies; infant formula; food and beverages for infants; food for babies, including food for babies based on fruit, berries, vegetables, meat, soya, milk; food for babies, including porridge, fruit and cereal porridge, instant porridge [grain porridge, grain porridge with fruit, grain porridge with milk, grain porridge with infant milk formula, grain porridge fortified with probiotics or prebiotics]; dairy-free instant porridge, fortified with vitamins and mineral substances for babies [food for babies]; fruit, berry, fruit and berry, vegetable, fruit and vegetable purées for babies [food for babies]; powdered instant or pre-cooked soup and pudding for babies [food for babies]; drinking water for babies [food for babies]; powdered and liquid starch drink for babies [food for babies]; fortified fruit juices and fruit and vegetable juices for babies [food for babies]; vegetable, berry, fruit based desserts for babies [food for babies].

(260) AM 2026 131416 A

(800) 1828457

(151) 2024 11 06

(891) 2024 11 06

(731) GitHub, Inc.

88 Colin P. Kelly Street, San Francisco
CA 94107, USA

(540)

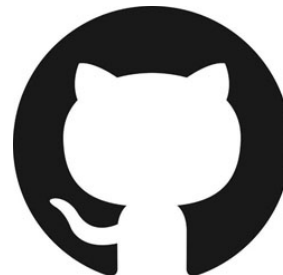

(591) Black, white

(531) 03.01.06; 03.01.16; 26.01.03; 26.01.15;
26.01.24

(511)

9 – Downloadable software that enables users to share and collaboratively develop software, computer code and user-generated content; downloadable computer software using artificial intelligence for code generation and software development; downloadable computer software in the nature of software extensions and plugins for code generation and software development; downloadable computer software development tools.

42 – Computer programming; computer services, namely, hosting and maintaining an on-line web site for others for collaboratively developing software; computer software consulting; computer technology support services, namely, help desk services; data migration services; design and development of computer software; electronic data storage; hosting on-line web facilities for others for a distributed control system for the collaborative development of software; hosting of digital content on the Internet; hosting of web sites; platform as a service (PAAS) featuring computer software platforms for the collaborative development of software; services for updating computer software; software as a service (SAAS) services, namely, hosting software for use by others for use in the collaborative development of software; technical support services, namely, troubleshooting of computer software problems; software as a service (SAAS) services featuring software using artificial intelligence for code generation and software development.

(260) AM 2026 131417 A

(800) 1828461

(151) 2024 07 19

(891) 2024 07 19

(731) Anton Konstantinov

Calle Ampolla, 14 C, E-08850 Gava,
Barcelona, Spain

(540)



PERFUMATIC

(591) White, black and gradient of red

(531) 10.05.19; 26.03.01; 27.03.15; 27.05.01;
27.05.09; 27.05.10; 27.05.19; 29.01.13

(511)

7 – Dispensing machines.

35 – Promotional, marketing and advertising services.

(260) AM 2026 131418 A

(800) 1828462

(151) 2024 09 17

(891) 2024 09 17

(731) LABORATORIOS NORMON, S.A.

Ronda de Valdecarrizo, 6, E-28760 Tres Cantos
(Madrid), Spain

(540)

BUCOMED

(591) Black, white

(511)

3 – Non-medicinal toiletry preparations and cosmetic products; non-medicinal dentifrices; perfumery, essential oils; bleaching preparations and other substances for laundry use; cleaning, polishing, degreasing and abrasive preparations.

5 – Pharmaceutical products, preparations for medical and veterinary use; hygienic and sanitary products for medical use; dietetic food and substances for medical or veterinary use, food for babies; food supplements for persons or animals; plasters, material for dressings; material for dental fillings and impressions; disinfectants; products for destroying vermin; fungicides, herbicides.

21 – Toothbrushes, interdental cleaners and dental floss.

(260) AM 2026 131419 A

(800) 1828518

(151) 2024 07 30

(891) 2024 07 30

(731) SAMSUNG ELECTRONICS CO., LTD.

129, Samsung-ro, Yeongtong-gu, Suwon-si,
Gyeonggi-do, Republic of Korea

(540)

Samsung Friends

(591) Black, white

(511)

7 – Robotic vacuum cleaners; dish washing machines for household purposes; washing machines for household purposes; vacuum cleaners; dust filters for vacuum cleaners; vacuum cleaner bags; air condensers; automatic dust exhausting installations for cleaners for household purposes; decorative replacement panels for robotic vacuum cleaners.

9 – Light emitting diode (LED) displays; virtual reality headsets; blank USB flash drives; blank flash memory cards; network routers; digital door locks; digital signage display panels; digital signage; digital signage monitors; semiconductors; battery chargers; video projectors; set-top boxes; solid state drives; smartphones; smart watches; audio speakers; wearable computers; ear buds; electric sensors; electronic pens; capacitive styluses for touch screen devices; stylus pen for touch screens; wearable activity trackers; rechargeable electric batteries; cameras; computers; computer monitors; tablet computers; televisions; headphones; earphones; portable computers; mobile telephones; bags adapted for laptops; bags adapted or shaped to contain electronic notepads; pouches for mobile telephones; pouches for smartphones; protective covers and cases for tablet computers; bags adapted for tablet computers; television monitor frames; cases adapted for projectors; protective cases for projectors; carrying cases adapted for projectors; covers

adapted for projectors; cases for projector batteries; protective covers for smartphones; protective films adapted for smartphones; protective films adapted for liquid crystal display screens for smartphones; reinforced glass specially adapted for use as smartphone screens; protective covers for ear buds; cases for wireless earphones; straps for smartwatches; bands for smartwatches; screens made of reinforced glass specially adapted for smartwatches; screens for projectors; virtual reality goggles.

11 – Filters for air purifiers; electric water purification filters for household purposes; filters for water purifying apparatus; filters for water filtering apparatus; air purification panels having decoration function; panels with decoration function being structural parts of refrigerators; panels with decoration function being structural parts of electric refrigerators; replacement doors having decoration function for electric refrigerators; LED lamps; LED light bulbs; electric cooking ovens; electric clothes drying machines for household purposes; electric clothes drying apparatus with deodorization, sterilization and steaming functions for household purposes; dehumidifiers for household use; air purifiers; electric fans; air conditioners; electric refrigerators; electric ranges; electric laundry dryers; microwave ovens; induction cooker for household purposes; air conditioning panels having decoration function.

(260) AM 2026 131420 A
 (800) 1828520
 (151) 2024 08 23
 (891) 2024 08 23
 (731) Obshchestvo s ogranichennoy otvetstvennostyu "STEELPOWERCAP" ul. Barykina, d. 291B, 246034 Gomel, Belarus

(540)

ПОЛИНКА

(591) Black, white
 (531) 28.05
 (511)

6 – Preserve tins; bottle caps of metal; screw tops of metal for bottles; metal lids for canning; sealing caps of metal; bottle closures of metal; metal closures for cans; tinplate packings.

35 – Wholesale and retail trade services, relating to preserve tins, bottle caps of metal, screw tops of metal for bottles, metal lids for canning, sealing caps of metal, bottle closures of metal, metal closures for cans, tinplate packings, the above mentioned goods are also provided through shops and using the global computer network (the Internet).

(260) AM 2026 131421 A
 (800) 1828535
 (151) 2024 10 22
 (891) 2024 10 22

(731) RENAULT s.a.s.
 122-122bis avenue du General Leclerc,
 F-92100 Boulogne Billancourt, France

(540)

RENO

(591) Black, white
 (531) 27.05.01
 (511)

12 – Vehicles, apparatus for locomotion by land, automobiles, their components, namely suspension shock absorbers for vehicles; shock absorbers for automobiles; headrests for vehicle seats; transmission shafts for land vehicles; gear boxes for land vehicles; hoods for vehicles; automobile hoods; hoods for vehicle engines; automobile bodies; safety belts for vehicle seats; automobile chassis; hydraulic circuits for vehicles; air bags [safety devices for automobiles]; brake disks for vehicles; clutches for land vehicles; hub caps; windshield wipers; vehicle brakes; vehicle wheel rims; vehicle running boards; engines for land vehicles; windshields; bumpers for automobiles; tires; luggage carriers for vehicles; doors for vehicles; vehicle wheels; rearview mirrors; vehicle seats; windows for vehicles; steering wheels for vehicles; vehicle covers [shaped].

(260) AM 2026 131422 A
 (800) 1828602
 (151) 2024 10 31
 (891) 2024 10 31
 (731) OSRAM GmbH
 Marcel-Breuer-Str. 4, 80807 München,
 Germany

(540)



(591) Red, orange, grey and white
 (531) 01.03.02; 01.15.09; 25.01.10; 25.05.02;
 25.12.01; 26.04.07; 26.04.10; 26.04.13;
 26.11.06; 26.11.08; 29.01.14

(511)

11 – Lighting apparatus, in particular electric lamps and luminaires; lighting apparatus; lighting apparatus based on light-emitting diodes (LEDs), including organic LEDs, LED lamps and LED luminaires and parts thereof; LED-based lighting equipment and parts thereof.

(260) AM 2026 131550 A

(800) 1830765

(151) 2024 07 05

(891) 2024 07 05

(731) Kasakin Evgeny Vitalievich

Parkovaya str. 12, RU-423603 Yelabuga,
Republic of Tatarstan, Russian Federation

(540)

Allai

(591) Black, white

(511)

9 – Interfaces for computers; monitors [computer programs]; downloadable application software for virtual environments; computer software, recorded; downloadable computer software for managing crypto asset transactions using blockchain technology; software as a medical device [SaMD], downloadable; computer software platforms, recorded or downloadable; computer software applications, downloadable; downloadable computer software applications for minting non-fungible tokens [NFTs]; computer programs, recorded; computer game software, downloadable; computer programs, downloadable; computer operating programs, recorded; computer screen saver software, recorded or downloadable; downloadable computer games; computer game software; downloadable electronic games; downloadable computer game programs.

28 – Bladders of balls for games; artificial fishing bait; caps for pistols [toys]; toys for pets; ring games; Christmas trees of synthetic material; bows for archery; archery implements; edges of skis; swings; balls for games; party balloons; billiard table cushions; rocking horses; batting gloves [accessories for games]; dolls' feeding bottles; stationary exercise bicycles; billiard balls; chalk for billiard cues; billiard markers; skittles; marbles for games; toys; building blocks [toys]; bob-sleighs; Christmas crackers [party novelties]; candle holders for Christmas trees; balls for playing boules games; bowling apparatus and machinery; boxing gloves; gut for rackets; golf clubs; rods for fishing; kites; kite reels; targets; bells for Christmas trees; counters [discs] for games; building games; strings for rackets; machines for physical exercises; body-building apparatus; body-training apparatus; body rehabilitation apparatus; novelty toys for parties; cricket bags; hockey sticks; draughts [games]; checkers [games]; dice; chest expanders [exercisers]; exercisers [expanders]; dominoes; chess games; chessboards; draughtboards; checkerboards; toy pistols; rollers for stationary exercise bicycles; landing nets for anglers; golf bags, with or without wheels; novelty toys for playing jokes; tennis nets; ski bindings; darts; floats for fishing; foosball tables; gloves for games; cups for dice; fish hooks; rattles [playthings]; board games; games; clay pigeon traps; rackets; bats for games; decoys for hunting or fishing; lures for hunting or fishing; fishing tackle; fishing lines; dolls' beds; dolls' houses; puppets; marionettes; dolls; theatrical masks;

carnival masks; reels for fishing; flippers for swimming; creels [fishing traps]; swimming pools [play articles]; artificial snow for Christmas trees; quoits; roller skates; ice skates; seal skins [coverings for skis]; clay pigeons [targets]; surfboards; dolls' clothes; dolls' rooms; conjuring apparatus; skittles [games]; ninepins; gut for fishing; sole coverings for skis; skis; tables for table tennis; spinning tops [toys]; backgammon games; scooters [toys]; shuttlecocks; toy air pistols; percussion caps [toys]; detonating caps [toys]; ornaments for Christmas trees, except lights, candles and confectionery; Christmas tree stands; billiard cues; billiard cue tips; billiard tables; coin-operated billiard tables; surf skis; sailboards; hang gliders; apparatus for games; appliances for gymnastics; fencing weapons; fencing masks; fencing gauntlets; fencing gloves; baseball gloves; climbers' harness; toy mobiles; paragliders; skateboards; slides [playthings]; teddy bears; waterskis; golf gloves; bite indicators [fishing tackle]; bite sensors [fishing tackle]; table-top games; fairground ride apparatus; flying discs [toys]; horseshoe games; mah-jong; plush toys; soap bubbles [toys]; toy vehicles; twirling batons; butterfly nets; bags especially designed for skis; harness for sailboards; jigsaw puzzles; masts for sailboards; surfboard leashes; tennis ball throwing apparatus; snow globes; bodyboards; bingo cards; divot repair tools [golf accessories]; pitch mark repair tools [golf accessories]; hunting game calls; roulette wheels; in-line roller skates; piñatas; punching bags; rosin used by athletes; snowshoes; kaleidoscopes; playing cards; confetti; electronic targets; scent lures for hunting or fishing; snowboards; scale model kits [toys]; pachinkos; ascenders [mountaineering equipment]; slot machines [gaming machines]; paper party hats; swimming kickboards; chips for gambling; scratch cards for playing lottery games; stuffed toys; trampolines; poles for pole vaulting; water wings; swimming belts; swimming jackets; portable games with liquid crystal displays; controllers for game consoles; toy models; toy figures; ball pitching machines; dumb-bells; masks [playthings]; matryoshka dolls; controllers for toys; golf bag trolleys; golf bag carts; paddleboards; gyroscopes and flight stabilizers for model aircraft; joysticks for video games; protective films adapted for screens for portable games; drones [toys]; toy robots; needles for pumps for inflating balls for games; pumps specially adapted for use with balls for games; baby gyms; plush toys with attached comfort blanket; tricycles for infants [toys]; toy imitation cosmetics; swimming pool air floats; rhythmic gymnastics ribbons; party poppers [party novelties]; toy putty; toy dough; portable games and toys incorporating telecommunication functions; boomerangs; trading cards for games; waist trimmer exercise belts; flippers for diving; swimming webs; webbed gloves for swimming; inflatable games for swimming pools; roller skis; ski sticks; ski poles; ski sticks for roller skis; ski poles for roller skis; yoga swings; play tents; video game consoles; hand-held

consoles for playing video games; playhouses for children; golf bag tags; skeleton sleds; bags especially designed for surfboards; fidget toys; bowling balls; exercise weights; toy glow stick bracelets for parties; hand clappers [noisemaker toys]; action figures; trading card games; card games; playground sandboxes; hoops for exercise incorporating measuring sensors; adhesive abdominal exercise belts, electric, for muscle stimulation; external cooling fans for game consoles; ball-jointed dolls [BJD]; grip tapes for rackets; toy musical instruments; fishing gaffs; balance bicycles [toys]; weight vests for physical training purposes.

35 – Business management assistance; business inquiries; bill-posting; import-export agency services; commercial information agency services; cost price analysis; dissemination of advertising matter; photocopying services; employment agency services; office machines and equipment rental; book-keeping; accounting; drawing up of statements of accounts; business auditing; business management and organization consultancy; personnel management consultancy; business management consultancy; typing; demonstration of goods; direct mail advertising; commercial or industrial management assistance; updating of advertising material; distribution of samples; business efficiency expert services; auctioneering; market studies; business appraisals; business investigations; publicity material rental; business organization consultancy; publication of publicity texts; advertising; publicity; radio advertising; business research; public relations; shorthand; television advertising; transcription of communications [office functions]; shop window dressing; advertising agency services; publicity agency services; advisory services for business management; modelling for advertising or sales promotion; marketing research; computerized file management; professional business consultancy; economic forecasting; organization of exhibitions for commercial or advertising purposes; providing business information; opinion polling; payroll preparation; personnel recruitment; administrative services for the relocation of businesses; rental of advertising space; sales promotion for others; secretarial services; tax preparation; telephone answering for unavailable subscribers; word processing; arranging newspaper subscriptions for others; advertising by mail order; business management of hotels; business management of performing artists; compilation of information into computer databases; systemization of information into computer databases; organization of trade fairs; rental of photocopying machines; online advertising on a computer network; procurement services for others [purchasing goods and services for other businesses]; data search in computer files for others; rental of advertising time on communication media; rental of vending machines; psychological testing for the selection of personnel; price comparison services; presentation of goods on communication media, for retail purposes; providing commercial information and advice for consumers in the choice of

products and services; arranging subscriptions to telecommunication services for others; administrative processing of purchase orders; commercial administration of the licensing of the goods and services of others; outsourcing services [business assistance]; invoicing; writing of publicity texts; compilation of statistics; layout services for advertising purposes; sponsorship search; organization of fashion shows for promotional purposes; production of advertising films; business management of sports people; marketing; telemarketing services; rental of sales stands; providing commercial and business contact information; search engine optimization for sales promotion; search engine optimisation for sales promotion; website traffic optimization; website traffic optimisation; pay per click advertising; commercial intermediation services; business management for freelance service providers; negotiation and conclusion of commercial transactions for third parties; updating and maintenance of data in computer databases; business project management services for construction projects; providing business information via a website; provision of an online marketplace for buyers and sellers of goods and services; development of advertising concepts; outsourced administrative management for companies; tax filing services; business management of reimbursement programmes for others; business management of reimbursement programs for others; rental of billboards [advertising boards]; writing of curriculum vitae for others; writing of résumés for others; web indexing for commercial or advertising purposes; administration of frequent flyer programs; appointment scheduling services [office functions]; appointment reminder services [office functions]; administration of consumer loyalty programs; scriptwriting for advertising purposes; registration of written communications and data; updating and maintenance of information in registries; compiling indexes of information for commercial or advertising purposes; business intermediary services relating to the matching of potential private investors with entrepreneurs needing funding; production of teleshopping programmes; production of teleshopping programs; consultancy regarding public relations communication strategies; consultancy regarding advertising communication strategies; negotiation of business contracts for others; promotion of goods and services through sponsorship of sports events; competitive intelligence services; market intelligence services; financial auditing; online retail services for downloadable digital music; online retail services for downloadable ring tones; online retail services for downloadable and pre-recorded music and movies; gift registry services; targeted marketing; interim business management; outdoor advertising; retail services for works of art provided by art galleries; administrative assistance in responding to calls for tenders; administrative assistance in responding to requests for proposals [RFPs]; marketing in the framework of software publishing; media relations services;

corporate communications services; rental of office equipment in co-working facilities; commercial lobbying services; providing user reviews for commercial or advertising purposes; providing user rankings for commercial or advertising purposes; providing user ratings for commercial or advertising purposes; consumer profiling for commercial or marketing purposes; administrative services for medical referrals; business consultancy services for digital transformation; business intermediary services relating to the matching of various professionals with clients; reception services for visitors [office functions]; preparation of business profitability studies; providing telephone directory information; arranging and conducting of commercial events; data processing services [office functions]; rental of cash registers; lead generation services; computerized management of medical records and files; advertising services to create brand identity for others; promotion of goods through influencers; influencer marketing; sales prospecting for others; development of marketing concepts.

38 – Electronic bulletin board services [telecommunications services]; providing user access to global computer networks; providing access to databases; providing internet chatrooms; providing telecommunications connections to a global computer network; video-on-demand transmission; message sending; computer aided transmission of messages and images; transmission of digital files; providing access to blockchain networks; providing information in the field of telecommunications; providing online forums; providing online virtual reality-based forums for work collaboration; providing chatrooms in virtual environments; news agency services; streaming of data.

41 – Academies [education]; entertainment services; organization of competitions [education or entertainment]; correspondence courses; providing recreation facilities; radio entertainment; publication of texts, other than publicity texts; teaching; educational services; instruction services; film production, other than advertising films; publication of books; television entertainment; mobile library services; bookmobile services; arranging and conducting of colloquiums; arranging and conducting of conferences; arranging and conducting of congresses; providing information in the field of education; providing information in the field of entertainment; organization of exhibitions for cultural or educational purposes; practical training [demonstration]; providing information relating to recreational activities; arranging and conducting of seminars; arranging and conducting of symposiums; arranging and conducting of workshops [training]; arranging of beauty contests; online publication of electronic books and journals; electronic desktop publishing; subtitling; game services provided online from a computer network; providing online electronic publications, not downloadable; photographic reporting; photography; vocational guidance [education or training

advice]; news reporters services; translation; sign language interpretation; arranging and conducting of concerts; coaching [training]; language interpretation; vocational retraining; providing online music, not downloadable; providing online videos, not downloadable; tutoring; arranging and conducting of in-person educational forums; providing films, not downloadable, via video-on-demand services; providing television programmes, not downloadable, via video-on-demand services; providing television programs, not downloadable, via video-on-demand services; know-how transfer [training]; educational services provided by special needs assistants; film directing, other than advertising films; providing user reviews for entertainment or cultural purposes; providing user rankings for entertainment or cultural purposes; providing user ratings for entertainment or cultural purposes; organization of electronic sports competitions; e-sports services; multimedia library services; transfer of business knowledge and know-how [training]; providing training and educational examination for certification purposes; research in the field of education; arranging and conducting of entertainment events; arranging and conducting of sports events; captioning; production of podcasts; providing online images, not downloadable; providing online virtual guided tours.

42 – Industrial design; computer programming; computer software design; updating of computer software; consultancy in the design and development of computer hardware; graphic arts design; research and development of new products for others; recovery of computer data; maintenance of computer software; computer system analysis; computer system design; duplication of computer programs; conversion of data or documents from physical to electronic media; creating and maintaining websites for others; hosting computer websites; installation of computer software; conversion of computer programs and data, other than physical conversion; computer software consultancy; computer virus protection services; providing search engines for the internet; digitization of documents [scanning]; monitoring of computer system operation by remote access; software as a service [SaaS]; information technology [IT] support services [troubleshooting of software]; server hosting; off-site data backup; electronic data storage; providing information relating to computer technology and programming via a website; cartography services; providing virtual computer systems through cloud computing; computer technology consultancy; telecommunications technology consultancy; computer security consultancy; interior design; monitoring of computer systems to detect breakdowns; creating and designing website-based indexes of information for others [information technology services]; internet security consultancy; data security consultancy; data encryption services; monitoring of computer systems for detecting unauthorized access or data breach; electronic monitoring of personally identifying information to detect identity theft via the

internet; electronic monitoring of credit card activity to detect fraud via the internet; software development in the framework of software publishing; platform as a service [PaaS]; development of computer platforms; business card design; research in the field of telecommunications technology; graphic design of promotional materials; user authentication services using technology for e-commerce transactions; user authentication services using single sign-on technology for on-line software applications; writing of computer code; telecommunication network security consultancy; design of computer-simulated models; computer graphic design for video projection mapping; digital forensic investigations in the field of computer crimes; technological consultancy services for digital transformation; rental of data centre facilities; providing geographic information; providing online geographic maps, not downloadable; artificial intelligence consultancy; research in the field of artificial intelligence technology; user authentication services using blockchain technology; development of video and computer games; computer programming services for data processing; software engineering services for data processing.

45 – Leasing of internet domain names; licensing [legal services] in the framework of software publishing; licensing of computer software [legal services]; registration of domain names [legal services].

(260) AM 2026 131551 A

(800) 1830792

(151) 2024 08 16

(891) 2024 08 16

(731) Euro Games Technology Ltd.

Panorama Sofia Str. 6, Richhill Business Center, ground floor, Vitosha Region, BG-1766 Sofia, Bulgaria

(540)

20 BURNING POWER

(591) Green, red, white and black

(531) 27.05.02; 27.05.03; 27.05.17; 27.07.02; 27.07.03; 27.07.17; 29.01.14

(511)

9 – Operating computer software for main frame computers; monitors (computer hardware); computer hardware; apparatus for recording images; monitors (computer programs); computer game programs; recorded computer game programs; apparatus for recording, transmission or reproduction of sound or images; communications servers (computer hardware); electronic components for gambling machines; computer application software featuring games and gaming; computer software for the administration of on-line games and gaming; computer hardware for games and gaming; computer hardware and software for gambling, gambling machines, gambling games on the internet and via telecommunication network; computer systems; computer operating system software; compu-

ter terminals; interactive terminals; multimedia terminals; electronic terminals for generating lottery tickets; interactive touch screen terminals; computer touchscreens; electronic display panels; liquid crystal display screens; digital signage display panels; multimedia software; multimedia apparatus and instruments; interactive multimedia software for playing games; computer screens; LCD large-screen displays; liquid crystal displays [LCDs] for home theatres; media streaming software; computer application software for streaming audio-visual media content via the internet; computer gaming software; software drivers; virtual reality software; games software; entertainment software for computer games; computer programs for network management; electronic lottery tickets; computer software platforms; operating systems; interactive computer systems; operating system programs; computer game software for use with on-line interactive games; interactive casino games provided through a computer or mobile platform; electronic ticket examination machines; software for slot machines, betting software, software for video slot games, for casino games, for gambling and bingo games, provided online or through computer networks and that can be played on any type of computer device, including arcade games, personal computers, portable devices and mobile phones; software; computer software packages; computer software, recorded.

28 – Gaming machines for gambling; chips for gambling; mah-jong; arcade games; gambling machines operating with coins, notes and cards; games; electronic games; parlor games; gaming chips; gaming tables; slot machines [gaming machines]; LCD game machines; slot machines and gaming devices; coin-operated amusement machines; roulette chips; poker chips; chips and dice [gaming equipment]; gaming equipment for casinos; roulette tables; gaming roulette wheels; casino games; gambling machines and amusement machines, automatic and coin-operated; coin-operated amusement machines with or without the possibility of gain; boxes for coin-operated amusement machines, slot machines and gaming machines; electronic or electrotechnical amusement machines and apparatus, gaming machines, coin-operated entertainment machines; housings for coin-operated amusement machines, gaming equipment, gaming machines, machines for gambling; electropneumatic and electrical gambling machines (slot machines); lottery games; electronic targets for games and sports; parlor game equipment and accessories therefor, included in this class, in particular gaming tokens, chips and marbles; parlor games, game apparatus and equipment and accessories therefor, included in this class, in particular electronic targets, backgammon games, scratch cards, playing cards, lottery cards, dice; lottery tickets; printed lottery tickets; lottery scratch cards; scratch cards for playing lottery games.

41 – Gambling; gaming services for entertainment purposes; casino, gaming and gambling services; training in the development of software systems; provision of gaming equipment for gambling halls; providing casino equipment [gambling]; gaming machine entertainment services; providing casino facilities [gambling]; amusement arcade services; games equipment rental; rental of gaming machines; providing amusement arcade services; rental of gaming machines with images of fruits; editing or recording of sounds and images; sound recording and video entertainment services; hire of sound reproducing apparatus; provision of gaming equipment for casinos; providing of casino facilities; online gambling services; entertainment services related to operation of amusement arcades, on-line casinos and on-line betting services via websites; online interactive entertainment; on-line casino services; online game services through mobile devices; providing online entertainment in the nature of game tournaments; providing on-line information in the field of computer gaming entertainment; sports betting services; online sports betting services; lottery services; organization of lotteries; conducting lotteries; prize draws [lotteries]; conducting lotteries for others; providing slot machine parlors; rental of slot machines [gaming machines]; providing online games and games of chance.

(260) AM 2026 131552 A

(800) 1830821

(151) 2024 11 15

(891) 2024 11 15

(731) Foodtech Holding Middle East FZ-LLC
T1-TF-48, RAKEZ Amenity Center, Al
Hamra Industria l Zone-FZ, Ras Al Khaimah,
United Arab Emirates

(540)



(591) Red

(531) 04.05.13; 27.05.10; 29.01.12

(511)

43 – Services for the preparation of food and beverages; temporary accommodation.

(260) AM 2026 131553 A

(800) 1830839

(151) 2024 07 16

(891) 2024 07 16

(731) Yandex LLC

Leo Tolstoy Str. 16, RU-119021 Moscow,
Russian Federation

(540)

Yandex Plus

(591) Black, white

(511)

9 – 3D spectacles; DVD players; coin-operated musical automata [juke boxes]; answering machines; electrical adapters; accumulators, electric; ear pads for headphones; high-frequency apparatus; monitoring apparatus, other than for medical purposes; sound recording apparatus; global positioning system [GPS] apparatus; remote control apparatus; sound transmitting apparatus; intercommunication apparatus; telephone apparatus; facsimile machines; accumulator jars; automated teller machines [ATM]; batteries, electric; binoculars; biochips; electronic tags for goods; computer memory devices; encoded identification bracelets, magnetic; connected bracelets [measuring instruments]; electronic key fobs being remote control apparatus; camcorders; video projectors; video telephones; video screens; mechanical signs; digital signs; hands-free kits for telephones; holders adapted for mobile telephones and smartphones; sound recording discs; electronic numeric displays; electronic interactive whiteboards; electronic notice boards; biometric locks; signs, luminous; downloadable emoticons for mobile phones; interfaces for computers; audio interfaces; biometric identity cards; identity cards, magnetic; memory cards for video game machines; encoded magnetic cards; computer keyboards; downloadable cryptographic keys for receiving and spending crypto assets; encoded key cards; electronic book readers; electronic agendas; mouse pads; dashboard mats adapted for holding mobile telephones and smartphones; portable speakers; mobile phone ring holders; mobile phone ring stands; compact discs [audio-video]; compact discs [read-only memory]; computers; quantum computers; wearable computers; laptop computers; tablet computers; notebook computers; virtual reality controllers; cryptocurrency hardware wallets; downloadable e-wallets; motion tracking mounts for cameras; lanyards for cell phones; magnets; decorative magnets; computer network routers; portable media players; modems; monitors [computer hardware]; monitors [computer programs]; selfie sticks [hand-held monopods]; data sets, recorded or downloadable; headphones; sound recording carriers; magnetic data media; computer game software, recorded; computer software, recorded; downloadable computer software for managing crypto asset transactions using blockchain technology; software as a medical device [SaMD], downloadable; computer hardware; selfie lenses; downloadable virtual clothing; eyeglasses; spectacles for correcting color vision deficiency; sunglasses; goggles for sports; signalling panels, luminous or mechanical; biometric passports; electronic pocket translators; computer software platforms, recorded or downloadable; protective films adapted for computer screens; protective films adapted for smartphones; sound recording strips; mobile phone screen protectors; gimbals for smartphones; gimbals for digital cameras; stands adapted for laptops; in-car telephone handset cradles; cooling pads for laptop computers;

personal digital assistants [PDAs]; distance recording apparatus; speed checking apparatus for vehicles; teaching apparatus; time recording apparatus; navigational instruments; navigation apparatus for vehicles [on-board computers]; satellite navigational apparatus; telecommunication apparatus in the form of jewelry; audio- and video-receivers; computer software applications, downloadable; downloadable computer software applications for minting non-fungible tokens [NFTs]; wireless portable printers for use with laptops and mobile devices; printers for use with computers; downloadable application software for virtual environments; computer programs, recorded; computer screen saver software, recorded or downloadable; computer game software, downloadable; computer programs, downloadable; computer operating programs, recorded; electronic publications, downloadable; voltage regulators for vehicles; security surveillance robots; laboratory robots; teaching robots; telepresence robots; user-programmable humanoid robots, not configured; humanoid robots with artificial intelligence for preparing beverages; electronic access control systems for interlocking doors; scanners for data processing; portable document scanners; hand-held electronic dictionaries; smart speakers; integrated circuit cards [smart cards]; smartglasses; smartphones; foldable smartphones; smartwatches; audiovisual teaching apparatus; charging stations for electric vehicles; bags adapted for laptops; integrated circuits; counters; parking meters; kilometer recorders for vehicles; television apparatus; cordless telephones; mobile telephones; ticket dispensing terminals, electronic; credit card terminals; interactive touchscreen terminals; point-of-sale [POS] terminals; self-checkout terminals; steering apparatus, automatic, for vehicles; video recorders; sound reproduction apparatus; invoicing machines; data processing apparatus; theft prevention installations, electric; devices for the projection of virtual keyboards; mobile phone chargers; portable power chargers; sound alarms; wearable activity trackers; computer peripheral devices; readers [data processing equipment]; bar code readers; downloadable ring tones for mobile phones; downloadable image files; downloadable music files; downloadable digital music files authenticated by non-fungible tokens [NFTs]; downloadable digital image files authenticated by non-fungible tokens [NFTs]; animated cartoons; filters for use in photography; USB flash drives; cameras [photography]; eyeglass cases; cases for smartphones; smart home hubs; eyeglass chains; sleeves for laptops; covers for personal digital assistants [PDAs]; covers for tablet computers; covers for smartphones; cases for smartphones incorporating a keyboard; pedometers; virtual reality headsets; neural helmets, not for medical purposes; cell phone straps; eyeglass cords; downloadable graphics for mobile phones.

16 – Fountain pens; albums; banners of paper; name badges [office requisites]; tickets; baggage claim

check tags of paper; tags for index cards; forms, printed; announcement cards [stationery]; note books; drawing pads; pads [stationery]; pamphlets; booklets; paper; paper sheets [stationery]; copying paper [stationery]; newsletters; signboards of paper or cardboard; newspapers; document holders [stationery]; magnetic boards being office requisites; galley racks [printing]; magazines [periodicals]; bookmarks; periodicals; printed publications; graphic representations; calendars; pencils; pictures; transfers [decalcomanias]; coloring pictures; paintings [pictures], framed or unframed; cards; index cards [stationery]; printed geographical maps; trading cards, other than for games; catalogues; books; coloring books; manifolds [stationery]; comic books; desk mats; envelopes [stationery]; boxes of paper or cardboard; printed coupons; barcode ribbons; self-adhesive tapes for stationery or household purposes; flyers; letter trays; postage stamps; graphic prints; teaching materials [except apparatus]; sealing compounds for stationery purposes; packing [cushioning, stuffing] materials of paper or cardboard; bags [envelopes, pouches] of paper or plastics, for packaging; stickers [stationery]; bottle envelopes of paper or cardboard; passport holders; protective covers for books; covers [stationery]; musical greeting cards; greeting cards; postcards; folders for papers; posters; handkerchiefs of paper; bookends; stands for pens and pencils; face towels of paper; towels of paper; writing materials; writing instruments; school supplies [stationery]; hand labelling appliances; printed matter; prospectuses; printed timetables; marking pens [stationery]; pens [writing implements] incorporating tips for operating touchscreen devices; tissue paper; tissues of paper for removing make-up; paper wipes for cleaning; clips for offices; shopping bags of paper or plastic; calculating tables; placards of paper or cardboard; writing or drawing books; stationery; bottle wrappers of paper or cardboard; manuals [handbooks]; paper coffee filters; flip charts; photographs [printed]; stencils [stationery]; printing type; advertisement boards of paper or cardboard; labels of paper or cardboard.

28 – Amusement machines, automatic and coin-operated; printed lottery tickets; jigsaw puzzles; joysticks for video games; surfboards; sailboards; chessboards; checkerboards; drones [toys]; kites; toys; fidget toys; toys for pets; stuffed toys; inflatable games for swimming pools; plush toys; toy mobiles; novelty toys for playing jokes; novelty toys for parties; games; portable games and toys incorporating telecommunication functions; card games; trading card games; building games; table-top games; board games; portable games with liquid crystal displays; educational games; ring games; toy imitation cosmetics; kaleidoscopes; trading cards for games; playing cards; gaming keyboards; bells for Christmas trees; confetti; dolls; carnival masks; theatrical masks; scale model vehicles; gaming mice; candle holders for Christmas trees; soap bubbles [toys]; toy robots; skateboards; snowboards; remote-controlled toy vehicles; ornaments for Christ-

mas trees, except lights, candles and confectionery; apparatus for games; toy figures; action figures; chips for gambling; counters [discs] for games; party poppers [party novelties]; hand clappers [noisemaker toys]; christmas crackers [party novelties]; marbles for games; party balloons; chess games; checkers [games]; paper party hats.

35 – Arranging subscriptions to telecommunication services for others; cost price analysis; rental of office equipment in co-working facilities; business auditing; financial auditing; business intermediary services relating to the matching of potential private investors with entrepreneurs needing funding; employment agency services; computerized file management; accounting; invoicing; transcription of communications [office functions]; opinion polling; business information; business research; personnel recruitment; business management and organization consultancy; business organization consultancy; business management consultancy; personnel management consultancy; professional business consultancy; consultancy regarding public relations communication strategies; business management of performing artists; business management of sports people; writing of resumes for others; updating and maintenance of information in registries; updating and maintenance of data in computer databases; word processing; online retail services for downloadable and pre-recorded music and movies; online retail services for downloadable ring tones; online retail services for downloadable digital music; arranging newspaper subscriptions for others; business appraisals; payroll preparation; data search in computer files for others; sponsorship search; providing business information via a website; provision of commercial and business contact information; media relations services; auctioneering; wholesale services for pharmaceutical, veterinary and sanitary preparations and medical supplies; retail services for works of art provided by art galleries; retail services for pharmaceutical, veterinary and sanitary preparations and medical supplies; office machines and equipment rental; rental of vending machines; rental of sales stands; rental of photocopying machines; registration of written communications and data; document reproduction; compilation of statistics; compilation of information into computer databases; business inquiries; systemization of information into computer databases; advisory services for business management; corporate communications services; compiling indexes of information for commercial or advertising purposes; tax preparation; drawing up of statements of accounts; psychological testing for the selection of personnel; interim business management; outsourced administrative management for companies; business management of hotels; business management for freelance service providers; business project management services for construction projects; commercial administration of the licensing of the goods and services of others; business management of reimbursement programs for others; adminis-

tration of consumer loyalty programs; administration of frequent flyer programs; public relations; commercial lobbying services; competitive intelligence services; typing; appointment reminder services [office functions]; web site traffic optimization; administrative services for the relocation of businesses; tax filing services; appointment scheduling services [office functions]; gift registry services; secretarial services; shorthand; telephone answering for unavailable subscribers; photocopying services; subscription to transmission, broadcasting and downloading services for music, video and audiovisual content; organization of subscriptions to transmission, broadcasting and downloading services for music, video and audiovisual content for others; market research services by tracking and measuring viewership, exposure, and reaction to online and television advertising; administration of consumer loyalty programs to provide compensation in the form of discounts on transportation services, early access to retail discounts and promotions, access to books and other publications, access to audiobooks, discounts on online photo and music storage, discounts on music, video and game streaming, discounts on ordering products on trading platforms and marketplaces; administration of consumer loyalty programs that provide participants with discounts on transportation services, early access to retail discounts and promotions, access to books and other publications, access to audiobooks, discounts on online storage of photos and music, and discounts on streaming music, videos and games; wholesale and retail services, including online wholesale and retail services; ordering services, including through a mobile or online application; all the abovementioned services, including provided via a mobile or online application.

36 – Issuance of gift certificates; providing rebates at participating establishments of others through use of a membership card; all the abovementioned services, including provided via a mobile or online application.

38 – News agency services; wireless broadcasting; television broadcasting; cable television broadcasting; electronic bulletin board services [telecommunications services]; information about telecommunication; providing user access to global computer networks; providing access to databases; providing internet chatrooms; providing telecommunications connections to a global computer network; providing telecommunication channels for teleshopping services; video-on-demand transmission; transmission of greeting cards online; message sending; computer aided transmission of messages and images; transmission of telegrams; transmission of digital files; providing online forums; videoconferencing services; rental of message sending apparatus; rental of access time to global computer networks; rental of modems; rental of telecommunication equipment; rental of telephone apparatus; rental of facsimile apparatus; radio broadcasting; radio communications; transmission of electronic mail; commu-

nications by fiber optic networks; communications by cellular phones; communications by computer terminals; satellite transmission; communications by telegrams; communications by telephone; facsimile transmission; paging services [radio, telephone or other means of electronic communication]; teleconferencing services; telex services; voice mail services; telecommunications routing and junction services; streaming of data; telegraph services; telephone services; telecommunications services, namely, transmission of electronic media, multimedia content, videos, films, pictures, images, text, photographs, user content, audio content and information via the Internet and other communication networks; broadcasting, webcasting, streaming and transmission of audio, video, pay-TV and video-on-demand content via the Internet and electronic communication networks; television broadcasting on mobile devices, namely on mobile phones, tablets and personal computers; telecommunications services, namely, provision of e-mail notifications and push notifications via the Internet; providing online forums and access to chatrooms to provide users an opportunity to post, search, view, share, criticize, rate and comment video and other multimedia content via the Internet and other communication networks; all the abovementioned services, including provided via a mobile or online application.

39 – Booking of seats for travel; travel reservation; transport reservation; delivery of newspapers; message delivery; delivery of goods; delivery of goods by mail order; locating and tracking of cargo for transportation purposes; locating and tracking of people for transportation purposes; arranging of cruises; arranging of passenger transportation services for others via an online application; arranging of transportation for travel tours; arranging for travel visas and travel documents for persons travelling abroad; passenger transport; transport brokerage; providing driving directions for travel purposes; providing information relating to storage services; providing transportation information; escorting of travellers; wrapping of goods; courier services [messages or merchandise]; salvaging; luggage storage; physical storage of electronically stored data or documents; storage of goods; warehousing; freight forwarding; all the abovementioned services, including provided via a mobile or online application.

41 – Modelling for artists; academies [education]; rental of indoor aquaria; rental of artwork; rental of sports grounds; rental of tennis courts; lending library services; booking of seats for shows; videotaping; physical education; production of music; discotheque services; animal training; dubbing; gambling services; publication of books; education information; recreation information; entertainment information; film distribution; movie studio services; health club services [health and fitness training]; nightclub services [entertainment]; layout services, other than for advertising

purposes; microfilming; videotape editing; production of radio and television programmes; screenplay writing; religious education; aikido instruction; gymnastic instruction; judo instruction; correspondence courses; practical training [demonstration]; training services provided via simulators; organization of balls; organization of exhibitions for cultural or educational purposes; providing recreation facilities; arranging and conducting of colloquiums; arranging and conducting of congresses; arranging and conducting of conferences; arranging and conducting of concerts; arranging and conducting of workshops [training]; arranging and conducting of in-person educational forums; arranging and conducting of seminars; arranging and conducting of symposiums; organization of competitions [education or entertainment]; arranging of beauty contests; organization of cosplay entertainment events; organization of lotteries; organization of fashion shows for entertainment purposes; organization of shows [impresario services]; organization of sports competitions; vocational guidance [education or training advice]; amusement park services; sign language interpretation; know-how transfer [training]; television entertainment; mobile library services; vocational retraining; providing online videos, not downloadable; providing online music, not downloadable; providing television programs, not downloadable, via video-on-demand services; providing films, not downloadable, via video-on-demand services; providing golf facilities; providing sports facilities; providing amusement arcade services; cinema presentations; providing online electronic publications, not downloadable; presentation of circus performances; presentation of variety shows; presentation of live performances; theatre productions; conducting guided climbing tours; conducting fitness classes; educational examination; film production, other than advertising films; rental of video cassette recorders; rental of videotapes; rental of show scenery; rental of sound recordings; toy rental; rental of cinematographic apparatus; rental of motion pictures; games equipment rental; rental of stadium facilities; rental of lighting apparatus for theatrical sets or television studios; rental of radio and television sets; rental of skin diving equipment; rental of sports equipment, except vehicles; rental of stage scenery; electronic desktop publishing; online publication of electronic books and journals; publication of texts, other than publicity texts; radio entertainment; entertainer services; entertainment; writing of texts; sado instruction [tea ceremony instruction]; zoological garden services; news reporters services; film directing, other than advertising films; party planning [entertainment]; music composition services; subtitling; tutoring; holiday camp services [entertainment]; video editing services for events; conducting guided tours; disc jockey services; sound engineering services for events; game services provided online from a computer network; personal trainer services [fitness training]; providing casino facilities

[gambling]; calligraphy services; karaoke services; club services; songwriting; cultural, educational or entertainment services provided by art galleries; providing museum facilities [presentation, exhibitions]; teaching; educational assistance services for persons with individual needs; educational services provided by schools; orchestra services; translation; scriptwriting, other than for advertising purposes; ticket agency services [entertainment]; educational examination for users to qualify to pilot drones; coaching [training]; lighting technician services for events; sport camp services; recording studio services; language interpreter services; nursery schools; photography; photographic reporting; timing of sports events; boarding school education; production of shows; instruction and educational services, entertainment services, namely providing non-downloadable audio and video entertainment featuring music performances, films, photographs and other multimedia contents via the Internet and other communication networks on a wide range of subjects and topics; providing films and television programs, not downloadable, via video-on-demand services; entertainment services in the form of providing non-downloadable entertainment content via the Internet and other communication networks, namely films, television programs and video featuring comedy, drama, action, adventure, sports, musical, current events, news, documentaries and animation; online publication of diaries [blog services] on the subject of user-generated web content-sites; entertainment services, namely, organization of contests; educational services, namely conducting educational programs in the field of online video production and distribution, user-generated content and online advertising strategy; conducting educational conferences for professionals in the field of online video production and distribution, user-generated content and online advertising strategy; all the abovementioned services, including provided via a mobile or online application.

42 – Artificial intelligence consultancy; computer technology consultancy; computer software consultancy; updating of computer software; software as a service [SaaS]; platform as a service [PaaS]; providing virtual computer systems through cloud computing; providing online geographic maps, not downloadable; providing geographic information; providing information relating to computer technology and programming via a website; providing search engines for the internet; conversion of computer programs and data, other than physical conversion; rental of computer software; development of video and computer games; development of computer platforms; computer software design; software development in the framework of software publishing; user authentication services using blockchain technology; creating and designing website-based indexes of information for others [information technology services]; creating and maintaining websites for others; computer graphic design for video projection mapping; computer programming; te-

chnical writing; duplication of computer programs; computer programming services for data processing; user authentication services using single sign-on technology for online software applications; user authentication services using technology for e-commerce transactions; weather forecasting; logo design services; styling [industrial design]; cartography services; software engineering services for data processing; data encryption services; electronic data storage; all the abovementioned services, including provided via a mobile or online application.

45 – Marriage agency services; detective agency services; night guard services; adoption agency services; arbitration services; leasing of internet domain names; rental of safes; embalming services; funerary undertaking; lost property return; releasing doves for special occasions; security screening of baggage; genealogical research; legal research; intellectual property consultancy; physical security consultancy; legal consultancy relating to patent mapping; legal advice in responding to calls for tenders; monitoring intellectual property rights for legal advisory purposes; monitoring of burglar and security alarms; crematorium services; licensing [legal services] in the framework of software publishing; licensing of intellectual property; licensing of computer software [legal services]; organization of political meetings; organization of religious meetings; opening of security locks; planning and arranging of wedding ceremonies; missing person investigations; kimono dressing assistance; litigation services; babysitting; pet sitting; conducting religious ceremonies; conducting funeral ceremonies; inspection of factories for safety purposes; evening dress rental; rental of fire extinguishers; clothing rental; rental of fire alarms; registration of domain names [legal services]; personal letter writing; personal background investigations; fire-fighting; astrological services; spiritual consultancy; personal wardrobe styling consultancy; escorting in society [chaperoning]; horoscope casting; copyright management; legal services relating to licences; legal advocacy services; cartomancy services; dating services; concierge services; guard services; alternative dispute resolution services; dog walking services; tracking of stolen property; legal document preparation services; house sitting; mediation; burial services; online social networking services; personal bodyguarding; legal services in relation to the negotiation of contracts for others; legal watching services.

(260) AM 2026 131554 A

(800) 1830844

(151) 2024 10 11

(891) 2024 10 11

(731) Shaoxing Taoyuan Imp. & Exp. Co., Ltd.

2301-5, Guomao Building, Didang, Shaoxing,
Zhejiang, China

(540)

VTAI
问通文具

(591) Black, white

(531) 27.05.01; 28.03

(511)

16 – Pencil sharpeners, electric or non-electric; book-binding material; staple removers [office requisites]; punches [office requisites]; pencil sharpeners; staples for paper; staplers for paper; note books; paper; writing instruments; pencil leads; paintbrushes; drawing materials; compasses for drawing; square rulers for drawing; glue for stationery or household purposes; adhesives [glues] for stationery or household purposes; stamp pads; elastic bands for offices; erasers; pen cases; clips for offices; pins [stationery]; correcting fluids [office requisites]; correcting tapes [office requisites]; covers [stationery]; folders for papers; bookends; drawing pins; binder clips.

(260) AM 2026 131635 A

(800) 1831738

(151) 2024 04 08

(891) 2024 04 08

(731) Fred Hutchinson Cancer Center
1100 Fairview Ave. N., Seattle
WA 98109-1024, USA

(540)

**FRED HUTCH CANCER
CENTER**

(591) Black, white

(526) CANCER CENTER

(511)

1 – Reagents and monoclonal antibodies for in vitro scientific or research use.

5 – Diagnostic reagents and monoclonal antibodies for medical use.

9 – Downloadable electronic publications in the nature of newsletters, pamphlets, brochures, magazines, instruction sheets, and manuals in the fields of research, prevention, detection, treatment, and cure of cancer, HIV/AIDS, other diseases, and related medical and public health problems.

16 – Printed publications, namely, newsletters, pamphlets, brochures, magazines, instruction sheets, and manuals in the fields of research, prevention, detection, treatment, and cure of cancer, HIV/AIDS, other diseases, and related medical and public health problems.

35 – Promoting public awareness about cancer; promoting public awareness about research, prevention, diagnosis, treatment, and cure of cancer, HIV/AIDS,

public health problems, and other diseases; providing information regarding promotional events for public awareness of cancer via a website; providing information regarding promotional events for public awareness of research, prevention, diagnosis, treatment, and cure of cancer, HIV/AIDS, public health problems, and other diseases via a website; providing medical referrals, namely, business administrative services for medical referrals; retail pharmacy services.

36 – Charitable fund raising in the area of research, prevention, detection, treatment, and cure of cancer and related medical and public health problems.

41 – Educational services, namely, developing and disseminating educational materials and programs of others to healthcare providers and patients in the fields of prevention, diagnosis, treatment, and cure of cancer, HIV/AIDS, public health problems, and other diseases; educational services, namely, providing classes, seminars, workshops, and conferences in the fields of prevention, diagnosis, treatment, and cure of cancer, HIV/AIDS, public health problems, and other diseases, and distribution of educational materials in connection therewith; providing non-downloadable articles in the fields of prevention, diagnosis, treatment, and cure of cancer, HIV/AIDS, other diseases, and public health problems via a website; providing on-line non-downloadable publications in the nature of newsletters, pamphlets, brochures, magazines, instruction sheets, and manuals in the fields of research, prevention, detection, treatment, and cure of cancer.

42 – Consulting related to medical research in the fields of cancer and related medical conditions; medical and scientific research in the fields of cancer treatment and diagnosis; scientific research for medical purposes in the fields of cancer, infectious diseases and related medical and public health problems; medical laboratory services.

44 – Medical consultations, namely, consultation services in the fields of prevention, diagnosis, treatment, and cure of cancer, HIV/AIDS, other diseases, and public health problems; medical services; medical consulting services, namely, providing medical second opinions, and prevention, diagnostic, and treatment protocols for cancer and related medical conditions; medical consulting services, namely, consulting on the treatment of cancer and other diseases, disease management, disease prevention, early detection of disease, performing standardized diagnosis of disease, staging and treatment of disease, medical care and medical care assessment, and patient care management; medical services, namely, medical counseling, diagnostic testing, and treatment services for patients with cancer and related medical conditions; medical consulting services in the area of clinical programs for bone marrow and stem cell transplants; medical services, namely, the treatment of cancer and other diseases, disease management, disease prevention, early detection of disease, performing standardized diagnosis,

sis of disease, staging and treatment of disease, medical care and medical care assessment, and counseling; medical services, namely, patient networking in the nature of providing a website via a global computer network featuring information in the fields of health, cancer treatment, cancer recovery and survival; medical and health clinic services, namely, providing clinical care for patients with cancer and related medical conditions, HIV/AIDS, and other diseases; outpatient medical services; home health care services; medical diagnosis services, namely, performing diagnosis of cancer, HIV/AIDS and related medical and public health problems; medical screening services for cancer, HIV/AIDS, and related medical and public health problems; medical imaging services; medical analysis services for diagnostic and treatment purposes provided by medical laboratories; provision of health care and medical services by health care professionals via the Internet or telecommunication networks; medical services, namely, medical and psychological counseling services for patients and families of patients; health care services, namely, disease prevention in the nature of medical screenings, clinical diagnosis and wellness programs; dietary and nutritional guidance services; providing information in the fields of prevention, diagnosis, treatment, the cure of cancer, HIV/AIDS, public health problems, and other disease via a website.

45 – Providing personal support services for patients and families of patients with cancer, namely, emotional counseling and emotional support; providing patient advocate services in the fields of prevention, diagnosis, treatment and cure of cancer, HIV/AIDS, public health problems, and other diseases; providing a website via a global computer network featuring supportive personal stories on the subjects of health, cancer, cancer recovery and survival; patient networking in the nature of online social networking services in the field of medical care; community outreach and patient counseling regarding disease prevention and wellness programs, namely, organizing and conducting in-person and online support groups in the field of cancer for patients and families of patients with cancer.

(260) AM 2026 131636 A

(800) 1831791

(151) 2024 07 02

(891) 2024 07 02

(731) DESTEK PATENT ANONİM ŞİRKETİ
MASLAK MAHALLESİ, SAAT SOKAK,
SPINE TOWER 5 128 Sarıyer, İstanbul,
Türkiye

(540)



(591) White, blue and purple

(531) 25.07.01; 27.05.01; 27.05.24; 27.07.01;
29.01.12

(511)

9 – Magnetic and optical data carriers and computer software and programmes recorded thereto, downloadable and recordable electronic publications, encoded magnetic and optical cards, movies, tv series and video music clips recorded on magnetic, optical and electronic media.

(260) AM 2026 131637 A

(800) 1831831

(151) 2024 07 05

(891) 2024 07 05

(731) "TABIA GROUP" LLC

153, Neftchilar ave., Nasimi district, AZ-1010
Baku, Azerbaijan

(540)



Tabia
GROUP

(591) Black, white

(531) 05.03.16; 27.05.01

(511)

35 – Advice on business organization and business management; assistance in the management of trade (commercial) or industrial enterprises; hotel management.

39 – Travel arrangements.

41 – Academies [education]; transfer of knowledge and expertise in the field of business [training].

43 – Hotel accommodation services; restaurant services; accommodation services [hotels, boarding houses].

44 – Sanatorium services; physiotherapy services; sauna services; therapeutic services; dispensaries / health center services; medical analysis services for diagnostic and therapeutic purposes provided by medical laboratories.

(260) AM 2026 131638 A

(800) 1831931

(151) 2024 10 18

(891) 2024 10 18

(731) Lightbox Jewelry Ltd

17 Charterhouse Street, London EC1N 6RA,
United Kingdom

(540)

BRINGING LIGHT TO LIFE.

(591) Black, white

(511)

14 – Precious metals and their alloys; badges of precious metal; ingots of precious metal; boxes of precious metal; ornaments of precious metal; jewellery including lab-grown diamonds; lab-grown diamonds; horological and chronometric instruments including watches, pocket watches and clocks.

35 – Retail and wholesale services, advertising and marketing services all in the field of precious metals and their alloys, badges of precious metal, ingots of precious metal, boxes of precious metal, ornaments of precious metal, jewellery (including lab-grown diamonds), lab-grown diamonds, horological and chronometric instruments (including watches, pocket watches and clocks); sales promotion for others.

(260) AM 2026 131639 A

(800) 1831973

(151) 2024 10 15

(891) 2024 10 15

(731) CEDROB SPÓŁKA AKCYJNA

Ujazdówek 2A, PL-06-400 Ciechanów, Poland

(540)

DUDA

(591) Black, white

(511)

29 – Meat and meat products; meat; prepared meat; fresh meat; processed meat products; cold cuts; fish, not live; poultry; game, not live; meat extracts; processed fruits, fungi, vegetables, nuts and pulses; vegetable burgers; vegetable chips; processed chickpeas; prepared vegetable products; vegetarian sausages; soya patties; tofu patties; legume-based spreads; vegetable pate; vegetable-based meat substitutes; vegetarian charcuterie; ready cooked meals consisting wholly or substantially wholly of meat; prepared meat dishes; meat-based snack food; cooked meat dishes; prepared vegetable dishes; vegetable-based snack food; snack foods based on legumes; soy-based snack foods; tofu-based snacks.

35 – Retail and wholesale services in relation to: meat and meat products, meat, prepared meat, fresh meat, processed meat products, cold cuts, fish, not live, poultry, game, not live, meat extracts; retail and wholesale services in relation to: processed fruits, fungi, vegetables, nuts and pulses, vegetable burgers, vegetable chips, processed chickpeas, prepared vegetable products, vegetarian sausages, soya patties, tofu patties, legume-based spreads, vegetable pate, vegetable-based meat substitutes, vegetarian charcuterie; retail and wholesale services in relation to: ready cooked meals consisting wholly or substantially wholly of meat, prepared meat dishes, meat-based snack food,

cooked meat dishes, prepared vegetable dishes, vegetable-based snack food, snack foods based on legumes, soy-based snack foods, tofu-based snacks.

(260) AM 2026 131640 A

(800) 1831979

(151) 2024 11 10

(891) 2024 11 10

(731) Apple Inc.

One Apple Park Way, Cupertino CA 95014, USA

(540)



(591) White, orange, pink, purple and blue

(531) 26.04.04; 26.04.16; 26.05.01; 26.13.25; 29.01.15

(511)

9 – Computers; computer hardware; smart phones; tablet computers; wireless communication devices for the transmission of voice, data, images, audio, video, and multimedia content; computer software; computer operating system software; computer chips.

(260) AM 2026 131641 A

(800) 1832025

(151) 2024 11 20

(891) 2024 11 20

(731) Roche Diagnostics GmbH

Sandhofer Strasse 116, 68305 Mannheim, Germany

(540)

COBAS INSTANT

(591) Black, white

(511)

5 – Chemical preparations for medical purposes; biological preparations for medical purposes; biochemical preparations for medical use; in vitro diagnostic preparations for medical use; diagnostic reagents for medical use; reagents for in-vitro laboratory use [for medical purposes]; diagnostic biomarker reagents for medical purposes.

9 – Scientific apparatus and instruments; laboratory instruments [other than for medical use]; instruments for diagnosis [for scientific use]; quantitative polymerase chain reaction [PCR] instruments for scientific use; real-time polymerase chain reaction [PCR] instruments for scientific use; diagnostic apparatus for research laboratory use; research laboratory analyzers for measuring, testing and analyzing blood and other

bodily fluids, laboratory instrument for the detection of pathogens and toxins in a biological sample for research use.

10 – Medical apparatus and instruments; testing apparatus for medical purposes; diagnostic apparatus for medical purposes; real-time polymerase chain reaction [PCR] instruments for medical use; diagnostic testing instruments for use in immunoassay procedure [medical]; immunochemical medical diagnostic testing apparatus for detecting and measuring antibody levels; apparatus for analyzing substances [for medical use]; diagnostic apparatus for medical purposes used in medical laboratories.

(260) AM 2026 131642 A

(800) 1832066

(151) 2024 09 30

(891) 2024 09 30

(731) Elaraby Germany GmbH

Markt 9, Aufgang B, 04109 Leipzig, Germany

(540)



(591) Black and purple

(531) 26.01.03; 26.01.11; 26.01.18; 26.04.03;

27.05.01; 27.05.09

(511)

7 – Sausage machines; robotic cleaning machines; printing machines; meat mincers (machines); meat choppers (machines); knives, electric; grinding machines; grating machines for vegetables; food processors, electric; door openers, electric; door closers, electric; carpet shampooing (machines and apparatus for -), electric; compressors for refrigerators; butter machines; bread cutting machines; beverage preparation machines, electromechanical; beating machines; beaters, electric; bags (vacuum cleaner); blenders, electric, for household purposes; cleaning (machines and apparatus for -), electric; coffee grinders, other than hand-operated; dishwashers; fruit presses, electric, for household purposes; grinders/crushers, electric for household purposes; kitchen machines electric; kneading machines; mixing machines; mixers (machines); vacuum cleaners; washing apparatus; washing machines; washing machines (coin – operated); washing machines [laundry]; water heaters [parts of machines]; vacuum cleaner bags; vacuum cleaner hoses; wringing machines for laundry.

8 – Tweezers; razors, electric or non-electric; pedicure sets; nail files; nail files, electric; nail clippers, electric or non-electric; manicure sets; manicure sets, electric; electric flat irons; irons [non-electric hand tools]; hair-removing tweezers; hair curling (hand implements for-); hair clippers for personal use, electric and non-electric; glazing irons; goffering irons; depilation app-

liances, electric and non electric; beard clippers; eyelash curlers; non-electric flat irons; caulking irons; crimping irons; curlers (eyelash-); curling tongs; cuticle nippers; cuticle tweezers.

9 – Batteries, electric; capacitors; radios; record players; television apparatus; flashing lights (luminous signals); flash lights for still-cameras; fluorescent screens; notice boards (electronic -).

11 – Footwarmers, electric or non-electric; footmuffs, electrically heated; filters for drinking water; filters for air conditioning; filters, (coffee)electric; extractor hoods for kitchens; electric appliances for making yogurt; driers (air); drinking water (filters for); discharge tubes, electric, for lighting; diffusers, light; deep fryers, electric; bidets; bath fittings (hot air -); air purifying apparatus and machines; air dryers; air deodorising apparatus; air conditioning installations; air conditioning apparatus; air cooling apparatus; air filtering installations; baths (heaters for); coffee roasters; cooking utensils, electric; cooling appliances and installations; curling lamps; ceiling lights; coffee machines, electric; coffee percolators, electric; cookers; cooking apparatus and installations; driers (hair); electric lamps; fans [air-conditioning]; fans (electric -) for personal use; fans [parts of air conditioning installations]; gas burners (brackets for); gas boilers; grills cooking appliances; gas burners; heat pumps; hair driers [dryers]; heaters for baths; heating apparatus; heating apparatus electric; hoods (extractor-) for kitchens; hot air ovens; hot air bath fittings; hot air apparatus; heating plates; ice boxes; ice machines and apparatus; ice chests; kettles, electric; kitchen ranges, ovens; lamps; lamps (burners for); lamps (electric); light bulbs; light bulbs, electric; light bulbs for directional signals; light-emitting diodes [led] lighting apparatus; light diffusers; microwave ovens [cooking apparatus]; percolators (coffee), electric; projector lamps; refrigerating apparatus and machines; refrigerating appliances; refrigerating apparatus; refrigerating display cabinets [display cases]; refrigerators; rotisseries; stoves; steam facial apparatus; stoves (heating apparatus); street lamps; toasters; ventilation [air-conditioning] installations and apparatus; ventilation [air-conditioning] installations for vehicles; ventilation hoods; waffle irons, electric; water heaters [apparatus]; water heaters; yogurt electric appliances for making.

(260) AM 2026 131643 A

(800) 1832115

(151) 2024 11 05

(891) 2024 11 05

(731) Nicola Negro

Strada dei Faveri 8, I-31054 Possagno (TV), Italy;

PAOLO PASQUALIN

Via G. Fantin, 146, I-31035 Crocetta del ontello (TV), Italy

(540)

PAUL EASTERLIN

(591) Black, white

(531) 27.05.01

(511)

9 – Corrective eyewear; sunglasses; prescription sunglasses; fashion eyeglasses; spectacle temples; sunglass temples; parts for spectacles; replacement lenses for glasses; coloured contact lenses; spectacle frames; spectacles; eyeglass shields; spectacle cases; spectacle chains; covers for glasses; glasses, sunglasses and contact lenses; fashion sunglasses; cords for sunglasses; spectacle lenses; bars for spectacles; prescription eyeglasses; spectacle cords.

18 – Luggage, bags, wallets and carrying bags; suitcases; luggage; trunks [luggage]; bags; purses; handbags; small bags for men; school bags; bumbags; rucksacks; daypacks; attaché cases; suitcases with wheels; haversacks; pocket wallets.

25 – Clothing; footwear; headgear; casualwear; work clothes; beach clothes; nightwear; loungewear; girls' clothing; evening wear; menswear; underwear; clothing for gymnastics; leisure shoes; leisure suits; sportswear; dresses; dressing gowns; children's wear; bandanas [neckerchiefs]; berets; bermuda shorts; bikinis; blouses; leotards; stockings; socks; shirts; tank tops; vest tops; hats; casual jackets; cardigans; stuff jackets [clothing]; slippers; waist belts; tights; collars; chemises; flat caps; suits; cravats; sweat shirts; foulards [clothing articles]; jackets [clothing]; overcoats; gilets; blousons; skirts; overalls; gloves [clothing]; clothing of leather; denims [clothing]; flip-flops; denim jeans; lingerie; jerseys [clothing]; undershirts; sweaters; trousers shorts; trousers; bowties; pyjamas; polo shirts; salopettes; sandals; neck warmers; shoes; ankle boots; shawls; scarves; boots; tee-shirts; tailleurs; woden shoes; tops [clothing]; snow suits; shell suits; jogging sets [clothing]; uniforms.

(260) AM 2026 131644 A

(800) 1832145

(151) 2024 08 22

(891) 2024 08 22

(731) Agraya GmbH

Spichernstraße 55, 50672 Köln,
Germany

(540)

AGRAYA

(591) Black, white

(511)

9 – Mobile apps; computer programs, recorded and downloadable; communication software; electronic publications.

29 – Meat, fish, poultry and game; meat extracts; preserved, dried and cooked fruits; jellies for food; jams;

compotes; eggs; milk; milk products; edible oils and fats; prepared meals consisting substantially of meat, fish, poultry or game; all the aforesaid goods also being chilled or frozen; frozen fruits and vegetables.

30 – Coffee; tea; cocoa; artificial coffee; sugar; rice; tapioca; sago; flour; cereal preparations; bread, pastries and confectionery; edible ices; golden syrup; mustard; vinegar; sauces, condiments; spices; herbs for culinary purposes; pizzas; prepared meals consisting substantially of pasta; all the aforesaid goods also being chilled or frozen.

31 – Agriculture, horticultural and forestry products, and aquaculture products; foodstuffs and fodder for animals; seeds for planting; flowers; animal foodstuffs; malt; animal foodstuffs, including being chilled or frozen; live animals; natural plants; fresh fruits and vegetables.

32 – Beer; mineral and aerated waters and other non-alcoholic beverages; fruit drinks; fruit juice beverages; syrups and other preparations for making beverages; all the aforesaid goods also being chilled or frozen.

35 – Business assistance, management and administrative services; business management; business organization; business administration; clerical services; providing advice relating to the organization and management of business; assistance, advisory services and consultancy with regard to business planning; professional business consultancy; personnel management consultancy; testing to determine professional competency; advertising, marketing and promotional services; consultancy regarding public relations communication and advertising strategies; public relations services; supply chain management services; information and data compiling and analyzing relating to business management; business analysis services; compilation of statistics; compilation of data in databases, in particular electronic databases.

41 – Teaching; educational instruction; training; education, training and instruction in the context of manufacturing and production; arranging and conducting of conferences, exhibitions and competitions; providing electronic publications, not downloadable.

42 – Scientific and technological services and research and design relating thereto; quality control and authentication services; design and development of computer software for logistics, supply chain management and e-business portals; testing, authentication and quality control; science and technology services; testing, analysis and evaluation of the goods and services of others for the purpose of certification; agricultural research services.

44 – Agricultural consultancy; cultivation advisory services relating to agriculture; information services relating to farming; aquaculture services.

45 – Legal assessment and review of business processes with regard to compliance with legal provisions; consultancy on regulations on safety at work; legal services, namely auditing, assessment and advice in relation to legal compliance with legal requirements and due diligence obligations; reviewing standards and practices to assure compliance with laws and regulations.

(260) AM 2026 131651 A

(800) 1832493

(151) 2024 06 28

(891) 2024 06 28

(731) "Malevich" Limited Liability Company
ul. Vysokaya, d. 12, kv. 87, RU-115533
Moscow, Russian Federation

(540)



(591) Black, white

(531) 25.01.13; 26.04.02; 26.04.05; 27.05.01;
27.05.17

(511)

2 – Primers; paints; watercolour paints for use in art; ceramic paints; oil paints for use in art; enamel paints; varnishes; paint thinners; thinners for lacquers; distempers; turpentine [thinner for paints]; metal foil for artistic and decorative purposes and printing; engraving ink.

16 – Fountain pens; albums; notepads; drawing pads; paper sheets [stationery]; papers for painting and calligraphy; carbon paper; rice paper; paper; modeling clay; polymer modelling clay; drawing sets; pencils; pencil leads; document holders [stationery]; pencil holders; chalk holders; drawing instruments; tracing paper; glassine paper; automatic pencils; charcoal pencils; cardboard; gluten [glue] for stationery or household purposes; paint brushes; painters' brushes; adhesive tapes for stationery or household purposes; plastics for modelling; modeling materials; pencil sharpening machines, electric or non-electric; chalk for lithography; writing chalk; tailor's chalk; marking chalk; easels; hand-rests for painters; palettes for painters; pastels [crayons]; modelling paste; pencil cases; writing pens; drawing pens; clipboards; stands for pens and pencils; writing utensils; drawing materials; school supplies [stationery]; paper cutters [office requisites]; erasers; marking pens [stationery]; paper wipes for cleaning; stationery; pencil sharpeners, electric or non-electric; stencil plates; cardboard tubes; drawing squares; moulds for modelling clays [artists' materials]; canvas for painting; drawing compasses; artists' watercolour saucers; ink; inkwells.

(260) AM 2026 131652 A

(800) 1832551

(151) 2024 11 21

(891) 2024 11 21

(731) Toyo Tire Corporation
2-2-13 Fujinoki, Itami-shi, Hyogo 664-0847,
Japan

(540)

THINK

(591) Black, white

(531) 27.05.01

(511)

12 – Tires for automobiles.

(260) AM 2026 131653 A

(800) 1832556

(151) 2024 11 12

(891) 2024 11 12

(731) Roborock International B.V.
Strawinskylaan 3051, Atrium, NL-1077 ZX
Amsterdam, Netherlands

(540)

Hello Rocky

(591) Black, white

(511)

7 – Robotic vacuum cleaners including voice recognition function.

9 – Downloadable voice command and voice recognition software and speech to text conversion software for operating internet of things (IoT) devices, including vacuum and mopping cleaning devices and autonomous cleaning device; downloadable voice-enabled software and speech to text conversion software for operating internet of things (IoT) devices, including vacuum and mopping cleaning devices and autonomous cleaning devices; home automation and home device integration downloadable software; downloadable wireless communication software for voice, audio, video, and data transmission for purposes of interacting with information-of-things devices, including vacuum and mopping cleaning devices and autonomous cleaning devices; downloadable computer software for use to connect and control internet of things (IoT) electronic devices; downloadable computer software for connecting, operating, integrating, controlling, and managing networked consumer electronic devices, including vacuum and mopping cleaning devices and autonomous cleaning devices; software for remote control of robot hoovers by voice commands.

(260) AM 2026 131654 A

(800) 1832565

(151) 2024 11 27

(891) 2024 11 27

(731) EARFUN, INC
8605 SANTA MONICA BLVD #79525,
WEST HOLLYWOOD CA 90069, USA

(540)

EARFUN

(591) Black, white

(511)

9 – Audio amplifiers; earphones and headphones; portable media players; wireless transmitters and receivers; audio speakers; consumer electronic products, namely, audio amplifiers, audio speakers, audio receivers, electrical audio and speaker cables and connectors, audio decoders, video decoders, speakers, power conversion devices, power converters, and power inverters; soundbar speakers; wireless headsets for smartphones; wireless speakers.

(260) AM 2026 131660 A

(800) 1171363

(151) 2013 04 29

(891) 2024 12 20

(731) Julius Blum GmbH

Industriestr. 1, A-6973 Höchst, Austria

(540)



(591) White and orange

(531) 24.15.01; 27.05.24; 29.01.12

(511)

6 – Furniture fittings, completely or predominantly made of metal; hinges, in particular furniture hinges, completely or predominantly made of metal; drawer guides and connecting pegs, completely or predominantly made of metal; touch-latch fittings, completely or predominantly made of metal; adjustable arms, completely or predominantly made of metal; fittings and mechanic adjustable arm drives for furniture flaps and cabinet doors, completely or predominantly made of metal; fittings for attaching fascia boards to drawers, completely or predominantly made of metal.

7 – Electric adjustable arm drives for furniture flaps and cabinet doors; electric drives for furniture parts, in particular drawers and flaps.

9 – Computer; data processing equipment; computer programs and computer software, in particular programs for use or mobile electronic devices; software for planning and ordering, in particular for kitchen planning, cabinet planning and ordering of fittings in the furniture industry; software for the visualisation of kitchens, furniture, fittings and their components; software for data export; magnetic, optical and/or electronic data media; digital storage media; compact-discs, DVDs, USB sticks; electronic publications

(downloadable), in particular electronic product catalogues (downloadable); all the aforesaid goods in particular relating to planning and arranging kitchens, furniture and their components; electronic controls for drives for furniture parts; cables and cable connectors for drives for furniture parts.

20 – Furniture components, in particular drawers and drawer components; furniture fittings, drawer guides, hinges and connecting pegs, completely or predominantly made of plastic; furniture, in particular kitchen furniture, cupboards, in particular corner cupboards for kitchens; furniture doors and furniture flaps; side walls and rear walls for furniture; side walls for drawers, partition walls and inserts for drawers; touch-latch fittings, completely or predominantly made of plastic.

(260) AM 2026 131661 A

(800) 1240163

(151) 2014 12 03

(891) 2024 12 04

(731) DESARROLLO AGRICOLA Y MINERO,
S.A.

Camino de Enmedio, 120., Pol. Ind. Miraflores,
E-50013 Zaragoza, Spain

(540)

NATURCOMPLET

(591) Black, white

(511)

1 – Chemical products for use in industry, as well as in agriculture, horticulture and forestry; manure for agriculture.

(260) AM 2026 131664 A

(800) 1728217

(151) 2022 10 24

(891) 2024 11 28

(731) UAB "VIČIŪNŲ GRUPĖ"

Karaliaus Mindaugo pr. 38, LT-44307 Kaunas,
Lithuania

(540)

SEAWILL

(591) Black, white

(511)

29 – Vegetable marrow paste; preserved peppers; aloe vera prepared for human consumption; albumen for culinary purposes; albumin milk; alginates for culinary purposes; oils for food; olive oil for food; anchovy, not live; yakitori; arrangements of processed fruit; flavoured nuts/flavored nuts; extra virgin olive oil for food; oysters, not live; oat milk; guacamole; aubergine paste/eggplant paste; protein milk; bacon; broth; potato-based dumplings; potato flakes; potato fritters; potato crisps/potato chips; lemon juice for culinary purposes; candied nuts; crystallized fruits/frosted fruits; vegetable mousses; vegetable salads; vegetable so-

up preparations; vegetable juices for cooking; vegetable-based cream; dates; hot dog sausages; sausages; sausages in batter; spiny lobsters, not live; jellies for food; coconut, desiccated; vegetables, dried; falafel; non-alcoholic eggnog; suet for food; animal marrow for food; smetana; cream (dairy products); buttercream; sea-cucumbers, not live; hummus; caviar; ginger jam; edible birds' nests; yogurt/yoghurt; seaweed extracts for food; clams, not live; cocoa butter for food; bone oil for food; kephir/kefir; liver; liver pâté; liver pastes; galbi; pork; eggs; white of eggs; powdered eggs; yolk of eggs; kimchi; coconut oil for food; coconut milk; coconut milk for culinary purposes; coconut milk-based beverages; coconut fat; coconut butter; compotes; meat, preserved; meat, tinned/meat, canned; fish, preserved; fish, tinned/fish, canned; artichokes, preserved; preserved garlic; mushrooms, preserved; laver, preserved; lentils, preserved; onions, preserved; truffles, preserved; fruit, preserved; fruits, tinned/fruits, canned; peas, preserved; olives, preserved; vegetables, preserved; vegetables, tinned/vegetables, canned; beans, preserved; soya beans, preserved, for food; berries, preserved; bulgogi; gherkins; black pudding/blood sausage; shrimps, not live; prawns, not live; croquettes; maize oil for food/corn oil for food; corn dogs; koumiss/kumys; ham; salmon, not live; game, not live; lecithin for culinary purposes; lyophilized meat/lyophilised meat; lyophilized vegetables/lyophilised vegetables; lard; edible fats; isinglass for food; margarine; marmalade; klipfish (salted and dried cod); meat; meat jellies; meat extracts; charcuterie; mussels, not live; almond milk; almond milk for culinary purposes; almond milk-based beverages; molluscs, not live/mollusks, not live; poultry, not live; sausage casings, natural or artificial; low-fat potato crisps/low-fat potato chips; apple purée; lobsters, not live; palm oil for food; palm kernel oil for food; hazelnuts, prepared; nuts, prepared; sweet corn, processed; peanuts, prepared; fish roe, prepared; sunflower seeds, prepared; seeds, prepared; edible ant larvae, prepared; pectin for culinary purposes; milk; milk ferments for culinary purposes; milk beverages, milk predominating; whey; milk shakes; powdered milk; milk substitutes; milk products; rennet; pickles; whipped cream; tomato paste; tomato puree; tomato juice for cooking; rape oil for food/colza oil for food; sauerkraut; raisins; fermented baked milk; fatty substances for the manufacture of edible fats; fat-containing mixtures for bread slices; nut-based spreads; rice milk; rice milk for culinary purposes; soured milk; sardines, not live; sunflower oil for food; linseed oil for food/flaxseed oil for food; sesame oil for food; tahini; herrings, not live; almonds, ground; soya patties; soya milk; soya bean oil for food; tofu; tofu patties; cranberry compote; fruit preserved in alcohol; snail eggs for consumption; soups; broth concentrates; preparations for making soup; salted fish; salted meats; bouillon; bouillon concentrates; preparations for making bouillon; cheese; condensed milk; butter; onion rings; freeze-dried

meat; freeze-dried vegetables; frozen fruits; silkworm chrysalis for human consumption; tofu skin; tuna, not live; jams; fruit-based snack food; fruit, stewed; pressed fruit paste; fruit pulp; fruit salads; fruit chips; fruit peel; edible insects, not live; curd; cottage cheese fritters; crustaceans, not live; crayfish, not live; vegetables, cooked; tripe; gelatine; peanut milk; peanut milk for culinary purposes; peanut milk-based beverages; peanut butter; pollen prepared as foodstuff; fish-based foodstuffs; fish, not live; fish fillets; fish meal for human consumption; fish mousses.

(260) AM 2026 131696 A

(800) 1832971

(151) 2024 12 03

(891) 2024 12 03

(731) PROTOX Inc.

94 Jeyakongdan 4-gil, Hyangnam-eup,

Hwaseong-si, Gyeonggi-do 18622, Republic of Korea

(540)

PROTOX

(591) Black, white

(511)

42 – Research and development of vaccines and medicines; biomedical research services; bacteriological research; drug development; inspection of pharmaceuticals; development of pharmaceutical preparations and medicines; providing medical and scientific research information in the field of pharmaceuticals and clinical trials; research on the subject of pharmaceuticals; testing, inspection and research services in the fields of pharmaceuticals, cosmetics and foodstuffs; pharmaceutical drug development services.

44 – Beauty therapy; medical analysis for the diagnosis and treatment of persons; advisory services relating to pharmaceutical products; medical and pharmaceutical consultation; remote monitoring of medical data for medical diagnosis and treatment; medical care; medical clinic services; rental of medical apparatus; medical equipment rental; medical information.

(260) AM 2026 131784 A

(800) 1833693

(151) 2024 12 18

(891) 2024 12 18

(731) UAB "Narbutas International"

Ukmergės g. 308, LT-12110 Vilnius, Lithuania

(540)

EIRA

(591) Black, white

(511)

20 – Office chairs.

(260) AM 2026 131803 A
 (800) 1834174
 (151) 2024 11 27
 (891) 2024 11 27
 (731) Richter Gedeon Nyrt.
 Gyömrői út 19-21., H-1103 Budapest,
 Hungary
 (540)

ALVEBA

(591) Black, white
 (511)
 5 – Pharmaceutical preparations.

(260) AM 2026 131805 A
 (800) 1834213
 (151) 2024 09 01
 (891) 2024 09 01
 (731) LABORATORIOS NORMON, S.A.
 Ronda de Valdecarrizo, 6, E-28750 Tres
 cantos (Madrid), Spain
 (540)

AZYNOR

(591) Black, white
 (511)
 5 – Pharmaceutical products for human use.

(260) AM 2026 131807 A
 (800) 282571
 (151) 1964 04 20
 (891) 2024 11 28
 (731) SPATEN-FRANZISKANER-BRÄU GmbH
 Marsstraße 46-48, 80335 München, Germany
 (540)

Franziskaner

(591) Black, white
 (531) 27.05.01; 27.05.17
 (511)
 32 – Beer, colour beer.

(260) AM 2026 131869 A
 (800) 1834342
 (151) 2024 11 27
 (891) 2024 11 27
 (731) Richter Gedeon Nyrt.
 Gyömrői út 19-21., H-1103 Budapest,
 Hungary
 (540)

CATRIMITRON

(591) Black, white
 (511)
 5 – Pharmaceutical preparations.

(260) AM 2026 132301 A
 (800) 1838776
 (151) 2024 12 12
 (891) 2024 12 12
 (731) The Federation for Associations connected to
 the International HUMANA PEOPLE TO
 PEOPLE Movement (FAIHPP)
 Rue Kitty-PONSE 4, CH-1205 Genève,
 Switzerland
 (540)

HUMANA VINTAGE

(591) Black, white
 (511)
 36 – Collection of charitable donations and charitable
 fund raising for third parties; provision of monetary
 grants to charities; fund investments for charitable
 purposes, provision of financial assistance to social,
 charitable and religious organizations; financial spon-
 sorship of social, charitable and religious organizati-
 ons; financing of development projects.

41 – Education, teaching and training; organization
 and conducting of symposiums, seminars and work-
 shops for training; publication of texts (other than ad-
 vertising texts); provision of training in the field of
 agriculture, horticulture and forestry; education and
 training relating to nature conservation and the envi-
 ronment; education and training relating to nutrition,
 health and food.

(260) AM 2026 132720 A
 (800) 1842381
 (151) 2024 11 08
 (891) 2024 11 08
 (731) Limited Liability Company "WIMM-BILL-
 DANN FOODS"
 Dmitrovskoe shosse, d.108, RU-127591
 Moscow, Russian Federation
 (540)



(591) White, dark blue, blue, light blue, yellow, dark
 green, green, light green, black, red, orange,
 pink, lilac, light lilac, burgundy, dark brown,
 brown, light brown and beige
 (531) 01.15.15; 02.05.02; 02.05.23; 02.05.30;
 02.09.01; 03.13.01; 05.05.20; 05.07.09;
 19.09.02; 28.05; 29.01.15

(511)

5 – Dietetic substances adapted for medical use; mineral waters for medical purposes; thermal water; dietary supplements for human beings; mineral dietary supplements; nutritional supplements; albumin dietary supplements; enzyme dietary supplements; milk sugar for pharmaceutical purposes; powdered milk for babies; milk ferments for pharmaceutical purposes; dietetic beverages adapted for medical purposes; food for babies; babies' diapers; veterinary preparations; vitamin preparations; pharmaceutical preparations; dietetic foods adapted for medical purposes; lacteal flour for babies; infant formula.

29 – Peanuts, prepared; berry-based food; jams; edible fats; fruit-based snack food; vegetable-based snack food; yogurt; quark; kephir; potato-based dumplings; milk shakes; onion rings; arrangements of processed fruit; cranberry compote; compotes; meat, tinned; vegetables, tinned; fish, tinned; fruits, tinned; vegetable-based concentrate for cooking; fruit-based concentrate for cooking; buttercream; croquettes; sweet corn, processed; koumiss; margarine; marmalade; oils for food; butter; milk; albumin milk; curd; condensed milk; soured milk; soya milk; powdered milk; fermented baked milk; vegetable mousses; fish mousses; fruit pulp; lactic acid drinks; milk beverages, milk predominating; vegetables, processed; vegetables, dried; vegetables, cooked; hash browns; potato fritters; nuts, prepared; tomato paste; pressed fruit paste; vegetable-based prepared meals for toddlers; milk products; white pudding; tomato purée; apple purée; vegetable salads; fruit salads; seeds, prepared; cream [dairy products]; whipped cream; vegetable-based cream; smetana; vegetable juices for cooking; fat-based spreads for bread slices; vegetable-based spreads; nut-based spreads; fruit jelly spreads; soups; vegetable soup preparations; whey; cottage cheese fritters; cheese; cottage cheese; milk ferments for culinary purposes; rennet; fruit, processed; fruit, stewed; potato flakes; potato crisps; low-fat potato crisps; fruit chips.

30 – Cereal bars; high-protein cereal bars; pancakes; bread rolls; burritos; waffles; croûtons; leaven; rice-based snack food; cereal-based snack food; fruit jellies [confectionery]; confectionery in the form of mousses; pastries; fruit confectionery; pasta; frozen yogurt [confectionery ices]; sweets; crackers; rice crackers; croissants; groats for human food; corn, milled; corn, roasted; noodles; ice pops; potato-based flatbreads; rice cakes; macaroons [pastries]; ice cream; chocolate mousses; muesli; cocoa beverages with milk; coffee beverages with milk; tea beverages with milk; chocolate beverages with milk; chocolate-coated nuts; lozenges [confectionery]; biscuits; petit-beurre biscuits; pies; noodle-based prepared meals for toddlers; fondants [confectionery]; popcorn; powders for making ice cream; pralines; cereal preparations; oat-based food; gingerbread; puddings; rice pudding; milk puddings; sorbets [ices]; chocolate-based spreads;

rusks; sandwiches; tapioca; tortillas; halvah; bread; corn flakes; oat flakes; iced tea; cheeseburgers [sandwiches]; chocolate-covered potato chips; chips [cereal products]; gruel; instant porridge; milk-based gruels for food; kasha; corn flour porridge; sorghum porridge; wheat porridge; rice porridge.

32 – Aperitifs, non-alcoholic; carbonated water; waters [beverages]; mineral water [beverages]; cocktails, non-alcoholic; lemonades; non-alcoholic beverages; whey beverages; soft drinks; non-alcoholic fruit juice beverages; fruit nectars, non-alcoholic; orgeat; powders for effervescing beverages; powders for making soft drinks; sarsaparilla [non-alcoholic beverage]; syrups for lemonade; syrups for beverages; smoothies; vegetable juices [beverages]; fruit juices; preparations for making non-alcoholic beverages; preparations for making carbonated water; pastilles for effervescing beverages; non-alcoholic fruit extracts; non-alcoholic essences for making beverages.

(260) AM 2026 132826 A

(800) 1843471

(151) 2024 11 27

(891) 2024 11 27

(731) SHENZHEN VSTAR CAM TECHNOLOGY CO., LTD.

Floor 1-4, Building 2, VStarcam Industrial Park, No. 8 Baotian Rd, Shuitian Community, Shiyuan Street, Bao'an District, Shenzhen City, 518108 Guangdong Province, China

(540)



(591) Blue, black

(531) 26.13.25; 27.05.01; 27.05.03; 27.05.09; 29.01.12

(511)

9 – Computer programs, downloadable; computer peripheral devices; computer software, recorded; intercommunication apparatus; video recorders; camcorders; protection devices for personal use against accidents; theft prevention installations, electric; anti-theft warning apparatus.

(260) AM 2026 132828 A

(800) 1843478

(151) 2024 11 26

(891) 2024 11 26

(731) Jinjiang DEVO Shoes&Garments Co., Ltd.

No.212, East District, Qiantou Village Chidian Town, Jinjiang Quanzhou City, 362212 Fujian Province, China

(540)

Devo Life

(591) Black, white

(531) 27.05.01

(511)
25 – Clothing; swimsuit; slippers; sandals; shoes; hats; hosiery; gloves [clothing]; neckties.

(260) AM 2026 132853 A

(800) 1843782

(151) 2024 11 26

(891) 2024 11 26

(731) Beijing Dajia Internet Information Technology Co., Ltd.
Room 101, 8th Floor, Building 12, No. 16
Xierqi West Road, Haidian District, Beijing,
China

(540)

KLING

(591) Black, white

(531) 27.05.01

(511)

9 – Computer software platforms, recorded or downloadable; quantum computers; computer programs for using the Internet and the World Wide Web; downloadable computer software applications for mobile phones; data sets, recorded or downloadable; downloadable computer software for collecting, analyzing and organizing data in the field of deep learning; computer peripheral devices; computer software applications, downloadable; data processing apparatus; computer chatbot software for simulating conversations.

42 – Platform as a service [PaaS]; computer programming services for data processing; design of computer-simulated models; software as a service [SaaS]; cloud computing; providing temporary use of online non-downloadable computer software for collecting, analyzing and organizing data in the field of deep learning; development of computer platforms; computer software design; research in the field of computer natural language processing.

(260) AM 2026 132868 A

(800) 1843827

(151) 2025 01 31

(891) 2025 01 31

(731) NAVIGATOR BRANDS, S.A.

Lavos, P-3090-451 Figueira da Foz, Portugal

(540)

**gCELL, Globulus Engineered
Pulp**

(591) Black, white

(511)

1 – Wood pulp; paper pulp; cellulose paste; thermal paste; thermomechanical pulp; paste fillers; esparto pulp; groundwood pulp; paper paste [pulp]; deinked pulp; recycled paper pulp; chemiground wood pulp; wood pulp for manufacturing purposes; pulp for use

in the manufacture of paper; dissolving wood pulp for manufacturing purposes; pulp for use in the manufacture of board; additives (chemical -) for use in the treatment of paper pulp; paper paste [adhesive] other than for stationery or household purposes; cellulose pulp [raw material]; cellulose pulp for the manufacture of paper; chemical sizing compositions for use in the manufacture of pulp; cellulose; cellulose for industrial purposes.

16 – Wood pulp paper; cellulose wipes; sheets of reclaimed cellulose for wrapping; napkins of cellulose for household purposes; packaging containers of regenerated cellulose; napkins of cellulose for cosmetic purposes; table runners of cellulose; paper; drawing pads; pads [stationery]; pamphlets; writing or drawing books; note books; cards; paper sheets [stationery]; cardboard; hat boxes of cardboard; cardboard tubes; folders for papers; conical paper bags; cream containers of paper; envelopes [stationery]; wrapping paper; postcards; prints; writing paper; towels of paper; flower-pot covers of paper; wood pulp board [stationery]; boxes of paper or cardboard; bottle envelopes of paper or cardboard; coasters of paper; announcement cards [stationery]; flags of paper; tablecloths of paper; tablemats of paper; bottle wrappers of paper or cardboard; placards of paper or cardboard; labels of paper or cardboard; signboards of paper or cardboard; copying paper [stationery]; packaging material made of starches; absorbent sheets of paper or plastic for foodstuff packaging; humidity control sheets of paper or plastic for foodstuff packaging; packing [cushioning, stuffing] materials of paper or cardboard; padding materials of paper or cardboard; table runners of paper; banners of paper; bunting of paper; paper bags for use in the sterilization of medical instruments.

(260) AM 2026 132876 A*

(800) 1844254

(151) 2025 02 11

(891) 2025 02 11

(731) Toyota Motor Europe

Avenue du Bourget 60, B-1140 Bruxelles,
Belgium

(540)

SAKURATOUCHE

(591) Black, white

(511)

12 – Seat covers for vehicles; vehicle seats; vehicle seats integrating artificial leather; body panels for vehicles; body panels for vehicles integrating artificial leather.

(260) AM 2026 132953 A

(800) 1844561

(151) 2024 11 20

(891) 2024 11 20

(731) Limited liability company PROMOMED RUS
prospekt Mira, d. 13, str. 1, of. 13, RU-129090
Moscow, Russian Federation

(540)



(591) Purple, burgundy and pink

(531) 02.09.01; 28.05; 29.01.13

(511)

5 – Acaricides; aconitine; alkaloids for medical purposes; alginates for pharmaceutical purposes; algicides; aldehydes for pharmaceutical purposes; dental amalgams of gold; dental amalgams; amino acids for veterinary purposes; amino acids for medical purposes; analgesics; anaesthetics; antibiotics; antiseptics; medicine cases, portable, filled; first-aid boxes, filled; aluminium acetate for pharmaceutical purposes; acetates for pharmaceutical purposes; germicides; oxygen cylinders, filled, for medical purposes; balms for medical purposes; bandages for dressings; diagnostic biomarker reagents for medical purposes; biocides; bracelets impregnated with insect repellent; bromine for pharmaceutical purposes; paper for mustard plasters; fly catching paper; reagent paper for veterinary purposes; reagent paper for medical purposes; moth-proofing paper; petroleum jelly for medical purposes; vaccines; oxygen baths; antiseptic cotton; aseptic cotton; absorbent cotton; wadding for medical purposes; cotton for medical purposes; dietetic substances adapted for medical use; radiological contrast substances for medical purposes; nutritive substances for microorganisms; radioactive substances for medical purposes; bismuth subnitrate for pharmaceutical purposes; melissa water for pharmaceutical purposes; seawater for medicinal bathing; mineral waters for medical purposes; thermal water; dietary fibre; moulding wax for dentists; gases for medical purposes; guaiacol for pharmaceutical purposes; massage gels for medical purposes; sexual stimulant gels; haematogen; haemoglobin; hydrastine; hydrastinine; glycerine for medical purposes; glycerophosphates; glucose for medical purposes; gentian for pharmaceutical purposes; hormones for medical purposes; mustard for pharmaceutical purposes; mustard plasters; mud for baths; medicinal mud; contraceptive sponges; gamboge for medical purposes; gurjun balsam for medical purposes; deodorizers for litter trays; deodorants for clothing and textiles; air deodorizing preparations; deodorants, other than for human beings or for animals; diastase for medical purposes; digitalin; vitamin supplement patches; mineral dietary supplements; nutritional supplements; albumin dietary supplements; dietary supplements for animals; yeast dietary supplements; alginate dietary supplements; glucose dietary supplements; casein dietary supplements; lecithin dietary

supplements; linseed oil dietary supplements; brewer's yeast dietary supplements; propolis dietary supplements; protein dietary supplements; protein supplements for animals; royal jelly dietary supplements; pollen dietary supplements; wheat germ dietary supplements; linseed dietary supplements; whey protein dietary supplements; acai powder dietary supplements; dietary supplements with a cosmetic effect; enzyme dietary supplements; yeast for pharmaceutical purposes; gelatine for medical purposes; cod liver oil; isotopes for medical purposes; immunostimulants; insecticides; iodine for pharmaceutical purposes; iodides for pharmaceutical purposes; alkaline iodides for pharmaceutical purposes; iodoform; calomel [fungicide]; cream of tartar for pharmaceutical purposes; tartar for pharmaceutical purposes; camphor for medical purposes; cannabidiol for medical use; capsules for medicines; cachets for pharmaceutical purposes; capsules made of dendrimer-based polymers, for pharmaceuticals; haemostatic pencils; wart pencils; caustic pencils; carbolineum [parasiticide]; caustics for pharmaceutical purposes; cachou for pharmaceutical purposes; quassia for medical purposes; quebracho for medical purposes; oxygen for medical purposes; gallic acid for pharmaceutical purposes; acids for pharmaceutical purposes; adhesives for dentures; surgical glues; stem cells for veterinary purposes; stem cells for medical purposes; cocaine for medical purposes; collagen for medical purposes; collodion for pharmaceutical purposes; corn rings for the feet; cannabis for medical purposes; medicated sweets; angostura bark for medical purposes; barks for pharmaceutical purposes; cedar wood for use as an insect repellent; condurango bark for medical purposes; croton bark; mangrove bark for pharmaceutical purposes; myrobalan bark for pharmaceutical purposes; quinquina for medical purposes; medicated animal feed; medicinal roots; rhubarb roots for pharmaceutical purposes; lint for medical purposes; starch for dietetic or pharmaceutical purposes; creosote for pharmaceutical purposes; blood for medical purposes; biological tissue cultures for veterinary purposes; biological tissue cultures for medical or veterinary use; curare; dental lacquer; liquorice for pharmaceutical purposes; milk sugar for pharmaceutical purposes; adhesive plasters; medicines for alleviating constipation; adhesive tapes for medical purposes; lecithin for medical purposes; lotions for veterinary purposes; medicated hair lotions; lotions for pharmaceutical purposes; medicated after-shave lotions; personal sexual lubricants; lupulin for pharmaceutical purposes; magnesia for pharmaceutical purposes; liniments; ointments for pharmaceutical purposes; sunburn ointments; mercurial ointments; frostbite salve for pharmaceutical purposes; gauze for dressings; medicinal oils; mustard oil for medical purposes; camphor oil for medical purposes; castor oil for medical purposes; oil of turpentine for pharmaceutical purposes; dill oil for medical purposes; dental

mastics; dental abrasives; dental impression materials; teeth filling material; dressings, medical; surgical dressings; drugs for medical purposes; medicines for veterinary purposes; serotherapeutic medicines; medicines for human purposes; medicines for dental purposes; menthol; medicinal drinks; moleskin for medical purposes; almond milk for pharmaceutical purposes; powdered milk for babies; royal jelly for pharmaceutical purposes; milk ferments for pharmaceutical purposes; Irish moss for medical purposes; flour for pharmaceutical purposes; linseed meal for pharmaceutical purposes; fish meal for pharmaceutical purposes; fly glue; antibacterial soap; disinfectant soap; medicated soap; freeze-dried meat adapted for medical purposes; mint for pharmaceutical purposes; dietetic beverages adapted for medical purposes; malted milk beverages for medical purposes; injectable dermal fillers; bone void fillers comprised of living tissues; narcotics; medicinal infusions; tincture of iodine; eucalyptol for pharmaceutical purposes; tinctures for medical purposes; opium; opodeldoc; aromatic deodorizers for toilets; decoctions for pharmaceutical purposes; antiparasitic collars for animals; cotton sticks for medical purposes; stick liquorice for pharmaceutical purposes; sulfur sticks [disinfectants]; pastilles for pharmaceutical purposes; medicated toothpaste; pectin for pharmaceutical purposes; pepsins for pharmaceutical purposes; peptones for pharmaceutical purposes; hydrogen peroxide for medical purposes; pesticides; food for babies; leeches for medical purposes; blood plasma; nicotine patches for use as aids to stop smoking; eyepatches for medical purposes; poultices; compresses; scapulars for surgical purposes; babies' diapers; diapers for pets; swim diapers, reusable, for babies; swim diapers, disposable, for babies; diapers for incontinence; disposable absorbent mats for lining pet crates; diaper changing mats, disposable, for babies; disposable housebreaking pads for pets; bunion pads; breast-nursing pads; diagnostic strips for testing breast milk for medical purposes; pomades for medical purposes; powder of cantharides; pyrethrum powder; anti-uric preparations; bacterial preparations for medical and veterinary use; bacteriological preparations for medical and veterinary use; balsamic preparations for medical purposes; albuminous preparations for medical purposes; biological preparations for veterinary purposes; biological preparations for medical purposes; veterinary preparations; bismuth preparations for pharmaceutical purposes; vitamin preparations; diagnostic preparations for veterinary purposes; diagnostic preparations for medical purposes; douching preparations for medical purposes; bath preparations for medical purposes; therapeutic preparations for the bath; haemorrhoid preparations; preparations for callouses; lice treatment preparations [pediculicides]; acne treatment preparations; preparations to facilitate teething; preparations for the treatment of burns; fumigation preparations for medical purposes; ophotherapy preparations; air purifying

preparations; bronchodilating preparations; preparations for reducing sexual activity; sterilizing preparations; soil-sterilizing preparations; corn remedies; pharmaceutical preparations for treating dandruff; preparations for destroying noxious animals; herbicides; preparations for destroying dry rot fungus; larvae exterminating preparations; fly destroying preparations; preparations for destroying mice; slug exterminating preparations; pharmaceutical preparations for skin care; contact lens cleaning preparations; preparations of microorganisms for medical or veterinary use; lime-based pharmaceutical preparations; styptic preparations; medicated eye-washes; medicinal hair growth preparations; nutraceutical preparations for therapeutic or medical purposes; opiates; anticryptogamic preparations; aloe vera preparations for pharmaceutical purposes; preparations of trace elements for human and animal use; sulfonamides [medicines]; pharmaceutical preparations; pharmaceutical preparations for treating sunburn; enzyme preparations for veterinary purposes; enzyme preparations for medical purposes; phytotherapy preparations for medical purposes; chemico-pharmaceutical preparations; chemical preparations for veterinary purposes; chemical preparations for the diagnosis of pregnancy; chemical preparations for medical purposes; chemical preparations for treating diseases affecting cereal plants; chemical preparations for treating wheat blight; chemical preparations for treating diseases affecting vine plants; chemical preparations for treating mildew; chemical preparations for treating phylloxera; chemical preparations for pharmaceutical purposes; chilblain preparations; mothproofing preparations; collyrium; lead water; chemical conductors for electrocardiograph electrodes; albuminous foodstuffs for medical purposes; dietetic foods adapted for medical purposes; by-products of the processing of cereals for dietetic or medical purposes; homogenized food adapted for medical purposes; freeze-dried food adapted for medical purposes; pharmaceuticals; sanitary towels; panty liners [sanitary]; propolis for pharmaceutical purposes; pearl powder for medical purposes; radium for medical purposes; hydrated chloral for pharmaceutical purposes; solvents for removing adhesive plasters; vaginal washes for medical purposes; solutions for contact lenses; chemical reagents for medical or veterinary purposes; gum for medical purposes; rubber for dental purposes; chewing gum for medical purposes; nicotine gum for use as an aid to stop smoking; insect repellents; insect repellent incense; repellents for dogs; tissues impregnated with pharmaceutical lotions; sarsaparilla for medical purposes; sugar for medical purposes; crystallized rock sugar for medical purposes; asthmatic tea; fumigating sticks; massage candles for therapeutic purposes; linseed for pharmaceutical purposes; tobacco-free cigarettes for medical purposes; siccatives [drying agents] for medical purposes; syrups for pharmaceutical purposes; turpentine for pharmaceutical purposes; milking grease; greases for veterinary pur-

poses; greases for medical purposes; lacteal flour for babies; infant formula; soporifics; bicarbonate of soda for pharmaceutical purposes; bath salts for medical purposes; salts for mineral water baths; salts for medical purposes; potassium salts for medical purposes; sodium salts for medical purposes; smelling salts; mineral water salts; malt for pharmaceutical purposes; semen for artificial insemination; alcohol for pharmaceutical purposes; medicinal alcohol; alloys of precious metals for dental purposes; ergot for pharmaceutical purposes; cooling sprays for medical purposes; antibacterial handwashes; adjuvants for medical purposes; astringents for medical purposes; vermifuges; disinfectants; disinfectants for hygiene purposes; disinfectants for chemical toilets; appetite suppressants for medical purposes; medical preparations for slimming purposes; parasiticides; mouthwashes for medical purposes; medicated dentifrices; febrifuges; depuratives; animal washes [insecticides]; detergents for medical purposes; cattle washes [insecticides]; dog washes [insecticides]; insecticidal veterinary washes; vesicants; purgatives; remedies for perspiration; remedies for foot perspiration; anti-inflammatories; chemical contraceptives; antiparasitic preparations; laxatives; tonics [medicines]; medicated toiletry preparations; digestives for pharmaceutical purposes; nervines; bouillons for bacteriological cultures; steroids; headache relief sticks; strychnine; suppositories; serums; tanning pills; appetite suppressant pills; slimming pills; jujube, medicated; antioxidant pills; sanitary tampons; vulnery sponges; tetrahydrocannabinol [THC] for medical use; thymol for pharmaceutical purposes; smoking herbs for medical purposes; medicinal herbs; tranquilizers; transplants [living tissues]; surgical implants comprised of living tissues; pants, absorbent, for incontinence; sanitary panties; babies' diaper-pants; charcoal for pharmaceutical purposes; fennel for medical purposes; porcelain for dental prostheses; phenol for pharmaceutical purposes; enzymes for veterinary purposes; enzymes for medical purposes; ferments for pharmaceutical purposes; formic aldehyde for pharmaceutical purposes; phosphates for pharmaceutical purposes; fungicides; quinine for medical purposes; chinoline for medical purposes; diabetic bread adapted for medical use; chloroform; flowers of sulfur for pharmaceutical purposes; cement for animal hooves; bone cement for surgical and orthopaedic purposes; dental cements; medicinal tea; herbal teas for medicinal purposes; bath tea for therapeutic purposes; insecticidal animal shampoos; medicated shampoos; medicated shampoos for pets; pediculicidal shampoos; medicated dry shampoos; pre-filled syringes for medical purposes; eucalyptus for pharmaceutical purposes; herbal extracts for medical purposes; plant extracts for pharmaceutical purposes; tobacco extracts [insecticides]; extracts of hops for pharmaceutical purposes; elixirs [pharmaceutical preparations]; ethers for pharmaceutical purposes; esters for pharmaceutical purposes; cellulose esters for pharma-

ceutical purposes; cellulose ethers for pharmaceutical purposes; rat poison; poisons; bacterial poisons; jalap; medicines; pharmaceutical substances; food products for therapeutic and prophylactic purposes; medicines, namely, for the treatment of viral diseases; medicines, namely, for the treatment of coronavirus infection; medicines, namely, for the treatment of HIV infection; medicines, namely, for the treatment of bacterial infections; medicines, namely antibiotics; medicines, namely for the treatment of diseases of the musculoskeletal system; medicines, namely, for the treatment of lung diseases; medicines, namely hypoglycemic agents; medicines, namely, for the treatment of obesity; medicines for the treatment of diabetes; medicines, namely, immunostimulants; medicines, namely anticoagulants; medicines, namely, analeptics; medicines, namely, analgesic non-narcotic medicines; medicines, namely antihypertensives; medicines, namely, antioxidants; medicines, namely, antiseptics; medicines, namely selective beta1-blockers; medicines, namely vasodilators; medicines, namely, venotonic and venoprotective agents; medicines, namely vitamins; medicines, namely, hemostatic agents; medicines, namely medicines for weight reduction; medicines, namely, glucocorticosteroids; medicines, namely, detoxification agents; medicines, namely diuretics; medicines, namely, cardiogenic drugs of a non-glycoside structure; medicines, namely, coronary dilating agents of reflex action; medicines, namely, correctors of cerebrovascular disorders; medicines, namely, local anesthetics; medicines, namely local irritants; medicines, namely, metabolic agents; medicines, namely painkillers; medicines, namely non-steroidal anti-inflammatory drugs; medicines, namely, plasma substitutes; medicines, namely antimicrobial agents; medicines, namely antifungal agents; medicines, namely anticancer drugs; medicines, namely antiemetics; medicines, namely anti-scabies; medicines, namely, rehydrating agents; medicines, namely, reparants; medicines, namely, tissue repair stimulant of natural origin; medicines, namely, antispasmodics; medicines, namely, means of carbon nutrition for medical purposes; medicines, namely electrolytes for medical purposes; medicines, namely tablets [pharmaceuticals]; medicines, namely medicines in the form of capsules; medicines, namely medicated powders; medicines, namely, lyophilizates for medical purposes; medicines, namely medicinal solutions; medicines, namely, medicinal solutions for injections; medicines, namely solutions for infusions; medicines, namely, concentrates for pharmaceutical purposes for the preparation of solutions for infusions and injections; medicines, namely medicated gels; medicines, namely, medicated ointments; medicines, namely medicated creams; medicines, namely, liniments; medicines, namely suppositories.

(260) AM 2026 132954 A

(800) 1844581

(151) 2024 10 25

(891) 2024 10 25

(731) Limited Liability Company "KIND COOKIES"

Dubninskaya str., 30, bldg. 2, sq. 95,

RU-127591 Moscow, Russian Federation

(540)

(591) White, light brown and brown

(531) 26.13.01; 28.05; 29.01.07

(511)

30 – Coffee, tea, cocoa and coffee substitutes; rice; tapioca and sago; flour and preparations made from cereals; bread, pastries and confectionery; sugar, honey, treacle; yeast, baking-powder; salt; vinegar, sauces [condiments]; vanilla flavourings for culinary purposes; flavourings, other than essential oils, for cakes; flavourings, other than essential oils, for beverages; coffee flavourings; food flavourings, other than essential oils; star aniseed; cereal bars; high-protein cereal bars; pancakes; noodle-based prepared meals; buns; bulgur; bread rolls; edible rice paper; edible paper; burritos; vanillin [vanilla substitute]; waffles; vermicelli; natural sweeteners; sausage binding materials; binding agents for ice cream; seawater for cooking; seaweed [condiment]; malt biscuits; cloves [spice]; mirror icing [mirror glaze]; cake frosting [icing]; glucose for culinary purposes; mustard; croûtons; buckwheat, processed; gluten additives for culinary purposes; thickening agents for cooking foodstuffs; leaven; rice-based snack food; cereal-based snack food; vegetal preparations for use as coffee substitutes; dressings for salad; fruit jellies [confectionery]; candy decorations for cakes; confectionery for decorating Christmas trees; cakes; pastries; peanut confectionery; almond confectionery; pasta; frozen yogurt [confectionery ices]; cream of tartar for culinary purposes; capers; caramels [sweets]; curry [spice]; ketchup [sauce]; quinoa, processed; quiches; gluten prepared as foodstuff; flour-based dumplings; sweets; liquorice [confectionery]; peppermint sweets; mints for breath freshening; dulce de leche; cinnamon [spice]; starch for food; crackers; custard; hominy grits; semolina; oatmeal; crushed barley; groats for human food; ice cubes; corn, milled; corn, roasted; meat pies; turmeric; noodles; soba noodles; udon noodles; ice for refreshment; ice, natural or artificial; edible ices; rice cakes; mayonnaise; macaroni; maltose; hominy; piccalilli; marinades; marzipan; royal jelly; ice cream; bean meal; buckwheat flour; tapioca flour; potato flour; corn flour; nut flours; flour; wheat flour; soya flour; barley meal; dessert mousses [confectionery]; chocolate mousses; muesli; mint for confectionery; cocoa beverages with milk; coffee beverages with milk; coffee-based beverages; chamomile-based beverages; tea-based beverages; chocolate beverages with milk; chocolate-based

beverages; infusions, not medicinal; crushed oats; husked oats; okonomiyaki [Japanese savory pancakes]; chocolate-coated nuts; stick liquorice [confectionery]; pastila [confectionery]; lozenges [confectionery]; treacle; pâtés en croûte; pepper; allspice; peppers [seasonings]; biscuits; petit-beurre biscuits; bibimbap [rice mixed with vegetables and beef]; pies; pizzas; meat gravies; fondants [confectionery]; popcorn; powders for making ice cream; baking powder; mustard meal; pralines; oat-based food; propolis; gingerbread; spices; puddings; cake powder; ravioli; chewing gum; chewing gum for breath freshening; relish [condiment]; instant rice; wheat germ for human consumption; spring rolls; palm sugar; sesame seeds [seasonings]; linseed for culinary purposes [seasoning]; processed seeds for use as a seasoning; aniseed; agave syrup [natural sweetener]; golden syrup; candy bars; baking soda [bicarbonate of soda for cooking purposes]; malt for human consumption; salt for preserving foodstuffs; cooking salt; celery salt; sorbets [ices]; ham glaze; cranberry sauce [condiment]; soya sauce; tomato sauce; pasta sauce; sauces [condiments]; apple sauce [condiment]; spaghetti; seasonings; chocolate-based spreads; chocolate spreads containing nuts; preparations for stiffening whipped cream; shaved ice with sweetened red beans; rusks; breadcrumbs; sushi; sandwiches; tabbouleh; tacos; tapioca; tarts; dough; pastry dough; almond paste; rice pulp for culinary purposes; cake batter; garden herbs, preserved [seasonings]; chocolate decorations for cakes; beer vinegar; ferments for dough; halvah; bread; unleavened bread; corn flakes; oat flakes; hot dog sandwiches; flowers or leaves for use as tea substitutes; chicory [coffee substitute]; iced tea; chutneys [condiments]; minced garlic [condiment]; cheeseburgers [sandwiches]; chow-chow [condiment]; saffron [seasoning]; chocolate; malt extract for food; essences for foodstuffs, except etheric essences and essential oils; husked barley; vanilla flavourings for foodstuffs; flavourings in the form of concentrated sauces; flavourings in the form of dehydrated sauces; flavourings made from shrimps; pandan flavourings for culinary purposes; food flavourings made from mushrooms; food flavourings made from shrimps; food flavourings made from poultry; food flavourings made from meat; flavourings made from poultry; food flavourings made from lobsters; flavourings made from fish; flavourings made from pickles; food flavourings made from truffles; flavourings made from snails; food flavourings made from snails; food flavourings made from oysters; flavourings made from meat; fruit flavourings, except essences; vanilla flavourings for food or beverages; flavourings, other than essential oils, for cheese; flavorings, other than essential oils, for soups; tea flavourings for food or beverages; baozi; freeze-dried dishes with the main ingredient being pasta; freeze-dried dishes with the main ingredient being rice; pierogi [stuffed dumplings]; zephyr being confectionery; ginger [spice]; kimbap; kimchijeon [fermented vegetable pancakes];

couscous [semolina]; non-medicated sugar candies; lollipops [confectionery]; potato-based flatbreads; macarons [pastries]; cocoa-based beverages; onigiri; nutmegs [spice]; soya bean paste [seasoning]; pelmeni [dumplings stuffed with meat]; pesto; meat tenderizers for culinary purposes; petits fours; fruit-based sauces; fruit coulis [sauces]; ramen [Japanese noodle-based dish]; batter mixes for okonomiyaki [Japanese savory pancakes]; senbei [rice crackers]; rice crackers; cereal flakes; jiaozi [stuffed dumplings].

35 – Business management; business administration; office functions; arranging subscriptions to telecommunication services for others; import-export agencies; cost price analysis; rental of advertising space; business auditing; financial auditing; business intermediary services relating to the matching of potential private investors with entrepreneurs needing funding; computerized file management; book-keeping; invoicing; demonstration of goods; transcription of communications [office functions]; opinion polling; market studies; business investigations; business research; marketing research; personnel recruitment; consultancy regarding advertising communication strategies; business management and organization consultancy; business organization consultancy; business management consultancy; personnel management consultancy; professional business consultancy; layout services for advertising purposes; marketing; targeted marketing; business management of professional singers; writing of curriculum vitae for others; scriptwriting for advertising purposes; updating and maintenance of information in registries; updating and maintenance of data in computer databases; updating of advertising material; word processing; online retail services for downloadable and pre-recorded music and movies; online retail services for downloadable ring tones; online retail services for downloadable digital music; organization of exhibitions for commercial or advertising purposes; arranging newspaper subscriptions for others; organization of fashion shows for promotional purposes; organization of trade fairs for commercial or advertising purposes; shop window dressing; business appraisals; payroll preparation; data search in computer files for others; administrative assistance in responding to calls for tenders; business management assistance; commercial or industrial management assistance; providing commercial and business contact information; presentation of goods on communication media, for retail purposes; economic forecasting; sales promotion for others; promotion of goods and services through sponsorship of sports events; production of teleshopping programmes; production of advertising films; publication of publicity texts; radio advertising; bill-posting; distribution of samples; dissemination of advertising matter; registration of written communications and data; editing of publicity texts; online advertising on a computer network; advertising by mail order; television advertising; document reproduction; compilation of information into computer da-

tabases; compilation of statistics; business inquiries; systemization of information into computer databases; negotiation of business contracts for others; compiling indexes of information for commercial or advertising purposes; tax preparation; drawing up of statements of accounts; psychological testing for the selection of personnel; interim business management; business management of hotels; business management for free-lance service providers; business project management services for construction projects; commercial administration of the licensing of the goods and services of others; business management of reimbursement programmes for others; administration of frequent flyer programs; administrative processing of purchase orders; public relations; competitive intelligence services; modelling for advertising or sales promotion; typing; market intelligence services; appointment reminder services [office functions]; website traffic optimization; tax filing services; search engine optimization for sales promotion; gift registry services; price comparison services; procurement services for others [purchasing goods and services for other businesses]; shorthand; outsourcing services [business assistance]; telephone answering for unavailable subscribers; photocopying services; commercial information agency services; analysis of business information; business management and administration; business secretarial services; marketing and promotional services; appointment scheduling and reminder services; consultancy regarding administrative services for the relocation of businesses; commercial information; advertising agency services; television advertising agency services; outsourced administrative management for companies; business information agency services; providing business information; providing consumer information relating to goods and services; consultancy regarding public relations communication strategies; marketing in the framework of software publishing; writing and publication of publicity texts; sponsorship search; commercial intermediation services; provision of an online marketplace for buyers and sellers of goods and services; arranging of auctions; retail services for works of art provided by art galleries; office machines and equipment rental; rental of advertising time on communication media; provision and rental of publicity material; rental of vending machines; vending machine services; rental of sales stands; rental of photocopying machines; rental of office equipment; distribution of advertising, marketing and promotional material; direct mail advertising; drafting of publicity material; commercial business management; negotiation and conclusion of commercial transactions for third parties; telemarketing services; retail or wholesale services for pharmaceutical, veterinary and sanitary preparations and medical supplies; administration of customer loyalty programs.

(260) AM 2026 132955 A

(800) 1844583

(151) 2024 11 18

(891) 2024 11 18

(731) Ehrmann SE

A.-Ehrmann-Straße 2, 87770 Oberschönegg,
Germany

(540)

PRIOLAC

(591) Black, white

(511)

5 – Powdered milk for babies; products based on powdered milk for babies; breast-milk substitutes; food for babies; lacteal flour for babies; infant formula; food and beverages for infants; food for babies, including food for babies based on fruit, berries, vegetables, meat, soya, milk; food for babies, including porridge, fruit and cereal porridge, instant porridge [grain porridge, grain porridge with fruit, grain porridge with milk, grain porridge with infant milk formula, grain porridge fortified with probiotics or prebiotics]; dairy-free instant porridge, fortified with vitamins and mineral substances for babies [food for babies]; fruit, berry, fruit and berry, vegetable, fruit and vegetable purées for babies [food for babies]; powdered instant or pre-cooked soup and pudding for babies [food for babies]; nutritionally fortified water for babies; powdered and liquid starch drink for babies [food for babies]; fortified fruit juices and fruit and vegetable juices for babies [food for babies]; vegetable, berry, fruit based desserts for babies [food for babies].

(260) AM 2026 132956 A

(800) 1844601

(151) 2024 11 20

(891) 2024 11 20

(731) Limited liability company PROMOMED RUS

prospekt Mira, d. 13, str. 1, of. 13,
RU-129090 Moscow, Russian Federation

(540)



(591) Purple, burgundy and pink

(531) 02.09.01; 26.07.04; 26.13.25; 28.05; 29.01.12

(511)

5 – Acaricides; aconitine; alkaloids for medical purposes; alginates for pharmaceutical purposes; algicides; aldehydes for pharmaceutical purposes; dental amalgams of gold; dental amalgams; amino acids for veterinary purposes; amino acids for medical purposes; analgesics; anaesthetics; antibiotics; antiseptics; medicine cases, portable, filled; first-aid boxes, filled;

aluminium acetate for pharmaceutical purposes; acetates for pharmaceutical purposes; germicides; oxygen cylinders, filled, for medical purposes; balms for medical purposes; bandages for dressings; diagnostic biomarker reagents for medical purposes; biocides; bracelets impregnated with insect repellent; bromine for pharmaceutical purposes; paper for mustard plasters; fly catching paper; reagent paper for veterinary purposes; reagent paper for medical purposes; moth-proofing paper; petroleum jelly for medical purposes; vaccines; oxygen baths; antiseptic cotton; aseptic cotton; absorbent cotton; wadding for medical purposes; cotton for medical purposes; dietetic substances adapted for medical use; radiological contrast substances for medical purposes; nutritive substances for microorganisms; radioactive substances for medical purposes; bismuth subnitrate for pharmaceutical purposes; melissa water for pharmaceutical purposes; seawater for medicinal bathing; mineral waters for medical purposes; thermal water; dietary fibre; moulding wax for dentists; gases for medical purposes; guaiacol for pharmaceutical purposes; massage gels for medical purposes; sexual stimulant gels; haematogen; haemoglobin; hydrastine; hydrastinine; glycerine for medical purposes; glycerophosphates; glucose for medical purposes; gentian for pharmaceutical purposes; hormones for medical purposes; mustard for pharmaceutical purposes; mustard plasters; mud for baths; medicinal mud; contraceptive sponges; gamboge for medical purposes; gurjun balsam for medical purposes; deodorizers for litter trays; deodorants for clothing and textiles; air deodorizing preparations; deodorants, other than for human beings or for animals; diastase for medical purposes; digitalin; vitamin supplement patches; mineral dietary supplements; nutritional supplements; albumin dietary supplements; dietary supplements for animals; yeast dietary supplements; alginate dietary supplements; glucose dietary supplements; casein dietary supplements; lecithin dietary supplements; linseed oil dietary supplements; brewer's yeast dietary supplements; propolis dietary supplements; protein dietary supplements; protein supplements for animals; royal jelly dietary supplements; pollen dietary supplements; wheat germ dietary supplements; linseed dietary supplements; whey protein dietary supplements; acai powder dietary supplements; dietary supplements with a cosmetic effect; enzyme dietary supplements; yeast for pharmaceutical purposes; gelatine for medical purposes; cod liver oil; isotopes for medical purposes; immunostimulants; insecticides; iodine for pharmaceutical purposes; iodides for pharmaceutical purposes; alkaline iodides for pharmaceutical purposes; iodoform; calomel [fungicide]; cream of tartar for pharmaceutical purposes; tartar for pharmaceutical purposes; camphor for medical purposes; cannabidiol for medical use; capsules for medicines; cachets for pharmaceutical purposes; capsules made of dendrimer-based polymers, for pharmaceuticals; haemostatic pencils; wart pencils;

caustic pencils; carbolineum [parasiticide]; caustics for pharmaceutical purposes; cachou for pharmaceutical purposes; quassia for medical purposes; quebracho for medical purposes; oxygen for medical purposes; gallic acid for pharmaceutical purposes; acids for pharmaceutical purposes; adhesives for dentures; surgical glues; stem cells for veterinary purposes; stem cells for medical purposes; cocaine for medical purposes; collagen for medical purposes; collodion for pharmaceutical purposes; corn rings for the feet; cannabis for medical purposes; medicated sweets; angostura bark for medical purposes; barks for pharmaceutical purposes; cedar wood for use as an insect repellent; condurango bark for medical purposes; croton bark; mangrove bark for pharmaceutical purposes; myrobalan bark for pharmaceutical purposes; quinquina for medical purposes; medicated animal feed; medicinal roots; rhubarb roots for pharmaceutical purposes; lint for medical purposes; starch for dietetic or pharmaceutical purposes; creosote for pharmaceutical purposes; blood for medical purposes; biological tissue cultures for veterinary purposes; biological tissue cultures for medical purposes; cultures of microorganisms for medical or veterinary use; curare; dental lacquer; liquorice for pharmaceutical purposes; milk sugar for pharmaceutical purposes; adhesive plasters; medicines for alleviating constipation; adhesive tapes for medical purposes; lecithin for medical purposes; lotions for veterinary purposes; medicated hair lotions; lotions for pharmaceutical purposes; medicated after-shave lotions; personal sexual lubricants; lupulin for pharmaceutical purposes; magnesium for pharmaceutical purposes; liniments; ointments for pharmaceutical purposes; sunburn ointments; mercurial ointments; frostbite salve for pharmaceutical purposes; marijuana for medical purposes; gauze for dressings; medicinal oils; mustard oil for medical purposes; camphor oil for medical purposes; castor oil for medical purposes; oil of turpentine for pharmaceutical purposes; dill oil for medical purposes; dental mastics; dental abrasives; dental impression materials; teeth filling material; dressings, medical; surgical dressings; drugs for medical purposes; medicines for veterinary purposes; serotherapeutic medicines; medicines for human purposes; medicines for dental purposes; menthol; medicinal drinks; moleskin for medical purposes; almond milk for pharmaceutical purposes; powdered milk for babies; royal jelly for pharmaceutical purposes; milk ferments for pharmaceutical purposes; Irish moss for medical purposes; flour for pharmaceutical purposes; linseed meal for pharmaceutical purposes; fish meal for pharmaceutical purposes; fly glue; antibacterial soap; disinfectant soap; medicated soap; freeze-dried meat adapted for medical purposes; mint for pharmaceutical purposes; dietetic beverages adapted for medical purposes; malted milk beverages for medical purposes; injectable dermal fillers; bone void fillers comprised of living tissues; narcotics; medicinal infusions; tincture of iodine; eucalyptol for phar-

maceutical purposes; tinctures for medical purposes; opium; opodeldoc; aromatic deodorizers for toilets; decoctions for pharmaceutical purposes; antiparasitic collars for animals; cotton sticks for medical purposes; stick liquorice for pharmaceutical purposes; sulfur sticks [disinfectants]; pastilles for pharmaceutical purposes; medicated toothpaste; pectin for pharmaceutical purposes; pepsins for pharmaceutical purposes; peptones for pharmaceutical purposes; hydrogen peroxide for medical purposes; pesticides; food for babies; leeches for medical purposes; blood plasma; nicotine patches for use as aids to stop smoking; eye-patches for medical purposes; poultices; compresses; scapulars for surgical purposes; babies' diapers; diapers for pets; swim diapers, reusable, for babies; swim diapers, disposable, for babies; diapers for incontinence; disposable absorbent mats for lining pet crates; diaper changing mats, disposable, for babies; disposable housebreaking pads for pets; bunion pads; breast-nursing pads; diagnostic strips for testing breast milk for medical purposes; pomades for medical purposes; powder of cantharides; pyrethrum powder; anti-uric preparations; bacterial preparations for medical and veterinary use; bacteriological preparations for medical and veterinary use; balsamic preparations for medical purposes; albuminous preparations for medical purposes; biological preparations for veterinary purposes; biological preparations for medical purposes; veterinary preparations; bismuth preparations for pharmaceutical purposes; vitamin preparations; diagnostic preparations for veterinary purposes; diagnostic preparations for medical purposes; douching preparations for medical purposes; bath preparations for medical purposes; therapeutic preparations for the bath; haemorrhoid preparations; preparations for callouses; lice treatment preparations [pediculicides]; acne treatment preparations; preparations to facilitate teething; preparations for the treatment of burns; fumigation preparations for medical purposes; opotherapy preparations; air purifying preparations; bronchodilating preparations; preparations for reducing sexual activity; sterilizing preparations; soil-sterilizing preparations; corn remedies; pharmaceutical preparations for treating dandruff; vermin destroying preparations; preparations for destroying noxious animals; herbicides; preparations for destroying dry rot fungus; larvae exterminating preparations; fly destroying preparations; preparations for destroying mice; slug exterminating preparations; pharmaceutical preparations for skin care; contact lens cleaning preparations; preparations of microorganisms for medical or veterinary use; lime-based pharmaceutical preparations; styptic preparations; medicated eye-washes; medicinal hair growth preparations; nutraceutical preparations for therapeutic or medical purposes; opiates; anticryptogamic preparations; aloe vera preparations for pharmaceutical purposes; preparations of trace elements for human and animal use; sulfonamides [medicines]; pharmaceutical preparations; pharmaceutical prepara-

tions for treating sunburn; enzyme preparations for veterinary purposes; enzyme preparations for medical purposes; phytotherapy preparations for medical purposes; chemico-pharmaceutical preparations; chemical preparations for veterinary purposes; chemical preparations for the diagnosis of pregnancy; chemical preparations for medical purposes; chemical preparations for treating diseases affecting cereal plants; chemical preparations for treating wheat blight; chemical preparations for treating diseases affecting vine plants; chemical preparations for treating mildew; chemical preparations for treating phylloxera; chemical preparations for pharmaceutical purposes; chilblain preparations; mothproofing preparations; collyrium; lead water; chemical conductors for electrocardiograph electrodes; albuminous foodstuffs for medical purposes; dietetic foods adapted for medical purposes; by-products of the processing of cereals for dietetic or medical purposes; homogenized food adapted for medical purposes; freeze-dried food adapted for medical purposes; pharmaceuticals; sanitary towels; panty liners [sanitary]; propolis for pharmaceutical purposes; pearl powder for medical purposes; radium for medical purposes; hydrated chloral for pharmaceutical purposes; solvents for removing adhesive plasters; vaginal washes for medical purposes; solutions for contact lenses; chemical reagents for medical or veterinary purposes; gum for medical purposes; rubber for dental purposes; chewing gum for medical purposes; nicotine gum for use as an aid to stop smoking; insect repellents; insect repellent incense; repellents for dogs; tissues impregnated with pharmaceutical lotions; sarsaparilla for medical purposes; sugar for medical purposes; crystallized rock sugar for medical purposes; asthmatic tea; fumigating sticks; massage candles for therapeutic purposes; linseed for pharmaceutical purposes; tobacco-free cigarettes for medical purposes; siccatives [drying agents] for medical purposes; syrups for pharmaceutical purposes; turpentine for pharmaceutical purposes; milking grease; greases for veterinary purposes; greases for medical purposes; lacteal flour for babies; infant formula; soporifics; bicarbonate of soda for pharmaceutical purposes; bath salts for medical purposes; salts for mineral water baths; salts for medical purposes; potassium salts for medical purposes; sodium salts for medical purposes; smelling salts; mineral water salts; malt for pharmaceutical purposes; semen for artificial insemination; alcohol for pharmaceutical purposes; medicinal alcohol; alloys of precious metals for dental purposes; ergot for pharmaceutical purposes; cooling sprays for medical purposes; antibacterial handwashes; adjuvants for medical purposes; astringents for medical purposes; vermifuges; disinfectants; disinfectants for hygiene purposes; disinfectants for chemical toilets; appetite suppressants for medical purposes; medical preparations for slimming purposes; parasitocides; mouthwashes for medical purposes; medicated dentifrices; febrifuges; depuratives; animal washes

[insecticides]; detergents for medical purposes; cattle washes [insecticides]; dog washes [insecticides]; insecticidal veterinary washes; vesicants; purgatives; remedies for perspiration; remedies for foot perspiration; anti-inflammatories; chemical contraceptives; antiparasitic preparations; sedatives; laxatives; tonics [medicines]; medicated toiletry preparations; digestives for pharmaceutical purposes; nervines; bouillons for bacteriological cultures; steroids; headache relief sticks; strychnine; suppositories; serums; tanning pills; appetite suppressant pills; slimming pills; jujube, medicated; antioxidant pills; cotton swabs for medical purposes; sanitary tampons; vulnerary sponges; tetrahydrocannabinol [THC] for medical use; thymol for pharmaceutical purposes; smoking herbs for medical purposes; medicinal herbs; tranquilizers; transplants [living tissues]; surgical implants comprised of living tissues; pants, absorbent, for incontinence; sanitary panties; babies' diaper-pants; charcoal for pharmaceutical purposes; fennel for medical purposes; porcelain for dental prostheses; phenol for pharmaceutical purposes; enzymes for veterinary purposes; enzymes for medical purposes; ferments for pharmaceutical purposes; formic aldehyde for pharmaceutical purposes; phosphates for pharmaceutical purposes; fungicides; quinine for medical purposes; chinoline for medical purposes; diabetic bread adapted for medical use; chloroform; flowers of sulfur for pharmaceutical purposes; cement for animal hooves; bone cement for surgical and orthopaedic purposes; dental cements; medicinal tea; herbal teas for medicinal purposes; bath tea for therapeutic purposes; insecticidal animal shampoos; medicated shampoos; medicated shampoos for pets; pediculicidal shampoos; medicated dry shampoos; pre-filled syringes for medical purposes; eucalyptus for pharmaceutical purposes; herbal extracts for medical purposes; plant extracts for pharmaceutical purposes; tobacco extracts [insecticides]; extracts of hops for pharmaceutical purposes; elixirs [pharmaceutical preparations]; ethers for pharmaceutical purposes; esters for pharmaceutical purposes; cellulose esters for pharmaceutical purposes; cellulose ethers for pharmaceutical purposes; rat poison; poisons; bacterial poisons; jalap; medications; medicines; pharmaceutical substances; food products for therapeutic and prophylactic purposes; medicines, namely, for the treatment of viral diseases; medicines, namely, for the treatment of coronavirus infection; medicines, namely, for the treatment of HIV infection; medicines, namely, for the treatment of bacterial infections; medicines, namely antibiotics; medicines, namely for the treatment of diseases of the musculoskeletal system; medicines, namely, for the treatment of lung diseases; medicines, namely, for the treatment of obesity; medicines, namely, immunostimulants; medicines, namely anticoagulants; medicines, namely, analeptics; medicines, namely, analgesic non-narcotic medicines; medicines, namely antihypertensives; medicines, namely, antioxidants; medicines, namely, antiseptics;

medicines, namely selective beta1-blockers; medicines, namely vasodilators; medicines, namely, venotonic and venoprotective agents; medicines, namely vitamins; medicines, namely, hemostatic agents; medicines, namely, glucocorticosteroids; medicines, namely, detoxification agents; medicines, namely diuretics; medicines, namely, cardiogenic drugs of a non-glycoside structure; medicines, namely, coronary dilating agents of reflex action; medicines, namely, correctors of cerebrovascular disorders; medicines, namely, local anesthetics; medicines, namely local irritants; medicines, namely, metabolic agents; medicines and biologically active supplements for weight reduction; medicines for the prevention and treatment of diabetes; dietary supplements for the prevention and treatment of diabetes; medicines, namely hypoglycemic agents; medicines, namely painkillers; medicines, namely non-steroidal anti-inflammatory drugs; medicines, namely, plasma substitutes; medicines, namely antimicrobial agents; medicines, namely antifungal agents; medicines, namely anticancer drugs; medicines, namely antiemetics; medicines, namely anti-scabies; medicines, namely, rehydrating agents; medicines, namely, reparants; medicines, namely, tissue repair stimulant of natural origin; medicines, namely, antispasmodics; medicines, namely, means of carbon nutrition for medical purposes; medicines, namely electrolytes for medical purposes; medicines, namely tablets [pharmaceuticals]; medicines, namely medicines in the form of capsules; medicines, namely medicated powders; medicines, namely, lyophilizates for medical purposes; medicines, namely medicinal solutions; medicines, namely, medicinal solutions for injections; medicines, namely solutions for infusions; medicines, namely, concentrates for pharmaceutical purposes for the preparation of solutions for infusions and injections; medicines, namely medicated gels; medicines, namely, medicated ointments; medicines, namely medicated creams; medicines, namely, liniments; medicines, namely suppositories.

(260) AM 2026 132958 A

(800) 1844607

(151) 2024 11 27

(891) 2024 11 27

(731) Richter Gedeon Nyrt.

Gyömrői út 19-21., H-1103 Budapest, Hungary

(540)

QATEXOZIN

(591) Black, white

(511)

5 – Pharmaceutical preparations.

(260) AM 2026 132959 A

(800) 1844611

(151) 2025 01 24

(891) 2025 01 24

(731) KHODZHER VALENTIN DMITRIEVICH

ul. Bezbokova, d.30/09, kv.119, Irkutsk,

RU-664056 Irkutskaya oblast, Russian

Federation

(540)



(591) Beige

(531) 03.05.05; 17.02.01; 25.01.06; 27.05.01;

29.01.11

(511)

14 – Agates; diamonds; amulets [jewellery]; bracelets [jewellery]; watch bands; key rings; charms [jewellery]; brooches [jewellery]; pins [jewellery]; ornamental pins; tie pins; beads for making jewellery; pearls made of ambroid [pressed amber]; busts of precious metal; jet, unwrought or semi-wrought; key rings [split rings with trinket or decorative fob]; pearls [jewellery]; copper tokens; tie clips; cuff links; clasps for jewellery; badges of precious metal; gold, unworked or semi-worked; works of art of precious metal; jewellery; ivory jewellery; jewellery of yellow amber; cabochons; precious stones; semi-precious stones; spun silver [silver wire]; necklaces [jewellery]; rings [jewellery]; boxes of precious metal; presentation boxes for jewellery; commemorative statuary cups of precious metal; prize cups of precious metal; medals; lockets [jewellery]; precious metals, unwrought or semi-wrought; coins; gold thread [jewellery]; threads of precious metal [jewellery]; silver thread [jewellery]; olivine [gems]; platinum [metal]; crucifixes of precious metal, other than jewellery; crucifixes as jewellery; jewellery rolls; silver, unwrought or beaten; earrings; ingots of precious metals; alloys of precious metal; statues of precious metal; statuettes made of or coated with precious or semi-precious metals or precious stones; paste jewellery; jewellery for pets; shoe jewellery; hat jewellery; figurines of precious metal; presentation boxes for watches; chronographs [watches]; chronometers; chains [jewellery]; watch chains; watches; clocks; wristwatches; jewellery boxes; spinel [precious stones].

(260) AM 2026 132960 A

(800) 1844633

(151) 2025 02 18

(891) 2025 02 18

(731) Calzedonia S.p.A.

Via Portici Umberto I, 5, I-37018 Malcesine

(Verona), Italy

(540)

WE ARE FOR BALLS

(591) Black, white

(511)

25 – Clothing, footwear, headwear; coats, vests, jeans, pants, shorts, shirts, suits, socks; combinations [clothing]; underwear; swimwear; beachwear; nightwear; pajamas; knitwear; knit shirts, knit robes; sports clothing; sports shirts, sports pants, sports jerseys; slippers; flip-flops; bath robes; bathing caps; gloves; mittens; earmuffs; headbands; hats, caps; visors [headwear]; bandanas; neck scarfs; neckties; ponchos; belts; money belts.

(260) AM 2026 132961 A

(800) 1844667

(151) 2024 09 26

(891) 2024 09 26

(731) Neoperl Group AG

Pfeffingerstrasse 21, CH-4153 Reinach,
Switzerland

(540)

NEOPERL

(591) Black, white

(511)

11 – Apparatus and installations for heating, air-conditioning, water supply and sanitary installations; sanitary plumbing components for water distribution in the form of pipes, hoses, fittings forming part of sink, washbasin, shower or bathtub faucets and in particular faucet aerators, faucet aerator tips, adapters for faucet aerators, faucet thread adapters, connecting pipes and hoses, protective caps for faucet connecting hoses, pipe and hose fittings, collectors, valves, filters, flow regulators, backflow prevention devices, diverters, plumbing clips and fasteners; tap cartridge adapters; aerators [tapware]; tap swirls, faucet bubbler; flow rate regulators; check valves, non-return device, non-return valves; diverters [plumbing components]; connecting pipes; shower hoses; flexible hoses for pull-out kitchen-sink sprayer; pipes for connecting the pull-out kitchen-sink sprayer hose; pipes for sanitary, climate-control, irrigation and heating installations; flexible pipes and pipe connectors being parts of plumbing installations, particularly faucets, sinks, wash-hand basins, bath tubs, showers, toilets/water closets and plumbing for household and commercial appliances; drip-proof hoses [faucet components]; pull-out kitchen-sink sprayer; valves [parts of sanitary installations]; diverter valves for sanitary installations; start / stop controls [parts of sanitary installations]; hot/cold water mixing valve [parts of sanitary installations]; pressure regulators [parts of sanitary installations], particularly pressure balancing valve; pressure regulator [parts of sanitary installations], particularly pressure limiter; swivel joints [parts of sanitary installations], accessories for faucet spouts, particularly swivel adapters, accessories for shower faucets, namely, swivel adapters, accessories for kitchen faucet pipes, particularly swivel adapters; plumbing connectors, namely, pipe and tube connectors; washers [parts of sanitary

installations]; adapters [parts of sanitary installations], plumbing fittings; plumbing accessories, namely filters and strainers; installation tools and kits for aerator installation; end-pieces for faucet aerators, rings for faucet aerators; faucets and fittings; plumbing accessories, namely, bathtub, washbasin, kitchen, shower and bathtub mixers; spouts (plumbing accessories); backflow-prevention safety devices for sanitary installations, in the form of air-gap fittings, vacuum breakers or vents; air knives with injector; shower heads; shower systems; flexible pipes (as components of sanitary installations).

35 – Advertising; business management, organization and administration; office functions; retail and wholesale and online sale services for sanitary installations and plumbing products.

(260) AM 2026 132964 A

(800) 1844760

(151) 2025 01 22

(891) 2025 01 22

(731) Honor Device Co., Ltd.

Suite 3401, Unit A, Building 6, Shum Yip Sky
Park, No. 8089, Hongli West Road, Xiangmihu
Street, Futian District, Shenzhen, 518040
Guangdong, China

(540)

Portrait Master

(591) Black, white

(511)

9 – tablet computers; smart rings [data processing]; smartwatches [data processing]; smartglasses [data processing]; wearable computers; notebook computers; integrated circuit cards [smart cards]; data processors; graphics accelerators; graphics processor units (GPU); central processing units for processing information, data, sound or images; tele vision apparatus; virtual reality headsets; earphone; USB cables for cell phones; electronic chips; sensors; cellphone screens; smartphone screens; video screens; optical position sensors; 3D spectacles.

(260) AM 2026 132968 A

(800) 1844825

(151) 2025 01 21

(891) 2025 01 21

(731) August Storck KG

Waldstrasse 27, 13403 Berlin,
Germany

(540)

Mamba Fruitparty

(591) Black, white

(511)

30 – Sweets; confectionery; fruit gums; foam kisses being confectionery; chocolate foam kisses being confectionery; chocolate; chocolate products; pastries;

ice-cream; popcorn; preparations for making the aforementioned products, included in this class.

(260) AM 2026 132972 A

(800) 1844971

(151) 2024 10 15

(891) 2024 10 15

(731) Dufry International AG (Dufry International SA) (Dufry International Ltd)
Brunngässlein 12, CH-4052 Basel, Switzerland

(540)



The logo for HMSHost features a stylized 'H' composed of three vertical bars of varying heights, followed by the text 'HMSHost' in a bold, sans-serif font.

(591) Blue

(531) 26.11.06; 26.11.07; 26.11.12; 27.05.10;
29.01.04

(511)

43 – Services for providing food and drink; Temporary accommodation; restaurant, cafe, snack bar, ice cream parlor, and pizzeria services, as well as self-service or take-away restaurant services; bar services; coffee shop services; salad bars; juice bar services; wine bars; cocktail lounge services; serving food and beverages in bistros and Internet cafes; serving food and beverages in doughnut shops; buffet restaurants; cafeteria services; tea room services; catering services; snack-bar services; self-service restaurant services; catering services for the provision of food and beverages; restaurant services in the framework of franchise; preparation of food and beverages for immediate consumption; advice concerning cooking recipes; restaurant reservation services; hotel services; provision of camping areas.

(260) AM 2026 132974 A

(800) 1845015

(151) 2024 11 25

(891) 2024 11 25

(731) Obshchestvo s ogranichennoy otvetstvennostyu "Samskiy Stroyfarfor"
pos. Stroykeramika, Voljskiy r-n, RU-443528
Samskaya oblast, Russian Federation

(540)



The logo for GRASARO features the word 'GRASARO' in a bold, sans-serif font, followed by a stylized graphic element consisting of three overlapping shapes: a white diamond, an orange arrow pointing right, and a green arrow pointing right.

(591) Black, white, beige and green

(531) 26.03.23; 26.04.03; 26.04.09; 29.01.14

(511)

19 – Granite; building materials, not of metal; wall claddings, not of metal, for building; floor tiles, not of metal; clay.

35 – Advertising; import-export agency services; demonstration of goods; sales promotion for others.

42 – Computer software design; technological research.

(260) AM 2026 133080 A

(800) 1845756

(151) 2025 01 22

(891) 2025 01 22

(731) Oemeta Chemische Werke GmbH
Ossenpadd 54, 25436 Uetersen, Germany

(540)

Frigomet

(591) Black, white

(511)

4 – Water-soluble drilling oils and grinding oils for metalworking purposes.

(260) AM 2026 133081 A

(800) 1845762

(151) 2024 06 28

(891) 2024 06 28

(731) Automobili Lamborghini S.p.A.
Via Modena, 12, I-40019 Sant'Agata
Bolognese (Bologna), Italy

(540)



(591) Black, white

(531) 03.04.04; 03.04.23; 03.04.24

(511)

9 – Electronic sensors; electronic regulators; electronic meters; electronic amplifiers; relays, electric; electronic components; electronic controllers; electronic tags; electronic chips; integrated electronic circuits; electronic power supplies; optical electronic components; electronic burglar alarms; transmitters of electronic signals; game software; game software; electronic cruise control apparatus; electrical and electronic components; electronic power transformers; downloadable electronic game programs; electronic navigation systems; electronic sports training simulators; electronic components used in machines; electronic data processing equipment; programmed-data-carrying electronic circuits; data processing information carriers; electrical remote control apparatus; testing apparatus for electronic equipment; electronic control systems for machines; optical sensors; sensors, detectors and monitoring instruments; liquid level sensors; sensors for measuring speed; fire-extinguishing apparatus; measuring apparatus; electronic distance meters; pres-

sure measuring apparatus; dynamometers; audio amplifiers; audio speakers for automobiles; car televisions; car telephones; car aerials; fire extinguishing apparatus for automobiles; car audio apparatus; car stereos; protective helmets for sports; fireproof automobile racing suits for safety purposes; traffic sign recognition systems; image recognition software; electronic keys for automobiles; protective helmets for motorists; computer applications for automotive control; car automatic driving control devices; computer applications for car audio video navigation; automated car parking control devices; tablet holders adapted for use in cars; control devices for car audio video navigation; integrated electronic hazard and collision avoidance systems for automobiles; car navigation computers; telemetry apparatus; car batteries; rechargeable electric batteries; power packs [batteries]; power units [batteries]; battery testers; anode batteries; batteries for electric vehicles; battery booster cables; solar-powered rechargeable batteries; battery charging devices for motor vehicles; electric batteries for powering electric vehicles; audio processing apparatus; surround sound systems; audio transmitter units; audio speakers for vehicles; audio effects apparatus; audio devices and radio receivers; parts and fittings for audio apparatus; audio speakers for vehicles; computer programs, recorded; computer programs, downloadable; computer software, recorded; monitors [computer programs]; computer programs, downloadable; software; all the aforesaid goods being in the field of cars.

12 – Cars; electric cars; automobile tyres; automobile tyres; spray prevention flaps for vehicles; motor car convertible tops; steering wheels for vehicles; anti-theft devices for vehicles; bumpers for automobiles; horns for motor cars; automobile bodies; car seats; automobile engines; motor racing cars; automobile chassis; shock absorbers for automobiles; upholstery for automobiles; electric motors for motor cars; autonomous cars; wheel rims [for automobiles]; automobiles and structural parts therefor; racing seats for automobiles; interior trim parts of automobiles; automatic gearboxes for motor cars; gear shifts for automobiles; powerboats; cycle cars; electric vehicles; hybrid cars; brakes for motor cars; disc brake pads for land vehicles; spoilers for vehicles; spoilers for water vehicles; spoilers for land vehicles; air flow spoilers for vehicles; spoilers for air vehicles; hydraulic brake pressure regulators for vehicles; aerodynamic attachments for vehicle bodies; self-balancing boards; motorised scooters; electric bicycles; engines for bicycles; motorcycles; folding electric bicycles; electrically operated wheelchairs; yachts; powerboats; water scooters; electric one wheel scooters; motorised scooters for the disabled and those with mobility difficulties; boats; jet boats; ships; motorcycles; inflatable boats.

(260) AM 2026 133083 A

(800) 1845810

(151) 2024 12 26

(891) 2024 12 26

(731) Shinflow JAPAN K.K.

Asia One Center, 1-17, Koyochi Naka,

Higashinada-ku, Kobe, Hyogo 658-0032, Japan

(540)

ShinFlow

(591) Black, white

(531) 27.05.01

(511)

11 – Air conditioning apparatus; air conditioning installations; fans [air-conditioning]; gas scrubbing apparatus; filters for air conditioning; cooking apparatus and installations; refrigerators; hair dryers; water heaters; steam facial apparatus [saunas]; water purification installations; radiators, electric; lighting apparatus and installations.

(260) AM 2026 133084 A

(800) 1845925

(151) 2024 12 18

(891) 2024 12 18

(731) Philip Morris Products S.A.

Quai Jeanrenaud 3, CH-2000 Neuchâtel,

Switzerland

(540)



(591) Black, white

(531) 26.01.05; 27.05.10

(511)

34 – Wired vaporizers for electronic cigarettes and electronic smoking devices; tobacco, raw or manufactured; tobacco products, including cigars, cigarettes, cigarillos, tobacco for roll-your-own cigarettes, pipe tobacco, chewing tobacco, snuff tobacco, kretek; snus; tobacco substitutes (not for medical purposes); smokers' articles, namely cigarette paper and tubes, cigarette filters, tobacco tins, cigarette cases and ashtrays, pipes, pocket apparatus for rolling cigarettes, lighters; matches; smoking tobacco sticks, tobacco products for the purpose of being heated, electronic devices and their parts for the purpose of heating cigarettes or tobacco in order to release nicotine-containing aerosol for inhalation; liquid nicotine solutions for use in electronic cigarettes; electronic smoking devices; electronic cigarettes; electronic cigarettes as substitutes for traditional cigarettes; electronic devices for the inhalation of nicotine-containing aerosols; oral vaporizing devices for smokers, tobacco products and tobacco

substitutes; smokers' articles for electronic cigarettes; parts and fittings for the aforementioned goods included in this class; devices for extinguishing heated cigarettes and cigars as well as heated tobacco sticks; electronic rechargeable cigarette cases.

(260) AM 2026 133091 A

(800) 1846042

(151) 2024 09 26

(891) 2024 09 26

(731) Neoperl Group AG

Pfeffingerstrasse 21, CH-4153 Reinach,
Switzerland

(540)



(591) Black, white

(531) 26.01.02; 26.01.03; 26.01.20

(511)

11 – Apparatus and installations for heating, air-conditioning, water supply and sanitary installations; sanitary plumbing components for water distribution in the form of pipes, hoses, fittings forming part of sink, washbasin, shower or bathtub faucets and in particular faucet aerators, faucet aerator tips, adapters for faucet aerators, faucet thread adapters, connecting pipes and hoses, protective caps for faucet connecting hoses, pipe and hose fittings, collectors, valves, filters, flow regulators, backflow prevention devices, diverters, plumbing clips and fasteners; tap cartridge adapters; aerators [tapware]; tap swirls, faucet bubbler; flow rate regulators; check valves, non-return device, non-return valves; diverters [plumbing components]; connecting pipes; shower hoses; flexible hoses for pull-out kitchen-sink sprayer; pipes for connecting the pull-out kitchen-sink sprayer hose; pipes for sanitary, climate-control, irrigation and heating installations; flexible pipes and pipe connectors being parts of plumbing installations, particularly faucets, sinks, wash-hand basins, bath tubs, showers, toilets/water closets and plumbing for household and commercial appliances; drip-proof hoses [faucet components]; pull-out kitchen-sink sprayer; valves [parts of sanitary installations]; diverter valves for sanitary installations; start/stop controls [parts of sanitary installations]; hot/cold water mixing valve [parts of sanitary installations]; pressure regulators [parts of sanitary installations], particularly pressure balancing valve; pressure regulator [parts of sanitary installations], particularly pressure limiter; swivel joints [parts of sanitary installations], accessories for faucet spouts, particularly swivel adapters, accessories for shower faucets, namely, swivel adapters, accessories for kitchen faucet pipes, particularly swivel adapters; plumbing connectors, namely, pipe and tube connectors; washers [parts

of sanitary installations]; adapters [parts of sanitary installations], plumbing fittings; plumbing accessories, namely filters and strainers; installation tools and kits for aerator installation; end-pieces for faucet aerators, rings for faucet aerators; faucets and fittings; plumbing accessories, namely, bathtub, washbasin, kitchen, shower and bathtub mixers; spouts (plumbing accessories); backflow-prevention safety devices for sanitary installations, in the form of air-gap fittings, vacuum breakers or vents; air knives with injector; shower heads; shower systems; flexible pipes (as components of sanitary installations).

(260) AM 2026 133092 A

(800) 1846079

(151) 2024 12 11

(891) 2024 12 11

(731) Shenzhen XiaoKuo Technology Co., Ltd.

Suite 1501, Tower #1, Jinlitong Financial
Center, No.1100 Xingye Road, Haiwang
Community, Xinan Street, Baoan District,
Shenzhen City, 518100 Guangdong Province,
China

(540)

Canban

(591) Black, white

(531) 27.05.17

(511)

3 – Mouth washes, not for medical purposes; preparations for cleaning dentures; breath freshening sprays; breath freshening strips; toothpaste; dental bleaching gels; dentifrices; teeth whitening pens; teeth whitening strips.

(260) AM 2026 133101 A

(800) 1846323

(151) 2025 02 19

(891) 2025 02 19

(731) Limited Liability Company "UNIKOM
LIMITED"

8F Hollywood Road 30, Central, Hong Kong,
China

(540)

DELOVOY STANDART

(591) Black, white

(511)

29 – Agar-agar for culinary purposes; aloe vera prepared for human consumption; alginates for culinary purposes; andouillettes; anchovy, not live; peanuts, prepared; artichokes, preserved; white of eggs; beans, preserved; soya beans, preserved, for food; broth; ginger jam; verjuice for culinary purposes; ham; fatty substances for the manufacture of edible fats; liver, preserved; edible birds' nests; cabbage rolls stuffed with meat; peas, preserved; mushrooms, preserved;

guacamole; berry-based fool; jams; game, not live; gelatine; meat jellies; jellies for food, other than confectionery; yolk of eggs; coconut fat; bone oil for food; lard; suet for food; edible fats; fruit-based snack food; meat-based snack food; vegetable-based snack food; fish-based snack food; tofu-based snack food; milk substitutes; meat substitutes; plant-based imitation meat; charcuterie; raisins; aubergine paste; vegetable marrow paste; caviar; fish roe, prepared; ginger, preserved; crystallized ginger; pickled ginger; yogurt; sauerkraut; cassoulet; quark; kephir; kimchi; isinglass for food; potato-based dumplings; klipfish [salted and dried cod]; clams, not live; milk shakes; black pudding; onion rings; arrangements of processed fruit; cranberry compote; compotes; meat, tinned; vegetables, tinned; fish, tinned; fruits, tinned; duck confits; broth concentrates; vegetable-based concentrate for cooking; fruit-based concentrate for cooking; corn dogs; gherkins; tofu patties; soya patties; shrimps, not live; prawns, not live; buttercream; croquettes; silkworm chrysalis for human consumption; sweet corn, processed; koumiss; spiny lobsters, not live; lecithin for culinary purposes; edible ant larvae, prepared; salmon, not live; onions, preserved; margarine; marmalade; oils for food; peanut butter; cocoa butter for food; coconut oil for food; coconut butter; maize oil for food; sesame oil for food; linseed oil for food; almond oil for food; extra virgin olive oil for food; olive oil for food; palm oil for food; palm kernel oil for food; sunflower oil for food; rape oil for food; butter; soya bean oil for food; mussels, not live; almonds, ground; animal marrow for food; shellfish, not live; molluscs, not live; milk; peanut milk; peanut milk for culinary purposes; coconut milk; coconut milk for culinary purposes; almond milk; almond milk for culinary purposes; oat milk; rice milk; rice milk for culinary purposes; albumin milk; curd; condensed milk; soured milk; soya milk; powdered milk; fermented baked milk; fish meal for human consumption; vegetable mousses; fish mousses; fruit pulp; meat, meat, preserved; freeze-dried meat; lactic acid drinks; milk beverages, milk predominating; peanut milk-based beverages; coconut milk-based beverages; almond milk-based beverages; edible insects, not live; sausage casings, natural or artificial; vegetables, preserved; freeze-dried vegetables; cut vegetables; vegetables, processed; vegetables, dried; vegetables, cooked; hash browns; potato fritters; olives, preserved; lobsters, not live; omelettes; flavoured nuts; candied nuts; coconut, desiccated; nuts, prepared; tomato paste; pressed fruit paste; liver pate; pectin for culinary purposes; preserved peppers; liver; pickles; vegetable-based prepared meals for toddlers; powdered eggs; milk products; fish-based foodstuffs; poultry, not live; white pudding; bulgogi; pollen prepared as foodstuff; tomato puree; apple puree; crayfish, not live; crustaceans, not live; ratatouille; tripe; fish, preserved; fish, not live; salted fish; vegetable salads; fruit salads; bacon; sardines, not live; pork; herrings, not live; seeds, prepa-

red; sunflower seeds, prepared; cream [dairy products]; whipped cream; vegetable-based cream; smetana; lemon juice for culinary purposes; tomato juice for cooking; vegetable juices for cooking; salted meats; sausages; sausages in batter; hot dog sausages; preparations for making bouillon; preparations for making soup; satay; tofu skin; fat-based spreads for bread slices; vegetable-based spreads; nut-based spreads; fruit jelly spreads; berry soup; soups; vegetable soup preparations; whey; cottage cheese fritters; cheese; tajine [prepared meat, fish or vegetable dish]; tahini; cottage cheese; tempeh; tofu; sea-cucumbers, not live; truffles, preserved; tuna, not live; oysters, not live; falafel; milk ferments for culinary purposes; rennet; fish fillets; dates, processed; crystallized fruits; frozen fruits; fruit, preserved; cut fruits; fruit, processed; fruit preserved in alcohol; fruit, stewed; hazelnuts, prepared; potato flakes; hummus; edible flowers, dried; fruit peel; preserved garlic; lentils, preserved; potato crisps; low-fat potato crisps; fruit chips; choucroute garnie; non-alcoholic eggnog; seaweed extracts for food; meat extracts for culinary purposes; berries, preserved; eggs; snail eggs for consumption; yakitori.

30 – Vanilla flavourings for culinary purposes; flavourings, other than essential oils, for cakes; flavourings, other than essential oils, for beverages; coffee flavourings; food flavourings, other than essential oils; aspartame for culinary purposes; star aniseed; baozi; cereal bars; high-protein cereal bars; pancakes; savoury pancakes; freeze-dried dishes with the main ingredient being pasta; freeze-dried dishes with the main ingredient being rice; noodle-based prepared meals; buns; bulgur; bread rolls; pains au chocolat; edible paper wafers; edible rice paper; edible paper; burritos; vanillin [vanilla substitute]; waffles; vermicelli; natural sweeteners; sausage binding materials; binding agents for ice cream; orange blossom water for culinary purposes; seawater for cooking; seaweed [condiment]; edible beeswax; malt biscuits; cloves [spice]; mirror icing [mirror glaze]; cake frosting [icing]; glucose for culinary purposes; mustard; croutons; buckwheat, processed; gluten additives for culinary purposes; doenjang [condiment]; yeast; yeast for brewing beer; thickening agents for cooking foodstuffs; leaven; rice-based snack food; cereal-based snack food; cocoa substitutes; coffee substitutes; vegetal preparations for use as coffee substitutes; sugar substitutes for culinary purposes; tea substitutes; dressings for salad; unroasted coffee beans; roasted coffee beans; edible gold for decorating food and beverages; fruit jellies [confectionery]; candy decorations for cakes; confectionery in the form of mousses; confectionery for decorating Christmas trees; Danish pastries; pastries; peanut confectionery; almond confectionery; confectionery; fruit confectionery; pasta; ground ginger; frozen yogurt [confectionery ices]; cocoa; cocoa nibs; cream of tartar for culinary purposes; capers; coffee capsules, filled; caramels [sweets]; cardamom [spice]; curry [spice]; ketchup [sauce]; kimbap; qui-

noa, processed; quiches; gluten prepared as foodstuff; flour-based dumplings; kombucha; sweets; liquorice [confectionery]; peppermint sweets; mints for breath freshening; liqueur chocolates; dulce de leche; cinnamon [spice]; coffee; gochujang; starch for food; crackers; rice crackers; custard; creme brulee; flavoured jelly crystals for making jelly confectionery; croisants; hominy grits; semolina; oatmeal; crushed barley; groats for human food; ice cubes; corn, milled; corn, roasted; meat pies; fruit coulis [sauces]; turmeric; couscous; laksa; noodles; soba noodles; udon noodles; ice [frozen water]; ice, natural or artificial; edible ices; ice pops; potato-based flatbreads; rice cakes; mayonnaise; macaroons [pastries]; macaroni; maltose; hominy; piccalilli; marinades; marzipan; honey; miso; royal jelly; ice cream; bean flour; buckwheat flour; fava bean flour; tapioca flour; potato flour; corn flour; nut flours; flour; wheat flour; soya flour; barley meal; chocolate mousses; muesli; mint for confectionery; cocoa beverages with milk; coffee beverages with milk; coffee-based beverages; cocoa-based beverages; chamomile-based beverages; tea-based beverages; tea beverages with milk; chocolate beverages with milk; chocolate-based beverages; infusions, not medicinal; nougat; gnocchi; crushed oats; husked oats; kimchi pancakes; onigiri; chocolate-coated nuts; nutmegs [spice]; stick liquorice [confectionery]; ginger paste [seasoning]; sugar paste for confectionery; lozenges [confectionery]; treacle; pelmeni; pepper; allspice; peppers [seasonings]; pesto; biscuits; coconut macaroons; filled biscuits; petit-beurre biscuits; bibimbap [rice mixed with vegetables and beef]; pies; noodle-based prepared meals for toddlers; pizzas; meat gravies; artificial sweeteners for culinary purposes; small spelt, processed; spelt, processed; fondants [confectionery]; popcorn; powders for making ice cream; baking powder; mustard meal; pralines; aromatic preparations for food; condiments; cereal preparations; oat-based food; propolis; profiteroles; gingerbread; spices; petits fours; rice pudding; puddings; milk puddings; cake powder; ravioli; meat tenderizers for culinary purposes; ramen; chewing gum; chewing gum for breath freshening; relish [condiment]; rice; prepared rice rolled in seaweed; instant rice; wheat germ for human consumption; spring rolls; sago; sugar; crystallized rock sugar; palm sugar; saccharin for culinary purposes; processed hemp seeds [seasonings]; sesame seeds [seasonings]; linseed for culinary purposes [seasoning]; processed seeds for use as a seasoning; processed squash seeds [seasonings]; aniseed; agave syrup [natural sweetener]; golden syrup; savoury pancake mixes; batter mixes; baking soda [bicarbonate of soda for cooking purposes]; crystallized lemon juice [seasoning]; malt for human consumption; salt for preserving foodstuffs; cooking salt; celery salt; sorbets [ices]; ham glaze; edible honeycombs; cranberry sauce [condiment]; soya sauce; tomato sauce; apple sauce [condiment]; sauces [condiments]; pasta sauce; spaghetti; seasonings; chocolate-

based spreads; chocolate spreads containing nuts; preparations for stiffening whipped cream; shaved ice with sweetened red beans; sumac [spice]; rusks; breadcrumbs; sushi; sandwiches; tabbouleh; tacos; tamarind [condiment]; tapioca; tarts; dough; pastry dough; almond paste; rice pulp for culinary purposes; cake batter; tortillas; cakes; garden herbs, preserved [seasonings]; chocolate decorations for cakes; vinegar; beer vinegar; ferments for dough; halvah; harissa [condiment]; bread; gluten-free bread; unleavened bread; corn flakes; oat flakes; hot dog sandwiches; flowers or leaves for use as tea substitutes; jiaozi; chicory [coffee substitute]; herbal teas; tea; kelp tea; iced tea; chutneys [condiments]; minced garlic [condiment]; cheeseburgers [sandwiches]; chips [cereal products]; chocolate-covered potato chips; chow-chow [condiment]; saffron [seasoning]; chocolate; malt extract for food; essences for foodstuffs, except etheric essences and essential oils; husked barley; pâtés en croûte.

31 – Peanuts, fresh; grapes, fresh; algae, unprocessed, for human or animal consumption; grains [cereals]; cocoa beans, unprocessed; vegetables, fresh; coconuts; nuts, unprocessed; wheat; dates, fresh; fruit, fresh; hazelnuts, fresh; berries, fresh.

32 – Aperitifs, non-alcoholic; barley wine [beer]; carbonated water; lithia water; seltzer water; soda water; waters [beverages]; mineral water [beverages]; table waters; hop pellets for brewing beer; kvass; cocktails, non-alcoholic; beer-based cocktails; non-alcoholic beer-based cocktails; lemonades; non-alcoholic beverages; non-alcoholic dried fruit beverages; non-alcoholic fruit vinegar beverages; isotonic beverages; non-alcoholic honey-based beverages; rice-based beverages, other than milk substitutes; soya-based beverages, other than milk substitutes; aloe vera drinks, non-alcoholic; whey beverages; protein-enriched sports beverages; soft drinks; non-alcoholic beverages flavoured with coffee; non-alcoholic beverages flavoured with tea; non-alcoholic fruit juice beverages; energy drinks; fruit nectars, non-alcoholic; orgeat; beer; non-alcoholic beer; ginger beer; malt beer; powders for effervescing beverages; powders for making soft drinks; sarsaparilla [non-alcoholic beverage]; cider, non-alcoholic; syrups for lemonade; syrups for beverages; starch-based dry mixes for beverage preparation; smoothies; tomato juice [beverage]; vegetable juices [beverages]; fruit juices; preparations for making non-alcoholic beverages; preparations for making carbonated water; must; grape must, unfermented; beer wort; malt wort; pastilles for effervescing beverages; frozen hops for brewing beer; dried hops for brewing beer; shandy; sherbets [beverages]; non-alcoholic fruit extracts; extracts of hops for making beer; grape ales; non-alcoholic essences for making beverages.

(260) AM 2026 133189 A
 (800) 1847058
 (151) 2024 11 14
 (891) 2024 11 14
 (731) CAREISMATIC BRANDS, LLC
 15301 Ventura Blvd, Building D Suite 300,
 Sherman Oaks CA 91403, USA

(540)

CAREISMATIC

(591) Black, white
 (511)
 10 – Medical apparel, namely, scrub pants, scrub tops
 and underwear being scrubs, all of the foregoing not
 for surgical purposes.

25 – Footwear; jackets.

(260) AM 2026 133190 A
 (800) 1847074
 (151) 2025 01 20
 (891) 2025 01 20
 (731) MÄURER & WIRTZ GmbH & Co. KG
 Zweifaller Str. 120, 52224 Stolberg, Germany

(540)

Strong Mind

(591) Black, white
 (511)
 3 – Perfumery products; essential oils; soaps; non-me-
 dicated cosmetics; hair lotions; non-medicated denti-
 frices.

(260) AM 2026 133191 A
 (800) 1847075
 (151) 2025 01 20
 (891) 2025 01 20
 (731) MÄURER & WIRTZ GmbH & Co. KG
 Zweifaller Str. 120, 52224 Stolberg, Germany

(540)

Grateful to be

(591) Black, white
 (511)
 3 – Perfumery products; essential oils; soaps; non-me-
 dicated cosmetics; hair lotions; non-medicated denti-
 frices.

(260) AM 2026 133192 A
 (800) 1847076
 (151) 2025 01 20
 (891) 2025 01 20
 (731) MÄURER & WIRTZ GmbH & Co. KG
 Zweifaller Str. 120, 52224 Stolberg, Germany

(540)

Dream to be

(591) Black, white

(511)
 3 – Perfumery products; essential oils; soaps; non-me-
 dicated cosmetics; hair lotions; non-medicated denti-
 frices.

(260) AM 2026 133193 A
 (800) 1847099
 (151) 2025 02 21
 (891) 2025 02 21
 (731) Bayer Aktiengesellschaft
 Kaiser-Wilhelm-Allee, 51373 Leverkusen,
 Germany

(540)

AMTERBY

(591) Black, white
 (511)
 5 – Pharmaceutical preparations, for use in the fo-
 llowing fields: treatment of oncological indications;
 pharmaceutical preparations, for use in the following
 fields: treatment and prevention of cardiovascular di-
 seases; pharmaceutical preparations for use in the
 following fields: treatment and prevention of infla-
 mmatory indications; pharmaceutical preparations for
 use in the following fields: treatment of Parkinson's
 disease.

(260) AM 2026 133194 A
 (800) 1847216
 (151) 2024 11 13
 (891) 2024 11 13
 (731) EVITA PERONI (Guangzhou)Trading Co., Ltd.
 Room 1901, Sicheng Building, 238 Guangyun
 Road, Helong Sub-district, Baiyun District,
 Guangzhou, 510440 Guangdong, China

(540)



(591) Black, white
 (531) 27.05.01; 27.05.22
 (511)
 26 – Lace for edgings; bobby pins; hair barrettes;
 bows for the hair; decorative articles for the hair; top-
 knots [pompoms]; buttons; false hair; artificial flo-
 wers; shoulder pads for clothing.

(260) AM 2026 133207 A
 (800) 1847582
 (151) 2024 12 07
 (891) 2024 12 07

(731) Maz Maz iranian food industries
Azadegan street – 1790 alley – no. 8596, kaveh
industrial city, center part, Taraz nahid village,
3914318596 Saveh, Islamic Republic of Iran

(540)

کیک میک
Cake Make

(591) Black, white

(531) 28.01; 28.19

(511)

30 – Cake flour; cookies; cake powder; petit-beurre
biscuits; tarts; biscuits; processed grains; waffles; pas-
tries; cheesecake; almond confectionery; bread; sugar
confectionery; rice bread; cake powder; gingerbread;
cakes.

35 – Radio advertising; import-export agencies; pub-
licity; outdoor advertising; online advertising in a
computer network.

(260) AM 2026 133208 A

(800) 1847606

(151) 2024 12 24

(891) 2024 12 24

(731) FİRÜZE DIŞ TİCARET İHTİYAÇ VE
TÜKETİM MADDELERİ İHRACATI VE
İTHALATI TİCARET LİMİTED ŞİRKETİ
CEVİZLİ MAH. TUGAY YOLU CAD.,
NUVO DRAGOS A BLOK 12 A 143,
Maltepe, İstanbul, Türkiye

(540)

 remaple®

(591) Yellow, green, white

(531) 05.03.14; 27.05.01; 29.01.03

(526) ®

(511)

3 – Bleaching and cleaning preparations, detergents
other than for use in manufacturing operations and for
medical purposes, laundry bleach, fabric softeners for
laundry use, stain removers, dishwasher detergents,
soaps (excluding soaps containing medicines), wipes
impregnated with cleaning preparations.

(260) AM 2026 133209 A

(800) 1847661

(151) 2025 01 30

(891) 2025 01 30

(731) AYD OTOMOTİV ENDÜSTRİ SANAYİ VE
TİCARET ANONİM ŞİRKETİ
BÜYÜKKAYACIKOSB MAH., VALİ
İHSAN DEDE CAD. 7 Selçuklu Konya,
Türkiye

(540)

 AYD
OE Excellence!

(591) Black, white

(531) 27.05.09; 27.05.10; 27.05.17; 27.05.19

(511)

12 – Brake discs for land vehicles; disc brakes for
land vehicles; disc brake pads for land vehicles; bra-
kes, brake discs and brake linings for land vehicles;
brake rotors for land vehicles; brake pads for auto-
mobiles; brake pads for vehicles; connecting rods for
land vehicles; idler arms [vehicle parts]; stabilizer
bars for land vehicle suspensions; stabilizers for ve-
hicles; sway bars for land vehicle suspensions; anti-
roll bars for land vehicle suspensions; anti-sway bars
for land vehicle suspensions; torsion bar springs for
land vehicle suspensions; torsion bars for land vehicle
suspensions; clutches for land vehicles.

35 – Provision of an online marketplace for buyers
and sellers of goods and services; the bringing to-
gether, for the benefit of others, of a variety of goods,
namely, brake discs for land vehicles, disc brakes for
land vehicles, disc brake pads for land vehicles, bra-
kes, brake discs and brake linings for land vehicles,
brake rotors for land vehicles, brake pads for auto-
mobiles, brake pads for vehicles, connecting rods for
land vehicles, idler arms [vehicle parts], stabilizer
bars for land vehicle suspensions, stabilizers for ve-
hicles, sway bars for land vehicle suspensions, anti-
roll bars for land vehicle suspensions, anti-sway bars
for land vehicle suspensions, torsion bar springs for
land vehicle suspensions, torsion bars for land vehicle
suspensions, clutches for land vehicles enabling custo-
mers to conveniently view and purchase those goods,
such services may be provided by retail stores, who-
lesale outlets, by means of electronic media or thro-
ugh mail order catalogues.

(260) AM 2026 133211 A

(800) 1847677

(151) 2024 12 25

(891) 2024 12 25

(731) Anaye Behdashti Saina

Unit 3, 1st Floor, Building 306, Parto Alley,
Tehransar Blvd, Tehransar, 1388797834
Tehran, Tehran Province, Islamic Republic
of Iran

(540)

 پریمکس
Prima

(591) White, blue and yellow
 (531) 01.03.01; 01.15.15; 01.15.24; 06.01.02;
 25.01.06; 27.05.24; 28.19; 29.01.13

(511)
 3 – Stain removers; deodorant soap; depilatories; toothpaste; make-up powder; non-medicated liquid preparations for cleaning the hands; fabric softeners for laundry use; liquid soaps, non-medicated; stain removing agents; shaving soap; laundry washing preparations; fabric softener; after-shave gel; hair bleaching preparations; skin whitening creams; descaling preparations for household purposes; dishwashing products; hair conditioner; laundry bleaching preparations; teeth whitening products; moisturizing creams; sharpening preparations; oven cleaners; fabric softener for laundry; non-medicated soap powders; stain removing preparations; antiperspirant soap; body gels [cosmetics]; shaving sprays; sunscreen; foot deodorant spray; laundry bleach; cleaning sprays; bleaching preparations and other substances for laundry use; creams for leather; depilatory creams; body mists; windshield cleaning liquids; bleaching and laundry preparations; denture cleaning preparations; bath salts, not for medical purposes; hair removal sprays; granulated soaps; glue removers other than for industrial purposes; almond soap; mouth washes, not for medical purposes; glass cleaners; polish for furniture and flooring; skin whitening creams; body deodorants; shining preparations; depilatory preparations; body sprays; incense; deodorant soap; dishwasher tablets; body creams; laundry glaze; bleaching preparations [decolorants] for cosmetic purposes; washing powder; bleaches for domestic use; non-medicated soap; non-medicated foot creams; bleaching salts; soap for brightening textile; ammonia [volatile alkali] [detergent]; deodorants for body care; body spray used as a personal deodorant and as a fragrance; bleaching preparations; polishing preparations; deodorising soaps; aloe vera gels for cosmetic purposes; bleaching preparations for household purposes; shining preparations [polish]; cosmetic creams; make-up preparations; preparations for cleaning dentures; nail polish; skin conditioners; massage gels, other than for medical purposes; shampoos; laundry detergent; cleaning preparations; scouring solutions; detergent tablets; non-medicated toothpastes; sachets for perfuming linen; powder laundry detergents; windscreen cleaning liquids.

(260) AM 2026 133212 A
 (800) 1847722
 (151) 2025 02 03
 (891) 2025 02 03
 (731) CLİENTO TEKSTİL SANAYİ VE TİCARET
 LİMİTED ŞİRKETİ
 TURGUT REİS MAH. 429. SK. NO: 11 İÇ
 KAPI NO: 4, Esenler, İstanbul, Türkiye

(540)

cliento

(591) Black, white
 (531) 27.05.01
 (511)
 25 – Clothing, including underwear and outer clothing, other than special purpose protective clothing, socks, bridal gowns, footwear, headgear.

(260) AM 2026 133296 A
 (800) 1848267
 (151) 2025 02 14
 (891) 2025 02 14
 (731) Midea Group Co., Ltd.
 B26-28F, Midea Headquarter Building,
 No.6 Midea Avenue, Beijiao, Shunde,
 Foshan, Guangdong, China

(540)

Space Master

(591) Black, white
 (511)
 11 – Refrigerators; refrigerating apparatus and machines; refrigerating cabinets; refrigerating containers; freezers; cool boxes, electric; refrigerating display cabinets; cooling installations and machines; ice-cream making machines; beverage cooling apparatus; food cooling apparatus.

(260) AM 2026 133297 A
 (800) 1848268
 (151) 2025 01 24
 (891) 2025 01 24
 (731) Beijing Roborock Technology Co., Ltd.
 Room 1001, Floor 10, Building 3, Yard 17,
 Anju Road, Changping District, Beijing, China

(540)

WaveFlow

(591) Black, white
 (511)
 7 – Self-propelled road sweeping machines; cleaning appliances utilizing steam; rechargeable floor cleaning machines; hand-held vacuum cleaners; vacuum cleaners; dust removing installations for cleaning purposes; dust exhausting installations for cleaning purposes; machines and apparatus for carpet shampooing, electric; washing apparatus; machines and apparatus for cleaning, electric; vacuum cleaner hoses; brushes for vacuum cleaners; suction nozzles for vacuum cleaners; vacuum cleaner attachments for disseminating perfumes and disinfectants; dust filters and bags for vacuum cleaners; automatic vacuum cleaners; steam mops, electric, for household purposes; water heaters being parts of machines.

(260) AM 2026 133298 A
 (800) 1848338
 (151) 2024 10 25
 (891) 2024 10 25
 (731) MOHAMMED SALMAN ATTARWALA
 Freedom Fragrances, 1st Floor, Nagree
 Compound, 234/A-M.A Road, Mumbai 400008,
 India

(540)



(591) Black, white
 (531) 26.04.04; 26.04.18; 26.04.24; 27.05.10
 (511)
 3 – Perfumes, creams, hair oil, deodorants, gels, included in this class.

(260) AM 2026 133299 A
 (800) 1848351
 (151) 2024 12 30
 (891) 2024 12 30
 (731) Beijing Chj Information Technology Co., Ltd.
 Room 101, Building 1 No. 4 Hengxing Road,
 Gaoliying Shunyi District, (Technological
 Innovation Industry Functional Zone), 101300
 Beijing, China

(540)



(591) Black, white
 (531) 27.05.21; 27.07.11; 27.07.17; 27.07.21
 (511)
 12 – Electric vehicles; remote control vehicles, other than toys; hybrid car; fuel cell cars; electric cars; hubs for automobile wheels; couplings for land vehicles; roof racks for vehicles; engines for land vehicles; cars; autonomous cars; bearings [parts of vehicles]; shock absorbers for automobiles; bumpers for automobiles; air bags [safety devices for automobiles]; motors, electric, for land vehicles; vehicles for locomotion by land, air, water or rail; tyres for vehicle wheels; steering wheels for vehicles; upholstery for vehicles; safety seats for children, for vehicles; wind-screens; vehicle seats; suspension shock absorbers for vehicles; non-skid devices for vehicle tyres; anti-glare devices for vehicles; brake linings for vehicles; air pumps [vehicle accessories].

(260) AM 2026 133300 A
 (800) 1848370
 (151) 2025 01 23
 (891) 2025 01 23

(731) Ultraforce Offroad Tires Co., Limited
 2024-0017 (A), 102, 1st Floor, East Office
 Building, No.45 Beijing Road, Qianwan
 Bonded Port Area, Qingdao District, 266000
 China (Shandong) Pilot Free Trade Zone, China

(540)

LANDSTORM

(591) Black, white
 (531) 27.05.01
 (511)
 12 – Tyres for vehicle wheels; automobile tires; solid tyres for vehicle wheels; pneumatic tyres; repair outfits for inner tubes; casings for pneumatic tires; bicycle tyres; inner tubes for pneumatic tires; treads for retreading tires; vehicle tires.

(260) AM 2026 133301 A
 (800) 1848371
 (151) 2025 01 07
 (891) 2025 01 07
 (731) Honor Device Co., Ltd.
 Suite 3401, Unit A, Building 6, Shum Yip Sky
 Park, No. 8089, Hongli West Road, Xiangmihu
 Street, Futian District, Shenzhen, 518040
 Guangdong, China

(540)



(591) Black, white
 (531) 01.01.03; 01.01.09; 01.01.15
 (511)
 9 – Downloadable software applications for mobile phones; computer programs, downloadable; data sets, recorded or downloadable; computer software platforms, recorded or downloadable; tablet computers; digital voice signal processors; chatbot software for simulating conversations; downloadable computer software for collecting, analyzing and organizing data in the field of deep learning; user-programmable humanoid robots, not configured; notebook computers; computer hardware; computer software, recorded; pedometers; face recognition devices; electronic notice boards; smartphones; network communication devices; portable media players; cabinets for loudspeakers; camcorders; television apparatus; earphones; humanoid robots having communication and learning functions for assisting and entertaining people; cameras [photography]; selfie lenses; digital weather stations; audiovisual teaching apparatus; humanoid robots with artificial intelligence for use in scientific research; remote control telemetering machines and

instruments; chips [integrated circuits]; sensors; video screens; batteries, electric.

(260) AM 2026 133302 A

(800) 1848375

(151) 2025 03 05

(891) 2025 03 05

(731) Beijing Chj Information Technology Co., Ltd.
Room 101, Building 1 No. 4 Hengxing Road,
Gaoliying, Shunyi District, 101300 Beijing
(Technological Innovation Industry Functional
Zone), China

(540)

L8

(591) Black, white

(531) 27.05.17; 27.05.21; 27.07.11; 27.07.17;
27.07.21

(511)

12 – Electric vehicles; remote control vehicles, other than toys; hybrid car; fuel cell cars; electric cars; hubs for automobile wheels; couplings for land vehicles; roof racks for vehicles; engines for land vehicles; cars; autonomous cars; bearings [parts of vehicles]; shock absorbers for automobiles; bumpers for automobiles; air bags [safety devices for automobiles]; motors, electric, for land vehicles; vehicles for locomotion by land, air, water or rail; tyres for vehicle wheels; steering wheels for vehicles; upholstery for vehicles; safety seats for children, for vehicles; windcreens; vehicle seats; suspension shock absorbers for vehicles; non-skid devices for vehicle tyres; anti-glare devices for vehicles; brake linings for vehicles; air pumps [vehicle accessories].

(260) AM 2026 133323 A

(800) 1848681

(151) 2024 12 06

(891) 2024 12 06

(731) Limited Liability Company Integrated
Technical Vision
vul. Chyhorina 12, m. Kyiv 01042, Ukraine

(540)

U-PROX

(591) Black, white

(531) 27.05.01

(511)

9 – Sound recording apparatus; sound transmitting apparatus; Global Positioning System [GPS] apparatus; testing apparatus not for medical purposes; electrodynamic apparatus for the remote control of signals; batteries, electric; detectors; smoke detectors; electronic numeric displays; electronic interactive whitebo-

ards; electronic notice boards; electronic access control systems for interlocking doors; biometric locks; locks, electric; downloadable application software for virtual environments; computer software applications, downloadable; acoustic alarms / sound alarms; readers [data processing equipment]; interfaces for computers; infrared detectors; computers; computer hardware; computer keyboards; computer operating programs, recorded; home automation hubs / smart home hubs; computer network routers; modems; transmitters of electronic signals; theft prevention installations, electric; computer programs, downloadable; computer programs, recorded; computer software, recorded; whistle alarms; alarms; sirens; scanners for data processing.

(260) AM 2026 133419 A

(800) 1849675

(151) 2024 11 13

(891) 2024 11 13

(731) Limited liability company PROMOMED RUS
prospekt Mira, d. 13, str. 1, of. 13, RU-129090
Moscow, Russian Federation

(540)

КВИНЛИРО

(591) Black, white

(531) 28.05

(511)

3 – Abrasives; amber [perfume]; descaling preparations for household purposes; antistatic preparations for household purposes; aromatics [essential oils]; air fragrancing preparations; cake flavourings [essential oils]; flavourings for beverages [essential oils]; food flavourings [essential oils]; breath freshening sprays; canned pressurized air for cleaning and dusting purposes; balms, other than for medical purposes; basma [cosmetic dye]; lip glosses; nail glitter; body glitter; polishing stones; abrasive paper; emery paper; polishing paper; petroleum jelly for cosmetic purposes; shoe polish; cobblers' wax; cotton wool for cosmetic purposes; cotton wool impregnated with make-up removing preparations; sachets for perfuming linen; drying agents for dishwashing machines; adhesives for cosmetic purposes; scented water; javelle water; lavender water; micellar water; toilet water; wax for parquet floors; floor wax; non-slipping wax for floors; depilatory wax; moustache wax; shoe wax; tailors' wax; creams for leather; polish for furniture and flooring; shoemakers' wax; polishing wax; massage gels, other than for medical purposes; heliotropine; dental bleaching gels; geraniol; starch glaze for laundry purposes; make-up; deodorants for pets; deodorants for human beings or for animals; depilatory preparations; air fragrance reed diffusers; scented wood; perfumes; non-slipping liquids for floors; windscreen cleaning liquids; greases for cosmetic purposes; volcanic ash for cleaning; perfumery; decorative transfers for cosmetic purposes; ionone [perfumery]; shaving

stones [astringents]; smoothing stones; eyebrow pencils; cosmetic pencils; silicon carbide [abrasive]; carbides of metal [abrasives]; alum stones [astringents]; tripoli stone for polishing; adhesives for affixing false eyelashes; adhesives for affixing false hair; hair conditioners; quillaia bark for washing; corundum [abrasive]; beard dyes; colorants for toilet purposes; cosmetic dyes; body paint for cosmetic purposes; starch for laundry purposes; shoe cream; waxes for leather; polishing creams; cosmetic creams; skin whitening creams; essential oil-based creams for aromatherapy use; polishing rouge; incense; hair spray; nail varnish; liquid latex body paint for cosmetic purposes; hair lotions; lotions for cosmetic purposes; after-shave lotions; beauty masks; sheet masks for cosmetic purposes; disposable steam-heated masks, not for medical purposes; oils for perfumes and scents; oils for cosmetic purposes; oils for toilet purposes; essential oils; essential oils for aromatherapy use; essential oils of cedarwood; essential oils of lemon; essential oils of citron; oils for cleaning purposes; bergamot oil; gaultheria oil; jasmine oil; lavender oil; almond oil; rose oil; oil of turpentine for degreasing; whiting; cleaning chalk; almond milk for cosmetic purposes; cleansing milk for toilet purposes; musk [perfumery]; deodorant soap; shaving soap; soap for brightening textile; cakes of toilet soap; antiperspirant soap; soap for foot perspiration; soap; almond soap; mint for perfumery; cosmetic kits; emery; gel eye patches for cosmetic purposes; nail art stickers; double eyelid tapes; false nails; eau de cologne; joss sticks; pastes for razor strops; toothpaste; pumice stone; lipstick cases; hydrogen peroxide for cosmetic purposes; dressings for nail reconstruction; breath freshening strips; teeth whitening strips; sandcloth; glass cloth [abrasive cloth]; lipsticks; pomades for cosmetic purposes; shaving preparations; cosmetic preparations for baths; bath preparations, not for medical purposes; hair straightening preparations; hair waving preparations; laundry soaking preparations; grinding preparations; smoothing preparations [starching]; colour-removing preparations; leather bleaching preparations; polishing preparations; denture polishes; mouthwashes, not for medical purposes; cosmetic preparations for slimming purposes; preparations to make the leaves of plants shiny; eye-washes, not for medical purposes; fabric softeners for laundry use; dry-cleaning preparations; paint stripping preparations; lacquer-removing preparations; make-up removing preparations; floor wax removers [scouring preparations]; varnish-removing preparations; rust removing preparations; nail care preparations; cleaning preparations; preparations for cleaning dentures; wallpaper cleaning preparations; preparations for unblocking drain pipes; chemical cleaning preparations for household purposes; collagen preparations for cosmetic purposes; bleaching preparations [decolorants] for household purposes; aloe vera preparations for cosmetic purposes; sunscreen preparations; colour-brightening chemicals for

household purposes [laundry]; breath freshening preparations for personal hygiene; shining preparations [polish]; make-up powder; diamantine [abrasive]; stain removers; wax melts [fragrancing preparations]; nail varnish removers; vaginal washes for personal sanitary or deodorant purposes; scouring solutions; false eyelashes; antistatic dryer sheets; baby wipes impregnated with cleaning preparations; colour run prevention laundry sheets; tissues impregnated with cosmetic lotions; tissues impregnated with make-up removing preparations; saftol; massage candles for cosmetic purposes; laundry blueing; turpentine for degreasing; potpourris [fragrances]; bleaching soda; washing soda, for cleaning; bath salts, not for medical purposes; bleaching salts; fumigation preparations [perfumes]; leather preservatives [polishes]; ammonia [volatile alkali] [detergent]; cooling sprays for cosmetic purposes; astringents for cosmetic purposes; eyebrow cosmetics; make-up preparations; sun-tanning preparations [cosmetics]; hair dyes; neutralizers for permanent waving; laundry glaze; cosmetic preparations for eyelashes; laundry preparations; cosmetic preparations for skin care; dentifrices; cosmetics; cosmetics for children; cosmetics for animals; mascara; cleansers for intimate personal hygiene purposes, non medicated; douching preparations for personal sanitary or deodorant purposes [toiletries]; detergents, other than for use in manufacturing operations and for medical purposes; degreasers, other than for use in manufacturing processes; bleaching preparations [decolorants] for cosmetic purposes; laundry bleach; antiperspirants [toiletries]; toiletry preparations; phyto-cosmetic preparations; detergent tablets for coffee machines; talcum powder, for toilet use; cotton swabs for cosmetic purposes; terpenes [essential oils]; emery cloth; toners for cosmetic purposes; cloths impregnated with a detergent for cleaning; henna [cosmetic dye]; bath tea for cosmetic purposes; shampoos for animals [non-medicated grooming preparations]; shampoos for pets [non-medicated grooming preparations]; dry shampoos; shampoos; sandpaper; cosmetic stamps, filled; soda lye; herbal extracts for cosmetic purposes; extracts of flowers [perfumes]; ethereal essences; badian essence; mint essence [essential oil]; cosmetics, namely cosmetic gels; cosmetics, namely cosmetic creams; cosmetics, namely cosmetic powders; cosmetics, namely, solutions for cosmetic purposes; cosmetics, namely cosmetic lotions; cosmetics, namely cosmetic balms; cosmetics, namely cosmetic oil.

5 – Acaricides; aconitine; alkaloids for medical purposes; alginates for pharmaceutical purposes; algicides; aldehydes for pharmaceutical purposes; dental amalgams of gold; dental amalgams; amino acids for veterinary purposes; amino acids for medical purposes; analgesics; anaesthetics; antibiotics; antiseptics; medicine cases, portable, filled; first-aid boxes, filled; aluminium acetate for pharmaceutical purposes; acetates for pharmaceutical purposes; germicides; oxygen

cylinders, filled, for medical purposes; balms for medical purposes; bandages for dressings; diagnostic biomarker reagents for medical purposes; biocides; bracelets impregnated with insect repellent; bromine for pharmaceutical purposes; paper for mustard plasters; fly catching paper; reagent paper for veterinary purposes; reagent paper for medical purposes; mothproofing paper; petroleum jelly for medical purposes; vaccines; oxygen baths; antiseptic cotton; aseptic cotton; absorbent cotton; wadding for medical purposes; cotton for medical purposes; dietetic substances adapted for medical use; radiological contrast substances for medical purposes; nutritive substances for microorganisms; radioactive substances for medical purposes; bismuth subnitrate for pharmaceutical purposes; melissa water for pharmaceutical purposes; seawater for medicinal bathing; mineral waters for medical purposes; thermal water; dietary fibre; moulding wax for dentists; gases for medical purposes; guaiacol for pharmaceutical purposes; massage gels for medical purposes; sexual stimulant gels; haematogen; haemoglobin; hydrastine; hydrastinine; glycerine for medical purposes; glycerophosphates; glucose for medical purposes; gentian for pharmaceutical purposes; hormones for medical purposes; mustard for pharmaceutical purposes; mustard plasters; mud for baths; medicinal mud; contraceptive sponges; gamboge for medical purposes; gurjun balsam for medical purposes; deodorizers for litter trays; deodorants for clothing and textiles; air deodorizing preparations; deodorants, other than for human beings or for animals; diastase for medical purposes; digitalin; vitamin supplement patches; mineral dietary supplements; nutritional supplements; albumin dietary supplements; dietary supplements for animals; yeast dietary supplements; alginate dietary supplements; glucose dietary supplements; casein dietary supplements; lecithin dietary supplements; linseed oil dietary supplements; brewer's yeast dietary supplements; propolis dietary supplements; protein dietary supplements; protein supplements for animals; royal jelly dietary supplements; pollen dietary supplements; wheat germ dietary supplements; linseed dietary supplements; whey protein dietary supplements; acai powder dietary supplements; dietary supplements with a cosmetic effect; enzyme dietary supplements; yeast for pharmaceutical purposes; gelatine for medical purposes; cod liver oil; isotopes for medical purposes; immunostimulants; insecticides; iodine for pharmaceutical purposes; iodides for pharmaceutical purposes; alkaline iodides for pharmaceutical purposes; iodoform; calomel [fungicide]; cream of tartar for pharmaceutical purposes; tartar for pharmaceutical purposes; camphor for medical purposes; cannabidiol for medical use; capsules for medicines; cachets for pharmaceutical purposes; capsules made of dendrimer-based polymers, for pharmaceuticals; haemostatic pencils; wart pencils; caustic pencils; carbolineum [parasiticide]; caustics for pharmaceutical purposes; cachou for

pharmaceutical purposes; quassia for medical purposes; quebracho for medical purposes; oxygen for medical purposes; gallic acid for pharmaceutical purposes; acids for pharmaceutical purposes; adhesives for dentures; surgical glues; stem cells for veterinary purposes; stem cells for medical purposes; cocaine for medical purposes; collagen for medical purposes; collodion for pharmaceutical purposes; corn rings for the feet; medicated sweets; angostura bark for medical purposes; barks for pharmaceutical purposes; cedar wood for use as an insect repellent; condurango bark for medical purposes; croton bark; mangrove bark for pharmaceutical purposes; myrobalan bark for pharmaceutical purposes; quinquina for medical purposes; medicated animal feed; medicinal roots; rhubarb roots for pharmaceutical purposes; lint for medical purposes; starch for dietetic or pharmaceutical purposes; creosote for pharmaceutical purposes; blood for medical purposes; biological tissue cultures for veterinary purposes; biological tissue cultures for medical purposes; cultures of microorganisms for medical or veterinary use; curare; dental lacquer; liquorice for pharmaceutical purposes; milk sugar for pharmaceutical purposes; adhesive plasters; medicines for alleviating constipation; adhesive tapes for medical purposes; lecithin for medical purposes; lotions for veterinary purposes; medicated hair lotions; lotions for pharmaceutical purposes; medicated after-shave lotions; personal sexual lubricants; lupulin for pharmaceutical purposes; magnesia for pharmaceutical purposes; liniments; ointments for pharmaceutical purposes; sunburn ointments; mercurial ointments; frostbite salve for pharmaceutical purposes; gauze for dressings; medicinal oils; mustard oil for medical purposes; camphor oil for medical purposes; castor oil for medical purposes; oil of turpentine for pharmaceutical purposes; dill oil for medical purposes; dental mastics; dental abrasives; dental impression materials; teeth filling material; dressings, medical; surgical dressings; drugs for medical purposes; medicines for veterinary purposes; serotherapeutic medicines; medicines for human purposes; medicines for dental purposes; menthol; medicinal drinks; moleskin for medical purposes; almond milk for pharmaceutical purposes; powdered milk for babies; royal jelly for pharmaceutical purposes; milk ferments for pharmaceutical purposes; Irish moss for medical purposes; flour for pharmaceutical purposes; linseed meal for pharmaceutical purposes; fish meal for pharmaceutical purposes; fly glue; antibacterial soap; disinfectant soap; medicated soap; freeze-dried meat adapted for medical purposes; mint for pharmaceutical purposes; dietetic beverages adapted for medical purposes; malted milk beverages for medical purposes; injectable dermal fillers; bone void fillers comprised of living tissues; narcotics; medicinal infusions; tincture of iodine; eucalyptol for pharmaceutical purposes; tinctures for medical purposes; opium; opodeldoc; aromatic deodorizers for toilets; decoctions for pharmaceutical purposes; antiparasitic collars

for animals; cotton sticks for medical purposes; stick liquorice for pharmaceutical purposes; sulfur sticks [disinfectants]; pastilles for pharmaceutical purposes; medicated toothpaste; pectin for pharmaceutical purposes; pepsins for pharmaceutical purposes; peptones for pharmaceutical purposes; hydrogen peroxide for medical purposes; pesticides; food for babies; leeches for medical purposes; blood plasma; nicotine patches for use as aids to stop smoking; eyepatches for medical purposes; poultices; compresses; scapulars for surgical purposes; babies' diapers; diapers for pets; swim diapers, reusable, for babies; swim diapers, disposable, for babies; diapers for incontinence; disposable absorbent mats for lining pet crates; diaper changing mats, disposable, for babies; disposable housebreaking pads for pets; bunion pads; breast-nursing pads; diagnostic strips for testing breast milk for medical purposes; pomades for medical purposes; powder of cantharides; pyrethrum powder; anti-uric preparations; bacterial preparations for medical and veterinary use; bacteriological preparations for medical and veterinary use; balsamic preparations for medical purposes; albuminous preparations for medical purposes; biological preparations for veterinary purposes; biological preparations for medical purposes; veterinary preparations; bismuth preparations for pharmaceutical purposes; vitamin preparations; diagnostic preparations for veterinary purposes; diagnostic preparations for medical purposes; douching preparations for medical purposes; bath preparations for medical purposes; therapeutic preparations for the bath; haemorrhoid preparations; preparations for callouses; lice treatment preparations [pediculicides]; acne treatment preparations; preparations to facilitate teething; preparations for the treatment of burns; fumigation preparations for medical purposes; ootherapy preparations; air purifying preparations; bronchodilating preparations; preparations for reducing sexual activity; sterilizing preparations; soil-sterilizing preparations; corn remedies; pharmaceutical preparations for treating dandruff; preparations for destroying noxious animals; herbicides; preparations for destroying dry rot fungus; larvae exterminating preparations; fly destroying preparations; preparations for destroying mice; slug exterminating preparations; pharmaceutical preparations for skin care; contact lens cleaning preparations; preparations of microorganisms for medical or veterinary use; lime-based pharmaceutical preparations; styptic preparations; medicated eye-washes; medicinal hair growth preparations; nutraceutical preparations for therapeutic or medical purposes; opiates; anticryptogamic preparations; aloe vera preparations for pharmaceutical purposes; preparations of trace elements for human and animal use; sulfonamides [medicines]; pharmaceutical preparations; pharmaceutical preparations for treating sunburn; enzyme preparations for veterinary purposes; enzyme preparations for medical purposes; phytotherapy preparations for medical purposes; chemico-pharmaceutical preparations; chemi-

cal preparations for veterinary purposes; chemical preparations for the diagnosis of pregnancy; chemical preparations for medical purposes; chemical preparations for treating diseases affecting cereal plants; chemical preparations for treating wheat blight; chemical preparations for treating diseases affecting vine plants; chemical preparations for treating mildew; chemical preparations for treating phyloxera; chemical preparations for pharmaceutical purposes; chilblain preparations; mothproofing preparations; collyrium; lead water; chemical conductors for electrocardiograph electrodes; albuminous foodstuffs for medical purposes; dietetic foods adapted for medical purposes; by-products of the processing of cereals for dietetic or medical purposes; homogenized food adapted for medical purposes; freeze-dried food adapted for medical purposes; pharmaceuticals; sanitary towels; panty liners [sanitary]; propolis for pharmaceutical purposes; pearl powder for medical purposes; radium for medical purposes; hydrated chloral for pharmaceutical purposes; solvents for removing adhesive plasters; vaginal washes for medical purposes; solutions for contact lenses; chemical reagents for medical or veterinary purposes; gum for medical purposes; rubber for dental purposes; chewing gum for medical purposes; nicotine gum for use as an aid to stop smoking; insect repellents; insect repellent incense; repellents for dogs; tissues impregnated with pharmaceutical lotions; sarsaparilla for medical purposes; sugar for medical purposes; crystallized rock sugar for medical purposes; asthmatic tea; fumigating sticks; massage candles for therapeutic purposes; linseed for pharmaceutical purposes; tobacco-free cigarettes for medical purposes; siccatives [drying agents] for medical purposes; syrups for pharmaceutical purposes; turpentine for pharmaceutical purposes; milking grease; greases for veterinary purposes; greases for medical purposes; lacteal flour for babies; infant formula; soporifics; bicarbonate of soda for pharmaceutical purposes; bath salts for medical purposes; salts for mineral water baths; salts for medical purposes; potassium salts for medical purposes; sodium salts for medical purposes; smelling salts; mineral water salts; malt for pharmaceutical purposes; semen for artificial insemination; alcohol for pharmaceutical purposes; medicinal alcohol; alloys of precious metals for dental purposes; ergot for pharmaceutical purposes; cooling sprays for medical purposes; antibacterial handwashes; adjuvants for medical purposes; astringents for medical purposes; vermifuges; disinfectants; disinfectants for hygiene purposes; disinfectants for chemical toilets; appetite suppressants for medical purposes; medical preparations for slimming purposes; parasitocides; mouthwashes for medical purposes; medicated dentifrices; febrifuges; depuratives; animal washes [insecticides]; detergents for medical purposes; cattle washes [insecticides]; dog washes [insecticides]; insecticidal veterinary washes; vesicants; purgatives; remedies for perspiration; remedies for foot perspirati-

on; anti-inflammatories; chemical contraceptives; antiparasitic preparations; laxatives; tonics [medicines]; medicated toiletry preparations; digestives for pharmaceutical purposes; nervines; bouillons for bacteriological cultures; steroids; headache relief sticks; strychnine; suppositories; serums; tanning pills; appetite suppressant pills; slimming pills; jujube, medicated; antioxidant pills; sanitary tampons; vulnerary sponges; tetrahydrocannabinol [THC] for medical use; thymol for pharmaceutical purposes; smoking herbs for medical purposes; medicinal herbs; tranquilizers; transplants [living tissues]; surgical implants comprised of living tissues; pants, absorbent, for incontinence; sanitary panties; babies' diaper-pants; charcoal for pharmaceutical purposes; fennel for medical purposes; porcelain for dental prostheses; phenol for pharmaceutical purposes; enzymes for veterinary purposes; enzymes for medical purposes; ferments for pharmaceutical purposes; formic aldehyde for pharmaceutical purposes; phosphates for pharmaceutical purposes; fungicides; quinine for medical purposes; chinoline for medical purposes; diabetic bread adapted for medical use; chloroform; flowers of sulfur for pharmaceutical purposes; cement for animal hooves; bone cement for surgical and orthopaedic purposes; dental cements; medicinal tea; herbal teas for medicinal purposes; bath tea for therapeutic purposes; insecticidal animal shampoos; medicated shampoos; medicated shampoos for pets; pediculicidal shampoos; medicated dry shampoos; pre-filled syringes for medical purposes; eucalyptus for pharmaceutical purposes; herbal extracts for medical purposes; plant extracts for pharmaceutical purposes; tobacco extracts [insecticides]; extracts of hops for pharmaceutical purposes; elixirs [pharmaceutical preparations]; ethers for pharmaceutical purposes; esters for pharmaceutical purposes; cellulose esters for pharmaceutical purposes; cellulose ethers for pharmaceutical purposes; rat poison; poisons; bacterial poisons; jalap; medicines; pharmaceutical substances; food products for therapeutic and prophylactic purposes; medicines, namely, for the treatment of viral diseases; medicines, namely, for the treatment of coronavirus infection; medicines, namely, for the treatment of HIV infection; medicines, namely, for the treatment of bacterial infections; medicines, namely antibiotics; medicines, namely for the treatment of diseases of the musculoskeletal system; medicines, namely, for the treatment of lung diseases; medicines, namely, for the treatment of obesity; medicines, namely, immunostimulants; medicines, namely anticoagulants; medicines, namely, analeptics; medicines, namely, analgesic non-narcotic medicines; medicines, namely antihypertensives; medicines, namely, antioxidants; medicines, namely, antiseptics; medicines, namely selective beta1-blockers; medicines, namely vasodilators; medicines, namely, venotonic and venoprotective agents; medicines, namely vitamins; medicines, namely, hemostatic agents; medicines and dietary supplements for weight reduction; medicines

for the treatment of diabetes; medicines, namely, glucocorticosteroids; medicines, namely, detoxification agents; medicines, namely diuretics; medicines, namely, cardiogenic drugs of a non-glycoside structure; medicines, namely, coronary dilating agents of reflex action; medicines, namely, correctors of cerebrovascular disorders; medicines, namely, local anesthetics; medicines, namely local irritants; medicines, namely, metabolic agents; medicines, namely painkillers; medicines, namely non-steroidal anti-inflammatory drugs; medicines, namely, plasma substitutes; medicines, namely antimicrobial agents; medicines, namely antifungal agents; medicines, namely anticancer drugs; medicines, namely antiemetics; medicines, namely anti-scabies; medicines, namely, rehydrating agents; medicines, namely, reparants; medicines, namely, tissue repair stimulant of natural origin; medicines, namely, antispasmodics; medicines, namely, means of carbon nutrition for medical purposes; medicines, namely electrolytes for medical purposes; medicines, namely tablets [pharmaceuticals]; medicines, namely medicines in the form of capsules; medicines, namely medicated powders; medicines, namely, lyophilizates for medical purposes; medicines, namely medicinal solutions; medicines, namely, medicinal solutions for injections; medicines, namely solutions for infusions; medicines, namely, concentrates for pharmaceutical purposes for the preparation of solutions for infusions and injections; medicines, namely medicated gels; medicines, namely, medicated ointments; medicines, namely medicated creams; medicines, namely, liniments; medicines, namely suppositories; cannabis for medical purposes.

35 – Arranging subscriptions to telecommunication services for others; import-export agency services; commercial information agency services; advertising agency services; cost price analysis; rental of cash registers; rental of office equipment in co-working facilities; rental of advertising space; business auditing; financial auditing; business intermediary services relating to the matching of potential private investors with entrepreneurs needing funding; employment agency services; computerized file management; book-keeping; invoicing; demonstration of goods; transcription of communications [office functions]; opinion polling; market studies; business investigations; business research; marketing research; personnel recruitment; business management and organization consultancy; business organization consultancy; business management consultancy; personnel management consultancy; professional business consultancy; consultancy regarding advertising communication strategies; consultancy regarding public relations communication strategies; layout services for advertising purposes; marketing; marketing in the framework of software publishing; influencer marketing; targeted marketing; business management of performing artists; business management of sports people; writing of curriculum vitae for others; writing of publicity texts;

scriptwriting for advertising purposes; news clipping services; updating and maintenance of information in registries; updating and maintenance of data in computer databases; updating of advertising material; word processing; online retail services for downloadable and pre-recorded music and movies; online retail services for downloadable ring tones; online retail services for downloadable digital music; organization of exhibitions for commercial or advertising purposes; arranging newspaper subscriptions for others; arranging subscriptions to electronic toll collection [ETC] services for others; organization of fashion shows for promotional purposes; organization of trade fairs; shop window dressing; business appraisals; preparation of business profitability studies; payroll preparation; data search in computer files for others; sponsorship search; administrative assistance in responding to calls for tenders; business management assistance; commercial or industrial management assistance; commercial intermediation services; providing business information; providing business information via a website; providing commercial and business contact information; providing telephone directory information; providing commercial information and advice for consumers in the choice of products and services; provision of an online marketplace for buyers and sellers of goods and services; providing user reviews for commercial or advertising purposes; web indexing for commercial or advertising purposes; providing user rankings for commercial or advertising purposes; presentation of goods on communication media, for retail purposes; media relations services; auctioneering; conducting of commercial events; economic forecasting; sales promotion for others; promotion of goods and services through sponsorship of sports events; promotion of goods through influencers; production of teleshopping programmes; production of advertising films; office machines and equipment rental; rental of advertising time on communication media; publicity material rental; rental of billboards [advertising boards]; rental of vending machines; rental of sales stands; rental of photocopying machines; consumer profiling for commercial or marketing purposes; publication of publicity texts; radio advertising; development of advertising concepts; bill-posting; distribution of samples; dissemination of advertising matter; direct mail advertising; registration of written communications and data; advertising; online advertising on a computer network; outdoor advertising; advertising by mail order; television advertising; compilation of statistics; compilation of information into computer databases; business inquiries; systemization of information into computer databases; administrative services for medical referrals; corporate communications services; negotiation of business contracts for others; negotiation and conclusion of commercial transactions for third parties; compiling indexes of information for commercial or advertising purposes; tax preparation; drawing up of state-

ments of accounts; telemarketing services; psychological testing for the selection of personnel; interim business management; outsourced administrative management for companies; business management of hotels; business management for freelance service providers; business project management services for construction projects; commercial administration of the licensing of the goods and services of others; business management of reimbursement programmes for others; computerized management of medical records and files; administration of consumer loyalty programs; administration of frequent flyer programs; administrative processing of purchase orders; administrative services for the relocation of businesses; public relations; commercial lobbying services; competitive intelligence services; business consulting services for digital transformation; advisory services for business management; lead generation services; modelling for advertising or sales promotion; typing; online ordering services in the field of restaurant take-out and delivery; market intelligence services; appointment reminder services [office functions]; data processing services [office functions]; website traffic optimization; wholesale services for pharmaceutical, veterinary and sanitary preparations and medical supplies; appointment scheduling services [office functions]; tax filing services; search engine optimization for sales promotion; retail services for works of art provided by art galleries; retail services for pharmaceutical, veterinary and sanitary preparations and medical supplies; retail services relating to bakery products; gift registry services; price comparison services; business intermediary services relating to the matching of various professionals with clients; reception services for visitors [office functions]; pay per click advertising; advertising services to create brand identity for others; secretarial services; procurement services for others [purchasing goods and services for other businesses]; shorthand; outsourcing services [business assistance]; telephone answering for unavailable subscribers; telephone switchboard services; photocopying services; business efficiency expert services; retail and wholesale services; wholesale services; retail services; online ordering services; retail or wholesale services for medicines; online ordering services for medicines; retail and wholesale services for nutritional supplements; retail and wholesale services for food products; retail and wholesale services for cosmetics; retail or wholesale services for medical supplies.

(260) AM 2026 133422 A

(800) 1849748

(151) 2025 02 18

(891) 2025 02 18

(731) AQUARIUS COSMETIC, S.L.U.

C/ Picapedrers, 3, Polígono industrial La Torruella, E-08508 Les Masies de Voltregà (La Gleva), Spain

(540)



(591) Black, white

(531) 27.05.09; 27.05.10

(526) No claim is made to the exclusive right to use of the term FRAGRANCES, but as part of the whole mark

(511)

3 – Perfumery products; perfumes; eau de toilette; cologne; fragrances; essential oils; deodorants for personal use (perfumery); body deodorants [perfumery]; body sprays; deodorants for the body [scented water in vaporizers]; aromatherapy lotions; toiletry articles; make-up products; pre-moistened cosmetic wipes; disposable wipes impregnated with cologne; cosmetic preparations for baths; bath salts; soaps; shower gels; cosmetic lotions; perfumed body lotions and creams; hair lotions; cosmetics; shampoos; cosmetic creams; cosmetic products for nail care; oils for cosmetic use; dentifrices.

(260) AM 2026 133432 A

(800) 1850018

(151) 2025 01 14

(891) 2025 01 14

(731) COMISA S.p.A.

Via Neziole 27, I-25055 Pisogne (BS), Italy

(540)



(591) Black, white

(531) 27.01.06; 27.01.12; 27.05.01; 27.05.09; 27.05.17

(511)

6 – Pipes, tubes and hoses, and junctions therefor, including valves (of metal); manifolds of metal for pipelines.

11 – Water regulating valves [safety accessories]; mixing valves, namely mixer taps for water or gas; radiator valves; ball valves; heat accumulators; filters and pressure reducers for water or gas (regulating accessories); filters and pressure reducers for water or gas (safety accessories); regulating accessories for water or gas apparatus and pipes; safety accessories for water or gas apparatus and pipes; cooling and refrigerating apparatus and installations; ventilation [air-conditioning] installations and apparatus; installations for de-humidifying; thermal storage instruments [solar energy] for heating; heat accumulators.

17 – Flexible pipes, tubes, hoses, and fittings therefor, including valves, non-metallic.

19 – Building materials, not of metal; rigid pipes, not of metal, for building and fittings relating thereto.

(260) AM 2026 133513 A

(800) 1851389

(151) 2025 01 21

(891) 2025 01 21

(731) Suzhou Dake Investment Consultation Co., Ltd.

Room 618, Building Number 1, Lucky

City Commercial Center, Suzhou Industrial

Park, Suzhou City, Jiangsu Province, China

(540)

EMBEST

(591) Black, white

(511)

7 – Agricultural machines; lawnmowers [machines]; milking machines; aerating pumps for aquaria; hair clipping machines for animals; disintegrators; forage cutters; woodworking machines; saws [machines]; paperboard making machines; printing machines; electromechanical food preparation machines; centrifugal mills; beverage preparation machines, electromechanical; tobacco processing machines; stitching machines; bicycle assembling machines; engraving machines; machines for making electric batteries; packaging machines; electric kitchen machines; washing machines [laundry]; glue applying machines; cutters [machines]; oil-well pumps specially for petroleum; mixing machines; hoists; cranes [lifting and hoisting apparatus]; trimming machines; pneumatic hammers; metalworking machines; foundry machines; igniting devices for internal combustion engines; wind-powered installations for generating electricity; tools [parts of machines]; electric cutting machines for the treatment of ceramics; electric cutting machines for the treatment of ceramics and parts for the aforementioned machines; machines for making wires and cables; machines and apparatus for polishing [electric]; stands for machines; drilling heads [parts of machines]; angle grinders; hand-held tools, other than hand-operated; paint spraying machines; dynamos; motors, other than for land vehicles; pneumatic cylinder (part of machines); pumps [machines]; compressed air machines; valves [parts of machines]; belts for machines; electric door openers; bearings [parts of machines]; propulsion mechanisms, other than for land vehicles; electric welding machines; electric machines and apparatus for cleaning; vacuum cleaners; high pressure washers; filter presses; electric shoe polishers.

8 – Hand-operated hand tools; abrading instruments [hand instruments]; hand-operated agricultural implements; hand-operated garden tools; instruments and tools for skinning animals; harpoons; manicure sets; bits [parts of hand tools]; hand-operated lifting jacks; hand-operated guns for the extrusion of mastics; perforating tools [hand tools]; riveters [hand tools]; masons' trowels; graving tools [hand tools]; secateurs; sabres; table cutlery [knives, forks and spoons]; handles for hand-operated hand tools.

9 – Face identification apparatus; voting machines; counters; counterfeit coin detectors; bathroom scales;

weighing apparatus and instruments; measures; electronic notice boards; video phones; interphones; radio signal tuners; radio receivers and transmitters; wireless routers; industrial endoscope cameras; cabinets for loudspeakers; electronic video surveillance apparatus; car video recorders; video monitor; rear-view cameras for vehicles; cameras [photography]; multimeters; electrolysis apparatus for laboratory use; levels [instruments for determining the horizontal]; pressure measuring apparatus; surveying apparatus and instruments; measuring apparatus; electric measuring devices; air analysis apparatus; speed checking apparatus for vehicles; lasers, not for medical purposes; optical apparatus and instruments; materials for electricity mains [wires, cables]; sensors; optical fibers [light conducting filaments]; semi-conductors; control panels [electricity]; circuit breakers; electric couplings; electronic chip cards; condensers [capacitors]; electric switches; electric contacts; electric plugs; electric sockets; covers for electric outlets; video screens; remote control apparatus; heat regulating apparatus; lightning rods; fire extinguishing apparatus; radiological apparatus for industrial purposes; protection devices for personal use against accidents; safety boots for industrial use; knee-pads for workers; protective face shields for workers; ear plugs for divers; clothing for protection against accidents, irradiation and fire; gloves for protection against accidents; alarms; biometric fingerprint door locks; electric theft prevention installations; electric locks; electric door bells; eyeglasses; electric batteries; chargers for electric batteries; mobile power supplies, namely rechargeable batteries.

35 – Advertising; online advertising on a computer network; administrative services for the relocation of businesses; commercial information agency services; business management assistance; commercial administration of the licensing of the goods and services of others; organization of exhibitions for commercial or advertising purposes; sales promotion for others; procurement services for others [purchasing goods and services for other businesses]; provision of an online marketplace for buyers and sellers of goods and services; marketing; import-export agency services; personnel management consultancy; employment agency services; office machines and equipment rental; systemization of information into computer databases; book-keeping; sponsorship search; rental of vending machines; rental of sales stands.

(260) AM 2026 133516 A

(800) 1851513

(151) 2024 12 27

(891) 2024 12 27

(731) BRANDS CORPORATION LP

39/5 Granton Crescent, EDINBURGH

EH5 1BN, United Kingdom

(540)

devente

(591) Black, white

(511)

16 – Adhesive tape dispensers [office requisites]; address stamps; posters; franking machines for office use; clips for offices; pen clips; stapling presses [office requisites]; albums; pencil sharpening machines, electric or non-electric; bookends; hand-rests for painters; aquarelles; document files [stationery]; writing slates; slate pencils; pencils; atlases; loose-leaf binders; gummed tape [stationery]; drawing pads; pads [stationery]; wristbands for the retention of writing instruments; drawing pins; moisteners [office requisites]; stamps [seals]; sealing stamps; inking pads; sealing wax; sealing machines for offices; sealing compounds for stationery purposes; writing or drawing books; tracing patterns; tracing paper; tracing cloth; carbon paper; paper; paper for recording machines; note books; square rulers for drawing; cards; teaching materials [except apparatus]; index cards [stationery]; paper sheets [stationery]; cardboard; cardboard tubes; catalogues; tags for index cards; folders for papers; painters' easels; painters' brushes; indian inks; modelling wax, not for dental purposes; files [office requisites]; office perforators; compasses for drawing; letter trays; correcting fluids [office requisites]; correcting ink [heliography]; pencil leads; french curves; covers [stationery]; writing chalk; chalk holders; pencil holders; pencil lead holders; paper clasps; rollers for typewriters; transfers [decalcomanias]; graphic prints; drawing boards; drawing materials; drawing instruments; envelopes [stationery]; wrapping paper; nibs; typewriters, electric or non-electric; pen cases; erasing products; writing materials; rubber erasers; punches [office requisites]; ink; inking ribbons; inkwells; envelope sealing machines, for offices; seals [stamps]; drawing sets; forms, printed; office requisites, except furniture; charcoal pencils; stencils [stationery]; artists' watercolour saucers; scrapers [erasers] for offices; moisteners for gummed surfaces [office requisites]; postcards; hand labelling appliances; printed matter; printing sets, portable [office requisites]; writing paper; drawing pens; luminous paper; marking chalk; plastics for modelling; modelling materials; modelling paste; handkerchiefs of paper; blackboards; paper-clips; palettes for painters; pantographs [drawing instruments]; stationery; parchment paper; pastels [crayons]; stencil cases; canvas for painting; paint boxes for use in schools; fountain pens; stencil plates; drawing rulers; stamp pads; school supplies [stationery]; bookmarks; greeting cards; desk mats; gluten [glue] for stationery or household purposes; adhesives [glues] for stationery or household purposes; adhesive tapes for stationery or household purposes; calendars; paintbrushes; self-adhesive tapes for stationery and household purposes; elastic bands for offices; wood pulp board [stationery];

nery]; wood pulp paper; boxes of cardboard or paper; stands for pens and pencils; paper shredders for office use; glue for stationery or household purposes; paper knives [letter openers]; pencil sharpeners, electric or non-electric; tissues of paper for removing make-up; table napkins of paper; place mats of paper; drawing squares; t-squares for drawing; penholders; writing cases [stationery]; inkstands; writing cases [sets]; stickers [stationery]; bookbinding apparatus and machines [office equipment]; copying paper [stationery]; ink sticks; musical greeting cards; waxed paper; passport holders; writing brushes; writing instruments; document laminators for office use; papers for painting and calligraphy; writing board erasers; clipboards; chart pointers, non-electronic; paint trays; marking pens [stationery]; document holders [stationery]; page holders; polymer modelling clay; obliterating stamps; packing [cushioning, stuffing] materials of paper or cardboard; padding materials of paper or cardboard; rice paper; washi; name badge holders [office requisites]; retractable reels for name badge holders [office requisites]; clips for name badge holders [office requisites]; paper cutters [office requisites]; protective covers for books; colouring pictures; origami folding paper; carrier bags of paper or plastic; magnetic boards being office requisites; flip charts; adhesive foils [stationery]; wrapping foils for books; foils of plastic for packaging; foils of plastic for wrapping; polypropylene foil for packing; carrier bags of paper or plastic.

18 – Backpacks; shoe bags; purses; school bags; card cases [notecases]; travelling trunks; umbrellas; sling bags for carrying infants; tool bags, empty; rucksacks; pocket wallets; wheeled shopping bags; reusable shopping bags; attaché cases; bags for climbers; bags for campers; beach bags; handbags; travelling bags; bags [envelopes, pouches] of leather, for packaging; briefcases; travelling sets [leatherware]; suitcases; boxes of leather or leatherboard; chain mesh purses; cases of leather or leatherboard; trunks [luggage]; vanity cases, not fitted; shoulder belts [straps] of leather; haversacks; garment bags for travel; key cases; net bags for shopping; valises; bags for sports; slings for carrying infants; pouch baby carriers; credit card cases [wallets]; business card cases; randsels [japanese school satchels]; luggage tags; suitcases with wheels; motorized suitcases; conference folders; backpacks for carrying infants; toilet bags, not fitted; suitcase packing organizers / luggage organizers set; bags; clutch bags; nose bags; athletic bags; purse frames; bags for clothes; small bags for men; bags for sports clothing; handbag straps; barrel bags; belt bags; book bags; bucket bags; bum bags; camping bags; carrying bags; courier bags; diaper bags; duffle bags; duffel bags; evening bags; flight bags; frames for bags [structural parts of bags]; game bags; grips [bags]; gym bags; hiking bags; hip bags; hunting bags; key bags; kit bags; knitted bags; leather bags; messenger bags; music bags; nappy bags; overnight bags; roll bags; saddle cloths; small purses; shoulder bags; souvenir bags;

sport bags; straps for handbags; travel bags; trolley duffels; weekend bags; wheeled bags; work bags; tote bags; belt bags and hip bags; luggage, bags, wallets and carrying bags; airline travel bags; all purpose sports bags; all-purpose athletic bags; animal carriers [bags]; artificial fur bags; imitation leather bags; changing bags; bags for carrying animals; bags made of leather; bags made of imitation leather; canvas shopping bags; carry-all bags; children's shoulder bags; cosmetic bags sold empty; cross-body bags; duffel bags for travel; flexible bags for garments; game bags [hunting accessories]; grips for holding shopping bags; grocery tote bags; leather bags and wallets; leather shopping bags; mesh bags for shopping; all-purpose sports bags; school book bags; shoe bags for travel; suit bags; textile shopping bags; knitted bags, not of precious metals; cloth bags; boston bags; handbags for men; clutch handbags; boot bags; canvas bags; luggage bags; bags [envelopes, pouches] of leather for packaging; baggage.

21 – Thermally insulated containers for food; glass bulbs [receptacles]; glass flasks [containers]; cooking pot sets; pouring spouts; drinking vessels; heat-insulated containers for beverages; basins [bowls]; demijohns; bottles; insulating flasks; vacuum bottles; refrigerating bottles; heat-insulated containers; decanters; cocktail shakers; glasses [receptacles]; blenders, non-electric, for household purposes; drinking bottles for sports; containers for household or kitchen use; dishes; cups; mugs; tea infusers; portable cool boxes, non-electric; kitchen containers; kitchen utensils; tankards; cups of paper or plastic; drinking glasses; drinking straws; hip flasks; cold packs for chilling food and beverages; mug sleeves; mug cosies.

35 – Import-export agency services; dissemination of advertising matter; demonstration of goods; distribution of samples; publication of publicity texts; advertising; sales promotion for others; presentation of goods on communication media, for retail purposes; organization of fashion shows for promotional purposes; marketing; provision of an online marketplace for buyers and sellers of goods and services; promotion of goods and services through sponsorship of sports events; promotion of goods through influencers.

(260) AM 2026 133610 A

(800) 1852152

(151) 2024 12 30

(891) 2024 12 30

(731) Guangdong Deerma Technology Co., Ltd.
No. 4-1, Longhui Road, Malong Village
Committee, Beijiao Town, Shunde District,
Foshan City, Guangdong Province, China

(540)

 The logo for DEERMA features the brand name in a bold, uppercase, sans-serif font. To the left of the text is a stylized graphic element consisting of a horizontal line with a small arrowhead pointing to the right, resembling a deer's antler or a branch.

(591) Black, white

(531) 18.05.01; 18.05.03; 27.05.01

(511)

7 – Kneading machines; scissors, electric; vacuum cleaners for industrial purposes; disintegrators; vacuum cleaner attachments for disseminating perfumes and disinfectants; washing apparatus; mills for household purposes, other than hand-operated; shoe polishers, electric; suction cups for milking machines; vacuum cleaners for household purposes; battery operated machines; bottle washing machines; spin dryers [not heated]; packaging machines for food; cleaning appliances utilizing steam; kitchen machines, electric; knives, electric; machines and apparatus for cleaning, electric; juice extractors, electric; mixing machines; whisks, electric, for household purposes; handling machines, automatic [manipulators]; dust removing installations for cleaning purposes; steam condensers [parts of machines]; curtain drawing devices, electrically operated; rotary steam presses, portable, for fabrics; hand-held tools, other than hand-operated; dish-washers; steam mops; nail extractors, electric; milking machines; spraying machines; machines and apparatus for carpet shampooing, electric; machines and apparatus for wax-polishing, electric; labellers [machines]; washing machines [laundry]; spinning machines; blenders, electric, for household purposes; woodworking machines; machines and apparatus for polishing [electric]; washing installations for vehicles; beaters, electric; compressed air machines; waste disposal units; printing presses; wringing machines for laundry; wrapping machines; shearing machines for animals; beverage preparation machines, electromechanical; apparatus for aerating beverages; industrial robots; grain husking machines; bread cutting machines; food preparation machines, electromechanical; food processors, electric; ironing machines.

9 – Pedometers; remote control apparatus; cinematographic cameras; stereoscopes; planimeters; integrated circuits; projection screens; cameras [photography]; battery charging equipment; measures; 3D spectacles; weighing apparatus and instruments; hygrometers; USB chargers; smartphones; computer software applications, downloadable; electrified fences; computer programs, downloadable; heat regulating apparatus; facial recognition apparatus; scales; time recording apparatus; electrolysis apparatus for laboratory use; scales with body mass analysers; materials for electricity mains [wires, cables]; air analysis apparatus; accumulators, electric; electronic agendas; data synchronization cables; electronic collars to train animals; thermometers, not for medical purposes; temperature indicators; electronic notice boards; bathroom scales; electronic animal identification apparatus; portable media players; animated cartoons; fire extinguishing apparatus; baby scales.

10 – Thermometers for medical purposes; gloves for massage; ultraviolet ray lamps for medical purposes; electric acupuncture instruments; medical masks;

masks for use by medical personnel; soporific pillows for insomnia; body fat monitors; abdominal corsets; esthetic massage apparatus; surgical apparatus and instruments; dental apparatus and instruments; moxibustion apparatus; physiotherapy apparatus; orthopedic articles; medical apparatus for facilitating the inhalation of pharmaceutical preparations; electric massage apparatus for household use; massage apparatus; anti-rheumatism bracelets; abdominal belts; nasal aspirators.

11 – Ultraviolet ray lamps, not for medical purposes; heating apparatus, electric; rotisseries; heating installations; electric appliances for making yogurt; coffee roasters; electric water boilers; humidifiers; toilet seats; footwarmers, electric or non-electric; fabric steamers; water heater for washing (gas or electric heating); cooking apparatus and installations; disinfectant apparatus; coffee machines, electric; air deodorizing apparatus; microwave ovens [cooking apparatus]; air filtering installations; hand drying apparatus for washrooms; kettles, electric; cooking utensils, electric; drying apparatus; germicidal lamps for purifying air; water purifying apparatus and machines; wash-hand basins [parts of sanitary installations]; heating and cooling apparatus for dispensing hot and cold beverages; showers; deep fryers, electric; radiators, electric; cooking stoves; hair dryers; portable evaporative cooling fans; hydromassage bath apparatus; sanitary apparatus and installations; ice-cream making machines; bakers' ovens; electrically heated carpets; pocket warmers; lamps; laundry dryers, electric; multicookers; electric fans for personal use; roasting apparatus; cooling appliances and installations; air humidifying apparatus; bath tubs; outdoor electric grills; toilet bowls; soya milk making machines, electric; air sterilizers; fountains; bread-making machines; freezers; extractor hoods for kitchens; ice machines and apparatus; USB-powered cup heaters; electric egg boilers; heaters, electric, for feeding bottles; USB-powered hand warmers; nail lamps; air fryers; steam facial apparatus [saunas]; bath tubs for sitz baths; food steamers, electric; fans [air-conditioning]; dehumidifiers for household use; taps; steam generating installations; air-conditioning installations.

21 – Reusable plastic water bottles sold empty; basins [receptacles]; fruit presses, non-electric, for household purposes; bottle openers, electric and non-electric; cooking pots, non-electric; sippy cups; cutting boards for the kitchen; place mats, not of paper or textile; blenders, non-electric, for household purposes; kitchen grinders, non-electric; containers for household or kitchen use; kitchen utensils; lunch boxes; ceramics for household purposes; drinking vessels; tea infusers; deodorizing apparatus for personal use; watering devices; drying racks for laundry; inflatable bath tubs for babies; smoke absorbers for household purposes; soap boxes; ironing boards; buckets made of woven fabrics; mop wringer buckets; garbage cans for hou-

shold purposes; baby baths, portable; stands for portable baby baths; toilet paper holders; brushes for cleaning tanks and containers; combs; electric combs; nail brushes; toilet brushes; bath brushes; washing brushes; toothbrushes; toothbrushes, electric; water apparatus for cleaning teeth and gums; heads for electric toothbrushes; toothpick holders; toothpicks; toilet cases; cosmetic utensils; reusable ice cubes; thermally insulated containers for food; isothermic bags; tea cosies; insulating flasks; ice buckets; squeegees [cleaning instruments]; brooms; lint removers, electric or non-electric; cleaning instruments, hand-operated; carpet sweepers; mops; crystal [glassware]; animal activated animal feeders; pet feeding bowls; automatic litter boxes for pets; plug-in diffusers for mosquito repellents; insect traps; electric devices for attracting and killing insects.

28 – Body rehabilitation apparatus; apparatus for games; hoops for exercise incorporating measuring sensors; shin guards [sports articles]; balls for games; waist trimmer exercise belts; machines for physical exercises; elliptical exercise machines; stationary exercise bicycles; toys; appliances for gymnastics; running machines; belts [sport articles]; archery implements; playing cards; body-building apparatus; body-training apparatus.

35 – Personnel management consultancy; commercial administration of the licensing of the goods and services of others; sponsorship search; presentation of goods on communication media, for retail purposes; business management and organization consultancy; import-export agency services; advertising; organization of exhibitions for commercial or advertising purposes; retail or wholesale services for medical supplies; procurement services for others [purchasing goods and services for other businesses]; marketing; sales promotion for others.

(260) AM 2026 133714 A

(800) 1853170

(151) 2025 02 25

(891) 2025 02 25

(731) SPEEDCAR OIL Spółka z ograniczoną

Odpowiedzialnością

ul. Jeleńska 38A, PL-13-230 Lidzbark,

Poland

(540)



(591) Black, red, dark red and white

(531) 26.04.04; 26.04.18; 27.05.10; 27.05.22;
29.01.13

(511)

1 – Quenching fluids; cooling fluids for vehicle radiators; refrigerants; antifreeze for vehicle radiators; oils

for brakes; brake fluid; transmission fluid; windshield de-icer fluids; anti-freeze for windscreen washer systems; de-icing sprays for windscreens.

3 – Windscreen cleaning liquids.

4 – Motor oil; lubricants; industrial lubricants; lubrication grease for vehicles; lubricants for machines; lubricants and industrial greases, waxes and fluids; industrial oils and greases, lubricants; grease for brake shoes; motor oil; mineral oils; oils for turbo units; lubricating oil; mould releasing oils; release agents [oils]; lubricants for the protection of the chains of chainsaws.

(260) AM 2026 133730 A

(800) 1853396

(151) 2025 03 18

(891) 2025 03 18

(731) Shenzhen King Quenson Industry Co., Ltd.

A1402, Future Plaza, Qiaocheng Bei Road,

Nanshan District, Shenzhen City, Guangdong

Province, China

(540)

NutriKing

(591) Black, white

(531) 27.05.01

(511)

1 – Plant growth regulating preparations; tensio-active agents; preparations of trace elements for plants; seaweeds [fertilizers]; fertilizers; agricultural chemicals, except fungicides, herbicides, insecticides and parasiticides; horticultural chemicals, except fungicides, herbicides, insecticides and parasiticides; chemicals for use in forestry, except fungicides, herbicides, insecticides and parasiticides; mixed fertilizers; garden chemicals other than fungicides, herbicides, insecticides and parasiticides.

5 – Disinfectants; animal washes [insecticides]; preparations for destroying mice; larvae exterminating preparations; herbicides; soil-sterilizing preparations; acaricides; pesticides; fungicides for agricultural purposes.

(260) AM 2026 133735 A

(800) 1853456

(151) 2024 12 26

(891) 2024 12 26

(731) Nataliia Holovchenko

Sosiury Volodymyra str., 4, apt. 15, Kyiv

02157, Ukraine

(540)

Na Gólov[y]

(591) Black, white

(531) 24.17.01; 24.17.06; 24.17.09

(511)

1 – Chemicals for use in industry; antioxidants for use in the manufacture of cosmetics; antioxidants for use in manufacture; antistatic preparations, other than for household purposes; vitamins for use in the manufacture of cosmetics; hydrogen; plant extracts for use in the manufacture of cosmetics, except essential oils; tea extracts for use in the manufacture of cosmetics; active chemical ingredients; glutamic acid for industrial purposes; sodium; spirits of vinegar, dilute acetic acid; hydrogen peroxide for industrial purposes; surfactants; surfactants for the production of hair products; surfactants for the production of cosmetics; chemical reagents, except for those intended for medical or veterinary needs; hyaluronic acid for the production of hair products; silicone fluids for use in the production of cosmetics; fermentation extracts for use in the production of cosmetics; surfactants for the production of medicinal products and products for hair restoration; protein [raw material]; proteins for use in manufacture; sulfides; chemicals for the manufacture of pigments; chemicals for hair dye manufacturing; hair color chemicals.

3 – Non-medicated cosmetics and toiletry preparations; non-medicated dentifrices; perfumery, essential oils; breath freshening sprays; cooling sprays for cosmetic purposes; amber [perfume]; antiperspirants [toiletries]; antistatic preparations for household purposes; joss sticks; aromatics [essential oils]; potpourris [fragrances]; balms, other than for medical purposes; basma [cosmetic dye]; bergamot oil; whitening; lip glosses; nail glitter; body glitter; petroleum jelly for cosmetic purposes; cotton wool for cosmetic purposes; cotton wool impregnated with make-up removing preparations; cotton swabs for cosmetic purposes; cotton sticks for cosmetic use; bleaching preparations [decolorants] for cosmetic purposes; decorative transfers for cosmetic purposes; moustache wax; mustache wax; depilatory wax; astringents for cosmetic purposes; gaultheria oil; dental bleaching gels; heliotropine; geraniol; make-up; lipsticks; deodorants for pets; deodorants for human beings or for animals; detergents, other than for use in manufacturing operations and for medical purposes; scented water; extracts of flowers [perfumes]; herbal extracts for cosmetic purposes; ethereal essences; essential oils for aromatherapy use; essential oils of cedarwood; essential oils of lemon; essential oils of citron; Javelle water; potassium hypochloride; jasmine oil; greases for cosmetic purposes; colorants for hair; colour-removing preparations; color-removing preparations; degreasers, other than for use in manufacturing processes; ionone [perfumery]; adhesives for affixing false eyelashes; adhesives for affixing false hair; adhesives for cosmetic purposes; collagen preparations for cosmetic purposes; hair conditioners; eyebrow cosmetics; cosmetics for children; cosmetics for animals; beauty masks; cosmetic preparations for baths; cosmetic preparations for eyelashes; cosmetic preparations for skin care; cosme-

tic preparations for slimming purposes; skin whitening creams; cosmetic creams; essential oil-based creams for aromatherapy use; lavender water; lavender oil; incense; hair spray; nail varnish; nail polish; hair lotions; lotions for cosmetic purposes; after-shave lotions; massage gels, other than for medical purposes; massage candles for cosmetic purposes; disposable steam-heated masks, not for medical purposes; sheet masks for cosmetic purposes; almond oil; almond milk for cosmetic purposes; deodorant soap; shaving soap; soap for brightening textile; cakes of toilet soap; cakes of soap; almond soap; antiperspirant soap; soap; micellar water; musk [perfumery]; mint for perfumery; mint essence [essential oil]; cosmetic kits; dressings for nail reconstruction; nail art stickers; neutralizers for permanent waving; fumigation preparations [perfumes]; eau de Cologne; eyebrow pencils; cosmetic pencils; oils for toilet purposes; oils for perfumes and scents; oils for cosmetic purposes; cleansing milk for toilet purposes; cleansers for intimate personal hygiene purposes, non medicated; scouring solutions; perfumes; pastes for razor strops; toothpaste; gel eye patches for cosmetic purposes; hydrogen peroxide for cosmetic purposes; pomades for cosmetic purposes; bath preparations, not for medical purposes; varnish-removing preparations; paint stripping preparations; hair straightening preparations; shaving preparations; depilatory preparations; nail care preparations; hair waving preparations; waving preparations for the hair; sun-tanning preparations [cosmetics]; make-up removing preparations; make-up preparations; breath freshening preparations for personal hygiene; aloe vera preparations for cosmetic purposes; air fragrance reed diffusers; make-up powder; nail polish removers; wax melts [fragrancing preparations]; eye-washes, not for medical purposes; antistatic dryer sheets; tissues impregnated with cosmetic lotions; tissues impregnated with make-up removing preparations; colour run prevention laundry sheets / color run prevention laundry sheets; teeth whitening strips; breath freshening strips; soda lye; bath salts, not for medical purposes; sunscreen preparations; douching preparations for personal sanitary or deodorant purposes [toiletries]; talcum powder, for toilet use; terpenes [essential oils]; toners for cosmetic purposes; toilet water; mascara; beard dyes; hair dyes; hair colorants; liquid latex body paint for cosmetic purposes; body paint for cosmetic purposes; cosmetic dyes; phytocosmetic preparations; lipstick cases; henna [cosmetic dye]; bath tea for cosmetic purposes; shampoos for pets [non-medicated grooming preparations]; shampoos for animals [non-medicated grooming preparations]; dry shampoos; shampoos; cosmetic stamps, filled; false eyelashes; false nails.

5 – Pharmaceuticals, medical and veterinary preparations; sanitary preparations for medical purposes; disinfectants; cooling sprays for medical purposes; dietary supplements with a cosmetic effect; cream of tartar for pharmaceutical purposes; lotions for phar-

maceutical purposes; medicated after-shave lotions; massage gels for medical purposes; massage candles for therapeutic purposes; almond milk for pharmaceutical purposes; antibacterial handwashes; dog washes [insecticides]; animal washes [insecticides]; antibacterial soap; disinfectant soap; medicated soap; medicinal infusions; tinctures for medical purposes; mouthwashes for medical purposes; headache relief sticks; stick liquorice for pharmaceutical purposes; medicinal hair growth preparations; aloe vera preparations for pharmaceutical purposes; preparations of trace elements for human and animal use; preparations of microorganisms for medical or veterinary use; anti-inflammatories; tissues impregnated with pharmaceutical lotions; pharmaceutical preparations for skin care; medicated shampoos; pediculicidal shampoos; medicated dry shampoos.

35 – Advertising; business management, organization and administration; office functions; administrative processing of purchase orders; opinion polling; arranging and conducting of commercial events; demonstration of goods; commercial administration of the licensing of the goods and services of others; marketing; influencer marketing; marketing in the framework of software publishing; targeted marketing; marketing through product placement for others in virtual environments; provision of an online marketplace for buyers and sellers of goods and services; organization of exhibitions for commercial or advertising purposes; organization of trade fairs; rental of advertising space; sales prospecting for others; procurement services for others (purchasing goods and services for the other business); purchasing goods and services for other businesses; wholesale services for sanitary preparations; retail services for sanitary preparations; presentation of goods on communication media, for retail purposes; publicity material rental; rental of advertising time on communication media; rental of sales stands; publication of publicity texts; radio advertising; advertising; publicity; pay per click advertising; outdoor advertising; advertising by mail order; direct mail advertising; online advertising on a computer network; distribution of samples; dissemination of advertising matter; sales promotion for others; promotion of goods through influencers; production of advertising films; production of teleshopping programs; television advertising; telemarketing services.

41 – Education; providing of training; entertainment; sporting and cultural activities; academies [education]; teaching; educational services; instruction services; arranging and conducting of congresses; arranging and conducting of colloquiums; arranging and conducting of conferences; arranging and conducting of in-person educational forums; arranging and conducting of workshops [training]; arranging and conducting of entertainment events; arranging and conducting of seminars; arranging and conducting of symposiums; arranging and conducting of sports events;

arranging of beauty contests; electronic desktop publishing; research in the field of education; educational examination; providing user reviews for entertainment or cultural purposes; providing information in the field of education; providing information in the field of entertainment; providing information relating to recreational activities; providing training and educational examination for certification purposes; providing online videos, not downloadable; providing online electronic publications, not downloadable; providing online images, not downloadable; correspondence courses; tutoring; educational services provided by schools; know-how transfer [training]; vocational retraining; coaching [training]; practical training [demonstration]; vocational guidance [education or training advice]; online publication of electronic books and journals; publication of books; publication of texts, other than publicity texts; production of podcasts; production of radio and television programmes; film production, other than advertising films.

44 – Hygienic and beauty care for human beings; health counselling; hair implantation; health spa services; beautician services; hair dyeing services; hair colouring services; hairdressing; aesthetician services; beauty salon services; barber shop services; manicuring; rental of hair styling apparatus; services for the diagnosis of hair and skin conditions for medical and cosmetological purposes; provision of information regarding hairdressing services, including via an online platform; consultations provided by cosmetologists on the selection of professional hair, nail and skin care products; cosmetic and medical-cosmetic services related to hair reconstruction; trichologist services; piercing services; depilatory waxing.

(260) AM 2026 133752 A

(800) 1853791

(151) 2025 02 12

(891) 2025 02 12

(731) B&B ITALIA S.P.A.

Via Manzoni 38, I-20121 MILANO, Italy

(540)

MAXALTO

(591) Black, white

(511)

20 – Covers for clothing [wardrobe]; coat hangers; air cushions not for medical use; air pillows, not for medical purposes; air beds, not for medical purposes; cupboards; works of art of wood, wax, plaster or plastic; freestanding towel racks [furniture]; coat-hooks, not of metal; coatstands; pipe or cable clips of plastics; picture frame brackets; curtain rods; benches [furniture]; worktables; chests, not of metal; library shelves; library racks; sideboards; dinner wagons [furniture]; settees; hat stands; trolleys [furniture]; bins [caskets], not of metal; wood or plastic crates; bins, not of metal; chests for toys; drawers [furniture]

parts]; trestles [furniture]; hampers [baskets]; baskets, not of metal; keyboards for hanging keys; caskets [furniture]; dresser; mobiles [decoration]; containers, not of metal [storage, transport]; cork bands; non-textile cords; picture frames; tea trolleys; kennels for household pets; cushions; pet cushions; drafting tables; meat safes, not of metal; divans; staves of wood; fair stands [display stands]; wall-mounted baby changing platforms; figurines of wood, wax, plaster and plastic; wax figurines; curtain hooks; rattan; pillows; beds fittings, not of metal; furniture fittings, not of metal; doors fittings, not of metal; windows fittings, not of metal; mirror tiles; mats, removable, for sinks; lecterns; bed bases; bed casters, not of metal; beds; bedsteads of wood; book rests [furniture]; framing strips; mattresses; shelves; furniture; edgings of plastic for furniture; furniture partitions of wood; doors for furniture; furniture shelves; furniture casters, not of metal; inflatable furniture; metal furniture; office furniture; school furniture; figures made of rattan; umbrella stands; straw edgings; straw plaits; plaited straw, except matting; screens [furniture]; table tops; tent pegs, not of metal; pedestal for flower pots; armchairs; knobs, not of metal; magazine racks; tissue holders [furniture]; door handles, not of metal; shelves for storage; curtain rails; curtain rollers; racks [furniture]; shelving units; step stools, not of metal; cases of wood or plastic; filing cabinets; writing desks; desks; seats; chaise longues; chairs [seats]; seats of metal; stools; sofas; mirrors [looking glasses]; statues of wood, wax, plaster and plastic; dressing tables; washstands [furniture]; trolleys for computers [furniture]; curtain rings; curtain rails; curtain tie-backs; interior textile window blinds; trays, not of metal; slatted indoor blinds; fans for personal use, non-electric; showcases [furniture].

(260) AM 2026 133755 A

(800) 1433751

(151) 2018 08 08

(891) 2025 04 04

(731) TERA

9 RUE NOTRE-DAME DE NAZARETH,
PARIS, F-75003, France

(540)



(591) Red, white, blue, black

(531) 01.01.02; 24.17.03; 26.04.04; 26.04.05;

26.04.16; 26.04.24; 27.05.09; 29.01.14

(511)

43 – Services for providing food and beverages; temporary accommodation; Bar services; Food and drink catering; Hotel services; Temporary accommodation reservations; Day-nurseries [crèches]; Providing cam-

pground facilities; Retirement homes; Boarding for animals.

(260) AM 2026 133791 A

(800) 1853822

(151) 2025 02 21

(891) 2025 02 21

(731) GUANGDONG LOONGON ANIMATION & CULTURE CO., LTD.

The east of Ningchuanbei Road and the north of Dengfeng Road, Chenghai New District, Chenghai, Shantou, 515800 Guangdong, China

(540)



(591) Black, white

(531) 04.03.03; 26.04.22; 26.04.24; 27.03.03

(511)

28 – Body-building apparatus.

(260) AM 2026 134281 A

(800) 1859697

(151) 2025 05 06

(891) 2025 05 06

(731) Longbohang (Hangzhou) Technology Co., Ltd. Room 704-1, Building 4, Wangqiantang Seal Center, Xiasha Street, Qiantang District, Hangzhou City, 310000 Zhejiang Province, China

(540)

BySence

(591) Black, white

(511)

28 – Toys; building blocks [toys]; magnetic building blocks being toys; infant toys; toy strollers; chess games; draughts [games]; backgammon games.

(260) AM 2026 134587 A

(800) 1862963

(151) 2025 05 19

(891) 2025 05 19

(731) LLC "ArtOptima"

ulitsa 5-ya Kabelnaya, 38 kabinet, 2 etazh, korpus 1, dom 3, RU-111024 Moscow, Russian Federation

(540)



(591) Blue

(531) 24.09.03; 24.09.05; 27.05.17; 28.05; 29.01.04

(511)

4 – Beeswax; methylated spirit; alcohol [fuel]; fuel with an alcohol base; paper spills for lighting fires;

wood shavings for lighting fires; firelighters; anthracite; non-slipping preparations for belts; Christmas tree candles; grease for arms [weapons]; dust binding compositions for sweeping; firewood; charcoal [fuel]; candles; coal briquettes; peat briquettes [fuel]; wood briquettes; combustible briquettes; vaporized fuel mixtures; carnauba wax; ceresine; coal; peat [fuel]; fuel; grease for footwear; wax [raw material]; belting wax; wax for lighting; industrial wax; coke; mineral fuel; grease for belts; grease for leather; industrial grease; oils for releasing form work [building]; tallow; dust removing preparations; oils for lighting; gas for lighting; lighting fuel; lubricating oil; petrol; petroleum ether; ligroin; wicks for candles; petroleum jelly for industrial purposes; diesel oil; fuel gas; oil-gas; lubricating graphite; coal tar oil; coal naphtha; oils for the preservation of masonry; moistening oil; fish oil for industrial purposes; soya bean oil preparations for non-stick treatment of cooking utensils; kerosene; lubricating grease; lamp wicks; lignite; lubricants; mazut; rape oil for industrial purposes; naphtha; bone oil for industrial purposes; oleine; ozokerite; paraffin; petroleum, raw or refined; coal dust [fuel]; stearine; wool grease; sunflower oil for industrial purposes; night-lights [candles]; dust laying compositions; textile oil; carburants; fuel oil; additives, non-chemical, to motor fuel; greases for the preservation of leather; industrial oil; solidified gases [fuel]; castor oil for industrial purposes; oils for the preservation of leather; cutting fluids; oils for paints; producer gas; motor oil; perfumed candles; electrical energy; ethanol [fuel]; tinder; dust absorbing compositions; benzine; biomass fuel; benzene fuel; xylene fuel; wax for skis; lanolin for use in the manufacture of cosmetics; beeswax for use in the manufacture of cosmetics; hookah charcoal; gear oil.

6 – Steel, unwrought or semi-wrought; steel alloys; steel strip; steel wire; cast steel; steel masts; roller blinds of steel; steel sheets; steel pipes; machine belt fasteners of metal; railway points; nozzles of metal; nickel silver; aluminium; bronze; aluminium wire; anchor plates; jets of metal; latch bars of metal; masts of metal; poles of metal; traps for wild animals; braces of metal for handling loads; anti-friction metal; tree protectors of metal; cashboxes [metal or non-metal]; silver solder; silver-plated tin alloys; reinforcing materials, of metal, for concrete; safes [metal or non-metal]; window stops of metal; door stops of metal; washers of metal; rings of metal; strap-hinges of metal; floor tiles of metal; barbed wire; bars for metal railings; beryllium [glucinium]; cattle chains; beak-irons; white metal; armour-plating of metal; box fasteners of metal; bolts of metal; bottles [containers] of metal for compressed gas or liquid air; identification bracelets of metal; iron slabs; brazing alloys; flanges of metal [collars]; bronzes for tombstones; bronzes [works of art]; telfer cables; rope thimbles of metal; cable joints of metal, non-electric; cadmium; padlocks of metal, other than electronic; shims; ferrules of metal for walking sticks; containers of metal for storing

acids; safety cashboxes; celtium [hafnium]; chains of metal; safety chains of metal; couplings of metal for chains; frames of metal for building; window pulleys of metal; ducts of metal, for central heating installations; horseshoe nails; chromium; chrome iron; chrome ores; cotter pins of metal; keys of metal; nails of metal; tacks of metal; wall plugs of metal; cobalt, raw; railway material of metal; pillars of metal for building; water-pipes of metal; sleeves [metal hardware]; preserve tins; containers of metal [storage, transport]; check rails of metal for railways; chill-moulds [foundry]; anvils; roof flashing of metal; elbows of metal for pipes; doors of metal; belt stretchers of metal; cramps of metal [crampons]; pot hooks of metal; window casement bolts; hooks [metal hardware]; iron-work for windows; wire of common metal; copper, unwrought or semi-wrought; copper rings; tubing of metal; containers of metal for compressed gas or liquid air; door scrapers; drain pipes of metal; iron, unwrought or semi-wrought; fish plates [rails]; screws of metal; tinplate packings; letter boxes of metal; spurs; brackets of metal for building; staircases of metal; window fasteners of metal; pipes of metal; rails of metal; fittings of metal for windows; iron strip; iron wire; cast iron, unwrought or semi-wrought; iron ores; door closers of metal, non-electric; molybdenum iron; silicon iron; titanium iron; tungsten iron; fittings of metal for building; pins [metal hardware]; eye bolts; locks of metal, other than electric; galena [ore]; lead seals; germanium; weather- or wind-vanes of metal; crampons [climbing irons]; ice moulds of metal; grease nipples; gratings of metal; spring locks; indium; badges of metal for vehicles; jalousies of metal; brass, unwrought or semi-wrought; outdoor blinds of metal; rocket launching platforms of metal; laths of metal; filings of metal; stringers [parts of staircases] of metal; limonite; ingots of common metal; lintels of metal; bed casters of metal; latches of metal; blooms [metallurgy]; magnesium; buildings, transportable, of metal; ferrules of metal for handles; pipe muffs of metal; manganese; handling pallets of metal; transport pallets of metal; steps [ladders] of metal; porches [structures] of metal; door knockers of metal; handcuffs; common metals, unwrought or semi-wrought; ores of metal; wire cloth; pyrophoric metals; furniture casters of metal; sheet piles of metal; molybdenum; monuments of metal; vice claws of metal; wall claddings of metal for building; nickel; niobium; flashing of metal for building; house numbers of metal, non-luminous; shutters of metal; palings of metal; baskets of metal; signalling panels, non-luminous and non-mechanical, of metal; wall linings of metal for building; clothes hooks of metal; skating rinks [structures] of metal; lock bolts; posts of metal; springs [metal hardware]; pulleys of metal, other than for machines; tent pegs of metal; ceilings of metal; floors of metal; linings of metal for building; turntables [railways]; roofing tiles of metal; lead, unwrought or semi-wrought; diving boards of metal; door handles of metal; rivets

of metal; gates of metal; door panels of metal; door bolts of metal; split rings of common metal for keys; telegraph posts of metal; zinc; beams of metal; joists of metal; platforms, prefabricated, of metal; ironmongery; road signs, non-luminous and non-mechanical, of metal; junctions of metal for pipes; wire stretchers [tension links]; packaging containers of metal; tanks of metal; signs, non-luminous and non-mechanical, of metal; greenhouses of metal, transportable; locks of metal for vehicles; stops of metal; bells for animals; bells; soldering wire of metal; valves of metal, other than parts of machines; statues of common metal; railway sleepers of metal; tantalum [metal]; bolts, flat; anvils [portable]; tension links; titanium; roofing of metal; tombac; tombs of metal; turnstiles of metal; latticework of metal; tungsten; pipework of metal; vanadium; ferrules of metal; aviaries [structures] of metal; zirconium; balls of steel; steel buildings; fittings of metal for compressed air lines; wire of common metal alloys, except fuse wire; alloys of common metal; aluminium foil; mooring bollards of metal; floating docks of metal, for mooring boats; anchors; wainscotting of metal; reinforcing materials of metal for pipes; reinforcing materials of metal for building; reinforcing materials of metal for machine belts; works of art of common metal; troughs of metal for mixing mortar; bird baths [structures] of metal; beacons of metal, non-luminous; stretchers for iron bands [tension links]; bands of metal for tying-up purposes; thread of metal for tying-up purposes; barrels of metal; barrel hoops of metal; casks of metal; swimming pools [structures] of metal; building materials of metal; shuttering of metal for concrete; bicycle parking installations of metal; paving blocks of metal; boxes of common metal; plugs of metal; sealing caps of metal; bottle caps of metal; bottle closures of metal; knobs of metal; rods of metal for brazing; rods of metal for brazing and welding; rods of metal for welding; straps of metal for handling loads; slings of metal for handling loads; busts of common metal; cabanas of metal; paint spraying booths of metal; cables of metal, non-electric; collars of metal for fastening pipes; clips of metal for cables and pipes; binding screws of metal for cables; window frames of metal; greenhouse frames of metal; duckboards of metal; chimney cowls of metal; binding thread of metal for agricultural purposes; door openers of metal, non-electric; tiles of metal for building; tile floorings of metal; burial vaults of metal; fittings of metal for coffins; loading pallets of metal; loading gauge rods of metal for railway wagons; hinges of metal; framework of metal for building; door frames of metal; materials of metal for funicular railway permanent ways; chimney pots of metal; roof gutters of metal; drain traps [valves] of metal; partitions of metal; casings of metal for oil-wells; containers of metal for liquid fuel; buildings of metal; floating containers of metal; ropes of metal; cornices of metal; mouldings of metal for cornices; angle irons of metal; windows of metal; ironwork for

doors; runners of metal for sliding doors; manhole covers of metal; roof coverings of metal; hooks of metal for roofing slates; hooks of metal for clothes rails; copper wire, not insulated; vats of metal; stair treads [steps] of metal; gutter pipes of metal; reels of metal, non-mechanical, for flexible hoses; towel dispensers of metal; water-pipe valves of metal; scaffolding of metal; ladders of metal; mobile boarding stairs of metal for passengers; bindings of metal; nuts of metal; posts of metal for power lines; branching pipes of metal; enclosures of metal for tombs; fences of metal; signboards of metal; props of metal; tin; tinplate; tin-foil; sheets and plates of metal; locks of metal for bags; fittings of metal for furniture; building panels of metal; figurines of common metal; stretchers for metal bands [tension links]; foundry moulds of metal; grave slabs of metal; monuments of metal for tombs; tombstone plaques of metal; tombstone stelae of metal; memorial plates of metal; furnace fireguards of metal; cask stands of metal; fittings of metal for beds; door fittings of metal; closures of metal for containers; sheaf binders of metal; crash barriers of metal for roads; chests of metal; nameplates of metal; registration plates of metal; cermets; taps of metal for casks; advertisement columns of metal; mooring buoys of metal; chimneys of metal; chimney shafts of metal; ducts of metal for ventilating and air-conditioning installations; foils of metal for wrapping and packaging; gold solder; hoppers of metal, non-mechanical; letters and numerals of common metal, except type; manifolds of metal for pipelines; penstock pipes of metal; telephone booths of metal; tool boxes of metal, empty; tool chests of metal, empty; chicken-houses of metal; wheel clamps [boots]; wire rope; insect screens of metal; pitons of metal; firedogs [an-dirons]; wind-driven bird-repelling devices made of metal; metal cages for wild animals; metals in powder form; refractory construction materials of metal; arbours [structures] of metal; stables of metal; pigsties of metal; prefabricated houses [ready-to-assemble] of metal; trays of metal; street gutters of metal; screw tops of metal for bottles; window openers of metal, non-electric; window closers of metal, non-electric; wall tiles of metal; paving slabs of metal; slabs of metal for building; step stools of metal; roofing of metal, incorporating photovoltaic cells; armoured doors of metal; bathtub grab bars of metal; dispensers of metal for dog waste bags; metals in foil or powder form for 3D printers; sash fasteners of metal for windows; door fasteners of metal; pantiles of metal; balustrades of metal; cladding of metal for building; hot-rolled steel bars; bright steel bars; peeled metal bars; drawn and polished metal bars; bag hangers of metal; brackets of metal for furniture; labels of metal; jerry-cans of metal; stakes of metal for plants or trees; flag-poles [structures] of metal; clips of metal for sealing bags; shoe pegs of metal; shoe dowels of metal; safes, electronic; folding doors of metal; mouldings of metal for building; fireplace mantles of metal; metal ramps

for use with vehicles; crucifixes of common metal, other than jewellery; swing doors of metal; oil drainage containers of metal; hand-held flagpoles of metal; stoppers of metal; accordion doors of metal; fireplace grates of metal; soundproof booths, transportable, of metal; acoustic panels of metal; horticultural frames of metal; casement windows of metal; hoop steel; steel tubes; railway switches; tie plates; harness of metal for handling loads; strongboxes [metal or non-metal]; stop collars of metal; glucinium [beryllium]; bick-irons; armor-plating of metal; monuments of bronze for tombs; cable linkages of metal, non-electric; hafnium [celtium]; sash pulleys of metal; pins [pegs] of metal; brads of metal; tin cans; guard rails of metal for railways; chill-molds [foundry]; crampons of metal [cramps]; tubes of metal; hoop iron; door springs of metal, non-electric; ferrotitanium; screw rings; wind vanes of metal; grilles of metal; wire gauze; pilings of metal; girders of metal; hardware of metal, small; reservoirs of metal; railroad ties of metal; trellis of metal; wrapping or binding bands of metal; construction materials of metal; bungs of metal; bottle fasteners of metal; belts of metal for handling loads; booths of metal for spraying paint; door casings of metal; moldings of metal for cornices; poles of metal for power lines; statuettes of common metal; foundry molds of metal; tomb slabs of metal; memorial plaques of metal; bins of metal; identity plates of metal; numberplates of metal; faucets of metal for casks; telephone boxes of metal; armored doors of metal; moldings of metal for building; crucifixes of common metal, other than jewelry; cold frames of metal.

7 – Shaft couplings [machines]; acetylene cleaning apparatus; converters for steelworks; tape dispensing machines for industrial use; aerating pumps for aquaria; aerocondensers; agitators; agricultural machines; agricultural elevators; filters for cleaning cooling air, for engines; air condensers; apparatus for drawing up beer under pressure; steamrollers; carburetter feeders; igniting devices for internal combustion engines; alternators; valves [parts of machines]; axles for machines; crank shafts; transmission shafts, other than for land vehicles; passenger lifts; elevators [machines]; mixing machines; self-oiling bearings; ploughs; aeroplane engines; whitewashing machines; grease rings [parts of machines]; piston segments; dynamo brushes; road sweeping machines, self-propelled; saw benches [parts of machines]; belts for conveyors; belt conveyors; churns; drums [parts of machines]; housings [parts of machines]; stands for machines; mills [machines]; threshing machines; beating machines; concrete mixers [machines]; butter machines; bicycle dynamos; connecting rods for machines, motors and engines; ball-bearings; bitumen making machines; harvesting machines; sheaf-binding machines; bobbins for weaving looms; woodworking machines; apparatus for aerating beverages; binding apparatus for hay; mud catchers and collectors [machines]; glow plugs for Diesel engines; threading machines; rinsing

machines; bottle filling machines; bottle washing machines; brewing machines; tambours for embroidery machines; brushes [parts of machines]; bulldozers; shovels, mechanical; mortising machines; capstans; automatic grapnels for marine purposes; belts for machines; cowlings [parts of machines]; type-setting machines [printing]; injectors for engines; carburetters; card clothing [parts of carding machines]; knives being parts of machines; boxes for matrices [printing]; cinder sifters [machines]; cream/milk separators; spin dryers [not heated]; lubricators [parts of machines]; centrifugal machines; centrifugal mills; centrifugal pumps; grain husking machines; milling machines; bearing brackets for machines; hangers [parts of machines]; carbon brushes [electricity]; coal-cutting machines; hoists; loading ramps; sliders for knitting machines; lathes [machine tools]; pulleys; ploughshares; fittings for engine boilers; wine presses; cigarette machines for industrial purposes; bending machines; shears, electric; scissors, electric; chisels for machines; clack valves [parts of machines]; filter presses; scale collectors for machine boilers; pedal drives for sewing machines; type-setting machines [photocomposition]; compressors [machines]; turbocompressors; steam condensers [parts of machines]; condensing installations; pulleys [parts of machines]; joints [parts of engines]; cord making machines; typecasting machines; clippers [machines]; cutters [machines]; current generators; drilling heads [parts of machines]; dynamo belts; stitching machines; air cushion devices for moving loads; bearings [parts of machines]; knives, electric; rack and pinion jacks; sifting installations; jacks [machines]; leather-working machines; cylinder heads for engines; cultivators [machines]; cylinders for machines; printing cylinders; rolling mill cylinders; sorting machines for industry; hoppers [mechanical discharging]; cutting machines; de-aerators for feedwater; turf removing ploughs; degreasers [machines]; starters for motors and engines; lace making machines; steam/oil separators; disintegrators; pressure reducers [parts of machines]; reeling apparatus, mechanical; leather paring machines; drainage machines; trimming machines; dynamos; sewage pulverizers; machines for the mineralization of drinking water; water heaters being parts of machines; fleshing machines; die-cutting and tapping machines; stalk separators [machines]; grain separators; ejectors; electricity generators; elevating apparatus; swaging machines; clutches, other than for land vehicles; inking apparatus for printing machines; feeders [parts of machines]; wrapping machines; moving staircases [escalators]; pumps [parts of machines, engines or motors]; stamping machines; die-stamping machines; labellers [machines]; metal drawing machines; excavators; haulage apparatus [mining]; tedding machines; sieves [machines or parts of machines]; knives for mowing machines; spinning machines; spinning wheels; filtering machines; finishing machines; chucks [parts of machines]; fodder presses; foundry machines; pistons

for cylinders; blowing machines for the compression, exhaustion and transport of gases; lawnmowers [machines]; tarring machines; blowing machines for the compression, sucking and carrying of grain; grease boxes [parts of machines]; lubricating pumps; embossing machines; engraving machines; notchers [machine tools]; guides for machines; straw [chaff] cutters; meat choppers, electric; gears for weaving looms; harrows; pulverisers [machines]; hydraulic turbines; printing machines for use on sheet metal; printing plates; printing machines; printing presses; printing rollers for machines; dairy machines; chaff cutter blades; loom shafts; blade sharpening [stropping] machines; saw blades [parts of machines]; blade holders [parts of machines]; rolling mills; thermic lances [machines]; cranks [parts of machines]; dishwashers; washing apparatus; washing machines [laundry]; washing installations for vehicles; coin-operated washing machines; lifting apparatus; wringing machines for laundry; smoothing presses; driving motors, other than for land vehicles; steam engines; machine tools; igniting magnetos; handling apparatus for loading and unloading; paper feeders [printing]; hammers [parts of machines]; power hammers; pneumatic hammers; tilt hammers; derricks; propulsion mechanisms, other than for land vehicles; transmission mechanisms, other than for land vehicles; regulators [parts of machines]; tobacco processing machines; crushers for kitchen use, electric; pump diaphragms; metalworking machines; looms [machines]; spinning frames; millstones; grinding machines; mine borers; ore treating machines; flour mill machines; mixers [machines]; reapers; reapers and binders; reapers and threshers; railway wagon lifts; jet engines, other than for land vehicles; anti-pollution devices for motors and engines; pistons for engines; speed governors for machines, engines and motors; moulds [parts of machines]; mills for household purposes, other than hand-operated; moulding machines; freewheels, other than for land vehicles; shuttles [parts of machines]; machines and apparatus for cleaning, electric; suction machines for industrial purposes; hemming machines; hand-held tools, other than hand-operated; tools [parts of machines]; holding devices for machine tools; tin openers, electric; bread cutting machines; journal boxes [parts of machines]; bearings for transmission shafts; papermaking machines; calenders; packing machines; kneading machines; pasta making machines, electric; painting machines; spray guns for paint; drilling machines; electric hand drills; stone-working machines; pistons [parts of machines or engines]; typographic presses; pneumatic transporters; punches for punching machines; punching machines; pepper mills, other than hand-operated; machines and apparatus for polishing [electric]; pumps [machines]; air pumps [garage installations]; pumps for heating installations; vacuum pumps [machines]; roller bridges; adhesive bands for pulleys; beverage preparation machines, electromechanical; presses [machines for industrial pur-

poses]; pressure regulators [parts of machines]; pressure valves [parts of machines]; puddling machines; steam traps; planing machines; rail-laying machines; rakes for raking machines; raking machines; friezing machines; trueing machines; bookbinding apparatus and machines for industrial purposes; ironing machines; darning machines; springs [parts of machines]; curtain drawing devices, electrically operated; riveting machines; taps [parts of machines, engines or motors]; rotary printing presses; machine wheelwork; machine wheels; machine fly-wheels; roller bearings; ball rings for bearings; road making machines; saws [machines]; mineworking machines; belts for motors and engines; weeding machines; satinizing machines; sausage making machines; sealing machines for industrial purposes; sowers [machines]; welding machines, electric; bellows [parts of machines]; forge blowers; lasts for shoes [parts of machines]; filling machines; stators [parts of machines]; stereotype machines; machines for the production of sugar; superchargers; tables for machines; aprons [parts of machines]; dyeing machines; carding machines; slide rests [parts of machines]; journals [parts of machines]; milking machines; suction cups for milking machines; transmissions for machines; pneumatic tube conveyors; conveyors [machines]; braiding machines; winches; knitting machines; turbines, other than for land vehicles; reels, mechanical, for flexible hoses; tympan [parts of printing presses]; typographic machines; winnowers; engines for air cushion vehicles; fans for motors and engines; glass-working machines; railroad constructing machines; vulcanization apparatus; couplings, other than for land vehicles; aeronautical engines; sharpening machines; agricultural implements, other than hand-operated; grindstones [parts of machines]; beer pumps; compressed air engines; compressed air machines; compressed air pumps; sparking plugs for internal combustion engines; shock absorber plungers [parts of machines]; anti-friction bearings for machines; diggers [machines]; air suction machines; fuel economisers for motors and engines; engines for boats; motors for boats; beaters, electric; rams [machines]; brake linings, other than for vehicles; brake shoes, other than for vehicles; brake segments, other than for vehicles; reels [parts of machines]; gear boxes, other than for land vehicles; bottle stoppering machines; bottle capping machines; bottle sealing machines; brushes, electrically operated [parts of machines]; waste disposal units; coffee grinders, other than hand-operated; flues for engine boilers; earth moving machines; waste compacting machines; shredders [machines] for industrial use; potters' wheels; handling machines, automatic [manipulators]; industrial robots; food preparation machines, electromechanical; cartridges for filtering machines; drive chains, other than for land vehicles; torque converters, other than for land vehicles; transmission chains, other than for land vehicles; drill chucks [parts of machines]; steam engine boilers; feeding apparatus for engine boilers; shearing machines

for animals; motors, other than for land vehicles; control cables for machines, engines or motors; control mechanisms for machines, engines or motors; matrices for use in printing; compressors for refrigerators; water separators; sewing machines; fan belts for motors and engines; incubators for eggs; gears, other than for land vehicles; blenders, electric, for household purposes; kitchen machines, electric; cylinders for motors and engines; reduction gears, other than for land vehicles; dividing machines; drilling bits [parts of machines]; heat exchangers [parts of machines]; exhausts for motors and engines; motors, electric, other than for land vehicles; cranes [lifting and hoisting apparatus]; peeling machines; grating machines for vegetables; compressed air guns for the extrusion of mastics; filters being parts of machines or engines; ditchers [ploughs]; whisks, electric, for household purposes; fruit presses, electric, for household purposes; hydraulic engines and motors; drilling rigs, floating or non-floating; fuel conversion apparatus for internal combustion engines; radiators [cooling] for motors and engines; boiler tubes [parts of machines]; hydraulic controls for machines, motors and engines; pneumatic controls for machines, motors and engines; crankcases for machines, motors and engines; food processors, electric; glue guns, electric; guns [tools using explosive cartridges]; net hauling machines [fishing]; universal joints [Cardan joints]; rotary steam presses, portable, for fabrics; machines and apparatus for carpet shampooing, electric; catalytic converters; central vacuum cleaning installations; chain saws; cleaning appliances utilizing steam; cutting blow pipes, gas-operated; dust exhausting installations for cleaning purposes; dust removing installations for cleaning purposes; electric hammers; electromechanical machines for chemical industry; elevator chains [parts of machines]; emergency power generators; expansion tanks [parts of machines]; glaziers' diamonds [parts of machines]; high pressure washers; machines for the textile industry; exhaust manifold for engines; oil refining machines; packaging machines; parquet wax-polishers, electric; shoe polishers, electric; snow ploughs; soldering apparatus, gas-operated; soldering blow pipes, gas-operated; soldering irons, gas-operated; vacuum cleaner attachments for disseminating perfumes and disinfectants; vacuum cleaner hoses; vacuum cleaners; vibrators [machines] for industrial use; machines and apparatus for wax-polishing, electric; racket stringing machines; bicycle assembling machines; motorized cultivators; air brushes for applying colour; door openers, hydraulic; kick starters for motorcycles; mechanized livestock feeders; moving walkways; mufflers for motors and engines; door openers, pneumatic; vacuum cleaner bags; gas-operated blow torches; wind turbines; brake pads, other than for vehicles; electrodes for welding machines; electric welding apparatus; soldering apparatus, electric; soldering irons, electric; electric arc welding apparatus; electric arc cutting apparatus; soldering lamps; basket

presses; blowing machines; electroplating machines; galvanizing machines; vending machines; door closers, electric; door openers, electric; passenger lift operating apparatus; electrical apparatus for sealing plastics [packaging]; fuel dispensing pumps for service stations; self-regulating fuel pumps; machines for processing plastics; window openers, electric; window closers, electric; window openers, hydraulic; window closers, hydraulic; window openers, pneumatic; window closers, pneumatic; door closers, hydraulic; door closers, pneumatic; kitchen grinders, electric; pneumatic jacks; 3D printers; sifting machines; engine mounts, other than for land vehicles; nail extractors, electric; brushes for vacuum cleaners; ski edge sharpening tools, electric; crushing machines; rammers [machines]; suction nozzles for vacuum cleaners; pigs for cleaning pipes; juice extractors, electric; screwdrivers, electric; joysticks being parts of machines, other than for game machines; camshafts for vehicle engines; rubber tracks being parts of crawlers on construction machines; rubber tracks being parts of crawlers on loading-unloading machines and apparatus; rubber tracks being parts of crawlers on agricultural machines; rubber tracks being parts of crawlers on mining machines; rubber tracks being parts of crawlers on snow ploughs; pneumatic waste oil drainers; pumps for counter-current swimming; 3D printing pens; tilling machines for agricultural purposes; vegetable spiralizers, electric; hydrogen dispensing pumps for service stations; industrial inkjet printing machines; steam mops; robotic exoskeleton suits, other than for medical purposes; mobile cranes; floating production, storage and offloading [FPSO] units; cheese slicers, electric; vegetable peelers, electric; road rollers; passenger elevators; colour-washing machines; piston rings; mowing and reaping machines; reels for weaving looms; trussing apparatus for hay; paring machines; hoods [parts of machines]; spin driers [not heated]; centrifuges [machines]; corn and grain husking machines; slides for knitting machines; sealing joints [parts of engines]; apparatus for machining; sewage pulverisers; machines for the mineralisation of drinking water; nut-tapping machines; escalators; extractors for mines; chaff cutters; meat mincers, electric; spraying machines; stropping machines; vehicle washing installations; molds [parts of machines]; molding machines; can openers, electric; mangles; faucets [parts of machines, engines or motors]; road building machines; shoe lasts [parts of machines]; carriage aprons; teat cups for milking machines; tube conveyors, pneumatic; sharpening wheels [parts of machines]; plunger pistons; anti-friction pads for machines; garbage disposal units; trash compacting machines; hair cutting machines for animals; engines, other than for land vehicles; drain cocks; welding apparatus, gas-operated; moving sidewalks; silencers for motors and engines; passenger elevator operating apparatus; nail pullers, electric.

8 – Abrading instruments [hand instruments]; sharpening stones; needle files; leather strops; awls; cutter bars [hand tools]; reamers; reamer sockets; extension pieces for braces for screw taps; palette knives; spatulas [hand tools]; punch rings [knuckle dusters]; bits [parts of hand tools]; squares [hand tools]; instruments and tools for skinning animals; annular screw plates; bow saws; side arms, other than firearms; nail extractors, hand-operated; lifting jacks, hand-operated; bayonets; beard clippers; hand drills, hand-operated; mortise chisels; holing axes; livestock marking tools; cattle shearers; nail drawers [hand tools]; pick-hammers; sharpening steels; riveting hammers [hand tools]; paring irons [hand tools]; scissors; tweezers; graving tools [hand tools]; pickaxes; caulking irons; penknives; stone hammers; jig-saws; drawing knives; nail punches; fullers [hand tools]; fulling tools [hand tools]; hunting knives; frames for handsaws; saws [hand tools]; lasts [shoemakers' hand tools]; curling tongs; table cutlery [knives, forks and spoons]; shears; shear blades; perforating tools [hand tools]; tap wrenches; spanners [hand tools]; ratchets [hand tools]; dies [hand tools]; borers; whetstone holders; axes; table forks; planes; hand tools, hand-operated; vegetable slicers, hand-operated; nail nippers; tube cutters [hand tools]; cleavers; cutlery; fruit pickers [hand tools]; spoons; ladles [hand tools]; razor strops; earth rammers [hand tools]; stamping-out tools [hand tools]; milling cutters [hand tools]; trowels [gardening]; trowels; apparatus for destroying plant parasites, hand-operated; glaziers' diamonds [parts of hand tools]; expanders [hand tools]; stropping instruments; sharpening instruments; blade sharpening instruments; scaling knives; thistle extractors [hand tools]; pruning scissors; budding knives; tree pruners; cuticle tweezers; hair-removing tweezers; marline spikes; carpenters' augers; embossers [hand tools]; pedicure sets; razor cases; hollowing bits [parts of hand tools]; rakes [hand tools]; shovels [hand tools]; spades [hand tools]; border shears; scythes; scythe rings; scythe stones; irons [non-electric hand tools]; goffering irons; polishing irons [glazing tools]; blades for planes; moulding irons; crimping irons; branding irons; gimlets [hand tools]; sword scabbards; hand implements for hair curling; lawn clippers [hand instruments]; ice picks; gouges [hand tools]; truncheons; engraving needles; farriers' knives; paring knives; grafting tools [hand tools]; rabbeting planes; vegetable choppers; hatchets; hoop cutters [hand tools]; harpoons; adzes [tools]; mattocks; oyster openers; insecticide vaporizers [hand tools]; garden tools, hand-operated; pruning knives; clamps for carpenters or coopers; razor blades; blades [hand tools]; blades [weapons]; saw blades [parts of hand tools]; levers; machetes; mallets [hand instruments]; hammers [hand tools]; sledge-hammers; masons' hammers; chisels; metal band stretchers [hand tools]; braiders [hand tools]; money scoops; mortars for pounding [hand tools]; wick trimmers [scissors]; shaving cases; numbering punches; nail fi-

les; tin openers, non-electric; picks [hand tools]; rammers [hand tools]; guns [hand tools]; centre punches [hand tools]; foundry ladles [hand tools]; plane irons; rasps [hand tools]; razors, electric or non-electric; pin punches; fire irons; riveters [hand tools]; hainault scythes; hoes [hand tools]; saw holders; hackles [hand tools]; bill-hooks; sickles; implements for decanting liquids [hand tools]; edge tools [hand tools]; taps [hand tools]; augers [hand tools]; screwdrivers, non-electric; priming irons [hand tools]; bits [hand tools]; tube cutting instruments; breast drills; agricultural implements, hand-operated; grindstones [hand tools]; syringes for spraying insecticides; silver plate [knives, forks and spoons]; diggers [hand tools]; knives; pliers; pincers; swords; sabres; rams [hand tools]; instruments for punching tickets; nail files, electric; fingernail polishers, electric or non-electric; drill holders [hand tools]; hair clippers for personal use, electric and non-electric; agricultural forks [hand tools]; nail clippers, electric or non-electric; hair clippers for animals [hand instruments]; shearers [hand instruments]; clothes irons; emery grinding wheels; files [tools]; punch pliers [hand tools]; punches [hand tools]; cutting tools [hand tools]; manicure sets; guns, hand-operated, for the extrusion of mastics; ditchers [hand tools]; scrapers [hand tools]; scraping tools [hand tools]; ear-piercing apparatus; depilation appliances, electric and non-electric; manicure sets, electric; vices; hand pumps; daggers; tool belts [holders]; cheese slicers, non-electric; pizza cutters, non-electric; crow bars; egg slicers, non-electric; eyelash curlers; mitre boxes [hand tools]; sand trap rakes; fireplace bellows [hand tools]; apparatus for tattooing; emery files; fish tapes [hand tools]; wire strippers [hand tools]; bench vices [hand implements]; non-electric caulking guns; metal wire stretchers [hand tools]; hobby knives [scalpels]; air pumps, hand-operated; ceramic knives; emery boards; ski edge sharpening tools, hand-operated; tattoo needles; spatulas for use by artists; sculptors' chisels; table knives, forks and spoons of plastic; table knives, forks and spoons for babies; scrapers for skis; handles for hand-operated hand tools; knife handles; scythe handles; vegetable spiralizers, hand-operated; vegetable peelers, hand-operated; box cutters; hair braiders, electric; stirring sticks for mixing paint; fruit segmenters; fruit corers; kitchen mandolines; meat claws; sterile body piercing instruments; laser hair removal apparatus, other than for medical purposes; emergency hammers; vegetable knives; carving forks; carving knives.

9 – Coils, electric; particle accelerators; reflective articles for wear, for the prevention of accidents; protection devices for personal use against accidents; clothing for protection against accidents, irradiation and fire; batteries, electric, for vehicles; battery jars; battery boxes; acidimeters for batteries; hydrometers; plates for batteries; whistle alarms; acoustic alarms; acoustic conduits; phonograph records; speaking tubes; actinometers; adding machines; aerometers; enla-

rging apparatus [photography]; electro-dynamic apparatus for the remote control of railway points; magnets; electromagnetic coils; air analysis apparatus; alarms; alcoholmeters; alidades; food analysis apparatus; igniting apparatus, electric, for igniting at a distance; ignition batteries; altimeters; asbestos gloves for protection against accidents; asbestos clothing for protection against fire; ammeters; amplifying tubes; anemometers; calibrating rings; fire extinguishers; anodes; anode batteries; aerials; visors for helmets; anti-interference devices [electricity]; transformers [electricity]; apertometers [optics]; money counting and sorting machines; distribution boxes [electricity]; surveying instruments; surveying chains; lenses for astrophotography; thermionic valves; audiovisual teaching apparatus; juke boxes, musical; mechanisms for coin-operated apparatus; mechanisms for counter-operated apparatus; calipers; comparators; fire alarms; automatic indicators of low pressure in vehicle tyres; protective suits for aviators; alarm bells, electric; rods for water diviners; life-saving rafts; scales; meteorological balloons; demagnetizing apparatus for magnetic tapes; tape recorders; magnetic tapes; barometers; weighing machines; weighbridges; fire beaters; chargers for electric accumulators; betatrons; ticket dispensing terminals, electronic; cabinets for loudspeakers; close-up lenses; terminals [electricity]; pressure indicator plugs for valves; galvanometers; push buttons for bells; branch boxes [electricity]; tone arms for record players; spirit levels; punched card machines for offices; sheaths for electric cables; frames for photographic transparencies; circular slide rules; slide-rules; calculating machines; slide calipers; jigs [measuring instruments]; blueprint apparatus; cinematographic cameras; capillary tubes for laboratory use; sound recording carriers; protective helmets; respiratory masks, not for medical purposes; solderers' helmets; spectacle chains; heat regulating apparatus; darkrooms [photography]; boiler control instruments; drying racks [photography]; apparatus for editing cinematographic film; printed circuits; flashing lights [luminous signals]; signal bells; containers for microscope slides; collectors, electric; electric installations for the remote control of industrial operations; switchboxes [electricity]; commutators; marine compasses; eyepieces; thread counters; pedometers; counters; metronomes; condensers [capacitors]; conductors, electric; electricity conduits; circuit closers; connectors [electricity]; junction boxes [electricity]; switchboards; contacts, electric; apparatus to check franking; regulating apparatus, electric; monitoring apparatus, other than for medical purposes; speed checking apparatus for vehicles; converters, electric; photocopiers [photographic, electrostatic, thermic]; spectacle cords; retorts; retorts' stands; correcting lenses [optics]; objectives [lenses] [optics]; cosmographic instruments; diving suits; electric apparatus for commutation; switches, electric; limiters [electricity]; electric plugs; current rectifiers; cell switches [electricity]; dressmakers'

measures; crucibles [laboratory]; appliances for measuring the thickness of leather; cyclotrons; counterfeit coin detectors; shutter releases [photography]; densimeters; animated cartoons; laboratory trays; metal detectors for industrial or military purposes; sonars; detectors; shutters [photography]; diaphragms [acoustics]; centering apparatus for photographic transparencies; cameras [photography]; transparencies [photography]; slide projectors; distance measuring apparatus; dictating machines; diffraction apparatus [microscopy]; loudspeakers; circuit breakers; record players; microscopes; distance recording apparatus; range finders; distribution boards [electricity]; distribution consoles [electricity]; compasses for measuring; measures; measuring apparatus; dynamometers; water level indicators; fire escapes; flash-bulbs [photography]; telephone receivers; fluorescent screens; projection screens; protective face shields for workers; screens [photography]; drainers for use in photography; electric loss indicators; measuring devices, electric; cables, electric; ducts [electricity]; control panels [electricity]; galvanic cells; connections for electric lines; couplings, electric; relays, electric; transmitters of electronic signals; transmitting sets [telecommunication]; cleaning apparatus for phonograph records; sound recording strips; mileage recorders for vehicles; spools [photography]; mechanical signs; epidiascopes; test tubes; balancing apparatus; thermostats; ergometers; material testing instruments and machines; egg-candlers; petrol gauges; spark-guards; cases especially made for photographic apparatus and instruments; testing apparatus not for medical purposes; refractometers; exposure meters [light meters]; invoicing machines; fermentation apparatus for laboratory use; railway traffic safety appliances; wires, electric; magnetic wires; plumb bobs; plumb lines; nets for protection against accidents; safety nets; safety tarpaulins; film cutting apparatus; filters for respiratory masks, not for medical purposes; filters for use in photography; battery chargers; high-frequency apparatus; frequency meters; fuses; radios; galena crystals [detectors]; galvanic batteries; gloves for protection against accidents; gloves for divers; gloves for protection against X-rays for industrial purposes; gas testing instruments; gasometers [measuring instruments]; surveying apparatus and instruments; levelling staffs [surveying instruments]; drying apparatus for photographic prints; glazing apparatus for photographic prints; rulers [measuring instruments]; measuring glassware; screens for photoengraving; grids for batteries; clothing for protection against fire; audio- and video-receivers; heliographic apparatus; holograms; hygrometers; identification threads for electric wires; identification sheaths for electric wires; fire hose nozzles; fire engines; fire pumps; slope indicators; taximeters; quantity indicators; vacuum gauges; speed indicators; armatures [electricity]; data processing apparatus; mirrors for inspecting work; intercommunication apparatus; carriers for dark plates [photography]; inverters

[electricity]; ionization apparatus not for the treatment of air or water; peepholes [magnifying lenses] for doors; hemline markers; furniture especially made for laboratories; lactodensimeters; lactometers; darkroom lamps [photography]; optical lanterns; magic lanterns; signal lanterns; lasers, not for medical purposes; optical lenses; letter scales; logs [measuring instruments]; sounding lines; magnifying glasses [optics]; signs, luminous; neon signs; spectacles; surveyors' levels; spectacle lenses; eyewear; pressure gauges; periscopes; mathematical instruments; coin-operated mechanisms for television sets; megaphones; computer memory devices; carpenters' rules; mercury levels; speed measuring apparatus [photography]; precision measuring apparatus; measuring instruments; meteorological instruments; rules [measuring instruments]; micrometer screws for optical instruments; microphones; microtomes; time switches, automatic; mirrors [optics]; breathing apparatus for underwater swimming; nautical apparatus and instruments; naval signalling apparatus; navigational instruments; spectacle frames; batteries, electric; accumulators, electric; levels [instruments for determining the horizontal]; levelling instruments; prisms [optics]; observation instruments; octants; ohmmeters; wavemeters; optical apparatus and instruments; optical glass; computers; computer programs, recorded; oscillographs; oxygen transvasing apparatus; micrometers; signalling panels, luminous or mechanical; lightning conductors; parking meters; apparatus and instruments for astronomy; apparatus for measuring the thickness of skins; acid hydrometers; weighing apparatus and instruments; salinometers; washing trays [photography]; stands for photographic apparatus; viewfinders, photographic; photometers; phototelegraphy apparatus; apparatus and instruments for physics; steering apparatus, automatic, for vehicles; pince-nez; laboratory pipettes; plane tables [surveying instruments]; planimeters; ear plugs for divers; bells [warning devices]; weights; polarimeters; radiotelephony sets; radiotelegraphy sets; pressure measuring apparatus; pressure indicators; projection apparatus; cathodic anti-corrosion apparatus; teeth protectors; pyrometers; radar apparatus; vehicle radios; radiological apparatus for industrial purposes; protractors [measuring instruments]; apparatus and installations for the production of X-rays, not for medical purposes; X-ray tubes not for medical purposes; protection devices against X-rays, not for medical purposes; telephone apparatus; refractors; X-ray apparatus not for medical purposes; spectrosopes; resistances, electric; thermometers, not for medical purposes; respirators for filtering air, not for medical purposes; breathing apparatus, not for medical purposes; rheostats; balances [steelyards]; signals, luminous or mechanical; saccharometers; probes for scientific purposes; satellites for scientific purposes; diaphragms for scientific apparatus; teaching apparatus; choking coils [impedance]; wire connectors [electricity]; locks, electric; sextants; signalling whistles; vehicle break-

down warning triangles; electro-dynamic apparatus for the remote control of signals; simulators for the steering and control of vehicles; sirens; sound transmitting apparatus; sound recording apparatus; sound reproduction apparatus; sounding apparatus and machines; sounding leads; sound locating instruments; spectrograph apparatus; spherometers; stereoscopes; stereoscopic apparatus; needles for record players; sulfimeters; teleprinters; tachometers; screw-tapping gauges; telegraphs [apparatus]; television apparatus; telegraph wires; remote control apparatus; masts for wireless aerials; teleprompters; telephone transmitters; telerupters; binoculars; telescopes; temperature indicators; time recording apparatus; theodolites; thermostats for vehicles; totalizers; revolution counters; speed regulators for record players; transmitters [telecommunication]; precision balances; marking gauges [joinery]; vacuum tubes [radio]; urinometers; variometers; verniers; videotapes; viscosimeters; theft prevention installations, electric; voltage regulators for vehicles; voting machines; voltmeters; apparatus for changing record player needles; stills for laboratory experiments; fuse wire; anticathodes; dog whistles; sighting telescopes for firearms; anti-theft warning apparatus; azimuth instruments; beacons, luminous; holders for electric coils; films, exposed; road signs, luminous or mechanical; life buoys; signalling buoys; buzzers; directional compasses; fog signals, non-explosive; cash registers; radiology screens for industrial purposes; identity cards, magnetic; photovoltaic cells; densitometers, not for medical purposes; disks, magnetic; floppy disks; head cleaning tapes [recording]; video recorders; computer keyboards; integrated circuits; semiconductors; chips [integrated circuits]; cathodes; life jackets; life belts; chemistry apparatus and instruments; cinematographic film, exposed; materials for electricity mains [wires, cables]; contact lenses; containers for contact lenses; incubators for bacteria culture; solar batteries; copper wire, insulated; discharge tubes, electric, other than for lighting; diaphragms [photography]; distillation apparatus for scientific purposes; dosimeters; electric door bells; spectacle cases; furnaces for laboratory use; optical fibres [light conducting filaments]; telephone wires; X-ray films, exposed; filters for ultraviolet rays, for photography; horns for loudspeakers; tripods for cameras; bar code readers; bullet-proof vests; marking buoys; wafers for integrated circuits; chromatography apparatus for laboratory use; chronographs [time recording apparatus]; compact discs [audio-video]; compact discs [read-only memory]; computer operating programs, recorded; computer peripheral devices; computer software, recorded; optical condensers; acoustic couplers; couplers [data processing equipment]; decompression chambers; plotters; divers' masks; encoded magnetic cards; facsimile machines; fire boats; interfaces for computers; juke boxes for computers; knee-pads for workers; light dimmers [regulators], electric; magnetic data media; magnetic encoders; mag-

netic tape units for computers; microprocessors; modems; monitors [computer hardware]; monitors [computer programs]; mouse [computer peripheral]; optical character readers; optical data media; optical discs; printers for use with computers; processors [central processing units]; readers [data processing equipment]; safety restraints, other than for vehicle seats and sports equipment; scanners for data processing; smoke detectors; transistors [electronic]; X-ray photographs, other than for medical purposes; junction sleeves for electric cables; abacuses; electronic agendas; answering machines; camcorders; cassette players; compact disc players; diagnostic apparatus, not for medical purposes; disk drives for computers; electrified rails for mounting spot lights; electronic pocket translators; electronic tags for goods; fire blankets; flashlights [photography]; integrated circuit cards [smart cards]; measuring spoons; notebook computers; electronic notice boards; pocket calculators; shoes for protection against accidents, irradiation and fire; sprinkler systems for fire protection; starter cables for motors; sunglasses; time clocks [time recording devices]; video cassettes; video game cartridges; video screens; video telephones; goggles for sports; nose clips for divers and swimmers; protective helmets for sports; electronic publications, downloadable; computer programs, downloadable; navigation apparatus for vehicles [on-board computers]; decorative magnets; cordless telephones; mouse pads; personal stereos; wrist rests for use with computers; coaxial cables; fibre optic cables; covers for electric outlets; marine depth finders; electrified fences; computer game software, recorded; headphones; lighting ballasts; radio pagers; satellite navigational apparatus; solenoid valves [electromagnetic switches]; voltage surge protectors; walkie-talkies; wind socks for indicating wind direction; light-emitting electronic pointers; resuscitation mannequins [teaching apparatus]; stage lighting regulators; egg timers [sandglasses]; DNA chips; DVD players; automated teller machines [ATM]; traffic-light apparatus [signalling devices]; hands-free kits for telephones; asbestos screens for firefighters; riding helmets; clothing especially made for laboratories; encoded identification bracelets, magnetic; transponders; downloadable ring tones for mobile phones; downloadable music files; downloadable image files; crash test dummies; laboratory centrifuges; printed circuit boards; USB flash drives; Global Positioning System [GPS] apparatus; portable media players; cell phone straps; light-emitting diodes [LED]; triodes; step-up transformers; laptop computers; fire hose; bags adapted for laptops; sleeves for laptops; digital photo frames; Petri dishes; Pitot tubes; stroboscopes; traffic cones; temperature indicator labels, not for medical purposes; computer software applications, downloadable; electronic book readers; smartphones; toner cartridges, unfilled, for printers and photocopiers; video baby monitors; lens hoods; tablet computers; encoded key cards; 3D spectacles;

memory cards for video game machines; bullet-proof clothing; accelerometers; electrical adapters; life-saving capsules for natural disasters; computer hardware; solar panels for the production of electricity; mobile telephones; telescopic sights for artillery; digital signs; wearable activity trackers; chargers for electronic cigarettes; connected bracelets [measuring instruments]; covers for smartphones; cases for smartphones; selfie sticks [hand-held monopods]; calorimeters; flowmeters; reflective safety vests; electronic collars to train animals; joysticks for use with computers, other than for video games; smartglasses; smartwatches; fire extinguishing apparatus; protective films adapted for computer screens; mouth guards for sports; head guards for sports; needles for surveying compasses; security tokens [encryption devices]; infrared detectors; covers for personal digital assistants [PDAs]; baby scales; electronic access control systems for interlocking doors; thermal imaging cameras; scales with body mass analysers; covers for tablet computers; black boxes [data recorders]; digital weather stations; charging stations for electric vehicles; interactive touchscreen terminals; smart rings; electric and electronic effects units for musical instruments; audio interfaces; equalizers [audio apparatus]; subwoofers; thermo-hygrometers; biochips; protective films adapted for smartphones; virtual reality headsets; electronic interactive whiteboards; humanoid robots with artificial intelligence for use in scientific research; audio mixers; batteries for electronic cigarettes; electronic key fobs being remote control apparatus; electronic sheet music, downloadable; T-squares for measuring; squares for measuring; square rulers for measuring; electronic numeric displays; laboratory robots; teaching robots; security surveillance robots; personal digital assistants [PDAs]; computer software platforms, recorded or downloadable; satellite finder meters; ring sizers; finger sizers; thin client computers; rearview cameras for vehicles; hand-held electronic dictionaries; resuscitation training simulators; electric wire harnesses for automobiles; snorkels; sports whistles; computer screen saver software, recorded or downloadable; selfie lenses; downloadable graphics for mobile phones; telecommunication apparatus in the form of jewellery; wearable computers; wearable video display monitors; magnetic resonance imaging [MRI] apparatus, not for medical purposes; rescue laser signalling flares; ink cartridges, unfilled, for printers and photocopiers; wah-wah pedals; height measuring instruments; hairdressing training heads [teaching apparatus]; devices for the projection of virtual keyboards; survival blankets; lifeboats; nanoparticle size analysers; ear pads for headphones; data gloves; trackballs [computer peripherals]; downloadable emoticons for mobile phones; telepresence robots; climate control digital thermostats; piezoelectric sensors; organic light-emitting diodes [OLED]; quantum dot light-emitting diodes [QLED]; droppers for measuring, other than for medical or household purposes; el-

electric sockets; computer game software, downloadable; stands adapted for laptops; headgear being protective helmets; padlocks, electronic; weight belts for divers; earpieces for remote communication; parking sensors for vehicles; ticket printers; body harnesses for support when lifting loads; animal signalling rattles for directing livestock; video projectors; downloadable cryptographic keys for receiving and spending crypto assets; downloadable e-wallets; credit card terminals; biometric passports; biometric identity cards; electronic pens for visual display units.

11 – Watering installations, automatic; heat accumulators; acetylene burners; acetylene generators; acetylene flares; ventilation hoods; lighting installations for air vehicles; hot air ovens; air deodorizing apparatus; air cooling apparatus; filters for air conditioning; air reheaters; air dryers; air-conditioning installations; air filtering installations; hot air apparatus; hot air bath fittings; friction lighters for igniting gas; gas lighters; light bulbs; light bulbs, electric; arc lamps; electric lamps; structural framework for ovens; refrigerating cabinets; lights for vehicles; headlights for automobiles; coolers for furnaces; bath tubs; bath tubs for sitz baths; Turkish bath cabinets, portable; bath fittings; heaters for baths; bath installations; lamps; lanterns for lighting; lamp mantles; incandescent burners; burners for lamps; bicycle lights; bidets; boilers, other than parts of machines; kilns; hydrants; radiator caps; electric torches; water heaters; bakers' ovens; anti-splash tap nozzles; roasting jacks; roasting spits; laboratory burners; flare stacks for use in the oil industry; burners; germicidal burners; laundry room boilers; toilets, portable; fans [air-conditioning]; coffee roasters; heating apparatus; taps for pipes and pipelines; heat regenerators; oven fittings made of fireclay; light bulbs for directional signals for vehicles; carbon for arc lamps; heating installations; flushing tanks; heating installations [water]; heating boilers; boiler pipes [tubes] for heating installations; air conditioners for vehicles; heating apparatus for solid, liquid or gaseous fuels; heaters for vehicles; heating apparatus, electric; central heating radiators; humidifiers for central heating radiators; heating elements; heaters for heating irons; footwarmers, electric or non-electric; footmuffs, electrically heated; plate warmers; immersion heaters; lamp glasses; lamp chimneys; chimney flues; chimney blowers; hair dryers; water distribution installations; drying apparatus; air-conditioning apparatus; glue-heating appliances; distillation columns; pipes [parts of sanitary installations]; water conduits installations; toilets [water-closets]; freezers; cooking utensils, electric; cooking stoves; cooking apparatus and installations; motorcycle lights; discharge tubes, electric, for lighting; defrosters for vehicles; disinfectant apparatus; desalination plants; desiccating apparatus; light diffusers; beverage cooling apparatus; distillation apparatus; showers; sockets for electric lights; water purification installations; water filtering apparatus; cooling installations for water; fountains; pressure wa-

ter tanks; water sterilizers; heat exchangers, other than parts of machines; lighting apparatus and installations; chandeliers; purification installations for sewage; ceiling lights; radiators, electric; gas scrubbing apparatus; drying apparatus for fodder and forage; evaporators; stoves [heating apparatus]; filaments for electric lamps; filters for drinking water; flaming torches; forges, portable; furnaces, other than for laboratory use; fittings, shaped, for furnaces; furnace grates; hearths; furnace ash boxes; refrigerating apparatus and machines; refrigerating chambers; refrigerating containers; curling lamps; fruit roasters; gas scrubbers [parts of gas installations]; gas burners; gas boilers; gas lamps; steam boilers, other than parts of machines; germicidal lamps for purifying air; ice machines and apparatus; cool boxes, electric; lamp globes; hot plates; bread toasters; roasting apparatus; incinerators; ionization apparatus for the treatment of air or water; ornamental fountains; laboratory lamps; milk cooling installations; pasteurisers; oil lamps; ultraviolet ray lamps, not for medical purposes; safety lamps; lamp reflectors; Chinese lanterns; wash-hand basins [parts of sanitary installations]; cooling installations for liquids; luminous tubes for lighting; magnesium filaments for lighting; malt roasters; miners' lamps; installations for processing nuclear fuel and nuclear moderating material; level controlling valves in tanks; lights, electric, for Christmas trees; luminous house numbers; oxyhydrogen burners; radiators [heating]; oil burners; vehicle headlights; heating plates; searchlights; polymerisation installations; kitchen ranges [ovens]; air valves for steam heating installations; water purifying apparatus and machines; air purifying apparatus and machines; refining towers for distillation; cooling installations and machines; cooking rings; vehicle reflectors; refrigerating appliances and installations; cooling appliances and installations; dampers [heating]; regulating accessories for water or gas apparatus and pipes; safety accessories for water or gas apparatus and pipes; taps; washers for water taps; rotisseries; sanitary apparatus and installations; drying apparatus and installations; hand drying apparatus for washrooms; coils [parts of distilling, heating or cooling installations]; fans [parts of air-conditioning installations]; sterilizers; cooling installations for tobacco; tobacco roasters; lighting apparatus for vehicles; roasters; ash conveyor installations, automatic; steam generating installations; ventilation [air-conditioning] installations and apparatus; ventilation [air-conditioning] installations for vehicles; toilet bowls; toilet seats; lampshades; lampshade holders; mixer taps for water pipes; regulating and safety accessories for gas pipes; regulating and safety accessories for water apparatus; steam accumulators; water softening apparatus and installations; ventilation hoods for laboratories; air sterilizers; stills; alcohol burners; anti-glare devices for vehicles [lamp fittings]; heating apparatus for defrosting vehicle windows; brackets for gas burners; water supply installations; nuclear reactors; autocla-

ves, electric, for cooking; lights for automobiles; heaters, electric, for feeding bottles; waffle irons, electric; regulating and safety accessories for gas apparatus; coffee percolators, electric; coffee machines, electric; street lamps; flues for heating boilers; barbecues; deep fryers, electric; fireplaces, domestic; heat pumps; solar thermal collectors [heating]; solar furnaces; tanning beds; water flushing installations; feeding apparatus for heating boilers; refrigerators; deodorizing apparatus, not for personal use; water intake apparatus; oil-scrubbing apparatus; kiln furniture [supports]; pocket warmers; spa baths [vessels]; chromatography apparatus for industrial purposes; heating filaments, electric; gas condensers, other than parts of machines; heating cushions, electric, not for medical purposes; sauna bath installations; shower cubicles; sinks; steam facial apparatus [saunas]; urinals being sanitary fixtures; hot water bottles; kettles, electric; bed warmers; blankets, electric, not for medical purposes; warming pans; aquarium filtration apparatus; aquarium heaters; aquarium lights; electrically heated carpets; dental ovens; electric appliances for making yogurt; expansion tanks for central heating installations; extractor hoods for kitchens; electric fans for personal use; laundry dryers, electric; microwave ovens [cooking apparatus]; swimming pool chlorinating apparatus; thermostatic valves [parts of heating installations]; whirlpool-jet apparatus; apparatus for dehydrating food waste; diving lights; drip irrigation emitters [irrigation fittings]; clean chambers [sanitary installations]; lava rocks for use in barbecue grills; watering machines for agricultural purposes; microwave ovens for industrial purposes; bread baking machines; refrigerating display cabinets; fabric steamers; bread-making machines; light-emitting diodes [LED] lighting apparatus; hydromassage bath apparatus; heated display cabinets; multicookers; food steamers, electric; tortilla presses, electric; book sterilization apparatus; heat guns; chocolate fountains, electric; disinfectant apparatus for medical purposes; wine cellars, electric; fairy lights for festive decoration; socks, electrically heated; head torches; nail lamps; sous-vide cookers, electric; microbubble generators for baths; heating and cooling apparatus for dispensing hot and cold beverages; electrically heated clothing; pounded rice cake making machines, electric, for household purposes; wicks adapted for oil stoves; electric cooktops; candle lanterns; air fryers; ice-cream making machines; directional lights for bicycles; refrigerators, cooling apparatus and freezers for medical storage purposes; curing lamps, not for medical purposes; hydroponic growing systems; thermo-pots, electric; food dehydrators, electric; USB-powered hand warmers; USB-powered cup heaters; couscous cookers, electric; standard lamps; tajines, electric; light projectors; fog machines; underfloor heating apparatus and installations; humidifiers; soya milk making machines, electric; coffee capsules, empty, for electric coffee machines; beverage urns, electric; dehumidifiers; walk-in refrigerators;

scrubbers [parts of gas installations]; coolers, electric; globes for lamps; toasters; grills [cooking appliances]; wash-hand bowls [parts of sanitary installations]; electric lights for Christmas trees; faucets; washers for water faucets; sterilisers; mixer faucets for water pipes; air sterilisers; anti-dazzle devices for vehicles [lamp fittings]; pressure cookers, electric; automobile lights; flushing apparatus; deodorising apparatus, not for personal use; heating pads, electric, not for medical purposes; shower enclosures; electric appliances for making yoghurt; laundry driers, electric; book sterilisation apparatus; string lights for festive decoration; portable headlamps; floor lamps; tagines, electric.

16 – Steel letters; steel pens; adhesive tape dispensers [office requisites]; address stamps; addressing machines; paper; posters; advertisement boards of paper or cardboard; franking machines for office use; clips for offices; pen clips; stapling presses [office requisites]; albums; pictures; prints [engravings]; cigar bands; pencil sharpening machines, electric or non-electric; bookends; hand-rests for painters; aquarelles; architects' models; document files [stationery]; writing slates; slate pencils; modelling clay; arithmetical tables; engravings; lithographic works of art; paintings [pictures], framed or unframed; pencils; newspapers; periodicals; atlases; loose-leaf binders; gummed tape [stationery]; mats of paper for beer glasses; tickets; biological samples for use in microscopy [teaching materials]; printing blocks; drawing pads; pads [stationery]; spools for inking ribbons; wristbands for the retention of writing instruments; pamphlets; embroidery designs [patterns]; drawing pins; moisteners [office requisites]; painters' brushes; blotters; stamps [seals]; sealing stamps; inking pads; sealing wax; sealing machines for offices; sealing compounds for stationery purposes; writing or drawing books; trays for sorting and counting money; tracing patterns; tracing paper; tracing cloth; fingerstalls for office use; printing type; carbon paper; paper for recording machines; note books; square rulers for drawing; cards; teaching materials [except apparatus]; index cards [stationery]; paper sheets [stationery]; cardboard; hat boxes of cardboard; perforated cards for Jacquard looms; cardboard tubes; catalogues; tags for index cards; song books; composing frames [printing]; folders for papers; painters' easels; numbers [type]; chromolithographs [chromos]; modelling wax, not for dental purposes; files [office requisites]; office perforators; toilet paper; books; compasses for drawing; type [numerals and letters]; composing sticks; letter trays; correcting fluids [office requisites]; correcting ink [heliography]; pencil leads; histological sections for teaching purposes; French curves; covers [stationery]; writing chalk; chalk for lithography; tailors' chalk; chalk holders; pencil holders; pencil lead holders; cream containers of paper; paper clasps; rollers for typewriters; transfers [decalcomanias]; graphic prints; graining combs; drawing boards; drawing materials; drawing instru-

ments; diagrams; envelopes [stationery]; duplicators; etchings; wrapping paper; nibs; typewriters, electric or non-electric; pen cases; nibs of gold; erasing products; writing materials; shields [paper seals]; erasing shields; erasers; electrocardiograph paper; punches [office requisites]; ink; inking ribbons; inkwells; envelope sealing machines for offices; photographs [printed]; pen wipers; seals [stamps]; fabrics for bookbinding; drawing sets; ledgers [books]; indexes; figurines of papier mâché; filter paper; filtering materials of paper; forms, printed; office requisites, except furniture; charcoal pencils; stencils [stationery]; galley racks [printing]; electrotypes; printed geographical maps; terrestrial globes; artists' watercolour saucers; graphic reproductions; graphic representations; scrapers [erasers] for offices; engraving plates; hectographs; printed timetables; moisteners for gummed surfaces [office requisites]; postcards; printed matter; hand labelling appliances; printers' blankets, not of textile; printing sets, portable [office requisites]; printed publications; manuals [handbooks]; writing paper; paperweights; tracing needles for drawing purposes; table linen of paper; lithographs; lithographic stones; booklets; luminous paper; papier mâché; manifolds [stationery]; marking chalk; plastics for modelling; modelling materials; modelling paste; handkerchiefs of paper; inking sheets for duplicators; tablecloths of paper; blackboards; paper-clips; numbering apparatus; oleographs; binding strips [bookbinding]; sealing wafers; palettes for painters; pantographs [drawing instruments]; stationery; parchment paper; pastels [crayons]; sewing patterns; stencil cases; house painters' rollers; canvas for painting; paint boxes for use in schools; plastic film for wrapping; apparatus for mounting photographs; photo-engravings; blueprints; paper creasers [office requisites]; fountain pens; stencil plates; stencils; portraits; flower-pot covers of paper; mimeograph apparatus and machines; prospectuses; paper for radiograms; drawing rulers; printers' reglets; bookbinding material; cloth for bookbinding; cords for bookbinding; inking sheets for document reproducing machines; pens [office requisites]; magazines [periodicals]; paper ribbons, other than haberdashery or hair decorations; typewriter ribbons; bags [envelopes, pouches] of paper or plastics, for packaging; stamp pads; school supplies [stationery]; bookmarks; greeting cards; steatite [tailor's chalk]; balls for ballpoint pens; desk mats; typewriter keys; holders for stamps [seals]; cases for stamps [seals]; postage stamps; stamp stands; transparencies [stationery]; vignetting apparatus; gluten [glue] for stationery or household purposes; adhesives [glues] for stationery or household purposes; adhesive tapes for stationery or household purposes; address plates for addressing machines; almanacs; calendars; starch paste [adhesive] for stationery or household purposes; paintbrushes; self-adhesive tapes for stationery or household purposes; elastic bands for offices; bibs of paper; wood pulp board [stationery]; wood pulp paper; boxes of

paper or cardboard; stands for pens and pencils; bottle envelopes of paper or cardboard; coasters of paper; announcement cards [stationery]; plastic blister packs for packaging; flags of paper; paper shredders for office use; sheets of reclaimed cellulose for wrapping; desktop cabinets for stationery [office requisites]; glue for stationery or household purposes; paper knives [letter openers]; garbage bags of paper or of plastics; pencil sharpeners, electric or non-electric; tissues of paper for removing make-up; table napkins of paper; place mats of paper; squares for drawing; T-squares for drawing; penholders; writing cases [stationery]; inkstands; handwriting specimens for copying; bottle wrappers of paper or cardboard; placards of paper or cardboard; towels of paper; face towels of paper; labels of paper or cardboard; etching needles; viscose sheets for wrapping; gums [adhesives] for stationery or household purposes; gummed cloth for stationery purposes; isinglass for stationery or household purposes; paper coffee filters; plastic cling film, extensible, for palletization; signboards of paper or cardboard; stickers [stationery]; bookbinding apparatus and machines [office equipment]; comic books; copying paper [stationery]; holders for cheque books; ink sticks; ink stones [ink reservoirs]; musical greeting cards; newsletters; packaging material made of starches; waxed paper; passport holders; writing brushes; writing instruments; drawer liners of paper, perfumed or not; credit card imprinters, non-electric; document laminators for office use; papers for painting and calligraphy; writing board erasers; clipboards; chart pointers, non-electronic; paper bows, other than haberdashery or hair decorations; moulds for modelling clay [artists' materials]; money clips; trading cards, other than for games; absorbent sheets of paper or plastic for foodstuff packaging; humidity control sheets of paper or plastic for foodstuff packaging; correcting tapes [office requisites]; paint trays; marking pens [stationery]; flyers; document holders [stationery]; page holders; polymer modelling clay; obliterating stamps; packing [cushioning, stuffing] materials of paper or cardboard; padding materials of paper or cardboard; banknotes; spray chalk; printed coupons; rice paper; plastic bags for pet waste disposal; wash; table runners of paper; printed sheet music; banners of paper; bunting of paper; animation cels; paper bags for use in the sterilization of medical instruments; name badge holders [office requisites]; retractable reels for name badge holders [office requisites]; clips for name badge holders [office requisites]; paper for medical examination tables; dental tray covers of paper; bibs, sleeved, of paper; paper cutters [office requisites]; stencils for decorating food and beverages; name badges [office requisites]; barcode ribbons; glitter for stationery purposes; baggage claim check tags of paper; paper wipes for cleaning; protective covers for books; colouring books.

39 – Escorting of travellers; water supplying; air transport; ambulance transport; vehicle breakdown towing

services; car rental; car transport; bus transport; pleasure boat transport; boat rental; ice-breaking; hauling; salvage of ships; lighterage services; carting; railway transport; rental of horses for transportation purposes; parcel delivery; portage; packaging of goods; ship-brokerage; arranging of cruises; transport services for sightseeing tours; unloading cargo; delivery of goods; storage of goods; water distribution; electricity distribution; operating canal locks; car park services; storage; rental of warehouses; ferry-boat transport; river transport; freight [shipping of goods]; freighting; garage rental; transport by pipeline; parking place rental; refrigerator rental; vehicle rental; railway coach rental; railway truck rental; transporting furniture; transport; boat transport; arranging of transportation for travel tours; passenger transport; piloting; towing; re-floating of ships; booking of seats for travel; salvaging; taxi transport; tram transport; freight forwarding; marine transport; armoured-car transport; transport of travellers; transport and storage of waste; removal services; boat storage; freight brokerage [forwarding (Am.)]; transport brokerage; chauffeur services; courier services [messages or merchandise]; providing information relating to storage services; providing transportation information; rental of diving bells; rental of atmospheric diving suits; rental of storage containers; rental of vehicle roof racks; rescue operations [transport]; transport reservation; travel reservation; underwater salvage; wrapping of goods; message delivery; delivery of newspapers; delivery of goods by mail order; distribution of energy; rental of motor racing cars; rental of wheelchairs; stevedoring; physical storage of electronically stored data or documents; launching of satellites for others; flower delivery; franking of mail; providing traffic information; rental of freezers; bottling services; transportation logistics; aircraft rental; barge transport; motor coach rental; rental of aircraft engines; guarded transport of valuables; rental of navigational systems; providing driving directions for travel purposes; gift wrapping; rental of tractors; collection of recyclable goods [transport]; rental of electric wine cellars; cash replenishment of automated teller machines; car sharing services; replenishment of vending machines; luggage storage; arranging of passenger transportation services for others via an online application; piloting of civilian drones; arranging for travel visas and travel documents for persons travelling abroad; carpooling services; temporary storage of keys; rental of photography drones; collection of domestic and industrial waste and trash; rental of storage lockers; locating and tracking of people for transportation purposes; services for transporting legal documents; cable car transport; rental of safety seats for children, for vehicles; cloakroom services; rental of surveillance drones; rental of security drones; locating and tracking of cargo for transportation purposes; parking lot services; warehousing; frozen-food locker rental; streetcar transport; armored-car transport; tran-

sport and storage of trash; freight brokerage; newspaper delivery; coat check services.

40 – Abrasion; processing of cinematographic films; air purification; magnetization; applying finishes to textiles; paper finishing; silver plating; fabric bleaching; woodworking; cloth edging; soldering; dressmaking; cadmium plating; permanent-press treatment of fabrics; pottery firing; shoe staining; chromium plating; metal plating; leather staining; fur conditioning; cloth cutting; pattern printing; photographic film development; gilding; water treating; electroplating; tin plating; custom fashioning of fur; blacksmithing; fur mothproofing; millworking; fruit crushing; food smoking; galvanization; engraving; cloth waterproofing; cloth fireproofing; crease-resistant treatment for clothing; wool treating; laminating; grinding; metal treating; metal tempering; flour milling; nickel plating; warping [looms]; skin dressing; burnishing by abrasion; bookbinding; planing of materials; saddlery working; sawing of materials; custom tailoring; tanning; taxidermy; dyeing services; textile dyeing; textile treating; textile mothproofing; cloth dyeing; paper treating; glass-blowing; embroidering; leather working; window tinting treatment being surface coating; food and drink preservation; timber felling and processing; recycling of waste and trash; cloth pre-shrinking; fur glossing; fur satining; fur dyeing; air deodorizing; air freshening; custom assembling of materials for others; framing of works of art; gold plating; laser scribing; providing information relating to material treatment; optical glass grinding; photographic printing; photogravure; processing of oil; quilting; refining services; slaughtering of animals; stripping finishes; waste treatment [transformation]; clothing alteration; boilermaking; metal casting; vulcanization [material treatment]; services of a dental technician; production of energy; rental of electricity generators; destruction of waste and trash; incineration of waste and trash; colour separation services; key cutting; decontamination of hazardous materials; lithographic printing; printing; knitting machine rental; offset printing; photocomposing services; silkscreen printing; sorting of waste and recyclable material [transformation]; freezing of foods; rental of air-conditioning apparatus; rental of space heating apparatus; fulling of cloth; cryopreservation services; sandblasting services; rental of boilers; upcycling [waste recycling]; welding services; tinting of car windows; custom 3D printing for others; beer brewing for others; custom manufacturing of bread; pasteurizing of food and beverages; wine making for others; consultancy in the field of wine making; firing pottery; fabric waterproofing; textile fireproofing; cloth treating; air deodorising; pasteurising of food and beverages.

(260) AM 2026 134589 A

(800) 1863160

(151) 2024 12 25

(891) 2024 12 25

(731) SHENZHEN MINDRAY BIO-MEDICAL
ELECTRONICS CO., LTD.Mindray Building, Keji 12th Road South,
High-tech Industrial Park, Nanshan, 518057
Shenzhen, China

(540)

mindray

(591) Black, white

(531) 27.05.01; 27.05.17

(511)

5 – Bacteriological preparations for medical and veterinary use; bacterial preparations for medical and veterinary use; chemico-pharmaceutical preparations; preparations of microorganisms for medical and veterinary use; biological preparations for medical purposes; chemical preparations for pharmaceutical purposes; biological tissue cultures for medical purposes; diagnostic preparations for medical purposes; chemical reagents for medical or veterinary purposes; cultures of microorganisms for medical or veterinary use; diagnostic reagents for medical use; diagnostic biomarker reagents for medical purposes; reagent paper for medical purposes; media for bacteriological cultures for medical purposes or veterinary purposes; bouillons for bacteriological cultures for medical purposes or veterinary purposes; radiological contrast substances for medical purposes; nutritional supplements; depuratives; medicines for veterinary purposes; biological preparations for veterinary purposes; enzymes for veterinary purposes; biological tissue cultures for veterinary purposes; diagnostic preparations for veterinary purposes; reagent paper for veterinary purposes; veterinary preparations; preparations for destroying vermin; wadding for medical purposes; medical dressings; first aid kits; adhesive tapes for medical purposes; dental adhesives; diapers for pets.

9 – Monitors [computer programs]; computer peripheral devices; computer software, recorded; computer programs, downloadable; computers; electronic publications, downloadable; computer programs, recorded; data processing apparatus; optical glass; microscopes; containers for microscope slides; integrated circuits; semiconductors; apparatus and installations for the production of x-rays, not for medical purposes; humanoid robots with artificial intelligence for preparing beverages; cell phones; wireless routers; switchboards; aerials; modems; sound transmitting apparatus; virtual reality headsets; wearable video display monitors; virtual reality glasses; video projectors; bioreactors for laboratory use; filters for blood and blood components for laboratory use; laboratory instrument for the detection of pathogens and toxins in a biological sample for research use; connected bracelets

[measuring instruments]; materials for electricity mains [wires, cables]; sensors; flow sensors; temperature sensors; biochip sensors; electrical adapters; ultrasonic sensors; breathing apparatus, not for medical purposes; eyeglasses; portable power chargers; batteries, electric; test tubes.

10 – Diagnostic apparatus for medical purposes; medical apparatus and instruments; apparatus for use in medical analysis; surgical apparatus and instruments; veterinary apparatus and instruments; apparatus for artificial respiration; anaesthetic apparatus; ultrasound instruments and components for medical use; radiotherapy apparatus; medical and surgical laparoscopes; endoscopy cameras for medical purposes; infusion apparatus for therapeutic purposes; surgical forceps; clips, surgical; operating tables; telemetry apparatus for medical use; wearable monitors used to measure biometric data for medical use; body composition monitors; heart rate monitors; thermometers for medical purposes; defibrillators; blood oxygen monitors; electronic blood pressure meters [for medical use]; cannulae for anaesthetics with receptacles; body composition analyzers for medical purposes; glucometers; hysteroscopes; surgical raspatories; arthroscopes; electric machines for use in orthopedic surgery; medical examination tables; medical and surgical cutters for cutting human or animal tissue and organs; vaporizers for medical purposes; hyperbaric oxygen chambers for medical purposes; stents; surgical apparatus and instruments for use in ophthalmic surgery; respiratory masks for medical purposes; surgical bougies; drainage tubes for medical purposes; catheters; respirators for medical purposes; respiration monitors; bone nail; bone retractors; bone forceps; biodegradable bone fixation implants; intramedullary nails; surgical robots; analysers for bacterial identification for medical purposes; thoroscopes; medical guidewires; anastomosis devices; surgical staple removers; apparatus for blood analysis; endoscopes for medical use; pumps for medical purposes; surgical lamps; eye testing apparatus; surgical apparatus and instruments for veterinary use; balloon catheters; electric scalpels [for surgical purposes]; beds, specially made for medical purposes; babies' bottles; artificial bones; artificial joints; substitutes for bones; surgical implants comprised of artificial materials; bone void fillers comprised of artificial materials; orthopaedic hip prostheses; spinal implants composed of artificial material; bone implants composed of artificial materials; splints, surgical; suture materials; all the aforementioned goods excluding dentomaxillofacial x-ray units and apparatus specially designed for dentomaxillofacial use.

(260) AM 2026 134591 A

(800) 1863176

(151) 2025 05 19

(891) 2025 05 19

(731) Pavlova Anna Sergeevna

Zhulebinskiy b-r, 9, kv. 254, RU-109145
Moscow, Russian Federation

(540)



(591) Black, white

(531) 07.03.01; 07.03.02; 27.05.10

(511)

25 – Clothing; footwear; headwear.

(260) AM 2026 134850 A

(800) 1709798

(151) 2022 12 21

(891) 2025 07 09

(731) Alexion Pharmaceuticals, Inc.

121 Seaport Boulevard, Boston MA 02210,
USA

(540)



(591) Black, white

(531) 26.11.13; 26.13.25

(511)

5 – Pharmaceutical preparations for the treatment of hematological, nephrological, autoimmune, immunological, ocular, neurological and inflammatory related diseases and disorders.

(260) AM 2026 134851 A

(800) 1740027

(151) 2023 04 18

(891) 2025 05 12

(731) Jinde Zhang

No. 965, Lianjie Village, Zhiying Town,
Yongkang City, Zhejiang Province, China

(540)



(591) Black, white

(531) 27.05.01; 27.05.17

(511)

7 – Lawnmowers [machines]; reapers; spraying machines; chainsaws; saw blades [parts of machines]; packing machines; cord making machines; cutting machines; scarifiers [machines]; electric hammers; carburetors; knives being parts of machines; housings [parts of machines]; circular saw blades being parts of machines; chain saws; drilling heads [parts of machines]; scissors, electric; hand-held tools, other than

hand-operated; dynamos; cylinders for machines; compressed air machines; bearings [parts of machines]; belts for machines; welding machines, electric; internal combustion motors [other than for land vehicles]; garbage disposal units.

8 – Hand tools, hand-operated; grindstones [hand tools]; pickhammers; garden tools, hand-operated; saws [hand tools]; lifting jacks, hand-operated; scissors; knife [hand tools]; table cutlery [knives, forks and spoons].

(260) AM 2026 134852 A

(800) 1785492

(151) 2024 03 20

(891) 2025 07 09

(731) Alexion Pharmaceuticals, Inc.

121 Seaport Boulevard, Boston MA 02210,
USA

(540)

VOYDEYA

(591) Black, white

(511)

5 – Pharmaceutical preparations and substances.

(260) AM 2026 134854 A

(800) 1793052

(151) 2024 03 28

(891) 2025 07 10

(731) Gilead Sciences Ireland UC

IDA Business and Technology Park,
Carrigtohill, Co. Cork, T45 DP77, Ireland

(540)

EZTUGO

(591) Black, white

(511)

5 – Pharmaceutical preparations.

(260) AM 2026 134855 A

(800) 1834627

(151) 2024 12 02

(891) 2025 06 17

(731) ATOMIC Austria GmbH

Atomic Straße 1, A-5541 Altenmarkt, Austria

(540)

ATOMIC

(591) Black, white

(511)

9 – Goggles for sports; ski goggles; cases for ski goggles; cases for sports glasses; replacement lenses for sports goggles and ski goggles; protective helmets for sports; ski helmets; helmets for bicycles; helmets for use in sports; visors for helmets; bags specially designed for protective helmets; bags specially designed for ski helmets; sleeves for laptops.

41 – Providing skiing facilities; sport camp services; organization of sports competitions; arranging and conducting of sports events; provision of training courses; arranging and conducting of ski races; instructional services for skiing; rental of skis; rental of equipment for use at sporting events; rental of ski equipment; rental of snowboarding equipment; training services for skiing.

(260) AM 2026 134898 A

(800) 1866741

(151) 2025 04 17

(891) 2025 04 17

(731) KANO LABORATORIES LLC

1000 E Thompson Lane, Nashville TN 37211,
USA

(540)

KROIL CLEAR

(591) Black, white

(511)

4 – Food grade penetrating oil.

(260) AM 2026 134899 A

(800) 1866825

(151) 2025 05 12

(891) 2025 05 12

(731) BLM Produktions- und Vertriebsgesellschaft

mbH & Co. KG

Neue Strasse 21, 21244 Buchholz, Germany

(540)

CAMALETTI

(591) Black, white

(511)

29 – Prepared fruit and vegetables; ready-made meals, including salads, soups, consisting mainly of one or more of fish, fish products, molluscs, crustaceans, shrimps, prepared vegetables, prepared fruits, legumes, potatoes, also with the addition of cheese, pasta and/or rice, all of the foregoing goods including ready-made meals containing meat, poultry, game and/or sausage, also as frozen food; cheese; cheese preparations and cheese products; fats and edible oils, in particular olive oil; preserved, frozen, dried and/or cooked fruit and vegetables; desserts made from milk products; desserts based on vegetable fats; milk drinks containing coffee; milk products, organic milk.

30 – Bakery products; bread; baguettes; pretzels; pasta, in particular fresh or dried pasta; sauces as condiments; ready-made meals including salads, pies, pizzas, pretzel pizzas, pizza products and filled baguettes, ready-made noodle meals, ready-made rice meals, each also with the addition of legumes, cheese and/or sauces; sauces, in particular pasta sauces; condiments and spices; all the aforementioned goods also as frozen goods or preserves; rice; vinegar, in particular aceto balsamico; table salt; mustard; ice; ice cream, fro-

zen yoghurt, sorbets; ready-to-eat desserts (confectionery); puddings as desserts; ready-to-eat chocolate-based desserts; ready-to-eat rice-based desserts; coffee beverages; milk-based coffee beverages; ready-to-drink coffee and coffee beverages.

(260) AM 2026 134900 A

(800) 1866929

(151) 2025 03 06

(891) 2025 03 06

(731) Shandong LEAD CNC Machinery Co., Ltd.

No. 1777 Guanda Street, Licheng District,
Jinan, Shandong, China

(540)

LEADCNC

(591) Black, white

(531) 27.05.01

(511)

7 – Machines for the glass industry; presses [machines for industrial purposes]; finishing machines; machines and apparatus for polishing [electric]; milling machines; gas-operated welding apparatus; machines for metalworking; parts for cutting machines; metal sawing machines; laser welding apparatus.

(260) AM 2026 135027 A

(800) 1868523

(151) 2025 03 13

(891) 2025 03 13

(731) Yarros Ink, Inc.

1235 Lake Plaza Drive #124, Colorado
Springs CO 80906, USA

(540)

BASGIATH WAR COLLEGE

(591) Black, white

(511)

4 – Candles.

9 – Protective covers and cases for cell phones, laptops and portable media players.

16 – Printed books; stationery; blank writing journals; printed notebooks; art prints; paper dust jackets for books; paper bookmarks; bookends; bookplates; stickers; page overlays (term considered too vague by the International Bureau pursuant to Rule 13 (2) (b) of the Regulations); spiral bound notebooks.

18 – Tote bags, shoulder bags and backpacks.

21 – Drinking cups and glasses, namely, tumblers, water bottles.

25 – Clothing, namely, t-shirts, sweaters, sweatshirts, hooded sweatshirts, jackets, hats, beanies, tank-tops, sweatpants and jogging pants.

(260) AM 2026 135028 A
(800) 1868556
(151) 2025 02 19
(891) 2025 02 19
(731) Hetsen & Klaver B.V.

De Dieze 2, NL-8253 PS Dronten, Netherlands

(540)



(591) Dark brown and sand beige
(531) 26.07.11; 29.01.11
(511)

2 – Paints, varnishes, lacquers; primers; coatings [paints and lacquers]; wall paint; lime wash paint; chalk paint; wood lacquer; floor coatings; concrete-look paint and lacquer; rust-preventing preparations and wood preservatives; mordants; preparations for drying paints.

4 – Candles; scented candles; lighter fluid for fireplaces and table burners.

11 – Apparatus and installations for lighting, heating, steam generating and cooking; lighting; lamps, floor lamps, hanging ceiling lamps, table lamps, wall lights, chandeliers; lamp glasses, incandescent light bulbs, lampshade holders, lampshades, fixtures for lamps, fairy lights for festive decoration; burners; table burners; lanterns; fireplaces, stoves [heating apparatus]; terrace lighting and heating; lighting and heating apparatus incorporating regulating and safety accessories.

20 – Furniture, living room furniture, kitchen furniture, bathroom furniture, garden furniture and bedroom furniture; office furniture; furniture, including chairs, stools, seats, armchairs, chaise longues, hanging chairs, sofas, couches, sofas, settees, divans, tables, coffee tables, side tables, beds, bed bases, cupboards, drawers, bookcases, wardrobes, clothes racks, credenzas; built-in furniture for kitchens; mirrors, mirror frames and picture frames of wood, cork, cane, reed, wicker, horn, bone, ivory, baleen, tortoiseshell, amber, mother of pearl, meerscham, plastic and substitutes for all of these materials, included in this class; works of art and decoration including carvings, of materials such as wood, straw, bone, shell, wax, resin, plastic or plaster, or substitutes therefor; wine racks; book stands; magazine racks; umbrella stands; coat racks, mattresses, cushions; seat or decorative pillows; baskets, not of metal; room screens; space dividers [furniture]; picnic baskets [not fitted].

21 – Household or kitchen utensils and tableware; raw or semimanufactured glass (except glass used for building purposes); glass, porcelain and earthenware; bakeware; baking molds; tableware of glass or porcelain;

in; mugs, cups, glasses; plates, bowls, dishes, jugs; cake domes and cake stands; candle holders, candle stands, tealight holders; trays; earthenware; statues, figurines, plaques and works of art of porcelain, terracotta, glass, ceramics and earthenware; works of art and decorations made of porcelain, earthenware, terracotta, glass, ceramics and acrylic glass; vases; trays for serving; cutlery trays; knife blocks; cutting boards; wine coolers; carafes; plant and flower pots; covers for dishes made of glass; boxes of glass, ceramic, earthenware and porcelain; bottles of glass, ceramic, earthenware and porcelain; teapots; thermos flasks; mugs; salt and pepper mills; spice holders; pans and woks; plastic ice cube molds; bottles; beverage can holders; dustbins; non-electric percolators; bottle openers; non-electric coffee makers; thermally insulated containers for food and drink; coolers [non-electric] and jugs [drinking utensils] of both rigid material and fabrics for use at home or at picnics; fully equipped picnic baskets; lunch boxes; cool bags and boxes; cosmetic and toilet utensils; cosmetic and cleaning brushes, except brush pens; toilet brushes; soap dispensers; toothbrush holders; bath sponges; cooking and table utensils, except forks, knives and spoons.

24 – Textile products and substitutes therefor; linen; bed clothes and blankets [except furniture]; quilt covers; fitted sheets, sheets [textile], bed blankets, throws, pillowcases; towels, tea towels; bath towels; washcloths; curtains of textile or plastic; plaids; tablecloths; runners [tablecloths]; wall decorations of textile; wall hangings of textile; picnic blankets; mosquito nets.

27 – Carpets and rugs, whether or not handmade; bath mats; wall hangings, not of textile; wallpaper and plastic wallpaper.

(260) AM 2026 135030 A
(800) 1868613
(151) 2025 05 14
(891) 2025 05 14

(731) KAHE CAM AKSESUARLARI HIRDAVAT SANAYİ VE TİCARET LİMİTED ŞİRKETİ
Hürriyet Mahallesi, Dr. Cemil Bengü Cadde,
No: 48 A, İç Kapı No: 1, Kağıthane, İstanbul,
Türkiye

(540)



(591) Blue and black
(531) 24.01.12; 24.01.17; 24.01.25; 27.05.01;
29.01.12

(511)
6 – Ores of non-precious metal; common metals and their alloys and semi-finished products made of these

materials: irons for construction; mats and stirrups of common metals for buildings; common metals in the form of plate, billet, stick, profile, sheet and sheeting; goods and materials of common metal used for storage, wrapping, packaging and sheltering purposes, containers of metal (storage, transport), buildings of metal, frames of metal for building, poles of metal for building, metal boxes, packaging containers of metal, aluminium foil, fences made of metal, guard barriers of metal, metal tubes, storage containers of metal, metal containers for the transportation of goods, ladders of metal; doors, windows, shutters, jalousies and their cases and fittings of metal; non-electric cables and wires of metal; ironmongery; small hardware of metal: screws of metal; nails; bolts of metal; nuts of metal; pegs of metal; flakes of metal; pitons of metal; metal chains; furniture casters of metal; fittings of metal for furniture; industrial metal wheels; door handles of metal; window handles of metal; hinges of metal; metal latches; metal locks; metal keys for locks; metal rings for carrying keys; metal pulleys; ventilation ducts, vents, vent covers, pipes, chimney caps, man-hole covers, grilles of metal for ventilation, heating, sewage, telephone, underground electricity and air conditioning installations; metal panels or boards (non-luminous and non-mechanical) used for signalling, route showing, publicity purposes, signboards of metal, advertisement columns of metal, signaling panels of metal, non-luminous and non-mechanical traffic signs of metal; pipes of metal for transportation of liquids and gas, drilling pipes of metal and their metal fittings, valves of metal, couplings of metal for pipes, elbows of metal for pipes, clips of metal for pipes, connectors of metal for pipes; safes (strong boxes) of metal; metal railway materials, metal rails, metal railway ties, railway switches; bollards of metal, floating docks of metal, mooring buoys of metal, anchors; metal moulds for casting, other than machine parts; works of art made of common metals or their alloys, trophies of common metal; metal closures, bottle caps of metal; metal poles; metal pillars; metal stakes; metal pallets and metal ropes for lifting, loading and transportation purposes; metal hangers, ties, straps, tapes and bands used for load-lifting and load-carrying; wheel chocks made primarily of metal.

35 – Advertising, marketing and public relations; organization of exhibitions and trade fairs for commercial or advertising purposes; development of advertising concepts; provision of an online marketplace for buyers and sellers of goods and services; office functions; secretarial services; arranging newspaper subscriptions for others; compilation of statistics; rental of office machines; systemization of information into computer databases; telephone answering for unavailable subscribers; business management, business administration and business consultancy; accounting; commercial consultancy services; personnel recruitment, personnel placement, employment agencies, import-export agencies; temporary personnel placement

services; auctioneering; the bringing together, for the benefit of others, of a variety of goods, namely, ores of non-precious metal, common metals and their alloys and semi-finished products made of these materials, irons for construction, mats and stirrups of common metals for buildings, common metals in the form of plate, billet, stick, profile, sheet and sheeting, goods and materials of common metal used for storage, wrapping, packaging and sheltering purposes, containers of metal (storage, transport), buildings of metal, frames of metal for building, poles of metal for building, metal boxes, packaging containers of metal, aluminium foil, fences made of metal, guard barriers of metal, metal tubes, storage containers of metal, metal containers for the transportation of goods, ladders of metal, doors, windows, shutters, jalousies and their cases and fittings of metal, non-electric cables and wires of metal, ironmongery, small hardware of metal, screws of metal, nails, bolts of metal, nuts of metal, pegs of metal, flakes of metal, pitons of metal, metal chains, furniture casters of metal, fittings of metal for furniture, industrial metal wheels, door handles of metal, window handles of metal, hinges of metal, metal latches, metal locks, metal keys for locks, metal rings for carrying keys, metal pulleys, ventilation ducts, vents, vent covers, pipes, chimney caps, man-hole covers, grilles of metal for ventilation, heating, sewage, telephone, underground electricity and air conditioning installations, metal panels or boards (non-luminous and non-mechanical) used for signalling, route showing, publicity purposes, signboards of metal, advertisement columns of metal, signaling panels of metal, non-luminous and non-mechanical traffic signs of metal, pipes of metal for transportation of liquids and gas, drilling pipes of metal and their metal fittings, valves of metal, couplings of metal for pipes, elbows of metal for pipes, clips of metal for pipes, connectors of metal for pipes, safes (strong boxes) of metal, metal railway materials, metal rails, metal railway ties, railway switches, bollards of metal, floating docks of metal, mooring buoys of metal, anchors, metal moulds for casting, other than machine parts, works of art made of common metals or their alloys, trophies of common metal, metal closures, bottle caps of metal, metal poles, metal pillars, metal stakes, metal pallets and metal ropes for lifting, loading and transportation purposes, metal hangers, ties, straps, tapes and bands used for load-lifting and load-carrying, wheel chocks made primarily of metal enabling customers to conveniently view and purchase those goods, such services may be provided by retail stores, wholesale outlets, by means of electronic media or through mail order catalogues.

(260) AM 2026 135031 A
 (800) 1868679
 (151) 2025 06 25
 (891) 2025 06 25

(731) RETAL INDUSTRIES LIMITED
Epimitheos 6, Industrial Area A, CY-3056
Limassol, Cyprus

(540)

RETAL

(591) Black, white

(511)

16 – Plastic film for wrapping.

17 – Semi-processed plastics, including semi-finished preformed plastic products, namely, preforms for manufacturing containers for food and non-food products, including bottles, cans, jars and other containers; plastic films, not for packaging.

20 – Plastic caps; polymer screw caps, polymer closure caps, polyethylene caps; non-metal polymer screw caps; non-metal polymer closure caps; caps, closure caps and closures not of metal and not of paper for bottles, jars, and other containers; plastic handles for carrying bottles.

21 – Plastic water bottles, disposable and reusable, empty; household containers for food and non-food products, including bottles, cans, jars and other containers, disposable and reusable.

(260) AM 2026 135032 A

(800) 1868685

(151) 2025 05 15

(891) 2025 05 15

(731) AKCO KİMYA SANAYİ VE TİCARET
ANONİM ŞİRKETİ
MAHMUTBEY MAH. 2416. SK., İSTOÇ
NO: 4 İÇ KAPI NO: 132, Bağcılar, İstanbul,
Türkiye

(540)



(591) Black, white and yellow

(531) 26.04.22; 26.04.24; 27.05.24; 29.01.13

(511)

1 – Chemicals used in industry, science, photography, agriculture, horticulture and forestry (including biological preparations used in industry and science, pectin, lecithin, enzymes and preservative chemicals used in the food industry and vitamins, preservatives and antioxidants used in cosmetics production); manures and soils; unprocessed artificial resins and unprocessed plastics; fire extinguishing compositions; adhesives not for medical, household and stationery purposes.

2 – Paints; varnishes; lacquers; preservatives against rust; preservatives against deterioration of wood; thin-

ners and binders for paints; pigments; coating materials in the form of paints; preservatives for metals; shoe dyes; printing dyes and ink; toners (including filled toner cartridges); colorants for food, pharmaceuticals and beverages; raw natural resins; metals in foil and powder form for painters, decorators, printers and artists.

17 – Rubber, gutta-percha, gum, asbestos, mica and semi-finished synthetic goods made from these materials in the form of powder, bars, panels and foils included in this class; profile laths made of synthetic rubber for vehicles for the purposes of decoration; flexible pipes made from rubber and plastic; hoses made of plastic and rubber, including those used for vehicles; junctions for pipes of plastic and rubber; pipe jackets of plastic and rubber; hoses of textile material; junctions for pipes, not of metal; pipe jackets, not of metal; connecting hose for vehicle radiators; insulation, stopping and sealing materials: insulating paints, insulating fabrics, insulating tape and band, insulation covers for industrial machinery, joint sealant compounds for joints, gaskets, O-rings for sealing purposes (other than gaskets for motors, cylinders and washer for water taps).

35 – Advertising, marketing and public relations; organization of exhibitions and trade fairs for commercial or advertising purposes; provision of an online marketplace for buyers and sellers of goods and services; auctioneering; business management, business administration and business consultancy; accounting; commercial consultancy services; personnel recruitment, personnel placement, employment agencies, import-export agencies; temporary personnel placement services; office functions; secretarial services; arranging newspaper subscriptions for others; compilation of statistics; rental of office machines; systemization of information into computer databases; telephone answering for unavailable subscribers; the bringing together, for the benefit of others, of a variety of goods, namely, chemicals used in industry, science, photography, agriculture, horticulture and forestry, biological preparations used in industry and science, pectin, lecithin, enzymes and preservative chemicals used in the food industry and vitamins, preservatives and antioxidants used in cosmetics production, manures and soils, unprocessed artificial resins and unprocessed plastics, fire extinguishing compositions, adhesives not for medical, household and stationery purposes, paints, varnishes, lacquers, preservatives against rust, preservatives against deterioration of wood, thinners and binders for paints, pigments, coating materials in the form of paints, preservatives for metals, shoe dyes, printing dyes and ink, toners, filled toner cartridges, colorants for food, pharmaceuticals and beverages, raw natural resins, metals in foil and powder form for painters, decorators, printers and artists, rubber, gutta-percha, gum, asbestos, mica and semi-finished synthetic goods made from these materials in the

form of powder, bars, panels and foils, profile laths made of synthetic materials for vehicles for the purposes of decoration, flexible pipes made from rubber and plastic, hoses made of plastic and rubber, including those used for vehicles, junctions for pipes of plastic and rubber, pipe jackets of plastic and rubber, hoses of textile material, junctions for pipes, not of metal, pipe jackets, not of metal, connecting hose for vehicle radiators, insulation, stopping and sealing materials, insulating paints, insulating fabrics, insulating tape and band, insulation covers for industrial machinery, joint sealant compounds for joints, gaskets, O-rings for sealing purposes (other than gaskets for motors, cylinders and washer for water taps), enabling customers to conveniently view and purchase those goods, such services may be provided by retail stores, wholesale outlets, by means of electronic media or through mail order catalogues.

(260) AM 2026 135033 A

(800) 1868720

(151) 2025 06 02

(891) 2025 06 02

(731) Schweizerische Eidgenossenschaft v.d.
Bundesamt für Rüstung armasuisse
Eidgenössisches Departement für Verteidigung,
Bevölkerungsschutz und Sport
Guisanplatz 1, CH-3003 Bern, Switzerland

(540)

SWISS MILITARY

(591) Black, white

(511)

5 – Portable filled first-aid boxes; filled first-aid boxes; portable first-aid boxes for pets; dressings, bandages; disinfectants; sanitary articles for medical use; all the aforesaid goods of Swiss origin.

(260) AM 2026 135136 A

(800) 1869403

(151) 2025 06 30

(891) 2025 06 30

(731) ASBISc Enterprises PLC
Iapetou 1, Agios Athanasios, CY-4101
Limassol, Cyprus

(540)

A E N O

AI ProDryer

(591) Black, white

(531) 27.05.10; 27.05.17; 27.05.25

(511)

11 – Electrical hair driers.

(260) AM 2026 135137 A

(800) 1869494

(151) 2025 05 27

(891) 2025 05 27

(731) Hongda Civil Explosives Group Co., Ltd.
No. 28, Guangda Road, Lianyi Village,
Zengjiang Street, Zengcheng, Guangzhou
City, 510000 Guangdong Province, China

(540)



(591) Black, white

(531) 01.01.02; 01.01.10; 26.01.04; 26.01.16;
26.01.24; 26.04.05; 26.11.03; 26.11.08;
26.11.13

(511)

13 – Dynamite; explosives; detonators; ammonium nitrate explosives; detonating fuses for explosives; explosive powders; gunpowder; explosive devices; explosive substances; liquid explosives.

(260) AM 2026 135138 A

(800) 1869504

(151) 2025 07 14

(891) 2025 07 14

(731) HOSPITAL & HOMECARE MEDICAL
DEVICE PTE. LTD.
1 RAFFLES PLACE, #02-01, ONE RAFFLES
PLACE, SINGAPORE 048616, Singapore

(540)



(591) Black, white

(531) 07.03.11; 24.17.25; 27.05.01; 27.05.09;
27.05.10

(511)

10 – Sphygmomanometers; medical apparatus and instruments; dental apparatus and instruments; radiotherapy apparatus; beds specially made for medical purposes; breast pumps; condoms; surgical implants comprised of artificial materials; bandages, elastic; catgut.

(260) AM 2026 135139 A

(800) 1869555

(151) 2025 05 23

(891) 2025 05 23

(731) Guangzhou Mastela Commodity Co., Ltd.
Rm 1603, No.166 Huangpu Ave Middle Road,
Tianhe District, Guangzhou, 510630
Guangdong, China

(540)



(591) Black, white
(531) 03.13.01; 03.13.24; 27.05.01
(511)
20 – Infant walkers; high chairs for babies; bassinets;
cots for babies; rocking chairs.

(260) AM 2026 135140 A

(800) 1869589

(151) 2025 05 24

(891) 2025 05 24

(731) Truking Technology Limited
No.1, Xinkang Road, Yutan Town, Ningxiang
City, Changsha City, 410600 Hunan Province,
China

(540)



(591) Blue, white
(531) 26.13.25; 29.01.04
(511)
11 – Germicidal lamps for purifying air; refrigerating
apparatus and machines; cooling installations and ma-
chines; refrigerating appliances and installations; cool-
ing appliances and installations; air dryers; drying
apparatus; air sterilizers; drying apparatus and insta-
llations; desiccating apparatus; furnaces, other than
for laboratory use; germicidal burners; hot air ovens;
pasteurisers.

(260) AM 2026 135141 A

(800) 1869653

(151) 2025 06 27

(891) 2025 06 27

(731) FICOSOTA Ltd.
Blvd. "MADARA" 48, BG-9700 SHUMEN,
Bulgaria

(540)



(591) Purple, gold, white
(531) 01.01.02; 01.01.05; 01.01.10; 27.05.07;
27.05.09; 27.05.17; 29.01.12

(511)

3 – Baby wipes impregnated with cleaning prepara-
tions; tissues impregnated with cosmetic lotions; c-
loths impregnated with a detergent for cleaning.

5 – Babies' diaper-pants; swim diapers, disposable, for
babies.

(260) AM 2026 135142 A

(800) 1869668

(151) 2025 05 23

(891) 2025 05 23

(731) Shenzhen Yizhita Technology Co., Ltd.
1901 Zhongxing Hotel (Qianhai HOP
International), No.19 Xinghua First Road
(Extension Section), Haiwang Community,
Xin'an Street, Bao'an District, Shenzhen City,
Guangdong Province, China

(540)

ATK GEAR

(591) Black, white

(531) 27.05.01

(511)

9 – Mouse pads [computer peripheral]; computer ke-
yboard keycaps; small keyboards for computers; mou-
se [computer peripheral]; wireless computer periphe-
rals; computer keyboards; network communication
equipments; headphones; headsets for use with com-
puters; computer display screens.

(260) AM 2026 135143 A

(800) 1869679

(151) 2025 05 22

(891) 2025 05 22

(731) Joint Stock Company "BIOCAD"
ul. Svyazi, d. 38, str. 1, pomeshch. 89, vn.ter.g.
poselok Strelna, RU-198515 Saint Petersburg,
Russian Federation

(540)

БИОКАД

(591) Black, white

(531) 28.05

(511)

5 – Biological preparations for medical purposes.

(260) AM 2026 135144 A

(800) 1869738

(151) 2024 12 16

(891) 2024 12 16

(731) EGIS Gyógyszergyár Zrt.
30-38 Keresztúri út, H-1106 Budapest,
Hungary

(540)

LEGATISY

(591) Black, white

(511)

5 – Pharmaceutical preparations for human use; vitamin preparations; food supplements; dietary supplements and dietetic preparations; medicinal ointments; medicated skin creams.

(260) AM 2026 135163 A

(800) 1870109

(151) 2025 05 23

(891) 2025 05 23

(731) CATERPILLAR (NI) LIMITED

Old Glenarm Road, Larne BT40 1EJ,
United Kingdom

(540)

COBALTOL

(591) Black, white

(511)

1 – Coolants; ethylene glycol; antifreeze; anti-freeze preparations; chemical additives for lubricants; chemical additives for engine cooling systems; chemical additives for use with internal combustion engine fuels; chemical additives for oils; chemical preparations in the nature of conditioners for enhancing the performance of engine cooling systems; chemical preparations in the nature of cleaners for enhancing the performance of engine cooling systems; hydraulic fluids; oils for hydraulic circuits.

4 – Industrial oils and greases, wax; lubricants; dust absorbing, wetting and binding compositions; fuels and illuminants; industrial oils and greases; lubricating oil; engine oils; anti-seizure lubricating compounds for use on engines; lubricants; non-chemical additives for lubricants; lubricating oils [industrial lubricants]; non-chemical additives for engine oils.

(260) AM 2026 135164 A

(800) 1870166

(151) 2025 06 23

(891) 2025 06 23

(731) UAB "ESSPO"

J. Biliūno g. 17, LT-29111 Anykščiai,
Lithuania

(540)

NORDWING

(591) Black, white

(511)

1 – Ice melting compositions; snow melting agents; rock salt [for deicing]; liquid salt for deicing; additives for frost protection; agents for the prevention of re-icing.

(260) AM 2026 135165 A

(800) 1870170

(151) 2025 07 04

(891) 2025 07 04

(731) MEDI plus TEC Medizinisch-technische
Handelsgesellschaft mbH

Baerler Strasse 100, 47441 Moers, Germany

(540)

SIPAHI

(591) Black, white

(511)

34 – Tobacco products [luxury products], in particular cigarettes and filter cigarettes; cigars and cigarillos; articles for use with tobacco; matches; tobacco sticks; tobacco products for the purpose of being heated; electrical and electronic devices for heating tobacco products, in particular tobacco sticks, as well as tobacco substitutes; electric cigarettes; electronic cigarettes; cigarette cases; cleaning devices and cleaning brushes for electric and electronic cigarettes; liquid solutions and liquid solutions with nicotine for electric and electronic cigarettes; tobacco free oral nicotine pouches [not for medical use]; ashtrays.

(260) AM 2026 135166 A

(800) 1870243

(151) 2025 02 10

(891) 2025 02 10

(731) YAKE (CHINA) CO., LTD.

Wuli Industrial Zone, Jinjiang City, Fujian
Province, China

(540)



(591) Black, white

(531) 05.05.24; 26.04.04; 26.04.18; 27.05.01;
27.05.24

(511)

29 – Meat; fish-based foodstuffs; fruits, tinned; crystallized fruits; vegetables, preserved; eggs; milk products; edible fats; fruit salads; processed nuts; dried edible mushroom; bean curd products; fruit chips, vegetable chips [puffed snack food].

30 – Cocoa product; tea; sugar; fruit jellies [confectionery]; sweets; chocolate; pastries; pies; cereal preparations; instant noodle; bean flour; starch for food; ice cream; cooking salt; soya sauce; condiments; yeast; aromatic preparations for food; meat tenderizers for culinary purposes.

(260) AM 2026 135167 A
 (800) 1870319
 (151) 2025 05 15
 (891) 2025 05 15
 (731) MAEX Limited

Silicon Avenue, 40 Cybercity The Cyberati
 Lounge, C/o Credentia International
 Management Ltd, Ground Floor, The Catalyst,
 Ebene 72201, Mauritius

(540)



Trade ON

(591) Red, blue, purple and black
 (531) 26.04.06; 26.04.09; 26.04.18; 27.05.01;
 27.05.10; 29.01.14

(511)

9 – Identity cards, magnetic; computer software, recorded; encoded magnetic cards; computer game software, recorded; magnetic data media; optical data media; computer software applications, downloadable; electronic publications, downloadable; smart cards [integrated circuit cards]; audiovisual teaching apparatus.

36 – Brokerage; mutual funds; capital investment; exchanging money; loans [financing]; financing services; financial management; lease-purchase financing; securities brokerage; financial analysis; financial consultancy; electronic funds transfer; providing financial information; stock exchange quotations; stocks and bonds brokerage; online banking; provident fund services; stock brokerage services; instalment loans; providing financial information via a website; financial advice; business brokerage.

42 – Computer programming; computer software design; updating of computer software; consultancy in the design and development of computer hardware; maintenance of computer software; computer system analysis; installation of computer software; computer software consultancy; computer virus protection services; computer technology consultancy; development of computer platforms; providing online non-downloadable computer software.

(260) AM 2026 135168 A
 (800) 1870326
 (151) 2025 05 15
 (891) 2025 05 15

(731) The Autonomous Cluster Fund "Park of Innovative Technologies"
 55/8 Mangilik Yel Avenue, Yesil district,
 010000 Astana, Kazakhstan

(540)



(591) Black, white
 (531) 26.01.05; 27.05.01; 27.05.07

(511)

41 – Arranging and conducting of conferences; arranging and conducting of seminars.

42 – Computer security consultancy; artificial intelligence consultancy; computer technology consultancy; hosting computer websites.

(260) AM 2026 135179 A

(800) 810683

(151) 2003 09 24

(891) 2025 06 04

(731) Novartis AG

CH-4002 Basel, Switzerland

(540)

VIGAMOX

(591) Black, white

(511)

5 – Pharmaceutical, veterinary and sanitary products; dietetic substances adapted for medical use, food for babies; plasters, materials for dressings; material for stopping teeth, dental wax; disinfectants; products for destroying vermin; fungicides, herbicides.

(260) AM 2026 135182 A

(800) 1312757

(151) 2016 05 24

(891) 2025 06 25

(731) MAVROGIANNIS EMPORIKI EISAGOGIKI
 VIOTECHNIKI TOURISTIKI XENODOC-
 HIAKI KATASKEYASTIKI ANONIMI
 ETAIRIA

Agioy Alexandroy, GR-716 01 Karteros
 Irakleioy Kritis, Greece

(540)



(591) Orange and brown

(531) 01.03.02; 29.01.12

(511)

3 – Sun creams, sun lotions, cosmetic creams, cosmetic preparations.

(260) AM 2026 135184 A

(800) 1739625

(151) 2023 04 19

(891) 2025 07 09

(731) PUERTAS PADILLA, S.L.

Avda de la Constitución, 73., E-30330 EL
ALBUJÓN – CARTAGENA (Murcia), Spain

(540)



(591) Black, white

(531) 26.04.24; 26.07.20; 26.11.13; 27.05.01

(511)

6 – Common metals and their alloys; building materials of metal; transportable buildings of metal; metallic materials for railway tracks; non-electric cables and wires of metal, ironmongery, small items of metal hardware; tubes of metal; safes [strong boxes]; metal products not included in other classes, namely building products of metal and metal products, semi-processed or unprocessed; ores of metal; aluminum; metal structures; armor plating; padlocks of metal other than electronic; spring locks; metal locks (other than electric); bolts of metal; metal sheets; non-electric door closers; nails; containers of metal; duckboards of metal; staircases of metal; hardware for doors and windows; hardware for building; door and window frames (of metal); porches (metal), mosquito nets (metal frame); furniture fittings of metal; wall claddings (metal); doors of metal; ceilings and tiles of metal; windows of metal; hardware for building, fire doors of metal; fire resistant doors of metal.

19 – Building materials not of metal; rigid pipes, not of metal, for building; asphalt, pitch and bitumen; transportable buildings, not of metal; monuments, not of metal; plywood; shutters, not of metal; roof coverings, not of metal; concrete formwork, not of metal; cement coatings for fireproofing; geotextiles; concrete, sandstone for building; parquet flooring; luminous paving blocks, not of metal; outdoor blinds, not of metal; stone; slate; doors, not of metal; refractory construction materials, not of metal; tiles, not of metal; insulating glass (building); door frames other than of metal; door panels not of metal; security doors not of metal; fire doors not of metal.

(260) AM 2026 135243 A

(800) 1870811

(151) 2025 06 24

(891) 2025 06 24

(731) Shiseido Americas Corporation

390 Madison Avenue, 15th Floor, New York
NY 10017, USA

(540)

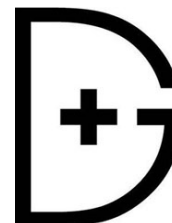

(591) Black, white

(531) 24.17.05; 24.17.07; 27.05.01; 27.05.08;
27.05.22

(511)

3 – Skin care products and skin care preparations, namely, anti-aging cleanser; anti-aging toner; anti-wrinkle creams; cleansing pads impregnated with skin cleansers; cosmetic creams; cosmetic creams for skin care; eye cream; eye gels; face and body beauty creams; face and body creams; face creams for cosmetic use; face toners; facial cleansers; facial moisturizers; a kit for cosmetics, namely, a kit comprising face and skin care lotions, peels, cleansers and creams; lotions for skincare; non-medicated skin creams; a proprietary mixture of anti-aging ingredients sold as an integral component of non-medicated skin care preparations and cosmetics; self-tanning preparations; skin cleansers; skin cleansing cream; skin cleansing lotion; skin creams; skin lotions; skin moisturizer; skin moisturizing gel; non-medicated skin peels; sun block, wrinkle removing skin care preparations, hair care preparations.

5 – Acne treatment preparations.

10 – Beauty devices for skin care, namely, light therapy devices featuring LED lights for the treatment of fine lines, wrinkles and acne.

(260) AM 2026 135252 A

(800) 1871098

(151) 2025 07 14

(891) 2025 07 14

(731) Deciphera Pharmaceuticals, LLC

200 Smith Street, Waltham MA 02451, USA

(540)

DECIPHERA

(591) Black, white

(511)

5 – Pharmaceutical oncology treatments, namely, preparations for gastrointestinal stromal tumors, systemic mastocytosis, glioma, non-small cell lung cancer, germ cell cancer, penile cancer, melanoma and soft tissue sarcoma.

42 – Pharmaceutical research and development; providing scientific research information in the field of pharmaceuticals and clinical trials.

44 – Medical services, namely, medical treatment for gastrointestinal stromal tumors, systemic mastocytosis, glioma, non-small cell lung cancer, germ cell

cancer, penile cancer, melanoma and soft tissue sarcoma.

(260) AM 2026 135253 A

(800) 1871099

(151) 2025 07 14

(891) 2025 07 14

(731) Deciphera Pharmaceuticals, LLC

200 Smith Street, Waltham MA 02451, USA

(540)

QINLOCK

(591) Black, white

(511)

5 – Pharmaceutical oncology treatments, namely, preparations for gastrointestinal stromal tumors, systemic mastocytosis, glioma, non-small cell lung cancer, germ cell cancer, penile cancer, melanoma and soft tissue sarcoma.

44 – Medical services, namely, medical treatment for gastrointestinal stromal tumors, systemic mastocytosis, glioma, non-small cell lung cancer, germ cell cancer, penile cancer, melanoma and soft tissue sarcoma.

(260) AM 2026 135254 A

(800) 1871143

(151) 2025 04 03

(891) 2025 04 03

(731) Limited Liability Company "FIOLINA"

ul. Usacheva, d. 2, srt. 1, pomeshch. 1/2,
vn.ter.g. munitsipal'niy okrug Hamovniki,
RU-119048 Moscow, Russian Federation

(540)



Namqin

(591) White, and dark green

(531) 05.03.13; 05.03.15; 26.13.25; 27.05.01;
29.01.12

(511)

29 – Agar-agar for culinary purposes; aloe vera prepared for human consumption; alginates for culinary purposes; andouillettes; anchovy, not live; peanuts, prepared; artichokes, preserved; white of eggs; beans, preserved; soya beans, preserved, for food; broth; ginger jam; verjuice for culinary purposes; ham; fatty substances for the manufacture of edible fats; laver, preserved; edible birds' nests; cabbage rolls stuffed with meat; peas, preserved; mushrooms, preserved; guacamole; berry-based fool; game, not live; gelatine; meat jellies; jellies for food, other than confectionery; yolk of eggs; coconut fat; bone oil for food; lard; suet

for food; edible fats; fruit-based snack food; milk substitutes; charcuterie; raisins; caviar; aubergine paste; vegetable marrow paste; fish roe, prepared; ginger, preserved; crystallized ginger; pickled ginger; yogurt; sauerkraut; cassoulet; quark; kephir; kimchi; isinglass for food; potato-based dumplings; klipfish [salted and dried cod]; clams, not live; milk shakes; black pudding; onion rings; arrangements of processed fruit; compotes; meat, tinned; vegetables, tinned; fish, tinned; fruits, tinned; duck confits; broth concentrates; vegetable-based concentrate for cooking; fruit-based concentrate for cooking; corn dogs; gherkins; tofu patties; soya patties; shrimps, not live; prawns, not live; buttercream; croquettes; silkworm chrysalis for human consumption; sweet corn, processed; koumiss; spiny lobsters, not live; lecithin for culinary purposes; edible ant larvae, prepared; salmon, not live; onions, preserved; margarine; marmalade; oils for food; peanut butter; cocoa butter for food; coconut oil for food; coconut butter; maize oil for food; sesame oil for food; linseed oil for food; extra virgin olive oil for food; olive oil for food; palm oil for food; palm kernel oil for food; sunflower oil for food; rape oil for food; butter; soya bean oil for food; mussels, not live; almonds, ground; animal marrow for food; shellfish, not live; molluscs, not live; milk; peanut milk; peanut milk for culinary purposes; coconut milk; coconut milk for culinary purposes; almond milk; almond milk for culinary purposes; oat milk; rice milk; rice milk for culinary purposes; albumin milk; curd; condensed milk; soured milk; soya milk; powdered milk; fermented baked milk; fish meal for human consumption; vegetable mousses; fish mousses; fruit pulp; meat; meat, preserved; freeze-dried meat; lactic acid drinks; milk beverages, milk predominating; peanut milk-based beverages; coconut milk-based beverages; almond milk-based beverages; edible insects, not live; sausage casings, natural or artificial; vegetables, preserved; freeze-dried vegetables; vegetables, processed; vegetables, dried; vegetables, cooked; hash browns; potato fritters; olives, preserved; lobsters, not live; omelettes; flavoured nuts; candied nuts; coconut, desiccated; nuts, prepared; tomato paste; pressed fruit paste; liver pâté; pectin for culinary purposes; preserved peppers; liver; pickles; vegetable-based prepared meals for toddlers; jams; powdered eggs; milk products; fish-based foodstuffs; poultry, not live; white pudding; bulgogi; pollen prepared as foodstuff; cranberry compote; tomato purée; apple purée; crayfish, not live; crustaceans, not live; ratatouille; fish, preserved; fish, not live; salted fish; vegetable salads; fruit salads; bacon; sardines, not live; satay; pork; herrings, not live; seeds, prepared; sunflower seeds, prepared; cream [dairy products]; whipped cream; vegetable-based cream; fat-based spreads for bread slices; smetana; lemon juice for culinary purposes; tomato juice for cooking; vegetable juices for cooking; salted meats; sausages; sausages in batter; hot dog sausages; preparations for making bouillon; preparations for making soup; tofu

skin; vegetable-based spreads; nut-based spreads; fruit jelly spreads; tripe; berry soup; soups; vegetable soup preparations; whey; cottage cheese fritters; cheese; tajine [prepared meat, fish or vegetable dish]; tahini; cottage cheese; tempeh; tofu; sea-cucumbers, not live; truffles, preserved; tuna, not live; oysters, not live; falafel; milk ferments for culinary purposes; rennet; fish fillets; dates, processed; crystallized fruits; frozen fruits; fruit, preserved; fruit, processed; fruit preserved in alcohol; fruit, stewed; hazelnuts, prepared; potato flakes; hummus; edible flowers, dried; fruit peel; preserved garlic; lentils, preserved; potato crisps; low-fat potato crisps; fruit chips; choucroute garnie; non-alcoholic eggnog; seaweed extracts for food; meat extracts; berries, preserved; snail eggs for consumption; eggs; yakitori.

30 – Vanilla flavourings for culinary purposes; flavourings, other than essential oils, for cakes; flavourings, other than essential oils, for beverages; coffee flavourings; food flavourings, other than essential oils; star aniseed; baozi; cereal bars; high-protein cereal bars; pancakes; savoury pancakes; freeze-dried dishes with the main ingredient being pasta; freeze-dried dishes with the main ingredient being rice; noodle-based prepared meals; buns; bulgur; bread rolls; pains au chocolat; edible paper wafers; edible rice paper; edible paper; burritos; vanillin [vanilla substitute]; waffles; vermicelli; natural sweeteners; sausage binding materials; binding agents for ice cream; orange blossom water for culinary purposes; seawater for cooking; seaweed [condiment]; malt biscuits; cloves [spice]; mirror icing [mirror glaze]; cake frosting [icing]; glucose for culinary purposes; mustard; croûtons; buckwheat, processed; gluten additives for culinary purposes; yeast for brewing beer; yeast; thickening agents for cooking foodstuffs; leaven; rice-based snack food; cereal-based snack food; cocoa substitutes; coffee substitutes; vegetal preparations for use as coffee substitutes; tea substitutes; dressings for salad; fruit jellies [confectionery]; candy decorations for cakes; confectionery in the form of mousses; confectionery for decorating Christmas trees; cakes; Danish pastries; pastries; peanut confectionery; almond confectionery; confectionery; fruit confectionery; pasta; ground ginger; frozen yogurt [confectionery ices]; cocoa; cream of tartar for culinary purposes; capers; coffee capsules, filled; caramels [sweets]; curry [spice]; ketchup [sauce]; quinoa, processed; quiches; gluten prepared as foodstuff; flour-based dumplings; kombucha; sweets; liquorice [confectionery]; peppermint sweets; mints for breath freshening; liqueur chocolates; dulce de leche; cinnamon [spice]; coffee; unroasted coffee beans; starch for food; crackers; rice crackers; custard; crème brûlée; flavoured jelly crystals for making jelly confectionery; croissants; hominy grits; semolina; oatmeal; crushed barley; groats for human food; ice cubes; corn, milled; corn, roasted; meat pies; fruit coulis [sauces]; turmeric; couscous; laksa; noodles; soba noodles; udon noodles; ice [fro-

zen water]; ice, natural or artificial; edible ices; ice pops; potato-based flatbreads; rice cakes; mayonnaise; macaroons [pastries]; macaroni; maltose; hominy; piccalilli; marinades; marzipan; honey; miso; royal jelly; ice cream; bean flour; buckwheat flour; tapioca flour; potato flour; corn flour; nut flours; flour; wheat flour; soya flour; barley meal; chocolate mousses; muesli; mint for confectionery; cocoa beverages with milk; coffee beverages with milk; coffee-based beverages; cocoa-based beverages; chamomile-based beverages; tea-based beverages; tea beverages with milk; chocolate beverages with milk; chocolate-based beverages; infusions, not medicinal; nougat; gnocchi; crushed oats; husked oats; kimchi pancakes; onigiri; nutmegs [spice]; chocolate-coated nuts; stick liquorice [confectionery]; ginger paste [seasoning]; lozenges [confectionery]; treacle; pâtés en croûte; pelmeni; pepper; allspice; peppers [seasonings]; pesto; biscuits; coconut macaroons; petit-beurre biscuits; bibimbap [rice mixed with vegetables and beef]; pies; noodle-based prepared meals for toddlers; pizzas; meat gravies; spelt, processed; fondants [confectionery]; popcorn; powders for making ice cream; baking powder; mustard meal; pralines; aromatic preparations for food; condiments; meat tenderizers for culinary purposes; cereal preparations; oat-based food; propolis; profiteroles; gingerbread; spices; petits fours; rice pudding; puddings; cake powder; ravioli; ramen; chewing gum for breath freshening; chewing gum; relish [condiment]; rice; prepared rice rolled in seaweed; instant rice; wheat germ for human consumption; spring rolls; sago; crystallized rock sugar; palm sugar; sugar; processed hemp seeds [seasonings]; sesame seeds [seasonings]; linseed for culinary purposes [seasoning]; processed seeds for use as a seasoning; processed squash seeds [seasonings]; aniseed; agave syrup [natural sweetener]; golden syrup; savoury pancake mixes; batter mixes; baking soda [bicarbonate of soda for cooking purposes]; crystallized lemon juice [seasoning]; malt for human consumption; salt for preserving foodstuffs; cooking salt; celery salt; sorbets [ices]; ham glaze; cranberry sauce [condiment]; soya sauce; tomato sauce; apple sauce [condiment]; sauces [condiments]; pasta sauce; spaghetti; seasonings; chocolate-based spreads; chocolate spreads containing nuts; preparations for stiffening whipped cream; shaved ice with sweetened red beans; rusks; bread-crumbs; sushi; sandwiches; tabbouleh; tacos; tamarind [condiment]; tapioca; tarts; dough; pastry dough; almond paste; rice pulp for culinary purposes; cake batter; tortillas; garden herbs, preserved [seasonings]; chocolate decorations for cakes; vinegar; beer vinegar; ferments for dough; halvah; harissa [condiment]; gluten-free bread; unleavened bread; bread; chips [cereal products]; corn flakes; oat flakes; hot dog sandwiches; flowers or leaves for use as tea substitutes; jiaozi; chicory [coffee substitute]; herbal teas; kelp tea; iced tea; tea; chutneys [condiments]; minced garlic [condiment]; cheeseburgers [sandwiches]; choco-

late-covered potato chips; chow-chow [condiment]; saffron [seasoning]; chocolate; malt extract for food; essences for foodstuffs, except etheric essences and essential oils; husked barley.

32 – Aperitifs, non-alcoholic; barley wine [beer]; carbonated water; lithia water; seltzer water; soda water; waters [beverages]; mineral water [beverages]; table waters; kvass; cocktails, non-alcoholic; beer-based cocktails; lemonades; non-alcoholic beverages; non-alcoholic dried fruit beverages; isotonic beverages; non-alcoholic honey-based beverages; rice-based beverages, other than milk substitutes; soya-based beverages, other than milk substitutes; aloe vera drinks, non-alcoholic; whey beverages; protein-enriched sports beverages; soft drinks; non-alcoholic beverages flavoured with coffee; non-alcoholic beverages flavoured with tea; non-alcoholic fruit juice beverages; energy drinks; fruit nectars, non-alcoholic; orgeat; beer; ginger beer; malt beer; powders for effervescing beverages; sarsaparilla [non-alcoholic beverage]; syrups for lemonade; syrups for beverages; starch-based dry mixes for beverage preparation; smoothies; tomato juice [beverage]; apple juice; vegetable juices [beverages]; fruit juices; preparations for making non-alcoholic beverages; preparations for making carbonated water; must; grape must, unfermented; beer wort; malt wort; pastilles for effervescing beverages; shandy; sherbets [beverages]; non-alcoholic fruit extracts; extracts of hops for making beer; non-alcoholic essences for making beverages.

(260) AM 2026 135255 A

(800) 1871154

(151) 2025 05 26

(891) 2025 05 26

(731) Barilla G. e R. Fratelli – Società per Azioni
Via Mantova 166, I-43122 Parma PR, Italy

(540)

THE PASTA TASTE YOU LOVE
PROTEIN 

(591) Blue

(531) 24.17.05; 27.05.01; 29.01.04

(511)

29 – Meat; fish, not live; poultry and game; meat extracts; preserved, frozen, dried and cooked fruits and vegetables; jellies; marmalade; eggs; milk and milk products; edible oils and fats; anchovy, not live; stock; soups; caviar; canned fruits; canned vegetables; cheese; milk shakes; fruit chips; frozen fruits; fruits, preserved; fruit preserved in alcohol; cooked fruits; crystallized fruits; mushrooms, preserved; gelatine; fruit jellies; vegetable soup preparations; vegetable preserves; vegetables, cooked; dried pulses; lentils, preserved; fruit salads; vegetable salads; margarine; whipped cream; cream (dairy products); potato chips;

low-fat potato crisps; fish, preserved; poultry (not live); preparations for making soup; fruit-based snack food; vegetable juices for cooking; tomato juice for cooking; yoghurt.

30 – Coffee; tea; cocoa and coffee substitutes; rice; tapioca and sago; flour and preparations made from cereals; bread; pastry; confectionery; edible ices; sugar; honey; golden syrup; yeast; baking powder; salt; mustard; vinegar; sauce (condiments); spices; ice; oat-based food; farinaceous foods; starch for food; aniseed; star aniseed; seasonings; coffee flavorings (flavourings); flavourings, other than essential oils; plant-based flavourings, other than essential oils, for beverages; flavourings, other than essential oils, for cakes; oatmeal; high-protein cereal bars; stick liquorice (confectionery); cocoa-based beverages; coffee-based beverages; chocolate-based beverages; tea-based beverages; baking soda (bicarbonate of soda for cooking purposes); petit-beurre biscuits; biscuits; malt biscuits; bonbons; brioches; puddings; cocoa; cocoa beverages with milk; coffee beverages with milk; coffee (unroasted -); cinnamon (spice); caramels; condiments; crackers; couscous (semolina); sponge cake; wheat flour; flour; fruit jellies (confectionery); baking powder; macaroni; mayonnaise; rusks; unleavened bread; breadcrumbs; bread rolls; pasta; pesto (sauce); pizza; cereal preparations; ravioli; table salt; tomato sauce; soya sauce; dressings for salad; sandwiches; semolina; hominy grits; cereal-based snack food; rice-based snack food; sorbets (ices); spaghetti; pasta sauce; noodles; tarts; vermicelli (noodles); saffron (seasoning); ginger (spice).

(260) AM 2026 135256 A

(800) 1871182

(151) 2025 06 23

(891) 2025 06 23

(731) Chanel SARM

Quai du Général-Guisan 24, CH-1204 Genève, Switzerland

(540)



(591) Black, white

(531) 19.07.10; 19.07.12; 19.07.25

(554) Three-dimensional

(511)

3 – Preparations for cosmetic use for skin, scalp, hair or nail care; preparations for cosmetic use for application on the skin, scalp, hair or nails; soaps; perfu-

mery products; perfumes; eau de Cologne; eaux de toilette; after-shave lotions; shaving soap; shaving products; essential oils; make-up products; cosmetics; toiletries for non-medical use; talcum powder for toiletry use; deodorants (antiperspirants) for personal use; make-up removing products, tissues impregnated with make-up removing preparations; nail polish removers; cosmetic preparations for tanning the skin, sunscreen preparations; tissues impregnated with cosmetic lotions; massage gels other than for medical use; nail polish; artificial nails for cosmetic use; nail art stickers; adhesives for affixing artificial nails; temporary tattoos for cosmetic use; false eyelashes; perfumed sprays for indoor use; air fragrances; potpourris [fragrances].

(260) AM 2026 135273 A

(800) 1687670

(151) 2022 06 07

(891) 2025 06 30

(731) MUNICH S.L.

Camí de la Serra, s/n. (Vilanova d'Espoia),
E-08789 Torre de Claramunt (Barcelona),
Spain

(540)

duuo

(591) Black, white

(531) 27.05.01

(511)

25 – Clothing, footwear, headwear; coats; layettes [clothing]; bath robes; esparto shoes or sandals; non-slipping devices for footwear; sleep masks; hat frames [skeletons]; motorists' clothing; bibs not of paper; swimsuits; bandanas [neckerchiefs]; bands; headbands [clothing]; bath slippers; bath sandals; overalls; dressing gowns; boas [mufflers]; teddies [undergarments]; berets; footmuffs, not electrically heated; pockets for clothing; lace boots; boots; ski boots; football boots; half-boots; panties; babies' pants [clothing]; socks; leggings [leg warmers]; footwear; sports footwear; beach shoes; boxer shorts; shirts; short-sleeve shirts; sports jerseys; tee-shirts; bodices [lingerie]; boot uppers; shirt yokes; hoods [clothing]; chasubles; vests; shawls; galoshes; jackets; fishing vests; stuff jackets; rain slickers; clothing for cyclists; money belts [clothing]; belts [clothing]; caps; slips [undergarments]; ready-made clothing; combinations [clothing]; heelpieces for footwear; neckties; corselets; corsets [underclothing]; camisoles; collars [clothing]; detachable collars; aprons [clothing]; sports shoes; masquerade costumes; petticoats; fur stoles; girdles [underwear]; skirts; skorts; ready-made linings [parts of clothing]; foulards; top coats; gabardines [clothing]; gymnastic shoes; bathing caps; shower caps; ski gloves; gloves [clothing]; metal fittings for footwear; jerseys [clothing]; leggings [trousers]; body linen [garments]; liveries; sock suspenders; garters; stocking suspenders; muffs [clothing]; maniples; mantillas; stockings; hosiery articles; mittens; miters [hats]; ear muffs [clothing]; footwear uppers; long pants; tights; pocket squares; Ascots; parkas; bootees; shirt fronts; pelerines; pelisses; jumper dresses; furs [clothing]; pajamas; inner soles; beach wear; spats; ponchos; knitwear [clothing]; collar protectors for clothing; pullovers; cuffs; toe caps for footwear; clothing of leather; clothing of imitation leather; clothing for gymnastics; paper clothing; outerclothing; sweat-absorbent underclothing [underwear]; sandals; saris; sarongs; bathing drawers; underpants; dress shields; skull caps; hats; top hats; paper hats [clothing]; brassieres; soles for footwear; sweaters; heels; studs for football boots; suspenders; head coverings [headgear]; wimples; togas; trouser straps; suits; wet suits for water-skiing; turbans; uniforms; veils [clothing]; dresses; clothing (garments); welts for footwear; visors [headwear]; cap peaks; shoes; wooden shoes; footwear uppers; gymnastic footwear; sports shoes [footwear]; ballet flats [footwear]; ladies' footwear; men's footwear; rain footwear; horse riding footwear; Japanese rice straw footwear [wara-ji]; leisure footwear; dance shoes; hiking footwear; footwear for cyclists; running shoes; casual footwear; golf shoes; sports shoes [footwear]; footwear for children; inner socks for footwear; ladies' boots; hiking boots; desert boots; army boots; hiking boots; snow-board boots; walking boots; hiking boots [mountaineering boots]; rubber soles for Japanese jikatabi boots; toe rands for boots; hunting boots; polo boots; ski boots; high boots for fishing; rugby boots; winter boots; studs for football boots; rubber boots (rainwear); trekking boots; lace boots; motorcycle boots; après-ski boots; galoshes; wellington boots; plimsolls; basketball shoes; tennis shoes; trainers; basketball sneakers; house slippers; indoor slippers; dance slippers; ballet shoes; football boots; soles for sports shoes; handball shoes; leather slippers; shoes made of leather; sports socks; slipper-socks; tennis socks; bed socks; sock ons; Japanese style socks (tabi); soquettes [socks]; ankle socks; woolen socks; protective covers for Japanese socks (tabi); sweat-absorbent stockings; footless stockings; heelpieces for stockings.

hing]; leggings [trousers]; body linen [garments]; liveries; sock suspenders; garters; stocking suspenders; muffs [clothing]; maniples; mantillas; stockings; hosiery articles; mittens; miters [hats]; ear muffs [clothing]; footwear uppers; long pants; tights; pocket squares; Ascots; parkas; bootees; shirt fronts; pelerines; pelisses; jumper dresses; furs [clothing]; pajamas; inner soles; beach wear; spats; ponchos; knitwear [clothing]; collar protectors for clothing; pullovers; cuffs; toe caps for footwear; clothing of leather; clothing of imitation leather; clothing for gymnastics; paper clothing; outerclothing; sweat-absorbent underclothing [underwear]; sandals; saris; sarongs; bathing drawers; underpants; dress shields; skull caps; hats; top hats; paper hats [clothing]; brassieres; soles for footwear; sweaters; heels; studs for football boots; suspenders; head coverings [headgear]; wimples; togas; trouser straps; suits; wet suits for water-skiing; turbans; uniforms; veils [clothing]; dresses; clothing (garments); welts for footwear; visors [headwear]; cap peaks; shoes; wooden shoes; footwear uppers; gymnastic footwear; sports shoes [footwear]; ballet flats [footwear]; ladies' footwear; men's footwear; rain footwear; horse riding footwear; Japanese rice straw footwear [wara-ji]; leisure footwear; dance shoes; hiking footwear; footwear for cyclists; running shoes; casual footwear; golf shoes; sports shoes [footwear]; footwear for children; inner socks for footwear; ladies' boots; hiking boots; desert boots; army boots; hiking boots; snow-board boots; walking boots; hiking boots [mountaineering boots]; rubber soles for Japanese jikatabi boots; toe rands for boots; hunting boots; polo boots; ski boots; high boots for fishing; rugby boots; winter boots; studs for football boots; rubber boots (rainwear); trekking boots; lace boots; motorcycle boots; après-ski boots; galoshes; wellington boots; plimsolls; basketball shoes; tennis shoes; trainers; basketball sneakers; house slippers; indoor slippers; dance slippers; ballet shoes; football boots; soles for sports shoes; handball shoes; leather slippers; shoes made of leather; sports socks; slipper-socks; tennis socks; bed socks; sock ons; Japanese style socks (tabi); soquettes [socks]; ankle socks; woolen socks; protective covers for Japanese socks (tabi); sweat-absorbent stockings; footless stockings; heelpieces for stockings.

(260) AM 2026 135275 A

(800) 1829988

(151) 2024 10 16

(891) 2025 08 07

(731) Philip Morris Products S.A.

Quai Jeanrenaud 3, CH-2000 Neuchâtel,
Switzerland

(540)

FOREVER CURIOUS

(591) Black, white

(511)
 34 – Wired vaporizers for electronic cigarettes and electronic smoking devices; tobacco, raw or manufactured; tobacco products, including cigars, cigarettes, cigarillos, tobacco for roll-your-own cigarettes, pipe tobacco, chewing tobacco, snuff tobacco, kretek; snus; tobacco substitutes (not for medical purposes); smokers' articles, namely cigarette paper and tubes, cigarette filters, tobacco tins, cigarette cases and ashtrays, pipes, pocket apparatus for rolling cigarettes, lighters; matches; tobacco sticks, tobacco products for the purpose of being heated, electronic devices and their parts for the purpose of heating cigarettes or tobacco in order to release nicotine-containing aerosol for inhalation; liquid nicotine solutions for use in electronic cigarettes; electronic smoking devices; electronic cigarettes; electronic cigarettes as substitutes for traditional cigarettes; electronic devices for the inhalation of nicotine-containing aerosols; oral vaporizing devices for smokers, tobacco products and tobacco substitutes; smokers' articles for electronic cigarettes; parts and fittings for the aforesaid products included in this class; devices for extinguishing heated cigarettes and cigars as well as heated tobacco sticks; electronic rechargeable cigarette cases.

(260) AM 2026 135276 A
 (800) 1853793
 (151) 2025 02 19
 (891) 2025 07 30
 (731) PHARMEXTRACTA S.p.A.
 Via G. Natta, 28, I-29010 Pontenure (PC), Italy
 (540)

PHARMEXTRACTA

(591) Black, white
 (511)
 5 – Pharmaceuticals; dietary supplements and dietetic preparations; chemical preparations for pharmaceutical purposes; probiotic bacterial formulations for medical use.

(260) AM 2026 135278 A
 (800) 1855718
 (151) 2025 02 28
 (891) 2025 07 31
 (731) RE/MAX, LLC
 5075 S. Syracuse St., DENVER CO 80237,
 USA
 (540)



(591) Red, white, and blue
 (531) 18.05.01; 18.05.06; 29.01.13
 (511)
 35 – Franchising, namely, consultation and assistance in business management, organization and promotion; franchising, namely, offering business management assistance in the establishment and/or operation of real estate brokerage offices; franchise services, namely, offering business management assistance in the establishment and operation of real estate brokerage offices, including an incentive award program for real estate professionals; administration of a customer loyalty program which provides incentive awards to real estate professionals; providing incentive award programs through issuance and processing of loyalty points for purchase of a company's goods and services; advertising services; preparing advertisements for others; creating and updating advertising material; internet advertising services; advertising of commercial or residential real estate; real estate advertising services; real estate marketing services; promoting the goods and services of others; promoting the goods and services of others over the internet; providing consumer information in the field of real estate; personnel recruitment consultancy; referrals in the field of real estate brokerage; business services, namely, registering, screening and verifying the credentials of third-party vendors, suppliers and contractors on behalf of others; arranging and conducting trade shows in the field of real estate and real estate franchise services; real estate auctions.

36 – Real estate brokerage; real estate agency services; real estate consultancy; real estate management services; agencies or brokerage for renting of buildings; real estate valuation services; providing real estate listings and real estate information via the internet; charitable fund raising.

(260) AM 2026 135279 A
 (800) 1857943
 (151) 2025 04 30
 (891) 2025 08 06
 (731) STADA Arzneimittel AG
 Stadastr. 2-18, 61118 Bad Vilbel, Germany
 (540)

AFIVEG

(591) Black, white
 (511)
 5 – Pharmaceuticals, medical and veterinary preparations; medicine; sanitary preparations for medical purposes; dietetic substances and foodstuffs adapted for medical or veterinary use, food for babies; dietary supplements for humans and animals; plasters, materials for dressings; material for stopping teeth, dental wax; disinfectants.
 10 – Surgical, medical, dental and veterinary apparatus and instruments; applicators for medications; me-

dical apparatus for introducing pharmaceutical preparations into the human body; diagnostic apparatus for medical purposes; orthopedic articles; suture materials; therapeutic and assistive devices adapted for the disabled.

(260) AM 2026 135318 A

(800) 1871780

(151) 2025 04 30

(891) 2025 04 30

(731) Deroni Ltd.

Saedinenie Blvd. 86, BG-6300 Haskovo,
Bulgaria

(540)



(591) Black, white

(531) 02.01.17; 02.01.21; 02.01.22; 26.04.19;
27.05.10

(511)

29 – Anchovy, not live; artichokes, preserved; bouillon; broth; shellfish, not live; berries, preserved; vegetable-based prepared meals for toddlers; peas, preserved; guacamole; mushrooms, preserved; ginger, preserved; tomato juice for cooking; tomato puree; tomato paste; jellies for food, other than confectionery; vegetable-based snack food; fruit-based snack food; fish-based snack food; tofu-based snack food; crystallized ginger; crystallized fruits; frosted fruits; cabbage rolls stuffed with meat; vegetable mousses; vegetables, tinned; vegetables, canned; vegetable soup preparations; vegetable salads; vegetable juices for cooking; vegetables, preserved; vegetables, processed; vegetables, cooked; vegetables, dried; extra virgin olive oil for food; olive oil for food; plant-based imitation meat; kimchi; sauerkraut; cranberry compote; fruit, stewed; compotes; preserved peppers; bouillon concentrates; broth concentrates; vegetable-based concentrate for cooking; fruit-based concentrate for cooking; gherkins; vegetable-based cream; spiny lobsters, not live; linseed oil for food; flaxseed oil for food; lentils, preserved; lemon juice for culinary purposes; freeze-dried vegetables; lyophilised vegetables; onions, preserved; edible fats; pickled ginger; marmalade; olives, preserved; molluscs, not live; mollusks, not live; meat, tinned; meat, canned; duck confits; meat, preserved; mussels, not live; sea-cucumbers, not live; cut vegetables; cut fruits; colza oil for food; rape oil for food; lobsters, not live; salted fish; aubergine paste; eggplant paste; vegetable marrow paste; vegetable-based spreads; pectin for culinary purposes; fruit pulp; fruit chips; fruits, tinned; fruits, canned; fruit, preserved; fruit preserved in alcohol; fruit, processed; fruit jelly spreads; fruit salads; crustaceans, not live; oils for food; ratatouille; crayfish, not live; tuna, not live;

fish, tinned; fish, canned; fish, not live; fish, preserved; isinglass for food; fish mousses; fish roe, prepared; fish fillets; sardines, not live; prawns, not live; shrimps, not live; sweet corn, processed; jams; ginger jam; sunflower oil for food; fat-based spreads for bread slices; soya beans, preserved, for food; raisins; oysters, not live; soups; preparations for making bouillon; preparations for making soup; sesame oil for food; salmon, not live; truffles, preserved; beans, preserved; caviar; herrings, not live; fish meal for human consumption; fish-based foodstuffs; hummus; corn oil for food; maize oil for food; preserved garlic; apple puree; clams, not live; nuts, prepared; laver, preserved.

30 – Bulgur; groats for human food; mustard; noodle-based prepared meals for toddlers; garden herbs, preserved [seasonings]; semolina; tomato sauce; buckwheat, processed; instant rice; ketchup [sauce]; quinoa, processed; couscous; freeze-dried dishes with the main ingredient being rice; lyophilised dishes with the main ingredient being rice; freeze-dried dishes with the main ingredient being pasta; relish [condiment]; mayonnaise; noodles; macaroni; marinades; chow-chow [condiment]; yeast; honey; gnocchi; husked barley; husked oats; oat-based food; rice; vinegar; pasta; miso; pesto; piccalilli; fruit jellies [confectionery]; fruit coulis [sauces]; condiments; seasonings; ravioli; crushed barley; soba noodles; soya sauce; doenjang [condiment]; cranberry sauce [condiment]; sauces [condiments]; meat gravies; pasta sauce; dressings for salad; spaghetti; spelt, processed; udon noodles; vermicelli; peppers [seasonings]; apple sauce [condiment]; edible beeswax; edible honeycombs; noodle-based prepared meals.

(260) AM 2026 135319 A

(800) 1871817

(151) 2025 05 29

(891) 2025 05 29

(731) SOLAR INDUSTRIES INDIA LIMITED

Solar House, 14, Kachimet, Amravati Road,
Nagpur 440023, India

(540)

(591) Black, white

(531) 27.05.01; 27.05.04

(511)

13 – Explosives, detonators, ammunition and firearms.

(260) AM 2026 135320 A

(800) 1871856

(151) 2025 07 07

(891) 2025 07 07

(731) Bacardi & Company Limited
Aeulestrasse 5, FL-9490 Vaduz, Liechtenstein
(540)



(591) Blue, white, grey and red
(531) 03.07.06; 03.07.16; 03.07.24; 06.01.02;
06.01.04; 19.07.01; 27.05.01; 27.05.08;
29.01.14
(511)
33 – Alcoholic beverages (except beers); alcoholic preparations for making beverages.

(260) AM 2026 135321 A
(800) 1871874
(151) 2025 07 10
(891) 2025 07 10
(731) FLY GROUP S.R.L.
Str. Vasile Alecsandri nr. 91, ap. (of.) 10,
MD-2012 Chişinău, Republic of Moldova
(540)

TravelOne

(591) Black, white
(511)
39 – Transport; packaging and storage of goods; travel arrangement.

(260) AM 2026 135322 A
(800) 1871883
(151) 2025 06 16
(891) 2025 06 16
(731) RUM ENTERPRISE
142 rue du Bac, F-75007 Paris, France
(540)



(591) Black, grey, brown, white
(531) 19.07.01; 19.07.22; 19.07.23; 29.01.13

(554) Three-dimensional
(511)
33 – Spirits; rums; alcoholic mixed beverages (except beers) based on rum.

(260) AM 2026 135323 A
(800) 1871898
(151) 2025 06 20
(891) 2025 06 20
(731) FERRERO S.P.A.
PIAZZALE PIETRO FERRERO 1, I-12051
ALBA, CUNEO, Italy
(540)



(591) Brown, black, red-orange and light blue
(531) 26.04.06; 27.05.02; 29.01.14
(511)
30 – Pastries; confectionery; chocolate; chocolate products; filled wafers; coated wafers; biscuits; edible ices; ice cream; sorbets [ices].

(260) AM 2026 135324 A
(800) 1871904
(151) 2025 06 16
(891) 2025 06 16
(731) GRUPO VALENJES CA SL
CASP, 118 PRA 4, E-08013 BARCELONA,
Spain
(540)



(591) Red, white, blue and black
(531) 01.01.05; 01.01.09; 05.01.06; 05.01.16;
25.01.06; 27.05.24; 29.01.13
(511)
32 – Non-alcoholic beverages; non-alcoholic beverages; beverages with carbohydrates; kvass [non-alcoholic beverage].

33 – Alcoholic beverages, except beers; alcoholic beverages, except beer; alcoholic beverages (except beer); alcoholic beverages, except beer; alcoholic beverages (except beers); alcoholic beverages (except beers); shochu [alcoholic beverage]; distilled beverages; spirits [beverages].

(260) AM 2026 135325 A
 (800) 1871914
 (151) 2025 07 29
 (891) 2025 07 29
 (731) Ferrara Candy Company
 404 W. Harrison Street, Ste 650, Chicago
 IL 60607, USA
 (540)

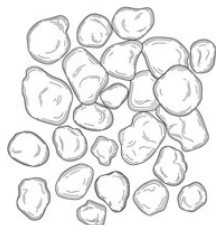

(591) Black, white
 (531) 08.01.19; 26.13.25
 (511)
 30 – Candy.

(260) AM 2026 135326 A
 (800) 1872016
 (151) 2025 03 31
 (891) 2025 03 31
 (731) Limited liability company PROMOMED RUS
 prospekt Mira, d. 13, str. 1, of. 13,
 RU-129090 Moscow, Russian Federation
 (540)

ТИРЗЕТТА

(591) Black, white
 (531) 28.05
 (511)
 3 – Abrasives; amber [perfume]; descaling preparations for household purposes; antistatic preparations for household purposes; aromatics [essential oils]; air fragrancing preparations; cake flavourings [essential oils]; flavourings for beverages [essential oils]; food flavourings [essential oils]; breath freshening sprays; canned pressurized air for cleaning and dusting purposes; balms, other than for medical purposes; basma [cosmetic dye]; lip glosses; nail glitter; body glitter; polishing stones; abrasive paper; emery paper; polishing paper; petroleum jelly for cosmetic purposes; shoe polish; cobblers' wax; cotton wool for cosmetic purposes; cotton wool impregnated with make-up removing preparations; sachets for perfuming linen; drying agents for dishwashing machines; adhesives for cosmetic purposes; scented water; javelle water; lavender water; micellar water; toilet water; wax for parquet floors; floor wax; non-slipping wax for floors; depilatory wax; moustache wax; shoe wax; tailors' wax; creams for leather; polish for furniture and flooring; shoemakers' wax; polishing wax; massage gels, other than for medical purposes; heliotropine; dental bleaching gels; geraniol; starch glaze for laundry purposes; make-up; deodorants for pets; deodorants for human beings or for animals; depilatory preparations;

air fragrance reed diffusers; scented wood; perfumes; non-slipping liquids for floors; windscreen cleaning liquids; greases for cosmetic purposes; volcanic ash for cleaning; perfumery; decorative transfers for cosmetic purposes; ionone [perfumery]; shaving stones [astringents]; smoothing stones; eyebrow pencils; cosmetic pencils; silicon carbide [abrasive]; carbides of metal [abrasives]; alum stones [astringents]; tripoli stone for polishing; adhesives for affixing false eyelashes; adhesives for affixing false hair; hair conditioners; quillaia bark for washing; corundum [abrasive]; beard dyes; colorants for toilet purposes; cosmetic dyes; body paint for cosmetic purposes; starch for laundry purposes; shoe cream; waxes for leather; polishing creams; cosmetic creams; skin whitening creams; essential oil-based creams for aromatherapy use; polishing rouge; incense; hair spray; nail varnish; liquid latex body paint for cosmetic purposes; hair lotions; lotions for cosmetic purposes; after-shave lotions; beauty masks; sheet masks for cosmetic purposes; disposable steam-heated masks, not for medical purposes; oils for perfumes and scents; oils for cosmetic purposes; oils for toilet purposes; essential oils; essential oils for aromatherapy use; essential oils of cedarwood; essential oils of lemon; essential oils of citron; oils for cleaning purposes; bergamot oil; gaultheria oil; jasmine oil; lavender oil; almond oil; rose oil; oil of turpentine for degreasing; whitening; cleaning chalk; almond milk for cosmetic purposes; cleansing milk for toilet purposes; musk [perfumery]; deodorant soap; shaving soap; soap for brightening textile; cakes of toilet soap; antiperspirant soap; soap for foot perspiration; soap; almond soap; mint for perfumery; cosmetic kits; emery; gel eye patches for cosmetic purposes; nail art stickers; double eyelid tapes; false nails; eau de cologne; joss sticks; pastes for razor strops; toothpaste; pumice stone; lipstick cases; hydrogen peroxide for cosmetic purposes; dressings for nail reconstruction; breath freshening strips; teeth whitening strips; sandcloth; glass cloth [abrasive cloth]; lipsticks; pomades for cosmetic purposes; shaving preparations; cosmetic preparations for baths; bath preparations, not for medical purposes; hair straightening preparations; hair waving preparations; laundry soaking preparations; grinding preparations; smoothing preparations [starching]; colour-removing preparations; leather bleaching preparations; polishing preparations; denture polishes; mouthwashes, not for medical purposes; cosmetic preparations for slimming purposes; preparations to make the leaves of plants shiny; eye-washes, not for medical purposes; fabric softeners for laundry use; dry-cleaning preparations; paint stripping preparations; lacquer-removing preparations; make-up removing preparations; floor wax removers [scouring preparations]; varnish-removing preparations; rust removing preparations; nail care preparations; cleaning preparations; preparations for cleaning dentures; wall-paper cleaning preparations; preparations for unblocking drain pipes; chemical cleaning preparations for

household purposes; collagen preparations for cosmetic purposes; bleaching preparations [decolorants] for household purposes; aloe vera preparations for cosmetic purposes; sunscreen preparations; colour-brightening chemicals for household purposes [laundry]; breath freshening preparations for personal hygiene; shining preparations [polish]; make-up powder; diamantine [abrasive]; stain removers; wax melts [fragrancing preparations]; nail varnish removers; vaginal washes for personal sanitary or deodorant purposes; scouring solutions; false eyelashes; antistatic dryer sheets; baby wipes impregnated with cleaning preparations; colour run prevention laundry sheets; tissues impregnated with cosmetic lotions; tissues impregnated with make-up removing preparations; saffrol; massage candles for cosmetic purposes; laundry blueing; turpentine for degreasing; potpourris [fragrances]; bleaching soda; washing soda, for cleaning; bath salts, not for medical purposes; bleaching salts; leather preservatives [polishes]; ammonia [volatile alkali] [detergent]; cooling sprays for cosmetic purposes; astringents for cosmetic purposes; eyebrow cosmetics; make-up preparations; sun-tanning preparations [cosmetics]; hair dyes; neutralizers for permanent waving; laundry glaze; cosmetic preparations for eyelashes; laundry preparations; cosmetic preparations for skin care; dentifrices; cosmetics; cosmetics for children; cosmetics for animals; mascara; cleansers for intimate personal hygiene purposes, non medicated; douching preparations for personal sanitary or deodorant purposes [toiletries]; detergents, other than for use in manufacturing operations and for medical purposes; degreasers, other than for use in manufacturing processes; bleaching preparations [decolorants] for cosmetic purposes; laundry bleach; antiperspirants [toiletries]; toiletry preparations; phytocosmetic preparations; detergent tablets for coffee machines; talcum powder, for toilet use; cotton swabs for cosmetic purposes; terpenes [essential oils]; emery cloth; toners for cosmetic purposes; cloths impregnated with a detergent for cleaning; henna [cosmetic dye]; bath tea for cosmetic purposes; shampoos for animals [non-medicated grooming preparations]; shampoos for pets [non-medicated grooming preparations]; dry shampoos; shampoos; sandpaper; cosmetic stamps, filled; soda lye; herbal extracts for cosmetic purposes; extracts of flowers [perfumes]; ethereal essences; badian essence; mint essence [essential oil]; cosmetics, namely cosmetic gels; cosmetics, namely cosmetic creams; cosmetics, namely cosmetic powders; cosmetics, namely, solutions for cosmetic purposes; cosmetics, namely cosmetic lotions; cosmetics, namely cosmetic balms; cosmetics, namely cosmetic oil.

5 – Acaricides; aconitine; alkaloids for medical purposes; alginates for pharmaceutical purposes; algicides; aldehydes for pharmaceutical purposes; dental amalgams of gold; dental amalgams; amino acids for veterinary purposes; amino acids for medical purposes; analgesics; anaesthetics; antibiotics; antiseptics;

medicine cases, portable, filled; first-aid boxes, filled; aluminium acetate for pharmaceutical purposes; acetates for pharmaceutical purposes; germicides; oxygen cylinders, filled, for medical purposes; balms for medical purposes; bandages for dressings; diagnostic biomarker reagents for medical purposes; biocides; bracelets impregnated with insect repellent; bromine for pharmaceutical purposes; paper for mustard plasters; fly catching paper; reagent paper for veterinary purposes; reagent paper for medical purposes; moth-proofing paper; petroleum jelly for medical purposes; vaccines; oxygen baths; antiseptic cotton; aseptic cotton; absorbent cotton; wadding for medical purposes; cotton for medical purposes; dietetic substances adapted for medical use; radiological contrast substances for medical purposes; nutritive substances for microorganisms; radioactive substances for medical purposes; bismuth subnitrate for pharmaceutical purposes; melissa water for pharmaceutical purposes; seawater for medicinal bathing; mineral waters for medical purposes; thermal water; dietary fibre; moulding wax for dentists; gases for medical purposes; guaiacol for pharmaceutical purposes; massage gels for medical purposes; sexual stimulant gels; haematogen; haemoglobin; hydrastine; hydrastinine; glycerine for medical purposes; glycerophosphates; glucose for medical purposes; gentian for pharmaceutical purposes; hormones for medical purposes; mustard for pharmaceutical purposes; mustard plasters; mud for baths; medicinal mud; contraceptive sponges; gamboge for medical purposes; gurjun balsam for medical purposes; deodorizers for litter trays; deodorants for clothing and textiles; air deodorizing preparations; deodorants, other than for human beings or for animals; diastase for medical purposes; digitalin; vitamin supplement patches; mineral dietary supplements; nutritional supplements; albumin dietary supplements; dietary supplements for animals; yeast dietary supplements; alginate dietary supplements; glucose dietary supplements; casein dietary supplements; lecithin dietary supplements; linseed oil dietary supplements; brewer's yeast dietary supplements; propolis dietary supplements; protein dietary supplements; protein supplements for animals; royal jelly dietary supplements; pollen dietary supplements; wheat germ dietary supplements; linseed dietary supplements; whey protein dietary supplements; acai powder dietary supplements; dietary supplements with a cosmetic effect; enzyme dietary supplements; yeast for pharmaceutical purposes; gelatine for medical purposes; cod liver oil; isotopes for medical purposes; immunostimulants; insecticides; iodine for pharmaceutical purposes; iodides for pharmaceutical purposes; alkaline iodides for pharmaceutical purposes; iodoform; calomel [fungicide]; cream of tartar for pharmaceutical purposes; tartar for pharmaceutical purposes; camphor for medical purposes; cannabidiol for medical use; capsules for medicines; cachets for pharmaceutical purposes; capsules made of dendrimer-based poly-

mers, for pharmaceuticals; haemostatic pencils; wart pencils; caustic pencils; carbolineum [parasiticide]; caustics for pharmaceutical purposes; cachou for pharmaceutical purposes; quassia for medical purposes; quebracho for medical purposes; oxygen for medical purposes; gallic acid for pharmaceutical purposes; acids for pharmaceutical purposes; adhesives for dentures; surgical glues; stem cells for veterinary purposes; stem cells for medical purposes; cocaine for medical purposes; collagen for medical purposes; collodion for pharmaceutical purposes; corn rings for the feet; cannabis for medical purposes; medicated sweets; angostura bark for medical purposes; barks for pharmaceutical purposes; cedar wood for use as an insect repellent; condurango bark for medical purposes; croton bark; mangrove bark for pharmaceutical purposes; myrobalan bark for pharmaceutical purposes; quinquina for medical purposes; medicated animal feed; medicinal roots; rhubarb roots for pharmaceutical purposes; lint for medical purposes; starch for dietetic or pharmaceutical purposes; creosote for pharmaceutical purposes; blood for medical purposes; biological tissue cultures for veterinary purposes; biological tissue cultures for medical purposes; cultures of microorganisms for medical or veterinary use; curare; dental lacquer; liquorice for pharmaceutical purposes; milk sugar for pharmaceutical purposes; adhesive plasters; medicines for alleviating constipation; adhesive tapes for medical purposes; lecithin for medical purposes; lotions for veterinary purposes; medicated hair lotions; lotions for pharmaceutical purposes; medicated after-shave lotions; personal sexual lubricants; lupulin for pharmaceutical purposes; magnesia for pharmaceutical purposes; liniments; ointments for pharmaceutical purposes; sunburn ointments; mercurial ointments; frostbite salve for pharmaceutical purposes; marijuana for medical purposes; gauze for dressings; medicinal oils; mustard oil for medical purposes; camphor oil for medical purposes; castor oil for medical purposes; oil of turpentine for pharmaceutical purposes; dill oil for medical purposes; dental mastics; dental abrasives; dental impression materials; teeth filling material; dressings, medical; surgical dressings; drugs for medical purposes; medicines for veterinary purposes; serotherapeutic medicines; medicines for human purposes; medicines for dental purposes; menthol; medicinal drinks; moleskin for medical purposes; almond milk for pharmaceutical purposes; powdered milk for babies; royal jelly for pharmaceutical purposes; milk ferments for pharmaceutical purposes; Irish moss for medical purposes; flour for pharmaceutical purposes; linseed meal for pharmaceutical purposes; fish meal for pharmaceutical purposes; fly glue; antibacterial soap; disinfectant soap; medicated soap; freeze-dried meat adapted for medical purposes; mint for pharmaceutical purposes; dietetic beverages adapted for medical purposes; malted milk beverages for medical purposes; injectable dermal fillers; bone void fillers comprised of living tissues; narcotics; me-

dicinal infusions; tincture of iodine; eucalyptol for pharmaceutical purposes; tinctures for medical purposes; opium; opodeldoc; aromatic deodorizers for toilets; decoctions for pharmaceutical purposes; antiparasitic collars for animals; cotton sticks for medical purposes; stick liquorice for pharmaceutical purposes; sulfur sticks [disinfectants]; pastilles for pharmaceutical purposes; medicated toothpaste; pectin for pharmaceutical purposes; pepsins for pharmaceutical purposes; peptones for pharmaceutical purposes; hydrogen peroxide for medical purposes; pesticides; food for babies; leeches for medical purposes; blood plasma; nicotine patches for use as aids to stop smoking; eyepatches for medical purposes; poultices; compresses; scapulars for surgical purposes; babies' diapers; diapers for pets; swim diapers, reusable, for babies; swim diapers, disposable, for babies; diapers for incontinence; disposable absorbent mats for lining pet crates; diaper changing mats, disposable, for babies; disposable housebreaking pads for pets; bunion pads; breast-nursing pads; diagnostic strips for testing breast milk for medical purposes; pomades for medical purposes; powder of cantharides; pyrethrum powder; anti-uric preparations; bacterial preparations for medical and veterinary use; bacteriological preparations for medical and veterinary use; balsamic preparations for medical purposes; albuminous preparations for medical purposes; biological preparations for veterinary purposes; biological preparations for medical purposes; veterinary preparations; bismuth preparations for pharmaceutical purposes; vitamin preparations; diagnostic preparations for veterinary purposes; diagnostic preparations for medical purposes; douching preparations for medical purposes; bath preparations for medical purposes; therapeutic preparations for the bath; haemorrhoid preparations; preparations for callouses; lice treatment preparations [pediculicides]; acne treatment preparations; preparations to facilitate teething; preparations for the treatment of burns; opotherapy preparations; air purifying preparations; bronchodilating preparations; preparations for reducing sexual activity; sterilizing preparations; soil-sterilizing preparations; corn remedies; pharmaceutical preparations for treating dandruff; vermin destroying preparations; preparations for destroying noxious animals; herbicides; preparations for destroying dry rot fungus; larvae exterminating preparations; fly destroying preparations; preparations for destroying mice; slug exterminating preparations; pharmaceutical preparations for skin care; contact lens cleaning preparations; preparations of microorganisms for medical or veterinary use; lime-based pharmaceutical preparations; styptic preparations; medicated eye-washes; medicinal hair growth preparations; nutraceutical preparations for therapeutic or medical purposes; opiates; anticryptogamic preparations; aloe vera preparations for pharmaceutical purposes; preparations of trace elements for human and animal use; sulfonamides [medicines]; pharmaceutical preparations; pharmaceutical prepara-

tions for treating sunburn; enzyme preparations for veterinary purposes; enzyme preparations for medical purposes; phytotherapy preparations for medical purposes; chemico-pharmaceutical preparations; chemical preparations for veterinary purposes; chemical preparations for the diagnosis of pregnancy; chemical preparations for medical purposes; chemical preparations for treating diseases affecting cereal plants; chemical preparations for treating wheat blight; chemical preparations for treating diseases affecting vine plants; chemical preparations for treating mildew; chemical preparations for treating phylloxera; chemical preparations for pharmaceutical purposes; chilblain preparations; mothproofing preparations; collyrium; lead water; chemical conductors for electrocardiograph electrodes; albuminous foodstuffs for medical purposes; dietetic foods adapted for medical purposes; by-products of the processing of cereals for dietetic or medical purposes; homogenized food adapted for medical purposes; freeze-dried food adapted for medical purposes; pharmaceuticals; sanitary towels; panty liners [sanitary]; propolis for pharmaceutical purposes; pearl powder for medical purposes; radium for medical purposes; hydrated chloral for pharmaceutical purposes; solvents for removing adhesive plasters; vaginal washes for medical purposes; solutions for contact lenses; chemical reagents for medical or veterinary purposes; gum for medical purposes; rubber for dental purposes; chewing gum for medical purposes; nicotine gum for use as an aid to stop smoking; insect repellents; insect repellent incense; repellents for dogs; tissues impregnated with pharmaceutical lotions; sarsaparilla for medical purposes; sugar for medical purposes; crystallized rock sugar for medical purposes; asthmatic tea; fumigating sticks; massage candles for therapeutic purposes; linseed for pharmaceutical purposes; tobacco-free cigarettes for medical purposes; siccatives [drying agents] for medical purposes; syrups for pharmaceutical purposes; turpentine for pharmaceutical purposes; milking grease; greases for veterinary purposes; greases for medical purposes; lacteal flour for babies; infant formula; soporifics; bicarbonate of soda for pharmaceutical purposes; bath salts for medical purposes; salts for mineral water baths; salts for medical purposes; potassium salts for medical purposes; sodium salts for medical purposes; smelling salts; mineral water salts; malt for pharmaceutical purposes; semen for artificial insemination; alcohol for pharmaceutical purposes; medicinal alcohol; alloys of precious metals for dental purposes; ergot for pharmaceutical purposes; cooling sprays for medical purposes; antibacterial handwashes; adjuvants for medical purposes; astringents for medical purposes; vermifuges; disinfectants; disinfectants for hygiene purposes; disinfectants for chemical toilets; appetite suppressants for medical purposes; medical preparations for slimming purposes; parasiticides; mouthwashes for medical purposes; medicated dentifrices; febrifuges; depuratives; animal washes

[insecticides]; detergents for medical purposes; cattle washes [insecticides]; dog washes [insecticides]; insecticidal veterinary washes; vesicants; purgatives; remedies for perspiration; remedies for foot perspiration; anti-inflammatories; chemical contraceptives; antiparasitic preparations; sedatives; laxatives; tonics [medicines]; medicated toiletry preparations; digestives for pharmaceutical purposes; nervines; bouillons for bacteriological cultures; steroids; headache relief sticks; strychnine; suppositories; serums; tanning pills; appetite suppressant pills; slimming pills; jujube, medicated; antioxidant pills; cotton swabs for medical purposes; sanitary tampons; vulnerary sponges; tetrahydrocannabinol [THC] for medical use; thymol for pharmaceutical purposes; smoking herbs for medical purposes; medicinal herbs; tranquilizers; transplants [living tissues]; surgical implants comprised of living tissues; pants, absorbent, for incontinence; sanitary panties; babies' diaper-pants; charcoal for pharmaceutical purposes; fennel for medical purposes; porcelain for dental prostheses; phenol for pharmaceutical purposes; enzymes for veterinary purposes; enzymes for medical purposes; ferments for pharmaceutical purposes; formic aldehyde for pharmaceutical purposes; phosphates for pharmaceutical purposes; fungicides; quinine for medical purposes; chinoline for medical purposes; diabetic bread adapted for medical use; chloroform; flowers of sulfur for pharmaceutical purposes; cement for animal hooves; bone cement for surgical and orthopaedic purposes; dental cements; medicinal tea; herbal teas for medicinal purposes; bath tea for therapeutic purposes; insecticidal animal shampoos; medicated shampoos; medicated shampoos for pets; pediculicidal shampoos; medicated dry shampoos; pre-filled syringes for medical purposes; eucalyptus for pharmaceutical purposes; herbal extracts for medical purposes; plant extracts for pharmaceutical purposes; tobacco extracts [insecticides]; extracts of hops for pharmaceutical purposes; elixirs [pharmaceutical preparations]; ethers for pharmaceutical purposes; esters for pharmaceutical purposes; cellulose esters for pharmaceutical purposes; cellulose ethers for pharmaceutical purposes; rat poison; poisons; bacterial poisons; jalap; medications; medicines; pharmaceutical substances; food products for therapeutic and prophylactic purposes; medicines, namely, for the treatment of viral diseases; medicines, namely, for the treatment of hepatitis; medicines, namely, for the treatment of coronavirus infection; medicines, namely, for the treatment of HIV infection; medicines, namely, for the treatment of bacterial infections; medicines, namely antibiotics; medicines, namely for the treatment of diseases of the musculoskeletal system; medicines, namely, for the treatment of lung diseases; medicines, namely, for the treatment and prevention of obesity; nutritional supplements for the treatment and prevention of obesity; medicines, namely, for the treatment and prevention of diabetes; nutritional supplements for the treatment

and prevention of diabetes; medicines, namely, immunostimulants; medicines, namely anticoagulants; medicines, namely, analeptics; medicines, namely, analgesic non-narcotic medicines; medicines, namely antihypertensives; medicines, namely, antioxidants; medicines, namely, antiseptics; medicines, namely selective beta1-blockers; medicines, namely vasodilators; medicines, namely, venotonic and venoprotective agents; medicines, namely vitamins; medicines, namely, hemostatic agents; medicines for weight reduction; preparations namely, glucocorticosteroids; medicines, namely, detoxification agents; medicines, namely diuretics; medicines, namely, cardiotonic drugs of a non-glycoside structure; medicines, namely, coronary dilating agents of reflex action; medicines, namely, correctors of cerebrovascular disorders; medicines, namely, local anesthetics; medicines, namely local irritants; medicines, namely, metabolic agents; medicines, namely painkillers; medicines, namely non-steroidal anti-inflammatory drugs; medicines, namely, plasma substitutes; medicines, namely antimicrobial agents; medicines, namely antifungal agents; medicines, namely anticancer drugs; medicines, namely antiemetics; medicines, namely anti-scabies; medicines, namely, rehydrating agents; medicines, namely, reparants; medicines, namely, tissue repair stimulant of natural origin; medicines, namely, antispasmodics; medicines, namely, means of carbon nutrition for medical purposes; medicines, namely electrolytes for medical purposes; medicines, namely tablets [pharmaceuticals]; medicines, namely medicines in the form of capsules; medicines, namely medicated powders; medicines, namely, lyophilizates for medical purposes; medicines, namely medicinal solutions; medicines, namely, medicinal solutions for injections; medicines, namely solutions for infusions; medicines, namely, concentrates for pharmaceutical purposes for the preparation of solutions for infusions and injections; medicines, namely medicated gels; medicines, namely, medicated ointments; medicines, namely medicated creams; medicines, namely, liniments; medicines, namely suppositories.

35 – Arranging subscriptions to telecommunication services for others; import-export agency services; commercial information agency services; advertising agency services; cost price analysis; rental of cash registers; rental of office equipment in co-working facilities; rental of advertising space; business auditing; financial auditing; business intermediary services relating to the matching of potential private investors with entrepreneurs needing funding; employment agency services; computerized file management; book-keeping; invoicing; demonstration of goods; transcription of communications [office functions]; opinion polling; market studies; business investigations; business research; marketing research; personnel recruitment; business organization consultancy; business management consultancy; personnel management consultancy; professional business consultancy; consul-

tancy regarding advertising communication strategies; consultancy regarding public relations communication strategies; layout services for advertising purposes; marketing; marketing in the framework of software publishing; influencer marketing; targeted marketing; business management of performing artists; business management of sports people; writing of curriculum vitae for others; writing of publicity texts; script-writing for advertising purposes; news clipping services; updating and maintenance of information in registries; updating and maintenance of data in computer databases; updating of advertising material; word processing; online retail services for downloadable and pre-recorded music and movies; online retail services for downloadable ring tones; online retail services for downloadable digital music; organization of exhibitions for commercial or advertising purposes; arranging newspaper subscriptions for others; arranging subscriptions to electronic toll collection [ETC] services for others; organization of fashion shows for promotional purposes; organization of trade fairs; shop window dressing; business appraisals; preparation of business profitability studies; payroll preparation; data search in computer files for others; sponsorship search; administrative assistance in responding to calls for tenders; business management assistance; commercial or industrial management assistance; commercial intermediation services; providing business information; providing business information via a website; providing commercial and business contact information; providing telephone directory information; providing commercial information and advice for consumers in the choice of products and services; provision of an online marketplace for buyers and sellers of goods and services; providing user reviews for commercial or advertising purposes; web indexing for commercial or advertising purposes; providing user rankings for commercial or advertising purposes; presentation of goods on communication media, for retail purposes; media relations services; auctioneering; conducting of commercial events; economic forecasting; sales promotion for others; promotion of goods and services through sponsorship of sports events; promotion of goods through influencers; production of teleshopping programmes; production of advertising films; office machines and equipment rental; rental of advertising time on communication media; publicity material rental; rental of billboards [advertising boards]; rental of vending machines; rental of sales stands; rental of photocopying machines; consumer profiling for commercial or marketing purposes; publication of publicity texts; radio advertising; development of advertising concepts; bill-posting; distribution of samples; dissemination of advertising matter; direct mail advertising; registration of written communications and data; advertising; online advertising on a computer network; outdoor advertising; advertising by mail order; television advertising; compilation of statistics; compilation of information

into computer databases; business inquiries; systemization of information into computer databases; administrative services for medical referrals; corporate communications services; negotiation of business contracts for others; negotiation and conclusion of commercial transactions for third parties; compiling indexes of information for commercial or advertising purposes; tax preparation; drawing up of statements of accounts; telemarketing services; psychological testing for the selection of personnel; interim business management; outsourced administrative management for companies; business management of hotels; business management for freelance service providers; business project management services for construction projects; commercial administration of the licensing of the goods and services of others; business management of reimbursement programmes for others; computerized management of medical records and files; administration of consumer loyalty programs; administration of frequent flyer programs; administrative processing of purchase orders; administrative services for the relocation of businesses; public relations; commercial lobbying services; competitive intelligence services; business consulting services for digital transformation; advisory services for business management; lead generation services; modelling for advertising or sales promotion; typing; online ordering services in the field of restaurant take-out and delivery; market intelligence services; appointment reminder services [office functions]; data processing services [office functions]; website traffic optimization; wholesale services for pharmaceutical, veterinary and sanitary preparations and medical supplies; appointment scheduling services [office functions]; tax filing services; search engine optimization for sales promotion; retail services for works of art provided by art galleries; retail services for pharmaceutical, veterinary and sanitary preparations and medical supplies; retail services relating to bakery products; gift registry services; price comparison services; business intermediary services relating to the matching of various professionals with clients; reception services for visitors [office functions]; pay per click advertising; advertising services to create brand identity for others; secretarial services; procurement services for others [purchasing goods and services for other businesses]; shorthand; outsourcing services [business assistance]; telephone answering for unavailable subscribers; telephone switchboard services; photocopying services; business efficiency expert services; retail and wholesale services; wholesale services; retail services; online ordering services; retail or wholesale services for medicines; online ordering services for medicines; retail and wholesale services for nutritional supplements; retail and wholesale services for food products; retail and wholesale services for cosmetics; retail or wholesale services for medical supplies.

(260) AM 2026 135327 A
 (800) 1872025
 (151) 2025 07 25
 (891) 2025 07 25
 (731) Vandemoortele Lipids, naamloze vennootschap
 Ottergemsesteenweg-Zuid 816, B-9000 Gent,
 Belgium

(540)



(591) Blue
 (531) 27.05.25; 29.01.04
 (511)
 29 – Edible oils and fats.

(260) AM 2026 135328 A
 (800) 1872033
 (151) 2024 06 07
 (891) 2024 06 07
 (731) Limited Liability Company TH GRASS
 Rokossovsky str., 41, Volgograd city,
 RU-400012 Volgograd region, Russian
 Federation

(540)

my muse

(591) Black, white
 511)
 3 – Fragrances [essential oils]; air fragrances; compressed air cylinders for cleaning and dust removal; balms, except for those used for medical purposes; basma [cosmetic dye]; polishing bars; abrasive paper; sandpaper; polishing paper; cotton wool impregnated with preparations for removing make-up; aromatic substances for perfuming linen; moisture-absorbing substances for dishwashers (term considered too vague by the International Bureau pursuant to Rule 13 (2) (b) of the Regulations); wax for parquet floors; floor wax; anti-slip floor wax; creams for leather; polish for furniture and flooring; polishing wax; massage gels, other than for medical purposes; air fragrance reed diffusers; non-slipping liquids for floors; windscreen cleaning liquids; cosmetic creams; skin whitening creams; hair lotions; lotions for cosmetic purposes; aftershave lotions; cosmetic masks; oils for perfumes and scents; cosmetic oils; oils for toilet purposes; essential oils; essential oils of cedarwood; essential oils of lemon; essential oils of citron; oils for cleaning purposes; bergamot oil; gaultheria oil; jasmine oil; lavender oil; almond oil for cosmetic purposes; rose oil; oil of turpentine for degreasing; cleansing milk for toilet purposes; soaps; deodorizing soaps; shaving soaps; soap for brightening textile; cakes of toilet soap; antiperspirant soap; soap for foot perspiration; almond soap; cosmetic kits; incense sticks; non-medicated dentifrices; teeth whitening strips; abrasive cloth; glass cloth [abrasive cloth]; shaving preparations; cos-

metic preparations for baths; bath preparations, not for medical purposes; hair straightening preparations; cosmetic hair care preparations; hair waving preparations; laundry soaking preparations; smoothing preparations [starching]; colour-removing preparations; leather bleaching preparations; polishing preparations; mouthwashes, not for medical purposes; starch glaze for laundry purposes; fabric softeners for laundry use; laundry preparations; dry cleaning preparations; paint stripping preparations; lacquer-removing preparations; make-up removing preparations; loor wax removers [scouring preparations] (term considered too vague by the International Bureau pursuant to Rule 13 (2) (b) of the Regulations); rust removing preparations; cleaning preparations; preparations for unblocking drain pipes; chemical cleaning preparations for household purposes; bleaching preparations [decolorants] for household purposes; preparations for washing; aloe vera preparations for cosmetic purposes; sunscreen preparations; colour-brightening chemicals for household purposes [laundry]; stain removers; scouring solutions; baby wipes impregnated with cleaning preparations; colour run prevention laundry sheets; tissues impregnated with cosmetic lotions; tissues impregnated with make-up removing preparations; laundry blueing; turpentine for degreasing; potpourris [fragrances]; bleaching soda; washing soda, for cleaning; bath salts, not for medical purposes; bleaching salts; leather preservatives [polishes]; astringents for cosmetic purposes; sun-tanning preparations [cosmetics]; cosmetic preparations for skin care; exfoliants; foam cleaning preparations; cleansing mousse; cleansing gels; perfumed body sprays; shoe wax; dentifrices; cosmetics; decorative cosmetics; cosmetics for children; cleansers for intimate personal hygiene purposes, non-medicated; douching preparations for personal sanitary or deodorant purposes [toiletries]; detergents, other than for use in manufacturing operations and for medical purposes; degreasing preparations, other than for use in manufacturing processes; toiletry products; antiperspirants [toiletries]; phyto-cosmetic preparations; cotton swabs for cosmetic purposes; emery cloth; cloths impregnated with a detergent for cleaning; shampoos; dry shampoos.

21 – Heads for electric toothbrushes; hair combs; make-up sponges; sponges for household purposes; sponge holders; toothpick holders; soap holders; napkin holders; shaving brush holders; toilet paper holders; soap dispensing bottles; plug-in diffusers for mosquito repellents; aromatic oil diffusers, other than reed diffusers, electric and non-electric; glass flasks [containers]; chamois leather for cleaning; toothpicks; shaving brushes; make-up brushes; polishing leather; cosmetic spatulas; valet trays [receptacles for small objects] for household purposes; polishing materials for making shiny, except preparations, paper and stone; toiletry bags; dental floss; abrasive mitts for scrubbing the skin; droppers for cosmetic purposes; plates for diffusing aromatic oil; cosmetic utensils; deodorizing

apparatus for personal use; make-up removing appliances; powder compacts, empty; perfume sprayers; powder puffs; foam toe separators for use in pedicures; combs; electric combs; shoe horns; squeegees [cleaning instruments]; currycombs; smart medicine bottles, empty; water apparatus for cleaning teeth and gums; electric devices for attracting and killing insects; watering devices; ultrasonic pest repellers; flasks for cosmetics; comb cases; cosmetic stamps, empty; brushes; sound wave vibration hairbrushes; scrubbing brushes; toothbrushes; electric toothbrushes; shoe brushes; eyebrow brushes; nail brushes; eyelash brushes.

(260) AM 2026 135329 A

(800) 1872038

(151) 2025 03 26

(891) 2025 03 26

(731) MİKRON-S MİKRONİZE MİNERAL
ENDÜSTRİSİ VE TİCARET ANONİM
ŞİRKETİ
SULTANTEPE MAHALLESİ, HÜSEYİN
BAYKARA SOKAK 3 3, Üsküdar İstanbul,
Türkiye

(540)



(591) Red, blue, grey, black, brown and white

(531) 01.13.15; 26.04.09; 27.05.01; 29.01.13

(511)

1 – Chemicals used in industry, science, photography, agriculture, horticulture and forestry; micronized calcium carbonate; micronized coated calcium carbonate (coated with stearic acid); micronized talc [magnesium silicate]; micronized barite; micronized kaolin; micronized calcined kaolin for industrial purposes; granulated calcium carbonate; animal manure; potting soil; soil for growing; unprocessed artificial resins and unprocessed plastics; fire extinguishing compositions; adhesives for industrial purposes.

(260) AM 2026 135330 A

(800) 1872064

(151) 2025 06 04

(891) 2025 06 04

(731) ARENSIA Exploratory Medicine GmbH
Speditionstraße 13, 40221 Düsseldorf,
Germany

(540)



(591) Red and black
 (531) 04.05.03; 26.11.03; 26.11.12; 27.05.10;
 29.01.12

(511)
 42 – Clinical trials; clinical and medical research; scientific research services and conducting scientific experiments; preparation of scientific reports; research on the subject of pharmaceuticals; consultancy in relation to scientific research; scientific consultancy services.

(260) AM 2026 135331 A

(800) 1872086

(151) 2025 06 18

(891) 2025 06 18

(731) SLOBODIANIUK VIKTOR PETROVICH
 Orekhovaya street, 2, Rudnytsya village,
 Tulchinsky district, Vinnitsa region, Ukraine

(540)



(591) White, green, dark-green, light-green, yellow and brown

(531) 07.15.08; 23.03.10; 23.03.13; 28.05; 29.01.14
 511)

6 – Aluminium wire; fasteners of metal for scaffolds; drywall corner beads of metal [building materials]; framework of metal for building; ironmongery and small items of metal hardware; ironmongery; cable junction sleeves of metal; couplings of metal for pipes; wire; wire of common metal; soldering wire of metal; welding wire; welded wire mesh; iron wire; steel strip; posts of metal; steel plates and sheets; copper wire, not insulated; rods of metal for welding; rods of metal for brazing; rods of metal for brazing and welding; common metals and their alloys; structures and transportable buildings of metal; silver solder; steel wire; cold-finished steel bars; steel packaging strips; steel buildings; metallic strip; hard solder; nails of metal; anchors of metal; connector anchors of metal; rods of metal for brazing and welding, including those made from alloy steel and titanium; brazing rods; spelters for welding.

7 – Abrasive wheels for power-operated grinders; grindstones [parts of machines]; flap discs for power-operated grinders; abrasive disks for power-operated sanders; circular saw blades being parts of machines; cutting discs for use as parts of machines; electric arc cutting apparatus; taps being machine tools; die-cutting and tapping machines; machine tools for cutting, threading machines; metalworking machines; gas-operated blow torches; metal welding machines, electric; machine tools; metal drawing machines; hydraulic engines and motors; electric hand drills; chisels for machines; steam engine boilers; foundry machines; sizing machines; slitting machines for industrial use;

metalworking machinery; machine tools for working metals; sifting machines; sifting installations; robotic cutters; industrial robots; agricultural machines; packing machines; grinding machines.

(260) AM 2026 135332 A

(800) 1872090

(151) 2025 07 11

(891) 2025 07 11

(731) "NL CONTINENT" LIMITED LIABILITY
 COMPANY

st. Yadrinsevskaya, 53/1, office 1015,

RU-630099 Novosibirsk, Russian Federation

(540)



(591) Black, white

(531) 27.05.01; 27.05.10; 27.05.24

(511)

5 – Amino acids for medical purposes; dietary fibre; mineral dietary supplements; nutritional supplements; albumin dietary supplements; alginate dietary supplements; glucose dietary supplements; casein dietary supplements; lecithin dietary supplements; linseed oil dietary supplements; protein dietary supplements; wheat germ dietary supplements; linseed dietary supplements; whey protein dietary supplements; dietary supplements with a cosmetic effect; enzyme dietary supplements; immunostimulants; milk ferments for pharmaceutical purposes; dietetic beverages adapted for medical purposes; albuminous preparations for medical purposes; vitamin preparations; preparations of trace elements for human and animal use; albuminous foodstuffs for medical purposes; dietetic foods adapted for medical purposes.

21 – Bottles; containers for household or kitchen use; kitchen containers; cups of paper or plastic; cocktail shakers.

29 – Milk shakes; milk beverages, milk predominating; milk substitutes; freeze-dried vegetables; vegetables, processed; vegetables, dried; vegetables, cooked; fruit, processed; fruit, stewed; flavoured nuts; candied nuts; coconut, desiccated; nuts, prepared; berries, preserved.

30 – Flavourings, other than essential oils, for beverages; coffee flavourings; food flavourings, other than essential oils; macaroons [pastries]; muesli; cocoa beverages with milk; coffee beverages with milk; coffee-based beverages; cocoa-based beverages; chocolate beverages with milk; chocolate-based beverages; biscuits; coconut macaroons; petit-beurre biscuits; cereal preparations; corn flakes; oat flakes.

32 – Cocktails, non-alcoholic; non-alcoholic beverages; whey beverages; preparations for making non-alcoholic beverages; smoothies; starch-based dry mixes for beverage preparation.

(260) AM 2026 135333 A

(800) 1872093

(151) 2025 07 08

(891) 2025 07 08

(731) Maryna Ilina

50E, Amathountos str., Pearl Building, Flat 1,
Agios Tychonas, CY-4532 Limassol,
Cyprus

(540)

RedCore

(591) Black, white

(511)

9 – Computer software platforms; computer software for controlling and managing access server applications; computer software for mobile phones; computer software for use on handheld mobile digital electronic devices and other consumer electronics; downloadable software; machine learning software; artificial intelligence software; data processing programs recorded on machine-readable data carriers; platform software; simulation software; computer software for use in providing multiple user access to a global computer information network; all the aforesaid goods not for measuring, analysing, evaluating, monitoring or diagnosing reputation, corporate image or business perception, and for the preparation of business intelligence reports on reputation or corporate image; electronic control apparatus; downloadable publications; electronic databases; scientific research and laboratory apparatus; educational apparatus and simulators.

42 – Scientific and technological services; scientific research; technological research; industrial analysis and research services; research and development of new products; design and development of new technology for others; conducting of technical feasibility studies; conducting of scientific studies; software development; technological consultancy; consultancy services relating to computing; artificial intelligence consultancy; development and testing of computing methods, algorithms and software; consultancy in the field of industrial research; consultancy in the field of scientific research; technical project studies; research services; software research; software design.

(260) AM 2026 135334 A

(800) 1872132

(151) 2025 07 22

(891) 2025 07 22

(731) Medice Arzneimittel Pütter GmbH & Co. KG
Kuhloweg 37, 58638 Iserlohn,
Germany

(540)

Dorisept

(591) Black, white

(511)

5 – Dietary supplements and dietetic preparations; medicine; pharmaceuticals; medical preparations.

(260) AM 2026 135336 A

(800) 1872342

(151) 2025 06 27

(891) 2025 06 27

(731) "Jupekchi" Economic Society

H7, Berkarar Business Centre, Ataturk (1972)
ave., Kopetdag distr., Ashgabat city,
Turkmenistan

(540)



(591) Black, white

(531) 25.01.13; 27.05.17

(511)

32 – Beers; mineral waters, sparkling waters and other non-alcoholic drinks; flavoring syrups for making beverages; flavored and unflavored bottled waters; fruit juices and juice based beverages; soda beverages; syrups.

(260) AM 2026 135337 A

(800) 1872343

(151) 2025 06 27

(891) 2025 06 27

(731) "Jupekchi" Economic Society

H7, Berkarar Business Centre, Ataturk (1972)
ave., Kopetdag distr., Ashgabat city,
Turkmenistan

(540)

Hoşal kids

(591) Black, white

(511)

32 – Beers; mineral waters, sparkling waters and other non-alcoholic drinks; flavoring syrups for making beverages; flavored and unflavored bottled waters; fruit juices and juice based beverages; soda beverages; syrups.

(260) AM 2026 135338 A

(800) 1872383

(151) 2025 07 10

(891) 2025 07 10

(731) "INTERNATIONAL MASIS TABAK" LLC

Hrant Vardanyan str. 10, 0802 Masis, Ararat
Region, Armenia

(540)



(591) Red, dark red, burgundy, gold and black
(531) 02.09.01; 05.03.13; 25.01.25; 26.04.09;
26.04.16; 26.04.18; 26.04.24; 27.05.01;
27.05.02; 27.05.24; 27.05.25; 29.01.15

(511)

34 – Matches; tips of yellow amber for cigar and cigarette holders; tobacco; tobacco pouches; cigarette tips; cigarette filters; lighters for smokers; gas containers for cigar lighters; tobacco pipes; books of cigarette papers; absorbent paper for tobacco pipes; chewing tobacco; cigars; cigar cutters; cigar cases; cigarette cases; cigar holders; cigarettes containing tobacco substitutes, not for medical purposes; cigarettes; pocket machines for rolling cigarettes; cigarette holders; mouthpieces for cigarette holders; cigarette paper; cigarrillos; pipe cleaners for tobacco pipes; firestones; herbs for smoking; pipe racks for tobacco pipes; match holders; tobacco jars; snuff; snuff boxes; match boxes; ashtrays for smokers; spittoons for tobacco users; humidors; electronic cigarettes; liquid solutions for use in electronic cigarettes; oral vaporizers for smokers; flavourings, other than essential oils, for tobacco; wicks adapted for cigarette lighters; hookahs; accessories and articles for hookahs (including hookah clay bowls and headgears), hookah hose; hookah pipes and filters, hookah hooks, hookah hoses with pipes (mouthpieces), hookah shaft, bags and cases for hookah, hookah water bowls; molasses for use in tobacco production; smoking articles; tobacco and molasses aromatic mixtures for use in hookah.

(260) AM 2026 135339 A

(800) 1872555

(151) 2025 07 29

(891) 2025 07 29

(731) Ferrara Candy Company

404 W. Harrison Street, Ste 650, Chicago IL
60607, USA

(540)



(591) The color(s) white, blue, green, yellow, pink and purple is/are claimed as a feature of the mark

(531) 01.15.11; 26.01.06; 27.05.02; 27.05.10;
29.01.15

(511)

28 – Toy figures; plush toys; fantasy character toys.

(260) AM 2026 135340 A

(800) 1872656

(151) 2025 06 25

(891) 2025 06 25

(731) NOVARTIS AG

CH-4002 Basel, Switzerland

(540)

ХАВЛУМИО

(591) Black, white

(531) 28.05

(511)

5 – Pharmaceutical preparations.

(260) AM 2026 135341 A

(800) 1872657

(151) 2025 07 16

(891) 2025 07 16

(731) BIOFARMA

50 rue Carnot, F-92284 Suresnes Cedex, France

(540)

BLOVARAK

(591) Black, white

(511)

5 – Cardiovascular pharmaceutical products; pharmaceutical products for prevention of diseases of the metabolic system; pharmaceutical products for treatment of diseases of the metabolic system.

(260) AM 2026 135358 A

(800) 1873007

(151) 2025 07 25

(891) 2025 07 25

(731) DORA KOZMETİK SANAYİ VE DIŞ

TİCARET LİMİTED ŞİRKETİ

İKİTELLİ OSB MAH., MUTFAKÇILAR M4

BLOK SK., MUTFAKÇI LAR SANAYİ M4

BLOK 4, Başakşehir, TR-34034 İstanbul, Türkiye

(540)

BR
BLACK RED

(591) Black, white

(531) 27.05.01; 27.05.09

(511)

3 – Perfumery; cosmetics; shampoos; hair care preparations; hair styling preparations; cosmetics, namely

creams, milks, lotions, gels and powders for the face, hair, body and hands; essential oils; fragrances; deodorants for personal use; soaps.

(260) AM 2026 135413 A

(800) 1873275

(151) 2025 07 25

(891) 2025 07 25

(731) DORA KOZMETİK SANAYİ VE DIŞ
TİCARET LİMİTED ŞİRKETİ
İKİTELLİ OSB MAH., MUTFAKÇILAR M4
BLOK SK., MUTFAKÇI LAR SANAYİ M4
BLOK 4, Başakşehir, TR-34034 İstanbul,
Türkiye

(540)

BIANNA
THE BEAUTY ATELIER

(591) Black, white

(531) 27.05.01; 27.05.09

(526) the beauty atelier

(511)

3 – Perfumery; cosmetics; shampoos; hair care preparations; hair styling preparations; cosmetics, namely creams, milks, lotions, gels and powders for the face, hair, body and hands; essential oils; fragrances; deodorants for personal use; soaps.

(260) AM 2026 135415 A

(800) 1873345

(151) 2025 06 24

(891) 2025 06 24

(731) NOVARTIS AG
CH-4002 BASEL, Switzerland

(540)

AKLANTO

(591) Black, white

(531) 28.05

(511)

5 – Pharmaceutical preparations.

(260) AM 2026 135416 A

(800) 1873354

(151) 2024 11 19

(891) 2024 11 19

(731) China Energy Investment Corporation Limited
No. 22 Xibinhe Road, Andingmen, Dongcheng
District, 100011 Beijing, China

(540)

国家能源集团
CHN ENERGY

(591) Black, white

(531) 27.05.01; 27.05.22; 28.03

(511)

1 – Unprocessed polyethylene resins; unprocessed polypropylene resins; acetal copolymer.

(260) AM 2026 135417 A

(800) 1873401

(151) 2025 06 27

(891) 2025 06 27

(731) National Paints Holdings Ltd.
Dubai International Financial Center, Gate
Village\Building 4\ Level 3\ Unit 5, Dubai,
United Arab Emirates

(540)

**NATIONAL
PAINTS**

(591) Black, white

(531) 26.07.04; 27.05.10; 27.05.24

511)

2 – Paints, varnishes, and lacquers; rust preventatives and wood preservatives; colorants*; color masterbatch; masterbatches for coloring of plastic materials; color fixatives; raw natural resins; metals in flakes or powder form for the use of painters, decorators, printers, and artists.

(260) AM 2026 135418 A

(800) 1873457

(151) 2025 07 22

(891) 2025 07 22

(731) KRKA, tovarna zdravil, d.d., Novo mesto
Šmarješka cesta 6, SI-8000 Novo mesto,
Slovenia

(540)

MEMPEGLYN

(591) Black, white

(511)

5 – Pharmaceutical preparations.

(260) AM 2026 135419 A

(800) 1873460

(151) 2025 07 22

(891) 2025 07 22

(731) KRKA, tovarna zdravil, d.d., Novo mesto
Šmarješka cesta 6, SI-8000 Novo mesto,
Slovenia

(540)

MEMPOGLYN

(591) Black, white

(511)

5 – Pharmaceutical preparations.

(260) AM 2026 135420 A
 (800) 1873509
 (151) 2025 08 01
 (891) 2025 08 01
 (731) Bayer Aktiengesellschaft
 Kaiser-Wilhelm-Allee, 51373 Leverkusen,
 Germany
 (540)



(591) Dark blue, cerise red and bright green
 (531) 04.05.03; 26.01.03; 29.01.13
 (511)
 5 – Pharmaceutical preparations, for use in the following fields: treatment of oncological indications; pharmaceutical preparations for the treatment and prevention of inflammatory indications.

(260) AM 2026 135423 A
 (800) 1873666
 (151) 2025 03 12
 (891) 2025 03 12
 (731) TEKNIKA BEREZIAK, S.L.
 Pgn. Ind. Bekolbarra, 33 Pab. 10, E-48300
 Gernika (Bizkaia), Spain
 (540)



(591) Purple and orange
 (531) 26.01.03; 26.15.01; 27.05.01; 27.05.09;
 27.05.10; 27.05.17; 27.05.22; 29.01.12
 (511)
 7 – Regulators for lubrication machines; dosing guns for oils, greases and all liquid and highly viscous products; pressure regulators.

9 – Gas analyzer; measuring, detecting, monitoring and controlling devices; electronic equipment used with tools for testing and adjusting vehicles and vehicle parts and accessories; electronic devices and instruments for analyzing and regulating the performance of vehicles and their parts and fittings; electronic equipment and instruments for controlling and adjusting vehicles and their parts and accessories; mechanical or electronic equipment, devices and instruments and computer programs for balancing (analysis), checking (analysis and inspection), adjusting and measuring; geometry equipment for checking and adjusting vehicles and vehicle parts and accessories; wheel inclination control devices; power banks for vehicles; brake test stands and suspensions for vehicles; air pre-

ssure sensors; gas analyzers for vehicles; opacity meters for vehicles; chassis dynamometers; calibration control bars; cables for measuring equipment; motor starter cables; electric cables; pressure gauges, including electronic tracing gauges; dynamometers, comparators, torque meters, voltmeters, electric or electronic measuring apparatus and instruments; precision measuring apparatus or for measuring distances; electronic control panels; electricity control cabinets or consoles; revolution counters; video opacity meters; gauges; screw-tapping gauges; multimeters; micrometers, including electronic micrometers; wheel balancers; engine diagnostic equipment; front axle adjusters; headlight regulators; capacity measures, densimeters, manometers, refractometers; pneumatic and mechanical controls for lubricator timers; lubrication level monitors; electronic control apparatus for lubrication pumps; timers for lubrication pumps; data alarms and recorders for lubricators; automatic lubrication dispensing distributors; electronic control units for pneumatic lubricators; electrical and electronic control and monitoring equipment programmed for central lubrication and lubricant distribution systems; dosing systems for oils, greases and all liquid and highly viscous products; tire pressure measurers; tire balancing units for land vehicles; electronic power controllers; electronic control units; touch-sensitive control panels; programmable control apparatus; heat meters; tire monitoring instruments; security check apparatus; level controllers [electrical apparatus]; apparatus for checking speed; sensors for use in the control of engines; apparatus for monitoring the level of liquids; control units for amplifiers for use in vehicles; devices for testing and quality control; temperature control devices [thermostats] for vehicles; oil level detectors; oil change monitors; sensors; scientific, optical, weighing, measuring, signaling, checking and supervision apparatus and instruments; data processing equipment; machines for the analysis of gases.

(260) AM 2026 135424 A
 (800) 1873674
 (151) 2025 06 17
 (891) 2025 06 17
 (731) AMB, SARL
 1 RUE JEAN JAURÈS, F-74000 ANNECY,
 France
 (540)



(591) Black, white
 (531) 06.01.02; 06.01.04; 19.07.01; 19.07.23;
 27.05.01; 27.05.08; 27.05.09; 27.05.10
 (554) Three-dimensional
 (526) No claim is made to the exclusive right to use
 the word elements "VODKA" or the phrase "Distilled
 and bottled in country".
 (511)
 33 – Vodka.

(260) AM 2026 135425 A
 (800) 1873725
 (151) 2025 07 24
 (891) 2025 07 24
 (731) CELLTRION, INC.
 23, Academy-ro, Yeonsu-gu Incheon,
 Republic of Korea

(540)

АЙДЕНЗЕЛТ

(591) Black, white
 (531) 28.05
 (511)
 5 – Ophthalmic preparations; pharmaceutical prepara-
 tions for the treatment of angiogenesis-related disea-
 ses.

(260) AM 2026 135426 A
 (800) 1873813
 (151) 2025 08 04
 (891) 2025 08 04
 (731) VAFO Brands s.r.o.
 K Brůdku 94, CZ-252 19 Chrášťany,
 Czech Republic

(540)

КАРНИЛАВ

(591) Black, white
 (531) 28.05
 (511)
 5 – Vitamin and mineral supplements for pets; vita-
 mins for animals; protein supplements for animals;
 dietary supplements for animals; medicated additives
 for animal foods; dietary pet supplements in the form
 of pet treats.

29 – Meat; meat extracts; soups; consommés.

31 – Fodder; animal foodstuffs in the form of pellets;
 foodstuffs for domestic animals; pet food; foodstuffs
 for cats; canned foodstuffs for cats; foodstuffs for
 dogs; canned foodstuffs for dogs; edible pet treats;
 edible chews for animals; dog treats [edible]; cat tre-
 ats [edible]; edible bones and sticks for pets; biscuits
 for animals; edible chewing products for domestic
 animals; beverages for pets; cuttlefish bones; litter pe-
 at.

(260) AM 2026 135427 A
 (800) 1873814
 (151) 2025 08 01
 (891) 2025 08 01
 (731) NATURA & CO UK HOLDINGS LIMITED
 5th Floor Halo, Counterslip, Bristol BS1 6AJ,
 United Kingdom

(540)

PERFECT NONSENSE

(591) Black, white
 (511)
 3 – Non-medicated toilet preparations; toiletries; skin
 care preparations; skin moisturizers; skin toners; body
 and beauty care preparations; powders, cleansers, cr-
 eams and lotions, all for the face, hands and body; ex-
 foliating scrubs for cosmetic purposes; cosmetic sun-
 tan preparations; sunscreen oils and lotions; soaps;
 shower and bath preparations; bath gel, bath oils, bath
 salts, bath beads, and effervescent bath preparations;
 beauty masks; talcum powder; nail polish; nail polish
 remover; false nails; adhesives for cosmetic purposes;
 cosmetics; eye cream; eye gels; eye lotions; eye ma-
 ke-up remover; eye shadow; eye liner; eyebrow cos-
 metics; mascara; lipstick; lip liner; lip-gloss; lip balm;
 make-up foundation; facial concealer; blusher; tissues
 impregnated with cosmetic lotions; powdered cosme-
 tic tissues; cotton sticks for cosmetic purposes; cotton
 wool for cosmetic purposes; pumice stone; preparati-
 ons for cleaning, moisturising, colouring and styling
 the hair; shampoos, conditioners, finishing spray, and
 gels, all for the hair; preparations for cleaning the te-
 eth; shaving and aftershave preparations; perfumes;
 fragrances; toilet waters; cologne; room fragrances;
 incense sticks; deodorants for human beings; anti-per-
 spirants for personal use (toiletries); essential oils
 (cosmetic); oils for perfumes and scents; potpourri;
 cosmetic and fragrance kits.

(260) AM 2026 135428 A
 (800) 1874010
 (151) 2025 05 28
 (891) 2025 05 28
 (731) CASAMODA Verwaltungs KG
 Gutenbergstraße 7, 26135 Oldenburg, Germany

(540)



CASAMODA

(591) Black, white
 (531) 01.01.02; 01.01.09; 01.01.17; 27.05.01;
 27.05.04; 27.05.15

(511)

18 – Leather; imitations of leather; goods made of
 leather and imitations of leather, namely leisure bags,
 shopping bags, shoulder bags, evening bags, beach
 bags, school knapsacks, shoulder straps, children's

bags, cosmetic bags, suitcases, cosmetic cases, hat cases, attaché cases, pouches, neck pouches, stocking bags, shoe bags, sports bags, satchels; small leather goods, namely card cases [wallets], identity card cases, purses, luggage tags; handbags; baggage; trunks; suitcases; attache cases; travel garment covers; rucksacks; bags; bags for sports; travelling bags; carrier bags (term considered too vague by the International Bureau pursuant to Rule 13 (2) (b) of the Regulations); cross-body bags; hipsacks; bucket bags; folio cases; briefcases; pocket wallets; wallets; leather pouches; umbrellas; parasols; walking sticks; saddlery; leather cases, namely credit card cases, driving licence cases, business card cases, time card cases [wallets]; key cases; toiletry bags; travelling sets.

25 – Clothing; shirts; suits; bathing suits; bathing trunks; blazers; sport coats; trousers; skirts; dresses; blouses; t-shirts; polo shirts; shorts; jackets; cardigans; sweat shirts; sweat jackets; coats; fleece tops; waistcoats; underwear; pullovers; stockings; socks; headgear; baseball caps; hats; caps being headwear; cap peaks; headscarves; footwear; parts of footwear (included in class 25) (term considered too vague by the International Bureau pursuant to Rule 13 (2) (b) of the Regulations); shoes; sneakers; sandals; boots; inner soles; gloves; belts; pocket squares; neckties; ascots; bowties; scarves; balaclava; bags for sneakers.

35 – Wholesale and retail services [all services also online], including electronic commerce, teleshopping services, homeshopping services, mail order services, catalogue mail order services and online mail order services, all the aforesaid services also with the aid of electronic means [for example via the internet], in relation to leather, imitations of leather, goods made of leather and imitations of leather, namely leisure bags, shopping bags, shoulder bags, evening bags, beach bags, school knapsacks, shoulder straps, children's bags, cosmetic bags, suitcases, cosmetic cases, hat cases, attaché cases, pouches, neck pouches, stocking bags, shoe bags, sports bags, satchels, small leather goods, namely card cases [wallets], identity card cases, purses, luggage tags, handbags, baggage, trunks, suitcases, attache cases, travel garment covers, rucksacks, bags, bags for sports, bags for sneakers, travelling bags, carrier bags, cross-body bags, hipsacks, bucket bags, folio cases, briefcases, pocket wallets, wallets, leather pouches, umbrellas, parasols, walking sticks, saddlery, leather cases, namely credit card cases, driving licence cases, business card cases, time card cases [wallets], key cases, toiletry bags, travelling sets; wholesale and retail services [all services also online], including electronic commerce, teleshopping services, homeshopping services, mail order services, catalogue mail order services and online mail order services, all the aforesaid services also with the aid of electronic means [for example via the internet], in relation to clothing, shirts, suits, bathing suits, bathing trunks, blazers, sport coats, trousers, skirts, dresses,

blouses, t-shirts, polo shirts, shorts, jackets, cardigans, sweat shirts, sweat jackets, coats, fleece tops, waistcoats, underwear, pullovers, stockings, socks, headgear, baseball caps, hats, caps being headwear, cap peaks, headscarves, footwear, parts of footwear, shoes, sneakers, sandals, boots, inner soles, gloves, belts, pocket squares, neckties, ascots, bowties, scarves, balaclavas; advertising; marketing and promotional services; professional business consultancy; business consultancy and advisory services; product demonstrations and product display services also via the internet; collective buying services; import and export services (term considered too vague by the International Bureau pursuant to Rule 13 (2) (b) of the Regulations); ordering services; purchasing agency services for others; data processing services [office functions]; office services for electronically collating data; compilation and systematization of data and information in electronic databases (term considered too vague by the International Bureau pursuant to Rule 13 (2) (b) of the Regulations); organization of exhibitions for commercial or advertising purposes; organization of trade fairs for commercial or advertising purposes; shop window dressing; public relations services; organization of fashion shows for promotional purposes; services rendered by a franchisor, namely, assistance in the running or management of industrial or commercial enterprises; franchising services providing marketing assistance; promotion of goods and services through sponsorship.

(260) AM 2026 135429 A

(800) 1874068

(151) 2025 03 19

(891) 2025 03 19

(731) Luisa Spagnoli S.p.A.

Strada Santa Lucia, 71, I-06125 Perugia, Italy

(540)

LUISA SPAGNOLI

(591) Black, white

(511)

3 – Perfumed creams; oils for perfumes and scents; perfumes; eau de parfum; toilet water; eau de Cologne; perfumery; cosmetic creams; fluid creams, cosmetics; moisturising gels, cosmetics; cosmetic soaps; cakes of toilet soap; cosmetics; lipsticks; lipstick cases; powder for make-up; powder compacts, cosmetics; rouges; make-up foundations; eyeliner; make-up pencils; mascara; eyelid shadow; eyeshadow palettes; make-up.

9 – Spectacles; sunglasses; fashion eyeglasses; prescription sunglasses; frames for spectacles and sunglasses; spectacle cases; cases for sunglasses; spectacle temples; sunglass temples; spectacle chains; spectacle cords; spectacle lanyards.

14 – Watch bands; watch chains; clock cases; medals; key rings, split rings with trinket or decorative fob;

paste jewellery; cases for watches [presentation]; jewellery; clock hands; imitation jewellery ornaments; semi-precious articles of bijouterie; body costume jewellery; necklaces, jewellery; choker necklaces; bracelets; bracelets, jewellery; rings, pendants; rings, jewellery; pendants, jewellery; pins, jewellery; tie pins; earrings; jewel pendants.

18 – Leather leashes; purses; beach bags; handbags; key cases; bags; leather purses; briefcases, leather goods; travelling sets, leatherware; bags for sports; clutches, purses; garment bags; evening bags; evening handbags; hand bags; cross-body bags; shoulder bags; shoe bags; canvas bags; garment carriers; knitted bags; knitted bags, not of precious metals; chain mesh purses; casual bags; bucket bags; small clutch purses; work bags; drawstring bags; valises; daypacks; rucksacks; umbrellas; walking sticks; cosmetic purses; bumbags; card cases, notecases; pocket wallets; luggage tags; baggage tags.

23 – Yarn; cotton thread and yarn; sewing thread and yarn; embroidery thread and yarn; elastic thread and yarn for textile use; rubber thread for textile use; glass fiber thread and yarn; semi-synthetic fiber thread and yarn, chemically treated natural fiber yarn; darning thread and yarn; yarns and threads; elastic thread; synthetic threads; worsted yarn; linen thread and yarn; yarns made of synthetic material for textile use; silk thread and yarn; elastic strips of synthetic fibres for textile use.

24 – Textiles; textile material; textile for linen; elastic woven fabrics; silk, cloth; printed textile piece goods; apparel fabrics; elastic fabrics for clothing; fabric for use in the manufacture of bags; fabric for use in the manufacture of wallets; bed linen and blankets; textiles and substitutes for textiles; breathable waterproof fabrics; lingerie fabric; knit lace fabrics; silk-wool mixed fabrics; mixed fiber fabrics; fabrics for underwear; elastic yarn mixed fabrics; linens; kitchen linen; terry linen; diapered linen; household linen; bath linen; sew-on tags of textile for clothing; adhesive tags of textile for bags; curtains of textile or plastic; textile tissues; handkerchiefs of textile.

25 – Boots; half-boots; belts, clothing; pullovers; pullover sweaters; clothing; combinations, clothing; scarves; sashes for wear; jackets, clothing; shoes; dress shoes; bandanas, neckerchiefs; clothing of leather; women's ceremonial dresses; dress pants; cashmere clothing; underwear; waterproof clothing; visors being headwear; shoulder straps for clothing; evening wear; beach clothes; cowls, clothing; roll necks, clothing; clothing for gymnastics; jackets being sports clothing; sweaters; short-sleeve shirts; dresses; evening dresses; shoe soles; blouses; top, clothing; neck scarves, mufflers; foulards, clothing articles; snoods, scarves; casual jackets; trench coats; down jackets; coats; leather jackets; jeans; denim jeans; blazers; cardigans; shirts; tee-shirts; polo shirts; denim jackets;

trousers; shorts; skirts; culotte skirts; headgear; caps being headwear; hats; headwear; millinery; headbands, clothing; headscarves; footwear; deck shoes; slippers; flip-flops, slippers; flip-flops; espadrilles; sandals; wooden shoes; bath robes; beach robes; bikinis; wedding dresses; suits; socks and stockings; bathing suits; neckties; pyjamas; dressing gowns; sportswear; children's wear; uniforms; pocket handkerchiefs of textile.

35 – Shop window dressing; economic forecasting; rental of advertising space; organization of trade fairs; online advertising on a computer network; presentation of goods on communication media, for retail purposes; administrative processing of purchase orders; commercial administration of the licensing of the goods and services of others; organization of fashion shows for promotional purposes; arranging business introductions relating to the buying and selling of products; wholesale and retail sale services, including online and offline, for perfumed creams, oils for perfumes and scents, perfumes, eau de parfum, toilet water, eau de Cologne, perfumery, cosmetic creams, fluid creams being cosmetics, moisturising gels being cosmetics, cosmetic soaps, cakes of toilet soap, cosmetics, lipsticks, lipstick cases, powder for make-up, powder compacts being cosmetics, rouges, make up foundations, eyeliner, make-up pencils, mascara, eyelid shadow, eyeshadow palettes, make-up; wholesale and retail sale services, including online and offline, for spectacles, sunglasses, fashion eyeglasses, prescription sunglasses, frames for spectacles and sunglasses, spectacle cases, cases for sunglasses, spectacle temples, sunglass temples, spectacle chains, spectacle cords, spectacle lanyards; wholesale and retail sale services, including online and offline, for watch bands, watch chains, clock cases, medals, key rings, split rings with trinket or decorative fob, paste jewellery, cases for watches presentation, jewellery, clock hands, imitation jewellery ornaments, semi-precious articles of bijouterie, body costume jewellery, necklaces being jewellery, choker necklaces, bracelets, bracelets being jewellery, rings being pendants, rings being jewellery, pendants being jewellery, pins being jewellery, tie pins, earrings, jewel pendants; wholesale and retail sale services, including online and offline, for leather leashes, purses, beach bags, handbags, key cases, bags, leather purses, briefcases being leather goods, travelling sets being leatherware, bags for sports, clutches being purses, garment bags, evening bags, evening handbags, hand bags, cross-body bags, shoulder bags, shoe bags, canvas bags, garment carriers, knitted bags, knitted bags not of precious metals, chain mesh purses, casual bags, bucket bags, small clutch purses, work bags, drawstring bags, valises, daypacks, rucksacks, umbrellas, walking sticks, cosmetic purses, bumbags, card cases being notecases, pocket wallets, luggage tags, baggage tags; advertising, marketing and promotional services; advertising particularly services for the promotion of goods;

promotion services; business promotion; promotion of fairs for trade purposes; Internet marketing; marketing; wholesale and retail sale services, including online and offline, for yarn, cotton thread and yarn, sewing thread and yarn, embroidery thread and yarn, elastic thread and yarn for textile use, rubber thread for textile use, glass fiber thread and yarn, semi-synthetic fiber thread and yarn being chemically treated natural fiber yarn, darning thread and yarn, yarns and threads being elastic thread, synthetic threads, worsted yarn, linen thread and yarn, yarns made of synthetic material for textile use, silk thread and yarn, elastic strips of synthetic fibres for textile use; wholesale and retail sale services, including online and offline, for textiles, textile material, textile for linen, elastic woven fabrics, silk being cloth, printed textile piece goods, apparel fabrics, elastic fabrics for clothing, fabric for use in the manufacture of bags, fabric for use in the manufacture of wallets, bed linen and blankets, textiles and substitutes for textiles, breathable waterproof fabrics, lingerie fabric, knit lace fabrics, silk-wool mixed fabrics, mixed fiber fabrics, fabrics for underwear, elastic yarn mixed fabrics, linens, kitchen linen, terry linen, diapered linen, household linen, bath linen, sew-on tags of textile for clothing, adhesive tags of textile for bags, curtains, textile tissues, pocket handkerchiefs of textile, handkerchiefs of textile; wholesale and retail sale services, including online and offline, for boots, half-boots, belts being clothing, pullovers, pullover sweaters, clothing, combinations being clothing, scarves, sashes for wear, jackets being clothing, shoes, dress shoes, bandanas being neckerchiefs, clothing of leather, women's ceremonial dresses, dress pants, cashmere clothing, underwear, waterproof clothing, visors being headwear, shoulder straps for clothing, evening wear, beach clothes, cowls being clothing, roll necks being clothing, clothing for gymnastics, jackets being sports clothing, sweaters, short-sleeve shirts, dresses, evening dresses, shoe soles, blouses, top being clothing, neck scarves being mufflers, foulards being clothing articles, snoods being scarves, casual jackets, trench coats, down jackets, coats, leather jackets, jeans, denim jeans, blazers, cardigans, shirts, tee-shirts, polo shirts, denim jackets, trousers, shorts, skirts, culotte skirts, headgear, caps being headwear, hats, headwear, millinery, headbands being clothing, headscarves, footwear, deck shoes, slippers, flip-flops, slippers, flip-flops, espadrilles, sandals, wooden shoes, bath robes, beach robes, bikinis, wedding dresses, suits, socks and stockings, bathing suits, neckties, pyjamas, dressing gowns, sportswear, children's wear, uniforms; modelling for advertising or sales promotion; commercial assistance in business management; consultancy services regarding business strategies; providing assistance in the management of franchised businesses; advisory services relating to publicity for franchisees; assistance in product commercialization, within the framework of a franchise contract; loyalty scheme services; management of customer

loyalty, incentive or promotional schemes; market survey analysis; promotion of goods and services through sponsorship; dissemination of advertising matter online; online data processing services; on-line advertising and marketing services; provision of online price comparison services; providing user reviews for commercial or advertising purposes; organization of trade fairs for commercial or advertising purposes; planning and conducting of trade fairs, exhibitions and presentations for economic or advertising purposes.

(260) AM 2026 135430 A

(800) 1874069

(151) 2025 03 19

(891) 2025 03 19

(731) Luisa Spagnoli S.p.A.

Strada Santa Lucia, 71, I-06125 Perugia, Italy

(540)



(591) Black, white

(531) 27.05.22

(511)

3 – Perfumed creams; oils for perfumes and scents; perfumes; eau de parfum; toilet water; eau de Cologne; perfumery; cosmetic creams; fluid creams, cosmetics; moisturising gels, cosmetics; cosmetic soaps; cakes of toilet soap; cosmetics; lipsticks; lipstick cases; powder for make-up; powder compacts, cosmetics; rouges; make-up foundations; eyeliner; make-up pencils; mascara; eyelid shadow; eyeshadow palettes; make-up.

9 – Spectacles; sunglasses; fashion eyeglasses; prescription sunglasses; frames for spectacles and sunglasses; spectacle cases; cases for sunglasses; spectacle temples; sunglass temples; spectacle chains; spectacle cords; spectacle lanyards.

14 – Watch bands; watch chains; clock cases; medals; key rings, split rings with trinket or decorative fob; paste jewellery; cases for watches [presentation]; jewellery; clock hands; imitation jewellery ornaments; semi-precious articles of bijouterie; body costume jewellery; necklaces, jewellery; choker necklaces; bracelets; bracelets, jewellery; rings, pendants; rings, jewellery; pendants, jewellery; pins, jewellery; tie pins; earrings; jewel pendants.

18 – Leather leashes; purses; beach bags; handbags; key cases; bags; leather purses; briefcases, leather goods; travelling sets, leatherware; bags for sports; clutches, purses; garment bags; evening bags; evening handbags; hand bags; cross-body bags; shoulder bags;

shoe bags; canvas bags; garment carriers; knitted bags; knitted bags, not of precious metals; chain mesh purses; casual bags; bucket bags; small clutch purses; work bags; drawstring bags; valises; daypacks; rucksacks; umbrellas; walking sticks; cosmetic purses; bumbags; card cases, notecases; pocket wallets; luggage tags; baggage tags.

23 – Yarn; cotton thread and yarn; sewing thread and yarn; embroidery thread and yarn; elastic thread and yarn for textile use; rubber thread for textile use; glass fiber thread and yarn; semi-synthetic fiber thread and yarn, chemically treated natural fiber yarn; darning thread and yarn; yarns and threads; elastic thread; synthetic threads; worsted yarn; linen thread and yarn; yarns made of synthetic material for textile use; silk thread and yarn; elastic strips of synthetic fibres for textile use.

24 – Textiles; textile material; textile for linen; elastic woven fabrics; silk, cloth; printed textile piece goods; apparel fabrics; elastic fabrics for clothing; fabric for use in the manufacture of bags; fabric for use in the manufacture of wallets; bed linen and blankets; textiles and substitutes for textiles; breathable waterproof fabrics; lingerie fabric; knit lace fabrics; silk-wool mixed fabrics; mixed fiber fabrics; fabrics for underwear; elastic yarn mixed fabrics; linens; kitchen linen; terry linen; diapered linen; household linen; bath linen; sew-on tags of textile for clothing; adhesive tags of textile for bags; curtains of textile or plastic; textile tissues; handkerchiefs of textile.

25 – Boots; half-boots; belts, clothing; pullovers; pullover sweaters; clothing; combinations, clothing; scarves; sashes for wear; jackets, clothing; shoes; dress shoes; bandanas, neckerchiefs; clothing of leather; women's ceremonial dresses; dress pants; cashmere clothing; underwear; waterproof clothing; visors being headwear; shoulder straps for clothing; evening wear; beach clothes; cowls, clothing; roll necks, clothing; clothing for gymnastics; jackets being sports clothing; sweaters; short-sleeve shirts; dresses; evening dresses; shoe soles; blouses; top, clothing; neck scarves, mufflers; foulards, clothing articles; snoods, scarves; casual jackets; trench coats; down jackets; coats; leather jackets; jeans; denim jeans; blazers; cardigans; shirts; tee-shirts; polo shirts; denim jackets; trousers; shorts; skirts; culotte skirts; headgear; caps being headwear; hats; headwear; millinery; headbands, clothing; headscarves; footwear; deck shoes; slippers; flip-flops, slippers; flip-flops; espadrilles; sandals; wooden shoes; bath robes; beach robes; bikinis; wedding dresses; suits; socks and stockings; bathing suits; neckties; pyjamas; dressing gowns; sportswear; children's wear; uniforms; pocket handkerchiefs of textile.

35 – Shop window dressing; economic forecasting; rental of advertising space; organization of trade fairs; online advertising on a computer network; presentati-

on of goods on communication media, for retail purposes; administrative processing of purchase orders; commercial administration of the licensing of the goods and services of others; organization of fashion shows for promotional purposes; arranging business introductions relating to the buying and selling of products; wholesale and retail sale services, including online and offline, for perfumed creams, oils for perfumes and scents, perfumes, eau de parfum, toilet water, eau de Cologne, perfumery, cosmetic creams, fluid creams being cosmetics, moisturising gels being cosmetics, cosmetic soaps, cakes of toilet soap, cosmetics, lipsticks, lipstick cases, powder for make-up, powder compacts being cosmetics, rouges, make up foundations, eyeliner, make-up pencils, mascara, eyelid shadow, eyeshadow palettes, make-up; wholesale and retail sale services, including online and offline, for spectacles, sunglasses, fashion eyeglasses, prescription sunglasses, frames for spectacles and sunglasses, spectacle cases, cases for sunglasses, spectacle temples, sunglass temples, spectacle chains, spectacle cords, spectacle lanyards; wholesale and retail sale services, including online and offline, for watch bands, watch chains, clock cases, medals, key rings, split rings with trinket or decorative fob, paste jewellery, cases for watches [presentation], jewellery, clock hands, imitation jewellery ornaments, semi-precious articles of bijouterie, body costume jewellery, necklaces being jewellery, choker necklaces, bracelets, bracelets being jewellery, rings being pendants, rings being jewellery, pendants being jewellery, pins being jewellery, tie pins, earrings, jewel pendants; wholesale and retail sale services, including online and offline, for leather leashes, purses, beach bags, handbags, key cases, bags, leather purses, briefcases being leather goods, travelling sets being leatherware, bags for sports, clutches being purses, garment bags, evening bags, evening handbags, hand bags, cross-body bags, shoulder bags, shoe bags, canvas bags, garment carriers, knitted bags, knitted bags not of precious metals, chain mesh purses, casual bags, bucket bags, small clutch purses, work bags, drawstring bags, valises, daypacks, rucksacks, umbrellas, walking sticks, cosmetic purses, bumbags, card cases being notecases, pocket wallets, luggage tags, baggage tags; advertising, marketing and promotional services; advertising particularly services for the promotion of goods; promotion services; business promotion; promotion of fairs for trade purposes; Internet marketing; marketing; wholesale and retail sale services, including online and offline, for yarn, cotton thread and yarn, sewing thread and yarn, embroidery thread and yarn, elastic thread and yarn for textile use, rubber thread for textile use, glass fiber thread and yarn, semi-synthetic fiber thread and yarn being chemically treated natural fiber yarn, darning thread and yarn, yarns and threads being elastic thread, synthetic threads, worsted yarn, linen thread and yarn, yarns made of synthetic material for textile use, silk thread

and yarn, elastic strips of synthetic fibres for textile use; wholesale and retail sale services, including on-line and offline, for textiles, textile material, textile for linen, elastic woven fabrics, silk being cloth, printed textile piece goods, apparel fabrics, elastic fabrics for clothing, fabric for use in the manufacture of bags, fabric for use in the manufacture of wallets, bed linen and blankets, textiles and substitutes for textiles, breathable waterproof fabrics, lingerie fabric, knit lace fabrics, silk-wool mixed fabrics, mixed fiber fabrics, fabrics for underwear, elastic yarn mixed fabrics, linens, kitchen linen, terry linen, diapered linen, household linen, bath linen, sew-on tags of textile for clothing, adhesive tags of textile for bags, curtains, textile tissues, pocket handkerchiefs of textile, handkerchiefs of textile; wholesale and retail sale services, including online and offline, for boots, half-boots, belts being clothing, pullovers, pullover sweaters, clothing, combinations being clothing, scarves, sashes for wear, jackets being clothing, shoes, dress shoes, bandanas being neckerchiefs, clothing of leather, women's ceremonial dresses, dress pants, cashmere clothing, underwear, waterproof clothing, visors being headwear, shoulder straps for clothing, evening wear, beach clothes, cowls being clothing, roll necks being clothing, clothing for gymnastics, jackets being sports clothing, sweaters, short-sleeve shirts, dresses, evening dresses, shoe soles, blouses, top being clothing, neck scarves being mufflers, foulards being clothing articles, snoods being scarves, casual jackets, trench coats, down jackets, coats, leather jackets, jeans, denim jeans, blazers, cardigans, shirts, tee-shirts, polo shirts, denim jackets, trousers, shorts, skirts, culotte skirts, headgear, caps being headwear, hats, headwear, millinery, headbands being clothing, headscarves, footwear, deck shoes, slippers, flip-flops, slippers, flip-flops, espadrilles, sandals, wooden shoes, bath robes, beach robes, bikinis, wedding dresses, suits, socks and stockings, bathing suits, neckties, pyjamas, dressing gowns, sportswear, children's wear, uniforms; modelling for advertising or sales promotion; commercial assistance in business management; consultancy services regarding business strategies; providing assistance in the management of franchised businesses; advisory services relating to publicity for franchisees; assistance in product commercialization, within the framework of a franchise contract; loyalty scheme services; management of customer loyalty, incentive or promotional schemes; market survey analysis; promotion of goods and services through sponsorship; dissemination of advertising matter online; online data processing services; on-line advertising and marketing services; provision of online price comparison services; providing user reviews for commercial or advertising purposes; organization of trade fairs for commercial or advertising purposes; planning and conducting of trade fairs, exhibitions and presentations for economic or advertising purposes.

(260) AM 2026 135431 A

(800) 1874071

(151) 2025 03 19

(891) 2025 03 19

(731) Luisa Spagnoli S.p.A.

Strada Santa Lucia, 71, I-06125 Perugia, Italy

(540)



(591) Black, white

(531) 02.09.01; 27.03.02; 27.05.01; 27.05.13

(511)

3 – Perfumed creams; oils for perfumes and scents; perfumes; eau de parfum; toilet water; eau de Cologne; perfumery; cosmetic creams; fluid creams, cosmetics; moisturising gels, cosmetics; cosmetic soaps; cakes of toilet soap; cosmetics; lipsticks; lipstick cases; powder for make-up; powder compacts, cosmetics; rouges; make-up foundations; eyeliner; make-up pencils; mascara; eyelid shadow; eyeshadow palettes; make-up.

9 – Spectacles; sunglasses; fashion eyeglasses; prescription sunglasses; frames for spectacles and sunglasses; spectacle cases; cases for sunglasses; spectacle temples; sunglass temples; spectacle chains; spectacle cords; spectacle lanyards.

14 – Watch bands; watch chains; clock cases; medals; key rings, split rings with trinket or decorative fob; paste jewellery; cases for watches [presentation]; jewellery; clock hands; imitation jewellery ornaments; semi-precious articles of bijouterie; body costume jewellery; necklaces, jewellery; choker necklaces; bracelets; bracelets, jewellery; rings, pendants; rings, jewellery; pendants, jewellery; pins, jewellery; tie pins; earrings; jewel pendants.

18 – Leather leashes; purses; beach bags; handbags; key cases; bags; leather purses; briefcases, leather goods; travelling sets, leatherware; bags for sports; clutches, purses; garment bags; evening bags; evening handbags; hand bags; cross-body bags; shoulder bags; shoe bags; canvas bags; garment carriers; knitted bags; knitted bags, not of precious metals; chain mesh purses; casual bags; bucket bags; small clutch purses; work bags; drawstring bags; valises; daypacks; rucksacks; umbrellas; walking sticks; cosmetic purses; bumbags; card cases, notecases; pocket wallets; luggage tags; baggage tags.

23 – Yarn; cotton thread and yarn; sewing thread and yarn; embroidery thread and yarn; elastic thread and yarn for textile use; rubber thread for textile use; glass fiber thread and yarn; semi-synthetic fiber thread and yarn, chemically treated natural fiber yarn; darning thread and yarn; yarns and threads; elastic thread; synthetic threads; worsted yarn; linen thread and yarn;

yarns made of synthetic material for textile use; silk thread and yarn; elastic strips of synthetic fibres for textile use.

24 – Textiles; textile material; textile for linen; elastic woven fabrics; silk, cloth; printed textile piece goods; apparel fabrics; elastic fabrics for clothing; fabric for use in the manufacture of bags; fabric for use in the manufacture of wallets; bed linen and blankets; textiles and substitutes for textiles; breathable waterproof fabrics; lingerie fabric; knit lace fabrics; silk-wool mixed fabrics; mixed fiber fabrics; fabrics for underwear; elastic yarn mixed fabrics; linens; kitchen linen; terry linen; diapered linen; household linen; bath linen; sew-on tags of textile for clothing; adhesive tags of textile for bags; curtains of textile or plastic; textile tissues; handkerchiefs of textile.

25 – Boots; half-boots; belts, clothing; pullovers; pullover sweaters; clothing; combinations, clothing; scarves; sashes for wear; jackets, clothing; shoes; dress shoes; bandanas, neckerchiefs; clothing of leather; women's ceremonial dresses; dress pants; cashmere clothing; underwear; waterproof clothing; visors being headwear; shoulder straps for clothing; evening wear; beach clothes; cowls, clothing; roll necks, clothing; clothing for gymnastics; jackets being sports clothing; sweaters; short-sleeve shirts; dresses; evening dresses; shoe soles; blouses; top, clothing; neck scarves, mufflers; foulards, clothing articles; snoods, scarves; casual jackets; trench coats; down jackets; coats; leather jackets; jeans; denim jeans; blazers; cardigans; shirts; tee-shirts; polo shirts; denim jackets; trousers; shorts; skirts; culotte skirts; headgear; caps being headwear; hats; headwear; millinery; headbands, clothing; headscarves; footwear; deck shoes; slippers; flip-flops, slippers; flip-flops; espadrilles; sandals; wooden shoes; bath robes; beach robes; bikinis; wedding dresses; suits; socks and stockings; bathing suits; neckties; pyjamas; dressing gowns; sportswear; children's wear; uniforms; pocket handkerchiefs of textile.

35 – Shop window dressing; economic forecasting; rental of advertising space; organization of trade fairs; online advertising on a computer network; presentation of goods on communication media, for retail purposes; administrative processing of purchase orders; commercial administration of the licensing of the goods and services of others; organization of fashion shows for promotional purposes; arranging business introductions relating to the buying and selling of products; wholesale and retail sale services, including online and offline, for perfumed creams, oils for perfumes and scents, perfumes, eau de parfum, toilet water, eau de Cologne, perfumery, cosmetic creams, fluid creams being cosmetics, moisturising gels being cosmetics, cosmetic soaps, cakes of toilet soap, cosmetics, lipsticks, lipstick cases, powder for make-up, powder compacts being cosmetics, rouges, make up foundations, eyeliner, make-up pencils, mascara, ey-

elid shadow, eyeshadow palettes, make-up; wholesale and retail sale services, including online and offline, for spectacles, sunglasses, fashion eyeglasses, prescription sunglasses, frames for spectacles and sunglasses, spectacle cases, cases for sunglasses, spectacle temples, sunglass temples, spectacle chains, spectacle cords, spectacle lanyards; wholesale and retail sale services, including online and offline, for watch bands, watch chains, clock cases, medals, key rings, split rings with trinket or decorative fob, paste jewellery, cases for watches presentation, jewellery, clock hands, imitation jewellery ornaments, semi-precious articles of bijouterie, body costume jewellery, necklaces being jewellery, choker necklaces, bracelets, bracelets being jewellery, rings being pendants, rings being jewellery, pendants being jewellery, pins being jewellery, tie pins, earrings, jewel pendants; wholesale and retail sale services, including online and offline, for leather leashes, purses, beach bags, handbags, key cases, bags, leather purses, briefcases being leather goods, travelling sets being leatherware, bags for sports, clutches being purses, garment bags, evening bags, evening handbags, hand bags, cross-body bags, shoulder bags, shoe bags, canvas bags, garment carriers, knitted bags, knitted bags not of precious metals, chain mesh purses, casual bags, bucket bags, small clutch purses, work bags, drawstring bags, valises, daypacks, rucksacks, umbrellas, walking sticks, cosmetic purses, bumbags, card cases being notecases, pocket wallets, luggage tags, baggage tags; advertising, marketing and promotional services; advertising particularly services for the promotion of goods; promotion services; business promotion; promotion of fairs for trade purposes; Internet marketing; marketing; wholesale and retail sale services, including online and offline, for yarn, cotton thread and yarn, sewing thread and yarn, embroidery thread and yarn, elastic thread and yarn for textile use, rubber thread for textile use, glass fiber thread and yarn, semi-synthetic fiber thread and yarn being chemically treated natural fiber yarn, darning thread and yarn, yarns and threads being elastic thread, synthetic threads, worsted yarn, linen thread and yarn, yarns made of synthetic material for textile use, silk thread and yarn, elastic strips of synthetic fibres for textile use; wholesale and retail sale services, including online and offline, for textiles, textile material, textile for linen, elastic woven fabrics, silk being cloth, printed textile piece goods, apparel fabrics, elastic fabrics for clothing, fabric for use in the manufacture of bags, fabric for use in the manufacture of wallets, bed linen and blankets, textiles and substitutes for textiles, breathable waterproof fabrics, lingerie fabric, knit lace fabrics, silk-wool mixed fabrics, mixed fiber fabrics, fabrics for underwear, elastic yarn mixed fabrics, linens, kitchen linen, terry linen, diapered linen, household linen, bath linen, sew-on tags of textile for clothing, adhesive tags of textile for bags, curtains, textile tissues, pocket handkerchiefs of textile, handkerchiefs of textile; wholesale and retail

sale services, including online and offline, for boots, half-boots, belts being clothing, pullovers, pullover sweaters, clothing, combinations being clothing, scarves, sashes for wear, jackets being clothing, shoes, dress shoes, bandanas being neckerchiefs, clothing of leather, women's ceremonial dresses, dress pants, cashmere clothing, underwear, waterproof clothing, visors being headwear, shoulder straps for clothing, evening wear, beach clothes, cowls being clothing, roll necks being clothing, clothing for gymnastics, jackets being sports clothing, sweaters, short-sleeve shirts, dresses, evening dresses, shoe soles, blouses, top being clothing, neck scarves being mufflers, foulards being clothing articles, snoods being scarves, casual jackets, trench coats, down jackets, coats, leather jackets, jeans, denim jeans, blazers, cardigans, shirts, tee-shirts, polo shirts, denim jackets, trousers, shorts, skirts, culotte skirts, headgear, caps being headwear, hats, headwear, millinery, headbands being clothing, headscarves, footwear, deck shoes, slippers, flip-flops, slippers, flip-flops, espadrilles, sandals, wooden shoes, bath robes, beach robes, bikinis, wedding dresses, suits, socks and stockings, bathing suits, neckties, pyjamas, dressing gowns, sportswear, children's wear, uniforms; modelling for advertising or sales promotion; commercial assistance in business management; consultancy services regarding business strategies; providing assistance in the management of franchised businesses; advisory services relating to publicity for franchisees; assistance in product commercialization, within the framework of a franchise contract; loyalty scheme services; management of customer loyalty, incentive or promotional schemes; market survey analysis; promotion of goods and services through sponsorship; dissemination of advertising matter online; online data processing services; on-line advertising and marketing services; provision of online price comparison services; providing user reviews for commercial or advertising purposes; organization of trade fairs for commercial or advertising purposes; planning and conducting of trade fairs, exhibitions and presentations for economic or advertising purposes.

(260) AM 2026 135438 A
 (800) 1874097
 (151) 2025 07 01
 (891) 2025 07 01
 (731) Ferrara Candy Company
 404 W. Harrison Street, Chicago IL 60607,
 USA
 (540)



(591) The color(s) pink, purple, dark blue, light blue, green, yellow, black, and white is/are claimed as a feature of the mark
 (531) 01.15.21; 04.05.15; 08.01.19; 21.01.15; 29.01.15
 (511)
 30 – Candy.

(260) AM 2026 135439 A
 (800) 1874135
 (151) 2025 08 04
 (891) 2025 08 04
 (731) VAFO Brands s.r.o.
 K Brůdku 94, CZ-252 19 Chrást'any,
 Czech Republic
 (540)



(591) Black, white
 (531) 27.01.16; 27.05.01; 27.05.17
 (511)
 5 – Vitamin and mineral supplements for pets; vitamins for animals; protein supplements for animals; dietary supplements for animals; medicated additives for animal foods; dietary pet supplements in the form of pet treats.
 29 – Meat; meat extracts; soups; consommés.

31 – Fodder; animal foodstuffs in the form of pellets; foodstuffs for domestic animals; pet food; foodstuffs for cats; canned foodstuffs for cats; foodstuffs for dogs; canned foodstuffs for dogs; edible pet treats; edible chews for animals; dog treats [edible]; cat treats [edible]; edible bones and sticks for pets; biscuits for animals; edible chewing products for domestic animals; beverages for pets; cuttlefish bones; litter peat.

(260) AM 2026 135440 A
 (800) 1874138
 (151) 2025 08 11
 (891) 2025 08 11
 (731) SOREMARTEC S.A.
 16, route de Trèves, L-2633 Senningerberg,
 Luxembourg
 (540)



(591) Brown, white and gold
 (531) 26.01.02; 26.01.24; 27.05.19; 27.05.24; 29.01.13

(511)
30 – Pastry and confectionery; biscuits; chocolate and chocolate products; pralines; edible ices; ice cream; sorbets [ices].

(260) AM 2026 135441 A

(800) 1874178

(151) 2025 04 08

(891) 2025 04 08

(731) EGT DIGITAL LTD.

6, "Panorama Sofia" Str., Business Center
"Richhill", block A, BG-1766 Sofia, Bulgaria

(540)



(591) Yellow, blue, purple, red, white and black

(531) 17.02.01; 17.02.02; 23.01.01; 24.09.03;

24.09.05; 29.01.15

(511)

9 – Operating computer software for main frame computers; monitors (computer hardware); computer hardware; apparatus for recording images; monitors (computer programs); computer game programs; recorded computer game programs; apparatus for recording, transmission or reproduction of sound or images; communications servers (computer hardware); electronic components for gambling machines; computer application software featuring games and gaming; computer software for the administration of on-line games and gaming; computer hardware for games and gaming; computer systems; computer operating system software; computer terminals; interactive terminals; multimedia terminals; electronic terminals for generating lottery tickets; interactive touch screen terminals; computer touchscreens; electronic display panels; liquid crystal display screens; digital signage display panels; multimedia software; multimedia apparatus and instruments; interactive multimedia software for playing games; computer screens; lcd large-screen displays; liquid crystal displays [lcds] for home theatres; media streaming software; computer application software for streaming audio-visual media content via the internet; computer gaming software; software; computer software packages; computer software, recorded; software drivers; virtual reality software; games software; entertainment software for computer games; computer programs for network management; electronic lottery tickets; computer software platforms; operating systems; interactive computer systems; operating system programs; computer game software for use with on-line interactive games; interactive casino games provided through a computer or mobile platform; software for slot machines, betting

software, software for video slot games, for casino games, for gambling and bingo games, provided online or through computer networks and that can be played on any type of computer device, including arcade games, personal computers, portable devices and mobile phones; electronic ticket examination machines; computer hardware and software for gambling, gambling machines, gambling games on the internet and via telecommunication network.

28 – Gaming machines for gambling; chips for gambling; mah-jong; arcade games; gambling machines operating with coins, notes and cards; games; electronic games; parlor games; gaming chips; gaming tables; slot machines [gaming machines]; LCD game machines; slot machines and gaming devices; coin-operated amusement machines; roulette chips; poker chips; chips and dice [gaming equipment]; gaming equipment for casinos; roulette tables; gaming roulette wheels; casino games; gambling machines and amusement machines, automatic and coin-operated; coin-operated amusement machines and / or electronic coin-operated amusement machines with or without the possibility of gain; boxes for coin-operated amusement machines, slot machines and gaming machines; electronic or electrotechnical amusement machines and apparatus, gaming machines, coin-operated entertainment machines; housings for coin-operated amusement machines, gaming equipment, gaming machines, machines for gambling; electropneumatic and electrical gambling machines (slot machines); lottery games; electronic targets for games and sports; parlor game equipment and accessories therefor, included in this class, in particular game tokens, chips and marbles; parlor game apparatus and equipment, and accessories therefor, included in this class, in particular electronic targets, backgammon games, scratch cards, playing cards, lottery cards, dice; lottery tickets; printed lottery tickets; lottery scratch cards; scratch cards for playing lottery games.

41 – Gambling; gaming services for entertainment purposes; casino, gaming and gambling services; training in the development of software systems; provision of gaming equipment for gambling halls; providing casino equipment [gambling]; gaming machine entertainment services; providing casino facilities [gambling]; amusement arcade services; games equipment rental; rental of gaming machines; providing amusement arcade services; rental of gaming machines with images of fruits; editing or recording of sounds and images; sound recording and video entertainment services; hire of sound reproducing apparatus; provision of gaming equipment for casinos; providing of casino facilities; online gambling services; entertainment services related to providing amusement arcades, on-line casinos and on-line betting services via websites; online interactive entertainment; on-line casino services; online game services through mobile devices; providing online entertainment in the nature of game tour-

naments; providing on-line information in the field of computer gaming entertainment; sports betting services; online sports betting services; lottery services; organization of lotteries; conducting lotteries; prize draws [lotteries]; conducting lotteries for others; providing slot machine parlors; rental of slot machines [gaming machines]; providing online games and games of chance.

(260) AM 2026 135442 A

(800) 1874200

(151) 2025 06 25

(891) 2025 06 25

(731) Mavie Med Holding GmbH

Rothschildplatz 4/6. Stock, A-1020 Wien,
Austria

(540)

Mavie Med

(591) Black, white

(511)

10 – Surgical and medical instruments and apparatus; orthopaedic articles; testing apparatus for medical purposes.

35 – Business management of hospitals, medical centers, outpatient clinics, medical practices, sanatoriums, rehabilitation centers and convalescent homes; business assistance and advice in the operation and management of hospitals, medical centers, outpatient clinics, medical practices, sanatoriums, rehabilitation centers and convalescent homes; procurement services for third parties, namely for hospitals, medical centers, outpatient clinics, medical practices, sanatoriums, rehabilitation centers and convalescent homes; conduction of business feasibility studies for hospitals, medical centers, outpatient clinics, medical practices, sanatoriums, rehabilitation centers and convalescent homes; planning of hospitals, medical centers, outpatient clinics, medical practices, sanatoriums, rehabilitation centers and convalescent homes from an organizational and business perspective.

36 – Financial planning of construction projects relating to hospitals, medical centers, outpatient clinics, medical practices, sanatoriums, rehabilitation centers and convalescent homes; financial intermediary services relating to hospitals, medical centers, outpatient clinics, medical practices, sanatoriums, rehabilitation centers and convalescent homes; facility management relating to hospitals, medical centers, outpatient clinics, medical practices, sanatoriums, rehabilitation centers and convalescent homes; consulting for hospitals, medical centers, outpatient clinics, medical practices, sanatoriums, rehabilitation centers and convalescent homes in the field of facility management.

37 – Maintenance and repair of building and operating technology in hospitals, medical centers, outpatient clinics, medical practices, sanatoriums, rehabilitation

centers and convalescent homes; cleaning services for hospitals, medical centers, outpatient clinics, medical practices, sanatoriums, rehabilitation centers and convalescent homes; maintenance and repair of medical instruments and apparatus.

42 – Scientific services and research, namely in the field of healthcare and medicine; scientific investigations, namely in the field of healthcare and medicine; scientific laboratory services; updating of computer software; computer software consultancy; consultancy relating to the design of websites; design and creation of websites; computer software design; services of a computer programmer (IT services); electronic data back-up; design and development of computer hardware and computer software; installation and maintenance of computer software; server administration; technical project management in the IT sector for hospitals, medical centers, outpatient clinics, medical practices, sanatoriums, rehabilitation centers and convalescent homes; technical planning of hospitals, medical centers, outpatient clinics, medical practices, sanatoriums, rehabilitation centers and convalescent homes; conducting technical feasibility studies for hospitals, medical centers, outpatient clinics, medical practices, sanatoriums, rehabilitation centers and convalescent homes; safety technology services relating to hospitals, medical centers, outpatient clinics, medical practices, sanatoriums, rehabilitation centers and convalescent homes; technological analysis relating to energy and power needs of others, namely hospitals, medical centers, outpatient clinics, medical practices, sanatoriums, rehabilitation centers and convalescent homes; technical advice relating to fire protection in hospitals, medical centers, outpatient clinics, medical practices, sanatoriums, rehabilitation centers and convalescent homes; technical inspections of hospitals, medical centers, outpatient clinics, medical practices, sanatoriums, rehabilitation centers and convalescent homes.

43 – Services for providing food and drink; temporary accommodation; catering for guests in cafés, cafeterias, canteens, restaurants, snack bars, self-service and fast food restaurants.

44 – Medical services; ambulant medical care; medical clinic services; human hygiene and beauty care; surgical treatment services; surgical diagnostic services; plastic surgery; services of medical clinics, doctors, outpatient clinics and hospitals; private hospital services; services of a maternity clinic; nursing, medical; sanatorium services; health center services; birth attendant services; chiropractic; dentistry; health counselling; medical information; in vitro fertilization services; orthodontic services; physiotherapy; consulting in the field of healthcare and medicine; medication counseling; conducting medical and clinical examinations; medical examination; medical treatment services; medical assistance; convalescent home services; medical imaging services; medical laboratory

services; health screening; advice on medical devices; occupational health consultancy; vaccination services; providing medical information in the field of dermatology; mobile health services.

(260) AM 2026 135443 A

(800) 1874201

(151) 2025 06 26

(891) 2025 06 26

(731) Mavie Med Holding GmbH

Rothschildplatz 4/6. Stock, A-1020 Wien,
Austria

(540)



(591) Dark green, light green, white

(531) 02.01.23; 25.01.25; 27.05.25; 29.01.12

(511)

10 – Surgical and medical instruments and apparatus; orthopedic articles; testing apparatus for medical purposes.

35 – Business management of hospitals, medical centers, outpatient clinics, medical practices, sanatoriums, rehabilitation centers and convalescent homes; business assistance and advice in the operation and management of hospitals, medical centers, outpatient clinics, medical practices, sanatoriums, rehabilitation centers and convalescent homes; procurement services for third parties, namely for hospitals, medical centers, outpatient clinics, medical practices, sanatoriums, rehabilitation centers and convalescent homes; conduction of business feasibility studies for hospitals, medical centers, outpatient clinics, medical practices, sanatoriums, rehabilitation centers and convalescent homes; planning of hospitals, medical centers, outpatient clinics, medical practices, sanatoriums, rehabilitation centers and convalescent homes from an organizational and business perspective.

36 – Financial planning of construction projects relating to hospitals, medical centers, outpatient clinics, medical practices, sanatoriums, rehabilitation centers and convalescent homes; financial intermediary services relating to hospitals, medical centers, outpatient clinics, medical practices, sanatoriums, rehabilitation centers and convalescent homes; facility management relating to hospitals, medical centers, outpatient clinics, medical practices, sanatoriums, rehabilitation centers and convalescent homes; consulting for hospitals, medical centers, outpatient clinics, medical practices, sanatoriums, rehabilitation centers and convalescent homes in the field of facility management.

37 – Maintenance and repair of building and operating technology in hospitals, medical centers, outpatient clinics, medical practices, sanatoriums, rehabilitation

centers and convalescent homes; cleaning services for hospitals, medical centers, outpatient clinics, medical practices, sanatoriums, rehabilitation centers and convalescent homes; maintenance and repair of medical instruments and apparatus.

42 – Scientific services and research, namely in the field of healthcare and medicine; scientific investigations, namely in the field of healthcare and medicine; scientific laboratory services; updating of computer software; computer software consultancy; consultancy relating to the design of websites; design and creation of websites; computer software design; services of a computer programmer (IT services); electronic data back-up; design and development of computer hardware and computer software; installation and maintenance of computer software; server administration; technical project management in the IT sector for hospitals, medical centers, outpatient clinics, medical practices, sanatoriums, rehabilitation centers and convalescent homes; technical planning of hospitals, medical centers, outpatient clinics, medical practices, sanatoriums, rehabilitation centers and convalescent homes; conducting technical feasibility studies for hospitals, medical centers, outpatient clinics, medical practices, sanatoriums, rehabilitation centers and convalescent homes; safety technology services relating to hospitals, medical centers, outpatient clinics, medical practices, sanatoriums, rehabilitation centers and convalescent homes; technological analysis relating to energy and power needs of others, namely hospitals, medical centers, outpatient clinics, medical practices, sanatoriums, rehabilitation centers and convalescent homes; technical advice relating to fire protection in hospitals, medical centers, outpatient clinics, medical practices, sanatoriums, rehabilitation centers and convalescent homes; technical inspections of hospitals, medical centers, outpatient clinics, medical practices, sanatoriums, rehabilitation centers and convalescent homes.

43 – Services for providing food and drink; temporary accommodation; catering for guests in cafés, cafeterias, canteens, restaurants, snack bars, self-service and fast food restaurants.

44 – Medical services; ambulant medical care; medical clinic services; human hygiene and beauty care; surgical treatment services; surgical diagnostic services; plastic surgery; services of medical clinics, doctors, outpatient clinics and hospitals; private hospital services; services of a maternity clinic; nursing, medical; sanatorium services; health center services; birth attendant services; chiropractic; dentistry; health counselling; medical information; in vitro fertilization services; orthodontic services; physiotherapy; consulting in the field of healthcare and medicine; medication counseling; conducting medical and clinical examinations; medical examination; medical treatment services; medical assistance; convalescent home services; medical imaging services; medical laboratory

services; health screening; advice on medical devices; occupational health consultancy; vaccination services; providing medical information in the field of dermatology; mobile health services.

(260) AM 2026 135444 A

(800) 1874221

(151) 2025 08 04

(891) 2025 08 04

(731) VAFO Brands s.r.o.

K Brůdku 94, CZ-252 19 Chrášťany,
Czech Republic

(540)



(591) Black, white

(531) 27.01; 27.01.16; 27.05.10; 27.05.17; 28.05

(511)

5 – Vitamin and mineral supplements for pets; vitamins for animals; protein supplements for animals; dietary supplements for animals; medicated additives for animal foods; dietary pet supplements in the form of pet treats.

29 – Meat; meat extracts; soups; consommés.

31 – Fodder; animal foodstuffs in the form of pellets; foodstuffs for domestic animals; pet food; foodstuffs for cats; canned foodstuffs for cats; foodstuffs for dogs; canned foodstuffs for dogs; edible pet treats; edible chews for animals; dog treats [edible]; cat treats [edible]; edible bones and sticks for pets; biscuits for animals; edible chewing products for domestic animals; beverages for pets; cuttlefish bones; litter peat.

(260) AM 2026 135445 A

(800) 1874242

(151) 2025 06 03

(891) 2025 06 03

(731) Otkrytoe aktsionernoe obshchestvo

"BABUSHKINA KRYNKA" -,
upravlyayushchaya kompaniya kholdinga,
"Mogilevskaya molochnaya
kompaniya "BABUSHKINA KRYNKA"
ul. Akademika Pavlova 3B 212013 Mogilev,
Belarus

(540)



(591) Blue, white and light blue

(531) 27.05.01; 28.05; 29.01; 29.01.04

(511)

29 – Jellies for food, other than confectionery; edible fats; fruit-based snack food; milk substitutes; yogurt; quark; kephir; milk shakes; buttercream; koumiss; lecithin for culinary purposes; margarine; oils for food; butter; soya bean oil for food; milk; peanut milk; peanut milk for culinary purposes; coconut milk; coconut milk for culinary purposes; almond milk; almond milk for culinary purposes; oat milk; rice milk; rice milk for culinary purposes; albumin milk; rennet starter; condensed milk; soured milk; soya milk; powdered milk; fermented baked milk; lactic acid drinks; milk beverages, milk predominating; peanut milk-based beverages; coconut milk-based beverages; almond milk-based beverages; milk products; white pudding; cream [dairy products]; whipped cream; vegetable-based cream; smetana; fat-based spreads for bread slices; whey; cottage cheese fritters; cheese; cottage cheese; tofu; milk ferments for culinary purposes; rennet.

30 – Rice-based snack food; cereal-based snack food; frozen yogurt [confectionery ices]; dulce de leche; edible ices; ice pops; ice cream; chocolate mousses; cocoa beverages with milk; coffee beverages with milk; cocoa-based beverages; chocolate beverages with milk; chocolate-based beverages; powders for making ice cream; cereal preparations; oat-based food; rice pudding; puddings; milk puddings; sorbets [ices].

32 – Carbonated water; waters [beverages]; mineral water [beverages]; table waters; cocktails, non-alcoholic; non-alcoholic beverages; rice-based beverages, other than milk substitutes; soya-based beverages, other than milk substitutes; whey beverages; protein-enriched sports beverages; soft drinks; smoothies; preparations for making non-alcoholic beverages.

(260) AM 2026 135446 A

(800) 1874245

(151) 2025 06 11

(891) 2025 06 11

(731) Otkrytoe aktsionernoe obshchestvo

"BABUSHKINA KRYNKA" –
upravlyayushchaya
kompaniya kholdinga "Mogilevskaya
molochnaya kompaniya "BABUSHKINA
KRYNKA"
3, Akademika Pavlova Street, 212013 Mogilev,
Belarus

(540)



(591) Black, white

(531) 28.05

(511)

29 – Yogurt; kephir; milk shakes; buttercream; koumiss; oils and fats for food; margarine; butter; milk;

condensed milk; albumin milk; milk beverages, milk predominating; milk products; prostokvasha being soured milk; ryazhenka being fermented baked milk; cream [dairy products]; whipped cream; smetana; whey; cheese; cottage cheese; milk ferments for culinary purposes.

(260) AM 2026 135509 A

(800) 1874568

(151) 2025 07 31

(891) 2025 07 31

(731) Limited Liability Company GIFT

Austrina street, 169, RU-440015 Penza, Penza Region, Russian Federation

(540)

BLACK HAWK

(591) Black, white

(511)

32 – Aperitifs, non-alcoholic; lithia water; soda water; waters [beverages]; carbonated water; mineral water [beverages]; table waters; cocktails, non-alcoholic; beer-based cocktails; lemonades; non-alcoholic beverages; isotonic beverages; aloe vera drinks, non-alcoholic; whey beverages; protein-enriched sports beverages; soft drinks; non-alcoholic beverages flavoured with coffee; non-alcoholic beverages flavoured with tea; non-alcoholic fruit juice beverages; fruit nectars, non-alcoholic; beer; ginger beer; malt beer; smoothies; tomato juice [beverage]; apple juice; vegetable juices [beverages]; fruit juices; preparations for making carbonated water.

(260) AM 2026 135511 A

(800) 1874619

(151) 2025 07 17

(891) 2025 07 17

(731) Midea Group Co., Ltd.

B26-28F, Midea Headquarter Building, No. 6 Midea Avenue, Beijiao, Shunde, Foshan, Guangdong, China

(540)

SPACE MASTER

(591) Black, white

(511)

7 – Centrifugal machines; washing machines [laundry]; laundry washing machines incorporating a drying tumbler; spin dryers [not heated]; wringing machines for laundry; dry-cleaning machines; coin-operated washing machines; dishwashers; dishwasher racks being parts of dishwashing machines; kitchen machines, electric; vacuum cleaners; rechargeable sweepers; electric cordless sweepers; household cleaning and laundry robots with artificial intelligence; steam engines; wrapping machines; electric fruit peelers; milk filtering machines; kneading machines; food preparation machines, electromechanical; bread cutting ma-

chines; condensed milk making machines; fish paste making machines; fruit washing machines; flour mill machines; dairy machines; butter machines; churns; cheese making machines; electric fruit squeezers; meat choppers, electric; electric food blenders; meat mincers, electric; centrifugal mills; electric food grinders; mixing machines; mills [machines]; beverage preparation machines, electromechanical; juice extractors, electric; food processors, electric; pepper mills, other than hand-operated; coffee grinders, other than hand-operated; vegetable spiralizers, electric; kitchen grinders, electric; whisks, electric, for household purposes; electric food blenders for household purposes; beaters, electric; can openers, electric; dust removing installations for cleaning purposes; snow ploughs; car washing machines; waste disposal units; cleaning appliances utilizing steam; machines and apparatus for cleaning, electric; automated washers for surgical, medical and laboratory equipment; brushes for vacuum cleaners.

11 – Dehumidifiers; air sterilisers; heat pumps; air conditioning apparatus; air purifying apparatus and machines; ventilation [air-conditioning] installations and apparatus; disinfectant apparatus; heating installations; underfloor heating apparatus and installations; air-source heat pump water heaters; fireplaces, domestic; pressure water tanks; thermostatic valves [parts of heating installations]; water heaters; refrigerators; wine refrigerators; refrigerating cabinets; ice machines and apparatus; heating and cooling apparatus for dispensing hot and cold beverages; beverage cooling apparatus; freezers; refrigerators, cooling apparatus and freezers for medical storage purposes; drying apparatus and installations; wine cellars, electric; refrigerating chambers; walk-in refrigerators; refrigerating containers; coolers, electric; cooling installations and machines; cooling appliances and installations; refrigerating display cabinets; heated display cabinets; beer brewing machines, electric, for household purposes; cooling installations for liquids; refrigerating appliances and installations; laundry dryers, electric; water purifying apparatus and machines; chilled purified water dispensers; electric hot water dispensers; cooking ranges; extractor hoods for kitchens; ionization apparatus for the treatment of air or water; heaters for baths; water softening apparatus and installations; ventilation hoods; kitchen ranges [ovens]; water purification installations; cookers; gas burners; filters for drinking water; microwave ovens [cooking apparatus]; food steamers, electric; steam generating installations; roasting apparatus; roasters; bread baking machines; smokers [cooking apparatus]; cooking ovens; induction cookers; electric cooktops; electric rice cookers; pressure cookers, electric; fans [air-conditioning]; radiators, electric; coffee machines, electric; humidifiers; air conditioning installations; filters for air conditioning; fans [parts of air-conditioning installations]; air filtering installations; air cooling apparatus; ventilation [air-conditioning] installations for

vehicles; air conditioners for vehicles; steam cabinets for the treatment of clothing; coffee machines incorporating water purifiers; coffee roasters; coffee percolators, electric; lamps; electric refrigerators for household purposes; cooking installations; cooking apparatus; electric water heating apparatus; hot water heating installations; bath installations; purification installations for sewage; kettles, electric; water supply installations.

(260) AM 2026 135512 A

(800) 1874663

(151) 2025 08 12

(891) 2025 08 12

(731) Ferrara Candy Company

404 W. Harrison Street, Ste 650, Chicago
IL 60607, USA

(540)



(591) Black, white

(531) 27.05.17; 27.05.19

(511)

30 – Candy.

(260) AM 2026 135513 A

(800) 1874667

(151) 2025 08 12

(891) 2025 08 12

(731) Ferrara Candy Company

404 W. Harrison Street, Chicago IL 60607,
USA(540)



(591) Black, white

(531) 27.05.02; 27.05.03; 27.05.09; 27.05.10;
27.05.17; 27.05.24

(526) CANDY

(511)

30 – Candy.

(260) AM 2026 135529 A

(800) 1875133

(151) 2025 07 08

(891) 2025 07 08

(731) Obshchestvo s ogranichennoj otvetstvennost'yu

"Syrovarnya"
ul. Letnikovskaya, dom 5, pom. 1/2,

RU-115114 vn.ter.g. munitsipalnyi okrug
Danilovskiy, Russian Federation

(540)



(591) White and orange

(531) 27.05.10; 28.05; 29.01.12

(526) The word in Cyrillic transliterated into
"TRATTORIYA"

(511)

43 – Services for providing food and drink; snack-bar services; café services; cafeteria services; restaurant services; self-service restaurant services; food sculpting; decorating of food; bar services; food reviewing services [provision of information about food and drinks]; food and drink catering; washoku restaurant services; udon and soba restaurant services; take-away restaurant services; canteen services.

(260) AM 2026 135530 A

(800) 1875154

(151) 2025 08 11

(891) 2025 08 11

(731) CAGS TOBACCO TUTUN VE TUTUN

MAMULLERI SANAYI TICARET ANONIM
SIRKETI

Fulya Mah. Buyukdere Cad., Torun Center A
Blok 74 A 19, Sisli, TR-34394 Istanbul,
Türkiye

(540)



(591) Black, white

(531) 27.05.01

511)

4 – Hookah coal; hookah charcoal.

34 – Tobacco; chewing tobacco; hookah tobacco; cigarettes; cigars; cigarette cases; tobacco pipes; cigar holders; cigarette holders; smokers' mouthpieces for cigarettes, cigars, cigarette holders and cigar holders; cigarette rolling papers; ashtrays for smokers; humidors; pocket machines for rolling cigarettes; cigarette paper; firestones; lighters for smokers; matches.

(260) AM 2026 135531 A

(800) 1875211

(151) 2025 01 04

(891) 2025 01 04

(731) Obshchestvo s ogranichennoj otvetstvennost'ju
"Joia Project"

Pokrovskaya doroga street, 8A, room 1, office
36, Novosaratovka village, Vsevolozhskij
m.s., RU-193149 Leningrad Region,
Russian Federation

(540)

The Earth. [ЗЕМЛЯ] Come on people don't let me down

(591) Black, white

(531) 28.05

(511)

32 – Beer; non-alcoholic beverages; mineral and aerated waters; fruit beverages and fruit juices; syrups and other non-alcoholic preparations for making beverages; aperitifs, non-alcoholic; non-alcoholic essences and fruit extracts for making beverages; de-alcoholized wines; barley wine [beer]; flavored water; vitamin enriched water [beverages]; carbonated water; vitamin enriched sparkling water [beverages]; spring water; glacial water; lithia water; flavored mineral water; natural deep drinking water; seltzer water; soda water; waters [beverages]; mineral water [beverages]; drinking water; table waters; guarana [syrups for beverages, other than for medical, dietetic or therapeutic purposes]; non-alcoholic preparations for making beverages; kvass; cocktails, non-alcoholic; frozen cocktails, non-alcoholic; beer-based cocktails; fruit cocktails, non-alcoholic; concentrates used in the preparation of soft drinks; concentrates for making non-carbonated isotonic electrolytic beverages; concentrates for making fruit juices; concentrates for making fruit beverages; fruit concentrates and purées used for making beverages; juice concentrates; fruit juice concentrates; concentrates of hops for making beer; concentrates for preparing sports beverages; lemonades; seed-based beverages, other than substitutes and rice-based and soy-based beverages, not being milk substitutes; malted milk being syrups for beverages; mors [fresh fruit- or berry-based beverages]; root and herb-based non-alcoholic beverages; non-alcoholic beverages made from seaweed; non-alcoholic dried fruit beverages; cajuína [cashew fruit-based non-alcoholic beverage]; non-alcoholic spearmint-flavored herbal-based beverages; non-alcoholic grenadine-flavored fruit-based beverages; non-alcoholic strawberry-flavored fruit-based beverages; non-alcoholic lemon-flavored fruit-based beverages; non-alcoholic passion fruit flavored fruit-based beverages; beverages, non-alcoholic; non-alcoholic beer; beer-flavoured beverages; non-alcoholic beverages flavoured with chocolate; non-alcoholic fruit juice beverages; non-alcoholic beverages containing ginger juice; non-alcoholic beverages containing vegetable juices; non-alcoholic beverages containing ginseng juice; frozen carbonated beverages; aloe vera gel beverages; de-alcoholised beverages; frozen fruit-based beverages; beverages made of flavored ice; mung bean beverages; grape juice beverages; ginger juice beverages being ginger beer; cranberry juice beverages; plant syrup beverages [non-alcoholic fruit flavored beverages]; garapa [sugarcane juice beverage]; isotonic beverages; table beverages, non-alcoholic; coconut-based beverages; non-alcoholic honey-based beverages; rice-based beverages, other than milk substitutes; soya-based beverages, other than milk substitutes; smoothies; grain-based beverages,

other than milk substitutes; rice-based and soya-based beverages, other than milk substitutes; aloe vera drinks, non-alcoholic; pineapple juice beverages; orange juice beverages; sesame-based beverages, other than milk substitutes; whey beverages; vegetable-based lacto-fermented drinks; millet-based beverages, other than milk substitutes; chia seed-based beverages; low-calorie non-alcoholic beverages; protein-enriched sports beverages; carbonated drinks [refreshing beverages]; soft drinks; instant energy drinks embedded in 3D-polycapsule printed cups; soft drinks flavored with tea; non-alcoholic beverages flavoured with coffee; non-alcoholic beverages flavoured with tea; energy drinks; sugar-free energy drinks; energy gel beverages; protein sports drinks; plant-based protein enriched beverages; grape juice beverages, non-alcoholic; nectars; fruit nectars, non-alcoholic; orgeat; non-alcoholic cocktail bases; fruit juice bases; flavored beers; non-alcoholic ginger beer; beer and beer-based beverages; agave beer; kiwicha beer; quinoa beer; sweet potato beer; ginger beer; potato beer; hemp-flavored beer; root beer; craft beer; corn beer; milk stout beer; wheat beer; draught beer; rice beer; coffee-flavored beer; high-alcohol content beer; fruit-flavored beer; pale ale; low-alcohol beer; malt beer; dark beer; fruit-based beer; black beers [roasted malt beers]; powders for effervescing beverages; powders for making soft drinks; powders for making fruit-based beverages; powders used in the preparation of sports drinks; non-alcoholic punch; non-alcoholic rice punch; sangrita [non-alcoholic beverage]; sarsaparilla [non-alcoholic beverage]; syrups for lemonade; syrups for beverages; syrups for making flavored mineral waters; syrups for making beverages; syrups for making fruit-flavored drinks; mixes for making smoothies; starch-based dry mixes for beverage preparation; frozen smoothies; frozen fruit smoothies; agave juice [beverage]; aloe vera juices; pineapple juice; orange juice; watermelon juice; birch juice; grape juice; watercress juices [beverages]; pomegranate juice; grapefruit juice; guava juice; melon juice; kiwi fruit juice; kaffir lime juice; maple juice; strawberry juice; tomato juice [beverage]; non-alcoholic apple juice; juices; vegetable juices [beverages]; fruit juices; aerated fruit juices; concentrated fruit juices; preparations for making non-alcoholic beverages; preparations for making carbonated water; must; grape must, unfermented; beer wort; malt wort; pastilles for effervescing beverages; shandy; sherbets [beverages]; non-alcoholic fruit extracts; extracts of hops for making beer; non-alcoholic essences for making beverages; cranberry juice; coconut water; concentrated smoked plum juice; lime juice for use in the preparation of beverages; lemon juice for use in the preparation of beverages; lemon juice [beverages]; mango juice; passion fruit juice; carrot juice; cucumber juice; papaya juice; peach juice; wheatgrass juice [beverages]; sugarcane juice [beverage]; beet juice; celery juice [beverages]; blackcurrant juice; spinach juice [beverages]; non-al-

coholic preparations for making beverages; sujeong-gwa [non-alcoholic cinnamon punch with dried persimmon]; tonic water; fruit purées for making beverages; processed hops for use in making beer; chicha de quinoa [quinoa-based non-alcoholic beverages]; chicha de oca [oca-based non-alcoholic beverages]; chicha morada [purple corn-based non-alcoholic beverages]; chicha [non-fermented non-alcoholic beverages]; sherbets [beverages] infused with alcohol; extracts of unfermented must; malt extracts for making liqueurs; non-alcoholic fruit extracts for making beverages; ales.

33 – Alcoholic beverages, except beer; alcoholic preparations for making beverages; absinthe; amontillado; distilled aperitifs; wine-based aperitifs; alcoholic aperitif bitters; liquor-based aperitifs; aperitifs; arrack [arak]; bitters; brandy; fruit brandy; vermouth; wine; aperitif wines; white wines; grape wine; sparkling grape wines; dessert wines; wines and wine-based beverages; sparkling wines; naturally sparkling wines; red wine; rosé wines; sweet wines; Japanese sweet grape wines containing extracts of ginseng and cinchona bark; table wines; fruit wines; sparkling fruit wines; liqueur wines; yellow rice wine; acanthopanax wine; piquette; black raspberry wine; low alcohol wine; whisky; flavor-infused whisky; bourbon whisky; single malt whisky; rye whisky; malt whisky; pure malt whisky; vodka; anisette [liqueur]; kirsch; juniper vodka; mulled wine; alcoholic eggnog; cocktails; gin; digestifs [liqueurs and spirits]; alcoholic preparations for making beverages; alcoholic cocktails; alcoholic cocktails in the form of non-chilled gelatins; alcoholic cocktails in the form of chilled gelatins; alcoholic cocktails in the form of frozen pops; alcoholic cocktails made of distilled spirits or wine; alcoholic cocktails containing milk; prepared wine cocktails; prepared cocktails consisting primarily of distilled spirits and also including beer; crème liqueurs; fortified wines; curacao; anise [liqueur]; liqueur containing herb extracts; blackcurrant liqueur; Japanese liqueur flavored with Asian plum extracts; Japanese liqueur flavored with pine needle extracts; Himalayan barley liqueur; liqueur flavored with pine needle extracts; liqueur flavored with Japanese plum extracts; liqueurs; flavoured tonic liqueur; Chinese distilled liqueur; lemon liqueurs; whisky-based liqueurs; coffee-based liqueurs; aquavit; Japanese sweet rice-based mixed liqueur; herbal liqueurs; fruit liqueurs; chocolate liqueurs; Japanese distilled liqueurs; Japanese liqueur containing herb extracts; liqueurs containing cream; grain-based distilled alcoholic beverages; sparkling alcoholic beverages; root and herb-based alcoholic beverages; alcoholic fruit beverages; sorghum-based Chinese spirits; Korean distilled spirits; cordials, alcoholic; agave-based distilled alcoholic beverages; vodka-based distilled alcoholic beverages; alcoholic coffee-based beverages; sake-based distilled alcoholic beverages; sugarcane-based alcoholic beverages; sugarcane-based and fruit-based alcoholic beverages; al-

coholic tea-based beverages; pre-mixed alcoholic beverages, other than beer-based; alcoholic beverages flavoured with chocolate; fermented alcoholic beverages; fermented corn-based alcoholic beverages; alcoholic beverages, except beer; distilled alcoholic beverages; alcoholic beverages containing fruit; flavoured brewed malt beverages, except beers; alcopops; Chinese alcoholic distilled beverages; wine-based beverages; sparkling wine-based beverages; rum-based beverages; low alcohol beverages, except beers; spirits [beverages]; alcoholic energy drinks; distilled beverages; alcoholic eggnog mixes; hydromel [mead]; peppermint liqueur; liqueur; alcoholic punch; rum; sugar cane juice rum; rum infused with vitamins; sake; anise-flavoured liqueurs; fruit-added wine; alcoholic cider; perry; cider and alcoholic pear liqueur; fortified cider; cider; alcoholic cocktail mixes; potable spirits; rice alcohol; spirits and liqueurs; agave-based spirits [beverages]; fermented spirits; fermented spirits; fruit spirits; cherry brandy; schnapps; alcoholic jelly shots; vodka jelly shots; rum jelly shots; soju jelly shots; extracts of spirituous liqueurs; alcoholic extracts; fruit extracts, alcoholic; alcoholic essences.

(260) AM 2026 135532 A

(800) 1875233

(151) 2025 04 04

(891) 2025 04 04

(731) Imkey Holding B.V.

Van Coothplein 39 A, NL-4811 ND Breda,
Netherlands

(540)



(591) Black, dark blue, light blue, white

(531) 26.01.03; 26.02.07; 27.05.17; 27.05.25;
29.01.12

(511)

9 – Software; web application software; downloadable application software; downloadable applications; computer software platform for creating and customizing online resumes, curricula vitae, and portfolios, recorded or downloadable; computer software platform for creating and customizing online resumes, curricula vitae, and portfolios.

35 – Recruitment services; employment services; business administration services; writing of curricula vitae and writing of cover letters for business purposes; writing of curriculum vitae for others; writing of resumes for others; writing of cover letters for others for business purposes; information services relating to jobs and career opportunities; career advisory services (other than education and training advice); providing business information via an online searchable database featuring curricula vitae and cover letters; providing online information in the field of employment;

writing of résumés for others through a website; providing online employment information in the field of resume writing and career services; information services in relation to curriculum vitae writing; consultancy in how to improve resumes and cover letters for business purposes; professional writing assistance tailored to job applications, including guidance in the job application process.

41 – Education services in relation to career development; training services in relation to career development; provision of online services in relation to the preparation of resumes, curricula vitae, and cover letters; career advisory services (education or training advice); workshops, online training; arranging and conducting events focused on career strategies for educational purposes, including information on how to write effective cover letters and resumes.

42 – Software as a service [SaaS]; software as a service [SaaS] featuring software for building and sharing online resumes, curricula vitae and cover letters; providing online software that enables users to create personalized resumes, curricula vitae and cover letters, through a website.

(260) AM 2026 135779 A

(800) 1878604

(151) 2025 06 09

(891) 2025 06 09

(731) Oatly AB

Box 588, SE-201 25 MALMÖ, Sweden

(540)



(591) Grey, white and black

(531) 01.15.11; 01.15.21; 11.03.04; 24.17.04;
27.01.05; 27.05.25; 29.01.12

(511)

29 – Dairy substitutes; milk substitutes; oat-based drinks for use as milk substitute; milk substitutes containing oats.

(260) AM 2026 135975 A

(800) 1881164

(151) 2025 04 16

(891) 2025 04 16

(731) Games Workshop Limited

Willow Road, Lenton, Nottingham NG7 2WS,
United Kingdom

(540)



(591) Black, white

(531) 03.07.17; 14.07.02; 14.07.11; 26.04.02;
26.04.15; 26.04.16

(511)

2 – Paints, varnishes, lacquers; preservatives against rust and against deterioration of wood; colorants; mordants; raw natural resins; metals in foil and powder form for painters, decorators, printers and artists.

6 – Badges namely vehicle badges of metal; keys, key blanks, split rings of common metal for keys; locks, all of common metals and their alloys; small items of metal hardware; tin boxes; bells; ornaments, statuettes, models and figurines, works of art all of common metals and their alloys; decorative and commemorative plaques and plates of non precious metals; signs, number plates, of all of common metals and their alloys; metal card holders; metallic waste bins, other than for domestic purposes; rope thimbles of metal; trinkets in the nature of ornaments all of common metals and their alloys; parts and fittings for the aforesaid goods.

8 – Hand tools; hand tools for use in arts and crafts, war games, skirmish games, role playing games, battle games, and fantasy/science fiction games; parts and fittings for all of the aforesaid goods.

9 – Computer games; video games; computer games software; video games software; computer programs; computer software and computer hardware apparatus with multimedia and interactive functions; computer software applications; application software; computer programs for accessing, browsing and searching online databases; computer software for use in connection with war games, skirmish games, role playing games, battle games, and fantasy/science fiction games; interactive multimedia computer games programs; interactive games programs; computer game discs, video game discs, downloadable computer game software, computer game software downloadable from a global computer network, downloadable electronic games via the internet and wireless devices; interactive multimedia computer game programs, records, discs, tapes, cassettes, cartridges, cards and other carriers bearing or for use in bearing sound recordings, video recordings, data, images, games, programs or information; DVDs; audio recordings in MP3 format; screen savers; digital audio, video and data (downloadable) provided from a computer database or the internet; talking books; audio books; wallpaper for desktops and mobile devices; downloadable ringtones for mobile phones, downloadable image files and downloa-

dable music files; mouse mats; downloadable electronic publications; downloadable electronic publications in the nature of books, art books, painting guides, novels, novellas, comics, manuals, rule books, newsletters, magazines and journals; downloadable electronic publications in the nature of books, art books, painting guides, novels, novellas, comics, manuals, rule books, newsletters, magazines and journals on the subject of fantasy, science fiction, war games, skirmish games, role playing games, battle games, and fantasy/science fiction games; instructional and teaching apparatus; computer hardware; computer hardware for use with video and computer game consoles; computer peripherals for use with video and computer game consoles; video and computer game interactive remote control units; memory cards for use with video and computer game consoles, hard drives for computers and video game consoles; headsets for use with computers and video game consoles; audio-visual computer cables; wireless computer network adapters; computer cameras (webcams); headphones; stereo headphones; in-ear headphones; measuring apparatus and instruments, namely tape measures, rulers, measuring templates; photographic, cinematographic, optical, measuring, signalling, checking (supervision) apparatus and instruments; sound recording and sound reproducing apparatus and instruments; CDs, CD-ROMs; cassettes; video cassettes; gramophone and phonographic records; downloadable audio and video recordings; downloadable ring tones, music, graphics, games and video images for wireless mobile communication devices; downloadable pre-recorded audio and audiovisual content, information, and commentary; downloadable electronic books, magazines, periodicals, newsletters, newspapers, journals, and other publications; downloadable smart phone applications (software); downloadable software in the nature of a mobile application for playing games, gaming or gambling; magnetic tapes for recording or reproducing sound or images; recording discs; magnetic tapes for recording and reproducing sound or images; audio recordings; video recordings; audio and video recordings; recorded programmes for television and for radio; motion picture films; animated cartoons; photographic transparencies and photographic and cinematographic films prepared for exhibition purposes; computers; PDAs (personal digital assistants); computer software; computer application software; electronic mail and messaging software; electronic bulletin boards; computer application software for mobile phones, smart phones and tablet devices featuring mobile phone functionality; computer application software for mobile devices, internet browsers, set-top boxes, electronic readers, and tablet computers, namely, software for video games and general interest software applications for shopping, rental of products, product comparison, entertainment, news, music and videos; computer game software; game software; interactive game software; pre-recorded games on CD, software,

video, mini discs; magnetic data carriers; payment cards, credit cards, charge cards, debit cards and smart cards; telephone cards; encrypted smartcards; encoded smartcards; encoded cards; magnetic identity cards; computer mice; keyboard and computer screen covers; customised computer disks and CD-ROMs; radios; televisions; plasma screens; binoculars; photographic apparatus and equipment, cameras, video cameras and parts and fittings therefor; camera films; barometers; telephones, mobile phones, smartphones and video phones and transmitters, receivers, covers, cases, fascia, holders, chargers, speakers, headsets, hands-free-kits, software, sounds, graphics, data input devices and media storage therefor; covers and cases for mobile telephones and laptop, notebook and tablet computers and PDAs; holders adapted for mobile phones; straps for mobile phones; covers and cases adapted for PDAs, MP3 players and laptops; earphones; mobile phone headsets and hands-free kits; batteries; battery chargers; electrical and electronic apparatus for use in the reception of satellite, terrestrial or cable broadcasts; tape recorders; cassette players; record players; MP3 players and MP3 readers; audio and/or video file recorders and/or players; remote control apparatus; digital photo frames; magnets; fridge magnets; compasses; tape measure; anti-dazzle shades; glasses and sun glasses and cases, chains, cords and frames therefor; visors; containers for contact lenses; optical goods; mechanical signs; neon signs; scales; time clocks [time recording devices]; cyclists helmets; magnifying glasses; alarms; thermometers; holograms; articles of protective clothing, footwear and headgear; protective helmets; sports helmets; electronic sign boards; height charts; parts and fittings for all the aforesaid goods.

14 – Horological and chronometric instruments; watches and clocks; jewellery; costume jewellery; imitation jewellery; precious and semi-precious stones; watch straps; earrings; key rings and key chains; key fobs; key fobs of leather; bracelets; brooches; lapel pins; tie pins; rings; necklaces; pendants; jewellery charms; cufflinks; amulets; statuettes, figurines, works of art, ornaments, models and trophies, all of precious metal or coated therewith; medals and medallions; coins; parts and fittings for the aforesaid goods.

16 – Printed matter; printed publications; publications in the nature of books, art books, painting guides, novels, novellas, comics, manuals, rule books, newsletters, magazines and journals; publications in the nature of books, art books, painting guides, novels, novellas, comics, manuals, rule books, newsletters, magazines and journals on the subject of war games, battle games, fantasy games, hobby games, skirmish games, table top games, science fiction games, role playing games; photographs; stationery; adhesives for stationery or household purposes; art paper, drawing paper, craft paper, transfer paper; artists' materials; paper crafts materials; paint brushes; paint boxes; painters'

easels; drawing instruments; drawing templates; drawing rulers; arts, craft and modelling equipment; coloured craft and art sand; instructional and teaching material (except apparatus); plastic materials for packaging (not included in other classes); printers' type; printing blocks; adhesive stickers; adhesive transfers; diaries; calendars; address books; greeting cards; collectable cards; decals; maps; posters; newspapers, periodical publications; books; newspapers, magazines and periodical publications; printed publicity and promotional material; printed programmes; booklets; brochures; leaflets; newsletters; comic books; bookbinding material; programme binders; instructional and teaching materials; greetings cards; postcards; notepads; writing pads; drawing pads; jotters; photograph albums; autograph books; pencils; erasers; pencil sharpeners; rulers; book markers; gift bags; gift wrapping paper; gift tags; envelopes, labels; set-squares; carrier bags of paper or plastic; personal organisers; stickers; sticker books; gift vouchers; paper weights; napkins; decalcomanias; paper and cardboard coasters; paper and cardboard place mats; paper table cloths and napkins; beer mats; tissues; paintings, framed or unframed; pens; folders; pads; party invitations; artists' materials; office requisites; plastic materials for packaging; scrap books; catalogues; files and folders; bookends; trading cards; collectors' cards; stencils; charts; wall charts; tickets; timetables; printed forms; certificates; menus; philatelic stamps; paper flags and pennants; paper banners; signs and advertisement boards of paper and cardboard; letter trays; letter openers; writing instruments; pencils; pencil sharpeners; cases and boxes for pens and pencils; pen and pencil holders; ink; ink pads; rubber stamps; prints and pictures; art prints; graphic prints, representations and reproductions; lithographs; engravings and etchings; portraits; paper towels; paper handkerchiefs; toilet paper; money clips; money clips of precious metals; cheque book holders; parts and fittings for all of the aforesaid goods.

20 – Furniture, mirrors, picture frames, photograph frames; plaques; picture frames; mirrors; split rings, not of metal, for keys; locks; works of art of wood, wax, plaster or plastic; plaques, statues, statuettes, figurines, works of art, ornaments, models and trophies, all of wood, wax, plaster or plastics; scale models of plastics; model stadia of plastics; non-metallic name plates and number plates; non-metallic and non-luminous house numbers; inflatable plastic signs; cushions and pillows; baskets, not of metal; non-metallic bins; display stands and boards; non-metal bottle caps and casing; bottle racks; containers, casks, chests, cases and boxes of wood or plastics; clothes hooks; coat hangers; hat and coat stands; mobiles; trays, not of metal; beanbags; dog beds; key rack; coat hooks; coat hangers; magazine racks; book shelves; stacking trays of plastics; seating for use in stadia; display stands and boards; plastic key cards (not encoded); holders for pennants; non-electric fans for personal use; non-

metallic plugs and stoppers; non-metallic closures for containers; non-metallic bottle caps and casings; corks for bottles; plastic decorations for foodstuffs; beds for animals; dog kennels; storage boxes of plastic for household use; pet baskets.

21 – Household or kitchen utensils and containers; glassware, porcelain, pottery and earthenware not included in other classes; chinaware; cookware; tableware; combs; sponges for household purposes; articles for cleaning purposes; household gloves; plates; commemorative plates; egg cups; coffee pots; non-metallic cookery moulds; bread boards and cutting boards; storage jars; drinking vessels; non-electric coolers for food and drinks; ice cube moulds; bottle buckets; glass stoppers; cocktail shakers; drinking straws; stands for bottles; menu card holders; place card holders; napkin holders; cutlery holders; condiment holders; salt cellars; toothpick holders and toothpicks; serving trays; bottle openers; corkscrews; decanters; mugs; picnic sets; tumblers; glasses; brushes; non-metallic money boxes and piggy banks; lunch boxes; tankards and hip flasks; drinking flasks; vacuum flasks; garden gnomes made of earthenware; drinking glasses; champagne flutes; beer mugs; heat insulated containers for beverages; refuse bins for household purposes; bottle openers; bottles; plastic sports bottles; decorative objects made of glass, ceramic, china, earthenware or porcelain; plaques, statuettes, figurines, works of art, ornaments, models and trophies, all of glass, ceramic, china, earthenware or porcelain; model stadia of glass, ceramic, china, earthenware or porcelain; enamelled glass; candlesticks; toothbrushes; holders for toothbrushes; soap boxes and holders; vanity cases; cosmetic powder compacts; picnic baskets; fitted picnic baskets including dishes; picnic boxes; picnic crockery; napkin holders and rings; paper plates; paper cups; plastic cups; tea caddies and tea services; teapots; tea cosies; flower pots; shaving brushes and shaving brush stands/holders; vases; coasters; baby beakers; plaques; oven gloves; pet feeding dishes; cool bags; baskets for domestic use; clothes-pegs; clothes pins; trays of precious metal; cool bags; goblets of precious metal; metal money boxes.

25 – Clothing, footwear, headgear; sports clothing; tracksuits; waterproof clothing; articles of underclothing; lingerie; hosiery; shirts; shorts; t-shirts; socks; sweatshirts; sweatpants; jackets; coats; fleeces; shirts; polo shirts; vests; singlets; blouses; knitwear; jerseys; jumpers; pullovers; sweaters; hooded tops; cardigans; shorts; leggings; skirts; ties; cravats; underwear; boxer shorts; briefs; thongs; lingerie; nightwear; pyjamas; night shirts; dressing gowns; bathrobes; beach clothes; swimwear; swim suits; bathing trunks; bathing caps; socks; gloves; mittens; scarves; ear muffs; wristbands; belts; braces; aprons (clothing); uniforms; ready-made clothes linings (parts of clothing); shoes; boots; sandals; slippers; sports shoes; training shoes; football boots and shoes; studs for football boots; hats;

caps; visors; headbands; sweat bands; articles of clothing, footwear and headgear for babies and children; bodysuits; romper suits; sleep suits; bibs; baby boots.

28 – Games; playthings; toys; role playing games; board games; playing cards and card games; dice; counters for games; miniatures and models; war games; battle games; fantasy games; hobby games; skirmish games; table top games; science fiction games; models in kit form; cases adapted for carrying miniatures and models; toy model hobby craft kits for constructing toy model landscapes, scenery and action figures; miniature landscapes, scenery, buildings and vehicles for use in war games, battle games, fantasy games, hobby games, skirmish games, table top games, science fiction games, role playing games; parts for constructing models; electronic games; video and computer game joysticks; video and computer game interactive control floor pads or mats; plastic covers for computer game consoles; balls for sport, none being punching balls and exercise weighted balls; playing balls for football, American football, tennis, rugby, volleyball, table tennis and golf; footballs; goal posts; miniature footballs; miniature replica football kits; tables for indoor football; goal keeper gloves; cases and bags adapted for carrying sporting articles (but not for boxing articles, for exercise apparatus or for exercise equipment); articles for playing golf; golf balls; golf tees; golf ball markers; golf bags; golf club covers; golf gloves; golf bag trolleys; articles for playing darts; darts; sporting articles for use in playing snooker; snooker tables; pool tables; sledges; fishing tackle; dominoes; marbles; dolls; action figure toys; soft toys; teddy bears; puppets; bathtub toys; inflatable toys; ride-on toys; toy vehicles; flying discs; electronic hand held game units; home video game machines and amusement apparatus all for use with television receivers; controllers and joysticks for use with home video game machines; jigsaw puzzles; toy models, figurines; kites; costume masks; costumes being children's playthings; party novelty hats; sponge hands in the nature of novelties; rattles; jokes and party novelties; confetti; balloons; conjuring apparatus; skittles; Christmas tree decorations; decorations for Christmas trees; Christmas crackers; synthetic Christmas trees and Christmas tree stands; mobiles (toys); bath time ducks; Santa sacks; Christmas stockings; snow globes; toys designed to be attached to car seats; flying discs; swim floats; none of the aforesaid goods for use in relation to the sport of bowling; parts and fittings for all of the aforesaid goods; coin or token operated gaming apparatus; covers and cases adapted for gaming devices.

35 – Compilation of information into databases; compilation of information for publishing on the internet or a global computer network; advertising text publication services; direct mail advertising; distribution of samples; organisation of exhibitions for commercial or advertising purposes; advisory services relating to

establishment and operation of franchises; provision of assistance in the establishment and operation of franchises; retail store services, department store retail services, mail order retail services and online retail services connected with the sale of perfumery, toiletries and cosmetics, pharmacy goods, paints, varnishes, lacquers, preservatives against rust and against deterioration of wood, colorants, mordants, raw natural resins, metals in foil and powder form for painters, decorators, printers and artists, paints, hand tools, hardware and metal goods, cutlery, household domestic products including white goods, computers, computer software, computer peripherals, computer games, video games, electronic games, computer games software, video games software, videos, DVDs and CDs, optical and photographic goods, sunglasses, telephones and mobile phones, lighting equipment and fixtures, televisions, audio equipment, signs and signage, printed publications and materials, magazines, books, guides, diaries, greeting cards, giftwrap, jewellery, watches and clocks, fashion accessories, leatherwear, bags, travel goods, belts, clothing, lingerie, footwear, hair accessories, furniture, garden furniture, furnishings and decorations, household textile products namely curtains, blinds and wall coverings, bedding, bed linen and table linen, towels, kitchenware, crystal, earthenware, glassware, porcelain and chinaware, ornaments, carpets and rugs, toys, games and playthings, fitness equipment, decorations, food and drink, pet products, tobacco goods, smoker's requisites, bicycles; print and radio advertising; advertising including on-line advertising services, promotional services, public relations.

41 – Arranging and conducting seminars, exhibitions, expositions, competitions, conventions and conferences; providing museum facilities; club services (entertainment and/or education); gaming services; on-line gaming services; entertainment services; entertainment services in the area of computer gaming; entertainment services, namely, providing on-line computer games, tips and strategies for computer games; arranging and conducting computer game competitions; arranging of games; provision of games; rental of gaming apparatus; rental of scenery; electronic games services provided by means of the Internet; providing Internet games (non-downloadable); provision of games by means of a computer based system; game services provided on-line from a computer network; entertainment services, namely, providing on-line computer games, providing computer games that may be accessed via a global computer network, providing online news and information in the field of games; educational and training services relating to fantasy, science fiction, war games, skirmish games, role play games, battle games, and fantasy/science fiction games; publishing services; publication of texts and books; electronic publishing services; providing on-line publications [non downloadable]; providing on-line publications [non downloadable] in the nature of bo-

oks, art books, painting guides, novels, novellas, comics, manuals, rule books, newsletters, magazines and journals; providing on-line publications [non downloadable] in the nature of books, art books, painting guides, novels, novellas, comics, manuals, rule books, newsletters, magazines and journals on the subject of fantasy, science fiction, war games, skirmish games, role playing games, battle games, and fantasy/science fiction games; book club services, arrangement and formation of book clubs, hire of audio and video cassettes; information services relating to books and printed publications; publication of computer games; providing on-line electronic publications; advisory services relating to publishing; information, advice and consultation in relation to all of the aforesaid services; entertainment services in the nature of television programming and motion pictures; production and distribution of motion pictures and television programming, games, and general entertainment content; audiovisual programming and games streamed, downloaded or otherwise exhibited via a worldwide communications network or on wireless devices; providing non-downloadable television shows, movies, and multimedia entertainment content, as well as information, reviews, and recommendations regarding television shows, movies, and multimedia entertainment content; entertainment and educational services, namely, providing non-downloadable movies and television shows via a video-on-demand service, as well as information, reviews, and recommendations regarding movies and television shows.

(260) AM 2026 135978 A
 (800) 1881195
 (151) 2025 06 30
 (891) 2025 06 30
 (731) KIRLOSKAR PROPRIETARY LTD
 13A Karve Road, Kothrud, Pune 411038, India
 (540)



(591) Black, white
 (531) 26.13.25; 27.03.01; 27.05.21
 511)
 9 – Software and applications for mobile devices; downloadable applications for use with mobile devices, scientific, nautical, surveying, measuring, signalling, checking (supervision), apparatus and instruments for conducting, switching, transforming, accumulating, regulating or controlling electricity; data processing equipment; computer software; accumula-

tors for vehicles; fire extinguishers and parts thereof, solar batteries, solar powered battery chargers, inverters used in solar power generation, apparatus for fermentation (laboratory apparatus), battery packs, battery boxes, photovoltaic inverters and solar panels for electricity generation.

(260) AM 2026 135979 A
 (800) 1881203
 (151) 2025 05 29
 (891) 2025 05 29
 (731) EGT DIGITAL LTD.
 "Panorama Sofia" Str. 6, Business Center
 "Richhill", block A, BG-1766 Sofia, Bulgaria
 (540)



(591) Pink, purple, yellow, orange, green, white and black
 (531) 01.15; 05.03.13; 05.07.24; 27.05.01; 29.01.15
 (511)
 9 – Operating computer software for main frame computers; monitors (computer hardware); computer hardware; apparatus for recording images; monitors (computer programs); computer game programs; recorded computer game programs; apparatus for recording, transmission or reproduction of sound or images; communications servers (computer hardware); electronic components for gambling machines; computer application software featuring games and gaming; computer software for the administration of on-line games and gaming; computer hardware for games and gaming; computer systems; computer operating system software; computer terminals; interactive terminals; multimedia terminals; electronic terminals for generating lottery tickets; interactive touch screen terminals; computer touchscreens; electronic display panels; liquid crystal display screens; digital signage display panels; multimedia software; multimedia apparatus and instruments; interactive multimedia software for playing games; computer screens; LCD large-screen displays; liquid crystal displays [LCDs] for home theatres; media streaming software; computer application software for streaming audio-visual media content via the internet; computer gaming software; software; computer software packages; computer software, recorded; software drivers; virtual reality software; games software; entertainment software for computer games; computer programs for network management; electronic lottery tickets; computer software platforms; operating systems; interactive computer systems; operating system programs; computer game software for use with on-line interactive games; interactive casino games provided through a computer or

mobile platform; software for slot machines, betting software, software for video slot games, for casino games, for gambling and bingo games, provided online or through computer networks and that can be played on any type of computer device, including arcade games, personal computers, portable devices and mobile phones; electronic ticket examination machines; computer hardware and software for gambling, gambling machines, gambling games on the internet and via telecommunication network.

28 – Gaming machines for gambling; chips for gambling; mah-jong; arcade games; gambling machines operating with coins, notes and cards; games; electronic games; parlor games; gaming chips; gaming tables; slot machines [gaming machines]; LCD game machines; slot machines and gaming devices; coin-operated amusement machines; roulette chips; poker chips; chips and dice [gaming equipment]; gaming equipment for casinos; roulette tables; gaming roulette wheels; casino games; gambling machines and amusement machines, automatic and coin-operated; coin-operated amusement machines and / or electronic coin-operated amusement machines with or without the possibility of gain; boxes for coin-operated amusement machines, slot machines and gaming machines; electronic or electrotechnical amusement machines and apparatus, gaming machines, coin-operated entertainment machines; housings for coin-operated amusement machines, gaming equipment, gaming machines, machines for gambling; electropneumatic and electrical gambling machines (slot machines); lottery games; electronic targets for games and sports; lottery tickets; printed lottery tickets; lottery scratch cards; scratch cards for playing lottery games; parlor game equipment and accessories therefor, included in this class, in particular game tokens, chips and marbles; parlor game apparatus and equipment, and accessories therefor, included in this class, in particular electronic targets, backgammon games, scratch cards, playing cards, lottery cards, dice.

41 – Gambling; gaming services for entertainment purposes; casino, gaming and gambling services; training in the development of software systems; provision of gaming equipment for gambling halls; providing casino equipment [gambling]; gaming machine entertainment services; providing casino facilities [gambling]; amusement arcade services; games equipment rental; rental of gaming machines; providing amusement arcade services; rental of gaming machines with images of fruits; editing or recording of sounds and images; sound recording and video entertainment services; hire of sound reproducing apparatus; provision of gaming equipment for casinos; providing of casino facilities; online gambling services; entertainment services related to operation of amusement arcades, on-line casinos and on-line betting services via websites; online interactive entertainment; on-line casino services; online game services through

mobile devices; providing online entertainment in the nature of game tournaments; providing on-line information in the field of computer gaming entertainment; sports betting services; online sports betting services; lottery services; organization of lotteries; conducting lotteries; prize draws [lotteries]; conducting lotteries for others; providing slot machine parlors; rental of slot machines [gaming machines]; providing online games and games of chance.

(260) AM 2026 135981 A

(800) 1881257

(151) 2025 09 22

(891) 2025 09 22

(731) SOREMARTEC S.A.

Route de Trèves 16, L-2633 Senningerberg,
Luxembourg

(540)



(591) Black, orange-red, brown, beige and white

(531) 01.15.15; 02.09.01; 05.07.02; 08.01.10;
08.01.11; 08.01.12; 08.01.19; 08.01.21;
27.01.11; 27.05.08; 27.05.17; 27.05.25;
29.01.15

(511)

30 – Pastries; confectionery; sugar confectionery; biscuits; cookies; chocolate; chocolate-based products; cereal-based snack food.

(260) AM 2026 136020 A

(800) 1862560

(151) 2025 04 11

(891) 2025 07 30

(731) NicomGroup AG

Baarerstrasse 21, CH-6302 Zug, Switzerland

(540)



(591) Black, white

(531) 03.06.01; 03.06.06; 27.05.10; 27.05.17

(511)

34 – Tobacco and tobacco substitutes; cigarettes and cigars; electronic cigarettes and oral sprays for smokers; smokers' articles; matches; tobacco products;

chewing tobacco; tobacco for oral use (moist tobacco powder known as snus).

(260) AM 2026 136071 A

(800) 1881689

(151) 2025 08 28

(891) 2025 08 28

(731) Simanov Aleksandr Vladimirovich
ul. Druzhby, d. 6, kv. 2, s. Kakmozh, r-n
Vavozhskij, RU-427305 Udmurtskaya
Respublika, Russian Federation

(540)

GRANDCHEF
ГРАНДШЕФ

(591) Black, white

(531) 27.05.01; 28.05

(511)

7 – 3D bioprinters; 3D printers; ticket vending machines; vending machines; welding machines, electric; soldering apparatus, gas-operated; apparatus for aerating water; vulcanization apparatus; acetylene cleaning apparatus; high pressure washers; apparatus for drawing up beer under pressure; apparatus for aerating beverages; electrical apparatus for sealing plastics [packaging]; electric arc cutting apparatus; electric arc welding apparatus; electric welding apparatus; inking apparatus for printing machines; soldering apparatus, electric; air brushes for applying colour; expansion tanks [parts of machines]; drums [parts of machines]; brake shoes, other than for vehicles; concrete mixers [machines]; bioreactors for use in manufacturing biopharmaceuticals; reels [parts of machines]; bobbins for weaving looms; harrows; journal boxes [parts of machines]; bulldozers; hoppers [mechanical discharging]; mine borers; rolling mill cylinders; crank shafts; printing rollers for machines; camshafts for vehicle engines; transmission shafts, other than for land vehicles; fans for motors and engines; saw benches [parts of machines]; winnowers; vibrators [machines] for industrial use; water heaters being parts of machines; bellows [parts of machines]; agitators; drilling rigs, floating or non-floating; lawnmowers [machines]; card clothing [parts of carding machines]; nail extractors, electric; emergency power generators; alternators; dynamos; bicycle dynamos; current generators; electricity generators; hydraulic controls for machines, motors and engines; mufflers for motors and engines; drilling heads [parts of machines]; drilling bits [parts of machines]; cylinder heads for engines; soldering blow pipes, gas-operated; gas-operated blow torches; raking machines; stalk separators [machines]; sieves [machines or parts of machines]; mud catchers and collectors [machines]; tarring machines; rubber tracks being parts of crawlers on mining machines; rubber tracks being parts of crawlers on snow ploughs; rubber tracks being parts of crawlers on loa-

ding-unloading machines and apparatus; rubber tracks being parts of crawlers on agricultural machines; rubber tracks being parts of crawlers on construction machines; hydraulic engines and motors; aeronautical engines; aeroplane engines; engines for air cushion vehicles; compressed air engines; jet engines, other than for land vehicles; engines for boats; driving motors, other than for land vehicles; motors, other than for land vehicles; propulsion mechanisms, other than for land vehicles; de-aerators for feedwater; disintegrators; tympan [parts of printing presses]; holding devices for machine tools; turf removing ploughs; pump diaphragms; door closers, hydraulic; door closers, pneumatic; door closers, electric; chisels for machines; jacks [machines]; rack and pinion jacks; moving walkways; electric hand drills; crushers for kitchen use, electric; reapers; reapers and binders; millstones; rakes for raking machines; needles for knitting machines; needles for wool combing machines; needles for sewing machines; shredders [machines] for industrial use; kitchen grinders, electric; injectors for engines; incubators for eggs; tools [parts of machines]; ski edge sharpening tools, electric; hand-held tools, other than hand-operated; agricultural implements, other than hand-operated; air condensers; control cables for machines, engines or motors; capstans; calenders; rotary steam presses, portable, for fabrics; ditchers [ploughs]; carburettors; sliders for knitting machines; crankcases for machines, motors and engines; steam-rollers; reels, mechanical, for flexible hoses; valves [parts of machines]; pressure valves [parts of machines]; clack valves [parts of machines]; pressure reducers [parts of machines]; cowlings [parts of machines]; machine wheels; freewheels, other than for land vehicles; scale collectors for machine boilers; lasts for shoes [parts of machines]; brake pads, other than for vehicles; piston segments; grease rings [parts of machines]; reapers and threshers; coal-cutting machines; compressors [machines]; air pumps [garage installations]; compressors for refrigerators; conveyors [machines]; belt conveyors; converters for steelworks; aerocondensers; steam condensers [parts of machines]; diggers [machines]; rams [machines]; thermic lances [machines]; mechanized livestock feeders; boxes for matrices [printing]; gear boxes, other than for land vehicles; stuffing boxes [parts of machines]; grease boxes [parts of machines]; housings [parts of machines]; harvesting machines; steam engine boilers; coffee grinders, other than hand-operated; taps [parts of machines, engines or motors]; cranes [lifting and hoisting apparatus]; roller bridges; mobile cranes; water separators; spray guns for paint; cranks [parts of machines]; potters' wheels; grindstones [parts of machines]; cultivators [machines]; soldering lamps; winches; blades [parts of machines]; ploughshares; belts for conveyors; passenger lifts; lubricators [parts of machines]; igniting magnetos; churns; matrices for use in printing; machine fly-wheels; shearing machines for animals; blowing machines; knitting machi-

nes; galvanizing machines; bending machines; ironing machines; mineworking machines; blowing machines for the compression, exhaustion and transport of gases; blowing machines for the compression, sucking and carrying of grain; net hauling machines [fishing]; electroplating machines; bottle sealing machines; sealing machines for industrial purposes; embossing machines; engraving machines; finishing machines; crushing machines; waste disposal units; furnace loading machines; blade sharpening [stropping] machines; earth moving machines; sausage making machines; cord making machines; lace making machines; butter machines; miso making machines; cigarette machines for industrial purposes; soy sauce making machines; stereotype machines; dyeing machines; bottle washing machines; machines for the application of sizing; bottle filling machines; cheese slicers, electric; racket stringing machines; leather-working machines; dairy machines; glass-working machines; tobacco processing machines; grain husking machines; painting machines; oil refining machines; peeling machines; machines for processing plastics; ore treating machines; printing machines for use on sheet metal; brewing machines; whitewashing machines; road sweeping machines, self-propelled; leather paring machines; machines for generating gas by electrolysis; bitumen making machines; papermaking machines; pasta making machines, electric; semiconductor manufacturing machines; machines for the production of sugar; weeding machines; sifting machines; cinder sifters [machines]; puddling machines; fluid dispensing machines for industrial use; tape dispensing machines for industrial use; notchers [machine tools]; bread cutting machines; road making machines; railroad constructing machines; machines for the textile industry; rammers [machines]; rail-laying machines; bottle capping machines; bottle stoppering machines; waste compacting machines; die-stamping machines; stamping machines; darning machines; milking machines; drainage machines; wrapping machines; grain separators; bookbinding apparatus and machines for industrial purposes; machines and apparatus for cleaning, electric; machines and apparatus for carpet shampooing, electric; machines and apparatus for polishing [electric]; punching machines; riveting machines; kitchen machines, electric; foundry machines; smoothing presses; fleshing machines; flour mill machines; type-setting machines [printing]; hemming machines; grating machines for vegetables; braiding machines; rinsing machines; wringing machines for laundry; cutting machines; steam engines; printing machines; rotary printing presses; industrial inkjet printing machines; compressed air machines; handling machines, automatic [manipulators]; tilling machines for agricultural purposes; trimming machines; spinning machines; filling machines; friezing machines; satinizing machines; agricultural machines; mixing machines; sorting machines for industry; stitching machines; washing machines [laundry]; coin-operated washing machines; laun-

dry washing machines incorporating a drying tumbler; clippers [machines]; spinning frames; kneading machines; typographic machines; type-setting machines [photocomposition]; beating machines; beaters, electric; packing machines; packaging machines; filtering machines; moulding machines; carding machines; sewing machines; typecasting machines; electromechanical machines for chemical industry; labellers [machines]; mills [machines]; mills for household purposes, other than hand-operated; pepper mills, other than hand-operated; centrifugal mills; machine wheelwork; feeders [parts of machines]; transmission mechanisms, other than for land vehicles; forge blowers; mixers [machines]; blenders, electric, for household purposes; vacuum cleaner bags; threshing machines; pneumatic hammers; hammers [parts of machines]; tilt hammers; power hammers; passenger boarding bridges, electromechanical; reeling apparatus, mechanical; motorized cultivators; motors for boats; clutches, other than for land vehicles; meat choppers, electric; superchargers; brake linings, other than for vehicles; guides for machines; suction nozzles for vacuum cleaners; vacuum cleaner attachments for disseminating perfumes and disinfectants; pumps [machines]; pumps [parts of machines, engines or motors]; aerating pumps for aquaria; vacuum pumps [machines]; compressed air pumps; petrol pumps for service stations; pumps for heating installations; beer pumps; pumps for counter-current swimming; lubricating pumps; self-regulating fuel pumps; fuel dispensing pumps for service stations; centrifugal pumps; hydrogen dispensing pumps for service stations; tin openers, electric; knives for mowing machines; chaff cutter blades; knives, electric; knives being parts of machines; shears, electric; scissors, electric; vegetable spiralizers, electric; vegetable slicers, electric; engine mounts, other than for land vehicles; bearing brackets for machines; axles for machines; steam traps; chucks [parts of machines]; drill chucks [parts of machines]; exhaust manifold for engines; soldering irons, gas-operated; soldering irons, electric; gears, other than for land vehicles; reduction gears, other than for land vehicles; drilling machines; saws [machines]; chain saws; guns [tools using explosive cartridges]; glue guns, electric; compressed air guns for the extrusion of mastics; sandblasting guns; carburetter feeders; feeding apparatus for engine boilers; loading ramps; ploughs; pneumatic transporters; pneumatic controls for machines, motors and engines; hangers [parts of machines]; bearings [parts of machines]; anti-friction bearings for machines; roller bearings; self-oiling bearings; bearings for transmission shafts; ball-bearings; mechanical vehicle stacking lifts; elevators [machines]; hoists; railway wagon lifts; pulleys; saw blades [parts of machines]; pistons [parts of machines or engines]; shock absorber plungers [parts of machines]; pistons for engines; pistons for cylinders; catalytic converters; torque converters, other than for land vehicles; fuel conversion apparatus for internal combustion engines; presses

[machines for industrial purposes]; wine presses; fruit presses, electric, for household purposes; fodder presses; basket presses; printing presses; typographic presses; swaging machines; pneumatic or hydraulic linear actuators, other than for land vehicles; pedal drives for sewing machines; cleaning appliances utilizing steam; food processors, electric; springs [parts of machines]; spinning wheels; punches for punching machines; vacuum cleaners; touchless stationary vacuums; tambours for embroidery machines; radiators [cooling] for motors and engines; sewage pulverizers; regulators [parts of machines]; pressure regulators [parts of machines]; speed governors for machines, engines and motors; cutters [machines]; cutting blow pipes, gas-operated; blade holders [parts of machines]; loom shafts; gears for weaving looms; belts for machines; fan belts for motors and engines; dynamo belts; belts for motors and engines; adhesive bands for pulleys; industrial robots; household cleaning and laundry robots with artificial intelligence; robotic arms for preparing beverages; 3D printing pens; kick starters for motorcycles; joysticks being parts of machines, other than for game machines; paper feeders [printing]; whisks, electric, for household purposes; sparking plugs for internal combustion engines; glow plugs for diesel engines; brake segments, other than for vehicles; tedding machines; steam/oil separators; cream/milk separators; ball rings for bearings; sowers [machines]; exhausts for motors and engines; pigs for cleaning pipes; snow ploughs; sheaf-binding machines; shaft couplings [machines]; joints [parts of engines]; juice extractors, electric; straw [chaff] cutters; suction cups for milking machines; stands for machines; machine tools; die-cutting and tapping machines; woodworking machines; sharpening machines; portable laser engraving machines; bicycle assembling machines; mortising machines; stone-working machines; metalworking machines; size adjustment cutting machines for industrial purposes; threading machines; trueing machines; planing machines; looms [machines]; lathes [machine tools]; milling machines; hosiery looms [machines]; grinding machines; electrical discharge machines [EDM]; metal drawing machines; rolling mills; starters for motors and engines; stators [parts of machines]; glaziers' diamonds [parts of machines]; tables for machines; derricks; slide rests [parts of machines]; spin dryers [not heated]; couplings, other than for land vehicles; heat exchangers [parts of machines]; transmissions for machines; boiler tubes [parts of machines]; wind turbines; hydraulic turbines; turbines, other than for land vehicles; turbo-compressors; turbochargers for motors; central vacuum cleaning installations; suction machines for industrial purposes; machines for the mineralization of drinking water; washing installations for vehicles; degreasers [machines]; dust exhausting installations for cleaning purposes; sifting installations; pneumatic tube conveyors; dust removing installations for cleaning purposes; condensing installations; floating produc-

tion, storage and offloading [FPSO] units; pneumatic waste oil drainers; lifting apparatus; air suction machines; dividing machines; igniting devices for internal combustion engines; window closers, hydraulic; window closers, pneumatic; window closers, electric; washing apparatus; binding apparatus for hay; haulage apparatus [mining]; door openers, hydraulic; door openers, pneumatic; door openers, electric; window openers, hydraulic; window openers, pneumatic; window openers, electric; curtain drawing devices, electrically operated; anti-pollution devices for motors and engines; beverage preparation machines, electromechanical; food preparation machines, electromechanical; portable ultrasonic washing devices for laundry; control mechanisms for machines, engines or motors; passenger lift operating apparatus; shoe polishers, electric; machines and apparatus for wax-polishing, electric; air cushion devices for moving loads; handling apparatus for loading and unloading; elevating apparatus; semiconductor exposure apparatus for use in manufacture; automatic tool changers for industrial robots; aprons [parts of machines]; filter presses; filters for cleaning cooling air, for engines; filters being parts of machines or engines; moulds [parts of machines]; printing plates; journals [parts of machines]; centrifugal machines; machining centres for metalworking; elevator chains [parts of machines]; drive chains, other than for land vehicles; transmission chains, other than for land vehicles; cylinders for motors and engines; cylinders for machines; printing cylinders; pneumatic jacks; shuttles [parts of machines]; universal joints [Cardan joints]; connecting rods for machines, motors and engines; steam mops; starter pinions; pulleys [parts of machines]; vacuum cleaner hoses; screwdrivers, electric; brushes [parts of machines]; dynamo brushes; brushes for vacuum cleaners; brushes, electrically operated [parts of machines]; carbon brushes [electricity]; ejectors; robotic exoskeleton suits, other than for medical purposes; fuel economisers for motors and engines; excavators; shovels, mechanical; grain elevators; agricultural elevators; motors, electric, other than for land vehicles; electrodes for welding machines; electric hammers; parquet wax-polishers, electric; cartridges for filtering machines; moving staircases [escalators]; automatic grapnels for marine purposes; fittings for engine boilers; flues for engine boilers; machines for washing crockery; vegetable peelers, electric.

11 – Lampshades; autoclaves, electric, for cooking; steam accumulators; heat accumulators; defrosters for vehicles; adsorption apparatus for generating gas; disinfectant apparatus for medical purposes; distillation apparatus; desiccating apparatus; hydromassage bath apparatus; disinfectant apparatus; air deodorizing apparatus; ionization apparatus for the treatment of air or water; coffee roasters; beverage cooling apparatus; apparatus for fertilizer irrigation; hand drying apparatus for washrooms; fruit roasters; water purifying apparatus and machines; refrigerating apparatus and ma-

chines; underfloor heating apparatus and installations; drying apparatus and installations; membrane apparatus for generating gas; freezers; heating and cooling apparatus for dispensing hot and cold beverages; drying apparatus; fermentation apparatus for industrial purposes; coolers for furnaces; expansion tanks for central heating installations; flushing tanks; refining towers for distillation; bidets; bioreactors for use in the treatment of wastewater; bioreactors for use in the treatment of waste; boilers, other than parts of machines; bath tubs; spa baths [vessels]; bath tubs for sitz baths; waffle irons, electric; fans [air-conditioning]; fans [parts of air-conditioning installations]; electric fans for personal use; roasting spits; refrigerating display cabinets; heated display cabinets; dehumidifiers; water heaters; water flushing installations; air reheaters; extractor hoods for kitchens; gas condensers, other than parts of machines; acetylene generators; microbubble generators for baths; fog machines; hydrants; fairy lights for festive decoration; burners; acetylene burners; gas burners; burners for lamps; germicidal burners; incandescent burners; oxyhydrogen burners; laboratory burners; oil burners; alcohol burners; hot water bottles; footwarmers, electric or non-electric; bed warmers; USB-powered hand warmers; pocket warmers; warming pans; roasting apparatus; food dehydrators, electric; lampshade holders; stills; showers; refrigerating containers; gas lighters; friction lighters for igniting gas; chimney blowers; coils [parts of distilling, heating or cooling installations]; furnace ash boxes; evaporators; electric appliances for making yogurt; shower cubicles; Turkish bath cabinets, portable; heating apparatus; cool boxes, electric; refrigerating chambers; fireplaces, domestic; chimney flues; coffee capsules, empty, for electric coffee machines; heated carving stations; structural framework for ovens; cooking pots, electric; air valves for steam heating installations; level controlling valves in tanks; thermostatic valves [parts of heating installations]; glue pots, electric; electrically heated carpets; light bulbs; light bulbs, electric; solar thermal collectors [heating]; distillation columns; furnace grates; ventilation hoods; ventilation hoods for laboratories; lamp globes; air conditioners for vehicles; smokers [cooking apparatus]; gas boilers; laundry room boilers; heating boilers; coffeepots, electric; coffee machines incorporating water purifiers; coffee machines, electric; taps; taps for pipes and pipelines; mixer taps for water pipes; electrically heated mugs; forges, portable; lava rocks for use in barbecue grills; couscous cookers, electric; lights, electric, for Christmas trees; light-emitting diode [LED] light bulbs; acetylene flares; safety lamps; gas lamps; curling lamps; nail lamps; smart light bulbs; curing lamps, not for medical purposes; germicidal lamps for purifying air; light bulbs for directional signals for vehicles; arc lamps; laboratory lamps; oil lamps; ultraviolet ray lamps, not for medical purposes; miners' lamps; electric lamps; chandeliers; barbecues; bread baking machines; wate-

ring machines for agricultural purposes; ice-cream making machines; beer brewing machines, electric, for household purposes; soya milk making machines, electric; snow-making machines; smoke machines; pounded rice cake making machines, electric, for household purposes; membranes for reverse osmosis units; membranes for water filtering apparatus; multicookers; footmuffs, electrically heated; heaters for baths; heaters for heating irons; immersion heaters; brackets for gas burners; anti-splash tap nozzles; heat pumps; magnesium filaments for lighting; heating filaments, electric; filaments for electric lamps; luminous house numbers; socks, electrically heated; heating apparatus for defrosting vehicle windows; hot air bath fittings; bath fittings; kiln furniture [supports]; sauna bath installations; refrigerating appliances and installations; directional lights for bicycles; running lights for vehicles; electrically heated clothing; blankets, electric, not for medical purposes; ozonizers for sanitizing purposes; air dryers; fabric steamers; lamp reflectors; vehicle reflectors; hearths; personal cooling packs, not for medical purposes; glow sticks for lighting; lightsticks, battery-operated; electric cooktops; food steamers, electric; steam boilers, other than parts of machines; pasteurisers; lamp mantles; sockets for electric lights; coffee percolators, electric; stoves [heating apparatus]; bakers' ovens; hot air ovens; kitchen ranges [ovens]; microwave ovens [cooking apparatus]; microwave ovens for industrial purposes; incinerators; kilns; solar furnaces; dental ovens; furnaces, other than for laboratory use; urinals being sanitary fixtures; feeding apparatus for heating boilers; heating plates; cooking stoves; hot plates; wine cellars, electric; aquarium heaters; USB-powered cup heaters; plate warmers; aquarium lights; heating cushions, electric, not for medical purposes; clean chambers [sanitary installations]; tortilla presses, electric; water intake apparatus; apparatus for dehydrating food waste; gas scrubbing apparatus; oil-scrubbing apparatus; glue-heating appliances; drying apparatus for fodder and forage; air purifying apparatus and machines; ice machines and apparatus; cooling appliances and installations; cooking apparatus and installations; lighting apparatus and installations; sanitary apparatus and installations; cooking rings; lighting apparatus for vehicles; light-emitting diodes [LED] lighting apparatus; heating apparatus for solid, liquid or gaseous fuels; heating apparatus, electric; hot air apparatus; safety accessories for water or gas apparatus and pipes; regulating and safety accessories for gas apparatus; regulating accessories for water or gas apparatus and pipes; regulating and safety accessories for water apparatus; regulating and safety accessories for gas pipes; roasting jacks; anti-glare devices for vehicles [lamp fittings]; rotisseries; radiator caps; searchlights; diving lights; light projectors; washers for water taps; heat guns; radiators [heating]; central heating radiators; radiators, electric; sinks; kitchen sinks incorporating integrated worktops; drip irrigation emitters [irrigation

fittings]; light diffusers; nuclear reactors; heat regenerators; pressure water tanks; roasters; beverage urns, electric; lamps; standard lamps; ceiling lights; toilet seats; hydroponic growing systems; lighting installations for air vehicles; frying pans, electric; gas scrubbers [parts of gas installations]; venturi scrubbers; tanning beds; lamp glasses; sterilizers; water sterilizers; air sterilizers; sterilizers for medical instruments; laundry dryers, electric; hair dryers; malt roasters; tobacco roasters; tajines, electric; heat exchangers, other than parts of machines; thermo-pots, electric; bread toasters; discharge tubes, electric, for lighting; lamp chimneys; luminous tubes for lighting; pipes [parts of sanitary installations]; flues for heating boilers; boiler pipes [tubes] for heating installations; heat-stabilized polypropylene pipes for heating installations; toilets [water-closets]; toilets, portable; humidifiers; humidifiers for central heating radiators; membrane filtration units for water treatment apparatus; wash-hand basins [parts of sanitary installations]; toilet bowls; water conduits installations; bath installations; air-conditioning installations; desalination plants; installations for processing nuclear fuel and nuclear moderating material; watering installations, automatic; cooling installations for water; cooling installations for liquids; milk cooling installations; cooling installations for tobacco; water purification installations; purification installations for sewage; steam generating installations; water distribution installations; air filtering installations; swimming pool chlorinating apparatus; ventilation [air-conditioning] installations and apparatus; ventilation [air-conditioning] installations for vehicles; water softening apparatus and installations; cooling installations and machines; reverse osmosis units; heating installations; heaters for vehicles; heating installations [water]; polymerisation installations; water supply installations; flare stacks for use in the oil industry; ash conveyor installations, automatic; disinfectant apparatus for dispensing solutions into water-pipes for sanitary installations; deodorizing apparatus, not for personal use; air-conditioning apparatus; whirlpool-jet apparatus; air cooling apparatus; apparatus for making ices and ice cream, electric; sous-vide cookers, electric; water filtering apparatus; full-body drying apparatus; aquarium filtration apparatus; cooking utensils, electric; flaming torches; headlights for automobiles; vehicle headlights; filters for air conditioning; filters for drinking water; filters for water filtering apparatus; reverse osmosis membrane filters for water treatment; wicks adapted for oil stoves; lights for automobiles; bicycle lights; motorcycle lights; lights for vehicles; electric torches; head torches; lanterns for lighting; candle lanterns; street lamps; Chinese lanterns; fountains; ornamental fountains; chocolate fountains, electric; air fryers; deep fryers, electric; fittings, shaped, for furnaces; oven fittings made of fireclay; bread-making machines; refrigerators; refrigerators, cooling apparatus and freezers for medical storage purposes; hot pots, electric; chro-

matography apparatus for industrial purposes; kettles, electric; dampers [heating]; book sterilization apparatus; refrigerating cabinets; carbon for arc lamps; heating elements.

(260) AM 2026 136072 A

(800) 1881690

(151) 2025 08 28

(891) 2025 08 28

(731) Simanov Aleksandr Vladimirovich

ul. Druzhby, d. 6, kv. 2, s. Kakmozh, r-n

Vavozhskij, RU-427305 Udmurtskaya

Respublika, Russian Federation

(540)

RETASTE

(591) Black, white

(531) 27.05.01

(511)

7 – 3D bioprinters; 3D printers; ticket vending machines; vending machines; welding machines, electric; soldering apparatus, gas-operated; apparatus for aerating water; vulcanization apparatus; acetylene cleaning apparatus; high pressure washers; apparatus for drawing up beer under pressure; apparatus for aerating beverages; electrical apparatus for sealing plastics [packaging]; electric arc cutting apparatus; electric arc welding apparatus; electric welding apparatus; inking apparatus for printing machines; soldering apparatus, electric; air brushes for applying colour; expansion tanks [parts of machines]; drums [parts of machines]; brake shoes, other than for vehicles; concrete mixers [machines]; bioreactors for use in manufacturing biopharmaceuticals; reels [parts of machines]; bobbins for weaving looms; harrows; journal boxes [parts of machines]; bulldozers; hoppers [mechanical discharging]; mine borers; rolling mill cylinders; crank shafts; printing rollers for machines; camshafts for vehicle engines; transmission shafts, other than for land vehicles; fans for motors and engines; saw benches [parts of machines]; winnowers; vibrators [machines] for industrial use; water heaters being parts of machines; bellows [parts of machines]; agitators; drilling rigs, floating or non-floating; lawnmowers [machines]; card clothing [parts of carding machines]; nail extractors, electric; emergency power generators; alternators; dynamos; bicycle dynamos; current generators; electricity generators; hydraulic controls for machines, motors and engines; mufflers for motors and engines; drilling heads [parts of machines]; drilling bits [parts of machines]; cylinder heads for engines; soldering blow pipes, gas-operated; gas-operated blow torches; raking machines; stalk separators [machines]; sieves [machines or parts of machines]; mud catchers and collectors [machines]; tarring machines; rubber tracks being parts of crawlers on mining machines; rubber tracks being parts of crawlers on snow ploughs; rubber tracks being parts of crawlers on loa-

ding-unloading machines and apparatus; rubber tracks being parts of crawlers on agricultural machines; rubber tracks being parts of crawlers on construction machines; hydraulic engines and motors; aeronautical engines; aeroplane engines; engines for air cushion vehicles; compressed air engines; jet engines, other than for land vehicles; engines for boats; driving motors, other than for land vehicles; motors, other than for land vehicles; propulsion mechanisms, other than for land vehicles; de-aerators for feedwater; disintegrators; tympan [parts of printing presses]; holding devices for machine tools; turf removing ploughs; pump diaphragms; door closers, hydraulic; door closers, pneumatic; door closers, electric; chisels for machines; jacks [machines]; rack and pinion jacks; moving walkways; electric hand drills; crushers for kitchen use, electric; reapers; reapers and binders; millstones; rakes for raking machines; needles for knitting machines; needles for wool combing machines; needles for sewing machines; shredders [machines] for industrial use; kitchen grinders, electric; injectors for engines; incubators for eggs; tools [parts of machines]; ski edge sharpening tools, electric; hand-held tools, other than hand-operated; agricultural implements, other than hand-operated; air condensers; control cables for machines, engines or motors; capstans; calenders; rotary steam presses, portable, for fabrics; ditchers [ploughs]; carburettors; sliders for knitting machines; crankcases for machines, motors and engines; steam-rollers; reels, mechanical, for flexible hoses; valves [parts of machines]; pressure valves [parts of machines]; clack valves [parts of machines]; pressure reducers [parts of machines]; cowlings [parts of machines]; machine wheels; freewheels, other than for land vehicles; scale collectors for machine boilers; lasts for shoes [parts of machines]; brake pads, other than for vehicles; piston segments; grease rings [parts of machines]; reapers and threshers; coal-cutting machines; compressors [machines]; air pumps [garage installations]; compressors for refrigerators; conveyors [machines]; belt conveyors; converters for steelworks; aerocondensers; steam condensers [parts of machines]; diggers [machines]; rams [machines]; thermic lances [machines]; mechanized livestock feeders; boxes for matrices [printing]; gear boxes, other than for land vehicles; stuffing boxes [parts of machines]; grease boxes [parts of machines]; housings [parts of machines]; harvesting machines; steam engine boilers; coffee grinders, other than hand-operated; taps [parts of machines, engines or motors]; cranes [lifting and hoisting apparatus]; roller bridges; mobile cranes; water separators; spray guns for paint; cranks [parts of machines]; potters' wheels; grindstones [parts of machines]; cultivators [machines]; soldering lamps; winches; blades [parts of machines]; ploughshares; belts for conveyors; passenger lifts; lubricators [parts of machines]; igniting magnetos; churns; matrices for use in printing; machine fly-wheels; shearing machines for animals; blowing machines; knitting machines; galva-

nizing machines; bending machines; ironing machines; mineworking machines; blowing machines for the compression, exhaustion and transport of gases; blowing machines for the compression, sucking and carrying of grain; net hauling machines [fishing]; electroplating machines; bottle sealing machines; sealing machines for industrial purposes; embossing machines; engraving machines; finishing machines; crushing machines; waste disposal units; furnace loading machines; blade sharpening [stropping] machines; earth moving machines; sausage making machines; cord making machines; lace making machines; butter machines; miso making machines; cigarette machines for industrial purposes; soy sauce making machines; stereotype machines; dyeing machines; bottle washing machines; machines for the application of sizing; bottle filling machines; cheese slicers, electric; racket stringing machines; leather-working machines; dairy machines; glass-working machines; tobacco processing machines; grain husking machines; painting machines; oil refining machines; peeling machines; machines for processing plastics; ore treating machines; printing machines for use on sheet metal; brewing machines; whitewashing machines; road sweeping machines, self-propelled; leather paring machines; machines for generating gas by electrolysis; bitumen making machines; papermaking machines; pasta making machines, electric; semiconductor manufacturing machines; machines for the production of sugar; weeding machines; sifting machines; cinder sifters [machines]; puddling machines; fluid dispensing machines for industrial use; tape dispensing machines for industrial use; notchers [machine tools]; bread cutting machines; road making machines; railroad constructing machines; machines for the textile industry; rammers [machines]; rail-laying machines; bottle capping machines; bottle stoppering machines; waste compacting machines; die-stamping machines; stamping machines; darning machines; milking machines; drainage machines; wrapping machines; grain separators; bookbinding apparatus and machines for industrial purposes; machines and apparatus for cleaning, electric; machines and apparatus for carpet shampooing, electric; machines and apparatus for polishing [electric]; punching machines; riveting machines; kitchen machines, electric; foundry machines; smoothing presses; fleshing machines; flour mill machines; type-setting machines [printing]; hemming machines; grating machines for vegetables; braiding machines; rinsing machines; wringing machines for laundry; cutting machines; steam engines; printing machines; rotary printing presses; industrial inkjet printing machines; compressed air machines; handling machines, automatic [manipulators]; tilling machines for agricultural purposes; trimming machines; spinning machines; filling machines; friezing machines; satinizing machines; agricultural machines; mixing machines; sorting machines for industry; stitching machines; washing machines [laundry]; coin-operated washing machines; la-

undry washing machines incorporating a drying tumbler; clippers [machines]; spinning frames; kneading machines; typographic machines; type-setting machines [photocomposition]; beating machines; beaters, electric; packing machines; packaging machines; filtering machines; moulding machines; carding machines; sewing machines; typecasting machines; electro-mechanical machines for chemical industry; labellers [machines]; mills [machines]; mills for household purposes, other than hand-operated; pepper mills, other than hand-operated; centrifugal mills; machine wheelwork; feeders [parts of machines]; transmission mechanisms, other than for land vehicles; forge blowers; mixers [machines]; blenders, electric, for household purposes; vacuum cleaner bags; threshing machines; pneumatic hammers; hammers [parts of machines]; tilt hammers; power hammers; passenger boarding bridges, electromechanical; reeling apparatus, mechanical; motorized cultivators; motors for boats; clutches, other than for land vehicles; meat choppers, electric; superchargers; brake linings, other than for vehicles; guides for machines; suction nozzles for vacuum cleaners; vacuum cleaner attachments for disseminating perfumes and disinfectants; pumps [machines]; pumps [parts of machines, engines or motors]; aerating pumps for aquaria; vacuum pumps [machines]; compressed air pumps; petrol pumps for service stations; pumps for heating installations; beer pumps; pumps for counter-current swimming; lubricating pumps; self-regulating fuel pumps; fuel dispensing pumps for service stations; centrifugal pumps; hydrogen dispensing pumps for service stations; tin openers, electric; knives for mowing machines; chaff cutter blades; knives, electric; knives being parts of machines; shears, electric; scissors, electric; vegetable spiralizers, electric; vegetable slicers, electric; engine mounts, other than for land vehicles; bearing brackets for machines; axles for machines; steam traps; chucks [parts of machines]; drill chucks [parts of machines]; exhaust manifold for engines; soldering irons, gas-operated; soldering irons, electric; gears, other than for land vehicles; reduction gears, other than for land vehicles; drilling machines; saws [machines]; chain saws; guns [tools using explosive cartridges]; glue guns, electric; compressed air guns for the extrusion of mastics; sandblasting guns; carburetter feeders; feeding apparatus for engine boilers; loading ramps; ploughs; pneumatic transporters; pneumatic controls for machines, motors and engines; hangers [parts of machines]; bearings [parts of machines]; anti-friction bearings for machines; roller bearings; self-oiling bearings; bearings for transmission shafts; ball-bearings; mechanical vehicle stacking lifts; elevators [machines]; hoists; railway wagon lifts; pulleys; saw blades [parts of machines]; pistons [parts of machines or engines]; shock absorber plungers [parts of machines]; pistons for engines; pistons for cylinders; catalytic converters; torque converters, other than for land vehicles; fuel conversion apparatus for internal combustion

engines; presses [machines for industrial purposes]; wine presses; fruit presses, electric, for household purposes; fodder presses; basket presses; printing presses; typographic presses; swaging machines; pneumatic or hydraulic linear actuators, other than for land vehicles; pedal drives for sewing machines; cleaning appliances utilizing steam; food processors, electric; springs [parts of machines]; spinning wheels; punches for punching machines; vacuum cleaners; touchless stationary vacuums; tambours for embroidery machines; radiators [cooling] for motors and engines; sewage pulverizers; regulators [parts of machines]; pressure regulators [parts of machines]; speed governors for machines, engines and motors; cutters [machines]; cutting blow pipes, gas-operated; blade holders [parts of machines]; loom shafts; gears for weaving looms; belts for machines; fan belts for motors and engines; dynamo belts; belts for motors and engines; adhesive bands for pulleys; industrial robots; household cleaning and laundry robots with artificial intelligence; robotic arms for preparing beverages; 3D printing pens; kick starters for motorcycles; joysticks being parts of machines, other than for game machines; paper feeders [printing]; whisks, electric, for household purposes; sparking plugs for internal combustion engines; glow plugs for diesel engines; brake segments, other than for vehicles; tedding machines; steam/oil separators; cream/milk separators; ball rings for bearings; sowers [machines]; exhausts for motors and engines; pigs for cleaning pipes; snow ploughs; sheaf-binding machines; shaft couplings [machines]; joints [parts of engines]; juice extractors, electric; straw [chaff] cutters; suction cups for milking machines; stands for machines; machine tools; die-cutting and tapping machines; woodworking machines; sharpening machines; portable laser engraving machines; bicycle assembling machines; mortising machines; stone-working machines; metalworking machines; size adjustment cutting machines for industrial purposes; threading machines; trueing machines; planing machines; looms [machines]; lathes [machine tools]; milling machines; hosiery looms [machines]; grinding machines; electrical discharge machines [EDM]; metal drawing machines; rolling mills; starters for motors and engines; stators [parts of machines]; glaziers' diamonds [parts of machines]; tables for machines; derricks; slide rests [parts of machines]; spin dryers [not heated]; couplings, other than for land vehicles; heat exchangers [parts of machines]; transmissions for machines; boiler tubes [parts of machines]; wind turbines; hydraulic turbines; turbines, other than for land vehicles; turbocompressors; turbochargers for motors; central vacuum cleaning installations; suction machines for industrial purposes; machines for the mineralization of drinking water; washing installations for vehicles; degreasers [machines]; dust exhausting installations for cleaning purposes; sifting installations; pneumatic tube conveyors; dust removing installations for cleaning purposes; condensing installa-

llations; floating production, storage and offloading [FPSO] units; pneumatic waste oil drainers; lifting apparatus; air suction machines; dividing machines; igniting devices for internal combustion engines; window closers, hydraulic; window closers, pneumatic; window closers, electric; washing apparatus; binding apparatus for hay; haulage apparatus [mining]; door openers, hydraulic; door openers, pneumatic; door openers, electric; window openers, hydraulic; window openers, pneumatic; window openers, electric; curtain drawing devices, electrically operated; anti-pollution devices for motors and engines; beverage preparation machines, electromechanical; food preparation machines, electromechanical; portable ultrasonic washing devices for laundry; control mechanisms for machines, engines or motors; passenger lift operating apparatus; shoe polishers, electric; machines and apparatus for wax-polishing, electric; air cushion devices for moving loads; handling apparatus for loading and unloading; elevating apparatus; semiconductor exposure apparatus for use in manufacture; automatic tool changers for industrial robots; aprons [parts of machines]; filter presses; filters for cleaning cooling air, for engines; filters being parts of machines or engines; moulds [parts of machines]; printing plates; journals [parts of machines]; centrifugal machines; machining centres for metalworking; elevator chains [parts of machines]; drive chains, other than for land vehicles; transmission chains, other than for land vehicles; cylinders for motors and engines; cylinders for machines; printing cylinders; pneumatic jacks; shuttles [parts of machines]; universal joints [Cardan joints]; connecting rods for machines, motors and engines; steam mops; starter pinions; pulleys [parts of machines]; vacuum cleaner hoses; screwdrivers, electric; brushes [parts of machines]; dynamo brushes; brushes for vacuum cleaners; brushes, electrically operated [parts of machines]; carbon brushes [electricity]; ejectors; robotic exoskeleton suits, other than for medical purposes; fuel economisers for motors and engines; excavators; shovels, mechanical; grain elevators; agricultural elevators; motors, electric, other than for land vehicles; electrodes for welding machines; electric hammers; parquet wax-polishers, electric; cartridges for filtering machines; moving staircases [escalators]; automatic grapnels for marine purposes; fittings for engine boilers; flues for engine boilers; machines for washing crockery; vegetable peelers, electric.

8 – Glaziers' diamonds [parts of hand tools]; apparatus for tattooing; laser hair removal apparatus, other than for medical purposes; razors, electric or non-electric; sharpening steels; scythe stones; gimlets [hand tools]; borers; augers [hand tools]; carpenters' augers; pickhammers; weeding forks [hand tools]; carving forks; table forks; agricultural forks [hand tools]; lawn clippers [hand instruments]; harpoons; nail extractors, hand-operated; rakes [hand tools]; sand trap rakes; cutter bars [hand tools]; whetstone holders; priming irons [hand tools]; sculptors' chisels; lifting jacks,

hand-operated; hand drills, hand-operated; trunchions; clamps for carpenters or cooperers; spades [hand tools]; rabbeting planes; mortise chisels; engraving needles; tattoo needles; cutlery; edge tools [hand tools]; choppers being knives; garden tools, hand-operated; abrading instruments [hand instruments]; numbering punches; goffering irons; implements for decanting liquids [hand tools]; depilation appliances, electric and non-electric; sharpening instruments; blade sharpening instruments; livestock marking tools; nail clippers, electric or non-electric; oyster openers; polishing irons [glazing tools]; ear-piercing apparatus; tube cutting instruments; wire strippers [hand tools]; riveters [hand tools]; expanders [hand tools]; cutting tools [hand tools]; ski edge sharpening tools, hand-operated; hand tools, hand-operated; sterile body piercing instruments; stamping-out tools [hand tools]; picks [hand tools]; sharpening stones; punch rings [knuckle dusters]; trowels; centre punches [hand tools]; daggers; pickaxes; mallets [hand instruments]; pliers; punch pliers [hand tools]; blades [weapons]; annular screw plates; spanners [hand tools]; tap wrenches; ladles [hand tools]; foundry ladles [hand tools]; meat claws; breast drills; lasts [shoemakers' hand tools]; scythe rings; instruments for punching tickets; diggers [hand tools]; rams [hand tools]; scythes; hainault scythes; fire irons; emery grinding wheels; grindstones [hand tools]; sledgehammers; thistle extractors [hand tools]; nail nippers; tree pruners; nail drawers [hand tools]; ice picks; blades [hand tools]; razor blades; blades for planes; plane irons; jig-saws; spoons; table knives, forks and spoons for babies; table knives, forks and spoons of plastic; crow bars; trowels [gardening]; shovels [hand tools]; palette knives; machetes; beard clippers; hair clippers for personal use, electric and non-electric; hair clippers for animals [hand instruments]; taps [hand tools]; fireplace bellows [hand tools]; swords; hammers [hand tools]; emergency hammers; fullers [hand tools]; stone hammers; masons' hammers; riveting hammers [hand tools]; mattocks; ditchers [hand tools]; manicure sets; manicure sets, electric; pedicure sets; needle files; bits [hand tools]; files [tools]; emery files; air pumps, hand-operated; hand pumps; shaving cases; knives; cheese slicers, non-electric; fruit segmenters; egg slicers, non-electric; vegetable knives; pizza cutters, non-electric; scaling knives; hobby knives [scalpels]; fruit corers; moulding irons; ceramic knives; tin openers, non-electric; farriers' knives; multi-tool knives; budding knives; hunting knives; penknives; grafting tools [hand tools]; carving knives; braiders [hand tools]; box cutters; bill-hooks; paring knives; cleavers; mincing knives; scissors; wick trimmers [scissors]; shears; cattle shearers; border shears; shearers [hand instruments]; sword scabbards; kitchen mandolines; vegetable slicers, hand-operated; vegetable spiralizers, hand-operated; vegetable peelers, hand-operated; agricultural implements, hand-operated; side arms, other than firearms; stropping instruments; screwdrivers,

non-electric; hand-operated corn cob strippers; stirring sticks for mixing paint; reamer sockets; drill holders [hand tools]; perforating tools [hand tools]; rammers [hand tools]; emery boards; nail files; nail files, electric; saws [hand tools]; bow saws; tweezers; hair-removing tweezers; guns [hand tools]; non-electric caulking guns; guns, hand-operated, for the extrusion of mastics; dies [hand tools]; fruit pickers [hand tools]; saw blades [parts of hand tools]; shear blades; tube squeezers, hand-operated, other than for household purposes; hair braiders, electric; table cutlery [knives, forks and spoons]; crimping irons; hand implements for hair curling; vegetable choppers; money scoops; instruments and tools for skinning animals; fingernail polishers, electric or non-electric; hackles [hand tools]; pin punches; nail punches; fish tapes [hand tools]; food processors, hand-operated; punches [hand tools]; insecticide vaporizers [hand tools]; syringes for spraying insecticides; reamers; frames for handsaws; saw holders; rasps [hand tools]; paring irons [hand tools]; wine bottle foil cutters, hand-operated; graving tools [hand tools]; milling cutters [hand tools]; razor strops; leather strops; planes; scythe handles; knife handles; handles for hand-operated hand tools; levers; sabres; marline spikes; bits [parts of hand tools]; hollowing bits [parts of hand tools]; pruning scissors; silver plate [knives, forks and spoons]; pruning knives; sickles; drawing knives; scrapers [hand tools]; scrapers for skis; chisels; caulking irons; gouges [hand tools]; portable handlooms, hand-operated; mortars for pounding [hand tools]; mitre boxes [hand tools]; long reach loppers; branding irons; hatchets; adzes [tools]; vices; bench vices [hand implements]; hoop cutters [hand tools]; axes; holing axes; fulling tools [hand tools]; earth rammers [hand tools]; tube cutters [hand tools]; hoes [hand tools]; squares [hand tools]; extension pieces for braces for screw taps; embossers [hand tools]; apparatus for destroying plant parasites, hand-operated; metal wire stretchers [hand tools]; metal band stretchers [hand tools]; irons [non-electric hand tools]; clothes irons; hair straightening irons; hand-operated fruit slicers; razor cases; ratchets [hand tools]; scraping tools [hand tools]; awls; spatulas [hand tools]; spatulas for use by artists; bayonets; pincers; curling tongs; cuticle tweezers; eyelash curlers.

11 – Lampshades; autoclaves, electric, for cooking; steam accumulators; heat accumulators; defrosters for vehicles; adsorption apparatus for generating gas; disinfectant apparatus for medical purposes; distillation apparatus; desiccating apparatus; hydromassage bath apparatus; disinfectant apparatus; air deodorizing apparatus; ionization apparatus for the treatment of air or water; coffee roasters; beverage cooling apparatus; apparatus for fertilizer irrigation; hand drying apparatus for washrooms; fruit roasters; water purifying apparatus and machines; refrigerating apparatus and machines; underfloor heating apparatus and installations; drying apparatus and installations; membrane apparatus for generating gas; freezers; heating and cooling

apparatus for dispensing hot and cold beverages; drying apparatus; fermentation apparatus for industrial purposes; coolers for furnaces; expansion tanks for central heating installations; flushing tanks; refining towers for distillation; bidets; bioreactors for use in the treatment of wastewater; bioreactors for use in the treatment of waste; boilers, other than parts of machines; bath tubs; spa baths [vessels]; bath tubs for sitz baths; waffle irons, electric; fans [air-conditioning]; fans [parts of air-conditioning installations]; electric fans for personal use; roasting spits; refrigerating display cabinets; heated display cabinets; dehumidifiers; water heaters; water flushing installations; air reheaters; extractor hoods for kitchens; gas condensers, other than parts of machines; acetylene generators; microbubble generators for baths; fog machines; hydrants; fairy lights for festive decoration; burners; acetylene burners; gas burners; burners for lamps; germicidal burners; incandescent burners; oxyhydrogen burners; laboratory burners; oil burners; alcohol burners; hot water bottles; footwarmers, electric or non-electric; bed warmers; USB-powered hand warmers; pocket warmers; warming pans; roasting apparatus; food dehydrators, electric; lampshade holders; stills; showers; refrigerating containers; gas lighters; friction lighters for igniting gas; chimney blowers; coils [parts of distilling, heating or cooling installations]; furnace ash boxes; evaporators; electric appliances for making yogurt; shower cubicles; Turkish bath cabinets, portable; heating apparatus; cool boxes, electric; refrigerating chambers; fireplaces, domestic; chimney flues; coffee capsules, empty, for electric coffee machines; heated carving stations; structural framework for ovens; cooking pots, electric; air valves for steam heating installations; level controlling valves in tanks; thermostatic valves [parts of heating installations]; glue pots, electric; electrically heated carpets; light bulbs; light bulbs, electric; solar thermal collectors [heating]; distillation columns; furnace grates; ventilation hoods; ventilation hoods for laboratories; lamp globes; air conditioners for vehicles; smokers [cooking apparatus]; gas boilers; laundry room boilers; heating boilers; coffeepots, electric; coffee machines incorporating water purifiers; coffee machines, electric; taps; taps for pipes and pipelines; mixer taps for water pipes; electrically heated mugs; forges, portable; lava rocks for use in barbecue grills; couscous cookers, electric; lights, electric, for Christmas trees; light-emitting diode [LED] light bulbs; acetylene flares; safety lamps; gas lamps; curling lamps; nail lamps; smart light bulbs; curing lamps, not for medical purposes; germicidal lamps for purifying air; light bulbs for directional signals for vehicles; arc lamps; laboratory lamps; oil lamps; ultraviolet ray lamps, not for medical purposes; miners' lamps; electric lamps; chandeliers; barbecues; bread baking machines; watering machines for agricultural purposes; ice-cream making machines; beer brewing machines, electric, for household purposes; soya milk making machines,

electric; snow-making machines; smoke machines; pounded rice cake making machines, electric, for household purposes; membranes for reverse osmosis units; membranes for water filtering apparatus; multicookers; footmuffs, electrically heated; heaters for baths; heaters for heating irons; immersion heaters; brackets for gas burners; anti-splash tap nozzles; heat pumps; magnesium filaments for lighting; heating filaments, electric; filaments for electric lamps; luminous house numbers; socks, electrically heated; heating apparatus for defrosting vehicle windows; hot air bath fittings; bath fittings; kiln furniture [supports]; sauna bath installations; refrigerating appliances and installations; directional lights for bicycles; running lights for vehicles; electrically heated clothing; blankets, electric, not for medical purposes; ozonizers for sanitizing purposes; air dryers; fabric steamers; lamp reflectors; vehicle reflectors; hearths; personal cooling packs, not for medical purposes; glow sticks for lighting; lightsticks, battery-operated; electric cooktops; food steamers, electric; steam boilers, other than parts of machines; pasteurisers; lamp mantles; sockets for electric lights; coffee percolators, electric; stoves [heating apparatus]; bakers' ovens; hot air ovens; kitchen ranges [ovens]; microwave ovens [cooking apparatus]; microwave ovens for industrial purposes; incinerators; kilns; solar furnaces; dental ovens; furnaces, other than for laboratory use; urinals being sanitary fixtures; feeding apparatus for heating boilers; heating plates; cooking stoves; hot plates; wine cellars, electric; aquarium heaters; USB-powered cup heaters; plate warmers; aquarium lights; heating cushions, electric, not for medical purposes; clean chambers [sanitary installations]; tortilla presses, electric; water intake apparatus; apparatus for dehydrating food waste; gas scrubbing apparatus; oil-scrubbing apparatus; glue-heating appliances; drying apparatus for fodder and forage; air purifying apparatus and machines; ice machines and apparatus; cooling appliances and installations; cooking apparatus and installations; lighting apparatus and installations; sanitary apparatus and installations; cooking rings; lighting apparatus for vehicles; light-emitting diodes [LED] lighting apparatus; heating apparatus for solid, liquid or gaseous fuels; heating apparatus, electric; hot air apparatus; safety accessories for water or gas apparatus and pipes; regulating and safety accessories for gas apparatus; regulating accessories for water or gas apparatus and pipes; regulating and safety accessories for water apparatus; regulating and safety accessories for gas pipes; roasting jacks; anti-glare devices for vehicles [lamp fittings]; rotisseries; radiator caps; searchlights; diving lights; light projectors; washers for water taps; heat guns; radiators [heating]; central heating radiators; radiators, electric; sinks; kitchen sinks incorporating integrated worktops; drip irrigation emitters [irrigation fittings]; light diffusers; nuclear reactors; heat regenerators; pressure water tanks; roasters; beverage urns, electric; lamps; standard lamps; ceiling lights;

toilet seats; hydroponic growing systems; lighting installations for air vehicles; frying pans, electric; gas scrubbers [parts of gas installations]; venturi scrubbers; tanning beds; lamp glasses; sterilizers; water sterilizers; air sterilizers; sterilizers for medical instruments; laundry dryers, electric; hair dryers; malt roasters; tobacco roasters; tajines, electric; heat exchangers, other than parts of machines; thermo-pots, electric; bread toasters; discharge tubes, electric, for lighting; lamp chimneys; luminous tubes for lighting; pipes [parts of sanitary installations]; flues for heating boilers; boiler pipes [tubes] for heating installations; heat-stabilized polypropylene pipes for heating installations; toilets [water-closets]; toilets, portable; humidifiers; humidifiers for central heating radiators; membrane filtration units for water treatment apparatus; wash-hand basins [parts of sanitary installations]; toilet bowls; water conduits installations; bath installations; air-conditioning installations; desalination plants; installations for processing nuclear fuel and nuclear moderating material; watering installations, automatic; cooling installations for water; cooling installations for liquids; milk cooling installations; cooling installations for tobacco; water purification installations; purification installations for sewage; steam generating installations; water distribution installations; air filtering installations; swimming pool chlorinating apparatus; ventilation [air-conditioning] installations and apparatus; ventilation [air-conditioning] installations for vehicles; water softening apparatus and installations; cooling installations and machines; reverse osmosis units; heating installations; heaters for vehicles; heating installations [water]; polymerisation installations; water supply installations; flare stacks for use in the oil industry; ash conveyor installations, automatic; disinfectant apparatus for dispensing solutions into water-pipes for sanitary installations; deodorizing apparatus, not for personal use; air-conditioning apparatus; whirlpool-jet apparatus; air cooling apparatus; apparatus for making ices and ice cream, electric; sous-vide cookers, electric; water filtering apparatus; full-body drying apparatus; aquarium filtration apparatus; cooking utensils, electric; flaming torches; headlights for automobiles; vehicle headlights; filters for air conditioning; filters for drinking water; filters for water filtering apparatus; reverse osmosis membrane filters for water treatment; wicks adapted for oil stoves; lights for automobiles; bicycle lights; motorcycle lights; lights for vehicles; electric torches; head torches; lanterns for lighting; candle lanterns; street lamps; Chinese lanterns; fountains; ornamental fountains; chocolate fountains, electric; air fryers; deep fryers, electric; fittings, shaped, for furnaces; oven fittings made of fireclay; bread-making machines; refrigerators; refrigerators, cooling apparatus and freezers for medical storage purposes; hot pots, electric; chromatography apparatus for industrial purposes; kettles, electric; dampers [heating]; book sterilization apparatus; refrigerating cabinets; carbon for arc lamps; heating elements.

21 – Autoclaves, non-electric, for cooking; indoor aquaria; cosmetic apparatus for microdermabrasion; wine aerators; buckets; dustbins for household purposes; automatic opening and closing trash cans for household purposes; cookie jars; candle jars [holders]; china ornaments; dishes; vegetable dishes; saucers; candle drip rings; boxes for sweets; bottles; demijohns; busts of porcelain, ceramic, earthenware, terracotta or glass; vases; epergnes; fruit bowls; inflatable bath tubs for babies; bird baths; baby baths, portable; plungers for clearing blocked drains; waffle irons, non-electric; diaper disposal pails; ice buckets; mop wringer buckets; buckets made of woven fabrics; whisks, non-electric, for household purposes; cooking skewers of metal; towel rails and rings; clothing stretchers; barbecue forks; serving forks; hair for brushes; horsehair for brush-making; funnels; pie funnels; candle warmers, electric and non-electric; carpet beaters [hand instruments]; signboards of porcelain or glass; candle extinguishers; heads for electric toothbrushes; potties for children; flower pots; chamber pots; disposable portable potties for adults and children; cruet; decanters; large-toothed combs for the hair; combs for animals; tea cosies; abrasive sponges for scrubbing the skin; bath sponges; make-up sponges; sponges for household purposes; scouring pads; sponge holders; toothpick holders; soap holders; table napkin holders; holders for flowers and plants [flower arranging]; tea bag rests; shaving brush stands; toilet paper holders; plug-in diffusers for mosquito repellents; aromatic oil diffusers, other than reed diffusers, electric and non-electric; ironing boards; cutting boards for the kitchen; bread boards; washing boards; crushers for kitchen use, non-electric; strainers for household purposes; smoke absorbers for household purposes; containers for household or kitchen use; kitchen containers; glass jars [carboys]; heat-insulated containers; heat-insulated containers for beverages; thermally insulated containers for food; glass flasks [containers]; closures for pot lids; chamois leather for cleaning; toothpicks; ceramics for household purposes; majolica; works of art of porcelain, ceramic, earthenware, terracotta or glass; kitchen grinders, non-electric; cleaning instruments, hand-operated; cabarets [trays]; couscous cooking pots, non-electric; cooking pots, non-electric; flower-pot covers, not of paper; tar-brushes, long handled; shaving brushes; make-up brushes; basting brushes; glue pots, non-electric; cages for household pets; birdcages; cages for collecting insects; baking mats; ladles for serving wine; polishing leather; shampoo shields; glass bulbs [receptacles]; shoe trees; napkin rings; poultry rings; rings for birds; disposable aluminium foil containers for household purposes; coin banks; piggy banks; bread baskets for household purposes; baskets for household purposes; waste paper baskets; feeding troughs; pet feeding bowls, automatic; mangers for animals; lunch boxes; insect collectors' boxes; tea caddies; washtubs; earthenware saucepans; mess-tins; cauldrons; coffee percolators, non-

electric; coffeepots, non-electric; coffee grinders, hand-operated; mugs; beer mugs; tankards; rat traps; pot lids; aquarium hoods; butter-dish covers; dish covers; cheese-dish covers; reusable silicone food covers; buttonhooks; reusable ice cubes; commemorative statuary cups of porcelain, ceramic, earthenware, terracotta or glass; prize cups of porcelain, ceramic, earthenware, terra-cotta or glass; jugs; perfume burners, electric and non-electric; watering cans; adhesive refill sheets for rollers for cleaning; fly traps; insect traps; ice cream scoops; mixing spoons [kitchen utensils]; basting spoons [cooking utensils]; serving spoons; pie servers; spatulas for kitchen use; valet trays [receptacles for small objects] for household purposes; litter boxes for pets; mug cosies; butter dishes; material for brush-making; polishing materials for making shiny, except preparations, paper and stone; tablemats, not of paper or textile; noodle machines, hand-operated; lint removers, electric or non-electric; pasta makers, hand-operated; polishing apparatus and machines, for household purposes, non-electric; pepper mills, hand-operated; mills for household purposes, hand-operated; feather-dusters; brooms; cocktail stirrers; isothermic bags; decorating bags for confectioners; cooking mesh bags; bowls [basins]; pet feeding bowls; soup bowls; mosaics of glass, not for building; dishcloths; saucepan scourers of metal; stainless steel soap; soap boxes; mouse traps; meat grinders, non-electric; spice sets; nozzles for watering cans; pouring spouts; wine pourers; cake decorating tips and tubes; nozzles for watering hose; fitted picnic baskets, including dishes; toilet cases; eyebrow thread; floss for dental purposes; fibreglass thread, other than for textile use; cookie [biscuit] cutters; zesters; pastry cutters; sprinklers; syringes for watering flowers and plants; pill organizers for personal use; electronic pill organizers for personal use; egg yolk separators; cotton waste for cleaning; wool waste for cleaning; cleaning tow; personal hydration packs comprising a fluid reservoir and a delivery tube; bags for use in cooking; cold packs for chilling food and beverages; chopsticks; sticks for frozen confections; food steamers, non-electric; pepper pots; abrasive mitts for scrubbing the skin; oven mitts; animal grooming gloves; gloves for household purposes; car washing mitts; polishing gloves; gardening gloves; pestles for kitchen use; droppers for household purposes; wine-tasting pipettes; droppers for cosmetic purposes; bulb basters; plates for diffusing aromatic oil; plates to prevent milk boiling over; dripping pans; trays for household purposes; trays of paper, for household purposes; lazy susans; candle holders; trivets [table utensils]; grill supports; menu card holders; knife rests for the table; stands for portable baby baths; mats, not of paper or textile, for beer glasses; stands for clothes irons; egg cups; abrasive pads for kitchen purposes; drinking troughs; serving ladles; powdered glass for decoration; pottery; pots; vessels for making ices and ice cream, non-electric; painted glassware;

tableware, other than knives, forks and spoons; porcelain ware; earthenware; cosmetic utensils; trouser presses; tortilla presses, non-electric [kitchen utensils]; tube squeezers for household purposes; fruit presses, non-electric, for household purposes; deodorizing apparatus for personal use; cruet sets for oil and vinegar; make-up removing appliances; apparatus for wax-polishing, non-electric; bottle openers, electric and non-electric; glove stretchers; boot jacks; crumb trays; tie presses; potholders; clothes-pegs; glass stoppers; roaster pans; powder compacts, empty; perfume vaporizers; powder puffs; dusting apparatus, non-electric; foam toe separators for use in pedicures; eyelash separators; combs; electric combs; grills [cooking utensils]; sifters [household utensils]; drinking horns; shoe horns; adhesive rollers for cleaning; broom handles; salad bowls; place mats, not of paper or textile; beverage urns, non-electric; sugar bowls; beaters, non-electric; egg separators, non-electric, for household purposes; coffee services [tableware]; liqueur sets; tea services [tableware]; sieves [household utensils]; cinder sifters [household utensils]; tea strainers; siphon bottles for carbonated water; rolling pins, domestic; frying pans, non-electric; squeegees [cleaning instruments]; steel wool for cleaning; currycombs; smart medicine bottles, empty; blenders, non-electric, for household purposes; scoops for household purposes; dustpans; straws for drinking; salt cellars; drinking vessels; refrigerating bottles; stew-pans; cups of paper or plastic; glasses [receptacles]; drinking glasses; statues of porcelain, ceramic, earthenware, terra-cotta or glass; figurines of porcelain, ceramic, earthenware, terra-cotta or glass; glass for vehicle windows [semi-finished product]; alabaster glass, not for building; fused silica [semi-worked product], other than for building; plate glass [raw material]; opal glass; glass, unworked or semi-worked, except building glass; opaline glass; glass incorporating fine electrical conductors; enamelled glass, not for building; glass wool, other than for insulation; vitreous silica fibres, other than for textile use; fibreglass, other than for insulation or textile use; dish drying racks; mortars for kitchen use; portable cool boxes, non-electric; soup tureens; drying racks for laundry; rotary washing lines; tajines, non-electric; basins [receptacles]; table plates; paper plates; disposable table plates; graters for kitchen use; insulating flasks; indoor terrariums [plant cultivation]; indoor terrariums [vivariums]; roller tubes for peeling garlic; cloth for washing floors; polishing cloths; cloths for cleaning; dusting cloths [rags]; furniture dusters; wax-polishing appliances, non-electric, for shoes; electric devices for attracting and killing insects; watering devices; ultrasonic pest repellents; utensils for household purposes; kitchen utensils; cooking utensils, non-electric; figurines of porcelain, ceramic, earthenware, terra-cotta or glass for cakes; coffee filters, non-electric; flasks; soap dispensing bottles; water flossers; hip flasks; drinking bottles for sports; boot trees; moulds [kitchen utensils];

egg poachers; cake moulds; baking cases of paper; baking cases of silicone; ice cube moulds; cookery moulds; deep fryers, non-electric; comb cases; bread bins; fly swatters; hot pots, non-electric; crystal [glassware]; teapots; kettles, non-electric; cups; garlic presses [kitchen utensils]; ironing board covers, shaped; covers for tissue boxes; laundry balls, empty; dryer balls; decorative glass spheres; mops; mop wringers; cocktail shakers; cosmetic spatulas; cosmetic stamps, empty; corkscrews, electric and non-electric; animal bristles [brushware]; pig bristles for brush-making; brushes; sound wave vibration hairbrushes; dishwashing brushes; ski wax brushes; facial cleansing brushes, electric and non-electric; brushes for cleaning tanks and containers; lamp-glass brushes; horse brushes; scrubbing brushes; toothbrushes; toothbrushes, electric; carpet sweepers; shoe brushes; toilet brushes; electric brushes, except parts of machines; eyebrow brushes; nail brushes; eyelash brushes; barbecue tongs; nutcrackers; ice tongs; salad tongs; sugar tongs; decanter tags; nest eggs, artificial; window-boxes; boxes of glass.

35 – Arranging subscriptions to telecommunication services for others; administration of consumer loyalty programs; cost price analysis; rental of cash registers; rental of office equipment in co-working facilities; office machines and equipment rental; rental of advertising space; rental of advertising time on communication media; publicity material rental; rental of billboards [advertising boards]; rental of vending machines; rental of sales stands; rental of photocopying machines; business auditing; financial auditing; business intermediary services relating to the matching of potential private investors with entrepreneurs needing funding; web indexing for commercial or advertising purposes; computerized file management; book-keeping; negotiation and conclusion of commercial transactions for third parties; invoicing; demonstration of goods; transcription of communications [office functions]; opinion polling; market studies; business investigations; business research; marketing research; personnel recruitment; business organization consultancy; business management consultancy; personnel management consultancy; professional business consultancy; consultancy regarding advertising communication strategies; consultancy regarding public relations communication strategies; layout services for advertising purposes; marketing; marketing in the framework of software publishing; influencer marketing; marketing through product placement for others in virtual environments; targeted marketing; writing of curriculum vitae for others; writing of publicity texts; scriptwriting for advertising purposes; updating and maintenance of information in registries; updating and maintenance of data in computer databases; updating of advertising material; word processing; online retail services for downloadable virtual clothing; online retail services for downloadable and pre-recorded music and movies; online retail services for downloadable

ring tones; online retail services for downloadable digital music; organization of exhibitions for commercial or advertising purposes; arranging and conducting of commercial events; arranging newspaper subscriptions for others; arranging subscriptions to electronic toll collection [ETC] services for others; organization of fashion shows for promotional purposes; organization of trade fairs; shop window dressing; business appraisals; preparation of business profitability studies; payroll preparation; data search in computer files for others; sales prospecting for others; business partnership search; sponsorship search; administrative assistance in responding to calls for tenders; business management assistance; commercial or industrial management assistance; providing business information; providing business information via a website; providing commercial and business contact information; providing telephone directory information; providing commercial information and advice for consumers in the choice of products and services; providing user reviews for commercial or advertising purposes; providing user rankings for commercial or advertising purposes; provision of an online marketplace for buyers and sellers of downloadable digital image files authenticated by non-fungible tokens [NFTs]; provision of an online marketplace for buyers and sellers of goods and services; presentation of goods on communication media, for retail purposes; media relations services; auctioneering; economic forecasting; sales promotion for others; promotion of goods and services through sponsorship of sports events; promotion of goods through influencers; production of teleshopping programmes; production of advertising films; consumer profiling for commercial or marketing purposes; publication of publicity texts; radio advertising; development of marketing concepts; development of advertising concepts; development of business organization strategies relating to corporate social responsibility; bill-posting; distribution of samples; dissemination of advertising matter; direct mail advertising; registration of written communications and data; advertising; online advertising on a computer network; outdoor advertising; advertising by mail order; pay per click advertising; television advertising; compilation of statistics; compilation of information into computer databases; business inquiries; systemization of information into computer databases; administrative services for medical referrals; corporate communications services; negotiation of business contracts for others; compiling indexes of information for commercial or advertising purposes; tax preparation; drawing up of statements of accounts; psychological testing for the selection of personnel; business management of performing artists; interim business management; business management of sports people; outsourced administrative management for companies; business management of hotels; business management for freelance service providers; business project management services for construction projects; commercial admini-

nistration of the licensing of the goods and services of others; business management of reimbursement programmes for others; computerized management of medical records and files; administration of frequent flyer programs; administrative processing of purchase orders; import-export agency services; commercial information agency services; employment agency services; administrative services for the relocation of businesses; public relations; commercial lobbying services; commercial intermediation services; competitive intelligence services; business consultancy services for digital transformation; advisory services for business management; lead generation services; modelling for advertising or sales promotion; typing; online ordering services in the field of restaurant take-out and delivery; news clipping services; market intelligence services; appointment reminder services [office functions]; data processing services [office functions]; website traffic optimization; appointment scheduling services [office functions]; tax filing services; search engine optimization for sales promotion; gift registry services; price comparison services; business intermediary services relating to the matching of various professionals with clients; reception services for visitors [office functions]; advertising services to create brand identity for others; advertising agency services; secretarial services; procurement services for others [purchasing goods and services for other businesses]; shorthand; outsourcing services [business assistance]; telemarketing services; telephone answering for unavailable subscribers; telephone switchboard services; photocopying services; business efficiency expert services.

(260) AM 2026 136075 A

(800) 1881794

(151) 2025 05 15

(891) 2025 05 15

(731) Shanghai XiaoBeiKe Catering Management Co., LTD

Room 108, Building 7, No. 950, Huiyi Road, Jiading District, 201800 Shanghai, China

(540)

陳香貴

Chen Xiang Gui

(591) Black, white

(531) 27.05.01; 28.03

(511)

30 – Tea; cereal-based snack food; noodles; ice cream; cooking salt; soya sauce; leaven; essences for foodstuffs, except etheric essences and essential oils; gluten prepared as foodstuff; meat tenderizers for culinary purposes.

(260) AM 2026 136168 A

(800) 1882782

(151) 2025 09 12

(891) 2025 09 12

(731) Planmeca Oy

Asentajankatu 6, FI-00880 Helsinki, Finland

(540)

PLANMECA ONYX

(591) Black, white

(511)

9 – Apparatus for recording, transmission or reproduction of images; data processing equipment; intraoral scanners, laser scanners, optical scanners and 3D scanners; computers for controlling and operating medical and dental imaging and scanning devices; computers for processing data and images received from medical and dental imaging and scanning devices; computers for rendering three-dimensional images received from medical and dental imaging and scanning devices; computers for processing and displaying images received from medical and dental imaging and scanning devices; computers for acquiring three-dimensional images from medical and dental imaging and scanning devices; computers for interpreting the results of medical and dental imaging and scanning devices; computers for processing digital images of the anatomy received from medical and dental imaging and scanning devices for diagnosis and treatment; computer software for controlling and operating medical and dental imaging and scanning devices; computer software for controlling and operating digital image sensors used in medical and dental imaging and scanning devices; computer software for processing data and images received from medical and dental imaging and scanning devices; computer software for rendering three-dimensional images received from medical and dental imaging and scanning devices; computer software for processing and displaying images received from medical and dental imaging and scanning devices; computer software for acquiring three-dimensional images from medical and dental imaging and scanning devices; computer software for interpreting the results of medical and dental imaging and scanning devices; computer software for processing digital images of the anatomy received from medical and dental imaging and scanning devices for diagnosis and treatment; computer software for processing graphics and text received from medical and dental imaging and scanning devices and computers.

10 – Surgical, medical, dental and veterinary apparatus and instruments, artificial teeth; cameras and video cameras for medical purposes, intra-oral cameras, endoscopy cameras, digital cameras for viewing cavities of humans and animals for diagnosis and treatment, intraoral scanners, 3D intraoral scanners, laser scanners for medical purposes, optical scanners for medical purposes, optical 3D scanners for medical purposes.

(260) AM 2026 136169 A

(800) 1882808

(151) 2025 09 08

(891) 2025 09 08

(731) TÜRK DEMİR DÖKÜM FABRİKALARI
ANONİM ŞİRKETİ

ATATURK MAH. MERIC CAD. 1 /4 4,
Atasehir, İstanbul, Türkiye

(540)

Vintomix

(591) Black, white

(531) 27.05.01; 27.05.17

(511)

11 – Lighting installations; lights for vehicles and interior-exterior spaces; heating installations using solid, liquid or gas fuels or electricity, namely central heating boilers, boilers for heating installations, radiators [heating], heat exchangers, not parts of machines, stoves, kitchen stoves, solar thermal collectors [heating]; steam, gas and fog generators, namely steam boilers, other than parts of machines, acetylene generators, oxygen generators, nitrogen generators; installations for air-conditioning and ventilating; cooling installations and freezers; electric and gas-powered devices, installations and apparatus for cooking, drying and boiling: cookers, electric cooking pots, electric water heaters, barbecues, electric laundry driers; hair driers; hand drying apparatus; sanitary installations, namely taps [faucets], shower installations, toilets [water-closets], shower and bathing cubicles, bath tubs, toilet seats, sinks, wash-hand basins [parts of sanitary installations], washers for water taps, stuffings (tap valves); water softening apparatus; water purification apparatus; water purification installations; waste water purification installations; electric bed warmers and electric blankets, not for medical use; electric pillow warmers; electric or non-electric footwarmers; hot water bottles, electrically heated socks; filters for aquariums and aquarium filtration apparatus; industrial type installations for cooking, drying and cooling purposes; pasteurizers and sterilizers.

(260) AM 2026 136174 A

(800) 1882928

(151) 2025 04 27

(891) 2025 04 27

(731) Ningbo Fanbo Enterprise Management Co., Ltd.

No.30, Beiyihuan Road, Industrial Zone,
Zhangqi Town, Cixi City, Ningbo City,
Zhejiang Province, China

(540)

DARCA

(591) Black, white

(531) 27.05.01

(511)
34 – Tobacco; tobacco pouches; electronic smoking pipes; matches; decorative covers for electronic smoking devices; lighters for smokers; wicks adapted for cigarette lighters; cigar lighters; cigarette filters; flavorings, other than essential oils, for tobacco.

(260) AM 2026 136182 A

(800) 1883178

(151) 2025 06 26

(891) 2025 06 26

(731) Zhejiang Aofeng Electrical Appliances Co., Ltd
No. 19, Shenbao Road, Baiyang Street,
Wuyi, Zhejiang Province, China

(540)

AOTE

(591) Black, white

(531) 27.05.01

(511)

9 – Letter scales; weights; precision balances; balances [steelyards]; lever scales [steelyards]; scales; weighing apparatus and instruments; weighing machines.

(260) AM 2026 136211 A

(800) 1883838

(151) 2025 06 25

(891) 2025 06 25

(731) QINGDAO HAWKWAY TYRE CO., LTD.
Room 1066, 1/F, East Office Building, No. 45,
Beijing Road, Qianwan Bonded Port Area,
Qingdao Area (Shandong) Pilot Free Trade
Zone, China

(540)

DOTHRAKI

(591) Black, white

(531) 27.05.17

(511)

12 – Trolleys; bicycle tyres; airplane tyres; pneumatic tyres; tyres for vehicle wheels; automobile tyres; solid tyres for vehicle wheels; vehicle wheels; valves for vehicle tyres; non-skid devices for vehicle tyres.

(260) AM 2026 136212 A

(800) 1883860

(151) 2025 07 07

(891) 2025 07 07

(731) TAILG Science and Technology Inc., Ltd.
NO.3-1&3-2, DONGSHENG RD, ANZHEN
STREET, XISHAN DISTRICT, WUXI CITY,
JIANGSU PROVINCE, China

(540)

Chaopao

(591) Black, white

(531) 27.05.01

(511)

12 – Electric vehicles; motorcycles; motor scooters; electric motorcycles; electric bicycles; self-balancing scooters; electric scooters (electric vehicles); electric wheelchair; water scooters [personal watercraft]; upholstery for vehicles.

(260) AM 2026 136213 A

(800) 1883873

(151) 2025 07 18

(891) 2025 07 18

(731) JIANGSU POMLEAD CO., LTD.

No.1 Pomlead Road, Economic Development
Zone, Peixian County, Jiangsu Province, China

(540)

POMLEAD

(591) Black, white

(531) 27.05.01; 27.05.17

(511)

12 – Remote control vehicles, other than toys; vehicles for locomotion by land, air, water or rail; axles for vehicles; engines for land vehicles; automobile; automobile wheels; hubs for automobile wheels; suspension shock absorbers for vehicles; hubs for vehicle wheels; anti-theft devices for vehicles.

(260) AM 2026 136244 A

(800) 1872509

(151) 2025 07 14

(891) 2025 10 10

(731) STADA Arzneimittel AG

Stadastr. 2-18, 61118 Bad Vilbel, Germany

(540)

Kefdensis

(591) Dark blue, blue and khaki.

(531) 27.05.25; 29.01.13

(511)

5 – Pharmaceuticals, medical and veterinary preparations; medicine; sanitary preparations for medical purposes; dietetic food and substances adapted for medical or veterinary use, food for babies; diagnostic preparations; dietary supplements for humans and animals; plasters, materials for dressings; material for stopping teeth, dental wax; disinfectants.

10 – Surgical, medical, dental and veterinary apparatus and instruments; artificial limbs, eyes and teeth; orthopedic articles; suture materials; therapeutic and assistive devices adapted for people with disabilities; massage apparatus; apparatus, devices and articles for nursing infants; sexual activity apparatus, devices and articles.

(260) AM 2026 136246 A

(800) 1876965

(151) 2025 06 13

(891) 2025 09 26

(731) AirGSM Pte. Ltd.

6 RAFFLES BOULEVARD, #03-308

MARINA SQUARE, SINGAPORE 039594,

Singapore

(540)

AIRALO

(591) Black, white

(511)

9 – Downloadable software featuring virtual goods, namely eSIM cards and virtual SIM cards; downloadable applications for mobile devices for purchasing eSIM cards and virtual SIM cards.

35 – Online retail store services featuring third-party eSIM cards for the purchase of telecommunication services; online retail store services featuring virtual SIM cards.

38 – Telecommunication access services; cellular telephone services; telecommunication services, namely, electric, digital, cellular and wireless transmission of voice, data, information, images, signals and messages; providing telecommunications connections over a global communications network; electronic mail, voice mail and messaging services; audio and video teleconferencing; providing user access to computer programs on data networks for use in operating and accessing telecommunications systems.

**INTERNATIONAL TRADEMARK PROTECTED
IN GEORGIA**

(260) AM 2026 129513 A
(800) 1803129
(151) 2024 02 19
(181) 2034 02 19
(891) 2024 02 19
(511) 12

(260) AM 2026 129619 A
(800) 1804512
(151) 2024 05 09
(181) 2034 05 09
(891) 2024 05 09
(511) 5, 29, 30, 32, 35, 43

(260) AM 2026 129563 A
(800) 1803978
(151) 2024 06 04
(181) 2034 06 04
(891) 2024 06 04
(511) 12

(260) AM 2026 129681 A
(800) 1805257
(151) 2024 06 19
(181) 2034 06 19
(891) 2024 06 19
(511) 9, 18, 25

(260) AM 2026 129564 A
(800) 1804002
(151) 2024 07 01
(181) 2034 07 01
(891) 2024 07 01
(511) 6

(260) AM 2026 129682 A
(800) 1805286
(151) 2024 06 01
(181) 2034 06 01
(891) 2024 06 01
(511) 9

(260) AM 2026 129565 A
(800) 1804010
(151) 2024 07 01
(181) 2034 07 01
(891) 2024 07 01
(511) 25

(260) AM 2026 129712 A
(800) 1805939
(151) 2024 04 09
(181) 2034 04 09
(891) 2024 04 09
(511) 3, 5, 10, 42, 44

(260) AM 2026 129566 A
(800) 1804020
(151) 2024 06 04
(181) 2034 06 04
(891) 2024 06 04
(511) 12

(260) AM 2026 129714 A
(800) 1805994
(151) 2024 01 23
(181) 2034 01 23
(891) 2024 01 23
(511) 7, 9, 16

(260) AM 2026 129567 A
(800) 1804051
(151) 2024 07 05
(181) 2034 07 05
(891) 2024 07 05
(511) 3

(260) AM 2026 129715 A
(800) 1805995
(151) 2024 02 08
(181) 2034 02 08
(891) 2024 02 08
(511) 10

(260) AM 2026 129568 A
(800) 1804071
(151) 2024 04 22
(181) 2034 04 22
(891) 2024 04 22
(511) 12

(260) AM 2026 129716 A
(800) 1806015
(151) 2024 02 26
(181) 2034 02 26
(891) 2024 02 26
(511) 43

(260) AM 2026 129804 A
 (800) 1806959
 (151) 2024 02 23
 (181) 2034 02 23
 (891) 2024 02 23
 (511) 30

(260) AM 2026 129806 A
 (800) 1806962
 (151) 2024 04 08
 (181) 2034 04 08
 (891) 2024 04 08
 (511) 23

(260) AM 2026 129807 A
 (800) 1806974
 (151) 2024 06 05
 (181) 2034 06 05
 (891) 2024 06 05
 (511) 9, 41, 42

(260) AM 2026 129808 A
 (800) 1806979
 (151) 2024 06 11
 (181) 2034 06 11
 (891) 2024 06 11
 (511) 1, 4

(260) AM 2026 129888 A
 (800) 1808139
 (151) 2024 04 25
 (181) 2034 04 25
 (891) 2024 04 25
 (511) 7, 35

(260) AM 2026 129889 A
 (800) 1808181
 (151) 2024 06 07
 (181) 2034 06 07
 (891) 2024 06 07
 (511) 32, 35

(260) AM 2026 129890 A
 (800) 1808236
 (151) 2024 07 12
 (181) 2034 07 12
 (891) 2024 07 12
 (511) 5

(260) AM 2026 129891 A
 (800) 1808252
 (151) 2024 05 14
 (181) 2034 05 14

(891) 2024 05 14
 (511) 3, 5, 35, 44

(260) AM 2026 129892 A
 (800) 1808272
 (151) 2024 06 27
 (181) 2034 06 27
 (891) 2024 06 27
 (511) 2

(260) AM 2026 129893 A
 (800) 1808306
 (151) 2024 07 29
 (181) 2034 07 29
 (891) 2024 07 29
 (511) 35, 43

(260) AM 2026 129894 A
 (800) 1808312
 (151) 2024 08 01
 (181) 2034 08 01
 (891) 2024 08 01
 (511) 32, 33

(260) AM 2026 129895 A
 (800) 1808363
 (151) 2024 06 17
 (181) 2034 06 17
 (891) 2024 06 17
 (511) 10

(260) AM 2026 129896 A
 (800) 1808382
 (151) 2024 06 07
 (181) 2034 06 07
 (891) 2024 06 07
 (511) 10

(260) AM 2026 129897 A
 (800) 1808449
 (151) 2024 07 12
 (181) 2034 07 12
 (891) 2024 07 12
 (511) 5

(260) AM 2026 129898 A
 (800) 1808453
 (151) 2024 07 08
 (181) 2034 07 08
 (891) 2024 07 08
 (511) 14

(260) AM 2026 129899 A
(800) 1808494
(151) 2024 04 29
(181) 2034 04 29
(891) 2024 04 29
(511) 29, 30

(260) AM 2026 129900 A
(800) 1808511
(151) 2024 05 12
(181) 2034 05 12
(891) 2024 05 12
(511) 1

(260) AM 2026 129901 A
(800) 1808562
(151) 2024 06 19
(181) 2034 06 19
(891) 2024 06 19
(511) 35, 36, 38, 42

(260) AM 2026 129969 A
(800) 1809023
(151) 2024 08 07
(181) 2034 08 07
(891) 2024 08 07
(511) 5

(260) AM 2026 129970 A
(800) 1809039
(151) 2024 03 07
(181) 2034 03 07
(891) 2024 03 07
(511) 6

(260) AM 2026 129971 A
(800) 1809047
(151) 2024 06 13
(181) 2034 06 13
(891) 2024 06 13
(511) 5

(260) AM 2026 129972 A
(800) 1809048
(151) 2024 06 13
(181) 2034 06 13
(891) 2024 06 13
(511) 5

(260) AM 2026 129973 A
(800) 1809075
(151) 2024 08 07
(181) 2034 08 07

(891) 2024 08 07
(511) 32, 33

(260) AM 2026 129974 A
(800) 1809111
(151) 2024 04 24
(181) 2034 04 24
(891) 2024 04 24
(511) 3, 35

(260) AM 2026 129975 A
(800) 1809113
(151) 2024 06 13
(181) 2034 06 13
(891) 2024 06 13
(511) 34

(260) AM 2026 129976 A
(800) 1809128
(151) 2024 06 11
(181) 2034 06 11
(891) 2024 06 11
(511) 5, 16, 44

(260) AM 2026 129977 A
(800) 1809164
(151) 2024 06 06
(181) 2034 06 06
(891) 2024 06 06
(511) 29, 35

(260) AM 2026 129984 A
(800) 1809244
(151) 2024 07 05
(181) 2034 07 05
(891) 2024 07 05
(511) 14

(260) AM 2026 129985 A
(800) 1809259
(151) 2024 03 08
(181) 2034 03 08
(891) 2024 03 08
(511) 3

(260) AM 2026 130023 A
(800) 1810011
(151) 2024 08 01
(181) 2034 08 01
(891) 2024 08 01
(511) 5

(260) AM 2026 130024 A
(800) 1810012
(151) 2024 08 01
(181) 2034 08 01
(891) 2024 08 01
(511) 5

(260) AM 2026 130025 A
(800) 1810013
(151) 2024 08 01
(181) 2034 08 01
(891) 2024 08 01
(511) 5

(260) AM 2026 130026 A
(800) 1810014
(151) 2024 08 02
(181) 2034 08 02
(891) 2024 08 02
(511) 5

(260) AM 2026 130027 A
(800) 1810015
(151) 2024 08 02
(181) 2034 08 02
(891) 2024 08 02
(511) 5

(260) AM 2026 130028 A
(800) 1810016
(151) 2024 08 02
(181) 2034 08 02
(891) 2024 08 02
(511) 5

(260) AM 2026 130029 A
(800) 1810017
(151) 2024 08 02
(181) 2034 08 02
(891) 2024 08 02
(511) 5

(260) AM 2026 130030 A
(800) 1810018
(151) 2024 08 01
(181) 2034 08 01
(891) 2024 08 01
(511) 5

(260) AM 2026 130031 A
(800) 1810019
(151) 2024 08 01
(181) 2034 08 01

(891) 2024 08 01
(511) 5

(260) AM 2026 130085 A
(800) 1810358
(151) 2024 03 21
(181) 2034 03 21
(891) 2024 03 21
(511) 36

(260) AM 2026 130086 A
(800) 1810363
(151) 2024 07 04
(181) 2034 07 04
(891) 2024 07 04
(511) 9, 11, 42

(260) AM 2026 130090 A
(800) 1810455
(151) 2024 07 08
(181) 2034 07 08
(891) 2024 07 08
(511) 5

(260) AM 2026 130091 A
(800) 1810547
(151) 2024 01 24
(181) 2034 01 24
(891) 2024 01 24
(511) 9, 10, 11, 16, 35, 37, 40, 41, 42

(260) AM 2026 130092 A
(800) 1810562
(151) 2024 04 15
(181) 2034 04 15
(891) 2024 04 15
(511) 9, 28, 41

(260) AM 2026 130161 A
(800) 1811252
(151) 2024 05 23
(181) 2034 05 23
(891) 2024 05 23
(511) 5

(260) AM 2026 130162 A
(800) 1811268
(151) 2024 06 12
(181) 2034 06 12
(891) 2024 06 12
(511) 7, 8, 9, 21

(260) AM 2026 130163 A
(800) 1811271
(151) 2024 08 02
(181) 2034 08 02
(891) 2024 08 02
(511) 5

(260) AM 2026 130164 A
(800) 1811278
(151) 2024 04 15
(181) 2034 04 15
(891) 2024 04 15
(511) 9, 28, 41

(260) AM 2026 130173 A
(800) 1811420
(151) 2024 07 18
(181) 2034 07 18
(891) 2024 07 18
(511) 32

(260) AM 2026 130174 A
(800) 1811427
(151) 2024 08 03
(181) 2034 08 03
(891) 2024 08 03
(511) 5

(260) AM 2026 130298 A
(800) 1813749
(151) 2024 07 22
(181) 2034 07 22
(891) 2024 07 22
(511) 5

(260) AM 2026 130299 A
(800) 1813757
(151) 2024 08 08
(181) 2034 08 08
(891) 2024 08 08
(511) 32, 33

(260) AM 2026 130300 A
(800) 1813758
(151) 2024 08 08
(181) 2034 08 08
(891) 2024 08 08
(511) 32, 33

(260) AM 2026 130301 A
(800) 1813777
(151) 2024 06 21
(181) 2034 06 21

(891) 2024 06 21
(511) 10, 25, 28, 41

(260) AM 2026 130303 A
(800) 1813824
(151) 2024 07 30
(181) 2034 07 30
(891) 2024 07 30
(511) 5

(260) AM 2026 130380 A
(800) 1814927
(151) 2024 05 22
(181) 2034 05 22
(891) 2024 05 22
(511) 1

(260) AM 2026 130381 A
(800) 1815057
(151) 2024 02 08
(181) 2034 02 08
(891) 2024 02 08
(511) 2, 8, 16

(260) AM 2026 130382 A
(800) 1815062
(151) 2024 03 20
(181) 2034 03 20
(891) 2024 03 20
(511) 7, 11, 24, 41

(260) AM 2026 130383 A
(800) 1815095
(151) 2024 04 24
(181) 2034 04 24
(891) 2024 04 24
(511) 7, 9, 11, 37

(260) AM 2026 130462 A
(800) 1815418
(151) 2024 03 25
(181) 2034 03 25
(891) 2024 03 25
(511) 43

(260) AM 2026 130463 A
(800) 1815441
(151) 2024 07 30
(181) 2034 07 30
(891) 2024 07 30
(511) 1, 17

(260) AM 2026 130464 A
(800) 1815445
(151) 2024 08 16
(181) 2034 08 16
(891) 2024 08 16
(511) 3

(260) AM 2026 130465 A
(800) 1815477
(151) 2024 07 04
(181) 2034 07 04
(891) 2024 07 04
(511) 3, 21

(260) AM 2026 130466 A
(800) 1815489
(151) 2024 06 21
(181) 2034 06 21
(891) 2024 06 21
(511) 11

(260) AM 2026 130468 A
(800) 1815584
(151) 2024 07 19
(181) 2034 07 19
(891) 2024 07 19
(511) 9

(260) AM 2026 130478 A
(800) 1815984
(151) 2024 08 05
(181) 2034 08 05
(891) 2024 08 05
(511) 5

(260) AM 2026 130479 A
(800) 1816034
(151) 2024 09 06
(181) 2034 09 06
(891) 2024 09 06
(511) 5

(260) AM 2026 130599 A
(800) 1817684
(151) 2024 08 01
(181) 2034 08 01
(891) 2024 08 01
(511) 9

(260) AM 2026 130613 A
(800) 1818150
(151) 2024 06 06
(181) 2034 06 06

(891) 2024 06 06
(511) 9, 28, 41

(260) AM 2026 130615 A
(800) 1818179
(151) 2024 07 05
(181) 2034 07 05
(891) 2024 07 05
(511) 9, 28, 41

(260) AM 2026 130618 A
(800) 1818204
(151) 2024 08 02
(181) 2034 08 02
(891) 2024 08 02
(511) 39

(260) AM 2026 130619 A
(800) 1818211
(151) 2024 05 14
(181) 2034 05 14
(891) 2024 05 14
(511) 3

(260) AM 2026 132006 A
(800) 1835343
(151) 2024 10 08
(181) 2034 10 08
(891) 2024 10 08
(511) 5

(260) AM 2026 132009 A
(800) 1835389
(151) 2024 12 31
(181) 2034 12 31
(891) 2024 12 31
(511) 33

(260) AM 2026 132057 A
(800) 1732133
(151) 2023 01 06
(181) 2033 01 06
(891) 2025 01 09
(511) 1, 02, 03

(260) AM 2026 132059 A
(800) 1789490
(151) 2023 11 26
(181) 2033 11 26
(891) 2024 12 22
(511) 2, 3, 04, 07

(260) AM 2026 132061 A
(800) 1819165
(151) 2024 07 22
(181) 2034 07 22
(891) 2025 01 16
(511) 9, 35, 38, 41, 42, 45

(260) AM 2026 132182 A
(800) 1837889
(151) 2024 10 10
(181) 2034 10 10
(891) 2024 10 10
(511) 1, 4, 7, 9, 12, 35, 37, 38, 39, 42

(260) AM 2026 132183 A
(800) 1837890
(151) 2024 11 05
(181) 2034 11 05
(891) 2024 11 05
(511) 36, 42

(260) AM 2026 132460 A
(800) 1499518
(151) 2019 10 01
(181) 2029 10 01
(891) 2025 01 22
(511) 39

(260) AM 2026 132892 A
(800) 1546069
(151) 2020 06 01
(181) 2030 06 01
(891) 2025 02 05
(511) 9

(260) AM 2026 133115 A
(800) 855106
(151) 2005 02 14
(181) 2035 02 14
(891) 2025 02 15
(511) 5, 29, 32

(260) AM 2026 133116 A
(800) 1084412
(151) 2011 03 09
(181) 2031 03 09
(891) 2025 03 13
(511) 35, 36

(260) AM 2026 133117 A
(800) 1125238
(151) 2012 03 07
(181) 2032 03 07

(891) 2025 01 21
(511) 7

(260) AM 2026 133118 A
(800) 1207862
(151) 2014 05 01
(181) 2034 05 01
(891) 2025 03 10
(511) 9

(260) AM 2026 133119 A
(800) 1464826
(151) 2018 12 10
(181) 2028 12 10
(891) 2024 11 25
(511) 03, 35

(260) AM 2026 133195 A
(800) 1847220
(151) 2024 11 28
(181) 2034 11 28
(891) 2024 11 28
(511) 3, 5

(260) AM 2026 133196 A
(800) 1847296
(151) 2024 12 17
(181) 2034 12 17
(891) 2024 12 17
(511) 30

(260) AM 2026 133198 A
(800) 1847395
(151) 2025 02 18
(181) 2035 02 18
(891) 2025 02 18
(511) 5

(260) AM 2026 133199 A
(800) 1847403
(151) 2024 11 21
(181) 2034 11 21
(891) 2024 11 21
(511) 9, 28, 41

(260) AM 2026 133310 A
(800) 1848526
(151) 2024 12 05
(181) 2034 12 05
(891) 2024 12 05
(511) 03

(260) AM 2026 133446 A
(800) 1850436
(151) 2025 01 31
(181) 2035 01 31
(891) 2025 01 31
(511) 17, 19, 20

(260) AM 2026 133492 A
(800) 1850846
(151) 2024 10 21
(181) 2034 10 21
(891) 2024 10 21
(511) 9, 28, 41

(260) AM 2026 133628 A
(800) 895160
(151) 2006 03 24
(181) 2026 03 24
(891) 2025 04 02
(511) 9

(260) AM 2026 133629 A
(800) 949403
(151) 2007 10 18
(181) 2027 10 18
(891) 2025 04 02
(511) 9

(260) AM 2026 133630 A
(800) 1150350
(151) 2012 12 18
(181) 2032 12 18
(891) 2025 03 26
(511) 3

(260) AM 2026 133632 A
(800) 1591856
(151) 2021 02 26
(181) 2031 02 26
(891) 2025 04 17
(511) 5

(260) AM 2026 133633 A
(800) 1629522
(151) 2021 07 30
(181) 2031 07 30
(891) 2025 02 10
(511) 3

(260) AM 2026 133634 A
(800) 1782448
(151) 2024 01 16
(181) 2034 01 16

(891) 2025 04 17
(511) 9, 41

(260) AM 2026 133635 A
(800) 1812993
(151) 2024 02 28
(181) 2034 02 28
(891) 2025 04 11
(511) 9, 12, 35, 36, 37, 38, 39, 42

(260) AM 2026 133636 A
(800) 1830730
(151) 2024 11 06
(181) 2034 11 06
(891) 2025 04 16
(511) 3, 35

(260) AM 2026 133637 A
(800) 1839327
(151) 2024 12 04
(181) 2034 12 04
(891) 2025 02 24
(511) 30

(260) AM 2026 133638 A
(800) 1849539
(151) 2024 12 20
(181) 2034 12 20
(891) 2025 04 11
(511) 9, 35, 36, 41

(260) AM 2026 133709 A
(800) 1853008
(151) 2025 03 31
(181) 2035 03 31
(891) 2025 03 31
(511) 26, 28

(260) AM 2026 133718 A
(800) 1853266
(151) 2025 03 17
(181) 2035 03 17
(891) 2025 03 17
(511) 7, 8, 9

(260) AM 2026 133722 A
(800) 1853309
(151) 2025 01 17
(181) 2035 01 17
(891) 2025 01 17
(511) 3, 5, 10

(260) AM 2026 133728 A
(800) 1853379
(151) 2025 01 23
(181) 2035 01 23
(891) 2025 01 23
(511) 6, 19

(260) AM 2026 133736 A
(800) 1853500
(151) 2025 02 19
(181) 2035 02 19
(891) 2025 02 19
(511) 3, 5, 10

(260) AM 2026 133738 A
(800) 1853530
(151) 2025 02 06
(181) 2035 02 06
(891) 2025 02 06
(511) 3, 5

(260) AM 2026 133753 A
(800) 628864
(151) 1994 10 13
(181) 2034 10 13
(891) 2025 03 24
(511) 42

(260) AM 2026 133807 A
(800) 1854240
(151) 2024 12 11
(181) 2034 12 11
(891) 2024 12 11
(511) 2, 6, 8, 9, 14, 16, 20, 21, 25, 28, 35, 41

(260) AM 2026 133832 A
(800) 1854762
(151) 2024 12 11
(181) 2034 12 11
(891) 2024 12 11
(511) 6, 9, 14, 16, 20, 21, 25, 28, 41

(260) AM 2026 133906 A
(800) 1855063
(151) 2025 03 10
(181) 2035 03 10
(891) 2025 03 10
(511) 11

(260) AM 2026 133907 A
(800) 1855135
(151) 2025 01 30
(181) 2035 01 30

(891) 2025 01 30
(511) 32

(260) AM 2026 133908 A
(800) 1855136
(151) 2025 01 30
(181) 2035 01 30
(891) 2025 01 30
(511) 32

(260) AM 2026 133909 A
(800) 1855137
(151) 2025 01 30
(181) 2035 01 30
(891) 2025 01 30
(511) 32

(260) AM 2026 133930 A
(800) 1855625
(151) 2024 10 21
(181) 2034 10 21
(891) 2024 10 21
(511) 30, 33, 35, 43

(260) AM 2026 133931 A
(800) 1855645
(151) 2024 12 27
(181) 2034 12 27
(891) 2024 12 27
(511) 3, 5, 9, 16, 21, 25, 29, 30, 32, 35, 41

(260) AM 2026 133932 A
(800) 1855683
(151) 2025 03 04
(181) 2035 03 04
(891) 2025 03 04
(511) 9, 35, 38, 41, 42

(260) AM 2026 133933 A
(800) 1855751
(151) 2025 03 25
(181) 2035 03 25
(891) 2025 03 25
(511) 5

(260) AM 2026 133934 A
(800) 1855941
(151) 2025 03 26
(181) 2035 03 26
(891) 2025 03 26
(511) 30

(260) AM 2026 134002 A
(800) 1856605
(151) 2024 12 18
(181) 2034 12 18
(891) 2024 12 18
(511) 20, 24

(260) AM 2026 134009 A
(800) 1856782
(151) 2024 12 05
(181) 2034 12 05
(891) 2024 12 05
(511) 9, 28, 41

(260) AM 2026 134011 A
(800) 1856803
(151) 2025 03 06
(181) 2035 03 06
(891) 2025 03 06
(511) 12

(260) AM 2026 134013 A
(800) 1856859
(151) 2024 10 18
(181) 2034 10 18
(891) 2024 10 18
(511) 3, 5, 10, 24, 25

(260) AM 2026 134014 A
(800) 1856889
(151) 2025 01 10
(181) 2035 01 10
(891) 2025 01 10
(511) 10

(260) AM 2026 134015 A
(800) 1856891
(151) 2024 12 19
(181) 2034 12 19
(891) 2024 12 19
(511) 3

(260) AM 2026 134044 A
(800) 1775650
(151) 2024 01 03
(181) 2034 01 03
(891) 2025 05 13
(511) 6

(260) AM 2026 134046 A
(800) 1790150
(151) 2024 04 10
(181) 2034 04 10

(891) 2025 04 15
(511) 35

(260) AM 2026 134047 A
(800) 1790150
(151) 2024 04 10
(181) 2034 04 10
(891) 2025 04 15
(511) 35

(260) AM 2026 134048 A
(800) 1791207
(151) 2024 04 10
(181) 2034 04 10
(891) 2025 04 15
(511) 35

(260) AM 2026 134049 A
(800) 1791207
(151) 2024 04 10
(181) 2034 04 10
(891) 2025 04 15
(511) 35

(260) AM 2026 134107 A
(800) 1857489
(151) 2025 03 14
(181) 2035 03 14
(891) 2025 03 14
(511) 18, 25

(260) AM 2026 134108 A
(800) 1857574
(151) 2024 12 11
(181) 2034 12 11
(891) 2024 12 11
(511) 31

(260) AM 2026 134110 A
(800) 1857582
(151) 2025 01 30
(181) 2035 01 30
(891) 2025 01 30
(511) 32

(260) AM 2026 134111 A
(800) 1857583
(151) 2025 01 30
(181) 2035 01 30
(891) 2025 01 30
(511) 32

(260) AM 2026 134112 A
(800) 1857595
(151) 2025 04 15
(181) 2035 04 15
(891) 2025 04 15
(511) 7

(260) AM 2026 134113 A
(800) 1857598
(151) 2025 03 24
(181) 2035 03 24
(891) 2025 03 24
(511) 5

(260) AM 2026 134222 A
(800) 1859327
(151) 2025 02 26
(181) 2035 02 26
(891) 2025 02 26
(511) 9, 28, 41, 42

(260) AM 2026 134223 A
(800) 1859438
(151) 2025 04 18
(181) 2035 04 18
(891) 2025 04 18
(511) 3

(260) AM 2026 134224 A
(800) 1859548
(151) 2025 01 22
(181) 2035 01 22
(891) 2025 01 22
(511) 9, 38, 42

(260) AM 2026 134225 A
(800) 1859560
(151) 2025 03 17
(181) 2035 03 17
(891) 2025 03 17
(511) 29, 35

OFFICIAL NOTIFICATIONS
INVENTION
RESTORATION OF PATENT

(21) AP 2010 12393
(11) P 2015 6211 B
(73) FMC Corporation
(54) FUNGICIDAL PYRAZOLES
DATE OF PATENT LAPSE: 2026 03 03
DATE OF PATENT RESTORATION: 2026 06 10

(21) AP 2010 12500
(11) P 2013 5968 B
(73) Thornton & Ross Limited
(54) COMPOSITION FOR ECTOPARASITES CONTROL AND USAGE THEREOF
DATE OF PATENT LAPSE: 2026 05 12
DATE OF PATENT RESTORATION: 2026 06 10

(21) AP 2020 15717
(11) P 2025 7829 B
(73) Marker Diagnostics Uk Limited
(54) SALIVARY BIOMARKERS OF BRAIN INJURY
DATE OF PATENT LAPSE: 2026 02 14
DATE OF PATENT RESTORATION: 2026 06 10

(21) AP 2020 15745
(11) P 2023 7472 B
(73) Curasept A.D.S.S.R.L
(54) ORAL CARE PRODUCT
DATE OF PATENT LAPSE: 2026 02 27
DATE OF PATENT RESTORATION: 2026 06 10

(21) AP 2021 16101
(11) P 2026 7875 B
(73) Exelixis Inc.
(54) PROCESSES FOR THE PREPARATION OF A KINASE INHIBITOR
DATE OF PATENT LAPSE: 2026 04 30
DATE OF PATENT RESTORATION: 2026 06 10

(21) AP 2021 16103
(11) P 2024 7704 B
(73) Anadolu Efes Biracilik Ve Malt San. A. Ş.
(54) PROCESS FOR THE PRODUCTION OF BEER
DATE OF PATENT LAPSE: 2025 06 16
DATE OF PATENT RESTORATION: 2026 06 10

(21) AP 2024 16513
(11) P 2024 7685 B
(73) Nino Dvali
(54) ASTIGMATISM CORRECTIVE INTRAOCULAR PHAKIC LENS DURING KERATOCONUS
DATE OF PATENT LAPSE: 2026 05 02
DATE OF PATENT RESTORATION: 2026 06 10

(21) AP 2024 16516
(11) P 2025 7740 B
(73) Giorgi Tsertsvadze
(54) MODIFIED CHESS PLAYING DEVICE
DATE OF PATENT LAPSE: 2026 05 14
DATE OF PATENT RESTORATION: 2026 06 10

LAPSE OF PATENT WITH THE RIGHT TO RESTORE

(21) AP 2020 15825
(11) P 2025 7822 B
(73) Novartis AG;
Les Laboratoires Servier
(54) MCL-1 INHIBITOR ANTIBODY-DRUG CONJUGATES AND METHODS OF USE
DATE OF PATENT LAPSE: 2026 05 19
PATENT RESTORATION TERM: 2027 05 19

(21) AP 2024 16516
(11) P 2025 7740 B
(73) Giorgi Tsertsvadze
(54) MODIFIED CHESS PLAYING DEVICE
DATE OF PATENT LAPSE: 2026 05 14
PATENT RESTORATION TERM: 2028 05 14

EXPIRATION OF PATENT RESTORATION TERM

(21) AP 2006 10418
(11) P 2021 7221 B
(73) Incyte Holdings Corporation
(54) MODULATORS OF INDOLEAMINE 2,3-DIOXYGENASE AND METHODS OF USING THE SAME
DATE OF PATENT LAPSE: 2025 05 09
DATE OF EXPIRATION OF PATENT RESTORATION TERM: 2026 05 09

(21) AP 2013 13630
(11) P 2017 6644 B
(73) Discovery Purchaser Corporation
(54) INSECTICIDAL WATER-IN-OIL (W/O) FORMULATION
DATE OF PATENT LAPSE: 2025 05 14
DATE OF EXPIRATION OF PATENT RESTORATION TERM: 2026 05 14

(21) AP 2015 14379
(11) P 2019 7011 B
(73) Takeda Pharmaceutical Company Limited
(54) HETEROARYL COMPOUNDS FOR KINASE INHIBITION
DATE OF PATENT LAPSE: 2025 05 13
DATE OF EXPIRATION OF PATENT RESTORATION TERM: 2026 05 13

(21) AP 2015 14706
(11) P 2020 7111 B
(73) Takeda Pharmaceutical Company Limited
(54) HETEROARYL COMPOUNDS FOR KINASE INHIBITION
DATE OF PATENT LAPSE: 2025 05 13
DATE OF EXPIRATION OF PATENT RESTORATION TERM: 2026 05 13

(21) AP 2018 15219
(11) P 2021 7318 B
(73) H.Lundbeck A/S
(54) PYRAZOLE MAGL INHIBITORS
DATE OF PATENT LAPSE: 2025 05 22
DATE OF EXPIRATION OF PATENT RESTORATION TERM: 2026 05 22

(21) AP 2022 15951
(11) P 2023 7555 B
(73) Barbara Kilosanidze;
Giorgi Kakauridze;
Georgian Technical University;
Shota Rustaveli Georgian National Science Foundation
(54) EQUIPMENT FOR POLARIZATION STATE AND CHANGE DETERMINATION AND USAGE THEREIN
ELLIPSOMETRY
DATE OF PATENT LAPSE: 2025 05 18
DATE OF EXPIRATION OF PATENT RESTORATION TERM: 2026 05 18

(21) AP 2021 16114
(11) P 2025 7719 B
(73) Sichuan Kelun-Biotech Biopharmaceutical Co., LTD.
(54) ANTIBODY DRUG CONJUGATE, PREPARATION METHOD THEREFOR AND USE THEREOF
DATE OF PATENT LAPSE: 2025 05 12
DATE OF EXPIRATION OF PATENT RESTORATION TERM: 2026 05 12

UTILITY MODEL
EXPIRATION OF PATENT RESTORATION TERM

(21) AU 2017 14496
(11) U 2018 1996 Y
(73) Tovaristvo Z Obmejenoiu Vidpovidalnituu "Ukrmaining" - Limited Liability Kompany "Ukrmining"
(54) LINE FOR MANGANESE CONCENTRATES PREPARATION WITH MANGANESE ORE PRIMARY
ENRICHMENT WITHDRAWAL
DATE OF PATENT LAPSE: 2025 05 18
DATE OF EXPIRATION OF PATENT RESTORATION TERM: 2026 05 18

(21) AU 2021 15629
(11) U 2022 2132 Y
(73) Nikoloz Kozanashvili
(54) FOOD FIXTURE
DATE OF PATENT LAPSE: 2025 05 13
DATE OF EXPIRATION OF PATENT RESTORATION TERM: 2026 05 13

(21) AU 2020 15677
(11) U 2022 2140 Y
(73) LLC "Zavod Metalicheskikh Agrazhdenii"
(54) SCREW PILE
DATE OF PATENT LAPSE: 2025 05 22
DATE OF EXPIRATION OF PATENT RESTORATION TERM: 2026 05 22

(21) AU 2023 16244
(11) U 2024 2185 Y
(73) LTD "I S I"
(54) SMART BIN
DATE OF PATENT LAPSE: 2025 05 10
DATE OF EXPIRATION OF PATENT RESTORATION TERM: 2026 05 10

(21) AU 2023 16251
(11) U 2024 2167 Y
(73) Davit Tavkheldidze;
Nia Natbiladze;
Lia Lursmanashvili;
Olgha Rukhadze;
Tinatin Iordanishvili
(54) DEVICE FOR TIGHTENING AND STRAIGHTENING NON-WOVEN FABRIC
DATE OF PATENT LAPSE: 2025 05 17
DATE OF EXPIRATION OF PATENT RESTORATION TERM: 2026 05 17

DESIGN CANCELLATION OF DESIGN REGISTRATION

(11) D 2021 901 S
(73) Ketevan Macharashvili (GE)
Shartava St. 35/37, ent. 1, ap. 47b, 0160, Tbilisi, Georgia (GE)
(54) VEIL
(18) 2025 11 17
(58) 2026 05 25

(11) D 2020 873 S
(73) LLC "Kakhetian Traditional Winemaking" (GE)
Tsintsadze St. 12, 0160, Tbilisi, Georgia (GE)
(54) BOTTLE
(18) 2025 11 20
(58) 2026 05 25

EXTENSION OF TERM OF INTERNATIONAL DESIGN REGISTRATION

(11) DM/213 220
(73) Harry Winston SA
Chemin Du Tourbillon 8, 1228 Plan-les-Ouates (CH)
(15) 2021 03 11
(24) 2021 03 11
(18) 2031 03 11
(28) 2
(28') 2
(54) 1.-2. PAIR OF EARRINGS

(11) DM/213 318
(73) Harry Winston SA
Chemin du Tourbillon 8, 1228 Plan-les-Ouates (CH)
(15) 2021 03 05
(24) 2021 03 05
(18) 2031 03 25
(28) 6
(28') 6
(54) 1.-2. PAIR OF EARRINGS, 3. FINGER RING, 4. NECKLACE, 5. FINGER RING, 6. PAIR OF EARRINGS

(11) DM/213 338
(73) Harry Winston SA
Chemin Du Tourbillon 8, 1228 Plan-les-Ouates (CH)
(15) 2021 03 19
(24) 2021 03 19
(18) 2031 03 19
(28) 6
(28') 6
(54) 1. NECKLACE, 2. PAIR OF EARRINGS, 3.-5. FINGER RING, 6. PAIR OF EARRINGS

(11) DM/213 344
(73) Harry Winston SA
Chemin Du Tourbillon 8, 1228 Plan-les-Ouates (CH)
(15) 2021 03 01
(24) 2021 03 01
(18) 2031 03 01
(28) 11
(28') 11
(54) 1.-2. FINGER RING, 10. NECKLACE, 11. PAIR OF EARRINGS, 3. NECKLACE,
4.-8. PAIR OF EARRINGS, 9. BRACELET

(11) DM/213 583
(73) Harry Winston SA
Chemin Du Tourbillon 8, 1228 Plan-les-Ouates (CH)
(15) 2021 03 31
(24) 2021 03 31
(18) 2031 03 31
(28) 5
(28') 5
(54) 1. FINGER RING, 2. PAIR OF EARRINGS, 3. NECKLACE, 4. BRACELET, 5. WEDDING RING

(11) DM/213 804
(73) Harry Winston SA
Chemin Du Tourbillon 8, 1228 Plan-les-Ouates (CH)
(15) 2021 04 16
(24) 2021 04 16
(18) 2031 04 16
(28) 6
(28') 6
(54) 1. NECKLACE, 2. BRACELET, 3.-4. PAIR OF EARRINGS, 5. FINGER RING, 6. BRACELET

(11) DM/214 065
(73) Harry Winston SA
Chemin Du Tourbillon 8, 1228 Plan-les-Ouates (CH)
(15) 2021 04 30
(24) 2021 04 30
(18) 2031 04 30
(28) 4
(28') 4
(54) 1. FINGER RING, 2.-3. BRACELET, 4. PAIR OF EARRINGS

(11) DM/214 083
(73) Harry Winston SA
Chemin Du Tourbillon 8, 1228 Plan-les-Ouates (CH)
(15) 2021 04 28
(24) 2021 04 28
(18) 2031 04 28
(28) 3
(28') 3
(54) 1.-3. DIAL

(11) DM/214 708
(73) Vaillant GmbH
 Berghauser Str. 40, 42859 Remscheid (DE)
(15) 2021 05 31
(24) 2021 05 31
(18) 2031 05 31
(28) 2
(28') 2
(54) 1.-2. HEATING BOILER

(11) DM/89634
(73) Omega SA (Omega AG) (Omega LTD.)
 Jakob-Stämpfli-Strasse 96, CH-2502 Biel/Bienne (CH)
(15) 2016 03 01
(24) 2016 03 01
(18) 2031 03 01
(28) 4
(28') 2
(54) 1.-2. WATCH RIMS, 3. WATCH CASE, 4. DIAL WITH HANDS

TRADEMARK**EXTENSION OF TERM OF TRADEMARK REGISTRATION**

(111) M 1996 4262 R3

(151) 1996 12 19

(186) 2036 12 19

(732) Kellanova

One Kellogg Square, Battle Creek,
Michigan 49016, USA

(511) 29, 30, 31

(111) M 1996 2761 R3

(151) 1996 07 29

(186) 2036 07 29

(732) Saft

26 quai Charles Pasqua, 92300
Levallois-Perret, France

(511) 9, 11

(111) M 1996 2535P R3

(151) 1996 06 28

(186) 2036 06 28

(732) Aulbach lizenz ag, a Swiss Corporation
Grabenstrasse 15, 7002 Chur, Switzerland

(511) 18, 25

(111) M 1996 2049 R3

(151) 1996 05 10

(186) 2036 05 10

(732) Kenvue Inc.

1 Kenvue Way, Summit, New Jersey 07901,
USA

(511) 5

(111) M 1996 2032 R3

(151) 1996 05 08

(186) 2036 05 08

(732) Kenvue Inc.

1 Kenvue Way, Summit, New Jersey 07901,
USA

(511) 5

(111) M 1996 2651 R3

(151) 1996 07 17

(186) 2036 07 17

(732) Oy Karl Fazer AB

Fazerintie 6, 01230Vantaa, Finland

(511) 30

(111) M 1996 2116 R3

(151) 1996 05 21

(186) 2036 05 21

(732) Cardinal Health 529, LLC

7000 Cardinal Place Dublin, Ohio 43017, USA

(511) 10

(111) M 2006 17205 R2

(151) 2006 12 27

(186) 2036 12 27

(732) Gpcp IP Holdings LLC

133 Peachtree Street NE, Atlanta, Georgia
30303, USA

(511) 21

(111) M 2006 16589 R2

(151) 2006 05 01

(186) 2036 05 01

(732) Rani Refreshments FZCO

Office No. LB191306, Jebel Ali, Dubai,
United Arab Emirates

(511) 29, 30

(111) M 1996 2150 R3

(151) 1996 05 27

(186) 2036 05 27

(732) Ansell Limited

Level 3, 678 Victoria Street Richmond,
Victoria, 3121, Australia

(511) 25

(111) M 2006 16620 R2

(151) 2006 05 17

(186) 2036 05 17

(732) Diageo Brands B.V.

a Netherlands Private Company
Molenwerf 10-12, 1014 BG Amsterdam,
Netherlands

(511) 33

(111) M 2006 16724 R2

(151) 2006 07 12

(186) 2036 07 12

(732) Merck Sharp & Dohme LLC

126 East Lincoln Ave., P.O. Box 2000,
Rahway New Jersey 07065, USA

(511) 5

(111) M 2006 16734 R2
 (151) 2006 07 12
 (186) 2036 07 12
 (732) Arysta LifeScience Corporation
 8-1, Akashi-cho, Chuo-ko, Tokyo 104 6591,
 Japan
 (511) 1, 5

(111) M 2006 16773 R2
 (151) 2006 08 01
 (186) 2036 08 01
 (732) The Coca-Cola Company
 a Corporate of the State of Delaware
 One Coca-Cola Plaza, Atlanta, Georgia
 30313, USA
 (511) 32

(111) M 2006 16960 R2
 (151) 2006 10 26
 (186) 2036 10 26
 (732) Himalaya Global Holdings Ltd.
 Himalaya House, 138 Elgin Avenue, P.O. Box
 1162, Grand Cayman, Cayman Islands
 (511) 5

(111) M 2006 17117 R2
 (151) 2006 11 28
 (186) 2036 11 28
 (732) Toto Ltd
 1-1, Nakashima 2-chome, Kokurakita-ku,
 Kitakyushu-shi, Fukuoka-Ken, Japan
 (511) 11

(111) M 2007 17316 R2
 (151) 2007 02 27
 (186) 2037 02 27
 (732) LEPL "Tbilisi State Medical University"
 Vazha-Pshavela Av. 33, 0186, Tbilisi, Georgia
 (511) 5

(111) M 1996 2837 R3
 (151) 1996 08 01
 (186) 2036 08 01
 (732) DC Comics, a New York general partnership
 1700 Broadway, New York, New York 10019,
 USA
 (511) 16

(111) M 1996 2838 R3
 (151) 1996 08 01
 (186) 2036 08 01
 (732) DC Comics, a New York general partnership

1700 Broadway, New York, New York 10019,
 USA
 (511) 16

(111) M 1996 2839 R3
 (151) 1996 08 01
 (186) 2036 08 01
 (732) DC Comics, a New York General Partnership
 1700 Broadway, New York, New York 10019,
 USA
 (511) 9, 14, 25, 28

(111) M 1996 2552 R3
 (151) 1996 07 02
 (186) 2036 07 02
 (732) DC Comics, A New York General Partnership
 1700 Broadway, New York, New York 10019,
 USA
 (511) 9, 14, 16, 25, 28

(111) M 1996 2840 R3
 (151) 1996 08 01
 (186) 2036 08 01
 (732) DC Comics, A New York General Partnership
 1700 Broadway, New York, New York 10019,
 USA
 (511) 9, 16, 41

(111) M 1996 2553 R3
 (151) 1996 07 02
 (186) 2036 07 02
 (732) DC Comics, A New York General Partnership
 1700 Broadway, New York, New York 10019,
 USA
 (511) 9, 14, 16, 25, 28

(111) M 1996 3074 R3
 (151) 1996 09 13
 (186) 2036 09 13
 (732) Universal City Studios LLC
 100 Universal City Plaza, Universal City,
 California 91608, USA
 (511) 41

(111) M 1996 3075 R3
 (151) 1996 09 13
 (186) 2036 09 13
 (732) Universal City Studios LLC
 100 Universal City Plaza, Universal City,
 California 91608, USA
 (511) 9

(111) M 1996 3076 R3
(151) 1996 09 13
(186) 2036 09 13
(732) Universal City Studios LLC
100 Universal City Plaza, Universal City,
California 91608, USA
(511) 9

(111) M 1996 3078 R3
(151) 1996 09 13
(186) 2036 09 13
(732) Universal City Studios LLC
100 Universal City Plaza, Universal City,
California 91608, USA
(511) 9

(111) M 1996 2421 R3
(151) 1996 06 19
(186) 2036 06 19
(732) Sabic Global Technologies B.V.
Urmonderbaan 22, Building 130, 6167 RD
Geleen, Netherlands
(511) 1

(111) M 1996 2433 R3
(151) 1996 06 20
(186) 2036 06 20
(732) Tigi Holdings Limited
1 Scott Place, 2 Hardman Street, Manchester,
M3 3AA, United Kingdom
(511) 3, 5

(111) M 1996 2288 R3
(151) 1996 06 10
(186) 2036 06 10
(732) Luxottica Group S.P.A.
Piazzale Cadorna 3, Milano 20123, Italy
(511) 9

(111) M 1996 3149 R3
(151) 1996 09 17
(186) 2036 09 17
(732) L'oreal
14, Rue Royale, 75008 Paris, France
(511) 3

(111) M 1996 1614 R3
(151) 1996 02 26
(186) 2036 02 26
(732) Bitzer KUhlmasCHinenbau GmbH
D-71065 Sindelfingen, Germany
(511) 11

(111) M 1996 3154 R3
(151) 1996 09 17
(186) 2036 09 17
(732) L'oreal
14, Rue Royale, 75008 Paris, France
(511) 3

(111) M 1996 3301 R3
(151) 1996 09 24
(186) 2036 09 24
(732) L'oreal
14 Rue Royale, 75008 Paris, France
(511) 35, 42

(111) M 1996 1357 R3
(151) 1996 01 12
(186) 2036 01 12
(732) Groupe SEB WMF Consumer GmbH
WMF Platz 1, 733 12 Geislingen an der
Steige, Germany
(511) 7, 11

(111) M 1996 1585 R3
(151) 1996 02 21
(186) 2036 02 21
(732) Laboratoires De Biologie Vegetale Yves
Rocher S.A.
F-56201 LA Gacilly, France
(511) 3, 4, 5, 6, 8, 9, 10, 11, 14, 16, 18, 20, 21, 22,
24, 25, 26, 28, 29, 31, 32, 34, 35, 39, 40, 41,
42

(111) M 1996 2320 R3
(151) 1996 06 11
(186) 2036 06 11
(732) ChampagnE Canard-Duchene
1 rue Edmond Canard, 51500 LUDES,
France
(511) 33

(111) M 1996 2570 R3
(151) 1996 07 05
(186) 2036 07 05
(732) L'oreal
14, rue Royale, 75008 Paris, France
(511) 3, 5

(111) M 1996 2493 R3
(151) 1996 06 25
(186) 2036 06 25
(732) N.V. Organon
Kloosterstraat 6, 5349 AB Oss, Netherlands
(511) 5

(111) M 1996 3158 R3
(151) 1996 09 17
(186) 2036 09 17
(732) L'oreal
14, Rue Royale, 75008 Paris, France
(511) 3

(111) M 1996 3159 R3
(151) 1996 09 17
(186) 2036 09 17
(732) L'oreal
14, Rue Royale, 75008 Paris, France
(511) 3

(111) M 1996 3161 R3
(151) 1996 09 17
(186) 2036 09 17
(732) L'oreal
14, Rue Royale, 75008 Paris, France
(511) 3, 5, 21

(111) M 1996 3163 R3
(151) 1996 09 17
(186) 2036 09 17
(732) L'oreal
14, Rue Royale, 75008 Paris, France
(511) 3, 21

(111) M 1996 2346 R3
(151) 1996 06 12
(186) 2036 06 12
(732) Tenneco Automotive Operating Company Inc.
500 North Field Draive, Lake Forest,
Illinois 60045, USA
(511) 7, 12

(111) M 2016 27784 R1
(151) 2016 11 09
(186) 2036 11 09
(732) Cheng Shin Rubber Ind. Co., Ltd.
No.215, Meei-Kong Road, Huang-Ts'o Villa
GE, Ta-Suen, Chang-Hwa Hwa Hsien Taiwan,
Taiwan, Province of China
(511) 12

(111) M 1996 3345 R3
(151) 1996 09 25
(186) 2036 09 25
(732) L'oreal
14, Rue Royale, F-75008 Paris, France
(511) 3

(111) M 2016 27216 R1
(151) 2016 06 26
(186) 2036 06 26
(732) a (a) i. p.Ojios Marani
Akhmeta, S. Ojio (0906), Georgia
(511) 33

(111) M 2016 27063 R1
(151) 2016 05 18
(186) 2036 05 18
(732) Obschestvo S Ogranichennoi Otvetstvennostiu
Iujnaya Sokovaya Companya
352630, Krasnodarski Krai, Belorechenski
Raion, G. Belorechensk, Ul. Pobedi, 132,
Russian Federation
(511) 29, 32

(111) M 2016 27065 R1
(151) 2016 05 18
(186) 2036 05 18
(732) Obschestvo S Ogranichennoi Otvetstvennostiu
Iujnaya Sokovaya Companya
352630, Krasnodarski Krai, Belorechenski
Raion, G. Belorechensk, Ul. Pobedi, 132,
Russian Federation
(511) 29, 32

(111) M 2016 27066 R1
(151) 2016 05 18
(186) 2036 05 18
(732) Obschestvo S Ogranichennoi Otvetstven-
nostiu Iujnaya Sokovaya Companya
352630, Krasnodarski Krai, Belorechenski
Raion, G. Belorechensk, Ul. Pobedi, 132,
Russian Federation
(511) 29, 32

(111) M 2016 27119 R1
(151) 2016 05 18
(186) 2036 05 18
(732) Ibercompany LLC
Ilia Chavchavadze Avenue 37L, Floor 3,
Block B, Vake District, Tbilisi, Georgia
(511) 36

(111) M 2016 27176 R1
(151) 2016 06 03
(186) 2036 06 03
(732) Ibercompany LLC
Ilia Chavchavadze Avenue 37L, Floor 3,
Block B, Vake District, Tbilisi, Georgia
(511) 35, 36, 37

-
- (111) M 2016 27364 R1
 (151) 2016 07 18
 (186) 2036 07 18
 (732) Monster Energy Company, a Delaware Corporation
 1 Monster Way, Corona, California 92879, USA
 (511) 9, 16, 18, 25
-
- (111) M 2016 27183 R1
 (151) 2016 06 03
 (186) 2036 06 03
 (732) Kentucky Fried Chicken International Holdings LLC
 7100 Corporate Drive, Plano, TX 75024, USA
 (511) 30
-
- (111) M 2016 27509 R1
 (151) 2016 08 22
 (186) 2036 08 22
 (732) Pernod Ricard USA LLC
 250 Park Avenue, 17th Floor, New York, NY 10177, USA
 (511) 33
-
- (111) M 2016 27510 R1
 (151) 2016 08 22
 (186) 2036 08 22
 (732) Pernod Ricard USA LLC
 250 Park Avenue, 17th Floor, New York, NY 10177, USA
 (511) 33
-
- (111) M 2016 27585 R1
 (151) 2016 09 12
 (186) 2036 09 12
 (732) Aik Cheong Coffee Roaster Sdn. Bhd.
 Lot 1-1, Jalan TTC 1, Kawasan Perindustrian Cheng, 75250 Melaka, Malaysia
 (511) 30
-
- (111) M 2016 27586 R1
 (151) 2016 09 12
 (186) 2036 09 12
 (732) Aik Cheong Coffee Roaster Sdn. Bhd.
 Lot 1-1, Jalan TTC 1, Kawasan Perindustrian Cheng, 75250 Melaka, Malaysia
 (511) 30
-
- (111) M 2016 27308 R1
 (151) 2016 06 29
 (186) 2036 06 29
 (732) Kentucky Fried Chicken International Holdings LLC
 7100 Corporate Drive, Plano, TX 75024, USA
 (511) 29, 30, 43
-
- (111) M 1996 2649 R3
 (151) 1996 07 17
 (186) 2036 07 17
 (732) Wolverine Outdoors Inc.
 9341 Courtland Drive, Rockford, Michigan 49351, USA
 (511) 25
-
- (111) M 2016 27622 R1
 (151) 2016 09 12
 (186) 2036 09 12
 (732) Nihon Nohyaku Co., Ltd.,
 (A corporation duly organized and existing under the laws of Japan
 19-8, Kyobashi 1-chome, Chuo-Ku, Tokyo, Japan
 (511) 1, 5
-
- (111) M 2015 26598 R1
 (151) 2015 12 07
 (186) 2035 12 07
 (732) Public Joint Stock Company "Pharmsintez" (JSC "Pharmsintez")
 188663, Leningrad Region, Vsevolozhsky Municipal District, City-type Settlement Kuzmolovsky, Kuzmolovsky City-type Settlement Zavodskaya St., Stroenie 3, Building, 134, Russian Federation
 (511) 5
-
- (111) M 2017 28242 R1
 (151) 2017 03 01
 (186) 2037 03 01
 (732) LEPL "Georgian National Museum"
 Rustaveli Av. 3, 0105, Tbilisi, Georgia
 (511) 35, 41, 43
-
- (111) M 2017 28507 R1
 (151) 2017 05 17
 (186) 2037 05 17
 (732) Representative Office of Nobel Ilac Sanayii Ve Ticaret Anonim Sikreti in Georgia
 4 Freedom Square, Tbilisi, Georgia
 (511) 5, 35
-
- (111) M 2016 27556 R1
 (151) 2016 08 23
 (186) 2036 08 23
 (732) LLC "Georgian Brothers"
-

Nutsubidze Slope, IV m/r, bld. 10B, ap. 42,
Tbilisi, Georgia
(511) 32, 33

(111) M 2016 27626 R1
(151) 2016 09 14
(186) 2036 09 14
(732) Renaissance Hotel Holdings Inc.
7750 Wisconsin Avenue, Bethesda, Maryland
20814, USA
(511) 35, 43

(111) M 2016 27627 R1
(151) 2016 09 14
(186) 2036 09 14
(732) Renaissance Hotel Holdings Inc.
7750 Wisconsin Avenue, Bethesda, Maryland
20814, USA
(511) 35, 43

(111) M 2016 27628 R1
(151) 2016 09 14
(186) 2036 09 14
(732) Renaissance Hotel Holdings, Inc.
7750 Wisconsin Avenue, Bethesda, Maryland
20814, USA
(511) 35, 43

(111) M 2016 27629 R1
(151) 2016 09 14
(186) 2036 09 14
(732) Renaissance Hotel Holdings Inc.
7750 Wisconsin Avenue, Bethesda, Maryland
20814, USA
(511) 35, 43

(111) M 2017 28422 R1
(151) 2017 04 24
(186) 2037 04 24
(732) LLC "Lady Healthcare"
Akaki Gakhokidze St. 2-4, Yuri Gagarin
St. 5, Office Space 6, Saburtalo District,
Tbilisi, Georgia
(511) 5

(111) M 2017 28423 R1
(151) 2017 04 24
(186) 2037 04 24
(732) LLC "Lady Healthcare"
Akaki Gakhokidze St. 2-4, Yuri Gagarin

St. 5, Office Space 6, Saburtalo District,
Tbilisi, Georgia
(511) 5

(111) M 2017 28424 R1
(151) 2017 04 24
(186) 2037 04 24
(732) LLC "Lady Healthcare"
Akaki Gakhokidze St. 2-4, Yuri Gagarin
St. 5, Office Space 6, Saburtalo District,
Tbilisi, Georgia
(511) 5

(111) M 1996 3470 R3
(151) 1996 10 02
(186) 2036 10 02
(732) Macdonald & Muir Limited
6 ST andrew Square, Level 4, Edinburgh,
Scotland EH2 2BD, United Kingdom
(511) 33

(111) M 1996 3119 R3
(151) 1996 09 16
(186) 2036 09 16
(732) Sabic Global Technologies B.V.
Urmonderbaan 22, Building 130, 6167
RD Geleen, Netherlands
(511) 1

(111) M 1996 3120 R3
(151) 1996 09 16
(186) 2036 09 16
(732) Sabic Global Technologies B.V.
Urmonderbaan 22, Building 130, 6167
RD Geleen, Netherlands
(511) 1

(111) M 1996 3123 R3
(151) 1996 09 16
(186) 2036 09 16
(732) SHPP Global Technologies B.V.
Plasticslaan 1, 4612 PX Bergen op Zoom,
Netherlands
(511) 1

COMPLETE TRANSFER OF RIGHT

(111) M 2020 32940 R
 (732) LLC "M² Group"
 Givi Kartoza St. 10, Building 6, Floor 0,
 Commercial Area 13, 0177, Saburtalo District,
 Tbilisi, Georgia

(770) JSC "Georgian Real Estate"
 G. Kartoza St. 10, Commercial Area 13,
 Building 6, Floor 0, Saburtalo District, Tbilisi,
 Georgia
 (580) 2026 05 20

(111) M 2020 32941 R
 (732) LLC "M² Group"
 Givi Kartoza St. 10, Building 6, Floor 0,
 Commercial Area 13, 0177, Saburtalo District,
 Tbilisi, Georgia

(770) JSC "Georgian Real Estate"
 G. Kartoza St. 10, Commercial Area 13,
 Building 6, Floor 0, Saburtalo District, Tbilisi,
 Georgia
 (580) 2026 05 20

(111) M 2019 31374 R
 (732) LLC "M² Group"
 Givi Kartoza St. 10, Building 6, Floor 0,
 Commercial Area 13, 0177, Saburtalo District,
 Tbilisi, Georgia

(770) JSC "Georgian Real Estate"
 G. Kartoza St. 10, Commercial Area 13,
 Building 6, Floor 0, Saburtalo District, Tbilisi,
 Georgia
 (580) 2026 05 20

(111) M 2019 31375 R
 (732) LLC "M² Group"
 Givi Kartoza St. 10, Building 6, Floor 0,
 Commercial Area 13, 0177, Saburtalo District,
 Tbilisi, Georgia

(770) JSC "Georgian Real Estate"
 G. Kartoza St. 10, Commercial Area 13,
 Building 6, Floor 0, Saburtalo District, Tbilisi,
 Georgia
 (580) 2026 05 20

(111) M 2021 34406 R
 (732) Rekit Benkizer Hels Limitid
 103-105 Bath Road, Slough, Berkshire,
 SL1 3UH, United Kingdom
 (770) Reckitt & Colman (Overseas) Hygiene Home
 Limited

103-105 Bath Road, Slough, Berkshire,
 SL1 3UH, Berkshire, United Kingdom
 (580) 2026 05 19

(111) M 2022 35295 R
 (732) Reckitt Benckiser Health Limited
 103-105 Bath Road, Slough, Berkshire,
 SL1 3UH, United Kingdom
 (770) Reckitt & Colman (Overseas) Health Limited
 103-105 Bath Road, Slough, Berkshire,
 SL1 3UH, United Kingdom
 (580) 2026 05 19

(111) M 2022 35312 R
 (732) Reckitt Benckiser Health Limited
 103-105 Bath Road, Slough, Berkshire,
 SL1 3UH, United Kingdom
 (770) Reckitt & Colman (Overseas) Hygiene Home
 Limited
 103-105 Bath Road, Slough, Berkshire,
 SL1 3UH, United Kingdom
 (580) 2026 05 19

(111) M 1997 4650 R
 (732) Rekit Benkizer Hels Limitid
 103-105 Bath Road, Slough, Berkshire,
 SL1 3UH, United Kingdom
 (770) Reckitt & Colman (Overseas) Health Limited
 103-105 Bath Road, Slough, Berkshire,
 SL1 3UH, United Kingdom
 (580) 2026 05 19

(111) M 1997 4719 R
 (732) Rekit Benkizer Hels Limitid
 103-105 Bath Road, Slough, Berkshire,
 SL1 3UH, United Kingdom
 (770) Reckitt & Colman (Overseas) Hygiene Home
 Limited
 103-105 Bath Road, Slough, Berkshire,
 SL1 3UH, United Kingdom
 (580) 2026 05 19

(111) M 2023 36920 R
 (732) Rekit Benkizer Hels Limitid
 103-105 Bath Road, Slough, Berkshire,
 SL1 3UH, United Kingdom
 (770) Reckitt & Colman (Overseas) Health Limited
 103-105 Bath Road, Slough, Berkshire,
 SL1 3UH, United Kingdom

(580) 2026 05 19

(111) M 2023 37741 R

(732) Rekit Benkizer Hels Limitid
103-105 Bath Road, Slough, Berkshire,
SL1 3UH, United Kingdom

(770) Reckitt & Colman (Overseas) Health Limited
103-105 Bath Road, Slough, Berkshire,
SL1 3UH, United Kingdom

(580) 2026 05 19

(111) M 1998 8984 R

(732) Rekit Benkizer Hels Limitid
103-105 Bath Road, Slough, Berkshire,
SL1 3UH, United Kingdom

(770) Reckitt & Colman (Overseas) Hygiene Home
Limited
103-105 Bath Road, Slough, Berkshire,
SL1 3UH, United Kingdom

(580) 2026 05 19

(111) M 1995 1299 R

(732) Rekit Benkizer Hels Limitid
103-105 Bath Road, Slough, Berkshire,
SL1 3UH, United Kingdom

(770) Reckitt & Colman (Overseas) Health Limited
103-105 Bath Road, Slough, Berkshire,
SL1 3UH, United Kingdom

(580) 2026 05 19

(111) M 2004 15401 R

(732) Rekit Benkizer Hels Limitid
103-105 Bath Road, Slough, Berkshire,
SL1 3UH, United Kingdom

(770) Reckitt & Colman (Overseas) Health Limited
103-105 Bath Road, Slough, Berkshire,
SL1 3UH, United Kingdom

(580) 2026 05 19

(111) M 2005 15821 R

(732) Rekit Benkizer Hels Limitid
103-105 Bath Road, Slough, Berkshire,
SL1 3UH, United Kingdom

(770) Reckitt & Colman (Overseas) Health Limited
103-105 Bath Road, Slough, Berkshire,
SL1 3UH, United Kingdom

(580) 2026 05 19

(111) M 2005 16384 R

(732) Rekit Benkizer Hels Limitid
103-105 Bath Road, Slough, Berkshire,
SL1 3UH, United Kingdom

(770) Reckitt & Colman (Overseas) Health Limited

103-105 Bath Road, Slough, Berkshire,
SL1 3UH, United Kingdom

(580) 2026 05 19

(111) M 2005 16385 R

(732) Rekit Benkizer Hels Limitid
103-105 Bath Road, Slough, Berkshire,
SL1 3UH, United Kingdom

(770) Reckitt & Colman (Overseas) Health Limited
103-105 Bath Road, Slough, Berkshire,
SL1 3UH, United Kingdom

(580) 2026 05 19

(111) M 2005 16386 R

(732) Rekit Benkizer Hels Limitid
103-105 Bath Road, Slough, Berkshire,
SL1 3UH, United Kingdom

(770) Reckitt & Colman (Overseas) Health Limited
103-105 Bath Road, Slough, Berkshire,
SL1 3UH, United Kingdom

(580) 2026 05 19

(111) M 2006 17043 R

(732) Rekit Benkizer Hels Limitid
103-105 Bath Road, Slough, Berkshire,
SL1 3UH, United Kingdom

(770) Reckitt & Colman (Overseas) Health Limited
103-105 Bath Road, Slough, Berkshire,
SL1 3UH, United Kingdom

(580) 2026 05 19

(111) M 2006 17044 R

(732) Rekit Benkizer Hels Limitid
103-105 Bath Road, Slough, Berkshire,
SL1 3UH, United Kingdom

(770) Reckitt & Colman (Overseas) Health Limited
103-105 Bath Road, Slough, Berkshire,
SL1 3UH, United Kingdom

(580) 2026 05 19

(111) M 2010 20459 R

(732) Rekit Benkizer Hels Limitid
103-105 Bath Road, Slough, Berkshire,
SL1 3UH, United Kingdom

(770) Reckitt & Colman (Overseas) Health Limited
103-105 Bath Road, Slough, Berkshire,
SL1 3UH, United Kingdom

(580) 2026 05 19

(111) M 2011 21544 R

(732) Rekit Benkizer Hels Limitid
103-105 Bath Road, Slough, Berkshire,
SL1 3UH, United Kingdom

(770) Reckitt & Colman (Overseas) Health Limited
103-105 Bat Roudi, Slou, Berqshiri,
SL1 3UH, United Kingdom
(580) 2026 05 19

(111) M 2011 22101 R
(732) Rekit Benkizer Hels Limitid
103-105 Bath Road, Slough, Berkshire,
SL1 3UH, United Kingdom
(770) Reckitt & Colman (Overseas) Health Limited
103-105 Bath Road, Slough, Berkshire,
SL1 3UH, United Kingdom
(580) 2026 05 19

(111) M 2012 22737 R
(732) Rekit Benkizer Hels Limitid
103-105 Bath Road, Slough, Berkshire,
SL1 3UH, United Kingdom
(770) Reckitt & Colman (Overseas) Health Limited
103-105 Bath Road, Slough, Berkshire,
SL1 3UH, United Kingdom
(580) 2026 05 19

(111) M 2012 22738 R
(732) Rekit Benkizer Hels Limitid
103-105 Bath Road, Slough, Berkshire,
SL1 3UH, United Kingdom
(770) Reckitt & Colman (Overseas) Health Limited
103-105 Bath Road, Slough, Berkshire,
SL1 3UH, United Kingdom
(580) 2026 05 19

(111) M 1998 8639 R
(732) Rekit Benkizer Hels Limitid
103-105 Bath Road, Slough, Berkshire,
SL1 3UH, United Kingdom
(770) Reckitt & Colman (Overseas) Health Limited
103-105 Bath Road, Slough, Berkshire,
SL1 3UH, United Kingdom
(580) 2026 05 19

(111) M 2015 26485 R
(732) Rekit Benkizer Hels Limitid
103-105 Bath Road, Slough, Berkshire,
SL1 3UH, United Kingdom
(770) Reckitt & Colman (Overseas) Health Limited
103-105 Bath Road, Slough, Berkshire,
SL1 3UH, United Kingdom
(580) 2026 05 19

(111) M 2016 27119 R
(732) LLC "Ibercompany"
Al. Kazbegi Av. 12A, 0160, Vake-Saburtalo
District, Tbilisi, Georgia
(770) LLC "Ibercompany"
Ilia Chavchavadze Av. 37L, 3rd Floor,
Block B, Vake District, Tbilisi, Georgia
(580) 2026 05 18

(111) M 2016 27119 R
(732) LLC "Ibercompany"
Ilia Chavchavadze Av. 37L, 3rd Floor,
Block B, Vake District, Tbilisi, Georgia
(770) LLC "Ibercompany"
Al. Kazbegi Av. 12A, 0160, Vake-Saburtalo
District, Tbilisi, Georgia
(580) 2026 05 18

(111) M 1997 5288 R
(732) Rekit Benkizer Hels Limitid
103-105 Bath Road, Slough, Berkshire,
SL1 3UH, United Kingdom
(770) Reckitt & Colman (Overseas) Health Limited
103-105 Bath Road, Slough, Berkshire,
SL1 3UH, United Kingdom
(580) 2026 05 19

(111) M 2018 29786 R
((732) LLC "M² Group"
Givi Kartoza St. 10, Building 6, Floor 0,
Commercial Area 13, 0177, Saburtalo District,
Tbilisi, Georgia
(770) JSC "Georgian Real Estate"
G. Kartoza St. 10, Commercial Area 13,
Building 6, Floor 0, Saburtalo District, Tbilisi,
Georgia
(580) 2026 05 20

(111) M 2018 29789 R
(732) LLC "M² Group"
Givi Kartoza St. 10, Building 6, Floor 0,
Commercial Area 13, 0177, Saburtalo District,
Tbilisi, Georgia
(770) JSC "Georgian Real Estate"
G. Kartoza St. 10, Commercial Area 13,
Building 6, Floor 0, Saburtalo District, Tbilisi,
Georgia
(580) 2026 05 20

(111) M 2018 29875 R
(732) LLC "M² Group"
Givi Kartoza St. 10, Building 6, Floor 0,
Commercial Area 13, 0177, Saburtalo District,
Tbilisi, Georgia
(770) JSC "Georgian Real Estate"
G. Kartoza St. 10, Commercial Area 13,
Building 6, Floor 0, Saburtalo District, Tbilisi,
Georgia
(580) 2026 05 20

(111) M 2018 29939 R
(732) LLC "M² Group"
Givi Kartoza St. 10, Building 6, Floor 0,
Commercial Area 13, 0177, Saburtalo District,
Tbilisi, Georgia
(770) JSC "Georgian Real Estate"
G. Kartoza St. 10, Commercial Area 13,
Building 6, Floor 0, Saburtalo District, Tbilisi,
Georgia
(580) 2026 05 20

(111) M 2018 29940 R
(732) LLC "M² Group"
Givi Kartoza St. 10, Building 6, Floor 0,
Commercial Area 13, 0177, Saburtalo District,
Tbilisi, Georgia
(770) JSC "Georgian Real Estate"
G. Kartoza St. 10, Commercial Area 13,
Building 6, Floor 0, Saburtalo District, Tbilisi,
Georgia
(580) 2026 05 20

CHANGE OF NAME AND/OR ADDRESS OF TRADEMARK OWNER

(111) M 2020 32940 R
(732) JSC "Georgian Real Estate"
G. Kartoza St. 10, Commercial Area 13,
Building 6, Floor 0, Saburtalo District, Tbilisi,
Georgia
(770) JSC "m² Real Estate"
Ilia Chavchavadze Av. 29, Floor 3, Tbilisi,
Georgia
(580) 2026 06 01

(111) M 2020 32941 R
(732) JSC "Georgian Real Estate"
G. Kartoza St. 10, Commercial Area 13,
Building 6, Floor 0, Saburtalo District, Tbilisi,
Georgia
(770) JSC "m² Real Estate"
Ilia Chavchavadze Av. 29, Floor 3, Tbilisi,
Georgia
(580) 2026 06 01

(111) M 2019 31374 R
(732) JSC "Georgian Real Estate"
G. Kartoza St. 10, Commercial Area 13,
Building 6, Floor 0, Saburtalo District, Tbilisi,
Georgia
(770) JSC "m² Real Estate"
Ilia Chavchavadze Av. 29, Floor 3, Tbilisi,
Georgia
(580) 2026 06 01

(111) M 2019 31375 R
(732) JSC "Georgian Real Estate"
G. Kartoza St. 10, Commercial Area 13,
Building 6, Floor 0, Saburtalo District, Tbilisi,
Georgia
(770) JSC "m² Real Estate"
Ilia Chavchavadze Av. 29, Floor 3, Tbilisi,
Georgia
(580) 2026 06 01

(111) M 1996 3747 R
(732) Compagnie Gervais Danone, societe anonyme
16 Route 128, 91190 Gif-sur-Yvette, France
(770) Compagnie Gervais Danone, societe Anonyme
17 Boulevard Haussmann, 75009 Paris,
France
(580) 2026 04 07

(111) M 2022 35468 R
(732) Reckitt Benckiser Vanish B.V.
Schiphol Boulevard 267, 1118 BH
Schiphol, Netherlands
(770) Reckitt Benckiser Vanish B.V.
Siriusdreef 14, 2132WT Hoofddorp,
Netherlands
(580) 2026 05 21

(111) M 2021 34777 R
(732) LLC "Dizi"
Vazha-Pshavela Av. 71, Office 33, Floor 6,
(Block 1), Vake District, Tbilisi, Georgia
(770) LLC "Pinriva"
Vazha-Pshavela Av. 71, Office 33, Floor 6,
(Block 1), Tbilisi, Georgia
(580) 2026 05 18

(111) M 2000 13174 R
(732) Reckitt Benckiser Vanish B.V.
Schiphol Boulevard 267, 1118 BH
Schiphol, Netherlands
(770) Reckitt Benckiser Vanish B.V.
Siriusdreef 14, 2132 WT, Hoofddorp,
Netherlands
(580) 2026 05 21

(111) M 1999 12428 R
(732) Haleon US Holdings LLC
Corporation Service Company, 251 Little
Falls Drive, Wilmington, Delaware 19808,
USA
(770) GlaxosmithKline Consumer Healthcare
Hotdings (US) LLC
Corporation Service Company, 251 Little
Falls Drive, Wilmington, Delaware 19808,
USA
(580) 2026 05 11

(111) M 2001 13825 R
(732) Compagnie Gervais Danone, societe anonyme
16 Route 128, 91190 Gif-sur-Yvette, France
(770) Compagnie Gervais Danone, societe anonyme
17 Boulevard Haussmann, 75009 Paris, France
(580) 2026 04 07

-
- (111) M 1996 2761 R
(732) Saft
26 quai Charles Pasqua, 92300 Levallois-Perret, France
(770) Saft
12, rue Sadi Carnot 93170 Begnolet, France
(580) 2026 05 18
-
- (111) M 1996 2106 R
(732) Gerflor
1 place Giovanni Da Verrazzano, Bâtiment B, Campus Verrazzano, 69009 Lyon, France
(770) Gerflor
50, cours de la Republique, F-69 100 Villeurbanne, France
(580) 2026 05 26
-
- (111) M 2006 16520 R
(732) Choice Hotels International Inc.
(a Delaware corporation)
915 Meeting Street, Suite 600, North Bethesda, Maryland 20852, USA
(770) Choice Hotels International Inc.
(a Delaware corporation)
1 Choice Hotels Circle, Rockville, Maryland 20850, USA
(580) 2026 05 20
-
- (111) M 2006 16699 R
(732) Gulf International Lubricants Ltd.
Victoria Place, 5th Floor, 31 Victoria Street, Hamilton, HM 10, Bermuda
(770) Gulf International Lubricants Ltd.
Canon's Court, 22 Victoria Street, HM12 Hamilton, Bermuda
(580) 2026 05 19
-
- (111) M 2006 17197 R
(732) Atmus Filtration Inc.
26 Century Blvd., Suite 500, Nashville, TN 37214, USA
(770) Cummins Filtration Inc.
26 Century Blvd., Suite 500, Nashville, TN 37214, USA
(580) 2026 02 13
-
- (111) M 2007 18139 R
(732) Compagnie Gervais Danone
16 Route 128, 91190 Gif-sur-Yvette, France
(770) Compagnie Gervais Danone
17 Boulevard Haussmann, 75009 Paris, France
-
- (580) 2026 04 07
-
- (111) M 1996 2320 R
(732) Champagne Canard-Duchene
1 rue Edmond Canard, 51500 Ludes, France
(770) Champagne Alain Thienot
14, Rue des Moissons 51100 Reims, France
(580) 2026 05 13
-
- (111) M 1996 3816 R
(732) Compagnie Gervais Danone, societe Anonyme
16 Route 128, 91190 Gif-sur-Yvette, France
(770) Compagnie Gervais Danone, societe Anonyme
17 Boulevard Haussmann, 75009 Paris, France
(580) 2026 04 07
-
- (111) M 1995 780 R
(732) Compagnie Gervais Danone, societe Anonyme
16 Route 128, 91190 Gif-sur-Yvette, France
(770) Compagnie gervais Danone, societe Anonyme
17 Boulevard Haussmann, 75009 Paris, France
(580) 2026 04 07
-
- (111) M 1996 2927 R
(732) Compagnie Gervais Danone, societe Anonyme
16 Route 128, 91190 Gif-sur-Yvette, France
(770) Compagnie Gervais Danone, societe anonyme
17 Boulevard Haussmann, 75009 Paris, France
(580) 2026 04 07
-
- (111) M 1996 2466 R
(732) Compagnie Gervais Danone, societe anonyme
16 Route 128, 91190 Gif-sur-Yvette, France
(770) Compagnie Gervais Danone, societe anonyme
17 Boulevard Haussmann, 75009 Paris, France
(580) 2026 04 07
-
- (111) M 1996 2728 R
(732) Perfetti Van Melle S.P.A.
7, Via XXV Aprile, 20045 Lainate (Milano), Italy
(770) Perfetti Van Melle S.P.A.
7, Via XXV Aprile, 20020 Lainate (Milano), Italy
(580) 2026 05 21
-
- (111) M 1996 2729 R
(732) Perfetti Van Melle S.P.A.
7, Via XXV Aprile, 20045 Lainate (Milano), Italy
-

(770) Perfetti Van Melle S.P.A.
7, Via XXV Aprile, 20020 Lainate (Milano),
Italy
(580) 2026 05 21

(111) M 2016 27434 R
(732) World Vet İlaç Sanayî Ve Ticaret
Limited Şirketi
15 Temmuz Mah. Camiyolu Cad. №50 K.1,
Güneşli, Bağcılar, İstanbul, Türkiye
(770) World Vet İlaç Sanayi Ve Ticaret
Limited Şirketi
Evren Mah. Camiyolu Cad. №50 K.1,
Güneşli, Bağcılar, İstanbul, Türkiye
(580) 2026 05 18

(111) M 2016 27436 R
(732) World Vet İlaç Sanayi Ve Ticaret
Limited Şirketi
15 Temmuz Mah. Camiyolu Cad. №50 K.1,
Güneşli, Bağcılar, İstanbul, Türkiye
(770) World Vet İlaç sanayi Ve Ticaret
Lİmited Şirketi
Evren Mah. Camiyolu Cad. №50 K.1,
Güneşli, Bağcılar, İstanbul, Türkiye
(580) 2026 05 18

(111) M 2016 27183 R
(732) Kentucky Fried Chicken International
Holdings LLC, 1441 Gardiner Lane,
Louisville, Kentucky 40213, USA
7100 Corporate Drive, Plano, TX 75024, USA
(770) Kentucky Fried Chicken International
Holdings LLC, 1441 Gardiner Lane,
Louisville, Kentucky 40213, USA
1441 Gardiner Lane, Louisville, Kentucky
40213, USA
(580) 2026 05 18

(111) M 2016 27581 R
(732) International Limited Liability
Company Headhunter Fsu
Pomeshch. X, d.37, ul. Oktyabrskaya,
Kaliningrad, g.o. Kaliningrad, Kaliningrad
Oblast, 236006, Russian Federation
(770) Headhunter Fsu Limited
Andrea Mikellidi, 19A, Strovolos, 2036,
Nicosia, Cyprus
(580) 2026 05 22

(111) M 2016 27582 R
(732) International Limited Liability Company
Headhunter FSU
Pomeshch. X, d.37, ul. Oktyabrskaya,

Kaliningrad, g.o. Kaliningrad, Kaliningrad
Oblast, 236006, Russian Federation
(770) Headhunter Fsu Limited
Andrea Mikellidi, 19A, Strovolos, 2036,
Nicosia, Cyprus
(580) 2026 05 22

(111) M 2016 27308 R
(732) Kentucky Fried Chicken International
Holdings LLC
7100 Corporate Drive, Plano, TX 75024, USA
(770) Kentucky Fried Chicken International
Holdings LLC
1441 Gardiner Lane, Louisville, Kentucky
40213, USA
(580) 2026 05 18

(111) M 2018 29786 R
(732) JSC "Georgian Real Estate"
G. Kartoziya St. 10, Commercial Area 13,
Building 6, Floor 0, Saburtalo District, Tbilisi,
Georgia
(770) JSC "m² Real Estate"
Ilia Chavchavadze Av. 29, Floor 3, Tbilisi,
Georgia
(580) 2026 06 01

(111) M 1996 3470 R
(732) Macdonald & Muir Limited
6 ST Andrew square, Level 4, Edinburgh,
Scotland EH2 2BD, United Kingdom
(770) Macdonald & Muir Limited
The Cube, 45 Leith Street, Edinburgh,
Scotland, EH1 3AT, United Kingdom
(580) 2026 05 21

(111) M 2018 29789 R
(732) JSC "Georgian Real Estate"
G. Kartoziya St. 10, Commercial Area 13,
Building 6, Floor 0, Saburtalo District, Tbilisi,
Georgia
(770) JSC "m² Real Estate"
Ilia Chavchavadze Av. 29, Floor 3, Tbilisi,
Georgia
(580) 2026 06 01

(111) M 2018 29875 R
(732) JSC "Georgian Real Estate"
G. Kartoziya St. 10, Commercial Area 13,
Building 6, Floor 0, Saburtalo District, Tbilisi,
Georgia
(770) JSC "m² Real Estate"
Ilia Chavchavadze Av. 29, Floor 3, Tbilisi,
Georgia

(580) 2026 06 01

(111) M 2018 29939 R

(732) JSC "Georgian Real Estate"

G. Kartoza St. 10, Commercial Area 13,
Building 6, Floor 0, Saburtalo District, Tbilisi,
Georgia

(770) JSC "m² Real Estate"

Ilia Chavchavadze Av. 29, Floor 3, Tbilisi,
Georgia

(580) 2026 06 01

(111) M 2018 29940 R

(732) JSC "Georgian Real Estate"

G. Kartoza St. 10, Commercial Area 13,
Building 6, Floor 0, Saburtalo District, Tbilisi,
Georgia

(770) JSC "m² Real Estate"

Ilia Chavchavadze Av. 29, Floor 3, Tbilisi,
Georgia

(580) 2026 06 01

(111) M 1997 4836 R

(732) Groupe SEB WMF Consumer GmbH

WMF Platz 1, 73312 Geislingen an der Steige,
Germany

(770) Groupe SEB Deutschland GmbH

Theodor-Stern-Kai 1, 60596 Frankfurt am
Main, Germany

(580) 2026 05 15

CANCELLATION OF TRADEMARK REGISTRATION

(111) M 1995 1211 R
(151) 1995 11 22
(732) Océ-Technologies B.V.
Sint Urbanusweg 43 5914 CA Venlo,
Netherlands
(141) 2026 05 29

(111) M 1995 1205 R
(151) 1995 11 22
(732) L'oreal
14, rue Royale, F-75008 Paris, France
(141) 2026 05 29

(111) M 1995 1202 R
(151) 1995 11 21
(732) L'oreal
14, rue Royale, F-75008 Paris, France
(141) 2026 05 27

(111) M 2015 26493 R
(151) 2015 11 16
(732) LLC "Company Bessin"
Gamrekeli St. 19, 0160, Vake-Saburtalo
District, Tbilisi, Georgia
(141) 2026 05 22

(111) M 2015 26495 R
(151) 2015 11 16
(732) Atterbury Property (Proprietary) Limited
2nd Floor, Die Klubhuis Building, Corner
18th Street And Pinaster Avenue, Hazelwood,
Pretoria, 0081, Gauteng, South Africa
(141) 2026 05 22

(111) M 2015 26500 R
(151) 2015 11 16
(732) Pier Balmen S.A.S.
44, rue Francois 1er, 75008 Paris, France
(141) 2026 05 22

(111) M 2015 26502 R
(151) 2015 11 16
(732) Novartis AG
4002 Basel, Switzerland Bazeli, CH,
Switzerland
(141) 2026 05 22

(111) M 2015 26503 R
(151) 2015 11 16
(732) Swiss Pharma International AG
Waldmannstrasse 8, 8001 Zurich, Switzerland
(141) 2026 05 22

(111) M 2015 26504 R
(151) 2015 11 16
(732) Swiss Pharma International AG
Waldmannstrasse 8, 8001 Zurich, Switzerland
(141) 2026 05 22

(111) M 2015 26506 R
(151) 2015 11 16
(732) Novartis AG
4002 Basel, Switzerland
(141) 2026 05 22

(111) M 2015 26507 R
(151) 2015 11 16
(732) Philip Morris Brands Sàrl
Quai Jeanrenaud 3, 2000 Neuchâtel,
Switzerland
(141) 2026 05 22

(111) M 2015 26508 R
(151) 2015 11 16
(732) LLC "AvtoMaxx"
B. Khmelniyskiy St. 153A, ap. 60, 0113,
Tbilisi, Georgia
(141) 2026 05 22

(111) M 2015 26510 R
(151) 2015 11 16
(732) Shulton Inc.
One Procter & Gamble Plaza, Cincinnati
OH 45202, USA
(141) 2026 05 22

INTERNATIONAL LICENSE AGREEMENT

(800) 1331290

(732) L'oreal

14, rue Royale, F-75008 Paris, France

(791) Limited Liability Partnership "L'Oréal
Kazakhstan"

050000, Almaty city, Kunaev Street,

House 77, Kazakhstan

(793) №1877

Exclusive

From 25 12 2025 for the term of the mark

(511)

3 – Cosmetics; make-up preparations.

35 – Retail store services relating to cosmetics,
makeup, nail polish, cosmetic bags, cosmetic cases,
cosmetic sponges, make-up brush holders, and make-
up brushes.

CLASSIFICATION INDEXES

INVENTION

CONCORDANCE TABLE OF INTERNATIONAL CLASSIFICATION INDEX AND PUBLICATION NUMBER

INTERNATIONAL CLASSIFICATION INDEXES (51)	NUMBER OF PUBLISHED APPLICATION (10)
A 61 K 39/00; A 61 P 37/00; C 07 K 16/24; C 07 K 16/18; C 07 K 16/28; C 12 N 15/85	AP 2026 16026 A

CONCORDANCE TABLE OF PUBLICATION NUMBER AND INTERNATIONAL CLASSIFICATION INDEX

NUMBER OF PUBLISHED APPLICATION (10)	INTERNATIONAL CLASSIFICATION INDEXES (51)
AP 2026 16026 A	A 61 K 39/00; A 61 P 37/00; C 07 K 16/24; C 07 K 16/18; C 07 K 16/28; C 12 N 15/85

APPLICATION***

CONCORDANCE TABLE OF INTERNATIONAL CLASSIFICATION INDEX AND PUBLICATION NUMBER

INTERNATIONAL CLASSIFICATION INDEXES (51)	NUMBER OF PUBLISHED APPLICATION (10)
A 61 K 31/4709; A 61 K 31/437; A 61 P 3/10; A 61 P 1/16; A 61 P 3/04; C 07 D 471/04; C 07 D 498/22	AP 2026 16917 A
A 61 K 31/4184; A 61 K 31/437; A 61 K 31/444; A 61 K 31/439; A 61 K 31/496; A 61 P 3/00; C 07 D 401/14; C 07 D 487/04; C 07 D 403/14; C 07 D 413/14; C 07 D 487/08; C 07 D 31/439; C 07 D 405/14	AP 2026 16925 A
A 61 K 39/00; A 61 K 39/395; A 61 K 38/17; C 07 K 16/28	AP 2026 16950 A
B 01 D 23/30; B 01 J 35/39; B 01 J 37/03; B 01 J 21/06; B 01 J 23/06; C 09 D 5/00; C 09 D 1/00; C 09 D 5/14; C 23 C 18/12	AP 2026 16909 A
B 65 G 1/04; B 65 G 1/137; B 66 F 9/06	AP 2026 16965 A
H 02 J 7/00; H 02 M 3/00	AP 2026 16842 A

**CONCORDANCE TABLE OF PUBLICATION NUMBER
AND INTERNATIONAL CLASSIFICATION INDEX**

NUMBER OF PUBLISHED APPLICATION (10)	INTERNATIONAL CLASSIFICATION INDEXES (51)
AP 2026 16842 A	H 02 J 7/00; H 02 M 3/00
AP 2026 16909 A	B 01 D 23/30; B 01 J 35/39; B 01 J 37/03; B 01 J 21/06; B 01 J 23/06; C 09 D 5/00; C 09 D 1/00; C 09 D 5/14; C 23 C 18/12
AP 2026 16917 A	A 61 K 31/4709; A 61 K 31/437; A 61 P 3/10; A 61 P 1/16; A 61 P 3/04; C 07 D 471/04; C 07 D 498/22
AP 2026 16925 A	A 61 K 31/4184; A 61 K 31/437; A 61 K 31/444; A 61 K 31/439; A 61 K 31/496; A 61 P 3/00; C 07 D 401/14; C 07 D 487/04; C 07 D 403/14; C 07 D 413/14; C 07 D 487/08; C 07 D 31/439; C 07 D 405/14
AP 2026 16950 A	A 61 K 39/00; A 61 K 39/395; A 61 K 38/17; C 07 K 16/28
AP 2026 16965 A	B 65 G 1/04; B 65 G 1/137; B 66 F 9/06

PATENT***

**CONCORDANCE TABLE OF INTERNATIONAL CLASSIFICATION INDEX,
PATENT NUMBER AND PUBLICATION NUMBER**

INTERNATIONAL CLASSIFICATION INDEX (51)	NUMBER OF PATENT (11)	NUMBER OF PUBLISHED APPLICATION (10)
A 01 N 1/02	P 2026 7902 B	AP 2025 16862 A
A 61 K 31/4184; A 61 K 31/496; A 61 K 31/444; A 61 K 31/439; A 61 K 31/437; A 61 P 3/00; C 07 D 487/04; C 07 D 413/14; C 07 D 405/14; C 07 D 403/14; C 07 D 401/14; C 07 D 487/08	P 2026 7901 B	AP 2023 16333 A
A 61 K 38/00; A 61 K 45/06; A 61 P 27/02; C 07 K 14/71	P 2026 7899 B	AP 2024 16461 A
H 02 J 7/00; H 02 M 3/00	P 2026 7900 B	AP 2026 16842 A

**CONCORDANCE TABLE OF PATENT NUMBER,
PUBLICATION NUMBER AND INTERNATIONAL CLASSIFICATION INDEX**

NUMBER OF PATENT (11)	NUMBER OF PUBLISHED APPLICATION (10)	INTERNATIONAL CLASSIFICATION INDEX (51)
P 2026 7899 B	AP 2024 16461 A	A 61 K 38/00; A 61 K 45/06; A 61 P 27/02; C 07 K 14/71
P 2026 7900 B	AP 2026 16842 A	H 02 J 7/00; H 02 M 3/00
P 2026 7901 B	AP 2023 16333 A	A 61 K 31/4184; A 61 K 31/496; A 61 K 31/444; A 61 K 31/439; A 61 K 31/437; A 61 P 3/00; C 07 D 487/04; C 07 D 413/14; C 07 D 405/14; C 07 D 403/14; C 07 D 401/14; C 07 D 487/08
P 2026 7902 B	AP 2025 16862 A	A 01 N 1/02

**CONCORDANCE TABLE OF APPLICATION NUMBER,
PUBLICATION NUMBER AND PATENT**

NUMBER OF APPLICATION (21)	NUMBER OF PUBLISHED APPLICATION (10)	NUMBER OF PATENT (11)
AP 2022 16333	AP 2023 16333 A	P 2026 7901 B
AP 2022 16461	AP 2024 16461 A	P 2026 7899 B
AP 2025 16842	AP 2026 16842 A	P 2026 7900 B
AP 2024 16862	AP 2025 16862 A	P 2026 7902 B

**UTILITY MODEL
APPLICATION*****

**CONCORDANCE TABLE OF INTERNATIONAL CLASSIFICATION INDEX
AND PUBLICATION NUMBER**

INTERNATIONAL CLASSIFICATION INDEXES (51)	NUMBER OF PUBLISHED APPLICATION (10)
A 23 L 2/00	AU 2026 16635 U

**CONCORDANCE TABLE OF PUBLICATION NUMBER
AND INTERNATIONAL CLASSIFICATION INDEX**

NUMBER OF PUBLISHED APPLICATION (10)	INTERNATIONAL CLASSIFICATION INDEXES (51)
AU 2026 16635 U	A 23 L 2/00

DESIGNCONCORDANCE TABLE OF INTERNATIONAL CLASSIFICATION INDEX,
NUMBER OF REGISTRATION AND PUBLICATION NUMBER

INTERNATIONAL CLASSIFICATION INDEXES (51)	NUMBER OF REGISTRATION (11)	NUMBER OF PUBLISHED APPLICATION (10)
09-01	D 2026 1120 S	AD 2026 1475 S
11-01	D 2026 1119 S	AD 2026 1469 S

CONCORDANCE TABLE OF NUMBER OF REGISTRATION,
PUBLICATION NUMBER AND INTERNATIONAL CLASSIFICATION INDEX

NUMBER OF REGISTRATION (11)	NUMBER OF PUBLISHED APPLICATION (10)	INTERNATIONAL CLASSIFICATION INDEXES (51)
D 2026 1119 S	AD 2026 1469 S	11-01
D 2026 1120 S	AD 2026 1475 S	09-01

CONCORDANCE TABLE OF APPLICATION NUMBER,
PUBLICATION NUMBER AND NUMBER OF REGISTRATION

NUMBER OF APPLICATION (21)	NUMBER OF PUBLISHED APPLICATION (10)	NUMBER OF REGISTRATION (11)
AD 2025 1469	AD 2026 1469 S	D 2026 1119 S
AD 2025 1475	AD 2026 1475 S	D 2026 1120 S

TRADEMARKCONCORDANCE TABLE OF REGISTRATION NUMBER, APPLICATION NUMBER,
PUBLICATION NUMBER AND BULLETIN NUMBER

NUMBER OF REGISTRATION (111)	NUMBER OF APPLICATIONS (210)	NUMBER OF PUBLISHED APPLICATIONS (260)	NUMBER OF BULLETIN
1	2	3	4
M 2026 41293 R	AM 134352	AM 2026 134352 A	2(677)2026
M 2026 41294 R	AM 134353	AM 2026 134353 A	2(677)2026
M 2026 41295 R	AM 134685	AM 2026 134685 A	3(678)2026
M 2026 41296 R	AM 133054	AM 2025 133054 A	21(672)2025
M 2026 41297 R	AM 133657	AM 2025 133657 A	23(674)2025
M 2026 41298 R	AM 132255	AM 2026 132255 A	1(676)2026
M 2026 41299 R	AM 134749	AM 2026 134749 A	3(678)2026
M 2026 41300 R	AM 133035	AM 2025 133035 A	21(672)2025
M 2026 41301 R	AM 133052	AM 2025 133052 A	21(672)2025
M 2026 41302 R	AM 133053	AM 2025 133053 A	21(672)2025
M 2026 41303 R	AM 130755	AM 2025 130755 A	11(662)2025
M 2026 41304 R	AM 134584	AM 2026 134584 A	3(678)2026
M 2026 41305 R	AM 134576	AM 2026 134576 A	3(678)2026
M 2026 41306 R	AM 134660	AM 2026 134660 A	3(678)2026
M 2026 41307 R	AM 134201	AM 2026 134201 A	1(676)2026
M 2026 41308 R	AM 133863	AM 2025 133863 A	24(675)2025
M 2026 41309 R	AM 133966	AM 2026 133966 A	2(677)2026
M 2026 41310 R	AM 133978	AM 2026 133978 A	2(677)2026
M 2026 41311 R	AM 130408	AM 2025 130408 A	10(661)2025
M 2026 41312 R	AM 134672	AM 2026 134672 A	3(678)2026
M 2026 41313 R	AM 134648	AM 2026 134648 A	3(678)2026
M 2026 41314 R	AM 134248	AM 2026 134248 A	2(677)2026
M 2026 41315 R	AM 134762	AM 2026 134762 A	3(678)2026
M 2026 41316 R	AM 134447	AM 2026 134447 A	3(678)2026
M 2026 41317 R	AM 133892	AM 2026 133892 A	2(677)2026
M 2026 41318 R	AM 134452	AM 2026 134452 A	3(678)2026
M 2026 41319 R	AM 134647	AM 2026 134647 A	3(678)2026
M 2026 41320 R	AM 134541	AM 2026 134541 A	3(678)2026
M 2026 41321 R	AM 134661	AM 2026 134661 A	3(678)2026
M 2026 41322 R	AM 134474	AM 2026 134474 A	3(678)2026
M 2026 41323 R	AM 134659	AM 2026 134659 A	3(678)2026
M 2026 41324 R	AM 134194	AM 2026 134194 A	2(677)2026
M 2026 41325 R	AM 134247	AM 2026 134247 A	2(677)2026
M 2026 41326 R	AM 134089	AM 2026 134089 A	2(677)2026
M 2026 41327 R	AM 134246	AM 2026 134246 A	2(677)2026
M 2026 41328 R	AM 134550	AM 2026 134550 A	2(677)2026
M 2026 41329 R	AM 134548	AM 2026 134548 A	2(677)2026
M 2026 41330 R	AM 134869	AM 2026 134869 A	3(678)2026
M 2026 41331 R	AM 139307	–	11(686)2026
M 2026 41332 R	AM 139196	–	11(686)2026
M 2026 41333 R	AM 139218	–	11(686)2026
M 2026 41334 R	AM 134549	AM 2026 134549 A	2(677)2026
M 2026 41336 R	AM 134539	AM 2026 134539 A	3(678)2026
M 2026 41337 R	AM 134680	AM 2026 134680 A	3(678)2026
M 2026 41338 R	AM 134681	AM 2026 134681 A	3(678)2026
M 2026 41339 R	AM 134264	AM 2026 134264 A	3(678)2026

1	2	3	4
M 2026 41340 R	AM 134172	AM 2026 134172 A	2(677)2026
M 2026 41341 R	AM 134674	AM 2026 134674 A	3(678)2026
M 2026 41342 R	AM 133584	AM 2025 133584 A	22(673)2025
M 2026 41343 R	AM 134336	AM 2026 134336 A	3(678)2026
M 2026 41344 R	AM 134335	AM 2026 134335 A	3(678)2026
M 2026 41345 R	AM 134334	AM 2026 134334 A	2(677)2026
M 2026 41346 R	AM 134650	AM 2026 134650 A	3(678)2026
M 2026 41347 R	AM 134333	AM 2026 134333 A	2(677)2026
M 2026 41348 R	AM 134567	AM 2026 134567 A	3(678)2026
M 2026 41349 R	AM 134332	AM 2026 134332 A	2(677)2026
M 2026 41350 R	AM 134331	AM 2026 134331 A	2(677)2026
M 2026 41351 R	AM 134271	AM 2026 134271 A	3(678)2026
M 2026 41352 R	AM 134440	AM 2026 134440 A	3(678)2026
M 2026 41353 R	AM 134437	AM 2026 134437 A	3(678)2026
M 2026 41354 R	AM 133673	AM 2025 133673 A	22(673)2025
M 2026 41355 R	AM 134664	AM 2026 134664 A	3(678)2026
M 2026 41356 R	AM 134374	AM 2026 134374 A	2(677)2026
M 2026 41357 R	AM 134337	AM 2026 134337 A	2(677)2026
M 2026 41359 R	AM 134338	AM 2026 134338 A	2(677)2026
M 2026 41360 R	AM 134339	AM 2026 134339 A	2(677)2026
M 2026 41361 R	AM 133273	AM 2025 133273 A	22(673)2025
M 2026 41362 R	AM 133580	AM 2025 133580 A	24(675)2025
M 2026 41363 R	AM 139124	–	11(686)2026
M 2026 41364 R	AM 139131	–	11(686)2026
M 2026 41365 R	AM 139207	–	11(686)2026
M 2026 41366 R	AM 139305	–	11(686)2026
M 2026 41367 R	AM 139322	–	11(686)2026
M 2026 41368 R	AM 139238	–	11(686)2026
M 2026 41369 R	AM 139324	–	11(686)2026
M 2026 41370 R	AM 139308	–	11(686)2026
M 2026 41371 R	AM 139389	–	11(686)2026
M 2026 41372 R	AM 139316	–	11(686)2026
M 2026 41373 R	AM 139315	–	11(686)2026
M 2026 41374 R	AM 139385	–	11(686)2026
M 2026 41375 R	AM 139386	–	11(686)2026
M 2026 41376 R	AM 139387	–	11(686)2026

CONCORDANCE TABLE OF INDEX OF GOODS AND/OR SERVICE
AND APPLICATION NUMBER

NUMBER OF PUBLISHED APPLICATION (260)	NUMBER OF APPLICATION (210)	1	2
1	2	AM 2026 136261 A	AM 136261
AM 2026 135708 A	AM 135708	AM 2026 136271 A	AM 136271
AM 2026 135731 A	AM 135731	AM 2026 136274 A	AM 136274
AM 2026 135761 A	AM 135761	AM 2026 136279 A	AM 136279
AM 2026 135763 A	AM 135763	AM 2026 136280 A	AM 136280
AM 2026 135801 A	AM 135801	AM 2026 136281 A	AM 136281
AM 2026 135928 A	AM 135928	AM 2026 136282 A	AM 136282
AM 2026 136064 A	AM 136064	AM 2026 136284 A	AM 136284
AM 2026 136132 A	AM 136132	AM 2026 136285 A	AM 136285
AM 2026 136137 A	AM 136137	AM 2026 136293 A	AM 136293
AM 2026 136138 A	AM 136138	AM 2026 136353 A	AM 136353
AM 2026 136151 A	AM 136151	AM 2026 136355 A	AM 136355
AM 2026 136152 A	AM 136152	AM 2026 136360 A	AM 136360
AM 2026 136153 A	AM 136153	AM 2026 136361 A	AM 136361
AM 2026 136158 A	AM 136158	AM 2026 136365 A	AM 136365
AM 2026 136159 A	AM 136159	AM 2026 136374 A	AM 136374
AM 2026 136160 A	AM 136160	AM 2026 136441 A	AM 136441
AM 2026 136161 A	AM 136161	AM 2026 136444 A	AM 136444
AM 2026 136252 A	AM 136252	AM 2026 136451 A	AM 136451
AM 2026 136253 A	AM 136253	AM 2026 136452 A	AM 136452
		AM 2026 136453 A	AM 136453
		AM 2026 136485 A	AM 136485
		AM 2026 136486 A	AM 136486

CONCORDANCE TABLE OF PUBLICATION NUMBER
AND APPLICATION NUMBER

INDEX OF GOODS AND/OR SERVICE (511)	NUMBER OF PUBLISHED APPLICATION (260)	1	2
1	2	36	AM 2026 136451 A
5	AM 2026 136132 A	36	AM 2026 136452 A
5	AM 2026 136158 A	36	AM 2026 136453 A
5	AM 2026 136159 A	37	AM 2026 136137 A
5	AM 2026 136161 A	37	AM 2026 136138 A
5	AM 2026 136374 A	37	AM 2026 136271 A
9	AM 2026 136252 A	38	AM 2026 136137 A
9	AM 2026 136274 A	38	AM 2026 136138 A
9	AM 2026 136285 A	39	AM 2026 136137 A
9	AM 2026 136451 A	39	AM 2026 136138 A
9	AM 2026 136452 A	40	AM 2026 136137 A
9	AM 2026 136453 A	40	AM 2026 136138 A
9	AM 2026 136485 A	41	AM 2026 135731 A
9	AM 2026 136486 A	41	AM 2026 135761 A
12	AM 2026 135708 A	41	AM 2026 135763 A
12	AM 2026 136152 A	41	AM 2026 135801 A
20	AM 2026 136293 A	41	AM 2026 136137 A
28	AM 2026 136064 A	41	AM 2026 136138 A
30	AM 2026 136253 A	42	AM 2026 136137 A
30	AM 2026 136361 A	42	AM 2026 136138 A
30	AM 2026 136365 A	42	AM 2026 136274 A
32	AM 2026 136360 A	42	AM 2026 136451 A
33	AM 2026 136151 A	42	AM 2026 136452 A
33	AM 2026 136153 A	42	AM 2026 136453 A
33	AM 2026 136261 A	43	AM 2026 135928 A
33	AM 2026 136444 A	43	AM 2026 136064 A
34	AM 2026 136355 A	43	AM 2026 136137 A
35	AM 2026 135731 A	43	AM 2026 136138 A
35	AM 2026 135801 A	43	AM 2026 136160 A
35	AM 2026 135928 A	43	AM 2026 136279 A
35	AM 2026 136137 A	43	AM 2026 136280 A
35	AM 2026 136138 A	43	AM 2026 136281 A
35	AM 2026 136151 A	43	AM 2026 136282 A
35	AM 2026 136451 A	43	AM 2026 136441 A
35	AM 2026 136452 A	44	AM 2026 136137 A
35	AM 2026 136453 A	44	AM 2026 136138 A
36	AM 2026 136137 A	44	AM 2026 136284 A
36	AM 2026 136138 A	44	AM 2026 136353 A
		44	AM 2026 136441 A
		45	AM 2026 136137 A
		45	AM 2026 136138 A
		45	AM 2026 136252 A

CONCORDANCE TABLE OF INDEX OF GOODS AND/OR SERVICE
AND NUMBER OF TRADEMARK REGISTERED ACCORDING
TO THE ACCELERATED PROCEDURE

INDEX OF GOODS AND/OR SERVICE (511)	NUMBER OF REGISTERED ACCORDING TO THE ACCELERATED PROCEDURE (111)
5	M 2026 41333 R
5	M 2026 41368 R
5	M 2026 41369 R
9	M 2026 41366 R
19	M 2026 41365 R
33	M 2026 41331 R
35	M 2026 41363 R
35	M 2026 41371 R
35	M 2026 41375 R
35	M 2026 41376 R
36	M 2026 41332 R
36	M 2026 41367 R
36	M 2026 41375 R
36	M 2026 41376 R
37	M 2026 41375 R
37	M 2026 41376 R
41	M 2026 41363 R
41	M 2026 41364 R
41	M 2026 41366 R
42	M 2026 41366 R
42	M 2026 41367 R
43	M 2026 41370 R
43	M 2026 41371 R
44	M 2026 41364 R

**LIST OF CODES, IN ALPHABETIC SEQUENCE, AND THE CORRESPONDING (SHORT) NAMES OF STATES, OTHER ENTITIES AND INTERGOVERNMENTAL ORGANIZATIONS
(WIPO STANDARD ST.3)**

AD	Andorra				
AE	United Arab Emirates	GD	Grenada	NE	Niger
AF	Afghanistan	GG	Guernsey	NG	Nigeria
AG	Antigua and Barbuda	GH	Ghana	NI	Nicaragua
AI	Anguilla	GI	Gibraltar	NL	Netherlands
AL	Albania	GT	Guatemala	NO	Norway
AM	Armenia	GW	Guinea- Bissau	NP	Nepal
AN	Netherlands Antilles	GY	Guyana	NR	Nauru
AO	Angola	HK	The Hong Kong Special Administrative Region of the People's Republic of China	NZ	New Zealand
AP	African Regional Intellectual Property Organization (ARIPO)	HN	Honduras	OA	African Intellectual Property Organization (OAPI)
AR	Argentina	HR	Croatia	OM	Oman
AT	Austria	HT	Haiti	PA	Panama
AU	Australia	HU	Hungary	PE	Peru
AW	Aruba	IB	International Bureau of the World Intellectual Property Organization (WIPO)	PG	Papua New Guinea
AZ	Azerbaijan	ID	Indonesia	PH	Philippines
BA	Bosnia and Herzegovina	IE	Ireland	PK	Pakistan
BB	Barbados	IL	Israel	PL	Poland
BD	Bangladesh	IM	Isle of Man	PT	Portugal
BE	Belgium	IN	India	PW	Palau
BF	Burkina Faso	IQ	Iraq	PY	Paraguay
BG	Bulgaria	IR	Iran (Islamic Republic of)	QA	Qatar
BH	Bahrain	IS	Iceland	QZ	Community Plant Variety Office (European Community) (CPVO)
BI	Burundi	IT	Italy	RO	Romania
BJ	Benin	JE	Jersey	RS	Serbia
BM	Bermuda	JM	Jamaica	RU	Russian Federation
BN	Brunei Darussalam	JO	Jordan	RW	Rwanda
BO	Bolivia	JP	Japan	SA	Saudi Arabia
BR	Brazil	KE	Kenya	SB	Solomon Islands
BS	Bahamas	KG	Kyrgyzstan	SC	Seychelles
BT	Bhutan	KH	Cambodia	SD	Sudan
BV	Bouvet Island	KI	Kiribati	SG	Singapore
BW	Botswana	KM	Saint Kitts and Nevis	SH	Saint Helena
BX	Benelux Office for Intellectual Property (BOIP)	KP	Democratic People's Republic of Korea	SI	Slovenia
BY	Belarus	KR	Republic of Korea	SK	Slovakia
BZ	Belize	KW	Kuwait	SL	Sierra Leone
CA	Canada	KY	Cayman Islands	SM	San Marino
CD	Democratic Republic of the Congo	KZ	Kazakhstan	SN	Senegal
CF	Central African Republic	LA	Lao People's Democratic Republic	SO	Somalia
CG	Congo	LB	Lebanon	SR	Suriname
CH	Switzerland	LC	Saint Lucia	ST	Sao Tome and Principe
CI	Cote d'Ivoire	LI	Liechtenstein	SV	El Salvador
CK	Cook Islands	LK	Sri Lanka	SY	Syrian Arab Republic
CL	Chile	LR	Liberia	SZ	Swaziland
CM	Cameroon	LS	Lesotho	TC	Turks and Caicos Islands
CN	China	LT	Lithuania	TD	Chad
CO	Colombia	LU	Luxembourg	TG	Togo
CR	Costa Rica	LV	Latvia	TH	Thailand
CU	Cuba	LY	Libyan Arab Jamahiriya	TJ	Tajikistan
CV	Cape Verde	MA	Morocco	TL	Timor-Leste
CY	Cyprus	MC	Monaco	TM	Turkmenistan
CZ	Czech Republic	MD	Republic of Moldova	TN	Tunisia
DE	Germany	ME	Montenegro	TO	Tonga
DJ	Djibouti	MG	Madagascar	TR	Turkey
DM	Dominica	MK	The former Yugoslav Republic of Macedonia	SE	Sweden
DO	Dominican Republic	ML	Mali	TT	Trinidad and Tobago
DZ	Algeria	MM	Myanmar	TV	Tuvalu
EA	Eurasian Patent Organization (EAPO)	MN	Mongolia	TW	Taiwan, Province of China
EC	Ecuador	MO	Macao	TZ	United Republic of Tanzania
EE	Estonia	MP	Northern Mariana Islands	UA	Ukraine
EG	Egypt	MR	Mauritania	UG	Uganda
EH	Western Sahara	MS	Montserrat	US	United States of America
EM	Office for Harmonization in the Internal Market (Trademarks and Designs)(OHIM)	MT	Malta	UY	Uruguay
EP	European Patent Office (EPO)	MU	Mauritius	UZ	Uzbekistan
ER	Eritrea	MV	Maldives	VA	Holy See
ES	Spain	MW	Malawi	VC	Saint Vincent and the Grenadines
ET	Ethiopia	MX	Mexico	VE	Venezuela
FI	Finland	MY	Malaysia	VG	Virgin Islands (British)
FJ	Fiji	MZ	Mozambique	VN	Viet Nam
FK	Falkland Islands (Malvinas)	NA	Namibia	VU	Vanuatu
FO	Faroe Islands			WO	World Intellectual Property Organization (WIPO)
FR	France			WS	Samoa
GA	Gabon			XN	Nordic Patent Institute (NPI)
GB	United Kingdom			YE	Yemen
GC	Patent Office of the Cooperation Council for the Arab States of the Gulf (GCC)			ZA	South Africa
				ZM	Zambia
				ZW	Zimbabwe

OFFICIAL BULLETIN OF THE INDUSTRIAL PROPERTY

INVENTION

UTILITY MODEL

VALIDATION OF EUROPEAN PATENT

DESIGN

TRADEMARK

11(686)

EDITOR-IN-CHIEF: N. Bebrishvili

EDITOR-TRANSLATOR: E. Gabunia

PROOFREADER: A. Shikhashvili

COMPUTER LAYOUT: M. Ordenidze
K. Svanidze

ISSN 2720-8486

info@sakpatenti.gov.ge
www.sakpatenti.gov.ge