



საქართველოს ინტელექტუალური საკუთრების ეროვნული ცენტრი  
NATIONAL INTELLECTUAL PROPERTY CENTER OF GEORGIA

საქპატენტი  
SAKPATENTI

**OFFICIAL BULLETIN  
OF THE INDUSTRIAL PROPERTY**

**1(533)**

2020  
TBILISI

# INID CODES FOR IDENTIFICATION OF BIBLIOGRAPHIC DATA

## INVENTIONS, UTILITY MODELS

- (10) Number of publication for application, which has been examined
- (11) Number of patent and kind of document
- (21) Serial number of application
- (22) Date of filing of the application
- (23) Date of exhibition or the date of the earlier filing and the number of application, if any
- (24) Date from which patent may have effect
- (31) Number of priority application
- (32) Date of filing of priority application
- (33) Code of the country or regional organization allotting priority application number
- (44) Date of publication of application not granted, but examined and number of bulletin
- (45) Date of publication of registered document
- (51) International Patent Classification Index

- (54) Title of the invention
- (57) Abstract
- (60) Number of examined patent document granted by foreign patent office, date from which patent has effect and country code
- (62) Number of the earlier application and in case of divided application, date of filing an application
- (71) Name, surname and address of applicant (country code)
- (72) Name, surname of inventor (country code)
- (73) Name, surname and address of patent owner (country code)
- (74) Name, surname of representative or patent attorney
- (85) Date of commencement of the national phase of International Application
- (86) Number and date of filing of international application
- (87) Number and date of publication of international application
- (94) Calculated date of expiry of the SPC or the duration of the SPC

## DESIGNS

- (10) Number of publication for application
- (11) Number of patent and kind of document or number of registration
- (15) Date of registration/Date of patent renewal
- (18) Expected expiration date of patent or registration
- (21) Serial number of application
- (22) Date of filing of the application
- (23) Date of exhibition or the date of the earlier filing and the number of application, if any
- (24) Date from which patent may have effect
- (28) Number of designs included in the application
- (30) Data relating to priority (number of application, date of filing of application, two-letter code identifying the authority with whom the priority application was made)
- (31) Number of priority application
- (32) Date of filing of priority application
- (33) Code of the country or regional organization allotting priority application number
- (34) Two-letter code according to WIPO St.3 identifying the authority with which the priority application was made
- (44) Date of publication of design and number of bulletin (the first publication)
- (45) Date of publication of design registered by WIPO and number of bulletin

- (51) International Classification for designs (class and subclass of the Locarno Classification)
- (54) Title of the invention
- (55) Reproduction of the design
- (57) Description of characteristic features of the design including indication of colors
- (58) Date of recording of any kind of amendment in the Register
- (62) Number of the earlier application, registration and document number and if available the date of filing an application in case of divided application
- (71) Name, surname and address of applicant (country code)
- (72) Name, surname of creator (country code)
- (73) Name, surname and address of patent owner (country code)
- (74) Name, surname of representative or patent attorney
- (81) Contracting states concerned
  - II designated contracting states according to the 1960 Act
  - III designated contracting states according to the 1999 Act
- (85) Owner's permanent address
- (86) Owner's nationality
- (87) Owner's residence
- (88) State in which the owner has a real and effective industrial or commercial establishment

## TRADEMARKS

- (111) - Number of registration
- (151) - Date of registration
- (156) - Date of the renewal
- (181) - Expected expiration date of registration
- (186) - Renewal expiration date of registration
- (141) - Date of cancel of duration of the mark
- (210) - Serial number of application
- (220) - Date of filing of the application
- (230) - Data concerning exhibition
- (260) - Number of application, for which favorable decision of examination about registration has been taken (publication number)
- (310) - Number of the first application
- (320) - Date of filing of the first application
- (330) - Code, identifying national or regional Office where the first application was made
- (511) - International Classification of Goods and Services for the purposes of registration of trade marks and/or list of goods and/or services classified according thereto
- (526) - Disclaimer
- (531) - Description of figurative elements of Trade Marks according to the International Classification of the Figurative Elements of Marks

- (540) - Reproduction of Trade Mark
- (550) - Nature and kind of Trade Mark
- (551) - Indication to the effect that the mark is a collective mark, a certification mark or a guarantee mark
- (554) - Three-dimensional mark
- (580) - Date of recording of any kind changes in respect of applications or registrations
- (591) - Information concerning colors claimed
- (731) - Name and address of the applicant
- (732) - Name and address of the holder of the registration
- (740) - Name and address of the representative
- (750) - Addreses for correspondence
- (770) - Name and address of the previous applicant or holder in case of change in ownership
- (771) - Previous name and address of the applicant or holder in case of change in ownership
- (791) - Name and address of the licensee
- (793) - Indication of conditions and/or restrictions under the license (Type of license, number of license agreement, data of license, data of validity of license)
- (800) - Certain data relating to the international registration of Trade Marks under the Protocol Relating to Madrid Agreement (International registration number
- (852) - Partial cancellation of the list of goods and services
- (891) - Date of subsequent designation

## CODES FOR PUBLICATION IN BULLETIN

- (21) AP 0000 000000 - serial number of application for invention
- (10) AP 0000 0000 A - number of published application for invention (first publication)
- (11) P 0000 0000 B - number of patent for invention (second publication)
- (21) API 0000 000000 - number of application for imported patent
- (11) PI 0000 0000 A - number of imported patent (first publication)
- (21) AU 0000 000000 - serial number of application for utility model
- (10) AU 0000 000 U - number of published application for utility model (first publication)
- (11) U 0000 000 Y - number of patent for utility model (second publication)
- (21) AD 0000 000000 - serial number of application for design
- (10) AD 0000 000 S - number of published application for design (first publication)
- (11) D 0000 000 S - registered design

## INTERNATIONAL PATENT CLASSIFICATION FOR INVENTIONS AND UTILITY MODELS

- SECTION A - HUMAN NECESSITIES
- SECTION B - PERFORMING OPERATIONS; TRANSPORTING
- SECTION C - CHEMISTRY; METALLURGY
- SECTION D - TEXTILES; PAPER
- SECTION E - FIXED CONSTRUCTIONS
- SECTION F - MECHANICAL ENGINEERING; LIGHTING; HEATING; WEAPONS; BLASTING
- SECTION G - PHYSICS
- SECTION H - ELECTRICITY

- 
- M - Trade Mark
  - (210) AM 0000 000000 - Serial number of application;
  - (260) AAM 0000 00000 A - Publication number of application;
  - (111) M 0000 00000 R - Number of registration;
  - (111) MMM0000 00000 Rn - Number of renewals, in which n=1,2,3;
  - (111) M 0000 00000 R(P) - Number of registration under partial assignment of rights
-

**LIST OF CODES, IN ALPHABETIC SEQUENCE, AND THE CORRESPONDING (SHORT) NAMES OF STATES, OTHER ENTITIES AND INTERGOVERNMENTAL ORGANIZATIONS  
(WIPO STANDARD ST.3)**

AD	Andorra				
AE	United Arab Emirates	GD	Grenada	NE	Niger
AF	Afghanistan	GG	Guernsey	NG	Nigeria
AG	Antigua and Barbuda	GH	Ghana	NI	Nicaragua
AI	Anguilla	GI	Gibraltar	NL	Netherlands
AL	Albania	GT	Guatemala	NO	Norway
AM	Armenia	GW	Guinea- Bissau	NP	Nepal
AN	Netherlands Antilles	GY	Guyana	NR	Nauru
AO	Angola	HK	The Hong Kong Special Administrative Region of the People's Republic of China	NZ	New Zealand
AP	African Regional Intellectual Property Organization (ARIPO)	HN	Honduras	OA	African Intellectual Property Organization (OAPI)
AR	Argentina	HR	Croatia	OM	Oman
AT	Austria	HT	Haiti	PA	Panama
AU	Australia	HU	Hungary	PE	Peru
AW	Aruba	IB	International Bureau of the World Intellectual Property Organization (WIPO)	PG	Papua New Guinea
AZ	Azerbaijan	ID	Indonesia	PH	Philippines
BA	Bosnia and Herzegovina	IE	Ireland	PK	Pakistan
BB	Barbados	IL	Israel	PL	Poland
BD	Bangladesh	IM	Isle of Man	PT	Portugal
BE	Belgium	IN	India	PW	Palau
BF	Burkina Faso	IQ	Iraq	PY	Paraguay
BG	Bulgaria	ID	Indonesia	QA	Qatar
BH	Bahrain	IE	Ireland	QZ	Community Plant Variety Office (European Community) (CPVO)
BI	Burundi	IL	Israel	RO	Romania
BJ	Benin	IM	Isle of Man	RS	Serbia
BM	Bermuda	IN	India	RU	Russian Federation
BN	Brunei Darussalam	IQ	Iraq	RW	Rwanda
BO	Bolivia	IR	Iran (Islamic Republic of)	SA	Saudi Arabia
BR	Brazil	IS	Iceland	SB	Solomon Islands
BS	Bahamas	IT	Italy	SC	Seychelles
BT	Bhutan	JE	Jersey	SD	Sudan
BV	Bouvet Island	JM	Jamaica	SG	Singapore
BW	Botswana	JO	Jordan	SH	Saint Helena
BX	Benelux Office for Intellectual Property (BOIP)	JP	Japan	SI	Slovenia
BY	Belarus	KE	Kenya	SK	Slovakia
BZ	Belize	KG	Kyrgyzstan	SL	Sierra Leone
CA	Canada	KH	Cambodia	SM	San Marino
CD	Democratic Republic of the Congo	KI	Kiribati	SN	Senegal
CF	Central African Republic	KM	Saint Kitts and Nevis	SO	Somalia
CG	Congo	KP	Democratic People's Republic of Korea	SR	Suriname
CH	Switzerland	KR	Republic of Korea	ST	Sao Tome and Principe
CI	Cote d'Ivoire	KW	Kuwait	SV	El Salvador
CK	Cook Islands	KY	Cayman Islands	SY	Syrian Arab Republic
CL	Chile	KZ	Kazakhstan	SZ	Swaziland
CM	Cameroon	LA	Lao People's Democratic Republic	TC	Turks and Caicos Islands
CN	China	LB	Lebanon	TD	Chad
CO	Colombia	LC	Saint Lucia	TG	Togo
CR	Costa Rica	LI	Liechtenstein	TH	Thailand
CU	Cuba	LK	Sri Lanka	TJ	Tajikistan
CV	Cape Verde	LR	Liberia	TL	Timor-Leste
CY	Cyprus	LS	Lesotho	TM	Turkmenistan
CZ	Czech Republic	LT	Lithuania	TN	Tunisia
DE	Germany	LU	Luxembourg	TO	Tonga
DJ	Djibouti	LV	Latvia	TR	Turkey
DM	Dominica	LY	Libyan Arab Jamahiriya	SE	Sweden
DO	Dominican Republic	MA	Morocco	TT	Trinidad and Tobago
DZ	Algeria	MC	Monaco	TV	Tuvalu
EA	Eurasian Patent Organization (EAPO)	MD	Republic of Moldova	TW	Taiwan, Province of China
EC	Ecuador	ME	Montenegro	TZ	United Republic of Tanzania
EE	Estonia	MG	Madagascar	UA	Ukraine
EG	Egypt	MK	The former Yugoslav Republic of Macedonia	UG	Uganda
EH	Western Sahara	ML	Mali	US	United States of America
EM	Office for Harmonization in the Internal Market (Trademarks and Designs)(OHIM)	MM	Myanmar	UY	Uruguay
EP	European Patent Office (EPO)	MN	Mongolia	UZ	Uzbekistan
ER	Eritrea	MO	Macao	VA	Holy See
ES	Spain	MP	Northern Mariana Islands	VC	Saint Vincent and the Grenadines
ET	Ethiopia	MR	Mauritania	VE	Venezuela
FI	Finland	MS	Montserrat	VG	Virgin Islands (British)
FJ	Fiji	MT	Malta	VN	Viet Nam
FK	Falkland Islands (Malvinas)	MU	Mauritius	VU	Vanuatu
FO	Faroe Islands	MV	Maldives	WO	World Intellectual Property Organization (WIPO)
FR	France	MW	Malawi	WS	Samoa
GA	Gabon	MX	Mexico	XN	Nordic Patent Institute (NPI)
GB	United Kingdom	MY	Malaysia	YE	Yemen
GC	Patent Office of the Cooperation Council for the Arab States of the Gulf (GCC)	MZ	Mozambique	ZA	South Africa
		NA	Namibia	ZM	Zambia
				ZW	Zimbabwe

# **OFFICIAL BULLETIN OF THE INDUSTRIAL PROPERTY**

## **1(533)**

**INVENTIONS  
UTILITY MODELS  
DESIGNS  
TRADEMARKS**

DATE OF PUBLICATION: 2020 01 10

# CONTENTS

<b>PUBLISHED TITLES OF PROTECTION .....</b>	<b>3</b>
<b>INVENTIONS</b>	
▪ APPLICATIONS APPROVED FOR GRANTING PATENTS .....	4
▪ PATENTED INVENTIONS .....	5
<b>UTILITY MODEL</b>	
▪ APPLICATION APPROVED FOR GRANTING PATENT .....	6
<b>DESIGNS</b>	
▪ APPLICATION APPROVED FOR REGISTRATION .....	7
▪ DESIGNS, WICH HAVE BEEN REGISTERED WITH THE INTERNATIONAL BUREAU CLAIMING PRIORITY ON THE TERRITORY OF GEORGIA .....	10
<b>TRADEMARKS</b>	
▪ APPLICATIONS FILED UNDER THE NATIONAL PROCEDURE APPROVED FOR REGISTRATION .....	59
▪ TRADEMARKS REGISTERED ACCORDING TO THE ACCELERATED PROCEDURE .....	64
▪ INTERNATIONAL TRADEMARKS FOR WHICH A DECISION ON GANTING PROTECTION IS TAKEN .....	66
▪ INTERNATIONAL TRADEMARKS PROTECTED IN GEORGIA .....	109
<b>OFFICIAL NOTIFICATIONS</b>	
<b>INVENTION</b>	
▪ EXPIRATION OF PATENT RESTORATION .....	118
<b>DESIGNS</b>	
▪ CANCELLATION OF DESIGN REGISTRATION .....	118
▪ EXTENSION OF REGISTRATION OF INTERNATIONAL DESIGNS .....	118
▪ CANCELLATION OF REGISTRATION OF INTERNATIONAL DESIGNS .....	120
<b>TRADEMARKS</b>	
▪ RENEWAL OF REGISTRATIONS .....	122
▪ COMPLET TRANSFER OF RIGHTS .....	123
▪ CHANGES OF NAMES AND/OR ADDRESSES OF OWNERS .....	124
▪ TERMINATION OF TRADEMARKS REGISTRATION .....	125
<b>CLASSIFICATION INDEXES</b>	
INVENTIONS .....	128
UTILITY MODEL .....	129
DESIGN .....	129
TRADEMARKS .....	130

## **PUBLISHED TITLES OF PROTECTION**

### **INVENTIONS**

- **APPLICATIONS APPROVED FOR GRANTING PATENT:**  
14958; 14690
- **PATENTED INVENTIONS:**  
7055, 7056

### **UTILITY MODEL**

- **APPLICATION APPROVED FOR GRANTING PATENT:**  
14990

### **DESIGNS**

- **APPLICATION APPROVED FOR GRANTING PATENT:**  
1098
- **DESIGNS, WHICH HAVE BEEN REGISTERED WITH THE INTERNATIONAL BUREAU CLAIMING PRIORITY ON THE TERRITORY OF GEORGIA:**  
202836; 200977; 202827; 203085; 203100; 202339; 200871; 203051; 202998; 203392; 200981; 203348; 203436; 203464; 203477; 203468; 203508; 200870

### **TRADEMARKS**

- **APPLICATIONS FILED UNDER THE NATIONAL PROCEDURE APPROVED FOR REGISTRATION:**  
100410; 100764\*; 103099; 103184-103186; 103209; 103302, 103303; 103312; 103315, 103316; 103430-103432; 103572; 103585; 103589; 103671, 103672; 103751-103755; 103768; 103856
- **TRADEMARKS REGISTERED ACCORDING TO THE ACCELERATED PROCEDURE:**  
32196-32203
- **INTERNATIONAL TRADEMARKS FOR WHICH A DECISION ON GRANTING PROTECTIONS IS TAKEN:**  
98530\*; 98928\*; 99554\*; 101144; 101196; 101262; 101715; 102095-102098; 102119; 102180; 102193; 102199-102204; 102213; 102217, 102218; 102281; 102283, 102284; 102287; 102289; 102291, 102292; 102297; 102299; 102306; 102315, 102316; 102323; 102327; 102329-102334; 102410, 102411; 102421-102426; 102428; 102430-102434; 102436; 102440; 102452, 102453; 102464, 102465; 102470-102476; 102753; 102755-102757; 102863; 102865; 102912; 102935; 103414-103419
- **INTERNATIONAL TRADEMARKS PROTECTED IN GEORGIA:**  
75267; 75519; 100247; 100316; 100580, 100581; 100583; 100615, 100616; 100621, 100622; 100624, 100625; 100657; 100710; 100714-100719; 100721; 100724-100726; 100729; 100731; 100734-100738; 100740-100742; 100755; 100823-100827; 100831, 100832; 100841, 100842; 100848-100851; 100854, 100855; 100937-100939; 100957-100966; 100974; 100977-100984; 100986-100989; 100991-100994; 100996; 101028, 101029; 101034-101038; 101040; 101058; 101106; 101117; 101123-101126; 101157; 101162; 101320-101322; 101324; 101350; 101352; 101354; 101357; 101442; 101458, 101459; 101462; 101474-101477; 101525; 101587; 101589-101592; 102998

# INVENTIONS

## APPLICATIONS APPROVED FOR GRANTING PATENTS

The decision can be appealed at the Chamber of Appeal of Sakpatenti within 3 months from the publication or at the Mtskheta District Court Administrative Cases Board (Address: №17, Samkhedro str., Mtskheta), within 1 month following the publication.

### PART A

#### A 01

(10) AP 2020 14958 A (51) Int. Cl. (2006)  
A 01 N 63/00  
C 12 R 1/425

(21) AP 2018 14958 (22) 2018 12 11  
(71) LTD "SHIELD" (GE)  
Vill. Rachisubani, 5<sup>th</sup> St. 25, Bolnisi (GE)

(72) Medgar Gavasheli (GE)

(74) Shalva Gvaramadze

(54) **METHOD FOR AGRICULTURE  
PROTECTION FROM BROWN  
MARMORATED STINK BUG**

(57) An invention concerns a method for agriculture protection from brown marmorated stink bug, providing brown marmorated stink bug dispersion treatment with 10% ammonium hydroxide in both: closed and open agriculture areas. 1.5 l-s of 10% limewater is added to 1000 l-s 10% ammonium hydroxide solution at open agriculture areas treatment.

Claims: 1 independent  
4 dependent

#### A 61

(10) AP 2020 14690 A (51) Int. Cl. (2006)  
A 61 K 31/407  
A 61 P 31/20  
C 07 D 515/04  
C 07 D 513/04  
C 07 D 515/20  
C 07 D 513/20  
C 07 D 291/08

(21) AP 2016 14690 (22) 2016 07 01

(31) 15175021.3; 15189903.6;  
15201332.2; 16157726.7

(32) 2015 07 02; 2015 10 15; 2015 12 18;  
2016 02 26

(33) EP; EP; EP; EP

(71) JANSSEN SCIENCES IRELAND UC (IE)  
Eastgate Village, Eastgate Little Island Co  
Cork (IE)

(72) VENDEVILLE, Sandrine, Marie, Helene (BE);  
DEMIN, Samuël, Dominique (BE);

GROSSE, Sandrine, Céline (BE);  
HU, Lili (BE);  
HACHÉ, Geerwin, Yvonne, Paul (BE);  
LAST, Stefaan, Julien (BE);  
PIETERS, Serge, Maria, Aloysius (BE);  
ROMBOUTS, Geert (BE);  
VANDYCK, Koen (BE);  
VERSCHUEREN, Wim, Gaston (BE);  
RABOISSON, Pierre, Jean-Marie, Bernard  
(BE)

(74) Tamar Kochlamazashvili

(85) 2018 02 01

(86) PCT/EP2016/065488, 2016 07 01

(54) **CYCLIZED SULFAMOYLARYLA-  
MIDE DERIVATIVES AND THE USE  
THEREOF AS MEDICAMENTS FOR  
THE TREATMENT OF HEPATITIS B**

(57) An invention relates to compounds of formula  
(I-A),

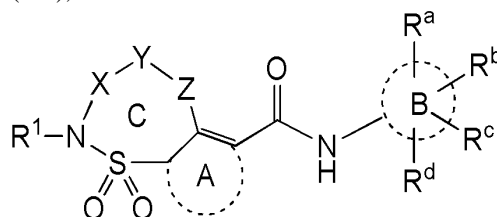

(I-A)

Pharmaceutical compositions containing them, preparation method thereof, and their usage for hepatitis B virus (HBV) infection treatment.

Claims: 8 independent  
22 dependent

---

**PATENTED INVENTIONS**
**PART A****A 61**

- (11) P 2020 7056 B (51) Int. Cl. (2006)  
 A 61 K 321/381  
 A 61 K 31/437  
 A 61 K 31/4355  
 A 61 P 35/00  
 C 07 D 487/04  
 C 07 D 471/04  
 C 07 D 409/12  
 C 07 D 405/12  
 C 07 D 495/04  
 C 07 D 209/12  
 C 07 D 405/04  
 C 07 D 403/12  
 C 07 D 333/56  
 C 07 D 307/81  
 C 07 D 307/80  
 C 07 D 491/04
- (10) AP 2019 14681 A (44) 17(525)/2019  
 (21) AP 2016 14681  
 (22) 2016 06 22  
 (24) 2016 06 22  
 (31) 1555750  
 (32) 2015 06 23  
 (33) FR  
 (86) PCT/EP2016/064418, 2016 06 22  
 (73) LES LABORATOIRES SERVIER (FR)  
 35 rue de Verdun 92284 Suresnes (FR);  
 VERNALIS (R&D) LIMITED (GB)  
 100 Berkshire Place Wharfedale Road  
 Berkshire Winnersh, Berkshire  
 RG41 5RD (GB)  
 (72) PROSZENYÁK, Ágnes (HU);  
 MURRAY, James Brooke (GB);  
 SIPOS, Szabolcs (HU);  
 KOTSCHY, András (HU);  
 ONDI, Levente (HU);  
 BÁLINT, Balázs (HU);  
 DAVIDSON, James Edward Paul (GB);  
 CSÉKEI, Márton (HU);  
 SZLÁVIK, Zoltán (HU);  
 CHEN, I-Jen (GB);  
 SZABÓ, Zoltán (HU);  
 GENESTE, Olivier (FR);  
 CHANRION, Maïa (FR)  
 (74) Tamaz Shilakadze  
 (54) **NEW BICYCLIC DERIVATIVES,  
 A PROCESS FOR THEIR PREPARA-  
 TION AND PHARMACEUTICAL  
 COMPOSITIONS CONTAINING THEM**
- 

**PART C****C 12**

- (11) P 2020 7055 B (51) Int. Cl. (2006)  
 C 12 G 1/00  
 C 12 N 1/16
- (10) AP 2019 14808 A (44) 17(525)/2019  
 (21) AP 2018 14808  
 (22) 2018 06 13  
 (24) 2018 06 13  
 (73) Teimuraz Ortoidze (GE)  
 Tabukashvili St. 47, 0108, Tbilisi (GE);  
 Elene Salia (GE)  
 Davit Aghmashebeli Av. 147, 0112,  
 Tbilisi (GE)  
 (72) Teimuraz Ortoidze (GE);  
 Elene Salia (GE)  
 (54) **GEORGIAN WINE YEAST**
-



---

# UTILITY MODEL

## APPLICATION APPROVED FOR GRANTING PATENT

The decision can be appealed at the Chamber of Appeal of Sakpatenti within 3 months from the publication or at the Mtskheta District Court Administrative Cases Board (Address: №17, Samkhedro str., Mtskheta), within 1 month following the publication.

### PART E

#### E 01

(10) AU 2020 14990 U (51) Int. Cl. (2006)  
E 01 C 3/04

(21) AU 2019 14990 (22) 2019 01 25

(71) Paata Gogoladze (GE)

Kutuzov St. 3, 0194, Tbilisi (GE)

(72) Paata Gogoladze (GE)

(74) Tamaz Shilakadze

(54) **METHOD FOR RETICULAR TISSUE  
PRODUCTION FOR ARMORING  
ASPHALT CONCRETE**

(57) A method for reticular tissue production provides tissue preparation with mineral basalt textile fiber, covering of reticular tissue with a lubricant made of synthetic rubber, heated up to 1700-1800°C temperature, and then cooled.

Claims: 1 independent

---

---

# DESIGNS

## APPLICATION APPROVED FOR REGISTRATION

The decision can be appealed at the Chamber of Appeal of Sakpatenti within 3 months from the publication or at the Mtskheta District Court Administrative Cases Board (Address: №17, Samkhedro str., Mtskheta), within 1 month following the publication.

(10) AD 2020 1098 S      (51) 03-01  
(21) AD 2019 1098      (22) 2019 07 25  
(28) 2  
(71) Giorgi Kalandadze (GE)  
Sakhalkho St. 17, 0113, Tbilisi (GE)  
(72) Giorgi Kalandadze (GE)  
(54) 1.-2. **HANDBAGS**  
(55)



1.1



1.2



1.3



1.4



1.5



2.1



2.2



2.3



2.4



2.5



2.6



2.7

## DESIGNS, WHICH HAVE BEEN REGISTERED WITH THE INTERNATIONAL BUREAU CLAIMING PRIORITY ON THE TERRITORY OF GEORGIA

The decision can be appealed at the Chamber of Appeal of Sakpatenti within 3 months from the publication or at the Mtskheta District Court Administrative Cases Board (Address: №17, Samkhedro Str., Mtskheta), within 1 month following the publication.

- (11) **DM/202 836**                      **(51) 09-03**  
 (15) 2019 12 21                      (44) 38/2019 (2019 09 20)  
 (22) 2018 12 21  
 (28) 1  
 (30) No1: 06.07.2018; 29/655776; US  
 (73) Orig3n, Inc.  
       27 Drydock Ave., 6th Floor, 02210 Boston (MA) (US)  
 (85) US  
 (86) US  
 (87) US  
 (88) US  
 (89) US  
 (81) III. AM, IS, MD, TJ, BW, ST, GH, MN, TR, KH, TN, KR, JP, KP, CH, BN, UA, AL, AZ, TM, ME, MC, SG, NA, OA, RS, NO, BA, MK, OM, GE, CA, LI, KG, EM, SY, RW, RU, EG  
 (72) Robin Y. Smith, Orig3n, Inc.  
       27 Drydock Ave., 02210 Boston (US)  
 (74) Graham Watt & Co LLP  
       St. Botolph's House, 7-9 St. Botolph's Road, TN13 3AJ Sevenoaks (GB)  
 (54) 1. Foldable box  
 (55)

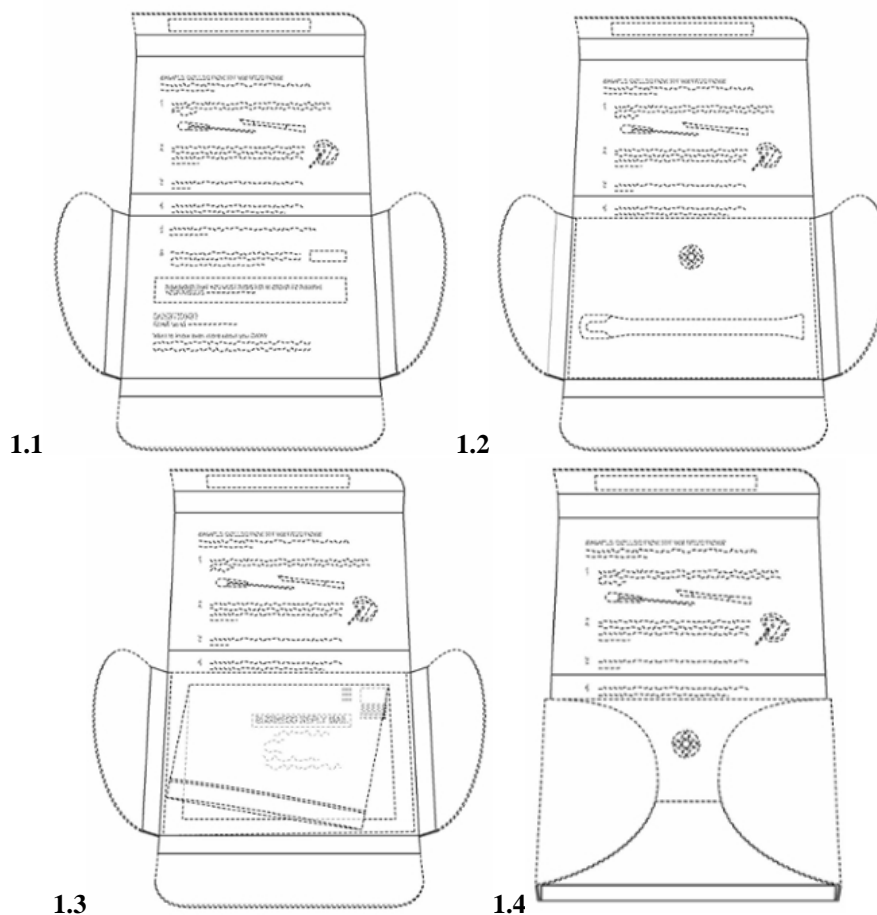

**(11) DM/200 977**

(15) 2019 03 18

(22) 2019 03 18

(28) 5

(73) Glashütter Uhrenbetrieb GmbH

Altenberger Strasse 1, 01768 Glashütte (DE)

(85) DE, EM

(86) DE, EM

(87) DE; EM

(88) DE, EM

(89) DE

(81) II. MA III. AM, AL, AZ, BZ, ME, MD, SG, MN, BA, GE, TR, MK, OM, LI, KG, GB, TN, EM, CH, RU

(72) 1-3 Katharina STEGMANN

Am Mühlfeld 84, 01744 Paulsdorf (DE)

4-5 Anika ENGELBRECHT

Scheunenhofstrasse 2, 01097 Dresden (DE)

(74) The Swatch Group AG (The Swatch Group SA) (The Swatch Group Ltd.)

6, Faubourg Du Lac, 2501 Biel/Bienne (CH)

(54) 1.-3. Watch, 4. Watch case, 5. Watch dial

(55)

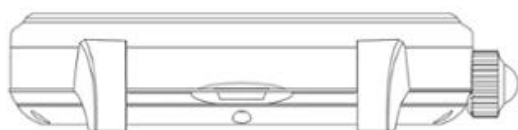
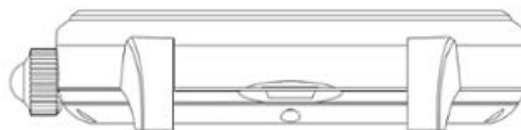
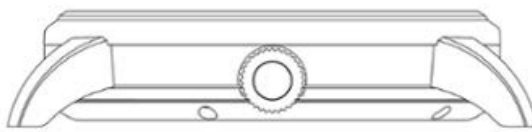
**1.1****1.2****1.3****1.4****1.5****1.6**

1.7



2.1



2.2



2.3

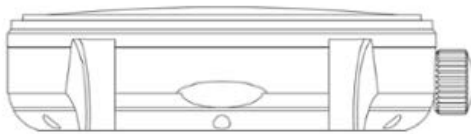

2.4

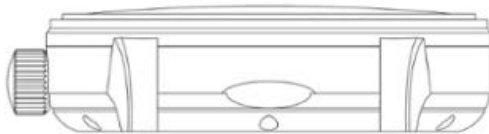

2.5

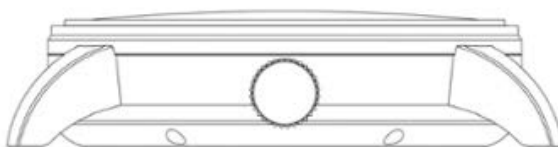

2.6





2.7



3.1



3.2



3.3



3.4



4.1





4.2



4.3

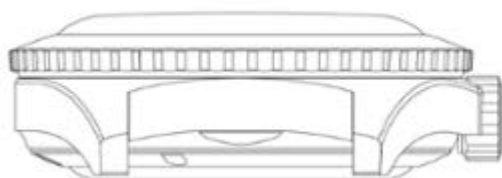

4.4

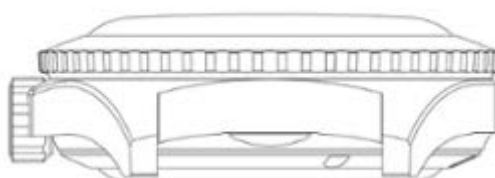

4.5

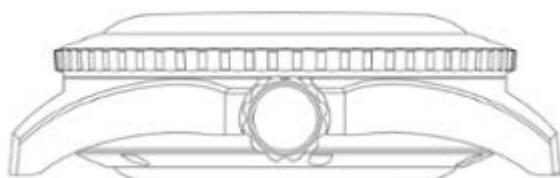

4.6

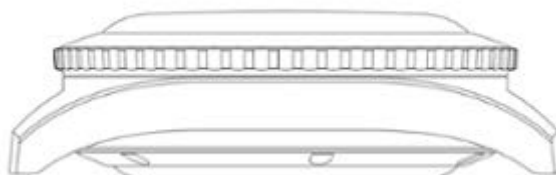

4.7



5.1



5.2

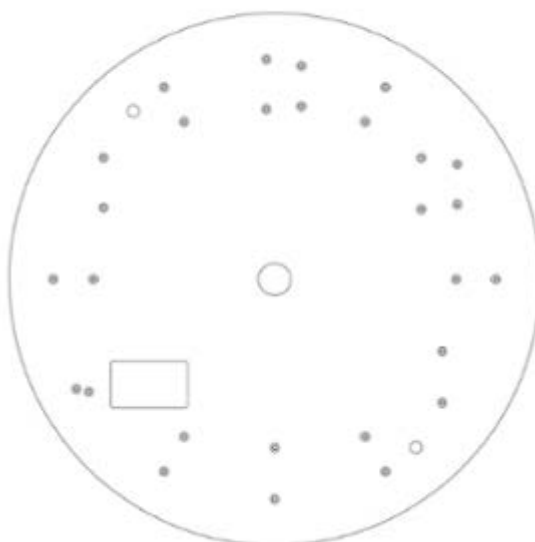

5.3



5.4



5.5



5.6



5.7



- (11) **DM/202 827** (51) **14-04**  
 (15) 2019 02 01 (44) 38/2019 (2019 09 20)  
 (22) 2019 02 01  
 (28) 1  
 (30) No1: 07.08.2018; 29/659182; US  
 (73) Orig3n, Inc.  
 27 Drydock Ave., 6th Floor, 02210 Boston (MA) (US)  
 (85) US  
 (86) US  
 (87) US  
 (88) US  
 (89) US  
 (81) III. AM, IS, MD, TJ, BW, ST, MN, GH, TR, KH, TN, KR, JP, KP, CH, BN, UA, AL, AZ, TM, ME, MC, SG, NA, OA, NO, RS, BA, GE, OM, CA, MK, LI, KG, EM, SY, RW, RU, EG  
 (72) Robin Y. Smith, Orig3n, Inc.  
 27 Drydock Ave., 02210 Boston (US)  
 (74) Graham Watt & Co LLP  
 St. Botolph's House, 7-9 St. Botolph's Road, TN13 3AJ Sevenoaks (GB)  
 (54) 1. Transitional graphical user interface  
 (55)

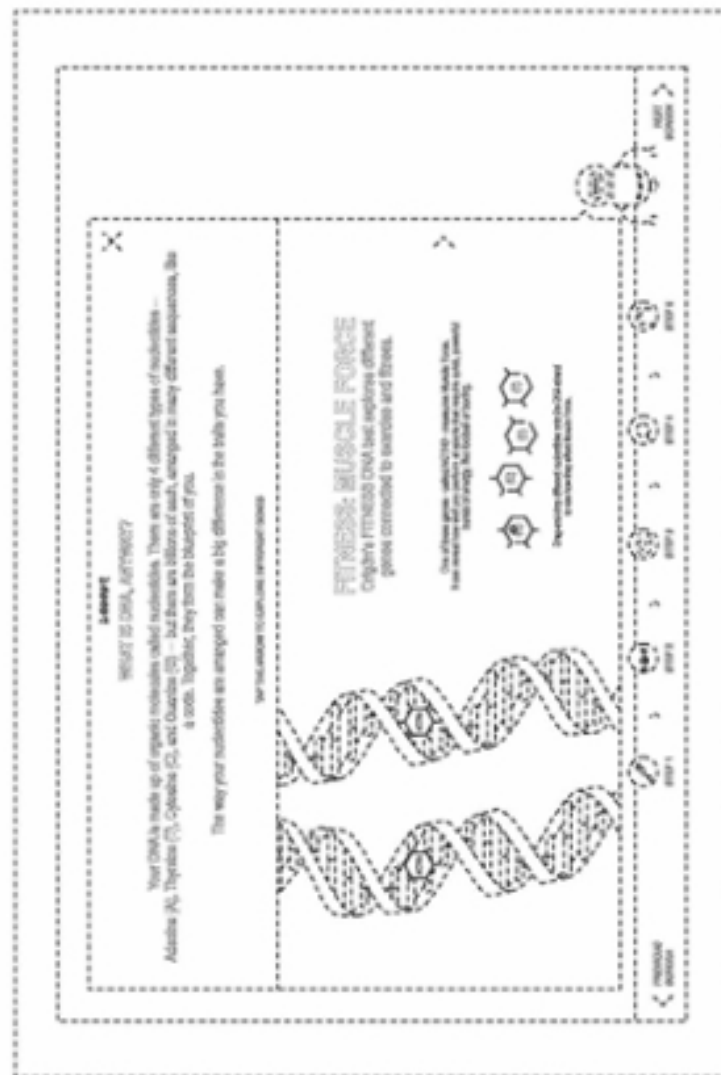

1.1

1.2

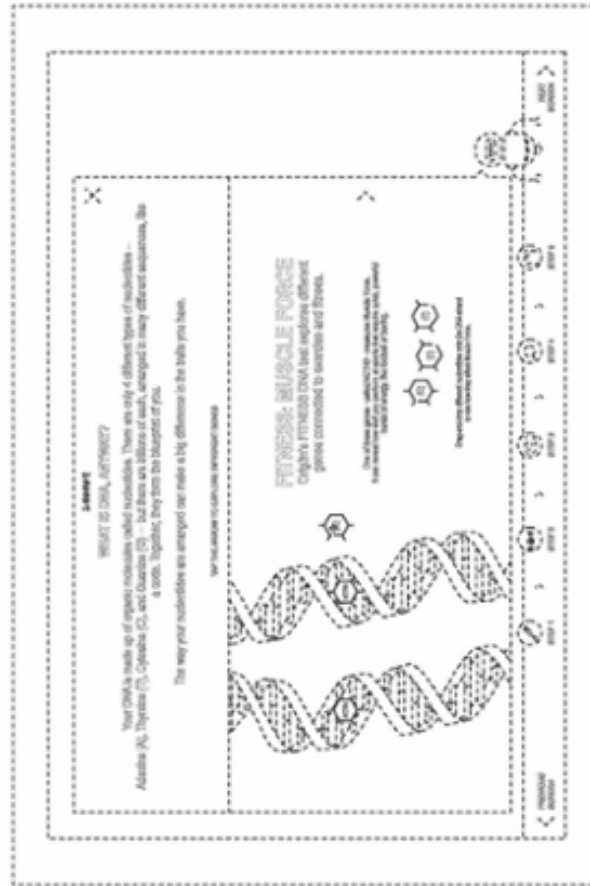

1.3

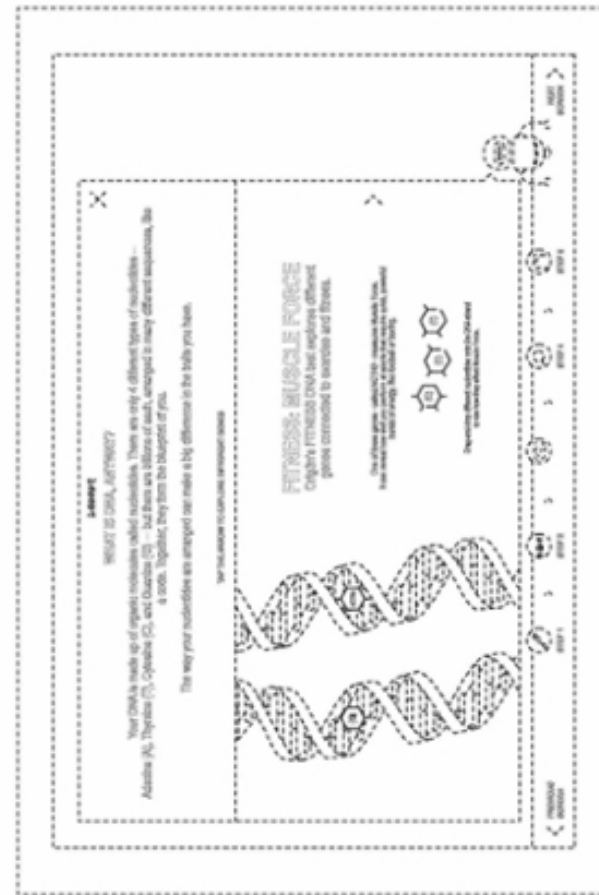

1.4

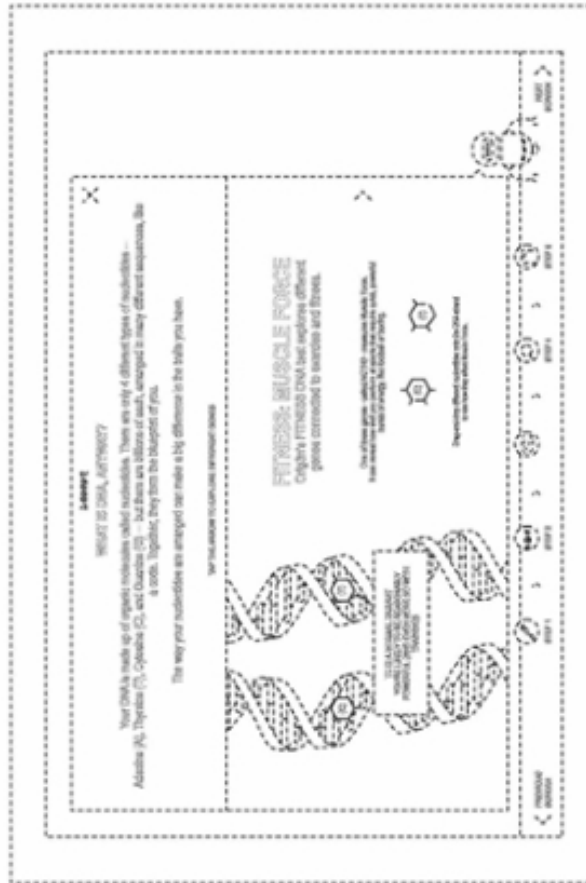

**(11) DM/203 085**

(15) 2019 07 18

(22) 2019 07 18

(28) 3

(73) Chanel SARL

Quai du Général-Guisan 24, 1204 Genève (CH)

(85) CH

(86) CH

(87) CH

(88) CH

(89) CH

(81) IL, GR, III, LV, NO, EE, TR, GE, PL, TN, LT, DK, BG, FI, RU

(72) Marianna NITSCH

135 Avenue Charles De Gaulle, 92521 Neuilly-sur-Seine (FR)

(54) 1.-3 Handbag

(55)

**(51) 03-01**

(44) 40/2019 (2019 10 04)

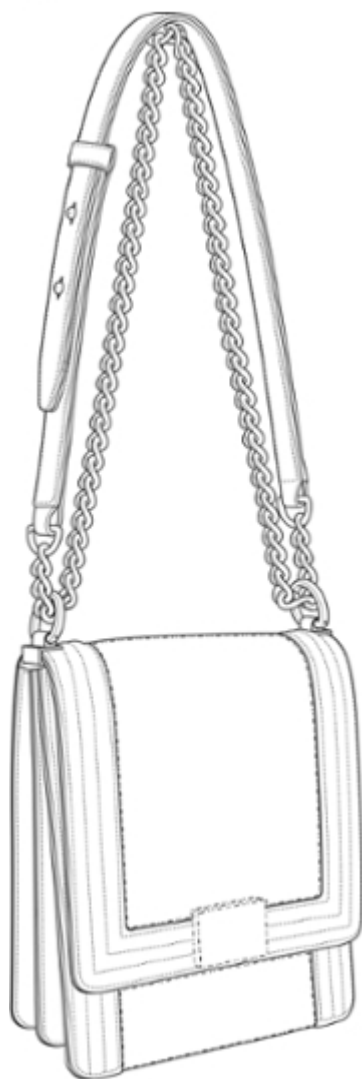
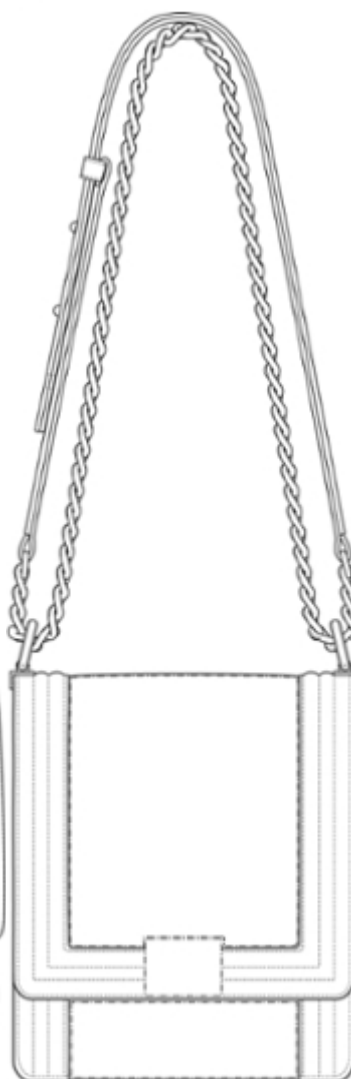
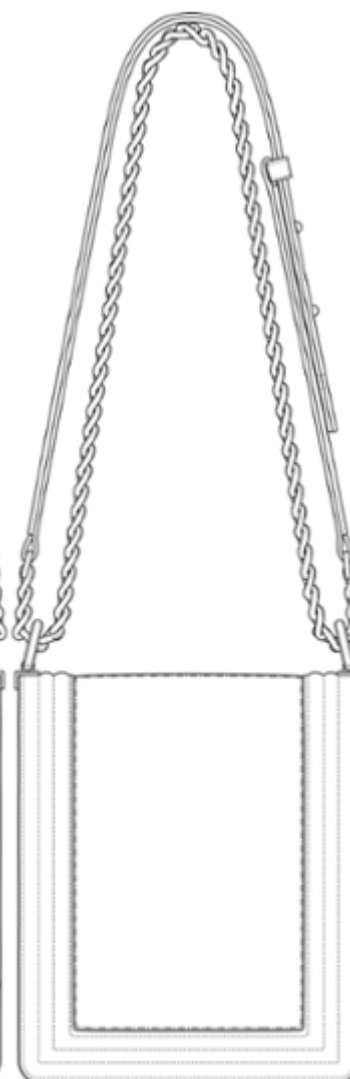
**1.1****1.2****1.3**

1.4



1.5



1.6



1.7

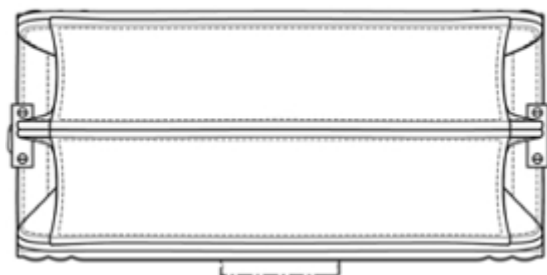

2.1



2.2



2.3



2.4

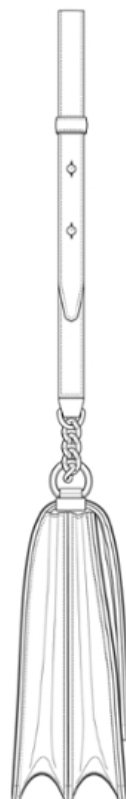

2.5





2.6

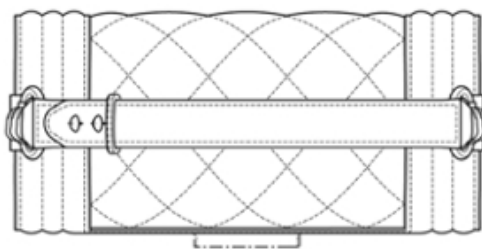

2.7

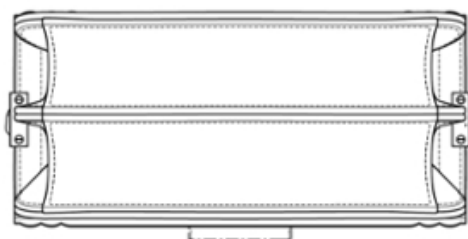

3.1



3.2



3.3

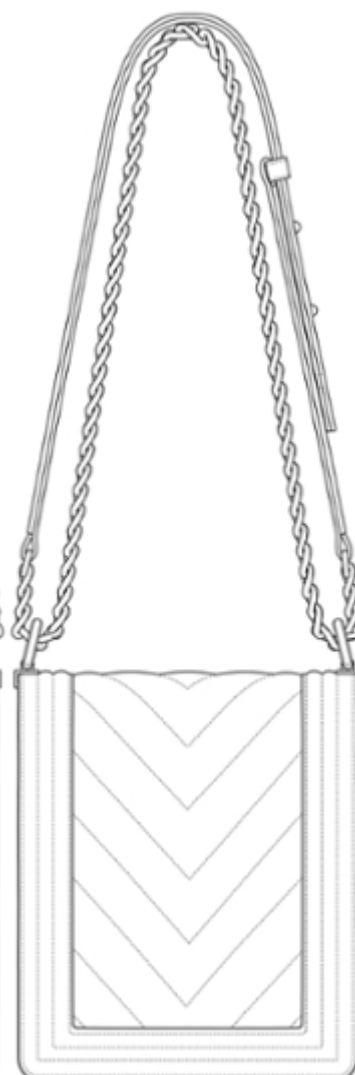

3.4



3.5



3.6

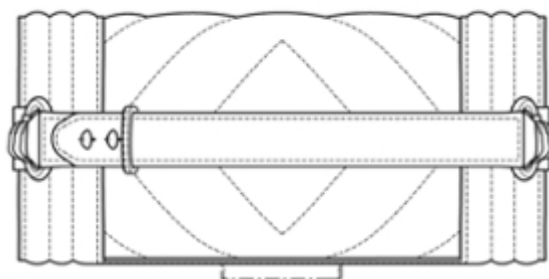

3.7

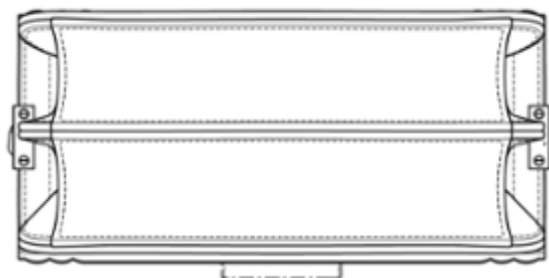

(11) DM/203 100

(15) 2019 08 30

(22) 2019 08 30

(28) 2

(73) Valentino S.p.A.

Via Turati, 16/18, 20121 Milan (IT)

(85) –

(86) IT, EM

(87) IT; EM

(88) IT, EM

(89) EM

(81) III. GE, TR, KG, UA, AZ, EM, KR, JP, TJ, RU

(72) Stefano Sassi

C/o VALENTINO S.p.A., Via Turati, 16/18, 20121 Milan (IT)

(74) Matteo MOZZI

C/o Jacobacci & Partners S.p.A., Via Senato, 8, 20121 Milan (IT)

(54) 1.-2. Bag

(55)

(51) 03-01

(44) 40/2019 (2019 10 04)



1.1



1.2

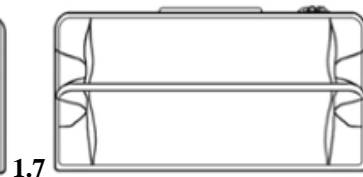
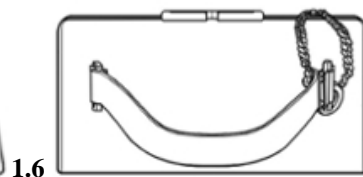
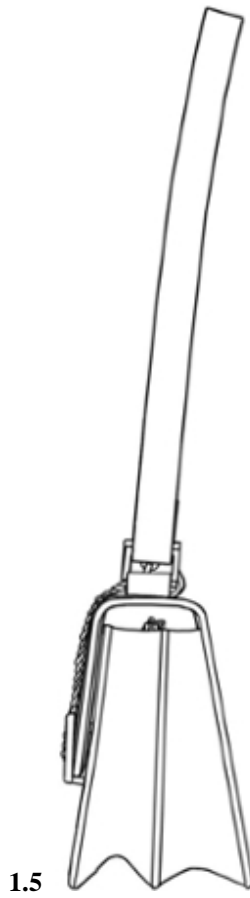
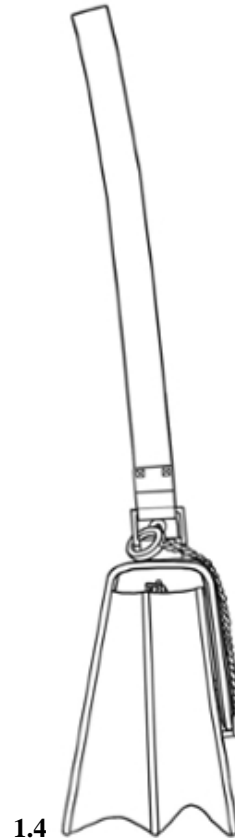

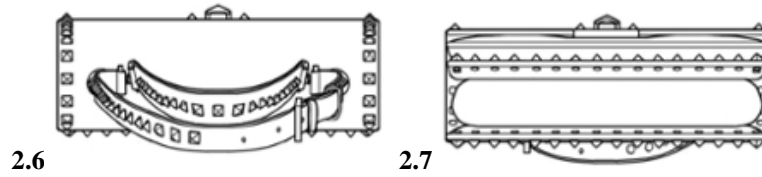
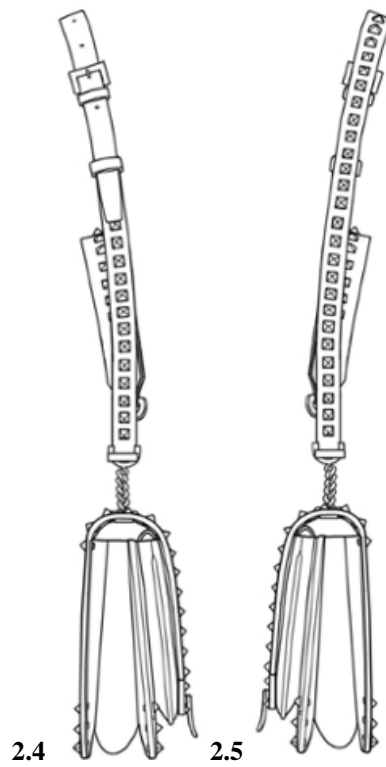
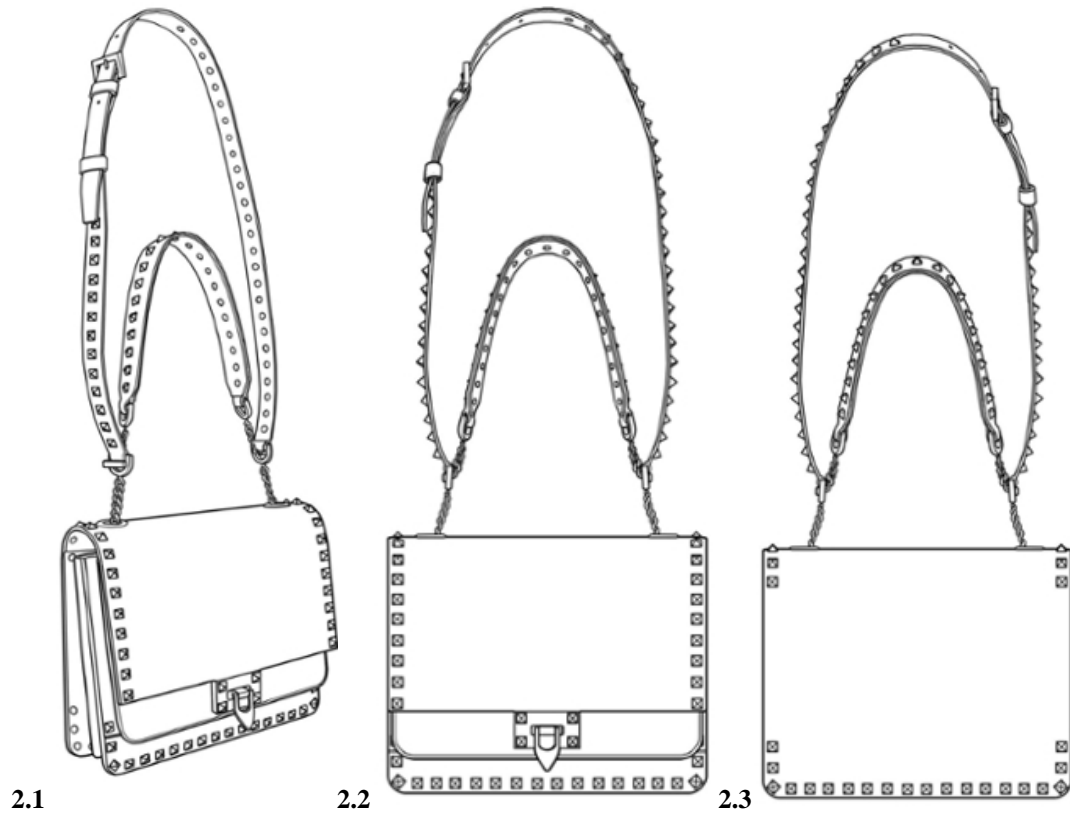

**(11) DM/202 339**

(15) 2019 04 04

(22) 2019 04 04

(28) 2

(73) Nemiroff Intellectual Property Establishment  
Städtle 31, 9490 Vaduz (LI)

(85) LI

(86) LI

(87) LI

(88) LI

(89) LI

(81) III. AM, IS, MD, TJ, TR, KH, TN, KR, JP, CH, UA, AL, TM, AZ, ME, MC, SG, RS, NO, BA, US, GE,  
CA, MK, OM, KG, SM, EM, SY, RW, RU, EG

(72) Iakiv GRIBOV

13A Staronavodnytska Street, App. 18, Kyiv (UA);

Anatoliy KIPISH

Provulok 2d Myrnyi, Building 20/2, Khmelnytskyi (UA)

(74) Isler &amp; Pedrazzini AG

Giesshübelstrasse 45, 8045 Zürich (CH)

(54) 1.-2. Bottle

(55)

**(51) 09-01**

(44) 40/2019 (2019 10 04)

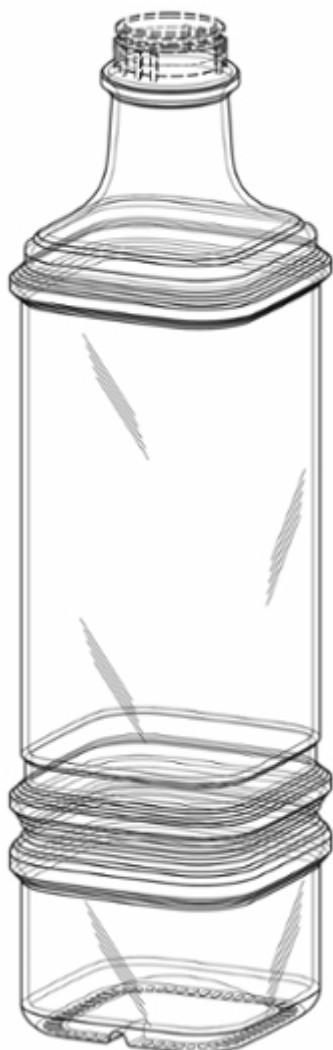
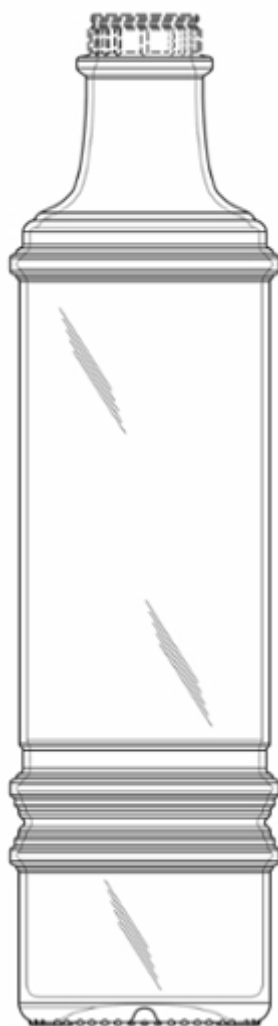
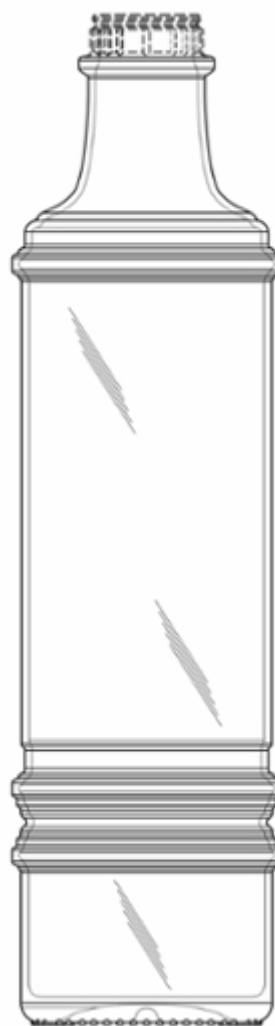
**1.1****1.2****1.3**

1.4

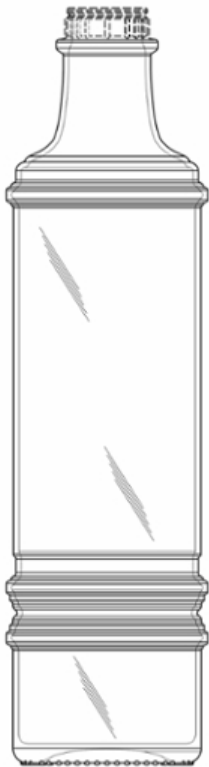

1.5

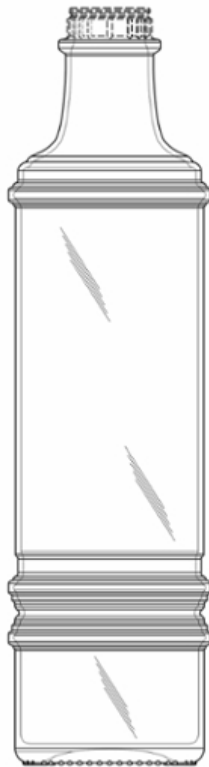

1.6

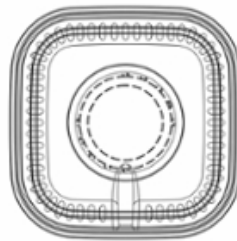

1.7

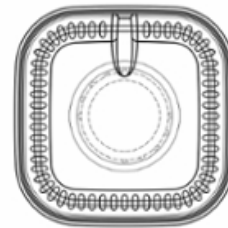

2.1

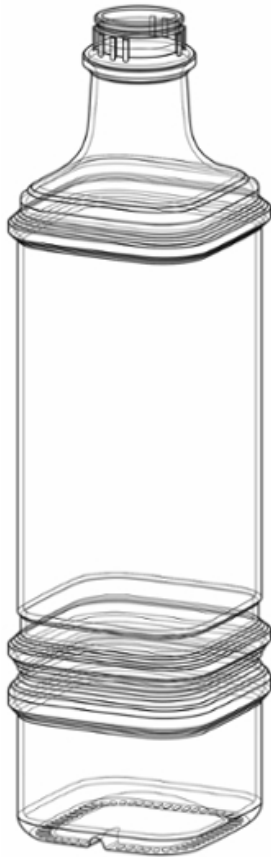

2.2



2.3

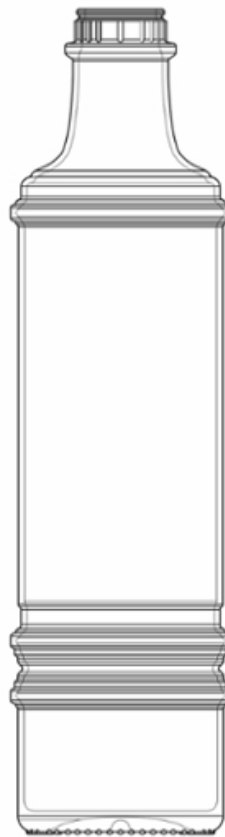

2.4



2.5



2.6

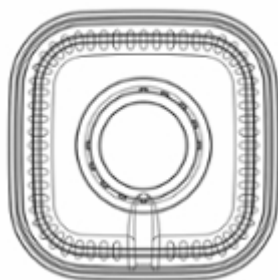

2.7

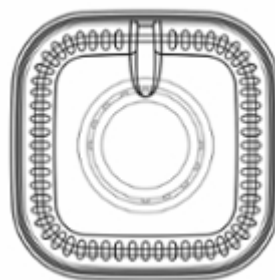



(11) DM/200 871

(15) 2019 04 02

(22) 2019 04 02

(28) 2

(73) HARRY WINSTON SA

Chemin Du Tourbillon 8, 1228 Plan-Les-Ouates (CH)

(85) CH

(86) CH

(87) CH

(88) CH

(89) CH

(81) IL, MA, III, AM, MD, MN, TR, GB, TN, CH, UA, AL, AZ, ME, BZ, MC, SG, NO, BA, CA, MK, GE, OM, LI, KG, EM, RU

(72) 1: Doninique RIVIERE

c/o Harry Winston Inc. 718 Fifth Avenue, 10019 New York (US)

2: Delphine ABDOURAHIM

c/o Harry Winston Inc. 718 Fifth Avenue, 10019 New York (US)

(74) The Swatch Group AG (The Swatch Group SA) (The Swatch Group Ltd.)

Faubourg Du Lac 6, 2501 BIEL/BIENNE (CH)

(54) 1. Earrings, 2. Ring

(55)

1.1



1.2



1.3



1.4



1.5



1.6



1.7



1.8



2.1



2.2



2.3



2.4



2.5



2.6



2.7



2.8



- (11) **DM/203 051** (51) **15-03**  
 (15) 2019 09 09 (44) 40/2019 (2019 10 04)  
 (22) 2019 09 09  
 (28) 1  
 (30) No1: 31.07.2019; WIPO86057; WO  
 (73) MZURI- AGRO Spółka Z Ograniczoną Odpowiedzialnością Spółka Komandytowa  
 Stawowa 1, Śmielin, 89-110 Sadki (PL)  
 (85) –  
 (86) –  
 (87) PL  
 (88) PL  
 (89) PL  
 (81) III, MN, RS, GE, TR, KG, AZ, TM, ME, TJ  
 (72) Marek Różniak  
 Stawowa 1, Śmielin, 89-110 Sadki (PL);  
 Michał Kopydłowski  
 Kaczory 77c, 64-810 Kaczory (PL);  
 Dariusz Jaskulski  
 Grochowskiego 28, 86-061 Brzoza (PL);  
 Jerzy Kaszkowiak  
 Oliwkowa 2, 08-005 Zielonka (PL);  
 Martin Christopher Lole  
 Springfield Farm, Peopleton, WR10 2BF Pershore (GB)  
 (74) Monika Ziełńska  
 PATPOL Kancelaria Patentowa Sp. z o.o. Nowoursynowska 162J, 02-776 Warsaw (PL)  
 (54) 1. Agricultural machine  
 (55)

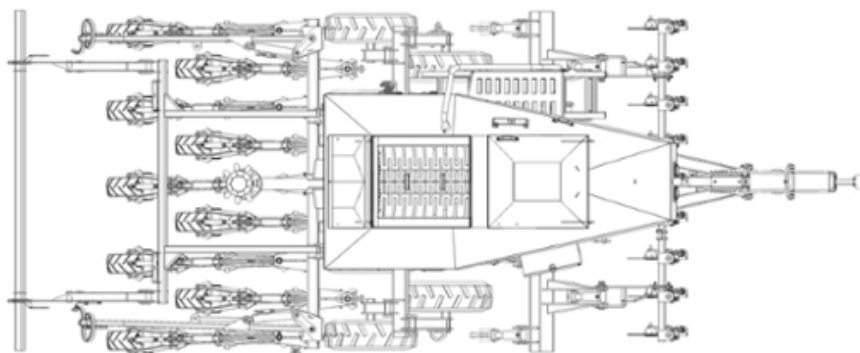

1.1

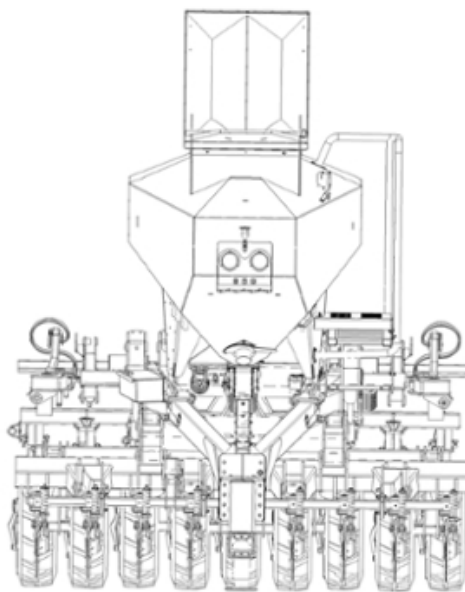

1.2

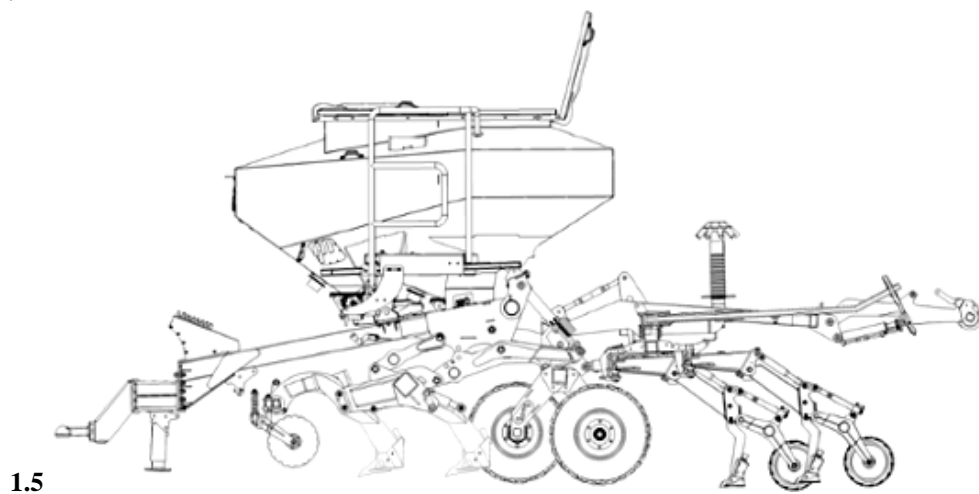
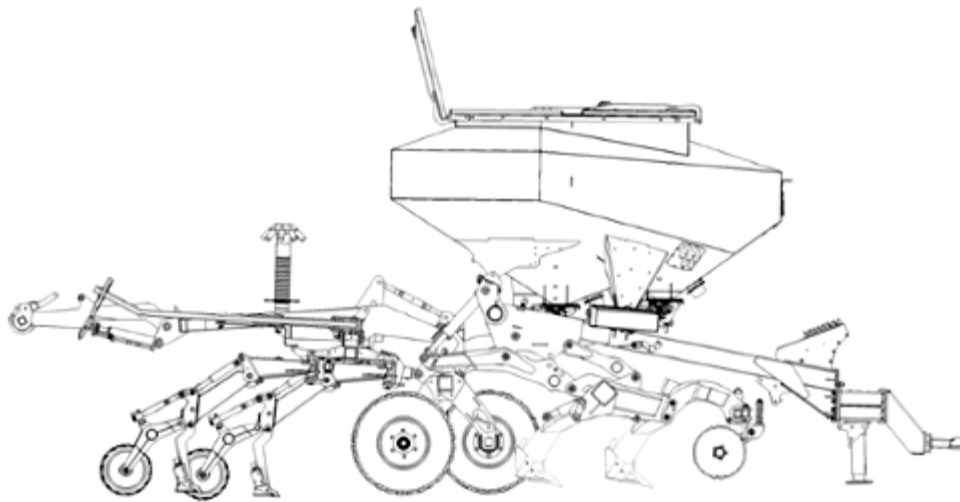
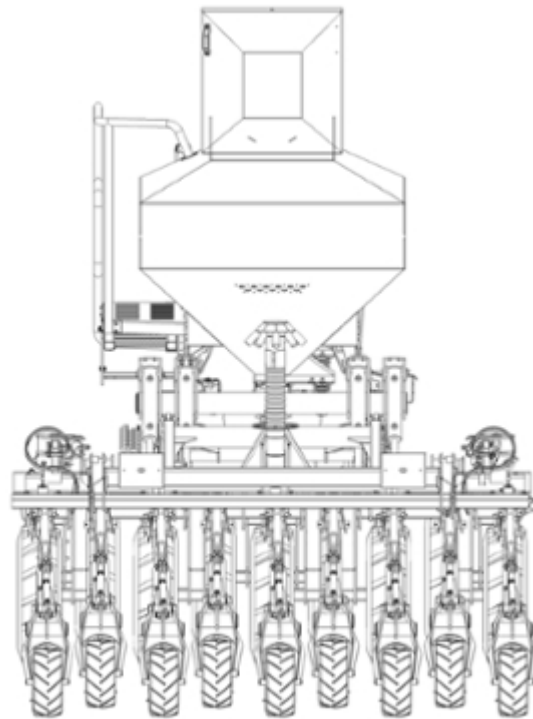

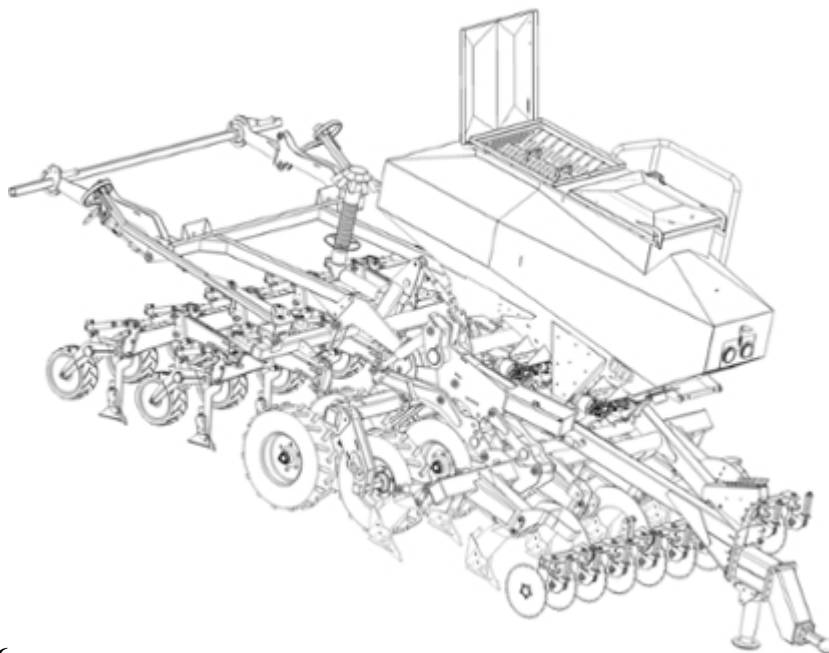

1.6

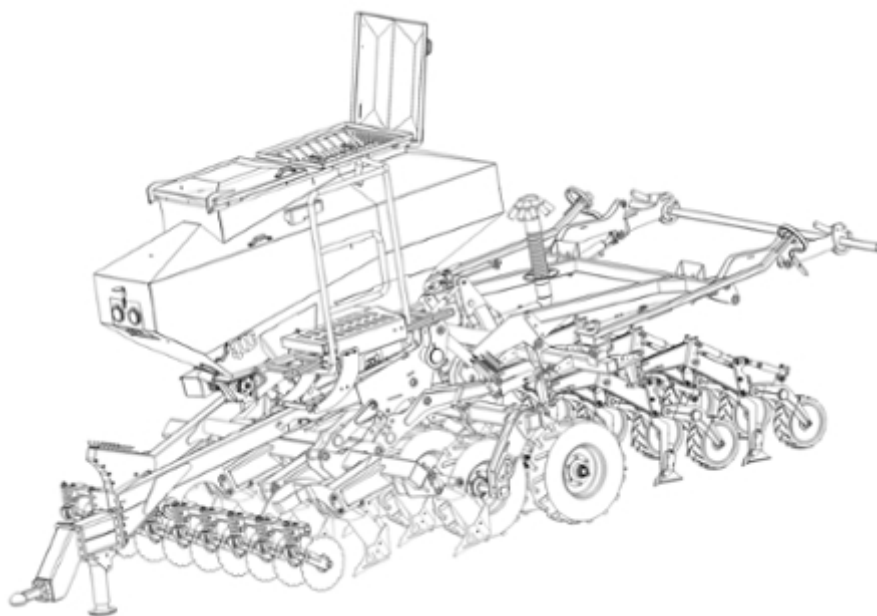

1.7

**(11) DM/202 998**

(15) 2019 08 27

(22) 2019 08 27

(28) 1

(30) No1: 25.02.2018; 29/638,171; US

(73) Shaul Shai Harari

119 West 40th Street 2nd Floor, 10018 New York (US)

Kelly Harari

119 West 40th Street 2nd Floor, 10018 New York (US)

(85) US; US

(86) –; US

(87) US; US

(88) –; –

(89) US; US

(81) III. ES, HU, IS, MN, PL, GB, LT, KR, JP, BN, FR, AL, HR, LV, TM, MC, SG, NA, DE, BA, US, MK, LI, KG, FI, RU, EG, AM, MD, TJ, BW, ST, GH, TR, KH, TN, KP, CH, UA, AZ, ME, SI, OA, RS, NO, EE, GE, OM, RO, EM, DK, SY, BG, RW

(72) Kelly Harari

119 West 40th Street 2nd Floor, 10018 New York (US);

Shaul Shai Harari

119 West 40th Street 2nd Floor, 10018 New York (US)

(74) Michael L. Greenberg

1775 Eye St., NW Suite 1150, 20006 Washington (US)

(54) 1. Cosmetics applicator

(55)

**(51) 28-02**

(44) 40/2019 (2019 08 27)

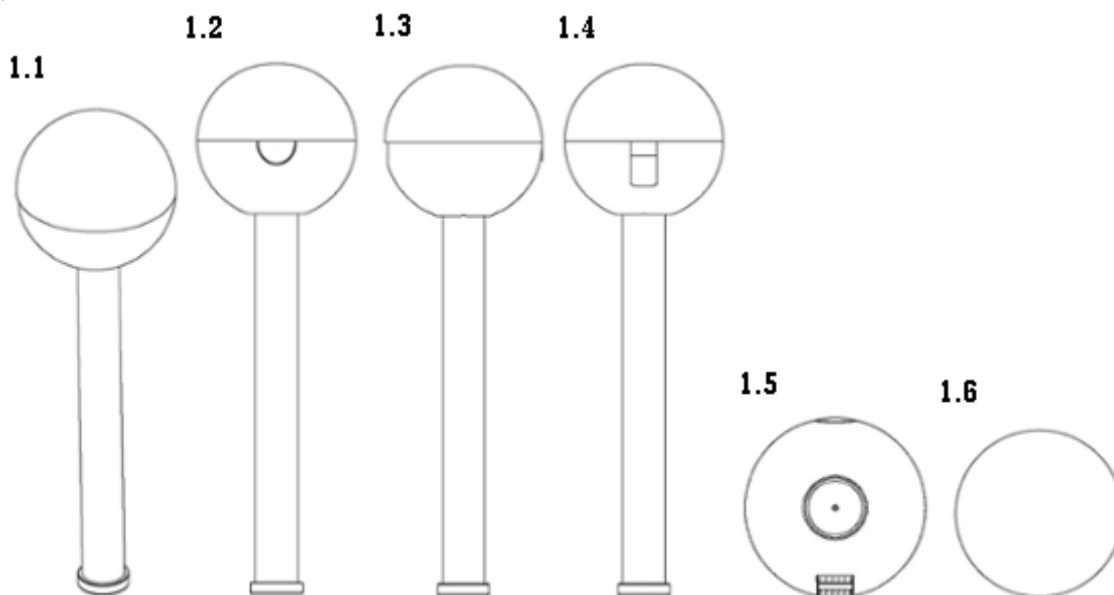

**(11) DM/203 392**

(15) 2019 09 24

(22) 2019 09 24

(28) 3

(73) Chanel SARL

Quai Du Général-Guisan 24, 1204 Genève (CH)

(85) CH

(86) CH

(87) CH

(88) CH

(89) CH

(81) II. GR, MA III. UA, LV, NO, EE, GE, TR, PL, TN, LT, DK, BG, FI, RU, EG

(72) Marianna NITSCH

135 Avenue Charles De Gaulle, 92521 Neuillysur-Seine (FR)

(54) 1.-3. Handbag

(55)

**(51) 03-01**

(44) 42/2019 (2019 10 18)

**1.1****1.2**



1.3



1.4



1.5



1.6

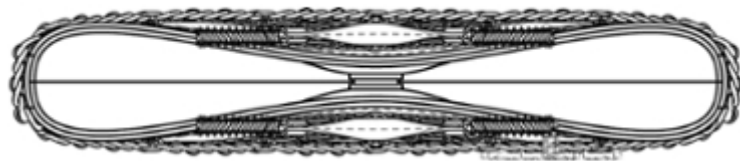

1.7

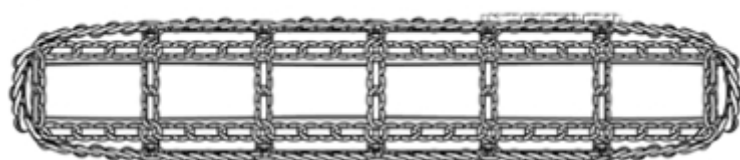

2.1

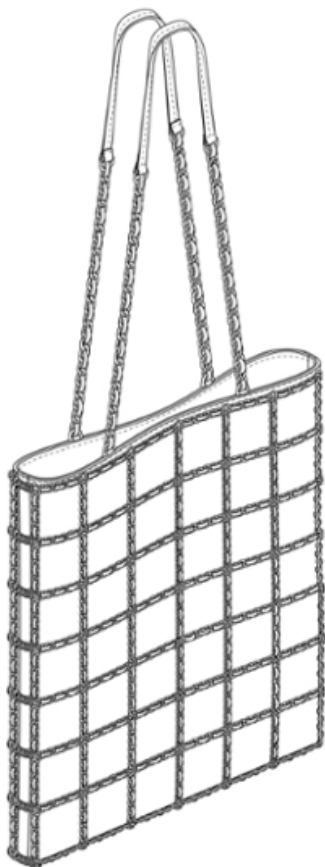

2.2



2.3



2.4

2.5



2.6

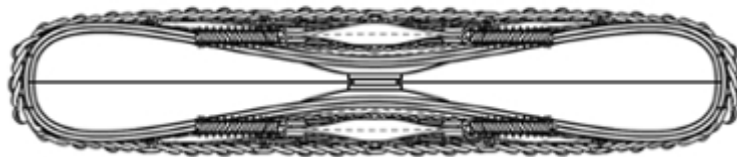

2.7

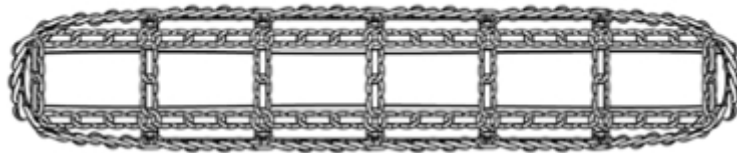

3.1

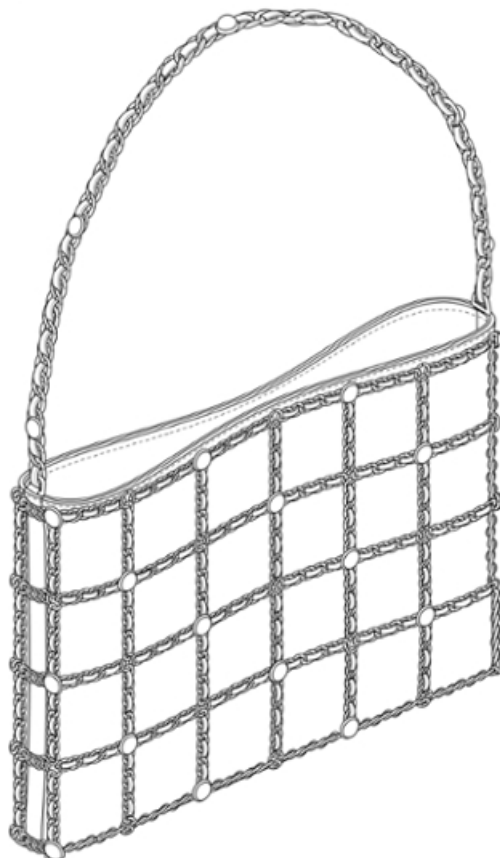

3.2

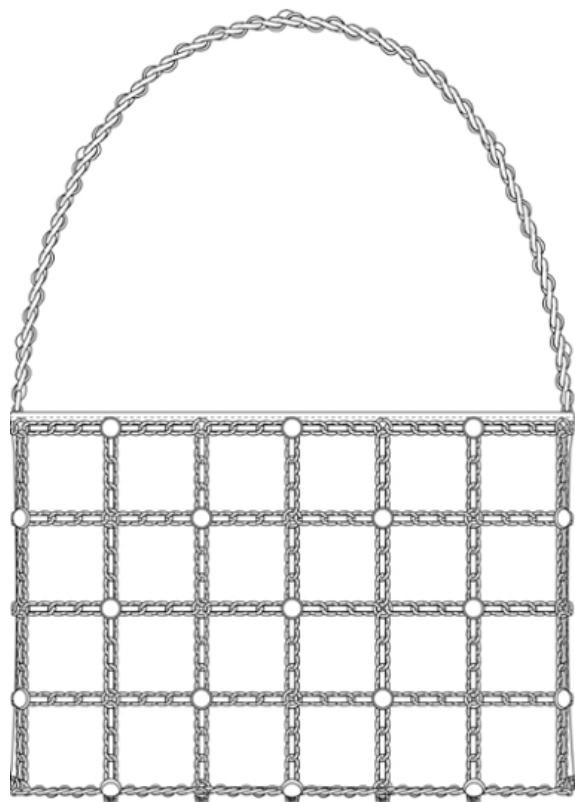

3.3

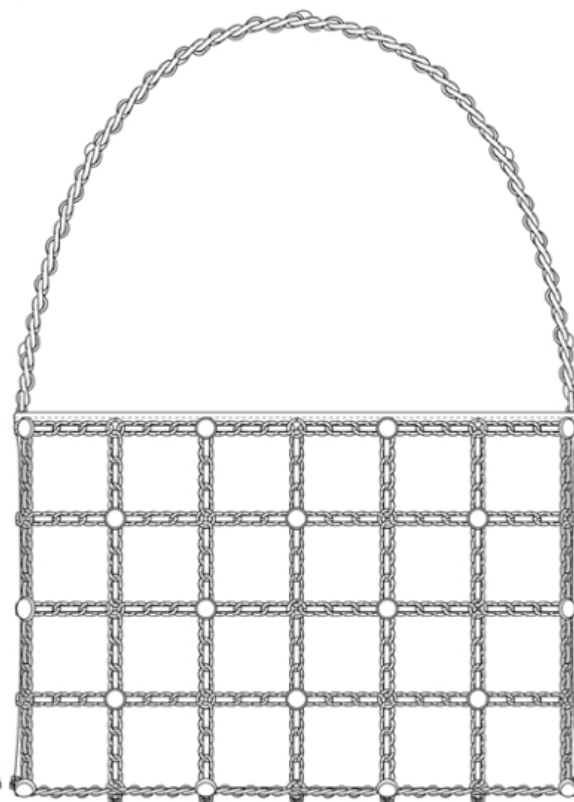

3.4

3.5

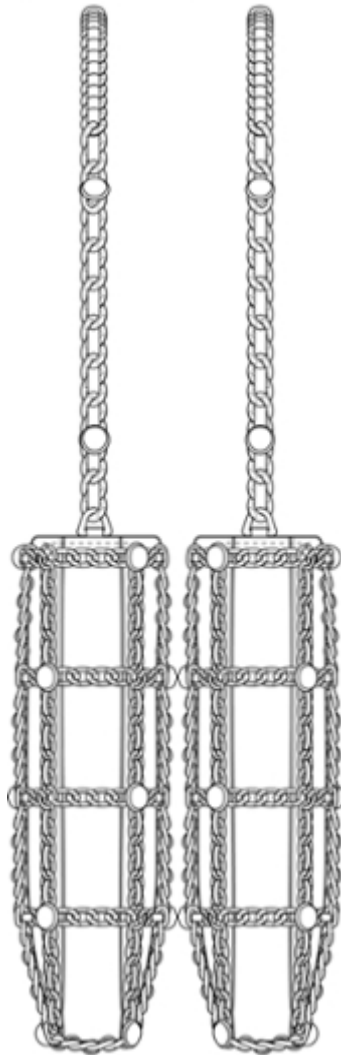

3.6

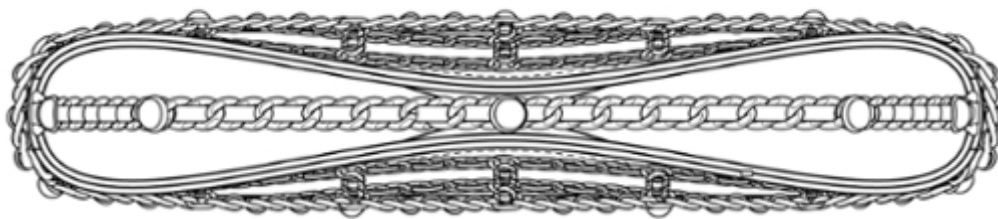

3.7

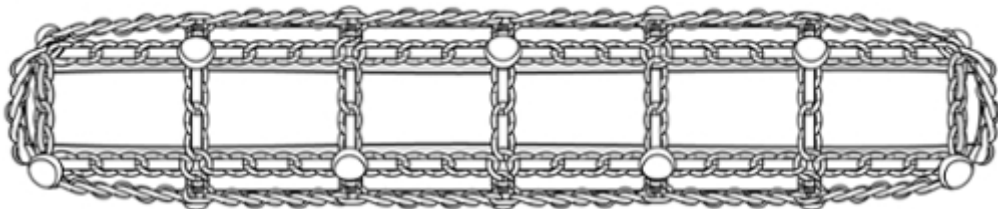

**(11) DM/200 981**

(15) 2019 04 16

(22) 2019 04 16

(28) 1

(73) HARRY WINSTON SA

Chemin Du Tourbillon 8, 1228 Plan-Les-Ouates (CH)

(85) CH

(86) CH

(87) CH

(88) CH

(89) CH

(81) IL, MA, III, AM, MD, MN, TR, GB, TN, CH, UA, AL, AZ, BZ, ME, MC, SG, NO, BA, CA, GE, MK, OM, LI, KG, EM, RU

(72) Rie YATSUGI-KANG

C/o Harry Winston Inc. 718 Fifth Avenue, 10019 New York (US)

(74) The Swatch Group AG (The Swatch Group SA) (The Swatch Group Ltd.)

Faubourg Du Lac 6, 2501 BIEL/BIENNE (CH)

(54) 1. Ring

(55)

1.1



1.2



1.4

1.3



1.5



1.6



1.7



1.8



1.9



**(11) DM/203 348**

(15) 2019 09 24

(22) 2019 07 25

(28) 2

(73) Rotel Tours - Das Rollende Hotel - Georg Höltl GmbH & Co. KG  
Herrenstrasse 11, 94104 Tittling (DE)

(85) DE

(86) DE

(87) DE

(88) DE

(89) DE

(81) II. MA, ML, SR III. AM, IS, MD, TJ, BW, MN, TR, KH, TN, CH, UA, BN, AL, TM, AZ, ME, BZ, MC,  
SG, NA, OA, RS, NO, BA, OM, GE, LI, KG, EM, RW, EG(72) Peter Alexander Höltl  
Herrenstrasse 11, 94104 Tittling (DE)(74) Weickmann & Weickmann Patent- Und Rechtsanwälte PartmbB  
Richard-Strauss-Strasse 80, 81679 Munich (DE)

(54) 1. Portable cabin, 2. Portable cabin

(55)

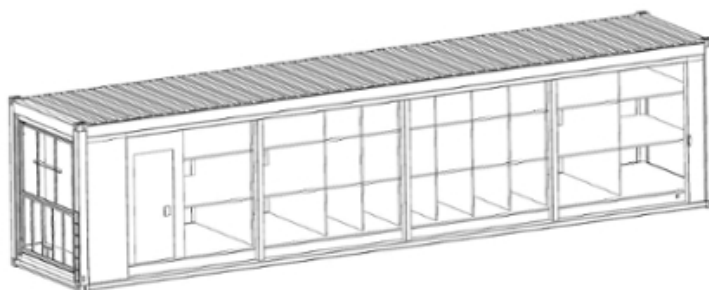
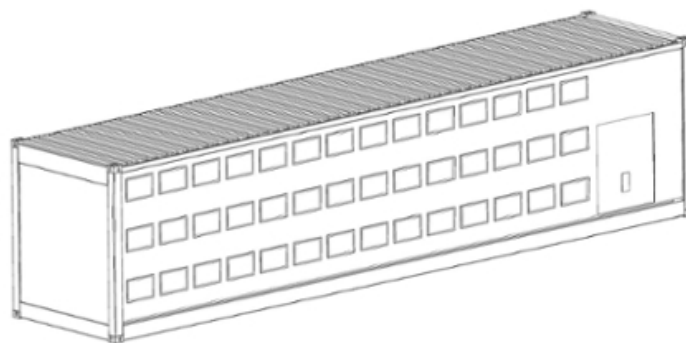
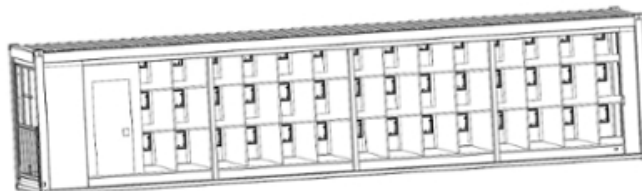
**1.1****1.2****2.1****2.2**



(11) DM/203 436

(15) 2019 05 10

(22) 2019 05 10

(28) 1

(73) Valentino S.p.A.

Via Turati, 16/18, 20121 MILANO (IT)

(85) --

(86) IT, EM

(87) IT, EM

(88) IT, EM

(89) EM

(81) III. GE, TR, US, KG, UA, AZ, EM, KR, JP, TJ, RU

(72) Stefano Sassi

C/o VALENTINO S.p.A., Via Turati, 16/18, 20121 Milano (IT)

(74) Salvatore Giovanni PENNACCHIO

C/o Jacobacci & Partners S.p.A., Via Senato, 8, 20121 MILANO (IT)

(54) 1. Shoe

(55)

(51) 02-04

(44) 43/2019 (2019 10 25)



1.1

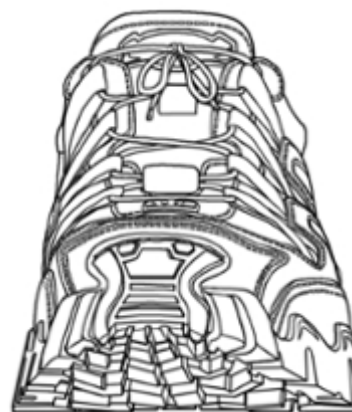

1.2

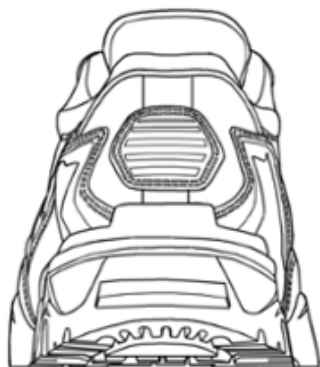

1.3

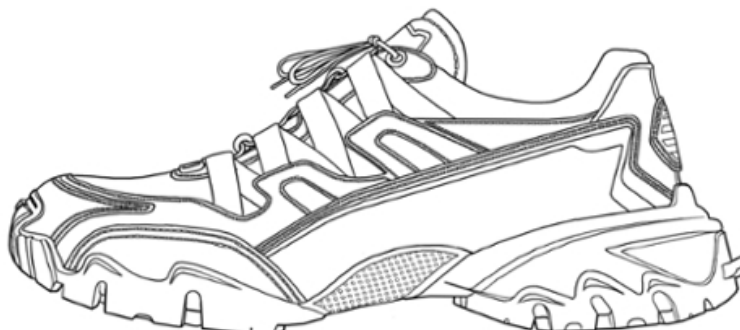

1.4

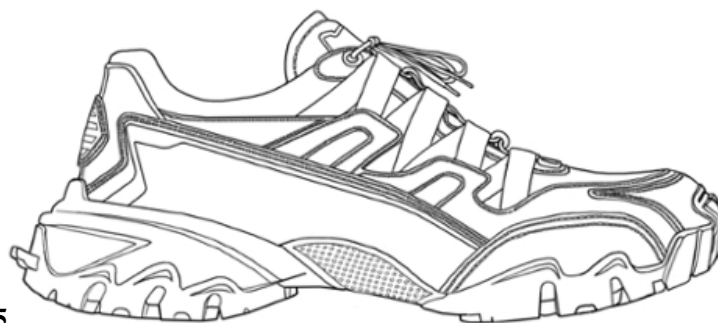

1.5

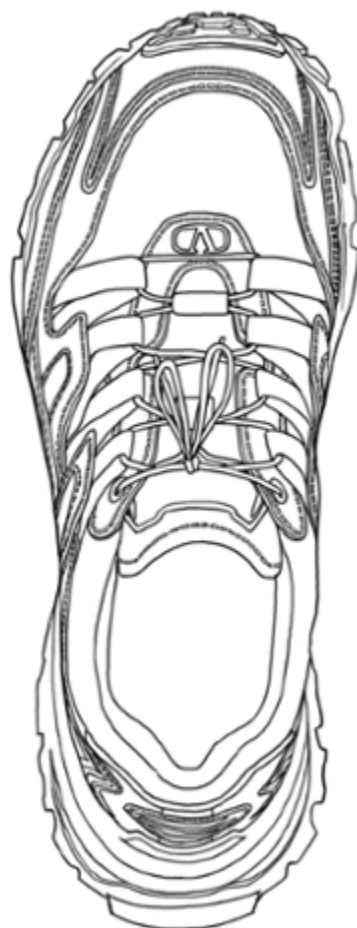

1.6



1.7



1.8

(11) DM/203 464

(15) 2019 03 28

(22) 2019 03 28

(28) 1

(73) Valentino S.p.A.

Via Turati, 16/18, I-20121 MILANO (IT)

(85) --

(86) IT, EM

(87) IT, EM

(88) IT, EM

(89) EM

(81) III. GE, TR, US, KG, UA, AZ, EM, KR, TJ, JP, RU

(72) Stefano Sassi

C/o VALENTINO S.p.A., Via Turati, 16/18, I-20121 Milano (IT)

(74) Mozzi Matteo

C/o Jacobacci & Partners S.p.A., Via Senato, 8, I-20121 MILANO (IT)

(54) 1. Shoes

(55)



1.1



1.2

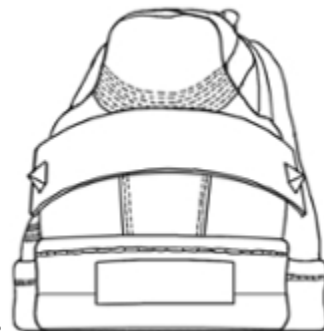

1.3

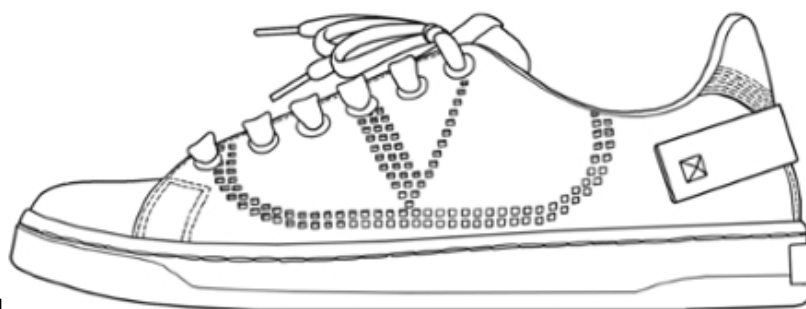

1.4

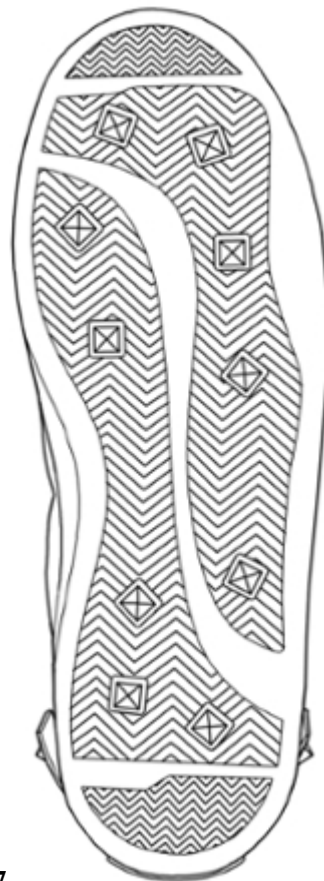
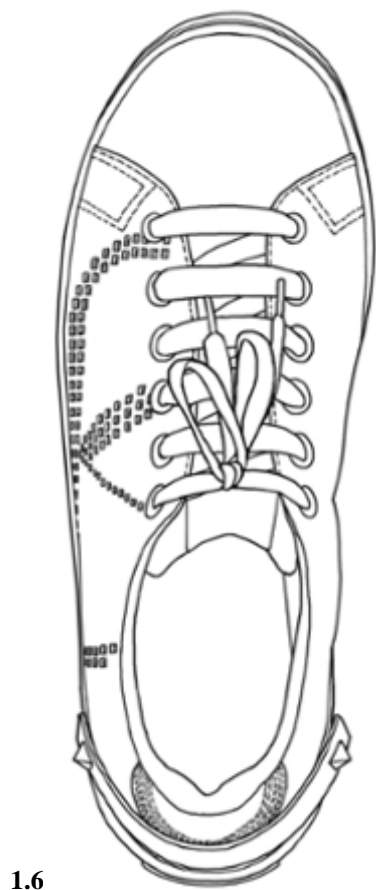
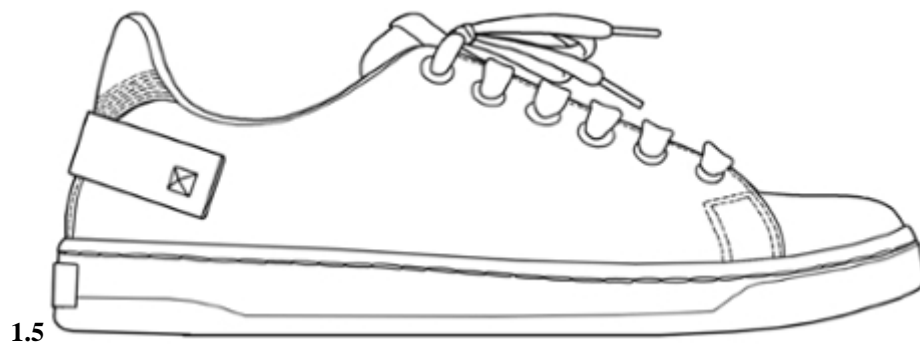

(11) DM/203 477

(15) 2019 05 24

(22) 2019 05 24

(28) 1

(73) Valentino S.p.A.

Via Turati, 16/18, I-20121 MILANO (IT)

(85) –

(86) IT, EM

(87) IT, EM

(88) IT, EM

(89) EM

(81) III. TR, US, GE, KG, UA, AZ, EM, KR, JP, TJ, RU

(72) Stefano Sassi

C/o VALENTINO S.p.A. Via Turati, 16/18, I-20121 Milano (IT)

(74) Matteo MOZZI

C/o Jacobacci & Partners S.p.A. Via Senato, 8, I-20121 MILANO (IT)

(54) 1. Shoe

(55)

(51) 02-04

(44) 43/2019 (2019 10 25)

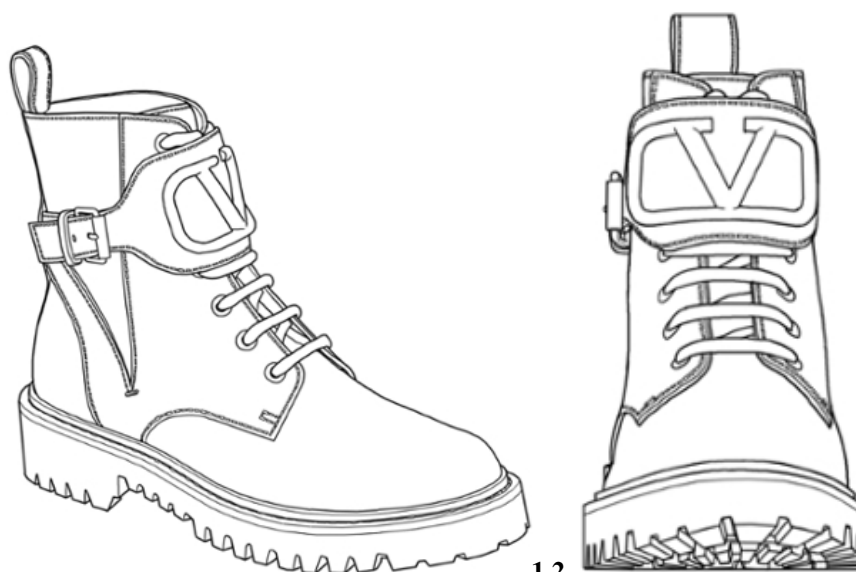

1.1

1.2

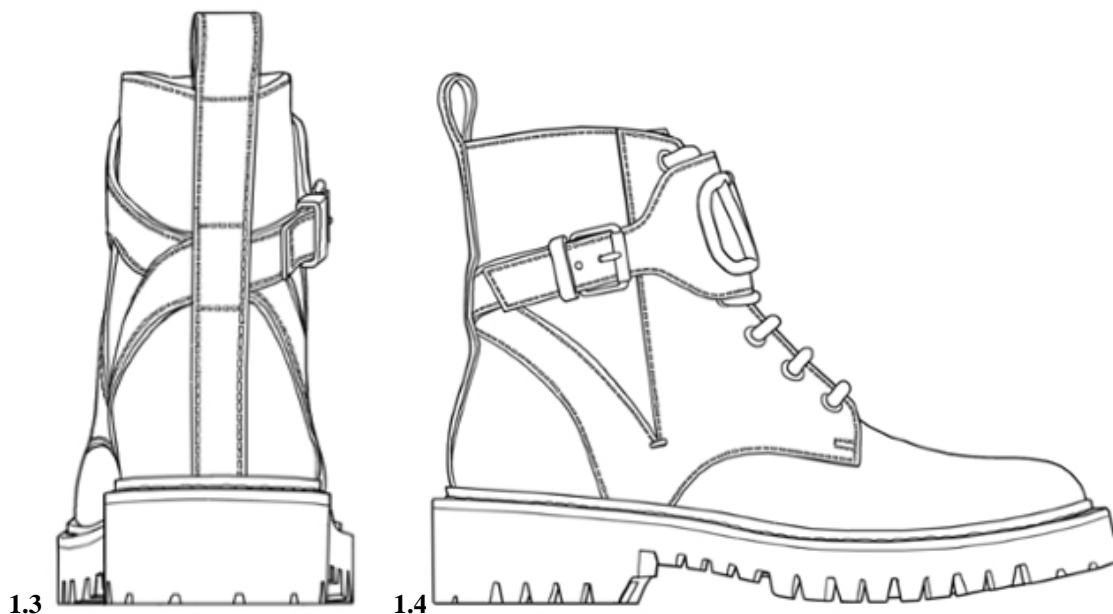

1.3

1.4

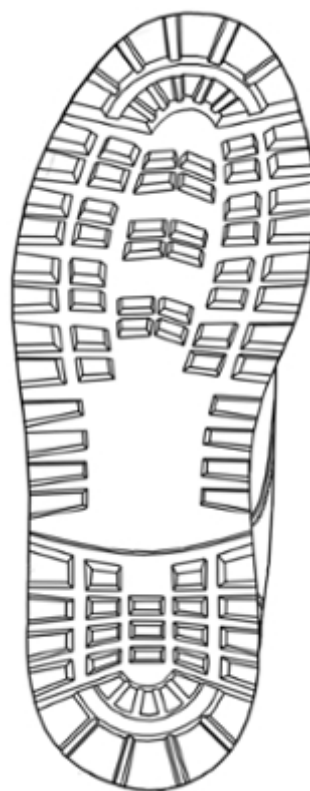
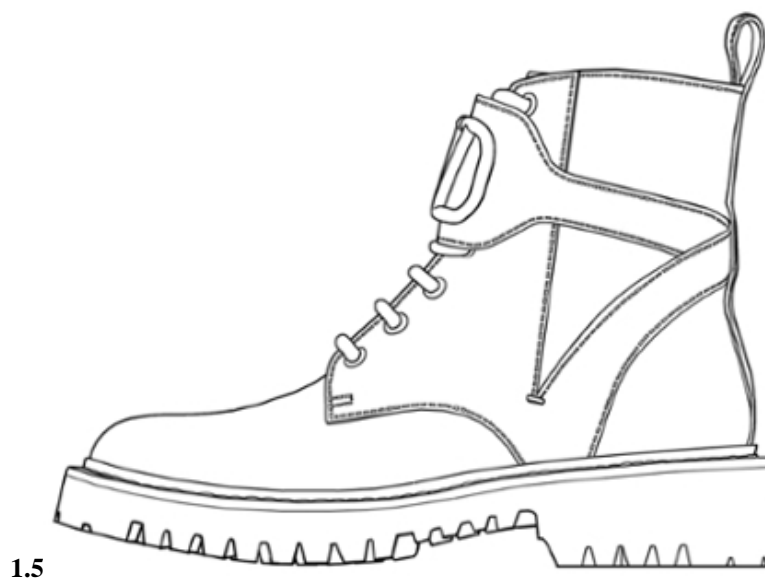

(11) DM/203 468

(15) 2019 06 06

(22) 2019 06 06

(28) 1

(73) Valentino S.p.A.

Via Turati, 16/18, I-20121 MILANO (IT)

(85) –

(86) IT, EM

(87) IT, EM

(88) IT, EM

(89) EM

(81) III. GE, TR, US, KG, UA, AZ, EM, KR, TJ, JP, RU

(72) Stefano Sassi

C/o VALENTINO S.p.A., Via Turati, 16/18, I-20121 Milano (IT)

(74) Matteo MOZZI

C/o Jacobacci & Partners S.p.A., Via Senato, 8, I-20121 MILANO (IT)

(54) 1. Bag

(55)

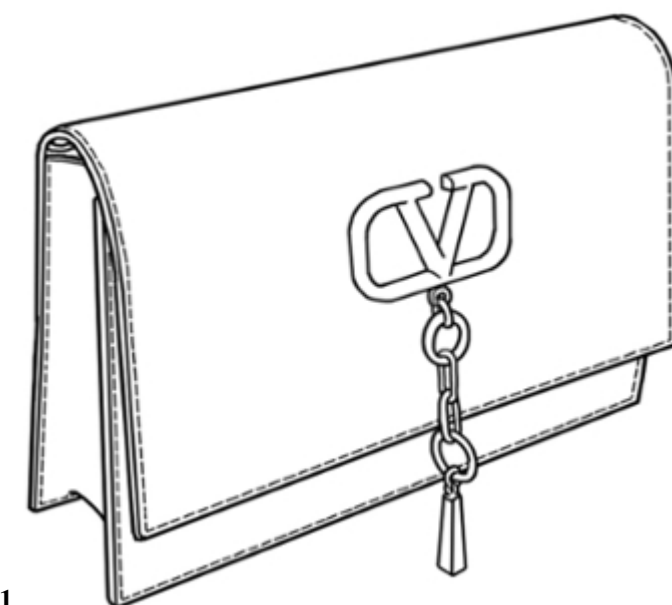

1.1

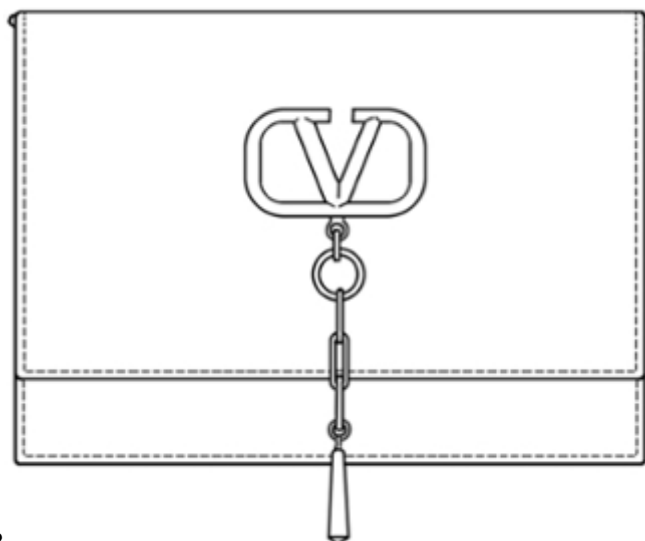

1.2

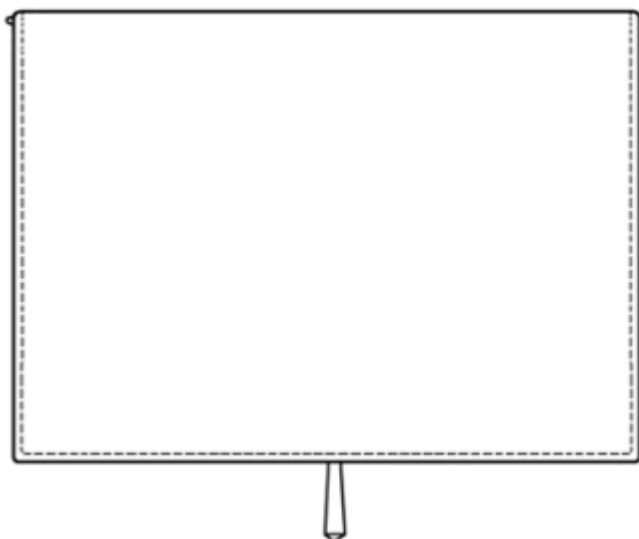

1.3

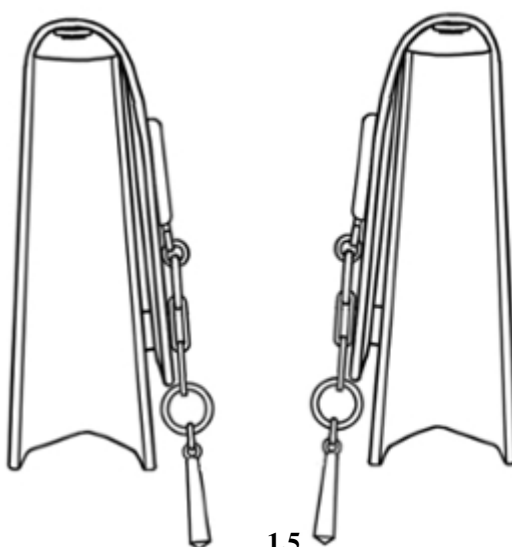

1.4

1.5

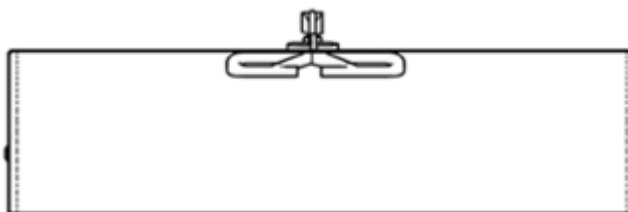

1.6

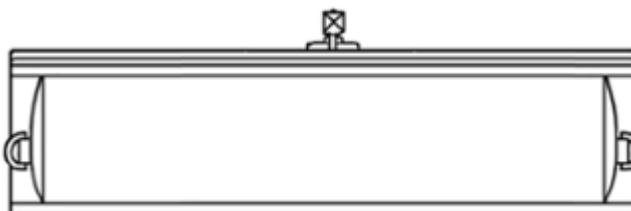

1.7



**(11) DM/203 508**

(15) 2019 03 14

(22) 2019 03 14

(28) 2

(30) No1: 23.12.2019; 005800240; EM; No2: 23.12.2019; 005800240; EM

(73) ADVENTIA PHARMA, S.L.

San Bernardo, 22, 1ª Planta, 35002 Las Palmas De Gran Canaria (ES);

Andrés CABELLO REY

Doctor Manuel Lezcano, 8., 35017 Las Palmas De Gran Canaria (ES)

(85) ES; ES

(86) ES; ES

(87) ES; ES

(88) ES; ES

(89) EM; EM

(81) III. AM, IS, MD, TJ, BW, ST, GH, MN, TR, KH, TN, KR, JP, KP, CH, BN, UA, AL, AZ, TM, ME, BZ,

MC, SG, NA, OA, NO, RS, BA, CA, GE, MK, US, OM, LI, KG, SM, SY, RW, RU, EG

(72) Andrés CABELLO REY

Doctor Manuel Lezcano, 8., 35017 Las Palmas De Gran Canaria (ES)

(74) ABG Intellectual Property Law, S.L.

Avenida De Burgos, 16 D, 28036 Madrid (ES)

(54) 1.-2. Container for food preparations and for drugs

(55)

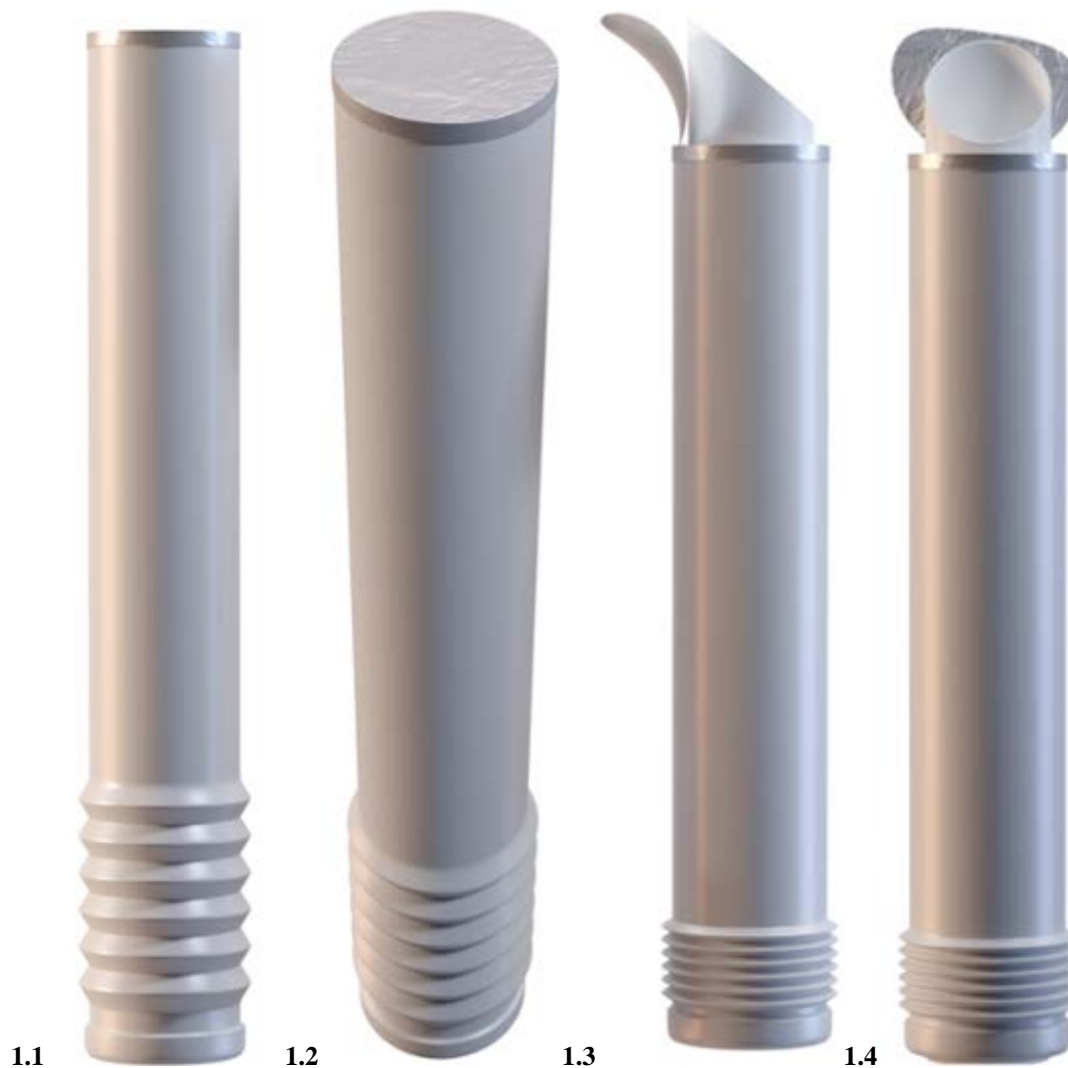



(11) DM/200 870

(15) 2019 04 23

(22) 2019 04 23

(28) 2

(73) HARRY WINSTON SA

Chemin Du Tourbillon 8, 1228 Plan-Les-Ouates (CH)

(85) CH

(86) CH

(87) CH

(88) CH

(89) CH

(81) IL, MA, III, AM, MD, MN, TR, GB, TN, CH, UA, AL, AZ, BZ, ME, MC, SG, NO, BA, CA, MK, GE, OM, LI, KG, EM, RU

(72) 1 Delphine ABDOURAHIM

C/o Harry Winston Inc. 718 Fifth Avenue, 10019 New York (US);

2 Doninique RIVIERE

C/o Harry Winston Inc. 718 Fifth Avenue, 10019 New York (US)

(74) The Swatch Group AG (The Swatch Group SA) (The Swatch Group Ltd.)

Faubourg Du Lac 6, 2501 BIEL/BIENNE (CH)

(54) 1.-2. Ring

(55)

(51) 11-01

(44) 43/2019 (2019 10 25)



1.1



1.2



1.3



1.4



1.5



1.6



1.7



1.8



2.1



2.2



2.3

2.4



2.5



2.6



2.7



2.8



---

# TRADEMARKS

## APPLICATIONS FILED UNDER THE NATIONAL PROCEDURE APPROVED FOR REGISTRATION

The decision can be appealed at the Chamber of Appeal of Sakpatenti within 3 months from the publication or at the Mtskheta District Court Administrative Cases Board (Address: №17, Samkhedro St., Mtskheta), within 1 month following the publication.

(260) AM 2020 100410 A  
(210) AM 100410  
(220) 2019 05 28  
(731) LTD "L COMPANY"  
Gldani, VII mkr., korp. 15, ap. 39,  
Tbilisi, Georgia  
(540)

**EL Company**

(591) Black, white  
(511) 35

---

(260) AM 2020 100764 A\*  
(210) AM 100764  
(220) 2018 12 07  
(731) ALIBABA GROUP HOLDING LIMITED  
4 Flor, One Capital Place, P.o. Box 847,  
George Town, Grand Cayman, Cayman  
Islands  
(740) Tamaz Shilakadze  
(540)

**ALIEXPRESS**

(591) Black, white  
(511) 35

---

(260) AM 2020 103099 A  
(210) AM 103099  
(220) 2019 05 14  
(731) Natia Baiashvili  
Gldani, II mkr., Korp. 46, ap. 29,  
Tbilisi, Georgia  
(540)

**ბროწეული  
pomegranate**

(591) Black, white  
(511) 43

---

(260) AM 2020 103184 A  
(210) AM 103184  
(220) 2019 05 20  
(731) Berlin-Chemie AG  
Gliniker Veg 125, Berlini, 12489, Germany

(740) Giorgi Ghvinjilia  
(540)

**Novo-Nail**

(591) Black, white  
(511) 10

---

(260) AM 2020 103185 A  
(210) AM 103185  
(220) 2019 05 20  
(731) Berlin-Chemie AG  
Gliniker Veg 125, Berlini, 12489, Germany  
(740) Giorgi Ghvinjilia  
(540)

**Ново-Нейл**

(591) Black, white  
(511) 10

---

(260) AM 2020 103186 A  
(210) AM 103186  
(220) 2019 05 20  
(731) Berlin-Chemie AG  
Gliniker Veg 125, Berlini, 12489, Germany  
(740) Giorgi Ghvinjilia  
(540)

**ნოვო-ნეილ**

(591) Black, white  
(511) 10

---

(260) AM 2020 103209 A  
(210) AM 103209  
(220) 2019 05 23  
(731) JOHNSON & JOHNSON  
ONE JOHNSON & JOHNSON PLAZA,  
NEW BRUNSWICK, NEW JERSEY 08933,  
USA  
(740) Giorgi Taktakishvili  
(540)

**AVEENO**

(591) Black, white  
(511) 5

---



(260) AM 2020 103302 A  
 (210) AM 103302  
 (220) 2019 05 24  
 (731) Archil Gegenava  
 Kaklebi Lane 12, Tskneti, Tbilisi, Georgia  
 (540)



(591) White, light green  
 (531) 01.15.21; 26.04.22; 26.04.24; 28.19; 29.01.12  
 (511) 35

(260) AM 2020 103303 A  
 (210) AM 103303  
 (220) 2019 05 24  
 (731) WILLIAM GRANT & SONS IRISH  
 BRANDS LIMITED  
 4th Floor, Block D, Iveagh Court, Harcourt  
 Road, Dublin 2, Ireland  
 (740) Tamaz Shilakadze  
 (540)

### AILSABAY

(591) Black, white  
 (511) 33

(260) AM 2020 103312 A  
 (210) AM 103312  
 (220) 2019 05 28  
 (731) AstraZeneca AB  
 SE-151 85 Södertälje, Sweden  
 (740) Tamaz Shilakadze  
 (540)

### TRIGZALTO

(591) Black, white  
 (511) 5

(260) AM 2020 103315 A  
 (210) AM 103315  
 (220) 2019 05 28  
 (731) Getz Pharma International FZ LLC  
 Ofis No.1307, 13 Flor, Al-turaia Tauer 1,  
 Dubai Media Siti, Dubai, United Arab  
 Emirates  
 (740) Merab Kvimsadze  
 (540)

### AMVAGET

(591) Black, white  
 (511) 5

(260) AM 2020 103316 A  
 (210) AM 103316  
 (220) 2019 05 28  
 (731) Bait Al Mandi Restaurant  
 P.O. Box N. 80998, Dubai, United Arab  
 Emirates  
 (740) Merab Kvimsadze  
 (540)



### مطعم بيت المندي Bait Al Mandi Restaurant

(591) Red, white  
 (531) 26.13.25; 28.01; 29.01.01  
 (511) 43

(260) AM 2020 103430 A  
 (210) AM 103430  
 (220) 2019 05 31  
 (731) JSC "m<sup>2</sup> Real Estate"  
 I. Chavchavadze Av. 29, fl. 3, Tbilisi, Georgia  
 (740) Nikoloz Jalaghania  
 (540)

### m<sup>2</sup> კოლექტივი

(591) Black, white  
 (511) 35, 36

(260) AM 2020 103431 A  
 (210) AM 103431  
 (220) 2019 05 31  
 (731) JSC "m<sup>2</sup> Real Estate"  
 I. Chavchavadze Av. 29, fl. 3, Tbilisi, Georgia  
 (740) Nikoloz Jalaghania  
 (540)

### m<sup>2</sup> Collective

(591) Black, white  
 (511) 35, 36

(260) AM 2020 103432 A  
 (210) AM 103432  
 (220) 2019 06 02  
 (731) LTD "Construction Investment"  
 Vazha-Pshavela Av. 3, 01177, Tbilisi,  
 Georgia  
 (740) Salome Kalandadze

(540)

ავტოგრაფი  
autograph

(591) Black, white  
(511) 37

(260) AM 2020 103572 A  
(210) AM 103572  
(220) 2019 06 11  
(731) LTD "GEO Hoteller Group"  
Ak. Tsereteli Av., korp. 11, ap. 41,  
Tbilisi, Georgia

(540)



(591) Grey, green, white  
(531) 14.05.01; 14.05.02; 29.01.13  
(511) 43

(260) AM 2020 103585 A  
(210) AM 103585  
(220) 2019 06 12  
(731) JSC "GEFA"  
Ak. Beliashvili St. 142, 0159,  
Tbilisi, Georgia  
(740) Salome Jeladze  
(540)



(591) White, turquoise  
(531) 26.04.02; 26.04.04; 26.04.22; 26.04.24; 28.19;  
29.01.12  
(511) 35, 44

(260) AM 2020 103589 A  
(210) AM 103589  
(220) 2019 06 13  
(731) LLC "Natur Import+"  
Volokolamskoe shosse1, bld.1, fl. 8 place  
IX, room 35, 36, office 5, Moscow, 125080,  
Russian Federation

(740) Mzia Nadaraia  
(540)



(591) Black, white  
(531) 05.09.14; 09.07.01; 09.07.17; 09.07.25;  
27.05.24  
(511) 29, 30

(260) AM 2020 103671 A  
(210) AM 103671  
(220) 2019 06 19  
(731) LTD "ZEARIS"  
Richard Holbrook St. 13, Tbilisi, Georgia  
(740) Ramaz Kritchinishvili  
(540)

**Wine Terminal**  
ღვინის ტერმინალი  
**Винный Терминал**

(591) Black, white  
(511) 43

(260) AM 2020 103672 A  
(210) AM 103672  
(220) 2019 06 19  
(731) LTD "ZEARIS"  
Richard Holbrook St. 13, Tbilisi, Georgia  
(740) Ramaz Kritchinishvili  
(540)

**Wine Station**  
ღვინის სადგური  
**Винная Станция**

(591) Black, white  
(511) 43

(260) AM 2020 103751 A  
(210) AM 103751  
(220) 2019 06 21  
(731) LTD "WINENAN LTD"  
Gudiashvili St. 11, 0105, Tbilisi, Georgia  
(740) Shalva Gvaramadze



(540)

INOKHI

(591) Black, white  
(511) 33

(260) AM 2020 103752 A  
(210) AM 103752  
(220) 2019 06 21  
(731) LTD "GLOBALPHARM"  
Almasyan St. 13a /Berbuti St. 8, 0171,  
Tbilisi, Georgia  
(740) Giorgi Taktakishvili  
(540)

(591) Golden  
(531) 28.19; 29.01.02  
(511) 35, 43

(260) AM 2020 103753 A  
(210) AM 103753  
(220) 2019 06 21  
(731) LTD "GLOBALPHARM"  
Almasyan St. 13a /Berbuti St. 8, 0171,  
Tbilisi, Georgia  
(740) Giorgi Taktakishvili  
(540)

(591) Golden  
(531) 27.05.01; 27.05.13; 27.05.19; 29.01.02  
(511) 35, 43

(260) AM 2020 103754 A  
(210) AM 103754  
(220) 2019 06 21  
(731) LTD "GLOBALPHARM"  
Almasyan St. 13a /Berbuti St. 8, 0171,  
Tbilisi, Georgia  
(740) Giorgi Taktakishvili

(540)

თავისუფლების მოედანი

(591) Black, white  
(531) 27.05.10; 28.19  
(511) 35, 43

(260) AM 2020 103755 A  
(210) AM 103755  
(220) 2019 06 21  
(731) LTD "GLOBALPHARM"  
Almasyan St. 13a /Berbuti St. 8, 0171,  
Tbilisi, Georgia  
(740) Giorgi Taktakishvili  
(540)

FREEDOM SQUARE

(591) Black, white  
(531) 27.05.01; 27.05.10  
(511) 35, 43

(260) AM 2020 103768 A  
(210) AM 103768  
(220) 2019 06 24  
(731) Dose Café for Light Food Mohamad A.  
Qabazard & Partners Co. W.L.L.  
Sharq, Mubarak Al Kabeer St., Block (6),  
Building (39), Alsaqer Complex, Shop № (1),  
Ground Floor, Kuwait  
(740) Merab Kvimsadze  
(540)

(591) Black, white  
(531) 27.05.01; 27.05.09; 27.05.10  
(511) 43

(260) AM 2020 103856 A

(210) AM 103856

(220) 2019 07 01

(731) GRINDEKS, JOINT STOCK COMPANY

53, Krustpils Street, Riga, 1057, Latvia

(740) Khatuna Imnadze

(540)

**გარღვიე ჩაკეტილი წრე!**

(591) Black, white

(511) 5, 35

---

**TRADEMARKS REGISTERED ACCORDING TO THE  
ACCELERATED PROCEDURE**

The decision can be appealed at the Chamber of Appeal of Sakpatenti within 3 months from the publication.

(111) M 2020 32196 R  
(151) 2019 12 24  
(181) 2029 12 24  
(210) AM 106165  
(220) 2019 12 16  
(732) BAKLACHOFF

Kentron Vardanants Str., build. 8, Area 1/4,  
Erevani, Armenia

(740) Sopio Khutchua  
(540)



(591) Black, grey, white  
(531) 02.01.01; 02.01.11; 27.05.01; 28.05; 28.19  
(511) 43

(111) M 2020 32197 R  
(151) 2019 12 25  
(181) 2029 12 25  
(210) AM 106054  
(220) 2019 12 09

(732) LTD "Global Beer Georgia"  
Vill. Tsilkani, 3319, Mtskheta District,  
Georgia

(540)

**go mad**  
**გოუ მად**

(591) Black, white  
(511) 32

(111) M 2020 32198 R  
(151) 2019 12 26  
(181) 2029 12 26  
(210) AM 106175  
(220) 2019 12 17

(732) JSC "Teliani Valley"  
Tbilisi highway 3, 2200, Telavi, Georgia

(540)

**WINE PEOPLE**  
**ღვინის ხალხი**  
**ВИННЫЕ ЛЮДИ**

(591) Black, white  
(511) 33

(111) M 2020 32199 R  
(151) 2019 12 31  
(181) 2029 12 31  
(210) AM 106094  
(220) 2019 12 12

(732) Consejo Regulador del Tequila, A.C.  
Av. Patria N723 Col. Jardines de Guadalupe,  
C.P. 45030 Zapopan, Jalisco, Mexico

(740) Giorgi Taktakishvili  
(540)

**Tequila**

(591) Black, white  
(551) Collectiv  
(511) 33

(111) M 2020 32200 R  
(151) 2019 12 31  
(181) 2029 12 31  
(210) AM 106173  
(220) 2019 12 17

(732) LTD "Kaveh Pars Georgia"  
Shartava str. 39, b. 66, Fl. 13, Saburtalo  
District, Tbilisi, Georgia

(740) Manoni Ghvinjilia  
(540)



**JUPITER**

(591) Black, white, orange  
(531) 01.15.23; 26.01.01; 26.01.05; 26.01.12;  
27.05.03; 29.01.13  
(511) 18, 35

(111) M 2020 32201 R  
 (151) 2020 01 03  
 (181) 2030 01 03  
 (210) AM 103583  
 (220) 2019 06 12  
 (732) GALLAHER LIMITED  
 Members Hill, Brooklands Road, Weybridge,  
 Surrey KT13 0QU, United Kingdom  
 (740) Shalva Gvaramadze  
 (540)

## **SOBRANIE EVOKE**

(591) Black, white  
 (511) 34

(111) M 2020 32202 R  
 (151) 2020 01 03  
 (181) 2030 01 03  
 (210) AM 106302  
 (220) 2019 12 24  
 (732) LTD "HIDEN INDUSTRY OF GEORGIA"  
 Ak. Tsereteli Av. 116, Tbilisi, Georgia  
 (540)



(591) Grey, red, black, white  
 (531) 02.09.01; 17.02.02; 24.09.12; 26.07.15;  
 26.07.17; 27.05.01; 27.05.07; 27.05.21;  
 29.01.14  
 (511) 5

(111) M 2020 32203 R  
 (151) 2020 01 06  
 (181) 2030 01 06  
 (210) AM 106289  
 (220) 2019 12 24  
 (732) LTD "MUD"  
 D. Uznadze St. 111, ap. 11, Bl. 2, Tbilisi,  
 Georgia,  
 (541)

## **ტრენდიზ TRENDYZ**

(591) Black, white  
 (511) 25

## INTERNATIONAL TRADEMARKS FOR WHICH A DECISION ON GRANTING PROTECTIONS IS TAKEN

The decision can be appealed at the Chamber of Appeal of Sakpatenti within 3 months from the publication or at the Mtskheta District Court Administrative Cases Board (Address: №17, Samkhedro str., Mtskheta), within 1 month following the publication.

(260) AM 2020 98530 A\*

(800) 879538

(151) 2005 10 10

(891) 2017 06 12

(731) P.P.H."ADAMEX" Jacek Karoń, Ewa Kasprzyk, Adam Kasprzyk, Spółka Jawna ul. Młodości 10, PL-42-200 Częstochowa, Poland

(540)



(591) Red and beige

(531) 26.01.02; 26.01.20; 27.05.01; 29.01.12

(511)

12 – Baby carriages, prams, pushchairs, strollers, shopping trolleys, luggage nets for vehicles, safety seats for children (for vehicles), baskets adapted for cycles, covers for prams, fitted perambulator covers, pushchair covers, stroller covers (pushchairs), pushchair hoods, bicycles.

35 – the bringing together, for the benefit of others, of a variety of goods, enabling customers to conveniently view and purchase them in a retail store and in a wholesale outlet of carts, prams, pushchairs, furniture, furniture for babies, bicycles, bags, toys, parts of prams and carts, prams and carts accessories, parts of furniture and bicycles, furniture and bicycles accessories; the bringing together, for the benefit of others, of a variety of goods, enabling customers to conveniently view and purchase those goods from a general merchandise Internet web site.

(260) AM 2020 98928 A\*

(800) 1416724

(151) 2018 03 09

(891) 2018 03 09

(731) Nokia Corporation Karakaari 7, FI-02610 Espoo, Finland

(540)

The logo for NOKIA consists of the word "NOKIA" in a bold, black, sans-serif font.

(591) Black, white

(531) 27.05.17

(511)

37 – Building construction; clock and watch repair; electric appliance installation and repair; machinery installation, maintenance and repair; photographic apparatus repair; repair information; repair of power lines; construction, maintenance, installation and repair of computers, tablet computers, computer hardware, phones, smartphones, electronic organizers, computer peripherals, smart glasses, smart watches, cameras, audio and visual equipment; construction, maintenance, installation and repair of scales, of earable and portable computing devices, of vehicles, of office machines and equipment, of machines for industrial and agricultural use; construction, installation and repair of household appliances, of energy management systems, of home automation systems, of lighting devices and equipment, of sanitary installations, of security systems, of home entertainment and audio/video equipment, of fitness and health equipment, of medical apparatus and instruments, of machine to machine (M2M) communications equipment, of electric and electronic consumer goods, of hand tools, of optical goods and of navigation devices; installation, maintenance and repair of telecommunications and networking devices, equipment and systems, communications networks (other than software), satellite communications and radio and television communications equipment, instruments and machines; upgrading of computer hardware; information, advisory and consultancy services relating to all the aforesaid services.

(260) AM 2020 99554 A\*

(800) 1423953

(151) 2018 07 03

(891) 2018 07 03

(731) Valvoline Licensing and Intellectual Property LLC  
100 Valvoline Way, Lexington KY 40509,  
USA

(540)

### TECTYL

(591) Black, white

(511)

2 – Anti-rust preparations; anti-corrosion preparations.

3 – Rust-removing preparations.

(260) AM 2020 101144 A  
 (800) 1443424  
 (151) 2018 07 18  
 (891) 2018 07 18  
 (731) DEUTSCHE LUFTHANSA  
 AKTIENGESELLSCHAFT  
 Venloer Straße 151 – 153, 50672 Köln,  
 Germany  
 (540)



(591) Dark blue  
 (531) 03.07.16; 03.07.24; 26.01.03; 26.01.15;  
 29.01.12  
 (511)  
 9 – Electronic entrance cards, tickets and boarding cards.

16 – Paper, paperboard and goods of these materials, namely posters, world maps, bookbinding material; office material, in particular paperweight, letter opener, letter holders, stationery; brochures; entrance cards, tickets and boarding cards in printed form; printed matter; travel and in-flight magazines; periodicals.

35 – Advertising; organization, operation and supervision of sales promotion incentive programs, frequent-flyer programs and customer-loyalty programs; management of airline passenger data sets through office work for check-in, boarding control and ticket sale and for passenger handling.

36 – Issuing of credit cards; financial affairs, namely money exchange transactions, credit counseling, providing of credits; safekeeping of valuables; estate and house management; providing of insurances.

37 – Repair and maintenance of products from the field of electro-technology, engineering, automobiles, aircraft, photographic apparatus, projectors and cinematographic apparatus.

38 – Telecommunication related to travel, transport by air and aviation; check in control systems; boarding control systems; electronic transmission of news and data for ticket sale; electronic transmission of data and documents for business purposes via computer terminals from a computer-based database; electronic news transmission related to flight reservations, check in and boarding controls for air travel; electronic transmission of data for ticket issuing and providing of access to data in flight reservation systems and databases.

39 – Services of an airline company, namely transport of passengers by aircraft, services of a travel agency; providing of travel and flight information inclusive of flight delays, cancellations and changes of flights and exits; planning and booking of airline travel, via electronic means; transport of passengers and goods by automobiles, trains, ships and aircraft; storage of goods of all kinds, rescuing of persons (transportation), transportation of money and valuables; transport of ill persons; arranging, booking, reservation and organization of travels of all kinds; organization of traffic services (transportation); arranging and booking of city sightseeing bus tours; providing of tourist guides; rental of aircraft and automobiles; packing and delivery of goods; online ticket booking services.

41 – Training and instruction of airline staff and cabin crews as well as others; translation and interpretation.

43 – Providing of food and drinks for guests, and temporary accommodation of guests; hotel reservation.

(260) AM 2020 101196 A  
 (800) 1444397  
 (151) 2018 07 23  
 (891) 2018 07 23  
 (731) ESSITY HYGIENE AND HEALTH AKTIEBOLAG  
 Mölndals bro 2, SE-405 03 Göteborg, Sweden  
 (540)



(591) Blue, white  
 (531) 02.09.01; 26.01.03; 26.01.20; 26.01.24;  
 27.05.24; 29.01.12

(511)  
 3 – Soaps, cleaning preparations, towels impregnated with cosmetic lotions, cellulose wadding for cosmetic use, cotton swabs for cosmetic use, make-up removing preparations, lotions for cosmetic use, cotton sticks for cosmetic use, tissues impregnated with cosmetic preparations for make-up and care purposes, paper products for household and hygienic purposes (included in this class), namely moist toilet paper; cosmetic wipes soaked with liquid; handkerchiefs impregnated with liquid cosmetics.

16 – Paper, cardboard, paper towels, hand towels of paper, face towels of paper, handkerchiefs of paper, toilet paper, makeup removing napkins of paper, paper table napkins, table linen, household paper rolls.



(260) AM 2020 101262 A  
 (800) 1444630  
 (151) 2018 07 23  
 (891) 2018 07 23  
 (731) ESSITY HYGIENE AND HEALTH  
 AKTIEBOLAG  
 Mölndals bro 2, SE-405 03 Göteborg, Sweden  
 (540)



(591) Blue, white, dark green  
 (531) 02.09.01; 26.01.03; 26.01.18; 26.01.24;  
 26.11.21; 27.05.09; 27.05.24; 29.01.13  
 (511)

3 – Soaps, cleaning preparations, towels impregnated with cosmetic lotions, cellulose wadding for cosmetic use, cotton swabs for cosmetic use, make-up removing preparations, lotions for cosmetic use, cotton sticks for cosmetic use, tissues impregnated with cosmetic preparations for make-up and care purposes, paper products for household and hygienic purposes (included in this class), namely moist toilet paper; cosmetic wipes soaked with liquid; handkerchiefs impregnated with liquid cosmetics.

16 – Paper, cardboard, paper towels, hand towels of paper, face towels of paper, handkerchiefs of paper, toilet paper, makeup removing napkins of paper, paper table napkins, table linen, household paper rolls.

(260) AM 2020 101715 A  
 (800) 1449309  
 (151) 2018 11 21  
 (891) 2018 11 21  
 (731) BOBKOV GLEB VIKTOROVICH  
 Trofimova ul, d. 10, kv. 179, RU-115432  
 Moscow, Russian Federation  
 (540)

## PRINCESS

(591) Black, white  
 (531) 27.05.01; 27.05.17  
 (511)

3 – Abrasive cloth; abrasive paper; abrasives; adhesives for affixing false eyelashes; adhesives for affixing false hair; adhesives for cosmetic purposes; after-shave lotions; air fragrancing preparations; almond milk for cosmetic purposes; almond oil; almond soap; aloe vera preparations for cosmetic purposes; alum stones [astringents]; amber [perfume]; ammonia [volatile alkali] [detergent]; antiperspirant

soap; antiperspirants [toiletries]; antistatic preparations for household purposes; aromatics [essential oils]; astringents for cosmetic purposes; badian essence; balms, other than for medical purposes; bases for flower perfumes; bath preparations, not for medical purposes; bath salts, not for medical purposes; beard dyes; beauty masks; bergamot oil; bleaching preparations [decolorants] for cosmetic purposes; bleaching salts; bleaching soda; breath freshening sprays; breath freshening strips; cake flavorings [essential oils]; cakes of toilet soap; canned pressurized air for cleaning and dusting purposes; carbides of metal [abrasives]; cleaning chalk; cleaning preparations; cleansers for intimate personal hygiene purposes, non medicated; cleansing milk for toilet purposes; cloths impregnated with a detergent for cleaning; cobblers' wax; colorants for toilet purposes; color- [colour-] brightening chemicals for household purposes [laundry]; color-removing preparations; corundum [abrasive]; cosmetic creams; cosmetic dyes; cosmetic kits; cosmetic pencils; cosmetic preparations for baths; cosmetic preparations for eyelashes; cosmetic preparations for skin care; cosmetic preparations for slimming purposes; cosmetics; cosmetics for animals; cotton sticks for cosmetic purposes; cotton wool for cosmetic purposes; creams for leather; decorative transfers for cosmetic purposes; degreasers, other than for use in manufacturing processes; dental bleaching gels; dentifrices; denture polishes; deodorants for human beings or for animals; deodorants for pets; deodorant soap; depilatory preparations; depilatory wax; descaling preparations for household purposes; detergents, other than for use in manufacturing operations and for medical purposes; diamantine [abrasive]; douching preparations for personal sanitary or deodorant purposes [toiletries]; dry-cleaning preparations; drying agents for dishwashing machines; dry shampoos; eau de Cologne; emery; emery cloth; emery paper; essential oils; essential oils of cedarwood; essential oils of citron; essential oils of lemon; ethereal essences; extracts of flowers [perfumes]; eyebrow cosmetics; eyebrow pencils; fabric softeners for laundry use; false eyelashes; false nails; flavorings for beverages [essential oils]; floor wax; floor wax removers [scouring preparations]; fumigation preparations [perfumes]; furnishing preparations; gaultheria oil; geraniol; glass cloth [abrasive cloth]; greases for cosmetic purposes; grinding preparations; hair conditioners; hair dyes; hair lotions; hair spray; hair straightening preparations; hair waving preparations; heliotropine; henna [cosmetic dye]; hydrogen peroxide for cosmetic purposes; incense; ionone [perfumery]; jasmine oil; Javelle water; joss sticks; lacquer-removing preparations; laundry bleach; laundry blueing; laundry glaze; laundry preparations; laundry soaking preparations; laundry starch; laundry wax; lavender oil; lavender water; leather bleaching preparations; lip glosses; lipstick cases; lipsticks; lotions for cosmetic

purposes; make-up; make-up powder; make-up preparations; make-up removing preparations; mascara; massage gels, other than for medical purposes; mint essence [essential oil]; mint for perfumery; mouth-washes, not for medical purposes; musk [perfumery]; mustache wax; nail art stickers; nail care preparations; nail polish; neutralizers for permanent waving; non-slipping liquids for floors; non-slipping wax for floors; oil of turpentine for degreasing; oils for cleaning purposes; oils for cosmetic purposes; oils for perfumes and scents; oils for toilet purposes; paint stripping preparations; pastes for razor strops; perfumery; perfumes; petroleum jelly for cosmetic purposes; polish for furniture and flooring; polishing creams; polishing paper; polishing preparations; polishing rouge; polishing stones; polishing wax; pomades for cosmetic purposes; potpourris [fragrances]; preparations for cleaning dentures; preparations for unblocking drain pipes; preparations to make the leaves of plants shiny; preservatives for leather [polishes]; pumice stone; quillaia bark for washing; rose oil; rust removing preparations; sachets for perfuming linen; safrol; sandpaper; scented water; scented wood; scouring solutions; shampoos; shampoos for pets [non-medicated grooming preparations]; shaving preparations; shaving soap; shaving stones [astringents]; shining preparations [polish]; shoe cream; shoemakers' wax; shoe polish; shoe wax; silicon carbide [abrasive]; skin whitening creams; smoothing preparations [starching]; smoothing stones; soap; soap for brightening textile; soap for foot perspiration; soda lye; stain removers; starch glaze for laundry purposes; sunscreen preparations; sun-tanning preparations [cosmetics]; tailors' wax; talcum powder, for toilet use; terpenes [essential oils]; tissues impregnated with cosmetic lotions; tissues impregnated with make-up removing preparations; toiletry preparations; toilet water; tripoli stone for polishing; turpentine for degreasing; varnish-removing preparations; volcanic ash for cleaning; wallpaper cleaning preparations; washing soda, for cleaning; whitening; wind-shield cleaning liquids.

(260) AM 2020 102095 A

(800) 1454059

(151) 2018 11 23

(891) 2018 11 23

(731) ADP GAUSELMANN GMBH

Merkur-Allee 1-15, 32339 Espelkamp,  
Germany

(540)

## Electric Fruit

(591) Black, white

(511)

9 – Computer software; coin-operated mechanisms; computer and video games software; games software in particular for use on any computer platform, including electronic entertainment and games consoles;

computer game programs; video games (software); computer games provided through a global computer network or supplied by means of multi-media electronic broadcast or through telecommunications or electronic transmission or via the internet; computer games, leisure and recreational software, video games and computer software, all being provided in the form of storage media; programs for operating electric and electronic apparatus for games, amusement and/or entertainment purposes; computer software for computer games on the internet; online games (software), in particular for online betting games, online prize games, online gambling games, online games of skill and online casino games; computer software in the form of an app for mobile devices and computers; calculating apparatus in coin-operated machines and parts for the aforesaid goods; electric, electronic, optical or automatic apparatus, for identifying data carriers, identity cards and credit cards, bank notes and coins; software in particular for casino and/or amusement arcade games, for gaming machines and/or slot machines each one with or without prize payouts; gaming software that generates or displays wager outcomes of gaming machines; operational computer games software; computer software for managing of games (game collection); computer programs for video games; video game software.

28 – Games; toys; gaming apparatus (including coin-operated apparatus); coin-operated arcade games (machines); games for amusement arcades (included in this class); coin-operated video gaming apparatus; video games apparatus adapted for use with external screens or monitors only; casino fittings, namely roulette tables, roulette wheels; coin-operated automatic gaming machines and gaming machines, in particular for gaming arcades, with or without a prize payout; electronic or electrotechnical gaming apparatus, automatic gaming machines, gaming machines, slot machines operated by coins, tokens, banknotes, tickets or by means of electronic, magnetic or biometric storage media, in particular for commercial use in casinos and amusement arcades, with or without a prize payout; automatic gaming machines and gaming machines, in particular for commercial use in casinos and gaming arcades, with or without a prize payout; coin-operated gaming machines and/or electronic money-based gaming apparatus (machines), with or without prizes; housings adapted for gaming machines, gaming apparatus and automatic gaming machines, operated by means of coins, tokens, tickets or by means of electronic, magnetic or biometric storage media, in particular for commercial use in casinos and gaming arcades, with or without a prize payout; electronic games; electronic game entertainment apparatus and parts thereof; video output game machines; drawing apparatus for prize games and lotteries, draws or raffles; housings of metal, plastic and/or wood for coin-operated auto-



matic machines; apparatus for games (including video games), other than adapted for use with external screens or monitors only; electropneumatic and electric slot machines with pulling handles (gaming machines); gaming tables, in particular for table football, billiards, sliding games; flying discs (toys) and darts; gaming machines, namely electric, electronic or electromechanical apparatus for bingo games, lotteries or video lottery games and for betting offices, connected or unconnected to a computer network; LCD games consoles; automatic gaming machines; all the aforesaid automatic gaming machines operating in networks; apparatus and devices for accepting and storing money, being fittings for the aforesaid automatic machines, included in this class; automatic lottery machines.

(260) AM 2020 102096 A

(800) 1454069

(151) 2018 08 09

(891) 2018 08 09

(731) HYPRED

55 boulevard Jules Verger, F-35800 DINARD,  
France

(540)



(591) Black, white

(531) 03.13.01; 03.13.24; 26.13.25; 27.05.01

(511)

1 – Chemical, biological and enzyme products for use in the agricultural, food, agri-food, pharmaceutical, cosmetic, laundry industries, by the health and veterinary sector, and in the restaurant and hotel industry, especially with respect to disinfection and detergents; chemical and biological products for the treatment of air and water; chemical products and chemical substances for the purification and disinfection of water; water softening chemicals; silage preservatives; biological products for preserving foodstuffs; milk ferments for preserving silage.

3 – Laundry preparations and substances; preparations for cleaning and degreasing materials, equipment, apparatus, installations, vehicles and containers, buildings, floors, surfaces, clothing, instruments for use in the agricultural, food, agri-food, pharmaceutical, cosmetic, health, laundry industry and in catering and hotel services; non-medicated preparations and products for care of animal udders and teats; hand soaps; moisturizing preparations and products for animal udders and teats; non-medicated preparations and products for cleaning animal udders and teats and animal shoes and claws.

5 – Sanitary products and preparations and disinfectants for materials, equipment, apparatus, installati-

ons, vehicles and containers, buildings, floors, surfaces, clothing, instruments for use in the agricultural, food, agri-food, pharmaceutical, cosmetic, laundry industry, in the health and veterinary sector, and in the restaurant and hotel industry; pharmaceutical and parapharmaceutical products for disinfecting water; sanitary products, preparations and disinfecting products for animal udders, teats, shoes and claws and animal milking equipment; hand sanitizer; food supplements for animals; dietetic foodstuffs for animals, nutritional supplements for animals, energy food supplements for animals.

7 – Industrial machines; machine tools, robots [machines] and mechanical equipment [machines] for treating, cleaning and purifying air and water; apparatus for the application of cleaning and disinfecting products.

9 – Dosing apparatus for cleaning and disinfecting products; apparatus and instruments for the diagnosis of contamination of air and water; apparatus and instruments for collecting and controlling air and water.

11 – Apparatus and machines for treating, cleaning and purifying air and water.

21 – Cleaning and washing equipment; brushes; brushmaking materials; utensils and containers for washing, deembedding, disinfecting and cleaning for the food, agri-food, pharmaceutical, cosmetic, agricultural, health, restaurant and laundry industry.

31 – Agricultural products; animal foodstuffs.

(260) AM 2020 102097 A

(800) 1454086

(151) 2018 12 21

(891) 2018 12 21

(731) BAUSCH & LOMB INCORPORATED

1400 North Goodman Street, Rochester,  
New York 14609, USA

(540)

**BAUSCH + LOMB ZEN RC**

(591) Black, white

(531) 24.17.05; 24.17.07

(511)

9 – Contact lenses, scleral lenses; containers for contact lenses.

(260) AM 2020 102098 A

(800) 1454096

(151) 2018 11 28

(891) 2018 11 28

(731) UIPATH SRL

Str. Vasile Alecsandri si Constantin Daniel,  
Nr. 4 si 11, Corp A, Et. 5-6, Sector 1,  
Bucharest, Romania

(540)

**UiPath Go!**

(591) Black, white

(511)

9 – Computer programs [downloadable software]; downloadable computer utility programs; computer software applications, downloadable; application software for cloud computing services.

35 – Assistance in management of business activities; assistance and advice regarding business management; management assistance in business affairs; business assistance, management and administrative services; management and operation assistance to commercial businesses; assistance and advice regarding business organisation and management; advice relating to the organisation and management of business; business management assistance for industrial or commercial companies; assistance, advisory services and consultancy with regard to business management; assistance to commercial enterprises in the management of their business; commercial assistance in business management; efficiency experts; business efficiency expert services; business organisation consulting; business organization and operation consultancy; business management and organization consultancy; business management and enterprise organization consultancy; business organization and management consultancy including personnel management; assistance, advisory services and consultancy with regard to business organization; advisory services for business management; business management consultancy and advisory services; business consulting; professional consultancy relating to business management; business information; collecting information for business; dissemination of business information; computer assisted business information; business advisory and information services; information in business matters; business information for enterprises (provision of -); business information and research services; computerised business information services; provision of business information; analysis of business information; computerised business information retrieval; business statistical information services; business advice, inquiries or information; provision of business and commercial information; computerised business information processing services; business research and information services; provision of statistical information relating to business; provision of business management information; provision of computerised data relating to business; information services relating to businesses; information services relating to business matters; providing business information via a web site; provision of computerised business management information; drawing up of business statistical information; economic information services for business purposes; business analysis, research and information services; compilation of business statistics and commercial in-

formation; advice and information concerning commercial business management; information or enquiries on business and marketing; computerised information services to business opportunities appraisals; provision of commercial and business contact information; provision of business information via global computer networks; provision of computerised information relating to business records; providing business information by way of computer terminals; provision of on-line business and commercial information; providing information about commercial business and commercial information via the global computer network; updating of business information on a computer data base; business consultancy relating to the administration of information technology; providing business information directory services, via a global computer network; information and data compiling and analyzing relating to business management; business management consulting services in the field of information technology; provision of commercial business information by means of a computer database; business information services provided on-line from a computer database or the internet; business information services provided online from a global computer network or the internet; providing business information, also via internet, the cable network or other forms of data transfer; compilation of information into computer databases; compilation and systemization of information into computer databases; compilation of statistics; compilation of business statistics; compilation of statistics [for business or commercial purposes]; computerized file management; data search in computer files for others; document reproduction; outsourcing services [business assistance]; systemization of information into computer databases; updating and maintenance of data in computer databases.

38 – Transmission of information for business purposes; providing access to databases; providing access to online computer databases; providing access to and leasing access time to computer databases; providing access to databases in computer networks; providing access to electronic communications networks and electronic databases; communications by computer terminals; computer-aided transmission of messages and images; computer aided transmission of messages, information and images; streaming of data; transmission of digital files.

41 – Teaching and training in business, industry and information technology; arranging and conducting of conferences; arranging, conducting and organisation of conferences; arranging and conducting of commercial, trade and business conferences; arranging and conducting of seminars; arranging and conducting of seminars and workshops; arranging, conducting and organisation of seminars; programming [scheduling of programs] on a global computer network.

42 – Providing temporary use of non-downloadable computer programs; cloud computing; consulting in the field of cloud computing networks and applications; rental of operating software for accessing and using a cloud computing network; programming of operating software for accessing and using a cloud computing network; design and development of operating software for accessing and using a cloud computing network; providing temporary use of on-line non-downloadable operating software for accessing and using a cloud computing network; computer programming; scientific computer programming services; computer software programming services; computer programming and maintenance of computer programs; computer programming for data processing; computer design and programming services; computer programming and software design; computer programming for the internet; research relating to computer programming; computer programming services for data warehousing; design, development and programming of computer software; technical consultancy services relating to computer programming; computer programming for data processing and communication systems; computer programming services for commercial analysis and reporting; programming of computer software for reading, transmitting and organising data; programming of computer software for evaluation and calculation of data; advisory services relating to computer programming; computer software design; software design and development; computer software design and updating; design and writing of computer software; design and development of computer software architecture; design, maintenance and updating of computer software; design, drawing and commissioned writing of computer software; research, development, design and upgrading of computer software; design, maintenance, development and updating of computer software; design, maintenance, rental and updating of computer software; design and development of computer software for process control; consultancy relating to the design and development of computer software programs; design and development of computer software for reading, transmitting and organising data; design and development of computer software for evaluation and calculation of data; providing information about the design and development of computer software, systems and networks; rental of software; rental of computer database software; rental of computer software and programs; rental and maintenance of computer software; computer system analysis; advisory services relating to computer systems analysis; computer system design; advisory services relating to computer systems design; design services relating to the development of computerised information processing systems; computer software consultancy; professional advisory services relating to computer software; technical consultancy relating to the installation and maintenance

of computer software; technical consultancy relating to the application and use of computer software; providing information, advice and consultancy services in the field of computer software; consultancy and information services relating to the design, programming and maintenance of computer software; research and consultancy services relating to computer software; consultancy services relating to computer networks using mixed software environments; computer technology consultancy; computer and information technology consultancy services; consultancy in the field of computer security; professional consultancy relating to computer security; conversion of computer programs and data, other than physical conversion; electronic data storage; computer services concerning electronic data storage; compression of data for electronic storage; electronic data storage and data back-up services; electronic storage services for archiving databases; electronic storage services for archiving databases, images and other electronic data; temporary electronic storage of information and data; information technology [it] consultancy; providing information on computer technology and programming via a web site; installation of software; installation and maintenance of computer programs; installation and customisation of computer applications software; installation, maintenance and updating of computer software; installation, repair and maintenance of computer software; installation, maintenance, updating and upgrading of computer software; installation, setting up and maintenance of computer software; installation, maintenance, repair and servicing of computer software; installation, maintenance and repair of software for computer systems; maintenance of computer programs; development and maintenance of computer software; maintenance and updating of computer software; maintenance and upgrading of computer software; development and maintenance of computer database software; maintenance of computer software relating to computer security and prevention of computer risks; updating and maintenance of computer software and programs; monitoring of computer systems by remote access; off-site data backup; outsource service providers in the field of information technology; research and development for others; software as a service [saas]; technological consultation services; updating of computer software; updating and upgrading of computer software; updating of computer software for others; updating of database software; updating of computer software relating to computer security and prevention of computer risks; updating of computer programs.

---

(260) AM 2020 102119 A  
(800) 1454546  
(151) 2018 10 17  
(891) 2018 10 17

(731) Limited Liability Company "SMART DISTRIBUTION"  
st. Smirnovskaya, 25, p. 12, of. 08A, fl. 4,  
RU-109052 Moscow, Russian Federation  
(540)



(591) Gray, light gray and dark gray  
(531) 24.01.03; 24.01.15; 24.01.25; 27.05.01  
(511)

7 – Kitchen mixers, electric; electric hand-held mixers for household purposes; mixers, electric, for household purposes; juice extractors, electric; vacuum cleaners; apparatus for aerating beverages; coffee grinders, other than hand-operated; dishwashers; bread cutting machines; machines and apparatus for cleaning, electric; rinsing machines; meat choppers [machines]; fruit presses, electric, for household purposes; washing machines [laundry]; spin dryers [not heated].

11 – Steam accumulators; heat accumulators; distillation apparatus; desiccating apparatus; hydromassage bath apparatus; disinfectant apparatus; air deodorizing apparatus; ionization apparatus for the treatment of air or water; coffee roasters; beverage cooling apparatus; hand drying apparatus for washrooms; fruit roasters; water purifying apparatus and machines; refrigerating apparatus and machines; drying apparatus and installations; freezers; drying apparatus; structural plates for ovens; expansion tanks for central heating installations; coolers for furnaces; flushing tanks; refining towers for distillation; boilers, other than parts of machines; waffle irons, electric; electric fans for personal use; fans [air-conditioning]; fans [parts of air-conditioning installations]; roasting spits; refrigerating display cabinets; heated display cabinets; water heaters; water heaters [apparatus]; air reheaters; extractor hoods for kitchens; burners; acetylene burners; petrol burners; gas burners; burners for lamps; alcohol burners; oil burners; laboratory burners; incandescent burners; oxyhydrogen burners; germicidal burners; hot water bottles; grills [cooking appliances]; stills; showers; refrigerating containers; lighters; gas lighters; friction lighters for igniting gas; chimney blowers; coils [parts of distilling, heating or cooling installations]; furnace ash boxes; evaporators; shower enclosures; cool boxes, electric; refrigerating chambers; fireplaces, domestic; chimney flues; electric pressure cookers; air valves for steam heating installations; level

controlling valves in tanks; distillation columns; furnace grates; ventilation hoods; ventilation hoods for laboratories; lamp globes; air-conditioning apparatus; air conditioners for vehicles; gas boilers; laundry room boilers; heating boilers; coffee machines, electric; chandeliers; bread baking machines; multicookers; heaters for baths; heaters for heating irons; immersion heaters; heat pumps; sauna bath installations; refrigerating appliances and installations; blankets, electric, not for medical purposes; fabric steamers; hearths; electrical steamer; steam boilers, other than parts of machines; pasteurisers; coffee percolators, electric; bakers' ovens; furnaces, other than for laboratory use; kitchen ranges [ovens]; microwave ovens for industrial purposes; cookers; hot plates; water intake apparatus; apparatus for dehydrating food waste; fumigation apparatus, not for medical purposes; air purifying apparatus and machines; water filtering apparatus; ice machines and apparatus; cooling appliances and installations; cooking apparatus and installations; lighting apparatus and installations; sanitary apparatus and installations; cooking rings; plate warmers; electric appliances for making yogurt; rôtisseries; central heating radiators; roasters; lamps; air dryers; sterilizers; water sterilizers; air sterilizers; bread toasters; flues for heating boilers; boiler pipes [tubes] for heating installations; air-conditioning installations; bath installations; water conduits installations; desalination plants; cooling installations for water; cooling installations for liquids; milk cooling installations; cooling installations for tobacco; water purification installations; steam generating installations; air filtering installations; water distribution installations; water softening apparatus and installations; cooling installations and machines; heating installations; hot water heating installations; filters for air conditioning; filters for drinking water; fittings, shaped, for ovens; deep fryers, electric; oven fittings made of fireclay; bread-making machines; refrigerators; kettles, electric; refrigerating cabinets; heating elements; faucets for pipes and pipelines.

35 – Demonstration of goods; rental of advertising space; organization of exhibitions for commercial or advertising purposes; shop window dressing; sales promotion for others; distribution of samples; dissemination of advertising matter; procurement services for others [purchasing goods and services for other businesses]; presentation of goods on communication media, for retail purposes; retail or wholesale services for goods provided by shops, tele-shops or the Internet sites.

(260) AM 2020 102180 A  
(800) 1454851  
(151) 2019 02 05  
(891) 2019 02 05  
(731) TRAXXAS, L.P.

6250 Traxxas Way, McKinney TX 75070,  
USA

(540)

**TRAXXAS**

(591) Black, white

(511)

9 – Batteries and battery chargers.

(260) AM 2020 102193 A

(800) 1455367

(151) 2018 07 26

(891) 2018 07 26

(731) Benefit IP spółka z ograniczoną  
odpowiedzialnością spółka komandytowa  
ul. Plac Europejski 2, PL-00-844 Warsaw,  
Poland

(540)



(591) Blue, black and white

(531) 26.01.03; 26.01.12; 26.01.16; 27.05.01;  
29.01.13

(511)

9 – Magnetically encoded cards; pre-recorded mag-  
netic cards; magnetic identification cards; integrated  
magnetic cards, electronic or encoded; Integrated  
circuit cards [smart cards]; magnetic data carriers;  
electronic cash cards, smart cards; staged card read-  
ers; encoded loyalty cards; encoded electronic chip  
cards; electronic, photographic, cinematographic and  
optical apparatus; apparatus and instruments for  
conducting, transforming, accumulating, regulating  
or controlling electricity; apparatus for recording,  
transmission or reproduction of sound or images;  
magnetic data carriers, recording discs; calculating  
machines, data processing equipment and compu-  
ters; readers (data processing equipment); bar code  
readers.

16 – Cheques; printed coupons; gift vouchers; credit  
cards without magnetic coding; tickets; brochures;  
magazines; journals; forms; stationery; teaching  
materials [except apparatus]; catalogues; newslet-  
ters; paper loyalty cards; gift cards; registration  
cards.

36 – Issuance of tokens of value; issuance of credit  
and debit cards; issuing of vouchers; financial infor-  
mation; insurance information; financial services;  
credit card and debit card services; installment loans;  
financial operations; financial transactions; insuran-  
ce brokerage; insurance services; issuing prepaid  
cards; issuing vouchers in connection with loyalty  
programs.

37 – Installation of computer hardware.

42 – Hosting computer sites (websites); analysis and  
design of computer systems; consultancy in the field

of computer hardware; installation, updating, main-  
tenance, duplication, design and rental of computer  
software; computer programming; conversion of da-  
ta or documents from physical to electronic media;  
conversion of data via computer software; rental of  
computer hardware; creating and maintaining websi-  
tes for others, including creation of online portals.

(260) AM 2020 102199 A

(800) 1455465

(151) 2018 12 17

(891) 2018 12 17

(731) Shanghai ASA Ceramic Co., Ltd.  
No.3988, Hongmei South Road, Minhang  
District, 201100 Shanghai, China

(540)

**ASA**

(591) Black, white

(531) 27.05.01; 27.05.23

(511)

19 – Bricks; ceramic tiles; marble; artificial stone;  
granite; rock crystal; floor tiles, not of metal; slate;  
quartz; wall tiles, not of metal.

(260) AM 2020 102200 A

(800) 1455466

(151) 2018 12 17

(891) 2018 12 17

(731) Shanghai ASA Ceramic Co., Ltd.  
No.3988, Hongmei South Road, Minhang  
District, 201100 Shanghai, China

(540)



(591) Black, white

(531) 01.05.02; 01.05.15; 27.01.01; 27.05.01;  
27.05.08; 27.05.23

(511)

19 – Ceramic tiles; bricks.

(260) AM 2020 102201 A

(800) 1455470

(151) 2018 12 21

(891) 2018 12 21

(731) PepsiCo, Inc., (a North Carolina corporation)  
700 Anderson Hill Road, Purchase,  
New York 10577, USA

(540)

**PEPSI FOR THE LOVE OF IT**

(591) Black, white  
 (531) 27.05.01  
 (511)  
 32 – Non-alcoholic beverages.

(260) AM 2020 102202 A  
 (800) 1455532  
 (151) 2018 12 28  
 (891) 2018 12 28  
 (731) Apple Inc.  
 One Apple Park Way, Cupertino CA 95014,  
 USA  
 (540)



(591) Black, red, white and blue  
 (531) 20.05.07; 25.07.20; 25.07.21; 26.04.04;  
 26.11.03; 26.11.22; 29.01.14

(511)  
 9 – Computer software for recording, editing, sharing, and playing voice memos; computer software for recording, editing, managing, and sharing audio content, for use in connection with handheld mobile digital electronic devices, mobile phones, digital audio and video players, handheld computers, and tablet computers.

(260) AM 2020 102203 A  
 (800) 1455553  
 (151) 2019 01 31  
 (891) 2019 01 31  
 (731) Aktsionernoe obshchestvo "VERTEX"  
 doroga v Kamenku, d. 62, lit. A, RU-197350  
 Saint-Petersburg, Russian Federation

(540)  
**ЭЛЬЖИНА**

(591) Black, white  
 (531) 28.05  
 (511)  
 5 – Pharmaceuticals, chemico-pharmaceutical preparations and drugs for human purposes included in class 05.

(260) AM 2020 102204 A  
 (800) 1455557  
 (151) 2019 01 21  
 (891) 2019 01 21

(731) Global Tobacco FZCO Ltd  
 Kemp House, 160 City Road, London  
 EC1V 2NX, United Kingdom  
 (540)

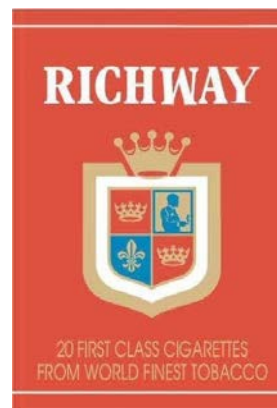

(591) Red, Blue, Gold, White  
 (531) 24.01.05; 24.09.02; 24.09.03; 26.04.05;  
 26.04.16; 26.04.18; 27.05.09; 27.05.10;  
 27.05.24; 29.01.14

(511)  
 34 – Cigarettes; cigarettes containing tobacco substitutes, e-cigarettes, vapour cigarettes, all smoking substitutes, not for medical purposes; cigarillos; cigars; chewing tobacco; any tobacco product; herbs for smoking; snuff; snuff boxes, tobacco, smokers' articles; molasses tobacco; shisha tobacco; hookah; hookah tobacco; matches.

(260) AM 2020 102213 A  
 (800) 1455827  
 (151) 2018 12 21  
 (891) 2018 12 21  
 (731) VALENTINO S.P.A.  
 Via Turati, 16/18, I-20121 MILANO, Italy  
 (540)

**VLTN**

(591) Black, white  
 (511)  
 3 – Cosmetics, including night and day creams; preparations for cleaning and care of the face and body; bubble bath; shaving foam; aftershave; make-up foundations; nail polish; body deodorants for men and women; hand and body soap; shampoos and hair rinses; hair spray; dentifrices; fragrances, namely perfume, eau de Cologne, and essential oils for personal use for men and women.

(260) AM 2020 102217 A  
 (800) 1455892  
 (151) 2018 10 17  
 (891) 2018 10 17  
 (731) BAHRAMAN SAFFRON CO.  
 No.386, Next to Mahdieh, Emam Reza  
 St., Mashhad, Islamic Republic of Iran

(540)



(591) Gold and red

(531) 25.01.05; 25.01.25; 27.05.01; 27.05.24; 28.01; 29.01.13

(511)

30 – Saffron [seasoning]; spices.

(260) AM 2020 102218 A

(800) 1455907

(151) 2019 01 02

(891) 2019 01 02

(731) TRINA SOLAR CO., LTD  
NO.2 TRINA ROAD, TRINA PV PARK,  
XINBEI, CHANGZHOU, JIANGSU, China

(540)

(591) Black, white

(531) 27.05.07; 27.05.10

(511)

6 – Buildings, transportable, of metal; ironmongery; roofing of metal, incorporating photovoltaic cells; poles of metal; buildings of metal; building materials of metal; reinforcing materials of metal for building; roof coverings of metal; props of metal; frames of metal for building.

9 – Inverters [electricity]; solar panels for the production of electricity; solar-powered battery chargers; solar batteries; photovoltaic cells; distribution boxes; photovoltaic inverters; accumulators, electric.

(260) AM 2020 102281 A

(800) 1456346

(151) 2019 01 14

(891) 2019 01 14

(731) ICC Intercertus Capital Ltd  
Antheon 2 Monovoliko, CY-4151 Limassol,  
Cyprus

(540)

(591) Black, white

(511)

36 – Financial services; financial investment services; financial research services; financial brokerage

services; financial transaction services; financial risk management services.

(260) AM 2020 102283 A

(800) 1456477

(151) 2018 11 09

(891) 2018 11 09

(731) FUTURE ENTERPRISE PTE. LTD.

31 Harrison Road, #08-01, Food Empire

Business Suites, Singapore 369649, Singapore

(540)



(591) Black, white

(531) 01.15.11; 01.15.15; 08.01.19; 11.03.04; 25.01.19; 26.11.08; 27.05.09; 27.05.11

(511)

30 – Coffee; coffee-based beverages; compositions for preparing coffee-based beverages.

(260) AM 2020 102284 A

(800) 1456487

(151) 2018 08 27

(891) 2018 08 27

(731) YMO TEKSTİL İNŞAAT SANAYİ İÇ VE  
DIŞ TİCARET LİMİTED ŞİRKETİ  
Eski Habipler Mahallesi, Eski Edirne Asfaltı,  
No:987/A, Sultangazi-Istanbul, Turkey

(540)

(591) Black, white

(531) 27.05.09; 27.05.10; 27.05.12

(526) Collection

(511)

18 – Unworked or semi-worked leather and animal skins, imitations of leather, stout leather, leather used for linings; goods made of leather, imitations of leather or other materials, designed for carrying items, included in this class; bags, wallets, boxes and trunks made of leather or stout leather; key cases, trunks [luggage], suitcases; umbrellas; parasols; sun umbrellas; walking sticks; whips; harness; saddlery; stirrups; straps of leather (saddlery).



25 – Clothing, including underwear and outer clothing, other than special purpose protective clothing; socks, mufflers [clothing], shawls, bandanas, scarves, belts [clothing]; footwear, shoes, slippers, sandals; headgear, hats, caps with visors, berets, caps [headwear], skull caps.

35 – Advertising, marketing and public relations; organization of exhibitions and trade fairs for commercial or advertising purposes; design of advertising materials; provision of an online marketplace for buyers and sellers of goods and services; office functions; secretarial services; arranging newspaper subscriptions for others; compilation of statistics; rental of office machines; systemization of information into computer databases; telephone answering for unavailable subscribers; business management, business administration and business consultancy; accounting; commercial consultancy services; personnel recruitment, personnel placement, employment agencies, import-export agencies; temporary personnel placement services; auctioneering; the bringing together, for the benefit of others, of a variety of goods, namely, unworked or semi-worked leather and animal skins, imitations of leather, stout leather, leather used for linings, goods made of leather, imitations of leather or other materials, designed for carrying items, bags, wallets, boxes and trunks made of leather or stout leather, key cases, trunks [luggage], suitcases, umbrellas, parasols, sun umbrellas, walking sticks, whips, harness, saddlery, stirrups, straps of leather (saddlery), clothing, including underwear and outer clothing, other than special purpose protective clothing, socks, mufflers [clothing], shawls, bandanas, scarves, belts [clothing], footwear, shoes, slippers, sandals, headgear, hats, caps with visors, berets, caps [headwear], skull caps, enabling customers to conveniently view and purchase those goods, such services may be provided by retail stores, wholesale outlets, by means of electronic media or through mail order catalogues.

(260) AM 2020 102287 A

(800) 1456507

(151) 2018 11 26

(891) 2018 11 26

(731) CHRYSANTI TRADING LIMITED

Agia Zoni, 33B, Flat 203, CY-3027 Limassol,  
Cyprus

(540)

**AREOL**

(591) Black and Light Green

(531) 27.05.01; 27.05.17; 29.01.12

(511)

1 – Adhesives for use in industry; chemical and organic compositions for use in the manufacture of

food and beverages; chemical preparations and materials for film, photography and printing; detergents for use in manufacture and industry; filtering media of chemical and non-chemical substances included in the class; growing media, fertilizers and chemicals for use in agriculture, horticulture and forestry; putties, and fillers and pastes for use in industry; salts for industrial purposes; starches for use in manufacturing and industry; unprocessed artificial and synthetic resins; unprocessed plastics; fertilisers, and chemicals for use in agriculture, horticulture and forestry; unprocessed and synthetic resins; combusting preparations [chemical additives to motor fuel]; motor fuel (chemical additives to -); chemical additives to motor fuel; additives, chemical, to motor fuel; anti-boil preparations for engine coolants; engine coolants (anti-boil preparations for -); coolants (anti-boil preparations for engine -); antifreeze; windshield antifreeze fluids; propylene glycol antifreeze; ethylene glycol antifreeze; antifreeze for vehicle radiators; antifreeze mixes; anti-frothing solutions for accumulators; batteries (anti-frothing solutions for -); anti-frothing solutions for batteries; anti-incrustants; internal combustion engines (anti-knock substances for -); anti-knock substances for internal combustion engines; brake fluid; brake fluids; fluids (brake -); hydraulic brake fluid; cement for pneumatic tires [tyres]; mastic for tires [tyres]; mastic for tires; tires (mastic for -); mastic for tyres; tyres (mastic for -); coolants for vehicle engines; vehicle engines (coolants for -); engines (coolants for vehicle -); corrosive preparations; detergent additives to gasoline [petrol]; detergent additives to petrol [gasoline]; additives (detergent -) to gasoline [petrol]; engine-decarbonising chemicals; decarbonising engines (chemical preparations for -); chemical preparations for decarbonising engines; fillers for automobile bodies; automobile body fillers; car body fillers; fillers for car bodies; filtering materials [chemical preparations]; filtering materials [mineral substances]; filtering materials [unprocessed plastics]; filtering materials [vegetable substances]; hydraulic circuits (fluids for -); fluids for hydraulic circuits; hydraulic circuits (liquids for -); liquids for hydraulic circuits; liquids for removing sulfates from accumulators; liquids for removing sulfates from batteries; magnetic fluid for industrial purposes; oil-bleaching chemicals; bleaching chemicals (oil- -); oil cement [putty]; cement (oil -) [putty]; oil dispersants; dispersants (oil -); purifying chemicals (oil- -); oil-purifying chemicals; oil-separating chemicals; oils for currying leather; oils for preparing leather in the course of manufacture; oils for tanning leather; oils for the preservation of food; power steering fluid; fluid (power steering -); synthetic materials for absorbing oil; absorbing oil (synthetic materials for -); oil (synthetic materials for absorbing -); test paper, chemical; chemical test paper; chemical test paper [sensitised]; transmission fluid; transmission fluids; che-



mical additives for transmission fluids; automatic transmission fluids; power transmission fluids; hydraulic transmission fluid; fluid (transmission -); transmission oil.

4 – Dust controlling compositions; electrical energy; lubricants and industrial greases, waxes and fluids; additives, non-chemical, to motor fuel; additives, non-chemical, to motor-fuel; motor fuel (additives, non-chemical, to -); benzine; biomass fuel; bone oil for industrial purposes; carburants; motor fuel; carnauba wax; castor oil for industrial purposes; cere-sine; combustible briquettes; cutting fluids; diesel oil; dust absorbing compositions; dust binding compositions for sweeping; dust laying compositions; dust removing preparations; ethanol [fuel]; ethanol fuels; fuel gas; combustible oil; gas for lighting; grease for arms [weapons]; grease for belts; grease for footwear; grease for leather; greases for the preservation of leather; illuminating grease; illuminating wax; industrial grease; industrial oil; industrial wax; kerosene; lanolin; wool grease; lignite; ligroin; lubricants; lubricating graphite; lubricating grease; lubricating oil; methylated spirit; mineral fuel; moistening oil; motor oil; naphtha; nightlights [candles]; non-slipping preparations for belts; oil-gas; oils for paints; oils for releasing form work [building]; oils for the preservation of leather; oils for the preservation of masonry; oleine; ozokerite [ozokerite]; paper spills for lighting; paraffin; peat briquettes [fuel]; peat [fuel]; perfumed candles; petroleum ether; petroleum jelly for industrial purposes; petroleum, raw or refined; producer gas; rape oil for industrial purposes; colza oil for industrial purposes; solidified gases [fuel]; soya bean oil preparations for non-stick treatment of cooking utensils; stearine; sunflower oil for industrial purposes; tallow; textile oil; textile oils; tinder; vaporized fuel mixtures; wax for skis; wax [raw material]; waxes [raw material]; wicks for candles; wood briquettes; wood spills for lighting.

(260) AM 2020 102289 A

(800) 1456514

(151) 2018 12 20

(891) 2018 12 20

(731) JAPAN TOBACCO INC.

2-2-1, Toranomom, Minato-ku, Tokyo  
105-8422, Japan

(540)



(591) Black, white

(531) 03.07.01; 03.07.16; 03.07.24; 25.07.01;  
26.11.02; 26.11.09; 26.11.13; 27.05.01

(511)

34 – Tobacco, raw or manufactured; smoking tobacco, pipe tobacco, rolling tobacco, chewing tobacco, snus; cigarettes, electronic cigarettes, cigars, cigari-  
llos; snuff; smokers' articles included in class 34; cigarette paper, cigarette tubes and matches.

(260) AM 2020 102291 A

(800) 1456574

(151) 2018 12 05

(891) 2018 12 05

(731) VIVETTA S.R.L.

Piazza Guido Monaco 11, I-52100 AREZZO  
(AR), Italy

(540)

**VIVETTA**

(591) Black, white

(531) 27.05.17

(511)

14 – Precious and semi-precious gems; imitation precious stones; precious metals and their alloys; pearl; imitation pearls; jewelry findings; paste jewelry [costume jewelry (Am)]; pearls [jewellery, jewelry (Am)]; jewellery being articles of precious stones; jewellery made of crystal; jewellery made of glass; jewellery made of plastics; sterling silver jewellery; jewellery fashioned from non-precious metals; jewellery made of precious metals; jewellery made of semi-precious materials; jewellery made of bronze; ivory jewelry; watch straps; horological articles; chronographs [watches]; chronometers; clocks; alarm clocks; cases for watches [presentation]; jewellery ornaments; clothing ornaments of precious metals; shoe ornaments of precious metal; ornamental figurines made of precious metal; figurines for ornamental purposes of precious stones; statuettes made of semi-precious stones; caskets for clocks and jewelry; jewelry cases [caskets or boxes].

18 – Umbrellas; covers for parasols; parasols; combination walking sticks and umbrellas; luggage; trunks [luggage]; suitcases; vanity cases, not fitted; bags; purses; handbags; overnight bags; hat boxes for travel; satchels; leather wallets; travel cases; bum-bags; luggage tags; card wallets [leatherware]; attache cases made of leather; business card cases; wallets; leather purses; haversacks; valises; day-packs; backpacks; animal skins; imitation leather; faux fur; collars for pets; leads for animals; clothing for pets.

25 – Coats; jackets; trousers; skirts; tops; raincoats; overcoats; belts; braces for clothing; suits; stuff jackets; jumpers; jeans; dresses; cloaks; parkas; shirts; T-shirts; sweaters; underwear; baby-dolls being nightwear; bathrobes; bathing costumes; negligee; swim suits; dressing gowns; shawls; neckerchiefs; scarves;

ties; neckties; sweat shirts; under shirts; polo shirts; body suits; shorts; combinations [clothing]; wedding dresses; stockings; socks; shoes; slippers; overshoes; galoshes; wooden clog; soles for footwear; footwear upper; boots; ski boots; snow boots; half boots; esparto shoes or sandals; sandals; bath sandals; gloves; mittens; hats and caps; visors (headwear).

(260) AM 2020 102292 A

(800) 1456606

(151) 2018 06 20

(891) 2018 06 20

(731) JUVENTUS FOOTBALL CLUB S.P.A.

Via Druento, 175, I-10151 Torino, Italy

(540)

## JUVENTUS

(591) Black, white

(511)

9 – Apparatus and instruments for recording, transmission and reproduction of sound or images; video and/or sound recordings; audio and/or video CDs; audio and/or video tapes and cassettes; DVD; optical discs containing sound recordings and/or video; audio and video film clips made for the purposes of teaching, training and information; PC games; downloadable application software for smartphones and tablets; electronic publications; downloadable publications and multimedia content in digital format; eyewear; glasses; sun glasses; spectacle frames; protective glasses; eyeglass cases; safety clothing for protection against accident or injury; protective work gloves; head protection; protective glasses; helmets; cases for telephones; cases for smartphones; tablet cases; cell phone straps; smartphone straps; tablet straps; shoulder straps for smartphones; acoustic headphones; headsets for mobile phones; headphones for smartphones and tablets.

16 – Stationery; writing and drawing instruments; office requisites (except furniture); adhesives (glues) for stationery or household purposes; artists' materials; printed photos; artists' brushes; instructional and teaching material (except apparatus); printed publications; books; newspapers; magazines; periodicals; bookmarks; greeting cards; notebooks; diaries; agendas; writing or drawing books; sketchbook; posters; calendars; figurines; paper towels.

25 – Casualwear; formalwear; sportswear; clothing, for the practice of sports, namely, shirts, team and competition jerseys and team and competition uniforms, polo shirts, tracksuits, warm-up suits, shorts, pants, socks, tights; underwear, namely, underpants, long underpants, tank tops, long and short sleeve undershirts; belts; ties; swimwear; bathrobes; footwear; boots; slippers; sports footwear; headgear.

28 – Games; toys; gymnastic and sporting articles; balls and balloons for sports; soccer balls; guards for

sports including elbow guards, knee pads, shin guards; goalkeeper gloves; soccer ball goal nets; soccer goals; Christmas tree decorations.

41 – Sporting and cultural activities; education and educational services; training courses; organisation of training courses, refresher courses, events, symposiums, colloquiums, exhibitions, workshops or other activities and events for educational, training, cultural, recreational or sporting purposes; arranging and conducting of events for cultural, educational, entertainment, training, sports and recreational purposes; organisation and conducting of sporting events and tournaments, shows, concerts, festivals, awards; organisation of awards ceremonies and ceremonies for awarding sporting and academic titles; hire of equipment for sports; provision of courses of instruction relating to sport; entertainment, namely publishing of multimedia content, information, libraries and podcasts via the Internet and/or other communications networks; publication of video, audio and digital multimedia content; publishing services and on-line digital publishing services; photographic services; on-paper and online publishing services.

(260) AM 2020 102297 A

(800) 1456663

(151) 2019 01 15

(891) 2019 01 15

(731) IEFYM SHABSHAI

19 Nissim Alon street, Tel Aviv, Israel

(540)

## High Studio

(591) Black, white

(511)

41 – Academies [education]; aikido instruction; amusement parks services; animal training; arranging and conducting of colloquiums; arranging and conducting of concerts; arranging and conducting of conferences; arranging and conducting of congresses; arranging and conducting of in-person educational forums; arranging and conducting of seminars; arranging and conducting of symposiums; arranging and conducting of workshops [training]; arranging of beauty contests; boarding school education; booking of seats for shows; calligraphy services; cinema presentations; club services [entertainment or education]; coaching [training]; conducting fitness classes; conducting guided tours; correspondence courses; disc jockey services; discotheque services; dubbing, educational examination; educational services provided by schools; education information; electronic desktop publishing; entertainer services; entertainment information; entertainment services; film production, other than advertising films; gambling services; games equipment rental; game services provided on-line from a computer network; gymnastic in-

struction; health club services [health and fitness training]; holiday camp services [entertainment]; karaoke services; language interpreter services; layout services, other than for advertising purposes; lending library services; microfilming; mobile library services; modelling for artists; movie studio services; music composition services; news reporters services; nightclub services [entertainment]; nursery schools; on-line publication of electronic books and journals; orchestra services; organization of balls; organization of competitions [education or entertainment]; organization of exhibitions for cultural or educational purposes; organization of fashion shows for entertainment purposes; organization of lotteries; organization of shows [impresario services]; organization of sports competitions; party planning [entertainment]; personal trainer services [fitness training]; photographic reporting; photography; physical education; practical training [demonstration]; presentation of circus performances; presentation of live performances; presentation of variety shows; production of music; production of radio and television programmes; production of shows; providing amusement arcade services; providing casino facilities [gambling]; providing films, not downloadable, via video-on-demand transmission services; providing golf facilities; providing museum facilities [presentation, exhibitions]; providing on-line electronic publications, not downloadable; providing on-line music, not downloadable; providing on-line videos, not downloadable; providing recreation facilities; providing sports facilities; providing television programs, not downloadable, via video-on-demand transmission services; providing films, not downloadable, via video-on-demand services; publication of books; publication of texts, other than publicity texts; radio entertainment; recording studio services; recreation information; religious education; rental of artwork; rental of audio equipment; rental of cinematographic apparatus; rental of indoor aquaria; rental of lighting apparatus for theatrical sets or television studios; rental of motion pictures; rental of radio and television sets; rental of show scenery; rental of skin diving equipment; rental of sound recordings; rental of sports equipment, except vehicles; rental of sports grounds; rental of stadium facilities; rental of stage scenery; rental of tennis courts; rental of video cameras; rental of video cassette recorders; rental of videotapes; sado instruction [tea ceremony instruction]; screenplay writing; scriptwriting, other than for advertising purposes; sign language interpretation; songwriting; sport camp services; subtitling; teaching; television entertainment; theatre productions; ticket agency services [entertainment]; timing of sports events; toy rental; training services provided via simulators; translation; tutoring; videotape editing; videotaping; vocational guidance [education or training advice]; vocational retraining; writing of texts; zoological garden services.

44 – Aerial and surface spreading of fertilizers and other agricultural chemicals; alternative medicine services; animal breeding; aquaculture services; artificial insemination services; blood bank services; convalescent home services; dentistry services; farming equipment rental; flower arranging; gardening; horticulture; hospice services; hospital services; human tissue bank services; in vitro fertilization services; landscape design; landscape gardening; lawn care; medical advice for individuals with disabilities; medical assistance; medical clinic services; medical equipment rental; midwife services; nursing home services; nursing, medical; opticians' services; orthodontic services; palliative care; pest control services for agriculture, aquaculture, horticulture and forestry; pet grooming; pharmacy advice; physiotherapy; plant nursery services; plastic surgery; preparation of prescriptions by pharmacists; reforestation services; rehabilitation for substance abuse patients; rental of sanitation facilities; services of a psychologist; speech therapy; telemedicine services; tree planting for carbon offsetting purposes; tree surgery; vermin exterminating for agriculture, aquaculture, horticulture and forestry; veterinary assistance; visagists' services; weed killing; wreath making.

(260) AM 2020 102299 A

(800) 1456741

(151) 2018 09 27

(891) 2018 09 27

(731) DOCAP OY

Varnankatu 2 E 63, FI-20320 Turku, Finland

(540)

## ZIPPIE

(591) Black, white

(511)

9 – Cellular phones; computer hardware; computer memory devices; computer operating programs, recorded; computer programs [downloadable software]; computers; computer software platforms, recorded or downloadable; computer software applications, downloadable; computer software, recorded; mobile software; downloadable mobile applications; downloadable mobile coupons; mobile computers; electronic encryption units; databases; identity cards, magnetic; security tokens [encryption devices]; telephone apparatus; commutators; electronic numeric displays; encoded key cards; encoded magnetic cards; smartphones.

38 – Communications by cellular phones; computer aided transmission of messages and images; message sending; providing access to databases; providing internet chatrooms; providing telecommunications connections to a global computer network; providing user access to global computer networks; transmission of digital files; transmission of telegrams; tele-

communication services; network transmission of sounds, images, signals and data.

42 – Computer programming; computer software design; computer system design; creating and designing website-based indexes of information for others [information technology services]; data encryption services; electronic data storage; updating of computer software; conversion of computer programs and data, other than physical conversion; hosting services and software as a service and rental of software; platform as a service [PaaS]; encryption, decryption and authentication of information, messages and data.

(260) AM 2020 102306 A

(800) 1456848

(151) 2018 12 28

(891) 2018 12 28

(731) MOROZOV VICTOR ALEXANDROVICH

Kosmonavtov street, 5, block G, apt 40,

RU-344092 Rostov-on-Don, Russian

Federation

(540)

# Pekarro

(591) Burgundy, white

(531) 27.05.01; 29.01.12

(511)

30 – Coffee, tea, cocoa and artificial coffee; rice, pasta and noodles; tapioca and sago; flour and preparations made from cereals; bread, pastries and confectionery; chocolate; ice cream, sorbets and other edible ices; sugar, honey, treacle; yeast, baking-powder; salt, seasonings, spices, preserved herbs; vinegar, sauces and other condiments; ice (frozen water); aromatic preparations for food; star aniseed; pancakes; buns; bread rolls; vanillin [vanilla substitute]; waffles; vermicelli [noodles]; natural sweeteners; sausage binding materials; mustard; yeast; thickening agents for cooking foodstuffs; artificial coffee; vegetal preparations for use as coffee substitutes; confectionery for decorating Christmas trees; fruit jellies [confectionery]; peanut confectionery; almond confectionery; pasta; pasties; cocoa; capers; gruel, with a milk base, for food; gluten prepared as foodstuff; sweetmeats [candy]; peppermint sweets; coffee; unroasted coffee; starch for food; crackers; hominy grits; groats for human food; corn, milled; corn, roasted; farinaceous foods; noodles; ice for refreshment; ice, natural or artificial; edible ices; candy; rice cakes; maltose; hominy; honey; ice cream; fruit ice-cream; muesli; mint for confectionery; cocoa beverages with milk; coffee beverages with milk; coffee-based beverages; chocolate beverages with milk; chocolate-based beverages; cocoa-based beverages; infusions, not medicinal; crushed oats; husked oats;

nutmegs; pastilles [confectionery]; molasses for food; pepper; cookies; pies; pizzas; fondants [confectionery]; popcorn; pralines; condiments; meat tenderizers for household purposes; cereal preparations; pastries; oat-based food; propolis; gingerbread; ravioli; rice; sugar; aniseed; confectionery; salt for preserving foodstuffs; cooking salt; celery salt; spaghetti; seasonings; preparations for stiffening whipped cream; rusks; breadcrumbs; sushi; sandwiches; tapioca; almond paste; garden herbs, preserved [seasonings]; vinegar; ferments for pastes; halvah; bread; unleavened bread; tea; iced tea; sponge cakes; vanilla flavorings for culinary purposes; coffee flavorings; binding agents for ice cream; sea water for cooking; glucose for culinary purposes; rice-based snack food; cereal-based snack food; cakes; frozen yogurt [confectionery ices]; prepared cocoa beverages; cocoa powder; cocoa mixes; caramels [candy]; quiches; liquorice [confectionery]; meat pies; turmeric; couscous [semolina]; marzipan; custard; royal jelly for human consumption, not for medical purposes; barley meal; soya flour; rice flour; wheat flour; flour; nut flours; corn flour; potato flour; tapioca flour; buckwheat flour; bean meal; tea-based beverages; powders for making ice cream; puddings; chewing gum, not for medical purposes; spring rolls; cake dough; baking soda [bicarbonate of soda for cooking purposes]; tacos; tortillas; malt extract for food; chicory [coffee substitute]; essences for foodstuffs, except etheric essences and essential oils; chips [cereal products]; fruit cakes; tabbouleh.

35 – Advertising; business management; business administration; office functions; arranging subscriptions to telecommunication services for others; commercial information agency services; advertising agency services; cost price analysis; rental of advertising space; account auditing; employment agency services; computerized file management; invoicing; demonstration of goods; opinion polling; market studies; business information; business investigations; business management and organization consultancy; personnel recruitment; business organization consultancy; business management consultancy; professional business consultancy; layout services for advertising purposes; business management of performing artists; news clipping services; updating of advertising material; word processing; shorthand; organization of exhibitions for commercial or advertising purposes; organization of trade fairs for commercial or advertising purposes; shop window dressing; business appraisals; payroll preparation; sponsorship search; business management assistance; commercial or industrial management assistance; economic forecasting; auctioneering; office machines and equipment rental; publicity material rental; rental of vending machines; rental of photocopying machines; publication of publicity texts; radio advertising; billposting; distribution of samples; dissemination of advertising matter; writing of publicity texts; on-line

advertising on a computer network; advertising by mail order; television advertising; document reproduction; compilation of statistics; business inquiries; systemization of information into computer databases; tax preparation; drawing up of statements of accounts; commercial administration of the licensing of the goods and services of others; public relations; modelling for advertising or sales promotion; relocation services for businesses; price comparison services; procurement services for others [purchasing goods and services for other businesses]; business efficiency expert services; book-keeping; transcription of communications [office functions]; commercial information and advice for consumers in the choice of products and services; marketing research; secretarial and clerical services; arranging newspaper subscriptions for others; data search in computer files for others; sales promotions at point of purchase or sale, for others; rental of advertising time on communication media; typing; photocopying services; telephone answering for unavailable subscribers; administrative processing of purchase orders; business management of hotels; compilation of information into computer databases; psychological testing for the selection of personnel; copywriting; presentation of goods on communication media, for retail purposes.

(260) AM 2020 102315 A  
(800) 1457136  
(151) 2019 02 14  
(891) 2019 02 14  
(731) THE ONCOR CORPORATION  
13030 Alondra Boulevard, Cerritos CA 90703,  
USA

(540)

## PLASMATIC EFFECT

(591) Black, white  
(526) EFFECT  
(511)  
3 – Cosmetic preparations for skin renewal.

(260) AM 2020 102316 A  
(800) 1457155  
(151) 2019 02 07  
(891) 2019 02 07  
(731) MULTALER ET Cie, Société anonyme  
43, rue Victor Hugo, F-92700 COLOMBES,  
France

(540)

## AROMA-FUSION

(591) Black, white  
(511)  
44 – Care provided in beauty parlors.

(260) AM 2020 102323 A  
(800) 1457369  
(151) 2018 12 31  
(891) 2018 12 31  
(731) BEYAZ KAĞIT VE HİJYENİK ÜRÜNLER  
TEMİZLİK İNŞAAT SANAYİ TİCARET  
ANONİM ŞİRKETİ, Hacı Sabancı Organize  
Sanayi Bölgesi  
Anavarza Caddesi No:3, Sarıçam – Adana,  
Turkey

(540)



(591) Red  
(531) 27.05.11; 29.01.01  
(511)  
3 – Bleaching and cleaning preparations, detergents other than for use in manufacturing operations and for medical purposes, laundry bleach, fabric softeners for laundry use, stain removers, dishwasher detergents; perfumery; non-medicated cosmetics; fragrances; deodorants for personal use and animals; soaps; dental care preparations; dentifrices, denture polishes, tooth whitening preparations, mouth washes, not for medical purposes; abrasive preparations; emery cloth; sandpaper; pumice stone; abrasive pastes; polishing preparations for leather, vinyl, metal and wood, polishes and creams for leather, vinyl, metal and wood, wax for polishing.

(260) AM 2020 102327 A  
(800) 1457488  
(151) 2018 10 25  
(891) 2018 10 25  
(731) VENTIS SRL  
Via Carlo Esterle, 9, I-20132 MILANO (MI),  
Italy

(540)



(591) Turquoise and Black  
(531) 27.05.01; 29.01.12  
(511)  
35 – Advertising, marketing and promotional services; commercial trading and consumer information services; rental of vending machines; rental of card-operated vending machines; rental of coin-operated vending machines; auctioneering services; auctioneering provided on the Internet; auctioning of vehicles; auction and reverse auction services; on-line auctioneering services via the Internet; auctioneering

services relating to agriculture; on-line trading services in which seller posts products to be auctioned and bidding is done via the Internet; arranging and conducting auctions; arranging of auctions; organisation of Internet auctions; on-line auction bidding for others; providing on-line auction services; telephone and television auctions; business analysis, research and information services; market research; analysis of the public awareness of advertising; analysis of advertising response; consumer response analysis; analysis of market research data; analysis of market research data and statistics; market analysis; market survey analysis; analysis of market research statistics; market analysis and research; analysis relating to marketing; advertising analysis; interviewing for qualitative market research; market research consultancy; audience rating determination for radio and television broadcasts; dissemination of data relating to advertising; provision of market research information; market surveys conducted by telephone; profit surveys; investigations of marketing strategy; pricing surveys; interpretation of market research data; interviewing for market research purposes; preparation of marketing surveys; preparation of public opinion surveys; business assistance, management and administrative services; administrative data processing; accountancy, book keeping and auditing; rental of office machines; business consultancy and advisory services; human resources management and recruitment services; clerical services; business acquisitions; administration relating to business planning; administration (business -) relating to statistical methods; business administration of employee share schemes; business administration in the field of transport and delivery; business administration; commercial administration of the licensing of the goods and services of others; administration of the business affairs of franchises; administration of the business affairs of retail stores; administration of business affairs; administration of foreign business affairs; business management and administration of commercial undertakings; administration relating to marketing; administration relating to sales methods; administration relating to business appraisal; assistance to industrial or commercial enterprises in the running of their business; assistance to industrial enterprises in the conduct of their business; assistance to commercial enterprises in the management of their business; business assistance; auditing utility rates for others; cost accounting; business advice relating to accounting; consulting and information concerning accounting; consultancy relating to auditing; taxation [accountancy] consultation; advice on tax preparation; accounting; administrative accounting; computerised accounting (preparation of -); balance sheet accounting; management accounting; school fee accounting services; accounting for third parties; cost management accounting; tracking and monitoring energy consumption for others for ac-

count auditing purposes; tracking and monitoring fluctuation in gasoline prices for others for account auditing purposes; provision of information relating to accounts [accountancy]; provision of reports relating to accounting information; business accounts management; tax planning [accountancy]; preparation of business balances; preparation of accounts; preparation of documents relating to taxation; providing consumer product advice; providing consumer product advice relating to cosmetics; administrative order processing; administrative processing and organising of mail order services; administrative processing of purchase orders within the framework of services provided by mail-order companies; administrative processing of purchase orders; providing consumer product advice relating to software; consulting in sales techniques and sales programmes; consultancy relating to costing of sales orders; advice and information about customer services and product management and prices on Internet sites in connection with purchases made over the Internet; advice relating to barter trade; purchasing of goods and services for other businesses; procurement of contracts for others relating to the sale of goods; procurement of contracts [for others]; telephone order-taking services for others; subscription to a television channel; subscription to an information media package; subscriptions to electronic journals; newspaper subscriptions; retail services in relation to alcoholic beverages (except beer); retail services in relation to meats; retail services in relation to headgear; retail services in relation to fodder for animals; retail services in relation to bedding for animals; retail services in relation to lighting; retail services in relation to teas; retail services in relation to coffee; retail services in relation to cleaning articles; retail services in relation to sanitation equipment; retail services in relation to cocoa; retail services in relation to gardening articles; retail services in relation to heating equipment; retail services in relation to articles for use with tobacco; retail services in relation to food cooking equipment; retail services in relation to fabrics; retail services in relation to heaters; retail services in relation to veterinary instruments; retail services in relation to time instruments; retail services in relation to litter for animals; retail services in relation to printed matter; retail services in relation to horticulture products; retail services in relation to preparations for making beverages; retail services in relation to foodstuffs; rental of sales stands; collection and systematization of business data; acquisition of commercial information; acquisition of business information relating to company status; acquisition of business information relating to company activities; statistical analysis and reporting; computerised compilation of order lists; computerised compilation of customer indexes; computerised compilation of stock control records; compilation of information into computer databases; data compila-

tion for others; compilation of statistical data for use in scientific research; compilation of statistical data relating to business; compilation of statistical data relating to medical research; compilation of directories for publishing on global computer networks or the Internet; compilation of lists of prospective customers; compilation of business directories; compilation of directories for publication on the Internet; compilation of indexed addresses; compilation of mailing lists; compilation of statistical information; compilation of direct mailing lists; compilation of statistical models for the provision of market dynamics information; compilation of registers relating to exporters; compilation of registers relating to importers; compilation of statistics [for business or commercial purposes]; compilation of statistics relating to advertising; compilation of information into computer databases; compilation and systematisation of information in databanks; consultancy relating to data processing; automated data processing; data processing; data processing for the collection of data for business purposes; data processing for businesses; processing of business survey results; electronic data processing; computerised data processing; business file management; computerised file management; management and compilation of computerised databases; data entry and data processing; collating of data in computer databases; administrative services relating to credit card registration; computerised business information retrieval; data search in computer files for others; business consultancy services relating to data processing; advisory services relating to electronic data processing; advisory services relating to data processing; computerised business information processing services; on-line data processing services; data processing services in the field of payroll; data processing services in the field of transportation; acquisition (business -) searches; commercial information agency services and provision of business information, including marketing and demographic data; updating of business information in computer databases; business analysis; business analysis of markets; benchmarking (evaluation of business organisation practices); cost price analysis; cost benefit analysis; business management analysis; analysis of company behaviour; analysis of business information; economic forecasting analysis for business purposes; analysis of business management systems; economic analysis for business purposes; analysis of business statistics; assessment analysis relating to business management; assistance, advisory services and consultancy with regard to business analysis; information and data compiling and analysing relating to business management; compilation and provision of trade and business price and statistical information; design of public opinion surveys; conducting of internal business communication surveys; conducting of business research; conducting of business feasibility studies; acquisitions

(advice relating to -); assistance and advice regarding business organization; assistance and advice regarding business organisation and management; assistance and advice regarding business management; advising commercial enterprises in the conduct of their business; advising industrial enterprises in the conduct of their business; business consultancy to firms; business consultancy to individuals; business consultancy relating to the administration of information technology; business advice relating to growth financing; business advice relating to franchising; business advice relating to marketing management consultations; business advice relating to strategic marketing; business advice relating to financial reorganisation; business advice relating to disposals; business consultancy, in the field of transport and delivery; professional business consultation relating to the setting up of businesses; professional business consultation relating to the operation of businesses; advice and information concerning commercial business management; management advice; business management advice relating to manufacturing business; business management consultancy in the field of transport and delivery; management advisory services related to franchising; business management consultancy, also via the Internet; administration of insurance business; administration of group insurance; dental health insurance administration; administration of insurance plans; administration of group insurance plans; insurance administration of prescription drug benefit plans; administration of insurance claims; administration of insurance claims adjustment; administration of employee benefit plans; administration of employee welfare benefit plans; administration of patient reimbursement programs; administration of pre-paid health care plan; administration of savings accounts.

36 – Fundraising and sponsorship; providing educational scholarships; charitable fund raising; providing college scholarships; providing monetary grants to charities; providing information relating to charitable fundraising; provision of charitable fundraising services in relation to carbon offsetting; investment of funds for charitable purposes; organising of charitable collections; arranging charitable collections [for others]; arranging of funds for overseas aid projects; arranging of financing for humanitarian projects; charitable fund raising in view of disaster precautions and prevention; charitable fundraising through the sale of charity stamps; charitable fundraising by means of entertainment events; organisation of collections; memorial fund raising; charitable services, namely financial services; eleemosynary services in the field of monetary donations; financing services for sponsoring businesses; benevolent fund services; fundraising; charitable fundraising services for underprivileged children; political fund-raising services; financial grant services; philanthropic services concerning monetary donations; insurance un-



derwriting; life insurance agencies; brokerage agency relating to ship insurance; management of insurance portfolios; fire insurance; insurance against loss of credit; health insurance; insuring of hotel accommodation; insurance of communications apparatus; insurance for garages; insurance of anti-theft systems; time and cost completion risk insurance; accident insurance; marine insurance; ship insurance agency; insurance agencies; insurance underwriting and appraisals and assessment for insurance purposes; accident insurance underwriting; life insurance underwriting; insurance underwriting consultancy; providing information relating to claims adjustment for non-life insurance; providing information relating to non-life insurance underwriting; providing information relating to life insurance underwriting; insurance risk management; claims adjustment for non-life insurance; insurance claims adjustment services; arranging of insurance claims assessment; loss adjustment; insurance claim settlements; claims settlement agency services; insurance claims adjustment and settlement services; underwriting services; insurance underwriting services; aviation underwriting services; underwriting of business insurance (services for the -); financial evaluation for reinsurance purposes; automobile accident insurance underwriting; financial valuation, adjustment and settlement services relating to insurance claims; underwriting insurance for pre-paid legal services; marine transportation insurance underwriting; underwriting insurance for pre-paid health care; valuation services; providing information, consultancy and advice in the field of financial valuation; providing information relating to the appraisal of used automobiles; providing information relating to antique appraisal; providing information relating to art appraisal; providing information relating to the appraisal of precious stones; intellectual property valuation services; numismatic appraisal; valuation of standing timber (financial -); appraisal of personal property for others; evaluation of chattels; stamp appraisal; jewellery appraisal; art appraisal; precious stone appraisal; antique appraisal; financial evaluation of wool; appraisal of used automobiles; valuation of diamonds; valuation of diamonds, precious stones and precious metals; valuation of machinery; valuation of freight and cargo; valuation of precious metals; issuance of prepaid cards and tokens of value; issuing of cash vouchers; issuing of vouchers for use as money; issuance of tokens of value; issuing tokens of value as a reward for customer loyalty; issuing tokens of value as part of a customer membership scheme; issuing of tokens of value in relation to incentive schemes; issuing of tokens of value in relation to customer loyalty schemes; issuing tokens of value in the nature of gift vouchers; issuing of travel vouchers; issuing stored value cards; issuing stored value cards for use as electronic travel tickets; issuing gift certificates which may then be

redeemed for goods or services; issue of tokens, coupons and vouchers of value; issue of tokens of value in the nature of phone cards; issuing traveler's checks by travel agencies; issuing of travellers' cheques and letters of credit; issue and redemption of tokens of value; issuing of vouchers for meals; providing information relating to the issue of tokens of value; financial and monetary services, and banking; financial information, data, advice and consultancy services; debt recovery and factoring services; securities and commodities trading services; financial investment; acquisition and transfer of monetary claims; financial affairs; facilitating and arranging financing; asset allocation; administration of financial affairs; financial management; pension fund management services; banking services relating to the deposit of money; financial rating and credit reports; financial planning services; financial appraisal services; investment analysis; financial investment analysis and stock research; financial evaluation and analysis; financial analysis; financial analysis; computerised financial analysis; conducting financial feasibility studies; comparison of performance of portfolios of securities; comparison of performance of securities; financial analysis and consultancy; financial advice; computerised financial advisory services; financial and investment consultancy services; financial consultancy in relation to the buying and selling of businesses; financial advice relating to inheritance; financial advice relating to investment; financial advice relating to settlements; financial advice relating to pensions; financial advice relating to employee share schemes; financial advice relating to share option schemes; financial advice relating to wills; credit reporting agency; provision of credit information; provision of credit rating; preparation of credit rating reports; credit assessment services; credit agencies; credit information services; credit reporting services; credit scoring services; financial credit scoring services; business credit verification services; preparation of credit reports; evaluation of the credit worthiness of companies and private individuals.

(260) AM 2020 102329 A

(800) 1457505

(151) 2019 01 30

(891) 2019 01 30

(731) TERIUS BUSINESS LIMITED

Vanerpool Plaza, Wickhams Cay 1, 2 Floor,  
Road Town, Tortola, Virgin Islands (British)

(540)

**МИШАНЯ**

(591) Black, white

(531) 28.05



(511)

5 – Dietetic foods, including dietetic foods adapted for medical purposes, dietetic beverages; albuminous foodstuffs; food for babies; mineral food supplements; nutritional supplements; albumin dietary supplements; dietary supplements for animals; yeast dietary supplements; alginate dietary supplements; glucose dietary supplements; casein dietary supplements; lecithin dietary supplements; linseed oil dietary supplements; flaxseed oil dietary supplements; propolis dietary supplements; protein dietary supplements; protein supplements for animals; royal jelly dietary supplements; pollen dietary supplements; wheat germ dietary supplements; linseed dietary supplements; flaxseed dietary supplements; enzyme dietary supplements; vitamin preparations; medicinal tea; herbal teas for medicinal purposes.

29 – Milk; albumin milk; protein milk; milk beverages, milk predominating; milk products.

(260) AM 2020 102330 A

(800) 1457543

(151) 2019 01 08

(891) 2019 01 08

(731) Jack Wolfskin Ausrüstung für Draussen

GmbH &amp; Co. KgaA

Jack Wolfskin Kreisel 1, 65510

Idstein/Taunus, Germany

(540)

## Jack Wolfskin

(591) Black, white

(511)

18 – Leather and imitation leather; cases, in particular travelling bags; bags, included in class 18, briefcases, holdalls, sports bags, carrying bags and shoulder bags; travel pouches, carrying bags and packs; pouches of leather for packaging (included in class 18); hipsacks; rucksacks and backpacks (for travel), daypacks (small rucksacks for day trips); shopping bags; handbags; toilet bags and wash bags for carrying toiletries; towel bags; papooses; satchels; school bags; neck pouches, including for passports; document cases and holders; purses, pocket wallets, key wallets; parasols and umbrellas; walking sticks, alpenstocks, trekking poles; saddlery; waist pouches; belt bags.

20 – Mattresses, in particular air mattresses (not for medical purposes); chair pads, pillows.

22 – Ropes, straps for packaging, of textile material (included in class 22), nets, tents, awnings, tarpaulins, sails, bags (envelopes, pouches) for packaging of textile material, sacks (included in class 22).

24 – Textiles and textile goods, included in class 24; cotton fabrics, woollen fabrics, linings, non-woven textile fabrics; bath linen, except clothing; towels of textile; blankets, namely travel blankets, woollen

blankets, fleece blankets; sleeping bags for trekking and camping.

27 – Mats, in particular for gymnastics, sports, travelling, trekking and camping purposes.

(260) AM 2020 102331 A

(800) 1457546

(151) 2019 01 24

(891) 2019 01 24

(731) ENSINGER GMBH

Rudolf-Diesel-Strasse 8, 71154 Nufringen, Germany

(540)

## TECA

(591) Black, white

(511)

1 – Unprocessed plastics and unprocessed plastic composites, in particular in the form of granulate, prepreps and compounds.

7 – Machines and machine tools for the processing and production of materials, including welding robots, as well as parts of the afore-mentioned goods.

10 – Medical apparatus and parts thereof.

12 – Automobile parts, including undercarriage components, in particular transverse control arms and ball joints; bicycles and parts therefor, in particular gearing parts and cranks.

17 – Goods made of plastics and plastic composites (semi-finished products), in particular in the form of foils, plates, blocks, rods, hollow rods, profile rods; goods made of plastics (semi-finished products), including plastic profiles, in particular for insulating glazing systems for window and facade glazing; plastic profiles for making composite structures of metal and plastic.

19 – Building materials and building elements (non-metallic); spacers of plastic for the building sector; building profiles of thermoplastic and foamed plastics.

40 – Material treatment.

(260) AM 2020 102332 A

(800) 1457581

(151) 2018 10 29

(891) 2018 10 29

(731) ADP GAUSELMANN GMBH

Mercur-Allee 1-15, 32339 Espelkamp, Germany

(540)

## BOLD ADVENTURE – BIG 5

(591) Black, white

(511)

9 – Computer software; coin-operated mechanisms; computer and video games software; games software

in particular for use on any computer platform, including electronic entertainment and games consoles; computer game programs; video games (software); computer games provided through a global computer network or supplied by means of multi-media electronic broadcast or through telecommunications or electronic transmission or via the internet; computer games, leisure and recreational software, video games and computer software, all being provided in the form of storage media; programs for operating electric and electronic apparatus for games, amusement and/or entertainment purposes; computer software for computer games on the internet; online games (software), in particular for online betting games, online prize games, online gambling games, online games of skill and online casino games; computer software in the form of an app for mobile devices and computers; calculating apparatus in coin-operated machines and parts for the aforesaid goods; electric, electronic, optical or automatic apparatus, for identifying data carriers, identity cards and credit cards, bank notes and coins; software in particular for casino and/or amusement arcade games, for gaming machines and/or slot machines each one with or without prize payouts; gaming software that generates or displays wager outcomes of gaming machines; operational computer games software; computer software for managing of games (game collection); computer programs for video games; video game software.

28 – Games; toys; gaming apparatus (including coin-operated apparatus); coin-operated arcade games (machines); games for amusement arcades (included in this class); coin-operated video gaming apparatus; video games apparatus adapted for use with external screens or monitors only; casino fittings, namely roulette tables, roulette wheels; coin-operated automatic gaming machines and gaming machines, in particular for gaming arcades, with or without a prize payout; electronic or electrotechnical gaming apparatus, automatic gaming machines, gaming machines, slot machines operated by coins, tokens, banknotes, tickets or by means of electronic, magnetic or biometric storage media, in particular for commercial use in casinos and amusement arcades, with or without a prize payout; automatic gaming machines and gaming machines, in particular for commercial use in casinos and gaming arcades, with or without a prize payout; coin-operated gaming machines and/or electronic money-based gaming apparatus (machines), with or without prizes; housings adapted for gaming machines, gaming apparatus and automatic gaming machines, operated by means of coins, tokens, tickets or by means of electronic, magnetic or biometric storage media, in particular for commercial use in casinos and gaming arcades, with or without a prize payout; electronic games; electronic game entertainment apparatus and parts thereof; video output game machines; drawing apparatus for

prize games and lotteries, draws or raffles; housings of metal, plastic and/or wood for coin-operated automatic machines; apparatus for games (including video games), other than adapted for use with external screens or monitors only; electropneumatic and electric slot machines with pulling handles (gaming machines); gaming tables, in particular for table football, billiards, sliding games; flying discs (toys) and darts; gaming machines, namely electric, electronic or electromechanical apparatus for bingo games, lotteries or video lottery games and for betting offices, connected or unconnected to a computer network; LCD games consoles; automatic gaming machines; all the aforesaid automatic machines operating in networks; apparatus and devices for accepting and storing money, being fittings for the aforesaid automatic machines, included in this class; automatic lottery machines.

(260) AM 2020 102333 A  
 (800) 1457600  
 (151) 2018 09 04  
 (891) 2018 09 04  
 (731) JINAN CREATEK TECHNOLOGY CO., LTD  
 No.3078, Airport West Road, Lingang Economic Development Zone, Jinan, 250000 Shandong, China

(540)

**CREATEK**

(591) Black, white  
 (531) 27.05.01  
 (511)

7 – Injectors for engines; sealing joints [parts of engines]; belts for motors and engines; cylinders for machines; fans for motors and engines; control mechanisms for machines, engines or motors; automobile engine mufflers and exhaust pipes; silencers for motors and engines; oil filter; pistons for engines; radiators [cooling] for motors and engines; fuel economizers for motors and engines; anti-pollution devices for motors and engines; hydraulic controls for machines, motors and engines; valves [parts of machines]; couplings other than for land vehicles; crank shafts; connecting rods for machines, motors and engines; speed governors for machines, engines and motors; springs [parts of machines]; engine bearings for vehicles; adhesive bands for pulleys; brake pads other than for vehicles.

(260) AM 2020 102334 A  
 (800) 1457638  
 (151) 2019 02 18  
 (891) 2019 02 18  
 (731) ZHEJIANG YAKEXI ABRASIVES CO., LTD.  
 Xialixi Industrial production base, Shizhu Town, Yongkang City, Zhejiang Province, China

(540)

**WINONE**

(591) Black, white

(531) 27.05.17

(511)

7 – Grinding wheels [parts of machines]; hand-held tools, other than hand-operated; electric hand-held drills, not including electric coal drill; air-operated power tools; electric grinders; metalworking machines; grinding stones [parts of machines]; electric hammers; angle grinders; circular saw blades [parts of machines].

(260) AM 2020 102410 A

(800) 1457704

(151) 2018 12 28

(891) 2018 12 28

(731) HONGDOU GROUP CO., LTD.

Gangxiashi Town, Xishan District,  
Wuxi City, Jiangsu Province, China

(540)

**Hodo**

(591) Black, white

(531) 26.04.05; 26.04.18; 26.04.24; 27.05.09;  
27.05.10; 27.05.24

(511)

25 – Clothing; tee-shirts; shirts; sports jerseys; underwear; raincoats; running shoes; hosiery; stockings; underpants.

(260) AM 2020 102411 A

(800) 1457711

(151) 2019 01 31

(891) 2019 01 31

(731) NOVARTIS AG

CH-4002 Basel, Switzerland

(540)



(591) Black, white

(531) 26.04.03; 26.04.04; 26.04.05; 26.04.16;  
26.04.24; 26.11.03; 26.11.12; 26.13.25

(511)

10 – Surgical apparatus and instruments for ophthalmic surgery.

(260) AM 2020 102421 A

(800) 1457829

(151) 2018 10 24

(891) 2018 10 24

(731) J. CHOO LIMITED

10 Howick Place, London SW1P 1GW,  
United Kingdom

(540)



(591) Black, white

(531) 25.07.17; 27.01.25; 27.05.01

(511)

14 – Precious metals and their alloys; jewellery; jewellery in the nature of jewellery ornaments; jewellery for use on shoes and handbags; jewellery in the nature of clip-on jewellery for use as fashion accessories; costume jewellery; costume jewellery in the nature of jewellery ornaments; costume jewellery for use on shoes and handbags; costume jewellery in the nature of clip-on jewellery for use as fashion accessories; earrings, bracelets, chains, necklaces, clip on jewellery, arm cuffs (jewellery), wrist bands (jewellery); jewellery made of leather; key rings (trinkets or fobs); key fobs; trinkets of metal; key fobs of leather or imitations of leather incorporating key rings; horological and chronometric instruments; watches, bracelets and straps for watches, cases adapted to contain watches; jewellery boxes, presentation boxes for jewellery, boxes of precious metals; tie clips, cufflinks; shoe ornaments and handbag ornaments of precious metal; ornaments (jewellery); key chains; parts and fittings for the aforesaid goods; key holders.

18 – Handbags, travelling bags, weekend bags, trunks, trunks for storing shoes, purses, wallets, clutch bags, travel wallets, luggage tags, luggage label holders, cosmetic bags, make-up bags, vanity bags, vanity cases not-fitted, pouches, cases, bags, shoe bags, cloth bags, backpacks, garment bags, beach bags, briefcases, suitcases, attaché cases; cases of leather or leather board; key cases, key bags; card cases; card holders, credit card holders, debit card holders, bank card holders, business card cases; document cases; hat boxes made of leather or imitations of leather; parasols, umbrellas, walking sticks; parts and fittings for the aforesaid goods; laces (leather); leashes; collars and leads for animals; garments and clothing for pets.

25 – Clothing, footwear and headgear; scarves; gloves, hats, belts, swimming hats; raincoats, hosiery, sashes for wear, wedding dresses, fur stoles, stoles of imitation fur, fur muffs, muffs of imitation fur, ear muffs, fur hats, hats of imitation fur, fur coats, coats of imitation fur; kaftans; swimwear; underclothing; outerclothing.

(260) AM 2020 102422 A

(800) 1457842

(151) 2019 02 19

(891) 2019 02 19

(731) Marussia Beverages B.V.

Siriusdreef 41 NL-2132 WT HOOFFDORP,  
Netherlands

(540)

**MAMONT BLOOD**

(591) Black, white

(511)

33 – Alcoholic beverages (except beers); vodka; spirits.

(260) AM 2020 102423 A

(800) 1457870

(151) 2018 12 28

(891) 2018 12 28

(731) LIXIN COUNTY FUYA GAUZE ELEMENT  
CO., LTD

Laodong Chuangye Park, Industrial Park,  
Lixin County, Bozhou City, Anhui, China

(540)



(591) Black, white

(531) 26.01.03; 26.04.04; 26.04.05; 26.04.12;  
26.11.12; 28.03

(511)

24 – Curtain holders of textile material; net curtains; shower curtains of textile or plastic; door curtains; curtains of textile or plastic.

(260) AM 2020 102424 A

(800) 1457876

(151) 2018 12 14

(891) 2018 12 14

(731) Audemars Piguet Holding SA

Route de France 16, CH-1348 Le Brassus,  
Switzerland

(540)



(591) Black, white

(531) 26.01.03; 26.01.08; 26.05.02; 26.05.18;  
27.05.01; 27.05.02

(511)

14 – Watch clasps; watch bands; watch cases; dials (clock and watch making); component parts of timepieces and accessories for timepieces not included in other classes.

(260) AM 2020 102425 A

(800) 1457896

(151) 2018 10 31

(891) 2018 10 31

(731) SUNGROW POWER SUPPLY CO., LTD.

No.1699 Xiyou Road, New & High  
Technology Industrial, Development Zone,  
Hefei, Anhui, China

(540)

**SUNGROW**

(591) Black, white

(531) 27.05.01

(511)

9 – Electric apparatus for commutation; solar batteries; semi-conductors; counters; materials for electricity mains [wires, cables]; distribution boxes [electricity]; condensers [capacitors]; current rectifiers; power station automation equipment; alarms; inverters [electricity]; transformers [electricity]; regulated power supply apparatus; chargers for electric batteries; electro-dynamic apparatus for the remote control of signals; accumulators, electric; measuring apparatus; electrolysers; fire extinguishing apparatus; radiological apparatus for industrial purposes.

(260) AM 2020 102426 A

(800) 1457935

(151) 2018 12 17

(891) 2018 12 17

(731) Obschestvo s ogranichennoy otvetstvennostiyu  
"ORTONICA"

ul. 11 Parkovaya, 95, app. 94, RU-105554  
Moscow, Russian Federation

(540)



(591) Burgundy color, black, white

(531) 18.01.20; 27.03.15; 27.05.01; 27.05.09;  
27.05.10; 29.01.12

(511)

10 – Surgical, medical, dental and veterinary apparatus and instruments; artificial limbs, eyes and teeth; orthopedic articles; suture materials; blood testing apparatus; anaesthetic apparatus; galvanic therapeu-

tic appliances; apparatus for artificial respiration; apparatus for the treatment of deafness; testing apparatus for medical purposes; physical exercise apparatus for medical purposes; body rehabilitation apparatus for medical purposes; dental apparatus and instruments; surgical apparatus and instruments; resuscitation apparatus; dental apparatus, electric; physiotherapy apparatus; bed vibrators; hot air therapeutic apparatus; diagnostic apparatus for medical purposes; traction apparatus for medical purposes; radiotherapy apparatus; microdermabrasion apparatus; fumigation apparatus for medical purposes; apparatus and installations for the production of X-rays, for medical purposes; radiological apparatus for medical purposes; X-ray apparatus for medical purposes; hearing aids; trusses; maternity belts; bandages, elastic; cupping glasses; dental burs; feeding bottles; air cushions for medical purposes; hot air vibrators for medical purposes; vibromassage apparatus; gastroscopes; hemocytometers; surgical sponges; defibrillators; dialyzers; containers especially made for medical waste; clips, surgical; mirrors for dentists; mirrors for surgeons; probes for medical purposes; urethral probes; artificial teeth; acupuncture needles; suture needles; needles for medical purposes; surgical implants comprised of artificial materials; inhalers; temperature indicator labels for medical purposes; injectors for medical purposes; incubators for medical purposes; incubators for babies; obstetric apparatus; obstetric apparatus for cattle; electric acupuncture instruments; surgical cutlery; insufflators; cannulae; droppers for medical purposes; dropper bottles for medical purposes; heart pacemakers; catheters; catgut; draw-sheets for sick beds; enema apparatus for medical purposes; artificial skin for surgical purposes; teething rings; compressors [surgical]; thermo-electric compresses [surgery]; abdominal corsets; corsets for medical purposes; crutches; dentists' armchairs; armchairs for medical or dental purposes; beds specially made for medical purposes; feeding bottle valves; love dolls [sex dolls]; lasers for medical purposes; lamps for medical purposes; quartz lamps for medical purposes; ultraviolet ray lamps for medical purposes; lancets; lenses [intraocular prostheses] for surgical implantation; spoons for administering medicine; masks for use by medical personnel; anaesthetic masks; childbirth mattresses; air mattresses for medical purposes; hydrostatic [water] beds for medical purposes; furniture especially made for medical purposes; water bags for medical purposes; douche bags; breast pumps; urinals [vessels]; knee bandages, orthopaedic; tips for crutches; finger guards for medical purposes; medical guidewires; pumps for medical purposes; thread, surgical; knives for surgical purposes; scissors for surgery; ambulance stretchers; stretchers, wheeled; boots for medical purposes; orthopaedic footwear; clothing especially for operating rooms; supports for flat feet; ophthalmometers; ophthalmoscopes; slings [supporting ban-

dages]; gloves for massage; gloves for medical purposes; pessaries; saws for surgical purposes; ear picks; spittoons for medical purposes; plaster bandages for orthopaedic purposes; supportive bandages; suspensory bandages; abdominal pads; cushions for medical purposes; pads [pouches] for preventing pressure sores on patient bodies; air pillows for medical purposes; soporific pillows for insomnia; heating cushions [pads], electric, for medical purposes; abdominal belts; galvanic belts for medical purposes; hypogastric belts; belts for medical purposes; orthopaedic belts; umbilical belts; belts, electric, for medical purposes; condoms; aerosol dispensers for medical purposes; sphygmomanometers; pulse meters; esthetic massage apparatus; massage apparatus; urological apparatus and instruments; orthodontic appliances; nursing appliances; brushes for cleaning body cavities; invalids' hoists; appliances for washing body cavities; corn knives; incontinence sheets; sterile sheets, surgical; surgical drapes; hair prostheses; artificial breasts; artificial jaws; ice bags for medical purposes; surgical bougies; X-ray photographs for medical purposes; respirators for artificial respiration; strait jackets; scalpels; tongue scrapers; babies' pacifiers [teats]; feeding bottle teats; receptacles for applying medicines; spirometers [medical apparatus]; vaginal syringes; hearing protectors; contraceptives, non-chemical; stents; stethoscopes; operating tables; commode chairs; basins for medical purposes; bed pans; instrument cases for use by doctors; arch supports for footwear; ear plugs [ear protection devices]; thermal packs for first aid purposes; thermometers for medical purposes; trocars; drainage tubes for medical purposes; X-ray tubes for medical purposes; radium tubes for medical purposes; ear trumpets; balling guns; protection devices against X-rays, for medical purposes; filters for ultraviolet rays, for medical purposes; cases fitted for medical instruments; elastic stockings for surgical purposes; stockings for varices; splints, surgical; syringes for injections; syringes for medical purposes; hypodermic syringes; uterine syringes; urethral syringes; pins for artificial teeth; forceps; castrating pincers; radiology screens for medical purposes; electrodes for medical use; electrocardiographs.

35 – Advertising; business management; business administration; office functions; arranging subscriptions to telecommunication services for others; import-export agency services; commercial information agency services; advertising agency services; cost price analysis; rental of advertising space; business auditing; employment agency services; computerized file management; book-keeping; invoicing; demonstration of goods; opinion polling; market studies; business information; commercial information and advice for consumers [consumer advice shop]; business investigations; business research; marketing research; personnel recruitment; business management and organization consultancy; business organi-

zation consultancy; business management consultancy; personnel management consultancy; professional business consultancy; layout services for advertising purposes; marketing; business management of performing artists; business management of sports people; news clipping services; updating of advertising material; word processing; organization of exhibitions for commercial or advertising purposes; arranging newspaper subscriptions for others; organization of fashion shows for promotional purposes; organization of trade fairs for commercial or advertising purposes; shop window dressing; business appraisals; payroll preparation; data search in computer files for others; sponsorship search; business management assistance; commercial or industrial management assistance; economic forecasting; auctioneering; retail or wholesale services for pharmaceutical, veterinary and sanitary preparations and medical supplies; production of advertising films; office machines and equipment rental; rental of advertising time on communication media; publicity material rental; rental of vending machines; rental of photocopying machines; publication of publicity texts; radio advertising; bill-posting; distribution of samples; dissemination of advertising matter; direct mail advertising; writing of publicity texts; on-line advertising on a computer network; advertising by mail order; television advertising; document reproduction; compilation of statistics; compilation of information into computer databases; business inquiries; systemization of information into computer databases; tax preparation; drawing up of statements of accounts; telemarketing services; psychological testing for the selection of personnel; business management of hotels; commercial administration of the licensing of the goods and services of others; administrative processing of purchase orders; public relations; modelling for advertising or sales promotion; typing; relocation services for businesses; price comparison services; secretarial services; procurement services for others [purchasing goods and services for other businesses]; shorthand; outsourcing services [business assistance]; telephone answering for unavailable subscribers; photocopying services; business efficiency expert services; sales promotions at point of purchase or sale, for others.

(260) AM 2020 102428 A

(800) 1458005

(151) 2018 09 24

(891) 2018 09 24

(731) MAERSK GTD INC.

185 HUDSON STREET, SUITE 2910,

JERSEY CITY NJ 07311, USA

(540)

## TradeLens

(591) Black, white

(511)

9 – Software for use in online global trade services that enables others to conduct paperless trade by exchanging shipping and supply chain related documents electronically; software for electronic data interchange; software for tracking shipments and freight over computer networks, intranets and the internet for supply chain, logistics, governmental security, and business administration purposes; software for management of business operations for importers, exporters, logistics service providers, and ocean carriers; software for targeting, risk assessment, and increased efficiency for customs and other governmental authorities involved in the global supply chain; software for creating inventory visibility and synchronizing supply chain processes; software for storing, tracking, and verifying freight contracts and other supply chain related documentation to optimize movement of inventory along the supply chain, and fulfillment decisions; software for management of, and searching of, supply chain and shipping data; software for database services in relation to supply chain, including creating searchable, customizable, supply chain related data sets and creating and distributing related reports; software for regulatory submission management, namely, assisting others in storing, tracking, and verifying documents related to customs with governmental regulatory bodies; software that assists with the automatic upload of data to APIs; software for facilitating managing logistics and delivery of intermodal freight shipments in the global supply chain, including providing shipping and freight quotes; software for facilitating booking intermodal freight shipments; software for facilitating freight shipment billing; software for facilitating the management of forwarding and shipping of end-to-end freight, ocean freight, and air freight; software for facilitating trucking logistics and delivery of goods; software for online filing of government agency documents, customs clearances, customs bonds registrations, product classifications, cargo insurance, quality inspections and testing; software for facilitating the managing of supply chain logistics and reverse logistics, namely, the storage, transportation and delivery of goods for others by air, rail, ship, or truck; software for facilitating the distribution of goods from ports; software for facilitating the management of warehouse inventories and order fulfillment; software for facilitating information gathering, analytics, and related services for marine and supply chain finance and insurance brokerage.

35 – Business consulting services relating to product distribution, logistics, reverse logistics, supply chain, pricing, and distribution solutions; providing database services, namely providing searchable, customizable, supply chain related data sets and preparing reports of same for business management and commercial information purposes; providing electronic tracking of freight information to others for business

administration and inventory purposes; administrative services relating to regulatory submission management, namely, assisting others in preparing and filing documents with customs and with governmental regulatory bodies; business management of freight logistics; business management of freight, namely, shipment processing, preparing shipping documents and invoices, tracking documents, packages and freight over computer networks, intranets, and the internet; administrative services relating to customs clearance services.

39 – Freight transportation consultation in the field of freight transportation by truck, rail, air and ocean; supply chain logistics and reverse logistics, namely, storage, transportation and delivery of documents, packages, raw materials, and other freight for others by air, rail, ship or truck.

42 – Providing temporary use of non-downloadable software for use in online global trade services that enables others to conduct paperless trade by exchanging shipping and supply chain related documents electronically, for electronic data interchange, and for tracking shipments and freight over computer networks, intranets and the internet for supply chain, logistics, governmental security, and business administration purposes; providing temporary use of non-downloadable software for management of business operations for importers, exporters, logistics service providers, and ocean carriers; providing temporary use of non-downloadable software for targeting, risk assessment, and increased efficiency for customs and other governmental authorities involved in the global supply chain; providing temporary use of non-downloadable software for creating inventory visibility and synchronizing supply chain processes, for storing, tracking, and verifying freight contracts and other supply chain related documentation to optimize movement of inventory along the supply chain, and fulfillment decisions; providing temporary use of non-downloadable software for management of, and searching of, supply chain and shipping data; providing temporary use of non-downloadable software for database services in relation to supply chain, including creating searchable, customizable, supply chain related data sets and creating and distributing related reports; providing temporary use of non-downloadable software for regulatory submission management, namely, assisting others in storing, tracking, and verifying documents related to customs with governmental regulatory bodies; providing temporary use of non-downloadable software that assists with the automatic upload of data to APIs; providing temporary use of non-downloadable software for facilitating managing logistics and delivery of intermodal freight shipments in the global supply chain, including providing shipping and freight quotes; providing temporary use of non-downloadable software for facilitating booking intermodal freight ship-

ments; providing temporary use of non-downloadable software for facilitating freight shipment billing; providing temporary use of non-downloadable software for facilitating the management of forwarding and shipping of end-to-end freight, ocean freight, and air freight; providing temporary use of non-downloadable software for facilitating trucking logistics and delivery of goods; providing temporary use of non-downloadable software for online filing of government agency documents, customs clearances, customs bonds registrations, product classifications, cargo insurance, quality inspections and testing; providing temporary use of non-downloadable software for facilitating the managing of supply chain logistics and reverse logistics, namely, the storage, transportation and delivery of goods for others by air, rail, ship, or truck; providing temporary use of non-downloadable software for facilitating the distribution of goods from ports; providing temporary use of non-downloadable software for facilitating the management of warehouse inventories and order fulfillment; providing temporary use of non-downloadable software for facilitating information gathering, analytics, and related services for marine and supply chain finance and insurance brokerage; providing technology information relating to the field of freight transportation by truck, rail, air and ocean; software as a service (SAAS) services for use in online global trade services that enables others to conduct paperless trade by exchanging shipping and supply chain related documents electronically, for electronic data interchange, and for tracking shipments and freight over computer networks, intranets and the internet for supply chain, logistics, governmental security, and business administration purposes; software as a service (SAAS) services for management of business operations for importers, exporters, logistics service providers, and ocean carriers; software as a service (SAAS) services for targeting, risk assessment, and increased efficiency for customs and other governmental authorities involved in the global supply chain; software as a service (SAAS) services for creating inventory visibility and synchronizing supply chain processes, for storing, tracking, and verifying freight contracts and other supply chain related documentation to optimize movement of inventory along the supply chain, and fulfillment decisions; software as a service (SAAS) services for management of, and searching of, supply chain and shipping data; software as a service (SAAS) services for database services in relation to supply chain, including creating searchable, customizable, supply chain related data sets and creating and distributing related reports; software as a service (SAAS) services for regulatory submission management, namely, assisting others in storing, tracking, and verifying documents related to customs with governmental regulatory bodies; software as a service (SAAS) services that assist with the automatic uplo-

ad of data to APIs; software as a service (SAAS) services for facilitating managing logistics and delivery of intermodal freight shipments in the global supply chain, including providing shipping and freight quotes; software as a service (SAAS) services for facilitating booking intermodal freight shipments; software as a service (SAAS) services for facilitating freight shipment billing; software as a service (SAAS) services for facilitating the management of forwarding and shipping of end-to-end freight, ocean freight, and air freight; software as a service (SAAS) services for facilitating trucking logistics and delivery of goods; software as a service (SAAS) services for online filing of government agency documents, customs clearances, customs bonds registrations, product classifications, cargo insurance, quality inspections and testing; software as a service (SAAS) services for facilitating the managing of supply chain logistics and reverse logistics, namely, the storage, transportation and delivery of goods for others by air, rail, ship, or truck; software as a service (SAAS) services for facilitating the distribution of goods from ports; software as a service (SAAS) services for facilitating the management of warehouse inventories and order fulfillment; software as a service (SAAS) services for facilitating information gathering, analytics, and related services for marine and supply chain finance and insurance brokerage; software development in the field of end-to-end freight forwarding and shipment, ocean freight, air freight, trucking and delivery, government agency filings, customs clearances, customs bonds registration, product classification, cargo insurance, quality inspections and testing, warehousing and fulfillment, and setting up distribution of goods from ports.

(260) AM 2020 102430 A  
(800) 1458048  
(151) 2018 11 16  
(891) 2018 11 16  
(731) APPLE INC.

One Apple Park Way, Cupertino CA 95014,  
USA

(540)



(591) Black, white  
(531) 03.01.08  
(511)

9 – Computer software used in developing other software applications; application development softwa-

re; computer software development tools; software for performing and providing machine learning, artificial intelligence, data mining, data analytics, and data analysis.

42 – Computer programming; design and development of computer software; computer software consulting services; support and consultation services for developing computer applications; providing computer software development information online; providing online non-downloadable software; application service provider (ASP) services featuring software for machine learning and artificial intelligence; consulting services in the field of computer machine learning and artificial intelligence software development.

(260) AM 2020 102431 A  
(800) 1458084

(151) 2018 12 07

(891) 2018 12 07

(731) RICHTER GEDEON NYRT.

Gyömrői út 19-21, H-1103 Budapest, Hungary

(540)

**SITIDIAB**

(591) Black, white

(511)

5 – Pharmaceutical preparations.

(260) AM 2020 102432 A  
(800) 1458137

(151) 2018 12 24

(891) 2018 12 24

(731) NAHAL EGHBALI AZAR (MS)

4th Floor, No. 39 Eghbal Melli Ave, Reshadat  
St, Sarv Sharghi St, Sa'Adat Abad, Tehran,  
Islamic Republic of Iran

(540)

**Sheikh**

شېخ

(591) Black, white

(531) 28.01

(511)

34 – Tobacco; smoking tobacco; tobacco pipes.

35 – Import-export agency services for the goods including distribution of smoking tobacco, tobacco pipes.

39 – Packing of the goods; delivery of the goods including tobacco, smoking tobacco, tobacco pipes.



(260) AM 2020 102433 A  
 (800) 1458208  
 (151) 2018 11 20  
 (891) 2018 11 20  
 (731) Obshchestvo s ogranichennoy  
 otvetstvennostyu "SISTEMA I"  
 ulitsa Kievskaya, 6, korpus 1, litera B,  
 pomeshchenie 21N, RU-196084 Saint-  
 Petersburg, Russian Federation  
 (540)



(591) Red, yellow and black  
 (531) 26.03.19; 26.07.15; 28.05; 29.01.13  
 (526) Elektro", "Instrument  
 (511)  
 35 – Advertising / publicity; business management;  
 business administration; office functions.  
 37 – Building construction; repair; installation ser-  
 vices.

(260) AM 2020 102434 A  
 (800) 1458243  
 (151) 2019 01 29  
 (891) 2019 01 29  
 (731) DR. THEISS NATURWAREN GMBH  
 Michelinstr. 10, 66424 Homburg, Germany  
 (540)



(591) Black, White, Pink  
 (531) 26.01.06; 26.01.22; 26.11.13; 26.15.01;  
 29.01.13  
 (511)  
 3 – Bleaching preparations and other substances for  
 laundry use; cleaning, polishing, scouring and abra-  
 sive preparations; perfumery, essential oils, cosme-  
 tics, not for medical purposes, including skin clean-  
 ing and care preparations, and hair care prepara-  
 tions, all not for medical purposes; non-medicated  
 dentifrices.  
 5 – Pharmaceuticals; medical and veterinary prepa-  
 rations; sanitary preparations for medical purposes;  
 dietetic foodstuffs and substances adapted for medi-  
 cal use; dietary supplements for humans and ani-  
 mals; vitamin preparations.

(260) AM 2020 102436 A  
 (800) 1458311  
 (151) 2018 08 16  
 (891) 2018 08 16  
 (731) CADOSA GRUP GIDA SAN. VE TİC.  
 ANONİM ŞİRKETİ  
 Egemenlik Mah. 6093 Sok., S.Kocaman  
 Apt. No:14 Bornova, İzmir, Turkey  
 (540)



(591) Orange and black  
 (531) 03.04.11; 03.04.24; 26.11.02; 26.11.08;  
 27.05.09; 27.05.10; 29.01.12  
 (526) Cafe & bakery  
 (511)  
 30 – Coffee, cocoa, coffee or cocoa based beverages,  
 chocolate based beverages, pasta, stuffed dumplings,  
 noodles, honey, bee glue for human consumption,  
 propolis for food purposes, condiments for foodstuff,  
 yeast, baking powder, flour, semolina, starch for fo-  
 od, sugar, cube sugar, powdered sugar, tea, iced tea,  
 chewing gums, ice-cream, edible ices, salt, cereals,  
 processed, molasses for food.  
 32 – Beers, preparations for making beer, mineral  
 water, spring water, table water, soda water, fruit  
 and vegetable juices, fruit and vegetable concentra-  
 tes and extracts for making beverages, non-alcoholic  
 soft drinks.  
 35 – The bringing together, for the benefit of others,  
 of a variety of goods, namely, beers, preparations for  
 making beer, mineral water, spring water, table wa-  
 ter, soda water, fruit and vegetable juices, fruit and  
 vegetable concentrates and extracts for making be-  
 verages, non-alcoholic soft drinks, coffee, cocoa,  
 coffee or cocoa based beverages, chocolate based  
 beverages, pasta, stuffed dumplings, noodles, honey,  
 bee glue for human consumption, propolis for food  
 purposes, condiments for foodstuff, yeast, baking  
 powder, flour, semolina, starch for food, sugar, cube  
 sugar, powdered sugar, tea, iced tea, chewing gums,  
 ice-cream, edible ices, salt, cereals, processed, mo-  
 lasses for food, meat, fish, poultry and game, proces-  
 sed meat products, dried pulses, soups, bouillon,  
 processed olives, olive paste, milks of animal origin,  
 milks of herbal origin, milk products, butter, edible  
 oils, dried, preserved, frozen, cooked, smoked or  
 salted fruits and vegetables, tomato paste, prepared  
 nuts and dried fruits as snacks, hazelnut spreads and  
 peanut butter, tahini (sesame seed paste), eggs and  
 powdered eggs, potato chips, enabling customers to

conveniently view and purchase those goods, such services may be provided by retail stores, wholesale outlets, by means of electronic media or through mail order catalogues.

43 – Services for providing food and drink, temporary accommodation, day-nurseries (crèches), boarding for animals.

(260) AM 2020 102440 A

(800) 1458524

(151) 2019 02 07

(891) 2019 02 07

(731) RDC GROUP LIMITED

Room 1501 A1, Grand Millennium Plaza  
(Lower Block), 181 Queen's Road Central,  
Hong Kong, China

(540)

**NEWWORLD**

(591) Blue

(531) 27.05.01; 29.01.04

511)

9 – Coils, electric; particle accelerators; reflective articles for wear, for the prevention of accidents; protection devices for personal use against accidents; clothing for protection against accidents, irradiation and fire; accumulators, electric, for vehicles; battery jars; battery boxes; acidimeters for batteries; hydrometers; plates for batteries; whistle alarms; acoustic alarms; acoustic conduits; sound recording discs; speaking tubes; actinometers; adding machines; aerometers; enlarging apparatus [photography]; electro-dynamic apparatus for the remote control of railway points; magnets; electromagnetic coils; air analysis apparatus; alarms; alcoholmeters; alidades; food analysis apparatus; igniting apparatus, electric, for igniting at a distance; batteries for lighting; altimeters; asbestos gloves for protection against accidents; asbestos clothing for protection against fire; ammeters; amplifiers; amplifying tubes; anemometers; calibrating rings; fire extinguishers; anodes; anode batteries; antennas; anti-glare glasses; visors for helmets; anti-interference devices [electricity]; transformers [electricity]; apertometers [optics]; money counting and sorting machines; distribution boxes [electricity]; surveying instruments; surveying chains; lenses for astrophotography; thermionic tubes; audiovisual teaching apparatus; coin-operated musical automata [juke boxes]; mechanisms for coin-operated apparatus; mechanisms for counter-operated apparatus; calipers; comparators; fire alarms; automatic indicators of low pressure in vehicle tires; protective suits for aviators; alarm bells, electric; rods for water diviners; life-saving rafts; scales; meteorological balloons; demagnetizing apparatus for magnetic tapes; tape recorders; magnetic tapes;

barometers; weighing machines; weighbridges; fire beaters; chargers for electric batteries; betatrons; ticket dispensers; cabinets for loudspeakers; close-up lenses; terminals [electricity]; pressure indicator plugs for valves; galvanometers; push buttons for bells; branch boxes [electricity]; tone arms for record players; spirit levels; punched card machines for offices; sheaths for electric cables; frames for photographic transparencies; circular slide rules; slide-rules; calculating machines; slide calipers; jigs [measuring instruments]; blueprint apparatus; cinematographic cameras; capillary tubes; sound recording carriers; protective helmets; respiratory masks, other than for artificial respiration; solderers' helmets; eyeglass chains; heat regulating apparatus; darkrooms [photography]; boiler control instruments; drying racks [photography]; apparatus for editing cinematographic film; printed circuits; flashing lights [luminous signals]; signal bells; containers for microscope slides; collectors, electric; electric installations for the remote control of industrial operations; switchboxes [electricity]; commutators; marine compasses; eyepieces; thread counters; pedometers; counters; metronomes; condensers [capacitors]; conductors, electric; electricity conduits; circuit closers; connectors [electricity]; junction boxes [electricity]; switchboards; contacts, electric; apparatus to check franking; regulating apparatus, electric; monitoring apparatus, other than for medical purposes; speed checking apparatus for vehicles; converters, electric; photocopiers [photographic, electrostatic, thermic]; eyeglass cords; retorts; retorts' stands; correcting lenses [optics]; objectives [lenses] [optics]; cosmographic instruments; diving suits; electric apparatus for commutation; switches, electric; limiters [electricity]; electric plugs; current rectifiers; cell switches [electricity]; dressmakers' measures; crucibles [laboratory]; appliances for measuring the thickness of leather; cyclotrons; counterfeit [false] coin detectors; shutter releases [photography]; densimeters; animated cartoons; laboratory trays; metal detectors for industrial or military purposes; sonars; detectors; shutters [photography]; diaphragms [acoustics]; centering apparatus for photographic transparencies; cameras [photography]; transparencies [photography]; slide projectors; distance measuring apparatus; dictating machines; diffraction apparatus [microscopy]; loudspeakers; circuit breakers; record players; microscopes; distance recording apparatus; range finders; distribution boards [electricity]; distribution consoles [electricity]; compasses for measuring; measures; measuring apparatus; dynamometers; water level indicators; fire escapes; flash-bulbs [photography]; telephone receivers; fluorescent screens; projection screens; workmen's protective face-shields; screens [photography]; drainers for use in photography; electric loss indicators; measuring devices, electric; cables, electric; ducts [electricity]; control panels [electricity]; galvanic

cells; connections for electric lines; couplings, electric; relays, electric; electrolyzers; transmitters of electronic signals; transmitting sets [telecommunication]; cleaning apparatus for sound recording discs; sound recording strips; kilometer recorders for vehicles; spools [photography]; mechanical signs; epidiascopes; test tubes; balancing apparatus; thermostats; ergometers; material testing instruments and machines; egg-candlers; gauges; gasoline gauges; spark-guards; cases especially made for photographic apparatus and instruments; testing apparatus not for medical purposes; refractometers; exposure meters [light meters]; invoicing machines; apparatus for fermentation [laboratory apparatus]; railway traffic safety appliances; wires, electric; magnetic wires; plumb bobs; plumb lines; nets for protection against accidents; safety nets; safety tarpaulins; film cutting apparatus; filters for respiratory masks; filters for use in photography; battery chargers; high-frequency apparatus; frequency meters; fuses; radios; galena crystals [detectors]; galvanic batteries; gloves for protection against accidents; gloves for divers; gloves for protection against X-rays for industrial purposes; gas testing instruments; gasometers [measuring instruments]; surveying apparatus and instruments; levelling staffs [surveying instruments]; drying apparatus for photographic prints; glazing apparatus for photographic prints; rulers [measuring instruments]; measuring glassware; screens for photo-engraving; grids for batteries; clothing for protection against fire; audio- and video-receivers; heliographic apparatus; holograms; hygrometers; identification threads for electric wires; identification sheaths for electric wires; life saving apparatus and equipment; fire hose nozzles; fire engines; fire pumps; slope indicators; taximeters; quantity indicators; vacuum gauges; speed indicators; inductors [electricity]; armatures [electricity]; data processing apparatus; mirrors for inspecting work; intercommunication apparatus; carriers for dark plates [photography]; inverters [electricity]; ionization apparatus not for the treatment of air or water; peepholes [magnifying lenses] for doors; hemline markers; furniture especially made for laboratories; lactodensimeters; lactometers; darkroom lamps [photography]; optical lamps; magic lanterns; signal lanterns; lasers, not for medical purposes; optical lenses; letter scales; logs [measuring instruments]; sounding lines; magnifying glasses [optics]; signs, luminous; neon signs; eyeglasses; instruments containing eyepieces; surveyors' levels; eyeglass lenses; eyewear; manometers; periscopes; protective masks; mathematical instruments; coin-operated mechanisms for television sets; megaphones; computer memory devices; carpenters' rules; mercury levels; speed measuring apparatus [photography]; precision measuring apparatus; measuring instruments; meteorological instruments; rules [measuring instruments]; micrometer screws for optical instruments; microphones; microtomes; time switch-

hes, automatic; mirrors [optics]; breathing apparatus for underwater swimming; nautical apparatus and instruments; naval signalling apparatus; navigational instruments; eyeglass frames; batteries, electric; accumulators, electric; levels [instruments for determining the horizontal]; levelling instruments; prisms [optics]; observation instruments; octants; ohmmeters; wavemeters; optical apparatus and instruments; optical glass; computers; computer programs, recorded; oscillographs; oxygen transvasing apparatus; ozonisers [ozonators]; micrometers; signalling panels, luminous or mechanical; lightning rods; parking meters; apparatus and instruments for astronomy; apparatus for measuring the thickness of skins; acid hydrometers; weighing apparatus and instruments; salinometers; washing trays [photography]; stands for photographic apparatus; viewfinders, photographic; photometers; phototelegraphy apparatus; apparatus and instruments for physics; steering apparatus, automatic, for vehicles; pince-nez; pipettes; plane tables [surveying instruments]; planimeters; ear plugs for divers; bells [warning devices]; weights; polarimeters; radiotelephony sets; radiotelegraphy sets; pressure measuring apparatus; pressure indicators; projection apparatus; cathodic anti-corrosion apparatus; teeth protectors; pyrometers; radar apparatus; vehicle radios; radiological apparatus for industrial purposes; protractors [measuring instruments]; apparatus and installations for the production of X-rays, not for medical purposes; X-ray tubes not for medical purposes; protection devices against X-rays, not for medical purposes; telephone apparatus; refractors; X-ray apparatus not for medical purposes; spectroscopes; resistances, electric; thermometers, not for medical purposes; respirators for filtering air; breathing apparatus, except for artificial respiration; rheostats; balances [steelyards]; signals, luminous or mechanical; saccharometers; probes for scientific purposes; satellites for scientific purposes; diaphragms for scientific apparatus; teaching apparatus; choking coils [impedance]; wire connectors [electricity]; locks, electric; sextants; signalling whistles; vehicle breakdown warning triangles; electrodynamic apparatus for the remote control of signals; simulators for the steering and control of vehicles; sirens; sound transmitting apparatus; sound recording apparatus; sound reproduction apparatus; sounding apparatus and machines; sounding leads; sound locating instruments; spectrograph apparatus; spherometers; stereoscopes; stereoscopic apparatus; needles for record players; sulfimeters; teleprinters; tachometers; screw-tapping gauges; telegraphs [apparatus]; television apparatus; telegraph wires; remote control apparatus; masts for wireless aerials; teleprompters; telephone transmitters; telerupters; binoculars; telescopes; temperature indicators; time recording apparatus; theodolites; thermostats for vehicles; totalizers; revolution counters; speed regulators for record players; transmitters [telecommuni-

cation]; precision balances; marking gauges [joinery]; vacuum tubes [radio]; urinometers; variometers; verniers; videotapes; viscosimeters; theft prevention installations, electric; voltage regulators for vehicles; voting machines; voltmeters; apparatus for changing record player needles; stills for laboratory experiments; fuse wire; anticathodes; dog whistles; sighting telescopes for firearms; anti-theft warning apparatus; azimuth instruments; beacons, luminous; holders for electric coils; films, exposed; road signs, luminous or mechanical; life buoys; signalling buoys; buzzers; directional compasses; fog signals, non-explosive; cash registers; radiology screens for Industrial purposes; identity cards, magnetic; photovoltaic cells; densitometers; disks, magnetic; floppy disks; head cleaning tapes [recording]; video recorders; computer keyboards; integrated circuits; semi-conductors; chips [integrated circuits]; cathodes; life jackets; life belts; chemistry apparatus and instruments; cinematographic film, exposed; materials for electricity mains [wires, cables]; contact lenses; containers for contact lenses; incubators for bacteria culture; solar batteries; copper wire, insulated; discharge tubes, electric, other than for lighting; diaphragms [photography]; distillation apparatus for scientific purposes; dosage dispensers; electric door bells; eyeglass cases; furnaces for laboratory use; optical fibers [fibres] [light conducting filaments]; telephone wires; X-ray films, exposed; filters for ultraviolet rays, for photography; horns for loudspeakers; tripods for cameras; bar code readers; bullet-proof waistcoats; marking buoys; wafers for integrated circuits; chromatography apparatus for laboratory use; chronographs [time recording apparatus]; compact discs [audio-video]; compact discs [read-only memory]; computer operating programs, recorded; computer peripheral devices; computer software, recorded; optical condensers; acoustic couplers; couplers [data processing equipment]; decompression chambers; plotters; divers' masks; electronic pens [visual display units]; encoded magnetic cards; facsimile machines; fire boats; interfaces for computers; juke boxes for computers; knee-pads for workers; light dimmers [regulators], electric; magnetic data media; magnetic encoders; magnetic tape units for computers; microprocessors; modems; monitors [computer hardware]; monitors [computer programs]; mouse [computer peripheral]; optical character readers; optical data media; optical discs; printers for use with computers; processors [central processing units]; readers [data processing equipment]; safety restraints, other than for vehicle seats and sports equipment; scanners [data processing equipment]; smoke detectors; transistors [electronic]; X-ray photographs, other than for medical purposes; junction sleeves for electric cables; abacuses; electronic agendas; answering machines; camcorders; cassette players; compact disc players; diagnostic apparatus, not for medical purposes; disk drives for

computers; electrified rails for mounting spot lights; electronic pocket translators; electronic tags for goods; fire blankets; flashlights [photography]; integrated circuit cards [smart cards]; measuring spoons; notebook computers; electronic notice boards; pocket calculators; shoes for protection against accidents, irradiation and fire; sprinkler systems for fire protection; starter cables for motors; sunglasses; time clocks [time recording devices]; video cassettes; video game cartridges; video screens; video telephones; goggles for sports; nose clips for divers and swimmers; protective helmets for sports; electronic publications, downloadable; computer programs, downloadable; navigation apparatus for vehicles [on-board computers]; decorative magnets; cordless telephones; mouse pads; personal stereos; wrist rests for use with computers; coaxial cables; fibre optic cables; covers for electric outlets; marine depth finders; electrified fences; computer game software, recorded; headphones; lighting ballasts; radio pagers; satellite navigational apparatus; solenoid valves [electromagnetic switches]; voltage surge protectors; walkie-talkies; wind socks for indicating wind direction; light-emitting electronic pointers; resuscitation mannequins [teaching apparatus]; stage lighting regulators; egg timers [sandglasses]; DNA chips; DVD players; automated teller machines [ATM]; traffic-light apparatus [signalling devices]; hands-free kits for telephones; asbestos screens for firemen; riding helmets; clothing especially made for laboratories; encoded identification bracelets, magnetic; transponders; downloadable ring tones for mobile phones; downloadable music files; downloadable image files; crash test dummies; laboratory centrifuges; printed circuit boards; USB flash drives; Global Positioning System [GPS] apparatus; portable media players; cell phone straps; light-emitting diodes [LED]; triodes; step-up transformers; laptop computers; fire hose; bags adapted for laptops; sleeves for laptops; digital photo frames; Petri dishes; Pitot tubes; stroboscopes; traffic cones; temperature indicator labels, not for medical purposes; computer software applications, downloadable; electronic book readers; smartphones; toner cartridges, unfilled, for printers and photocopiers; baby monitors; video baby monitors; lens hoods; tablet computers; encoded key cards; 3D spectacles; memory cards for video game machines; bulletproof clothing; accelerometers; electrical adapters; life-saving capsules for natural disasters; computer hardware; solar panels for the production of electricity; cellular phones; telescopic sights for artillery; digital signs; wearable activity trackers; chargers for electronic cigarettes; connected bracelets [measuring instruments]; covers for smartphones; cases for smartphones; selfie sticks [hand-held monopods]; calorimeters; flowmeters; reflective safety vests; electronic collars to train animals; joysticks for use with computers, other than for video games; smartglasses; smartwatches; fire

extinguishing apparatus; protective films adapted for computer screens; mouth guards for sports; head guards for sports; needles for surveying compasses; security tokens [encryption devices]; infrared detectors; covers for personal digital assistants [PDAs]; baby scales; electronic access control systems for interlocking doors; thermal imaging cameras; scales with body mass analysers; covers for tablet computers; black boxes [data recorders]; digital weather stations; charging stations for electric vehicles; interactive touch screen terminals; smart rings; electric and electronic effects units for musical instruments; audio interfaces; equalisers [audio apparatus]; subwoofers; bathroom scales; thermo-hygrometers; biochips; protective films adapted for smartphones; virtual reality headsets; electronic interactive whiteboards; humanoid robots with artificial intelligence; audio mixers; batteries for electronic cigarettes; electronic key fobs being remote control apparatus; electronic sheet music, downloadable; T-squares for measuring; squares for measuring; square rulers for measuring.

35 – Business management assistance; business inquiries; bill-posting; import-export agency services; commercial information agency services; cost price analysis; dissemination of advertising matter; photocopying services; employment agency services; office machines and equipment rental; accounting; drawing up of statements of accounts; business auditing; business management and organization consultancy; personnel management consultancy; business management consultancy; typing; demonstration of goods; direct mail advertising; commercial or Industrial management assistance; document reproduction; updating of advertising material; distribution of samples; business efficiency expert services; auctioneering; market studies; business appraisals; business investigations; publicity material rental; business organization consultancy; publication of publicity texts; advertising; radio advertising; business research; public relations; shorthand; television advertising; transcription of communications [office functions]; shop window dressing; advertising agencies; advisory services for business management; modelling for advertising or sales promotion; marketing research; computerized file management; professional business consultancy; economic forecasting; organization of exhibitions for commercial or advertising purposes; business information; opinion polling; payroll preparation; personnel recruitment; relocation services for businesses; rental of advertising space; sales promotion for others; secretarial services; tax preparation; telephone answering for unavailable subscribers; word processing; arranging newspaper subscriptions for others; advertising by mail order; business management of hotels; business management of performing artists; compilation of information into computer databases; systemization of information into computer databases; organization of

trade fairs for commercial or advertising purposes; rental of photocopying machines; online advertising on a computer network; procurement services for others [purchasing goods and services for other businesses]; data search in computer files for others; rental of advertising time on communication media; news clipping services; rental of vending machines; psychological testing for the selection of personnel; price comparison services; presentation of goods on communication media, for retail purposes; commercial information and advice for consumers in the choice of products and services; arranging subscriptions to telecommunication services for others; administrative processing of purchase orders; commercial administration of the licensing of the goods and services of others; outsourcing services [business assistance]; invoicing; writing of publicity texts; compilation of statistics; layout services for advertising purposes; sponsorship search; organization of fashion shows for promotional purposes; production of advertising films; business management of sports people; marketing; telemarketing services; retail services for pharmaceutical, veterinary and sanitary preparations and medical supplies; rental of sales stands; provision of commercial and business contact information; search engine optimization for sales promotion; web site traffic optimization; pay per click advertising; commercial intermediation services; business management for freelance service providers; negotiation and conclusion of commercial transactions for third parties; updating and maintenance of data in computer databases; business project management services for construction projects; providing business information via a web site; provision of an online marketplace for buyers and sellers of goods and services; design of advertising materials; outsourced administrative management for companies; tax filing services; business management of reimbursement programs for others; rental of billboards [advertising boards]; writing of curriculum vitae for others; web indexing for commercial or advertising purposes; administration of frequent flyer programs; appointment scheduling services [office functions]; appointment reminder services [office functions]; administration of consumer loyalty programs; scriptwriting for advertising purposes; registration of written communications and data; updating and maintenance of information in registries; compiling indexes of information for commercial or advertising purposes; business intermediary services relating to the matching of potential private investors with entrepreneurs needing funding; production of teleshopping programs; consultancy regarding public relations communication strategies; consultancy regarding advertising communication strategies; negotiation of business contracts for others; retail, wholesale store services; online retail store services.

---

(260) AM 2020 102452 A  
 (800) 1458648  
 (151) 2018 10 03  
 (891) 2018 10 03  
 (731) XIAOMI INC.

Floor 13, Rainbow City Shopping Mall II,  
 of China Resources, No.68 Qinghe Middle  
 Street, Haidian District, Beijing, China

(540)



## PatchWall

(591) Black, white  
 (531) 26.04.08; 26.04.09  
 (511)

9 – Computer software applications, downloadable; smartphones; portable media players; 3D spectacles; video screens; remote control apparatus; measuring instruments; sensors; chips [integrated circuits]; video projectors; mirrors [optics]; light dimmers [regulators], electric; quantity indicators; transparencies [photography]; theft prevention installations, electric; batteries, electric; inductors [electricity]; television apparatus; launching and receiving apparatus for television broadcasting; electric cables for cable television signals transmitting and receiving.

42 – Monitoring of computer systems by remote access; computer software design; computer video games programming; conversion of data or documents from physical to electronic media; technical research; certification [quality control]; cosmetic research; industrial design; design of interior decor.

(260) AM 2020 102453 A  
 (800) 1458677  
 (151) 2018 11 12  
 (891) 2018 11 12

(731) BOYNER PERAKENDE VE TEKSTİL  
 YATIRIMLARI ANONİM ŞİRKETİ  
 Eski Büyükdere Caddesi No.14, Park Plaza  
 Kat 15-16, Maslak Sarıyer, İstanbul, Turkey

(540)

ALTINYILDIZ | CLASSICS  
**AC&co.**  
 EST. 1952

(591) Black, white  
 (531) 24.17.09; 24.17.25; 27.05.01; 27.05.09;  
 27.05.10

(526) EST. 1952  
 (511)

35 – Advertising; marketing; public relations; organization of exhibitions for commercial or advertising purposes; organization of fashion shows for promotional purposes; organization of trade fairs for commercial or advertising purposes; provision of an on-line marketplace for buyers and sellers of goods and services; import-export agency services; business organization consultancy; commercial information agency services; commercial information and advice for consumers in the choice of products and services; business management consultancy; administration of consumer loyalty programs; business information; the bringing together, for the benefit of others, of cosmetics, perfumery, deodorants, cleaning materials, dentifrices, soaps, metal and wood polishing and care materials, waxes and candles, clothing, footwear and headgear, eye glasses, sun glasses, protective glasses, jewellery, watches, clocks, precious stones, cuff links, cups, paper, cardboard, articles made of cardboard and paper, wrapping paper, packaging paper, printed paper, printed matters, books, brochures, magazines, newsletter, newspaper, tissues, handkerchiefs of paper, calendars, posters, photographs, pictures, labels, stickers, stationery, writing and drawing materials and articles, parasols, threads, fibres, fabrics, bed linen, drapery, blankets, bed covers, towels, curtains, fabrics, sheets, artificial flowers and fruit, cloth fasteners, laces, braids, brooches, embroidery, hair bands, hair decorations, ribbons, playthings, games, new year tree decorations, party hats, party novelties, enabling customers to conveniently view and purchase those goods, such services may be provided by retail stores, wholesale outlets, by means of electronic media or through mail order catalogues.

(260) AM 2020 102464 A  
 (800) 1458797  
 (151) 2018 12 14  
 (891) 2018 12 14  
 (731) LEVEL (FZE)

Saif Desk Q1-07-120/A, P.O.Box 513873,  
 Sharjah, United Arab Emirates

(540)

## Arizona

(591) Black, white  
 (531) 27.05.17  
 (511)

34 – Absorbent paper for tobacco pipes; flavourings, other than essential oils, for use in electronic cigarettes/flavourings, other than essential oils, for use in electronic cigarettes; flavourings, other than essential oils, for tobacco/flavourings, other than essential oils, for tobacco; tips of yellow amber for cigar and



cigarette holders; oral vaporizers for smokers; tobacco jars; gas containers for cigar lighters; chewing tobacco; lighters for smokers; pipe cleaners for tobacco pipes; tobacco pouches; pocket machines for rolling cigarettes; books of cigarette papers; firestones; tobacco pipes; cigar holders; cigarette holders; cigarette tips; mouthpieces for cigarette holders; pipe racks for tobacco pipes; spittoons for tobacco users; ashtrays for smokers; cigarette cases; liquid solutions for use in electronic cigarettes; cigarettes; electronic cigarettes; cigarettes containing tobacco substitutes, not for medical purposes; cigarette paper; cigarette filters; cigars; cigarillos; cigar cases; cigar cutters; matches; matchboxes; match holders; snuff boxes; herbs for smoking; tobacco; snuff; humidors.

(260) AM 2020 102465 A  
(800) 1458798  
(151) 2018 12 27  
(891) 2018 12 27  
(731) BIONORICA SE  
Kerschensteinerstrasse 11-15, 92318  
Neumarkt, Germany

(540)  
**მასკოდინონი**

(591) Black, white  
(531) 28.19  
(511)  
5 – Pharmaceuticals; medicine; dietetic preparations and food supplements; nutritional supplements for humans; nutritional supplements for animals; medicinal preparations; veterinary preparations.

(260) AM 2020 102470 A  
(800) 1458834  
(151) 2018 09 25  
(891) 2018 09 25  
(731) GORENJE gospodinjski aparati, d.d.  
Partizanska cesta 12, SI-3320 Velenje,  
Slovenia

(540)  
**gorenje kitchen**

(591) Black, white  
(531) 27.05.01; 27.05.17  
(511)  
20 – Furniture, mirrors, picture frames; unworked or semi-worked bone, horn, ivory, whalebone or mother-of-pearl; shells; meerschaum; yellow amber; kitchen furniture; fitted kitchen furniture; mini kitchens (furniture) belonging to this class; kitchen cabinets; kitchen counters, counters (furniture); work counters (furniture); counters used with kitchen sinks; removable mats or covers for sinks; counter stands; kitchen elements (furniture); kitchen units; kitchen tables; dressers (furniture); plate racks; sideboards; bo-

ttle racks; dinner wagons (furniture), trolleys (furniture); end tables, tea trolleys (furniture); table leaves, table tops; cupboards; meat safes; seats, chairs; benches (furniture); stools, footstools; cabinets; chests of drawers; bins, not of metal; chests, not of metal; flower-stands (furniture); bathroom furniture; furniture for living rooms, bedrooms, children's rooms, youth rooms, halls; individual furniture items belonging to this class; office furniture; furniture shelves; racks (furniture); furniture casters, not of metal; edgings of plastic for furniture; doors for furniture.

(260) AM 2020 102471 A  
(800) 1458841  
(151) 2019 01 25  
(891) 2019 01 25  
(731) PANOLIN Holding AG  
Bläsimühle, CH-8322 Madetswil, Switzerland  
(540)



(591) Green, black and blue  
(531) 18.01.15; 18.01.16; 27.03.15; 27.05.01;  
29.01.13  
(511)  
4 – Technical oils and greases, lubricants, oils for motors, for hydraulic, gear and industrial motors, in particular synthetic and biodegradable lubricants.

(260) AM 2020 102472 A  
(800) 1458859  
(151) 2019 01 16  
(891) 2019 01 16  
(731) ASAHI EUROPE LTD  
One Forge End, Woking, Surrey GU21 6DB,  
United Kingdom  
(540)



(591) Black, white, red, blue  
(531) 01.01.02; 03.07.02; 25.01.05; 25.01.15;  
27.01.06; 27.05.03; 27.05.09; 27.07.01;  
29.01.14  
(511)  
32 – Beers.

(260) AM 2020 102473 A  
 (800) 1458861  
 (151) 2019 01 11  
 (891) 2019 01 11  
 (731) DOBLESTAR GROUP CO., LTD.  
 No.666 of Lianghe Road, Huangdao District,  
 Qingdao City, Shandong Province, China

(540)



(591) Black, white  
 (531) 07.11.10; 27.03.15; 27.05.01; 27.05.17  
 (511)

12 – Vehicles for locomotion by land, air, water or rail; tires for vehicle wheels; automobile tires; treads for retreading tires; aircraft tires; adhesive rubber patches for repairing inner tubes; repair outfits for inner tubes; non-skid devices for vehicle tires; automobile wheels; automobile wheel hubs.

(260) AM 2020 102474 A  
 (800) 1458882  
 (151) 2018 11 17  
 (891) 2018 11 17  
 (731) PACIFIC PHARMACEUTICALS PTE LTD  
 101 Cecil Street, #17-07 Tong Eng Building,  
 Singapore 069533, Singapore

(540)

**CareFlu**

(591) Black, white  
 (511)  
 5 – Mineral dietary supplements for humans; pharmaceutical drugs.

(260) AM 2020 102475 A  
 (800) 1458891  
 (151) 2018 12 17  
 (891) 2018 12 17  
 (731) GONSIN CONFERENCE EQUIPMENT CO., LTD.  
 10TH FLOOR, BLOCK 2, JINYUEHON-GTAI BUILDING, NO.4 CHENGYE ROAD, FENGXIANG INDUSTRIAL PARK, SHUNDE DISTRICT, FOSHAN, 528300 GUANGDONG PROVINCE, China

(540)



(591) Black, white  
 (531) 27.05.01  
 (511)  
 9 – Couplers [data processing equipment]; processors [central processing units]; computer software, recorded; readers [data processing equipment]; vo-

ting machines; aerials; intercommunication apparatus; transmitters of electronic signals; anti-interference devices [electricity]; sound transmitting apparatus; speaking tubes; microphones; telephone transmitters.

38 – Communications by computer terminals; computer aided transmission of messages and images; rental of message sending apparatus; teleconferencing services; videoconferencing services; streaming of data; radio communications; video-on-demand transmission.

(260) AM 2020 102476 A  
 (800) 1458895  
 (151) 2018 09 25  
 (891) 2018 09 25  
 (731) Limited liability company "SAS Industrial"  
 Pekinsky Prospekt, 18, China-Belarus  
 Industrial Park, "The Great Stone",  
 Smolevichi District, 222210 Minsk Region,  
 Belarus

(540)



(591) Orange, blue and red  
 (531) 26.11.02; 26.11.12; 27.05.01; 29.01.13  
 (511)

11 – Hot air ovens; bath fittings; heaters for baths; boilers, other than parts of machines; radiator caps; water heaters; fans [air-conditioning]; heating apparatus; heating installations; hot water heating installations/heating installations [water]; heating boilers; heating apparatus for solid, liquid or gaseous fuels; heating apparatus, electric; central heating radiators; humidifiers for central heating radiators; heating elements; heaters for heating irons; plate warmers; immersion heaters; water distribution installations; drying apparatus; air-conditioning apparatus; glue-heating appliances; water conduits installations; pipes [parts of sanitary installations]/water-pipes for sanitary installations; cooking utensils, electric; cookers/cooking stoves; cooking apparatus and installations; heat exchangers, other than parts of machines; radiators, electric; stoves [heating apparatus]; refrigerating apparatus and machines; gas burners; gas boilers; hot plates; radiators [heating]; oil burners, heating plates; kitchen ranges [ovens]; air valves for steam heating installations; water heaters [apparatus]; water supply installations; heaters, electric, for feeding bottles; deep fryers, electric; heat pumps;



solar thermal collectors [heating]; hot water bottles; warming pans; multicookers.

21 – Cooking pots; frying pans; pots; deep fryers, non-electric; kitchen utensils; hot pots, not electrically heated.

(260) AM 2020 102753 A

(800) 1461353

(151) 2018 10 11

(891) 2018 10 11

(731) NEXT EVENTS GMBH

Katharinenquartier 4-6, 47652 Weeze,  
Germany

(540)



(591) Black and dark yellow

(531) 25.01.06; 27.05.10; 29.01.13

(511)

9 – Information technology and audiovisual equipment; recorded content; navigation, guidance, tracking, targeting and map making devices.

25 – Clothing; hats; footwear.

32 – Beer and beer making kits consisting of malt extracts, hops, specialty grains and brewer's yeast; non-alcoholic beverages; preparations for making beverages.

41 – Music services; musical entertainment; arranging of music performances; ticket agency services [entertainment]; popular entertainment services; interactive entertainment services; provision of live entertainment; live entertainment; live entertainment; entertainer services provided by musicians; party planning [entertainment]; live entertainment; provision of on-line entertainment; hospitality services (entertainment).

(260) AM 2020 102755 A

(800) 1461372

(151) 2018 08 10

(891) 2018 08 10

(731) PROMAST KIMYA SANAYI VE TICARET

ANONIM SIRKETI

Sanayi Man. Carsi Yapi Sitesi A, Blok No:16  
Izmit, Kocaeli, Turkey

(540)



(591) Black, white

(531) 26.04.01; 27.05.09; 27.05.10; 29.01.12

(511)

1 – Adhesives not for medical, household and stationary purposes; hybrid glue sealants for industrial use and construction use; all afore-mentioned goods not in the field of passive fire protection or high performance thermal insulation; silicones, silicon carbide [raw material].

17 – Aerosol polyurethane foams not in the field of passive fire protection or high performance thermal insulation.

(260) AM 2020 102756 A

(800) 1461400

(151) 2018 07 06

(891) 2018 07 06

(731) GENERAL FITTINGS S.R.L.

Via Golgi, 73/75, I-25064 GUSSAGO  
(Brescia), Italy

(540)



(591) Red, blue and black.

(531) 24.15.13; 27.05.01; 29.01.13

(511)

6 – Metal valves not being part of machine; manually operated metal valves; water-pipe valves of metal; pipes of metal and fittings thereof; manifolds of metal for pipelines, junctions of metal for pipes; pipe muffs of metal; multilayer water pipes of brass and cooper; multilayer gas pipes of brass and cooper.

11 – Manually operated plumbing valves; thermostatic valves as parts of heating installations; pipes for heating installations; waste pipes for sanitary installations; water supply apparatus and plumbing fixtures; flushing tanks; adjustment and safety accessories for water appliances and gas pipes; water intake apparatus; showers; toilets [water-closets]; toilet tank balls; bath installations; water conduits installations; water distribution installations; sinks; taps; mixer faucets for water pipes; stoves; electric stoves; gas stoves for household purposes; heating installations; heating elements; infrared heating panels; heating plates; heating apparatus, electric; solar thermal collectors [heating].

17 – Valves of rubber or vulcanized fiber [not including machine elements]; flexible pipes not of metal; junctions not of metal for pipes; pipe muffs not of metal.

(260) AM 2020 102757 A

(800) 1461433

(151) 2019 01 13

(891) 2019 01 13

(731) WEIFANG HUADONG RUBBER CO., LTD.  
LIUJIAHETOU VILLAGE, TAITOU  
TOWN, SHOUGUANG CITY, WEIFANG  
CITY, 262700 SHANDONG PROVINCE,  
China

(540)

**ZODO**

(591) Black, white

(531) 27.05.17

(511)

12 – Tires for vehicle wheels; solid tires for vehicle wheels; automobile tires; inner tubes for pneumatic tires; repair outfits for inner tubes; spikes for tires; pneumatic tires; casings for pneumatic tires [tyres]; adhesive rubber patches for repairing inner tubes; inner tubes for bicycle tires.

(260) AM 2020 102863 A

(800) 1462696

(151) 2018 10 05

(891) 2018 10 05

(731) FIDIA FARMACEUTICI S.p.A.

Via Ponte della Fabbrica, 3/A, I-35031  
ABANO TERME (PD), Italy

(540)

**TEARFID**

(591) Black, white

(511)

10 – Surgical, medical, dental and veterinary apparatus and instruments; artificial limbs, eyes and teeth; orthopedic articles; suture materials; therapeutic and assistance apparatus adapted for disabled persons; massage apparatus; apparatus, devices and articles for nursing infants; applicators and devices for the administration of pharmaceutical preparations; pharmaceutical instruments; medical devices.

(260) AM 2020 102865 A

(800) 1462738

(151) 2019 01 14

(891) 2019 01 14

(731) BOJER INNOVATIV INGENIØR

RÅDGIVNING APS

Holger Drachmanns Vej 9, DK-8000 Aarhus  
C, Denmark

(540)

**BIIR**

(591) Black, white

(511)

35 – Business management; business administration; office functions.

42 – Scientific and technological services and research and design relating thereto; industrial analysis

and industrial research services; design and development of computer hardware and software.

(260) AM 2020 102912 A

(800) 1377808

(151) 2017 06 13

(891) 2018 12 27

(731) CONSTRUPLAS, S.L.

POL .IND. BELCAIRE, CALLE C,  
PARCELA 1201, E-12600 Val de Uxo  
(Castellon), Spain

(540)



(591) Black, white

(531) 01.15.15; 27.05.01; 27.05.21

(511)

11 – Apparatus for lighting, heating, steam generating, cooking, refrigerating, drying, ventilating, water supply and sanitary purposes; bathtub enclosures; shower screens; bath cubicles; shower cubicles; showers; bathtubs; wash-hand basins [parts of sanitary installations]; shower trays; faucets; whirlpool-jet apparatus; sauna bath installations; whirlpools.

20 – Furniture; mirrors [looking glasses]; picture frames; bathroom furniture; stools; seats; worktops; shelves for storage; racks [furniture].

(260) AM 2020 102935 A

(800) 1463728

(151) 2019 02 21

(891) 2019 02 21

(731) UiPath SRL

Str. Vasile Alecsandri si Constantin Daniel,  
Nr. 4 si 11, Corp A, Et. 5-6, Sector 1,  
Bucharest, Romania

(540)

**Accelerate Human  
Achievement**

(591) Black, white

(511)

9 – Computer programs [downloadable software]; downloadable computer utility programs; computer software applications, downloadable; application software for cloud computing services.

35 – Assistance in management of business activities; assistance and advice regarding business management; management assistance in business affairs;

business assistance, management and administrative services; management and operation assistance to commercial businesses; assistance and advice regarding business organisation and management; advice relating to the organisation and management of business; business management assistance for Industrial or commercial companies; assistance, advisory services and consultancy with regard to business management; assistance to commercial enterprises in the management of their business; commercial assistance in business management; efficiency experts; business efficiency expert services; business organisation consulting; business organization and operation consultancy; business management and organization consultancy; business management and enterprise organization consultancy; business organization and management consultancy including personnel management; assistance, advisory services and consultancy with regard to business organization; advisory services for business management; business management consultancy and advisory services; business consulting; professional consultancy relating to business management; business information; collecting information for business; dissemination of business information; computer assisted business information; business advisory and information services; information in business matters; business information for enterprises (provision of -); business information and research services; computerised business information services; provision of business information; analysis of business information; computerised business information retrieval; business statistical information services; business advice, inquiries or information; provision of business and commercial information; computerised business information processing services; business research and information services; provision of statistical information relating to business; provision of business management information; provision of computerised data relating to business; information services relating to businesses; information services relating to business matters; providing business information via a web site; provision of computerised business management information; drawing up of business statistical information; economic information services for business purposes; business analysis, research and information services; compilation of business statistics and commercial information; advice and information concerning commercial business management; information or enquiries on business and marketing; computerised information services to business opportunities appraisals; provision of commercial and business contact information; provision of business information via global computer networks; provision of computerised information relating to business records; providing business information by way of computer terminals; provision of on-line business and commercial information; providing information about commercial business and commercial informa-

tion via the global computer network; updating of business information on a computer data base; business consultancy relating to the administration of information technology; providing business information directory services, via a global computer network; information and data compiling and analyzing relating to business management; business management consulting services in the field of information technology; provision of commercial business information by means of a computer database; business information services provided on-line from a computer database or the Internet; business information services provided online from a global computer network or the Internet; providing business information, also via Internet, the cable network or other forms of data transfer; compilation of information into computer databases; compilation and systemization of information into computer databases; compilation of statistics; compilation of business statistics; compilation of statistics [for business or commercial purposes]; computerized file management; data search in computer files for others; document reproduction; outsourcing services [business assistance]; systemization of information into computer databases; updating and maintenance of data in computer databases; advertising, marketing and promotional services; distribution of advertising, marketing and promotional material; dissemination of advertisements; dissemination of advertising matter; dissemination of advertising, marketing and publicity materials; dissemination of advertising matter online; dissemination of advertising for others; distribution of advertisements and commercial announcements; dissemination of advertising material [leaflets, brochure and printed matter]; distribution of advertising material; distribution of prospectuses and samples for advertising purposes; distribution of flyers, brochures, printed matter and samples for advertising purposes; distribution of products for advertising purposes; distribution and dissemination of advertising materials [leaflets, prospectuses, printed material, samples]; dissemination services of advertisement matter; product demonstrations and product display services; arranging of displays for commercial purposes; arranging of displays for advertising purposes; organisation and conducting of product presentations; preparation and presentation of audio visual displays for advertising purposes; presentation of goods and services; demonstration of goods; advertising, marketing and promotional consultancy, advisory and assistance services; providing assistance in the field of business promotion; marketing assistance; consultancy regarding advertising communications strategy; consultations relating to business advertising; business advice relating to marketing management consultations; advice relating to marketing management; consultations relating to business promotion; advisory services relating to sales promotion; professional consultancy relating to marketing;

consultancy relating to advertising and promotion services; business advice relating to strategic marketing; advertising and marketing consultancy; marketing advice; consultancy relating to advertising; business advice relating to marketing; business consultancy services relating to the marketing of fund raising campaigns; business consultancy services relating to the promotion of fund raising campaigns; organisation and management of business incentive and loyalty schemes; public relations consultancy; conducting studies in the field of public relations; commercial lobbying services; arranging of demonstrations for advertising purposes; organisation of events for commercial and advertising purposes; provision of computerised advertising services; provision of advertising space by electronic means and global information networks; provision of space on web-sites for advertising goods and services; provision of advertising space on electronic media; provision of advertising space on a global computer network; rental of advertising space on-line; leasing of advertising space on pamphlets; updating of advertising information on a computer data base; business assistance relating to business image; assistance to management in commercial enterprises in respect of advertising; management assistance for promoting business; market campaigns; collection of information relating to advertising; design of advertising logos; design of advertising materials; development of promotional campaigns; development of marketing strategies and concepts; cost analysis for marketing purposes; providing business marketing information; provision of information relating to advertising; affiliate marketing; trade marketing [other than selling]; database marketing; product marketing; arranging of presentations for advertising purposes; arranging and conducting of marketing events; arranging of competitions for advertising purposes; arrangement of advertising; planning of marketing strategies; preparation of advertising campaigns; preparing audio-visual presentations for use in advertising; production of advertising matter and commercials; design of marketing surveys; computerised business promotion; promoting the goods and services of others via computer and communication networks; promoting the goods and services of others via a global computer network; promoting the goods and services of others; on-line promotion of computer networks and websites; promotion, advertising and marketing of on-line websites; promotion [advertising] of business; business promotion; sales promotion; publication of publicity materials; publication of publicity materials on-line; on-line advertising on a computer network; online advertising; advertising through all public communication means; radio and television advertising; advertising in the popular and professional press; magazine advertising; advertising and marketing; updating of advertising material; preparation of advertising material; production of video

recordings for advertising purposes; electronic commerce services, namely, providing information about products via telecommunication networks for advertising and sales purposes; brand creation services (advertising and promotion); graphic advertising services; information services relating to advertising; merchandising; services with regard to product presentation to the public; promotion services; advertising services provided via the Internet; advertising services provided via a data base; advertising and marketing services provided by means of blogging; advertising and marketing services provided by means of social media; advertising and promotion services and related consulting; brand strategy services; advertising services to create corporate and brand identity; advertising services relating to data bases; preparation of marketing plans; provision of marketing reports.

38 – Transmission of information for business purposes; providing access to databases; providing access to online computer databases; providing access to and leasing access time to computer databases; providing access to databases in computer networks; providing access to electronic communications networks and electronic databases; communications by computer terminals; computer-aided transmission of messages and images; computer aided transmission of messages, information and images; streaming of data; transmission of digital files.

41 – Teaching and training in business, industry and information technology; arranging and conducting of conferences; arranging, conducting and organisation of conferences; arranging and conducting of commercial, trade and business conferences; arranging and conducting of seminars; arranging and conducting of seminars and workshops; arranging, conducting and organisation of seminars; programming [scheduling of programs] on a global computer network.

42 – Providing temporary use of non-downloadable computer programs; cloud computing; consulting in the field of cloud computing networks and applications; rental of operating software for accessing and using a cloud computing network; programming of operating software for accessing and using a cloud computing network; design and development of operating software for accessing and using a cloud computing network; providing temporary use of on-line non-downloadable operating software for accessing and using a cloud computing network; computer programming; scientific computer programming services; computer software programming services; computer programming and maintenance of computer programs; computer programming for data processing; computer design and programming services; computer programming and software design; computer programming for the internet; research relating to computer programming; computer programming

services for data warehousing; design, development and programming of computer software; technical consultancy services relating to computer programming; computer programming for data processing and communication systems; computer programming services for commercial analysis and reporting; programming of computer software for reading, transmitting and organising data; programming of computer software for evaluation and calculation of data; advisory services relating to computer programming; computer software design; software design and development; computer software design and updating; design and writing of computer software; design and development of computer software architecture; design, maintenance and updating of computer software; design, drawing and commissioned writing of computer software; research, development, design and upgrading of computer software; design, maintenance, development and updating of computer software; design, maintenance, rental and updating of computer software; design and development of computer software for process control; consultancy relating to the design and development of computer software programs; design and development of computer software for reading, transmitting and organising data; design and development of computer software for evaluation and calculation of data; providing information about the design and development of computer software, systems and networks; rental of software; rental of computer database software; rental of computer software and programs; rental and maintenance of computer software; computer system analysis; advisory services relating to computer systems analysis; computer system design; advisory services relating to computer systems design; design services relating to the development of computerised information processing systems; computer software consultancy; professional advisory services relating to computer software; technical consultancy relating to the installation and maintenance of computer software; technical consultancy relating to the application and use of computer software; providing information, advice and consultancy services in the field of computer software; consultancy and information services relating to the design, programming and maintenance of computer software; research and consultancy services relating to computer software; consultancy services relating to computer networks using mixed software environments; computer technology consultancy; computer and information technology consultancy services; consultancy in the field of computer security; professional consultancy relating to computer security; conversion of computer programs and data, other than physical conversion; electronic data storage; computer services concerning electronic data storage; compression of data for electronic storage; electronic data storage and data back-up services; electronic storage services for archiving databases; elec-

tronic storage services for archiving databases, images and other electronic data; temporary electronic storage of information and data; information technology [IT] consultancy; providing information on computer technology and programming via a web site; installation of software; installation and maintenance of computer programs; installation and customisation of computer applications software; installation, maintenance and updating of computer software; installation, repair and maintenance of computer software; installation, maintenance, updating and upgrading of computer software; installation, setting up and maintenance of computer software; installation, maintenance, repair and servicing of computer software; installation, maintenance and repair of software for computer systems; maintenance of computer programs; development and maintenance of computer software; maintenance and updating of computer software; maintenance and upgrading of computer software; development and maintenance of computer database software; maintenance of computer software relating to computer security and prevention of computer risks; updating and maintenance of computer software and programs; monitoring of computer systems by remote access; off-site data backup; outsource service providers in the field of information technology; research and development for others; software as a service [SaaS]; technological consultation services; updating of computer software; updating and upgrading of computer software; updating of computer software for others; updating of software databases; updating of computer software relating to computer security and prevention of computer risks; updating of computer programs.

---

(260) AM 2020 103414 A

(800) 1469524

(151) 2019 03 25

(891) 2019 03 25

(731) BITFURY GROUP LIMITED

c/o Harneys Services (Cayman) Limited,  
4th Floor, Harbour Place, 103 South Church  
Street, PO Box 10240; George Town,  
Grand Cayman KY1-1002, Cayman Islands

(540)

**BITFURY CLARKE**

(591) Black, white

(511)

9 – Microprocessors; microprocessors for collecting, analyzing and displaying data using block chain technology and for cryptocurrency transactions; data mining computer chips; integrated circuits; printed circuits; microchip sets; computer chipsets; multiprocessors chips; integrated circuit chips; printed circuit chips; data processing equipment used in the fields of blockchain technology and for cryptocurrency transactions; computer chips for processing data; data storage devices; data capture equipments.

42 – Data security consultancy; microchip design; microprocessor design; data mining computer chips design; integrated circuits design; printed circuits design; multiprocessor chips design; integrated circuits chips design; printed circuits chips design; data processing equipment design; research and development in the field of cryptocurrency micropayment protocols; technical advise and consultancy relating to data security; collection of data for others.

(260) AM 2020 103415 A  
 (800) 1469565  
 (151) 2019 04 03  
 (891) 2019 04 03  
 (731) BEATS ELECTRONICS, LLC  
 8600 Hayden Place, Culver City CA 90232,  
 USA

(540)

## POWERBEATS PRO

(591) Black, white

(511)

9 – Headphones; earphones; earbuds; audio cables; chargers, charging cables, and power adaptors for use with headphones, earphones, and earbuds; carrying cases for headphones, earphones, and earbuds; protective cases for headphones, earphones, and earbuds; covers, bags and cases adapted or shaped to contain headphones, earphones, and earbuds; headphone, earphone, and earbud accessories, namely straps, neck cords, wires and bands; computer software for controlling and updating headphones, earphones, and earbuds.

(260) AM 2020 103416 A  
 (800) 1469636  
 (151) 2019 04 16  
 (891) 2019 04 16  
 (731) APPLE INC.  
 One Apple Park Way, Cupertino CA 95014,  
 USA

(540)



(591) The color(s) black, blue and green is/are claimed as a feature of the mark

(531) 05.07.13; 05.07.23; 26.04.04; 26.04.15;  
 26.04.18; 26.04.24; 29.01.13

(526) TV

(511)

9 – Computer software for use in searching, selecting, playing, streaming, and sharing television, movies, images, and other audio, video, data, and multimedia content.

(260) AM 2020 103417 A  
 (800) 1469683  
 (151) 2019 04 05  
 (891) 2019 04 05  
 (731) YU HONGLIANG  
 Shanghuaxi, Lianwu Village, 23 Li Street,  
 Yiwu, Zhejiang, China

(540)



(591) Black, white

(531) 27.05.01; 27.05.03; 28.03

(511)

16 – Writing instruments; fountain pens; writing cases [sets]; printed matter; stationery; pencil sharpeners, electric or non-electric; drawing rulers; rubber erasers; magnetic drawing boards; gummed cloth for stationery purposes.

(260) AM 2020 103418 A  
 (800) 1469690  
 (151) 2018 11 30  
 (891) 2018 11 30  
 (731) ŠKODA AUTO a.s.  
 Tř. Václava Klementa 869, Mladá Boleslav II,  
 CZ-293 01 Mladá Boleslav, Czech Republic

(540)



(591) Black, white

(531) 03.07.17; 24.11.25; 24.15.01; 24.15.11;  
 26.01.04; 26.01.16

(511)

9 – Recorded content (computer programs, data and information); information and audio-visual equipment; navigation, control, tracking, aiming and cartography equipment (terms considered too vague by the International Bureau – rule 13 (2) (b) of the Common Regulations); measuring, detection and monitoring instruments, indicators and controls; sci-

entific research and laboratory apparatus; navigation apparatus for vehicles; computer software for the coordination of transport services; computer software for the acquisition, provision and booking of transport services; navigation software; computer software for the use of operators and passengers of motor vehicles and potential passengers for shared driving; computer software for the coordination and retrieval of delivery services; mobile application software for the coordination of transport services; mobile application software for navigation; mobile application software for use by operators and passengers of motor vehicles and potential passengers for shared driving; all in connection with automobiles (terms considered too vague by the International Bureau – rule 13 (2) (b) of the Common Regulations).

12 – Vehicles for max 9 persons and/or to max. 3,5 t and automobiles and their parts and accessories, all included in this class.

36 – Insurance; finance; monetary affairs; leasing (terms considered too vague by the International Bureau – rule 13 (2) (b) of the Common Regulations); fundraising and sponsorship; valuation services; insurance brokerage; financial consultancy; banking; repair costs evaluation; all in connection with automobiles (terms considered too vague by the International Bureau – rule 13 (2) (b) of the Common Regulations).

37 – Automobile repair and maintenance services and activities; reconstruction, repair, dismantling, maintenance and servicing and of vehicles; vehicle repair in the course of vehicle breakdown service; customized carrying out of alterations on body, chassis and motor of motor vehicles (tuning), included in this class; varnishing of vehicles; vehicle polishing; anti-rust treatments for vehicles; vehicle maintenance; vehicle cleaning; retreading of tires; repair information; leather care, cleaning and repair; disinfecting; burglar alarm installation and repair; advice, consultancy and information, all in connection with automobiles (terms considered too vague by the International Bureau – rule 13 (2) (b) of the Common Regulations).

38 – Telecommunication services; telecommunication; electronic data transmission, communication provided electronically; telecommunication via platforms and portals and the internet; provision of access to the internet; all in connection with automobiles (terms considered too vague by the International Bureau – rule 13 (2) (b) of the Common Regulations).

39 – Transport; packaging and storage of goods; organizing trips; towing; taxi, car transport, transportation logistics; vehicle rental, in particular automobiles; transport of passengers; mediation of transport services (terms considered too vague by the Inter-

national Bureau – rule 13 (2) (b) of the Common Regulations); traffic information services; control of motor car park via navigation apparatus and locating apparatus (transport services); all in connection with automobiles (terms considered too vague by the International Bureau – rule 13 (2) (b) of the Common Regulations).

---

(260) AM 2020 103419 A

(800) 1469720

(151) 2019 04 29

(891) 2019 04 29

(731) SOLVAY SA

Rue de Ransbeek 310, B-1120 Bruxelles,  
Belgium

(540)

**XENCOR**

(591) Black, white

(511)

1 – Unprocessed artificial resins; unprocessed plastics.

17 – Semi-processed resins; semi-processed plastics; glass fiber for insulation; compounds made of semi-processed resins; compounds made of semi-processed plastics.

---

---

**INTERNATIONAL TRADEMARKS PROTECTED  
IN GEORGIA**

(260) AM 2020 75267 A  
(800) 1185125  
(151) 2013 10 08  
(181) 2023 10 08  
(891) 2013 10 08  
(511) 33

---

(260) AM 2020 100615 A  
(800) 1353377  
(151) 2016 12 20  
(181) 2026 12 20  
(891) 2016 12 20  
(511) 09

---

(260) AM 2020 75519 A  
(800) 1142321  
(151) 2012 11 12  
(181) 2022 11 12  
(891) 2013 11 29  
(511) 05, 10

---

(260) AM 2020 100616 A  
(800) 1436281  
(151) 2018 09 12  
(181) 2028 09 12  
(891) 2018 09 12  
(511) 09, 11, 34

---

(260) AM 2020 100247 A  
(800) 1431456  
(151) 2018 03 09  
(181) 2028 03 09  
(891) 2018 03 09  
(511) 09, 35

---

(260) AM 2020 100621 A  
(800) 1436604  
(151) 2018 09 11  
(181) 2028 09 11  
(891) 2018 09 11  
(511) 33, 35

---

(260) AM 2020 100316 A  
(800) 1432735  
(151) 2018 09 28  
(181) 2028 09 28  
(891) 2018 09 28  
(511) 09, 35

---

(260) AM 2020 100622 A  
(800) 1436607  
(151) 2018 06 18  
(181) 2028 06 18  
(891) 2018 06 18  
(511) 34

---

(260) AM 2020 100580 A  
(800) 1254216  
(151) 2015 04 09  
(181) 2025 04 09  
(891) 2018 09 10  
(511) 06, 35, 40

---

(260) AM 2020 100624 A  
(800) 1436681  
(151) 2018 09 10  
(181) 2028 09 10  
(891) 2018 09 10  
(511) 14

---

(260) AM 2020 100581 A  
(800) 1350413  
(151) 2017 03 10  
(181) 2027 03 10  
(891) 2018 10 12  
(511) 09, 35

---

(260) AM 2020 100625 A  
(800) 1436685  
(151) 2018 10 26  
(181) 2028 10 26  
(891) 2018 10 26  
(511) 03

---

(260) AM 2020 100583 A  
(800) 1408475  
(151) 2018 02 01  
(181) 2028 02 01  
(891) 2018 10 16  
(511) 03, 11, 29

---

(260) AM 2020 100657 A  
(800) 1334291  
(151) 2016 08 12  
(181) 2026 08 12  
(891) 2018 10 15  
(511) 05, 29

---



(260) AM 2020 100710 A  
(800) 1437504  
(151) 2018 10 01  
(181) 2028 10 01  
(891) 2018 10 01  
(511) 30

---

(260) AM 2020 100714 A  
(800) 1437595  
(151) 2018 08 03  
(181) 2028 08 03  
(891) 2018 08 03  
(511) 29

---

(260) AM 2020 100715 A  
(800) 1437651  
(151) 2018 07 17  
(181) 2028 07 17  
(891) 2018 07 17  
(511) 30, 32

---

(260) AM 2020 100716 A  
(800) 1437666  
(151) 2018 09 03  
(181) 2028 09 03  
(891) 2018 09 03  
(511) 29

---

(260) AM 2020 100717 A  
(800) 1437677  
(151) 2018 10 15  
(181) 2028 10 15  
(891) 2018 10 15  
(511) 03, 07, 11, 37

---

(260) AM 2020 100718 A  
(800) 1437735  
(151) 2018 09 06  
(181) 2028 09 06  
(891) 2018 09 06  
(511) 09

---

(260) AM 2020 100719 A  
(800) 1437819  
(151) 2018 09 04  
(181) 2028 09 04  
(891) 2018 09 04  
(511) 18, 24, 25

---

(260) AM 2020 100721 A  
(800) 1437856  
(151) 2018 09 04  
(181) 2028 09 04

(891) 2018 09 04  
(511) 11

---

(260) AM 2020 100724 A  
(800) 1437951  
(151) 2018 09 07  
(181) 2028 09 07  
(891) 2018 09 07  
(511) 30, 33

---

(260) AM 2020 100725 A  
(800) 1437959  
(151) 2018 09 04  
(181) 2028 09 04  
(891) 2018 09 04  
(511) 34

---

(260) AM 2020 100726 A  
(800) 1437968  
(151) 2018 06 28  
(181) 2028 06 28  
(891) 2018 06 28  
(511) 30

---

(260) AM 2020 100729 A  
(800) 1438003  
(151) 2018 02 21  
(181) 2028 02 21  
(891) 2018 02 21  
(511) 03

---

(260) AM 2020 100731 A  
(800) 1438129  
(151) 2018 08 20  
(181) 2028 08 20  
(891) 2018 08 20  
(511) 29, 30

---

(260) AM 2020 100734 A  
(800) 1438177  
(151) 2018 08 22  
(181) 2028 08 22  
(891) 2018 08 22  
(511) 25

---

(260) AM 2020 100735 A  
(800) 1438187  
(151) 2018 06 21  
(181) 2028 06 21  
(891) 2018 06 21  
(511) 01, 02, 17

---

(260) AM 2020 100736 A  
(800) 1438205  
(151) 2018 07 11  
(181) 2028 07 11  
(891) 2018 07 11  
(511) 03, 16, 21

---

(260) AM 2020 100737 A  
(800) 1438209  
(151) 2018 08 30  
(181) 2028 08 30  
(891) 2018 08 30  
(511) 09, 35, 36

---

(260) AM 2020 100738 A  
(800) 1438239  
(151) 2018 10 16  
(181) 2028 10 16  
(891) 2018 10 16  
(511) 30

---

(260) AM 2020 100740 A  
(800) 1438263  
(151) 2018 10 04  
(181) 2028 10 04  
(891) 2018 10 04  
(511) 02, 16

---

(260) AM 2020 100741 A  
(800) 1438274  
(151) 2018 09 07  
(181) 2028 09 07  
(891) 2018 09 07  
(511) 12

---

(260) AM 2020 100742 A  
(800) 1438320  
(151) 2018 08 14  
(181) 2028 08 14  
(891) 2018 08 14  
(511) 42

---

(260) AM 2020 100755 A  
(800) 1374829  
(151) 2017 07 06  
(181) 2027 07 06  
(891) 2018 11 22  
(511) 07, 09, 11, 35, 36, 37

---

(260) AM 2020 100823 A  
(800) 1439499  
(151) 2018 08 24  
(181) 2028 08 24

(891) 2018 08 24  
(511) 09, 28

---

(260) AM 2020 100824 A  
(800) 1439501  
(151) 2018 08 22  
(181) 2028 08 22  
(891) 2018 08 22  
(511) 09, 28

---

(260) AM 2020 100825 A  
(800) 1439539  
(151) 2018 09 27  
(181) 2028 09 27  
(891) 2018 09 27  
(511) 05

---

(260) AM 2020 100826 A  
(800) 1439629  
(151) 2018 09 07  
(181) 2028 09 07  
(891) 2018 09 07  
(511) 17

---

(260) AM 2020 100827 A  
(800) 1439636  
(151) 2018 09 07  
(181) 2028 09 07  
(891) 2018 09 07  
(511) 09

---

(260) AM 2020 100831 A  
(800) 1439760  
(151) 2018 09 13  
(181) 2028 09 13  
(891) 2018 09 13  
(511) 34

---

(260) AM 2020 100832 A  
(800) 1439779  
(151) 2018 09 04  
(181) 2028 09 04  
(891) 2018 09 04  
(511) 19, 35

---

(260) AM 2020 100841 A  
(800) 1440080  
(151) 2018 08 27  
(181) 2028 08 27  
(891) 2018 08 27  
(511) 05

---

(260) AM 2020 100842 A  
(800) 1440101  
(151) 2018 11 12  
(181) 2028 11 12  
(891) 2018 11 12  
(511) 03

---

(260) AM 2020 100848 A  
(800) 614497A  
(151) 1993 11 09  
(181) 2023 11 09  
(891) 2018 11 08  
(511) 03, 05

---

(260) AM 2020 100849 A  
(800) 1073949  
(151) 2011 03 09  
(181) 2021 03 09  
(891) 2018 11 14  
(511) 16, 18

---

(260) AM 2020 100850 A  
(800) 1233236  
(151) 2014 03 26  
(181) 2024 03 26  
(891) 2018 10 26  
(511) 01, 04, 06, 07, 09, 10, 11, 12, 17, 19, 37

---

(260) AM 2020 100851 A  
(800) 1250997  
(151) 2014 09 16  
(181) 2024 09 16  
(891) 2018 11 20  
(511) 06

---

(260) AM 2020 100854 A  
(800) 1360544  
(151) 2017 06 12  
(181) 2027 06 12  
(891) 2018 11 13  
(511) 03

---

(260) AM 2020 100855 A  
(800) 1360702  
(151) 2017 06 08  
(181) 2027 06 08  
(891) 2018 11 20  
(511) 40

---

(260) AM 2020 100937 A  
(800) 1438462  
(151) 2018 07 24  
(181) 2028 07 24

(891) 2018 07 24  
(511) 30

---

(260) AM 2020 100938 A  
(800) 1438508  
(151) 2018 08 20  
(181) 2028 08 20  
(891) 2018 08 20  
(511) 09, 28

---

(260) AM 2020 100939 A  
(800) 1438523  
(151) 2018 08 22  
(181) 2028 08 22  
(891) 2018 08 22  
(511) 09, 28

---

(260) AM 2020 100957 A  
(800) 1438708  
(151) 2018 09 10  
(181) 2028 09 10  
(891) 2018 09 10  
(511) 34

---

(260) AM 2020 100958 A  
(800) 1438714  
(151) 2018 09 11  
(181) 2028 09 11  
(891) 2018 09 11  
(511) 34

---

(260) AM 2020 100959 A  
(800) 1438726  
(151) 2018 07 25  
(181) 2028 07 25  
(891) 2018 07 25  
(511) 18, 24, 25, 28

---

(260) AM 2020 100960 A  
(800) 1438727  
(151) 2018 09 14  
(181) 2028 09 14  
(891) 2018 09 14  
(511) 34

---

(260) AM 2020 100961 A  
(800) 1438738  
(151) 2018 09 10  
(181) 2028 09 10  
(891) 2018 09 10  
(511) 34

---

(260) AM 2020 100962 A  
(800) 1438825  
(151) 2018 11 10  
(181) 2028 11 10  
(891) 2018 11 10  
(511) 09

---

(260) AM 2020 100963 A  
(800) 1438896  
(151) 2018 11 07  
(181) 2028 11 07  
(891) 2018 11 07  
(511) 09

---

(260) AM 2020 100964 A  
(800) 1438901  
(151) 2018 09 07  
(181) 2028 09 07  
(891) 2018 09 07  
(511) 09

---

(260) AM 2020 100965 A  
(800) 1438903  
(151) 2018 08 03  
(181) 2028 08 03  
(891) 2018 08 03  
(511) 29

---

(260) AM 2020 100966 A  
(800) 1438915  
(151) 2018 11 14  
(181) 2028 11 14  
(891) 2018 11 14  
(511) 32

---

(260) AM 2020 100974 A  
(800) 1439186  
(151) 2018 09 30  
(181) 2028 09 30  
(891) 2018 09 30  
(511) 07

---

(260) AM 2020 100977 A  
(800) 1439413  
(151) 2018 10 18  
(181) 2028 10 18  
(891) 2018 10 18  
(511) 29, 30, 32, 43

---

(260) AM 2020 100978 A  
(800) 1439442  
(151) 2018 10 31  
(181) 2028 10 31

(891) 2018 10 31  
(511) 09, 39

---

(260) AM 2020 100979 A  
(800) 699815  
(151) 1998 08 24  
(181) 2028 08 24  
(891) 2018 11 07  
(511) 05

---

(260) AM 2020 100980 A  
(800) 1248834  
(151) 2015 04 13  
(181) 2025 04 13  
(891) 2018 11 07  
(511) 05

---

(260) AM 2020 100981 A  
(800) 1255021  
(151) 2015 01 06  
(181) 2025 01 06  
(891) 2017 11 23  
(511) 28

---

(260) AM 2020 100982 A  
(800) 1274778  
(151) 2015 10 08  
(181) 2025 10 08  
(891) 2018 11 15  
(511) 18

---

(260) AM 2020 100983 A  
(800) 1294066  
(151) 2016 02 23  
(181) 2026 02 23  
(891) 2018 11 23  
(511) 05, 10

---

(260) AM 2020 100984 A  
(800) 1424138  
(151) 2018 05 07  
(181) 2028 05 07  
(891) 2018 10 29  
(511) 31

---

(260) AM 2020 100986 A  
(800) 1440340  
(151) 2018 07 13  
(181) 2028 07 13  
(891) 2018 07 13  
(511) 03, 05, 35

---

(260) AM 2020 100987 A  
(800) 1440459  
(151) 2018 09 13  
(181) 2028 09 13  
(891) 2018 09 13  
(511) 11

---

(260) AM 2020 100988 A  
(800) 1440462  
(151) 2018 09 25  
(181) 2028 09 25  
(891) 2018 09 25  
(511) 09, 14

---

(260) AM 2020 100989 A  
(800) 1440485  
(151) 2018 11 16  
(181) 2028 11 16  
(891) 2018 11 16  
(511) 36

---

(260) AM 2020 100991 A  
(800) 1440493  
(151) 2018 07 17  
(181) 2028 07 17  
(891) 2018 07 17  
(511) 09

---

(260) AM 2020 100992 A  
(800) 1440496  
(151) 2018 10 09  
(181) 2028 10 09  
(891) 2018 10 09  
(511) 18, 25

---

(260) AM 2020 100993 A  
(800) 1440506  
(151) 2018 07 17  
(181) 2028 07 17  
(891) 2018 07 17  
(511) 09

---

(260) AM 2020 100994 A  
(800) 1440546  
(151) 2018 07 16  
(181) 2028 07 16  
(891) 2018 07 16  
(511) 05

---

(260) AM 2020 100996 A  
(800) 1440582  
(151) 2018 07 16  
(181) 2028 07 16

(891) 2018 07 16  
(511) 05

---

(260) AM 2020 101028 A  
(800) 1441112  
(151) 2018 06 29  
(181) 2028 06 29  
(891) 2018 06 29  
(511) 18, 25

---

(260) AM 2020 101029 A  
(800) 1441122  
(151) 2018 10 10  
(181) 2028 10 10  
(891) 2018 10 10  
(511) 16

---

(260) AM 2020 101034 A  
(800) 1441214  
(151) 2018 10 01  
(181) 2028 10 01  
(891) 2018 10 01  
(511) 30

---

(260) AM 2020 101035 A  
(800) 1441232  
(151) 2018 07 04  
(181) 2028 07 04  
(891) 2018 07 04  
(511) 03

---

(260) AM 2020 101036 A  
(800) 1441262  
(151) 2018 10 10  
(181) 2028 10 10  
(891) 2018 10 10  
(511) 35

---

(260) AM 2020 101037 A  
(800) 1441266  
(151) 2018 11 20  
(181) 2028 11 20  
(891) 2018 11 20  
(511) 30

---

(260) AM 2020 101038 A  
(800) 1441299  
(151) 2018 07 17  
(181) 2028 07 17  
(891) 2018 07 17  
(511) 16, 41, 43

---

(260) AM 2020 101040 A  
(800) 1441313  
(151) 2018 10 03  
(181) 2028 10 03  
(891) 2018 10 03  
(511) 09

---

(260) AM 2020 101058 A  
(800) 863063  
(151) 2005 07 19  
(181) 2025 07 19  
(891) 2018 11 23  
(511) 05, 29, 30, 32

---

(260) AM 2020 101106 A  
(800) 1442771  
(151) 2018 08 20  
(181) 2028 08 20  
(891) 2018 08 20  
(511) 04, 12, 35

---

(260) AM 2020 101117 A  
(800) 1443027  
(151) 2018 09 06  
(181) 2028 09 06  
(891) 2018 09 06  
(511) 01, 19, 40

---

(260) AM 2020 101123 A  
(800) 494541  
(151) 1985 06 28  
(181) 2025 06 28  
(891) 2018 11 29  
(511) 09, 16, 41

---

(260) AM 2020 101124 A  
(800) 1099704  
(151) 2011 11 02  
(181) 2021 11 02  
(891) 2018 11 16  
(511) 33

---

(260) AM 2020 101125 A  
(800) 1099705  
(151) 2011 11 02  
(181) 2021 11 02  
(891) 2018 11 16  
(511) 33

---

(260) AM 2020 101126 A  
(800) 1180135  
(151) 2013 08 15  
(181) 2023 08 15

(891) 2018 10 19  
(511) 30

---

(260) AM 2020 101157 A  
(800) 1443680  
(151) 2018 12 10  
(181) 2028 12 10  
(891) 2018 12 10  
(511) 39

---

(260) AM 2020 101162 A  
(800) 1443741  
(151) 2018 12 04  
(181) 2028 12 04  
(891) 2018 12 04  
(511) 10

---

(260) AM 2020 101320 A  
(800) 1445348  
(151) 2018 11 23  
(181) 2028 11 23  
(891) 2018 11 23  
(511) 12

---

(260) AM 2020 101321 A  
(800) 1445357  
(151) 2018 05 22  
(181) 2028 05 22  
(891) 2018 05 22  
(511) 03, 09, 14, 18, 25

---

(260) AM 2020 101322 A  
(800) 1445411  
(151) 2018 10 17  
(181) 2028 10 17  
(891) 2018 10 17  
(511) 25

---

(260) AM 2020 101324 A  
(800) 1445441  
(151) 2018 09 13  
(181) 2028 09 13  
(891) 2018 09 13  
(511) 30

---

(260) AM 2020 101350 A  
(800) 1445957  
(151) 2018 11 23  
(181) 2028 11 23  
(891) 2018 11 23  
(511) 18, 25

---

(260) AM 2020 101352 A  
(800) 1445981  
(151) 2018 10 03  
(181) 2028 10 03  
(891) 2018 10 03  
(511) 28

---

(260) AM 2020 101354 A  
(800) 1446045  
(151) 2018 11 23  
(181) 2028 11 23  
(891) 2018 11 23  
(511) 32

---

(260) AM 2020 101357 A  
(800) 1446090  
(151) 2018 10 15  
(181) 2028 10 15  
(891) 2018 10 15  
(511) 34

---

(260) AM 2020 101442 A  
(800) 1446855  
(151) 2018 12 20  
(181) 2028 12 20  
(891) 2018 12 20  
(511) 30

---

(260) AM 2020 101458 A  
(800) 1447158  
(151) 2018 07 12  
(181) 2028 07 12  
(891) 2018 07 12  
(511) 02, 09, 16, 17

---

(260) AM 2020 101459 A  
(800) 1447210  
(151) 2018 10 31  
(181) 2028 10 31  
(891) 2018 10 31  
(511) 09

---

(260) AM 2020 101462 A  
(800) 1447396  
(151) 2018 06 20  
(181) 2028 06 20  
(891) 2018 06 20  
(511) 01, 17, 19

---

(260) AM 2020 101474 A  
(800) 1447679  
(151) 2018 08 03  
(181) 2028 08 03

(891) 2018 08 03  
(511) 09, 41, 45

---

(260) AM 2020 101475 A  
(800) 1447694  
(151) 2018 07 17  
(181) 2028 07 17  
(891) 2018 07 17  
(511) 09, 28

---

(260) AM 2020 101476 A  
(800) 1447709  
(151) 2018 08 03  
(181) 2028 08 03  
(891) 2018 08 03  
(511) 06, 19, 37

---

(260) AM 2020 101477 A  
(800) 1447713  
(151) 2018 07 17  
(181) 2028 07 17  
(891) 2018 07 17  
(511) 09, 28

---

(260) AM 2020 101525 A  
(800) 1446277  
(151) 2018 10 14  
(181) 2028 10 14  
(891) 2018 10 14  
(511) 34

---

(260) AM 2020 101587 A  
(800) 1449033  
(151) 2018 07 13  
(181) 2028 07 13  
(891) 2018 07 13  
(511) 03, 05, 09, 10, 16, 17, 20, 21, 22, 23, 24, 25, 27

---

(260) AM 2020 101589 A  
(800) 1449091  
(151) 2018 09 04  
(181) 2028 09 04  
(891) 2018 09 04  
(511) 29, 32

---

(260) AM 2020 101590 A  
(800) 1449098  
(151) 2018 07 05  
(181) 2028 07 05  
(891) 2018 07 05  
(511) 05, 16

---

(260) AM 2020 101591 A  
(800) 1449105  
(151) 2018 11 09  
(181) 2028 11 09  
(891) 2018 11 09  
(511) 28

---

(260) AM 2020 101592 A  
(800) 598867  
(151) 1993 02 19  
(181) 2023 02 19  
(891) 2018 09 10  
(511) 25

---

(260) AM 2020 102998 A  
(800) 1371747  
(151) 2017 07 05  
(181) 2027 07 05  
(891) 2019 02 14  
(511) 30

---



---

# OFFICIAL NOTIFICATIONS

## INVENTION

### EXPIRATION OF PATENT RESTORATION

(21) AP 2017 14629

**(11) P 2019 7022 B**

(73) Tamaz Agladze;

Marine Donadze;

Shota Rustaveli National Science Foundation of Georgia

(54) **METHOD FOR SILVER MONODISPERSE NANOPARTICLES PREPARATION**

DATE OF CANCELLATION OF PATENT: 2019 11 20

DATE OF RESTORATION OF PATENT: 2020 01 10

---

## DESIGNS

### CANCELLATION OF DESIGN REGISTRATION

**(11) D 2009 401 S**

(73) JSC "LOMISI" (GE)

Ksani Beach Street 1, 0600, Akhlagori, Georgia (GE)

(54) **BOTTLE**

(18) 2019 04 07

(58) 2019 12 23

---

### EXTENSION OF REGISTRATION OF INTERNATIONAL DESIGNS

(11) DM/66002

(73) BRAUN GMBH

Frankfurter Str. 145, 61476 Kronberg (DE)

(15) 2004 10 26

(24) 2004 10 26

(18) 2024 10 26

(28) 3

(28') 3

(54) Toothbrushes

---

(11) DM/66433

(73) TOTAL SA

2, Place de la Coupole, LA DEFENSE 6, F-92400 COURBEVOIE (FR)

(15) 2004 12 22

(24) 2004 12 22

(18) 2024 12 22

(28) 1

(28') 1

(54) Can

---

---

(11) DM/71890  
(73) MONTRES BREGUET S.A.  
CH-1344 L'ABBAYE (CH)  
(15) 2009 06 11  
(24) 2009 06 11  
(18) 2024 06 11  
(28) 1  
(28') 1  
(54) Jewelry, in particular bracelet

---

(11) DM/83383  
(73) PIAGGIO & C. S.P.A.  
Viale Rinaldo Piaggio, 25, I-56025 PONTEDERA (PISA) (EM)  
(15) 2014 04 15  
(24) 2014 04 15  
(18) 2024 04 15  
(28) 1  
(28') 1  
(54) Motor scooter

---

(11) DM/84429  
(73) GUNSAN ELEKTRIK MALZEMELERI SANAYI VE TICARET ANONIM SIRKETI  
Osmangazi Mahallesi Yildirim Beyazit Caddesi No:29, Sancaktepe/Istanbul (TR)  
(15) 2014 09 18  
(24) 2014 09 18  
(18) 2024 09 18  
(28) 2  
(28') 2  
(54) Electric switches

---

(11) DM/84558  
(73) SWATCH AG (SWATCH SA) (SWATCH LTD)  
Jakob-Stämpfli-Strasse 94, CH-2502 Biel/ Bienne (CH)  
(15) 2014 10 03  
(24) 2014 10 03  
(18) 2024 10 03  
(28) 3  
(28') 3  
(54) Watch bracelets

---

(11) DM/84748  
(73) KVADRA D.O.O. ZA PROIZVODNJU, TRGOVINU I USLUGE  
Pustodol Začretski 19G, HR-49223 Sveti Križ Začretje (HR)  
(15) 2014 07 21  
(24) 2014 07 21  
(18) 2024 07 21  
(28) 2  
(28') 2  
(54) Rotating armchair, Rotating sofa

---

## CANCELLATION OF REGISTRATION OF INTERNATIONAL DESIGNS

(11) DM/71130  
(73) SWATCH AG (SWATCH SA) (SWATCH LTD.)  
Jakob-Stämpfli-Strasse 94, CH-2502 Biel/Bienne (CH)  
Cancellation Date: 2018 12 30  
(58) 2019 12 23

---

(11) DM/71137  
(73) ALFACOMMERCE JSC  
Prof. Tsvetan Lazarov Blvd. 113, BG-1582 Sofia (BG)  
Cancellation Date: 2018 09 30  
(58) 2019 12 23

---

(11) DM/71177  
(73) SWATCH AG (SWATCH SA)(SWATCH LTD)  
Jakob-Stämpfli-Strasse 94, CH-2502 BIEL/BIENNE (CH)  
Cancellation Date: 2019 01 12  
(58) 2019 12 23

---

(11) DM/71311  
(73) SHADYPACK FOR PACKING MEDICINAL & FOODSTUFFS  
Al Obur City, Industrial Zone, Piece No 3 Block 1316, Cairo (EG)  
Cancellation Date: 2018 10 28  
(58) 2019 12 23

---

(11) DM/71313  
(73) SWATCH AG (SWATCH SA)(SWATCH LTD)  
Jakob-Stämpfli-Strasse 94, CH-2502 BIEL/BIENNE (CH)  
Cancellation Date: 2019 02 10  
(58) 2019 12 23

---

(11) DM/71562  
(73) NOKIA CORPORATION  
Keilalahdentie 4, FI-02150 Espoo (EM)  
Cancellation Date: 2018 09 16  
(58) 2019 12 23

---

(11) DM/71616  
(73) SWATCH AG (SWATCH SA) (SWATCH LTD.)  
Jakob-Stämpfli-Strasse 94, CH-2502 Biel/Bienne (CH)  
Cancellation Date: 2019 04 07  
(58) 2019 12 23

---

(11) DM/71627  
(73) ETA SA MANUFACTURE HORLOGERE SUISSE  
CH-2540 GRENCHEN (CH)  
Cancellation Date: 2019 04 09  
(58) 2019 12 23

---

(11) DM/71702  
(73) BRAUN GMBH  
Frankfurter Strasse 145, 61476 Kronberg (DE)  
Cancellation Date: 2019 04 21  
(58) 2019 12 23

---

(11) DM/71803  
(73) SWATCH AG (SWATCH SA) (SWATCH LTD.)  
94, rue Jakob Stämpfli, CH-2502 Biel/Bienne (CH)  
Cancellation Date: 2019 05 04  
(58) 2019 12 23

---

## TRADEMARKS

### RENEWAL OF REGISTRATIONS

(111) M 2009 19745 R1

(156) 2009 09 11

(186) 2029 09 11

(732) Adamed Pharma S.A.

Pienkow, Ul. Mariana Adamkiewiczza 6A  
05-152 Czosnow, Poland

---

Oberstdorfer Strasse 7, 87435 Kempten,

Germany

---

(111) M 2009 20119 R1

(156) 2009 12 28

(186) 2029 12 28

(732) JSC "GEPHA"

Akaki Belashvili St. 142, 0159, Tbilisi,  
Georgia

---

(111) M 2010 20339 R1

(156) 2010 03 25

(186) 2030 03 25

(732) NEC Solution Innovators, Ltd.

1-18-7, Shinkiba, Koto-ku, Tokyo, Japan

---

(111) M 2009 20096 R1

(156) 2009 12 15

(186) 2029 12 15

(732) LALI RUBIN

Kekelidze St. 6, ap. 9, Tbilisi, Georgia

---

(111) M 2009 20103 R1

(156) 2009 12 15

(186) 2029 12 15

(732) "INTERCHEM" SUBSIDIARY LIABILITY  
COMPANY

86, Lustdorfskaya doroga, Odessa, 65080,  
Ukraine

---

(111) M 2009 20104 R1

(156) 2009 12 15

(186) 2029 12 15

(732) "INTERCHEM" SUBSIDIARY LIABILITY  
COMPANY

86, Lustdorfskaya doroga, Odessa, 65080,  
Ukraine

---

(111) M 2009 20111 R1

(156) 2009 12 15

(186) 2029 12 15

(732) NOW Health Group, Inc.

244 Knolwood Drive, Sute 300,  
Bloomington, Illinois 60108, USA

---

(111) M 2010 20307 R1

(156) 2010 03 15

(186) 2030 03 15

(732) Edelweiss GmbH & Co. KG

---

## COMPLETE TRANSFER OF RIGHTS

(111) M 1999 11880 R  
(732) Manifattura Corona S.r.l.  
Via Roma, 39, 35020 Kasalserugo (PD), Italy  
(770) COSE DI LANA S.P.A.  
Zona Industriale S. Fiora, 52037 Sansepolcro,  
Arezzo, Italy  
(580) 28 11 2019

---

(111) M 2009 19745 R  
(732) Adamed Pharma S.A.  
Pienkow, Ul. Mariana Adamkiewicza 6A  
05-152 Czosnow, Poland  
(770) Admarka Sp. z o.o.  
Pieńków 149, 05-152 Czosnow, Poland  
(580) 11 09 2019

---

(111) M 2010 20238 R  
(732) LTD "YAMUNA GEORGIA"  
Giorgi Brtskinvale St. 1, korp. 1, Vake-  
Saburtalo District, Tbilisi, Georgia  
(770) MAMUKA JAPARIDZE  
Uiaragho St. 10, 0101, Tbilisi, Georgia  
(580) 17 12 2019

---

(111) M 2010 20339 R  
(732) NEC Solution Innovators Ltd  
1-18-7, Shinkiba, Koto-ku, Tokyo, Japan  
(770) NEC Informatec Systems, Ltd  
8-2, SHIBA 3-CHOME, MINATO-KU,  
TOKYO, Japan  
(580) 16 12 2019

---

(111) M 1996 2271 R  
(732) HFS Prestige International Germany GmbH  
Berliner Allee 65, 64295 Darmstadt, Germany  
(770) Coty Germany GmbH  
Berliner Allee 65, 64295 Darmstadt, Germany  
(580) 11 09 2019

---

(111) M 2015 26196 R  
(732) GEORGIAN LEGEND LLC  
Ilia Chavchavadze Av. 29/31/33, ap. 32,  
0179, Tbilisi, Georgia;  
Eldar Iukuridze  
Zhukovskiy St. 19, ap. 9, Odesa, Ukraine  
(770) ELDAR IUKURIDZE  
Zhukovskiy St. 19, ap. 9, Odesa, Ukraine  
(580) 17 12 2019

---

(111) M 1997 7875 R  
(732) Valvoline Licensing And Intellectual  
Property LLC  
100 Valvolain Vei, Leqsingleton KY  
40509, USA  
(770) Ashland Licensing and Intellectual  
Property LLC  
5200 Blazer Parkway, Dublin, Ohio  
43017, USA  
(580) 17 12 2019

---

(111) M 1999 12121 R  
(732) Valvoline Licensing And Intellectual  
Property LLC  
100 Valvolain Vei, Leqsingleton KY  
40509, USA  
(770) Ashland Licensing and Intellectual  
Property LLC  
5200 Blazer Parkway, Dublin, Ohio  
43017, USA  
(580) 17 12 2019

---

## CHANGES OF NAMES AND/OR ADDRESS OF OWNERS

- 
- (111) M 1995 629 R  
(732) MITSUBISHI CHEMICAL MEDIA CO. LTD.  
3-20, Kandaogawamachi, Chiyoda-ku,  
Tokyo, Japan  
(770) MITSUBISHI KAGAKU MEDIA CO. LTD.  
3-20, Kandaogawamachi, Chiyoda-ku,  
Tokyo, Japan  
(580) 20 12 2019
- 
- (111) M 1995 834 R  
(732) Evonik Operations GmbH  
Rellinghauser Strasse 1-11, 45128 Essen,  
Germany  
(770) EVONIK DEGUSSA GmbH  
Rellinghauser Strasse 1-11, 45128 Essen,  
Germany  
(580) 17 12 2019
- 
- (111) M 1995 813 R  
(732) Evonik Operations GmbH  
Rellinghauser Strasse 1-11, 45128 Essen,  
Germany  
(770) EVONIK DEGUSSA GmbH  
Rellinghauser Strasse 1-11, 45128 Essen,  
Germany  
(580) 18 12 2019
- 
- (111) M 2009 20119 R  
(732) JSC "GEPHA"  
Akaki Beliasvili St. 42, 0159, Tbilisi,  
Georgia  
(770) JSC "GPC"  
Marjanishvili St. 26, 0102, Tbilis, Georgia  
(580) 16 12 2019
- 
- (111) M 2009 20103 R  
(732) "INTERCHEM" SUBSIDIARY LIABILITY  
COMPANY  
86, Lustdorfskaya doroga, Odessa, 65080,  
Ukraine  
(770) Open Joint-Stock Company "International  
Ukrainian-Belgian Chemical Enterprises  
"INTERCHEM" (JV. "INTERCHEM")  
86, Lustdorfskaya doroga, Odessa, 65080,  
Ukraine  
(580) 06 12 2019
- 
- (111) M 2009 20104 R  
(732) "INTERCHEM" SUBSIDIARY LIABILITY  
COMPANY  
86, Lustdorfskaya doroga, Odessa, 65080,
- (770) Open Joint-Stock Company "International  
Ukrainian-Belgian Chemical Enterprises  
INTERCHEM" (JV. "INTERCHEM")  
86, Lustdorfskaya doroga, Odessa, 65080,  
Ukraine  
(580) 06 12 2019
- 
- (111) M 2009 20111 R  
(732) NOW Health Group, Inc.  
244 Knolwood Drive, Sute 300,  
Bloomington, Illinois 60108, USA  
(770) NOW Health Group, Inc.  
395 South Glen Ellyn Road, Bloomington,  
Illinois 60108, USA  
(580) 16 12 2019
- 
- (111) M 1996 2271 R  
(732) Coty Germany GmbH  
Berliner Allee 65, 64295 Darmstadt, Germany  
(770) Coty Germany GmbH  
Fort Malakoff Park, 4E Rheinstrasse, D-55116  
Mainz, Germany  
(580) 11 09 2019
- 
- (111) M 1996 2271 R  
(732) Coty Beauty Germany GmbH  
Berliner Allee 65, 64295 Darmstadt, Germany  
(770) HFS Prestige International Germany GmbH  
Berliner Allee 65, 64295 Darmstadt, Germany  
(580) 11 09 2019
- 
- (111) M 2017 28854 R  
(732) LTD "Georgian Hospitality Investments"  
Bambis Rigi 7, Tbilisi, Georgia  
(770) LTD "Georgian Hospitality Investments"  
Besiki St. 4, ap.4, 0108, Tbilisi, Georgia  
(580) 11 12 2019
-

## TERMINATION OF TRADEMARKS REGISTRATIONS

(111) M 1999 12373 R  
(151) 1999 06 15  
(732) MARS, INCORPORATED  
6885, Elm Street, McLean, Virginia, USA  
(141) 2019 12 24

---

(111) M 1999 12374 R  
(151) 1999 06 15  
(732) MARS, INCORPORATED  
6885, Elm Street, McLean, Virginia, USA  
(141) 2019 12 24

---

(111) M 1999 12375 R  
(151) 1999 06 15  
(732) Betek Boya ve Kimya Sanayi Anonim Şirketi  
Kaynarca, Kavakpınar Mah. Tandoğan Cad.  
Kocamezarlık Karşısı, Pendik-İSTANBUL,  
Turkey  
(141) 2019 12 24

---

(111) M 1999 12383 R  
(151) 1999 06 15  
(732) INTEL CORPORATION  
2200 Mission College Boulevard, Santa Clara,  
California 95052-8119, USA  
(141) 2019 12 24

---

(111) M 1999 12390 R  
(151) 1999 06 15  
(732) FERRING B.V.  
Polarisavenue 144, 2132 JX Hoofddorp,  
Netherlands  
(141) 2019 12 24

---

(111) M 1999 12391 R  
(151) 1999 06 15  
(732) FERRING B.V.  
Polarisavenue 144, 2132 JX Hoofddorp,  
Netherlands  
(141) 2019 12 24

---

(111) M 2009 19394 R  
(151) 2009 06 16  
(732) Jonson Controls Technology Company  
915 East 32nd Street, Holland, Michigan,  
49423, USA  
(141) 2019 12 24

---

(111) M 2009 19395 R  
(151) 2009 06 16  
(732) LTD "ZHORZHOLIANI TRADING"  
Zh. Shartava St. 43, 0160, Tbilisi, Georgia  
(141) 2019 12 24

---

(111) M 2009 19397 R  
(151) 2009 06 16  
(732) LTD "VITEL GEORGIA"  
Freedom Square 4, 0105, Tbilisi, Georgia  
(141) 2019 12 24

---

(111) M 2009 19398 R  
(151) 2009 06 16  
(732) LTD "VITEL GEORGIA"  
Freedom Square 4, 0105, Tbilisi, Georgia  
(141) 2019 12 24

---

(111) M 2009 19399 R  
(151) 2009 06 16  
(732) LTD "GD GROUP"  
Tamar Mepe Av. 8, 0112, Tbilisi, Georgia  
(141) 2019 12 24

---

(111) M 2009 19401 R  
(151) 2009 06 16  
(732) LEVAN NIKOLISHVILI  
Airport Settlement 46, ap. 32, 0158, Tbilisi,  
Georgia  
(141) 2019 12 24

---

(111) M 2009 19402 R  
(151) 2009 06 16  
(732) LEVAN NIKOLISHVILI  
Airport Settlement 46, ap. 32, 0158, Tbilisi,  
Georgia  
(141) 2019 12 24

---

(111) M 2009 19403 R  
(151) 2009 06 16  
(732) LERI JIBLADZE  
Gagarini St. 27, ap. 16, 0160, Tbilisi,  
Georgia  
(141) 2019 12 24

---



(111) M 2009 19404 R  
 (151) 2009 06 16  
 (732) LTD "RUSSIAN HOUSE"  
 Kekelidze St. 23, 0179, Tbilisi, Georgia  
 (141) 2019 12 24

(111) M 2009 19408 R  
 (151) 2009 06 16  
 (732) LTD "Georgian Beverage Company"  
 I. Chavchavadze Av. 75, korp. 3a, ap.19,  
 Tbilisi, Georgia  
 (141) 2019 12 24

(111) M 2009 19409 R  
 (151) 2009 06 16  
 (732) LTD "EUROCOM INVESTMENT"- Branch  
 Saburtalo St. 40, korp. 1, ap. 50, 0194, Tbilisi,  
 Georgia  
 (141) 2019 12 24

(111) M 2009 19410 R  
 (151) 2009 06 16  
 (732) LTD "EUROCOM INVESTMENT"- Branch  
 Saburtalo St. 40, korp. 1, ap. 50, 0194, Tbilisi,  
 Georgia  
 (141) 2019 12 24

(111) M 2009 19411 R  
 (151) 2009 06 16  
 (732) SHOTA BITADZE  
 Gia Abesadze St. 17, 0105, Tbilisi, Georgia  
 (141) 2019 12 24

(111) M 2009 19412 R  
 (151) 2009 06 16  
 (732) LTD "MUKHAMBAZI"  
 Beliashvili St. 5a, 0159, Tbilisi, Georgia  
 (141) 2019 12 24

(111) M 2009 19413 R  
 (151) 2009 06 16  
 (732) British American Tobacco (Brands) Inc.  
 (a Delaware corporation)  
 2711 Centerville Road, Suite 300,  
 Wilmington, Delaware 19808, USA  
 (141) 2019 12 24

(111) M 2009 19415 R  
 (151) 2009 06 16  
 (732) JSC "TBILCHIMPHARM"  
 Tsuladze St. 34, 0113, Tbilisi,  
 Georgia

(141) 2019 12 24

(111) M 2009 19416 R  
 (151) 2009 06 16  
 (732) JSC "TBILCHIMPHARM"  
 Tsuladze St. 34, 0113, Tbilisi, Georgia  
 (141) 2019 12 24

(111) M 2009 19417 R  
 (151) 2009 06 16  
 (732) NOVARTIS AG  
 Basel 4002, Switzerland  
 (141) 2019 12 24

(111) M 2009 19418 R  
 (151) 2009 06 16  
 (732) GlaxoSmithKline LLC  
 Corporation Service Company, 251 Little  
 Falls Drive, Wilmington, Delaware 19808,  
 USA  
 (141) 2019 12 24

(111) M 2009 19423 R  
 (151) 2009 06 16  
 (732) LTD N1 Liqueur and Vodka Factory  
 "SAMGORI ALKO"  
 Abuseridze-Tbelis St. 13, 0120, Tbilisi,  
 Georgia  
 (141) 2019 12 24

(111) M 2009 19424 R  
 (151) 2009 06 16  
 (732) HFC Prestige International Holding  
 Switzerland Sàrl  
 Chemin Louis-Hubert 1-3, 1213 Petit-Lancy,  
 Switzerland  
 (141) 2019 12 24

(111) M 2009 19425 R  
 (151) 2009 06 16  
 (732) HFC Prestige International Holding  
 Switzerland Sàrl  
 Chemin Louis-Hubert 1-3, 1213 Petit-Lancy,  
 Switzerland  
 (141) 2019 12 24

(111) M 2009 19427 R  
 (151) 2009 06 16  
 (732) R.C.S. Periodici S.p.A.  
 Via A. Rizzoli, 8-20132 MILANO, Italy  
 (141) 2019 12 24

(111) M 2009 19428 R  
(151) 2009 06 16  
(732) HFC Prestige International Holding  
Switzerland Sàrl  
Chemin Louis-Hubert 1-3, 1213 Petit-Lancy,  
Switzerland  
(141) 2019 12 24

---

Veerlaan 17-23, 3072 AN Rotterdam,  
Netherlands  
(141) 2019 12 24

---

(111) M 2009 19431 R  
(151) 2009 06 16  
(732) Japan Tobacco Inc.  
2-2-1, Toranomom, Minato-ku, Tokyo, Japan  
(141) 2019 12 24

---

(111) M 2009 19436 R  
(151) 2009 06 16  
(732) LTD "KALA GROUP"  
Erekle II St. 8/10, 0105, Tbilisi, Georgia  
(141) 2019 12 24

---

(111) M 2009 19437 R  
(151) 2009 06 16  
(732) SHOTA MARGISHVILI  
Belinsky St. 32, 0108, Tbilisi, Georgia  
(141) 2019 12 24

---

(111) M 2009 19438 R  
(151) 2009 06 16  
(732) LTD Insurance Company "PARTNER"  
T. Tabidze St. 106, 0162, Tbilisi, Georgia  
(141) 2019 12 24

---

(111) M 2009 19440 R  
(151) 2009 06 16  
(732) LTD "AYAN"  
M. Gashgai St. 7, Baku, Nasimi District,  
AZ 1000, Azerbaijan  
(141) 2019 12 24

---

(111) M 1999 12329 R  
(151) 1999 06 08  
(732) CASTROL LIMITED  
Technology Centre, Whitechurch Hill,  
Pangbourne, Reading RG8 7QR, United  
Kingdom  
(141) 2019 12 24

---

(111) M 2017 28514 R  
(151) 2017 05 17  
(732) Provimi B.V.

---

# CLASSIFICATION INDEXES

## INVENTIONS

### CONCORDANCE TABLE OF INTERNATIONAL CLASSIFICATION INDEX AND PUBLICATION NUMBERS

INTERNATIONAL CLASSIFICATION INDEXES (51)	NUMBER OF PUBLISHED APPLICATION (10)
A 01 N 63/00; C 12 R 1/425	AP 2020 14958 A
A 61 K 31/407; A 61 P 31/20; C 07 D 515/04; C 07 D 513/04; C 07 D 515/20; C 07 D 513/20; C 07 D 291/08	AP 2020 14690 A

### CONCORDANCE TABLE OF PUBLICATION NUMBERS AND INTERNATIONAL CLASSIFICATION INDEX

NUMBER OF PUBLISHED APPLICATION (10)	INTERNATIONAL CLASSIFICATION INDEXES (51)
AP 2020 14690 A	A 61 K 31/407; A 61 P 31/20; C 07 D 515/04; C 07 D 513/04; C 07 D 515/20; C 07 D 513/20; C 07 D 291/08
AP 2020 14958 A	A 01 N 63/00; C 12 R 1/425

### CONCORDANCE TABLE OF INTERNATIONAL CLASSIFICATION INDEX, PATENT NUMBERS AND PUBLICATION NUMBERS

INTERNATIONAL CLASSIFICATION INDEX (51)	NUMBER OF PATENT (11)	NUMBER OF PUBLISHED APPLICATION (10)
A 61 K 321/381; A 61 K 31/437; A 61 K 31/4355; A 61 P 35/00; C 07 D 487/04; C 07 D 471/04; C 07 D 409/12; C 07 D 405/12; C 07 D 495/04; C 07 D 209/12; C 07 D 405/04; C 07 D 403/12; C 07 D 333/56; C 07 D 307/81; C 07 D 307/80; C 07 D 491/04	P 2020 7056 B	AP 2019 14681 A
C 12 G 1/00; C 12 N 1/16	P 2020 7055 B	AP 2019 14808 A

### CONCORDANCE TABLE OF PATENT NUMBERS, PUBLICATION NUMBERS AND INTERNATIONAL CLASSIFICATION INDEX

NUMBER OF PATENT (11)	NUMBER OF PUBLISHED APPLICATION (10)	INTERNATIONAL CLASSIFICATION INDEX (51)
P 2020 7055 B	AP 2019 14808 A	C 12 G 1/00; C 12 N 1/16
P 2020 7056 B	AP 2019 14681 A	A 61 K 321/381; A 61 K 31/437; A 61 K 31/4355; A 61 P 35/00; C 07 D 487/04; C 07 D 471/04; C 07 D 409/12; C 07 D 405/12; C 07 D 495/04; C 07 D 209/12; C 07 D 405/04; C 07 D 403/12; C 07 D 333/56; C 07 D 307/81; C 07 D 307/80; C 07 D 491/04

**CONCORDANCE TABLE OF APPLICATION NUMBERS, PUBLICATION NUMBERS  
AND PATENTS**

NUMBER OF APPLICATION (21)	NUMBER OF PUBLISHED APPLICATION (10)	NUMBER OF PATENT (11)
AP 2016 14681	AP 2019 14681 A	P 2020 7056 B
AP 2018 14808	AP 2019 14808 A	P 2020 7055 B

**UTILITY MODELS**

**CONCORDANCE TABLE OF INTERNATIONAL CLASSIFICATION INDEX  
AND PUBLICATION NUMBERS**

INTERNATIONAL CLASSIFICATION INDEXES (51)	NUMBER OF PUBLISHED APPLICATION (10)
E 01 C 3/04	AU 2020 14990 U

**CONCORDANCE TABLE OF PUBLICATION NUMBERS  
AND INTERNATIONAL CLASSIFICATION INDEX**

NUMBER OF PUBLISHED APPLICATION (10)	INTERNATIONAL CLASSIFICATION INDEXES (51)
AU 2020 14990 U	E 01 C 3/04

**DESIGN**

**CONCORDANCE TABLE OF INTERNATIONAL CLASSIFICATION INDEX  
AND PUBLICATION NUMBERS**

INTERNATIONAL CLASSIFICATION INDEXES (51)	NUMBER OF PUBLISHED APPLICATION (10)
03-01	AD 2020 1098 S

**CONCORDANCE TABLE OF PUBLICATION NUMBERS  
AND INTERNATIONAL CLASSIFICATION INDEX**

NUMBER OF PUBLISHED APPLICATION (10)	INTERNATIONAL CLASSIFICATION INDEXES (51)
AD 2020 1098 S	03-01

## TRADEMARKS

### CONCORDANCE TABLE OF REGISTRATION NUMBERS, APPLICATION NUMBERS, PUBLICATION NUMBERS AND BULLETIN NUMBERS

NUMBER OF REGISTRATION (111)	NUMBER OF APPLICATIONS (210)	NUMBER OF PUBLISHED APPLICATIONS (260)	NUMBER OF BULLETIN
M 2020 32196 R	AM 106165	–	1(533)2020
M 2020 32197 R	AM 106054	–	1(533)2020
M 2020 32198 R	AM 106175	–	1(533)2020
M 2020 32199 R	AM 106094	–	1(533)2020
M 2020 32200 R	AM 106173	–	1(533)2020
M 2020 32201 R	AM 103583	–	1(533)2020
M 2020 32202 R	AM 106302	–	1(533)2020
M 2020 32203 R	AM 106289	–	1(533)2020

### CONCORDANCE TABLE OF PUBLICATION NUMBERS AND APPLICATION NUMBERS

NUMBER OF PUBLISHED APPLICATION (260)	NUMBER OF APPLICATION (210)	1	2
1	2		
AM 2020 100410 A	AM 100410	AM 2020 103316 A	AM 103316
AM 2020 100764 A*	AM 100764	AM 2020 103430 A	AM 103430
AM 2020 103099 A	AM 103099	AM 2020 103431 A	AM 103431
AM 2020 103184 A	AM 103184	AM 2020 103432 A	AM 103432
AM 2020 103185 A	AM 103185	AM 2020 103572 A	AM 103572
AM 2020 103186 A	AM 103186	AM 2020 103585 A	AM 103585
AM 2020 103209 A	AM 103209	AM 2020 103589 A	AM 103589
AM 2020 103302 A	AM 103302	AM 2020 103671 A	AM 103671
AM 2020 103303 A	AM 103303	AM 2020 103672 A	AM 103672
AM 2020 103312 A	AM 103312	AM 2020 103751 A	AM 103751
AM 2020 103315 A	AM 103315	AM 2020 103752 A	AM 103752
		AM 2020 103753 A	AM 103753
		AM 2020 103754 A	AM 103754
		AM 2020 103755 A	AM 103755
		AM 2020 103768 A	AM 103768
		AM 2020 103856 A	AM 103856

CONCORDANCE TABLE OF INDEX OF GOODS AND/OR SERVICES  
AND APPLICATION NUMBERS

INDEX OF GOODS AND/OR SERVICES (511)	NUMBER OF PUBLISHED APPLICATIONS (26)	1	2
1	2		
5	AM 2020 103209 A	35	AM 2020 103585 A
5	AM 2020 103312 A	35	AM 2020 103752 A
5	AM 2020 103315 A	35	AM 2020 103753 A
5	AM 2020 103856 A	35	AM 2020 103754 A
10	AM 2020 103184 A	35	AM 2020 103755 A
10	AM 2020 103185 A	35	AM 2020 103856 A
10	AM 2020 103186 A	36	AM 2020 103430 A
10	AM 2020 103186 A	36	AM 2020 103431 A
29	AM 2020 103589 A	37	AM 2020 103432 A
30	AM 2020 103589 A	43	AM 2020 103099 A
33	AM 2020 103303 A	43	AM 2020 103316 A
33	AM 2020 103751 A	43	AM 2020 103572 A
35	AM 2020 100410 A	43	AM 2020 103671 A
35	AM 2020 100764 A*	43	AM 2020 103672 A
35	AM 2020 103302 A	43	AM 2020 103752 A
35	AM 2020 103430 A	43	AM 2020 103753 A
35	AM 2020 103431 A	43	AM 2020 103754 A
35	AM 2020 103431 A	43	AM 2020 103755 A
35	AM 2020 103431 A	43	AM 2020 103768 A
35	AM 2020 103431 A	44	AM 2020 103585 A

CONCORDANCE TABLE OF INDEX OF GOODS AND/OR SERVICES  
AND NUMBERS OF TRADEMARKS REGISTERED ACCORDING  
TO THE ACCELERATED PROCEDURE

INDEX OF GOODS AND/OR SERVICES (511)	NUMBERS OF REGISTERED ACCORDING TO THE ACCELERATED PROCEDURE (111)
5	M 2020 32202 R
18	M 2020 32200 R
25	M 2020 32203 R
32	M 2020 32197 R
33	M 2020 32198 R
33	M 2020 32199 R
34	M 2020 32201 R
35	M 2020 32200 R
43	M 2020 32196 R

# OFFICIAL BULLETIN OF THE INDUSTRIAL PROPERTY

INVENTIONS  
UTILITY MODELS  
DESIGNS  
TRADEMARKS

**1(533)**

EDITOR-IN-CHIEF: N. Bebrishvili

EDITOR-TRANSLATOR: E. Gabunia

PROOFREADER: A. Shikhashvili

COMPUTER LAYOUT: M. Ordenidze  
K. Svanidze

[www.sakpatenti.gov.ge](http://www.sakpatenti.gov.ge)

E-mail: [info@sakpatenti.org.ge](mailto:info@sakpatenti.org.ge)