

Official Bulletin of the Industrial Property

Inventions

Utility Models

Designs

Traademarks

Appellations of Origin of Goods



საქართველოს ინტელექტუალური
საკუთრების ეროვნული ცენტრი

საქპატენტი

SAKPATENTI

NATIONAL INTELLECTUAL PROPERTY
CENTER OF GEORGIA

www.sakpatenti.gov.ge

Date of Publication – 2021 07 26

13(569)

INID CODES FOR IDENTIFICATION OF BIBLIOGRAPHIC DATA

INVENTIONS, UTILITY MODELS

- (10) Number of publication for application, which has been examined
- (11) Number of patent and kind of document
- (21) Serial number of application
- (22) Date of filing of the application
- (23) Date of exhibition or the date of the earlier filing and the number of application, if any
- (24) Date from which patent may have effect
- (31) Number of priority application
- (32) Date of filing of priority application
- (33) Code of the country or regional organization allotting priority application number
- (44) Date of publication of application not granted, but examined and number of bulletin
- (45) Date of publication of registered document
- (51) International Patent Classification Index

- (54) Title of the invention
- (57) Abstract
- (60) Number of examined patent document granted by foreign patent office, date from which patent has effect and country code
- (62) Number of the earlier application and in case of divided application, date of filing an application
- (71) Name, surname and address of applicant (country code)
- (72) Name, surname of inventor (country code)
- (73) Name, surname and address of patent owner (country code)
- (74) Name, surname of representative or patent attorney
- (85) Date of commencement of the national phase of International Application
- (86) Number and date of filing of international application
- (87) Number and date of publication of international application
- (94) Calculated date of expiry of the SPC or the duration of the SPC

DESIGNS

- (10) Number of publication for application
- (11) Number of patent and kind of document or number of registration
- (15) Date of registration/Date of patent renewal
- (18) Expected expiration date of patent or registration
- (21) Serial number of application
- (22) Date of filing of the application
- (23) Date of exhibition or the date of the earlier filing and the number of application, if any
- (24) Date from which patent may have effect
- (28) Number of designs included in the application
- (30) Data relating to priority (number of application, date of filing of application, two-letter code identifying the authority with whom the priority application was made)
- (31) Number of priority application
- (32) Date of filing of priority application
- (33) Code of the country or regional organization allotting priority application number
- (34) Two-letter code according to WIPO St.3 identifying the authority with which the priority application was made
- (44) Date of publication of design and number of bulletin (the first publication)
- (45) Date of publication of design registered by WIPO and number of bulletin

- (51) International Classification for designs (class and subclass of the Locarno Classification)
- (54) Title of the invention
- (55) Reproduction of the design
- (57) Description of characteristic features of the design including indication of colors
- (58) Date of recording of any kind of amendment in the Register
- (62) Number of the earlier application, registration and document number and if available the date of filing an application in case of divided application
- (71) Name, surname and address of applicant (country code)
- (72) Name, surname of creator (country code)
- (73) Name, surname and address of patent owner (country code)
- (74) Name, surname of representative or patent attorney
- (81) Contracting states concerned
 - II designated contracting states according to the 1960 Act
 - III designated contracting states according to the 1999 Act
- (85) Owner's permanent address
- (86) Owner's nationality
- (87) Owner's residence
- (88) State in which the owner has a real and effective industrial or commercial establishment

TRADEMARKS

- (111) - Number of registration
- (151) - Date of registration
- (156) - Date of the renewal
- (181) - Expected expiration date of registration
- (186) - Renewal expiration date of registration
- (141) - Date of cancel of duration of the mark
- (210) - Serial number of application
- (220) - Date of filing of the application
- (230) - Data concerning exhibition
- (260) - Number of application, for which favorable decision of examination about registration has been taken (publication number)
- (310) - Number of the first application
- (320) - Date of filing of the first application
- (330) - Code, identifying national or regional Office where the first application was made
- (511) - International Classification of Goods and Services for the purposes of registration of trade marks and/or list of goods and/or services classified according thereto
- (526) - Disclaimer
- (531) - Description of figurative elements of Trade Marks according to the International Classification of the Figurative Elements of Marks

- (540) - Reproduction of Trade Mark
- (550) - Nature and kind of Trade Mark
- (551) - Indication to the effect that the mark is a collective mark, a certification mark or a guarantee mark
- (554) - Three-dimensional mark
- (580) - Date of recording of any kind changes in respect of applications or registrations
- (591) - Information concerning colors claimed
- (731) - Name and address of the applicant
- (732) - Name and address of the holder of the registration
- (740) - Name and address of the representative
- (750) - Addreses for correspondence
- (770) - Name and address of the previous applicant or holder in case of change in ownership
- (771) - Previous name and address of the applicant or holder in case of change in ownership
- (791) - Name and address of the licensee
- (793) - Indication of conditions and/or restrictions under the license (Type of license, number of license agreement, data of license, data of validity of license)
- (800) - Certain data relating to the international registration of Trade Marks under the Protocol Relating to Madrid Agreement (International registration number
- (852) - Partial cancellation of the list of goods and services
- (891) - Date of subsequent designation

CODES FOR PUBLICATION IN BULLETIN

- (21) AP 0000 000000 - serial number of application for invention
- (10) AP 0000 0000 A - number of published application for invention (first publication)
- (11) P 0000 0000 B - number of patent for invention (second publication)
- (21) API 0000 000000 - number of application for imported patent
- (11) PI 0000 0000 A - number of imported patent (first publication)
- (21) AU 0000 000000 - serial number of application for utility model
- (10) AU 0000 000 U - number of published application for utility model (first publication)
- (11) U 0000 000 Y - number of patent for utility model (second publication)
- (21) AD 0000 000000 - serial number of application for design
- (10) AD 0000 000 S - number of published application for design (first publication)
- (11) D 0000 000 S - registered design

INTERNATIONAL PATENT CLASSIFICATION FOR INVENTIONS AND UTILITY MODELS

- SECTION A - HUMAN NECESSITIES
- SECTION B - PERFORMING OPERATIONS; TRANSPORTING
- SECTION C - CHEMISTRY; METALLURGY
- SECTION D - TEXTILES; PAPER
- SECTION E - FIXED CONSTRUCTIONS
- SECTION F - MECHANICAL ENGINEERING; LIGHTING; HEATING; WEAPONS; BLASTING
- SECTION G - PHYSICS
- SECTION H - ELECTRICITY

-
- M - Trade Mark
 - (210) AM 0000 000000 - Serial number of application;
 - (260) AAM 0000 00000 A - Publication number of application;
 - (111) M 0000 00000 R - Number of registration;
 - (111) MMM0000 00000 Rn - Number of renewals, in which n=1,2,3;
 - (111) M 0000 00000 R(P) - Number of registration under partial assignment of rights
-

Official Bulletin of the Industrial Property

Inventions

Utility Models

Designs

Trademarks

Appellations of Origin of Goods

CONTENTS

PUBLISHED TITLES OF PROTECTION	3
INVENTIONS	
▪ APPLICATIONS APPROVED FOR GRANTING PATENTS	4
▪ PATENTED INVENTIONS	6
DESIGNS	
▪ APPLICATIONS APPROVED FOR REGISTRATION	7
▪ DESIGN REGISTERED ACCORDING TO THE ACCELERATED PROCEDURE	11
▪ DESIGNS, WHICH HAVE BEEN REGISTERED WITH THE INTERNATIONAL BUREAU CLAIMING PRIORITY ON THE TERRITORY OF GEORGIA	12
TRADEMARKS	
▪ APPLICATIONS FILED UNDER THE NATIONAL PROCEDURE APPROVED FOR REGISTRATION	34
▪ REGISTERED TRADEMARKS	42
▪ TRADEMARKS REGISTERED ACCORDING TO THE ACCELERATED PROCEDURE	45
▪ INTERNATIONAL TRADEMARKS FOR WHICH A DECISION ON GRANTING PROTECTION IS TAKEN	48
▪ INTERNATIONAL TRADEMARKS PROTECTED IN GEORGIA	94
APPELLATIONS OF ORIGIN OF GOODS	
▪ INTERNATIONAL APPELLATIONS OF ORIGIN OF GOODS	105
OFFICIAL NOTIFICATIONS	
INVENTIONS	
▪ EXPIRATION OF PATENT RESTORATION	106
▪ ABOLITION OF PATENTS WITH THE RIGHT TO RESTORE	106
▪ EXPIRATION OF TERM OF RESTORATION OF PATENTS	107
▪ EXPIRATION OF PATENT	108
UTILITY MODELS	
▪ EXPIRATION OF PATENT RESTORATION	109
▪ ABOLITION OF PATENTS WITH THE RIGHT TO RESTORE	109
▪ EXPIRATION OF TERM OF RESTORATION OF PATENT	109
DESIGN	
▪ CANCELLATION OF REGISTRATION OF DESIGNS	110
▪ CANCELLATION OF REGISTRATION OF INTERNATIONAL DESIGNS	110
TRADEMARKS	
▪ RENEWAL OF REGISTRATION	114
▪ COMPLETE TRANSFER OF RIGHT	117
▪ CHANGES OF NAMES AND/OR ADDRESSES OF OWNER	119
▪ CANCELLATION OF TRADEMARKS REGISTRATION	123
▪ REGISTRATION OF LICENSE AGREEMENTS	125
▪ INTERNATIONAL LICENSE AGREEMENT	126
CLASSIFICATION INDEXES	
INVENTIONS	127
DESIGNS	128
TRADEMARKS	130

PUBLISHED TITLES OF PROTECTION

INVENTIONS

- **APPLICATIONS APPROVED FOR GRANTING PATENT:**
14756; 14453; 15436; 14450
- **PATENTED INVENTIONS:**
7277, 7278

DESIGNS

- **APPLICATIONS APPROVED FOR REGISTRATION:**
1208; 1206; 1210
- **DESIGN REGISTERED ACCORDING TO THE ACCELERATED PROCEDURE:**
899
- **DESIGNS, WHICH HAVE BEEN REGISTERED WITH THE INTERNATIONAL BUREAU CLAIMING PRIORITY ON THE TERRITORY OF GEORGIA:**
213990; 211165; 211318; 211498; 214355

TRADEMARKS

- **APPLICATIONS FILED UNDER THE NATIONAL PROCEDURE APPROVED FOR REGISTRATION:**
105975; 106956*, 106957*; 107479*; 108206; 109019*; 110447, 110448; 110675; 110684; 110686; 110688, 110689; 110694, 110695; 110747; 110751; 110753; 110756; 110758; 110761; 110764; 110769, 110780; 110784; 110790; 110858; 110864; 110866, 110867; 110942; 110950, 110951; 110953; 110962; 110964; 110966; 110971; 110978; 111064; 111074; 111280, 111281
- **REGISTERED TRADEMARKS:**
24292-34312; 34321-34329
- **TRADEMARKS REGISTERED ACCORDING TO THE ACCELERATED PROCEDURE:**
34285-34291; 34313-34320
- **INTERNATIONAL TRADEMARKS FOR WHICH A DECISION ON GRANTING PROTECTIONS IS TAKEN:**
109706; 109717; 109796-109798; 109811; 109855; 109857-109859; 109875, 109876; 109880; 109883, 109884; 109890-109892; 109895, 109896; 109898; 109967; 109973; 109976-109979; 109982; 109988-109994; 110008-110010; 110047, 110048; 110061-110063; 110065, 110066; 110068-110071; 110083; 110087-110089; 110091; 110098; 110102; 110105; 110107-110109; 110149, 110150; 110159, 110160; 110174, 110175; 110235; 110238; 110262; 110265; 110268; 110312; 110341, 110342; 110347-110349; 110396; 110398, 110399; 110430; 110432-110435; 110495-110498; 110579-110581; 110617; 110619, 110620; 110651; 110654; 110656, 110657
- **INTERNATIONAL TRADEMARKS PROTECTED IN GEORGIA:**
108465; 108614, 108615; 108617-108620; 108647; 108649-108651; 108703; 108707-108711; 108713, 108714; 108799; 108801, 108802; 108811-108828; 108830; 108834; 108896; 108899; 108901; 108903-108907; 108912; 108921; 108929-108932; 108934-108936; 108938-108940; 108994-109003; 109057; 109059-109061; 109063; 109065; 109088-109090; 109094; 109096-109099; 109147-109149; 109151-109157; 109188-109194; 109234-109238; 109249; 109270-109274; 109322-109325; 109336-109340; 109400-109403; 109414-109416; 109418; 109461-109466; 109480; 109483; 109497; 109549-109551; 109553-109555; 109570, 109572

APPELLATIONS OF ORIGIN OF GOODS

- **INTERNATIONAL APPELLATIONS OF ORIGINE OF GOODS:**
1153, 1154

INVENTIONS

APPLICATIONS APPROVED FOR GRANTING PATENTS

The decision can be appealed at the Chamber of Appeal of Sakpatenti within 3 months from the publication or at the Mtskheta District Court Administrative Cases Board (Address: №17, Samkhedro str., Mtskheta), within 1 month following the publication.

PART A

A 61

(10) AP 2021 14756 A (51) Int. Cl. (2006)
A 61 K 39/395
A 61 K 35/04
C 07 K 16/18
C 07 K 16/28

(21) AP 2016 14756 (22) 2016 10 06

(31) 62/239,020

(32) 2015 10 08

(33) US

(71) MACROGENICS, INC. (US)
9704 Medical Center Drive, Rockville,
MD 20850, USA (US)

(72) VASSELLI, James (US);
WIGGINTON, Jon, Marc (US);
BONVINI, Ezio (US);
KOENIG, Scott (US)

(74) Shalva Gvaramadze

(85) 2018 04 13

(86) PCT/US2016/055750, 2016 10 06

(54) COMBINATION THERAPY FOR THE
TREATMENT OF CANCER

(57) Present invention relates to usage of anti-B7-
H3 and anti-PD-1 antibodies combination for can-
cer treatment in human.

Claims: 1 independent
45 dependents

(10) AP 2021 14453 A (51) Int. Cl. (2006)
A 61 K 39/395
A 61 K 39/00
A 61 P 37/02
C 07 K 16/28

(21) AP 2015 14453 (22) 2015 08 17

(31) 62/171,319; 62/.039, 081

(32) 2015 06 05; 2014 08 19

(33) US; US

(71) MERCK SHARP & DOHME CORP. (US)
126 EastLincoln Ave, Rahway,
NJ 07065 – 0907 (US)

(72) LIANG, Linda (US);
FAYADAT-DILMAN, Laurence (US);
MALEFYT, Rene De Waal (NL);
RAGHUNATHAN, Gopalan (US)

(74) Shalva Gvaramadze

(85) 2017 03 17

(86) PCT/US2015/045481, 2015 08 17

(54) ANTI-LAG3 ANTIBODIES AND
ANTIGEN-BINDING FRAGMENTS

(57) Antibodies and antigen-binding fragments
thereof specifically bind to human LAG3 are
disclosed. Said antibodies are used for cancer
treatment.

Claims: 18 independents
10 dependents

Fig.: 12

PART B

B 60

(10) AP 2021 15436 A (51) Int. Cl. (2006)
B 60 T 1/06

(21) AP 2020 15436 (22) 2020 09 07

(71) Ramzan Goytemirov (RU)

Razdelnaya St. 13, Grozno, Russian Federation (RU)

(72) Ramzan Goytemirov (RU)

(74) Besik Kobakhidze

(54) SLOWING VEHICLE BRAKE DEVICE

(57) A device includes hinged onto wheel supporting
clew the case 1, brake disc 2, a slipper 4 mounted
radially movable in the guides 3 executed on the case
1, and having installed therein the radial rolling
bearing 5 having inner and outer rings 6 and 7. The
slipper is connected to brake system control body 8.
Flexible componentry 9, e.g. springs are installed
between one bearing ring 6 and disc 2; at that, one end
of flexible componentry 9 is hingedly connected to
the disc, and another end is in contact therewith or
detached bearing inner ring 6 inner surface with
motion gap.

Claims: 1 independent

Fig.: 2

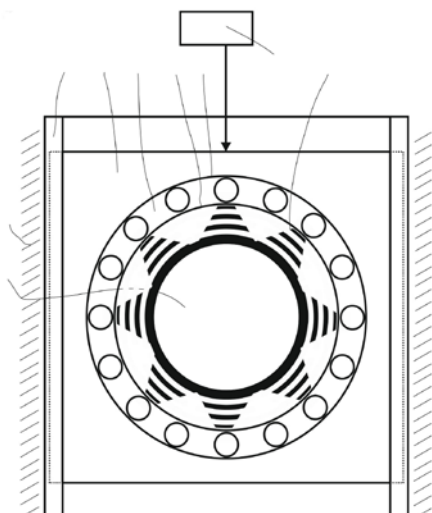

Fig. 1

PART C

C 07

- (10) AP 2021 14450 A (51) Int. Cl. (2006)
 C 07 K 16/28
 A 61 K 39/395
 A 61 P 37/02
 A 61 K 39/00
- (21) AP 2015 14450 (22) 2015 08 17
 (31) 62/126,733; 62/038,912
 (32) 2015 03 02; 2014 08 19
 (33) US; US
 (71) MERCK SHARP & DOHME CORP. (US)
 126 EastLincoln Ave, Rahway, NJ 07065 – 0907
 (US)
 (72) WILLIAMS, Sybil, M. G. (US);
 LAFACE, Drake (US);
 FAYADAT-DILMAN, Laurence (US);
 RAGHUNATHAN, Gopalan (US);
 LIANG, Linda (US);
 SEGHEZZI, Wolfgang (DE)
- (74) Shalva Gvaramadze
 (85) 2017 03 15
 (86) PCT/US2015/045447, 2015 08 17
 (54) ANTI-TIGIT ANTIBODIES
 (57) Present invention relates to humanized mono-
 clonic anti-TIGIT antibodies and usage therefor
 cancer treatment.
 Claims: 11 independents
 18 dependents
 Fig.: 17

PATENTED INVENTIONS**PART F****F 16**

- (11) P 2021 7277 B (51) Int. Cl. (2006)
F 16 L 37/00
F 16 L 17/00
- (10) AP 2021 15200 A (44) 5(561)/2021
(21) AP 2018 15200
(22) 2018 03 20
(24) 2018 03 20
(31) 201711009888
(32) 2017 03 21
(33) IN
(86) PCT/IB2018/051843, 2018 03 20
(73) JINDAL SAW LTD (IN)
Jindal Centre 12, Bhikhaji Cama Place,
New Delhi, 110066, India (IN)
- (72) SHRIVASTAVA, Anurag (IN);
RAJASEKARAN, V. (IN);
BOSE, Partha (IN);
SUBRAMONIAN, K. (IN)
- (74) Tamaz Shilakadze
(54) POSITIVE LOCK SYSTEM FOR
RESTRAINED JOINTS OF DUCTILE
IRON SPUN PIPES AND FITTINGS
-

PART H**H 01**

- (11) P 2021 7278 B (51) Int. Cl. (2006)
H 01 H 73/00
H 02 H 9/04
- (10) AP 2021 15264 A (44) 2(558)/2021
(21) AP 2018 15264
(22) 2018 06 27
(24) 2018 06 27
(31) 2017123107
(32) 2017 06 29
(33) RU
(86) PCT/RU2018/050066, 2018 06 27
(73) OOO "Svel-Silovye Transformatory" (RU)
Ul. Chernyahovskogo 61, 620010, Ekaterinburg,
Russian Federation (RU)
- (72) TOKAREV, Aleksey Anatolyevich (RU);
LAVROV, Ivan Pavlovich (RU);
MARCHENKO, Igor Nikolaevich (RU)
- (74) Aleksandre Gegechkori
(54) SAFETY DEVICE
-

DESIGNS

APPLICATIONS APPROVED FOR REGISTRATION

The decision can be appealed at the Chamber of Appeal of Sakpatenti within 3 months from the publication or at the Mtskheta District Court Administrative Cases Board (Address: №17, Samkhedro str., Mtskheta), within 1 month following the publication.

- (10) AD 2021 1208 S (51) 06-13
- (21) AD 2021 1208 (22) 2021 03 18
- (28) 1
- (71) Teimuraz Pachechyan (GE)
Bodbe Line 6, app. 6, 0144, Tbilisi, Georgia (GE);
Roman Darchiashvili (GE)
Dighomi, II qu., corp 8b, app. 30, 0159, Tbilisi, Georgia (GE)
- (72) Teimuraz Pachechyan (GE);
Roman Darchiashvili (GE)
- (54) GEORGIAN TABLECLOTH
- (55)



1.1

- (10) AD 2021 1206 S (51) 09-01
(21) AD 2021 1206 (22) 2021 02 18
(28) 3
(71) Giorgi Zautashvili (GE)
D. Tavdadebuli St. 3, 4800, Kvareli, Georgia (GE)
(72) Giorgi Zautashvili (GE)
(74) Giorgi Kartvelishvili (GE)
(54) 1.-3. BOTTLE
(55)

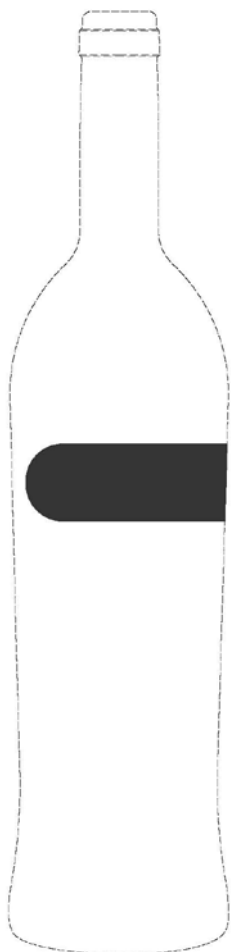

1.1

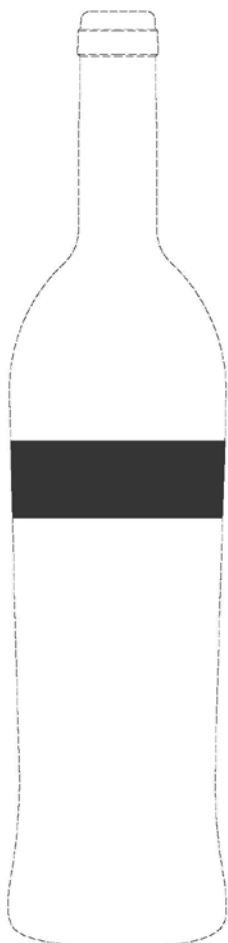

1.2



1.3



1.4



2.1

2.2

2.3

2.4



3.1

3.2

3.3

3.4

(10) AD 2021 1210 S (51) 09-01
(21) AD 2021 1210 (22) 2021 03 20
(28) 1
(71) Giorgi Zautashvili (GE)
D. Tavdadebuli St. 3, 4800, Kvareli, Georgia (GE)
(72) Giorgi Zautashvili (GE)
(74) Giorgi Kartvelishvili (GE)
(54) 1.-3. BOTTLE
(55)



DESIGN REGISTERED ACCORDING TO THE ACCELERATED PROCEDURE

The decision can be appealed at the Chamber of Appeal of Sakpatenti within 3 months from the publication.

(11) D 2021 899 S (51) 25-03
(21) AD 2021 1220 (22) 2021 06 09
(24) 2021 06 09
(28) 1
(18) 2026 06 09
(73) Uta Zedgenidze (GE)
 Inola Gurgulia St. 3, 0179, Tbilisi, Georgia (GE)
(72) Uta Zedgenidze (GE)
(54) SPORTIVE COVERING
(55)

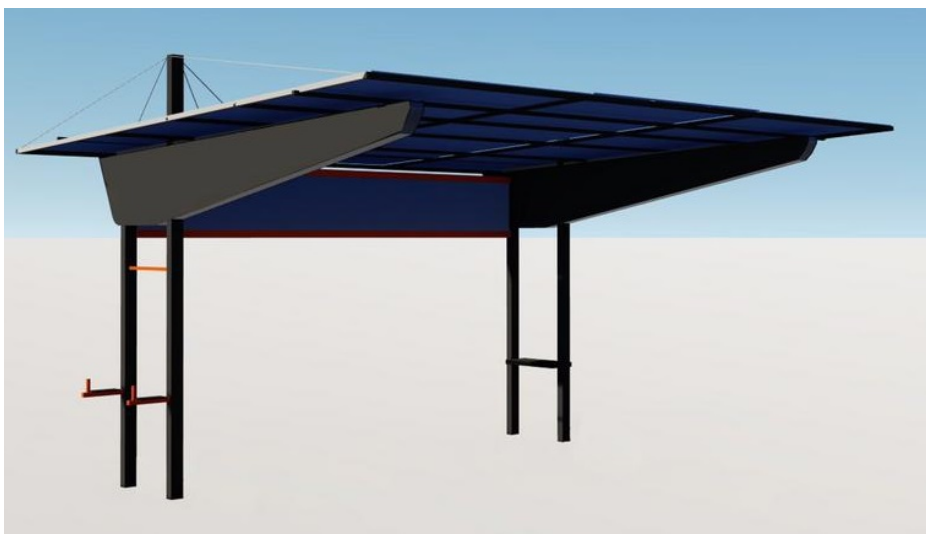

1.1

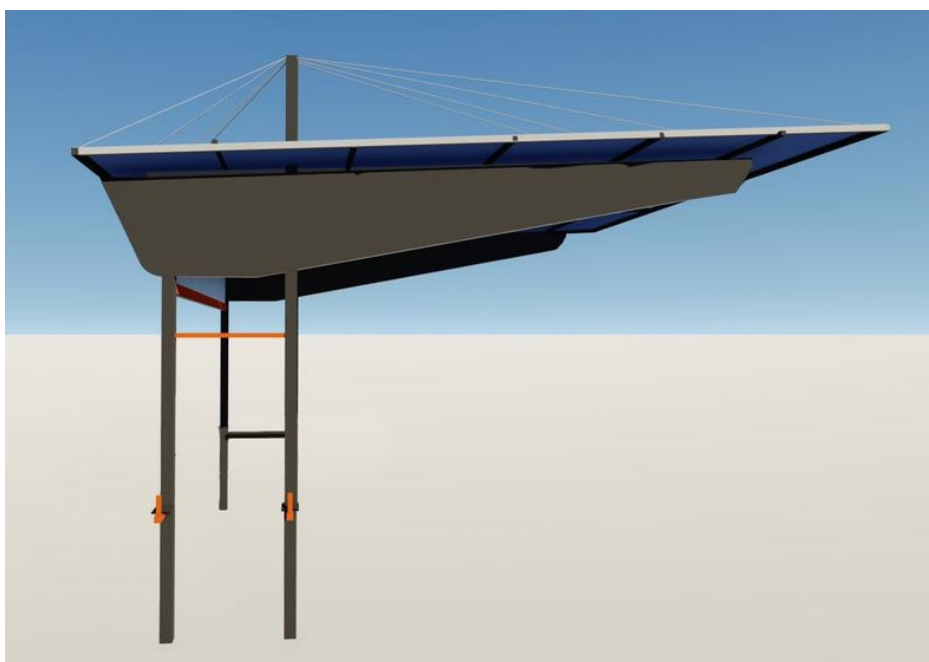

1.2

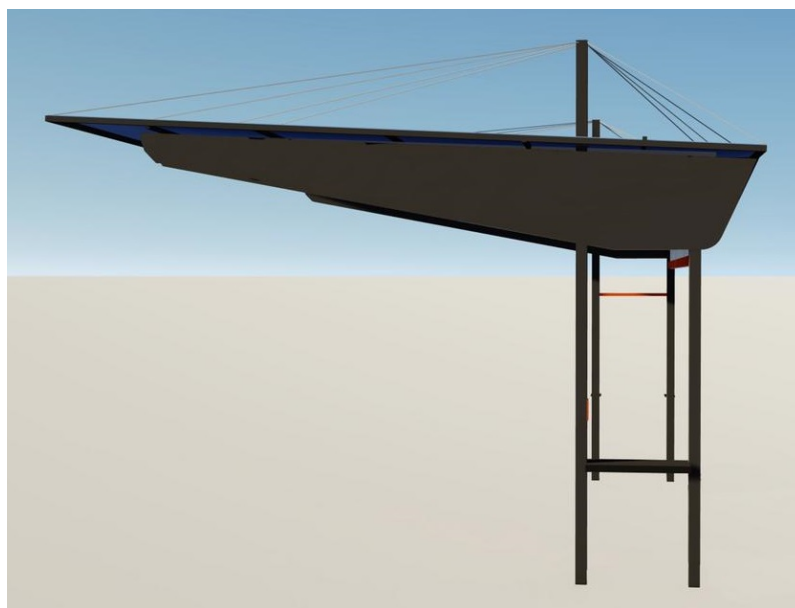
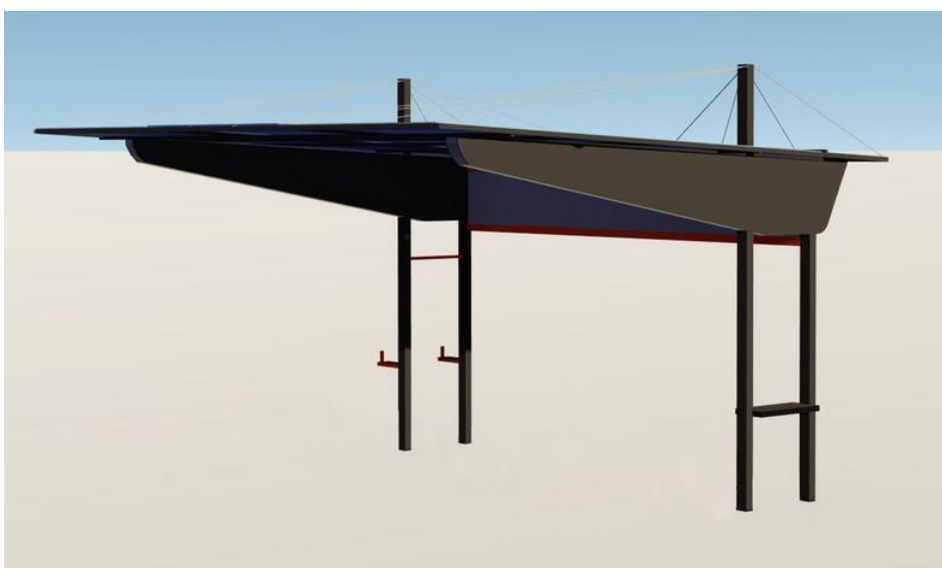
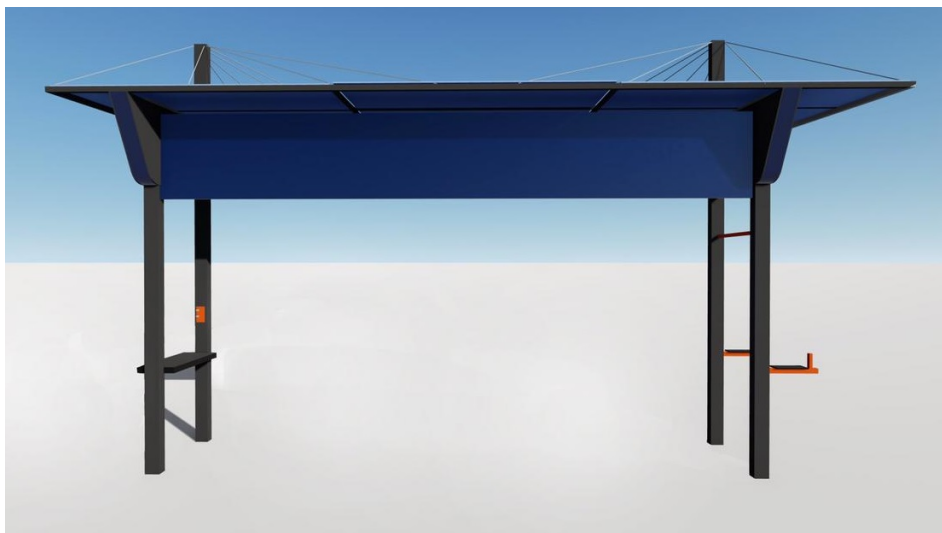



1.6

DESIGNS, WHICH HAVE BEEN REGISTERED WITH THE INTERNATIONAL BUREAU CLAIMING PRIORITY ON THE TERRITORY OF GEORGIA

The decision can be appealed at the Chamber of Appeal of Sakpatenti within 3 months from the publication or at the Mtskheta District Court Administrative Cases Board (Address: №17, Samkhedro Str., Mtskheta), within 1 month following the publication.

- (11) DM/213 990 (51) 02-02
 (15) 2020 03 18 (44) 18/2021 (2021 05 07)
 (22) 2020 03 18
 (28) 16
 (30) No1: 18.09.2019; 2019503996; RU; No2: 18.09.2019; 2019503996; RU; No3: 18.09.2019; 2019503996; RU; No4: 18.09.2019; 2019503996; RU; No5: 18.09.2019; 2019503996; RU; No6: 18.09.2019; 2019503996; RU; No7: 18.09.2019; 2019503996; RU; No8: 18.09.2019; 2019503996; RU; No9: 18.09.2019; 2019503996; RU; No10: 18.09.2019; 2019503996; RU; No11: 18.09.2019; 2019503996; RU; No12: 18.09.2019; 2019503996; RU; No13: 18.09.2019; 2019503996; RU; No14: 18.09.2019; 2019503996; RU; No15: 18.09.2019; 2019503996; RU; No16: 18.09.2019; 2019503996; RU
 (73) Public Joint Stock Company "Oil Company "LUKOIL"
 Sretensky Boulevard, 11, RU-101000 Moscow (RU)
 (85) –
 (86) –
 (87) –
 (88) RU
 (89) RU
 (81) III. MK, GE, TR, RS, MD, EM, ME, AZ
 (72) Yuliya Viktorovna Martynova
 Ul. Zavodskaya, D. 24, Kv. 15, RU-194356, Saint Petersburg (RU);
 Olesya Nikolaevna Savonicheva
 Ul. Marinesco, D. 1, Kv. 58, RU-198096, Saint Petersburg (RU);
 Nadezhda Leonidovna Kapitonova
 Ul. Lensoveta, D. 4, Kv. 44, RU-196135, Saint Petersburg (RU);
 Irina Vladimirovna Nikolaeva
 Ul. Kirochnaya, D. 23, Kv. 30, RU-191123, Saint Petersburg (RU)
 (74) Alexey Tuleninov
 P.O. Box 64, 129327 Moscow (RU)
 (54) 10. Uniform for staff of petrol stations, 11. Uniform for staff of petrol stations,
 12. Uniform for staff of petrol stations, 13. Uniform for staff of petrol stations,
 14. Uniform for staff of petrol stations, 15. Uniform for staff of petrol stations,
 16. Uniform for staff of petrol stations, 1. Uniform for staff of petrol stations,
 2. Uniform for staff of petrol stations, 3. Uniform for staff of petrol stations,
 4. Uniform for staff of petrol stations, 5. Uniform for staff of petrol stations,
 6. Uniform for staff of petrol stations, 7. Uniform for staff of petrol stations,
 8. Uniform for staff of petrol stations, 9. Uniform for staff of petrol stations
 (55)



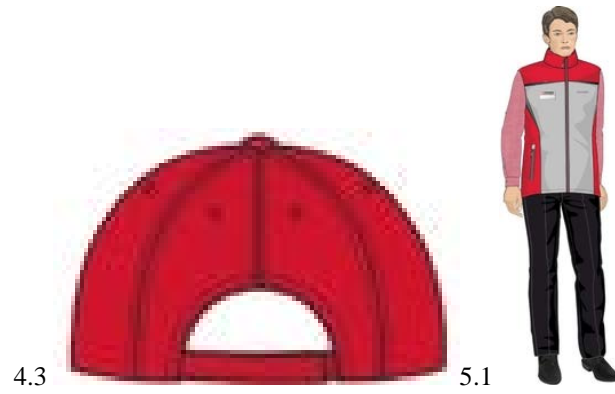

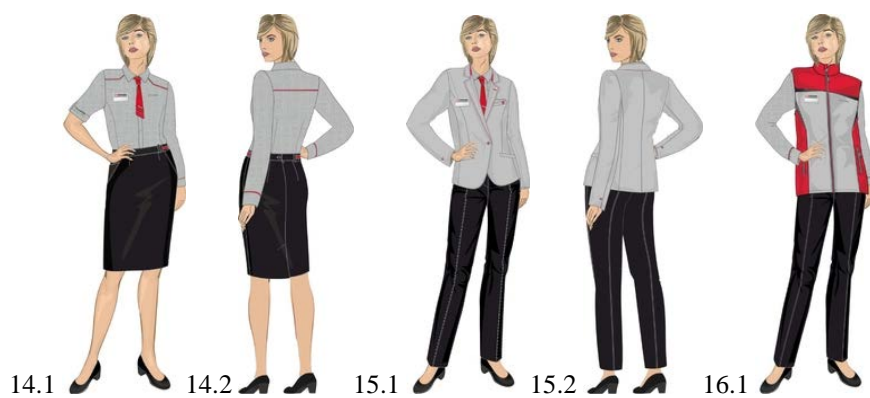

- (11) DM/211 165 (51) 11-01
 (15) 2020 11 04 (44) 18/2021 (2021 05 07)
 (22) 2020 11 04
 (28) 6
 (73) HARRY WINSTON SA
 Chemin Du Tourbillon 8, 1228 Plan-les-Ouates (CH)
 (85) CH
 (86) CH
 (87) CH
 (88) CH
 (89) CH
 (81) IL, MA III, KG, LI, MK, OM, GE, TR, CA, BA, MN, NO, CH, EM, AL, AM, UA, SG, MC, MD, ME, BZ,
 AZ, TN, GB
 (72) 1; 3; 6 Rie YATSUGI-KANG
 C/o Harry Winston Inc., 718 Fifth Avenue, 10019, New York, NY (US);
 2;4 Dominique RIVIERE
 C/o Harry Winston Inc., 718 Fifth Avenue, 10019, New York, NY (US);
 5 Tobias WUEST
 C/o Harry Winston Inc., 718 Fifth Avenue, 10019, New York, NY (US)
 (74) The Swatch Group AG (The Swatch Group SA) (The Swatch Group Ltd.)
 Faubourg Du Lac 6, 2501 Biel/Bienne (CH)
 (54) 1. Bracelet, 2.-6. Finger ring
 (55)





1.8



2.1



2.2



2.3



2.4



2.5



2.6



2.7



2.8



3.1



3.2



3.3



3.4



3.5



3.6



3.7



6.2



6.3



6.4



6.5



6.6



6.7



6.8

- (11) DM/211 318 (51) 11-01
 (15) 2020 11 06 (44) 18/2021 (2021 05 07)
 (22) 2020 11 06
 (28) 4
 (73) HARRY WINSTON SA
 Chemin Du Tourbillon 8, 1228 Plan-les-Ouates (CH)
 (85) CH
 (86) CH
 (87) CH
 (88) CH
 (89) CH
 (81) IL, MA, III, KG, LI, CA, OM, TR, GE, MK, BA, NO, MN, CH, EM, AL, UA, AM, SG, MC, MD, ME, BZ, AZ, TN, GB
 (72) 1; 4 Rie YATSUGI-KANG
 C/o Harry Winston Inc. 718 Fifth Avenue, 10019, New York (US);
 2. Delphine ABDOURAHIM
 C/o Harry Winston Inc. 718 Fifth Avenue, 10019, New York (US);
 3. Dominique RIVIERE
 C/o Harry Winston Inc. 718 Fifth Avenue, 10019, New York (US)
 (74) The Swatch Group AG (The Swatch Group SA) (The Swatch Group Ltd.)
 Faubourg Du Lac 6, 2501 Biel/Bienne (CH)
 (54) 1. Finger ring, 2. Pair of earrings, 3. Tiara, 4. Finger ring
 (55)

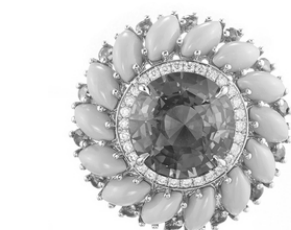

1.1



1.2



1.3



1.4



1.5



1.6



1.7



1.8



2.1



2.2



2.3



2.4



2.5



2.6



2.7



2.7



2.8



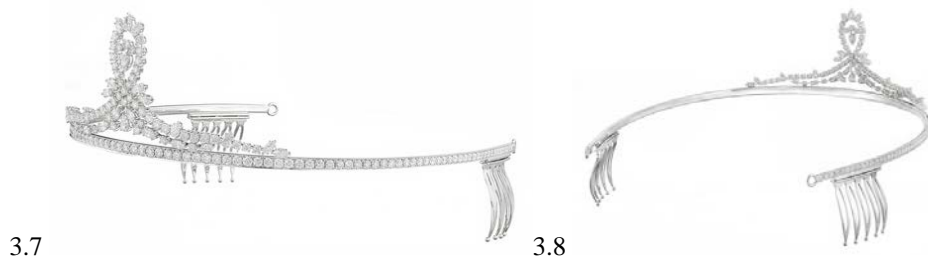

- (11) DM/211 498 (51) 11-01
 (15) 2020 11 27 (44) 21/2021 (2021 05 28)
 (22) 2020 11 27
 (28) 10
 (73) HARRY WINSTON SA
 Chemin Du Tourbillon 8, 1228 Plan-les-Ouates (CH)
 (85) CH
 (86) CH
 (87) CH
 (88) CH
 (89) CH
 (81) IL, MA, III, AL, AM, AZ, BA, BZ, CA, CH, EM, GB, GE, KG, LI, MC, MD, ME, MK, MN, NO, OM, SG,
 TN, TR, UA
 (72) 1; 8-9 Tobias WUEST
 C/o Harry Winston Inc., 718 Fifth Avenue, 10019, New York, NY (US);
 2-4; 10 Rie YATSUGI-KANG
 C/o Harry Winston Inc., 718 Fifth Avenue, 10019, New York, NY (US);
 5-6; Dominique RIVIERE
 C/o Harry Winston Inc., 718 Fifth Avenue, 10019, New York, NY (US);
 7 7: Delphine ABDOURAHIM
 C/o Harry Winston Inc. 718 Fifth Avenue, 10019, New York, NY (US)
 (74) The Swatch Group AG (The Swatch Group SA) (The Swatch Group Ltd.)
 Faubourg Du Lac 6, 2501 Biel/Bienne (CH)
 (54) 1.-2. Finger ring, 3.-4. Necklace, 5. Finger ring, 6. Pair of earrings, 7. Necklace, 8. Finger ring,
 9.-10. Pair of earrings
 (55)



1.1



1.2



1.3



1.4



1.5



1.6



1.7



1.8



2.1



2.2



2.3



2.4



2.5



2.6



2.7



2.8



3.1



3.2



3.3

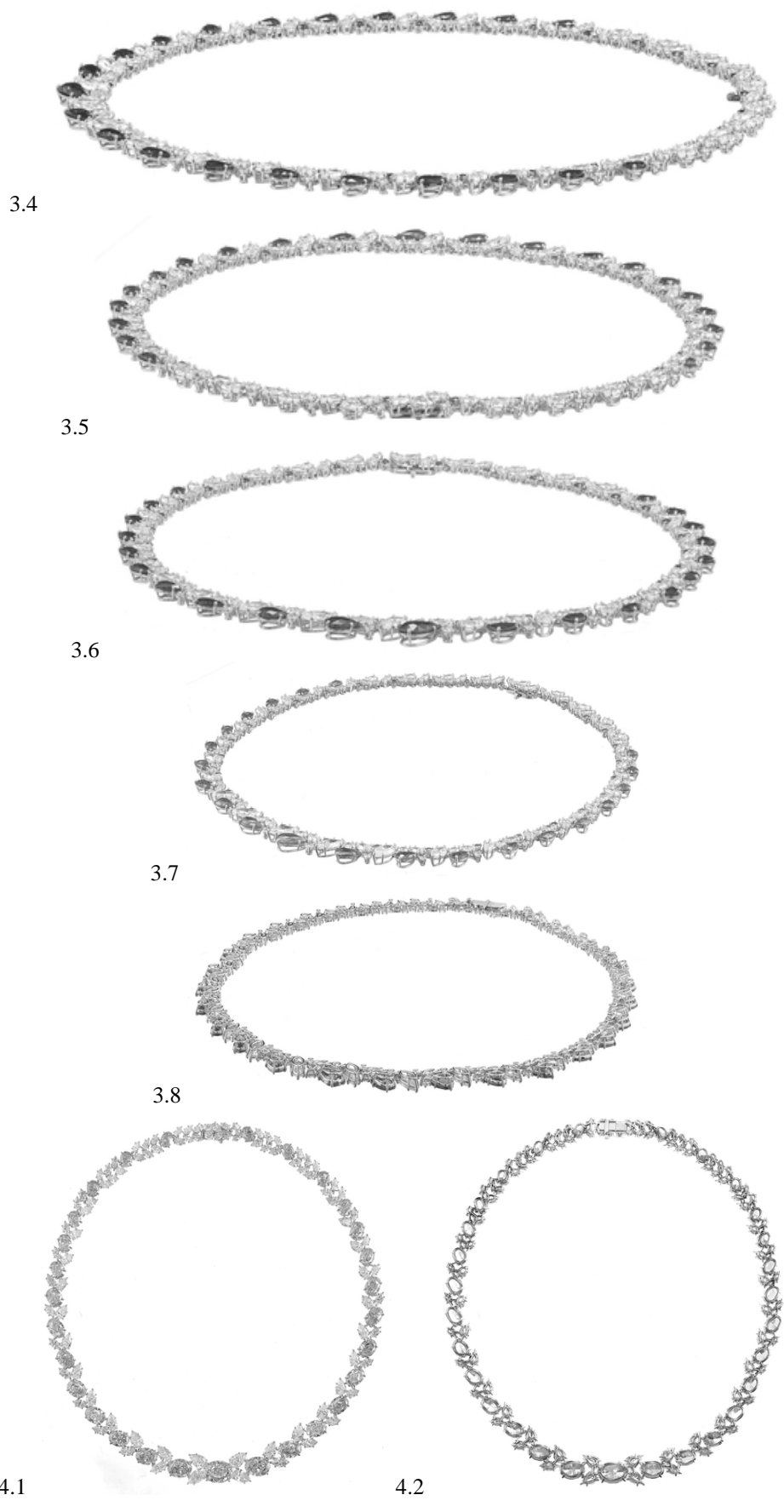



4.3



4.4



4.5



4.6



4.7



4.8



5.1



5.2



5.3



5.4



5.5



5.6



5.7



5.8



6.1



6.2



6.3



6.4



6.5



6.6



6.7



6.8







7.6



7.7



7.8

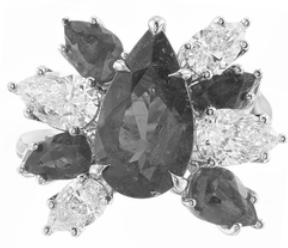

8.1



8.2



8.3



8.4



8.5



8.6



8.7



8.8



9.1



9.2



9.3



9.4



9.5



9.6



9.7



9.8



10.1



10.2

10.3



10.4

10.5



10.6

10.7



10.8

- (11) DM/214 355 (51) 14-04
- (15) 2020 03 12 (44) 22/2021 (2021 06 04)
- (22) 2020 03 12
- (28) 2
- (30) No1: 12.09.2019; 62/899,605; US; No2: 12.09.2019; 62/899,605; US
- (73) Biosense Webster (Israel) Ltd.
4 Hatnufa Street, 2066717 Yokneam (IL)
- (85) –
- (86) US
- (87) US
- (88) US
- (89) US
- (81) III. AL, AM, AZ, BA, BG, BN, BW, BX, BZ, CA, CH, DE, DK, EE, EG, EM, ES, FI, FR, GB, GE, GH, HR, HU, IL, IS, JP, KG, KH, KP, KR, LI, LT, LV, MC, MD, ME, MK, MN, NA, NO, OA, OM, PL, RO, RS, RU, RW, SG, SI, SM, ST, SY, TJ, TM, TN, TR, UA, VN, WS
- (72) Eid Adawi
P.O. Box 275, 4 Hatnufa Street, 2066717, Yokneam (IL);
Avigdor Rosenberg
P.O. Box 275, 4 Hatnufa Street, 2066717, Yokneam (IL)
- (74) Volpe And Koenig, P.C.
Norton Todd A., 30 S. 17th Street, 18th Floor, 19103 Philadlephia (US)
- (54) 1. Animated graphical user interface for a display screen or portion thereof, 2. Display screen with animated graphical user interface
- (55)

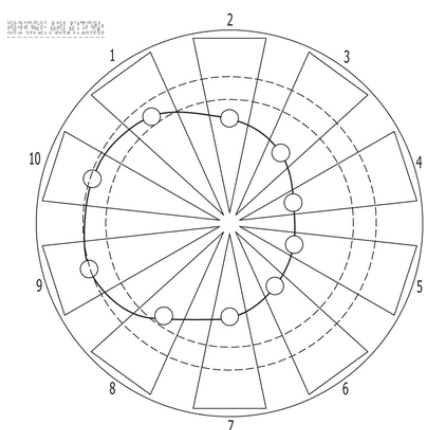

1.1

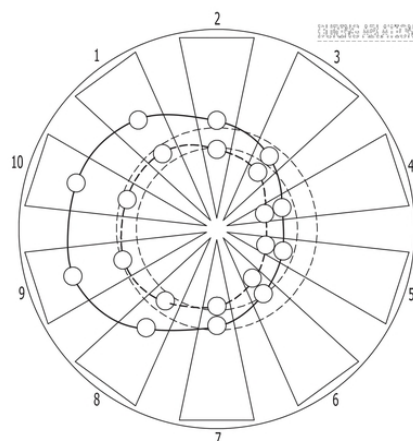

1.2

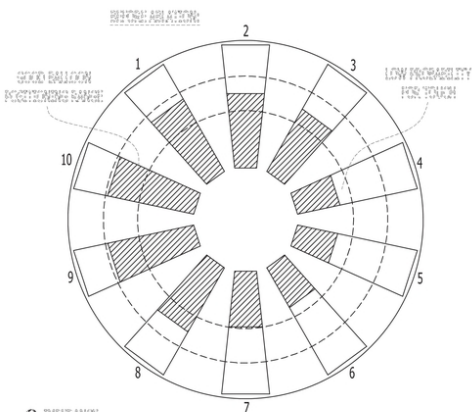

1.3

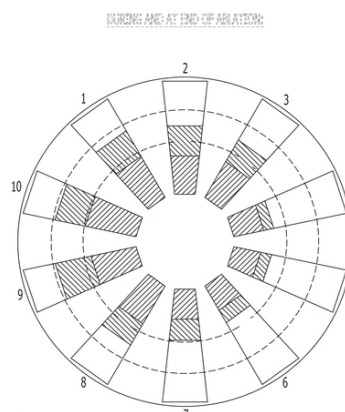

1.4

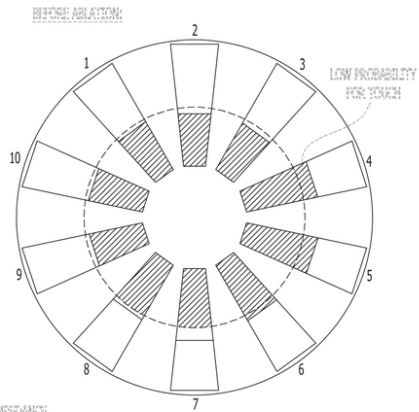

1.5 ○ IMPEDANCE
● TEMPERATURE

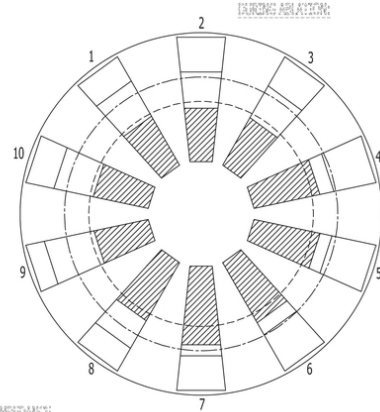

1.6 ○ IMPEDANCE
● TEMPERATURE

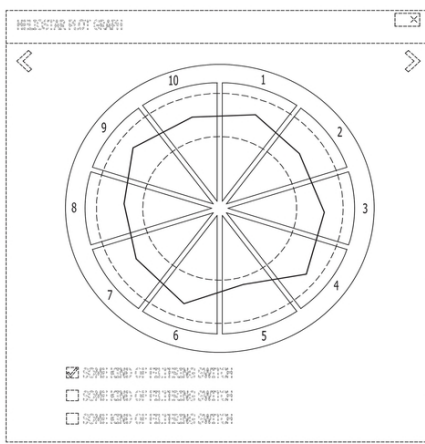

2.1

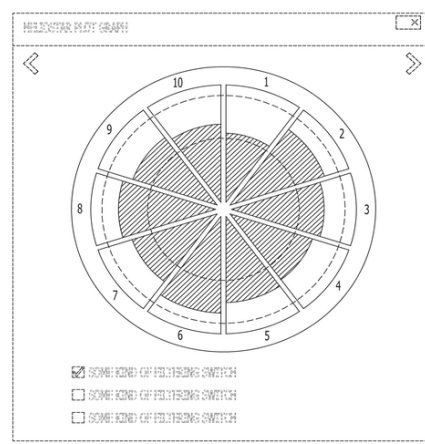

2.2

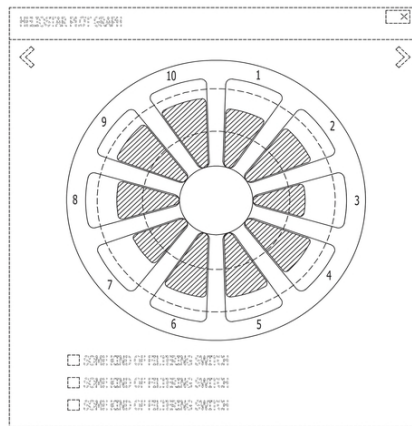

2.3

TRADEMARKS

APPLICATIONS FILED UNDER THE NATIONAL PROCEDURE APPROVED FOR REGISTRATION

The decision can be appealed at the Chamber of Appeal of Sakpatenti within 3 months from the publication or at the Mtskheta District Court Administrative Cases Board (Address: №17, Samkhedro St., Mtskheta), within 1 month following the publication.

(260) AM 2021 105975 A
(210) AM 105975
(220) 2020 09 29
(731) LLC "Tchrebalo Cellar"
Chrebalo, 0418, Ambrolauri Municipality,
Georgia
(540)



(591) Black-white
(531) 25.01.19; 25.07.25
(526) "ჭრებალო", "Tchrebalo", "ჭაჭა",
"CHACHA"
(511) 33, 35

(260) AM 2021 106956 A*
(210) AM 106956
(220) 2020 02 06
(731) LLC "ArtPharma"
Gamrekeli St. 19 (512), 0160, Tbilisi,
Georgia
(740) Giorgi Taktakishvili
(540)

ვიტაფეროლი D3 სპრეი
Витаферол D3 спрей
Vitaferol D3 spray

(591) Black-white
(511) 5

(260) AM 2021 106957 A*
(210) AM 106957
(220) 2020 02 06
(731) LLC "ArtPharma"
Gamrekeli St. 19 (512), 0160, Tbilisi,
Georgia
(740) Giorgi Taktakishvili
(540)

ვიტაფეროლი მეგა D3
Витаферол Мега D3
Vitaferol Mega D3

(591) Black-white
(511) 5

(260) AM 2021 107479 A*
(210) AM 107479
(220) 2020 03 09
(731) Archil Maziashvili
Il. Chavchavadze Av. 78, corp. 6, app. 6,
Tbilisi, Georgia
(540)



(591) White, golden, grey
(531) 02.03.01; 27.05.01; 27.05.19; 29.01.12
(511) 32, 33

(260) AM 2021 108206 A
(210) AM 108206
(220) 2020 11 27
(731) Bekar Mikaberidze
Ingorokva St. 26, 0108, Tbilisi,
Georgia
(740) Bekar Mikaberidze

(540)



(591) Grey, black, white
 (531) 02.03.16; 02.03.23; 05.03.17; 05.03.20;
 26.01.14; 26.01.15; 28.19; 29.01.13
 (511) 3, 35

(260) AM 2021 109019 A*
 (210) AM 109019
 (220) 2020 07 10
 (731) Pediatrica Specialist S.r.l.
 Via Nicolodi 28/A, 57121 Livorno (LI), Italy
 (740) Giorgi Taktakishvili
 (540)

Pedia Milk



(591) Grey, black, white
 (531) 02.09.15; 04.05.02; 04.05.05
 (511) 5

(260) AM 2021 110447 A
 (210) AM 110447
 (220) 2020 11 06
 (731) Gizo Akhvlediani
 Zghvisubani Settlement, III mcr., III qu.,
 corp. 45, app. 45 (Forever Temka
 Settlement, III mcr., III qu.), Tbilisi,
 Georgia
 (740) Natia Gogadze
 (540)



(591) Black-white

(531) 03.04.07; 05.03.19; 05.07.10; 27.05.01;
 27.05.05

(526) "Akriani", "აკრიანი"
 (511) 33, 35

(260) AM 2021 110448 A
 (210) AM 110448
 (220) 2020 11 06
 (731) Gizo Akhvlediani
 Zghvisubani Settlement, III mcr., III qu.,
 corp. 45, app. 45 (Forever Temka
 Settlement, III mcr., III qu.), Tbilisi,
 Georgia

(740) Natia Gogadze

(540)



(591) Black, dark yellow
 (531) 03.04.07; 03.04.13; 03.04.24; 05.03.19;
 05.07.10; 27.05.01; 27.05.05; 29.01.12

(526) "Akriani", "აკრიანი"
 (511) 33, 35

(260) AM 2021 110675 A
 (210) AM 110675
 (220) 2020 11 28
 (731) Shenzhen Relx Technology Co., Ltd
 B402, Boton Technology Park, No.1044
 Chaguang Road, Shuguang Community, Xi Li
 Sub-District, Nan Shan District, Shenzhen
 City, China
 (740) Giorgi Kartvelishvili
 (540)

RELX

(591) Black-white
 (531) 27.05.01; 27.05.17
 (511) 34

(260) AM 2021 110684 A
 (210) AM 110684
 (220) 2020 12 01
 (310) UK00003497528
 (320) 2020 06 05
 (330) UK
 (731) The Coca-Cola Company
 One Coca-Cola Plaza, Atlanta, Georgia
 30313, USA

(740) Giorgi Taktakishvili
(540)

TOPO CHICO

(591) Black-white
(511) 33

(260) AM 2021 110686 A
(210) AM 110686
(220) 2020 12 01
(731) Bayer Aktiengesellschaft
Kaiser-Wilhelm-Allee, 51373 Leverkusen,
Germany
(740) Shalva Gvaramadze
(540)

CAMBALIO

(591) Black-white
(511) 5

(260) AM 2021 110688 A
(210) AM 110688
(220) 2020 12 01
(731) LLC "G-M-P"
Vill. Ponichala 65, 0165, Tbilisi, Georgia
(740) Nugzar Ksovreli
(540)

ბრეილი Брейл Breil

(591) Black-white
(511) 5

(260) AM 2021 110689 A
(210) AM 110689
(220) 2020 12 01
(731) LLC "Georgian Lemonade"
Aleksidze St., I qu., corp. 4, app. 25, 0112,
Tbilisi, Georgia
(540)



(591) Green, white, yellow, brown, black
(531) 05.07.17; 25.01.19; 29.01.14
(511) 32

(260) AM 2021 110694 A
(210) AM 110694
(220) 2020 12 03
(731) Abdi İbrahim İlaç Sanayi ve Ticaret Anonim
Şirketi

Reşitpaşa Mahallesi Eski Büyükdere Caddesi
No: 4 34467 Maslak Sarıyer İstanbul, Turkey

(740) Tamaz Shilakadze
(540)

Coriva

(591) Black-white
(511) 5

(260) AM 2021 110695 A
(210) AM 110695
(220) 2020 12 03
(731) Abdi İbrahim İlaç Sanayi ve Ticaret Anonim
Şirketi
Reşitpaşa Mahallesi Eski Büyükdere Caddesi
No: 4 34467 Maslak Sarıyer İstanbul, Turkey
(740) Tamaz Shilakadze
(540)

კორივა

(591) Black-white
(511) 5

(260) AM 2021 110747 A
(210) AM 110747
(220) 2020 12 06
(731) Greenme SA
Route de Pré-Bois 20, c/o Seges Conseils SA,
1215 Geneva 15 Airport, Switzerland
(740) Pavle Meipariani
(540)

NIRVANA

(591) Black-white
(511) 33

(260) AM 2021 110751 A
(210) AM 110751
(220) 2020 12 07
(731) LTD "Nail Club"
Nearly near Nutsubidze St. 77, Plot 01/216)
/Nutsubidze St. 77, fl. 1, Commercial Area,
Tbilisi, Georgia
(740) Nino Bakhtadze
(540)



(591) Golden, white
(531) 26.04.01; 26.04.18; 27.05.22; 29.01.12
(511) 35, 44

(260) AM 2021 110753 A
 (210) AM 110753
 (220) 2020 12 07
 (731) LTD "Amber Trade"
 Mukhran Machavariani St. 6b, app. 8,
 Saburtalo District, Tbilisi, Georgia
 (540)

Vinoveli
ვინოველი
Виновели

(591) Black-white
 (511) 32, 33, 35

(260) AM 2021 110756 A
 (210) AM 110756
 (220) 2020 12 07
 (731) LTD "Bolero & Company"
 Kuchishvili St. 12-14-16, 0179, Tbilisi,
 Georgia
 (540)

სარბიელი
Sarbieli
Сарбиели

(591) Black-white
 (511) 33

(260) AM 2021 110758 A
 (210) AM 110758
 (220) 2020 12 07
 (731) LTD "Bolero & Company"
 Kuchishvili St. 12-14-16, 0179, Tbilisi,
 Georgia
 (540)

ღვინის რელიგია
Винная религия
Wine religion

(591) Black-white
 (511) 33

(260) AM 2021 110761 A
 (210) AM 110761
 (220) 2020 12 07
 (731) Greenme SA
 Route de Pré-Bois 20, c/o Seges Conseils SA,
 1215 Geneva 15 Airport, Switzerland
 (740) Pavle Meipariani

(540)



(591) Black, white, blue, yellow, grey, red
 (531) 18.03.02; 18.03.03; 18.03.05; 18.03.09;
 24.01.05; 24.01.13; 24.01.19
 (511) 33

(260) AM 2021 110764 A
 (210) AM 110764
 (220) 2020 12 07
 (731) Greenme SA
 Route de Pré-Bois 20, c/o Seges Conseils SA,
 1215 Geneva 15 Airport, Switzerland
 (740) Pavle Meipariani
 (540)

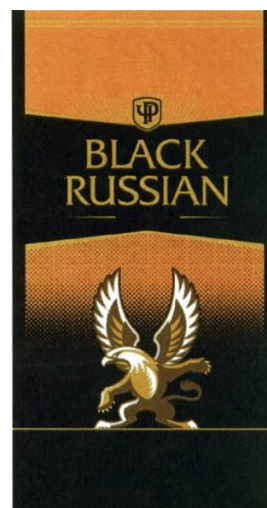

(591) Black, white, yellow, brown, orange,
 beige
 (531) 04.02.05; 04.03.01; 04.03.07; 24.01.15;
 27.05.01; 27.05.22; 27.05.24; 28.05; 29.01.14
 (511) 33

(260) AM 2021 110769 A
 (210) AM 110769
 (220) 2020 12 08
 (731) Otar Bidzinashvili
 Vill. Tibaani, Sighnaghi, Georgia
 (540)

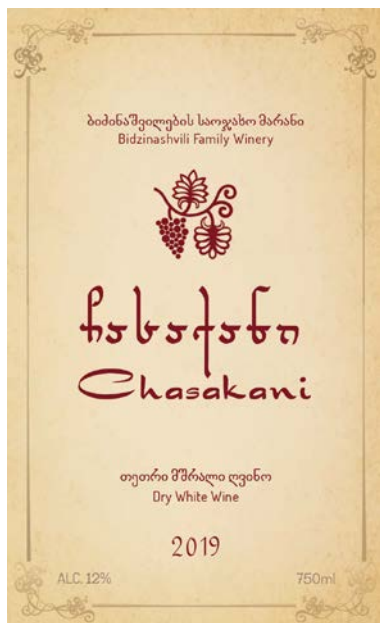

(591) Carnelian, golden
 (531) 05.03.19; 05.07.10; 25.01.05; 25.01.09;
 25.01.10; 25.01.19; 27.05.01; 28.19; 29.01.13
 (511) 33, 43

(260) AM 2021 110780 A
 (210) AM 110780
 (220) 2020 12 09
 (731) LLC "Winery Khareba"
 Davit Aghmashenebeli Alley 170a, 0131,
 Tbilisi Georgia
 (540)



(591) Light pink, morengo, grey, light grey, carnelian,
 dark carnelian, orange, light orange
 (531) 02.01.15; 02.01.18; 02.01.22; 02.01.23;
 03.07.11; 03.07.16; 03.07.24; 07.03.09;
 07.03.25; 07.05.02; 07.05.10; 07.05.25;
 25.01.10; 25.01.19; 28.19; 29.01.15
 (511) 32, 33, 35, 43

(260) AM 2021 110784 A
 (210) AM 110784
 (220) 2020 12 10
 (731) Mariam Dumbadze
 Gldani, VII mcr., corp. 16, app. 89, Tbilisi,
 Georgia

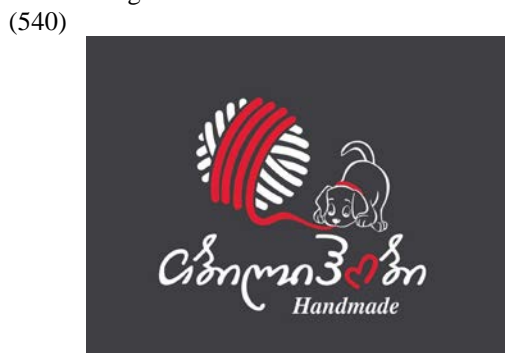

(591) FFFFFF white, E61D35 red, 414042 morengo
 (531) 03.01.08; 09.01.01; 09.01.02; 28.19; 29.01.13
 (511) 24, 25

(260) AM 2021 110790 A
 (210) AM 110790
 (220) 2020 12 10
 (731) Sopio Sioridze
 Didi Dighomi, III mcr., corp. 7, app. 47,
 Tbilisi, Georgia
 (540)

ღვინელ ღვინელი

(591) Black-white
 (511) 33, 43

(260) AM 2021 110858 A
 (210) AM 110858
 (220) 2020 12 11
 (731) LTD "Simba"
 Varketili 3, I mcr., corp. 13, app. 94, Tbilisi,
 Georgia
 (540)

**აურა
 AURA**

(591) Black-white
 (511) 43

(260) AM 2021 110864 A
 (210) AM 110864
 (220) 2020 12 13
 (731) LLC "Deutsche Produkte"
 Marabda St. 34a, 0179, Tbilisi,
 Georgia
 (540)



(591) 383333 black, E02F2F red, FCD602 yellow
 (531) 24.13.05; 27.05.01; 27.05.10; 27.05.22;
 29.01.13
 (511) 35, 44

(260) AM 2021 110866 A
 (210) AM 110866
 (220) 2020 12 13
 (731) LLC "Deutsche Produkte"
 Marabda St. 34a, 0179, Tbilisi,
 Georgia
 (540)



DEUTSCHE PRODUKTE[®]

(591) F7DB07 black, F70707 yellow, 0A0000 red
 (531) 03.07.01; 03.07.02; 03.07.24; 24.13.01;
 24.13.05; 24.13.24; 29.01.13
 (511) 35, 44

(260) AM 2021 110867 A
 (210) AM 110867
 (220) 2020 12 13
 (731) LLC "Deutsche Produkte"
 Marabda St. 34a, 0179, Tbilisi,
 Georgia
 (540)

Drogeria
დროგერია

(591) 020000 black-white
 (511) 35, 44

(260) AM 2021 110942 A
 (210) AM 110942
 (220) 2020 12 19
 (731) China Tobacco Zhejiang Industrial Co., Ltd
 No.77 Zhongshan Nan Road, Hangzhou City,
 Zhejiang Province, China
 (740) Giorgi Meipariani

(540)

MD

(591) Black-white
 (531) 27.05.22
 (511) 34

(260) AM 2021 110950 A
 (210) AM 110950
 (220) 2020 12 22
 (731) LTD "Lermont"
 Lermontov St. 10, 0105, Tbilisi, Georgia
 (540)



(591) 000000 black, FCF9F9 white, 9E2D04 copper
 (531) 01.15.05; 01.15.11; 05.09.14; 13.03.01;
 13.03.02; 13.03.03; 13.03.07; 13.03.09; 28.19;
 29.01.12
 (511) 43

(260) AM 2021 110951 A
 (210) AM 110951
 (220) 2020 12 22
 (731) LTD "Lermont"
 Lermontov St. 10, 0105, Tbilisi, Georgia
 (540)



(591) FFFFFFFF black-white
 (531) 26.01.01; 26.01.03; 28.19
 (511) 43

(260) AM 2021 110953 A
 (210) AM 110953
 (220) 2020 12 22
 (731) LTD "Krinti"
 Madneuli St. 10, Kazreti, Bolnisi, Georgia
 (540)

CAVU

(591) Blue, red, white
 (531) 26.11.08; 27.05.01; 27.05.11; 29.01.12
 (511) 2, 8

(260) AM 2021 110962 A
 (210) AM 110962
 (220) 2020 12 22
 (731) LTD "Omo Systems"
 Griva Digeni, 80, Swepko Court 6,
 Limassol, 31016, Cyprus
 (740) Sopio Ordinidze
 (540)

OMO

(591) 070202 black-white
 (531) 27.07.01; 27.07.17
 (511) 9, 42

(260) AM 2021 110964 A
 (210) AM 110964
 (220) 2020 12 22
 (731) LTD "Kartveli"
 Kakheti Highway 110a, 0151,
 Tbilisi, Georgia
 (740) Davit Dzamukashvili
 (540)

Aramianz
արամյանց
Арамянц

(591) Black-white
 (531) 27.05.01; 28.05; 28.19
 (511) 33

(260) AM 2021 110966 A
 (210) AM 110966
 (220) 2020 12 23
 (731) Giorgi Chrelashvili
 Vill. Abooshik, Dedoplistskaro Region,
 Georgia
 (740) Shalva Gvaramadze
 (540)



(591) Black-white, green
 (531) 03.04.18; 26.01.01; 26.01.15; 27.01.12;
 27.05.01; 27.05.24; 28.19; 29.01.13
 (511) 29

(260) AM 2021 110971 A
 (210) AM 110971
 (220) 2020 12 23
 (731) JSC "Biopharm"
 Gotua St. 3, 0160, Tbilisi, Georgia
 (740) Giorgi Taktakishvili
 (540)

ნეირობლოკი
Neuroblock
Нейроблок

(591) Black-white
 (511) 5

(260) AM 2021 110978 A
 (210) AM 110978
 (220) 2020 12 24
 (731) Naqel Company
 P.O. Box 6164, Riyadh 11442, Saudi Arabia
 (740) Merab Kvimsadze
 (540)



(591) Blue, red, white
 (531) 26.04.05; 27.05.01; 27.05.09; 27.05.10;
 29.01.12
 (526) "EXPRESS"
 (511) 39

(260) AM 2021 111064 A
 (210) AM 111064
 (220) 2020 12 26
 (731) LTD "Nali"
 Al. Meskhishvili St., corp. 11, app. 81, 3700,
 Rustavi, Georgia
 (540)

NALI

(591) Black-white
 (511) 43

(260) AM 2021 111074 A
 (210) AM 111074
 (220) 2020 12 28
 (731) Ioseb Kelenjeridze
 Tsintsadze St. 26, app. 18-4, 1804, Tbilisi,
 Georgia

(540)



(591) White, sky-blue, black

(531) 26.01.01; 26.01.03; 26.11.03; 26.11.12;
26.15.01; 27.05.01; 29.01.12

(511) 16

(260) AM 2021 111280 A

(210) AM 111280

(220) 2021 01 13

(731) LLC "My.Ge"

Shalva Nutsubidze St. 129 A, fl. 4, 0186,
Tbilisi, Georgia

(740) Giorgi Ghvinjilia

(540)



(591) 000000 black, FFFFFFF white, ED2F5 red

(531) 25.03.01; 25.03.03; 27.05.01; 27.05.10;
27.05.23; 29.01.13

(511) 16, 18, 24, 35

(260) AM 2021 111281 A

(210) AM 111281

(220) 2021 01 13

(731) LLC "My.Ge"

Shalva Nutsubidze St. 129 A, fl. 4, 0186,
Tbilisi, Georgia

(740) Giorgi Ghvinjilia

(540)

(591) 000000 black, FFFFFFF white, ED6355 light
brown(531) 25.03.01; 25.03.03; 27.05.10; 27.05.17;
27.05.23; 29.01.13

(511) 35, 36, 39, 41, 42, 43

REGISTERED TRADEMARKS

(111) M 2021 34292 R
(151) 2021 07 14
(181) 2031 07 14
(260) AM 2020 108484 A
(220) 2020 05 29
(732) Irine Egadze
N. Zhvania St. 10, Tbilisi, Georgia

(111) M 2021 34293 R
(151) 2021 07 14
(181) 2031 07 14
(260) AM 2020 108496 A
(220) 2020 06 01
(732) Hyatt International Corporation
150 North Riverside Plaza, 14th Floor,
Chicago, IL 60606, USA

(111) M 2021 34294 R
(151) 2021 07 14
(181) 2031 07 14
(260) AM 2020 108497 A
(220) 2020 06 01
(732) Hyatt International Corporation
150 North Riverside Plaza, 14th Floor,
Chicago, IL 60606, USA

(111) M 2021 34295 R
(151) 2021 07 14
(181) 2031 07 14
(260) AM 2020 108522 A
(220) 2020 06 04
(732) Aleksandr Levakov
N. Kipshidze St. 3b, app. 82, 0162, Tbilisi,
Georgia

(111) M 2021 34296 R
(151) 2021 07 14
(181) 2031 07 14
(260) AM 2020 108685 A
(220) 2020 06 17
(732) Affinity Petcare S.A.
Plaza Europa, 54-56, 08902
L'hospitalet DE Llobregat,
Barcelona, Spain

(111) M 2021 34297 R
(151) 2021 07 14
(181) 2031 07 14
(260) AM 2020 108749 A
(220) 2020 06 23
(732) LTD "Arson Technology"

Tsabadze St. 8b, cor. 2, Shop 3, 0112,
Didube District, Tbilisi, Georgia

(111) M 2021 34298 R
(151) 2021 07 14
(181) 2031 07 14
(260) AM 2020 108780 A
(220) 2020 06 25
(732) Chery Commercial Vehicle (Anhui) Co., Ltd.
8th Building, Science and Technology
Industrial Park, No.717 Zhongshan Road
(South), Yijiang Area, Wuhu City, Anhui
Province, China

(111) M 2021 34299 R
(151) 2021 07 14
(181) 2031 07 14
(260) AM 2020 108955 A
(220) 2020 07 08
(732) PT. Bukit Perak
JL. Raya Semarang Kendal km 10.5,
Semarang 50153, Indonesia

(111) M 2021 34300 R
(151) 2021 07 14
(181) 2031 07 14
(260) AM 2020 109006 A
(220) 2020 07 10
(732) Shenzhen Nito Power Source
Technology Co., Ltd
201, №8 Building, №49 Wuhenan Rd.,
Jinfanghua Electricity Industrial Park,
Bantian St., Longgang District, Shenzhen, China

(111) M 2021 34301 R
(151) 2021 07 14
(181) 2031 07 14
(260) AM 2020 109010 A
(220) 2020 07 10
(732) AstraZeneca AB
SE-151 85 Södertälje, Sweden

(111) M 2021 34302 R
(151) 2021 07 14
(181) 2031 07 14
(260) AM 2020 109302 A
(220) 2020 08 06
(732) OOO "Parapharm"
Ul. Sverdlova, dom 4, 440026, Penza,
Russian Federation

(111) M 2021 34303 R
 (151) 2021 07 15
 (181) 2031 07 15
 (260) AM 2020 109360 A
 (220) 2020 08 11
 (732) Purity Pump Co., Ltd.
 №2, Building 4, Phase 1, Wufeng Industrial
 Park, Daxi Town, Wenling City, Taizhou
 City, Zhejiang Province, China

(111) M 2021 34309 R
 (151) 2021 07 15
 (181) 2031 07 15
 (260) AM 2020 109500 A
 (220) 2020 08 21
 (732) OOO "Rinwol"
 196084, St. Petersburg, ul. Kievskaya, dom 6,
 bldg. 1, Litera B, Russian federation

(111) M 2021 34304 R
 (151) 2021 07 15
 (181) 2031 07 15
 (260) AM 2020 109383 A
 (220) 2020 08 13
 (732) LLC "Paragraph Shekvetili"
 I. Chavchavdze Av. 39a, Tbilisi, Georgia

(111) M 2021 34310 R
 (151) 2021 07 15
 (181) 2031 07 15
 (260) AM 2020 109602 A
 (220) 2020 09 01
 (732) Stryten Manufacturing LLC
 13000 Deerfield Parkway, Building 200,
 Milton, Georgia 30004, Georgia, 30004, USA

(111) M 2021 34305 R
 (151) 2021 07 15
 (181) 2031 07 15
 (260) AM 2020 109384 A
 (220) 2020 08 13
 (732) LLC "Paragraph Shekvetili"
 I. Chavchavdze Av. 39a, Tbilisi, Georgia

(111) M 2021 34311 R
 (151) 2021 07 15
 (181) 2031 07 15
 (260) AM 2020 109668 A
 (220) 2020 09 08
 (732) LTD "Imexpharm"
 On the right bank of the River Mtkvari, nearby
 Bacteriophage, 0160, Tbilisi, Georgia

(111) M 2021 34306 R
 (151) 2021 07 15
 (181) 2031 07 15
 (260) AM 2020 109385 A
 (220) 2020 08 13
 (732) LLC "Paragraph Shekvetili"
 I. Chavchavdze Av. 39a, Tbilisi, Georgia

(111) M 2021 34312 R
 (151) 2021 07 15
 (181) 2031 07 15
 (260) AM 2020 108687 A
 (220) 2020 06 17
 (732) LTD "Georgian Wine House"
 Vill. Zegaani, 1500, Gurjaani, Georgia

(111) M 2021 34307 R
 (151) 2021 07 15
 (181) 2031 07 15
 (260) AM 2020 109498 A
 (220) 2020 08 21
 (732) LLC "Agava"
 Sandro Euli St. 7, Tbilisi, Georgia

(111) M 2021 34321 R
 (151) 2021 07 19
 (181) 2031 07 19
 (260) AM 2020 108761 A
 (220) 2020 06 23
 (732) VALIO LTD
 Meijeritie 6, Helsinki, FI-00370, Finland

(111) M 2021 34308 R
 (151) 2021 07 15
 (181) 2031 07 15
 (260) AM 2020 109499 A
 (220) 2020 08 21
 (732) OOO "Rinwol"
 196084, St. Petersburg, ul. Kievskaya, dom 6,
 bldg. 1, Litera B, Russian federation

(111) M 2021 34322 R
 (151) 2021 07 19
 (181) 2031 07 19
 (260) AM 2020 109512 A
 (220) 2020 08 26
 (732) LTD "Ori Nabiji"
 Navtlughi St. 39-41, 0113, Isani-Samgori
 District, Tbilisi, Georgia

(111) M 2021 34323 R
(151) 2021 07 19
(181) 2031 07 19
(260) AM 2020 109514 A
(220) 2020 08 26
(732) Dow AgroSciences LLC
a Delaware limited liability company
9330 Zionsville Road, Indianapolis, Indiana
46268, USA

(111) M 2021 34324 R
(151) 2021 07 19
(181) 2031 07 19
(260) AM 2020 109516 A
(220) 2020 08 26
(732) Dow AgroSciences LLC
a Delaware limited liability company
9330 Zionsville Road, Indianapolis, Indiana
46268, USA

(111) M 2021 34325 R
(151) 2021 07 19
(181) 2031 07 19
(260) AM 2020 109591 A
(220) 2020 08 31
(732) Dow AgroSciences LLC
a Delaware limited liability company
9330 Zionsville Road, Indianapolis, Indiana
46268, USA

(111) M 2021 34326 R
(151) 2021 07 19
(181) 2031 07 19
(260) AM 2020 109601 A
(220) 2020 09 01
(732) FLAMAGAS, S.A.
Metalurgia Street 38-42, BARCELONA,
08038, Spain

(111) M 2021 34327 R
(151) 2021 07 19
(181) 2031 07 19
(260) AM 2020 109766 A
(220) 2020 09 16
(732) Sun Pharma Global FZE
Executive Suite Y-43, P.O. Box 122304,
SAIF Zone, Sharjah, United Arab Emirates

(111) M 2021 34328 R
(151) 2021 07 19
(181) 2031 07 19
(260) AM 2020 109835 A
(220) 2020 09 22

(732) JSC "Nikora"
M. Kavtaradze St. 11, 0180, Tbilisi, Georgia

(111) M 2021 34329 R
(151) 2021 07 19
(181) 2031 07 19
(260) AM 2020 109836 A
(220) 2020 09 22
(732) JSC "Nikora"
M. Kavtaradze St. 11, 0180, Tbilisi, Georgia

TRADEMARKS REGISTERED ACCORDING TO THE ACCELERATED PROCEDURE

The decision can be appealed at the Chamber of Appeal of Sakpatenti within 3 months from the publication.

(111) M 2021 34285 R
(151) 2021 07 05
(181) 2031 07 05
(210) AM 113691
(220) 2021 06 28
(732) LTD "Slotech"
Shevchenko St. 1, 0108, Tbilisi, Georgia
(540)



(591) FCFCFC white, FC0505 red, 0C0C0C black
(531) 14.05.21; 24.01.13; 26.03.01; 26.03.05;
26.03.06; 29.01.13
(511) 9, 41, 42

(111) M 2021 34286 R
(151) 2021 07 06
(181) 2031 07 06
(210) AM 113357
(220) 2021 06 04
(732) LTD "Postv"
Nodar Bokhua St. 6, 0159, Didube District,
Tbilisi, Georgia
(540)



(591) White, orange, black
(531) 26.04.02; 26.04.04; 26.04.05; 26.04.07;
27.05.01; 27.05.10; 29.01.12
(511) 9, 35, 38, 41

(111) M 2021 34287 R
(151) 2021 07 09
(181) 2031 07 09
(210) AM 113377
(220) 2021 06 06
(310) 161157
(320) 2020 12 23
(330) BG
(732) BioNTech SE
An der Goldgrube 12, 55131 Mainz, Germany
(740) Pavle Meipariani
(540)

КОМІРНАТИ

(591) Black-white
(511) 5

(111) M 2021 34288 R
(151) 2021 07 09
(181) 2031 07 09
(210) AM 113773
(220) 2021 07 05
(732) Zviad Tsikolia
Ar. Kurdiani St. 6, app. 73, 0112, Tbilisi,
Georgia
(740) Shalva Gvaramadze
(540)



ცოკოლია TSIKOLIA

(591) Black-white
(531) 27.05.01; 28.19
(511) 3, 9, 14

(111) M 2021 34289 R
(151) 2021 07 09
(181) 2031 07 09
(210) AM 113394
(220) 2021 06 08
(732) LTD "Istanbul Restaurant"
Petre Melikishvili St. 132, 6001, Batumi,
Georgia
(540)



(591) Golden, 050000 black
(531) 06.07.04; 07.01.03; 07.11.01; 27.05.01;
27.05.11; 29.01.12
(511) 43

(111) M 2021 34290 R
(151) 2021 07 12
(181) 2031 07 12
(210) AM 113707
(220) 2021 07 01
(732) LTD "Ge Trade"
M. Lermontov St. 76, Batumi, Georgia

(540)



(591) White, red, grey, yellow
 (531) 24.15.03; 24.15.13; 27.05.01; 27.05.24; 28.19;
 29.01.14
 (511) 4, 35, 37

(111) M 2021 34315 R
 (151) 2021 07 16
 (181) 2031 07 16
 (210) AM 113766
 (220) 2021 07 02
 (732) LTD "West Invest"
 Grigol Lortkipanidze St. 13a, 0137, Tbilisi,
 Georgia
 (540)

(111) M 2021 34291 R
 (151) 2021 07 14
 (181) 2031 07 14
 (210) AM 113777
 (220) 2021 07 06
 (732) JSC "Evex Hospitals"
 Akaki Belashvili St. 142, 0159, Tbilisi,
 Georgia

(540)

საკარგადმყოფო

(591) Black-white
 (511) 5, 10, 32, 33, 36, 44



(591) Black, white
 (531) 26.01.04; 26.01.20; 28.19
 (511) 29, 30, 35

(111) M 2021 34313 R
 (151) 2021 07 15
 (181) 2031 07 15
 (210) AM 113705
 (220) 2021 06 30
 (732) LTD "Nextra Group"
 Irodion Evdoshvili St. 18, fl. 2, Office Space 3,
 0154, Tbilisi, Georgia

(540)

ალფოსცეტი
Alphoscet
Альфосцет

(591) Black-white
 (511) 5

(111) M 2021 34316 R
 (151) 2021 07 16
 (181) 2031 07 16
 (210) AM 113858
 (220) 2021 07 13
 (732) LTD "Nextra Group"
 Irodion Evdoshvili St. 18, fl. 2, Office Space 3,
 0154, Tbilisi, Georgia
 (540)

ციტიკოლი
Citiqol
Цитикол

(591) Black-white
 (511) 5

(111) M 2021 34314 R
 (151) 2021 07 15
 (181) 2031 07 15
 (210) AM 113792
 (220) 2021 07 09
 (732) LLC "Schuchmann Wines Georgia"
 Vill. Kisiskhevi, 2200, Telavi, Georgia

(540)

Schuchmann

(591) Lilac
 (531) 27.05.01; 29.01.05
 (511) 33

(111) M 2021 34317 R
 (151) 2021 07 19
 (181) 2031 07 19
 (210) AM 113862
 (220) 2021 07 14
 (732) JSC "Oppa"
 Kazbegi Av. 15, Office Space 6, fl. 3,
 Block "B", 0160, Tbilisi, Georgia
 (740) Giorgi Taktakishvili
 (540)



(591) Blue, red, orange, green, yellow
 (531) 26.04.01; 26.04.03; 26.04.04; 29.01.15
 (511) 9, 36

(540)

ფოსტა
POSTA

(111) M 2021 34318 R
 (151) 2021 07 19
 (181) 2031 07 19
 (210) AM 113863
 (220) 2021 07 14
 (732) JSC "Oppa"

Kazbegi Av. 15, Office Space 6, fl. 3,
 Block "B", 0160, Tbilisi, Georgia

(740) Giorgi Taktakishvili
 (540)

(591) Black-white
 (511) 43



(591) Blue, orange, green, grey, black
 (531) 07.01.17; 07.01.19; 07.11.25; 16.01.04;
 16.01.06; 29.01.14
 (554) Three Dimensional
 (511) 9, 36

(111) M 2021 34319 R
 (151) 2021 07 19
 (181) 2031 07 19
 (210) AM 113767
 (220) 2021 07 05
 (732) Nobel Ilac Sanayii Ve Ticaret Anonim Sirketi
 Representative in Georgia
 Liberty Square 4, 0105, Tbilisi, Georgia
 (740) Tinatin Tskhvediani
 (540)

Bisenius
ბისენიუსი

(591) Black-white
 (511) 5, 35

(111) M 2021 34320 R
 (151) 2021 07 19
 (181) 2031 07 19
 (210) AM 113865
 (220) 2021 07 14
 (732) LTD "Telegraph"
 D. Aghmashenebeli Av. 44, Tbilisi, Georgia

INTERNATIONAL TRADEMARKS FOR WHICH A DECISION ON GRANTING PROTECTIONS IS TAKEN

The decision can be appealed at the Chamber of Appeal of Sakpatenti within 3 months from the publication or at the Mtskheta District Court Administrative Cases Board (Address: №17, Samkhedro str., Mtskheta), within 1 month following the publication.

(260) AM 2021 109706 A
 (800) 1549438
 (151) 2020 07 16
 (891) 2020 07 16
 (731) Future Enterprises Pte. Ltd.
 31 Harrison Road, #08-01 Food Empire
 Building, Singapore 369649, Singapore

(540)



(591) Background in special green and tone of green
 (531) 02.03.11; 05.07.06; 05.07.27; 11.03.14;
 19.03.03; 25.01.06; 28.05; 29.01.14

(511)

30 – Coffee; iced coffee; coffee beans; coffee drinks; ground coffee; instant coffee; cappuccino; flavoured coffee; coffee-based beverages; coffee substitutes; chicory [coffee substitute]; coffee beverages with milk; coffee mixtures; cocoa; cocoa mixes; cocoa powder; hot cocoa mix; cocoa beverages; cocoa-based beverages; cocoa beverages with milk; tea; iced tea; black tea; green tea; fruit flavoured tea; tea-based beverages; tea-based beverages with fruit flavoring; chocolate-based beverages.

35 – Wholesale services; retail services; advertising, marketing and promotional services.

(260) AM 2021 109717 A
 (800) 1549742
 (151) 2020 07 14
 (891) 2020 07 14
 (731) Pocketbook International SA
 Crocicchio Cortogna 6, CH-6900 Lugano,
 Switzerland

(540)

PocketBook InkPad

(591) Black, white

(511)

9 – Electronic book readers; portable readers for electronically stored book content.

(260) AM 2021 109796 A

(800) 1550714

(151) 2020 07 03

(891) 2020 07 03

(731) Bugatti International S.A.

412F, route d'Esch, L-1030 Luxembourg,
 Luxembourg

(540)

BUGATTI

(591) Black, white

(511)

8 – Hand tools and implements, hand-operated; cutlery; side arms, except firearms; razors.

20 – Furniture, mirrors, picture frames; containers, not of metal, for storage or transport; unworked or semi-worked bone, horn, whalebone or mother-of-pearl; shells; meerschaum; yellow amber; beds, bedding, mattresses, pillows and cushions.

21 – Household or kitchen utensils and containers; cookware and tableware, except forks, knives and spoons; combs and sponges; brushes, except paintbrushes; brush-making materials; articles for cleaning purposes; unworked or semi-worked glass, except building glass; glassware, porcelain and earthenware; ceramics for household purposes; cups, mugs, glasses [drinking vessels], plates, salad bowls; casseroles [dishes], frying pans, moulds [kitchen utensils]; cookery moulds; cake moulds; vacuum bottles; vacuum mugs.

35 – Advertising; business management; business administration; office functions; loyalty, incentive and bonus program services; administration of consumer loyalty programs; organisation and management of customer loyalty programs; administration of loyalty rewards programs featuring trading stamps; administration of loyalty programs involving discounts or incentives; administrative loyalty card services; sales promotion through customer loyalty programs; loyalty scheme services; organisation and management of business incentive and loyalty schemes; administration of customer loyalty and incentive schemes.

(260) AM 2021 109797 A
 (800) 1550715
 (151) 2020 07 03
 (891) 2020 07 03
 (731) Bugatti International S.A.
 412F, route d'Esch, L-1030 Luxembourg,
 Luxembourg

9540)



(591) Black, white
 (531) 27.05.17; 27.05.22
 (511)

8 – Hand tools and implements, hand-operated; cutlery; side arms, except firearms; razors.

20 – Furniture, mirrors, picture frames; containers, not of metal, for storage or transport; unworked or semi-worked bone, horn, whalebone or mother-of-pearl; shells; meerschaum; yellow amber; beds, bedding, mattresses, pillows and cushions.

21 – Household or kitchen utensils and containers; cookware and tableware, except forks, knives and spoons; combs and sponges; brushes, except paintbrushes; brush-making materials; articles for cleaning purposes; unworked or semi-worked glass, except building glass; glassware, porcelain and earthenware; ceramics for household purposes; cups, mugs, glasses [drinking vessels], plates, salad bowls; casseroles [dishes], frying pans, moulds [kitchen utensils]; cookery moulds; cake moulds; vacuum bottles; vacuum mugs.

24 – Textiles and substitutes for textiles; household linen; curtains of textile or plastic; duvet covers, bedsheets, pillowcases, towels, bed covers, bed linen and blankets, woollen blankets.

25 – Clothing, footwear, headgear, bathrobes.

35 – Advertising; business management; business administration; office functions; loyalty, incentive and bonus program services; administration of consumer loyalty programs; organisation and management of customer loyalty programs; administration of loyalty rewards programs featuring trading stamps; administration of loyalty programs involving discounts or incentives; administrative loyalty card services; sales promotion through customer loyalty programs; loyalty scheme services; organisation and management of business incentive and loyalty schemes; administration of customer loyalty and incentive schemes.

(260) AM 2021 109798 A
 (800) 1550769
 (151) 2020 07 23
 (891) 2020 07 23
 (731) Alessandro Gualtieri
 Veemarkt 40, NL-1019 DD Amsterdam,
 Netherlands

(540)

CA' DEL NASO

(591) Black, white

(511)

33 – Wine; wines; red wine; white wine; alcoholic wines; dessert wines; sweet wines; table wines; red wines; white wines; fortified wines; sparkling wines; sparkling white wines; natural sparkling wines; spirits; distilled spirits; spirits [beverages]; spirits and liquors; digesters [liqueurs and spirits].

(260) AM 2021 109811 A

(800) 1551212

(151) 2020 06 02

(891) 2020 06 02

(731) Euro Games Technology Ltd.

4, "Maritsa" Str., "Vranya-Lozen-Triugulnika",
 BG-1151 Sofia, Bulgaria

(540)



(591) Blue, pink, purple, orange, white, green, brown, gold, yellow and black

(531) 05.05.20; 07.15.22; 27.05.02; 28.03; 29.01.15

(511)

28 – Gaming machines for gambling; chips for gambling; mah-jong; arcade games; gambling machines operating with coins, notes and cards; games; electronic games; parlor games; gaming chips; gaming tables; slot machines [gaming machines]; LCD game machines; slot machines and gaming devices; coin-operated amusement machines; roulette chips; poker chips; chips and dice [gaming equipment]; equipment for casinos; roulette tables; gaming roulette wheels; casino games; gambling machines and amusement machines, automatic and coin-operated; coin-operated amusement machines and/or electronic coin-operated amusement machines with or without the possibility of gain; boxes for coin-operated machines, slot machines and gaming machines; electronic or electro-technical amusement machines and apparatus, gaming machines, coin-operated entertainment machines; housings for coin-operated machines, gaming equipment, gaming machines, machines for gambling; electropneumatic and electrical slot machines (gaming machines for gambling).

41 – Gambling; services related to gambling; gaming services for entertainment purposes; casino, gaming and gambling services; training in the development of software systems; provision of equipment for gambling halls; providing casino equipment [gambling]; gaming machine entertainment services; providing casino facilities [gambling]; gaming hall services; amusement arcade services; games equipment rental; rental of gaming machines; providing amusement arcade services; rental of gaming machines with images of fruits; editing or recording of sounds and images; sound recording and video entertainment services; hire of sound reproducing apparatus; provision of gaming equipment for casinos; providing of casino facilities; online gambling services; casino, gaming and gambling services; provision of gaming facilities, gaming halls, Internet casinos, online gaming services.

(260) AM 2021 109855 A

(800) 1551244

(151) 2020 06 02

(891) 2020 06 02

(731) Euro Games Technology Ltd.

4, "Maritsa" Str., "Vranya-Lozen-Triugulnika",
BG-1151 Sofia, Bulgaria



(591) Red, green, orange, gold, brown, blue, white,
yellow and black

(531) 08.07.01; 11.03.06; 27.05.02; 29.01.15

(511)

9 – Software; computer gaming software; computer software packages; computer operating system software; computer software, recorded; software drivers; virtual reality software; games software; entertainment software for computer games; computer programs for network management; operating computer software for main frame computers; monitors (computer hardware); computer hardware; apparatus for recording images; monitors (computer programs); computer game programs; computer programs for recorded games; apparatus for recording, transmission or reproduction of sound or images; communications servers [computer hardware]; electronic components for gambling machines; computer application software featuring games and gaming; computer software for the administration of on-line games and gaming; computer hardware for games and gaming; electronic components and computer software for gambling, gaming machines, gambling games on the internet and via telecommunication network.

28 – Gaming machines for gambling; chips for gambling; mah-jong; arcade games; gambling machines operating with coins, notes and cards; games; electronic games; parlor games; gaming chips; gaming tables; slot machines [gaming machines]; LCD game machines; slot machines and gaming devices; coin-operated amusement machines; roulette chips; poker chips; chips and dice [gaming equipment]; equipment for casinos; roulette tables; gaming roulette wheels; casino games; gambling machines and amusement machines, automatic and coin-operated; coin-operated amusement machines and/or electronic coin-operated amusement machines with or without the possibility of gain; boxes for coin-operated machines, slot machines and gaming machines; electronic or electrotechnical amusement machines and apparatus, gaming machines, coin-operated entertainment machines; housings for coin-operated machines, gaming equipment, gaming machines, machines for gambling; electropneumatic and electrical slot machines (gaming machines for gambling).

41 – Gambling; services related to gambling; gaming services for entertainment purposes; casino, gaming and gambling services; training in the development of software systems; provision of equipment for gambling halls; providing casino equipment [gambling]; gaming machine entertainment services; providing casino facilities [gambling]; gaming hall services; amusement arcade services; games equipment rental; rental of gaming machines; providing amusement arcade services; rental of gaming machines with images of fruits; editing or recording of sounds and images; sound recording and video entertainment services; hire of sound reproducing apparatus; provision of gaming equipment for casinos; providing of casino facilities; online gambling services; casino, gaming and gambling services; provision of gaming facilities, gaming halls, Internet casinos, online gaming services.

(260) AM 2021 109857 A

(800) 1551299

(151) 2020 08 18

(891) 2020 08 18

(731) Alcon Inc.

Rue Louis-d'Affry 6, CH-1701 Fribourg,
Switzerland

(540)

SYSTANE

(591) Black, white

(511)

10 – Medical and surgical ophthalmic instruments and apparatus.

(260) AM 2021 109858 A

(800) 1551348

(151) 2020 07 17

(891) 2020 07 17

(731) Limited Liability Company "Russian Mining Chemical Company"

Lyusinovskaya ul., d. 36, str. 1, et 8,

RU-115093 Moskva, Russian Federation

(540)



(591) Brown, light brown, pale orange and black

(531) 26.13.25; 29.01.12

(511)

1 – Chemicals intended for industrial use; chemicals for use in paper production; chemicals for use in the pulp and paper industry; chemicals for bleaching paper.

(260) AM 2021 109859 A

(800) 1551385

(151) 2020 07 22

(891) 2020 07 22

(731) R&S consumer goods GmbH

Wasserburger Landstr. 264, 81827 München, Germany

(540)

MY.SIZE PRO

(591) Black, white

(511)

10 – Condoms.

16 – Packaging cardboard.

(260) AM 2021 109875 A

(800) 1551628

(151) 2020 05 29

(891) 2020 05 29

(731) Euro Games Technology Ltd.

4, "Maritsa" Str., "Vranya-Lozen-Triugulnika", BG-1151 Sofia, Bulgaria

(540)



(591) Blue, purple, pink, gold, black, yellow and white

(531) 01.15.09; 27.05.02; 27.07.02; 28.03; 29.01.15

(511)

9 – Software; computer gaming software; computer software packages; computer operating system software; computer software, recorded; software drivers; virtual reality software; games software; entertainment software for computer games; computer programs for network management; operating computer software for main frame computers; monitors (computer hardware); computer hardware; apparatus for recording images; monitors (computer programs); computer game programs; computer programs for recorded games; apparatus for recording, transmission or reproduction of sound or images; communications servers [computer hardware]; electronic components for gambling machines; computer application software featuring games and gaming; computer software for the administration of on-line games and gaming; computer hardware for games and gaming; electronic components and computer software for gambling, gambling machines, gambling games on the internet and via telecommunication network.

28 – Gaming machines for gambling; chips for gambling; mah-jong; arcade games; gambling machines operating with coins, notes and cards; games; electronic games; parlor games; gaming chips; gaming tables; slot machines [gaming machines]; LCD game machines; slot machines and gaming devices; coin-operated amusement machines; roulette chips; poker chips; chips and dice [gaming equipment]; equipment for casinos; roulette tables; gaming roulette wheels; casino games; gambling machines and amusement machines, automatic and coin-operated; coin-operated amusement machines and/or electronic coin-operated amusement machines with or without the possibility of gain; boxes for coin-operated machines, slot machines and gaming machines; electronic or electrotechnical amusement machines and apparatus, gaming machines, coin-operated entertainment machines; housings for coin-operated machines, gaming equipment, gaming machines, machines for gambling; electropneumatic and electrical slot machines (gaming machines for gambling).

41 – Gambling; services related to gambling; gaming services for entertainment purposes; casino, gaming and gambling services; training in the development of software systems; provision of equipment for gambling halls; providing casino equipment [gambling]; gaming machine entertainment services; providing casino facilities [gambling]; gaming hall services; amusement arcade services; games equipment rental; rental of gaming machines; providing amusement arcade services; rental of gaming machines with images of fruits; editing or recording of sounds and images; sound recording and video entertainment services; hire of sound reproducing apparatus; provision of gaming equipment for casinos; providing of casino facilities; online gambling services; casino, gaming and gam-

bling services; provision of gaming facilities, gaming halls, Internet casinos, online gaming services.

(260) AM 2021 109876 A

(800) 1551629

(151) 2020 06 02

(891) 2020 06 02

(731) Euro Games Technology Ltd.

4, "Maritsa" Str., "Vranya-Lozen-Triugulnika",
BG-1151 Sofia, Bulgaria

(540)



(591) Red, orange, gold, brown, blue, white, yellow, black

(531) 24.05.05; 27.05.02; 28.03; 29.01.15

(511)

28 – Gaming machines for gambling; chips for gambling; mah-jong; arcade games; gambling machines operating with coins, notes and cards; games; electronic games; parlor games; gaming chips; gaming tables; slot machines [gaming machines]; LCD game machines; slot machines and gaming devices; coin-operated amusement machines; roulette chips; poker chips; chips and dice [gaming equipment]; equipment for casinos; roulette tables; gaming roulette wheels; casino games; gambling machines and amusement machines, automatic and coin-operated; coin-operated amusement machines and/or electronic coin-operated amusement machines with or without the possibility of gain; boxes for coin-operated machines, slot machines and gaming machines; electronic or electro-technical amusement machines and apparatus, gaming machines, coin-operated entertainment machines; housings for coin-operated machines, gaming equipment, gaming machines, machines for gambling; electropneumatic and electrical slot machines (gaming machines for gambling).

41 – Gambling; services related to gambling; gaming services for entertainment purposes; casino, gaming and gambling services; training in the development of software systems; provision of equipment for gambling halls; providing casino equipment [gambling]; gaming machine entertainment services; providing casino facilities [gambling]; gaming hall services; amusement arcade services; games equipment rental; rental of gaming machines; providing amusement arcade services; rental of gaming machines with images of fruits; editing or recording of sounds and images; sound recording and video entertainment services; hire of sound reproducing apparatus; provision of gaming equipment for casinos; providing of casino facilities; online gambling services; casino, gaming and

gambling services; provision of gaming facilities, gaming halls, Internet casinos, online gaming services.

(260) AM 2021 109880 A

(800) 1551712

(151) 2020 07 07

(891) 2020 07 07

(731) MONCLER S.P.A.

Via Stendhal, 47, I-20144 MILANO, Italy

(540)



(591) Black, white

(531) 03.07.03; 03.07.24; 22.03.01; 22.03.05;
26.13.25; 27.01.01

(511)

3 – Perfumes; eau de toilette and eau de Cologne; deodorants for human beings or for animals; incense; joss sticks; air fragrancing preparations; sachets for perfuming linen; air fragrance reed diffusers; scented room sprays; extracts of flowers (perfumes); potpourris (fragrances); essential oils for personal use; oils for toilet purposes; henna [cosmetic dye]; make-up; eye shadow; cosmetic pencils; eyeliner; foundation; foundation creams; make-up powder; pressed face powder; creamy face powder; face powder [for cosmetic use]; talcum powder, for toilet use; blusher; lipsticks; lipstick cases; lip glosses, non-medicated lip balms; cocoa butter for cosmetic purposes; mascara; sunscreen preparations; sun-tanning preparations [cosmetics]; skin bronzing creams; self-tanning creams; sun-tanning creams and lotions; after-sun creams and preparations; sun protectors for lips [cosmetics]; cosmetic preparations to protect against sunburn; nail polish; nail glitter; beauty masks; facial scrubs [cosmetic]; skin exfoliants; face creams for cosmetic purposes; cosmetic body creams; cosmetic creams; pomades for cosmetic purposes; cosmetic preparations for slimming purposes; creams for cellulite reduction for cosmetic use; hair sprays; cosmetic hair lotions; hair bleaching preparations; hair dyes; hair coloring preparations; hair rinses [shampoo-conditioners]; hair lighteners; hair conditioners; hair moisturizers; preparations for the permanent waving of hair; gels, sprays, mousses and balms for hair styling and hair care; brilliantine; depilatory preparations; depilatory creams, hair straightening preparations; tissues impregnated with make-up removing preparations; phytocosmetic preparations; nail art stickers; false nails; adhesives

for cosmetic purposes; nail conditioners; cotton sticks for cosmetic purposes; pre-moistened or impregnated cleansing pads, tissues or wipes; cosmetic patches containing sunscreen and sun block for use on the skin; facial concealer; under-eye enhancers; non-medicated foot creams; skin whitening creams; bleaching preparations [decolorants] for cosmetic purposes; massage gels, other than for medical purposes; cleansing milk for toilet purposes; hair mascara; gel eye masks; decorative transfers for cosmetic purposes; cotton wool for cosmetic purposes; cloths impregnated with a detergent for cleaning spectacles; eye-washes, not for medical purposes; antiperspirants [toiletries]; make-up removing preparations; micellar water; body paints for cosmetic purposes; cotton wool impregnated with make-up removing preparations; hand soap; cosmetic soap; facial soaps; skin cleansing creams; skin cleansing lotions; shower gel; bubble bath for cosmetic use; bath oils, not for medical purposes; bath pearls, not for medical purposes; bath salts, not for medical purposes; cosmetic creams and lotions for face and body care; shaving balms; shaving creams, shaving soap; after-shave balms; after-shave cologne; after-shave lotions; hair shampoos; bath preparations, not for medical purposes; cleansers for intimate personal hygiene purposes, non medicated; mouthwashes, not for medical purposes; cosmetic preparations for the care of mouth and teeth; breath freshening preparations for personal hygiene; laundry starch; laundry soap; stain removers; rust removing preparations; carpet shampoos; cloths impregnated with a detergent for cleaning; emery, pumice stone; polishing powder; shoe polish; shoe wax; shoe cream; creams for leather; leather bleaching preparations; floor wax; baby lotions [toiletries]; baby oils [toiletries]; baby powder [toiletries]; shampoos for babies; hair conditioners for babies; children's play cosmetics; cosmetics for children; baby wipes impregnated with cleaning preparations; cosmetics for animals; preparations for cleaning, protecting and preserving vehicle surfaces; massage candles for cosmetic purposes; non-medicated cosmetics and toiletry preparations; non-medicated dentifrices; perfumery, essential oils; bleaching preparations and other substances for laundry use; cleaning, polishing, scouring and abrasive preparations.

(260) AM 2021 109883 A

(800) 1551755

(151) 2020 03 31

(891) 2020 03 31

(731) KITZ CORPORATION

10-1, Nakase 1-chome, Mihama-ku, Chiba-shi,
Chiba-ken 261-8577, Japan

(540)

KITZ

(591) Black, white

(531) 27.05.01; 27.05.17

(511)

6 – Metal valves with actuators, not including machine elements; metal valves, not including machine elements; metal cocks, not including machine elements; metal strainers for filtering liquid in pipes; metal stoppers for industrial packaging containers; metal lids and caps for industrial packaging containers.

7 – Hydrogen refueling station equipment; valves for hydrogen refueling station; valves, machine elements, not for land vehicles; cocks, machine elements, not for land vehicles; junction for pipes, machine elements, not for land vehicles; electric-driven, pneumatic-driven, hydraulic-driven industrial actuators to be mounted on valves for opening and closing valves, not for land vehicles; pneumatic actuators; mechanical actuators; gas unit for semiconductor manufacturing machines; antistatic device for semiconductor manufacturing machine; pure water booster for semiconductor manufacturing machine; filter for filtering machines; hollow fiber membrane filter for filtering machines; hollow fiber membrane filters for machines used for filtering liquid or gas.

(260) AM 2021 109884 A

(800) 1551779

(151) 2020 06 23

(891) 2020 06 23

(731) PepsiCo, Inc., (a North Carolina corporation)
700 Anderson Hill Road, Purchase NY 10577,
USA

(540)



(591) Black, white, red, dark blue, blue, brown, dark brown

(531) 04.05.21; 08.01.25; 24.15.21; 27.03.01; 28.05
29.01.14

(511)

30 – Cereal bars; croûtons; cereal-based snack food; crackers; muesli; cookies; petit-beurre biscuits; pizzas; popcorn; cereal preparations; rusks; sandwiches; unleavened bread; chips [cereal products]; corn flakes; oat flakes.

(260) AM 2021 109890 A

(800) 1551978

(151) 2020 01 09

(891) 2020 01 09

(731) Biodrug s. r. o.

Boženy Němcovej 8, SK-811 04 Bratislava,
Slovakia

(540)

VACDITE

(591) Black, white

(511)

5 – Vaccines.

(260) AM 2021 109891 A

(800) 1552000

(151) 2020 08 04

(891) 2020 08 04

(731) ONVIF, Inc.

5000 Executive Parkway, Suite 302,
San Ramon CA 94583, USA

(540)

ONVIF

(591) Black, white

(511)

9 – Downloadable computer software, namely, a software interface for network video cameras; interface for computers, namely, high definition multimedia interface cables, interface cards for data processing equipment in the form of printed circuits, and computer interface boards; interface for computers for cinematographic, optic apparatus and instruments; interface for computers for apparatus and instruments for measuring, signaling, transmission and video surveillance; interface for computers for apparatus for recording, receiving, transmitting or reproducing sound and images; interfaces for computers for computer streaming or reproduction of data stream; interface for computers for IP-based video systems consisting of network video cameras, network switches, network monitors and computer software; downloadable computer software for interoperability among IP-based devices used in applications for security, video surveillance, building automation systems, security information management systems, namely, electronic readers and controllers for controlling access to premises, electronic access control systems for interlocking doors, security and fire alarms, and electronic video surveillance products, namely, electronic components of security systems.

42 – Providing temporary use of non-downloadable computer software, namely, a software interface for network video cameras; providing temporary use of non-downloadable computer software for interoperability among IP-based devices used in applications for security, video surveillance, building automation systems, security information management systems, na-

mely, electronic readers and controllers for controlling access to premises, electronic access control systems for interlocking doors, security and fire alarms, and electronic video surveillance products, namely, electronic components of security systems.

(260) AM 2021 109892 A

(800) 1552005

(151) 2020 08 04

(891) 2020 08 04

(731) City Sightseeing Limited

Stanley House, 49a High Street, Henley-in-Arden, West Midlands B95 5AA, United Kingdom

(540)

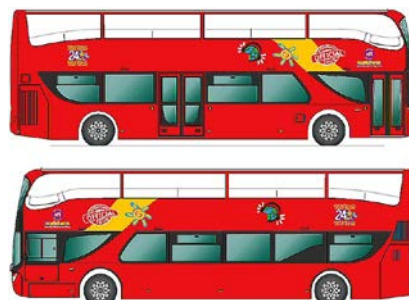

(591) Black, white, red, yellow, green

(531) 01.03.02; 01.05.15; 18.01.07; 18.01.08;
27.05.01; 29.01.15

(511)

35 – Advertising services; business management services; business management services relating to franchising; business management advisory services related to franchising.

39 – Transport services; travel arrangement services; tourism services, namely providing vehicles for tours and excursions; arranging, booking and conducting travel tours and excursions; information services in the field of tourism, namely information on the reservation of tickets for transport; booking agency services for tours.

41 – Education; providing of training; entertainment; sporting and cultural activities; provision of educational and cultural information.

(260) AM 2021 109895 A

(800) 1552180

(151) 2020 06 30

(891) 2020 06 30

(731) Guangzhou Xianyou Intelligent Technology Co.,Ltd

NO.32 Xixiu Road, Xiuquan street, Huadu District, Guangzhou, Guangdong, China

(540)



(591) Black, white
(531) 27.05.01; 27.05.23
(511)

9 – Notebook computers; computers; computer software, recorded; computer peripheral devices; monitors [computer hardware]; cell phones; television apparatus; coin-operated mechanisms for television sets; television receivers [TV sets]; television camera; cabinets for loudspeakers; slide projectors; video projectors.

(260) AM 2021 109896 A

(800) 1552190
(151) 2020 06 20
(891) 2020 06 20

(731) Hangzhou JNBY Finery Co., Ltd.
Room 18A01, Building 1, No.39 Yile Road,
Xihu District, Hangzhou, Zhejiang Province,
China

(540)

JNBY HOME

(591) Black, white
(531) 27.05.01
(511)

24 – Cloth; cord fabric; wall hangings of textile; towels of textile; bed covers; bed linen; bed blankets; tablecloths, not of paper; curtains of textile or plastic.

(260) AM 2021 109898 A

(800) 1552264
(151) 2020 07 15
(891) 2020 07 15

(731) Fujian Kirisun Communications Co., Ltd.
Building C, Haixi Electronic Information,
Industry Breeding Base, Technology Road,
Hi-tech Industrial Park, Fengze District,
Quanzhou City, Fujian Province, China

(540)



(591) Black, white
(531) 26.15.01
(511)

9 – Computer programs, recorded; computer software applications, downloadable; computer programs, downloadable; computer network servers; sim cards; digital sound processors; internet servers; electronic

memory devices; computer hardware; communications computers.

(260) AM 2021 109967 A

(800) 1552559
(151) 2020 08 04
(891) 2020 08 04

(731) City Sightseeing Limited
Stanley House, 49a High Street, Henley-in-Arden, West Midlands B95 5AA, United Kingdom

(540)



(591) Black, white, red, yellow, green
(531) 01.03; 01.03.02; 01.05; 01.05.15; 18.01;
18.01.07; 18.01.07; 18.01.08; 18.01.08; 27.05;
27.05.01; 29.01; 29.01.15; 29.01.15

(511)

35 – Advertising services; business management services; business management services relating to franchising; business management advisory services related to franchising.

41 – Education; providing of training; entertainment; sporting and cultural activities; provision of educational and cultural information.

(260) AM 2021 109973 A

(800) 1552722
(151) 2020 07 03
(891) 2020 07 03

(731) Bugatti International S.A.
412F route d'Esch, L-1030 Luxembourg,
Luxembourg

(540)



(591) Red, white, black, silver
(531) 24.17.02; 26.01.02; 26.01.20; 26.01.24;
27.05.02; 27.05.03; 27.05.14; 27.05.22;
27.05.24; 29.01.13; 29.01.14

(511)

8 – Hand tools and implements, hand-operated; cutlery; side arms, except firearms; razors.

20 – Furniture, mirrors, picture frames; containers, not of metal, for storage or transport; unworked or semi-worked bone, horn, whalebone or mother-of-pearl; shells; meerschaum; yellow amber; beds, bedding, mattresses, pillows and cushions.

21 – Household or kitchen utensils and containers; cookware and tableware, except forks, knives and spoons; combs and sponges; brushes, except paintbrushes; brush-making materials; articles for cleaning purposes; unworked or semi-worked glass, except building glass; glassware, porcelain and earthenware; ceramics for household purposes; cups, mugs, glasses [drinking vessels], plates, salad bowls; casseroles [dishes], frying pans, moulds [kitchen utensils]; cookery moulds; cake moulds; vacuum bottles; vacuum mugs.

35 – Advertising; business management; business administration; office functions; loyalty, incentive and bonus program services; administration of consumer loyalty programs; organisation and management of customer loyalty programs; administration of loyalty rewards programs featuring trading stamps; administration of loyalty programs involving discounts or incentives; administrative loyalty card services; sales promotion through customer loyalty programs; loyalty scheme services; organisation and management of business incentive and loyalty schemes; administration of customer loyalty and incentive schemes.

(260) AM 2021 109976 A

(800) 1552744

(151) 2020 05 07

(891) 2020 05 07

(731) DISTILLERIA F.LLI CAFFO S.R.L.

Via Matteotti, 11, I-89844 Limbadi (VV), Italy

(540)

CAFFO

(591) Black, white

(511)

32 – Beers; mineral water and aerated water; fruit beverages and fruit juices; syrups and other non-alcoholic preparations for making beverages; tonic water [non-medicated beverages]; non-alcoholic beverages; beers; syrups for making non-alcoholic beverages; juices; mineral water [beverages]; mineral water [beverages]; carbonated mineral water; fruit-based beverages; non-alcoholic sparkling fruit juice drinks.

33 – Alcopops; spirits [beverages]; alcoholic energy drinks; liqueurs; grappa; wine; alcoholic beverages (except beers); spirits [beverages]; distilled beverages; vodka; bitters; rum; whisky; alcoholic beverages of fruit; preparations for making alcoholic beverages; pre-mixed alcoholic beverages, other than beer-based.

(260) AM 2021 109977 A

(800) 1552752

(151) 2020 08 18

(891) 2020 08 18

(731) PROSTECH LTD

48 Inomenon Ethnon, Guricon House, CY-6042
Larnaca, Cyprus

(540)



(591) Red and black

(531) 26.04.04; 27.05.01; 29.01.13

(511)

2 – White lead; dyes; binding preparations for paints; glazes [paints, lacquers]; primers; indigo [colorant]; colophony; copal; alizarine dyes; aniline dyes; dye-wood; colorants; aluminium paints; asbestos paints; bactericidal paints; wood stains; ceramic paints; distempers; fireproof paints; enamels for painting; paints; creosote for wood preservation; black japan; bitumen varnish; bronzing lacquers; copal varnish; lacquers; anti-corrosive bands; anti-rust oils; oils for the preservation of wood; mastic [natural resin]; silver paste; pigments; coatings [paints]; coatings for roofing felt [paints]; wood coatings [paints]; anti-fouling paints; varnishes; aluminium powder for painting; bronze powder for painting; silvering powders; anti-corrosive preparations; protective preparations for metals; wood mordants; mordants; thinners for paints; thinners for lacquers; whitewash; soot [colorant]; thickeners for paints; siccatives [drying agents] for paints; anti-rust greases; natural resins, raw; badigeon; anti-tarnishing preparations for metals; wood preservatives; turpentine [thinner for paints]; fixatives [varnishes]; dye-wood extracts; enamels [varnishes].

19 – Alabaster; door frames, not of metal; window frames, not of metal; asbestos cement; asphalt; beams, not of metal; concrete; bitumen; binding agents for making briquettes; binding material for road repair; stained-glass windows; geotextiles; clay; gravel; granite; doors, not of metal; roofing shingles; wood for making household utensils; veneer wood; moldable wood; jalousies, not of metal; limestone; lime; stone; cornices, not of metal; paperboard for building; bricks; buildings, not of metal; buildings, transportable, not of metal; stringers [parts of staircases], not of metal; roofing, not of metal; xylolith; building timber; manufactured timber; wood, semi-worked; staircases, not of metal; reinforcing materials, not of metal, for building; bituminous products for building; tar; materials for making and coating roads; road coating materials; grog [fired refractory material]; pitch; building materials, not of metal; refractory construction materials, not of metal; raw chalk; calcareous marl; mosaics for building; marble; slate powder; flashing, not of metal, for building; roof flashing, not of

metal; duckboards, not of metal; coatings [building materials]; wood panelling; windows, not of metal; olivine for building; shuttering, not of metal, for concrete; wainscotting, not of metal; building panels, not of metal; parquet flooring; partitions, not of metal; lintels, not of metal; casement windows, not of metal; sand, except foundry sand; sandstone for building; floor tiles, not of metal; paving slabs, not of metal; cement slabs; paving blocks, not of metal; fireproof cement coatings; roof coverings, not of metal; linings, not of metal, for building; mortar for building; asbestos mortar; furrings of wood; shutters, not of metal; building glass; hips for roofing; water-pipes, not of metal; gutter pipes, not of metal; drain pipes, not of metal; chimneys, not of metal; tufa; angle irons, not of metal; plywood; cement; slate; slag [building material]; clinker stone; wood veneers; clinker ballast; concrete building elements.

(260) AM 2021 109978 A

(800) 1552754

(151) 2020 08 18

(891) 2020 08 18

(731) Alcon Inc.

Rue Louis-d'Affry 6, CH-1701 Fribourg,
Switzerland

(540)

Systane
iLux

(591) Black, white

(531) 01.15.15; 27.05; 27.05.01

(511)

10 – Medical and surgical ophthalmic instruments and apparatus.

(260) AM 2021 109979 A

(800) 1552762

(151) 2020 08 18

(891) 2020 08 18

(731) PROSTECH LTD

48 Inomenon Ethnon, Guricon House,
CY-6042 Larnaca, Cyprus

(540)

ИНДАСТРО
INDASTRO

(591) Black, white

(531) 28.05

(511)

2 – White lead; dyes; binding preparations for paints; glazes [paints, lacquers]; primers; indigo [colorant]; colophony; copal; alizarine dyes; aniline dyes; dye-wood; colorants; aluminium paints; asbestos paints; bactericidal paints; wood stains; ceramic paints; distempers; fireproof paints; enamels for painting; paints; creosote for wood preservation; black japan; bitumen varnish; bronzing lacquers; copal varnish; lacquers; anti-corrosive bands; anti-rust oils; oils for the preservation of wood; mastic [natural resin]; silver paste; pigments; coatings [paints]; coatings for roofing felt [paints]; wood coatings [paints]; anti-fouling paints; varnishes; aluminium powder for painting; bronze powder for painting; silvering powders; anti-corrosive preparations; protective preparations for metals; wood mordants; mordants; thinners for paints; thinners for lacquers; whitewash; soot [colorant]; thickeners for paints; siccatives [drying agents] for paints; anti-rust greases; natural resins, raw; badigeon; anti-tarnishing preparations for metals; wood preservatives; turpentine [thinner for paints]; fixatives [varnishes]; dyewood extracts; enamels [varnishes].

19 – Alabaster; door frames, not of metal; window frames, not of metal; asbestos cement; asphalt; beams, not of metal; concrete; bitumen; binding agents for making briquettes; binding material for road repair; stained-glass windows; geotextiles; clay; gravel; granite; doors, not of metal; roofing shingles; wood for making household utensils; veneer wood; moldable wood; jalousies, not of metal; limestone; lime; stone; cornices, not of metal; paperboard for building; bricks; buildings, not of metal; buildings, transportable, not of metal; stringers [parts of staircases], not of metal; roofing, not of metal; xylolith; building timber; manufactured timber; wood, semi-worked; staircases, not of metal; reinforcing materials, not of metal, for building; bituminous products for building; tar; materials for making and coating roads; road coating materials; grog [fired refractory material]; pitch; building materials, not of metal; refractory construction materials, not of metal; raw chalk; calcareous marl; mosaics for building; marble; slate powder; flashing, not of metal, for building; roof flashing, not of metal; duckboards, not of metal; coatings [building materials]; wood panelling; windows, not of metal; olivine for building; shuttering, not of metal, for concrete; wainscotting, not of metal; building panels, not of metal; parquet flooring; partitions, not of metal; lintels, not of metal; casement windows, not of metal; sand, except foundry sand; sandstone for building; floor tiles, not of metal; paving slabs, not of metal; cement slabs; paving blocks, not of metal; fireproof cement coatings; roof coverings, not of metal; linings, not of metal, for building; mortar for building; asbestos mortar; furrings of wood; shutters, not of metal; building glass; hips for roofing; water-pipes, not of

metal; gutter pipes, not of metal; drain pipes, not of metal; chimneys, not of metal; tufa; angle irons, not of metal; plywood; cement; slate; slag [building material]; clinker stone; wood veneers; clinker ballast; concrete building elements.

(260) AM 2021 109982 A

(800) 1552783

(151) 2020 07 14

(891) 2020 07 14

(731) TIRELINK CO., LTD

Diaomeng Road, Dawang Town, Guangrao County, Dongying City, Shandong Province, China

(540)

SUNFULL

(591) Black, white

(511)

12 – Casings for pneumatic tires; tyres for vehicle wheels; vehicle tyres; automobile tires [tyres]; pneumatic tires [tyres]; bicycle tyres; solid tyres for vehicle wheels; inner tubes for pneumatic tires; tyre tread [tractor type].

(260) AM 2021 109988 A

(800) 1552973

(151) 2020 08 18

(891) 2020 08 18

(731) Alcon Inc.

Rue Louis-d'Affry 6, CH-1701 Fribourg, Switzerland

(540)

Systeme
iLux²

(591) Black, white

(531) 01.15.15; 27.05.10

(511)

10 – Medical and surgical ophthalmic instruments and apparatus.

(260) AM 2021 109989 A

(800) 1553011

(151) 2020 05 22

(891) 2020 05 22

(731) Ally Financial Inc.

500 Woodward Avenue, Detroit MI 48226, USA

(540)



(591) Black, white

(531) 27.05.21

(511)

36 – Providing information in the fields of foreign currency, commodities, financial derivatives, interest rate products, and equities via the Internet and intranet systems; providing financial services, namely, motor vehicle loans, financing services, financing for motor vehicles, asset-based lending, commercial cash flow lending, structured financing, consumer lending services, vehicle title loan services, and revolving loans; insurance services, namely, insurance underwriting and insurance claims processing of extended motor vehicle service contracts for the repair and maintenance of motor vehicles; financial information provided by electronic and audio means; providing customer bank account information via voice-controlled automated inquiries; extended warranty services, namely, insurance underwriting; real estate mortgage banking and lending services; origination, acquisition, servicing, securitization and brokerage of mortgage loans; loan origination and financing via a global communications network; home equity loans; wealth management services; strategic investment services, namely, strategic investment risk assessment services, strategic corporate financial investment advisory services; venture capital services, namely, venture capital advisory services, providing financing to emerging and start-up companies; banking and financing services; online banking services; online banking services accessible by means of downloadable mobile applications; online debit card services, namely, processing of financial transactions, financial consultancy relating to transactions, account balances and spending featuring electronic alerts related to spending, all accessible by means of downloadable mobile applications; automobile dealer inventory financing; financing loans for car dealerships and small businesses; automobile lease financing.

(260) AM 2021 109990 A

(800) 1553033

(151) 2020 07 28

(891) 2020 07 28

(731) Alcon Inc.

Rue Louis-d'Affry 6, CH-1701 Fribourg, Switzerland

(540)

X-WAVE

(591) Black, white

(511)

10 – Ophthalmic medical and surgical instruments and apparatus used in ophthalmic surgery; intraocular lenses.

(260) AM 2021 109991 A

(800) 1553056

(151) 2020 08 20

(891) 2020 08 20

(731) Limited Liability Company "Evrosnack-YUG"
Imama Shamilya pr-kt, 76, korp. A, 5/1,
Makhachkala, RU-367026 Respublika
Dagestan, Russian Federation

(540)



(591) Black, white, light green, green, dark red, red, orange, blue, pink, yellow and purple

(531) 01.15.11; 02.07.10; 27.03.12; 27.05.01; 29.01.15

(511)

30 – Baozi [stuffed buns]; cereal bars; high-protein cereal bars; pancakes; noodle-based prepared meals; buns; bread rolls; waffles; malt biscuits; rice-based snack food; cereal-based snack food; zephyr [confectionery]; fruit jellies [confectionery]; candy decorations for cakes; confectionery for decorating Christmas trees; cakes; pastries; peanut confectionery; almond confectionery; pasta; frozen yogurt [confectionery ices]; caramels [candy]; quiches; sweetmeats [candy]; liquorice [confectionery]; peppermint sweets; mints for breath freshening; dulce de leche; crackers; custard; meat pies; couscous; noodles; candies; rice cakes; macaroons [pastry]; macaroni; hominy; marzipan; honey; royal jelly; ice cream; dessert mousses [confectionery]; chocolate mousses; muesli; chocolate-coated nuts; stick liquorice [confectionery]; pastila [confectionery]; pastilles [confectionery]; molasses for food; cookies; petit-beurre biscuits; pies; pizzas; fondants [confectionery]; popcorn; pralines; cereal preparations; gingerbread; petits fours [cakes]; puddings; cake powder; ravioli; spring rolls; confectionery; sherbets [ices]; rusks; breadcrumbs; senbei [rice crackers]; sandwiches; tabbouleh; tacos; tarts; dough; pastry dough; almond paste; cake dough; halvah; bread; unleavened bread; chips [cereal products]; corn flakes; chocolate.

(260) AM 2021 109992 A

(800) 1553131

(151) 2020 02 27

(891) 2020 02 27

(731) JUPITER ONE LTD.

20-22 Wenlock Road, London N1 7GU,
United Kingdom

(540)

Real Estate Matching

(591) Blue, white

(531) 14.05.01; 14.05.02; 14.05.18; 26.04.05; 26.04.16; 26.04.24; 27.05.01; 29.01.04

(511)

36 – Issuance of prepaid cards and tokens of value; safe deposit services; financial and monetary services, and banking; valuation services; fundraising and financial sponsorship; real estate services; finance services; real estate affairs; insurance underwriting; monetary affairs.

(260) AM 2021 109993 A

(800) 1553160

(151) 2020 08 28

(891) 2020 08 28

(731) Miconvey Technologies Co., LTD.

No. 56, No. 117, Yunhan Avenue, Beibei
District, Chongqing, China

(540)

AUTO FORCE

(591) Black, white

(531) 27.05.10; 27.05.15

(511)

10 – Medical apparatus and instruments; veterinary apparatus and instruments; ultrasound apparatus for use in medical; surgical sponges; feeding bottles; contraceptives, non-chemical; orthopedic articles; suture materials; fumigation apparatus for medical purposes; surgical implants comprised of artificial materials.

(260) AM 2021 109994 A

(800) 1553178

(151) 2020 05 04

(891) 2020 05 04

(731) "Amalgame Luxe", Community with limited
Responsibility
Hromadyanska Str, 119, of. 109, Mykolayiv
54017, Ukraine

(540)



(591) Red, white and orange

(531) 25.05.02; 26.04.02; 26.04.18; 28.05; 29.01.13

(511)

3 – Abrasives; glass cloth [abrasive cloth]; abrasive paper; breath freshening sprays; diamantine [abrasive]; alum stones [astringents]; amber [perfume]; ammonia [volatile alkali] [detergent]; antiperspirants [toiletries]; antistatic preparations for household purposes; flavorings for beverages [essential oils]; cake flavorings [essential oils]; food flavorings [essential oils]; joss sticks; aromatics [essential oils]; potpourris [fragrances]; balms, other than for medical purposes; basma [cosmetic dye]; bergamot oil; whitening; lip glosses; nail glitter; badian essence; vaginal washes for personal sanitary or deodorant purposes; petroleum jelly for cosmetic purposes; cotton wool for cosmetic purposes; cotton wool impregnated with make-up removing preparations; cotton sticks for cosmetic purposes; bleaching soda; laundry bleach; bleaching preparations [decolorants] for cosmetic purposes; bleaching preparations [decolorants] for household purposes; bleaching preparations and other substances for laundry use; bleaching salts; decorative transfers for cosmetic purposes; shoe wax; mustache wax; depilatory wax; wax for parquet floors; floor wax; volcanic ash for cleaning; astringents for cosmetic purposes; cloths impregnated with a detergent for cleaning; galtheria oil; dental bleaching gels; heliotropine; geraniol; make-up; lipsticks; deodorants for pets; deodorants for human beings or for animals; detergents, other than for use in manufacturing operations and for medical purposes; scented water; scented wood; extracts of flowers [perfumes]; herbal extracts for cosmetic purposes; ethereal essences; essential oils; essential oils of cedarwood; essential oils of lemon; essential oils of citron; Javelle water; jasmine oil; greases for cosmetic purposes; colorants for toilet purposes; preservatives for leather [polishes]; color-removing preparations; degreasers, other than for use in manufacturing processes; toothpaste; dentifrices; ionone [perfumery]; shaving stones [astringents]; carbides of metal [abrasives]; silicon carbide [abrasive]; adhesives for affixing false eyelashes; adhesives for affixing false hair; adhesives for cosmetic purposes; collagen preparations for cosmetic purposes; hair con-

ditioners; quillaia bark for washing; corundum [abrasive]; cosmetics; eyebrow cosmetics; cosmetics for children; cosmetics for animals; beauty masks; cosmetic preparations for baths; cosmetic preparations for eyelashes; cosmetic preparations for skin care; cosmetic preparations for slimming purposes; tailors' wax; shoe cream; skin whitening creams; creams for leather; polishing creams; cosmetic creams; starch glaze for laundry purposes; laundry starch; lavender water; lavender oil; incense; hair spray; nail polish; hair lotions; lotions for cosmetic purposes; after-shave lotions; massage gels, other than for medical purposes; massage candles for cosmetic purposes; non-slipping wax for floors; almond oil; almond milk for cosmetic purposes; washing soda, for cleaning; soap; deodorant soap; shaving soap; soap for brightening textile; cakes of toilet soap; almond soap; antiperspirant soap; soap for foot perspiration; micellar water; musk [perfumery]; mint for perfumery; mint essence [essential oil]; cosmetic kits; emery; emery cloth; emery paper; nail art stickers; neutralizers for permanent waving; non-medicated cosmetics and toiletry preparations; non-medicated dentifrices; non-medicated soaps; fumigation preparations [perfumes]; eau de Cologne; eyebrow pencils; cosmetic pencils; oils for toilet purposes; oils for perfumes and scents; oils for cosmetic purposes; oils for cleaning purposes; oil of turpentine for degreasing; mouthwashes, not for medical purposes; bases for flower perfumes; drying agents for dishwashing machines; cleansing milk for toilet purposes; cleansers for intimate personal hygiene purposes, non medicated; scouring solutions; perfumery, perfumery, essential oils; perfumery, essential oils, non-medicated cosmetics, non-medicated hair lotions; toiletry preparations; perfumes; perfumery, essential oils, cosmetics, hair lotions; pastes for razor strops; gel eye patches for cosmetic purposes; pumice stone; hydrogen peroxide for cosmetic purposes; polishing wax; polishing paper; polishing rouge; polishing stones; polishing preparations; shoe polish; polish for furniture and flooring; pomades for cosmetic purposes; fabric softeners for laundry use; laundry blueing; laundry preparations; air fragrancing preparations; bath preparations, not for medical purposes; leather bleaching preparations; floor wax removers [scouring preparations]; rust removing preparations; varnish-removing preparations; paint stripping preparations; descaling preparations for household purposes; stain removers; lacquer-removing preparations; hair straightening preparations; shaving preparations; depilatory preparations; nail care preparations; hair waving preparations; laundry soaking preparations; sun-tanning preparations [cosmetics]; make-up removing preparations; make-up preparations; laundry glaze; preparations to make the leaves of plants shiny; shining preparations [polish]; breath freshening preparations for personal hygiene; denture polishes; preparations for unblocking drain pipes; smoothing preparations [starching]; dry-cleaning preparations; prepa-

rations for cleaning dentures; wallpaper cleaning preparations; aloe vera preparations for cosmetic purposes; air fragrance reed diffusers; make-up powder; nail varnish removers; windshield cleaning liquids; non-slipping liquids for floors; eye-washes, not for medical purposes; safrol; sachets for perfuming linen; baby wipes impregnated with cleaning preparations; antistatic dryer sheets; tissues impregnated with cosmetic lotions; tissues impregnated with make-up removing preparations; colour run prevention laundry sheets; turpentine for degreasing; teeth whitening strips; breath freshening strips; soda lye; bath salts, not for medical purposes; sunscreen preparations; do-uching preparations for personal sanitary or deodorant purposes [toiletries]; canned pressurized air for cleaning and dusting purposes; talcum powder, for toilet use; terpenes [essential oils]; tripoli stone for polishing; rose oil; toilet water; mascara; beard dyes; hair dyes; liquid latex body paint for cosmetic purposes; body paint for cosmetic purposes; cosmetic dyes; phytocosmetic preparations; lipstick cases; color-brightening chemicals for household purposes [laundry]; henna [cosmetic dye]; cleaning chalk; cleaning, polishing, scouring and abrasive preparations; cleaning preparations; chemical cleaning preparations for household purposes; shampoos; shampoos for pets [non-medicated grooming preparations]; shampoos for animals [non-medicated grooming preparations]; dry shampoos; cobblers' wax; shoemakers' wax; sandpaper; abrasive cloth; smoothing stones; grinding preparations; false eyelashes; false nails.

5 – Adjuvants for medical purposes; cooling sprays for medical purposes; acaricides; aconitine; alkaloids for medical purposes; albumin dietary supplements; alginates for pharmaceutical purposes; alginate dietary supplements; algicides; aldehydes for pharmaceutical purposes; amino acids for veterinary purposes; amino acids for medical purposes; analgesics; anaesthetics; antibiotics; vermifuges; anti-uric preparations; antiseptics; first-aid boxes, filled; aluminium acetate for pharmaceutical purposes; acetates for pharmaceutical purposes; germicides; bacterial preparations for medical and veterinary use; bacteriological preparations for medical and veterinary use; oxygen cylinders, filled, for medical purposes; balms for medical purposes; balsamic preparations for medical purposes; royal jelly for pharmaceutical purposes; tobacco-free cigarettes for medical purposes; bandages for dressings; bicarbonate of soda for pharmaceutical purposes; albuminous preparations for medical purposes; albuminous foodstuffs for medical purposes; biological preparations for veterinary purposes; biological preparations for medical purposes; biocides; bismuth subnitrate for pharmaceutical purposes; linseed meal for pharmaceutical purposes; flour for pharmaceutical purposes; bracelets impregnated with insect repellent; bromine for pharmaceutical purposes; bronchodilating preparations; vaginal washes for medical purposes;

petroleum jelly for medical purposes; vaccines; absorbent cotton; antiseptic cotton; aseptic cotton; cotton for medical purposes; wadding for medical purposes; cotton sticks for medical purposes; veterinary preparations; tartar for pharmaceutical purposes; decoctions for pharmaceutical purposes; vitamin preparations; mineral waters for medical purposes; hydrated chloral for pharmaceutical purposes; dietary fiber; charcoal for pharmaceutical purposes; astringents for medical purposes; gases for medical purposes; gallic acid for pharmaceutical purposes; guaiacol for pharmaceutical purposes; sexual stimulant gels; hematogen; hemoglobin; hemostatic pencils; herbicides; sanitary preparations for medical purposes; sanitary tampons; hydrastine; hydrastinine; mustard for pharmaceutical purposes; mustard oil for medical purposes; mustard plasters; glycerine for medical purposes; glycerophosphates; glucose for medical purposes; homogenized food adapted for medical purposes; hormones for medical purposes; mud for baths; medicinal mud; vulnery sponges; contraceptive sponges; rubber for dental purposes; gamboge for medical purposes; gurjun balsam for medical purposes; disinfectants; disinfectants for chemical toilets; disinfectants for hygiene purposes; deodorants for clothing and textiles; deodorants, other than for human beings or for animals; cedar wood for use as an insect repellent; detergents for medical purposes; digitalin; infant formula; diagnostic preparations for veterinary purposes; diagnostic preparations for medical purposes; diastase for medical purposes; dietary supplements for human beings and animals; dietary supplements for animals; royal jelly dietary supplements; glucose dietary supplements; pollen dietary supplements; dietary supplements with a cosmetic effect; linseed dietary supplements; linseed oil dietary supplements; acai powder dietary supplements; propolis dietary supplements; wheat germ dietary supplements; dietetic beverages adapted for medical purposes; dietetic food and substances adapted for medical or veterinary use, food for babies; dietetic substances adapted for medical use; dietetic foods adapted for medical purposes; yeast for pharmaceutical purposes; yeast dietary supplements; eucalyptus for pharmaceutical purposes; eucalyptol for pharmaceutical purposes; plant extracts for pharmaceutical purposes; extracts of hops for pharmaceutical purposes; elixirs [pharmaceutical preparations]; enzymes for veterinary purposes; enzymes for medical purposes; enzyme dietary supplements; enzyme preparations for medical purposes; esters for pharmaceutical purposes; cellulose esters for pharmaceutical purposes; ethers for pharmaceutical purposes; cellulose ethers for pharmaceutical purposes; febrifuges; gelatine for medical purposes; milking grease; greases for veterinary purposes; greases for medical purposes; nicotine gum for use as an aid to stop smoking; chewing gum for medical purposes; nervines; bunion pads; isotopes for medical purposes; immunostimulants; reagent paper

for medical or veterinary purposes; reagent paper for veterinary purposes; reagent paper for medical purposes; insecticides; Irish moss for medical purposes; alkaline iodides for pharmaceutical purposes; iodides for pharmaceutical purposes; iodine for pharmaceutical purposes; iodoform; casein dietary supplements; calomel [fungicide]; gum for medical purposes; camphor for medical purposes; camphor oil for medical purposes; capsules for medicines; capsules made of dendrimer-based polymers, for pharmaceuticals; carbolineum [parasiticide]; caustics for pharmaceutical purposes; caustic pencils; cachou for pharmaceutical purposes; quassia for medical purposes; quebracho for medical purposes; oxygen for medical purposes; acids for pharmaceutical purposes; oxygen baths; bone cement for surgical and orthopaedic purposes; fly glue; adhesive tapes for medical purposes; adhesives for dentures; cocaine; collagen for medical purposes; collodion for pharmaceutical purposes; compresses; chemical contraceptives; angostura bark for medical purposes; condurango bark for medical purposes; croton bark; mangrove bark for pharmaceutical purposes; myrobalan bark for pharmaceutical purposes; barks for pharmaceutical purposes; quinquina for medical purposes; rhubarb roots for pharmaceutical purposes; lint for medical purposes; collyrium; cream of tartar for pharmaceutical purposes; creosote for pharmaceutical purposes; blood for medical purposes; depuratives; styptic preparations; dill oil for medical purposes; starch for dietetic or pharmaceutical purposes; biological tissue cultures for veterinary purposes; biological tissue cultures for medical purposes; cultures of microorganisms for medical or veterinary use; curare; dental lacquer; breast-nursing pads; lactose for pharmaceutical purposes; adhesive plasters; lecithin for medical purposes; lecithin dietary supplements; fly catching paper; medicines for alleviating constipation; medicines for human purposes; medicines for veterinary purposes; drugs for medical purposes; medicines for dental purposes; medicinal roots; medicated animal feed; medicinal tea; corn remedies; remedies for perspiration; remedies for foot perspiration; medicated toothpaste; medicated dentifrices; medicated hair lotions; medicated after-shave lotions; medicinal drinks; medicinal infusions; medicinal oils; medicated toiletry preparations; medicinal hair growth preparations; medicated eye-washes; medicinal herbs; liniments; liquorice for pharmaceutical purposes; lotions for veterinary purposes; lotions for pharmaceutical purposes; personal sexual lubricants; lupulin for pharmaceutical purposes; magnesia for pharmaceutical purposes; sunburn ointments; ointments for pharmaceutical purposes; frostbite salve for pharmaceutical purposes; gauze for dressings; massage gels for medical purposes; massage candles for therapeutic purposes; bone void fillers comprised of living tissues; dental impression materials; teeth filling material; material for dental fillings and dental impressions; diaper changing mats, disposable, for babies; medic-

nal alcohol; medicine cases, portable, filled; medical preparations for slimming purposes; melissa water for pharmaceutical purposes; menthol; almond milk for pharmaceutical purposes; antibacterial handwashes; dog washes [insecticides]; animal washes [insecticides]; cattle washes [insecticides]; insecticidal veterinary washes; antibacterial soap; disinfectant soap; medicated soap; mineral food supplements; molding wax for dentists; moleskin for medical purposes; powdered milk for babies; lacteal flour for babies; milk ferments for pharmaceutical purposes; sea water for medicinal bathing; mint for pharmaceutical purposes; vitamin supplement patches; nicotine patches for use as aids to stop smoking; scapulars for surgical purposes; vesicants; narcotics; linseed for pharmaceutical purposes; tincture of iodine; tinctures for medical purposes; nutraceutical preparations for therapeutic or medical purposes; fumigating sticks; fumigation preparations for medical purposes; cachets for pharmaceutical purposes; wart pencils; oil of turpentine for pharmaceutical purposes; opiates; opium; opodeldoc; mouthwashes for medical purposes; rat poison; poisons; bacterial poisons; headache relief sticks; stick liquorice for pharmaceutical purposes; paper for mustard plasters; mothproofing paper; parasiticides; pastilles for pharmaceutical purposes; pectin for pharmaceutical purposes; pepsins for pharmaceutical purposes; peptones for pharmaceutical purposes; dressings, medical; hydrogen peroxide for medical purposes; pearl powder for medical purposes; pesticides; antioxidant pills; tanning pills; appetite suppressant pills; slimming pills; babies' diapers; diapers for pets; swim diapers, reusable, for babies; swim diapers, disposable, for babies; diapers for incontinence; babies' diaper-pants; blood plasma; plasters, materials for dressings; by-products of the processing of cereals for dietetic or medical purposes; eyepatches for medical purposes; nutritional supplements; nutritive substances for microorganisms; media for bacteriological cultures; pomades for medical purposes; powder of cantharides; pyrethrum powder; porcelain for dental prostheses; laxatives; bismuth preparations for pharmaceutical purposes; hemorrhoid preparations; preparations for callouses; chilblain preparations; pre-filled syringes for medical purposes; bath preparations for medical purposes; air deodorising preparations; mothproofing preparations; preparations for reducing sexual activity; preparations for destroying dry rot fungus; larvae exterminating preparations; preparations for destroying mice; fly destroying preparations; slug exterminating preparations; preparations for destroying noxious animals; vermin destroying preparations; acne treatment preparations; preparations for the treatment of burns; lice treatment preparations [pediculicides]; ootherapy preparations; air purifying preparations; appetite suppressants for medical purposes; sterilising preparations; soil-sterilising preparations; contact lens cleaning preparations; aloe vera preparations for pharmaceutical purposes; preparations of trace elements for hu-

man and animal use; preparations of microorganisms for medical or veterinary use; preparations to facilitate teething; poultices; chemical conductors for electrocardiograph electrodes; food for babies; sanitary towels; purgatives; propolis for pharmaceutical purposes; protein dietary supplements; protein supplements for animals; asthmatic tea; corn rings for the feet; antiparasitic collars for animals; antiparasitic preparations; anticryptogamic preparations; leeches for medical purposes; radium for medical purposes; radioactive substances for medical purposes; diagnostic biomarker reagents for medical purposes; radiological contrast substances for medical purposes; insect repellents; insect repellent incense; repellents for dogs; digestives for pharmaceutical purposes; fish meal for pharmaceutical purposes; cod liver oil; castor oil for medical purposes; ergot for pharmaceutical purposes; solutions for contact lenses; solvents for removing adhesive plasters; cannabis for medical purposes; mercurial ointments; sarsaparilla for medical purposes; lead water; sedatives; tissues impregnated with pharmaceutical lotions; serotherapeutic medicines; siccatives [drying agents] for medical purposes; serums; syrups for pharmaceutical purposes; sulfur sticks [disinfectants]; turpentine for pharmaceutical purposes; soporifics; salts for mineral water baths; bath salts for medical purposes; smelling salts; potassium salts for medical purposes; mineral water salts; salts for medical purposes; sodium salts for medical purposes; malt for pharmaceutical purposes; malted milk beverages for medical purposes; semen for artificial insemination; alcohol for pharmaceutical purposes; alloys of precious metals for dental purposes; douching preparations for medical purposes; steroids; stem cells for veterinary purposes; stem cells for medical purposes; dental abrasives; dental amalgams; dental amalgams of gold; dental mastics; dental cements; strychnine; freeze-dried meat adapted for medical purposes; freeze-dried food adapted for medical purposes; sulfonamides [medicines]; suppositories; therapeutic preparations for the bath; thermal water; thymol for pharmaceutical purposes; gentian for pharmaceutical purposes; tonics [medicines]; smoking herbs for medical purposes; herbal teas for medicinal purposes; transplants [living tissues]; pants, absorbent, for incontinence; sanitary panties; tobacco extracts [insecticides]; pharmaceuticals, medical and veterinary preparations; pharmaceutical preparations; pharmaceutical preparations for treating dandruff; pharmaceutical preparations for skin care; pharmaceutical preparations for treating sunburn; lime-based pharmaceutical preparations; pharmaceuticals; phenol for pharmaceutical purposes; fennel for medical purposes; ferments for pharmaceutical purposes; enzyme preparations for veterinary purposes; injectable dermal fillers; phytotherapy preparations for medical purposes; formic aldehyde for pharmaceutical purposes; phosphates for pharmaceutical purposes; fungicides; fungicides, herbicides; chemico-pharmaceutical preparations; chemi-

cal preparations for the diagnosis of pregnancy; chemical preparations for treating wheat blight; chemical preparations for treating phylloxera; chemical preparations for treating diseases affecting vine plants; chemical preparations for treating diseases affecting cereal plants; chemical preparations for treating mildew; chemical preparations for veterinary purposes; chemical preparations for medical purposes; chemical preparations for pharmaceutical purposes; chemical reagents for medical or veterinary purposes; quinine for medical purposes, chinoline for medical purposes; surgical implants comprised of living tissues; surgical glues; surgical dressings; diabetic bread adapted for medical use; chloroform; flowers of sulfur for pharmaceutical purposes; cement for animal hooves; medicated sweets; crystallized rock sugar for medical purposes; sugar for medical purposes; medicated shampoos for pets; insecticidal animal shampoos; medicated shampoos; pediculicidal shampoos; medicated dry shampoos; panty liners [sanitary]; jujube, medicated; jalap.

(260) AM 2021 110008 A

(800) 1365758

(151) 2017 05 04

(891) 2020 09 16

(731) Daimler AG

Mercedesstrasse 120, 70372 Stuttgart,
Germany

(540)

SELECTRUCKS

(591) Black, white

(511)

12 – Motor vehicles and their parts [included in this class].

35 – Wholesale and retail services in connection with used vehicles; retail services in connection with vehicles; advisory services in connection with business management of vehicle fleet.

36 – Warranty services for used vehicles; vehicle insurance services; financing of vehicles, lease-purchase financing, advisory services relating to financing of vehicles.

37 – Repair and maintenance of vehicles.

(260) AM 2021 110009 A

(800) 1430868

(151) 2018 03 19

(891) 2020 08 14

(731) YIWU SUNMETA DIGITAL GRAPHIC CO.,
LTD

No. 199, Chunhan South Road, Beiyuan Jiedao,
Yiwu City, Zhejiang Province, China

(540)

FreesUB

(591) Black, white

(531) 27.05.09

(511)

7 – Printing presses; stamping machines; rotary printing presses; printing machines; inking apparatus for printing machines; typographic presses; printing rubber plates (terms considered too vague by the International Bureau – Rule 13 (2) (b) of the Common Regulations); satinizing machines; dyeing machines; hand-held tools, other than hand-operated.

(260) AM 2021 110010 A

(800) 1528394

(151) 2020 04 01

(891) 2020 09 14

(731) DORCO CO., LTD.

(Golim-Dong), 350 Kyungahnchun-Ro,
Cheoin-Gu, Yongin-Si, Kyunggi-Do,
Republic of Korea

(540)

EVE

(591) Black, white

(511)

8 – Razor cases; razor blade cases; razor blades; cartridges containing razor blades; razor knives; non-electric razors; disposable razors; straight razors.

(260) AM 2021 110047 A

(800) 1553365

(151) 2020 09 02

(891) 2020 09 02

(731) VIOKOX, S.A.

Calle nº 5, Parcela 10, Polígono Industrial de
Picassent, E-46220 PICASSENT
(VALENCIA), Spain

(540)

skintsugi

(591) Black, white

(531) 27.05.01

(511)

3 – Bleaching preparations; cleaning and aromatic preparations; laundry preparations; polishing preparations; degreasing preparations; abrasive preparations; soaps; perfumery products; essential oils; cosmetics; hair lotions; depilatory products; dentifrices.

260) AM 2021 110048 A

(800) 1553391

(151) 2020 06 03

(891) 2020 06 03

(731) HYUNDAI MOTOR COMPANY

12, Heolleung-ro, Seocho-gu, Seoul,
Republic of Korea

(540)

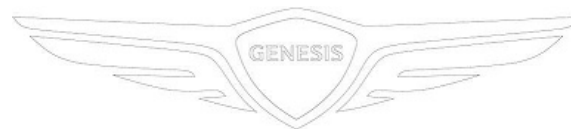

(591) Black, white

(531) 03.07.17; 24.01.15; 24.01.17; 27.05.02

(511)

28 – Golf flags [sports articles]; golf equipment; grip tapes for golf clubs; fitted protective covers specially adapted for golf clubs; shaped covers for golf putters; golf trolleys, motorized; non-motorized golf trolleys; model cars; tricycles for children (playthings); model vehicles for child; toys (playthings); scooters as toys; dolls; toys; scale model vehicles; radio-controlled scale model vehicles; remote-controlled scale model vehicles; toy cars; toys designed to be attached to car seats; electric ride-on toy cars for children or infants; golf balls; golf practice balls; markers for golf balls; golf tees; golf gloves; golf bags with or without wheels; bag stands for golf bags; automatic golf ball dispenser; counters for golf; covers for golf clubs; divot repair tools [golf accessories]; fitted head covers for golf clubs; golf bag carts; golf bag trolleys; golf ball markers; golf ball return; golf ball dispenser; golf club bags; golf club covers; golf club grips; golf club heads; golf club shafts; golf club; golf drivers; golf flags; golf nets; golf practice nets; golf putters; golf putting alignment apparatus; golf putting exercising apparatus; golf putting mat; golf swing alignment apparatus; golf swing analyzer; golf swing exercisers; golf bag tags; golf tee bags; repair apparatus for repairing divot; stands specially adapted for holding golf clubs; trolley bags for golf equipment; driving practice mats [golf articles]; golf bag straps; shaped covers for golf bags; golf ball retrievers; golf irons.

(260) AM 2021 110061 A

(800) 1553683

(151) 2020 07 15

(891) 2020 07 15

(731) Bugatti International S.A.

412F route d'Esch, L-1030 Luxembourg,
Luxembourg

(540)

BUGATTI

(591) Black, white

(511)

8 – Hand tools and implements, hand-operated; cutlery; side arms, except firearms; razors; razors, elec-

tric or non-electric; razor blades, razor strops, razor cases, razor knives, razor blade dispensers, cartridges containing razor blades, cassettes for razor blades, containers adapted for razor blades.

9 – Scientific, research, navigation, surveying, photographic, cinematographic, audiovisual, optical, weighing, measuring, signalling, detecting, testing, inspecting, life-saving and teaching apparatus and instruments; apparatus and instruments for conducting, switching, transforming, accumulating, regulating or controlling the distribution or use of electricity: apparatus and instruments for recording, transmitting, reproducing or processing sound, images or data; recorded and downloadable media, computer software, blank digital or analogue recording and storage media; mechanisms for coin-operated apparatus; cash registers, calculating devices; computers and computer peripheral devices; diving suits, divers' masks, ear plugs for divers, nose clips for divers and swimmers, gloves for divers, breathing apparatus for underwater swimming; fire-extinguishing apparatus; power cables, chargers, battery chargers, portable chargers, charging docks, battery cases, cases adapted for battery chargers; headphones, in-car headphones, cases for headphones, adapter cables for headphones, ear pads for headphones, two-way plugs for headphones, headphone stands; loudspeakers, loudspeaker stands, loudspeaker systems, loudspeaker cables, racks for loudspeakers, cases for loudspeakers, loudspeakers with built in amplifiers; soundbars, hi-fi sound systems; audio amplifiers, audio cable; audio apparatus; parts and fittings for audio apparatus; audio players, audio devices and radio receivers, racks adapted to house audio apparatus.

(260) AM 2021 110062 A
(800) 1553711
(151) 2020 09 09
(891) 2020 09 09
(731) Shenzhen Century Digital Technology Co., Ltd.
Block C 39A, Electronic Science and
Technology Building, 2070 Shennan Middle
Road, Fuqiang Community, Huaqiang North
Street Futian District, Shenzhen, Guangdong,
China

(540)

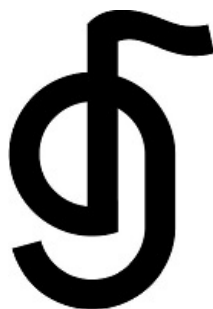

(591) Black, white
(531) 26.11.12; 27.01.13; 27.03.15

(511)
9 – Selfie sticks for mobile phones; smartwatches (data processing apparatus); earphones; wearable activity trackers; USB cables for cellular phones; headphones; cabinets for loudspeakers; 3D spectacles; battery chargers.

(260) AM 2021 110063 A
(800) 1553717
(151) 2020 07 28
(891) 2020 07 28
(731) Ludovico Martelli S.p.A.
Via Faentina 169/12, I-50014 Fiesole,
Firenze, Italy

(540)

FLOID

(591) Black, white

(511)

3 – Non-medicated cosmetics; non-medicated toiletry preparations; non-medicated toilet soaps; non-medicated dentifrices; non-medicated mouthwashes; fragrances and perfumery; eau de cologne; eau de toilette; essential oils for cosmetic purposes, non-medicated skin care preparations; non-medicated bath soaps in liquid, solid or gel form; non-medicated body soaps, cakes of non-medicated soap, non-medicated cosmetic soaps; perfumed soaps; non-medicated soaps for body care; non-medicated beauty soaps; non-medicated soaps for personal use; non-medicated soaps for toilet purposes; non-medicated beauty creams for body care; non-medicated body and beauty care cosmetics; non-medicated body lotions; pre-shave and after-shave preparations; pre-shave creams; shaving balm; shaving creams; shaving foam; shaving gels; shaving lotions; shaving mousse; shaving preparations; shaving soaps; exfoliating shaving paste and powders; non-medicated shaving oils.

(260) AM 2021 110065 A
(800) 1553798
(151) 2020 07 24
(891) 2020 07 24
(731) Santen Pharmaceutical Co., Ltd.
4-20 Ofuka-cho, Kita-ku, Osaka-shi,
Osaka 530-8552, Japan

(540)

ПЬЮРАЛИД

(591) Black, white

(531) 28.05

(511)

3 – Non-medical skin cleansing preparations.

5 – Ophthalmic preparations and sanitary preparations.

(260) AM 2021 110066 A

(800) 1553812

(151) 2020 08 27

(891) 2020 08 27

(731) LYKOS Pharma Ltd

7 Sir William Reid Street, GZR 1039 Gzira,
Malta

(540)

Fe **ratin**

(591) Red

(531) 26.04.02; 26.04.05; 26.04.18; 26.04.19;
29.01.01

(511)

5 – Dietary food supplements; nutritional supplements consisting primarily of iron; food supplements for sportsmen; food supplements for non-medical purposes; vitamin and mineral food supplements.

(260) AM 2021 110068 A

(800) 1553851

(151) 2020 07 17

(891) 2020 07 17

(731) TCL Technology Group Corporation

TCL Technology Building, 17 Huifeng 3rd
Road, Zhongkai High, Technology
Development District, Huizhou, Guangdong,
China

(540)

TCL
CHANNEL

(591) Black, white

(531) 26.03.01; 27.05.01

(511)

9 – Computers; data processing apparatus; couplers [data processing equipment]; humanoid robots with artificial intelligence; recorded computer operating programs; recorded computer programs, for providing online videos, entertainment, online films, online music, online games and online education; recorded computer software, for providing online videos, entertainment, online films, online music, online games and online education; downloadable computer programs, for providing online videos, entertainment, online films, online music, online games and online education; recorded or downloadable computer software platforms, for providing online videos, entertainment, online films, online music, online games and online education; downloadable computer software applications, for providing online videos, entertainment, online

films, online music, online games and online education; downloadable smartphone software applications, for providing online videos, entertainment, online films, online music, online games and online education; cellular phones; television apparatus; cabinets for loudspeakers; headsets; microphones; audio- and video-receivers; video projectors; video screens.

35 – Advertising for others; business management consultancy; public relations; providing business information via a web site; sales promotion for others; procurement services for others [purchasing goods and services for other businesses]; marketing; provision of an online marketplace for buyers and sellers of goods and services; systemization of information into computer databases.

41 – Teaching; organization of competitions in the field of education and entertainment; organization of sports competitions; lending library services; providing online electronic publications, not downloadable; television entertainment; providing online music, not downloadable; providing online videos, not downloadable; providing films, not downloadable, via video-on-demand services; providing television programs, not downloadable, via video-on-demand services; entertainment services; game services provided online from a computer network.

(260) AM 2021 110069 A

(800) 1553912

(151) 2020 07 16

(891) 2020 07 16

(731) Future Enterprises Pte. Ltd.

31 HARRISON ROAD, #08-01 FOOD
EMPIRE BUILDING, Singapore 369649,
Singapore

(540)



(591) Background in special pink and tone of pink

(531) 02.03.01; 02.03.04; 02.03.11; 05.07.06;
05.07.27; 11.03.04; 11.03.05; 11.03.14;
19.03.05; 25.01.06; 25.01.25; 26.01.02;
26.01.14; 28.05; 29.01.15

(511)

30 – Coffee; iced coffee; coffee beans; coffee drinks; ground coffee; instant coffee; cappuccino; flavoured

coffee; coffee-based beverages; coffee substitutes; chicory [coffee substitute]; coffee beverages with milk; coffee mixtures; cocoa; cocoa mixes; cocoa powder; hot cocoa mix; cocoa beverages; cocoa-based beverages; cocoa beverages with milk; tea; iced tea; black tea; green tea; fruit flavoured tea; tea-based beverages; tea-based beverages with fruit flavoring; chocolate-based beverages.

35 – Wholesale services; retail services; advertising, marketing and promotional services.

(260) AM 2021 110070 A

(800) 1553945

(151) 2020 05 01

(891) 2020 05 01

(731) "Grand Tobacco" LLC

Shahamiryanneri street 22, 0061 Yerevan,
Armenia

(540)



(591) Silver, white, blue and grey

(531) 19.03.03; 25.07.20; 26.04.06; 26.04.07;
26.04.18; 26.04.24; 26.13.25; 27.05.03;
27.05.09; 29.01.14

(511)

34 – Raw and manufactured tobacco; cigarettes; cigarrillos; cigars; snuff; electronic cigarettes; liquid solutions for use in electronic cigarettes; chewing tobacco; cigarettes containing tobacco substitutes, not for medical purposes; herbs for smoking; cigarette filters; matches; matchboxes; lighters for smokers; wicks adapted for cigarette lighters; match holders; tips of yellow amber for cigar and cigarette holders; tobacco pouches; cigarette tips; gas containers for cigar lighters; tobacco pipes; books of cigarette papers; absorbent paper for tobacco pipes; cigar cutters; cigar cases; cigarette cases; cigar holders; pocket machines for rolling cigarettes; cigarette holders; mouthpieces for cigarette holders; cigarette paper; pipe cleaners for tobacco pipes; firestones; pipe racks for tobacco pipes; tobacco jars; snuff boxes; ashtrays for smokers; spittoons for tobacco users; humidors; oral vaporizers for smokers; flavourings, other than essential oils, for tobacco; flavourings, other than essential oils, for use in electronic cigarettes; hookahs; accessories and articles for hookahs (including hookah clay bowls and

headgears, hookah hose, hookah pipes and filters, hookah hooks, hookah hoses with pipes (mouthpieces), hookah shafts, bags and cases for hookah, hookah water bowls); tobacco, smoking herb and molasses aromatic mixtures for use in hookah.

(260) AM 2021 110071 A

(800) 1554005

(151) 2020 07 01

(891) 2020 07 01

(731) CLEMENTONI S.P.A.

Località Zona Industriale Fontenoce Snc,
I-62019 RECANATI (MC), Italy

(540)



(591) Black, white

(531) 26.01.03; 26.02.01; 27.05.01

(511)

9 – Computer software; video games software; electronic game software; computer game software; interactive multimedia game programs; joy sticks; computer and video game software; video game discs; video game cartridges; video game programs for computer; downloadable video game programs; apparatus for recording, transmission or reproduction of sound or images; audio- and video-receivers; headphones; MP3 players; computer mice; mouse pads; computer hardware; notebook computers; electronic agendas; tablet computers; keyboards for tablets; stands adapted for tablet computers; hand-held computers; software for tablet computers; radio alarm clocks; radios; DVDs; CD-ROMs; blank discs; pre-recorded audio and video DVDs and CD-ROMs; magnetic data carriers, recording discs; digital recording media; recorded tapes; data storage devices; USB flash drives; audiovisual teaching apparatus; audio books; digital books downloadable from the Internet; electronic book readers; electronic publications, downloadable; downloadable publications; electronic publications recorded on computer media; eyeglasses; sunglasses; eyeglass cases; eyeglass cords; eyeglass frames; spectacle lenses; binoculars; telescopes; optical apparatus and instruments; cellular phones; smartphones; smartwatches; telecommunication devices; portable telecommunication apparatus; telephone earpieces; batteries for cellular phones; battery chargers for cellular phones; selfie sticks [hand-held monopods]; auxiliary speakers for mobile phones; software for mobile phones; downloadable ring tones for mobile phones; cell phone covers; cases for smartphones; cellular phone covers made of cloth or textile materials; display screen protectors in the nature of films for mobile phones; cell phone straps; flip covers for tablet computers; bags adapted for laptops; cases adapted for computers; compact disc cases; DVD cases; bags for came-

ras; photographic apparatus and instruments; camera mounts; helmet cameras; helmet camera mounts; helmets for sports; data gloves; instructional and teaching apparatus and instruments; electronic interactive whiteboards.

28 – Games and playthings; dolls; dolls' clothing; dolls' clothing accessories; dolls' houses; furniture for dolls' houses; toy houses; bean bag dolls; carnival masks; toy figures; playsets for action figures; plush toys; marionettes; imitation cosmetic preparations being toys; parlour games; toys adapted for educational purposes; electronic educational teaching games; toy clocks and watches; electronic toys; hand-held electronic video games; free-standing video games apparatus; electronic games apparatus incorporating a liquid crystal display; free-standing video games machines; protective carrying cases specially adapted for handheld video games; mechanical toys; building games; toy building blocks; jigsaw puzzles; action skill games; chess games; board games; clockwork toys; magic tricks; playing cards; toy figures; musical toys; toy musical boxes; toy record cassette players; bathtub toys; infants' swings; multiple activity toys for babies; snow globes; marbles for games; spinning tops [toys]; novelty toys for parties; party favor hats; toy horns; Halloween masks; costume masks; carnival caps; toy money boxes; inflatable toys; bouncy castles; inflatable bath toys; stuffed toys; bubble making wand and solution sets; kites; toy buckets and spades; swimming rings; toy furniture; play tents; play mats incorporating infant toys [playthings]; toy bicycles; ride-on toy vehicles; scale model vehicles; toy scooters; toy cars; toy trucks; toy model hobby craft kits; water squirting toys; gymnastic and sporting articles; rubber balls; balloons; soccer balls; basketballs; baseballs; beach balls; bowling balls; tennis balls; tables for table tennis; golf balls; golf gloves; gloves for games; gloves made specifically for use in playing sports; baseball bats; hockey pucks; roller skates; scooters [toys]; snowboards; wakeboards; bags especially designed for skis and surfboards; protectors for elbows for use when riding bicycles [sports articles]; skipping rope; targets; punching bags; shuttlecocks; flying discs [toys]; paper party favours; paper party hats; streamers [party novelties]; decorations for Christmas trees, except illumination articles and confectionery; Christmas stockings, accessories for games; toy putty; toy jewellery; toy cookware; toy sewing sets; remote controls for operating flying toys.

(260) AM 2021 110083 A
(800) 1554369
(151) 2020 07 27
(891) 2020 07 27
(731) mytheresa.com GmbH
Einsteinring 9, 85609 Aschheim,
Germany

(540)

MYTHERESA

(591) Black, white

(531) 27.05.01

(511)

9 – Downloadable electronic publications; sunglasses; spectacles; spectacle frames; spectacle cases.

16 – Printed matter; printed publications.

18 – Luggage, bags, wallets and other carrying bags; luggage tags; vanity cases, not fitted; travelling sets; straps for handbags; make-up bags sold empty; shoulder bags; beach bags; hand bags; shopping bags; sports and leisure bags not adapted to their content; rucksacks; trunks; suitcases; travelling bags; beauty cases; school bags; satchels; purses; wallets; key cases of leather; key cases of imitation leather; umbrellas; parasols.

25 – Clothing; footwear; headgear.

35 – Retail services relating to clothing, footwear, headgear, luggage, bags, hand bags, wallets, spectacles, sunglasses and/or jewellery; online retail services and mail order retail services relating to clothing, footwear, headgear, luggage, bags, hand bags, wallets, spectacles, sunglasses and/or jewellery; the bringing together and displaying of clothing, footwear, headgear, luggage, bags, hand bags, wallets, spectacles, sunglasses and/or jewellery; advertising.

(260) AM 2021 110087 A

(800) 1554468

(151) 2020 06 09

(891) 2020 06 09

(731) DAIMLER AG

Mercedesstraße 120, 70372 Stuttgart, Germany

(540)

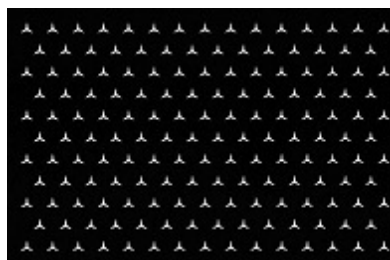

(591) Black and white

(531) 01.01.01; 01.01.08; 25.07.25; 26.04.05;
26.04.16; 26.04.24

(511)

3 – Bleaching preparations and other substances for laundry use; cleaning, polishing, scouring and abrasive preparations; soap; perfumery, essential oils; cosmetics; hair lotions; dentifrices; sandcloth; abrasive paper; adhesives for affixing false hair; adhesives for cosmetic purposes; alum stones [astringents]; antiper-

spirants [toiletries]; antistatic preparations for household purposes; bath salts, not for medical purposes; breath freshening sprays; cobblers' wax; cotton swabs for cosmetic purposes; cotton wool for cosmetic purposes; dental bleaching gels; denture polishes; emery cloth; emery paper; adhesives for affixing false eyelashes; false eyelashes; false nails; fumigation preparations [perfumes]; glass cloth [abrasive cloth]; sandpaper; incense; joss sticks; lacquer-removing preparations; preparations to make the leaves of plants shiny; sachets for perfuming linen; mouthwashes, not for medical purposes; paint stripping preparations; shampoos for pets [non-medicated grooming preparations]; polishing paper; potpourris [fragrances]; pumice stone; scented wood; shampoos; shaving stones [astringents]; shoemakers' wax; smoothing stones; tailors' wax; toiletry preparations; decorative transfers for cosmetic purposes; tripoli stone for polishing; varnish-removing preparations.

6 – Common metals and their alloys; metal materials for building and construction; buildings, transportable, of metal; railway material of metal; non-electric cables and wires of common metal; metal hardware; ironmongery; pipes and tubes of metal; safes [metal or non-metal]; building and construction materials and elements of metal; structures and transportable buildings of metal; statues and works of art of common metals; containers of metal for the storage and transportation of goods; packaging, wrapping and bundling articles, of metal; ores of metal; gold solder; silver solder; turnstiles.

7 – Electroplating apparatus.

9 – Scientific, nautical, surveying, photographic, cinematographic, optical, weighing, measuring, signalling, checking [supervision], life-saving and teaching apparatus and instruments; apparatus and instruments for conducting, switching, transforming, accumulating, regulating or controlling electricity; apparatus for recording, transmission or reproduction of sound or images; magnetic data media; phonograph records; mechanisms for coin-operated apparatus; cash registers; calculating devices; data processing apparatus; computers; fire extinguishers; asbestos clothing for protection against fire; asbestos gloves for protection against accidents; asbestos screens for firemen; protective suits for aviators; fire boats; breathing apparatus for underwater swimming; breathing apparatus, except for artificial respiration; bullet-proof waistcoats; cabinets for loudspeakers; animated cartoons; spectacle cases, except for snow goggles; cases especially made for photographic apparatus and instruments; cases fitted with dissecting instruments [microscopy]; spectacle chains; cleaning apparatus for phonograph records; nose clips for divers and swimmers; clothing especially made for laboratories; clothing for protection against accidents, irradiation and fire; clothing for protection against fire; holders for

electric coils; coin-operated mechanisms for operating gates for car parks or parking lots; computer gaming software; computer keyboards; computer peripheral devices; computer programs, recorded; computer programs, downloadable; computer software, recorded; holders for contact lenses; containers for contact lenses; containers for microscope slides; covers for electric outlets; diving equipment; divers' masks; diving suits; ear plugs for divers; electric installations for the remote control of industrial operations; electrified fences; electronic publications, downloadable; downloadable electronic publications; spectacle cords, except for snow goggles; spectacle frames, except for snow goggles; workmen's protective face-shields; filters for respiratory masks; fire beaters; fire blankets; fire engines; fire hose nozzles; furniture especially made for laboratories; coin-operated mechanisms for gates for car parks; gloves for divers; gloves for protection against accidents; gloves for protection against x-rays for industrial purposes; goggles for sports, except snow goggles; protective helmets, except ski helmets; protective helmets for sports, except ski helmets; riding helmets; interfaces for computers; juke boxes for computers; hands-free kits for telephones; knee-pads for workers; electronic locks; magnets; decorative magnets; protective masks; masts for wireless aerials; micrometer screws for optical instruments; monitors [computer programs]; mouse pads; safety nets; nets for protection against accidents; oxygen transvasing apparatus; plotters; computer operating programs, recorded; protection devices against x-rays, not for medical purposes; protection devices for personal use against accidents; push buttons for bells; railway traffic safety appliances; reflecting discs for wear, for the prevention of traffic accidents; respirators for filtering air; respiratory masks, other than for artificial respiration; safety restraints, other than for vehicle seats and sports equipment; retorts' stands; road signs, luminous or mechanical; safety tarpaulins; shoes for protection against accidents, irradiation and fire; signs, luminous; solderers' helmets; spark-guards; stands for photographic apparatus; steering apparatus, automatic, for vehicles; teeth protectors; theft prevention installations, electric; tripods for cameras; vehicle breakdown warning triangles; wrist rests for use with computers; credit cards; electronic machines for reading credit cards; credit card terminals; software for facilitating secure credit card transactions.

11 – Lighting and lighting reflectors; air-conditioning installations; heaters for vehicles; parts and accessories for the aforesaid goods.

12 – Vehicles; apparatus for locomotion by land, air or water; air bags [safety devices for automobiles]; air pumps [vehicle accessories]; anti-glare devices for vehicles; anti-skid chains; anti-theft alarms for vehicles; anti-theft devices for vehicles; coachwork for motor vehicles; automobile chains; automobile chassis; automobile hoods; automobile tyres; sun visors for auto-

mobiles; axle journals; axles for vehicles; prams; pushchair hoods; balance weights for vehicle wheels; bands for wheel hubs; torsion bars for vehicles; baskets adapted for bicycles; bells for bicycles; sleeping berths for vehicles; bicycle bells; bicycle brakes; bicycle chains; bicycle frames; bicycle handlebars; pumps for bicycle tyres; rims for bicycle wheels; bicycle saddles; spokes for bicycle wheels; bicycle kickstands; bicycle tyres; boat hooks; masts for boats; bodies for vehicles; bogies for railway cars; brake linings for vehicles; brake segments for vehicles; brake shoes for vehicles; brakes for vehicles; buffers for railway rolling stock; vehicle bumpers; bumpers for automobiles; caps for vehicle fuel tanks; luggage carriers for vehicles; casings for pneumatic tyres; casters for trolleys [vehicles] [carts (Am.)]; vehicle chassis; cleaning trolleys; cleats [nautical]; spoke clips for wheels; clutches for land vehicles; connecting rods for land vehicles, other than parts of motors and engines; torque converters for land vehicles; railway couplings; couplings for land vehicles; seat covers for vehicles; covers for vehicle steering wheels; crankcases for land vehicle components, other than for engines; bicycle cranks; cycle bells; hubs for bicycle wheels; bicycle mudguards; cycle stands; davits for boats; direction indicators for bicycles; signal arms for vehicles; disengaging gear for ships; doors for vehicles; dress guards for bicycles; driving chains for land vehicles; driving motors for land vehicles; ejector seats for aircraft; elevating tailgates (Am.) [parts of land vehicles]; traction engines; engines for land vehicles; fenders for ships; flanges for railway wheel tyres; freewheels for land vehicles; funnels for locomotives; funnels for ships; gear boxes for land vehicles; gearing for land vehicles; gears for cycles; trolleys; security harness for vehicle seats; head-rests for vehicle seats; pushchair hoods; hoods for vehicle engines; hoods for vehicles; horns for vehicles; hub caps; hubs for vehicle wheels; ship hulls; hydraulic circuits for vehicles; inclined ways for boats; adhesive rubber patches for repairing inner tubes; repair outfits for inner tubes; inner tubes for bicycle tyres; inner tubes for pneumatic tyres; jet engines for land vehicles; tailboard lifts [parts of land vehicles]; luggage nets for vehicles; two-wheeled trolleys; mine cart wheels; rear-view mirrors; bicycle motors; motors, electric, for land vehicles; mudguards; non-skid devices for vehicle tyres; oars; paddles for canoes; panniers adapted for bicycles; bicycle pedals; pneumatic tyres; port-holes; power tailgates (Am.) [parts of land vehicles]; propulsion mechanisms for land vehicles; pushchairs; reduction gears for land vehicles; reversing alarms for vehicles; rims for vehicle wheels; rowlocks; rudders; vehicle running boards; saddle covers for bicycles or motorcycles; saddles for bicycles, cycles or motorcycles; safety belts for vehicle seats; safety seats for children, for vehicles; screw-propellers; marine propellers; screws [propellers] for ships; sculls; vehicle seats; timbers [frames] for ships; steering gears for

ships; vehicle shock absorbers; shock absorbers for automobiles; shock absorbing springs for vehicles; shopping trolleys; ski carriers for cars; spars for ships; spikes for tyres; spoke clips for wheels; vehicle wheel spokes; steering wheels for vehicles; vehicle suspension springs; tipping apparatus, parts of trucks and waggons; tipping bodies for lorries; tyres for vehicle wheels; solid tyres for vehicle wheels; trailer hitches for vehicles; transmission chains for land vehicles; transmission shafts for land vehicles; transmissions for land vehicles; treads for retreading tyres; treads for vehicles [tractor type]; tubeless tyres for bicycles; turbines for land vehicles; undercarriages for vehicles; upholstery for vehicles; valves for vehicle tyres; vehicle covers [shaped]; vehicle tires; vehicle wheels; audible warning systems for bicycles; human-powered trolleys and carts; bicycle wheels; windows for vehicles; windshield wipers; windscreens; cigarette lighters for automobiles.

14 – Precious metals and their alloys; jewels; ornaments [jewellery, jewelry (Am.)]; precious stones; clocks; chronometrical instruments; agates; anchors [clock- and watchmaking]; barrels [clock- and watchmaking]; cases for clock- and watchmaking; cases for watches [presentation]; watch chains; clock cases; clock hands; clockworks; coins; copper tokens; dials [clock- and watchmaking]; ornaments of jet; jet, unwrought or semi-wrought; jewel cases; key rings [split rings with trinket or decorative fob]; medals; movements for clocks and watches; olivine [gems]; pearls made of ambroid [pressed amber]; pendulums [clock- and watchmaking]; semi-precious stones; spinel [precious stones]; watch springs; watch bands; watch cases [parts of watches]; watch glasses.

16 – Paper and cardboard; bags and articles for packaging, wrapping and storage of paper, cardboard or plastics; printed matter; bookbinding material; photographs [printed]; stationery; adhesives for stationery or household purposes; artists' materials; paintbrushes; typewriters, electric or non-electric; office requisites, except furniture; teaching materials [except apparatus]; plastic materials for packaging; printing fonts; printing blocks; adhesive tapes for stationery or household purposes; architects' models; garbage bags of paper or of plastics; bags for microwave cooking; balls for ball-point pens; marking chalk; holders for cheque books; money clips; composing frames [printing]; composing sticks; engraving plates; galley racks [printing]; graining combs; hand labelling appliances; passport holders; house painters' rollers; apparatus for mounting photographs; packaging material made of starches; photograph stands; printers' blankets, not of textile; printers' galleys; self-adhesive tapes for stationery or household purposes; sheets of reclaimed cellulose for wrapping; steatite [tailor's chalk]; tailors' chalk; trays for sorting and counting money; vignetting apparatus; wristbands for the retention of writing instruments.

18 – Leather and imitations of leather; animal skins, hides; trunks and suitcases; umbrellas; parasols; walking sticks; whips; harnesses; saddlery; attaché cases; rucksacks; game bags [hunting accessories]; net bags for shopping; nose bags [feed bags]; sports bags; shoulder belts [straps] of leather; beach bags; briefcases; card cases [notecases]; chain mesh purses; clothing for pets; collars for animals; umbrella covers; covers for animals; dog collars; handbag frames; frames for umbrellas or parasols; goldbeaters' skin; handbags; suitcase handles; cane handles; haversacks; horse blankets; horseshoes; slings for carrying infants; knee-pads for horses; music cases; muzzles; pocket wallets; purses; umbrella or parasol ribs; school bags; shopping bags; straps for skates; sling bags for carrying infants; slings for carrying infants; straps for soldiers' equipment; umbrella handles; umbrella rings; umbrella sticks; vanity cases, not fitted; walking stick seats; roller bags.

20 – Furniture; mirrors [looking glasses]; picture frames; air cushions, not for medical purposes; air mattresses, not for medical purposes; air pillows, not for medical purposes; yellow amber; animal hooves; animal horns; stuffed animals; stag antlers; works of art of wood, wax, plaster or plastic; comb foundations for beehives; bamboo; fishing baskets; bead curtains for decoration; bed casters, not of metal; bedding, except linen; vice benches [furniture]; bins, not of metal; stuffed birds; slatted indoor blinds; bolsters; bottle caps, not of metal; bottle closures, not of metal; nesting boxes; beds for household pets; picture frame brackets; mooring buoys, non-metallic; busts of wood, wax, plaster or plastic; cabinet work; sealing caps, not of metal; furniture casters, not of metal; wind chimes [decoration]; animal claws; clothes hooks, not of metal; coat hangers; coathooks, not of metal; funerary caskets; coral; corozo; costume stands; garment covers [storage]; covers for clothing [wardrobe]; curtain holders, not of textile material; curtain hooks; curtain rails; curtain rings; curtain rods; curtain rollers; curtain tie-backs; cushions; pet cushions; dog kennels; door fittings, not of metal; door handles, not of metal; doors for furniture; mannequins and tailors' dummies; fans for personal use, non-electric; figurines [statuettes] of wood, wax, plaster or plastic; screens for fireplaces [furniture]; furniture fittings, not of metal; floating containers, not of metal; flower-pot pedestals; funerary urns; coat hangers; honeycombs; horn, unworked or semi-worked; house numbers, not of metal, non-luminous; nesting boxes for household pets; indoor window blinds [furniture]; mats for infant playpens; infant walkers; inflatable publicity objects; ivory, unworked or semi-worked; kennels for household pets; mats, removable, for sinks; mattresses; meerschau; mobiles [decoration]; mouldings for picture frames; mother-of-pearl, unworked or semi-worked; oyster shells; pillows; plaited straw, except matting; straw plaits; rattan; reeds [plaiting materials];

stair rods; saw horses; shells; statues of wood, wax, plaster or plastic; straw edgings; table tops; tortoiseshell; imitation tortoiseshell; wax figures; whalebone, unworked or semi-worked.

21 – Household or kitchen utensils and containers; combs and sponges; brushes; material for brush-making; articles for cleaning purposes; steelwool; glass, unworked or semi-worked, except building glass; glassware, porcelain and earthenware; indoor aquaria; aquarium hoods; bird baths; birdcages; cages for household pets; cosmetic utensils; deodorizing apparatus for personal use; feeding troughs; feeding troughs for animals; floss for dental purposes; fly catchers [traps or whisks]; fly swatters; gardening gloves; indoor terrariums [plant cultivation]; indoor terrariums [vivariums]; insect traps; litter boxes for pets; appliances for removing make-up, non-electric; mangers for animals; mangers for livestock; menu card holders; mouse traps; nest eggs, artificial; nozzles for watering hose; nozzles for watering cans; poultry rings; powder compacts; powder puffs; rat traps; rings for birds; lawn sprinklers; syringes for watering flowers and plants; watering devices; watering cans; electric devices for attracting and killing insects; electric make-up removing appliances.

24 – Textiles; bed covers; table linen of textile; banners of textile or plastic; bunting of textile or plastic; furniture coverings of plastic; curtains of textile or plastic; flags of textile or plastic; plastic material [substitute for fabrics]; shower curtains of textile or plastic; sleeping bags for camping.

25 – Clothing, except ski wear, ski balaclavas, ski suits for competition, snowboard jackets, snow boarding suits, snow suits, thermally insulated clothing, sweat-absorbent underwear, ski gloves; footwear, except ski footwear, snowboarding boots; hats, except ski hats; boot uppers; heelpieces for footwear; iron fittings for boots; non-slipping devices for boots; welts for boots; cap peaks; dress shields; metal fittings for footwear; studs for football boots; tips for footwear; footwear uppers; hat frames [skeletons]; heelpieces for stockings; heels; inner soles; ready-made linings [parts of clothing]; non-slipping devices for footwear; pockets for clothing; shirt fronts; shirt yokes; welts for footwear; soles for footwear; cap visors.

27 – Carpets; door mats; mats; linoleum; carpet tiles for covering floors; non-textile wall coverings; artificial turf; mats of woven rope for ski slopes; wallpaper.

28 – Games; toys; gymnastic and sporting articles, except for skis and snowboards; decorations for christmas trees; bags especially designed for surfboards; lures for fishing; billiard cue tips; billiard markers; pool table cushions; bite indicators [fishing tackle]; bite sensors [fishing tackle]; bladders of balls for games; chalk for billiard cues; christmas tree stands;

christmas trees of synthetic material; confetti; cricket bags; divot repair tools [golf accessories]; rollers for stationary exercise bicycles; fairground ride apparatus; fish hooks; floats for fishing; golf bags, with or without wheels; gut for fishing; gut for rackets; kite reels; fishing lines; masts for sailboards; novelty toys for playing jokes; protective paddings [parts of sports suits]; paintballs [ammunition for paintball guns] [sports apparatus]; caps for pistols [toys]; strings for rackets; reels for fishing; rosin used by athletes; surfboard leashes; swimming floats; swimming belts; swimming jackets; water wings.

35 – Advertising; business management; business administration; office functions; rental of advertising space; commercial information and advice for consumers [consumer advice shop]; auctioneering services; business investigations; business research; commercial information agency services; presentation of goods on communication media, for retail purposes; price comparison services; economic forecasting; organization of exhibitions for commercial or advertising purposes; export-import agency services; market research; modelling for advertising or sales promotion; news clipping services; rental of office machinery and equipment; opinion polling; organization of exhibitions for commercial or advertising purposes; organization of trade fairs for commercial or advertising purposes; procurement services for others [purchasing goods and services for other businesses]; personnel selection using psychological testing; public relations services; publicity material rental; rental of advertising time on communication media; rental of photocopying machines; rental of vending machines; shop window dressing; sponsorship search.

36 – Insurance services; financial services; monetary affairs; real estate affairs; charitable fund raising; organization of monetary collections; financial consultancy; insurance consultancy; deposits of valuables; financial information; financial sponsorship; insurance information; safe deposit services; processing of credit card payments; issuance of credit cards; processing of credit card payments; provision of credit cards; financial services relating to credit cards; management of credit card services; bank card, credit card, debit card and electronic payment card services.

37 – Construction; automobile repair; assembly [installation] of parts for vehicles; airplane maintenance and repair; anti-rust treatment for vehicles; artificial snow-making services; boiler cleaning and repair; building construction supervision; cleaning of buildings [exterior surface]; cleaning of building interiors; rental of bulldozers; burner maintenance and repair; automobile washing; chimney sweeping; diaper cleaning; dry cleaning; vehicle cleaning; rental of cleaning machines; cleaning of clothing; installation, maintenance and repair of computer hardware; rental of construction equipment; construction information; de-

molition of buildings; disinfecting; drilling of wells; rental of excavators; vermin exterminating, other than for agriculture, aquaculture, horticulture and forestry; mining extraction; film projector repair and maintenance; fur care, cleaning and repair; furniture maintenance; vehicle greasing; provision of construction information; repair information; linen ironing; laundering; leather care, cleaning and repair; machinery installation, maintenance and repair; vehicle maintenance; motor vehicle maintenance and repair; office machines and equipment installation, maintenance and repair; painting, interior and exterior; paper hanging; pipeline construction and maintenance; vehicle polishing; clothing ironing; quarrying services; rat exterminating; refilling of toner cartridges; rental of cranes [construction equipment]; rental of road sweeping machines; rustproofing; safe maintenance and repair; vehicle service stations [refuelling and maintenance]; shipbuilding; painting or repair of signs; street cleaning; strong-room maintenance and repair; swimming-pool maintenance; varnishing; vehicle cleaning; vehicle washing; washing; washing of linen; window cleaning.

39 – Transport; packaging and storage of goods; arranging of transportation for travel tours; boat rental; freight brokerage [forwarding (Am.)]; transport brokerage; operating canal locks; car parking; car rental; motor coach rental; distribution of energy; rental of diving bells; rental of diving suits; electricity distribution; escorting of travellers; franking of mail; freight transportation brokerage; freight forwarding; refrigerator rental; garage rental; horse rental; ice-breaking; storage information; transportation information; launching of satellites for others; parking place rental; transport by pipeline; refloating of ships; rental of motor racing cars; rental of storage containers; rental of vehicle roof racks; rental of warehouses; rental of wheelchairs; underwater salvage; salvage of ships; salvaging; shipbrokerage; sightseeing [tourism]; traffic information; rental of lorries; vehicle rental; water distribution; water supplying.

41 – Education; training; entertainment services; sporting and cultural activities; booking of seats for shows; publication of books; calligraphy services; digital imaging services [editing of images]; rental of skin diving equipment; education information; electronic publishing services; entertainment information; recreation information; sign language interpretation; layout services, other than for advertising purposes; microfilming; modelling for artists; rental of movie projectors and accessories; providing online electronic publications, not downloadable; online publication of electronic books and journals; publication of texts, other than publicity texts; rental of radio and television sets; rental of video cassette recorders; rental of audio equipment; rental of video cameras; rental of lighting apparatus for theatrical sets or television studios; rental of show scenery; rental of sports equip-

ment, except vehicles; rental of stage scenery; timing of sports events; ticket agency services [entertainment]; translation services; videotaping.

43 – Services for providing food and drink; temporary accommodation; temporary accommodation reservations; boarding house bookings; rental of transportable buildings; hotel reservations; rental of chairs, tables, table linen, glassware; rental of tents.

(260) AM 2021 110088 A

(800) 1554469

(151) 2020 06 08

(891) 2020 06 08

(731) ACTIVENT 365 s.r.o.

Příkop 27/2a, CZ-602 00 Brno, Zábřovice,
Czech Republic

(540)



(591) Black, white

(531) 26.04.03; 26.04.24; 27.05.01

(511)

18 – Backpacks, bumbags, backpacks for cyclists and their accessories.

(260) AM 2021 110089 A

(800) 1554546

(151) 2020 08 12

(891) 2020 08 12

(731) CLW AUTOMOBILE GROUP CO., LTD

Zengdu Economic Development Zone, 430000
Suizhou City, Hubei Province, China

(540)



(591) Black, white

(531) 26.01.02; 26.01.03; 26.01.18; 26.01.20;
27.05.17; 27.05.23

(511)

6 – Armour-plating of metal; building materials of metal; steel wire; hardware of metal, small; wheel clamps [boots]; tanks of metal for gas storage or liquid storage; containers of metal [storage, transport]; containers of metal for compressed gas or liquid air; troughs of metal for mixing mortar.

12 – Motor cars; automobile bodies; automobile chassis; anti-theft devices for vehicles; shock absorbers for automobiles; engines for land vehicles; trucks fitted with the crane.

(260) AM 2021 110091 A

(800) 1554560

(151) 2020 05 06

(891) 2020 05 06

(731) ThermoElektrika Limited Liability Company

Bol'shoy bul'var st., 42, bldg. 1, flr. 2, office
757, Territory of the Skolkovo Innovation
Center, RU-121205 Moscow, Russian
Federation

(540)

LESIV

(591) Black, white

(511)

1 – Chemicals for use in industry and science; fire extinguishing and fire prevention compositions; fire extinguishing compositions; fireproofing preparations; test paper, chemical.

9 – Scientific, research, navigation, surveying, photographic, cinematographic, audiovisual, optical, weighing, measuring, signalling, detecting, testing, inspecting, life-saving and teaching apparatus and instruments; apparatus and instruments for conducting, switching, transforming, accumulating, regulating or controlling the distribution or use of electricity; apparatus and instruments for recording, transmitting, reproducing or processing sound, images or data; recorded or downloadable media, computer software, blank digital or analogue recording and storage media; computers and computer peripheral devices; fire extinguishers; fire engines; fire extinguishing apparatus; fire escapes; fire pumps; fire beaters; sprinkler systems for fire protection; fire alarms; signals, luminous or mechanical; rescue flares, non-explosive and non-pyrotechnic; sirens; fire boats; fire blankets; asbestos screens for firemen; fire hose; apparatus and devices for life-saving and protection; protection devices for personal use against accidents; temperature indicator labels, not for medical purposes.

37 – Installation, maintenance and repair services; providing information relating to installation, maintenance and repair services.

(260) AM 2021 110098 A

(800) 1554799

(151) 2020 08 27

(891) 2020 08 27

(731) Aerzener Maschinenfabrik GmbH

Reherweg 28, 31855 Aerzen, Germany

(540)



(591) Black, white
 (531) 26.01.05; 26.01.18; 26.01.24; 27.05.01;
 27.05.22; 27.05.24

(511)
 7 – Apparatus for air and gas conveyance and compression, blowers, densifiers, compressors, turbocompressors, rotary compressors, gas coolers, rotary piston blowers for pressure and vacuum, rotary lobe pumps; densifiers and compressors for overland gas transport pipelines.

11 – Overland gas transport pipelines and parts therefor, namely barrier devices, valves, refrigerating and heating devices.

37 – Construction; laying, construction and repair of gas transport pipelines laid overland and undersea.

(260) AM 2021 110102 A
 (800) 622789
 (151) 1994 03 26
 (891) 2020 09 17

(731) Ha-Be Betonchemie GmbH & Co. KG
 Stüvestrasse 39, 31785 HAMELN, Germany

(540)

PANTARHIT

(591) Black, white
 (531) 27.05.01; 27.05.17
 (511)

1 – Chemical products for use in industry, namely additives for fluidifying concrete and mortar, as solvents and retarding agents, additives for bulk grouping of numerous spherical pores, additives for stabilization.

(260) AM 2021 110105 A
 (800) 1068957
 (151) 2011 02 10
 (891) 2020 08 24

(731) Ashley Furniture Industries, LLC
 One Ashley Way, Arcadia WI 54612, USA

(540)

**ASHLEY FURNITURE
 HOMESTORE**

(591) Black, white
 (526) FURNITURE HOMESTORE
 (511)

35 – Retail store services in the field of furniture.

(260) AM 2021 110107 A

(800) 1471941
 (151) 2019 05 08
 (891) 2020 09 08

(731) QITELE GROUP CO., LTD.
 XIAOJINGAO INDUSTRIAL ZONE,
 QIAOXIA TOWN, YONGJIA COUNTY,
 WENZHOU CITY, 325000 ZHEJIANG
 PROVINCE, China

(540)

Qitele

(591) Black, white
 (531) 27.05.01; 27.05.17
 (511)

28 – Toys; slides [playthings]; swings; rocking horses; trampolines; toy building blocks; swimming pools [play articles]; game machine.

(260) AM 2021 110108 A
 (800) 1511186
 (151) 2019 12 13
 (891) 2020 08 26

(731) Kamiki Drinks LLP
 11 Church Road, Great Bookham,
 Surrey KT23 3PB, United Kingdom

(540)

UMIKI

(591) Black, white
 (511)

33 – Alcoholic beverages; distilled spirits, whisky, vodka and gin.

(260) AM 2021 110109 A
 (800) 1523856
 (151) 2020 02 10
 (891) 2020 08 17

(731) NOVARTIS AG
 CH-4002 Basel, Switzerland

(540)



(591) Orange, blue and yellow
 (531) 26.03.23; 26.11.02; 26.11.12; 26.13.25;
 29.01.13

(511)
 5 – Pharmaceutical preparations.

(260) AM 2021 110149 A
 (800) 1554885
 (151) 2020 05 07
 (891) 2020 05 07
 (731) Zhuhai YASI Cell Medical Technology Co., Ltd.
 Room 312-63, on the third floor of the Aviation City, New Town Planning Exhibition Building, Jinwan Zone, Zhuhai City, 519000 Guangdong Province, China

(540)

YAQI
雅奇

(591) Black, white
 (531) 27.05.01; 27.05.17; 28.03
 (511)
 3 – Cosmetics; perfumes; facial washing milk; hair lotions; bath lotion; whitening cream; baths (cosmetic preparations for-); beauty masks; cosmetic kits; toiletries.

10 – Surgical apparatus and instruments; receptacles for applying medicines; sterilized medical instruments; sterile sheets [surgical]; apparatus, devices and articles for nursing infants; fumigation apparatus for medical purposes; dropper bottles for medical purposes; medical apparatus and instruments; analysis (apparatus for use in medical-); aerosol dispenser for medical purposes.

(260) AM 2021 110150 A
 (800) 1554888
 (151) 2020 08 03
 (891) 2020 08 03
 (731) Henan Suda Electric Vehicle Technology Co., Ltd.
 East District, economic development zone, Sanmenxia City; 472000 Henan Province, China

(540)



(591) Black, white
 (531) 01.01.02; 01.01.09; 24.11.25; 24.11.25; 26.01.02; 26.01.13; 26.01.18; 27.05.03; 27.05.08; 27.05.21

(511)
 12 – Wheels for automobiles; electric vehicles; vehicle anti-theft device; fork lift trucks; motor coaches; tilting-carts; motor homes; coaches; concrete mixing vehicles; ambulances; lorries; refrigerated vehicles; motors, electric, for land vehicles; motorcycles; dinner wagons; sprinkling trucks; vans [vehicles]; motor cars; wheels for automobiles; bodies for vehicles.

(260) AM 2021 110159 A
 (800) 1555369
 (151) 2020 07 09
 (891) 2020 07 09
 (731) KPO MARKETING COMPANY LIMITED
 Egypt Street, 12, CY-1097 Nicosia, Cyprus
 (540)



(591) Black, white
 (531) 19.07.01; 19.07.23; 27.05.13
 (511)
 6 – Metal bottle hoods; metal crown-caps for bottles; metal caps for bottles; metal screw caps for bottles; sealing caps of metal.

20 – Non-metal bottle hoods; non-metal screw caps for bottles; bottle corks; non-metal corks; bottle caps, not of metal.

32 – Beer, mineral and aerated waters and other non-alcoholic drinks; syrups and other preparations for making beverages.

33 – Wines, spirits and liqueurs.

34 – Tobacco, raw or manufactured; smokers' articles; matches.

35 – Advertising agencies; rental of advertising space; demonstration of goods; marketing research; marketing; organization of exhibitions for commercial or advertising purposes; presentation of products on all media types for retail sale; production of advertising films; radio advertising; advertising.

41 – Night clubs/cafes [entertainment]; layout of publications, except for advertising; organization of balls; recreation facilities services [entertainment]; club services [entertainment or education].

43 – Hotels; motels; restaurants.

(260) AM 2021 110160 A

(800) 1555373

(151) 2020 08 14

(891) 2020 08 14

(731) IPCO LLC

8275 S EASTERN AVE., STE 200-434,

LAS VEGAS NV 89123, USA

(540)

BK POKER

(591) Black, white

(511)

9 – Sunglasses; downloadable computer application software for desk top computers, lap top computers, mobile phones, portable media players, and handheld computers, namely, software for social networking in connection with games, card games, games of skill, poker, poker games, casino games, gambling, sports betting, poker tournaments, poker competitions, live action cash games, sit-and-go poker, gameshows and events; downloadable computer game software; downloadable computer software platforms for social networking in connection with games, card games, games of skill, poker, poker games, casino games, gambling, sports betting, poker tournaments, poker competitions, live action cash games, sit-and-go poker, gameshows and events; downloadable electronic game software for cellular telephones; downloadable electronic newsletters in the field of games, card games, games of skill, poker, poker games, casino games, gambling, sports betting, poker tournaments, poker competitions, live action cash games, sit-and-go poker, gameshows and events; downloadable electronic publications in the nature of newsletters, guides, instruction manuals, handbooks and programs in the field of games, card games, games of skill, poker, poker games, casino games, gambling, sports betting, poker tournaments, poker competitions, live action cash games, sit-and-go poker, gameshows and events; dust masks; mouse mats; mouse pads; protective covers and cases for cell phones, laptops and portable media players; blank USB flash drives.

16 – Decals; posters; stickers; coasters of cardboard; coasters of paper; passport cases; printed art reproductions; printed tickets; publications, namely, newsletters, newspapers, magazines, pamphlets, articles, features, periodicals, books, manuals, leaflets, brochures and programs in the fields of games, card games, games of skill, poker, poker games, casino games, gambling, sports betting, poker tournaments, poker competitions, live action cash games, sit-and-go poker, gameshows and events; art and photograph portfolio cases; event programs; greeting cards; score cards.

41 – Betting services; gaming services in the nature of conducting games, tournaments, casino gaming, and online games and tournaments; sweepstake services; educational and entertainment services, namely, a continuing program about poker games and tournaments accessible by means of television, cable television, satellite television, Internet, video on demand, web-based applications, social media, mobile phone applications, and computer networks; entertainment services, namely, an ongoing series featuring poker games and tournaments, poker news and poker information provided through television, cable television, satellite television, Internet, video on demand, web-based applications, social media, mobile phone applications, and computer networks; entertainment services, namely, casino gaming; entertainment services, namely, conducting live poker games; entertainment services, namely, providing online electronic games; organizing, conducting and arranging live and online cash games, poker games and poker tournaments; providing on-line card games; providing on-line digital publications in the nature of magazines, brochures, newsletters, articles, blogs and books in the field of poker, games and tournaments, poker news, and poker information via the Internet; providing instructional information on poker; providing on-line poker games; provision of non-downloadable films and movies via a video-on-demand service.

(260) AM 2021 110174 A

(800) 1555916

(151) 2020 08 11

(891) 2020 08 11

(731) China State Construction Engineering

Corporation Ltd.

No. 15 Sanlihe Road, Haidian District, Beijing, China

(540)

(591) Black, white

(531) 28.03

(511)

37 – Building construction supervision; providing construction information; construction; factory construction; warehouse construction and repair; masonry; demolition of buildings; building insulating; damp-proofing of buildings; bricklaying; road paving; asphaltting; pipeline construction and maintenance; pumicing; harbour construction; pier breakwater building; underwater repair; scaffolding; rental of construction equipment; rental of bulldozers; rental of excavators; rental of cleaning machines; drilling of

wells; installation and maintenance of entertainment or sports apparatus; mining extraction; quarrying services; upholstering; upholstery repair; paper hanging; painting, interior and exterior; painting or repair of signs; cleaning of buildings [exterior surface]; cleaning of buildings [interior]; window cleaning; installation of heating systems; boiler cleaning and repair; irrigation devices installation and repair; electric appliance installation and repair; installation and repair of air-conditioning apparatus; installation and repair of freezing apparatus; office machines and equipment installation, maintenance and repair; kitchen equipment installation; machinery installation, maintenance and repair; installation, maintenance and repair of computer hardware; interference suppression in electrical apparatus; installation and maintenance of medical devices; installation and maintenance of sanitary apparatus; installation and maintenance of illuminating apparatus; vehicle service stations [refuelling and maintenance]; strong-room maintenance and repair; rustproofing; re-tinning; furniture restoration; furniture maintenance; pump repair; elevator installation and repair; telephone installation and repair; burglar alarm installation and repair; fire alarm installation and repair.

(260) AM 2021 110175 A

(800) 1555918

(151) 2020 06 18

(891) 2020 06 18

(731) Limited Liability Company "Novye

Tekhnologii"

Pavlovicha street, b.13, Khabarovsk,

RU-680030 Khabarovsky krai, Russian

Federation

(540)



(591) Black, white

(531) 02.09.01; 05.05.20; 27.05.07

(511)

3 – Wet wipes for babies; pre-moistened cosmetic wipes; pre-moistened or impregnated cleansing pads, tissues or wipes; disposable wipes impregnated with cleansing compounds for use on the face; wipes impregnated with a skin cleanser; tissues impregnated with essential oils, for cosmetic use; disposable wet wipes with cleaning chemicals or compounds for personal hygiene; cotton wool for cosmetic purposes; cotton wool and cotton sticks for cosmetic purposes; cosmetic pads; baby oils [toiletries]; baby powder [toiletries]; children's play cosmetics; baby lotions [toiletries]; shampoos for babies; hair conditioners for babies.

5 – Babies' napkin-pants [diaper-pants] of paper and cellulose, disposable; babies' diapers of paper and cellulose, disposable; babies' diapers of textile; babies' diapers; paper liners for diapers; babies' diaper-pants; disposable training pants for infants; tissues and wipes impregnated with pharmaceutical lotions and creams; antiseptic cotton; aseptic cotton; wadding for medical purposes; cotton for medical purposes; food for babies; lacteal flour for babies; dietetic food and substances adapted for medical or veterinary use, food for babies; ointments for treating diaper rash; medicated baby oils; babies' diapers of paper; medicated baby powder; powdered milk for babies; food for infants; menthol vapor bath preparations for babies.

10 – Surgical, medical, dental and veterinary apparatus and instruments, artificial limbs, eyes and teeth; orthopedic articles; suture materials.

16 – Tissue paper; tissues of paper; cellulose wipes; modelling clay for children; children's books incorporating an audio component; modelling materials and compounds for use by children; bibs of paper; babies' bibs of paper; children's storybooks; children's books; children's activity books; painting sets for children; burp pads of paper.

35 – Advertising; business management; business administration; office services; sales promotion for third parties.

(260) AM 2021 110235 A

(800) 1556108

(151) 2020 09 02

(891) 2020 09 02

(731) Limited Liability Company "ORIMI"

1 mkr-n, 15/4 plot, Sverdlov settlement,

Vsevolozhskiy district, RU-188682 Leningrad

oblast, Russian Federation

(540)

ГРИНФИЛД

(591) Black, white

(531) 28.05

(511)

30 – Coffee; unroasted coffee; coffee-based beverages; coffee beverages with milk; artificial coffee; chicory [coffee substitute]; tea; iced tea; tea-based beverages; cocoa; prepared cocoa beverages; chocolate beverages with milk; chocolate-based beverages; chocolate; infusions, not medicinal; sugar; glucose for culinary purposes; rice; macaroni; flour and preparations made from cereals; muesli; chips [cereal products]; bread, pastries and confectionery; ice cream; honey; yeast; baking powder; salt; mustard; vinegar; condiments; spices; seasonings; aromatic preparations for food; natural sweeteners; essences for foodstuffs, except etheric essences and essential oils.

(260) AM 2021 110238 A
 (800) 1556165
 (151) 2020 09 15
 (891) 2020 09 15
 (731) FESTINA LOTUS, S.A.
 C/ Velázquez 150, planta 3, puerta 1,
 E-28002 MADRID, Spain
 (540)



(591) Black, white
 (531) 26.04.05; 26.04.18; 27.05.01; 27.05.09;
 27.05.10

(511)
 9 – Spectacles [optics]; eyewear for sports; sunglasses; lenses for spectacles; spectacle frames; cases for spectacles and sunglasses; parts for spectacles; eye-glass cords; chains for spectacles; smart watches; software for hand-held electronic digital devices; hand-held and mobile digital electronic devices that can enable Internet access and are used to send, receive and store telephone calls, faxes, email and other digital data; computers; hardware for computers; audio and video apparatus; peripheral devices for computers; wireless communication devices; in-ear headphones, earphones; loudspeakers; microphones; software; computer application software for mobile phones; Global Positioning System (GPS) software; computer software for use in hand-held mobile digital electronic devices and other consumer electronic products; electric and electronic connectors, couplers, electric wires, connection cables, electric cables, chargers, couplers, docking stations, interfaces and adapters for use with all the aforesaid goods; parts, components, accessories and cases for all the aforementioned goods.

16 – Writing instruments, particularly fountain pens, ball-point pens, mechanical pencils, ink for ball-point pens and fountain pens, ink cartridges, replacement parts for writing instruments, cases for writing instruments, holders for writing instruments and office supplies (except furniture).

18 – Leather and imitation leather articles, specifically; coin purses, wallets, billfolds, card cases, document cases, passport holders, check holders, key cases, sling bags, hip bags, luggage, bags, briefcases, travel sets, travel bags; travel cases, suitcases; backpacks; vanity cases; diaper bags; handbags; leather covers.

(260) AM 2021 110262 A
 (800) 1557068
 (151) 2020 06 12
 (891) 2020 06 12
 (731) Oriflame Cosmetics AG
 c/o Oriflame Global Management AG,
 Bleicheplatz 3, CH-8200 Schaffhausen,
 Switzerland
 (540)

ORIFLAME WELLOSOPHY

(591) Black, white
 (511)

3 – Non-medicated conditioning and care preparations for application to the hair, scalp, skin and nails; shampoos; hair conditioner; soaps; perfumes; perfumery; eau de cologne; toilet waters; essential and herbal oils; cosmetics; make-up; make-up preparations; make-up removers; lipsticks; nail varnishes; nail varnish removers; eyeliner; mascara; non-medicated toilet preparations; hair lotions; hair sprays and hair gels; preparations for use in the bath or shower; bath and shower oils, gels, creams and foams; face and body masks; face and body scrubs; facial washes; skin cleansers and hydrators; skin toners; skin moisturizers; blemish creams and blemish gels; deodorants; antiperspirants; shaving soaps; shaving creams; shaving gels; after-shave preparations; pre-shave preparations; talcum powders; toiletries; dentifrices; toothpastes; mouth washes; foot care preparations (non-medicated); cotton for cosmetic purposes; cotton wool, sticks, buds, swabs, puffs, balls and pads; cotton wool in the form of wipes for cosmetic use; cotton puffs and pads impregnated with make-up removing preparations.

5 – Pharmaceutical preparations; sanitary preparations; vitamins; dietetic substance adapted for medical use; medicated food supplements; dietary food supplements; mineral food supplements; food supplements for non-medical purposes; food for babies; plasters, materials for dressings; material for stopping teeth, dental wax; disinfectants; nutritional supplements; protein supplements; protein supplement shakes; dietary supplement drinks; vitamin drinks.

29 – Meat, fish, poultry and game; meat extracts; preserved, frozen, dried and cooked fruits and vegetables; jellies, jams, compotes; eggs; milk and milk products; edible oils and fats; prepared meals consisting primarily of meat, fish, poultry or vegetables, soups and stocks, dried fruit-based snacks, fruit-based snack bars, nut-based snack foods, seed-based snack bars; soup (preparations for making); soup powders; milk shakes; soya and whey based products; vitamin, protein and mineral enriched foods and foodstuffs consisting primarily of meat, fish, poultry or vegetables; milk powder for nutritional purposes; protein milk.

30 – Coffee, tea, cocoa and artificial coffee; rice; tapioca and sago; flour and preparations made from cereals; cereals; flavourings, other than essential oils, for milk shakes; foodstuffs made from cereals; cereal bars; high-protein cereal bars; cereal-based snacks; corn-based snacks; rice-based snacks; wheat-based snacks; puddings; chocolate desserts; confectionery items, chocolate covered or plain; energy bars.

32 – Beer; non-alcoholic beverages; isotonic beverages; fruit juices; non-alcoholic fruit extracts; fruit juice beverages (beverages); non-alcoholic cocktails; fruit nectars (non-alcoholic); grape must, unfermented; preparations for making beverages.

(260) AM 2021 110265 A

(800) 1557164

(151) 2020 09 30

(891) 2020 09 30

(731) JINLANG SCIENCE AND TECHNOLOGY CO., LTD.

No. 1111, Jinlin Road, Jinqing, Luqiao, Taizhou, 318058 Zhejiang, China

(540)

ARIC

(591) Black, white

(531) 27.05.01; 27.05.01

(511)

12 – Vehicles for locomotion by land, air, water or rail; cars; motors for motorcycle; electric vehicles; upholstery for vehicles; electric motorcycle; automobile chassis; cycles; motors, electric, for land vehicles; motorcycles.

(260) AM 2021 110268 A

(800) 1370445

(151) 2017 05 12

(891) 2020 10 02

(731) CHRISTEYNS LUXEMBOURG S.A.

412F, route d'Esch, L-2086 LUXEMBOURG, Luxembourg

(540)

PHAGO

(591) Black, white

(511)

1 – Chemical products for use in industry, science, photography, as well as in agriculture, horticulture and forestry; unprocessed artificial resins, unprocessed plastics; soil fertilizers; fire-extinguishing compositions; tempering and soldering preparations; chemical products for preserving foodstuffs; tanning materials; adhesives for use in industry; detergents having disinfectant properties and used during manufacturing operations; fuel-saving products; chemical additives to motor fuel; chemical additives for oils; detergent additives to gasoline; bleaching products for industrial

use; oil-purifying chemicals; chemical products for use in destroying oils and fats; chemical products for the manufacture of paints; color-brightening chemicals; peracetic acid; stearate calcium; moistening (wetting) products for use in bleaching; chemical products for use in construction, particularly, in the concrete industry; additives for concrete; masonry preservatives, excluding paints and oils; cement-waterproofing products, excluding paints; agglutinants for concrete; concrete-aeration chemicals; concrete preservatives, excluding paints and oils; tile preservatives, excluding paints and oils; chemical products for facilitating the alloying of metals; chemical products for laboratory analyses other than for medical or veterinary use; chemical preparations for scientific use, other than for medical or veterinary use; water-softening and water-purifying products; metallic soaps for industrial use; filtering materials (chemical products); chemical additives used for disinfecting water.

3 – Bleaching preparations and other substances for laundry use; cleaning, polishing, degreasing and abrasive preparations; soaps; detergents other than those used in manufacturing operations and for medical use; perfumery; essential oils; cosmetics; hair lotions; dentifrices.

5 – Pharmaceutical, veterinary and sanitary products; sanitary products for medical purposes; dietetic substances for medical use, food for babies; plasters, material for dressings, particularly bandages for dressings, gauze for dressings, cloths for dressings, bandages for dressings, elastic materials for dressings, suspension and support material for dressings and cleaning solvents for removing adhesive dressings or plasters; wound dressings; hemostatic dressings; adhesive dressings, sterilized dressings, elastic dressings, disinfectant dressings; compresses for dressings; material for dental fillings and dental impressions; disinfectants; disinfecting products; preparations for destroying vermin; products for destroying vermin; fungicides, herbicides; products for destroying plants; vermin destroying products; pesticides; chemical preparations for medical, pharmaceutical or veterinary use; depuratives; deodorants other than for personal use; air fresheners; deodorants for clothing or textile materials; disinfectants for hygienic use; disinfectants for chemical toilets; antibacterial agents for sanitary use for the disinfection of machines; air purifying products; detergents for medical use; soil-sterilizing agents; preparation for cleaning contact lenses; contact lens solutions; chemical products to treat mildew; chemical products for treating phylloxera; vine disease treating chemicals; disinfectant soaps.

(260) AM 2021 110312 A
 (800) 1557500
 (151) 2020 06 17
 (891) 2020 06 17
 (731) Sanaye Rang Razin Arko Co.
 Blook 37, 30 metri str., shahrak salimi,
 Azarshahr, Tabriz, Islamic Republic of
 Iran

(540)



(591) Gray and red
 (531) 25.03.01; 27.05.01; 29.01.12
 (511)
 2 – Paints, automobile paints, paint thinner; primer.

(260) AM 2021 110341 A
 (800) 1558394
 (151) 2020 06 24
 (891) 2020 06 24
 (731) SAHNI DISTRIBUTORS PVT. LTD.
 Road No. 3, Khasra No. 38, Dabri Industrial
 Area, New Delhi-110042, India

(540)



(591) Black, white
 (531) 25.05.02; 26.04.04; 26.04.05; 26.04.18;
 27.05.09; 27.05.10
 (511)
 12 – Motor land vehicles parts included in this class.

(260) AM 2021 110342 A
 (800) 1558395
 (151) 2020 09 17
 (891) 2020 09 17
 (731) Philip Morris Products S.A.
 Quai Jeanrenaud 3, CH-2000 Neuchâtel,
 Switzerland

(540)



(591) Black, white
 (531) 26.03.01; 26.03.07; 26.03.10; 26.03.24;
 27.05.01

(511)
 9 – Batteries for electronic cigarettes; batteries for electronic devices that are used for heating tobacco; chargers for electronic devices that are used for heating tobacco; USB chargers for electronic devices that are used for heating tobacco; car chargers for electronic cigarettes; car chargers for devices that are used for heating tobacco; battery chargers for electronic cigarettes.

18 – Leather and imitation leather; skins and hides; multipurpose bags of leather or imitation leather, briefcases (leather goods), carrying cases, pocket wallets, billfolds, briefcases, pouches, purses, key cases, card cases, luggage tags, handbags; traveling trunks, suitcases, tote bags, garment bags for travel, backpacks, vanity cases; umbrellas, parasols and walking sticks.

34 – Wired vaporizers for electronic cigarettes and electronic smoking devices; tobacco, raw or manufactured; tobacco products, including cigars, cigarettes, cigarillos, tobacco for roll-your-own cigarettes, pipe tobacco, chewing tobacco, snuff tobacco, kretek; snus; tobacco substitutes (not for medical purposes); smokers' articles, including cigarette paper and tubes, cigarette filters, tobacco tins, cigarette cases and ashtrays, pipes, pocket apparatus for rolling cigarettes, lighters; matches; tobacco sticks, tobacco products for the purpose of being heated, electronic devices and their parts for the purpose of heating cigarettes or tobacco in order to release nicotine-containing aerosol for inhalation; liquid nicotine solutions for use in electronic cigarettes; electronic smoking devices; electronic cigarettes; electronic cigarettes as substitutes for traditional cigarettes; electronic devices for the inhalation of nicotine-containing aerosol; oral vaporizing devices for smokers, tobacco products and tobacco substitutes; smokers' articles for electronic cigarettes; parts and fittings for the aforesaid products included in this class; devices for extinguishing heated cigarettes and cigars as well as heated tobacco sticks; electronic rechargeable cigarette cases; protective cases, decorative covers and carrying cases for electronic cigarettes, tobacco heating devices and electronic smoking devices; in-car cradles and in-car holders for electronic cigarettes, tobacco heating devices and elec-

tronic smoking devices; containers for the disposal of used tobacco sticks; cleaners, cleaning utensils and cleaning brushes for electronic cigarettes, tobacco heating devices and electronic smoking devices.

35 – Retail services and online retail services relating to heated tobacco products, electronic cigarettes, electronic smoking devices, electronic devices and their parts for the purpose of heating cigarettes or tobacco, oral vaporizing devices, vaporizers for electronic cigarettes and smoking devices, electronic rechargeable cigarette cases, chargers and charging docks for the aforementioned goods, extinguishers for heated cigarettes and heated tobacco sticks, parts and fittings for the aforementioned goods, liquid nicotine solutions for use in electronic cigarettes, tobacco substitutes (not for medical purposes), smokers' articles, protective cases, decorative covers and carrying cases for electronic cigarettes and electronic smoking devices, cleaning utensils, household goods; marketing research, market studies, market intelligence services, opinion polling; customer relationship management services; customer service management; organization and management of customer loyalty programs; all these services being exclusively related to electronic cigarettes, tobacco heating devices, electronic smoking devices and batteries and battery chargers for electronic cigarettes, tobacco heating devices and electronic smoking devices.

37 – Maintenance and repair of electronic cigarettes, tobacco heating devices and electronic smoking devices; maintenance and repair of batteries and battery chargers for electronic cigarettes, tobacco heating devices and electronic smoking devices; all these services being exclusively related to electronic cigarettes, tobacco heating devices, electronic smoking devices and batteries and battery chargers for electronic cigarettes, tobacco heating devices and electronic smoking devices.

41 – Entertainment services; arranging events for cultural and entertainment purposes; organization of cultural activities.

(260) AM 2021 110347 A
(800) 1099808
(151) 2011 11 04
(891) 2020 10 01
(731) Ashley Furniture Industries, LLC
One Ashley Way, Arcadia WI 54612, USA
(540)

BENCHCRAFT

(591) Black, white
(511)

20 – Mattresses; home furnishings, namely, pillows, picture frames, curtain rings, curtain rods, window blinds, magazine racks, and mirrors; furniture.

27 – Area rugs.

(260) AM 2021 110348 A
(800) 1133111
(151) 2012 07 30
(891) 2020 09 25
(731) Zhebrovska Filya
6, vul. Starytskoho, Kyiv 04078, Ukraine
(540)

Бисопрол

(591) Black, white

(531) 28.05

(511)

5 – Pharmaceutical preparations; medicines for human purposes; antihypertensives; antiarrhythmics; cardiovascular treatment preparations.

(260) AM 2021 110349 A
(800) 1244241
(151) 2015 02 17
(891) 2020 09 25
(731) Zhebrovska Filya
6, vul. Starytskoho, Kyiv 04078, Ukraine
(540)

ГЛИАТОН

(591) Black, white

(531) 28.05

(511)

5 – Pharmaceutical preparations; medicines for human purposes; medicines affecting the nervous system.

(260) AM 2021 110396 A
(800) 1558672
(151) 2020 09 24
(891) 2020 09 24
(731) Limited Liability Company "SLADKIJ ORESHEK"
d. Melechkino, 123, Solnechnogorsky rayon, RU-141554 Moskovskaya oblast, Russian Federation
(540)

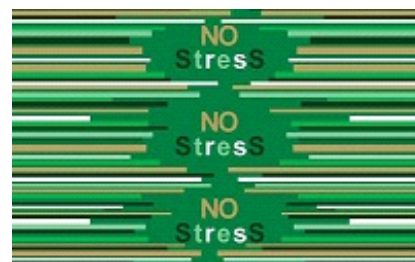

(591) Green, dark green, light green, light green, white and beige-golden

(531) 25.07.20; 25.07.21; 26.11.08; 29.01.13

(511)

30 – Aromatic preparations for food; vanilla flavorings for culinary purposes; flavorings, other than essential oils, for cakes; flavorings, other than essential oils, for beverages; coffee flavorings; food flavorings, other than essential oils; star aniseed; baozi [stuffed buns]; cereal bars; high-protein cereal bars; pancakes; freeze-dried dishes with the main ingredient being pasta; freeze-dried dishes with the main ingredient being rice; noodle-based prepared meals; buns; bulgur; bread rolls; edible rice paper; edible paper; burritos; vanillin [vanilla substitute]; vareniki [stuffed dumplings]; waffles; vermicelli [noodles]; natural sweeteners; sausage binding materials; binding agents for ice cream; sea water for cooking; seaweed [condiment]; malt biscuits; cloves [spice]; mirror icing [mirror glaze]; cake frosting [icing]; glucose for culinary purposes; mustard; croûtons; buckwheat, processed; gluten additives for culinary purposes; yeast; thickening agents for cooking foodstuffs; leaven; rice-based snack food; cereal-based snack food; artificial coffee; vegetal preparations for use as coffee substitutes; dressings for salad; zephyr [confectionery]; fruit jellies [confectionery]; candy decorations for cakes; confectionery for decorating Christmas trees; cakes; pastries; peanut confectionery; almond confectionery; pasta; ginger [spice]; frozen yogurt [confectionery ices]; cocoa; cream of tartar for culinary purposes; capers; caramels [candy]; curry [spice]; ketchup [sauce]; gim-bap [Korean rice dish]; kimchi-jeon [fermented vegetable pancakes]; quinoa, processed; quiches; gluten prepared as foodstuff; flour-based dumplings; sweetmeats [candy]; liquorice [confectionery]; peppermint sweets; mints for breath freshening; dulce de leche; cinnamon [spice]; coffee; unroasted coffee; starch for food; crackers; custard; hominy grits; semolina; oatmeal; crushed barley; groats for human food; ice cubes; corn, milled; corn, roasted; meat pies; turmeric; couscous [semolina]; noodles; soba noodles; udon noodles; ice for refreshment; candies; ice, natural or artificial; edible ices; rice cakes; lomper [potato-based flatbread]; mayonnaise; macaroons [pastry]; macaroni; maltose; hominy; piccalilli; marinades; marzipan; honey; royal jelly; ice cream; bean meal; buckwheat flour; tapioca flour; potato flour; corn flour; nut flours; flour; wheat flour; soya flour; barley meal; dessert mousses [confectionery]; chocolate mousses; muesli; mint for confectionery; infusions, not medicinal; crushed oats; husked oats; okonomiyaki [Japanese savory pancakes]; onigiri [rice balls]; chocolate-coated nuts; nutmegs; stick liquorice [confectionery]; miso; pastila [confectionery]; pastilles [confectionery]; molasses for food; pâtés en croûte; pelmeni [dumplings stuffed with meat]; pepper; allspice; peppers [seasonings]; pesto [sauce]; cookies; petit-beurre biscuits; bibimbap [rice mixed with vegetables and beef]; pies; pizzas; meat gravies; fondants [confectionery]; popcorn; powders for making ice cream; baking powder; mustard meal; pralines; condiments; meat ten-

derizers for household purposes; cereal preparations; oat-based food; propolis; gingerbread; spices; petits fours [cakes]; puddings; rice pudding; cake powder; fruit coulis [sauces]; ravioli; ramen [Japanese noodle-based dish]; chewing gum; chewing gum for breath freshening; relish [condiment]; rice; instant rice; wheat germ for human consumption; spring rolls; sago; sugar; palm sugar; sesame seeds [seasonings]; linseed for culinary purposes [seasoning]; processed seeds for use as a seasoning; aniseed; agave syrup [natural sweetener]; golden syrup; confectionery; batter mixes for okonomiyaki [Japanese savory pancakes]; baking soda [bicarbonate of soda for cooking purposes]; malt for human consumption; salt for preserving foodstuffs; cooking salt; celery salt; sherbets [ices]; ham glaze; cranberry sauce [condiment]; soya sauce; tomato sauce; pasta sauce; sauces [condiments]; apple sauce [condiment]; spaghetti; seasonings; chocolate-based spreads; chocolate spreads containing nuts; preparations for stiffening whipped cream; shaved ice with sweetened red beans; rusks; breadcrumbs; sushi; senbei [rice crackers]; sandwiches; tabbouleh; tacos; tapioca; tarts; dough; pastry dough; almond paste; rice pulp for culinary purposes; cake dough; tortillas; garden herbs, preserved [seasonings]; chocolate decorations for cakes; vinegar; beer vinegar; ferments for pastes; halvah; bread; unleavened bread; corn flakes; oat flakes; chips [cereal products]; hot dog sandwiches; flowers or leaves for use as tea substitutes; jiaozi [stuffed dumplings]; chicory [coffee substitute]; tea; iced tea; chutneys [condiments]; minced garlic [condiment]; cheeseburgers [sandwiches]; chow-chow [condiment]; saffron [seasoning]; chocolate; malt extract for food; essences for foodstuffs, except etheric essences and essential oils; husked barley.

(260) AM 2021 110398 A

(800) 1558710

(151) 2020 07 24

(891) 2020 07 24

(731) SOYTEX LTD

CHARALAMPOU MOUSKOU, 20,
ATHINODOROU BUSINESS CENTRE,
OFFICE 404, CY-8010 PAPHOS, Cyprus

(540)



(591) Red, white

(531) 26.04.02; 26.04.18; 26.04.24; 27.05.10;
27.05.17; 27.05.24; 29.01.12

(511)

29 – Powdered milk; powdered whey; dehumidified milk fat; rape oil for food.

31 – Animal foodstuffs; stall food for animals; strengthening animal forage; ingredients for animal forage (other than for medical or veterinary use); sunflower meal; soybean meal; fruit residue [marc]; yeast for animal consumption; oil cake; rape cake for cattle; meal for animals; fish meal for animal consumption; animal fattening preparations; high-protein by-products of the processing of oil crops for feeding animals; by-products of the processing of cereals, for animal consumption; grains for animal consumption; cereal seeds, unprocessed; grains [cereals]; bran; soya beans, fresh.

(260) AM 2021 110399 A

(800) 1558730

(151) 2020 07 15

(891) 2020 07 15

(731) PSA AUTOMOBILES SA

2-10 boulevard de l'Europe, Poissy, F-78300,
France

(540)

STELLANTIS

(591) Black, white

(511)

9 – Holders for telephone handsets installed in motor cars; electronic global positioning systems (GPS); electronic apparatus and instruments for navigation, location and tracking; telematic and telephone terminals, particularly for access from vehicles to global telecommunication networks (Internet) or private networks (Intranet); connection equipment installed in a car for computer equipment (modems); connectors to a computer or telephone network; apparatus and instruments for testing and checking products related to mobility services: software, contact or contactless smart cards, terminals, readers, electronic labels for merchandise or any object equipped with an electronic chip, computer apparatus, telecommunication apparatus, data processing apparatus, telecommunication networks and computer systems; software (computer programs); interfaces (software), all these goods relating to mobility (transport) services; software for remote payment of highway tolls, rental of parking spaces and all services related to transport from cell phones, digital tablets and computers; warning lights for motor vehicles, namely flashing lights.

11 – Lighting apparatus for vehicles; direction indicator bulbs for vehicles; taillights for vehicles, position lights and reversing lights for land vehicles; lights for automobiles; vehicle headlights; vehicle reflectors and beam reflectors for vehicles.

12 – Vehicles, apparatus for locomotion by land, motor vehicles, component parts thereof, namely sus-

pension shock absorbers for vehicles; shock absorbers (springs) for vehicles; motors and engines for land vehicles; gear boxes for land vehicles; vehicle chassis; vehicle bodies; transmission shafts for land vehicles; hydraulic circuits for vehicles; torque converters for land vehicles; clutches for land vehicles; axles; brakes for vehicles; steering wheels; vehicle seats; headrests for vehicle seats; security devices for vehicles such as safety belts and air bags; rearview mirrors; windshield wipers; torsion bars; vehicle bumpers; protective molding rods; deflectors for vehicles; spoilers; windshields; sunroofs; windows for vehicles; caps for gas tanks; luggage racks for vehicles; armrests for automobile seats; shaft couplings for land vehicles; remote alarms for land vehicles; anti-intrusion alarms for vehicles; anti-theft alarms for vehicles; shock absorbers for vehicle suspension devices; Cardan shafts for vehicles; reversing sound alarms for vehicles; mud flaps for vehicles; glove boxes for automobiles; brake cables for vehicles; hoods for vehicles; casings as parts of gearboxes for land vehicles; ashtrays for vehicles; gearbox casings for land vehicles; steering columns for vehicles; transmission belts for the driving of land vehicles; safety, security and anti-theft devices and equipment for vehicles; clutch disks for land vehicles; brake pads for vehicle braking systems; automobile roof racks; interior fittings of automobiles; power trains, including motors for land vehicles; adjustable covers for vehicle steering wheels; adjustable protective covers for vehicle seats; horns for motor cars; gear levers; power transmission parts [belts] for land vehicles; brake pads for land vehicles; doors for vehicles; headlamp covers; child safety seats for motor cars; vehicle dashboards; trays for vehicle seats; car roofs; convertible tops for motor cars; tire valves; hybrid cars; driverless cars [autonomous cars].

35 – Bringing together (excluding the transport thereof) of vehicles and second-hand vehicles, their parts and accessories, enabling customers to conveniently view and purchase said goods; presentation of vehicles and second-hand vehicles, their parts and accessories on all communication media for retail purposes; organization of exhibitions for commercial or advertising purposes.

36 – Insurance services; financial affairs; financing services; real estate affairs; loans (financing); credit and hire-purchase services.

37 – Maintenance, servicing and repair of motor vehicles; vehicle breakdown assistance (repair); information and consulting services relating to maintenance, servicing and repair of motor vehicles.

39 – Escorting of travelers, organization of tours and excursions, sightseeing tours, transport of travelers; rental, reservation and provision of vehicles and vehicle accessories, rental of parking spaces and parking areas for vehicles, rental of vehicle parking lots, rental of vehicle garages, car sharing services, taxi transport

service, driver service, carpooling services; passenger transport service; information regarding public transport; packaging and storage of merchandise; information relating to transport and storage; ferry operations; marine towing; unloading; ships refloating.

(260) AM 2021 110430 A

(800) 587028

(151) 1991 12 20

(891) 2020 10 16

(731) J. WAGNER GMBH

Otto-Lilienthal-Strasse 18, 88677 Markdorf,
Germany

(540)



(591) Black, white

(531) 26.03.18; 27.05.01; 27.05.06; 27.05.08

(511)

7 – Apparatus for atomizing, projection and application of paints, lacquers, dispersions, roughcasts, glues, resins, cooling and lubricating products, disinfecting agents as well as installations consisting thereof; parts of such apparatus and installations, also as electrostatic versions; hand-held apparatus operated electrically, namely projection and atomization, stapling and nailing apparatus, separation and rectification apparatus.

8 – Apparatus, hand tools and instruments for surface treatment, in particular those to be covered with paint.

(260) AM 2021 110432 A

(800) 1355045

(151) 2017 04 12

(891) 2020 10 16

(731) ANHUI KANGTAI GLASSWARE

TECHNOLOGY, CO., LTD

Xujishen Road, Lu'An City Economic
Development Zone; Anhui Province,
China

(540)

POUGINE 波匠



(591) Both the characters and the image of the trademark are blue

(531) 02.01.01; 26.11.07; 27.05.01; 28.03; 29.01.04

(511)

21 – Cups; glass caps; glass caps; glass bowls; painted glassware; household glassware (including cups, plates, pots and jugs); signboards of porcelain or glass; boxes of glass; glasses [receptacles]; works of art of porcelain, ceramic, earthenware or glass; tea balls; coffee grinders, hand-operated; coffeepots, non-electric; coffee services[tableware]; coffee percolators, non-electric; tea strainers; tankards; drinking glasses; tea balls; mugs; liqueur sets; wine tasters [siphons]; siphon bottles for carbonated water; tea caddies; drinking horns; decanters; cabarets[trays]; drinking vessels; beer mugs; teapots; saucers; tea services[tableware]; drinking straws; vases; wine tasters[siphons]; [glassware]; opal glass; shatterproof glass; tempered glass.

(260) AM 2021 110433 A

(800) 1386615

(151) 2017 06 21

(891) 2020 10 16

(731) POWERFUL TOOLS LTD

46 St. Leonards Road, Far Cotton, Northampton
NN4 8DP, United Kingdom

(540)



(591) Light blue, yellow

(531) 14.03.01; 14.03.03; 15.07.01; 17.05.09;

27.03.15; 29.01.12

(511)

7 – Tools (machine -) for grinding; tools (machine -) for reaming; tools (hand-held -), other than hand-operated; tools (machine -) for cutting; tools for machines; tools (machine -) for use in binding hoses; tools for machine tools; tools for use with machine tools; tools for use in machine tools; tools [parts of machines]; tools (machine -) for boring; tools (machine -) for drilling; tools (machine -) for use in packaging; tools (holding devices for machine -); electric arc welders; electric arc welding apparatus; electric arc welding machines; electric generators; electrical generating machines; electrical generator plant; electricity generators; electric power generators; electrical generators; electricity generating sets; electric current generators; electric nail extractors; electric pizza cutters; electric window cleaning equipment; electric kitchen mixers; electric cleaning apparatus for household use; electric cleaners for household purposes; electric food grinders for industrial use; electric food grinders for commercial use; electric pumps for swimming pools; electric water pumps for baths; electric water pumps for spa baths; electric water pumps for swimming pools; electric water pumps; electrical engines, other than for land vehicles; electric door openers-closers used in land vehicles; electric punching machines; electric food grinders for domestic use; electric grinders

for use in households; electrical appliances used in kitchen for grinding; electrical appliances used in kitchen for crushing; electrical appliances used in kitchen for milling; electric vacuum cleaners for bedding; electric cordless sweepers; electric steam mops; electric steam mops for household purposes; electric caulking guns; electric scissors; electric shearing machines; electric shears; electric mixers for household purposes; electric blenders for household purposes; electric food blenders [for household purposes]; electric soldering apparatus; electric welding machines; electrical welding machines; electric soldering irons; electric powered soldering irons; electric welding apparatus; electrical welding apparatus; electric food grinders; electric food blenders; electric mixers for mixing food; electric blenders; electric food processors; electrical food processors; electric food choppers; electric fruit juice extractors; electrical juice extractors for fruit; electric fruit squeezers; electric fruit presses; electric juicers; electric juice extractors; electric fruit presses for household use; electric fruit presses for household purposes; electric fruit squeezers for household purposes; electric jacks; electric pulley blocks; electric hoists; electric hammers; electric coffee frothers; electrical squeezers for fruit and vegetable; electric chaff-cutters; electric graters; electric cable hoists; electric carving knives; electric milk frothers; electric pepper mills; electric salt mills; electric arc cutting apparatus; electric vegetable peelers; electric propulsion mechanisms for machines; electric sharpeners; electric sanders; electrical drills; electrical drilling machines; electric kitchen appliances for chopping, mixing, pressing; electric brooms; electric sweepers; electric ignition devices [other than for igniting at a distance]; electric power supplies [generators]; electric washing machines for industrial purposes; electric knives; electric power generators for ships; electrical drives for machines; electric drives for machines; electric generator power sets; electric power generators for emergency use; electric carpet shampooers; electric floor polishers; electrical cleaning [polishing] machines; electrically operated floor polishing machines; electrically operated brushes, being parts of machines; electric brushes being parts of machines; electrical brushes being parts of machines; electrically driven tools; electric power tools; electric planers; electric planes; electric knitting machines; electrical generators using solar cells; electric alternators for land vehicles; electric sewing machines; electric vacuum cleaners for industrial use; electrical coffee grinders; electric coffee grinders; electric washing machines; electrical domestic machines for vacuuming; electrically operated drives for drawing curtains; electric carpet sweepers; electric egg beaters; electric knife sharpeners; electric hammers [hand-held]; electric carpet vacuum cleaners; electrical appliances used in kitchen for whisking; electric saws; electric arc torches; electric welding torches; electric driving motors for machines; electric motors for machines; electrical beaters for car-

pets; electric beaters [machines]; electric alternators for water vehicles; electric starter motors; electric wax-polishing machines for industrial purposes; electric glue guns; electric ignition coils; electric drives for motors [other than for land vehicles]; electric driving motors [other than for land vehicles]; electric motors [other than for land vehicles]; electric motors, not for land vehicles; electric alternating current motor drives; electric garbage disposal machines; electrical pumps for ponds; electric motors, and their parts, not for land vehicles; electric drives for elevators; electric drives for lifts; electric vacuum cleaners; electrical carpet cleaning [shampooing] machines; electrical generator stations; electric clothing pressing machines; electrical ironing machines; electric ironing machines; electric food slicers; electric motors for machines with a digital servo drive controller; electric meat slicers for kitchen use; electric nail guns; electrical pumps; electric pumps; electric ignition apparatus for internal combustion engines; electric vacuum cleaners and their components; electrical apparatus for sealing plastics [packaging]; electric propulsion mechanisms for water vehicles; electrical motor pump units; electric drives for machine tools; electrically operated hand guided tools; electrically powered hand tools; electrically powered hand-held tools; electrically heated soldering irons; electric washing machines for household purposes; electric compressors; electrically operated suction cleaners [domestic]; electric pasta makers for domestic use; electric motors for heating installations; electric alternators for machines; electric lawnmowers; electric lawn trimmers; electric concrete vibrators; electric fan units for vacuum cleaners; electric rotary hammers; electric wood saw machines; electric meat grinders; electric hedge shears; electric door openers; electric motors for use with doors; electrical vacuum cleaners for domestic use; electric domestic vacuum cleaners; electric vacuum cleaners for domestic use; electrical winches for sailboats; electric alternating current generators; electric alternators; electric can openers; electric tin openers; electrical can-openers; electric hand-held drills; electric hand drills; electric drills [hand-held]; electrical brushes; electric ice crushing machines; electric ice crushers; electric sausage stuffers; electric scissor sharpeners; electric wax-polishing machines for household purposes; electric kitchen tools; electric shoe cleaning [polishing] machines; electric steam cleaning machines; electrical brakes for machines; electric babies' food processors; electrical generator groups (terms too vague in the opinion of the International Bureau – Rule 13 (2) (b) of the Common Regulations); electric chain saws; electrically powered windlasses; electrically powered winches; electric screwdrivers; electric bag sealers; electric fruit peelers; electric knives and knife sharpeners; discharging hoppers; discharge screws for compressed air [parts of machines]; discharge screws for gaseous materials [parts of machines]; disc brakes for machines; disc brakes

being parts of machines; disc shaped rotating grinding tools [parts for machines]; discs for cutting for use with power tools; disc harrows [tractor towed agricultural implements]; disc screens [parts of machines]; discharge screws for hydraulic fluids [parts of machines]; disc sanding machines; disc shaped rotating grinding tools [machines]; discharge screws for liquid materials [parts of machines]; discs made of abrasive materials [parts of machines]; discs for abrading for use with power tools; discs for clutch thrust bearings, other than for land vehicles; disc harrows; abrasive belts for power-operated sanders; abrasive disks for power-operated sanders; abrasive sharpening stones [parts of machines]; abrasive stones [parts of machines]; abrasive wheels being parts for machines; abrasive grinding wheels [machines]; abrasive instruments [tools for machines]; abrasive wheels for power-operated grinders; abrasive disks for power-operated grinders; abrasive grinding wheels [tools for machines]; abrasive discs [machine tools]; abrasive bits for use with machines; abrasive instruments [machines]; abrasive tools being parts of machines; abrasive sheets all being parts of machines or power tools; diamond drill bits for machines; diamond cutting tools for machines; diamond-pointed metal-cutting tools; diamonds (glaziers' -) [parts of machines]; drilling machines and parts therefor; drill presses being machines; drilling hammers; drill aligning instruments for use with machines; drill presses [power tools]; drill cooling apparatus [parts of machines]; drilling rods; drill chucks for power drills; drilling rigs, floating or non-floating; drills being cordless electric power tools; drilling heads [parts of machines]; drilling tips for drilling machines; drilling machines [for metalworking]; drilling machines for metalworking; drills for the mining industry; drill sharpening machines; drilling rigs for drilling off-shore wells; drills (electric hand -); drilling tools for use with machines; drilling rigs; drill bits for machines; drill bits for rotary power tools; drill stands for drilling machines; drilling rigs for drilling wells on land; drill aligning squares being machines; drilling bits [parts of machines]; drill chucks [parts of machines]; drill bits for rock drilling; drilling apparatus for mineral exploration; drilling machine supports; drilling machines; drill machines; drills for machine tools; drill aligning instruments being machines; drills [power tools]; tape readers for use with embroidery machines; tape stretching machines; taper shank bits [parts of machines]; wire brushes [parts of machines]; wire mesh conveyor belts; wire wheels for power-operated grinders; wire extruding machines; wire making machines; wire stripping machines for removing the covering from electric cables; wire cutters [machines]; wire pulling grips [machines]; wire-coiling machines; wire drawing dies being parts of machines; wire chain belts for machines; wire forming machines; wire welding machines; wire cut machines; wire stitching machines; wiremesh cutters [machines]; wire brushes for use in machines; wire

drawing machines; wire hoists; brushes being parts of generators; brushes [parts of machines]; brushes being parts of motors; brushes being parts of machines; brushing [sweeping] machines; brushes being parts of motors, generators and dynamos; brush cutters [machines]; brushwood cutters [machines]; brushes (dynamo -); brushes being parts of dynamos; brushes for vacuum cleaners; brushes, electrically operated [parts of machines]; brushes, electrically operated; wheelwork (machine -); wheels (spinning -); wheel hubs being parts of machines; wheels being parts of machines; wheels (machine -); wheels and tracks for machines.

8 – Hand-operated ski files; hand-operated ski sharpening instruments; hand-operated cattle prods; hand-operated sanders; hand-operated sharpening tools and instruments; hand-operated tile spacer removal tools; hand-operated tools for repair of vehicles; hand-operated tools for forestry; hand-operated apparatus for the cosmetic care of eyebrows; hand-operated weed diggers; hand-operated weed cutters; hand-operated tools for bending pipes; hand-operated tools and implements for treatment of materials, and for construction, repair and maintenance; hand-operated cutting tools; hand-operated insecticide sprayers; hand-operated sprayers for insecticide; hand-operated wrenches; hand-operated pipe cutters; hand-operated dibbers; hand-operated implements; hand-operated slicers; hand-operated choppers; hand-operated implements for dicing food; hand-operated riveting tools; hand-operated hair clippers; hand-operated tools for drilling; hand-operated jigsaws; hand-operated vegetable shredders; hand-operated tools for skinning fish; hand-operated hack saws; hand-operated milling cutters; hand-operated tin snips; hand-operated grease guns; hand-operated tools for gardening; hand-operated sprayers for agricultural purposes; hand-operated caulking guns; hand-operated files; hand-operated tools for agriculture; hand-operated lawn edgers; hand-operated guns for the extrusion of mastics; hand-operated tools for skinning animals; hand-operated tiller; hand-operated jacks; electric shavers; electric razors; electric hair curling irons; electric steam irons; electric hair clippers for personal use [hand instruments]; electric pedicure sets; electrical shavers for removing threads from fabric [hand instruments]; electrically operated hair clippers [hand instruments]; electric manicure sets; electric hair clippers for animals [hand instruments]; electric and non-electric depilatory appliances; electric hair clippers; electric hair cutters; electric hair trimmers; electrical shavers for removing fuzz from fabric [hand instruments]; electric fingernail polishers; electric beard trimmers; electric nail buffers; electric nail files; electric hair crimper; electric hair crimpers; electric hair straightening irons; electric irons for styling hair; electric hand-held hair styling irons; electric irons; electric flat irons; electric animal nail grinders; electric hair braiders; electric

hair straighteners; electric and battery-powered hair clippers; electric ear hair trimmers; electric nasal hair trimmers; discs for abrading being hand-operated tools; abrasive tools (hand-operated -); abrasive stones [hand-operated tools]; abrasive wheels for use with hand tools; abrasive discs [parts for hand operated tools]; abrasive grinding wheels [parts of hand operated tools]; abrasive grinding wheels [hand-operated tools]; diamond cutting tools for hand-operated tools; diamond drill bits for hand-operated tools; diamonds (glaziers' -) [parts of hand tools]; drill bits for hand operated tools; drills (hand-operated -); drills [hand tools]; drill bits for hand drills; drill holders [hand tools]; drill bits for use in hand tools; drill presses (hand operated -); drills; drill chucks [parts of hand-operated tools]; drill sharpeners (hand operated -); wire pulling grips [hand-operated tools]; wire cutters; wire cutters [hand tools]; wire cutters (hand operated -); wiremesh cutters (hand operated -); wire nippers [hand tools]; wire brushes [hand-operated tools]; wire stretchers [hand tools]; wire strippers [hand tools]; wire strippers; wire strippers (hand operated -); brushes (steel -) [hand-operated tools]; wheels (sharpening -) [hand tools].

9 – Electrical rotary converters.

(260) AM 2021 110434 A

(800) 1396907

(151) 2017 10 02

(891) 2020 09 24

(731) XIE RONG CHU

1, Building 4, Yangxi Sea Farm, Chengcun Town, Yangxi Town, Yangjiang, 529821 Guangdong, China

(540)



(591) Black, white

(531) 27.05.01

(511)

3 – Toilet soap; perfumery; nail polish; false eyelashes; cosmetic preparations for eyelashes; depilatories; cosmetics; false nails; adhesives for affixing false eyelashes; glue for eyelid (terms considered too vague by the International Bureau – Rule 13 (2) (b) of the Common Regulations).

(260) AM 2021 110435 A

(800) 1406251

(151) 2018 01 18

(891) 2020 10 12

(731) Andronnik Limited Liability Company

floor 5, building 77, Sacco and Vanzetti street, RU-630008 Novosibirsk, Russian Federation

(540)

ADRIACATS

(591) Black, white

(511)

35 – Arranging subscriptions to telecommunication services for others; import-export agency services; commercial information agency services; advertising agency services; cost price analysis; rental of advertising space; business auditing; employment agency services; computerized file management; book-keeping; invoicing; business efficiency expert services; demonstration of goods; transcription of communications [office functions]; opinion polling; market studies; business information; commercial information and advice for consumers [consumer advice shop]; business investigations; business research; marketing research; personnel recruitment; business management and organization consultancy; business organization consultancy; business management consultancy; personnel management consultancy; professional business consultancy; layout services for advertising purposes; marketing; business management of performing artists; business management of sports people; news clipping services; updating of advertising material; word processing; organization of exhibitions for commercial or advertising purposes; arranging newspaper subscriptions for others; organization of fashion shows for promotional purposes; organization of trade fairs for commercial or advertising purposes; shop window dressing; business appraisals; payroll preparation; data search in computer files for others; sponsorship search; business management assistance; commercial or industrial management assistance; presentation of goods on communication media, for retail purposes; economic forecasting; auctioneering; sales promotion for others; production of advertising films; office machines and equipment rental; rental of advertising time on communication media; publicity material rental; rental of vending machines; rental of photocopying machines; publication of publicity texts; radio advertising; bill-posting; distribution of samples; dissemination of advertising matter; direct mail advertising; writing of publicity texts; advertising; on-line advertising on a computer network; advertising by mail order; television advertising; document reproduction; compilation of statistics; compilation of information into computer databases; business inquiries; systemization of information into computer databases; advisory services for business management; tax preparation; drawing up of statements of accounts; telemarketing services; psychological testing for the selection of personnel; business management of hotels; commercial administration of the licensing of the goods and services of others; administrative processing of purchase orders; public relations; modelling for advertising or sales promotion; typing; relocation services for businesses; price comparison services; secretarial services; procurement services for others

[purchasing goods and services for other businesses]; shorthand; outsourcing services [business assistance]; telephone answering for unavailable subscribers; photocopying services.

(260) AM 2021 110495 A
(800) 1560077
(151) 2020 10 02
(891) 2020 10 02
(731) COMPAGNIE GERVAIS DANONE
17 boulevard Haussmann, F-75009 PARIS,
France
(540)

DANISSIMO

(591) Black, white
(511)
29 – Milk, dairy products and substitutes thereof; powdered milk; flavored jellied milks and buttermilk; milk desserts; yogurts; drinking yogurts; white cheese; petit suisse; beverages mainly consisting of milk or dairy products; milk beverages, milk predominating; milk beverages containing fruit; unflavored or flavored fermented dairy products; milk substitutes of vegetable origin; substitutes of dairy products based on plants or nuts; fruit or vegetable beverages consisting mainly of milk products; compotes; fruit compotes.

30 – Cocoa; chocolate; cocoa-based beverages; chocolate-based beverages; coffee-based beverages; tea-based beverages; custard; chocolate mousses; dessert mousses [confectionery]; confectionery; sugar confectionery; sugar; puffed rice; cereal preparations; breakfast cereals; biscuits (sweet or savory); cakes; pastries; waffles; cereal-based desserts; rice cakes; semolina cakes; rice pudding; rice-based snacks; cereal-based snacks; edible ices; edible ices essentially made with yogurt; ice cream; sherbets (ices); frozen yogurts (edible ices); flavored frozen-water-based edible ice; fruit coulis [sauces]; chocolate-based spreads; chocolate spreads containing nuts; prepared foodstuffs in the form of sauces.

32 – Still or sparkling water (mineral or other); fruit or vegetable juices; beverages with fruit or vegetables; lemonades; soda water; sherbets; preparations for making beverages; syrups for beverages; non-alcoholic vegetable or fruit extract; non-alcoholic beverages; non-alcoholic plant-based beverages; non-alcoholic beverages of vegetable origin excluding dairy substitutes.

(260) AM 2021 110496 A
(800) 1560091
(151) 2020 07 13
(891) 2020 07 13
(731) DONİNO ESA TEKSTİL KONFEKSİYON,
AKSESUAR GIDA İNŞAAT SAN.VE
TİC.LTD.ŞTİ YUNUSEMRE MAH/SEMT AY
CAD. 21/1, YILDIRIM, BURSA, Turkey
(540)

Donino Baby

(591) Black, white
(511)
25 – Clothing, including underwear and outer clothing, other than special purpose protective clothing; socks, mufflers [clothing], shawls, bandanas, scarves, belts [clothing]; footwear, shoes, slippers, sandals; headgear, hats, caps with visors, berets, caps [headwear], skull caps.

(260) AM 2021 110497 A
(800) 1560172
(151) 2020 07 31
(891) 2020 07 31
(731) AROUSHA CONSTRUCTION
DEVELOPMENT INDUSTRIES CO.
NO 1602., Eghab ST(3/1), Chelcheleh ST(5
Alley)., Abbas Abad Industrial, Sharifabad
District, Pakdasht, 3393178184 Tehran
Province, Islamic Republic of Iran
(540)

شودر

 Shouder

(591) Crimson Red
(531) 26.01.03; 26.01.18; 26.01.24; 27.05.01;
27.05.09; 27.05.10; 27.05.24; 28.19; 29.01.01
(511)
11 – Faucet; hot air bath fittings; taps; taps for pipes and pipelines; washers for water taps; washers for water faucets; water control valves for faucets; thermostat valves [part of heating installations]; sanitary apparatus and installations; automatic faucet; water-pipes for sanitary installations.

(260) AM 2021 110498 A
(800) 1560256
(151) 2020 09 18
(891) 2020 09 18
(731) Apple Inc.
One Apple Park Way, Cupertino CA 95014,
USA

(540)

APPLE FITNESS+

(591) Black, white

(526) FITNESS+

(511)

9 – Downloadable digital media, namely, podcasts, images, audio and video recordings in the field of health, wellness, lifestyle, exercise, physical training, fitness instruction, guided workouts, and personal development; downloadable computer software application for accessing, browsing and searching online databases for audio, video, and multimedia content; computer software for use in generating customized recommendations of audio, video, data, text and other multimedia content, including podcasts, images, audio and video recordings, and cultural events determined from an analysis of user preferences; computer software for use in connection with an online fitness subscription service; database synchronization software; database management software; computer software for use in playing, organizing, downloading, transmitting, manipulating, and reviewing audio files, video files, and media files; computer software for use in the delivery, distribution and transmission of digital music and education-related audio, video, text and multimedia content; computer software for creating searchable databases of information and data for peer-to-peer social networking databases; computer software for accessing, browsing and searching online databases; computer software for setting up, configuring, operating and controlling mobile devices, wearable devices, mobile phones, computers, and computer peripherals, and audio and video players; computer software to enable users to program and distribute audio, video, data, text and other multimedia content, including music, videos, radio, cultural events, and entertainment-related and educational programs via communication networks.

(260) AM 2021 110579 A

(800) 1561164

(151) 2020 09 23

(891) 2020 09 23

(731) CLAIREFONTAINE RHODIA

RD 52, F-68490 OTTMARSHEIM, France;

NUSSE GUILLAUME

RD 52; F-68490 OTTMARSHEIM, France

(540)

PASTELMAT

(591) Black, white

(511)

16 – Printing products (printed matter); bookbinding material; photographs; stationery; adhesives for stationery or household purposes; artists' materials; paintbrushes; typewriters and office requisites (except furniture); instructional or teaching material (except ap-

paratus); printing type; printing blocks; paper; cardboard; boxes of cardboard or paper; posters; albums; cards; books; newspapers; prospectuses; pamphlets; calendars; writing instruments; engravings or lithographic works of art; paintings (pictures), framed or unframed; aquarelles; drawings; drawing instruments; bags (covers, pouches) for packaging (made of paper or plastic).

(260) AM 2021 110580 A

(800) 1561168

(151) 2020 04 21

(891) 2020 04 21

(731) PRO.MED.CS Praha a.s.

Telčská 1, CZ-140 00 Praha 4, Czech Republic

(540)

PROMETIS

(591) Black, white

(511)

5 – Pharmaceutical preparations.

(260) AM 2021 110581 A

(800) 1561185

(151) 2020 10 05

(891) 2020 10 05

(731) COMPAGNIE GERVAIS DANONE

17 boulevard Haussmann, F-75009 PARIS,

France

(540)

Даниссимо

(591) Black, white

(531) 28.05

(511)

29 – Milk, dairy products and substitutes thereof; powdered milk; flavored jellied milks and buttermilk; milk desserts; yogurts; drinking yogurts; white cheese; petit suisse; beverages mainly consisting of milk or dairy products; milk beverages, milk predominating; milk beverages containing fruit; unflavored or flavored fermented dairy products; milk substitutes of vegetable origin; substitutes of dairy products based on plants or nuts; fruit or vegetable beverages consisting mainly of milk products; compotes; fruit compotes.

30 – Cocoa; chocolate; cocoa-based beverages; chocolate-based beverages; coffee-based beverages; tea-based beverages; custard; chocolate mousses; dessert mousses [confectionery]; confectionery; sugar confectionery; sugar; puffed rice; cereal preparations; breakfast cereals; biscuits (sweet or savory); cakes; pastries; waffles; cereal-based desserts; rice cakes; semolina cakes; rice pudding; rice-based snacks; cereal-based snacks; edible ices; edible ices essentially made with yogurt; ice cream; sherbets (ices); frozen yogurts

(edible ices); flavored frozen-water-based edible ice; fruit coulis [sauces]; chocolate-based spreads; chocolate spreads containing nuts; prepared foodstuffs in the form of sauces.

32 – Still or sparkling water (mineral or other); fruit or vegetable juices; beverages with fruit or vegetables; lemonades; soda water; sherbets; preparations for making beverages; syrups for beverages; non-alcoholic vegetable or fruit extract; non-alcoholic beverages; non-alcoholic plant-based beverages; non-alcoholic beverages of vegetable origin excluding dairy substitutes.

(260) AM 2021 110617 A

(800) 1561367

(151) 2020 10 16

(891) 2020 10 16

(731) JONATHAN MARINI

Via Don Quaranta 2/C, I-12089 Villanova
Mondovì, Italy

(540)

TURPIAL

(591) Black, white

(511)

33 – Alcoholic beverages (except beer); rum.

(260) AM 2021 110619 A

(800) 1561380

(151) 2020 06 04

(891) 2020 06 04

(731) Aktsionernoe obshchestvo "Kaspi Bank"

ul. Nauryzbay batyra, d. 154A, 050013
Gorod Almaty, Kazakhstan

(540)



(591) Black, white

(531) 02.07.10; 02.07.11; 04.05.05; 26.01.01;

26.01.14; 26.01.14; 26.04.10

(511)

35 – Arranging subscriptions to telecommunication services for others; import-export agency services; commercial information agency services; advertising agency services; cost price analysis; rental of advertising space; business auditing; financial auditing; business intermediary services relating to the matching of potential private investors with entrepreneurs needing funding; employment agency services; computerized file management; book-keeping; invoicing; de-

monstration of goods; transcription of communications [office functions]; opinion polling; market studies; business information; information and advice for consumers in the field of choosing products and services; business investigations; business research; marketing research; personnel recruitment; business management and organization consultancy; business organization consultancy; business management consultancy; personnel management consultancy; professional business consultancy; consultancy regarding public relations communication strategies; consultancy regarding advertising communication strategies; layout services for advertising purposes; marketing; marketing in the framework of software publishing; targeted marketing; business management of performing artists; business management of sports people; writing of resumes for others; scriptwriting for advertising purposes; news clipping services; updating and maintenance of information in registries; updating and maintenance of data in computer databases; updating of advertising material; word processing; online retail services for downloadable and pre-recorded music and movies; online retail services for downloadable ring tones; online retail services for downloadable digital music; organization of exhibitions for commercial or advertising purposes; arranging newspaper subscriptions for others; organization of fashion shows for promotional purposes; organization of trade fairs for commercial or advertising purposes; shop window dressing; development of advertising concepts; business appraisals; payroll preparation; data search in computer files for others; sponsorship search; administrative assistance in responding to calls for tenders; business management assistance; commercial or industrial management assistance; commercial intermediation services; providing business information via a web site; providing commercial and business contact information; provision of an online marketplace for buyers and sellers of goods and services; web indexing for commercial or advertising purposes; presentation of goods on communication media, for retail purpose; economic forecasting; auctioneering; retail services for works of art provided by art galleries; sales promotion for others; promotion of goods and services through sponsorship of sports events; production of teleshopping programmes; production of advertising films; office machines and equipment rental; rental of advertising time on communication media; publicity material rental; rental of billboards [advertising boards]; rental of vending machines; rental of sales stands; rental of photocopying machines; publication of publicity texts; radio advertising; bill-posting; distribution of samples; dissemination of advertising matter; direct mail advertising; registration of written communications and data; writing of publicity texts; advertising; online advertising on a computer network; advertising by mail order; television advertising; document reproduction; compilation of statistics; compilation of information into computer

databases; business inquiries; systemization of information into computer databases; advisory services for business management; negotiation of business contracts for others; negotiation and conclusion of commercial transactions for third parties; compiling indexes of information for commercial or advertising purposes; tax preparation; drawing up of statements of accounts; telemarketing services; psychological testing for the selection of personnel; wholesale of pharmaceutical, veterinary, hygiene products and medical supplies; retail sale of pharmaceutical, veterinary, hygiene products and medical supplies; interim business management; external administrative management for companies; business management of hotels; business management for freelance service providers; business project management services for construction projects; commercial administration of the licensing of the goods and services of others; business management of reimbursement programs for others; administration of consumer loyalty programs; administration of frequent flyer programs; administrative processing of purchase orders; public relations; competitive intelligence services; modelling for advertising or sales promotion; typing; market intelligence services; appointment reminder services [office functions]; web site traffic optimization; administrative services for the relocation of businesses; tax filing services; search engine optimization for sales promotion; appointment scheduling services [office functions]; gift registry services; price comparison services; pay per click advertising; secretarial services; procurement services for others [purchasing goods and services for other businesses]; shorthand; outsourcing services [business assistance]; telephone answering for unavailable subscribers; photocopying services; business efficiency expert services; media relations services; corporate communications services; rental of office equipment in co-working facilities; commercial lobbying services.

36 – Credit bureau services; debt collection agency services; real estate agency services; financial analysis; rental of apartments; rental of offices for co-working; rental of real estate; rental of offices [real estate]; rental of farms; lease-purchase financing; savings bank services; accommodation bureau services [apartments]; rent collection; issuance of travelers' checks; issuance of credit cards; issuance of tokens of value; capital investment; insurance information; financial information; clearing, financial; insurance consultancy; financial consultancy; debt advisory services; stock exchange quotations; lending against security; business liquidation services, financial; brokerage; financial management; exchanging money; online banking; processing of debit card payments; processing of credit card payments; factoring; organization of monetary collections; arranging finance for construction projects; antique appraisal; jewelry appraisal; financial evaluation of standing timber; stamp app-

raisal; real estate appraisal; numismatic appraisal; art appraisal; financial evaluation of wool; financial evaluation [insurance, banking, real estate]; financial appraisals in responding to calls for tenders; repair costs evaluation [financial appraisal]; electronic funds transfer; surety services; securities brokerage; real estate brokerage; brokerage of carbon credits; insurance brokerage; providing rebates at participating establishments of others through use of a membership card; loans [financing]; pawnbrokerage; providing financial information via a web site; check verification; investment of funds; charitable fund raising; stocks and bonds brokerage; financial sponsorship; mortgage banking; instalment loans; insurance underwriting; life insurance underwriting; health insurance underwriting; accident insurance underwriting; marine insurance underwriting; fire insurance underwriting; apartment house management; real estate management; financial management of reimbursement payments for others; actuarial services; banking; stock brokerage services; retirement payment services; bail-bonding; trusteeship; provident fund services; financial customs brokerage services; mutual funds; financing services; safe deposit services; deposits of valuables; fiscal valuation; financial evaluation of development costs relating to the oil, gas and mining industries; financial research.

(260) AM 2021 110620 A
 (800) 1561398
 (151) 2020 07 10
 (891) 2020 07 10
 (731) Egis Gyógyszergyár Zrt.
 Keresztúri út 30-38., H-1106 Budapest,
 Hungary
 (540)

УРИАЛОР

(591) Black, white
 (531) 28.05
 (511)
 5 – Pharmaceutical preparations for human use.

(260) AM 2021 110651 A
 (800) 1562179
 (151) 2020 10 14
 (891) 2020 10 14
 (731) Apple Inc.
 One Apple Park Way, Cupertino CA 95014, USA
 (540)



(591) Black and blue
 (531) 01.15.03; 01.15.15; 26.04.04; 26.04.13;
 29.01.12

(511)
 9 – Electronic sensors, measurement instruments and computer hardware for use in compiling and measuring weather and climate data for use in making weather and climate forecasts; computer software, namely, software development tools for the creation of mobile internet applications and client interfaces for acquiring, analyzing, generating and displaying weather and climate data and making weather and climate forecasts.

(260) AM 2021 110654 A
 (800) 1562449
 (151) 2020 09 14
 (891) 2020 09 14
 (731) Apple Inc.
 One Apple Park Way, Cupertino CA 95014,
 USA

(540)

Apple Music 1

(591) Black, white
 (526) music
 (511)
 38 – Broadcasting and transmission of voice, data, images, music, audio, video, multimedia, podcasts, and radio by means of telecommunications networks; broadcast and transmission of streamed music, audio, video, podcasts, and multimedia content by means of telecommunications networks; providing access to websites, databases, music, audio and video content programs on the Internet by means of telecommunications networks; streaming audio material on the internet; radio broadcasting.

(260) AM 2021 110656 A
 (800) 1562500
 (151) 2020 09 14
 (891) 2020 09 14
 (731) Apple Inc.
 One Apple Park Way, Cupertino CA 95014,
 USA

(540)



(591) Black, white
 (531) 05.07.13
 (526) Music
 (511)
 38 – Broadcasting and transmission of voice, data, images, music, audio, video, multimedia, podcasts, and radio by means of telecommunications networks;

broadcast and transmission of streamed music, audio, video, podcasts, and multimedia content by means of telecommunications networks; providing access to websites, databases, music, audio and video content programs on the Internet by means of telecommunications networks; streaming audio material on the internet; radio broadcasting.

(260) AM 2021 110657 A
 (800) 1562510
 (151) 2020 07 09
 (891) 2020 07 09
 (731) GRATIS İÇ VE DIŞ TİCARET ANONİM
 ŞİRKETİ
 Levent Mah., Yapı Kredi Plaza C Blok, Cömert
 Sok 1C Kat.5, Beşiktaş, İstanbul, Turkey
 (540)



(591) Pink, white
 (531) 26.04.04; 26.04.18; 27.05.24; 29.01.13
 (511)
 3 – Bleaching and cleaning preparations, detergents other than for use in manufacturing operations and for medical purposes, laundry bleach, fabric softeners for laundry use, stain removers, dishwasher detergents; perfumery; cosmetics; fragrances; (including deodorants for personal use and animals, except for medicated cosmetics); soaps (except for medicated soaps); dental care preparations: dentifrices, denture polishes, tooth whitening preparations, mouth washes, not for medical purposes; abrasive preparations; emery cloth; sandpaper; pumice stone; abrasive pastes; polishing preparations for leather, vinyl, metal and wood, polishes and creams for leather, vinyl, metal and wood, wax for polishing.

5 – Pharmaceutical and veterinary preparations for medical purposes; chemical preparations for medical and veterinary purposes, chemical reagents for pharmaceutical and veterinary purposes, medicated cosmetics; dietary supplements for pharmaceutical and veterinary purposes; dietary supplements, nutritional supplements for human beings and animals; medical preparations for slimming purposes; food for babies; herbs and herbal beverages adapted for medicinal purposes; dental preparations and articles (except for instruments/devices): teeth filling material, dental impression material, dental adhesives and material for repairing teeth; sanitary preparations; hygienic pads; hygienic tampons; plasters; materials for dressings; diapers for adults and pets including those made of paper and textiles; preparations for destroying pest, vermin;

fungicides, herbicides; deodorants, other than for human beings or for animals; air deodorising preparations; disinfectants; antiseptics; detergents for medical purposes, medicated soaps, disinfectant soaps, anti-bacterial hand lotions.

16 – Paper and cardboard; paper and cardboard for packaging and wrapping purposes, cardboard boxes; paper towels; toilet paper; paper napkins; plastic materials for packaging and wrapping purposes; printing blocks and types; bookbinding material; printed publications; printed matter; books, magazines, newspapers, bill books, printed dispatch notes, printed vouchers, calendars; posters; photographs [printed]; paintings; stickers [stationery]; postage stamps; stationery, office stationery, instructional and teaching material [except furniture and apparatus]; writing and drawing implements; artists' materials; paper products for stationery purposes; adhesives for stationery purposes, pens, pencils, erasers, adhesive tapes for stationery purposes, cardboard cartons [artists' materials], writing paper, copying paper, paper rolls for cash registers, drawing materials, chalkboards, painting pencils, watercolors [paintings]; office requisites; paint rollers and paintbrushes for painting.

21 – Hand-operated non-electric cleaning instruments and appliances, brushes, other than paintbrushes, steel chips for cleaning, sponges for cleaning, steel wool for cleaning, cloths of textile for cleaning, gloves for dishwashing, non-electric polishing machines for household purposes, brooms for carpets, mops; toothbrushes, electric toothbrushes, dental floss, shaving brushes, hair brushes, combs; non-electric household or kitchen utensils, included in this class, [other than forks, knives, spoons], services [dishes], pots and pans, bottle openers, flower pots, drinking straws, non-electric cooking utensils; ironing boards and shaped covers therefor, drying racks for washing, clothes drying hangers; cages for household pets, indoor aquariums, vivariums and indoor terrariums for animals and plant cultivation; ornaments and decorative goods of glass, porcelain, earthenware or clay, included in this class, namely statues, figurines and vases and trophies made of these materials; mouse traps, insect traps, electric devices for attracting and killing flies and insects, fly catchers, fly swatters; perfume burners, perfume sprayers, perfume vaporizers, electric or non-electric make-up removing appliances, powder puffs, toilet cases; nozzles for sprinkler hose, nozzles for watering cans, watering devices, garden watering cans; unworked or semi-worked glass, except building glass, mosaics of glass and powdered glass for decoration, except for building, glass wool other than for insulation or textile use.

INTERNATIONAL TRADEMARKS PROTECTED IN GEORGIA

(260) AM 2021 108465 A
(800) 1532901
(151) 2020 02 13
(181) 2030 02 13
(891) 2020 02 13
(511) 07, 08, 09, 11, 12

(260) AM 2021 108647 A
(800) 1535697
(151) 2020 05 03
(181) 2030 05 03
(891) 2020 05 03
(511) 01, 04

(260) AM 2021 108614 A
(800) 1534499
(151) 2019 12 13
(181) 2029 12 13
(891) 2019 12 13
(511) 35

(260) AM 2021 108649 A
(800) 1535768
(151) 2020 03 20
(181) 2030 03 20
(891) 2020 03 20
(511) 03, 05, 35, 41, 44

(260) AM 2021 108615 A
(800) 1534508
(151) 2020 03 19
(181) 2030 03 19
(891) 2020 03 19
(511) 25

(260) AM 2021 108650 A
(800) 789746
(151) 2002 09 30
(181) 2022 09 30
(891) 2020 05 26
(511) 31

(260) AM 2021 108617 A
(800) 1534613
(151) 2020 02 18
(181) 2030 02 18
(891) 2020 02 18
(511) 03

(260) AM 2021 108651 A
(800) 1023000
(151) 2009 11 11
(181) 2029 11 11
(891) 2020 05 19
(511) 05

(260) AM 2021 108618 A
(800) 1534615
(151) 2020 01 13
(181) 2030 01 13
(891) 2020 01 13
(511) 01, 05, 31, 35, 41, 44

(260) AM 2021 108703 A
(800) 1535959
(151) 2020 05 06
(181) 2030 05 06
(891) 2020 05 06
(511) 29

(260) AM 2021 108619 A
(800) 1534617
(151) 2020 02 24
(181) 2030 02 24
(891) 2020 02 24
(511) 09

(260) AM 2021 108707 A
(800) 1536087
(151) 2020 03 27
(181) 2030 03 27
(891) 2020 03 27
(511) 09, 35

(260) AM 2021 108620 A
(800) 1534679
(151) 2020 03 13
(181) 2030 03 13
(891) 2020 03 13
(511) 11, 17, 20

(260) AM 2021 108708 A
(800) 1536098
(151) 2019 11 13
(181) 2029 11 13
(891) 2019 11 13
(511) 03, 08, 21

(260) AM 2021 108709 A
(800) 1536130
(151) 2019 11 13
(181) 2029 11 13
(891) 2019 11 13
(511) 03, 07, 08, 09, 10, 11, 14, 16, 18, 20, 21, 24, 25,
28, 29, 31, 32

(260) AM 2021 108710 A
(800) 1536151
(151) 2020 03 30
(181) 2030 03 30
(891) 2020 03 30
(511) 09, 41

(260) AM 2021 108711 A
(800) 1536201
(151) 2020 03 02
(181) 2030 03 02
(891) 2020 03 02
(511) 25, 29, 30, 35, 39, 43

(260) AM 2021 108713 A
(800) 1536223
(151) 2020 01 29
(181) 2030 01 29
(891) 2020 01 29
(511) 03, 37, 39, 41, 43, 44

(260) AM 2021 108714 A
(800) 1536232
(151) 2020 01 28
(181) 2030 01 28
(891) 2020 01 28
(511) 36

(260) AM 2021 108799 A
(800) 1537127
(151) 2020 04 17
(181) 2030 04 17
(891) 2020 04 17
(511) 30

(260) AM 2021 108801 A
(800) 1537247
(151) 2020 03 26
(181) 2030 03 26
(891) 2020 03 26
(511) 35, 43

(260) AM 2021 108802 A
(800) 1537267
(151) 2020 03 02
(181) 2030 03 02
(891) 2020 03 02
(511) 09, 29, 30, 35, 39, 43

(260) AM 2021 108811 A
(800) 1537399
(151) 2020 02 05
(181) 2030 02 05
(891) 2020 02 05
(511) 20, 21, 24, 25, 26, 35

(260) AM 2021 108812 A
(800) 1537477
(151) 2019 11 22
(181) 2029 11 22
(891) 2019 11 22
(511) 09, 35, 38, 41, 42, 45

(260) AM 2021 108813 A
(800) 1537479
(151) 2020 06 01
(181) 2030 06 01
(891) 2020 06 01
(511) 29, 31

(260) AM 2021 108814 A
(800) 1537480
(151) 2019 12 19
(181) 2029 12 19
(891) 2019 12 19
(511) 01, 16, 35, 36, 37, 38, 39, 40, 41, 42

(260) AM 2021 108815 A
(800) 1537585
(151) 2020 01 30
(181) 2030 01 30
(891) 2020 01 30
(511) 03, 05, 10

(260) AM 2021 108816 A
(800) 1537606
(151) 2020 04 26
(181) 2030 04 26
(891) 2020 04 26
(511) 05

(260) AM 2021 108817 A
 (800) 1537651
 (151) 2019 12 19
 (181) 2029 12 19
 (891) 2019 12 19
 (511) 01, 16, 35, 36, 37, 38, 39, 40, 41, 42

(260) AM 2021 108824 A
 (800) 1537796
 (151) 2020 05 20
 (181) 2030 05 20
 (891) 2020 05 20
 (511) 10

(260) AM 2021 108818 A
 (800) 1537664
 (151) 2020 01 07
 (181) 2030 01 07
 (891) 2020 01 07
 (511) 11, 20

(260) AM 2021 108825 A
 (800) 1537797
 (151) 2020 05 20
 (181) 2030 05 20
 (891) 2020 05 20
 (511) 10

(260) AM 2021 108819 A
 (800) 1537731
 (151) 2020 03 13
 (181) 2030 03 13
 (891) 2020 03 13
 (511) 12, 37

(260) AM 2021 108826 A
 (800) 1537884
 (151) 2020 05 28
 (181) 2030 05 28
 (891) 2020 05 28
 (511) 05

(260) AM 2021 108820 A
 (800) 1537753
 (151) 2020 04 28
 (181) 2030 04 28
 (891) 2020 04 28
 (511) 34

(260) AM 2021 108827 A
 (800) 1537892
 (151) 2020 03 16
 (181) 2030 03 16
 (891) 2020 03 16
 (511) 03, 09, 14, 18, 20, 24, 25, 26, 35

(260) AM 2021 108821 A
 (800) 1537762
 (151) 2020 05 18
 (181) 2030 05 18
 (891) 2020 05 18
 (511) 01, 05, 09, 10

(260) AM 2021 108828 A
 (800) 1537926
 (151) 2020 05 12
 (181) 2030 05 12
 (891) 2020 05 12
 (511) 07

(260) AM 2021 108822 A
 (800) 1537778
 (151) 2020 01 30
 (181) 2030 01 30
 (891) 2020 01 30
 (511) 03, 05, 10

(260) AM 2021 108830 A
 (800) 1537944
 (151) 2020 02 28
 (181) 2030 02 28
 (891) 2020 02 28
 (511) 35

(260) AM 2021 108823 A
 (800) 1537793
 (151) 2020 05 20
 (181) 2030 05 20
 (891) 2020 05 20
 (511) 10

(260) AM 2021 108834 A
 (800) 1538059
 (151) 2020 02 07
 (181) 2030 02 07
 (891) 2020 02 07
 (511) 31

(260) AM 2021 108896 A
(800) 1538172
(151) 2020 03 30
(181) 2030 03 30
(891) 2020 03 30
(511) 03, 05

(260) AM 2021 108899 A
(800) 1538233
(151) 2020 03 30
(181) 2030 03 30
(891) 2020 03 30
(511) 03, 05

(260) AM 2021 108901 A
(800) 1538246
(151) 2020 05 12
(181) 2030 05 12
(891) 2020 05 12
(511) 07

(260) AM 2021 108903 A
(800) 1538339
(151) 2020 02 18
(181) 2030 02 18
(891) 2020 02 18
(511) 35

(260) AM 2021 108904 A
(800) 1538430
(151) 2020 03 05
(181) 2030 03 05
(891) 2020 03 05
(511) 05, 10

(260) AM 2021 108905 A
(800) 1538451
(151) 2020 02 10
(181) 2030 02 10
(891) 2020 02 10
(511) 35, 42, 44

(260) AM 2021 108906 A
(800) 1538491
(151) 2020 04 22
(181) 2030 04 22
(891) 2020 04 22
(511) 35, 36

(260) AM 2021 108907 A
(800) 1538495
(151) 2020 05 11
(181) 2030 05 11
(891) 2020 05 11
(511) 09

(260) AM 2021 108912 A
(800) 1538783
(151) 2020 03 17
(181) 2030 03 17
(891) 2020 03 17
(511) 09, 42

(260) AM 2021 108921 A
(800) 1539038
(151) 2020 03 09
(181) 2030 03 09
(891) 2020 03 09
(511) 30, 35

(260) AM 2021 108929 A
(800) 1539188
(151) 2020 05 18
(181) 2030 05 18
(891) 2020 05 18
(511) 05

(260) AM 2021 108930 A
(800) 1539194
(151) 2020 03 27
(181) 2030 03 27
(891) 2020 03 27
(511) 29, 30, 32, 35

(260) AM 2021 108931 A
(800) 1539215
(151) 2020 03 09
(181) 2030 03 09
(891) 2020 03 09
(511) 09

(260) AM 2021 108932 A
(800) 1539251
(151) 2019 05 09
(181) 2029 05 09
(891) 2019 05 09
(511) 08, 09, 11, 21

(260) AM 2021 108934 A
(800) 1539269
(151) 2020 05 29
(181) 2030 05 29
(891) 2020 05 29
(511) 30

(260) AM 2021 108995 A
(800) 1540032
(151) 2020 06 04
(181) 2030 06 04
(891) 2020 06 04
(511) 03, 05

(260) AM 2021 108935 A
(800) 1539297
(151) 2020 03 25
(181) 2030 03 25
(891) 2020 03 25
(511) 38, 41, 42

(260) AM 2021 108996 A
(800) 1540117
(151) 2020 03 09
(181) 2030 03 09
(891) 2020 03 09
(511) 30, 35

(260) AM 2021 108936 A
(800) 1539303
(151) 2020 04 29
(181) 2030 04 29
(891) 2020 04 29
(511) 32

(260) AM 2021 108997 A
(800) 1540119
(151) 2020 03 10
(181) 2030 03 10
(891) 2020 03 10
(511) 41

(260) AM 2021 108938 A
(800) 1262537
(151) 2015 04 22
(181) 2025 04 22
(891) 2020 04 07
(511) 32

(260) AM 2021 108998 A
(800) 1540150
(151) 2020 03 05
(181) 2030 03 05
(891) 2020 03 05
(511) 01

(260) AM 2021 108939 A
(800) 1484780
(151) 2019 06 28
(181) 2029 06 28
(891) 2020 06 15
(511) 05

(260) AM 2021 108999 A
(800) 394013
(151) 1972 10 26
(181) 2022 10 26
(891) 2020 06 23
(511) 01, 05

(260) AM 2021 108940 A
(800) 1526662
(151) 2019 11 11
(181) 2029 11 11
(891) 2020 06 03
(511) 03, 05, 10, 35

(260) AM 2021 109000 A
(800) 821091
(151) 2004 02 09
(181) 2024 02 09
(891) 2020 05 29
(511) 05

(260) AM 2021 108994 A
(800) 1540016
(151) 2020 06 10
(181) 2030 06 10
(891) 2020 06 10
(511) 09

(260) AM 2021 109001 A
(800) 1407124
(151) 2018 03 06
(181) 2028 03 06
(891) 2020 06 10
(511) 03

(260) AM 2021 109002 A
(800) 1466812
(151) 2018 12 03
(181) 2028 12 03
(891) 2020 02 21
(511) 06

(260) AM 2021 109003 A
(800) 1485074
(151) 2019 03 15
(181) 2029 03 15
(891) 2020 02 14
(511) 24

(260) AM 2021 109057 A
(800) 1540371
(151) 2020 01 28
(181) 2030 01 28
(891) 2020 01 28
(511) 02, 16

(260) AM 2021 109059 A
(800) 1540379
(151) 2020 06 03
(181) 2030 06 03
(891) 2020 06 03
(511) 12

(260) AM 2021 109060 A
(800) 1540440
(151) 2020 02 05
(181) 2030 02 05
(891) 2020 02 05
(511) 30

(260) AM 2021 109061 A
(800) 1540506
(151) 2020 02 10
(181) 2030 02 10
(891) 2020 02 10
(511) 29, 30

(260) AM 2021 109063 A
(800) 1540590
(151) 2020 05 13
(181) 2030 05 13
(891) 2020 05 13
(511) 30

(260) AM 2021 109065 A
(800) 1540755
(151) 2020 05 27
(181) 2030 05 27
(891) 2020 05 27
(511) 25

(260) AM 2021 109088 A
(800) 1541235
(151) 2020 01 10
(181) 2030 01 10
(891) 2020 01 10
(511) 01, 05, 09, 10

(260) AM 2021 109089 A
(800) 331610A
(151) 1967 01 12
(181) 2027 01 12
(891) 2020 06 26
(511) 33

(260) AM 2021 109090 A
(800) 851722
(151) 2004 09 23
(181) 2024 09 23
(891) 2020 06 29
(511) 05, 42, 44

(260) AM 2021 109094 A
(800) 1260963
(151) 2015 06 03
(181) 2025 06 03
(891) 2020 06 04
(511) 13

(260) AM 2021 109096 A
(800) 1284462
(151) 2015 09 16
(181) 2025 09 16
(891) 2020 06 16
(511) 29, 30

(260) AM 2021 109097 A
(800) 1291580
(151) 2015 11 09
(181) 2025 11 09
(891) 2020 06 29
(511) 05, 42, 44

(260) AM 2021 109098 A
(800) 1469793
(151) 2018 12 28
(181) 2028 12 28
(891) 2020 07 01
(511) 05

(260) AM 2021 109153 A
(800) 1541372
(151) 2020 04 15
(181) 2030 04 15
(891) 2020 04 15
(511) 10

(260) AM 2021 109099 A
(800) 1477291
(151) 2019 05 17
(181) 2029 05 17
(891) 2020 06 12
(511) 05

(260) AM 2021 109154 A
(800) 1541392
(151) 2020 05 08
(181) 2030 05 08
(891) 2020 05 08
(511) 09

(260) AM 2021 109147 A
(800) 1541301
(151) 2020 05 18
(181) 2030 05 18
(891) 2020 05 18
(511) 31

(260) AM 2021 109155 A
(800) 1541460
(151) 2020 06 18
(181) 2030 06 18
(891) 2020 06 18
(511) 31

(260) AM 2021 109148 A
(800) 1541303
(151) 2020 05 18
(181) 2030 05 18
(891) 2020 05 18
(511) 05

(260) AM 2021 109156 A
(800) 1541463
(151) 2020 06 10
(181) 2030 06 10
(891) 2020 06 10
(511) 07, 09

(260) AM 2021 109149 A
(800) 1541307
(151) 2020 05 18
(181) 2030 05 18
(891) 2020 05 18
(511) 31

(260) AM 2021 109157 A
(800) 1541538
(151) 2019 08 27
(181) 2029 08 27
(891) 2019 08 27
(511) 01

(260) AM 2021 109151 A
(800) 1541323
(151) 2019 12 13
(181) 2029 12 13
(891) 2019 12 13
(511) 33

(260) AM 2021 109188 A
(800) 1542316
(151) 2020 06 19
(181) 2030 06 19
(891) 2020 06 19
(511) 34

(260) AM 2021 109152 A
(800) 1541327
(151) 2020 05 18
(181) 2030 05 18
(891) 2020 05 18
(511) 05

(260) AM 2021 109189 A
(800) 1542335
(151) 2020 06 17
(181) 2030 06 17
(891) 2020 06 17
(511) 05

(260) AM 2021 109190 A
(800) 1542364
(151) 2020 04 08
(181) 2030 04 08
(891) 2020 04 08
(511) 05

(260) AM 2021 109236 A
(800) 1542467
(151) 2020 03 18
(181) 2030 03 18
(891) 2020 03 18
(511) 33, 39, 40

(260) AM 2021 109191 A
(800) 1542384
(151) 2020 01 24
(181) 2030 01 24
(891) 2020 01 24
(511) 03, 08, 35, 44

(260) AM 2021 109237 A
(800) 1542494
(151) 2020 05 21
(181) 2030 05 21
(891) 2020 05 21
(511) 05

(260) AM 2021 109192 A
(800) 899011
(151) 2006 08 14
(181) 2026 08 14
(891) 2020 06 26
(511) 05

(260) AM 2021 109238 A
(800) 1542496
(151) 2020 06 11
(181) 2030 06 11
(891) 2020 06 11
(511) 01, 05, 31

(260) AM 2021 109193 A
(800) 938609
(151) 2007 03 14
(181) 2027 03 14
(891) 2020 07 06
(511) 01, 17, 19, 27, 35, 37

(260) AM 2021 109249 A
(800) 1542835
(151) 2020 05 14
(181) 2030 05 14
(891) 2020 05 14
(511) 05

(260) AM 2021 109194 A
(800) 940393
(151) 2007 03 14
(181) 2027 03 14
(891) 2020 07 06
(511) 01, 19, 27, 37

(260) AM 2021 109270 A
(800) 1543428
(151) 2020 06 02
(181) 2030 06 02
(891) 2020 06 02
(511) 30

(260) AM 2021 109234 A
(800) 1542452
(151) 2020 04 28
(181) 2030 04 28
(891) 2020 04 28
(511) 03, 05

(260) AM 2021 109271 A
(800) 1543430
(151) 2020 03 21
(181) 2030 03 21
(891) 2020 03 21
(511) 19

(260) AM 2021 109235 A
(800) 1542457
(151) 2019 12 19
(181) 2029 12 19
(891) 2019 12 19
(511) 09

(260) AM 2021 109272 A
(800) 1543445
(151) 2020 06 16
(181) 2030 06 16
(891) 2020 06 16
(511) 03, 08, 09, 10, 11, 12, 20, 21, 24, 28

(260) AM 2021 109273 A
(800) 1543466
(151) 2020 02 26
(181) 2030 02 26
(891) 2020 02 26
(511) 05

(260) AM 2021 109274 A
(800) 1543579
(151) 2020 06 19
(181) 2030 06 19
(891) 2020 06 19
(511) 09

(260) AM 2021 109322 A
(800) 1544329
(151) 2020 06 23
(181) 2030 06 23
(891) 2020 06 23
(511) 34

(260) AM 2021 109323 A
(800) 1544412
(151) 2020 04 01
(181) 2030 04 01
(891) 2020 04 01
(511) 12

(260) AM 2021 109324 A
(800) 1544439
(151) 2020 07 03
(181) 2030 07 03
(891) 2020 07 03
(511) 33

(260) AM 2021 109325 A
(800) 1544454
(151) 2020 05 19
(181) 2030 05 19
(891) 2020 05 19
(511) 05

(260) AM 2021 109336 A
(800) 1544677
(151) 2020 02 25
(181) 2030 02 25
(891) 2020 02 25
(511) 05

(260) AM 2021 109337 A
(800) 1544679
(151) 2020 04 30
(181) 2030 04 30
(891) 2020 04 30
(511) 11

(260) AM 2021 109338 A
(800) 1544758
(151) 2020 03 20
(181) 2030 03 20
(891) 2020 03 20
(511) 09, 28

(260) AM 2021 109339 A
(800) 1544782
(151) 2020 04 22
(181) 2030 04 22
(891) 2020 04 22
(511) 09

(260) AM 2021 109340 A
(800) 1544790
(151) 2019 12 18
(181) 2029 12 18
(891) 2019 12 18
(511) 28, 38, 41

(260) AM 2021 109400 A
(800) 1545242
(151) 2019 06 21
(181) 2029 06 21
(891) 2019 06 21
(511) 01, 04

(260) AM 2021 109401 A
(800) 1545244
(151) 2020 03 20
(181) 2030 03 20
(891) 2020 03 20
(511) 09, 28

(260) AM 2021 109402 A
(800) 1545297
(151) 2020 06 02
(181) 2030 06 02
(891) 2020 06 02
(511) 30

(260) AM 2021 109403 A
(800) 1545339
(151) 2020 01 28
(181) 2030 01 28
(891) 2020 01 28
(511) 35, 36, 38, 42

(260) AM 2021 109463 A
(800) 1546466
(151) 2020 06 08
(181) 2030 06 08
(891) 2020 06 08
(511) 33

(260) AM 2021 109414 A
(800) 1545714
(151) 2020 05 22
(181) 2030 05 22
(891) 2020 05 22
(511) 09, 42

(260) AM 2021 109464 A
(800) 1546473
(151) 2020 06 02
(181) 2030 06 02
(891) 2020 06 02
(511) 30

(260) AM 2021 109415 A
(800) 1545773
(151) 2020 03 10
(181) 2030 03 10
(891) 2020 03 10
(511) 09, 38, 42

(260) AM 2021 109465 A
(800) 1546530
(151) 2020 01 31
(181) 2030 01 31
(891) 2020 01 31
(511) 09, 10, 25, 42

(260) AM 2021 109416 A
(800) 1545793
(151) 2020 04 21
(181) 2030 04 21
(891) 2020 04 21
(511) 10

(260) AM 2021 109466 A
(800) 1546550
(151) 2020 04 08
(181) 2030 04 08
(891) 2020 04 08
(511) 10

(260) AM 2021 109418 A
(800) 1545831
(151) 2020 03 23
(181) 2030 03 23
(891) 2020 03 23
(511) 09, 35, 38, 42

(260) AM 2021 109480 A
(800) 1546793
(151) 2020 06 02
(181) 2030 06 02
(891) 2020 06 02
(511) 29, 30

(260) AM 2021 109461 A
(800) 1546397
(151) 2020 05 19
(181) 2030 05 19
(891) 2020 05 19
(511) 05

(260) AM 2021 109483 A
(800) 1546872
(151) 2020 02 24
(181) 2030 02 24
(891) 2020 02 24
(511) 09

(260) AM 2021 109462 A
(800) 1546440
(151) 2020 03 13
(181) 2030 03 13
(891) 2020 03 13
(511) 07, 11, 21

(260) AM 2021 109497 A
(800) 1544862
(151) 2020 06 23
(181) 2030 06 23
(891) 2020 07 31
(511) 05

(260) AM 2021 109549 A
(800) 1547500
(151) 2020 06 03
(181) 2030 06 03
(891) 2020 06 03
(511) 05

(260) AM 2021 109572 A
(800) 1268095
(151) 2015 06 30
(181) 2025 06 30
(891) 2020 07 21
(511) 05, 29, 30, 35

(260) AM 2021 109550 A
(800) 1547529
(151) 2020 07 31
(181) 2030 07 31
(891) 2020 07 31
(511) 37

(260) AM 2021 109551 A
(800) 1547530
(151) 2020 07 31
(181) 2030 07 31
(891) 2020 07 31
(511) 12

(260) AM 2021 109553 A
(800) 1547541
(151) 2020 06 03
(181) 2030 06 03
(891) 2020 06 03
(511) 41

(260) AM 2021 109554 A
(800) 1547542
(151) 2020 07 23
(181) 2030 07 23
(891) 2020 07 23
(511) 30

(260) AM 2021 109555 A
(800) 1547545
(151) 2020 06 03
(181) 2030 06 03
(891) 2020 06 03
(511) 03

(260) AM 2021 109570 A
(800) 1141714
(151) 2012 10 30
(181) 2022 10 30
(891) 2020 07 14
(511) 09

APPELLATIONS OF ORIGIN OF GOODS

INTERNATIONAL APPELLATIONS OF ORIGINE OF GOODS

(800) 1153
(151) 2020 10 23
(210) 3505
(540)

Злакуса – Zlakusa

(731) Association of the Potters "Zlakusa"
Village Zlakusa bb, 31205 Sevojno, Serbia

(511)

21 – Handmade pottery in a traditional way, on potters wheel from the mass of clay and calcite in equal ratio 50%-50% or 60%-40% for large pots.

(800) 1154
(151) 2020 10 23
(210) 3506
(540)

Пешкири шабачког краја – Peškiri šabačkog kraja

(731) Zanatska zadruga "Povesmo iz Šabac" (Handicraft Association "Povesmo from Sabac")

Boračka 20, 15000 Šabac, Serbia;

Gradska organizacija invalida rada Šabac-tkačka radionica "Stari zanati" (Town Association of Invalids of Work of Sabac – Weaving Workshop Old Skills)

Kraljice Marije 13, 15000 Šabac, Serbia

(511)

24 – Hand woven towels made from natural raw material decorated by embroidery, lace or fringes.

OFFICIAL NOTIFICATIONS

INVENTIONS

EXPIRATION OF PATENT RESTORATION

(21) AP 2013 13715

(11) P 2017 6672 B

(73) Arven Ilac Sanayi Ve Ticaret A.S.

(54) DRY POWDER INHALER COMPOSITIONS COMPRISING LONG ACTING MUSCORINIC ANTAGONISTS

DATE OF CANCELLATION OF PATENT: 2021 06 24

THE TERM OF RESTORATION OF PATENT: 2021 07 26

ABOLITION OF PATENTS WITH THE RIGHT TO RESTORE

(21) AP 2010 12562

(11) P 2014 6016 B

(73) Boehringer Ingelheim International GMBH

(54) PHARMACEUTICAL COMPOSITION CONTAINING HEPATITIS C VIRAL PROTEASE INHIBITOR

DATE OF CANCELLATION OF PATENT: 2021 07 01

THE TERM OF RESTORATION OF PATENT: 2022 07 01

(21) AP 2012 12766

(11) P 2013 5987 B

(73) Sarki Markaryan

(54) METHOD OF WATER COMPLEX DEACTIVATION AND MODULE FOR EXECUTION THEREOF

DATE OF CANCELLATION OF PATENT: 2021 06 27

THE TERM OF RESTORATION OF PATENT: 2022 06 27

(21) AP 2013 13145

(11) P 2014 6149 B

(73) Kakhaber Dzodzuashvili

(54) EQUIPMENT HEATING FOOD PRODUCTS

DATE OF CANCELLATION OF PATENT: 2021 06 27

THE TERM OF RESTORATION OF PATENT: 2022 06 27

(21) AP 2018 14819

(11) P 2020 7109 B

(73) LEPL Institute of Rapiel Dvali Machine Mechanics

(54) MARTENSITIC HEAT ENGINE

DATE OF CANCELLATION OF PATENT: 2021 06 27

THE TERM OF RESTORATION OF PATENT: 2022 06 27

(21) AP 2017 14989

(11) P 2020 7204 B

(73) Durect Corporation;

Santen Pharmaceutical Co., LTD

(54) DEPOT FORMULATIONS

DATE OF CANCELLATION OF PATENT: 2021 06 29

THE TERM OF RESTORATION OF PATENT: 2022 06 29

EXPIRATION OF TERM OF RESTORATION OF PATENTS

(21) AP 2012 12769
(11) P 2014 6020 B
(73) General Electric Company
(54) METHOD OF BORON POWDERING BY PRESSURE MILL WITH INERT GAS USAGE TO SATISFY
CLEANNESS NEED
DATE OF CANCELLATION OF PATENT: 2020 06 27
THE TERM OF RESTORATION OF PATENT VALIDITY HAS EXPIRED: 2021 06 27

(21) AP 2013 13150
(11) P 2017 6751 B
(73) Avtandil Metreveli
(54) SUSPENDED FALSEWORK WITH LIFTERS
DATE OF CANCELLATION OF PATENT: 2020 07 03
THE TERM OF RESTORATION OF PATENT VALIDITY HAS EXPIRED: 2021 07 03

(21) AP 2012 13365
(11) P 2015 6399 B
(73) Syngenta Participations AG
(54) MICROBIOCIDAL HETEROCYCLES
DATE OF CANCELLATION OF PATENT: 2020 06 27
THE TERM OF RESTORATION OF PATENT VALIDITY HAS EXPIRED: 2021 06 27

(21) AP 2012 13378
(11) P 2017 6592 B
(73) H. Lundbeck A/S
(54) POSITIVE ALLOSTERIC MODULATORS OF NICOTINIC ACETYLCHOLINE RECEPTOR
DATE OF CANCELLATION OF PATENT: 2020 07 06
THE TERM OF RESTORATION OF PATENT VALIDITY HAS EXPIRED: 2021 07 06

(21) AP 2012 13999
(11) P 2018 6802 B
(73) H. Lundbeck A/S
(54) POSITIVE ALLOSTERIC MODULATORS OF NICOTINIC ACETYLCHOLINE RECEPTOR
DATE OF CANCELLATION OF PATENT: 2020 07 06
THE TERM OF RESTORATION OF PATENT VALIDITY HAS EXPIRED: 2021 07 06

(21) AP 2014 14043
(11) P 2017 6793 B
(73) Alios Biopharma Inc.
(54) SUBSTITUTED NUCLEOSIDES, NUCLEOTIDES AND ANALOGS THEREOF
DATE OF CANCELLATION OF PATENT: 2020 06 24
THE TERM OF RESTORATION OF PATENT VALIDITY HAS EXPIRED: 2021 06 24

(21) AP 2015 14395
(11) P 2019 7047 B
(73) Millennium Pharmaceuticals Inc.
(54) HETEROARYL COMPOUNDS USEFUL AS INHIBITORS OF SUMO ACTIVATING ENZYME
DATE OF CANCELLATION OF PATENT: 2020 06 30
THE TERM OF RESTORATION OF PATENT VALIDITY HAS EXPIRED: 2021 06 30

(21) AP 2015 14401
(11) P 2019 6942 B
(73) Takeda Pharmaceutical Company Limited
(54) HETEROCYCLIC COMPOUNDS AND THEIR USE AS RETINOIDRELATED ORPHAN RECEPTOR
(ROR) GAMMA-T INHIBITORS
DATE OF CANCELLATION OF PATENT: 2020 06 30
THE TERM OF RESTORATION OF PATENT VALIDITY HAS EXPIRED: 2021 06 30

(21) AP 2015 14408
(11) P 2018 6934 B
(73) Lupin Limited
(54) QUINOLIZINONE DERIVATIVES AS PI3K INHIBITORS
DATE OF CANCELLATION OF PATENT: 2020 07 01
THE TERM OF RESTORATION OF PATENT VALIDITY HAS EXPIRED: 2021 07 01

(21) AP 2015 14415
(11) P 2019 6944 B
(73) Arven Ilac Sanayi Ve Ticaret A.S.
(54) PROCESS FOR PREPARING THE INHALATION FORMULATIONS
DATE OF CANCELLATION OF PATENT: 2020 07 08
THE TERM OF RESTORATION OF PATENT VALIDITY HAS EXPIRED: 2021 07 08

(21) AP 2003 8601
(11) P 2011 5296 B
(73) Geox S.P.A.
(54) WATERPROOF AND BREATHABLE SOLE FOR SHOES
DATE OF CANCELLATION OF PATENT: 2020 07 07
THE TERM OF RESTORATION OF PATENT VALIDITY HAS EXPIRED: 2021 07 07

(21) AP 2004 9844
(11) P 2008 4556 B
(73) Bankinter S.A.;
Caja De Ahorros De Galicia
(54) METHOD FOR OBTAINING CASH AT CARDLESS TELLER MACHINES WITHOUT CARD USING
A PAYMENT ORDER VIA SM
DATE OF CANCELLATION OF PATENT: 2020 07 05
THE TERM OF RESTORATION OF PATENT VALIDITY HAS EXPIRED: 2021 07 05

EXPIRATION OF PATENT

(21) AP 2001 5976
(11) P 2003 2908 B
(73) Genadi Gedevanishvili
(54) METHOD AND DEVICE FOR NON-INVASIVE RESEARCH OF BLOOD DISTRIBUTION AND ITS
CIRCULATORY CHARACTERISTICS IN WARM-BLOODED ORGANISM
EXPIRATION DATE OF PATENT: 05 07 2021

UTILITY MODELS

EXPIRATION OF PATENT RESTORATION

(21) AU 2013 12956
(11) U 2016 1909 Y
(73) Davit Zukakishvili
(54) LOWER JAW DENTAL MODEL MEASURING SPOON
DATE OF CANCELLATION OF PATENT: 2021 01 09
THE TERM OF RESTORATION OF PATENT: 2021 07 26

ABOLITION OF PATENTS WITH THE RIGHT TO RESTORE

(21) AU 2013 13155
(11) U 2014 1819 Y
(73) Giorgi Bikov
(54) POKER TYPE CARD GAME SYSTEM
DATE OF CANCELLATION OF PATENT: 2021 07 08
THE TERM OF RESTORATION OF PATENT: 2022 07 08

(21) AU 2015 13872
(11) U 2016 1898 Y
(73) Giorhi Jighauri
(54) METHOD FOR KAKHETIAN TATARA PREPARATION
DATE OF CANCELLATION OF PATENT: 2021 06 30
THE TERM OF RESTORATION OF PATENT: 2022 06 30

(21) AU 2019 15122
(11) U 2020 2043 Y
(73) Aleksandre Moseshvili
(54) WIND POWER DEVICE
DATE OF CANCELLATION OF PATENT: 2021 06 27
THE TERM OF RESTORATION OF PATENT: 2022 06 27

(21) AU 2019 15133
(11) U 2020 2042 Y
(73) Evgeni Gogogtishvili
(54) CONSTRUCTIONAL WALL HOLLOW STONE
DATE OF CANCELLATION OF PATENT: 2021 07 05
THE TERM OF RESTORATION OF PATENT: 2022 07 05

EXPIRATION OF TERM OF RESTORATION OF PATENT

(21) AU 2015 13873
(11) U 2017 1916 Y
(73) Nodat Gasviani
(54) METHOD FOR POLYMERIC COMPOSITE MATERIALS ELECTROCHEMICAL ALUMINIZATION
DATE OF CANCELLATION OF PATENT: 2020 06 30
THE TERM OF RESTORATION OF PATENT VALIDITY HAS EXPIRED: 2021 06 30

DESIGNS

CANCELLATION OF REGISTRATION OF DESIGNS

(11) D 2016 685 S
(73) LLC "Orbi-Alco" (GE)
V. Ninua St. 3, Fl. I, 0103, Tbilisi, Georgia (GE)
(54) CLAY PRODUCTS
(18) 2020 12 02
(58) 2021 07 12

(11) D 2016 660 S
(73) Giorgi Zautashvili (GE)
M. Kantaria St. 10, app. 2, 0186, Tbilisi, Georgia (GE)
(54) BOTTLE
(18) 2020 12 30
(58) 2021 07 12

CANCELLATION OF REGISTRATION OF INTERNATIONAL DESIGNS

(11) DM/66587
(73) DAIMLERCHRYSLER AG
Epplestrasse 225, 70567 Stuttgart (DE)
DATE OF CANCELLATION OF REGISTRATION:2020 05 06
(58) 2021 07 09

(11) DM/66642
(73) DAIMLERCHRYSLER AG
Epplestrasse 225, 70567 Stuttgart (DE)
DATE OF CANCELLATION OF REGISTRATION:2020 05 12
(58) 2021 07 09

(11) DM/66643
(73) DAIMLERCHRYSLER AG
Epplestrasse 225, 70567 Stuttgart (DE)
DATE OF CANCELLATION OF REGISTRATION:2020 05 12
(58) 2021 07 09

(11) DM/66651
(73) DAIMLERCHRYSLER AG
Epplestrasse 225, 70567 Stuttgart (DE)
DATE OF CANCELLATION OF REGISTRATION:2020 05 06
(58) 2021 07 09

(11) DM/66673
(73) RENTSCH A.G.
Industriestrasse 6W, CH-4613 Rickenbach (CH)
DATE OF CANCELLATION OF REGISTRATION:2020 06 10
(58) 2021 07 09

(11) DM/66693
(73) SWATCH AG (SWATCH SA) (SWATCH LTD.)
94, Rue Jakob Stämpfli, CH-2502 BIENNE (CH)
DATE OF CANCELLATION OF REGISTRATION:2020 06 17
(58) 2021 07 09

(11) DM/66705
(73) DAIMLERCHRYSLER AG
Epplestrasse 225, 70567 Stuttgart (DE)
DATE OF CANCELLATION OF REGISTRATION:2020 05 26
(58) 2021 07 09

(11) DM/66710
(73) SOCIÉTÉ DES PRODUITS NESTLÉ S.A
CH-1800 VEVEY (CH)
DATE OF CANCELLATION OF REGISTRATION:2020 05 25
(58) 2021 07 09

(11) DM/66723
(73) SMART GMBH
Leibnizstrasse 2, 71032 Böblingen (DE)
DATE OF CANCELLATION OF REGISTRATION:2020 06 03
(58) 2021 07 09

(11) DM/66750
(73) SWATCH AG (SWATCH SA) (SWATCH LTD.)
94, Rue Jakob Stämpfli, CH-2502 BIENNE (CH)
DATE OF CANCELLATION OF REGISTRATION:2019 12 20
(58) 2021 07 09

(11) DM/66766
(73) SOCIÉTÉ DES PRODUITS NESTLÉ S.A
CH-1800 Vevey (CH)
DATE OF CANCELLATION OF REGISTRATION:2020 05 27
(58) 2021 07 09

(11) DM/66791
(73) SWATCH AG (SWATCH SA) (SWATCH LTD.)
94, Rue Jakob Stämpfli, CH-2502 BIENNE (CH)
DATE OF CANCELLATION OF REGISTRATION:2020 07 01
(58) 2021 07 12

(11) DM/66804
(73) SWATCH AG (SWATCH SA) (SWATCH LTD.)
94, Rue Jakob Stämpfli, CH-2502 BIENNE (CH)
DATE OF CANCELLATION OF REGISTRATION:2020 07 01
(58) 2021 07 12

(11) DM/66825
(73) MGI LUXURY GROUP SA
Nidaugasse 35, CH-2502 Bienne (CH)
DATE OF CANCELLATION OF REGISTRATION:2020 06 15
(58) 2021 07 12

(11) DM/66848
(73) SEAT S.A.
Zona Franca, Calle 2, no. 1, E-08040 BARCELONA (ES)
DATE OF CANCELLATION OF REGISTRATION:2020 06 24
(58) 2021 07 12

(11) DM/66855
(73) SWATCH AG (SWATCH SA) (SWATCH LTD.)
94, Rue Jakob Stämpfli, CH-2502 BIENNE (CH)
DATE OF CANCELLATION OF REGISTRATION:2020 07 19
(58) 2021 07 12

(11) DM/66856
(73) SMART GMBH
Leibnizstrasse 2, 71032 Böblingen (DE)
DATE OF CANCELLATION OF REGISTRATION:2020 07 15
(58) 2021 07 12

(11) DM/66915
(73) MAKEL ELEKTRIK MALZEMELERI SANAYI VE TICARET LIMITED SIRKETI
Fevzi Cakmak Cd. Muhacir Mh. No: 51 Kirac Mevkii Buyukcekmece, Istanbul (TR)
DATE OF CANCELLATION OF REGISTRATION:2020 08 17
(58) 2021 07 12

(11) DM/66952
(73) BRAUN GMBH
Frankfurter Str. 145, 61476 Kronberg (DE)
DATE OF CANCELLATION OF REGISTRATION:2020 08 02
(58) 2021 07 12

(11) DM/66994
(73) SWATCH AG (SWATCH SA) (SWATCH LTD.)
94, Rue Jakob Stämpfli, CH-2502 BIENNE (CH)
DATE OF CANCELLATION OF REGISTRATION:2020 09 14
(58) 2021 07 12

(11) DM/67019
(73) BRAUN GMBH
Frankfurter Strasse 145, 61476 Kronberg (DE)
DATE OF CANCELLATION OF REGISTRATION:2020 09 20
(58) 2021 07 12

(11) DM/67037
(73) DAIMLERCHRYSLER AG
Epplestrasse 225, 70567 Stuttgart (DE)
DATE OF CANCELLATION OF REGISTRATION:2020 09 07
(58) 2021 07 12

(11) DM/67044
(73) DAIMLERCHRYSLER AG
Epplestrasse 225, 70567 Stuttgart (DE)
DATE OF CANCELLATION OF REGISTRATION:2020 09 07
(58) 2021 07 12

(11) DM/67045
(73) DAIMLERCHRYSLER AG
Epplestrasse 225, 70567 Stuttgart (DE)
DATE OF CANCELLATION OF REGISTRATION:2020 08 31
(58) 2021 07 12

(11) DM/67131
(73) UNILEVER N.V.
Weena 455, NL-3013 AL Rotterdam (NL)
DATE OF CANCELLATION OF REGISTRATION:2020 09 28
(58) 2021 07 13

(11) DM/67175
(73) DAIMLERCHRYSLER AG
Epplestrasse 225, 70567 Stuttgart (DE)
DATE OF CANCELLATION OF REGISTRATION:2020 11 09
(58) 2021 07 13

(11) DM/67258
(73) DAIMLERCHRYSLER AG
Epplestrasse 225, 70567 Stuttgart (DE)
DATE OF CANCELLATION OF REGISTRATION:2020 11 28
(58) 2021 07 13

(11) DM/67273
(73) HANSA METALLWERKE AG
Sigmaringer Strasse 107, 70567 Stuttgart (DE)
DATE OF CANCELLATION OF REGISTRATION:2020 06 01
(58) 2021 07 13

TRADEMARKS

RENEWAL OF REGISTRATIONS

(111) M 2001 13863 R2
(156) 2001 05 29
(186) 2031 05 29
(732) Delphi Technologies Inc.
a Delaware Corporation
5725 Delphi Drive, Troy, Michigan
48098-2815, USA

(111) M 2001 13889 R2
(156) 2001 05 29
(186) 2031 05 29
(732) Carolina Herrera LTD
501 Seventh Avenue, 17th Floor,
10018 New York, USA

(111) M 2001 13890 R2
(156) 2001 05 29
(186) 2031 05 29
(732) Carolina Herrera LTD
501 Seventh Avenue, 17th Floor,
10018 New York, USA

(111) M 2001 14012 R2
(156) 2001 09 13
(186) 2031 09 13
(732) Balkanpharma Dupnitsa AD
3 Samokovsko Chaussee, 2600 Dupnitsa,
Bulgaria;
Actavis EAD
ul. Atanas Dukov 29, Sofia, Bulgaria

(111) M 2001 14013 R2
(156) 2001 09 13
(186) 2031 09 13
(732) Balkanpharma Dupnitsa AD
3 Samokovsko Chaussee, 2600 Dupnitsa,
Bulgaria;
Actavis EAD
ul. Atanas Dukov 29, Sofia, Bulgaria

(111) M 2001 13893 R2
(156) 2001 05 29
(186) 2031 05 29
(732) Carolina Herrera Ltd
501 Seventh Avenue, 17th Floor,
10018 New York, USA

(111) M 2001 14024 R2
(156) 2001 10 01
(186) 2031 10 01
(732) Actavis EAD
ul. Atanas Dukov 29, Sofia, Bulgaria

(111) M 2001 14025 R2
(156) 2001 10 01
(186) 2031 10 01
(732) Actavis EAD
ul. Atanas Dukov 29, Sofia, Bulgaria

(111) M 2001 14014 R2
(156) 2001 09 13
(186) 2031 09 13
(732) Balkanpharma Dupnitsa AD
3 Samokovsko Chaussee, 2600 Dupnitsa,
Bulgaria;
Actavis EAD
ul. Atanas Dukov 29, Sofia, Bulgaria

(111) M 2001 14026 R2
(156) 2001 10 01
(186) 2031 10 01
(732) Actavis EAD
ul. Atanas Dukov 29, Sofia, Bulgaria

(111) M 2001 14031 R2
(156) 2001 10 01
(186) 2031 10 01
(732) Actavis EAD
ul. Atanas Dukov 29, Sofia, Bulgaria

(111) M 2001 14016 R2
(156) 2001 09 13
(186) 2031 09 13
(732) Actavis EAD
ul. Atanas Dukov 29, Sofia, Bulgaria

(111) M 2001 14034 R2
(156) 2001 10 01
(186) 2031 10 01
(732) Actavis EAD
ul. Atanas Dukov 29, Sofia, Bulgaria

(111) M 2001 14017 R2
(156) 2001 09 13
(186) 2031 09 13
(732) Balkanpharma Dupnitsa AD
3 Samokovsko Chaussee, 2600 Dupnitsa,
Bulgaria;
Actavis EAD
ul. Atanas Dukov 29, Sofia, Bulgaria

(111) M 2001 14041 R2
(156) 2001 10 01
(186) 2031 10 01
(732) Actavis EAD
ul. Atanas Dukov 29, Sofia, Bulgaria

(111) M 2001 14038 R2
(156) 2001 10 01
(186) 2031 10 01
(732) Actavis EAD
ul. Atanas Dukov 29, Sofia, Bulgaria

(111) M 2001 14039 R2
(156) 2001 10 01
(186) 2031 10 01
(732) Actavis EAD
ul. Atanas Dukov 29, Sofia, Bulgaria

(111) M 2001 14040 R2
(156) 2001 10 01
(186) 2031 10 01
(732) Actavis EAD
ul. Atanas Dukov 29, Sofia, Bulgaria

(111) M 2001 14018 R2
(156) 2001 09 13
(186) 2031 09 13
(732) Actavis EAD
ul. Atanas Dukov 29, Sofia, Bulgaria

(111) M 2001 14114 R2
(156) 2001 10 31
(186) 2031 10 31
(732) Actavis EAD
ul. Atanas Dukov 29, Sofia, Bulgaria

(111) M 2001 14195 R2
(156) 2001 12 13
(186) 2031 12 13
(732) Actavis EAD
ul. Atanas Dukov 29, Sofia, Bulgaria

(111) M 2011 21601 R1
(156) 2011 07 13
(186) 2031 07 13
(732) JSC "Tbilvino"
Sarajishvili Ave. 2, 0153, Tbilisi,
Georgia

(111) M 2011 21554 R1
(156) 2011 06 14
(186) 2031 06 14
(732) JSC "Kievmedpreparat"
Ul. Saksaganskogo, 139, 01032, Kiev,
Ukraine

(111) M 2011 21556 R1
(156) 2011 06 14
(186) 2031 06 14
(732) LTD "Lux 2004"
Tevdore Mghvdeli St. 53, 0154, Tbilisi,
Georgia

(111) M 2011 21592 R1
(156) 2011 06 27
(186) 2031 06 27
(732) Orion Corporation
Orionintie 1, 02200 Espoo, Finland

(111) M 2011 21675 R1
(156) 2011 08 04
(186) 2031 08 04
(732) Shimano Inc.
3-77, Oimatsu-cho, Sakai-ku, Sakai City,
Osaka, Japan

(111) M 2011 21862 R1
(156) 2011 10 17
(186) 2031 10 17
(732) The Absolut Company Aktiebolag
Se-117 97 Stockholm, Sweden

(111) M 2011 21656 R1
(156) 2011 07 22
(186) 2031 07 22
(732) LTD "PSP Pharma"
Iakob Tsurtaveli St. 54, 1700, Dmanisi,
Georgia

(111) M 2011 21801 R1
(156) 2011 09 19
(186) 2031 09 19
(732) LTD "Lux 2004"

Tevdore Mghvdeli St. 53, 0154, Tbilisi,
Georgia

(111) M 2011 22080 R1
(156) 2011 12 14
(186) 2031 12 14
(732) LTD "Barambo"
Vill. Natakhtari, 3308, Mtskheta, Georgia

(111) M 2011 22081 R1
(156) 2011 12 14
(186) 2031 12 14
(732) LTD "Barambo"
Vill. Natakhtari, 3308, Mtskheta, Georgia

(111) M 2011 22082 R1
(156) 2011 12 14
(186) 2031 12 14
(732) LTD "Barambo"
Vill. Natakhtari, 3308, Mtskheta, Georgia

(111) M 2012 22223 R1
(156) 2012 01 18
(186) 2032 01 18
(732) LTD "Barambo"
Vill. Natakhtari, 3308, Mtskheta, Georgia

(111) M 2011 21993 R1
(156) 2011 11 29
(186) 2031 11 29
(732) LTD "Barambo"
Vill. Natakhtari, 3308, Mtskheta, Georgia

(111) M 2011 21994 R1
(156) 2011 11 29
(186) 2031 11 29
(732) LTD "Barambo"
Vill. Natakhtari, 3308, Mtskheta, Georgia

(111) M 2002 14448P1 R2
(156) 2002 05 01
(186) 2032 05 01
(732) LTD "Standard Tobacco Incorporated"
Abuseridze-Tbeli St. 13, 0120, Tbilisi,
Georgia

COMPLETE TRANSFER OF RIGHTS

(111) M 2019 31346 R
 (732) Apple Inc.
 One Apple Park Way Cupertino California
 95014, USA
 (770) Coast Research LLC
 1209 Orange Street, Wilmington DE
 19801, USA
 (580) 2021 07 06

(111) M 1997 6727 R
 (732) LG Household & Health Care LTD
 58, Saemunan-ro, Jongno-gu, Seoul,
 Republic of Korea
 (770) Johnson & Johnson
 One Johnson & Johnson Plaza, New
 Brunswick, New Jersey 08933, USA
 (580) 2021 07 08

(111) M 1997 6103 R
 (732) LG Household & Health Care LTD
 58, Saemunan-ro, Jongno-gu, Seoul,
 Republic of Korea
 (770) JOHNSON & JOHNSON (a corporation the
 state of New Jersey)
 One Johnson & Johnson Plaza, New
 Brunswick, New Jersey, USA
 (580) 2021 07 08

(111) M 1997 6734 R
 (732) LG Household & Health Care LTD
 58, Saemunan-ro, Jongno-gu, Seoul,
 Republic of Korea
 (770) Johnson & Johnson
 One Johnson & Johnson Plaza, New
 Brunswick, New Jersey 08933, USA
 (580) 2021 07 08

(111) M 1997 7482 R
 (732) LG Household & Health Care LTD
 58, Saemunan-ro, Jongno-gu, Seoul,
 Republic of Korea
 (770) Johnson & Johnson (a corporation the
 state of New Jersey)
 One Johnson & Johnson Plaza, New
 Brunswick, New Jersey, USA
 (580) 2021 07 08

(111) M 1998 8898 R
 LG Household & Health Care Ltd
 58, Saemunan-ro, Jongno-gu, Seoul,
 Republic of Korea

(770) Johnson & Johnson (a corporation the
 state of New Jersey)
 One Johnson & Johnson Plaza, New
 Brunswick, New Jersey, USA
 (580) 2021 07 08

(111) M 2003 14951 R
 (732) JSC "Silknet"
 Tsinamdzghvrishvili St. 95, Chughureti
 District, Tbilisi, Georgia
 (770) LTD "Geocell"
 Gotua St. 3, the right of the Mtkvari Coast,
 0160, Tbilisi Georgia
 (580) 2021 06 18

(111) M 1996 2369 R
 (732) Covestro Intellectual Property
 GmbH & Co. KG
 Kaiser-Wilhelm-Allee 60, 51373 Leverkusen,
 Germany
 (770) Covestro Deutschland AG
 Kaiser-Wilhelm-Alee 60, 51373 Leverkusen,
 Germany
 (580) 2021 07 15

(111) M 2004 15392P R
 (732) Limited liability Company
 "Upravlyayuschaya Kompania Alyans"
 (LLC "UK Alyans")
 Ul. Ryabinovaya, dom 26, Stroenie 1,
 Etazh 7, komnata 4, 121471, Moscow, Russian
 Federation
 (770) OOO "Issi Royalty"
 Ul. Ryabinovaya, dom 26, Stroenie 1,
 Etazh 7, komnata 4, 121471, Moscow, Russian
 Federation
 (580) 2021 07 07

(111) M 2006 16443 R
 (732) Monsoon TM LTD,
 a company incorporated in England and
 Wales (Company's number 01098034) Yellow
 Building, 1 Nicholas Road,
 London, England, W11 4AN, United Kingdom
 (770) Monsoon Accessorize Limited
 1 Nicholas Road, London, W11 4 AN,
 United Kingdom
 (580) 2021 07 06

(111) M 1996 1358 R
 (732) Covestro Intellectual Property GmbH & Co. KG
 Kaiser-Wilhelm-Allee 60, 51373 Leverkusen, Germany
 (770) Covestro Deutschland AG
 Kaiser-Wilhelm-Allee 60, 51373 Leverkusen, Germany
 (580) 2021 07 15

(111) M 1997 5033 R
 (732) Laura Ashley IP Holdings, LLC
 Prudential Tower, 800 Boylston Street, 27th Floor, Boston, MA 02199, USA
 (770) Laura Ashly Limited
 27 Bagleys Lane, Fulham, London, England, United Kingdom
 (580) 2021 06 21

(111) M 1997 5034 R
 (732) Laura Ashley IP Holdings, LLC
 Prudential Tower, 800 Boylston Street, 27th Floor, Boston, MA 02199, USA
 (770) Laura Ashly Limited
 27 Bagleys Lane, Fulham, London, England, United Kingdom
 (580) 2021 06 21

(111) M 1996 3374 R
 (732) C & C IP UK Limited
 c/o Matthew Clark, Whitchurch Lane, Whitchurch, Bristol, BS 14 0JZ, United Kingdom
 (770) C & C IP SARL
 18 Avenue Marie-Thérèse, L-2132, Luxembourg
 (580) 2021 06 15

(111) M 2011 21221 R
 (732) JSC "Silknet"
 Tsinamdzghvrishvili St. 95, Chughureti District, Tbilisi, Georgia
 (770) LTD "Geocell"
 Gotua St. 3, the right of the Mtkvari Coast, 0160, Tbilisi Georgia
 (580) 2021 07 07

(111) M 2011 21222 R
 (732) JSC "Silknet"
 Tsinamdzghvrishvili St. 95, Chughureti District, Tbilisi, Georgia
 (770) LTD "Geocell"
 Gotua St. 3, the right of the Mtkvari Coast, 0160, Tbilisi Georgia

(580) 2021 06 18

(111) M 2011 21582 R
 (732) Seven for All Mankind International SAGL
 Via Penate 4, 6850 Mendrisio, Switzerland
 (770) Seven For All Mankind LLC
 a Delaware Corporation
 777 South Alameda Street, Los Angeles, CA 90021, USA
 (580) 2021 06 21

(111) M 2011 21583 R
 (732) Seven for All Mankind International SAGL
 Via Penate 4, 6850 Mendrisio, Switzerland
 (770) Seven For All Mankind LLC
 a Delaware Corporation
 777 South Alameda Street, Los Angeles, CA 90021, USA
 (580) 2021 06 21

(111) M 2011 22113 R
 (732) "Amber Beverage Group" Sia
 A. Čaka iela 160, Rīga, LV-1012, Latvia
 (770) Spirits Product International Intellectual Property B.V.
 44, rue de la Vallée, L-2661 Luxembourg, Luxembourg
 (580) 2021 06 23

(111) M 2012 22441 R
 (732) "Amber Beverage Group" Sia
 A. Čaka iela 160, Rīga, LV-1012, Latvia
 (770) Spirits Product International Intellectual Property B.V.
 44, rue de la Vallée, L-2661 Luxembourg, Luxembourg
 (580) 2021 06 23

(111) M 2013 24023 R
 (732) "Amber Beverage Group" Sia
 A. Čaka iela 160, Rīga, LV-1012, Latvia
 (770) Spirits Product International Intellectual Property B.V.
 44, rue de la Vallée, L-2661 Luxembourg, Luxembourg
 (580) 2021 06 23

(111) M 2013 24024 R
 (732) "Amber Beverage Group" Sia
 A. Čaka iela 160, Rīga, LV-1012, Latvia
 (770) Spirits Product International Intellectual Property B.V.

44, rue de la Vallée, L-2661 Luxembourg,
Luxembourg
(580) 2021 06 23

(111) M 1998 11130 R
(732) LG Household & Health Care LTD
58, Saemunan-ro, Jongno-gu, Seoul,
Republic of Korea
(770) Johnson & Johnson
One Johnson & Johnson Plaza, New
Brunswick, New Jersey 08933, USA
(580) 2021 07 08

(111) M 1998 11131 R
(732) LG Household & Health Care LTD
58, Saemunan-ro, Jongno-gu, Seoul,
Republic of Korea
(770) Johnson & Johnson
One Johnson & Johnson Plaza, New
Brunswick, New Jersey 08933, USA
(580) 2021 07 08

(111) M 1999 12903 R
(732) C & C IP UK Limited
c/o Matthew Clark, Whitchurch Lane,
Whitchurch, Bristol, BS 14 0JZ,
United Kingdom
(770) C & C IP SARL
18 Avenue Marie-Thérèse, L-2132,
Luxembourg
(580) 2021 07 13

(111) M 2019 31329 R
(732) Limited liability Company
"Upravlyayuschaya Kompania Alyans"
(LLC "UK Alyans")
Ul. Ryabinovaya, dom 26, Stroenie 1,
Etazh 7, komnata 4, 121471, Moscow, Russian
Federation
(770) OOO "Issi Royalty"
Ul. Ryabinovaya, dom 26, Stroenie 1,
Etazh 7, komnata 4, 121471, Moscow, Russian
Federation
(580) 2021 07 07

(111) M 2019 31090 R
(732) Limited liability Company
"Upravlyayuschaya Kompania Alyans"
(LLC "UK Alyans")
Ul. Ryabinovaya, dom 26, Stroenie 1,
Etazh 7, komnata 4, 121471, Moscow, Russian
Federation
(770) OOO "Issi Royalty"
Ul. Ryabinovaya, dom 26, Stroenie 1,

Etazh 7, komnata 4, 121471, Moscow, Russian
Federation

(111) M 2019 31220 R
(732) Limited liability Company
"Upravlyayuschaya Kompania Alyans"
(LLC "UK Alyans")
Ul. Ryabinovaya, dom 26, Stroenie 1,
Etazh 7, komnata 4, 121471, Moscow, Russian
Federation
(770) OOO "Issi Royalty"
Ul. Ryabinovaya, dom 26, Stroenie 1,
Etazh 7, komnata 4, 121471, Moscow, Russian
Federation
(580) 2021 07 07

CHANGES OF NAMES AND/OR ADDRESS OF OWNERS

(111) M 1998 9054 R
(732) Ferrosan ApS
Nykaer 68, Brondby, DK-2605, Denmark
(770) Ferrosan ApS
Lautrupvang 8, DK-2750 Balerupi, Denmark
(580) 2021 05 13

(111) M 1998 9071 R
(732) Ferrosan ApS
Nykaer 68, Brondby, DK-2605, Denmark
(770) Ferrosan ApS
Lotrupveng 8, DK-2750 Balerupi, Denmark
(580) 2021 05 13

(111) M 2004 15617 R
(732) Biogen MA Inc.
a Massachusetts Corporation
225 Binney Street, Cambridge, Massachusetts
02142, USA
(770) Biogen MA Inc.
a Massachusetts Corporation
250 Binney Street, Cambridge, Massachusetts
02142, USA
(580) 2021 06 29

(111) M 2007 18011 R
(732) Biogen MA Inc.,
a Massachusetts Corporation
225 Binney Street, Cambridge, Massachusetts
02142, USA
(770) Biogen MA Inc.
a Massachusetts Corporation
250 Binney Street, Cambridge, Massachusetts
02142, USA
(580) 2021 06 29

(111) M 2011 21670 R
(732) Solar Turbines Incorporated
2200 Pacific Highway, San Diego,
California 92101, USA
(770) Solar Turbines Incorporated
2200 Pacific Highway, San Diego,
92138, USA
(580) 2021 07 09

(111) M 2011 21553 R
(732) JSC "Kievmedpreparat"
Ul. Saksaganskogo, 139, 01032, Kiev,
Ukraine

(770) LTD "Kievmedpreparat"
Ul. Saksaganskogo, 139, 01032, Kiev,
Ukraine
(580) 2021 06 17

(111) M 2011 21554 R
(732) JSC "Kievmedpreparat"
Ul. Saksaganskogo, 139, 01032, Kiev,
Ukraine
(770) LTD "Kievmedpreparat"
Ul. Saksaganskogo, 139, 01032, Kiev,
Ukraine
(580) 2021 06 17

(111) M 2011 21582 R
(732) Seven For All Mankind LLC
a Delaware Corporation
777 South Alameda Street, Los Angeles,
CA 90021, USA
(770) Seven For All Mankind LLC
a Delaware Corporation
4440 East 26th street, Vernon, California
90058, USA
(580) 2021 06 21

(111) M 2011 21583 R
(732) Seven For All Mankind LLC
a Delaware Corporation
777 South Alameda Street, Los Angeles,
CA 90021, USA
(770) Seven For All Mankind LLC
a Delaware Corporation
4440 East 26th street, Vernon, 90058, USA
(580) 2021 06 21

(111) M 2011 22020 R
(732) LTD "G-M-P"
Vill. Ponitchala 65, 0165, Tbilisi, Georgia
(770) LTD "G-M-P"
Zemo Vedzisi St. 103, 0160, Tbilisi, Georgia
(580) 2021 06 22

(111) M 2011 22021 R
(732) LTD "G-M-P"
Vill. Ponitchala 65, 0165, Tbilisi, Georgia
(770) LTD "G-M-P"
Zemo Vedzisi St. 103, 0160, Tbilisi, Georgia
(580) 2021 06 22

(111) M 2011 22022 R (732) LTD "G-M-P" Vill. Ponitchala 65, 0165, Tbilisi, Georgia (770) LTD "G-M-P" Zemo Vedzisi St. 103, 0160, Tbilisi, Georgia (580) 2021 06 22	225 Binney Street, Cambridge, Massachusetts 02142, USA (770) Biogen MA Inc. a Massachusetts Corporation 250 Binney Street, Cambridge, Massachusetts 02142, USA (580) 2021 06 29
(111) M 2011 22023 R (732) LTD "G-M-P" Vill. Ponitchala 65, 0165, Tbilisi, Georgia (770) LTD "G-M-P" Zemo Vedzisi St. 103, 0160, Tbilisi, Georgia (580) 2021 06 22	(111) M 2014 24621 R (732) Biogen MA Inc. a Massachusetts Corporation 225 Binney Street, Cambridge, Massachusetts 2142, USA (770) Biogen MA Inc. a Massachusetts Corporation 250 Binney Street, Cambridge, Massachusetts 02142, USA (580) 2021 06 29
(111) M 2011 22024 R (732) LTD "G-M-P" Vill. Ponitchala 65, 0165, Tbilisi, Georgia (770) LTD "G-M-P" Zemo Vedzisi St. 103, 0160, Tbilisi, Georgia (580) 2021 06 22	(111) M 2014 25063 R (732) Biogen MA Inc. a Massachusetts Corporation 225 Binney Street, Cambridge, Massachusetts 2142, USA (770) Biogen MA Inc. a Massachusetts Corporation 250 Binney Street, Cambridge, Massachusetts 02142, USA (580) 2021 06 29
(111) M 2011 21981 R (732) LTD "G-M-P" Vill. Ponitchala 65, 0165, Tbilisi, Georgia (770) LTD "G-M-P" Zemo Vedzisi St. 103, 0160, Tbilisi, Georgia (580) 2021 06 22	(111) M 2014 25073 R (732) Biogen MA Inc. a Massachusetts Corporation 225 Binney Street, Cambridge, Massachusetts 2142, USA (770) Biogen MA Inc. a Massachusetts Corporation 250 Binney Street, Cambridge, Massachusetts 02142, USA (580) 2021 06 29
(111) M 2013 23321 R (732) Biogen MA Inc. a Massachusetts Corporation 225 Binney Street, Cambridge, Massachusetts 02142, USA (770) Biogen MA Inc. a Massachusetts Corporation 250 Binney Street, Cambridge, Massachusetts 02142, USA (580) 2021 06 29	(111) M 2014 25144 R (732) Biogen MA Inc. a Massachusetts Corporation 225 Binney Street, Cambridge, Massachusetts 2142, USA (770) Biogen MA Inc. a Massachusetts Corporation 250 Binney Street, Cambridge, Massachusetts 02142, USA (580) 2021 06 29
(111) M 2013 23322 R (732) Biogen MA Inc. a Massachusetts Corporation 225 Binney Street, Cambridge, Massachusetts 02142, USA (770) Biogen MA Inc. a Massachusetts Corporation 250 Binney Street, Cambridge, Massachusetts 02142, USA (580) 2021 06 29	(111) M 2014 24703 R (732) Biogen MA Inc. a Massachusetts Corporation

(111) M 2015 25680 R
 (732) Biogen MA Inc.
 a Massachusetts Corporation
 225 Binney Street, Cambridge, Massachusetts
 2142, USA
 (770) Biogen MA Inc.
 a Massachusetts Corporation
 250 Binney Street, Cambridge, Massachusetts
 02142, USA
 (580) 2021 06 29

(111) M 2016 27344 R
 (732) Biogen MA Inc.
 a Massachusetts Corporation
 225 Binney Street, Cambridge, Massachusetts
 2142, USA
 (770) Biogen MA Inc.
 a Massachusetts Corporation
 250 Binney Street, Cambridge, Massachusetts
 02142, USA
 (580) 2021 06 29

(111) M 2016 27591 R
 (732) Biogen MA Inc.
 a Massachusetts Corporation
 225 Binney Street, Cambridge, Massachusetts
 2142, USA
 (770) Biogen MA Inc.
 a Massachusetts Corporation
 250 Binney Street, Cambridge, Massachusetts
 02142, USA
 (580) 2021 06 29

(111) M 2017 28291 R
 (732) FERROSAN ApS
 Nykaer 68, Brondby, DK-2605, Denmark
 (770) FERROSAN ApS
 Lautrupvang 8, 2750 Ballerup, Denmark
 (580) 2021 06 11

(111) M 2017 28292 R
 (732) FERROSAN ApS
 Nykaer 68, Brondby, DK-2605, Denmark
 (770) FERROSAN ApS
 Lautrupvang 8, 2750 Ballerup, Denmark
 (580) 2021 05 13

(111) M 2017 28293 R
 (732) FERROSAN ApS
 Nykaer 68, Brondby, DK-2605, Denmark
 (770) FERROSAN ApS
 Lautrupvang 8, 2750 Ballerup, Denmark
 (580) 2021 05 13

(111) M 2017 28615 R
 (732) Biogen MA Inc. a Massachusetts Corporation
 225 Binney Street, Cambridge, Massachusetts
 2142, USA
 (770) Biogen MA Inc.
 a Massachusetts Corporation
 250 Binney Street, Cambridge, Massachusetts
 02142, USA
 (580) 2021 06 29

(111) M 2018 29263 R
 (732) Biogen MA Inc.
 a Massachusetts Corporation
 225 Binney Street, Cambridge, Massachusetts
 2142, USA
 (770) Biogen MA Inc.
 a Massachusetts Corporation
 250 Binney Street, Cambridge, Massachusetts
 02142, USA
 (580) 2021 06 29

(111) M 2018 29264 R
 (732) Biogen MA Inc.
 a Massachusetts Corporation
 225 Binney Street, Cambridge, Massachusetts
 2142, USA
 (770) Biogen MA Inc.
 a Massachusetts Corporation
 250 Binney Street, Cambridge, Massachusetts
 02142, USA
 (580) 2021 06 29

(111) M 2019 31023 R
 (732) JSC "LOTTE Rakhat"
 Zenkovi St. 2a, Almati, Kazakhstan
 (770) JSC "Rakhat"
 Zenkovi St. 2a, Almati, Kazakhstan
 (580) 2021 06 30

(111) M 2019 31024 R
 (732) JSC "LOTTE Rakhat"
 Zenkovi St. 2a, Almati, Kazakhstan
 (770) JSC "Rakhat"
 Zenkovi St. 2a, Almati, Kazakhstan
 (580) 2021 06 30

(111) M 1997 4969 R
 (732) Biogen MA Inc.
 a Massachusetts Corporation
 225 Binney Street, Cambridge, Massachusetts
 2142, USA
 (770) Biogen MA Inc.
 a Massachusetts Corporation
 250 Binney Street, Cambridge, Massachusetts
 02142, USA
 (580) 2021 06 29

CANCELLATION OF TRADEMARKS REGISTRATION

(111) M 2000 13663 R
(151) 2000 12 28
(732) The Gillette Company LLC
One Gillette Park, Boston, Massachusetts
02127, USA
(141) 2021 07 06

(111) M 2000 13664 R
(151) 2000 12 28
(732) FM Group World Andrzej Trawinski Sp. k.
ul. Zmigrodzka 247, 51-129 Wroclaw,
Poland
(141) 2021 07 06

(111) M 2000 13667 R
(151) 2000 12 28
(732) Gallaher Limited
Members Hill, Brooklands Road, Weybridge,
Surrey KT13 0QU, United Kingdom
(141) 2021 07 06

(111) M 2010 21029 R
(151) 2010 12 29
(732) GTx, Inc.
175 Toyota Plaza, 7 th Floor Memphis,
38103, USA
(141) 2021 07 08

(111) M 2010 21021 R
(151) 2010 12 24
(732) "European Tobacco-Baku" OJSC
Baku city, Keshla set., 1st kondalan str., 21,
Azerbaijan
(141) 2021 07 06

(111) M 2010 21022 R
(151) 2010 12 24
(732) "European Tobacco-Baku" OJSC
Baku city, Keshla set., 1st kondalan str., 21
Azerbaijan
(141) 2021 07 06

(111) M 2010 21023 R
(151) 2010 12 24
(732) "European Tobacco-Baku" OJSC
Baku city, Keshla set., 1st kondalan str., 21,
Azerbaijan
(141) 2021 07 05

(111) M 2010 21024 R
(151) 2010 12 24
(732) "European Tobacco-Baku" OJSC
Baku city, Keshla set., 1st kondalan str., 21,
Azerbaijan
(141) 2021 07 06

(111) M 2010 21030 R
(151) 2010 12 29
(732) General Motors LLC
300 Renaissance Center, City of Detroit,
State of Michigan 48265-3000, USA
(141) 2021 07 08

(111) M 2010 21033 R
(151) 2010 12 29
(732) GlaxoSmithKline Trading Services Limited
Currabinny, Carrigaline, County Cork, Ireland
(141) 2021 07 08

(111) M 2010 21034 R
(151) 2010 12 29
(732) GlaxoSmithKline Trading Services Limited
Currabinny, Carrigaline, County Cork, Ireland
(141) 2021 07 08

(111) M 2010 21035 R
(151) 2010 12 29
(732) GlaxoSmithKline Trading Services Limited
Currabinny, Carrigaline, County Cork, Ireland
(141) 2021 07 08

(111) M 2010 21036 R
(151) 2010 12 29
(732) GlaxoSmithKline Trading Services Limited
Currabinny, Carrigaline, County Cork, Ireland
(141) 2021 07 08

(111) M 2010 21037 R
(151) 2010 12 29
(732) TELEFÓNICA S.A.
Gran Via, 28, 28013 Madrid, Spain
(141) 2021 07 08

(111) M 2010 21039 R
(151) 2010 12 29
(732) General Motors LLC
300 Renaissance Center, City of Detroit,
State of Michigan 48265-3000, USA

(141) 2021 07 08

(111) M 2010 21041 R
(151) 2010 12 29
(732) GlaxoSmithKline Trading Services Limited
Currabinny, Carrigaline, County Cork,
Ireland
(141) 2021 07 08

(111) M 2010 21042 R
(151) 2010 12 29
(732) Colgate-Palmolive Company
300 Park Avenue, New York, N.Y. 10022,
USA
(141) 2021 07 08

(111) M 2010 21043 R
(151) 2010 12 29
(732) Colgate-Palmolive Company
300 Park Avenue, New York, N.Y. 10022,
(141) 2021 07 08

(111) M 2010 21044 R
(151) 2010 12 29
(732) GlaxoSmithKline Trading Services Limited
Currabinny, Carrigaline, County Cork, Ireland
(141) 2021 07 08

(111) M 2010 21028 R
(151) 2010 12 24
(732) LTD "Argo Construction 2"
Rustaveli Av. 24/M. Laghidze St. 1,
0108, Tbilisi, Georgia
(141) 2021 07 06

(111) M 2010 21051 R
(151) 2010 12 29
(732) JSC "Bagrationi 1882"
David Sarajishvili Av. 12, 0153, Tbilisi
Georgia
(141) 2021 07 08

(111) M 2010 21046 R
(151) 2010 12 29
(732) LTD "Cognac and Wine Factory Vaziani"
Tamar Mepe Av. 6, 0112, Tbilisi, Georgia
(141) 2021 07 08

(111) M 2010 21047 R
(151) 2010 12 29
(732) LTD "Cognac and Wine Factory Vaziani"
Tamar Mepe Av. 6, 0112, Tbilisi, Georgia
(141) 2021 07 08

(111) M 2010 21048 R
(151) 2010 12 29
(732) LTD "Deluxe Georgia"
Kakheti St., Lane 23, 0182, Tbilisi,
Georgia
(141) 2021 07 07

(111) M 2010 21049 R
(151) 2010 12 29
(732) LTD "Deluxe Georgia"
Kakheti St., Lane 23, 0182, Tbilisi,
Georgia
(141) 2021 07 08

REGISTRATION OF LICENSE AGREEMENTS

(111) M 2011 22150 R
(732) BR IP Holder LLC
130 Royall Street, Suite 300, P.O. Box 9141,
Canton, Massachusetts 02021, USA
(791) Baskin-Robin's Franchising LLC
P.O. Box 9141, Canton, Massachusetts
02021, USA
(793) №1323
Validity period: 01 07 2015-17 07 2030
License type: Simple
30, 32, 43

(111) M 2011 22150 R
(732) BR IP Holder LLC
130 Royall Street, Suite 300, P.O. Box 9141,
Canton, Massachusetts 02021, USA
(791) Baskin-Robin's Franchising LLC
P.O. Box 9141, Canton, Massachusetts
02021, USA
(793) №1319
Validity period: 17 07 2015-17 07 2030
License type: Simple
30, 32, 43

(111) M 2011 22151 R
(732) BR IP Holder LLC
130 Royall Street, Suite 300, P.O. Box 9141,
Canton, Massachusetts 02021, USA
(791) Baskin-Robin's Franchising LLC
P.O. Box 9141, Canton, Massachusetts
02021, USA
(793) №1320
Validity period: 17 07 2015-17 07 2030
License type: Simple
30, 32, 43

(111) M 2011 22151 R
(732) BR IP Holder LLC
130 Royall Street, Suite 300, P.O. Box 9141,
Canton, Massachusetts 02021, USA
(791) Baskin-Robin's Franchising LLC
P.O. Box 9141, Canton, Massachusetts
02021, USA
(793) №1324
Validity period: 17 07 2015-17 07 2030
License type: Simple
30, 32, 43

(111) M 2011 22152 R
(732) BR IP Holder LLC
130 Royall Street, Suite 300, P.O. Box 9141,
Canton, Massachusetts 02021, USA
(791) Baskin-Robin's Franchising LLC
P.O. Box 9141, Canton, Massachusetts
02021, USA
(793) №1321
Validity period: 17 07 2015-17 07 2030
License type: Simple
30, 32, 43

(111) M 2011 22152 R
(732) BR IP Holder LLC
130 Royall Street, Suite 300, P.O. Box 9141,
Canton, Massachusetts 02021, USA
(791) Baskin-Robin's Franchising LLC
P.O. Box 9141, Canton, Massachusetts
02021, USA
(793) №1325
Validity period: 17 07 2015-17 07 2030
License type: Simple
30, 32, 43

INTERNATIONAL LICENSE AGREEMENT

(800) 909533

(732) OOO "IEK HOLDING"

Prospect Lenina 107/49, Office 457,

RU-142100 Podolsk, Moscovskaya

Oblast RU

(791) LTD "Iveriaelectrocomplect"

Shuamta St. 20, Samgori District, Tbilisi,

Georgia

(793) №1645

Validity period: 12 07 2021-12 07 2026

License type: Simple

6, 9, 11, 17

CLASSIFICATION INDEXES

INVENTIONS

CONCORDANCE TABLE OF INTERNATIONAL CLASSIFICATION INDEX AND PUBLICATION NUMBERS

INTERNATIONAL CLASSIFICATION INDEXES (51)	NUMBER OF PUBLISHED APPLICATION (10)
A 61 K 39/395; A 61 K 35/04; C 07 K 16/18; C 07 K 16/28	AP 2021 14756 A
A 61 K 39/395; A 61 K 39/00; A 61 P 37/02; C 07 K 16/28	AP 2021 14453 A
B 60 T 1/06	AP 2021 15436 A
C 07 K 16/28; A 61 K 39/395; A 61 P 37/02; A 61 K 39/00	AP 2021 14450 A

CONCORDANCE TABLE OF PUBLICATION NUMBERS AND INTERNATIONAL CLASSIFICATION INDEX

NUMBER OF PUBLISHED APPLICATION (10)	INTERNATIONAL CLASSIFICATION INDEXES (51)
AP 2021 14450 A	C 07 K 16/28; A 61 K 39/395; A 61 P 37/02; A 61 K 39/00
AP 2021 14453 A	A 61 K 39/395; A 61 K 39/00; A 61 P 37/02; C 07 K 16/28
AP 2021 14756 A	A 61 K 39/395; A 61 K 35/04; C 07 K 16/18; C 07 K 16/28
AP 2021 15436 A	B 60 T 1/06

CONCORDANCE TABLE OF INTERNATIONAL CLASSIFICATION INDEX, PATENT NUMBERS AND PUBLICATION NUMBERS

INTERNATIONAL CLASSIFICATION INDEX (51)	NUMBER OF PATENT (11)	NUMBER OF PUBLISHED APPLICATION (10)
F 16 L 37/00; F 16 L 17/00	P 2021 7277 B	AP 2021 15200 A
H 01 H 73/00; H 02 H 9/04	P 2021 7278 B	AP 2021 15264 A

CONCORDANCE TABLE OF PATENT NUMBERS, PUBLICATION NUMBERS AND INTERNATIONAL CLASSIFICATION INDEX

NUMBER OF PATENT (11)	NUMBER OF PUBLISHED APPLICATION (10)	INTERNATIONAL CLASSIFICATION INDEX (51)
P 2021 7277 B	AP 2021 15200 A	F 16 L 37/00; F 16 L 17/00
P 2021 7278 B	AP 2021 15264 A	H 01 H 73/00; H 02 H 9/04

**CONCORDANCE TABLE OF APPLICATION NUMBERS,
PUBLICATION NUMBERS AND PATENTS**

NUMBER OF APPLICATION (21)	NUMBER OF PUBLISHED APPLICATION (10)	NUMBER OF PATENT (11)
AP 2018 15200	AP 2021 15200 A	P 2021 7277 B
AP 2018 15264	AP 2021 15264 A	P 2021 7278 B

DESIGNS

**CONCORDANCE TABLE OF INTERNATIONAL CLASSIFICATION INDEX
AND PUBLICATION NUMBERS**

INTERNATIONAL CLASSIFICATION INDEXES (51)	NUMBER OF PUBLISHED APPLICATION (10)
06-13	AD 2021 1208 S
09-01	AD 2021 1206 S
09-01	AD 2021 1210 S

**CONCORDANCE TABLE OF PUBLICATION NUMBERS
AND INTERNATIONAL CLASSIFICATION INDEX**

NUMBER OF PUBLISHED APPLICATION (10)	INTERNATIONAL CLASSIFICATION INDEXES (51)
AD 2021 1206 S	09-01
AD 2021 1208 S	06-13
AD 2021 1210 S	09-01

DESIGN REGISTERED ACCORDING TO THE ACCELERATED PROCEDURE

CONCORDANCE TABLE OF INTERNATIONAL CLASSIFICATION INDEXES AND NUMBERS OF REGISTRATION

INTERNATIONAL CLASSIFICATION INDEXES (51)	NUMBER OF REGISTRATION (11)
25-03	D 2021 899 S

CONCORDANCE TABLE OF NUMBERS OF REGISTRATION AND INTERNATIONAL CLASSIFICATION INDEXES

NUMBER OF REGISTRATION (11)	INTERNATIONAL CLASSIFICATION INDEXES (51)
D 2021 899 S	25-03

CONCORDANCE TABLE OF NUMBERS OF PUBLICATION AND NUMBERS OF REGISTRATION

NUMBER OF PUBLISHED APPLICATION (21)	NUMBER OF REGISTRATION (11)
AD 2021 1220	D 2021 899 S

TRADEMARKS

CONCORDANCE TABLE OF REGISTRATION NUMBERS, APPLICATION NUMBERS, PUBLICATION NUMBERS AND BULLETIN NUMBERS

NUMBER OF REGISTRATION (111)	NUMBER OF APPLICATIONS (210)	NUMBER OF PUBLISHED APPLICATIONS (260)	NUMBER OF BULLETIN
M 2021 34285 R	AM 113691	-	13(569)2021
M 2021 34286 R	AM 113357	-	13(569)2021
M 2021 34287 R	AM 113377	-	13(569)2021
M 2021 34288 R	AM 113773	-	13(569)2021
M 2021 34289 R	AM 113394	-	13(569)2021
M 2021 34290 R	AM 113707	-	13(569)2021
M 2021 34291 R	AM 113777	-	13(569)2021
M 2021 34292 R	AM 108484	AM 2021 108484 A	1(557)2021
M 2021 34293 R	AM 108496	AM 2021 108496 A	5(561)2021
M 2021 34294 R	AM 108497	AM 2021 108497 A	5(561)2021
M 2021 34295 R	AM 108522	AM 2021 108522 A	1(557)2021
M 2021 34296 R	AM 108685	AM 2021 108685 A	1(557)2021
M 2021 34297 R	AM 108749	AM 2021 108749 A	2(558)2021
M 2021 34298 R	AM 108780	AM 2021 108780 A	2(558)2021
M 2021 34299 R	AM 108955	AM 2021 108955 A	2(558)2021
M 2021 34300 R	AM 109006	AM 2021 109006 A	5(561)2021
M 2021 34301 R	AM 109010	AM 2021 109010 A	5(561)2021
M 2021 34302 R	AM 109302	AM 2021 109302 A	5(561)2021
M 2021 34303 R	AM 109360	AM 2021 109360 A	5(561)2021
M 2021 34304 R	AM 109383	AM 2021 109383 A	5(561)2021
M 2021 34305 R	AM 109384	AM 2021 109384 A	5(561)2021
M 2021 34306 R	AM 109385	AM 2021 109385 A	5(561)2021
M 2021 34307 R	AM 109498	AM 2021 109498 A	5(561)2021
M 2021 34308 R	AM 109499	AM 2021 109499 A	4(560)2021
M 2021 34309 R	AM 109500	AM 2021 109500 A	4(560)2021
M 2021 34310 R	AM 109602	AM 2021 109602 A	5(561)2021
M 2021 34311 R	AM 109668	AM 2021 109668 A	5(561)2021
M 2021 34312 R	AM 108687	AM 2021 108687 A	1(557)2021
M 2021 34313 R	AM 113705	-	13(569)2021
M 2021 34314 R	AM 113792	-	13(569)2021
M 2021 34315 R	AM 113766	-	13(569)2021
M 2021 34316 R	AM 113858	-	13(569)2021
M 2021 34317 R	AM 113862	-	13(569)2021
M 2021 34318 R	AM 113863	-	13(569)2021
M 2021 34319 R	AM 113767	-	13(569)2021
M 2021 34320 R	AM 113865	-	13(569)2021
M 2021 34321 R	AM 108761	AM 2021 108761 A	2(558)2021
M 2021 34322 R	AM 109512	AM 2021 109512 A	5(561)2021
M 2021 34323 R	AM 109514	AM 2021 109514 A	6(562)2021
M 2021 34324 R	AM 109516	AM 2021 109516 A	6(562)2021
M 2021 34325 R	AM 109591	AM 2021 109591 A	6(562)2021
M 2021 34326 R	AM 109601	AM 2021 109601 A	5(561)2021
M 2021 34327 R	AM 109766	AM 2021 109766 A	6(562)2021
M 2021 34328 R	AM 109835	AM 2021 109835 A	6(562)2021
M 2021 34329 R	AM 109836	AM 2021 109836 A	6(562)2021

CONCORDANCE TABLE OF PUBLICATION NUMBERS
AND APPLICATION NUMBERS

NUMBER OF PUBLISHED APPLICATION (260)	NUMBER OF APPLICATION (210)	1	2
1	2		
AM 2021 105975 A	AM 105975	AM 2021 110761 A	AM 110761
AM 2021 106956 A*	AM 106956	AM 2021 110764 A	AM 110764
AM 2021 106957 A*	AM 106957	AM 2021 110769 A	AM 110769
AM 2021 107479 A*	AM 107479	AM 2021 110780 A	AM 110780
AM 2021 108206 A	AM 108206	AM 2021 110784 A	AM 110784
AM 2021 109019 A*	AM 109019	AM 2021 110790 A	AM 110790
AM 2021 110447 A	AM 110447	AM 2021 110858 A	AM 110858
AM 2021 110448 A	AM 110448	AM 2021 110864 A	AM 110864
AM 2021 110675 A	AM 110675	AM 2021 110866 A	AM 110866
AM 2021 110684 A	AM 110684	AM 2021 110867 A	AM 110867
AM 2021 110686 A	AM 110686	AM 2021 110942 A	AM 110942
AM 2021 110688 A	AM 110688	AM 2021 110950 A	AM 110950
AM 2021 110689 A	AM 110689	AM 2021 110951 A	AM 110951
AM 2021 110694 A	AM 110694	AM 2021 110953 A	AM 110953
AM 2021 110695 A	AM 110695	AM 2021 110962 A	AM 110962
AM 2021 110747 A	AM 110747	AM 2021 110964 A	AM 110964
AM 2021 110751 A	AM 110751	AM 2021 110966 A	AM 110966
AM 2021 110753 A	AM 110753	AM 2021 110971 A	AM 110971
AM 2021 110756 A	AM 110756	AM 2021 110978 A	AM 110978
AM 2021 110758 A	AM 110758	AM 2021 111064 A	AM 111064
		AM 2021 111074 A	AM 111074
		AM 2021 111280 A	AM 111280
		AM 2021 111281 A	AM 111281

**CONCORDANCE TABLE OF INDEX OF GOODS AND/OR SERVICES
AND APPLICATION NUMBERS**

INDEX OF GOODS AND/OR SERVICES (511)	NUMBER OF PUBLISHED APPLICATIONS (260)	1	2
1	2		
2	AM 2021 110953 A	33	AM 2021 110764 A
3	AM 2021 108206 A	33	AM 2021 110769 A
5	AM 2021 106956 A*	33	AM 2021 110780 A
5	AM 2021 106957 A*	33	AM 2021 110790 A
5	AM 2021 109019 A*	33	AM 2021 110964 A
5	AM 2021 110686 A	34	AM 2021 110675 A
5	AM 2021 110688 A	34	AM 2021 110942 A
5	AM 2021 110694 A	35	AM 2021 105975 A
5	AM 2021 110695 A	35	AM 2021 108206 A
5	AM 2021 110971 A	35	AM 2021 110447 A
8	AM 2021 110953 A	35	AM 2021 110448 A
9	AM 2021 110962 A	35	AM 2021 110751 A
16	AM 2021 111074 A	35	AM 2021 110753 A
16	AM 2021 111280 A	35	AM 2021 110780 A
18	AM 2021 111280 A	35	AM 2021 110864 A
24	AM 2021 110784 A	35	AM 2021 110866 A
24	AM 2021 111280 A	35	AM 2021 110867 A
25	AM 2021 110784 A	35	AM 2021 111280 A
29	AM 2021 110966 A	35	AM 2021 111281 A
32	AM 2021 107479 A*	35	AM 2021 111281 A
32	AM 2021 110689 A	36	AM 2021 111281 A
32	AM 2021 110753 A	39	AM 2021 110978 A
32	AM 2021 110780 A	39	AM 2021 111281 A
33	AM 2021 105975 A	41	AM 2021 111281 A
33	AM 2021 107479 A*	42	AM 2021 110962 A
33	AM 2021 110447 A	42	AM 2021 111281 A
33	AM 2021 110448 A	43	AM 2021 110769 A
33	AM 2021 110684 A	43	AM 2021 110780 A
33	AM 2021 110747 A	43	AM 2021 110790 A
33	AM 2021 110753 A	43	AM 2021 110858 A
33	AM 2021 110756 A	43	AM 2021 110950 A
33	AM 2021 110758 A	43	AM 2021 110951 A
33	AM 2021 110761 A	43	AM 2021 111064 A
		43	AM 2021 111281 A
		44	AM 2021 110751 A
		44	AM 2021 110864 A
		44	AM 2021 110866 A
		44	AM 2021 110867 A

CONCORDANCE TABLE OF INDEX OF GOODS AND/OR SERVICES
AND NUMBERS OF TRADEMARKS REGISTERED ACCORDING
TO THE ACCELERATED PROCEDURE

INDEX OF GOODS AND/OR SERVICES (511)	NUMBERS OF REGISTERED ACCORDING TO THE ACCELERATED PROCEDURE (111)
3	M 2021 34288 R
4	M 2021 34290 R
5	M 2021 34287 R
5	M 2021 34291 R
5	M 2021 34313 R
5	M 2021 34316 R
5	M 2021 34319 R
9	M 2021 34285 R
9	M 2021 34286 R
9	M 2021 34288 R
9	M 2021 34317 R
9	M 2021 34318 R
10	M 2021 34291 R
14	M 2021 34288 R
29	M 2021 34315 R
30	M 2021 34315 R
32	M 2021 34291 R
33	M 2021 34291 R
33	M 2021 34314 R
35	M 2021 34286 R
35	M 2021 34290 R
35	M 2021 34315 R
35	M 2021 34319 R
36	M 2021 34291 R
36	M 2021 34317 R
36	M 2021 34318 R
37	M 2021 34290 R
38	M 2021 34286 R
41	M 2021 34285 R
41	M 2021 34286 R
42	M 2021 34285 R
43	M 2021 34289 R
43	M 2021 34320 R
44	M 2021 34291 R

OFFICIAL BULLETIN OF THE INDUSTRIAL PROPERTY

**INVENTIONS
UTILITY MODELS
DESIGNS
TRADEMARKS
APPELLATIONS OF ORIGIN OF GOODS**

13(569)

EDITOR-IN-CHIEF: N. Bebrishvili

EDITOR-TRANSLATOR: E. Gabunia

PROOFREADER: A. Shikhashvili

COMPUTER LAYOUT: M. Ordenidze
K. Svanidze

www.sakpatenti.gov.ge

E-mail: info@sakpatenti.org.ge