

# Official Bulletin of the Industrial Property

Inventions

Utility Models

Designs

Trademarks



საქართველოს ინტელექტუალური  
საკუთრების ეროვნული ცენტრი

**საქპატენტი**

**SAKPATENTI**

NATIONAL INTELLECTUAL PROPERTY  
CENTER OF GEORGIA

[www.sakpatenti.gov.ge](http://www.sakpatenti.gov.ge)

Date of Publication – 2022 08 25

**16(595)**

# INID CODES FOR IDENTIFICATION OF BIBLIOGRAPHIC DATA

## INVENTIONS, UTILITY MODELS

- (10) Number of publication for application, which has been examined
- (11) Number of patent and kind of document
- (21) Serial number of application
- (22) Date of filing of the application
- (23) Date of exhibition or the date of the earlier filing and the number of application, if any
- (24) Date from which patent may have effect
- (31) Number of priority application
- (32) Date of filing of priority application
- (33) Code of the country or regional organization allotting priority application number
- (44) Date of publication of application not granted, but examined and number of bulletin
- (45) Date of publication of registered document
- (51) International Patent Classification Index

- (54) Title of the invention
- (57) Abstract
- (60) Number of examined patent document granted by foreign patent office, date from which patent has effect and country code
- (62) Number of the earlier application and in case of divided application, date of filing an application
- (71) Name, surname and address of applicant (country code)
- (72) Name, surname of inventor (country code)
- (73) Name, surname and address of patent owner (country code)
- (74) Name, surname of representative or patent attorney
- (85) Date of commencement of the national phase of International Application
- (86) Number and date of filing of international application
- (87) Number and date of publication of international application
- (94) Calculated date of expiry of the SPC or the duration of the SPC

## DESIGNS

- (10) Number of publication for application
- (11) Number of patent and kind of document or number of registration
- (15) Date of registration/Date of patent renewal
- (18) Expected expiration date of patent or registration
- (21) Serial number of application
- (22) Date of filing of the application
- (23) Date of exhibition or the date of the earlier filing and the number of application, if any
- (24) Date from which patent may have effect
- (28) Number of designs included in the application
- (30) Data relating to priority (number of application, date of filing of application, two-letter code identifying the authority with whom the priority application was made)
- (31) Number of priority application
- (32) Date of filing of priority application
- (33) Code of the country or regional organization allotting priority application number
- (34) Two-letter code according to WIPO St.3 identifying the authority with which the priority application was made
- (44) Date of publication of design and number of bulletin (the first publication)
- (45) Date of publication of design registered by WIPO and number of bulletin

- (51) International Classification for designs (class and subclass of the Locarno Classification)
- (54) Title of the invention
- (55) Reproduction of the design
- (57) Description of characteristic features of the design including indication of colors
- (58) Date of recording of any kind of amendment in the Register
- (62) Number of the earlier application, registration and document number and if available the date of filing an application in case of divided application
- (71) Name, surname and address of applicant (country code)
- (72) Name, surname of creator (country code)
- (73) Name, surname and address of patent owner (country code)
- (74) Name, surname of representative or patent attorney
- (81) Contracting states concerned
  - II designated contracting states according to the 1960 Act
  - III designated contracting states according to the 1999 Act
- (85) Owner's permanent address
- (86) Owner's nationality
- (87) Owner's residence
- (88) State in which the owner has a real and effective industrial or commercial establishment

## TRADEMARKS

- (111) - Number of registration
- (151) - Date of registration
- (156) - Date of the renewal
- (181) - Expected expiration date of registration
- (186) - Renewal expiration date of registration
- (141) - Date of cancel of duration of the mark
- (210) - Serial number of application
- (220) - Date of filing of the application
- (230) - Data concerning exhibition
- (260) - Number of application, for which favorable decision of examination about registration has been taken (publication number)
- (310) - Number of the first application
- (320) - Date of filing of the first application
- (330) - Code, identifying national or regional Office where the first application was made
- (511) - International Classification of Goods and Services for the purposes of registration of trade marks and/or list of goods and/or services classified according thereto
- (526) - Disclaimer
- (531) - Description of figurative elements of Trade Marks according to the International Classification of the Figurative Elements of Marks

- (540) - Reproduction of Trade Mark
- (550) - Nature and kind of Trade Mark
- (551) - Indication to the effect that the mark is a collective mark, a certification mark or a guarantee mark
- (554) - Three-dimensional mark
- (580) - Date of recording of any kind changes in respect of applications or registrations
- (591) - Information concerning colors claimed
- (731) - Name and address of the applicant
- (732) - Name and address of the holder of the registration
- (740) - Name and address of the representative
- (750) - Addreses for correspondence
- (770) - Name and address of the previous applicant or holder in case of change in ownership
- (771) - Previous name and address of the applicant or holder in case of change in ownership
- (791) - Name and address of the licensee
- (793) - Indication of conditions and/or restrictions under the license (Type of license, number of license agreement, data of license, data of validity of license)
- (800) - Certain data relating to the international registration of Trade Marks under the Protocol Relating to Madrid Agreement (International registration number)
- (852) - Partial cancellation of the list of goods and services
- (891) - Date of subsequent designation

## CODES FOR PUBLICATION IN BULLETIN

- (21) AP 0000 000000 - serial number of application for invention
- (10) AP 0000 0000 A - number of published application for invention (first publication)
- (11) P 0000 0000 B - number of patent for invention (second publication)
- (21) API 0000 000000 - number of application for imported patent
- (11) PI 0000 0000 A - number of imported patent (first publication)
- (21) AU 0000 000000 - serial number of application for utility model
- (10) AU 0000 000 U - number of published application for utility model (first publication)
- (11) U 0000 000 Y - number of patent for utility model (second publication)
- (21) AD 0000 000000 - serial number of application for design
- (10) AD 0000 000 S - number of published application for design (first publication)
- (11) D 0000 000 S - registered design

## INTERNATIONAL PATENT CLASSIFICATION FOR INVENTIONS AND UTILITY MODELS

- SECTION A - HUMAN NECESSITIES
- SECTION B - PERFORMING OPERATIONS; TRANSPORTING
- SECTION C - CHEMISTRY; METALLURGY
- SECTION D - TEXTILES; PAPER
- SECTION E - FIXED CONSTRUCTIONS
- SECTION F - MECHANICAL ENGINEERING; LIGHTING; HEATING; WEAPONS; BLASTING
- SECTION G - PHYSICS
- SECTION H - ELECTRICITY

- 
- M - Trade Mark
  - (210) AM 0000 000000 - Serial number of application;
  - (260) AAM 0000 00000 A - Publication number of application;
  - (111) M 0000 00000 R - Number of registration;
  - (111) MMM0000 00000 Rn - Number of renewals, in which n=1,2,3;
  - (111) M 0000 00000 R(P) - Number of registration under partial assignment of rights
-

# Official Bulletin of the Industrial Property

Inventions

Utility Models

Designs

Trademarks

# CONTENT

<b>PUBLISHED TITLES OF PROTECTION .....</b>	<b>3</b>
<b>INVENTIONS</b>	
▪ APPLICATIONS APPROVED FOR GRANTING PATENT .....	4
▪ PATENTED INVENTIONS .....	8
<b>UTILITY MODELS</b>	
▪ APPLICATIONS APPROVED FOR GRANTING PATENT .....	9
▪ PATENTED UTILITY MODELS .....	10
<b>DESIGNS</b>	
DESIGNS, WHICH HAVE BEEN REGISTERED WITH THE INTERNATIONAL BUREAU CLAIMING PRIORITY ON THE TERRITORY OF GEORGIA .....	11
<b>TRADEMARKS</b>	
▪ APPLICATIONS FILED UNDER THE NATIONAL PROCEDURE APPROVED FOR REGISTRATION .....	24
▪ REGISTERED TRADEMARKS .....	29
▪ TRADEMARKS REGISTERED ACCORDING TO THE ACCELERATED PROCEDURE .....	35
▪ INTERNATIONAL TRADEMARKS FOR WHICH A DECISION ON GRANTING PROTECTION IS TAKEN .....	45
▪ INTERNATIONAL TRADEMARKS PROTECTED IN GEORGIA .....	68
<b>OFFICIAL NOTIFICATIONS</b>	
<b>INVENTIONS</b>	
▪ ABOLITION OF PATENTS WITH THE RIGHT TO RESTORE .....	80
▪ EXPIRATION OF TERMS OF PATENTS RESTORATION .....	80
▪ EXPIRATION OF TERMS OF PATENT .....	81
<b>DESIGNS</b>	
▪ EXTENSION OF TERMS OF INTERNATIONAL DESIGN REGISTRATION .....	81
▪ CANCELLATION OF INTERNATIONAL DESIGNS REGISTRATION .....	82
<b>TRADEMARKS</b>	
▪ EXTENSION OF TERMS OF TRADEMARKS REGISTRATION .....	85
▪ COMPLETE TRANSFER OF RIGHTS .....	87
▪ CHANGES OF NAMES AND/OR ADDRESSES OF TRADEMARKS OWNERS .....	89
▪ CANCELLATION OF TRADEMARKS REGISTRATION .....	92
<b>CLASSIFICATION INDEXES</b>	
INVENTIONS .....	96
UTILITY MODELS .....	97
TRADEMARKS .....	99

## **PUBLISHED TITLES OF PROTECTION**

### **INVENTIONS**

- **APPLICATIONS APPROVED FOR GRANTING PATENT:**  
15488; 15511; 15446; 15770; 15565; 15578; 15709; 15088
- **PATENTED INVENTIONS:**  
7406-7408

### **UTILITY MODELS**

- **APPLICATIONS APPROVED FOR GRANTING PATENT:**  
15543; 15765
- **PATENTED UTILITY MODELS:**  
2127, 2128

### **DESIGNS**

#### **DESIGNS, WHICH HAVE BEEN REGISTERED WITH THE INTERNATIONAL BUREAU CLAIMING PRIORITY ON THE TERRITORY OF GEORGIA:**

218368; 221358; 221388; 221397; 221571; 221375; 221661; 221796, 221797

### **TRADEMARKS**

- **APPLICATIONS FILED UNDER THE NATIONAL PROCEDURE APPROVED FOR REGISTRATION:**  
115593; 115843; 116145-116148; 116162; 116171; 116215-116219; 116305, 116306; 116309-116312; 116319, 116320; 116326; 116329, 116330; 116402; 116405; 116407, 116408; 116413; 116435; 116528; 116542; 116552; 117318
- **REGISTERED TRADEMARKS:**  
35803-35867
- **TRADEMARKS REGISTERED ACCORDING TO THE ACCELERATED PROCEDURE:**  
35746-35802; 35868-35870
- **INTERNATIONAL TRADEMARKS FOR WHICH A DECISION ON GRANTING PROTECTIONS IS TAKEN:**  
115158; 115279-115281; 115283, 115284; 115286-115288; 115396; 115398; 115459, 115460; 115462-115464; 115797; 115938; 116094, 116095; 116098-116103; 116213
- **INTERNATIONAL TRADEMARKS PROTECTED IN GEORGIA:**  
102134; 110841; 112427; 112744; 112746; 113630; 113713; 113842; 113899- 113908; 113935-113937; 113944-113947; 113949; 113951-113953; 113955, 113956; 113963; 114009; 114012; 114016; 114018, 114019; 114066-114069; 114071-114074; 114081; 114084, 114085; 114087; 114089-114092; 114098, 114099; 114101-114108; 114110-114116; 114122-114124; 114157-114161; 114172-114175; 114177; 114179-114183; 114189-114196; 114204; 114209; 114255-114259; 114266; 114271-114275; 114306-114308; 114348; 114350; 114357; 114359; 114439; 114441; 114523-114525; 114548, 114549; 114580; 114582-114584; 114646-114649; 114655-114664; 114703, 114704; 114710-114714; 114729; 114769; 114830, 114831; 114833; 114836; 114964

# INVENTIONS

## APPLICATIONS APPROVED FOR GRANTING PATENT

The decision can be appealed at the Chamber of Appeal of Sakpatenti within 3 months from the publication or at the Mtskheta District Court Administrative Cases Board (Address: №17, Samkhedro St., Mtskheta), within 1 month following the publication.

### PART A

#### A 24

- (10) AP 2022 15488 A (51) Int. Cl. (2006)  
A 24 D 3/14  
A 61 K 38/44  
A 61 K 7/00  
A 61 L 2/00
- (21) AP 2020 15488 (22) 2020 11 10
- (71) LTD "DZALA" (GE)  
Rustaveli Av. 40/40a, Tbilisi, Georgia (GE)
- (72) Teymuraz Kurzchalia (DE);  
Veronica Diez (DE);  
Vakhtang Pavlenishvili (GE);  
Jan Prochazka (CZ)
- (74) Nikoloz Gogilidze
- (54) NOVEL COMPOSITIONS FOR NEUTRALIZING TOXIC EFFECTS OF HYDROGEN PEROXIDE IN LIVING CELLS OR TISSUES
- (57) A composition for neutralizing toxic effects of hydrogen peroxide in living cells or tissues is described, that comprises at least two components: component 1 and component 2, wherein component 1 is selected from the group consisting of glycolic acid, glyoxylic acid, glycine, serine or salts thereof, and component 2 is hydrogen peroxide.
- Claims: 10 independents  
24 dependents
- Fig.: 9

#### A 61

- (10) AP 2022 15511 A (51) Int. Cl. (2006)  
A 61 K 31/165  
A 61 P 11/00  
A 61 P 1/00  
C 07 C 237/22  
C 07 C 231/02
- (21) AP 2019 15511 (22) 2019 05 07
- (31) 2018117463
- (32) 2018 05 11
- (33) RU
- (71) IBD Therapeutics LLC (RU)  
Bolshoj Boulevard, 42/1, 3<sup>rd</sup> fl., Space 1280,  
Mozhaysky Municipality, Skolkovo Innovation

Centre, 121205 Moscow, Russian Federation (RU)

- (72) NEBOLSIN, Vladimir Evgenievich (RU)
- (74) Shalva Gvaramadze
- (85) 2020 12 07
- (86) PCT/RU2019/050060, 2019 05 07
- (54) NOVEL MODULATOR OF METABOTROPIC AND IONOTROPIC TRANSMEMBRANE RECEPTORS AND USE THEREOF
- (57) 2-phenylethylamide N-(p-hydroxyphenylacetyl) phenylalanine compound of formula

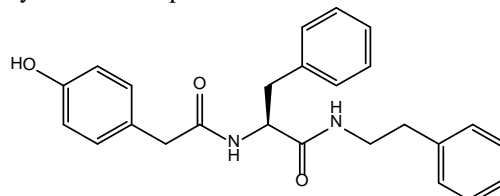

is used for the treatment of coughing, asthma, chronic obstructive pulmonary disease (COPD), bronchitis, rhinitis, diarrhea, irritable bowel syndrome, Crohn's disease, colitis, psoriasis, pruritus, atopic dermatitis and itching.

Claims: 11 independents  
3 dependents

- (10) AP 2022 15446 A (51) Int. Cl. (2006)  
A 61 K 31/437  
A 61 P 35/00  
C 07 D 471/04
- (21) AP 2019 15446 (22) 2019 07 22
- (31) 201810867252.2
- (32) 2018 07 31
- (33) CN
- (71) Ascentage Pharma (Suzhou) Co., LTD. (CN)  
Unit 701, Bldg. B7, 218 Xinghu Street, Suzhou  
Industrial Park, Suzhou Jiangsu  
215000, Public Republic of China (CN)
- (72) YANG, Dajun (CN);  
ZHAI, Yifan (CN);  
WANG, Guangfeng (CN)
- (74) Tamaz Shilakadze
- (85) 2020 09 17
- (86) PCT/CN2019/097028, 2019 07 22
- (54) SYNERGISTIC ANTITUMOR EFFECT OF BCL-2 INHIBITOR COMBINED WITH RITUXIMAB AND/OR BENDAMUSTINE OR BCL-2 INHIBITOR COMBINED WITH CHOP

(57) Combination product comprises Bcl-2 inhibitor and anti-CD20 mAb, wherein Bcl-2 inhibitor is compound of formula II or pharmaceutical salt or solvate thereof:

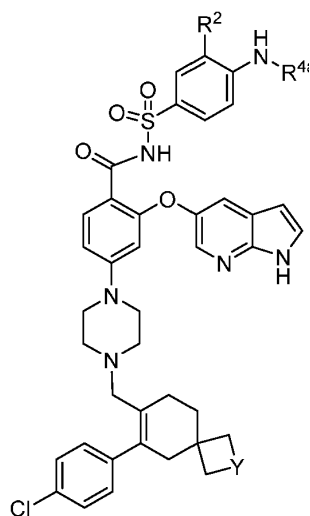

(II)

wherein values of Y, R<sup>2</sup>, R<sup>4a</sup> substitutes are provided in the claims, and mAb is selected from the group consisted of: rituximab, IF5, ibritumomab, tuxetan, tozitumomab, ocrelizumab, veltuzumab, ofatumumab, obinutuzumab, AME133V, Pro13192, and GA101, TRU-015. Said combination product is used for drug preparation treating cancer, rheumatoid arthritis (RA), granulomatosis with polyangiitis (GPA), and microscopic polyangiitis.

Claims: 2 independents

6 dependents

Table: 8

Fig.: 5

## PART B

### B 29

- (10) AP 2022 15770 A (51) Int. Cl. (2006)  
 B 29 B 17/00  
 B 29 B 17/04  
 C 08 J 3/12  
 C 08 J 3/00  
 C 08 L 95/00  
 E 01 C 7/26
- (21) AP 2020 15770 (22) 2020 05 04  
 (31) 102019000006600  
 (32) 2019 05 07  
 (33) IT
- (71) Iterchimica S.P.A. (IT)  
 Via G. Marconi, 21, Suisio 24040, Italy (IT)
- (72) GIANNATTASIO, Federica (IT);  
 CISANI, Sergio (IT);  
 BERTULETTI, Elisa (IT)

(74) Nugzar Ksovreli

(85) 2021 10 26

(86) PCT /EP2020/062260, 2020 05 04

(54) PROCESS FOR PRODUCTION OF ADDITIVE FOR BITUMINOUS CONGLOMERATES WITH HIGH MECHANICAL PERFORMANCES AND ADDITIVE COMPOSITION

(57) Present invention relates to a process for the production of additive composition intended to be mixed into bituminous conglomerate for road paving, in other words a mixture of polymers and additives, which can be used in the modification of bituminous conglomerates, bitumen and bituminous products, such as bituminous membranes, in order to provide resilience to the bituminous preparations, starting from mixed waste material containing mixture of plastic materials, wherein said mixture of plastic materials comprises at least one plastic material based on polyolefin thermoplastic polymer, grinding to particle size of 20-40 mm, washing, separating a portion of plastic material having average density of 1.0 kg/m<sup>3</sup> or lower and comprising polyolefin thermoplastic polymer, grinding said plastic portion to particle size of 10-20 mm, mixing it with PVB and further grinding to particle size of 4-6 mm. Also additive composition obtainable by this process.

Claims: 1 independent

13 dependents

## B 61

- (10) AP 2022 15565 A (51) Int. Cl. (2006)  
 B 61 B 7/00
- (21) AP 2021 15565 (22) 2021 02 19
- (71) Ramaz Tkemaladze (GE)  
 Vill. Etseri, 5510, Chiatura, Georgia (GE);  
 Malkhaz Tsutskiridze (GE)  
 Ikalto St. 3, 0171, Tbilisi, Georgia (GE);  
 Nugzar Tsintsadze (GE)  
 Gldani, I m/r., bld. 13, app. 2, 0167, Tbilisi, Georgia (GE);  
 Zaur Chitidze (GE)  
 Tarkhnishvili St. 16, 0179, Tbilisi, Georgia (GE);  
 Vakhtang Abaishvili (GE)  
 Shartava St. 6, app. 53, 0160, Tbilisi, Georgia (GE);  
 Tinatin Gogishvili (GE)  
 Gldani Gorge, bld. 3, app. 111, 0107, Tbilisi, Georgia (GE);  
 Malkhaz Akhvlediani (GE)  
 Gldani, II m/r., bld. 45, app. 95, 0167, Tbilisi, Georgia (GE);  
 Irakli Grdzlishvili (GE)  
 Vazha-Pshavela St. 4a, app. 6, 3700, Rustavi, Georgia (GE);  
 Nikoloz Gelashvili (GE)  
 Dighomi Array, III qu., bld. 1a, app. 74, 0159, Tbilisi, Georgia (GE);

Igor Gelashvili (GE)  
 Rustavi Highway 28a, app. 1, 0165, Tbilisi,  
 Georgia (GE);  
 Davit Mosulishvili (GE)  
 Megobroba Av., bld. 41, app. 64, 3700, Rustavi,  
 Georgia (GE);  
 Zaur Balamtsarashvili (GE)  
 S. Tsintsadze St. 7, 0160, Tbilisi, Georgia (GE)

(72) Ramaz Tkemaladze (GE);  
 Malkhaz Tsutskiridze (GE);  
 Nugzar Tsintsadze (GE);  
 Zaur Chitidze (GE);  
 Vakhtang Abaishvili (GE);  
 Tinatin Gogishvili (GE);  
 Malkhaz Akhvlediani (GE);  
 Irakli Grdzlishvili (GE);  
 Nikoloz Gelashvili (GE);  
 Igor Gelashvili (GE);  
 Davit Mosulishvili (GE);  
 Zaur Balamtsarashvili (GE)

(54) SHORT DISTANCE MOBILE AERIAL  
 ROPEWAY LOG PULLER MACHINE

(57) Log puller machine includes couple of self-loading aggregates 1 and 2 for log installed onto the platforms II and V disposed at the bottom and top of slope. Closed-contour pulling rope blocks 18 and 19 are mounted on vertical plane of pulling ropes 9 and 10 having hooks 7 and 8, and the blocks 15 and 16 forced on aggregate body 11 and 12 front boards 13 and 14, above. Closed-contour pulling ropes 17, the ends whereof are rigidly fixed onto the clamp 20, and equipped with two blocks 21 and 22, wherein self-loading aggregates winches 3 and 4 having hooks are separately passed, are bypassed closed-contour pulling rope blocks, and logging self-loading aggregates are installed along closed-contour pulling ropes at the head and bottom of clamp; at that, self-loading aggregates with bodies, in the lowered position onto the ground, together with closed-contour pulling ropes are disposed in self-loading aggregates symmetrical longitudinal axes congruent one vertical plane.

Claims: 1 independent

Fig.: 3

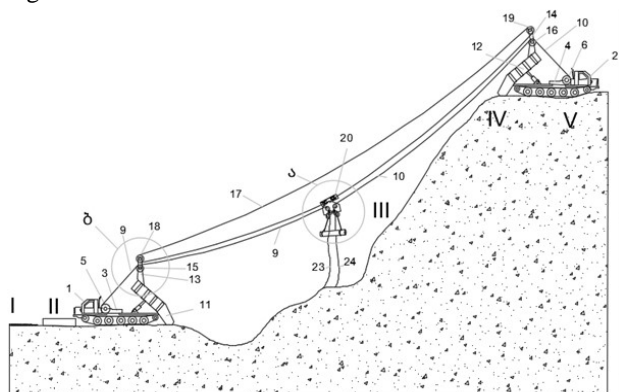

Fig. 1

PART C

C 04

(10) AP 2022 15578 A (51) Int. Cl. (2006)  
 C 04 B 7/36  
 (21) AP 2021 15578 (22) 2021 03 03  
 (71) Lepi Shota Rustaveli National Scientific  
 Foundation Of Georgia (GE)  
 Merab Aleksidze St. 1, 0193, Tbilisi,  
 Georgia (GE);  
 Razhden Skhvitaridze (GE)  
 E. Ninoshvili St. 3a, 0102, Tbilisi, Georgia (GE)  
 (72) Teimuraz Kordzakhia (GE);  
 Giorgi Tsintskaladze (GE);  
 Irakli Giorgadze (GE);  
 Shalva Verulava (GE);  
 Givi Loladze (GE);  
 Teimuraz Cheishvili (GE);  
 Giorgi Kavtiashvili (GE);  
 Razhden Skhvitaridze (GE);  
 Akaki Skhvitaridze (GE)

(54) METHOD OF CEMENT PRODUCTION

(57) A method of cement production includes roasting clinker in a furnace at the temperature of 1450°C, purifying the dust from furnace flue gases containing CO<sub>2</sub>, SO<sub>x</sub>, NO<sub>x</sub>, at the temperature of 150-350°C, by passing them through filters, drying the zeolitic tuff containing clinoptilolite by feeding it to drying unit, at the time with modification therewith CO<sub>2</sub>, SO<sub>x</sub>, NO<sub>x</sub>, and emissions into the atmosphere through smoke pipe, grinding of burnt clinker, and dried and modified zeolite tuff together with gypsum in the mill; at that, flue gases are supplied into the drying unit through direct flow pipe of 3-8 mm with fraction zeolitic tuff, at which time, flue gases having the temperature of 150-350°C are mixed with zeolite tuff to provide residual moisture content of 0.2-0.8%, and simultaneous modification therewith CO<sub>2</sub>, SO<sub>x</sub>, NO<sub>x</sub>, absorbent together with zeolitic tuff, while passing through drying unit, maintaining the temperature of 50±5°C, moving with speed of 1-3 m/s, wherefore the filling coefficient of drying unit with zeolitic tuff should be at least 30%, and slope inclination angle relative to the horizon is 1-30°, the speed of rotation varies within 1-3 RPM.

Claims: 1 independent

C 07

(10) AP 2022 15709 A (51) Int. Cl. (2006)  
 C 07 D 231/40  
 C 07 D 401/12  
 C 07 D 401/14  
 C 07 D 403/12  
 C 07 D 403/14  
 C 07 D 405/12



(21) AP 2020 15709 (22) 2020 01 28

(31) 62/959,042

(32) 2020 01 09

(33) US

(71) PFIZER INC. (US)

235 East 42<sup>nd</sup> Street, New York, NY 10017,  
USA (US)

(72) BEHENNA, Douglas Carl (US);

FREEMAN-COOK, Kevin Daniel (US);

HOFFMAN, Robert Louis (US);

NAGATA, Asako (US);

NINKOVIC, Sacha (US);

SUTTON, Scott Channing (US)

(74) Shalva Gvaramadze

(85) 2021 07 28

(86) PCT/IB2020/050653, 2020 01 28

(54) 3-CARBONYLAMINO-5-CYCLOPENTYL-1

H-PYRAZOLE COMPOUNDS HAVING

INHIBITORY ACTIVITY ON CDK2

(57) Compound of formula (I):

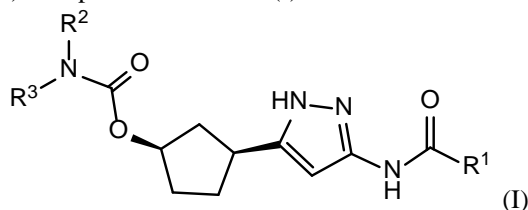

wherein values of  $R^1$ ,  $R^2$ ,  $R^3$  substitutes are provided in the claims or their pharmaceutically acceptable salt, pharmaceutical composition on the basis thereof, and usage therefor cancer treatment.

Claims: 7 independents

13 dependents

Table: 5

Fig.: 2

(10) AP 2022 15088 A

(51) Int. Cl. (2006)

C 07 D 295/26

C 07 D 403/04

C 07 D 295/205

C 07 D 471/10

C 07 D 498/08

(21) AP 2017 15088

(22) 2017 11 15

(31) 62/423,099

(32) 2016 11 16

(33) US

(71) H. Lundbeck A/S (DK)

Ottliavej 9, DK-2500, Valby, Denmark (DK)

(72) GRICE, Cheryl A. (US);

BUZARD, Daniel J. (US);

SHAGHAFI, Michael B. (US)

(74) Tamaz Shilakadze

(85) 2019 05 22

(86) PCT/US2017/061868, 2017 11 15

(54) MAGL INHIBITORS

(57) Compound of structural formula (I):

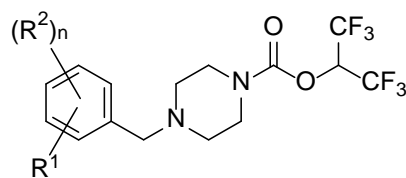

wherein values of  $R^1$ ,  $R^2$  substitutes, and  $n$  variable are provided in the claims or their pharmaceutically acceptable salt or solvate, and pharmaceutical composition on the basis thereof.

Claims: 2 independents

9 dependents

Table: 4

## PATENTED IVENTIONS

### PART A

#### A 61

- |  |   |   |
|--|---|---|
| <p>(11) P 2022 7406 B</p> <p>(10) AP 2022 15303 A</p> <p>(21) AP 2018 15303</p> <p>(22) 2018 09 27</p> <p>(24) 2018 09 27</p> <p>(31) 62/566,779</p> <p>(32) 2017 10 02</p> <p>(33) US</p> <p>(86) PCT/US2018/053039, 2018 09 27</p> <p>(73) Merck Sharp &amp; Dohme Corp. (US)<br/>126 East Lincoln Avenue, Rahway,<br/>NJ 07065-0907, USA (US)</p> <p>(72) BIFTU, Tesfaye (US);<br/>HUANG, Xianhai (US);<br/>LIU, Weiguo (US);<br/>PAN, Weidong (US);<br/>PARK, Min (US);<br/>PASTERNAK, Alexander (US);<br/>SUN, Wanying (US);<br/>TANG, Haifeng (US);<br/>ZANG, Yi (US)</p> <p>(74) Tamaz Shilakadze</p> <p>(54) CHROMANE MONOBACTAM<br/>COMPOUNDS FOR THE TREATMENT<br/>OF BACTERIAL INFECTIONS</p> | <p>(51) Int. Cl. (2006)<br/>A 61 K 31/427<br/>A 61 K 31/433<br/>A 61 K 31/4439</p> <p>(44) ) 7(586)2022</p> | <p>(11) P 2022 7408 B</p> <p>(10) AP 2022 15229 A</p> <p>(21) AP 2018 15229</p> <p>(22) 2018 05 03</p> <p>(24) 2018 05 03</p> <p>(31) 201721015961</p> <p>(32) 2017 05 05</p> <p>(33) IN</p> <p>(86) PCT/IB2018/053069, 2018 05 03</p> <p>(73) Serum Institute Of India Private Limited (IN)<br/>212/2, Off Soli Poonawalla Rd., Hadapsar,<br/>Pune, Maharashtra 411028, India (IN)</p> <p>(72) PISAL, Sambhaji Shankar (IN);<br/>ANNAMRAJU, Dattatreya Sarma (IN);<br/>DHERE, Rajeev Mhalasakant (IN)</p> <p>(74) Giorgi Ghvinjilia</p> <p>(54) METHOD FOR REMOVAL OF<br/>IMPURITIES FROM BACTERIAL<br/>CAPSULAR POLYSACCHARIDE<br/>BASED PREPARATIONS</p> |
| <p>(11) P 2022 7407 B</p> <p>(10) AP 2022 15414 A</p> <p>(21) AP 2019 15414</p> <p>(22) 2019 02 07</p> <p>(24) 2019 02 07</p> <p>(31) 18160586.6; 18155571.5</p> <p>(32) 2018 03 07; 2018 02 07</p> <p>(33) EP; EP</p> <p>(86) PCT/EP2019/052980, 2019 02 07</p> <p>(73) Estetra SPRL (BE)<br/>Rue Saint-Georges 5, 4000, Liège,<br/>Belgium (BE)</p> <p>(72) RAUSIN, Glwadys (BE);<br/>JOST, Maud (BE)</p> <p>(74) Larisa Amirkhanyan</p> <p>(54) CONTRACEPTIVE COMPOSITION WITH<br/>REDUCED CARDIOVASCULAR EFFECTS</p>   | <p>(51) Int. Cl. (2006)<br/>A 61 K 31/565<br/>A 61 P 15/18</p> <p>(44) 8(587)2022</p>                       |   |

# UTILITY MODELS

## APPLICATIONS APPROVED FOR GRANTING PATENT

The decision can be appealed at the Chamber of Appeal of Sakpatenti within 3 months from the publication or at the Mtskheta District Court Administrative Cases Board (Address: №17, Samkhedro St., Mtskheta), within 1 month following the publication.

### PART A

#### A 61

(10) AU 2022 15543 U (51) Int. Cl. (2006)

A 61 M 1/10

(21) AU 2021 15543 (22) 2021 01 25

(71) Nodar Khodeli (GE)

Budapest St. 40, Tbilisi, Georgia (GE);

Zurab Chkhaidze (GE)

Marie Brose St. 2, Tbilisi, Georgia (GE);

Otar Shengelia (GE)

Davit Garejeli St. 49, Tbilisi, Georgia (GE);

Davit Songhulashvili (GE)

Theodore Tironi St. 10, Vill. Dighomi,

Tbilisi, Georgia (GE)

(72) Nodar Khodeli (GE);

Zurab Chkhaidze (GE);

Otar Shengelia (GE);

Davit Songhulashvili (GE)

(54) PORTABLE DEVICE FOR MANAGEMENT OF ARTIFICIAL BLOOD FLOW

(57) A device includes a case 1 having a groove 2 intended to be placed on the blood-conducting tube, support threshold 3 thereof, tube locking core 4 having head 5 and piston 6 mounted into the case, and piston abutment limit 7 is provided therein. The device includes gas supply channels 8 and 9, as well, to be connected to core piston receiver 10; at that, airflow switching electrical valve 11 is connected to the compressor with a stutzer 12 is mounted therein, and working thereof is executed with control unit having developed software.

Claims: 1 independent

Table: 1

### PART F

#### F 24

(10) AU 2022 15765 U (51) Int. Cl. (2006)

F 24 D 19/00

F 24 H 9/00

(21) AU 2021 15765 (22) 2021 10 22

(71) Giorgi Tsiramua (GE)

Nutsubidze Plateau, II m/r., I qu., bld. 5,

app. 7, 0183, Tbilisi, Georgia (GE)

(72) Giorgi Tsiramua (GE)

(54) THERMAL INSULATION CABINET FOR CENTRAL HEATING BOILER

(57) A cabinet includes a frame and a door having a lock connected thereto, at least two sides and a head, the head and sides of cabinet are covered with heat-insulating material; at that, the door, sides and head of cabinet are made in the form of sandwich panel consisted of first 1 and second 8 metallic sheets, the upper corners whereof are cut off, and rectangular cutouts 3 are made on the slats 2 obtained as a result of cutting; also, rectangular cutouts 9 are made on lower end of second metallic sheet, wherein the ledge 10 obtained between the cutouts is bent into the direction of surface of metallic second sheet, on both ends of first and second sheets, along entire length of sheets and on their upper side; one notch is formed on first sheet 6 having inclination of 160-180° relative to the surface of first sheet, and first groove is formed on second sheet (notches) 6 bent on 90° inside of metallic sheet, and second groove 7 on connecting line of ridges cut outside the sheet and the tips of cutouts 4; in the case of first sheet, the groove is directed inside of sheet surface, and in the case of second sheet – outside of sheet surface, in such a way that heat insulation material is placed between them.

Claims: 1 independent

7 dependents

Table: 5

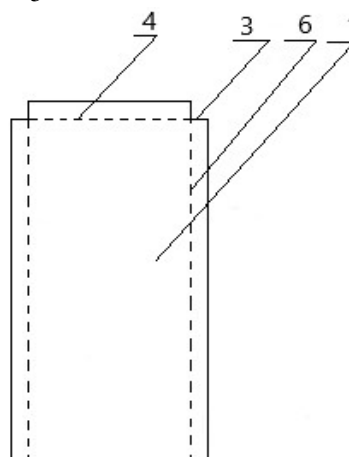

Fig. 1

---

# PATENTED UTILITY MODELS

## PART A

### A 61

- (11) U 2022 2127 Y (51) Int. Cl. (2006)  
A 61 L 9/00
- (10) AU 2022 15658 U (44) 8(587)2022
- (21) AU 2021 15658
- (22) 2021 06 10
- (24) 2021 06 10
- (73) Ramaz Gakhokidze (GE)  
Barnov St. 82, app. 7, 0179, Tbilisi,  
Georgia (GE);  
Sopio Burjanadze (GE)  
Dighomi Array, VI qu., bld. 5, app. 25, 0159,  
Tbilisi, Georgia (GE);  
Giorgi Burjanadze (GE)  
Dighomi Array, VI qu., bld. 5, app. 25, 0159,  
Tbilisi, Georgia (GE);  
Jano Burjanadze (GE)  
Dighomi Array, VI qu., bld. 5, app. 25, 0159,  
Tbilisi, Georgia (GE);  
Nikoloz Mekvabishvili (GE)  
Barnov St. 67, Tbilisi, Georgia (GE)
- (72) Ramaz Gakhokidze (GE);  
Sopio Burjanadze (GE);  
Giorgi Burjanadze (GE);  
Jano Burjanadze (GE);  
Nikoloz Mekvabishvili (GE)
- (74) Tamaz Shilakadze
- (54) DEVICE FOR DISINFECTION  
AGAINST THE VIRUS COVID 19
- 

## PART F

### F 02

- (11) U 2022 2128 Y (51) Int. Cl. (2006)  
F 02 F 7/00
- (10) AU 2022 15640 U (44) 8(587)/2022
- (21) AU 2021 15640
- (22) 2021 05 27
- (24) 2021 05 27
- (73) Pridon Karanadze (GE)  
Sherozia St. 5, 5200, Tsalenjikha,  
Georgia (GE)
- (72) Pridon Karanadze (GE)
- (74) Khatuna Imnadze
- (54) CAR GAS DISTRIBUTION MECHANISM  
ACTUATING CHAIN LID
-

---

# DESIGNS

## DESIGNS, WHICH HAVE BEEN REGISTERED WITH THE INTERNATIONAL BUREAU CLAIMING PRIORITY ON THE TERRITORY OF GEORGIA

The decision can be appealed at the Chamber of Appeal of Sakpatenti within 3 months from the publication or at the Mtskheta District Court Administrative Cases Board (Address: №17, Samkhedro St., Mtskheta), within 1 month following the publication.

- (11) DM/218 368 (51) 09-03  
(15) 2021 12 14 (44) 24/2022 (2022 06 17)  
(22) 2021 12 14  
(28) 1  
(73) Peter Ammann  
Rebbergweg 4, 3653 Oberhofen (CH)  
(85) –  
(86) CH  
(87) –  
(88) –  
(89) CH  
(81) II. BJ, CI, GA, GR, IT, MA, ML, NE, SN III. AL, AM, AZ, BA, BG, BN, BW, BX, BY, BZ, CA, CH, DE, DK, EE, EG, EM, ES, FI, FR, GB, GE, GH, HR, HU, IL, IS, JP, KG, KH, KP, KR, LI, LT, LV, MC, MD, ME, MK, MN, MX, NA, NO, OA, OM, PL, RO, RS, RU, RW, SG, SI, SM, SR, ST, SY, TJ, TM, TN, TR, UA, US, VN, WS  
(72) Peter Ammann  
Rebbergweg 4, 3653 Oberhofen (CH)  
(74) Lenz & Staehelin  
Brandschenkestrasse 24, 8027 Zurich (CH)  
(54) 1. CARDBOARD BOX [PACKAGING]  
(55)

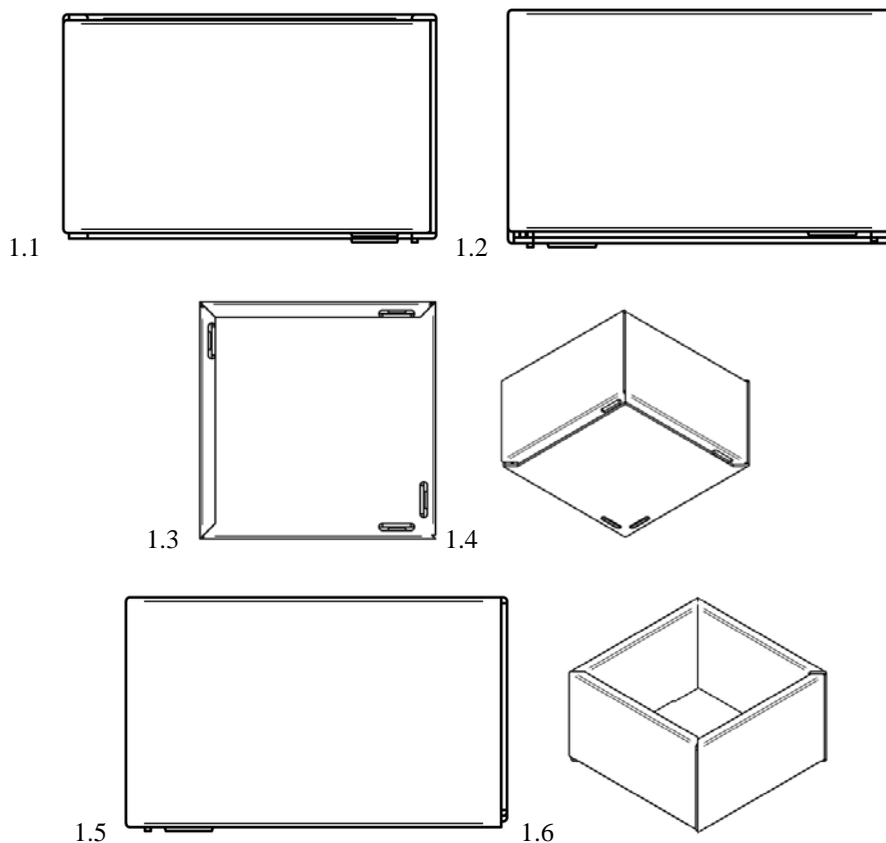

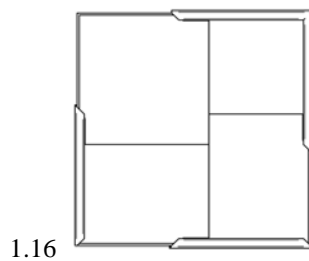
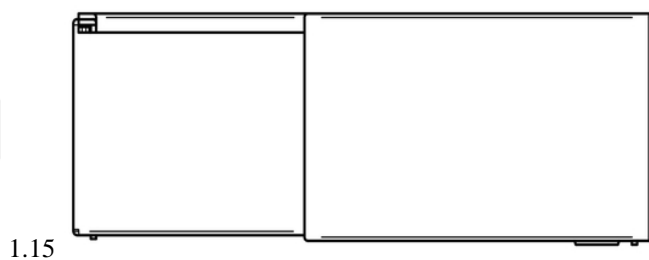
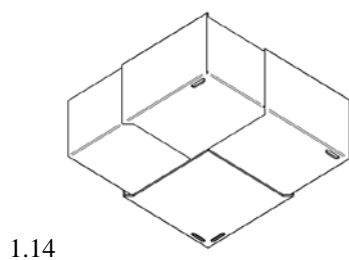
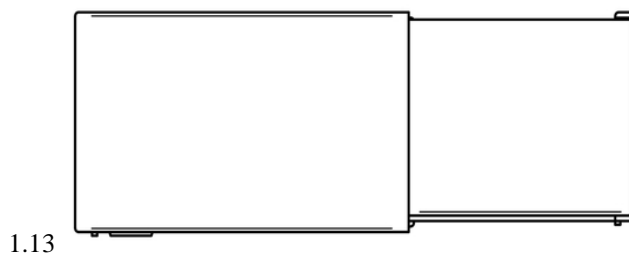
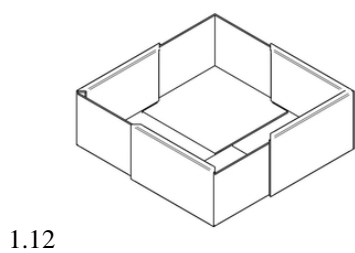
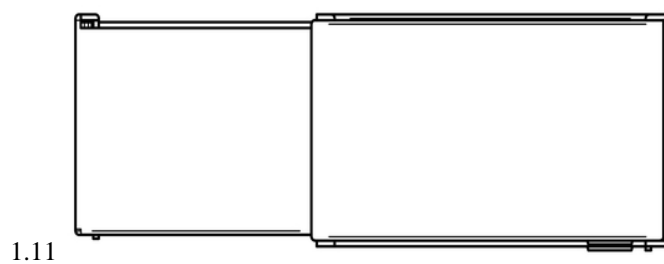
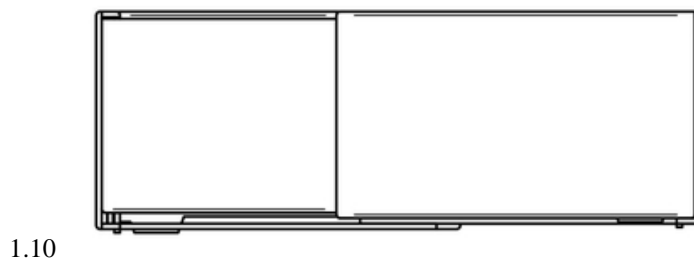
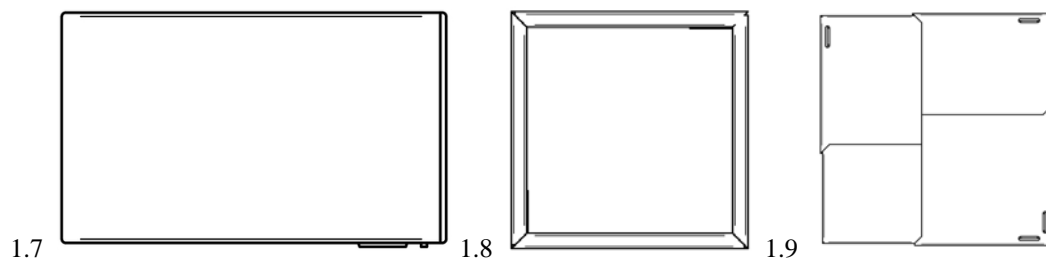

- (11) DM/221 358 (51) 10-07  
 (15) 2022 06 17 (44) 26/2022 (2022 07 01)  
 (22) 2022 06 17  
 (28) 1  
 (30) No1: 14.03.2022; 146644; CH  
 (73) ROLEX SA  
 Rue François-Dussaud 3-5-7, 1211 Genève 26 (CH)  
 (85) CH  
 (86) CH  
 (87) CH  
 (88) CH  
 (89) CH  
 (81) II. MA III. AL, AM, AZ, BA, BN, BW, BY, BZ, CA, EG, EM, GB, GE, GH, IL, IS, JM, JP, KG, KH, KP, KR, LI, MC, MD, ME, MK, MN, MX, NA, NO, OA, OM, RS, RU, RW, SG, SM, SR, ST, SY, TJ, TM, TN, TR, UA, VN, WS  
 (72) Giovanni SICILIANO  
 Chemin Docteur-Adolphe Pasteur, 1209, Genève (CH)  
 (74) BUGNION S.A  
 10, route de Florissant, 1211 Genève 12 (CH)  
 (46) 2022 07 01  
 (54) 1. WATCH CASE  
 (55)

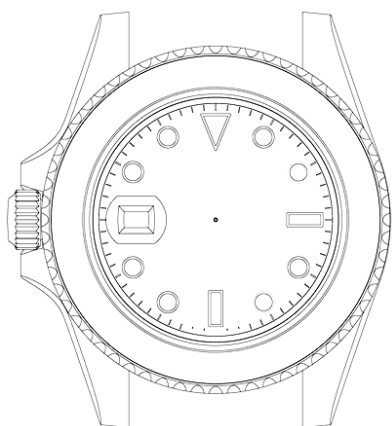

1.1

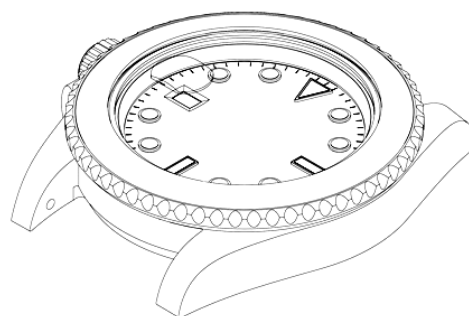

1.2

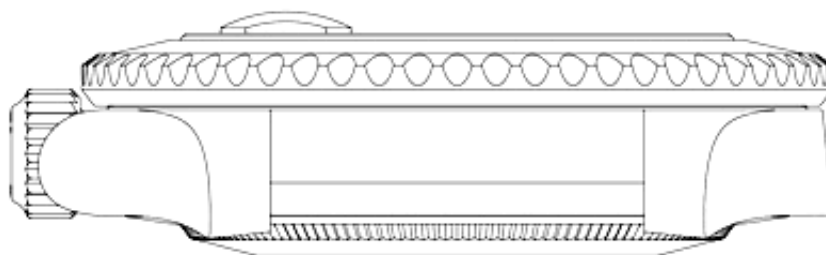

1.3

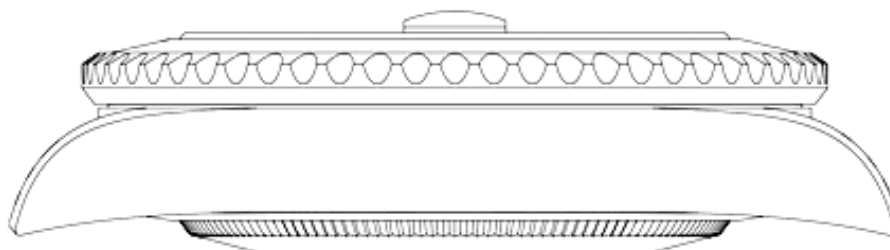

1.4

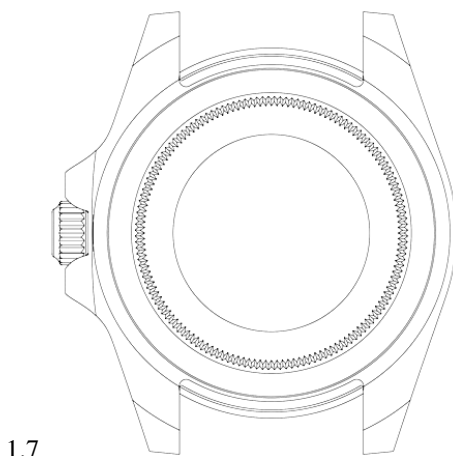
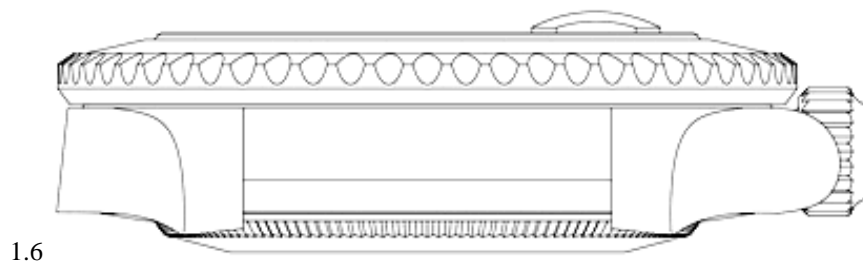
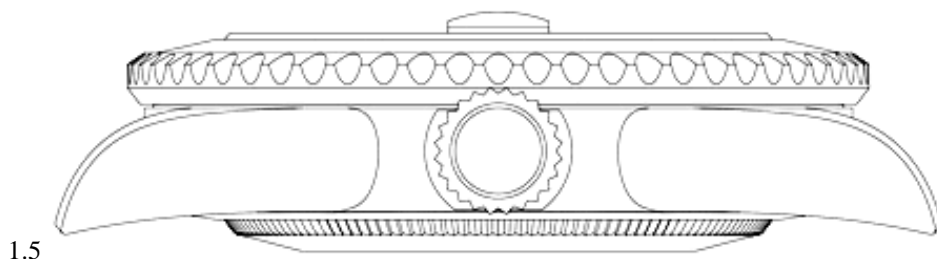



(11) DM/221 388

(51) 10-07

(15) 2022 06 17

(44) 26/2022 (2022 07 01)

(22) 2022 06 17

(28) 2

(73) ROLEX SA

Rue François-Dussaud 3-5-7, 1211 Genève 26 (CH)

(85) CH

(86) CH

(87) CH

(88) CH

(89) CH

(81) II. MA III. AL, AM, AZ, BA, BN, BW, BY, BZ, CA, EG, EM, GB, GE, GH, IL, IS, JM, JP, KG, KH, KP, KR, LI, MC, MD, ME, MK, MN, MX, NA, NO, OA, OM, RS, RU, RW, SG, SM, SR, ST, SY, TJ, TM, TN, TR, UA, VN, WS

(72) Giovanni SICILIANO

9, Chemin Docteur-Adolphe Pasteur, 1209, Genève (CH)

(74) BUGNION S.A.

10, Route De Florissant, 1211 Genève 12 (CH)

(46) 2022 07 01

(54) 1.-2. WATCH CASE

(55)

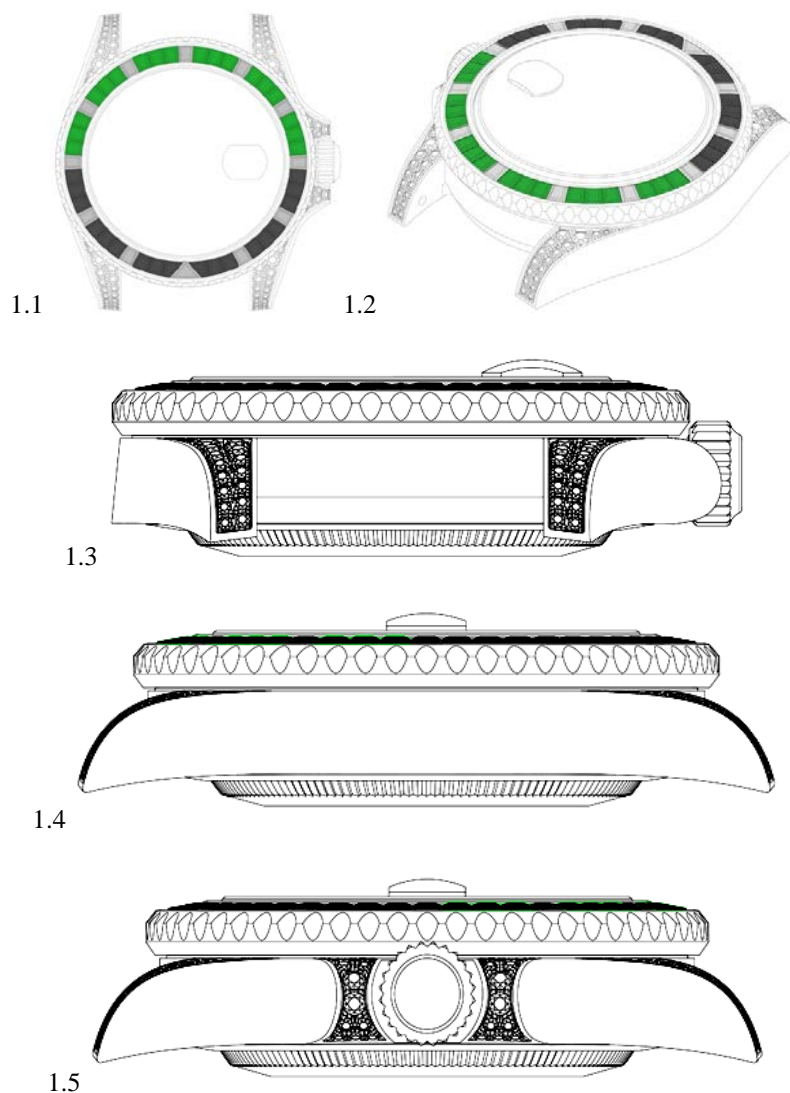

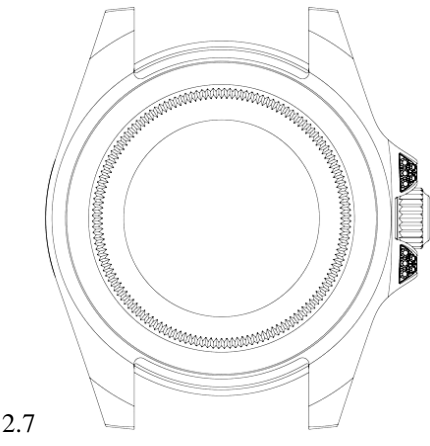
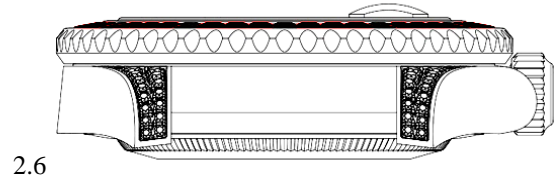
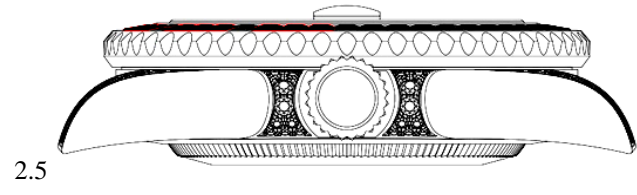
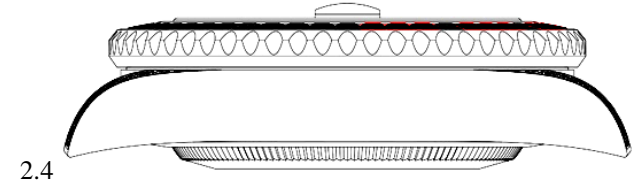
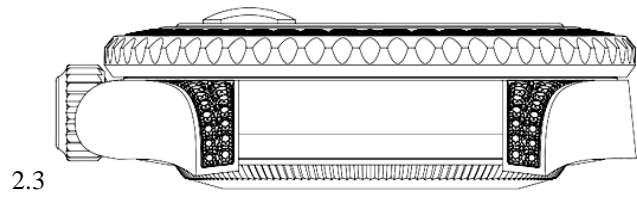
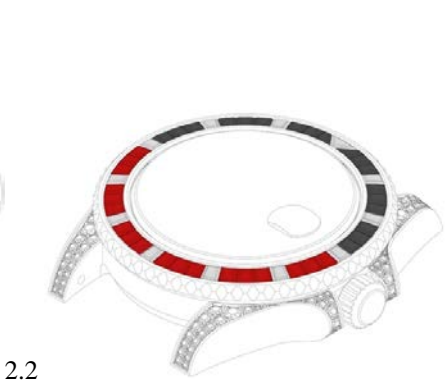
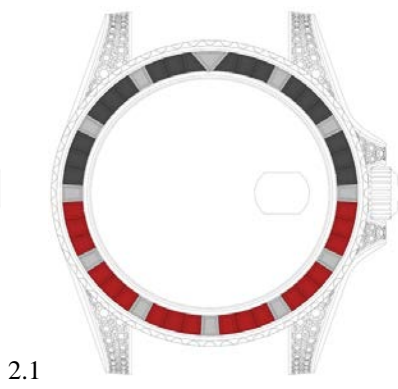
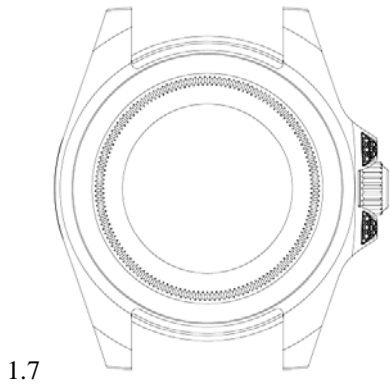
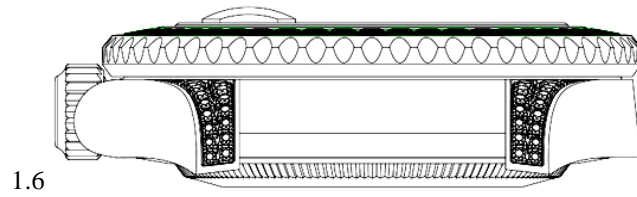

- (11) DM/221 397 (51) 10-07  
 (15) 2022 06 17 (44) 26/2022 (2022 07 01)  
 (22) 2022 06 17  
 (28) 1  
 (30) No1: 14.03.2022; 146645; CH  
 (73) ROLEX SA  
 Rue François-Dussaud 3-5-7, 1211 Genève 26 (CH)  
 (85) CH  
 (86) CH  
 (87) CH  
 (88) CH  
 (89) CH  
 (81) II. MA III. AL, AM, AZ, BA, BN, BW, BY, BZ, CA, EG, EM, GB, GE, GH, IL, IS, JM, JP, KG, KH, KP, KR, LI, MC, MD, ME, MK, MN, MX, NA, NO, OA, OM, RS, RU, RW, SG, SM, SR, ST, SY, TJ, TM, TN, TR, UA, VN, WS  
 (72) Giovanni SICILIANO  
 9, Chemin Docteur-Adolphe Pasteur, 1209, Genève (CH)  
 (74) BUGNION S.A.  
 Route de Florissant, 1211 Genève 12 (CH)  
 (46) 2022 07 01  
 (54) 1. WATCH RIM  
 (55)

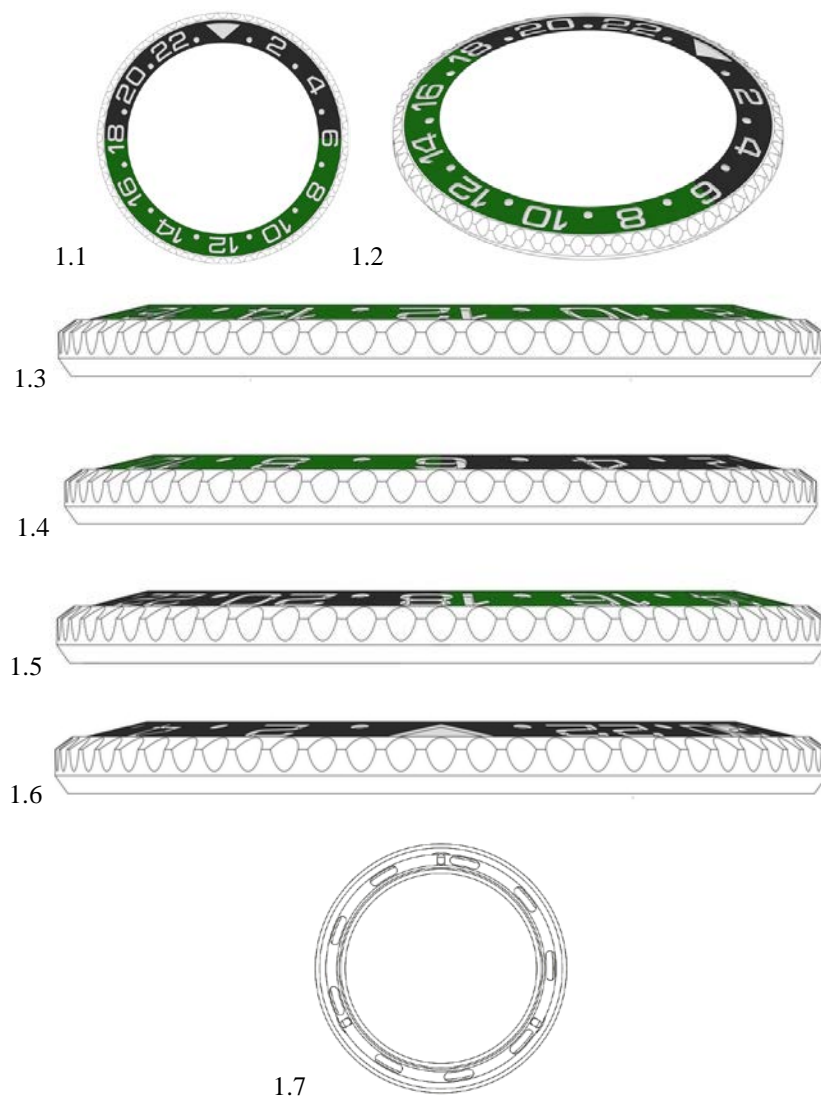

- (11) DM/221 571 (51) 18-03  
 (15) 2022 05 18 (44) 26/2022 (2022 07 01)  
 (22) 2022 05 18  
 (28) 3  
 (30) No1: 31.03.2022; 008924450-0001; EM; No2: 31.03.2022; 008924450-002; EM;  
 No3: 31.03.2022; 008924450-003; EM  
 (73) PPF A.s.  
 Evropská 2690/17, 16041 Prague 6 (CZ)  
 (85) –  
 (86) –  
 (87) –  
 (88) EM  
 (89) EM  
 (81) III. AL, BA, BY, CH, GB, GE, IS, LI, MC, MD, ME, MK, NO, RS, RU, SM, TR, UA  
 (72) Anthony Sheret  
 Colophon Foundry, 16A Crane Grove, N7 8NN, London (GB)  
 (74) Cermak A Spol.  
 Elisky Peskove735/15, 15000 Prague (CZ)  
 (46) 2022-07-01  
 (54) 1.-3. TYPEFACES  
 (55)

1.1	<p>AÄÄBCČDĎEÉF            GHCHIÍJKLĹLM            NŇOÓÔPQRŘŠŠ            TŤUÚVWXYÝŽŽ            aääbcčddeéf            ghchiiijklílm            nňoóôpqrřšš            tťuúvwxyýžž            1234567890</p>	<p>Yettel light</p> <p>At Yettel, we see this. And we understand.            That's why we go outof our way to understand the            role that technology and telecomsplays in all our            lives, and we strive to offer products and services            that help everyone to achieve balance in their lives.</p>
2.1	<p>AÄÄBCČDĎEÉF            GHCHIÍJKLĹLM            NŇOÓÔPQRŘŠŠ            TŤUÚVWXYÝŽŽ            aääbcčddeéf            ghchiiijklílm            nňoóôpqrřšš            tťuúvwxyýžž            1234567890</p>	<p>Yettel regular</p> <p>At Yettel, we see this. And we understand.            That's why we go outof our way to understand the            role that technology and telecomsplays in all our            lives, and we strive to offer products and services            that help everyone to achieve balance in their lives.</p>
3.1	<p>AÄÄBCČDĎEÉF            GHCHIÍJKLĹLM            NŇOÓÔPQRŘŠŠ            TŤUÚVWXYÝŽŽ            aääbcčddeéf            ghchiiijklílm            nňoóôpqrřšš            tťuúvwxyýžž            1234567890</p>	<p>Yettel bold</p> <p>At Yettel, we see this. And we understand.            That's why we go outof our way to understand the            role that technology and telecomsplays in all our            lives, and we strive to offer products and services            that help everyone to achieve balance in their lives.</p>

(11) DM/221 375

(51) 24-02

(15) 2022 06 01

(44) 26/2022 (2022 07 01)

(22) 2022 06 01

(28) 1

(73) ADVENTIA PHARMA, S.L.

Viera y Clavijo, 30, 2ª Planta, 35002 Las Palmas de Gran Canarias, Las Palmas (ES);

ANDRÉS CABELLO REY

Viera y Clavijo, 30, 2ª Planta, 35002 Las Palmas de Gran Canarias, Las Palmas (ES)

(85) -; -

(86) ES; ES

(87) -; -

(88) -; -

(89) EM; EM

(81) III. AL, AM, AZ, BA, BN, BW, BY, BZ, CA, CH, CN, EG, EM, GB, GE, GH, IL, IS, JM, JP, KG, KH, KP, KR, LI, MC, MD, ME, MK, MN, MX, NA, NO, OA, OM, RO, RS, RU, RW, SG, SM, SR, ST, SY, TJ, TN, TR, UA, US, VN

(72) ANDRÉS CABELLO REY

Viera y Clavijo, 30, 2ª Planta, 35002 Las Palmas de Gran Canarias, Las Palmas (ES)

(74) ABG INTELLECTUAL PROPERTY, S.L.

Avda. de Burgos 16D – Edificio Euromor, 4ª planta, 28036 Madrid (ES)

(46) 2022 07 01

(54) 1. DROP COUNTER FOR DROPPERS

(55)

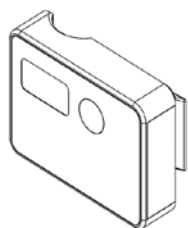

1.1

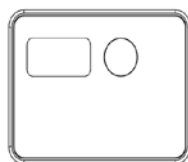

1.2

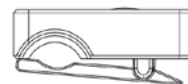

1.3



1.4



1.5

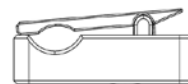

1.6

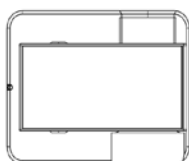

1.7

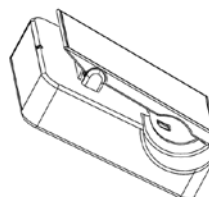

1.8

- (11) DM/221 661
- (15) 2022 06 15
- (22) 2022 06 15
- (28) 2
- (30) No1: 01.03.2022; 146627; CH; No2: 01.03.2022; 146627; CH
- (73) ROLEX SA  
Rue François-Dussaud 3-5-7, 1211 Genève 26 (CH)
- (85) CH
- (86) CH
- (87) CH
- (88) CH
- (89) CH
- (81) II. MA III. AL, AM, AZ, BA, BN, BW, BY, BZ, CA, EG, EM, GB, GE, GH, IL, IS, JM, JP, KG, KH, KP, KR, LI, MC, MD, ME, MK, MN, MX, NA, NO, OA, OM, RS, RU, RW, SG, SM, SR, ST, SY, TJ, TM, TN, TR, UA, VN, WS
- (72) Davide Airoldi  
16 Rue Du Grand-Bureau, 1227, Genève (CH)
- (74) BUGNION S.A  
10, Route De Florissant, 1211 Genève 12 (CH)
- (46) 2022 07 08
- (54) 1.-2. WATCH DIAL
- (55)

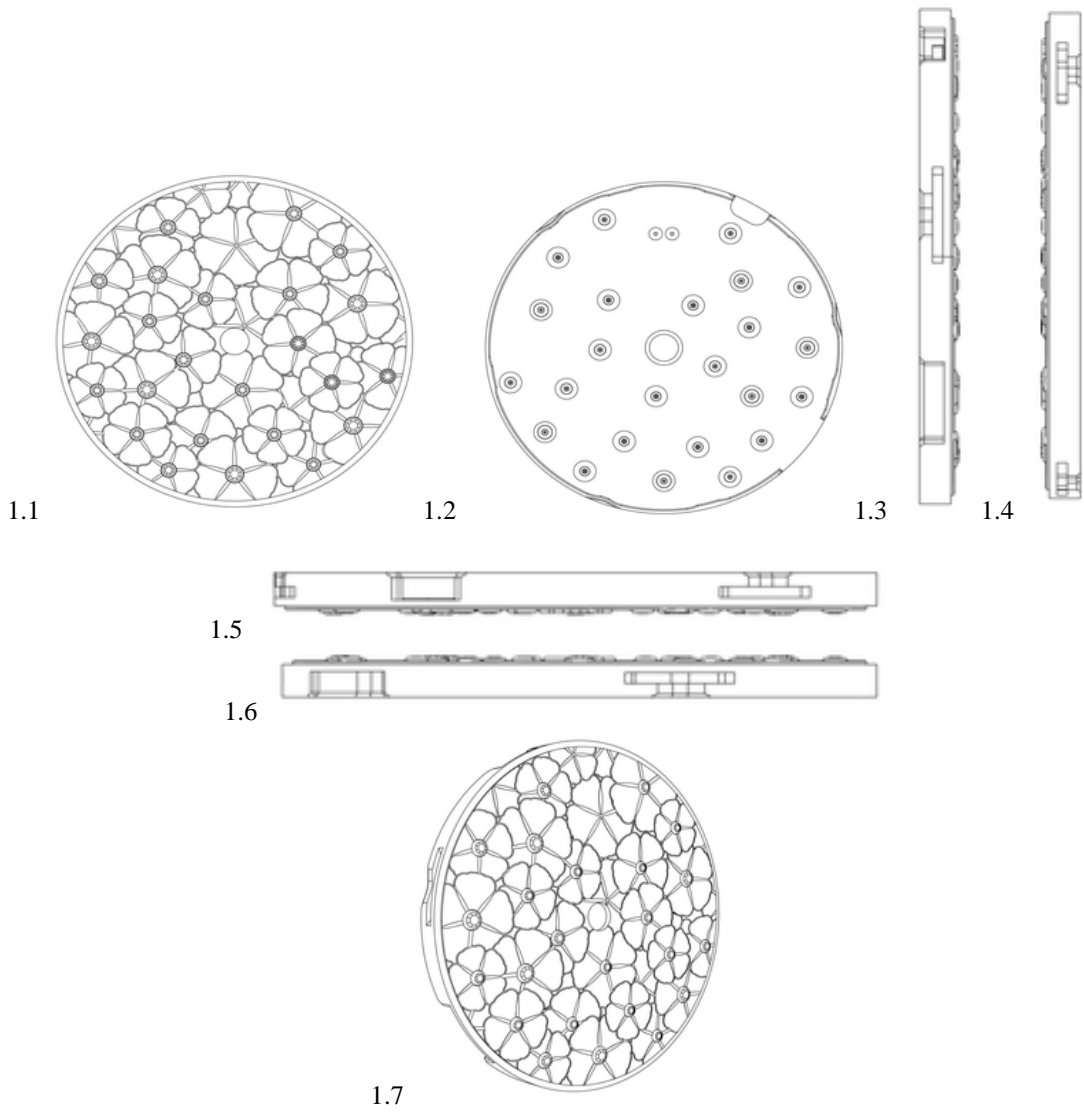

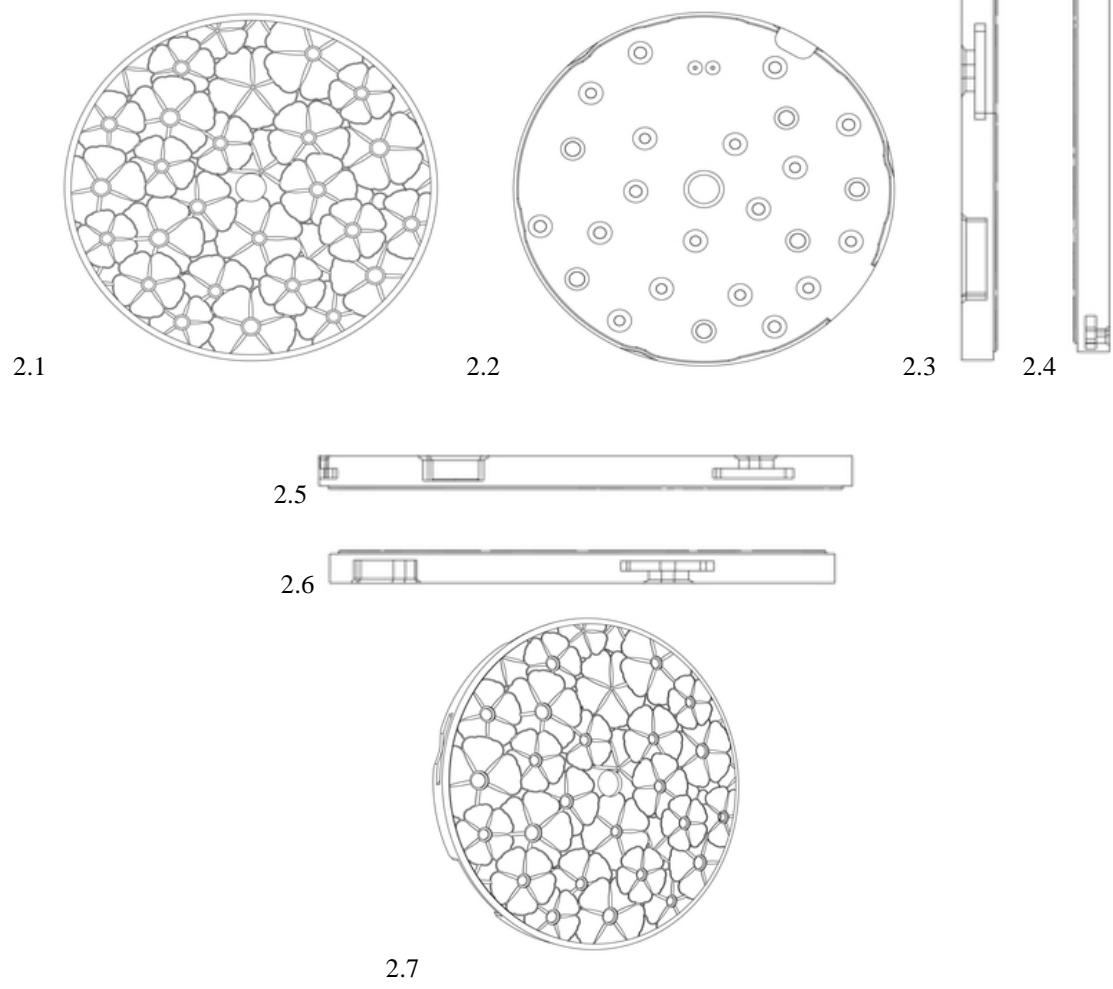

- (11) DM/221 796
- (15) 2022 06 15
- (22) 2022 06 15
- (28) 1
- (30) No1: 14.03.2022; 146647; CH
- (73) ROLEX SA  
Rue François-Dussaud 3-5-7, 1211 Genève 26 (CH)
- (85) CH
- (86) CH
- (87) CH
- (88) CH
- (89) CH
- (81) II. MA III. AL, AM, AZ, BA, BN, BW, BY, BZ, CA, EG, EM, GB, GE, GH, IL, IS, JM, JP, KG, KH, KP, KR, LI, MC, MD, ME, MK, MN, MX, NA, NO, OA, OM, RS, RU, RW, SG, SM, SR, ST, SY, TJ, TM, TN, TR, UA, VN, WS
- (72) Giovanni SICILIANO  
Chemin Docteur-Adolphe-Pasteur, 1209, Genève (CH)
- (74) BUGNION S.A.  
10, Route De Florissant, 1211 Genève 12 (CH)
- (46) 2022 07 08
- (54) 1. WATCH BEZEL
- (55)

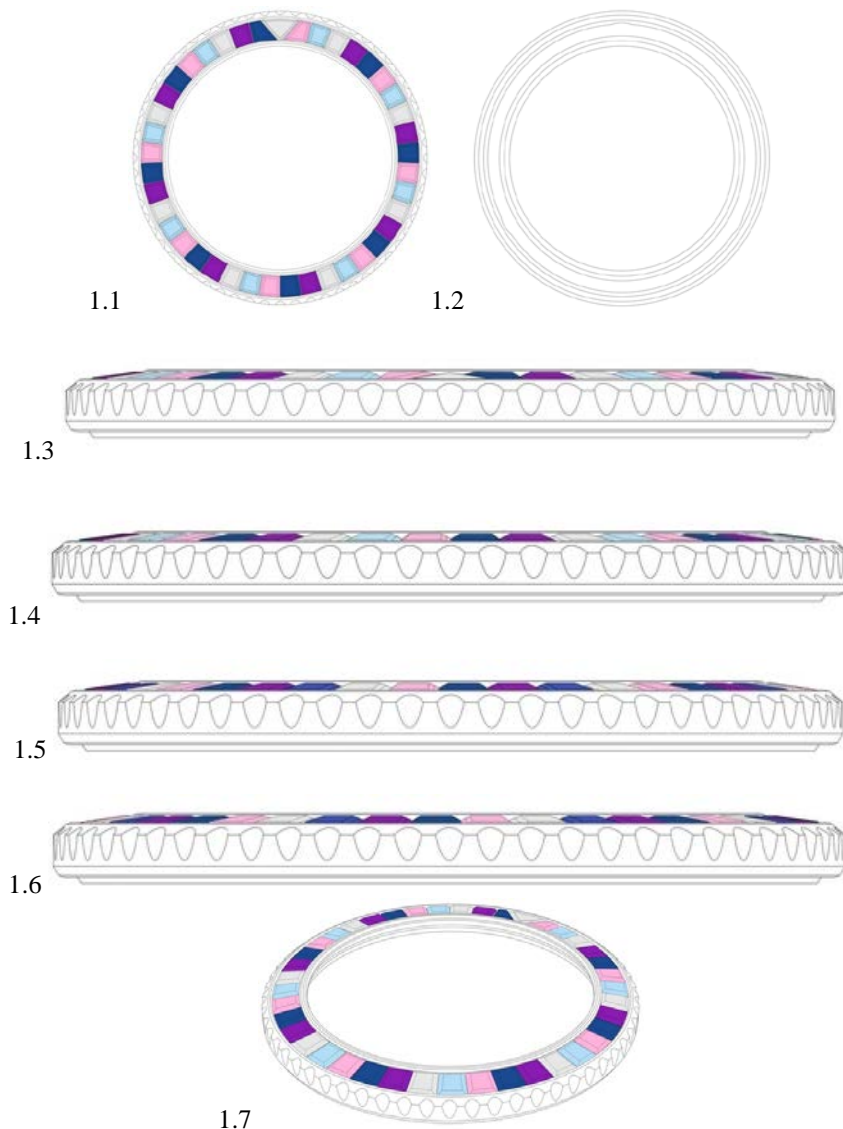



- (11) DM/221 797 (51) 10-07  
 (15) 2022 06 15 (44) 27/2022 (2022 07 08)  
 (22) 2022 06 15  
 (28) 1  
 (30) No1: 01.03.2022; 146628; CH  
 (73) ROLEX SA  
 Rue François-Dussaud 3-5-7, 1211 Genève 26 (CH)  
 (85) CH  
 (86) CH  
 (87) CH  
 (88) CH  
 (89) CH  
 (81) II. MA III. AL, AM, AZ, BA, BN, BW, BY, BZ, CA, EG, EM, GB, GE, GH, IL, IS, JM, JP, KG, KH,  
 KP, KR, LI, MC, MD, ME, MK, MN, MX, NA, NO, OA, OM, RS, RU, RW, SG, SM, SR, ST, SY, TJ,  
 TM, TN, TR, UA, VN, WS  
 (72) Davide Airoldi  
 16 Rue Du Grand-Bureau, 1227, Genève (CH)  
 (74) BUGNION S.A.  
 10, Route De Florissant, 1211 Genève 12 (CH)  
 (46) 2022 07 08  
 (54) 1. WATCH DIAL  
 (55)

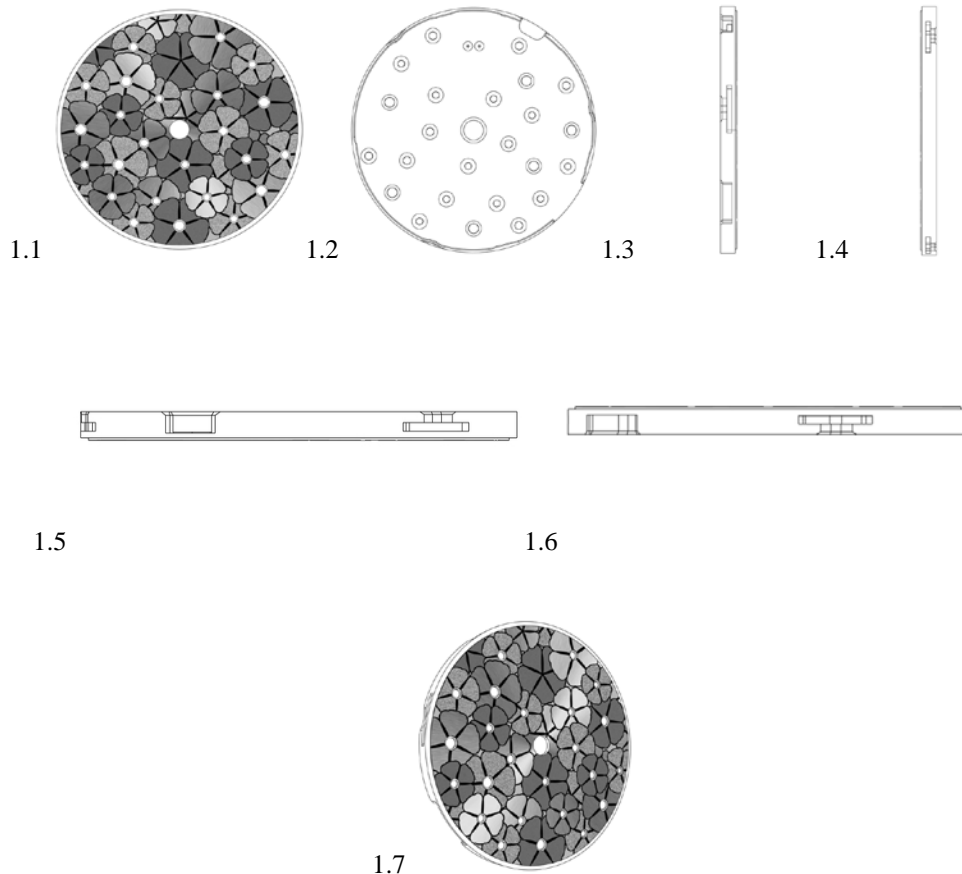

---

# TRADEMARKS

## APPLICATIONS FILED UNDER THE NATIONAL PROCEDURE APPROVED FOR REGISTRATION

The decision can be appealed at the Chamber of Appeal of Sakpatenti within 3 months from the publication or at the Mtskheta District Court Administrative Cases Board (Address: №17, Samkhedro St., Mtskheta), within 1 month following the publication.

(260) AM 2022 115593 A  
(210) AM 115593  
(220) 2021 11 29  
(731) LTD "Ninana"  
Sulkhan Tsintsadze St. 11, app. 43, 0171,  
Tbilisi, Georgia  
(540)

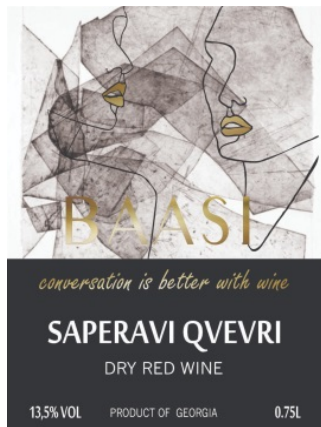

(591) Black, golden, white  
(531) 02.01.01; 02.01.16; 02.03.01; 02.03.02;  
02.03.16; 02.09.08  
(526) GEORGIA  
(511) 33, 35, 41, 43

---

(260) AM 2022 115843 A  
(210) AM 115843  
(220) 2021 12 17  
(731) JSC "Telavi Wine Cellar"  
Vill. Kurdghelauri, Telavi Region, Georgia  
(740) Giorgi Taktakishvili  
(540)



(591) Black-white  
(531) 02.01.04; 19.09.02  
(526) KONDOLI  
(511) 33

---

(260) AM 2022 116145 A  
(210) AM 116145  
(220) 2022 01 10  
(731) Sichuan Machinery Imp. & Exp. Corp. LTD  
C-8F, Fengde International Plaza, NO.6  
Hong Kong Rd., Chengdu City, Sichuan  
Province, Public Republic of China  
(740) Giorgi Taktakishvili  
(540)

**Dasqua**

(591) Black-white  
(531) 27.05.01  
(511) 9

---

(260) AM 2022 116146 A  
(210) AM 116146  
(220) 2022 01 10  
(731) Karium, LTD  
The Capital Bld., Oldberry Castle, Brinkley,  
England RG12 8FZ, UK  
(740) Giorgi Taktakishvili  
(540)

**SOFT & GENTLE**

(591) Black-white  
(511) 3

---

(260) AM 2022 116147 A  
(210) AM 116147  
(220) 2022 01 10  
(731) Riot Games Inc.  
12333 W. Olympic Blvd., Los Angeles,  
CA 90064, USA  
(740) Tamaz Shilakadze  
(540)

**Wild Rift EMEA  
Championship**

(591) Black-white  
(511) 25, 38, 41

---

(260) AM 2022 116148 A  
 (210) AM 116148  
 (220) 2022 01 10  
 (731) LTD "Neogas"  
 Gazapkhuli St. 18, Tbilisi, Georgia  
 (540)

**ნეო ენერჯი**  
**NEO ENERGY**

(591) Black-white  
 (511) 4, 35, 37

(260) AM 2022 116162 A  
 (210) AM 116162  
 (220) 2022 01 13  
 (731) Intersun Holding FZCO  
 Jebal Ali Free Zone, Dubai, 61051, United  
 Arab Emirates  
 (740) Mariam Gogitidze  
 (540)

*SuperFish*

(591) Black-white  
 (531) 03.09.01; 03.09.24; 27.05.01; 27.05.06;  
 27.05.08; 27.05.19  
 (511) 29, 35, 39

(260) AM 2022 116171 A  
 (210) AM 116171  
 (220) 2022 01 14  
 (731) Georgi Tsaguria  
 Samtredia St. 13, app. 48, 0119, Tbilisi,  
 Georgia  
 (740) Georgi Tsaguriya  
 (540)

**LTA**

**YOUR  
 WEALTH  
 COUNSEL**

(591) Black-white  
 (531) 26.04.02; 26.04.05; 26.04.18; 27.05.01;  
 27.05.15  
 (511) 35, 36, 45

(260) AM 2022 116215 A  
 (210) AM 116215  
 (220) 2022 01 14  
 (731) LTD "G M Pharmaceuticals"  
 Rustavi Highway 52, 0114, Tbilisi, Georgia  
 (740) Nugzar Ksovreli

(540)

**ბიფილაქტი**  
**Бифилакт**  
**Bifilact**

(591) Black-white  
 (511) 5

(260) AM 2022 116216 A  
 (210) AM 116216  
 (220) 2022 01 14  
 (731) LTD "G M Pharmaceuticals"  
 Rustavi Highway 52, 0114, Tbilisi, Georgia  
 (740) Nugzar Ksovreli  
 (540)

**გერდჰილი**  
**Гердхил**  
**Gerdheal**

(591) Black-white  
 (511) 5

(260) AM 2022 116217 A  
 (210) AM 116217  
 (220) 2022 01 14  
 (731) LTD "G M Pharmaceuticals"  
 Rustavi Highway 52, 0114, Tbilisi, Georgia  
 (740) Nugzar Ksovreli  
 (540)

**რეფლუსტოპი**  
**Рефлюстоп**  
**Reflustop**

(591) Black-white  
 (511) 5

(260) AM 2022 116218 A  
 (210) AM 116218  
 (220) 2022 01 14  
 (731) LTD "G M Pharmaceuticals"  
 Rustavi Highway 52, 0114, Tbilisi, Georgia  
 (740) Nugzar Ksovreli  
 (540)

**ლიპოკარდი**  
**LIPOCARD**  
**ЛИПОКАРД**

(591) Black-white  
 (511) 5

(260) AM 2022 116219 A  
 (210) AM 116219  
 (220) 2022 01 14  
 (731) LTD "G M Pharmaceuticals"  
 Rustavi Highway 52, 0114, Tbilisi, Georgia  
 (740) Nugzar Ksovreli  
 (540)

ელექსაბან  
 Эликсабан  
 Elixaban

(591) Black-white  
 (511) 5

(260) AM 2022 116305 A  
 (210) AM 116305  
 (220) 2022 01 21  
 (731) LTD "Aspharma – Georgian Pharmaceutical  
 Company"  
 Mtskheta St. 8, 0179, Tbilisi, Georgia  
 (540)

АМРЕСОР  
 АМПЕКОР  
 ამპეკორი

(591) Black-white  
 (511) 5

(260) AM 2022 116306 A  
 (210) AM 116306  
 (220) 2022 01 21  
 (731) LTD "Aspharma – Georgian Pharmaceutical  
 Company"  
 Mtskheta St. 8, 0179, Tbilisi, Georgia  
 (540)

Dilutix  
 Дилютикс  
 დილუტიქსი

(591) Black-white  
 (511) 5

(260) AM 2022 116309 A  
 (210) AM 116309  
 (220) 2022 01 24  
 (731) LTD "Senso Vita Pharmacy"  
 Akaki Beliashvili St. 43, 0159, Tbilisi,  
 Georgia  
 (540)

DECAFEROL

(591) Black-white  
 (511) 5

(260) AM 2022 116310 A  
 (210) AM 116310  
 (220) 2022 01 24  
 (731) LTD "Senso Vita Pharmacy"  
 Akaki Beliashvili St. 43, 0159, Tbilisi,  
 Georgia  
 (540)

COLLIPTUS

(591) Black-white  
 (511) 5

(260) AM 2022 116311 A  
 (210) AM 116311  
 (220) 2022 01 24  
 (731) LTD "Senso Vita Pharmacy"  
 Akaki Beliashvili St. 43, 0159, Tbilisi,  
 Georgia  
 (540)

BETINAPAN

(591) Black-white  
 (511) 5

(260) AM 2022 116312 A  
 (210) AM 116312  
 (220) 2022 01 24  
 (731) LTD "Senso Vita Pharmacy"  
 Akaki Beliashvili St. 43, 0159, Tbilisi,  
 Georgia  
 (540)

LARGOSID

(591) Black-white  
 (511) 5

(260) AM 2022 116319 A  
 (210) AM 116319  
 (220) 2022 01 25  
 (731) LLC "Wellington"  
 Navtlughi St. 82, 0108, Isani District, Tbilisi,  
 Georgia  
 (540)

ლუდისა  
 LUDISA  
 ЛУДИСА

(591) Black-white  
 (511) 29

(260) AM 2022 116320 A  
 (210) AM 116320  
 (220) 2022 01 25  
 (731) LLC "Wellington"  
 Navtlughi St. 82, 0108, Isani District, Tbilisi,  
 Georgia  
 (540)

**პოპს**  
**POPs**  
**Попс**

(591) Black-white  
 (511) 29

(260) AM 2022 116326 A  
 (210) AM 116326  
 (220) 2022 01 26  
 (731) Hu Aijun  
 Xinjiang Uygur Autonomous Region, Urumqi  
 City District, Tianshan District, Yan'an Road,  
 No. 662, "Bianjiang" ("Border") Hotel, line 6,  
 floor 4, room No. 6401, Public Republic of  
 China  
 (740) Giorgi Taktakishvili  
 (540)

**PKAS**

(591) Black-white  
 (511) 35

(260) AM 2022 116329 A  
 (210) AM 116329  
 (220) 2022 01 26  
 (731) LTD "MS Group"  
 Chirnakhuli St. 4, 0151, Tbilisi, Georgia  
 (540)

  
**მე მს ჯგუფი**  
**MS GROUP**

(591) Red, brown  
 (531) 26.03.23; 26.11.03; 26.11.08; 26.11.11;  
 29.01.12  
 (511) 35

(260) AM 2022 116330 A  
 (210) AM 116330  
 (220) 2022 01 26  
 (731) LLC "Biopolus"  
 I. Noneshvili St. 65, Batumi, Georgia

(740) Monika Kvaratskhelia  
 (540)

**Contryvita**  
**Контривита**  
**კონტრივიტა**

(591) Black-white  
 (511) 5

(260) AM 2022 116402 A  
 (210) AM 116402  
 (220) 2022 01 31  
 (731) Public Joint Stok Company "Gazprom Neft"  
 Ul. Pochtamtskaya, Dom. 3-5, Liter A,  
 Ch. Pomeschenie 1n, Kabinet 2401,  
 St. Petersburg, 190000, the Russian Federation  
 (740) Tamaz Shilakadze  
 (540)

**ჯი-პროფი სერვისი**

(591) Black-white  
 (511) 1, 4, 16, 25, 35, 37, 41

(260) AM 2022 116405 A  
 (210) AM 116405  
 (220) 2022 01 31  
 (731) Public Joint Stok Company "Gazprom Neft"  
 Ul. Pochtamtskaya, Dom. 3-5, Liter A,  
 Ch. Pomeschenie 1n, Kabinet 2401,  
 St. Petersburg, 190000, the Russian Federation  
 (740) Tamaz Shilakadze  
 (540)

**ენერჯი სერვისი**

(591) Black-white  
 (511) 1, 4, 16, 25, 35, 37, 41

(260) AM 2022 116407 A  
 (210) AM 116407  
 (220) 2022 01 31  
 (731) LLC "Multiverse"  
 Merab Kostava St. 59, Tbilisi, Georgia  
 (540)



(591) Black-white

(531) 26.04.02; 26.04.22; 26.04.24; 27.05.01;  
27.05.24  
(511) 9, 36

(260) AM 2022 116408 A  
(210) AM 116408  
(220) 2022 01 31  
(731) JSC "Progress Energy Group"  
M. Tamarashvili St. 130, app. 227, 0177,  
Tbilisi, Georgia  
(540)



(591) Turquoise, lilac, green, black, white  
(531) 26.11.03; 26.11.05; 26.11.06; 26.11.09;  
28.19; 29.01.14  
(511) 40

(260) AM 2022 116413 A  
(210) AM 116413  
(220) 2022 02 01  
(731) Alkaloid AD Skopje  
Blvd. Aleksandar Makedonski 12, Skopje,  
1000, The Republic of North Macedonia  
(740) Shalva Gvaramadze  
(540)

**MAZENID**

(591) Black-white  
(511) 5

(260) AM 2022 116435 A  
(210) AM 116435  
(220) 2022 02 03  
(731) LLC "Biopolus"  
Noneshvili St. 65, Batumi, Georgia  
(740) Monika Kvaratskhelia  
(540)

**ბიოესცინო**  
**Биоэцин**  
**Bioescin**

(591) Black-white  
(511) 5

(260) AM 2022 116528 A  
(210) AM 116528  
(220) 2022 02 08  
(731) LTD "Formula"  
Adam Mitskevich St. 29, Tbilisi, Georgia

(540)



(591) FFFFFFF white, B92333 red, 182C62 blue,  
947C68 brown  
(531) 01.01.02; 01.01.10; 26.11.03; 26.11.05;  
27.05.01; 27.05.11; 29.01.13  
(511) 41

(260) AM 2022 116542 A  
(210) AM 116542  
(220) 2022 02 09  
(731) LTD "Automoby"  
M. and A. Balanchivadze's St. 51, app. 51,  
0171, Tbilisi, Georgia  
(540)



(591) White, blue, yellow, green  
(531) 27.05.01; 27.05.11; 29.01.13  
(511) 35, 36, 39

(260) AM 2022 116552 A  
(210) AM 116552  
(220) 2022 02 10  
(731) Philip Morris Products S.A.  
Quai Jeanrenaud 3, Neuchâtel, 2000 Switzerland  
(740) Pavle Meipariani  
(540)

**L & M LOFT XL FIRST CUT  
BLUE**

(591) Black-white  
(511) 34

(260) AM 2022 117318 A  
(210) AM 117318  
(220) 2022 04 07  
(731) LTD "Formula"  
Adam Mitskevich St. 29, Tbilisi, Georgia  
(540)



(591) 947C68 brown, 182C62 blue  
B92333 red, FFFFFFF white  
(531) 01.01.02; 01.01.10; 26.11.03; 26.11.05;  
27.05.01; 27.05.11; 29.01.13  
(511) 41

**REGISTERED TRADEMARKS**

(111) M 2022 35803 R  
(151) 2022 08 16  
(181) 2032 08 16  
(260) AM 2021 111398 A  
(220) 2021 06 03

(732) LTD "Georgian Legend"  
Irakli Abashidze St. 70, Ent. 3, app. 118, 0162,  
Tbilisi, Georgia

---

(111) M 2022 35804 R  
(151) 2022 08 16  
(181) 2032 08 16  
(260) AM 2021 111399 A  
(220) 2021 06 03

(732) LTD "Georgian Legend"  
Irakli Abashidze St. 70, Ent. 3, app. 118, 0162,  
Tbilisi, Georgia

---

(111) M 2022 35805 R  
(151) 2022 08 16  
(181) 2032 08 16  
(260) AM 2021 111400 A  
(220) 2021 06 03

(732) LTD "Georgian Legend"  
Irakli Abashidze St. 70, Ent. 3, app. 118, 0162,  
Tbilisi, Georgia

---

(111) M 2022 35806 R  
(151) 2022 08 16  
(181) 2032 08 16  
(260) AM 2021 112167 A  
(220) 2021 08 11

(732) LLC "NGT Rokit Solutions"  
Zhiuli Shartava St. 40, 0160, Saburtalo  
District, Tbilisi, Georgia

---

(111) M 2022 35807 R  
(151) 2022 08 16  
(181) 2032 08 16  
(260) AM 2021 112278 A  
(220) 2021 05 17

(732) JSC "Phubber"  
D. Aghmashenebeli Av. 55/1, Tbilisi, Georgia

---

(111) M 2022 35808 R  
(151) 2022 08 16  
(181) 2032 08 16  
(260) AM 2021 112668 A  
(220) 2021 04 16

(732) LTD "Bolero & Company"  
Kuchishvili St. 12-14-16, 0179, Tbilisi, Georgia

---

(111) M 2022 35809 R  
(151) 2022 08 16  
(181) 2032 08 16  
(260) AM 2021 112698 A  
(220) 2021 04 21

(732) Posco International Corporation  
134 Teheran-ro, Gangnam-gu, Seoul,  
Republic of Korea

---

(111) M 2022 35810 R  
(151) 2022 08 16  
(181) 2032 08 16  
(260) AM 2021 112699 A  
(220) 2021 04 21

(732) Posco International Corporation  
134 Teheran-ro, Gangnam-gu, Seoul,  
Republic of Korea

---

(111) M 2022 35811 R  
(151) 2022 08 16  
(181) 2032 08 16  
(260) AM 2021 113260 A  
(220) 2021 07 08

(732) N(N)LE "Internews-Georgia"  
Paolo Iashvili St. 14/22, Tbilisi, Georgia

---

(111) M 2022 35812 R  
(151) 2022 08 16  
(181) 2032 08 16  
(260) AM 2021 113261 A  
(220) 2021 07 08

(732) N(N)LE "Internews-Georgia"  
Paolo Iashvili St. 14/22, Tbilisi, Georgia

---

(111) M 2022 35813 R  
(151) 2022 08 16  
(181) 2032 08 16  
(260) AM 2021 113275 A  
(220) 2021 06 03

(732) LTD "Fidelio"  
Vakhtang Gorgasali St. 37, app. 32, 0114,  
Tbilisi Georgia

---

---

(111) M 2022 35814 R (151) 2022 08 16 (181) 2032 08 16 (260) AM 2021 113283 A (220) 2021 06 03 (732) ) LTD "Tertmeti" Mtskheta St. 40a, Benchmark 23.10, Vake-Saburtalo District, Tbilisi, Georgia	(220) 2021 06 06 (732) Tamar Peikrishvili Nutsubidze St. 77, app. 8, 0186, Tbilisi, Georgia
(111) M 2022 35815 R (151) 2022 08 16 (181) 2032 08 16 (260) AM 2021 113335 A (220) 2021 06 04 (732) LTD "Hotels Management Group – HMG" Didveli, 1200, Bakuriani, Georgia	(111) M 2022 35821 R (151) 2022 08 16 (181) 2032 08 16 (260) AM 2021 113427 A (220) 2021 06 10 (732) Posco International Corporation 134 Teheran-ro, Gangnam-gu, Seoul, Republic of Korea
(111) M 2022 35816 R (151) 2022 08 16 (181) 2032 08 16 (260) AM 2021 113336 A (220) 2021 06 04 (732) LTD "Hotels Management Group – HMG" Didveli, 1200, Bakuriani, Georgia	(111) M 2022 35822 R (151) 2022 08 16 (181) 2032 08 16 (260) AM 2021 113428 A (220) 2021 06 10 (732) Posco International Corporation 134 Teheran-ro, Gangnam-gu, Seoul, Republic of Korea
(111) M 2022 35817 R (151) 2022 08 16 (181) 2032 08 16 (260) AM 2021 113354 A (220) 2021 06 04 (732) Lasha Bitsadze Akaki Tsereteli Av. 91, app. 56, Tbilisi, Georgia	(111) M 2022 35823 R (151) 2022 08 16 (181) 2032 08 16 (260) AM 2021 113511 A (220) 2021 06 16 (732) LTD "Gurila" Shalva Nutsubidze St. 56 / Vazha-Pshavela Av., I qu., bld. 17, app. 82, Tbilisi, Georgia
(111) M 2022 35818 R (151) 2022 08 16 (181) 2032 08 16 (260) AM 2021 113375 A (220) 2021 06 06 (732) Giorgi Galdavadze Tsoetne Dadiani Str. 21/23, 0101, Tbilisi, Georgia	(111) M 2022 35824 R (151) 2022 08 16 (181) 2032 08 16 (260) AM 2021 113512 A (220) 2021 06 16 (732) LTD "Gurila" Shalva Nutsubidze St. 56 / Vazha-Pshavela Av., I qu., bld. 17, app. 82, Tbilisi, Georgia
(111) M 2022 35819 R (151) 2022 08 16 (181) 2032 08 16 (260) AM 2021 113378 A (220) 2021 06 06 (732) Tamar Peikrishvili Nutsubidze St. 77, app. 8, 0186, Tbilisi, Georgia	(111) M 2022 35825 R (151) 2022 08 16 (181) 2032 08 16 (260) AM 2021 113515 A (220) 2021 06 16 (732) LTD "Gurila" Shalva Nutsubidze St. 56 / Vazha-Pshavela Av., I qu., bld. 17, app. 82, Tbilisi, Georgia
(111) M 2022 35820 R (151) 2022 08 16 (181) 2032 08 16 (260) AM 2021 113379 A	(111) M 2022 35826 R (151) 2022 08 16 (181) 2032 08 16 (260) AM 2021 113518 A (220) 2021 06 17

---



(732) J&B Limited  
3rd Floor, Yamraj Building, Market Square,  
P.O. Box 3175, Road Town, Tortola, Virgin  
Islands (British)

---

(111) M 2022 35827 R  
(151) 2022 08 16  
(181) 2032 08 16  
(260) AM 2021 113584 A  
(220) 2021 06 18  
(732) Burn to Give SpA  
Miguel Claro 195 of. 806, Providencia,  
Santiago de Chile, Chile

---

(111) M 2022 35828 R  
(151) 2022 08 16  
(181) 2032 08 16  
(260) AM 2021 113609 A  
(220) 2021 06 23  
(732) LTD "Salo"  
Ivane Javakhishvili St. 59, Tetrtskaro, Georgia

---

(111) M 2022 35829 R  
(151) 2022 08 16  
(181) 2032 08 16  
(260) AM 2021 113617 A  
(220) 2021 06 24  
(732) Asia Symbol China Holdings Limited  
21/F, China Building, No. 29 Queen's Road  
Central, Hong Kong

---

(111) M 2022 35830 R  
(151) 2022 08 16  
(181) 2032 08 16  
(260) AM 2021 113699 A  
(220) 2021 06 30  
(732) LTD "Kerki"  
Vill. Dzentsmani, Keda, Georgia

---

(111) M 2022 35831 R  
(151) 2022 08 16  
(181) 2032 08 16  
(260) AM 2021 113848 A  
(220) 2021 07 11  
(732) LTD "Ninea"  
Nino Zhvania St. 28, app. 1, Tbilisi, Georgia

---

(111) M 2022 35832 R  
(151) 2022 08 16  
(181) 2032 08 16  
(260) AM 2021 113873 A  
(220) 2021 07 15

(732) Khairat Al Minafie CO for Transport and  
General Trading LTD  
27, Boulevard Saborni, Varna, 9000, Bulgaria

---

(111) M 2022 35833 R  
(151) 2022 08 16  
(181) 2032 08 16  
(260) AM 2021 113994 A  
(220) 2021 07 21  
(732) Aleksandre Bolkvadze  
Paliashvili St. 66, app. 51, 0179, Tbilisi, Georgia

---

(111) M 2022 35834 R  
(151) 2022 08 16  
(181) 2032 08 16  
(260) AM 2021 113995 A  
(220) 2021 07 21  
(732) Aleksandre Bolkvadze  
Z. Paliashvili St. 66, app. 51, 0179, Tbilisi,  
Georgia

---

(111) M 2022 35835 R  
(151) 2022 08 16  
(181) 2032 08 16  
(260) AM 2021 113996 A  
(220) 2021 07 21  
(732) Aleksandre Bolkvadze  
Z. Paliashvili St. 66, app. 51, 0179, Tbilisi,  
Georgia

---

(111) M 2022 35836 R  
(151) 2022 08 16  
(181) 2032 08 16  
(260) AM 2021 113997 A  
(220) 2021 07 21  
(732) Aleksandre Bolkvadze  
Z. Paliashvili St. 66, app. 51, 0179, Tbilisi,  
Georgia

---

(111) M 2022 35837 R  
(151) 2022 08 16  
(181) 2032 08 16  
(260) AM 2021 113998 A  
(220) 2021 07 21  
(732) Aleksandre Bolkvadze  
Z. Paliashvili St. 66, app. 51, 0179, Tbilisi,  
Georgia

---

(111) M 2022 35838 R  
(151) 2022 08 16  
(181) 2032 08 16  
(260) AM 2021 114137 A  
(220) 2021 08 02

(732) LTD "Talisman"  
Niko Tskhvedadze St. 28, 0162, Tbilisi, Georgia

---

(111) M 2022 35839 R  
(151) 2022 08 16  
(181) 2032 08 16  
(260) AM 2021 114138 A  
(220) 2021 08 02  
(732) LTD "Talisman"  
Niko Tskhvedadze St. 28, 0162, Tbilisi, Georgia

---

(111) M 2022 35840 R  
(151) 2022 08 16  
(181) 2032 08 16  
(260) AM 2021 114141 A  
(220) 2021 08 02  
(732) LTD "Gurilla"  
Shalva Nutsbidze St. 56/Vazha-Pshavela Av.,  
I qu., bld. 17, app. 82, Tbilisi, Georgia

---

(111) M 2022 35841 R  
(151) 2022 08 16  
(181) 2032 08 16  
(260) AM 2021 114223 A  
(220) 2021 08 10  
(732) LTD "Iveriapharma"  
Zona "B", Cottage7, 0181, Tskneti, Tbilisi,  
Georgia

---

(111) M 2022 35842 R  
(151) 2022 08 16  
(181) 2032 08 16  
(260) AM 2021 114324 A  
(220) 2021 08 17  
(732) Reckitt & Colman (Overseas) Health Limited  
103-105 Bath Road, Slough, Berkshire,  
SL1 3UH, United Kingdom

---

(111) M 2022 35843 R  
(151) 2022 08 16  
(181) 2032 08 16  
(260) AM 2021 114325 A  
(220) 2021 08 17  
(732) Vivo Mobile Communication Co., LTD  
Dongguan, Changani, Vivo Road N1,  
Guangdong, 0100, People's Republic of  
China

---

(111) M 2022 35844 R  
(151) 2022 08 16  
(181) 2032 08 16  
(260) AM 2021 114326 A  
(220) 2021 08 17

(732) Vivo Mobile Communication Co., LTD  
Dongguan, Changani, Vivo Road N1,  
Guangdong, 0100, People's Republic of China

---

(111) M 2022 35845 R  
(151) 2022 08 16  
(181) 2032 08 16  
(260) AM 2021 114337 A  
(220) 2021 08 18  
(732) The Procter & Gamble Company  
One Procter & Gamble Plaza, Cincinnati,  
Ohio 45202, USA

---

(111) M 2022 35846 R  
(151) 2022 08 16  
(181) 2032 08 16  
(260) AM 2021 114413 A  
(220) 2021 08 25  
(732) Private Joint-Stock Company "MHP"  
vul. Elevatorna 1, Myronivka, Kyivska obl.,  
08800, Ukraine

---

(111) M 2022 35847 R  
(151) 2022 08 16  
(181) 2032 08 16  
(260) AM 2021 114531 A  
(220) 2021 09 03  
(732) LTD "Lerto"  
Aleksandre Kazbegi Ave. 11a, app. 21, 0160,  
Saburtalo District, Tbilisi, Georgia

---

(111) M 2022 35848 R  
(151) 2022 08 16  
(181) 2032 08 16  
(260) AM 2021 114534 A  
(220) 2021 09 06  
(732) Toyota Jidosha Kabushiki Kaisha  
(also trading as Toyota Motor Corporation)  
1, Toyota-cho, Toyota-shi, Aichi-ken, Japan

---

(111) M 2022 35849 R  
(151) 2022 08 16  
(181) 2032 08 16  
(260) AM 2021 114539 A  
(220) 2021 09 07  
(732) Toyota Jidosha Kabushiki Kaisha  
(also trading as Toyota Motor Corporation)  
1, Toyota-cho, Toyota-shi, Aichi-ken, Japan

---

(111) M 2022 35850 R  
(151) 2022 08 16  
(181) 2032 08 16  
(260) AM 2021 114544 A

(220) 2021 09 09  
(732) INPHA LLP Representative Office in Georgia  
Nearby of Besiki St. 4, plot 46/10, 0108,  
Tbilisi, Georgia

---

(111) M 2022 35851 R  
(151) 2022 08 16  
(181) 2032 08 16  
(260) AM 2021 114546 A  
(220) 2021 09 09  
(732) LTD "Khairat al Minafie Co for Transport and  
General Trading"  
27 Boulevard Saborni, Varna, 9000, Bulgaria

---

(111) M 2022 35852 R  
(151) 2022 08 16  
(181) 2032 08 16  
(260) AM 2021 114590 A  
(220) 2021 09 10  
(732) Limited Liability Company "Georgian Natural  
Gas Transmission Network Owner"  
Kakheti Highway 21, 0190, Tbilisi, Georgia

---

(111) M 2022 35853 R  
(151) 2022 08 16  
(181) 2032 08 16  
(260) AM 2021 114609 A  
(220) 2021 09 14  
(732) Tp-Link Corporation Limited  
Room 901, 9/F., New East Ocean Centre,  
9 Science Museum Road, Tsim Sha Tsui,  
Kowloon, Hong Kong

---

(111) M 2022 35854 R  
(151) 2022 08 16  
(181) 2032 08 16  
(260) AM 2021 114611 A  
(220) 2021 09 15  
(732) LTD "Anbani"  
Shota Rustaveli Av. 52a, 0108, Tbilisi, Georgia

---

(111) M 2022 35855 R  
(151) 2022 08 16  
(181) 2032 08 16  
(260) AM 2021 114617 A  
(220) 2021 09 16  
(732) Novartis AG  
4002 Basel, Switzerland

---

(111) M 2022 35856 R  
(151) 2022 08 16  
(181) 2032 08 16  
(260) AM 2021 114618 A  
(220) 2021 09 16

(732) Novartis AG  
4002 Basel, Switzerland

---

(111) M 2022 35857 R  
(151) 2022 08 16  
(181) 2032 08 16  
(260) AM 2021 114677 A  
(220) 2021 09 17  
(732) Giorgi Gamsakhurdia  
Davit Aghmashenebeli Str. 32, Kvareli, Georgia

---

(111) M 2022 35858 R  
(151) 2022 08 16  
(181) 2032 08 16  
(260) AM 2021 114742 A  
(220) 2021 09 27  
(732) Colgate-Palmolive Company  
Delaware Corporation  
300 Park Avenue, New York, NY 10022, USA

---

(111) M 2022 35859 R  
(151) 2022 08 16  
(181) 2032 08 16  
(260) AM 2021 114743 A  
(220) 2021 09 27  
(732) Gilead Sciences Inc.  
a Delaware corporation  
333 Lakeside Drive, Foster City, CA 94404,  
USA

---

(111) M 2022 35860 R  
(151) 2022 08 16  
(181) 2032 08 16  
(260) AM 2021 114806 A  
(220) 2021 10 05  
(732) Elene Malvenishvili  
Kavkasioni St. 53, Telavi, Georgia;  
Mamuka Baghnashvili  
Osip Mandelshtam St. 8, app. 13, Tbilisi,  
Georgia

---

(111) M 2022 35861 R  
(151) 2022 08 16  
(181) 2032 08 16  
(260) AM 2021 114904 A  
(220) 2021 10 08  
(732) LTD "Rock"  
Ketevan Tsamebuli Ave, vis-a-vis to 91, 0144,  
Tbilisi, Georgia

---

(111) M 2022 35862 R  
(151) 2022 08 16  
(181) 2032 08 16  
(260) AM 2021 114050 A

(220) 2021 07 28  
(732) LTD "Barbarestan"  
Vazha-Pshavela Av., III qu., bld. 10, app. 60,  
Tbilisi, Georgia

---

(111) M 2022 35863 R  
(151) 2022 08 16  
(181) 2032 08 16  
(260) AM 2021 114794 A  
(220) 2021 10 01  
(732) LTD "G-T Motors"  
David Aghmashenebeli Alley 155, 0131,  
Saburtalo District, Tbilisi, Georgia

---

(111) M 2022 35864 R  
(151) 2022 08 16  
(181) 2032 08 16  
(260) AM 2021 114809 A  
(220) 2021 10 06  
(732) LTD "Avaza"  
Z. Gorgiladze St. 2. app. 29, 8010, Batumi,  
Georgia

---

(111) M 2022 35865 R  
(151) 2022 08 16  
(181) 2032 08 16  
(260) AM 2021 114810 A  
(220) 2021 10 06  
(732) LTD "Avaza"  
Z. Gorgiladze St. 2. app. 29, 8010, Batumi,  
Georgia

---

(111) M 2022 35866 R  
(151) 2022 08 16  
(181) 2032 08 16  
(260) AM 2021 115015 A  
(220) 2021 10 21  
(732) BTC Media LLC  
438 Houston St., No. 257, Nashville, Tennessee,  
37203, USA

---

(111) M 2022 35867 R  
(151) 2022 08 16  
(181) 2032 08 16  
(260) AM 2021 115016 A  
(220) 2021 10 21  
(732) BTC Media LLC  
438 Houston St., No. 257, Nashville, Tennessee,  
37203, USA

---

## TRADEMARKS REGISTERED ACCORDING TO THE ACCELERATED PROCEDURE

The decision can be appealed at the Chamber of Appeal of Sakpatenti within 3 months from the publication.

(111) M 2022 35746 R  
(151) 2022 08 09  
(181) 2032 08 09  
(210) AM 118484  
(220) 2022 07 10  
(732) Philip Morris Brands Sàrl  
Quai Jeanrenaud 3, 2000, Neuchâtel,  
Switzerland  
(740) Pavle Meipariani  
(540)

**პარლამენტი**

(591) Black-white  
(511) 34

(220) 2022 07 29  
(732) JSC "ProCredit Bank"  
Al. Kazbegi Av. 21, 0160, Saburtalo District,  
Tbilisi, Georgia  
(740) Zurab Bezhashvili;  
Lia Shikhiashvili;  
Ioane Iarajuli  
(540)

**უკვანდა**

(591) White, dark green  
(531) 28.19; 29.01.03  
(511) 36

(111) M 2022 35747 R  
(151) 2022 08 09  
(181) 2032 08 09  
(210) AM 118485  
(220) 2022 07 10  
(732) Philip Morris Brands Sàrl  
Quai Jeanrenaud 3, 2000, Neuchâtel,  
Switzerland  
(740) Pavle Meipariani  
(540)

**ფილიპ მორისი**

(591) Black-white  
(511) 34

(111) M 2022 35750 R  
(151) 2022 08 09  
(181) 2032 08 09  
(210) AM 118482  
(220) 2022 07 10  
(732) Philip Morris Brands Sàrl  
Quai Jeanrenaud 3, 2000, Neuchâtel,  
Switzerland  
(740) Pavle Meipariani  
(540)

**მალბორო**

(591) Black-white  
(511) 34

(111) M 2022 35748 R  
(151) 2022 08 09  
(181) 2032 08 09  
(210) AM 118486  
(220) 2022 07 10  
(732) Philip Morris Brands Sàrl  
Quai Jeanrenaud 3, 2000, Neuchâtel,  
Switzerland  
(740) Pavle Meipariani  
(540)

**კარატი**

(591) Black-white  
(511) 34

(111) M 2022 35751 R  
(151) 2022 08 09  
(181) 2032 08 09  
(210) AM 118480  
(220) 2022 07 10  
(732) Philip Morris Brands Sàrl  
Quai Jeanrenaud 3, 2000, Neuchâtel,  
Switzerland  
(740) Pavle Meipariani  
(540)

**ჰიტსი**

(591) Black-white  
(511) 34

(111) M 2022 35749 R  
(151) 2022 08 09  
(181) 2032 08 09  
(210) AM 118829

(111) M 2022 35752 R  
(151) 2022 08 09  
(181) 2032 08 09  
(210) AM 118481  
(220) 2022 07 10

(732) Philip Morris Brands Sàrl  
 Quai Jeanrenaud 3, 2000, Neuchâtel,  
 Switzerland  
 (740) Pavle Meipariani  
 (540)

**მ & მ**

(591) Black-white  
 (511) 34

(111) M 2022 35753 R  
 (151) 2022 08 09  
 (181) 2032 08 09  
 (210) AM 118489  
 (220) 2022 07 10  
 (732) Philip Morris Brands Sàrl  
 Quai Jeanrenaud 3, 2000, Neuchâtel,  
 Switzerland  
 (740) Pavle Meipariani  
 (540)

**რასეტი**

(591) Black-white  
 (511) 34

(111) M 2022 35754 R  
 (151) 2022 08 09  
 (181) 2032 08 09  
 (210) AM 118487  
 (220) 2022 07 10  
 (732) Philip Morris Brands Sàrl  
 Quai Jeanrenaud 3, 2000, Neuchâtel,  
 Switzerland  
 (740) Pavle Meipariani  
 (540)

**ფარფლ ვეივი**

(591) Black-white  
 (511) 34

(111) M 2022 35755 R  
 (151) 2022 08 09  
 (181) 2032 08 09  
 (210) AM 118491  
 (220) 2022 07 10  
 (732) Philip Morris Brands Sàrl  
 Quai Jeanrenaud 3, 2000, Neuchâtel,  
 Switzerland  
 (740) Pavle Meipariani  
 (540)

**ვისტა სამერი**

(591) Black-white  
 (511) 34

(111) M 2022 35756 R  
 (151) 2022 08 09  
 (181) 2032 08 09  
 (210) AM 118921  
 (220) 2022 08 08  
 (732) LTD "Mon Chou"  
 Zakaria Paliashvili St. 23, Entr. 1,  
 app. 1, Fl. 1-2, Vake District, Tbilisi, Georgia  
 (540)



(591) Red, white, black  
 (531) 01.15.11; 21.01.16; 27.05.02; 29.01.12  
 (554) Three Dimensional  
 (511) 24, 25, 28, 41

(111) M 2022 35757 R  
 (151) 2022 08 10  
 (181) 2032 08 10  
 (210) AM 118528  
 (220) 2022 07 11  
 (732) Philip Morris Brands Sàrl  
 Quai Jeanrenaud 3, 2000, Neuchâtel,  
 Switzerland  
 (740) Pavle Meipariani  
 (540)

**ტერეა თურქოიზი**

(591) Black-white  
 (511) 34

(111) M 2022 35758 R  
 (151) 2022 08 10  
 (181) 2032 08 10  
 (210) AM 118529  
 (220) 2022 07 11  
 (732) Philip Morris Brands Sàrl  
 Quai Jeanrenaud 3, 2000, Neuchâtel,  
 Switzerland  
 (740) Pavle Meipariani  
 (540)

**ტერეა იელოუ**

(591) Black-white  
 (511) 34

(111) M 2022 35759 R  
 (151) 2022 08 10  
 (181) 2032 08 10  
 (210) AM 118828

(220) 2022 07 29  
 (732) Tamaz Bekauri  
 Otar Oniashvili St. 89, app. 2, 0160, Tbilisi,  
 Georgia  
 (740) Zurab Bezhashvili;  
 Ioane Iarajuli;  
 Lia Shikhiashvili  
 (540)



CHATEAU  
KVETERA

(591) White, golden  
 (531) 07.01.01; 26.04.09; 26.05.02; 26.05.11;  
 27.05.01; 27.05.10; 29.01.12  
 (526) KVETERA  
 (511) 33

(111) M 2022 35760 R  
 (151) 2022 08 10  
 (181) 2032 08 10  
 (210) AM 118515  
 (220) 2022 07 11  
 (732) Philip Morris Brands Sàrl  
 Quai Jeanrenaud 3, 2000, Neuchâtel,  
 Switzerland  
 (740) Pavle Meipariani  
 (540)

**ლ & მ ბლუ ლეიბლი**

(591) Black-white  
 (511) 34

(111) M 2022 35761 R  
 (151) 2022 08 10  
 (181) 2032 08 10  
 (210) AM 118516  
 (220) 2022 07 11  
 (732) Philip Morris Brands Sàrl  
 Quai Jeanrenaud 3, 2000, Neuchâtel,  
 Switzerland  
 (740) Pavle Meipariani  
 (540)

**ლ & მ რედი**

(591) Black-white  
 (511) 34

(111) M 2022 35762 R  
 (151) 2022 08 10  
 (181) 2032 08 10  
 (210) AM 118517  
 (220) 2022 07 11  
 (732) Philip Morris Brands Sàrl  
 Quai Jeanrenaud 3, 2000, Neuchâtel,  
 Switzerland  
 (740) Pavle Meipariani  
 (540)

**ლ & მ რედ ლეიბლი**

(591) Black-white  
 (511) 34

(111) M 2022 35763 R  
 (151) 2022 08 10  
 (181) 2032 08 10  
 (210) AM 118518  
 (220) 2022 07 11  
 (732) Philip Morris Brands Sàrl  
 Quai Jeanrenaud 3, 2000, Neuchâtel,  
 Switzerland  
 (740) Pavle Meipariani  
 (540)

**ჰიტს ამბერ სელექშენი**

(591) Black-white  
 (511) 34

(111) M 2022 35764 R  
 (151) 2022 08 10  
 (181) 2032 08 10  
 (210) AM 118519  
 (220) 2022 07 11  
 (732) Philip Morris Brands Sàrl  
 Quai Jeanrenaud 3, 2000, Neuchâtel,  
 Switzerland  
 (740) Pavle Meipariani  
 (540)

**ჰიტს რასეტ სელექშენი**

(591) Black-white  
 (511) 34

(111) M 2022 35765 R  
 (151) 2022 08 10  
 (181) 2032 08 10  
 (210) AM 118520  
 (220) 2022 07 11  
 (732) Philip Morris Brands Sàrl  
 Quai Jeanrenaud 3, 2000, Neuchâtel,  
 Switzerland  
 (740) Pavle Meipariani

(540)

**ჰითს სიენა სელექშენი**

(591) Black-white

(511) 34

(111) M 2022 35766 R

(151) 2022 08 10

(181) 2032 08 10

(210) AM 118495

(220) 2022 07 11

(732) Philip Morris Brands Sàrl

Quai Jeanrenaud 3, 2000, Neuchâtel,

Switzerland

(740) Pavle Meipariani

(540)

**პარლამენტ ნაით ბლუ**

(591) Black-white

(511) 34

(111) M 2022 35767 R

(151) 2022 08 10

(181) 2032 08 10

(210) AM 118496

(220) 2022 07 11

(732) Philip Morris Brands Sàrl

Quai Jeanrenaud 3, 2000, Neuchâtel,

Switzerland

(740) Pavle Meipariani

(540)

**ნური**

(591) Black-white

(511) 34

(111) M 2022 35768 R

(151) 2022 08 10

(181) 2032 08 10

(210) AM 118497

(220) 2022 07 11

(732) Philip Morris Brands Sàrl

Quai Jeanrenaud 3, 2000, Neuchâtel,

Switzerland

(740) Pavle Meipariani

(540)

**სიენა**

(591) Black-white

(511) 34

(111) M 2022 35769 R

(151) 2022 08 10

(181) 2032 08 10

(210) AM 118498

(220) 2022 07 11

(732) Philip Morris Brands Sàrl

Quai Jeanrenaud 3, 2000, Neuchâtel,

Switzerland

(740) Pavle Meipariani

(540)

**იუგენი**

(591) Black-white

(511) 34

(111) M 2022 35770 R

(151) 2022 08 10

(181) 2032 08 10

(210) AM 118499

(220) 2022 07 11

(732) Philip Morris Brands Sàrl

Quai Jeanrenaud 3, 2000, Neuchâtel,

Switzerland

(740) Pavle Meipariani

(540)

**პარლამენტ აქვა ბლუ**

(591) Black-white

(511) 34

(111) M 2022 35771 R

(151) 2022 08 10

(181) 2032 08 10

(210) AM 118500

(220) 2022 07 11

(732) Philip Morris Brands Sàrl

Quai Jeanrenaud 3, 2000, Neuchâtel,

Switzerland

(740) Pavle Meipariani

(540)

**პარლამენტ რეზერვი**

(591) Black-white

(511) 34

(111) M 2022 35772 R

(151) 2022 08 10

(181) 2032 08 10

(210) AM 118501

(220) 2022 07 11

(732) Philip Morris Brands Sàrl

Quai Jeanrenaud 3, 2000, Neuchâtel,

Switzerland

(740) Pavle Meipariani

(540)

**პარლამენტ სლიმსი**

(591) Black-white

(511) 34



(111) M 2022 35773 R  
 (151) 2022 08 10  
 (181) 2032 08 10  
 (210) AM 118502  
 (220) 2022 07 11  
 (732) Philip Morris Brands Sàrl  
 Quai Jeanrenaud 3, 2000, Neuchâtel,  
 Switzerland  
 (740) Pavle Meipariani  
 (540)

## პარლამენტ სილვერ ბლუ

(591) Black-white  
 (511) 34

(111) M 2022 35774 R  
 (151) 2022 08 10  
 (181) 2032 08 10  
 (210) AM 118503  
 (220) 2022 07 11  
 (732) Philip Morris Brands Sàrl  
 Quai Jeanrenaud 3, 2000, Neuchâtel,  
 Switzerland  
 (740) Pavle Meipariani  
 (540)

## მალბორო ბლექ გოლდი

(591) Black-white  
 (511) 34

(111) M 2022 35775 R  
 (151) 2022 08 10  
 (181) 2032 08 10  
 (210) AM 118504  
 (220) 2022 07 11  
 (732) Philip Morris Brands Sàrl  
 Quai Jeanrenaud 3, 2000, Neuchâtel,  
 Switzerland  
 (740) Pavle Meipariani  
 (540)

## მალბორო ფლეივორი

(591) Black-white  
 (511) 34

(111) M 2022 35776 R  
 (151) 2022 08 10  
 (181) 2032 08 10  
 (210) AM 118505  
 (220) 2022 07 11  
 (732) Philip Morris Brands Sàrl  
 Quai Jeanrenaud 3, 2000, Neuchâtel,  
 Switzerland  
 (740) Pavle Meipariani  
 (540)

## მალბორო გოლდი

(591) Black-white  
 (511) 34

(111) M 2022 35777 R  
 (151) 2022 08 10  
 (181) 2032 08 10  
 (210) AM 118507  
 (220) 2022 07 11  
 (732) Philip Morris Brands Sàrl  
 Quai Jeanrenaud 3, 2000, Neuchâtel,  
 Switzerland  
 (740) Pavle Meipariani  
 (540)

## მალბორო მიკრო

(591) Black-white  
 (511) 34

(111) M 2022 35778 R  
 (151) 2022 08 10  
 (181) 2032 08 10  
 (210) AM 118508  
 (220) 2022 07 11  
 (732) Philip Morris Brands Sàrl  
 Quai Jeanrenaud 3, 2000, Neuchâtel,  
 Switzerland  
 (740) Pavle Meipariani  
 (540)

## მალბორო თაჩი

(591) Black-white  
 (511) 34

(111) M 2022 35779 R  
 (151) 2022 08 10  
 (181) 2032 08 10  
 (210) AM 118509  
 (220) 2022 07 11  
 (732) Philip Morris Brands Sàrl  
 Quai Jeanrenaud 3, 2000, Neuchâtel,  
 Switzerland  
 (740) Pavle Meipariani  
 (540)

## მალბორო რედი

(591) Black-white  
 (511) 34

(111) M 2022 35780 R  
 (151) 2022 08 10  
 (181) 2032 08 10  
 (210) AM 118510  
 (220) 2022 07 11  
 (732) Philip Morris Brands Sàrl  
 Quai Jeanrenaud 3, 2000, Neuchâtel,  
 Switzerland

(740) Pavle Meipariani  
(540)

## ფილიპ მორის ბლუ

(591) Black-white  
(511) 34

(111) M 2022 35781 R  
(151) 2022 08 10  
(181) 2032 08 10  
(210) AM 118511  
(220) 2022 07 11  
(732) Philip Morris Brands Sàrl  
Quai Jeanrenaud 3, 2000, Neuchâtel,  
Switzerland  
(740) Pavle Meipariani  
(540)

## ფილიპ მორის კომპაქტ ბლექი

(591) Black-white  
(511) 34

(111) M 2022 35782 R  
(151) 2022 08 10  
(181) 2032 08 10  
(210) AM 118512  
(220) 2022 07 11  
(732) Philip Morris Brands Sàrl  
Quai Jeanrenaud 3, 2000, Neuchâtel,  
Switzerland  
(740) Pavle Meipariani  
(540)

## ფილიპ მორის კომპაქტ ბლუ

(591) Black-white  
(511) 34

(111) M 2022 35783 R  
(151) 2022 08 10  
(181) 2032 08 10  
(210) AM 118513  
(220) 2022 07 11  
(732) Philip Morris Brands Sàrl  
Quai Jeanrenaud 3, 2000, Neuchâtel,  
Switzerland  
(740) Pavle Meipariani  
(540)

## ფილიპ მორის კომპაქტ მიქსი

(591) Black-white  
(511) 34

(111) M 2022 35784 R  
(151) 2022 08 10  
(181) 2032 08 10  
(210) AM 118514  
(220) 2022 07 11  
(732) Philip Morris Brands Sàrl  
Quai Jeanrenaud 3, 2000, Neuchâtel,  
Switzerland  
(740) Pavle Meipariani  
(540)

## ფილიპ მორის რედი

(591) Black-white  
(511) 34

(111) M 2022 35785 R  
(151) 2022 08 10  
(181) 2032 08 10  
(210) AM 118521  
(220) 2022 07 11  
(732) Philip Morris Brands Sàrl  
Quai Jeanrenaud 3, 2000, Neuchâtel,  
Switzerland  
(740) Pavle Meipariani  
(540)

## ჰიტს სილვერ სელექშენი

(591) Black-white  
(511) 34

(111) M 2022 35786 R  
(151) 2022 08 10  
(181) 2032 08 10  
(210) AM 118522  
(220) 2022 07 11  
(732) Philip Morris Brands Sàrl  
Quai Jeanrenaud 3, 2000, Neuchâtel,  
Switzerland  
(740) Pavle Meipariani  
(540)

## ჰიტს თურქოიზ სელექშენი

(591) Black-white  
(511) 34

(111) M 2022 35787 R  
(151) 2022 08 10  
(181) 2032 08 10  
(210) AM 118524  
(220) 2022 07 11

(732) Philip Morris Brands Sàrl  
Quai Jeanrenaud 3, 2000, Neuchâtel,  
Switzerland

(740) Pavle Meipariani  
(540)

## ჰიტოს იელოუ სელექშენი

(591) Black-white  
(511) 34

(111) M 2022 35788 R

(151) 2022 08 10

(181) 2032 08 10

(210) AM 118525

(220) 2022 07 11

(732) Philip Morris Brands Sàrl  
Quai Jeanrenaud 3, 2000, Neuchâtel,  
Switzerland

(740) Pavle Meipariani  
(540)

## ლ & მ ბლუ

(591) Black-white  
(511) 34

(111) M 2022 35789 R

(151) 2022 08 10

(181) 2032 08 10

(210) AM 118526

(220) 2022 07 11

(732) Philip Morris Brands Sàrl  
Quai Jeanrenaud 3, 2000, Neuchâtel,  
Switzerland

(740) Pavle Meipariani  
(540)

## ტერეა ამბერი

(591) Black-white  
(511) 34

(111) M 2022 35790 R

(151) 2022 08 10

(181) 2032 08 10

(210) AM 118527

(220) 2022 07 11

(732) Philip Morris Brands Sàrl  
Quai Jeanrenaud 3, 2000, Neuchâtel,  
Switzerland

(740) Pavle Meipariani  
(540)

## ტერეა სილვერი

(591) Black-white  
(511) 34

(111) M 2022 35791 R

(151) 2022 08 10

(181) 2032 08 10

(210) AM 118835

(220) 2022 07 31

(732) Enriko Beridze  
G. Tsitsishvili St. 18, Tbilisi, Georgia

(740) Salome Jeladze

(540)

ზედაშელი



ZEDASHELI

(591) Black-white

(531) 02.01.02; 02.01.03; 02.01.20; 05.03.15;  
05.05.20; 05.07.10; 22.05.03; 22.05.17;  
24.13.24; 26.04.04; 27.05.01; 28.19

(511) 33, 35, 43

(111) M 2022 35792 R

(151) 2022 08 10

(181) 2032 08 10

(210) AM 118493

(220) 2022 07 11

(732) Philip Morris Brands Sàrl  
Quai Jeanrenaud 3, 2000, Neuchâtel,  
Switzerland

(740) Pavle Meipariani  
(540)

## დაიმენშენს

(591) Black-white  
(511) 34

(111) M 2022 35793 R

(151) 2022 08 10

(181) 2032 08 10

(210) AM 118490

(220) 2022 07 10

(732) Philip Morris Brands Sàrl  
Quai Jeanrenaud 3, 2000, Neuchâtel,  
Switzerland

(740) Pavle Meipariani  
(540)

## ვისტა ფორესტი

(591) Black-white  
(511) 34

(111) M 2022 35794 R  
 (151) 2022 08 10  
 (181) 2032 08 10  
 (210) AM 118506  
 (220) 2022 07 11  
 (732) Philip Morris Brands Sàrl  
 Quai Jeanrenaud 3, 2000, Neuchâtel,  
 Switzerland  
 (740) Pavle Meipariani  
 (540)

## მალბორო გოლდ თაჩი

(591) Black-white  
 (511) 34

(111) M 2022 35795 R  
 (151) 2022 08 11  
 (181) 2032 08 11  
 (210) AM 118492  
 (220) 2022 07 11  
 (732) Philip Morris Brands Sàrl  
 Quai Jeanrenaud 3, 2000, Neuchâtel,  
 Switzerland  
 (740) Pavle Meipariani  
 (540)

## ტურეა

(591) Black-white  
 (511) 34

(111) M 2022 35796 R  
 (151) 2022 08 11  
 (181) 2032 08 11  
 (210) AM 118494  
 (220) 2022 07 11  
 (732) Philip Morris Brands Sàrl  
 Quai Jeanrenaud 3, 2000, Neuchâtel,  
 Switzerland  
 (740) Pavle Meipariani  
 (540)

## აფრისიოთი

(591) Black-white  
 (511) 34

(111) M 2022 35797 R  
 (151) 2022 08 11  
 (181) 2032 08 11  
 (210) AM 118837  
 (220) 2022 08 01  
 (732) LTD Skynet Distribution  
 2<sup>nd</sup> St. 75, Vill. Akhasheni, Gurjaani Region,  
 Georgia

(540)



(591) Black, white, red  
 (531) 16.03.01; 16.03.11; 16.03.15; 16.03.25;  
 24.01.15; 28.19; 29.01.12  
 (511) 9

(111) M 2022 35798 R  
 (151) 2022 08 12  
 (181) 2032 08 12  
 (210) AM 118929  
 (220) 2022 08 10  
 (732) LLC "N G"  
 Cross of Wine Ascent and Dutu Megreli  
 Streets, Tbilisi, Georgia  
 (540)



(591) Black-white  
 (531) 11.03.01; 11.03.02; 11.03.05; 27.03.15;  
 27.07.01  
 (511) 43

(111) M 2022 35799 R  
 (151) 2022 08 15  
 (181) 2032 08 15  
 (210) AM 118848  
 (220) 2022 08 03  
 (732) LTD "Geo Latex"  
 Nearby Demetre Tavidadbuli St. 30,  
 Didi Dighomi, Tbilisi, Georgia  
 (740) Giorgi Taktakishvili  
 (540)

## SICO

(591) Black-white  
 (511) 10

(111) M 2022 35800 R  
 (151) 2022 08 15  
 (181) 2032 08 15  
 (210) AM 118863  
 (220) 2022 08 04  
 (732) Davit Kurtsikidze  
 Danelia St. 29, 0186, Tbilisi, Georgia

(540)



(591) 0F0000 black  
 (531) 27.05.01; 27.05.09; 27.05.10; 27.05.17;  
 27.05.23  
 (511) 35, 45

(111) M 2022 35801 R  
 (151) 2022 08 15  
 (181) 2032 08 15  
 (210) AM 118919  
 (220) 2022 08 05  
 (732) Davit Kurtsikidze  
 Danelia St. 29, 0186, Tbilisi, Georgia  
 (540)



(591) 141313 black, 205AAA blue  
 (531) 27.05.01; 27.05.09; 27.05.10; 27.05.17;  
 27.05.23; 29.01.12  
 (511) 35, 45

(111) M 2022 35802 R  
 (151) 2022 08 16  
 (181) 2032 08 16  
 (210) AM 118926  
 (220) 2022 08 09  
 (732) LTD "Leader System"  
 The Streets: Khosharauli and Eliava,  
 between the left bank of the River Mtkvari and  
 Vakhushti Bridge, Didube District, Tbilisi,  
 Georgia  
 (540)



(591) FFFFFFF white, 000000 black  
 (531) 01.01.02; 01.01.10; 03.07.01; 03.07.02;  
 03.07.24; 26.11.03; 26.11.06; 27.05.01  
 (511) 11, 17

(111) M 2022 35868 R  
 (151) 2022 08 17  
 (181) 2032 08 17  
 (210) AM 118994  
 (220) 2022 08 12  
 (732) LTD "Ori Nabiji"  
 Navtlughi St. 39-41, 0113, Isani District,  
 Tbilisi, Georgia  
 (540)



(591) Black, white, light green, green  
 (531) 01.15.15; 05.03.16; 05.07.12; 05.07.22;  
 27.05.01; 29.01.13  
 (511) 32

(111) M 2022 35869 R  
 (151) 2022 08 18  
 (181) 2032 08 18  
 (210) AM 118727  
 (220) 2022 07 22  
 (732) Nino Egnatashvili  
 Pirosmeni St. 15, Tbilisi, Georgia  
 (540)

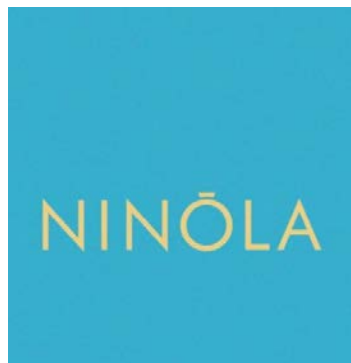

(591) Sky-blue, yellow  
 (531) 26.04.05; 26.04.22; 26.04.24; 27.05.01;  
 27.05.24; 29.01.12  
 (511) 14, 25

(111) M 2022 35870 R  
 (151) 2022 08 18  
 (181) 2032 08 18  
 (210) AM 118924  
 (220) 2022 08 09  
 (732) LTD "Delta Pharm"  
 Vill. Kapanakhchi, Marneuli Region, Georgia  
 (740) Eltun Akhmedov

(540)

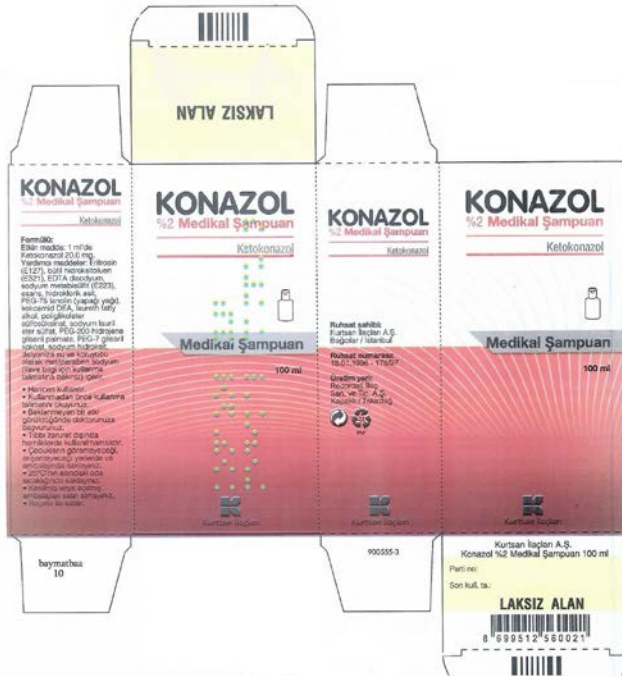

- (591) Red, green, white, black, yellow
- (531) 19.03.24; 19.07.01; 27.05.01; 29.01.14
- (554) Three Dimensional
- (511) 5

## INTERNATIONAL TRADEMARKS FOR WHICH A DECISION ON GRANTING PROTECTIONS IS TAKEN

The decision can be appealed at the Chamber of Appeal of Sakpatenti within 3 months from the publication or at the Mtskheta District Court Administrative Cases Board (Address: №17, Samkhedro St., Mtskheta), within 1 month following the publication.

(260) AM 2022 115158 A  
(800) 1622580  
(151) 2021 09 30  
(891) 2021 09 30  
(731) ELANCO US INC  
GREENFIELD IN 46140, USA  
(540)

### BIOMEDIT

(591) Black, white  
(511)  
5 – Pharmaceutical and veterinary preparations; dietetic food and substances adapted for medical or veterinary use; dietary supplements for humans and animals.  
42 – Scientific and technological services and research and design relating thereto in the field of human and animal health.

(260) AM 2022 115279 A  
(800) 1624304  
(151) 2021 06 04  
(891) 2021 06 04  
(731) "TD Ramtex-Trading" Limited Liability Company  
Krasnozvezdnaya str., 18B-56, 220034 Minsk, Belarus  
(540)



(591) Black, white  
(531) 05.03.13; 05.07.10; 05.07.13; 05.13.25;  
25.01.10; 25.01.13; 25.03.03; 26.04.05;  
26.04.16; 26.04.24; 28.05  
(511)  
6 – Lids of metal for cans and bottles; sealing caps of metal; crown caps of metal for bottles; bottle caps of metal; preserve tins; tinplate packings.  
29 – Meat, fish, poultry and game; meat extracts; preserved, frozen, dried and cooked fruits and vegetables; jellies, jams, compotes; eggs, milk and milk products; edible oils and fats.

30 – Coffee, tea, cocoa, artificial coffee; rice, tapioca, sago; flour and preparations made from cereals; bread, pastry and confectionery; ice cream; sugar, honey, treacle; yeast; baking-powder; salt; mustard; vinegar; sauces (condiments); spices; ice for refreshment.

32 – Beers; mineral and aerated waters and other non-alcoholic drinks; fruit drinks and fruit juices; syrups and other preparations for making beverages.

(260) AM 2022 115280 A  
(800) 1624312  
(151) 2021 06 30  
(891) 2021 06 30  
(731) Obshchestvo s ogranichennoi otvetstvennostyu "Autsorsingovaya gruppa "Aspekt"  
Nauchnyj proezd, d. 20, stroenie 3, pomezhenie 6, RU-117246 Moscow, Russian Federation  
(540)

### SUPRAMIL

(591) Black, white  
(511)  
5 – Veterinary preparations; anthelmintics and acaricides and insecticides for animals.

(260) AM 2022 115281 A  
(800) 1624476  
(151) 2021 05 28  
(891) 2021 05 28  
(731) ADELBEL S.R.L.  
Via Lecce, Zona Industriale Km 2 S.N.,  
I-73048 Nardò (LE), Italy  
(540)



### ADELBEL

(591) Black, white  
(531) 27.05.01  
(511)  
14 – Jewellery and costume jewellery including necklaces, bracelets, earrings, rings [jewellery], jewellery set, cuff links, pins and pendants, tie pins, tie clips; cuff links; pearl; precious, semi-precious and synthetic stones; medals, medallions and coins; paste jewellery; key rings [split rings with trinket or decorative

fob]; jewellery cases (caskets) of precious metal; figurines of precious metal; horological and chronometric instruments including wristwatches and wall clocks, watch straps and watch bracelets.

18 – Articles of leather, imitation leather and hide including bags, handbags, ladies' bags, cases, shoulder belts, travel baggage, bags for sports, holdalls, bum-bags, rucksacks, small rucksacks, haversacks, suitcases, attaché cases, overnight bags, portfolio cases [briefcases], wallets and other carriers, purses, change purses, business card cases, card holders, credit card holders, banknote holders, pass holders, document holders, cases, travel garment covers; key cases, cases of leather, vanity cases, clutch bags, cosmetic cases and bags; trunks [luggage]; luggage labels of leather; clothing for pets of leather and hide; collars and leashes for animals of leather and hide; animal carriers [bags] of leather and hide; umbrellas; walking sticks; saddlery, whips and apparel for animals.

24 – Fabrics and textile material for textile use and for the production of clothing, underwear, bags and footwear including jersey fabrics, woollen fabrics, elastic fabrics, mixed fabrics, woven and knitted fabrics, warp-knitted fabrics, synthetic and semi-synthetic fabrics, printed textile piece goods; waterproof textile fabrics, breathable fabrics, flame resistant fabrics, adhesive fabric for application by heat, pile fabrics, fabric of imitation animal skins, non-woven fabrics; coated fabrics; wall fabrics; curtain fabrics; fabrics for furnishing and interior decoration; household textile articles and linens; household textile goods and linens; bath linen including towels and bath sheets; beach towels and sheets; bed linen including bed blankets, bed throws, plaids, bed sheets, pillowcases, mattress covers, bed throws, cushion covers, quilts, eider-downs (down coverlets); kitchen linen and table linens including table covers, table mats, table cloths, placemats, table runners, napkins, dish towels for drying, textile handkerchiefs; linens including curtains, drapes, pillow shams, covers and loose covers for furniture; filtering materials of textile.

25 – Clothing for men, women and children including sportswear, leisure clothing, coats, raincoats, top coats, overcoats, anoraks, jackets, sports jackets, padded jackets, hooded jackets, blousons, trenches, parkas, mantles, outerwear, men's suits, women's dresses, trousers, shorts, bermudas, jeans, leggings, skirts, shirts, undershirts, t-shirts, polo shirts, blouses, tops, leotards, sweaters, pullovers, cardigans, sweatshirts, gilets, hosiery, including knitted shirts, knitted caps, knitted gloves, tracksuits, combinations clothing, jumper suits, one-piece coveralls, bathing suits, sundresses, beach clothes, underwear, bras, underpants, night gowns, sleep shirts, pyjamas, chemises, baby doll nighties, overalls, robes, bathing caps, suspenders, ties, ascots, bow ties, neckerchiefs, scarves, neck scarves, shawls, scarves, stoles, shoulder wraps, gloves,

mittens, muffs, socks and stockings, tights; belts, belts of leather, belts of hide, belts [clothing]; footwear including shoes, gymnastic shoes, boots, half-boots, mountaineering boots, sandals, flip-flops, clogs, espadrilles, slippers, mules, shoe covers (not for medical purposes), soles for footwear, shoe uppers; headwear including hats, caps, berets, headwear, visors and bandanas.

26 – Accessories for clothing, headwear and footwear, sewing articles and decorative textile articles including brooches [clothing accessories], ornamental novelty badges [buttons], top-knots [pompoms], sequins, spangles for decoration, not of precious metal, feathers [clothing accessories], arrangements of artificial flowers, intertwined cords for clothing, arm bands and expanding bands for holding sleeves [clothing accessories], shoulder pads for clothing, skirt flounces, hat decorations, ornaments for shoes [not of precious metal], shoe laces, buttons, clasps, belt clasps, clasps for clothing, metal fasteners for footwear, buckles [clothing accessories], buckles for belts, shoe fasteners, zip fasteners, fastenings for clothing, fastenings for suspenders, snap fasteners, scarf clips not being jewellery, appliques [haberdashery], artificial blossoms for attachment to clothing, bindings for hemming clothing, lace, tapes, reinforcing tapes for clothing, beads for trimming, embroidery lace, embroidery for garments, ornamental cloth patches; decorative articles for the hair including hair elastics, hair bands, hair barrettes, hair weaves; charms (other than for jewellery, key rings or key chains) including decorative charms for eyewear, decorative charms for mobile telephones.

35 – Wholesale and retail store services for the benefit of others, also by mail order catalogues and by means of electronic media including the internet in relation to jewellery and costume jewellery including necklaces, bracelets, earrings, rings [jewellery], jewellery set, cufflinks, pins and pendants, tie pins, tie clips, cuff links, pearl, precious, semi-precious and synthetic stones, medals, medallions and coins, paste jewellery, key rings [split rings with trinket or decorative fob], jewellery cases (caskets) of precious metal, figurines of precious metal, horological and chronometric instruments including wristwatches and wall clocks, watch straps and watch bracelets, patterns for dressmaking, templates and patterns for dressmaking, including templates and patterns for marking and for embroidery, templates and patterns for design, templates and printed templates for suits, templates and stencils for dressmaking for designing, three-dimensional models for educational purposes, articles of leather, imitation leather and hide including bags, handbags, ladies' bags, cases, shoulder belts, travel baggage, bags for sports, holdalls, bum-bags, rucksacks, small rucksacks, haversacks, suitcases, attaché cases, overnight bags, portfolio cases [briefcases], wallets and other carriers, purses, change purses, business card cases,



card holders, credit card holders, banknote holders, pass holders, document holders, cases, travel garment covers, key cases, cases of leather, vanity cases, clutch bags, cosmetic cases and bags, cases for manicure sets, trunks [luggage], luggage labels of leather, clothing for pets of leather and hide, collars and leashes for animals of leather and hide, animal carriers [bags] of leather and hide, umbrellas, walking sticks, saddlery, whips and apparel for animals, fabrics and textile material for textile use and for the production of clothing, underwear, bags and footwear including jersey fabrics, woollen fabrics, elastic fabrics, mixed fabrics, woven and knitted fabrics, warp-knitted fabrics, synthetic and semi-synthetic fabrics, printed textile piece goods, waterproof textile fabrics, breathable fabrics, filtering materials, flame resistant fabrics, adhesive fabric for application by heat, pile fabrics, fabric of imitation animal skins; wholesale and retail store services for the benefit of others, also by mail order catalogues and by means of electronic media including the internet in relation to non-woven fabrics, coated fabrics, wall fabrics and wallpaper, curtain fabrics, fabrics for furnishing and interior decoration, household textile articles and linens, household textile goods and linens, bath linen including towels, sponges and bath sheets, beach towels and sheets, bed linen including bed blankets, bed throws, plaids, bed sheets, pillowcases, mattress covers, bed throws, cushion covers, quilts, eiderdowns (down coverlets), kitchen linen and table linens including table covers, table mats, table cloths, placemats, table runners, napkins, dish towels for drying, textile handkerchiefs, linens including curtains, drapes, pillow shams, covers and loose covers for furniture, clothing for men, women and children including sportswear, leisure clothing, coats, raincoats, top coats, overcoats, anoraks, jackets, sports jackets, padded jackets, hooded jackets, blousons, trenchs, parkas, mantles, outerwear, men's suits, women's dresses, trousers, shorts, bermudas, jeans, leggings, skirts, shirts, undershirts, t-shirts, polo shirts, blouses, tops, leotards, sweaters, pullovers, cardigans, sweatshirts, gilets, hosiery, including knitted shirts, knitted caps, knitted gloves, tracksuits, combinations clothing, jumper suits, one-piece coveralls, bathing suits, sundresses, beach clothes, underwear, bras, underpants, night gowns, sleep shirts, pyjamas, chemises, baby doll nighties, overalls, robes, bathing caps, suspenders, ties, ascots, bow ties, neckerchiefs, scarves, neck scarves, shawls, scarves, stoles, shoulder wraps, gloves, mittens, muffs, socks and stockings, tights, belts, belts of leather, belts of hide, belts [clothing], footwear including shoes, gymnastic shoes, boots, half-boots, mountaineering boots, sandals, flip-flops, clogs, espadrilles, slippers, mules, shoe covers (not for medical purposes), soles for footwear, shoe uppers, headwear including hats, caps, berets, headwear, visors and bandanas; wholesale and retail store services for the benefit of others, also by mail order catalogues and by means of electronic media inclu-

ding the internet in relation to accessories for clothing, headwear and footwear, sewing articles and decorative textile articles including brooches [clothing accessories], ornamental novelty badges [buttons], top-knots [pompoms], sequins, spangles for decoration, not of precious metal, feathers [clothing accessories], arrangements of artificial flowers, intertwined cords for clothing, bracelets and expanding bands for holding sleeves [clothing accessories], shoulder pads for clothing, skirt flounces, hat decorations, ornaments for shoes [not of precious metal], shoe laces, buttons, clasps, belt clasps, clasps for clothing, metal fasteners for footwear, buckles [clothing accessories], buckles for belts, shoe fasteners, zip fasteners, fastenings for clothing, fastenings for suspenders, snap rings [fasteners], scarf clips not being jewellery, appliques [haberdashery], artificial blossoms for attachment to clothing, bindings for hemming clothing, lace, tapes, reinforcing tapes for clothing, beads for trimming, embroidery lace, embroidery for garments, ornamental cloth patches, decorative articles for the hair including hair elastics, hair bands, hair barrettes, hair weaves, charms (other than for jewellery, key rings or key chains) including decorative charms for eyewear, decorative charms for mobile telephones; business advisory services relating to franchising namely business management assistance in the establishment and running of franchised outlets relating to jewellery, costume jewellery and horological instruments, templates and patterns for dressmaking and the manufacture of clothing, leather goods, fabrics and textile material for textile use and for the manufacture of clothing, bags, footwear, bath linen, bedlinen, kitchen linens, table linens, household linen, upholstery goods, woven fabrics for furnishing and interior decoration, clothing, footwear, headgear, accessories for clothing, footwear, headgear and headwear, articles for sewing and decorative textiles articles, hair ornaments, decorative charms; advice and information services relating to organization and business management of franchised outlets and related advertising and promotion in relation to jewellery, costume jewellery and horological instruments, templates and patterns for dressmaking and the manufacture of clothing, leather goods, fabrics and textile material for textile use and for the manufacture of clothing, bags, footwear, bath linen, bedlinen, kitchen linens, table linens, household linen, upholstery goods, woven fabrics for furnishing and interior decoration, clothing, footwear, headgear, accessories for clothing, footwear, headgear and headwear, articles for sewing and decorative textiles articles, hair ornaments, decorative charms; sales promotion; sales promotion relating to jewellery, costume jewellery and horological instruments, templates and patterns for dressmaking and the manufacture of clothing, leather goods, fabrics and textile material for textile use and for the manufacture of clothing, bags, footwear, bath linen, bedlinen, kitchen linens, table linens, household linen, upholstery goods, woven fab-

rics for furnishing and interior decoration, clothing, footwear, headgear, accessories for clothing, footwear, headgear and headwear, articles for sewing and decorative textiles articles, hair ornaments, decorative charms; presentation of goods on communication media, for retail purposes; presentation of goods on communications media for the purposes of retailing relating to jewellery, costume jewellery and horological instruments, templates and patterns for dressmaking and the manufacture of clothing, leather goods, fabrics and textile material for textile use and for the manufacture of clothing, bags, footwear, bath linen, bedlinen, kitchen linens, table linens, household linen, upholstery goods, woven fabrics for furnishing and interior decoration, clothing, footwear, headgear, accessories for clothing, footwear, headgear and headwear, articles for sewing and decorative textiles articles, hair ornaments, decorative charms; procurement services for others [purchasing goods and services for other businesses]; procurement services for others [purchasing goods and services for other businesses] in relation to jewellery, costume jewellery and horological instruments, templates and patterns for dressmaking and the manufacture of clothing, leather goods, fabrics and textile material for textile use and for the manufacture of clothing, bags, footwear, bath linen, bedlinen, kitchen linens, table linens, household linen, upholstery goods, woven fabrics for furnishing and interior decoration, clothing, footwear, headgear, accessories for clothing, footwear, headgear and headwear, articles for sewing and decorative textiles articles, hair ornaments, decorative charms; provision of an online marketplace for buyers and sellers of goods and services; provision of an online marketplace for buyers and sellers of goods and services in relation to jewellery, costume jewellery and horological instruments, templates and patterns for dressmaking and the manufacture of clothing, leather goods, fabrics and textile material for textile use and for the manufacture of clothing, bags, footwear, bath linen, bedlinen, kitchen linens, table linens, household linen, upholstery goods, woven fabrics for furnishing and interior decoration, clothing, footwear, headgear, accessories for clothing, footwear, headgear and headwear, articles for sewing and decorative textiles articles, hair ornaments, decorative charms; advertising, marketing and promotion services; advertising, marketing and promotion services in relation to jewellery, costume jewellery and horological instruments, templates and patterns for dressmaking and the manufacture of clothing, leather goods, fabrics and textile material for textile use and for the manufacture of clothing, bags, footwear, bath linen, bedlinen, kitchen linens, table linens, household linen, upholstery goods, woven fabrics for furnishing and interior decoration, clothing, footwear, headgear, accessories for clothing, footwear, headgear and headwear, articles for sewing and decorative textiles articles, hair ornaments, decorative charms; marketing services; marketing services in re-

lation to jewellery, costume jewellery and horological instruments, templates and patterns for dressmaking and the manufacture of clothing, leather goods, fabrics and textile material for textile use and for the manufacture of clothing, bags, footwear, bath linen, bedlinen, kitchen linens, table linens, household linen, upholstery goods, woven fabrics for furnishing and interior decoration, clothing, footwear, headgear, accessories for clothing, footwear, headgear and headwear, articles for sewing and decorative textiles articles, hair ornaments, decorative charms; providing commercial information and advice for consumers in the choice of products and services; providing commercial information and advice for consumers in the choice of products and services in relation to jewellery, costume jewellery and horological instruments, templates and patterns for dressmaking and the manufacture of clothing, leather goods, fabrics and textile material for textile use and for the manufacture of clothing, bags, footwear, bath linen, bedlinen, kitchen linens, table linens, household linen, upholstery goods, woven fabrics for furnishing and interior decoration, clothing, footwear, headgear, accessories for clothing, footwear, headgear and headwear, articles for sewing and decorative textiles articles, hair ornaments, decorative charms; business information; business information services in relation to jewellery, costume jewellery and horological instruments, templates and patterns for dressmaking and the manufacture of clothing, leather goods, fabrics and textile material for textile use and for the manufacture of clothing, bags, footwear, bath linen, bedlinen, kitchen linens, table linens, household linen, upholstery goods, woven fabrics for furnishing and interior decoration, clothing, footwear, headgear, accessories for clothing, footwear, headgear and headwear, articles for sewing and decorative textiles articles, hair ornaments, decorative charms; commercial administration of the licensing of the goods and services of others; commercial administration of the licensing of the goods and services of others in relation to jewellery, costume jewellery and horological instruments, templates and patterns for dressmaking and the manufacture of clothing, leather goods, fabrics and textile material for textile use and for the manufacture of clothing, bags, footwear, bath linen, bedlinen, kitchen linens, table linens, household linen, upholstery goods, woven fabrics for furnishing and interior decoration, clothing, footwear, headgear, accessories for clothing, footwear, headgear and headwear, articles for sewing and decorative textiles articles, hair ornaments, decorative charms; organisation of fashion shows for commercial purposes, organization of fashion shows for promotional purposes.

40 – Tailoring or dressmaking; tailoring [custom manufacture], clothing alteration.

41 – Education and training services relating to fashion and design, education and training services for dressmaking, organisation of training courses, teaching

activities, workshops, seminars and conventions relating to fashion and design; organisation of fashion shows, fashion and design events and competitions; organizing and presenting displays of entertainment relating to style and fashion.

42 – Dress designing including the design of clothing, footwear and headwear, design of leather goods, design of jewellery, costume jewellery and time instruments, textile design, design of templates; design of fashion accessories; fashion design consulting services, providing information about fashion design services; dress designing; research and industrial and technological development regarding materials, printing, sewing and washing techniques in the clothing sector.

(260) AM 2022 115283 A

(800) 1624503

(151) 2021 07 07

(891) 2021 07 07

(731) Yupatov Oleg Vasilevich

ul. Nizhegorodskaya, 13A, kv. 28, RU-109029  
Moscow, Russian Federation

(540)

# Patrisa Nail

(591) Black, white

(531) 27.05.01; 27.05.09

(511)

3 – Non-medicated cosmetics and toiletry preparations; non-medicated dentifrices; perfumery, essential oils; bleaching preparations and other substances for laundry use; cleaning, polishing, scouring and abrasive preparations; abrasives; amber [perfume]; descaling preparations for household purposes; antistatic preparations for household purposes; air fragrancing preparations; aromatics [essential oils]; cake flavourings [essential oils]; flavourings for beverages [essential oils]; food flavourings [essential oils]; breath freshening sprays; canned pressurized air for cleaning and dusting purposes; balms, other than for medical purposes; basma [cosmetic dye]; lip glosses; nail glitter; body glitter; polishing stones; abrasive paper; emery paper; polishing paper; petroleum jelly for cosmetic purposes; shoe polish; cobblers' wax; cotton wool for cosmetic purposes; cotton wool impregnated with make-up removing preparations; sachets for perfuming linen; drying agents for dishwashing machines; adhesives for cosmetic purposes; scented water; Javelle water; lavender water; micellar water; toilet water; wax for parquet floors; floor wax; non-slipping wax for floors; depilatory wax; moustache wax; tailors' wax; creams for leather; polish for furniture and flooring; shoemakers' wax; polishing wax; massage gels, other than for medical purposes; heliotropine; dental bleaching gels; geraniol; make-up; deodorants for pets; deodorants for human beings or for animals; depilatory preparations; air fragrance reed diffusers;

scented wood; perfumes; non-slipping liquids for floors; windscreen cleaning liquids; greases for cosmetic purposes; volcanic ash for cleaning; perfumery; decorative transfers for cosmetic purposes; ionone [perfumery]; shaving stones [astringents]; smoothing stones; eyebrow pencils; cosmetic pencils; silicon carbide [abrasive]; carbides of metal [abrasives]; alum stones [astringents]; tripoli stone for polishing; adhesives for affixing false eyelashes; adhesives for affixing false hair; hair conditioners; quillaia bark for washing; corundum [abrasive]; beard dyes; colorants for toilet purposes; cosmetic dyes; body paint for cosmetic purposes; starch for laundry purposes; laundry glaze; shoe cream; polishing creams; cosmetic creams; skin whitening creams; polishing rouge; incense; hair spray; nail varnish; liquid latex body paint for cosmetic purposes; hair lotions; lotions for cosmetic purposes; after-shave lotions; beauty masks; oils for perfumes and scents; oils for cosmetic purposes; oils for toilet purposes; essential oils; essential oils of cedarwood; essential oils of lemon; essential oils of citron; oils for cleaning purposes; bergamot oil; gaultheria oil; jasmine oil; rose oil; oil of turpentine for degreasing; whiting; cleaning chalk; almond milk for cosmetic purposes; cleansing milk for toilet purposes; musk [perfumery]; shaving soap; soap; deodorant soap; soap for brightening textile; cakes of toilet soap; antiperspirant soap; soap for foot perspiration; almond soap; mint for perfumery; cosmetic kits; emery; gel eye patches for cosmetic purposes; nail art stickers; double eyelid tapes; false nails; eau de Cologne; bases for flower perfumes; joss sticks; pastes for razor strops; pumice stone; lipstick cases; hydrogen peroxide for cosmetic purposes; breath freshening strips; teeth whitening strips; sandcloth; glass cloth [abrasive cloth]; lipsticks; pomades for cosmetic purposes; shaving preparations; cosmetic preparations for baths; bath preparations, not for medical purposes; hair straightening preparations; hair waving preparations; laundry soaking preparations; grinding preparations; smoothing preparations [starching]; colour-removing preparations; leather bleaching preparations; polishing preparations; denture polishes; mouthwashes, not for medical purposes; cosmetic preparations for slimming purposes; starch glaze for laundry purposes; preparations to make the leaves of plants shiny; eye-washes, not for medical purposes; fabric softeners for laundry use; laundry bleach; dry-cleaning preparations; paint stripping preparations; lacquer-removing preparations; make-up removing preparations; floor wax removers [scouring preparations]; varnish-removing preparations; rust removing preparations; nail care preparations; cleaning preparations; preparations for cleaning dentures; wallpaper cleaning preparations; preparations for unblocking drain pipes; chemical cleaning preparations for household purposes; collagen preparations for cosmetic purposes; laundry preparations; bleaching preparations [decolorants] for household purposes; aloe vera preparations for cosmetic purposes;

ses; sunscreen preparations; breath freshening preparations for personal hygiene; colour-brightening chemicals for household purposes [laundry]; shining preparations [polish]; make-up powder; diamantine [abrasive]; stain removers; nail varnish removers; vaginal washes for personal sanitary or deodorant purposes; scouring solutions; false eyelashes; antistatic dryer sheets; baby wipes impregnated with cleaning preparations; colour run prevention laundry sheets; tissues impregnated with cosmetic lotions; tissues impregnated with make-up removing preparations; saffrol; massage candles for cosmetic purposes; laundry blueing; turpentine for degreasing; potpourris [fragrances]; bleaching soda; washing soda, for cleaning; bath salts, not for medical purposes; bleaching salts; fumigation preparations [perfumes]; leather preservatives [polishes]; ammonia [volatile alkali] [detergent]; astringents for cosmetic purposes; eyebrow cosmetics; make-up preparations; sun-tanning preparations [cosmetics]; hair dyes; neutralizers for permanent waving; cosmetic preparations for eyelashes; cosmetic preparations for skin care; dentifrices; cosmetics; cosmetics for children; cosmetics for animals; mascara; cleansers for intimate personal hygiene purposes, non medicated; douching preparations for personal sanitary or deodorant purposes [toiletries]; detergents, other than for use in manufacturing operations and for medical purposes; degreasers, other than for use in manufacturing processes; bleaching preparations [decolorants] for cosmetic purposes; toiletry preparations; antiperspirants [toiletries]; phytocosmetic preparations; talcum powder, for toilet use; cotton swabs for cosmetic purposes; terpenes [essential oils]; emery cloth; cloths impregnated with a detergent for cleaning; henna [cosmetic dye]; shampoos; shampoos for animals [non-medicated grooming preparations]; shampoos for pets [non-medicated grooming preparations]; dry shampoos; sandpaper; soda lye; herbal extracts for cosmetic purposes; extracts of flowers [perfumes]; ethereal essences; badian essence; mint essence [essential oil].

35 – Advertising; business management services; business administration services; office functions; arranging subscriptions to telecommunication services for others; import-export agency services; commercial information agency services; advertising agency services; cost price analysis; rental of office equipment in co-working facilities; rental of advertising space; business auditing; financial auditing; business intermediary services relating to the matching of potential private investors with entrepreneurs needing funding; employment agency services; computerized file management; book-keeping; invoicing; demonstration of goods; transcription of communications [office functions]; opinion polling; market studies; business investigations; business research; marketing research; personnel recruitment; business management and organization consultancy; business organization consultancy; business management consultancy; personnel ma-

agement consultancy; professional business consultancy; consultancy regarding advertising communication strategies; consultancy regarding public relations communication strategies; layout services for advertising purposes; marketing; marketing in the framework of software publishing; targeted marketing; business management of performing artists; business management of sports people; writing of curriculum vitae for others; scriptwriting for advertising purposes; news clipping services; updating and maintenance of information in registries; updating and maintenance of data in computer databases; updating of advertising material; word processing; online retail services for downloadable and pre-recorded music and movies; online retail services for downloadable ring tones; online retail services for downloadable digital music; organization of exhibitions for commercial or advertising purposes; arranging newspaper subscriptions for others; organization of fashion shows for promotional purposes; organization of trade fairs; shop window dressing; business appraisals; payroll preparation; data search in computer files for others; sponsorship search; administrative assistance in responding to calls for tenders; business management assistance; commercial or industrial management assistance; commercial intermediation services; providing business information; providing business information via a website; providing commercial and business contact information; providing commercial information and advice for consumers in the choice of products and services; provision of an online marketplace for buyers and sellers of goods and services; providing user reviews for commercial or advertising purposes; web indexing for commercial or advertising purposes; providing user rankings for commercial or advertising purposes; presentation of goods on communication media, for retail purposes; media relations services; economic forecasting; auctioneering; retail services for works of art provided by art galleries; sales promotion for others; promotion of goods and services through sponsorship of sports events; production of teleshopping programmes; production of advertising films; office machines and equipment rental; rental of advertising time on communication media; publicity material rental; rental of billboards [advertising boards]; rental of vending machines; rental of sales stands; rental of photocopying machines; consumer profiling for commercial or marketing purposes; publication of publicity texts; radio advertising; development of advertising concepts; bill-posting; distribution of samples; dissemination of advertising matter; direct mail advertising; registration of written communications and data; writing of publicity texts; online advertising on a computer network; advertising by mail order; television advertising; compilation of statistics; compilation of information into computer databases; business inquiries; systemization of information into computer databases; administrative services for medical referrals; advisory services for busi-

ness management; corporate communications services; negotiation of business contracts for others; negotiation and conclusion of commercial transactions for third parties; compiling indexes of information for commercial or advertising purposes; tax preparation; drawing up of statements of accounts; telemarketing services; psychological testing for the selection of personnel; wholesale services for pharmaceutical, veterinary and sanitary preparations and medical supplies; retail services for pharmaceutical, veterinary and sanitary preparations and medical supplies; interim business management; outsourced administrative management for companies; business management of hotels; business management for freelance service providers; business project management services for construction projects; commercial administration of the licensing of the goods and services of others; business management of reimbursement programmes for others; administration of consumer loyalty programs; administration of frequent flyer programs; administrative processing of purchase orders; administrative services for the relocation of businesses; public relations; commercial lobbying services; competitive intelligence services; modelling for advertising or sales promotion; typing; market intelligence services; appointment reminder services [office functions]; website traffic optimization; appointment scheduling services [office functions]; tax filing services; search engine optimization for sales promotion; retail services relating to bakery products; gift registry services; price comparison services; pay per click advertising; secretarial services; procurement services for others [purchasing goods and services for other businesses]; shorthand; outsourcing services [business assistance]; telephone answering for unavailable subscribers; telephone switchboard services; photocopying services; business efficiency expert services; retail services and wholesale services for nail care and nail treatment preparations; retail services and wholesale services for false nails, nail care and nail treatment accessories; retail services and wholesale services for nail art stickers, nail polish, nail polish remover, nail glitter, nail gels, nail files.

41 – Education; providing of training; entertainment; sporting and cultural activities; modelling for artists; academies [education]; rental of indoor aquaria; rental of artwork; rental of sports grounds; rental of tennis courts; lending library services; booking of seats for shows; videotaping; physical education; production of music; discotheque services; animal training; dubbing; publication of books; film distribution; movie studio services; health club services [health and fitness training]; nightclub services [entertainment]; layout services, other than for advertising purposes; microfilming; videotape editing; production of radio and television programmes; screenplay writing; religious education; aikido instruction; gymnastic instruction; judo instruction; correspondence courses; practical training [demonstration]; training services provi-

ded via simulators; organization of balls; organization of exhibitions for cultural or educational purposes; providing recreation facilities; arranging and conducting of colloquiums; arranging and conducting of congresses; arranging and conducting of conferences; arranging and conducting of concerts; arranging and conducting of workshops [training]; arranging and conducting of in-person educational forums; arranging and conducting of seminars; arranging and conducting of symposiums; organization of competitions [education or entertainment]; arranging of beauty contests; organization of cosplay entertainment events; organization of lotteries; organization of fashion shows for entertainment purposes; organization of shows [impresario services]; organization of sports competitions; vocational guidance [education or training advice]; amusement park services; sign language interpretation; know-how transfer [training]; television entertainment; mobile library services; vocational retraining; providing online videos, not downloadable; providing information in the field of education; providing information relating to recreational activities; providing information in the field of entertainment; providing online music, not downloadable; providing television programmes, not downloadable, via video-on-demand services; providing films, not downloadable, via video-on-demand services; providing user reviews for entertainment or cultural purposes; providing golf facilities; providing user rankings for entertainment or cultural purposes; providing sports facilities; providing amusement arcade services; cinema presentations; providing online electronic publications, not downloadable; presentation of circus performances; presentation of variety shows; presentation of live performances; theatre productions; conducting guided climbing tours; conducting fitness classes; educational examination; film production, other than advertising films; rental of audio equipment; rental of video cameras; rental of video cassette recorders; rental of videotapes; rental of show scenery; rental of sound recordings; toy rental; rental of cinematographic apparatus; rental of motion pictures; games equipment rental; rental of stadium facilities; rental of lighting apparatus for theatrical sets or television studios; rental of radio and television sets; rental of skin diving equipment; rental of sports equipment, except vehicles; rental of stage scenery; rental of training simulators; electronic desktop publishing; online publication of electronic books and journals; publication of texts, other than publicity texts; radio entertainment; writing of texts; sado instruction [tea ceremony instruction]; zoological garden services; news reporters services; film directing, other than advertising films; party planning [entertainment]; music composition services; subtitling; tutoring; holiday camp services [entertainment]; gambling services; video editing services for events; conducting guided tours; disc jockey services; sound engineering services for events; game services provided online from a

computer network; personal trainer services [fitness training]; providing casino facilities [gambling]; calligraphy services; karaoke services; club services [entertainment or education]; songwriting; cultural, educational or entertainment services provided by art galleries; providing museum facilities [presentation, exhibitions]; teaching; educational services provided by special needs assistants; educational services provided by schools; orchestra services; translation; scriptwriting, other than for advertising purposes; physical fitness assessment services for training purposes; face painting; ticket agency services [entertainment]; educational examination for users to qualify to pilot drones; coaching [training]; lighting technician services for events; sport camp services; recording studio services; nursery schools; photography; photographic reporting; timing of sports events; boarding school education; production of shows; entertainment services provided by performing artists.

44 – Medical services; veterinary services; hygienic and beauty care for human beings or animals; agriculture, aquaculture, horticulture and forestry services; rental of animals for gardening purposes; rental of beehives; rental of surgical robots; public bath services for hygiene purposes; Turkish bath services; hospital services; depilatory waxing; reforestation services; cultivation of plants; landscape design; health centre services; nursing home services; wreath making; hair implantation; medical advice for individuals with disabilities; consultancy in the field of viticulture; pharmacy advice; aromatherapy services; animal-assisted therapy; manicuring; massage; medical screening; horticulture; artificial insemination services; hairdressing; body piercing; midwife services; veterinary assistance; dentistry services; medical assistance; tree planting for carbon offsetting purposes; preparation of prescriptions by pharmacists; medical equipment rental; rental of hair styling apparatus; rental of sanitary installations; farming equipment rental; aerial and surface spreading of fertilizers and other agricultural chemicals; animal breeding; gardening; landscape gardening; beauty salon services; sanatorium services; blood bank services; health care; health counselling; dietary and nutritional advice; flower arranging; tattooing; vermin exterminating for agriculture, aquaculture, horticulture and forestry; weed killing; health spa services; human tissue bank services; aquaculture services; viticulture services; visagists' services; convalescent home services; rest home services; medical clinic services; medical analysis services for diagnostic and treatment purposes provided by medical laboratories; home-visit nursing care; alternative medicine services; opticians' services; plant nursery services; pest control services for agriculture, aquaculture, horticulture and forestry; in vitro fertilization services; services of a psychologist; sauna services; solarium services; telemedicine services; therapy services; nursing, medical; lawn care; animal grooming; pet grooming; physiotherapy; plastic surgery; tree sur-

gery; hospice services; chiropractic; orthodontic services; palliative care; rehabilitation for substance abuse patients; speech therapy.

(260) AM 2022 115284 A

(800) 1624530

(151) 2021 07 20

(891) 2021 07 20

(731) ROYAL ARMENIA JV LTD

Davtashen 2nd Block 268, 0054 Yerevan,  
Armenia

(540)

## TIMEOFF

(591) Black, white

(511)

30 – Coffee; ground coffee; roasted coffee beans; instant coffee; instant coffee mixes; artificial coffee; vegetal preparations for use as coffee substitutes; unroasted coffee; coffee beverages with milk; coffee-based beverages; hot chocolate; cocoa; cocoa-based beverages; cocoa beverages with milk; tea; instant tea; iced tea; tea-based beverages; seasonings; pepper; peppercorns; ground black pepper.

(260) AM 2022 115286 A

(800) 1624591

(151) 2021 06 16

(891) 2021 06 16

(731) JBAR

180 avenue de l'Europe, F-33260 LA  
TESTE-DE-BUCH, France

(540)



(591) Black, white

(531) 04.03.07; 24.03.07; 24.03.13; 24.03.18;

27.05.01

(511)

32 – Beer and brewing products; beer made with spring water from Arcachon Bay; lemonades; colas (non-alcoholic beverages); non-alcoholic beverages; non-alcoholic cocktails; fruit juices; flavored water (beverages).

33 – Alcoholic beverages; whisky; gin; liqueurs; aperitifs; cocktails.

35 – Retail sale services for beers, alcoholic and non-alcoholic beverages; retail sale or wholesale services online or by all electronic means for remote ordering

of beers, alcoholic and non-alcoholic beverages, glassware, musical instruments; services provided by a franchiser, namely assistance for the operation or management of a commercial enterprise; commercial advice in the field of franchising; advice concerning the management of establishments as franchises; business management and organization consultancy; services for purchasing goods for other businesses (procurement); presentation of goods on all communication media, for retail purposes; promotion of music concerts; promotion of the music of others by providing online portfolios via a website.

41 – Organizing musical concerts, musical events; live musical performances; provision of equipment and facilities for live band performances; music studio recording and rehearsal services; renting music recording and rehearsal studios; training and teaching in the field of music; publishing journals and newsletters; writing blogs in the field of music; provision of non-downloadable electronic publications on line in the field of music; music news programming services for rebroadcasting over the Internet.

43 – Brasserie services; serving drinks in breweries; bar services; tea rooms; food service; delicatessens (restaurants); snack bar services; renting rooms for events and parties.

(260) AM 2022 115287 A

(800) 478563

(151) 1983 07 09

(891) 2021 10 20

(731) Kaiserdom-Privatbrauerei Bamberg Wörner GmbH & Co. KG  
Breitackerstrasse 9, 96049 Bamberg, Germany

(540)

# Kaiserdom

(591) Black, white

(531) 27.05.01; 27.05.17

(511)

30 – Cooling ice.

(260) AM 2022 115288 A

(800) 914905A

(151) 2007 01 17

(891) 2021 10 19

(731) P&C TECHNOLOGIE ZRT  
Bajcsy-Zsilinszky út 48.2.EM, BUDAPEST,  
Hungary

(540)

# PIERRE CARDIN

(591) Black, white

(511)

7 – Mixers for household use.

11 – Hair dryers; electric coffee machines; heating apparatus; toasters.

(260) AM 2022 115396 A

(800) 1396276

(151) 2017 09 26

(891) 2021 10 19

(731) ERSAĞ ENDÜSTRİYEL VE KİMYASAL  
TEMİZLİK ÜRÜNLERİ PAZARLAMA  
TURİZM GIDA İNŞAAT SANAYİ TİCARET  
LİMİTED ŞİRKETİ  
Bozburun Mahallesi 7114 Sokak No:5,  
Merkezefendi Denizli, Turkey

(540)



(591) Black, white

(531) 05.13.04; 05.13.07; 27.05.02

(511)

3 – Bleaching preparations and other substances for laundry use; cleaning, polishing, scouring and abrasive preparations; non-medicated soaps; perfumery, essential oils, non-medicated cosmetics, non-medicated hair lotions; non-medicated dentifrices; adhesives for affixing false hair, adhesives for affixing false eyelashes, adhesives for cosmetic purposes, after-shave lotions, air fragrancing preparations, almond oil, almond soap, almond milk for cosmetic purposes, aloe vera preparations for cosmetic purposes, alum stones [astringents], amber [perfume], ammonia [volatile alkali] [detergent], antiperspirant soap, antiperspirants [toilettries], antistatic preparations for household purposes, aromatics [essential oils], astringents for cosmetic purposes, badian essence; balms, other than for medical purposes; bases for flower perfumes; bath salts, not for medical purposes; bath preparations, not for medical purposes; beard dyes, beauty masks, bergamot oil, bleaching salts, bleaching soda, bleaching preparations [decolorants] for cosmetic purposes, breath freshening sprays, breath freshening strips, cake flavourings [essential oils], cakes of soap; canned pressurized air for cleaning and dusting purposes; cleaning chalk, cleaning preparations, preparations for cleaning dentures; cleansers for intimate personal hygiene purposes, non medicated; cleansing milk for toilet purposes, cloths impregnated with a detergent for cleaning, cobblers' wax, collagen preparations for cosmetic purposes, colour-brightening chemicals for household purposes [laundry], colorants for toilet purposes, colour-removing preparations, cosmetic preparations for baths, cosmetic preparations for eyelashes, cosmetic kits, cosmetic pencils, cosmetic creams,

cosmetic preparations for skin care, cosmetic dyes, cosmetic preparations for slimming purposes, cosmetics for animals, cosmetics, cotton sticks for cosmetic purposes, cotton wool for cosmetic purposes, creams for leather, decorative transfers for cosmetic purposes; degreasers, other than for use in manufacturing processes; dental bleaching gels, dentifrices, denture polishes, deodorant soap, deodorants for human beings or for animals, depilatory preparations, depilatory wax, descaling preparations for household purposes; detergents, other than for use in manufacturing operations and for medical purposes; douching preparations for personal sanitary or deodorant purposes [toiletries], dry shampoos, dry-cleaning preparations, drying agents for dishwashing machines, eau de Cologne, emery cloth, essential oils of cedarwood, essential oils of lemon, essential oils of citron, ethereal essences, essential oils, extracts of flowers [perfumes]; eye-washes, not for medical purposes; eyebrow cosmetics, eyebrow pencils, fabric softeners for laundry use, false eyelashes, false nails, flavourings for beverages [essential oils], floor wax removers [scouring preparations], food flavourings [essential oils], fumigation preparations [perfumes], refurbishing preparations, gaultheria oil, geraniol, glass cloth [abrasive cloth], greases for cosmetic purposes, grinding preparations, sharpening preparations, hair lotions, hair dyes, hair waving preparations, hair spray, hair conditioners, hair straightening preparations, heliotropine, henna [cosmetic dye], herbal extracts for cosmetic purposes, hydrogen peroxide for cosmetic purposes, incense, ionone [perfumery], jasmine oil, javelle water, joss sticks, lacquer-removing preparations, laundry blueing, laundry bleaching preparations, laundry glaze, laundry wax, laundry soaking preparations, laundry preparations, lavender water, lavender oil, leather bleaching preparations, leather preservatives [polishes], lip glosses, lipstick cases, lipsticks, lotions for cosmetic purposes, make-up preparations, make-up removing preparations, make-up powder, mascara; massage gels, other than for medical purposes; mint essence [essential oil], mint for perfumery, mustache wax; mouthwashes, not for medical purposes; musk [perfumery], nail polish, nail care preparations, nail art stickers, nail polish removers, neutralizers for permanent waving, non-slipping wax for floors, non-slipping liquids for floors, oil of turpentine for degreasing, oils for cosmetic purposes, oils for cleaning purposes, oils for perfumes and scents, oils for toilet purposes, paint stripping preparations, pastes for razor stops, perfumes, petroleum jelly for cosmetic purposes, phytocosmetic preparations, polish for furniture and flooring, jewellers' rouge, polishing preparations, polishing wax, polishing creams, polishing paper, polishing stones, pomades for cosmetic purposes, potpourris [fragrances], quillaia bark for washing, rose oil, rust removing preparations, sachets for perfuming linen, safrol, abrasive cloth, scented wood, scented water, scouring solutions, shampoos, shampoos for

animals [non-medicated grooming preparations], shaving stones [astringents], shaving soap, shaving preparations, shining preparations [polish], preparations to make shiny the leaves of plants, skin whitening creams/cream for whitening the skin, smoothing preparations [starching], soap, soap for brightening textile, soap for foot perspiration, soda lye, stain removers, starch glaze for laundry purposes, starch for laundry purposes/laundry starch, sun-tanning preparations [cosmetics], sunscreen preparations; talcum powder, for toilet use; teeth whitening strips, terpenes [essential oils], tissues impregnated with cosmetic lotions, tissues impregnated with make-up removing preparations, toilet water, toilet water, toiletry preparations, turpentine for degreasing, preparations for unblocking drain pipes, varnish-removing preparations, volcanic ash for cleaning, wallpaper cleaning preparations; washing soda, for cleaning; wax for parquet floors, whitening, windscreen cleaning liquids.

5 – Pharmaceuticals, medical and veterinary preparations; sanitary preparations for medical purposes; dietetic food and substances adapted for medical or veterinary use, food for babies; dietary supplements for humans and animals; plasters, materials for dressings; material for stopping teeth, dental wax; disinfectants; preparations for destroying vermin; fungicides, herbicides; absorbent cotton/absorbent wadding, acaricides, acetates for pharmaceutical purposes, acids for pharmaceutical purposes, acne treatment preparations, adhesive plasters/sticking plasters, air purifying preparations, air deodorising preparations, albumin dietary supplements, albuminous foodstuffs for medical purposes, albuminous preparations for medical purposes, alcohol for pharmaceutical purposes, alginate dietary supplements, almond milk for pharmaceutical purposes, aloe vera preparations for pharmaceutical purposes, amino acids for medical purposes, animal washes [insecticides], antibacterial soap, antibacterial handwashes, antiseptic cotton, antiseptics, appetite suppressants for medical purposes, aseptic cotton, asthmatic tea, babies' diapers [napkins], bath, preparations for medical purposes, bath salts for medical purposes, biocides, by-products of the processing of cereals for dietetic or medical purposes, candy for medical purposes, capsules for medicines, casein dietary supplements, castor oil for medical purposes, chemical preparations to treat mildew, chemical preparations for medical purposes, chemical preparations for veterinary purposes, chewing gum for medical purposes, chloroform, cooling sprays for medical purposes, corn rings for the feet, cotton for medical purposes, cotton sticks for medical purposes, dental abrasives; deodorants, other than for human beings or for animals; deodorants for clothing and textiles, preparations for destroying animals, detergents for medical purposes, diabetic bread adapted for medical use, dietary fibre, dietary supplements for animals, dietetic foods adapted for medical purposes, dietetic beverages adapted for medical purposes, dietetic substances



adapted for medical use, dill oil for medical purposes, disinfectant soap, disinfectants for hygiene purposes, disinfectants for chemical toilets, enzyme dietary supplements, esters for pharmaceutical purposes, ethers for pharmaceutical purposes, eucalyptus for pharmaceutical purposes, fennel for medical purposes, flour for pharmaceutical purposes, fly catching paper, fly catching adhesives, freeze-dried food adapted for medical purposes, freeze-dried meat adapted for medical purposes, glucose dietary supplements, gum for medical purposes, haemorrhoid preparations, herbal teas for medicinal purposes, herbal extracts for medical purposes, homogenized food adapted for medical purposes, insect repellents, insect repellent incense, insecticidal animal shampoo, insecticides, laxatives, lecithin dietary supplements, linseed dietary supplements, linseed oil dietary supplements, lotions for pharmaceutical purposes, malt for pharmaceutical purposes, malted milk beverages for medical purposes, medical preparations for slimming purposes, medicated after-shave lotions, medicated shampoos, medicated toilet-ry preparations, medicated hair lotions, medicated dry shampoos, medicated soap, medicinal mud, medicinal tea, medicinal oils, medicinal drinks, medicinal hair growth preparations, sanitary pads, menthol, mineral waters for medical purposes, mineral water salts, mineral food supplements, mint for pharmaceutical purposes, mud for baths, nutritional supplements, pharmaceutical preparations for skin care, pharmaceutical preparations for treating dandruff, pollen dietary supplements, propolis for pharmaceutical purposes, propolis dietary supplements, protein dietary supplements, protein supplements for animals, remedies for perspiration, royal jelly dietary supplements, royal jelly for medical purposes, salts for mineral water baths, slimming pills, sunburn ointments, therapeutic preparations for the bath, thermal water, tobacco-free cigarettes for medical purposes, tonics [medicines], preparations of trace elements for human and animal use, vitamin preparations, wart pencils, wheat germ dietary supplements, yeast dietary supplements.

21 – Household or kitchen utensils and containers; combs and sponges; brushes, except paintbrushes; brush-making materials; articles for cleaning purposes; unworked or semi-worked glass, except building glass; glassware, porcelain and earthenware; abrasive pads for kitchen purposes, abrasive sponges for scrubbing the skin; aerosol dispensers, not for medical purposes; electric devices for attracting and killing insects, bottles, bowls [basins], boxes for dispensing paper towels, boxes of glass, broom handles, brooms, brushes for footwear, brushes for cleaning tanks and containers, buckets/pails, car washing mitts, carpet sweepers; cleaning instruments, hand-operated; cloth for washing floors, cosmetic utensils, cosmetic spatulas, cotton waste for cleaning, deodorising apparatus for personal use, dishwashing brushes, dispensers for paper towels, drinking glasses; dusting apparatus, non-electric; dusting cloths [rags], eyebrow brushes,

eyelash brushes, feather-dusters; fiberglass, other than for insulation or textile use; fiberglass thread, not for textile use; figurines [statuettes] of porcelain, ceramic, earthenware or glass/statuettes of porcelain, ceramic, earthenware or glass; fly swatters, fly traps, foam toe separators for use in pedicures, gardening gloves, glass flasks [containers], glass jars [carboys], glass bowls, glove stretchers, gloves for household purposes, hair for brushes, holders for paper towels, insect traps, make-up removing appliances, make-up sponges, make-up brushes, microfiber cloths for cleaning, mop wringers, mop wringer buckets, mops, nail brushes, kitchen mitts, perfume burners, perfume vaporizers/perfume sprayers; place mats, not of paper or textile; plug-in diffusers for mosquito repellents, polishing leather, polishing gloves, polishing cloths, rags [cloth] for cleaning, saucers, scouring pads/pads for cleaning, scrubbing brushes, soap boxes, soap dispensers, soap holders/dishes for soap, sponges for household purposes; statues of porcelain, ceramic, earthenware or glass; steel wool for cleaning, table napkin holders; tablemats, not of paper or textile; toilet paper dispensers, toilet sponges, toilet paper holders, toothbrushes, toothpicks, water apparatus for cleaning teeth, wool waste for cleaning; works of art of porcelain, ceramic, earthenware or glass.

29 – Meat, fish, poultry and game; meat extracts; preserved, frozen, dried and cooked fruits and vegetables; jellies, jams, compotes; eggs; milk and milk products; edible oils and fats; albumin milk/protein milk, almond milk; almonds, ground; aloe vera prepared for human consumption, arrangements of processed fruit, butter, buttercream, candied nuts, caviar, charcuterie, cocoa butter for food, coconut oil for food, coconut milk, coconut milk-based beverages, coffee whiteners (cream substitutes), cream [dairy products], frosted fruits, extra virgin olive oil; fish, preserved; fish, tinned; flavoured nuts, freeze-dried meat, freeze-dried vegetables; fruit, preserved; fruit, stewed; fruit jellies, fruit pulp, fruit-based snack food, frozen fruits; fruits, tinned; hazelnuts, prepared; hummus [chickpea paste], jellies for food, kephir (milk beverage), corn oil for food, marmalade; nuts, prepared; oils for food, olive oil for food, olives, preserved, palm oil for food, peanut butter, peanuts, prepared, pollen prepared as foodstuff, raisins, colza oil for food, sesame oil for food, soups, bouillon, tahini (sesame seed paste), potato chips, soya bean oil for food, sunflower oil for food, tea whiteners (cream substitutes); vegetables, preserved; vegetables, cooked; vegetables, dried; vegetables, tinned; yoghurt.

30 – Coffee, tea, cocoa and artificial coffee; rice; tapioca and sago; flour and preparations made from cereals; bread, pastries and confectionery; edible ices; sugar, honey, treacle; yeast, baking-powder; salt; mustard; vinegar, sauces (condiments); spices; ice; agave syrup [natural sweetener], allspice, aromatic preparations for food, biscuits/cookies, candy, choco-

late, chocolate beverages with milk, cinnamon [spice], cloves [spice], cocoa beverages with milk, cocoa-based beverages, coffee extracts, coffee flavourings, coffee beverages with milk, coffee-based beverages, corn flakes, crackers, curry [spice], custard; essences for foodstuffs, except etheric essences and essential oils; flavourings, other than essential oils, for cakes; flavourings, other than essential oils, for beverages; flowers or leaves for use as tea substitutes; food flavourings, other than essential oils; fruit jellies [confectionery], fruit coulis [sauces]; garden herbs, preserved [seasonings]; ginger [spice], halvah, high-protein cereal bars, ice cream, iced coffee, iced tea, liquorice [confectionery], pastilles [confectionery], muesli, oat flakes, oat-based food, oatmeal, preparations for stiffening whipped cream, propolis/bee glue for human consumption; royal jelly for human consumption, not for medical purposes; saffron [seasoning], seasonings, tapioca flour, tea extracts, tea-based beverages, unroasted coffee, vanillin [vanilla substitute], vegetal preparations for use as coffee substitutes, waffles, wheat germ for human consumption, frozen yoghurt [confectionery ices].

41 – Education; providing of training; entertainment; sporting and cultural activities; academics [education], club services [entertainment or education], coaching [training], arranging and conducting of conferences, arranging and conducting of congresses, education information, educational examination, electronic desktop publishing, entertainer services, entertainment services, game services provided on-line from a computer network, conducting guided tours, health club services [health and fitness training], holiday camp services [entertainment or education], arranging and conducting of in-person educational forums, language interpreter services, providing museum facilities [presentation, exhibitions], on-line publication of electronic books and journals; providing on-line electronic publications, not downloadable; providing on-line videos, not downloadable; organization of competitions [education or entertainment], organization of exhibitions for cultural or educational purposes, practical training [demonstration], publication of books, production of radio and television programmes, arranging and conducting of seminars, arranging and conducting of symposiums, teaching/educational services; instruction services, translation, vocational guidance [education or training advice], vocational retraining, arranging and conducting of workshops [training].

(260) AM 2022 115398 A

(800) 1548187

(151) 2020 05 29

(891) 2021 10 09

(731) DELI GROUP CO., LTD.

Deli Industrial Park, Ninghai County,  
Ningbo, Zhejiang, China

(540)



(591) Black, white

(531) 27.05.01

(511)

11 – Desk lamp; coffee percolators, electric; heating cushions, electric, not for medical purposes; ventilation [air-conditioning] installations and apparatus; air purifying apparatus and machines; electric torches; electric fans for personal use; kettles, electric; filters for drinking water.

(260) AM 2022 115459 A

(800) 1626342

(151) 2021 07 12

(891) 2021 07 12

(731) WENZHOU RONGRUIXIANG

INTERNATIONAL TRADE CO., LTD

No.94 Pumen, Yongqiang Avenue, Tianhe

Sub-District, Wenzhou Economic and,

Technological Development Zone, 325000

Zhejiang Province, China

(540)



(591) Black, white

(531) 27.05.01

(511)

6 – Metal display racks; valves of metal, other than parts of machines; cramps of metal [crampons]; metal joints for pipes; fittings of metal for pipes; rings of metal; drain traps of metal; nozzles of metal; water-pipes of metal; props of metal; stop collars of metal; metal collars for fastening pipes; buckles of common metal [hardware]; greenhouse frames of metal.

11 – Flushing tanks; water closets; lamps; floor drains; pipes [parts of sanitary installations]; showers; heating apparatus; clean chambers [sanitary installations]; hot steam bath installations; water distribution installations; water filtering apparatus; taps; hot water heating installations; pipe joint for water heating installations; pipe parts for water heating device; sanitary apparatus and installations; water-pipes for sanitary installations; sinks; bath installations; bath tubs; regulating and safety accessories for water apparatus; bath fittings; wash-hand bowls [parts of sanitary installations]; wash-hand basins [parts of sanitary installations].

21 – Kitchen utensils; soap holders; garbage cans; towel rails and rings; daily pottery (including pots, bowls, plates, jars, jars, casseroles, pots and sto-

neware); nozzles for sprinkler hose; toilet paper holders; toilet utensils; drying racks for laundry.

(260) AM 2022 115460 A

(800) 1626350

(151) 2021 07 07

(891) 2021 07 07

(731) Danapha Pharmaceutical Joint Stock Company  
253 Dung Si Thanh Khe str., Danang City, Viet Nam

(540)



(591) Red, yellow, golden yellow and green

(531) 01.01.01; 01.01.10; 24.03.07; 26.01.05;  
29.01.15

(511)

3 – Abrasives; amber [perfume]; descaling preparations for household purposes; antistatic preparations for household purposes; aromatics [essential oils]; air fragrancing preparations; cake flavourings [essential oils]; flavourings for beverages [essential oils]; food flavourings [essential oils]; breath freshening sprays; canned pressurized air for cleaning and dusting purposes; balms other than for medical purposes; basma [cosmetic dye]; lip glosses; nail glitter; polishing stones; abrasive paper; emery paper; polishing paper; petroleum jelly for cosmetic purposes; shoe polish; cobblers' wax; cotton wool for cosmetic purposes; sachets for perfuming linen; drying agents for dish-washing machines; adhesives for cosmetic purposes; scented water; javelle water; lavender water; toilet water; wax for parquet floors; floor wax; non-slipping wax for floors; depilatory wax; mustache wax; creams for leather/waxes for leather; polish for furniture and flooring; shoemakers' wax, polishing wax; tailors' wax; massage gels other than for medical purposes; heliotropine; dental bleaching gels; geraniol; make-up; deodorants for pets; deodorants for human beings or for animals; depilatory preparations; air fragrance reed diffusers; scented wood; perfumes; non-slipping liquids for floors; windscreen cleaning liquids; greases for cosmetic purposes; volcanic ash for cleaning; perfumery; decorative transfers for cosmetic purposes; ionone [perfumery]; shaving stones [astringents]; smoothing stones; eyebrow pencils; cosmetic pencils; silicon carbide [abrasive]; carbides of metal [abrasives]; alum stones [astringents]; tripoli stone for polishing; adhesives for affixing false eyelashes; adhesives for affixing false hair; hair conditioners; quillaia bark for washing; corundum [abrasive]; beard dyes; colo-

rants for toilet purposes; cosmetic dyes; laundry starch; laundry glaze; shoe cream; polishing creams; cosmetic creams; skin whitening creams; polishing rouge; incense; hair spray; nail polish; hair lotions; lotions for cosmetic purposes; after-shave lotions; beauty masks; oils for cleaning purposes; oils for perfumes and scents; oils for cosmetic purposes; oils for toilet purposes; essential oils; essential oils of cedar-wood; essential oils of lemon; essential oils of citron; bergamot oil; gaultheria oil; jasmine oil; lavender oil; almond oil; rose oil; oil of turpentine for degreasing; whitening; cleaning chalk; almond milk for cosmetic purposes; cleansing milk for toilet purposes; musk [perfumery]; soap; deodorant soap; shaving soap; soap for brightening textile; cakes of toilet soap; anti-perspirant soap; soap for foot perspiration; almond soap; mint for perfumery; cosmetic kits; emery; gel eye patches for cosmetic purposes; nail art stickers; false nails; eau de cologne; bases for flower perfumes; joss sticks; pastes for razor strops; dentifrices/toothpaste; pumice stone; lipstick cases; hydrogen peroxide for cosmetic purposes; breath freshening strips; teeth whitening strips; abrasive cloth; glass cloth [abrasive cloth]; lipsticks; pomades for cosmetic purposes; breath freshening preparations for personal hygiene; shaving preparations; bath preparations, not for medical purposes; cosmetic preparations for baths; hair straightening preparations; hair waving preparations; laundry soaking preparations; grinding preparations; smoothing preparations [starching]; color-removing preparations; leather bleaching preparations; polishing preparations; denture polishes; mouth washes, not for medical purposes; cosmetic preparations for slimming purposes; starch glaze for laundry purposes; preparations to make the leaves of plants shiny; polishing preparations; eyewashes, not for medical purposes; fabric softeners for laundry use; laundry bleach; dry-cleaning preparations; paint stripping preparations; lacquer-removing preparations; make-up removing preparations; floor wax removers [scouring preparations]; varnish-removing preparations; rust removing preparations; nail care preparations; cleaning preparations; preparations for cleaning dentures; wallpaper cleaning preparations; preparations for unblocking drain pipes; chemical cleaning preparations for household purposes; collagen preparations for cosmetic purposes; bleaching preparations [decolorants] for household purposes; laundry preparations; aloe vera preparations for cosmetic purposes; sunscreen preparations; color-brightening chemicals for household purposes [laundry]; shining preparations [polish]; make-up powder; diamantine [abrasive]; stain removers; nail varnish removers; vaginal washes for personal sanitary or deodorant purposes; scouring solutions; false eyelashes; tissues impregnated with cosmetic lotions; tissues impregnated with make-up removing preparations; baby wipes impregnated with cleaning preparations; safrol; massage candles for cosmetic purposes; laundry blueing; turpentine, for degreasing;

potpourris [fragrances]; bleaching soda; washing soda, for cleaning; bath salts, not for medical purposes; bleaching salts; fumigation preparations [perfumes]; preservatives for leather [polishes]; ammonia [volatile alkali] [detergent]; astringents for cosmetic purposes; eyebrow cosmetics; make-up preparations; sun-tanning preparations [cosmetics]; hair dyes; neutralizers for permanent waving; cosmetic preparations for eyelashes; cosmetic preparations for skin care; shoe wax; cosmetics; cosmetics for children; cosmetics for animals; mascara; detergents other than for use in manufacturing operations and for medical purposes; cleansers for intimate personal hygiene purposes, non medicated; douching preparations for personal sanitary or deodorant purposes [toiletries]; degreasers other than for use in manufacturing processes; bleaching preparations [decolorants] for cosmetic purposes; toiletry preparations; antiperspirants [toiletries]; phyto-cosmetic preparations; talcum powder, for toilet use; cotton sticks for cosmetic purposes/cotton swabs for cosmetic purposes; terpenes [essential oils]; emery cloth; cloths impregnated with a detergent for cleaning; henna [cosmetic dyes]; shampoos; shampoos for animals [non-medicated grooming preparations]; shampoos for pets [non-medicated grooming preparations]; dry shampoos; sandpaper; soda lye; herbal extracts for cosmetic purposes; extracts of flowers [perfumes]; ethereal essences; badian essence; mint essence [essential oil].

5 – Acaricides, aconitine; alkaloids for medical purposes; alginates for pharmaceutical purposes; algicides; aldehydes for pharmaceutical purposes; dental amalgams of gold; dental amalgams; amino acids for veterinary purposes; amino acids for medical purposes; analgesics; anaesthetics; antibiotics; antiseptics; medicine cases, portable, filled; first-aid boxes, filled; aluminium acetate for pharmaceutical purposes; acetates for pharmaceutical purposes; germicides; balms for medical purposes; bandages for dressings; diagnostic biomarker reagents for medical purposes; biocides; bracelets impregnated with insect repellent; bromine for pharmaceutical purposes; paper for mustard plasters; fly catching paper; reagent paper for veterinary purposes; reagent paper for medical purposes; moth-proofing paper; petroleum jelly for medical purposes; vaccines; oxygen baths; antiseptic cotton; aseptic cotton; absorbent cotton; wadding for medical purposes; cotton for medical purposes; dietetic substances adapted for medical use; radiological contrast substances for medical purposes; nutritive substances for microorganisms; radioactive substances for medical purposes; bismuth subnitrate for pharmaceutical purposes; melissa water for pharmaceutical purposes; sea water for medicinal bathing; mineral waters for medical purposes; thermal water; dietary fiber; molding wax for dentists; gases for medical purposes; guaiacol for pharmaceutical purposes; sexual stimulant gels; hematogen; hemoglobin; hydrastine; hydrastinine; glycerine for medical purposes; glycerophosphates; glu-

cose for medical purposes; gentian for pharmaceutical purposes; hormones for medical purposes; mustard for pharmaceutical purposes; mustard plasters; mud for baths; medicinal mud; gamboge for medical purposes; gurjun balsam for medical purposes; disinfectants; deodorants, other than for human beings or for animals; air deodorising preparations; deodorants for clothing and textiles; diastase for medical purposes; digitalin, vitamin supplement patches; mineral food supplements; nutritional supplements; albumin dietary supplements; dietary supplements for animals; yeast dietary supplements; alginate dietary supplements; glucose dietary supplements; casein dietary supplements; lecithin dietary supplements; linseed oil dietary supplements; propolis dietary supplements; protein dietary supplements; protein supplements for animals; royal jelly dietary supplements; pollen dietary supplements; wheat germ dietary supplements; linseed dietary supplements; acai powder dietary supplements; dietary supplements with a cosmetic effect; enzyme dietary supplements; yeast for pharmaceutical purposes; gelatine for medical purposes; cod liver oil; isotopes for medical purposes; immunostimulants; insecticides; iodine for pharmaceutical purposes; iodides for pharmaceutical purposes; alkaline iodides for pharmaceutical purposes; iodoform; calomel [fungicide]; cream of tartar for pharmaceutical purposes; tartar for pharmaceutical purposes; camphor for medical purposes; capsules for medicines; cachets for pharmaceutical purposes; capsules made of dendrimer-based polymers, for pharmaceuticals; hemostatic pencils; wart pencils; caustic pencils; carbolineum [parasiticide]; caustics for pharmaceutical purposes; cachou for pharmaceutical purposes; quassia for medical purposes; quebracho for medical purposes; oxygen for medical purposes; gallic acid for pharmaceutical purposes; acids for pharmaceutical purposes; adhesives for dentures; surgical glues; stem cells for veterinary purposes; stem cells for medical purposes; cocaine; collagen for medical purposes; collodion for pharmaceutical purposes; corn rings for the feet; medicated sweets; angostura bark for medical purposes; barks for pharmaceutical purposes; cedar wood for use as an insect repellent; condurango bark for medical purposes; croton bark; mangrove bark for pharmaceutical purposes; myrobalan bark for pharmaceutical purposes; quinquina for medical purposes; medicated animal feed; medicinal roots; rhubarb roots for pharmaceutical purposes; lint for medical purposes; starch for dietetic or pharmaceutical purposes; creosote for pharmaceutical purposes; blood for medical purposes; cultures of microorganisms for medical or veterinary use; curare; dental lacquer; liquorice for pharmaceutical purposes; lactose for pharmaceutical purposes; medicated candies; adhesive plasters; medicines for alleviating constipation; adhesive tapes for medical purposes; lecithin for medical purposes; lotions for veterinary purposes; medicated hair lotions; lotions for pharmaceutical purposes; medicated after-shave

lotions; personal sexual lubricants; lupulin for pharmaceutical purposes; magnesia for pharmaceutical purposes; liniments; frostbite salve for pharmaceutical purposes; ointments for pharmaceutical purposes; sunburn ointments; mercurial ointments; gauze for dressings; medicinal oils; mustard oil for medical purposes; camphor oil for medical purposes; castor oil for medical purposes; oil of turpentine for pharmaceutical purposes; dill oil for medical purposes; dental mastics; dental abrasives; dental impression materials; teeth filling material; dressings, medical; surgical dressings; drugs for medical purposes; medicines for veterinary purposes; serotherapeutic medicines; medicines for human purposes; medicines for dental purposes; menthol; medicinal drinks; moleskin for medical purposes; almond milk for pharmaceutical purposes; powdered milk for babies; royal jelly for pharmaceutical purposes; milk ferments for pharmaceutical purposes; Irish moss for medical purposes; flour for pharmaceutical purposes; linseed meal for pharmaceutical purposes; fish meal for pharmaceutical purposes; fly glue; antibacterial soap; disinfectant soap; medicated soap; freeze-dried meat adapted for medical purposes; mint for pharmaceutical purposes; dietetic beverages adapted for medical purposes; malted milk beverages for medical purposes; injectable dermal fillers; narcotics; medicinal infusions; tincture of iodine; eucalyptol for pharmaceutical purposes; tinctures for medical purposes; opium; opodeldoc; decoctions for pharmaceutical purposes; antiparasitic collars for animals; cotton sticks for medical purposes/cotton swabs for medical purposes; stick liquorice for pharmaceutical purposes; sulfur sticks [disinfectants]; pastilles for pharmaceutical purposes; medicated dentifrices; pectin for pharmaceutical purposes; pepsins for pharmaceutical purposes; peptones for pharmaceutical purposes; hydrogen peroxide for medical purposes; pesticides; food for babies; leeches for medical purposes; blood plasma; nicotine patches for use as aids to stop smoking; eyepatches for medical purposes; poultices; compresses; scapulars for surgical purposes; babies' diapers; diapers for pets; diapers for incontinence; breast-nursing pads; bunion pads; pomades for medical purposes; powder of cantharides; pyrethrum powder; chilblain preparations; moth-proofing preparations; anti-uric preparations; bacterial preparations for medical and veterinary use; bacteriological preparations for medical and veterinary use; balsamic preparations for medical purposes; albuminous preparations for medical purposes; biological preparations for veterinary purposes; biological preparations for medical purposes; veterinary preparations; bismuth preparations for pharmaceutical purposes; vitamin preparations; diagnostic preparations for veterinary purposes; diagnostic preparations for medical purposes; douching preparations for medical purposes; bath preparations for medical purposes; therapeutic preparations for the bath; hemorrhoid preparations; preparations for callouses; lice treatment prepara-

tions [pediculicides]; acne treatment preparations; preparations to facilitate teething; preparations for the treatment of burns; fumigation preparations for medical purposes; opotherapy preparations/organotherapy preparations; air purifying preparations; bronchodilating preparations; preparations for reducing sexual activity; sterilising preparations; soil-sterilising preparations; corn remedies; pharmaceutical preparations for treating dandruff; preparations for destroying noxious animals; herbicides/weedkillers/preparations for destroying noxious plants; preparations for destroying dry rot fungus; larvae exterminating preparations; fly destroying preparations; preparations for destroying mice; slug exterminating preparations; vermin destroying preparations; pharmaceutical preparations for skin care; contact lens cleaning preparations; lime-based pharmaceutical preparations; preparations of microorganisms for medical or veterinary use; hemostatic preparations; medicated eye-washes; medicinal hair growth preparations; nutraceutical preparations for therapeutic or medical purposes; opiates; anticryptogamic preparations; aloe vera preparations for pharmaceutical purposes; preparations of trace elements for human and animal use; sulfonamides [medicines]; pharmaceutical preparations; pharmaceutical preparations for treating sunburn; enzyme preparations for veterinary purposes; enzyme preparations for medical purposes; phytotherapy preparations for medical purposes; chemico-pharmaceutical preparations; chemical preparations for veterinary purposes; chemical preparations for the diagnosis of pregnancy; chemical preparations for medical purposes; chemical preparations for treating diseases affecting cereal plants; chemical preparations for treating wheat blight/chemical preparations for treating wheat smut; chemical preparations for treating diseases affecting vine plants; chemical preparations for treating mildew; chemical preparations for treating phylloxera; chemical preparations for pharmaceutical purposes; collyrium; lead water; chemical conductors for electrocardiograph electrodes; albuminous foodstuffs for medical purposes; dietetic foods adapted for medical purposes; by-products of the processing of cereals for dietetic or medical purposes; homogenized food adapted for medical purposes; freeze-dried food adapted for medical purposes; pharmaceuticals; sanitary towels/sanitary napkins/sanitary pads; panty liners [sanitary]; propolis for pharmaceutical purposes; pearl powder for medical purposes; radium for medical purposes; solvents for removing adhesive plasters; hydrated chloral for pharmaceutical purposes; vaginal washes for medical purposes; solutions for contact lenses; chemical reagents for medical or veterinary purposes; gum for medical purposes; rubber for dental purposes; chewing gum for medical purposes; nicotine gum for use as an aid to stop smoking; insect repellents; insect repellent incense; repellents for dogs; tissues impregnated with pharmaceutical lotions; sarsaparilla for medical purposes; sugar for medical purposes; asthmatic tea; fu-

migating sticks; medicinal massage candles; suppositories; linseed for pharmaceutical purposes; tobacco-free cigarettes for medical purposes; siccatives [drying agents] for medical purposes; syrups for pharmaceutical purposes; turpentine for pharmaceutical purposes; milking grease; greases for veterinary purposes; greases for medical purposes; lacteal flour for babies; infant formula; soporifics; bicarbonate of soda for pharmaceutical purposes; mineral water salts; bath salts for medical purposes; salts for mineral water baths; salts for medical purposes; potassium salts for medical purposes; sodium salts for medical purposes; smelling salts; malt for pharmaceutical purposes; semen for artificial insemination; alcohol for pharmaceutical purposes; medicinal alcohol; alloys of precious metals for dental purposes; ergot for pharmaceutical purposes; cooling sprays for medical purposes; digestives for pharmaceutical purposes; nervines; antibacterial handwashes; adjuvants for medical purposes; astringents for medical purposes; vermifuges; disinfectants for hygiene purposes; disinfectants for chemical toilets; appetite suppressants for medical purposes; medical preparations for slimming purposes; parasiticides; mouthwashes for medical purposes; febrifuges; depuratives; animal washes [insecticides]; detergents for medical purposes; cattle washes [insecticides]; dog washes [insecticides]; insecticidal veterinary washes; vesicants; purgatives; chemical contraceptives; antiparasitic preparations; remedies for perspiration; remedies for foot perspiration; sedatives/tranquillizers; laxatives; tonics [medicines]; medicated toiletry preparations; media for bacteriological cultures; steroids, strychnine; serums; antioxidant pills; tanning pills; appetite suppressant pills; slimming pills; jujube, medicated; sanitary tampons; vulnerary sponges; thymol for pharmaceutical purposes; biological tissue cultures for veterinary purposes; biological tissue cultures for medical purposes; smoking herbs for medical purposes; medicinal herbs; grafts [living tissue]; surgical implants comprised of living tissues; babies' diaper-pants; pants, absorbent, for incontinence; sanitary panties; charcoal for pharmaceutical purposes; fennel for medical purposes; porcelain for dental prostheses; phenol for pharmaceutical purposes; enzymes for veterinary purposes; enzymes for medical purposes; ferments for pharmaceutical purposes; formic aldehyde for pharmaceutical purposes; phosphates for pharmaceutical purposes; fungicides; quinine for medical purposes; chinoline for medical purposes; diabetic bread adapted for medical use; chloroform; flowers of sulfur for pharmaceutical purposes; cement for animal hooves; bone cement for surgical and orthopaedic purposes; dental cements; medicinal tea; herbal teas for medicinal purposes; insecticidal animal shampoos; medicated shampoos; medicated shampoos for pets; pediculicidal shampoos; medicated dry shampoos; pre-filled syringes for medical purposes; eucalyptus for pharmaceutical purposes; herbal extracts for medical purposes; plant ex-

tracts for pharmaceutical purposes; tobacco extracts [insecticides]; extracts of hops for pharmaceutical purposes; elixirs [pharmaceutical preparations]; ethers for pharmaceutical purposes; esters for pharmaceutical purposes; cellulose esters for pharmaceutical purposes; cellulose ethers for pharmaceutical purposes; rat poison; poisons; bacterial poisons; jalap.

35 – Arranging subscriptions to telecommunication services for others; import-export agency services; commercial information agency services; advertising agency services; cost price analysis; rental of office equipment in coworking facilities; rental of advertising space; business auditing; financial auditing; business intermediary services relating to the matching of potential private investors with entrepreneurs needing funding; employment agency services; computerized file management; book-keeping; invoicing; demonstration of goods; transcription of communications [office functions]; opinion polling; market studies; business information; providing commercial information and advice for consumers in the choice of products and services; business investigations; business research; marketing research; personnel recruitment; consultancy regarding advertising communication strategies; consultancy regarding public relations communication strategies; business management and organization consultancy; business organization consultancy; business management consultancy; personnel management consultancy; professional business consultancy; layout services for advertising purposes; marketing; marketing in the framework of software publishing; targeted marketing; business management of performing artists; business management of sports people; writing of resumes for others; scriptwriting for advertising purposes; news clipping services; updating and maintenance of information in registries; updating and maintenance of data in computer databases; updating of advertising material; word processing; online retail services for downloadable and pre-recorded music and movies; online retail services for downloadable ring tones; online retail services for downloadable digital music; organization of exhibitions for commercial or advertising purposes; arranging newspaper subscriptions for others; organization of fashion shows for promotional purposes; organization of trade fairs for commercial or advertising purposes; shop window dressing; preparation of advertising material; business appraisals; payroll preparation; data search in computer files for others; sponsorship search; administrative assistance in responding to calls for tenders; business management assistance; commercial or industrial management assistance; commercial intermediation services; providing business information via a web site; providing commercial and business contact information; provision of an online marketplace for buyers and sellers of goods and services; web indexing for commercial or advertising purposes; presentation of goods on communication media, for retail purposes; media relations services;

economic forecasting; auctioneering; wholesale services for pharmaceutical, veterinary and sanitary preparations and medical supplies; retail services for works of art provided by art galleries; retail services for pharmaceutical, veterinary and sanitary preparations and medical supplies; sales promotion for others; promotion of goods and services through sponsorship of sports events; production of teleshopping programmes; production of advertising films; office machines and equipment rental; rental of advertising time on communication media; publicity material rental; rental of billboards [advertising boards]; rental of vending machines; rental of sales stands; rental of photocopying machines; publication of publicity texts; radio advertising; bill-posting, distribution of samples; dissemination of advertising matter; direct mail advertising; registration of written communications and data; writing of publicity texts; advertising; online advertising on a computer network; outdoor advertising; advertising by mail order; television advertising; reproduction of documents; compilation of information into computer databases; compilation of statistics; business inquiries; systemization of information into computer databases; advisory services for business management; corporate communications services; negotiation of business contracts for others; negotiation and conclusion of commercial transactions for third parties; compiling indexes of information for commercial or advertising purposes; tax preparation; drawing up of statements of accounts; telemarketing services; psychological testing for the selection of personnel; interim business management; outsourced administrative management for companies; business management of hotels; business management for freelance service providers; business project management services for construction projects; commercial administration of the licensing of the goods and services of others; business management of reimbursement programs for others; administration of consumer loyalty programs; administration of frequent flyer programs; administrative processing of purchase orders; public relations; commercial lobbying services; competitive intelligence services; modelling for advertising or sales promotion; typing; market intelligence services; appointment reminder services [office functions]; web site traffic optimization; administrative services for the relocation of businesses; tax filing services; search engine optimization for sales promotion; appointment scheduling services [office functions]; gift registry services; price comparison services; pay per click advertising; secretarial services; procurement services for others [purchasing goods and services for other businesses]; shorthand; outsourcing services [business assistance]; telephone answering for unavailable subscribers; photocopying services; business efficiency expert services.

(260) AM 2022 115462 A

(800) 1626490

(151) 2021 09 14

(891) 2021 09 14

(731) Neway Valve (Suzhou) Co., Ltd.

No.666 Taishan Road, New &amp; Hi-tech

Industrial Development Zone, Suzhou, 215000

Jiangsu Province, China

(540)



(591) Black, white

(531) 27.05.09; 27.05.22

(511)

6 – Valves of metal, other than parts of machines; pipework of metal; junctions of metal for pipes; wall hooks of metal for pipes; water-pipe valves of metal; collars of metal for fastening pipes; reinforcing materials of metal for pipes; drain traps [valves] of metal; flanges of metal [collars]; washers of metal.

(260) AM 2022 115463 A

(800) 1626549

(151) 2021 05 25

(891) 2021 05 25

(731) H &amp; M Hennes &amp; Mauritz AB

Mäster Samuelsgatan 46A, SE-106 38

Stockholm, Sweden

(540)

## H&M MOVE

(591) Black, white

(511)

9 – Pedometers; sunglasses; mobile telephone cases; glasses for sports; swim goggles.

10 – Graduated compression hosiery; compression panty hose; foam massage rollers; trigger balls; massage balls; pressure relief pads and cushions; face masks for medical use.

18 – Leather and imitations of leather; animal skins and hides; luggage; bags; umbrellas; travelling bags; wallets; handbags; evening handbags; work bags; shoulder bags; canvas bags; shopping bags; cases for toiletries, sold empty; rucksacks; athletics bags; purses; trunks (luggage); key cases.

25 – Clothing; footwear; headgear; sport suits; bathing drawers; swimsuits; bath robes; bikinis; pantsuits; sports pants; neckerchiefs; gloves; sports jackets; shell jackets; soft shell jackets; padded jackets; sports shorts; skirts; sports underwear; short-sleeve shirts; sports jumpers; overalls; pocket squares; polo neck jumpers; rainwear; scarves; sports shirts; beachwear; sports tank tops; sports bras; athletic tights; sports stockings; sweaters; sports t-shirts; waistcoats; underclothing; mittens; outer clothing; coats; jackets;

children's clothing; t-shirts; shorts; tights; tank tops; pants; jumpers; underwear; stockings; hats; caps; beanies; toques; visors; headbands; running shoes; training shoes; hiking shoes; hiking boots; face masks [fashion wear]; wetsuits for surface watersports; neck tubes; sweatbands.

28 – Games; playthings; gymnastic and sporting articles; rubber bands for exercise; dumbbells; exercise weights; yoga blocks; gym balls for yoga; yoga straps; kettle bells; rings for sports; manually operated rings for lower and upper body resistance exercise; pilates balls; skipping ropes.

35 – Advertising and marketing services; providing consumer information relating to goods and services; retail services regarding sunglasses, glasses for sports, swim glasses, glass bottles, plastic bottles, clothing, footwear, headgear, compression socks, yoga mats, games and playthings, gymnastic and sporting articles, sport accessories, mobile cases, key holders, card holders, foam massage rollers, massage balls, pillows.

41 – Gym activity classes; yoga instruction; pilates instruction; sports and fitness services; rental services relating to equipment and facilities for sports.

(260) AM 2022 115464 A

(800) 1626555

(151) 2021 06 08

(891) 2021 06 08

(731) Euro Games Technology Ltd.

4, "Maritsa" Str., "Vranya-Lozen-Triugulnika",  
BG-1151 Sofia, Bulgaria

(540)



(591) Yellow, gold, orange, red, green and black

(531) 27.05.02; 27.05.03; 27.05.04; 27.05.17;  
27.05.19; 29.01.15

(511)

9 – Software; computer gaming software; computer software packages; computer operating system software; computer software, recorded; software drivers; virtual reality software; games software; entertainment software for computer games; computer programs for network management; operating computer software for main frame computers; monitors (computer hardware); computer hardware; apparatus for recording images; monitors (computer programs); computer game programs; computer programs for recorded games; apparatus for recording, transmission or reproduction of sound or images; communications servers [computer hardware]; electronic components

for gambling machines; computer application software featuring games and gaming; computer software for the administration of on-line games and gaming; computer hardware for games and gaming; electronic components and software for gambling, gambling machines, gambling games on the Internet and via telecommunication network.

28 – Gaming machines for gambling; chips for gambling; mah-jong; arcade games; gambling machines operating with coins, notes and cards; games; electronic games; parlor games; gaming chips; gaming tables; slot machines [gaming machines]; LCD game machines; slot machines and gaming devices; coin-operated amusement machines; roulette chips; poker chips; chips and dice [gaming equipment]; gaming equipment for casinos; roulette tables; gaming roulette wheels; casino games; gambling machines and amusement machines, automatic and coin-operated; coin-operated amusement machines and/or electronic coin-operated amusement machines with or without the possibility of gain; boxes for coin-operated machines, slot machines and gaming machines; electronic or electrotechnical amusement machines and apparatus, gaming machines, coin-operated entertainment machines; housings for coin-operated machines, gaming equipment, gaming machines, machines for gambling; electropneumatic and electrical gambling machines (slot machines).

41 – Gambling; entertainment services related to gambling; gaming services for entertainment purposes; casino, gaming and gambling services; training in the development of software systems; provision of equipment for gambling halls; providing casino equipment [gambling]; gaming machine entertainment services; providing casino facilities [gambling]; gaming hall services; amusement arcade services; games equipment rental; rental of gaming machines; providing amusement arcade services; rental of gaming machines with images of fruits; editing or recording of sounds and images; sound recording and video entertainment services; hire of sound reproducing apparatus; provision of gaming equipment for casinos; providing of casino facilities; online gambling services; casino, gaming and gambling services; provision of gaming facilities, gaming hall facilities, Internet casinos and online gambling services.

(260) AM 2022 115797 A

(800) 1633371

(151) 2021 10 19

(891) 2021 10 19

(731) Philip Morris Products S.A.

Quai Jeanrenaud 3, CH-2000 Neuchâtel,  
Switzerland

(540)

**BLACK PURPLE**

(591) Black, white



(511)  
34 – Wired vaporizers for electronic cigarettes and electronic smoking devices; tobacco, raw or manufactured; tobacco products, including cigars, cigarettes, cigarillos, tobacco for roll-your-own cigarettes, pipe tobacco, chewing tobacco, snuff tobacco, kretek; snus; tobacco substitutes (not for medical purposes); smokers' articles, including cigarette paper and tubes, cigarette filters, tobacco tins, cigarette cases and ashtrays, pipes, pocket apparatus for rolling cigarettes, lighters; matches; tobacco sticks, tobacco products for the purpose of being heated, electronic devices and their parts for the purpose of heating cigarettes or tobacco in order to release nicotine-containing aerosols for inhalation; liquid nicotine solutions for use in electronic cigarettes; electronic smoking devices; electronic cigarettes; electronic cigarettes as substitutes for traditional cigarettes; electronic devices for the inhalation of nicotine-containing aerosols; oral vaporizing devices for smokers, tobacco products and tobacco substitutes; smokers' articles for electronic cigarettes; parts and fittings for the aforesaid products included in this class; devices for extinguishing heated cigarettes and cigars as well as heated tobacco sticks; electronic rechargeable cigarette cases.

(260) AM 2022 115938 A  
(800) 1634984  
(151) 2021 10 06  
(891) 2021 10 06  
(731) Datum Dental Ltd.  
1 Bat Sheva St., 7120101 Lod, Israel  
(540)

## OSSIX

(591) Black, white  
(511)  
5 – Collagen for medical purposes; biodegradable implants for use in guided tissue regeneration; dental implant materials; bone void and soft tissue fillers consisting of biological and natural materials; bone growth media consisting of biological materials for medical purposes.  
10 – Regenerative membranes for use in dentistry; surgical implants comprised of artificial materials for gum tissue regeneration; surgical implants comprised of artificial materials for use in guided tissue regeneration; bone void and soft tissue fillers comprising of artificial materials; prosthetic tissues for parietal use.

(260) AM 2022 116094 A  
(800) 1637200  
(151) 2021 02 02  
(891) 2021 02 02  
(731) MARSALA DOKUMA BOYA SANAYİ VE  
TİCARET ANONİM ŞİRKETİ

Işıktepe Osb Mah. Turuncu Cad. 2.,  
Sok. No:3, Nilüfer, Bursa, Turkey  
(540)

## MARSALA HOME

(591) Black, white  
(531) 27.05.10  
(511)  
20 – Mattresses; pillows; air mattresses and cushions, not for medical purposes, water beds.  
24 – Woven or non-woven textile fabrics; textile goods for household use, not included in other classes: curtains, bed covers, sheets (textile), pillowcases, blankets, quilts, towels; flags, pennants, labels of textile; swaddling blankets; sleeping bags for camping.  
35 – The bringing together, for the benefit of others, of a variety of goods, namely, mattresses, pillows, air mattresses and cushions, not for medical purposes, water beds, woven or non-woven textile fabrics, textile goods for household use, not included in other classes: curtains, bed covers, sheets (textile), pillowcases, blankets, quilts, towels, flags, pennants, labels of textile, swaddling blankets, sleeping bags for camping, clothing, including underwear and outer clothing, other than special purpose protective clothing, socks, mufflers [clothing], shawls, bandanas, scarves, belts [clothing], footwear, shoes, slippers, sandals, headgear, hats, caps with visors, berets, caps [headwear], skull caps, enabling customers to conveniently view and purchase those goods, such services may be provided by retail stores, wholesale outlets, by means of electronic media or through mail order catalogues.

(260) AM 2022 116095 A  
(800) 1637222  
(151) 2021 05 10  
(891) 2021 05 10  
(731) BMC OTOMOTİV SANAYİ VE TİCARET  
A.Ş.  
SANAYİ MAHALLESİ, TEKNOPARK  
BULVARI, NO:1/4C 301, TR-34906 PENDİK  
İSTANBUL, Turkey  
(540)

## TUĞRA

(591) Black, white  
(531) 27.05.01  
(511)  
12 – Motor land vehicles and motors, parts for these vehicles (including motorcycles, scooters); bicycles and their bodies, handlebars, mud flaps; vehicle trailers, dumper trailers, tractor-trailers, refrigerated trailers, trailer connections, dumps for vehicles, lifting car; vehicle seats, headrests for vehicles seats, baby's safety seats for vehicles, seat sheaths for vehicles, vehicle covers, sun visors for vehicles; direction signals

and arms for direction signals for vehicles, windscreens wipers for vehicle, wiper arms for vehicle; inner tubes and tyres for vehicles, tubeless tires, tire repair sets, patches for vehicle tires, weld patches, valves for vehicle tires; vehicle windows made of glass, vehicle windows made of safety glass, rearview mirrors and side mirrors for vehicles; tire chains, numberplate mounts; trolleys for vehicles, bicycle and ski carriers, bicycle saddles; air pumps for vehicle tires; anti-theft alarms for vehicles, vehicle horns; seat belts for passengers, airbags for vehicles; buggies, wheelchairs, strollers; handcarts, bazaar carts, handcarts with one or more wheels, market carts, wheeled carriers for household goods; rail vehicles: locomotives, trains, tramways, wagons, cable cars, chair lifts; sea vehicles and parts (except motors); air vehicles and their parts (except motors).

(260) AM 2022 116098 A  
 (800) 1637326  
 (151) 2021 10 05  
 (891) 2021 10 05  
 (731) ŠKODA AUTO a.s.  
 tř. Václava Klementa 869, CZ-293 01  
 Mladá Boleslav, Mladá Boleslav II,  
 Czech Republic

(540)



(591) Silver, grey and black

(531) 27.05.03

(511)

9 – Wallboxes, battery energy storage, chargers, wall chargers for home, car chargers, electric-car and hybrid-car chargers, chargers for electric batteries, battery chargers, chargers for accumulators, wireless chargers, portable chargers, chargers for electric accumulators, battery charging devices for motor vehicles, fast chargers for mobile devices, charging stations for electric cars, power packs, photovoltaic apparatus for generating electricity, electric control devices for energy management, bags for charging cables.

(260) AM 2022 116099 A

(800) 1637337

(151) 2021 09 08

(891) 2021 09 08

(731) WAHL GmbH

Roggenbachweg 9, 78089 Unterkirnach,  
 Germany

(540)



(591) Black, white

(531) 27.05.01; 27.05.19; 27.05.22

(511)

7 – Electric and non-electric animal shearing machines and hair clipping machines for animals; accessories and parts for the aforesaid goods.

8 – Electric and non-electric hair clippers, hair trimmers, hair cutting machines, beard trimmers, beard clippers, shavers, and razors; hair straighteners and curling tongs; accessories and parts for the aforesaid goods in particular attachment combs, cutting sets, shaving foils, trimming attachments and blades as well as attachable diffusers, nozzles, brushes and combs.

11 – Electric hair dryers; accessories and parts for the aforesaid goods in particular attachable diffusers, nozzles, brushes and combs.

35 – Retail services relating to shampoos, hair conditioners, hair dyes, hair colorants, hair lotions, hair spray, hair straightening preparations and hair waxing preparations, all of the aforesaid goods for humans and animals; retail services relating to electric and non-electric animal shearing machines and hair clipping machines for animals; accessories and parts for the aforesaid goods; retail services relating to electric batteries; battery chargers and battery packs; retail services relating to electric and non-electric hair clippers, hair trimmers, hair cutting machines, beard trimmers, beard clippers, shavers, and razors; accessories and parts for the aforesaid goods, in particular attachment combs, cutting sets, shaving foils, trimming attachments and blades; retail services relating to hair dryers, hair straighteners and curling tongs; accessories and parts for the aforesaid goods, in particular attachable diffusers, nozzles, brushes and combs; retail services relating to brushes for animals, fur brushes for animals.

(260) AM 2022 116100 A

(800) 1637350

(151) 2021 10 19

(891) 2021 10 19

(731) International commercial company

"CROSTALIA TRADING LIMITED"

Totalserve Trust Company Limited, Trust  
 Offices, P.O. Box 3540, Road Town, Tortola,  
 VG1110, Virgin Islands (British)

(540)



(591) White, green, light green, blue

(531) 09.07.19; 28.05; 29.01.12

(526) The "R" element in the circle.

(511)

29 – Ajvar being preserved peppers; aloe vera prepared for human consumption; alginates for culinary purposes; anchovy, not live; peanuts, prepared; artichokes, preserved; albumen for culinary purposes; white of eggs; beans, preserved; soya beans, preserved, for food; broth; ginger jam; ham; fatty substances for the manufacture of edible fats; laver, preserved; edible birds' nests; peas, preserved; mushrooms, preserved; guacamole; game, not live; gelatine; meat jellies; jellies for food; fruit jellies; yolk of eggs; coconut fat; bone oil for food; lard; suet for food; edible fats; fruit-based snack food; milk substitutes; soya patties; charcuterie; raisins; caviar; aubergine paste; vegetable marrow paste; fish roe, processed; yogurt; sauerkraut; kephir; kimchi; isinglass for food; clams, not live; potato-based dumplings; klipfish [salted and dried cod]; milk shakes; black pudding; onion rings; arrangements of processed fruit; compotes; meat, tinned; vegetables, tinned; fish, tinned; fruits, tinned; broth concentrates; corn dogs; gherkins; shrimps, not live; prawns, not live; buttercream; croquettes; silk-worm chrysalis for human consumption; sweet corn, processed; koumiss; spiny lobsters, not live; lecithin for culinary purposes; salmon, not live; onions, preserved; margarine; marmalade; oils for food; peanut butter; cocoa butter for food; coconut oil for food; coconut butter; maize oil for food; sesame oil for food; linseed oil for food; extra virgin olive oil for food; olive oil for food; palm oil for food; palm kernel oil for food; sunflower oil for food; rape oil for food; butter; soya bean oil for food; shellfish, not live; almonds, ground; animal marrow for food; mussels, not live; milk; peanut milk; peanut milk for culinary purposes; coconut milk; coconut milk for culinary purposes; almond milk; almond milk for culinary purposes; oat milk; rice milk; rice milk for culinary purposes; albumin milk; condensed milk; soya milk; powdered milk; fish meal for human consumption; vegetable mousses; fish mousses; fruit pulp; meat; meat, preserved; freeze-dried meat; milk beverages, milk predominating; peanut milk-based beverages; coconut milk-based beverages; almond milk-based beverages; edible insects, not live; sausage casings, natural or artificial; vegetables, preserved; freeze-dried vegetables; vegetables, dried; vegetables, cooked; potato fritters; olives, preserved; lobsters, not live; flavoured nuts; candied nuts; coconut, desiccated; nuts, prepared; tomato purée; pressed fruit paste; liver pâté; pectin for culinary purposes; liver; pickles; jams; powdered eggs; milk products; fish-based foodstuffs; curd; poultry, not live; bulgogi; pollen prepared as foodstuff; cranberry compote; dense tomato purée; apple purée; crayfish, not live; crustaceans, not live; fish, preserved; fish, not live; salted fish; ryazhenka being fermented baked milk; vegetable salads; fruit salads; bacon; sardines, not live; pork; herrings, not live; seeds, prepared; sunflower seeds, prepared; cream [dairy products]; whipped cream; vegetable-based cream; fat-containing

mixtures for bread slices; smetana; lemon juice for culinary purposes; tomato juice for cooking; vegetable juices for cooking; salted meats; sausages; sausages in batter; hot dog sausages; preparations for making bouillon; preparations for making soup; nut-based spreads; tripe; soups; vegetable soup preparations; whey; cottage cheese fritters; cheese; tajine [prepared meat, fish or vegetable dish]; tahini; tofu; sea-cucumbers, not live; truffles, preserved; tuna, not live; oysters, not live; falafel; milk ferments for culinary purposes; rennet; fish fillets; dates; crystallized fruits; frozen fruits; fruit, preserved; fruit preserved in alcohol; fruit, stewed; hazelnuts, prepared; potato flakes; hummus [chickpea paste]; fruit peel; preserved garlic; lentils, preserved; potato crisps; low-fat potato crisps; fruit chips; non-alcoholic eggnog; seaweed extracts for food; meat extracts; escamoles being prepared edible ant larvae; yuba being tofu skin; berries, preserved; eggs; snail eggs for consumption; yakitori.

30 – Aromatic preparations for food; vanilla flavourings for culinary purposes; flavourings, other than essential oils, for cakes; flavourings, other than essential oils, for beverages; coffee flavourings; food flavourings, other than essential oils; star aniseed; baozi; cereal bars; high-protein cereal bars; pancakes; noodle-based prepared meals; freeze-dried dishes with the main ingredient being pasta; freeze-dried dishes with the main ingredient being rice; buns; bulgur; bread rolls; edible rice paper; edible paper; burritos; vanillin [vanilla substitute]; vareniki [stuffed dumplings]; waffles; vermicelli; natural sweeteners; sausage binding materials; binding agents for ice cream; seawater for cooking; seaweed [condiment]; malt biscuits; cloves [spice]; mirror icing [mirror glaze]; cake frosting [icing]; glucose for culinary purposes; mustard; croûtons; buckwheat, processed; gluten additives for culinary purposes; yeast; thickening agents for cooking foodstuffs; leaven; rice-based snack food; cereal-based snack food; artificial coffee; vegetal preparations for use as coffee substitutes; dressings for salad; zephyr being confectionery; fruit jellies [confectionery]; candy decorations for cakes; confectionery for decorating Christmas trees; cakes; pastries; peanut confectionery; almond confectionery; pasta; ginger [spice]; frozen yogurt [confectionery ices]; cocoa; cream of tartar for culinary purposes; capers; caramels [sweets]; curry [spice]; ketchup [sauce]; prepared rice rolled in seaweed; kimchi pancakes; quinoa, processed; quiches; gluten prepared as foodstuff; flour-based dumplings; sweets; liquorice [confectionery]; peppermint sweets; mints for breath freshening; dulce de leche; cinnamon [spice]; coffee; unroasted coffee; starch for food; crackers; custard; hominy grits; semolina; oatmeal; crushed barley; groats for human food; ice cubes; corn, milled; corn, roasted; meat pies; turmeric; couscous; noodles; soba noodles; udon noodles; ice for refreshment; ice, natural or artificial; edible ices; lollipops [confectionery]; rice cakes; potato-based flatbreads; mayonnaise; macarons; macaroni;

maltose; hominy; piccalilli; marinades; marzipan; honey; miso [seasoning]; royal jelly; ice cream; bean meal; buckwheat flour; tapioca flour; potato flour; corn flour; nut flours; flour; wheat flour; soya flour; barley meal; dessert mousses [confectionery]; chocolate mousses; muesli; mint for confectionery; cocoa beverages with milk; coffee beverages with milk; coffee-based beverages; cocoa-based beverages; chamomile-based beverages; tea-based beverages; chocolate beverages with milk; chocolate-based beverages; infusions, not medicinal; crushed oats; husked oats; okonomiyaki [Japanese savory pancakes]; onigiri; nutmegs; chocolate-coated nuts; stick liquorice [confectionery]; soya bean paste [seasoning]; pastila [confectionery]; lozenges [confectionery]; molasses for food; pâtés en croûte; pelmeni; pepper; allspice; peppers [seasonings]; pesto; biscuits; petit-beurre biscuits; bibimbap [rice mixed with vegetables and beef]; pies; pizzas; meat gravies; fondants [confectionery]; popcorn; powders for making ice cream; baking powder; mustard meal; pralines; condiments; meat tenderizers for household purposes; cereal preparations; oat-based food; propolis; gingerbread; spices; petits fours; rice pudding; puddings; cake powder; fruit coulis [sauces]; ravioli; ramen; chewing gum; chewing gum for breath freshening; relish [condiment]; rice; instant rice; wheat germ for human consumption; spring rolls; sago; sugar; palm sugar; sesame seeds [seasonings]; linseed for culinary purposes [seasoning]; processed seeds for use as a seasoning; aniseed; agave syrup [natural sweetener]; golden syrup; confectionery; batter mixes for okonomiyaki [Japanese savory pancakes]; baking soda [bicarbonate of soda for cooking purposes]; malt for human consumption; salt for preserving foodstuffs; cooking salt; celery salt; sorbets [ices]; ham glaze; cranberry sauce [condiment]; soya sauce; tomato sauce; apple sauce [condiment]; sauces [condiments]; pasta sauce; spaghetti; seasonings; chocolate-based spreads; chocolate spreads containing nuts; preparations for stiffening whipped cream; shaved ice with sweetened red beans; rusks; breadcrumbs; sushi; senbei [rice crackers]; sandwiches; tabbouleh; tacos; tapioca; tarts; dough; pastry dough; almond paste; rice pulp for culinary purposes; cake batter; tortillas; garden herbs, preserved [seasonings]; chocolate decorations for cakes; vinegar; beer vinegar; ferments for pastes; halvah; bread; unleavened bread; chips [cereal products]; corn flakes; oat flakes; hot dog sandwiches; flowers or leaves for use as tea substitutes; jiaozi; chicory [coffee substitute]; tea; iced tea; chutneys [condiments]; minced garlic [condiment]; cheeseburgers [sandwiches]; chow-chow [condiment]; saffron [seasoning]; chocolate; malt extract for food; essences for foodstuffs, except etheric essences and essential oils; husked barley.

(260) AM 2022 116101 A  
 (800) 1637405  
 (151) 2021 11 13  
 (891) 2021 11 13  
 (731) Papa John's International, Inc.  
 2002 Papa John's Boulevard, Louisville  
 KY 40299, USA

(540)

**PAPAJOHNS**  
 Better Ingredients. Better Pizza.

(591) red and green  
 (531) 27.05.01; 27.05.14; 29.01.12  
 (511)  
 29 – Chicken; chicken nuggets; chicken wings; prepared foods for consumption on or off the premises, namely chicken; cheese sticks.  
 30 – Pizza; flatbread, piadina, pizza turnover, calzone and Stromboli; pizza cheese sticks; bread rolls; pepperoni rolls; breadsticks; cookies; brownies; baked desserts, namely cinnamon bread and cookie cakes; sauces; spicy sauces; seasonings.  
 39 – Pizza delivery services; delivery of food and drinks by restaurants.  
 43 – Restaurant services; restaurant services featuring in-restaurant dining and carryout and delivery services; takeaway restaurant services.

(260) AM 2022 116102 A  
 (800) 1637433  
 (151) 2021 11 23  
 (891) 2021 11 23  
 (731) ZAMZAMTECHNOLOGY LLC  
 8 The Green Suite #6932, Dover DE 19901,  
 USA  
 (540)



(591) Black, white  
 (531) 26.01.03; 26.01.16; 26.01.24; 26.13.25  
 (511)  
 36 – Financial cryptocurrency exchange services; banking services; financial securities and commodity trading services for others; margin lending, namely, money lending that allows the borrower to invest the money; financial services, namely, brokerage and trading services for securities, stocks, bonds, capital investments, commodities and equities; financial investment brokerage services; providing information in the fields of investment and finance over computer

networks and global communication networks; financial information provided by electronic means in the field of finance, securities trading, investments, securities brokerage; electronic financial trading services; electronic financial trading services for others via a global computer network; cryptocurrency, namely, providing a virtual currency, namely, digital currency and digital tokens, for use by members of a community via a global computer network; cryptocurrency, namely, providing electronic transfer of a virtual currency for use by members of an online community via a global computer network; issuance of digital tokens of value; payment processing services in the field of digital currency, cryptocurrency, and the electronic transfer of financial instruments and digital tokens; cryptocurrency exchange services; virtual currency trading services; digital currency trading services; financial services, namely, providing a virtual currency for use by members of an online community via a global computer network; financial services, namely, providing electronic transfer of a virtual currency for use by members of an online community via a global computer network; electronic funds transfer services; providing monetary exchange services, namely, exchanging cash of others for digitized assets, namely, bitcoins, cryptocurrency, digital tokens, collateral for derivatives, derivative contracts, virtual currency, and digital currency; financial services, namely, providing virtual currency tokens using blockchain technology for use by members of an online community via a global computer network.

(260) AM 2022 116103 A

(800) 1637434

(151) 2021 11 23

(891) 2021 11 23

(731) ZAMZAMTECHNOLOGY LLC

8 The Green Suite #6932, Dover DE 19901,  
USA

(540)



(591) Black, white

(531) 26.01.03; 26.01.16; 26.01.18; 26.01.24;  
27.05.10

(526) TOKEN

(511)

36 – Financial cryptocurrency exchange services; banking services; financial securities and commodity trading services for others; margin lending, namely, money lending that allows the borrower to invest the money; financial services, namely, brokerage and trading services for securities, stocks, bonds, capital investments, commodities and equities; financial investment brokerage services; providing information in the fields of investment and finance over computer networks and global communication networks; finan-

cial information provided by electronic means in the field of finance, securities trading, investments, securities brokerage; electronic financial trading services; electronic financial trading services for others via a global computer network; cryptocurrency, namely, providing a virtual currency, namely, digital currency and digital tokens, for use by members of a community via a global computer network; cryptocurrency, namely, providing electronic transfer of a virtual currency for use by members of an online community via a global computer network; issuance of digital tokens of value; payment processing services in the field of digital currency, cryptocurrency, and the electronic transfer of financial instruments and digital tokens; cryptocurrency exchange services; virtual currency trading services; digital currency trading services; financial services, namely, providing a virtual currency for use by members of an online community via a global computer network; financial services, namely, providing electronic transfer of a virtual currency for use by members of an online community via a global computer network; electronic funds transfer services; providing monetary exchange services, namely, exchanging cash of others for digitized assets, namely, bitcoins, cryptocurrency, digital tokens, collateral for derivatives, derivative contracts, virtual currency, and digital currency; financial services, namely, providing virtual currency tokens using blockchain technology for use by members of an online community via a global computer network.

(260) AM 2022 116213 A

(800) 1602531

(151) 2021 05 20

(891) 2021 11 24

(731) Jingheng Tengwei (Huizhou) Electronic  
Technology Co., Ltd

Dahetian, Shangnan Village, Yuanzhou Town,  
Boluo County, Huizhou City, Guangdong  
Province, China

(540)

**HOTSPARD**

(591) Black, white

(531) 27.05.01

(511)

9 – Computer peripheral devices; computer keyboards; mouse [computer peripheral]; wrist rests for use with computers; computer game software, recorded; headphones; cabinets for loudspeakers; microphones; eyeglasses; chargers for electric accumulators.

---

**INTERNATIONAL TRADEMARKS PROTECTED IN GEORGIA**

(260) AM 2022 102134 A  
(800) 1342799  
(151) 2016 12 27  
(181) 2026 12 27  
(891) 2019 02 08

---

(260) AM 2022 110841 A  
(800) 1564860  
(151) 2020 09 02  
(181) 2030 09 02  
(891) 2020 09 02  
(511) 30

---

(260) AM 2022 112427 A  
(800) 1583491  
(151) 2021 01 28  
(181) 2031 01 28  
(891) 2021 01 28  
(511) 29

---

(260) AM 2022 112744 A  
(800) 1587252  
(151) 2021 03 11  
(181) 2031 03 11  
(891) 2021 03 11  
(511) 36

---

(260) AM 2022 112746 A  
(800) 1587376  
(151) 2021 03 11  
(181) 2031 03 11  
(891) 2021 03 11  
(511) 36

---

(260) AM 2022 113630 A  
(800) 1597690  
(151) 2021 02 15  
(181) 2031 02 15  
(891) 2021 02 15  
(511) 25

---

(260) AM 2022 113713 A  
(800) 1599135  
(151) 2021 03 31  
(181) 2031 03 31  
(891) 2021 03 31  
(511) 29

---

(260) AM 2022 113842 A  
(800) 1580793  
(151) 2021 01 19  
(181) 2031 01 19  
(891) 2021 05 21  
(511) 35, 41

---

(260) AM 2022 113899 A  
(800) 1601921  
(151) 2021 05 10  
(181) 2031 05 10  
(891) 2021 05 10  
(511) 43

---

(260) AM 2022 113900 A  
(800) 1602036  
(151) 2021 04 08  
(181) 2031 04 08  
(891) 2021 04 08  
(511) 13, 35

---

(260) AM 2022 113901 A  
(800) 1602037  
(151) 2020 10 12  
(181) 2030 10 12  
(891) 2020 10 12  
(511) 03, 09, 14, 16, 18, 21, 24, 25, 28, 35, 39, 40, 42

---

(260) AM 2022 113902 A  
(800) 1602062  
(151) 2021 04 27  
(181) 2031 04 27  
(891) 2021 04 27  
(511) 05, 10, 35

---

(260) AM 2022 113903 A  
(800) 1602077  
(151) 2021 02 18  
(181) 2031 02 18  
(891) 2021 02 18  
(511) 21

---

(260) AM 2022 113904 A  
(800) 1602104  
(151) 2021 02 18  
(181) 2031 02 18  
(891) 2021 02 18  
(511) 21

---

(260) AM 2022 113905 A  
(800) 1602109  
(151) 2021 05 21  
(181) 2031 05 21  
(891) 2021 05 21  
(511) 01, 05

---

(260) AM 2022 113944 A  
(800) 1602824  
(151) 2021 03 23  
(181) 2031 03 23  
(891) 2021 03 23  
(511) 09

---

(260) AM 2022 113906 A  
(800) 1602133  
(151) 2021 04 29  
(181) 2031 04 29  
(891) 2021 04 29  
(511) 29, 30

---

(260) AM 2022 113945 A  
(800) 1602881  
(151) 2021 05 18  
(181) 2031 05 18  
(891) 2021 05 18  
(511) 05, 10, 44

---

(260) AM 2022 113907 A  
(800) 1602188  
(151) 2021 05 10  
(181) 2031 05 10  
(891) 2021 05 10  
(511) 43

---

(260) AM 2022 113946 A  
(800) 1602914  
(151) 2021 06 23  
(181) 2031 06 23  
(891) 2021 06 23  
(511) 21

---

(260) AM 2022 113908 A  
(800) 1602194  
(151) 2021 06 14  
(181) 2031 06 14  
(891) 2021 06 14  
(511) 12

---

(260) AM 2022 113947 A  
(800) 1602916  
(151) 2021 04 29  
(181) 2031 04 29  
(891) 2021 04 29  
(511) 21, 33

---

(260) AM 2022 113935 A  
(800) 1602534  
(151) 2021 04 30  
(181) 2031 04 30  
(891) 2021 04 30  
(511) 03, 08, 21

---

(260) AM 2022 113949 A  
(800) 1602924  
(151) 2021 05 10  
(181) 2031 05 10  
(891) 2021 05 10  
(511) 03, 05

---

(260) AM 2022 113936 A  
(800) 1602604  
(151) 2020 11 14  
(181) 2030 11 14  
(891) 2020 11 14  
(511) 01, 02, 03, 05, 08, 16, 17, 19, 27

---

(260) AM 2022 113951 A  
(800) 1602947  
(151) 2021 04 20  
(181) 2031 04 20  
(891) 2021 04 20  
(511) 36, 42

---

(260) AM 2022 113937 A  
(800) 1602615  
(151) 2021 05 11  
(181) 2031 05 11  
(891) 2021 05 11  
(511) 30

---

(260) AM 2022 113952 A  
(800) 1602964  
(151) 2021 04 12  
(181) 2031 04 12  
(891) 2021 04 12  
(511) 30

---

(260) AM 2022 113953 A  
 (800) 541660  
 (151) 1989 07 20  
 (181) 2029 07 20  
 (891) 2021 06 24  
 (511) 03, 05

---

(260) AM 2022 114018 A  
 (800) 1603616  
 (151) 2021 05 19  
 (181) 2031 05 19  
 (891) 2021 05 19  
 (511) 28

---

(260) AM 2022 113955 A  
 (800) 639180  
 (151) 1995 06 08  
 (181) 2025 06 08  
 (891) 2021 06 25  
 (511) 03, 05

---

(260) AM 2022 114019 A  
 (800) 1603686  
 (151) 2021 05 28  
 (181) 2031 05 28  
 (891) 2021 05 28  
 (511) 09

---

(260) AM 2022 113956 A  
 (800) 792926  
 (151) 2002 08 26  
 (181) 2022 08 26  
 (891) 2021 06 29  
 (511) 03, 05, 44

---

(260) AM 2022 114066 A  
 (800) 1603836  
 (151) 2021 05 13  
 (181) 2031 05 13  
 (891) 2021 05 13  
 (511) 28

---

(260) AM 2022 113963 A  
 (800) 1268411  
 (151) 2015 09 16  
 (181) 2025 09 16  
 (891) 2021 06 24  
 (511) 03

---

(260) AM 2022 114067 A  
 (800) 1603846  
 (151) 2021 05 03  
 (181) 2031 05 03  
 (891) 2021 05 03  
 (511) 05

---

(260) AM 2022 114009 A  
 (800) 1603287  
 (151) 2021 04 14  
 (181) 2031 04 14  
 (891) 2021 04 14  
 (511) 30

---

(260) AM 2022 114068 A  
 (800) 1603861  
 (151) 2021 05 05  
 (181) 2031 05 05  
 (891) 2021 05 05  
 (511) 10

---

(260) AM 2022 114012 A  
 (800) 1603322  
 (151) 2020 12 21  
 (181) 2030 12 21  
 (891) 2020 12 21  
 (511) 38, 42

---

(260) AM 2022 114069 A  
 (800) 1603864  
 (151) 2021 06 23  
 (181) 2031 06 23  
 (891) 2021 06 23  
 (511) 09

---

(260) AM 2022 114016 A  
 (800) 1603405  
 (151) 2020 12 15  
 (181) 2030 12 15  
 (891) 2020 12 15  
 (511) 03, 04, 05, 06, 07, 08, 09, 11, 12, 14, 16, 18, 20,  
 21, 22, 24, 25, 27, 28, 34

---

(260) AM 2022 114071 A  
 (800) 1603914  
 (151) 2021 04 15  
 (181) 2031 04 15  
 (891) 2021 04 15  
 (511) 09, 36, 41, 42

---



---

(260) AM 2022 114072 A  
(800) 1603924  
(151) 2021 05 18  
(181) 2031 05 18  
(891) 2021 05 18  
(511) 39

---

---

(260) AM 2022 114089 A  
(800) 1604457  
(151) 2021 02 05  
(181) 2031 02 05  
(891) 2021 02 05  
(511) 09, 28, 41

---

---

(260) AM 2022 114073 A  
(800) 1603930  
(151) 2021 06 22  
(181) 2031 06 22  
(891) 2021 06 22  
(511) 03

---

---

(260) AM 2022 114090 A  
(800) 1604474  
(151) 2021 02 04  
(181) 2031 02 04  
(891) 2021 02 04  
(511) 09, 28, 35, 38, 41, 42

---

---

(260) AM 2022 114074 A  
(800) 1603931  
(151) 2021 06 14  
(181) 2031 06 14  
(891) 2021 06 14  
(511) 12

---

---

(260) AM 2022 114091 A  
(800) 1604476  
(151) 2021 05 14  
(181) 2031 05 14  
(891) 2021 05 14  
(511) 06, 07, 09, 11, 12, 14, 19, 20, 25, 37, 40, 42

---

---

(260) AM 2022 114081 A  
(800) 1604273  
(151) 2021 05 18  
(181) 2031 05 18  
(891) 2021 05 18  
(511) 39

---

---

(260) AM 2022 114092 A  
(800) 1604493  
(151) 2021 05 12  
(181) 2031 05 12  
(891) 2021 05 12  
(511) 16, 35, 43

---

---

(260) AM 2022 114084 A  
(800) 1604362  
(151) 2021 03 01  
(181) 2031 03 01  
(891) 2021 03 01  
(511) 17, 19

---

---

(260) AM 2022 114098 A  
(800) 1604686  
(151) 2021 04 19  
(181) 2031 04 19  
(891) 2021 04 19  
(511) 10

---

---

(260) AM 2022 114085 A  
(800) 1604369  
(151) 2021 03 01  
(181) 2031 03 01  
(891) 2021 03 01  
(511) 17, 19

---

---

(260) AM 2022 114099 A  
(800) 1604687  
(151) 2021 01 07  
(181) 2031 01 07  
(891) 2021 01 07  
(511) 05, 10, 41, 42, 44

---

---

(260) AM 2022 114087 A  
(800) 1604413  
(151) 2021 02 04  
(181) 2031 02 04  
(891) 2021 02 04  
(511) 07, 09, 11, 35, 37, 41, 42

---

---

(260) AM 2022 114101 A  
(800) 1604740  
(151) 2021 07 02  
(181) 2031 07 02  
(891) 2021 07 02  
(511) 09, 42

---

(260) AM 2022 114102 A  
(800) 1604770  
(151) 2020 12 31  
(181) 2030 12 31  
(891) 2020 12 31  
(511) 06

---

(260) AM 2022 114110 A  
(800) 1604987  
(151) 2021 04 22  
(181) 2031 04 22  
(891) 2021 04 22  
(511) 30

---

(260) AM 2022 114103 A  
(800) 1604843  
(151) 2021 04 14  
(181) 2031 04 14  
(891) 2021 04 14  
(511) 30

---

(260) AM 2022 114111 A  
(800) 1605064  
(151) 2021 04 30  
(181) 2031 04 30  
(891) 2021 04 30  
(511) 05

---

(260) AM 2022 114104 A  
(800) 1604868  
(151) 2021 05 09  
(181) 2031 05 09  
(891) 2021 05 09  
(511) 09

---

(260) AM 2022 114112 A  
(800) 1605082  
(151) 2020 12 30  
(181) 2030 12 30  
(891) 2020 12 30  
(511) 06, 08, 35

---

(260) AM 2022 114105 A  
(800) 1604878  
(151) 2021 05 09  
(181) 2031 05 09  
(891) 2021 05 09  
(511) 09

---

(260) AM 2022 114113 A  
(800) 1605083  
(151) 2021 05 25  
(181) 2031 05 25  
(891) 2021 05 25  
(511) 28

---

(260) AM 2022 114106 A  
(800) 1604892  
(151) 2020 11 19  
(181) 2030 11 19  
(891) 2020 11 19  
(511) 29, 30, 43

---

(260) AM 2022 114114 A  
(800) 1605099  
(151) 2021 04 02  
(181) 2031 04 02  
(891) 2021 04 02  
(511) 05, 10

---

(260) AM 2022 114107 A  
(800) 1604916  
(151) 2021 02 12  
(181) 2031 02 12  
(891) 2021 02 12  
(511) 28

---

(260) AM 2022 114115 A  
(800) 1239074  
(151) 2014 12 09  
(181) 2024 12 09  
(891) 2021 06 29  
(511) 18, 25, 28, 35, 45

---

(260) AM 2022 114108 A  
(800) 1604940  
(151) 2020 11 05  
(181) 2030 11 05  
(891) 2020 11 05  
(511) 07, 08, 09, 11

---

(260) AM 2022 114116 A  
(800) 1254107  
(151) 2015 01 07  
(181) 2025 01 07  
(891) 2021 06 29  
(511) 18, 25, 28, 35, 45

---

---

(260) AM 2022 114122 A  
(800) 1577156  
(151) 2021 01 21  
(181) 2031 01 21  
(891) 2021 07 15  
(511) 05, 31

---

---

(260) AM 2022 114161 A  
(800) 1605295  
(151) 2021 02 08  
(181) 2031 02 08  
(891) 2021 02 08  
(511) 06, 07, 20, 21

---

---

(260) AM 2022 114123 A  
(800) 1588212  
(151) 2021 01 18  
(181) 2031 01 18  
(891) 2021 06 21  
(511) 05

---

---

(260) AM 2022 114172 A  
(800) 1605519  
(151) 2020 10 01  
(181) 2030 10 01  
(891) 2020 10 01  
(511) 09, 18, 25, 28

---

---

(260) AM 2022 114124 A  
(800) 1588497  
(151) 2021 01 18  
(181) 2031 01 18  
(891) 2021 06 22  
(511) 05

---

---

(260) AM 2022 114173 A  
(800) 1605582  
(151) 2021 02 19  
(181) 2031 02 19  
(891) 2021 02 19  
(511) 05, 29, 30, 32, 35, 43

---

---

(260) AM 2022 114157 A  
(800) 1605279  
(151) 2021 03 23  
(181) 2031 03 23  
(891) 2021 03 23  
(511) 03, 05

---

---

(260) AM 2022 114174 A  
(800) 1605587  
(151) 2021 01 05  
(181) 2031 01 05  
(891) 2021 01 05  
(511) 09, 11

---

---

(260) AM 2022 114158 A  
(800) 1605287  
(151) 2021 05 25  
(181) 2031 05 25  
(891) 2021 05 25  
(511) 28

---

---

(260) AM 2022 114175 A  
(800) 1605599  
(151) 2021 06 29  
(181) 2031 06 29  
(891) 2021 06 29  
(511) 09

---

---

(260) AM 2022 114159 A  
(800) 1605292  
(151) 2021 03 23  
(181) 2031 03 23  
(891) 2021 03 23  
(511) 03, 05

---

---

(260) AM 2022 114177 A  
(800) 1605691  
(151) 2021 06 22  
(181) 2031 06 22  
(891) 2021 06 22  
(511) 10

---

---

(260) AM 2022 114160 A  
(800) 1605294  
(151) 2021 05 09  
(181) 2031 05 09  
(891) 2021 05 09  
(511) 09

---

---

(260) AM 2022 114179 A  
(800) 1605762  
(151) 2021 02 08  
(181) 2031 02 08  
(891) 2021 02 08  
(511) 06, 07, 08, 09, 10, 11, 21, 35

---

(260) AM 2022 114180 A  
(800) 1605773  
(151) 2021 07 05  
(181) 2031 07 05  
(891) 2021 07 05  
(511) 34

---

(260) AM 2022 114192 A  
(800) 1606021  
(151) 2021 04 30  
(181) 2031 04 30  
(891) 2021 04 30  
(511) 05

---

(260) AM 2022 114181 A  
(800) 1605844  
(151) 2021 06 08  
(181) 2031 06 08  
(891) 2021 06 08  
(511) 33

---

(260) AM 2022 114193 A  
(800) 1606046  
(151) 2021 06 14  
(181) 2031 06 14  
(891) 2021 06 14  
(511) 12

---

(260) AM 2022 114182 A  
(800) 1605859  
(151) 2021 06 09  
(181) 2031 06 09  
(891) 2021 06 09  
(511) 05, 31

---

(260) AM 2022 114194 A  
(800) 1606048  
(151) 2021 06 14  
(181) 2031 06 14  
(891) 2021 06 14  
(511) 12

---

(260) AM 2022 114183 A  
(800) 1605867  
(151) 2021 01 21  
(181) 2031 01 21  
(891) 2021 01 21  
(511) 03

---

(260) AM 2022 114195 A  
(800) 1606062  
(151) 2021 06 14  
(181) 2031 06 14  
(891) 2021 06 14  
(511) 12

---

(260) AM 2022 114189 A  
(800) 1605988  
(151) 2020 12 31  
(181) 2030 12 31  
(891) 2020 12 31  
(511) 03, 35

---

(260) AM 2022 114196 A  
(800) 1606156  
(151) 2021 02 25  
(181) 2031 02 25  
(891) 2021 02 25  
(511) 07

---

(260) AM 2022 114190 A  
(800) 1606016  
(151) 2021 05 31  
(181) 2031 05 31  
(891) 2021 05 31  
(511) 29

---

(260) AM 2022 114204 A  
(800) 1606285  
(151) 2021 03 09  
(181) 2031 03 09  
(891) 2021 03 09  
(511) 36

---

(260) AM 2022 114191 A  
(800) 1606020  
(151) 2021 05 21  
(181) 2031 05 21  
(891) 2021 05 21  
(511) 29

---

(260) AM 2022 114209 A  
(800) 931548  
(151) 2007 07 12  
(181) 2027 07 12  
(891) 2021 07 16  
(511) 14, 24, 25

---

(260) AM 2022 114255 A  
(800) 1606500  
(151) 2021 06 07  
(181) 2031 06 07  
(891) 2021 06 07  
(511) 11

---

(260) AM 2022 114272 A  
(800) 1607051  
(151) 2021 06 16  
(181) 2031 06 16  
(891) 2021 06 16  
(511) 03, 05

---

(260) AM 2022 114256 A  
(800) 1606544  
(151) 2021 05 21  
(181) 2031 05 21  
(891) 2021 05 21  
(511) 29, 30, 31, 35

---

(260) AM 2022 114273 A  
(800) 1607073  
(151) 2021 06 10  
(181) 2031 06 10  
(891) 2021 06 10  
(511) 20

---

(260) AM 2022 114257 A  
(800) 1606550  
(151) 2021 06 07  
(181) 2031 06 07  
(891) 2021 06 07  
(511) 11

---

(260) AM 2022 114274 A  
(800) 1607089  
(151) 2021 06 16  
(181) 2031 06 16  
(891) 2021 06 16  
(511) 35

---

(260) AM 2022 114258 A  
(800) 1606669  
(151) 2021 01 18  
(181) 2031 01 18  
(891) 2021 01 18  
(511) 01

---

(260) AM 2022 114275 A  
(800) 1607106  
(151) 2021 05 04  
(181) 2031 05 04  
(891) 2021 05 04  
(511) 05

---

(260) AM 2022 114259 A  
(800) 1606711  
(151) 2021 05 11  
(181) 2031 05 11  
(891) 2021 05 11  
(511) 29, 30, 32

---

(260) AM 2022 114306 A  
(800) 1456928  
(151) 2019 01 30  
(181) 2029 01 30  
(891) 2021 06 28  
(511) 03

---

(260) AM 2022 114266 A  
(800) 1606857  
(151) 2021 06 23  
(181) 2031 06 23  
(891) 2021 06 23  
(511) 10

---

(260) AM 2022 114307 A  
(800) 1602241  
(151) 2021 05 10  
(181) 2031 05 10  
(891) 2021 07 23  
(511) 05

---

(260) AM 2022 114271 A  
(800) 1606995  
(151) 2021 06 16  
(181) 2031 06 16  
(891) 2021 06 16  
(511) 03, 05

---

(260) AM 2022 114308 A  
(800) 1602315  
(151) 2021 05 10  
(181) 2031 05 10  
(891) 2021 07 23  
(511) 05

---

(260) AM 2022 114348 A  
(800) 1607894  
(151) 2021 06 23  
(181) 2031 06 23  
(891) 2021 06 23  
(511) 01

---

(260) AM 2022 114524 A  
(800) 1514353  
(151) 2019 10 14  
(181) 2029 10 14  
(891) 2021 07 08  
(511) 34

---

(260) AM 2022 114350 A  
(800) 1607957  
(151) 2021 05 26  
(181) 2031 05 26  
(891) 2021 05 26  
(511) 03

---

(260) AM 2022 114525 A  
(800) 1519094  
(151) 2020 01 27  
(181) 2030 01 27  
(891) 2021 07 28  
(511) 09, 35

---

(260) AM 2022 114357 A  
(800) 1608089  
(151) 2021 05 18  
(181) 2031 05 18  
(891) 2021 05 18  
(511) 10, 35

---

(260) AM 2022 114548 A  
(800) 1611564  
(151) 2021 06 29  
(181) 2031 06 29  
(891) 2021 06 29  
(511) 09

---

(260) AM 2022 114359 A  
(800) 1608147  
(151) 2021 04 21  
(181) 2031 04 21  
(891) 2021 04 21  
(511) 11, 20, 35

---

(260) AM 2022 114549 A  
(800) 1611565  
(151) 2021 06 29  
(181) 2031 06 29  
(891) 2021 06 29  
(511) 09

---

(260) AM 2022 114439 A  
(800) 1609644  
(151) 2021 06 01  
(181) 2031 06 01  
(891) 2021 06 01  
(511) 05, 10, 44

---

(260) AM 2022 114580 A  
(800) 1612473  
(151) 2021 07 08  
(181) 2031 07 08  
(891) 2021 07 08  
(511) 25

---

(260) AM 2022 114441 A  
(800) 1609668  
(151) 2021 02 09  
(181) 2031 02 09  
(891) 2021 02 09  
(511) 32

---

(260) AM 2022 114582 A  
(800) 1087383  
(151) 2011 01 04  
(181) 2031 01 04  
(891) 2021 07 06  
(511) 07, 12, 17

---

(260) AM 2022 114523 A  
(800) 1500497  
(151) 2019 11 01  
(181) 2029 11 01  
(891) 2021 06 17  
(511) 12

---

(260) AM 2022 114583 A  
(800) 1428273  
(151) 2018 06 27  
(181) 2028 06 27  
(891) 2021 08 19  
(511) 07, 08, 11

---

(260) AM 2022 114584 A  
(800) 1507528  
(151) 2019 11 19  
(181) 2029 11 19  
(891) 2021 07 30  
(511) 18, 25

---

(260) AM 2022 114657 A  
(800) 1614048  
(151) 2021 07 12  
(181) 2031 07 12  
(891) 2021 07 12  
(511) 12

---

(260) AM 2022 114646 A  
(800) 1613710  
(151) 2021 06 09  
(181) 2031 06 09  
(891) 2021 06 09  
(511) 05

---

(260) AM 2022 114658 A  
(800) 929506  
(151) 2007 04 27  
(181) 2027 04 27  
(891) 2021 08 27  
(511) 17

---

(260) AM 2022 114647 A  
(800) 1613713  
(151) 2021 07 13  
(181) 2031 07 13  
(891) 2021 07 13  
(511) 03, 05

---

(260) AM 2022 114659 A  
(800) 1093108  
(151) 2011 08 26  
(181) 2031 08 26  
(891) 2021 08 27  
(511) 07, 11

---

(260) AM 2022 114648 A  
(800) 1613717  
(151) 2021 07 16  
(181) 2031 07 16  
(891) 2021 07 16  
(511) 05

---

(260) AM 2022 114660 A  
(800) 1093110  
(151) 2011 08 26  
(181) 2031 08 26  
(891) 2021 08 27  
(511) 07, 11

---

(260) AM 2022 114649 A  
(800) 1613758  
(151) 2021 07 15  
(181) 2031 07 15  
(891) 2021 07 15  
(511) 09, 16, 35, 36, 39, 42

---

(260) AM 2022 114661 A  
(800) 1111446  
(151) 2011 09 16  
(181) 2021 09 16  
(891) 2021 06 10  
(511) 05, 10, 16, 35, 41, 42

---

(260) AM 2022 114655 A  
(800) 1613994  
(151) 2021 07 27  
(181) 2031 07 27  
(891) 2021 07 27  
(511) 09, 42

---

(260) AM 2022 114662 A  
(800) 1471077  
(151) 2019 01 09  
(181) 2029 01 09  
(891) 2021 07 02  
(511) 25, 35

---

(260) AM 2022 114656 A  
(800) 1614018  
(151) 2021 06 30  
(181) 2031 06 30  
(891) 2021 06 30  
(511) 09

---

(260) AM 2022 114663 A  
(800) 1485110  
(151) 2019 07 23  
(181) 2029 07 23  
(891) 2021 08 26  
(511) 34

---

(260) AM 2022 114664 A  
 (800) 1571089  
 (151) 2020 12 08  
 (181) 2030 12 08  
 (891) 2021 08 01  
 (511) 43

---

(260) AM 2022 114714 A  
 (800) 1614785  
 (151) 2021 07 21  
 (181) 2031 07 21  
 (891) 2021 07 21  
 (511) 29

---

(260) AM 2022 114703 A  
 (800) 1614337  
 (151) 2021 06 04  
 (181) 2031 06 04  
 (891) 2021 06 04  
 (511) 05, 10, 42

---

(260) AM 2022 114729 A  
 (800) 1550934  
 (151) 2020 07 27  
 (181) 2030 07 27  
 (891) 2021 08 18  
 (511) 05

---

(260) AM 2022 114704 A  
 (800) 1614414  
 (151) 2021 02 12  
 (181) 2031 02 12  
 (891) 2021 02 12  
 (511) 06

---

(260) AM 2022 114769 A  
 (800) 1615388  
 (151) 2021 03 13  
 (181) 2031 03 13  
 (891) 2021 03 13  
 (511) 30, 35, 39

---

(260) AM 2022 114710 A  
 (800) 1614648  
 (151) 2021 04 27  
 (181) 2031 04 27  
 (891) 2021 04 27  
 (511) 03, 05, 10, 42, 44

---

(260) AM 2022 114830 A  
 (800) 1616720  
 (151) 2021 07 15  
 (181) 2031 07 15  
 (891) 2021 07 15  
 (511) 10

---

(260) AM 2022 114711 A  
 (800) 1614696  
 (151) 2021 06 15  
 (181) 2031 06 15  
 (891) 2021 06 15  
 (511) 21

---

(260) AM 2022 114831 A  
 (800) 1616721  
 (151) 2021 07 13  
 (181) 2031 07 13  
 (891) 2021 07 13  
 (511) 10

---

(260) AM 2022 114712 A  
 (800) 1614722  
 (151) 2020 12 01  
 (181) 2030 12 01  
 (891) 2020 12 01  
 (511) 09, 35, 36, 42, 45

---

(260) AM 2022 114833 A  
 (800) 1616747  
 (151) 2021 08 30  
 (181) 2031 08 30  
 (891) 2021 08 30  
 (511) 28, 30

---

(260) AM 2022 114713 A  
 (800) 1614761  
 (151) 2021 06 15  
 (181) 2031 06 15  
 (891) 2021 06 15  
 (511) 41

---

(260) AM 2022 114836 A  
 (800) 1616845  
 (151) 2021 07 13  
 (181) 2031 07 13  
 (891) 2021 07 13  
 (511) 30

---



(260) AM 2022 114964 A  
(800) 1619718  
(151) 2021 08 30  
(181) 2031 08 30  
(891) 2021 08 30  
(511) 09, 28, 30, 41

---

---

**OFFICIAL NOTIFICATIONS  
INVENTIONS  
ABOLITION OF PATENTS WITH THE RIGHT TO RESTORE**

(21) AP 2007 11072  
(11) P 2012 5505 B  
(73) E.I. Du Pont De Nemours and Company  
(54) FUNGICIDAL AZOCYCLIC AMIDES  
DATE OF PATENT CANCELLATION: 2022 07 27  
LIMITED DATE OF PATENT RESTORATION: 2023 07 27

---

(21) AP 2009 12122  
(11) P 2013 5920 B  
(73) Pierre Fabre Dermo-Cosmetique  
(54) KIT FOR ONYCHOMYCOSIS TREATMENT  
DATE OF PATENT CANCELLATION: 2022 07 31  
LIMITED DATE OF PATENT RESTORATION: 2023 07 31

---

(21) AP 2015 14478  
(11) P 2019 7004 B  
(73) Ioulia Tseti  
(54) IRON (III) HYDROXIDE COMPLEXES WITH ACTIVATED GLUCOSE SYRUPS AND PROCESS FOR PREPARING SAME  
DATE OF PATENT CANCELLATION: 2022 07 28  
LIMITED DATE OF PATENT RESTORATION: 2023 07 28

---

**EXPIRATION OF TERMS OF PATENTS RESTORATION**

(21) AP 2010 12599  
(11) P 2016 6513 B  
(73) Millennium Pharmaceuticals Inc.  
(54) PHARMACEUTICAL COMPOSITIONS FOR THE TREATMENT OF CANCER AND OTHER DISEASES OR DISORDERS  
DATE OF PATENT CANCELLATION: 2021 07 28  
DATE OF PATENT RESTORATION VALIDITY IS EXPIRED: 2022 07 28

---

(21) AP 2010 12609  
(11) P 2015 6287 B  
(73) Aziende Chimiche Riunite Angelini Francesco A.C.R.A.F. S.p.A. (IT)  
(54) FOOD FORMULATION COMPRISING GLYCOGEN  
DATE OF PATENT CANCELLATION: 2021 07 29  
DATE OF PATENT RESTORATION VALIDITY IS EXPIRED: 2022 07 29

---

(21) AP 2019 15155  
(11) P 2021 7225 B  
(73) Aleksandre Kharibegashvili;  
Vladimir Miruashvili;  
Manana Kevlishvili;  
Levan Shavadze;  
Mzia Ghagholishvili;  
Telavi State University  
(54) GRAPE TRELLIS  
DATE OF PATENT CANCELLATION: 2021 07 26  
DATE OF PATENT RESTORATION VALIDITY IS EXPIRED: 2022 07 26

---

## EXPIRATION OF TERMS OF PATENT

(21) AP 2002 8053  
(11) P 2006 3777 B  
(73) Pharmacia & Upjohn Company  
(54) CRYSTALS INCLUDING MALIC ACID SALT OF N-[2-(DIETHYLAMINO) ETHYL]-5-[(5-FLUORO-2-  
OXO-3H-INDOLE-3-YLIDENE) METHYL]-2, 4-DIMETHYL-1H-PYRROLE-3-CARBOXAMIDE,  
PROCESSES FOR ITS PREPARATION AND COMPOSITIONS THEREOF  
DATE OF PATENT EXPIRATION: 2022 08 13

---

## DESIGNS

### EXTENSION OF TERMS OF INTERNATIONAL DESIGN REGISTRATION

(11) DM/97514  
(73) LIQUI MOLY GMBH  
Jerg-Wieland-Str. 4, 89081 Ulm (DE)  
(15) 2017 07 20  
(24) 2017 07 20  
(18) 2027 07 20  
(28) 2  
(28') 2  
(54) BOTTLES FOR LIQUIDS

---

## CANCELLATION OF INTERNATIONAL DESIGNS REGISTRATION

(11) DM/67447  
(73) DAIMLERCHRYSLER AG  
Epplestrasse 225, 70567 Stuttgart (DE)  
DATE OF REGISTRATION CANCELLATION: 2021 02 01  
(58) 2022 08 04

---

(11) DM/67586  
(73) THE SWATCH GROUP MANAGEMENT SERVICES AG (THE SWATCH GROUP MANAGEMENT SERVICES SA) (THE SWATCH GROUP MANAGEMENT SERVICES LTD)  
Seevorstadt 6, CH-2502 Biel/Bienne (CH)  
DATE OF REGISTRATION CANCELLATION: 2021 03 28  
(58) 2022 08 04

---

(11) DM/68274  
(73) ETA SA MANUFACTURE HORLOGERE SUISSE  
CH-2540 GRENCHEN (CH)  
DATE OF REGISTRATION CANCELLATION: 2021 10 09  
(58) 2022 08 04

---

(11) DM/68282  
(73) SAINT-GOBAIN GLASS FRANCE  
"Les Miroirs" - 18, avenue d'Alsace, F-92400 COURBEVOIE (FR)  
DATE OF REGISTRATION CANCELLATION: 2021 10 24  
(58) 2022 08 04

---

(11) DM/68295  
(73) VIKO ELEKTRIK VE ELEKTRONIK ENDÜSTRISI SANAYI VE TICARET ANONIM SIRKETI  
Osmangazi Mah., Battalgazi Cad. No:29, Samandira Istanbul (TR)  
DATE OF REGISTRATION CANCELLATION: 2021 11 13  
(58) 2022 08 04

---

(11) DM/68305  
(73) UNILEVER N.V.  
Weena 455, NL-3013 AL Rotterdam (NL)  
DATE OF REGISTRATION CANCELLATION: 2021 11 16  
(58) 2022 08 04

---

(11) DM/68667  
(73) HENKEL KOMMANDITGESELLSCHAFT AUF AKTIEN  
Henkelstrasse 67, 40589 Düsseldorf (DE)  
DATE OF REGISTRATION CANCELLATION: 2021 10 27  
(58) 2022 08 04

---

(11) DM/72924  
(73) MICROSOFT MOBILE OY  
Keilalahdentie 2-4, FI-02150 Espoo (FI) (EM)  
DATE OF REGISTRATION CANCELLATION: 2019 09 04  
(58) 2022 08 04

---

(11) DM/74589  
(73) SAVERGLASS  
3 rue de la Gare, F-60960 FEUQUIERES (FR)  
DATE OF REGISTRATION CANCELLATION: 2020 09 30  
(58) 2022 08 04

---

(11) DM/74598  
(73) MILONAS A GEORGIOS  
Kilkis Industrial Area, GR-611 00 Kilkis (GR)  
DATE OF REGISTRATION CANCELLATION: 2020 10 12  
(58) 2022 08 04

---

(11) DM/76961  
(73) LABORATOIRES LA PRAIRIE SA  
Industriestrasse 8, CH-8604 Volketswil (CH)  
DATE OF REGISTRATION CANCELLATION: 2021 10 20  
(58) 2022 08 12

---

(11) DM/76983  
(73) THE SWATCH GROUP MANAGEMENT SERVICES AG (THE SWATCH GROUP MANAGEMENT SERVICES SA) (THE SWATCH GROUP MANAGEMENT SERVICES LTD.)  
Faubourg du Lac 6, CH-2502 Biel/Bienne (CH)  
DATE OF REGISTRATION CANCELLATION: 2021 10 19  
(58) 2022 08 12

---

(11) DM/76985  
(73) ETA SA MANUFACTURE HORLOGÈRE SUISSE  
CH-2540 Grenchen (CH)  
DATE OF REGISTRATION CANCELLATION: 2021 10 20  
(58) 2022 08 12

---

(11) DM/76989  
(73) BHS TABLETOP AG  
Ludwigsmühle, 95100 Selb (EM)  
DATE OF REGISTRATION CANCELLATION: 2021 05 29  
(58) 2022 08 12

---

(11) DM/77012  
(73) ALFRED KÄRCHER GMBH & CO. KG  
Alfred-Kärcher-Straße 28-40, 71364 Winnenden (DE)  
DATE OF REGISTRATION CANCELLATION: 2021 10 26  
(58) 2022 08 12

---

(11) DM/77733  
(73) MICROSOFT MOBILE OY  
Keilalahdentie 2-4, FI-02150 Espoo (FI) (EM)  
DATE OF REGISTRATION CANCELLATION: 2021 10 14  
(58) 2022 08 12

---

(11) DM/78574

(73) ENIGMA LTD.

23, "Saedinenie" Blvd., BG-6300 Haskovo (BG)

DATE OF REGISTRATION CANCELLATION: 2021 10 26

(58) 2022 08 12

---

(11) DM/88419

(73) VİKO ELEKTRİK VE ELEKTRONİK ENDÜSTRİSİ SANAYİ VE TİCARET ANONİM ŞİRKETİ

Abdurrahmangazi Mah. Ebubekir Cd. No:44, TR-34887 Sancaktepe - İstanbul (TR)

DATE OF REGISTRATION CANCELLATION: 2020 11 04

(58) 2022 08 12

---

(11) DM/88442

(73) KATUSHA IP AG, c/o MOORE STEPHENS ZUG AG

Alpenstrasse 15, CH-6300 Zug (CH)

DATE OF REGISTRATION CANCELLATION: 2020 11 27

(58) 2022 08 12

---

## TRADEMARKS

### EXTENSION OF TERMS OF TRADEMARKS REGISTRATION

(111) M 2002 14755 R2

(156) 2002 10 15

(186) 2032 10 15

(732) Ricoh Company LTD  
Tokyo, Japan

---

(111) M 2002 14588 R2

(156) 2002 08 15

(186) 2032 08 15

(732) KImberly-Clark Worldwide Inc.  
Neenah, WI 54956, USA

---

(111) M 2002 14654 R2

(156) 2002 09 13

(186) 2032 09 13

(732) H-D U.S.A. LLC  
3700 West Juneau Avenue, Milwaukee,  
WI 53208, USA

---

(111) M 2002 14655 R2

(156) 2002 09 13

(186) 2032 09 13

(732) H-D U.S.A. LLC  
3700 West Juneau Avenue, Milwaukee,  
WI 53208, USA

---

(111) M 2002 14656 R2

(156) 2002 09 13

(186) 2032 09 13

(732) H-D U.S.A. LLC  
3700 West Juneau Avenue, Milwaukee,  
WI 53208, USA

---

(111) M 2002 14795 R2

(156) 2002 11 15

(186) 2032 11 15

(732) Accenture Global Services Limited  
3 Grand Canal Plaza, Upper Grande canal  
Street, Dublin 4, Ireland

---

(111) M 2002 14704 R2

(156) 2002 09 30

(186) 2032 09 30

(732) LTD "Wine Company Shumi"  
Sulkhan Tsintsadze St. 18, 0160, Tbilisi,  
Georgia

---

(111) M 2002 14782 R2

(156) 2002 10 29

(186) 2032 10 29

(732) Wella International Operations Switzerland  
Sàrl  
Chemin Louis-Hubert 1, 1213 Petit-Lancy,  
Switzerland

---

(111) M 2012 22238 R1

(156) 2012 02 03

(186) 2032 02 03

(732) LTD "Alta"  
Saburtalo St. 35, 0194, Tbilisi, Georgia

---

(111) M 2012 22239 R1

(156) 2012 02 03

(186) 2032 02 03

(732) LTD "Alta"  
Saburtalo St. 35, 0194, Tbilisi, Georgia

---

(111) M 2012 22537 R1

(156) 2012 04 30

(186) 2032 04 30

(732) LTD "Monastris Nobati"  
Vill. Ude, 0308, Adigeni Regions, Georgia

---

(111) M 2012 22933 R1

(156) 2012 09 24

(186) 2032 09 24

(732) Costa Limited  
Whitbread Court, Houghton Hall Business  
Park, Porz Avenue, Dunstable, Bedfordshire  
LU5 5XE, United Kingdom

---

(111) M 2012 22821 R1

(156) 2012 07 30

(186) 2032 07 30

(732) Intel Corporation,  
a Delaware corporation  
2200 Mission College Boulevard,  
Santa Clara, California 95052-8119, USA

---

(111) M 2012 22828 R1

(156) 2012 07 30

(186) 2032 07 30

(732) Apple Inc.

One Apple Park Way, Cupertino,  
California 95014, USA

---

(111) M 2012 22781 R1  
(156) 2012 07 13  
(186) 2032 07 13  
(732) BrandCo CND 2020 LLC  
3411 Silversaid Roudi, Tatnal Bidingi # 104,  
Uilmingtoni, Delaveri 19810, USA

---

(111) M 2012 22941 R1  
(156) 2012 09 24  
(186) 2032 09 24  
(732) Imax Corporation  
2525 Speakman Drive, Misissauga, ON L5K  
1B1, Canada

---

(111) M 2012 22730 R1  
(156) 2012 07 02  
(186) 2032 07 02  
(732) Obshchestvo s Ogranichennoy Otvetstven-  
nostiu "Lira Sapr"  
Kiianovskiy pereulok 7a, office 209, Kiev,  
04053, Ukraine

---

(111) M 2012 22731 R1  
(156) 2012 07 02  
(186) 2032 07 02  
(732) Obshchestvo s Ogranichennoy Otvetstven-  
nostiu "Lira Sapr"  
Kiianovskiy pereulok 7a, office 209, Kiev,  
04053, Ukraine

---

(111) M 2012 23009 R1  
(156) 2012 10 09  
(186) 2032 10 09  
(732) Daimler AG  
Mercedesstrasse 137, 70327 Stuttgart,  
Germany

---

(111) M 2012 23010 R1  
(156) 2012 10 09  
(186) 2032 10 09  
(732) Daimler AG  
Mercedesstrasse 137, 70327 Stuttgart,  
Germany

---

(111) M 2012 22900 R1  
(156) 2012 08 30  
(186) 2032 08 30  
(732) Visa International Service Association

900 Metro Center Boulevard, Foster City,  
California 94404, USA

---

(111) M 2012 23015 R1  
(156) 2012 10 09  
(186) 2032 10 09  
(732) Samsung Electronics Co., LTD  
129, Samsung-ro, Yeongtong-gu, Suwon-si,  
Gyeonggi-do, Republic of Korea

---

(111) M 2012 23016 R1  
(156) 2012 10 09  
(186) 2032 10 09  
(732) Samsung Electronics Co., LTD  
129, Samsung-ro, Yeongtong-gu, Suwon-si,  
Gyeonggi-do, Republic of Korea

---

(111) M 2013 23785 R1  
(156) 2013 06 25  
(186) 2033 06 25  
(732) JSC" Iveria"  
Gudauta St. 7, 0119, Didube District, Tbilisi,  
Georgia

---



## COMPLETE TRANSFER OF RIGHTS

- 
- (111) M 1998 9706 R  
 (732) Axalta Coating Systems GmbH  
 Uferstr. 90, 4057 Basel, Switzerland  
 (770) Coatings Foreign IP Co. LLC  
 c/o The Corporation Trust Company,  
 Corporation  
 Trust Center, 1209 Orange Street, Wilmington,  
 Delaware 19801, USA  
 (580) 2022 07 21
- 
- (111) M 2021 34153 R  
 (732) R-Pharm International LLC  
 19, bld.1, Berzarina Street, first floor,  
 premise V, room 9 Moscow, 123154,  
 Russian Federation  
 (770) UCB Biopharma SRL  
 Allee de la Recherche 60, Brussels B-1070,  
 Belgium  
 (580) 2022 07 28
- 
- (111) M 1997 4435 R  
 (732) Axalta Coating Systems GmbH  
 Uferstr. 90, 4057 Basel, Switzerland  
 (770) Coatings Foreign IP Co. LLC  
 c/o The Corporation Trust Company,  
 Corporation Trust Center, 1209 Orange  
 Street, Wilmington, Delaware 19801, USA  
 (580) 2022 07 21
- 
- (111) M 1999 11566 R  
 (732) Bunge SA  
 13 Route de Florissant, 1206 Geneve,  
 Switzerland  
 (770) Oleina S.A.  
 13 Rut De Florisani, 1206 Jeneva, Switzerland  
 (580) 2022 07 20
- 
- (111) M 1999 12454 R  
 (732) Bunge SA  
 13 Route de Florissant, 1206 Geneve,  
 Switzerland  
 (770) Oleina S.A.  
 13 Rut De Florisani, 1206 Jeneva, Switzerland  
 (580) 2022 07 20
- 
- (111) M 2000 13571 R  
 (732) Philip Morris International Finance  
 Corporation  
 9711 Farrar Court, Richmond, VA 23236,  
 USA
- (770) Pmpii LLC  
 9711 Farrar Court, Richmond, VA23236, USA  
 (580) 2022 07 29
- 
- (111) M 2009 20132 R  
 (732) Bunge SA  
 13 Route de Florissant, 1206 Geneve,  
 Switzerland  
 (770) Oleina S.A.  
 13 Rut De Florisani, 1206 Jeneva, Switzerland  
 (580) 2022 07 20
- 
- (111) M 2009 20133 R  
 (732) Bunge SA  
 13 Route de Florissant, 1206 Geneve,  
 Switzerland  
 (770) Oleina S.A.  
 13 Rut De Florisani, 1206 Jeneva, Switzerland  
 (580) 2022 07 20
- 
- (111) M 1996 2234 R  
 (732) Obshchestvo s Ogranichennoy Otvetstven  
 nostyu "KDV Tula"  
 Shosse Novomoskovskoe, dom 54,  
 pomeschenie 3, offis 318, etazh 3, Tula,  
 Tulsckaya Oblast, 300045, Russian Federation  
 (770) Unilever IP Holdings B.V.  
 Weena 455, 3013 AL Rotterdam, Netherlands  
 (580) 2022 08 11
- 
- (111) M 1996 2098 R  
 (732) Henkel AG & Co. KgaA  
 Henkelstrasse 67, 40589 Düsseldorf, Germany  
 (770) Menelaus B.V.  
 Archimedesbaan 18-D, 3439 ME Nieuwegein,  
 Netherlands  
 (580) 2021 12 21
- 
- (111) M 2011 21502 R  
 (732) Bunge SA  
 13 Route de Florissant, 1206 Geneve,  
 Switzerland  
 (770) Oleina S.A.  
 13 Rut De Florisani, 1206 Jeneva, Switzerland  
 (580) 2022 07 20
- 
- (111) M 1996 2684 R  
 (732) Dore Dore 1819, the French Company  
 54 rue de Bitche 92400 Courbevoie, France  
 (770) Geduma S.A.
-

1, rue Jean Piret, L-2350, Luxembourg,  
Luxembourg  
(580) 2022 07 21

(111) M 2012 22866 R  
(732) LTD "AAF-Management"  
Vazha-Pshavela Av. 41, 4th Floor, 0177,  
Tbilisi, Georgia  
(770) LTD "Soft-Info"  
Vazha-Pshavela Av. 41, 4th Floor, 0177,  
Tbilisi, Georgia  
(580) 2022 08 11

(111) M 2012 22781 R  
(732) BrandCo CND 2020 LLC  
3411 Silversaid Roudi, Tatnal Bildingi # 104,  
Uilmingtoni, Delaveri 19810, USA  
(770) Beautyge I  
Uokers Korporeit Limitidi, Kaiman Korporeit  
Centri, 27 Hospital Roudi, Jorj-tauni, Grand  
Kaimani KY1-9008, Cayman Islands  
(580) 2022 07 12

(111) M 2012 22781 R  
(732) Beautyge I  
Uokers Korporeit Limitidi, Kaiman Korporeit  
Centri, 27 Hospital Roudi, Jorj-tauni, Grand  
Kaimani KY1-9008, Cayman Islands  
(770) Creative Nail Design, Inc.  
1125 Joshua Way, Vista, California 92083,  
USA  
(580) 2022 07 12

(111) M 2013 23440 R  
(732) Bunge SA  
13 Route de Florissant, 1206 Geneve,  
Switzerland  
(770) Oleina S.A.  
13 Rut De Florisani, 1206 Jeneva, Switzerland  
(580) 2022 07 20

(111) M 2013 23453 R  
(732) Obshchestvo s Ogranichennoy Otvetstven  
nostyu "KDV Tula"  
Shosse Novomoskovskoe, dom 54,  
pomeshchenie 3, offis 318, etazh 3, Tula,  
Tulskaya Oblast, 300045, Russian Federation  
(770) Unilever IP Holdings B.V.  
Weena 455, 3013 AL Rotterdam, Netherlands  
(580) 2022 08 11

(111) M 2016 26851 R  
(732) Giorgi Kharebashvili  
Mikheil Tsinamdzghvrishvili St. 6  
Tbilisi Georgia  
(770) LLC "Minions"  
Khizanishvili St. 17, 0167, Tbilisi, Georgia  
(580) 2022 07 28

(111) M 1997 5375 R  
(732) Axalta Coating Systems GmbH  
Uferstr. 90, 4057 Basel, Switzerland  
(770) Coatings Foreign IP Co. LLC  
c/o The Corporation Trust Company,  
Corporation Trust Center, 1209 Orange  
Street, Wilmington, Delaware 19801, USA  
(580) 2022 07 21

(111) M 1997 5378 R  
(732) Axalta Coating Systems GmbH  
Uferstr. 90, 4057 Basel, Switzerland  
(770) Coatings Foreign IP Co. LLC  
c/o The Corporation Trust Company,  
Corporation Trust Center, 1209 Orange  
Street, Wilmington, Delaware 19801, USA  
(580) 2022 07 21

(111) M 1998 9366 R  
(732) Henkel AG & Co. KgaA  
Henkelstrasse 67, 40589 Düsseldorf, Germany  
(770) Menelaus B.V.  
Archimedesbaan 18-D, 3439 ME Nieuwegein,  
Netherlands  
(580) 2021 12 21

(111) M 1997 5554 R  
(732) Axalta Coating Systems GmbH  
Uferstr. 90, 4057 Basel, Switzerland  
(770) Coatings Foreign IP Co. LLC  
c/o The Corporation Trust Company,  
Corporation Trust Center, 1209 Orange  
Street, Wilmington, Delaware 19801, USA  
(580) 2022 07 21

(111) M 1997 5556 R  
(732) Axalta Coating Systems GmbH  
Uferstr. 90, 4057 Basel, Switzerland  
(770) Coatings Foreign IP Co. LLC  
c/o The Corporation Trust Company,  
Corporation Trust Center, 1209 Orange  
Street, Wilmington, Delaware 19801, USA  
(580) 2022 07 21

(111) M 1997 5557 R  
 (732) Axalta Coating Systems GmbH  
 Uferstr. 90, 4057 Basel, Switzerland  
 (770) Coatings Foreign IP Co. LLC  
 c/o The Corporation Trust Company,  
 Corporation Trust Center, 1209 Orange  
 Street, Wilmington, Delaware 19801, USA  
 (580) 2022 07 21

(111) M 2019 31414 R  
 (732) R-Pharm International LLC  
 19 bld.1, Berzarina Street, First floor,  
 premise V, room 9, Moscow, 123154,  
 Russian Federation  
 (770) UCB Biopharma SRL  
 Allée de la Recherche 60, B-1070 Brussels,  
 Belgium  
 (580) 2022 07 28

## CHANGES OF NAMES AND/OR ADDRESSES OF TRADEMARKS OWNERS

(111) M 2021 33731 R  
 (732) LLC "Baffalos"  
 Mikheil Tamarashvili Av. 13o, app. 163,  
 Tbilisi, Georgia  
 (770) LLC "Baffalos"  
 Mikheil Tamarashvili Av. 13o, app. 163,  
 Tbilisi, Georgia  
 (580) 2022 07 28

(111) M 1997 7228 R  
 (732) Galderma Holding SA  
 Zählerweg 10 6300 Zug, Switzerland  
 (770) Galderma Holding SA  
 Rue d'Entre-deux-Villes 10, 1814 La Tour-  
 de-Peilz, Switzerland  
 (580) 2022 07 18

(111) M 1997 5196 R  
 (732) Galderma Holding SA  
 Zehlerveg 10 6300 Cugi, Switzerland  
 (770) Galderma Holding SA  
 Rue d'Entre-deux-Villes 10, 1814 La Tour-  
 de-Peilz, Switzerland  
 (580) 2022 07 18

(111) M 2012 22755 R  
 (732) Beiben Trucks Group Co., Ltd  
 N9 Binggong East Road, Equipment  
 Manufacturing Industry Park, Baotou City,  
 Inner Mongolia Autonomous Region, China  
 (770) Baotou Bei Ben Heavy-Duty Truck  
 Co., Ltd  
 East of N1 Machinery Factory, Qingshan  
 District, Baotou City, Inner Mongolia  
 Autonomous Region, China  
 (580) 2022 07 12

(111) M 2000 13571 R  
 (732) Philip Morris Global Brands Inc.  
 120 Park Avenue, New York,  
 New York 10017, USA  
 (770) Philip Morris Global Brands Inc.  
 9201 Arboretum Parkway, Richmond,  
 VA 23236, USA  
 (580) 2022 07 29

(111) M 2012 22756 R  
 (732) Beiben Trucks Group Co., Ltd  
 N9 Binggong East Road, Equipment  
 Manufacturing Industry Park, Baotou City,  
 Inner Mongolia Autonomous Region, China  
 (770) Baotou Bei Ben Heavy-Duty Truck  
 Co., Ltd

East of N1 Machinery Factory, Qingshan  
District, Baotou City, Inner Mongolia  
Autonomous Region, China  
(580) 2022 07 12

(111) M 2012 22757 R  
(732) Beiben Trucks Group Co., Ltd  
N9 Binggong East Road, Equipment  
Manufacturing Industry Park, Baotou City,  
Inner Mongolia Autonomous Region, China  
(770) Baotou Bei Ben Heavy-Duty Truck  
Co., Ltd  
East of N1 Machinery Factory, Qingshan  
District, Baotou City, Inner Mongolia  
Autonomous Region, China  
(580) 2022 07 12

(111) M 2011 22146 R  
(732) Harrington Business Inc.  
4th Floor, RJT Edifice, Waterfront Drive,  
P.O. Box 260, Road Town, Tortola, Virgin  
Islands (British)  
(770) Harrington Development Inc.  
Arango-Orillac Bldg. East 54 th street,  
Panama, Republic of Panama  
(580) 2022 07 22

(111) M 2012 22917 R  
(732) Popeyes Louisiana Kitchen Inc.  
A Minnesota Corporation  
5707 Blue Lagoon Drive, Miami,  
Florida 33126, USA  
(770) AFC Enterprises Inc.  
5555 Glenridge Connector, NE, Suite 300,  
Atlanta, GA 30342-4741, USA  
(580) 2022 08 03

(111) M 2012 22918 R  
(732) Popeyes Louisiana Kitchen Inc.  
A Minnesota Corporation  
5707 Blue Lagoon Drive, Miami, Florida  
33126, USA  
(770) AFC Enterprises, Inc.  
5555 Glenridge Connector, NE, Suite 300,  
Atlanta, GA 30342-4741, USA  
(580) 2022 08 03

(111) M 2012 23145 R  
(732) Galderma Holding SA  
Zählerweg 10 6300 Zug, Switzerland  
(770) Galderma Holding SA  
Rue d'Entre-deux-Villes 10, 1814 La Tour-  
de-Peilz, Switzerland  
(580) 2022 07 18

(111) M 2012 23146 R  
(732) Galderma Holding SA  
Zählerweg 10 6300 Zug, Switzerland  
(770) Galderma Holding SA  
Rue d'Entre-deux-Villes 10, 1814 La Tour-  
de-Peilz, Switzerland  
(580) 2022 07 18

(111) M 2014 24498 R  
(732) Galderma Holding SA  
Zählerweg 10 6300 Zug, Switzerland  
(770) Galderma Holding SA  
Rue d'Entre-deux-Villes 10, 1814 La Tour-  
de-Peilz, Switzerland  
(580) 2022 07 18

(111) M 2014 24499 R  
(732) Galderma Holding SA  
Zählerweg 10 6300 Zug, Switzerland  
(770) Galderma Holding SA  
Rue d'Entre-deux-Villes 10, 1814 La Tour-  
de-Peilz, Switzerland  
(580) 2022 07 18

(111) M 2014 24500 R  
(732) Galderma Holding SA  
Zählerweg 10 6300 Zug, Switzerland  
(770) Galderma Holding SA  
Rue d'Entre-deux-Villes 10, 1814 La Tour-  
de-Peilz, Switzerland  
(580) 2022 07 18

(111) M 2014 24861 R  
(732) Galderma Holding SA  
Zählerweg 10 6300 Zug, Switzerland  
(770) Galderma Holding SA  
Rue d'Entre-deux-Villes 10, 1814 La Tour-  
de-Peilz, Switzerland  
(580) 2022 07 18

(111) M 2014 25021 R  
(732) Galderma Holding SA  
Zählerweg 10 6300 Zug, Switzerland  
(770) Galderma Holding SA  
Rue d'Entre-deux-Villes 10, 1814 La Tour-  
de-Peilz, Switzerland(580) 2022 07 18

(111) M 2015 25997 R  
(732) Galderma Holding SA  
Zählerweg 10 6300 Zug, Switzerland  
(770) Galderma Holding SA  
Rue d'Entre-deux-Villes 10, 1814 La Tour-  
de-Peilz, Switzerland

---

(580) 2022 07 18

(111) M 2017 28373 R

(732) Galderma Holding SA  
Zählerweg 10 6300 Zug, Switzerland

(770) Galderma Holding SA  
Rue d'Entre-deux-Villes 10, 1814 La Tour-  
de-Peilz, Switzerland

(580) 2022 07 18

---

(111) M 2016 27098 R

(732) Galderma Holding SA  
Zählerweg 10 6300 Zug, Switzerland

(770) Galderma Holding SA  
Rue d'Entre-deux-Villes 10, 1814 La Tour-  
de-Peilz, Switzerland

(580) 2022 07 18

---

(111) M 2016 27375 R

(732) Galderma Holding SA  
Zählerweg 10 6300 Zug, Switzerland

(770) Galderma Holding SA  
Rue d'Entre-deux-Villes 10, 1814 La Tour-  
de-Peilz, Switzerland

(580) 2022 07 18

---

(111) M 2016 27699 R

(732) Galderma Holding SA  
Zählerweg 10 6300 Zug, Switzerland

(770) Galderma Holding SA  
Rue d'Entre-deux-Villes 10, 1814 La Tour-  
de-Peilz, Switzerland

(580) 2022 07 18

---

(111) M 2016 27924 R

(732) Galderma Holding SA  
Zählerweg 10 6300 Zug, Switzerland

(770) Galderma Holding SA  
Rue d'Entre-deux-Villes 10, 1814 La Tour-  
de-Peilz, Switzerland

(580) 2022 07 18

---

(111) M 2017 28319 R

(732) Galderma Holding SA  
Zählerweg 10 6300 Zug, Switzerland

(770) Galderma Holding SA  
Rue d'Entre-deux-Villes 10, 1814 La Tour-  
de-Peilz, Switzerland

(580) 2022 07 18

---

(111) M 2019 31414 R

(732) UCB Biopharma SRL  
Allée de la Recherche 60, B-1070 Brussels,  
Belgium

(770) UCB Biopharma SPRL  
Allée de la Recherche 60, B-1070 Brussels,  
Belgium

(580) 2022 07 28

---

## CANCELLATION OF TRADEMARKS REGISTRATION

(111) M 2002 14285 R  
(151) 2002 02 08  
(732) JSC "Tbilisi Tobacco"  
C. Nadareishvili St. 5, 0137, Tbilisi, Georgia  
(141) 2022 08 16

---

(111) M 2002 14256 R  
(151) 2002 01 18  
(732) LTD "Iasoni"  
Shota Rustaveli Av. 44, 0108, Tbilisi,  
Georgia  
(141) 2022 08 15

---

(111) M 2002 14265 R  
(151) 2002 01 18  
(732) Sopharma AD  
16, Iliensko Shaussee Str., 1220 Sofia,  
Bulgaria  
(141) 2022 08 15

---

(111) M 2002 14259 R  
(151) 2002 01 18  
(732) Marsa Yag Gida Sanayi ve Ticaret Anonim  
Şirketi, Organize Sanayi Bolgesi  
Cumhuriyet Cad., No: 2/26 Manisa, Turkey  
(141) 2022 08 15

---

(111) M 2012 22233 R  
(151) 2012 02 03  
(732) LTD "TV Company Mze"  
Merab Kostava St. 75b, 0179, Tbilisi,  
Georgia  
(141) 2022 08 15

---

(111) M 2012 22237 R  
(151) 2012 02 03  
(732) LTD "Konditholding"  
Shota Rustaveli St. 13, 4200, Sighnaghi,  
Georgia  
(141) 2022 08 15

---

(111) M 2012 22194 R  
(151) 2012 01 18  
(732) Harrington Development Inc.  
Arango-Orillac Bldg., East 54th street,  
Republic of Panama  
(141) 2022 08 15

---

(111) M 2012 22195 R  
(151) 2012 01 18  
(732) Harrington Development Inc.  
Arango-Orillac Bldg., East 54th street,  
Republic of Panama  
(141) 2022 08 15

---

(111) M 2012 22196 R  
(151) 2012 01 18  
(732) Lali Bukia  
Ilia Chavchavadze Av. 75b, app. 13, 0179,  
Tbilisi Georgia  
(141) 2022 08 15

---

(111) M 2012 22241 R  
(151) 2012 02 03  
(732) LTD "Konditholding"  
Shota Rustaveli St. 13, 4200, Sighnaghi,  
Georgia  
(141) 2022 08 15

---

(111) M 2012 22242 R  
(151) 2012 02 03  
(732) AbbVie Inc.,  
a Corporation of the State of Delaware  
1 N. Waukegan Road, North Chicago,  
Illinois 60064, USA  
(141) 2022 08 15

---

(111) M 2012 22243 R  
(151) 2012 02 03  
(732) AbbVie Inc.,  
a Corporation of the State of Delaware  
1 N. Waukegan Road, North Chicago,  
Illinois 60064, USA  
(141) 2022 08 15

---

(111) M 2012 22200 R  
(151) 2012 01 18  
(732) Abbott Laboratories  
Abbott Park, Illinois 60064, USA  
(141) 2022 08 15

---

(111) M 2012 22201 R  
(151) 2012 01 18  
(732) Abbott Laboratories  
Abbott Park, Illinois 60064, USA  
(141) 2022 08 15

---

(111) M 2012 22246 R  
(151) 2012 02 03  
(732) LTD "Adjaratour"  
Giorgi Brtskinvale St. 122, 6000, Batumi  
Georgia  
(141) 2022 08 15

---

(111) M 2012 22247 R  
(151) 2012 02 03  
(732) Internationall Relief & Development  
a Corporation Delaware  
1621 North Kent Street, Arlington, Virginia  
22209, USA  
(141) 2022 08 15

---

(111) M 2012 22248 R  
(151) 2012 02 03  
(732) Internationall Relief & Development  
a Corporation Delaware  
1621 North Kent Street, Arlington, Virginia  
22209, USA  
(141) 2022 08 15

---

(111) M 2012 22204 R  
(151) 2012 01 18  
(732) Global Tobacco International LLC  
520 S. 7th Street, Suite C, Las Vegas, Nevada,  
NV 89101, USA  
(141) 2022 08 15

---

(111) M 2012 22249 R  
(151) 2012 02 03  
(732) Global Tobacco International LLC  
520 S. 7th Street, Suite C, Las Vegas, Nevada,  
NV 89101, USA  
(141) 2022 08 15

---

(111) M 2012 22250 R  
(151) 2012 02 03  
(732) Harrington Development Inc.  
Arango-Orillac Bldg. East 54 th street,  
Panama, Republic of Panama  
(141) 2022 08 15

---

(111) M 2012 22251 R  
(151) 2012 02 03  
(732) Harrington Development Inc.  
Arango-Orillac Bldg. East 54 th street,  
Panama, Republic of Panama  
(141) 2022 08 15

---

(111) M 2012 22252 R  
(151) 2012 02 03  
(732) Harrington Development Inc.  
Arango-Orillac Bldg. East 54 th street,  
Panama, Republic of Panama  
(141) 2022 08 15

---

(111) M 2012 22205 R  
(151) 2012 01 18  
(732) Harrington Development Inc.  
Arango-Orillac Bldg. East 54 th street,  
Panama, Republic of Panama  
(141) 2022 08 15

---

(111) M 2012 22207 R  
(151) 2012 01 18  
(732) Joint Stock Company "G-P-C"  
Kote Marjanishvili St. 26, 0102, Tbilisi,  
Georgia  
(141) 2022 08 15

---

(111) M 2012 22208 R  
(151) 2012 01 18  
(732) Joint Stock Company "G-P-C"  
Kote Marjanishvili St. 26, 0102, Tbilisi,  
Georgia  
(141) 2022 08 15

---

(111) M 2012 22209 R  
(151) 2012 01 18  
(732) Obshchestvo s Ogranichennoy Otvestven  
nostyu "Mon'delez Rus" (Mon'delez Rus LLC)  
Ul. Frantsa Shtolverka 10, Vladimirskaia  
Oblast, Petushinskiy Rayon, 601123 Pokrov,  
Russian Federation  
(141) 2022 08 15

---

(111) M 2012 22253 R  
(151) 2012 02 03  
(732) LTD "Konditholding"  
Shota Rustaveli St. 13, 4200, Sighnaghi,  
Georgia  
(141) 2022 08 15

---

(111) M 2012 22211 R  
(151) 2012 01 18  
(732) Taras Gagnidze  
Kipshidze St. 8, app. 24, 0162, Tbilisi,  
Georgia  
(141) 2022 08 15

---

(111) M 2012 22212 R  
(151) 2012 01 18  
(732) Vasili Maghlaperidze  
Vakhtang Gorgasali St. 39, app. 17, 0114,  
Tbilisi Georgia  
(141) 2022 08 15

---

(111) M 2012 22255 R  
(151) 2012 02 03  
(732) British American Tobacco (Brands) Inc.  
(a Delaware corporation)  
2711 Centerville Road, Suite 300, Wilmington,  
Delaware 19808, USA  
(141) 2022 08 15

---

(111) M 2012 22259 R  
(151) 2012 02 03  
(732) British American Tobacco (Brands) Limited  
Globe House, 4 Temple Place, London  
WC 2R 2PG, United Kingdom  
(141) 2022 08 15

---

(111) M 2012 22262 R  
(151) 2012 02 03  
(732) LTD Aspharma – Georgian Pharmaceu  
tical Company  
Mtskheta Str. 8, 0179, Tbilisi, Georgia  
(141) 2022 08 15

---

(111) M 2012 22265 R  
(151) 2012 02 03  
(732) LTD Aspharma – Georgian Pharmaceu  
tical Company  
Mtskheta Str. 8, 0179, Tbilisi, Georgia  
(141) 2022 08 15

---

(111) M 2012 22268 R  
(151) 2012 02 03  
(732) Bidzina Tsutskiridze  
Vazisubani, IV mcr., I qu., bld. 5, app. 35,  
Tbilisi, Georgia  
(141) 2022 08 15

---

(111) M 2012 22218 R  
(151) 2012 01 18  
(732) Harrington Development Inc.  
Elvira Mendez Street, Vallarino bldg., 3rd  
Floor, Panama, Republic of Panama  
(141) 2022 08 15

---

(111) M 2012 22219 R  
(151) 2012 01 18  
(732) Harrington Development Inc.  
Elvira Mendez Street, Vallarino bldg., 3rd  
Floor, Panama, Republic of Panama  
(141) 2022 08 15

---

(111) M 2012 22274 R  
(151) 2012 02 03  
(732) Prenatal S.P.A.  
Via tornese, 10, grandate, 22070 Como, Italy  
(141) 2022 08 15

---

(111) M 2012 22221 R  
(151) 2012 01 18  
(732) Hyundai Mobis Co., Ltd  
Ing Tower, 679-4, Yeoksam-1-dong,  
Gangnam-gu, Seoul 135-977, Republic of  
Korea  
(141) 2022 08 15

---

(111) M 2012 22275 R  
(151) 2012 02 03  
(732) Daiichi Sankyo Company, Limited  
3-5-1, Nihonbashi Honcho, Chuo-ku,  
Tokyo 103-8426, Japan  
(141) 2022 08 15

---

(111) M 2012 22276 R  
(151) 2012 02 03  
(732) JSC "Teliani Valley"  
Tbilisi Highway 3, 2200, Telavi, Georgia  
(141) 2022 08 15

---

(111) M 2012 22279 R  
(151) 2012 02 03  
(732) Mitel Networks Corporation  
350 Legget Drive, Ottawa, Ontario K2K 2W7,  
Canada  
(141) 2022 08 15

---

(111) M 2012 22280 R  
(151) 2012 02 03  
(732) Publichnoe Aktsionerhoe Obshestvo  
Komercheskiy Bank "Privatbank"  
Ul. Naberezhnaya Pobedi 50, Dnepropet-  
rovsk, 49094, Ukraine  
(141) 2022 08 15

---



(111) M 2012 22281 R  
(151) 2012 02 03  
(732) Publichnoe Aktsionernoe Obshestvo  
Komercheskiy Bank "Privatbank"  
Ul. Naberezhnaya Pobedi 50, Dnepropet-  
rovsk, 49094, Ukraine  
(141) 2022 08 15

---

(111) M 2012 22282 R  
(151) 2012 02 03  
(732) Publichnoe Aktsionernoe Obshestvo  
Komercheskiy Bank "Privatbank"  
Ul. Naberezhnaya Pobedi 50, Dnepropet-  
rovsk, 49094, Ukraine  
(141) 2022 08 15

---

(111) M 2012 22232 R  
(151) 2012 02 01  
(732) JSC "Imani Georgia"  
Ilia Chavchavadze Av. 74, Vake-Saburtalo  
District, Tbilisi, Georgia  
(141) 2022 08 15

---

(111) M 2012 22225 R  
(151) 2012 01 31  
(732) Harrington Development Inc.  
Arango-Orillac Bldg., East 54th street,  
Republic of Panama  
(141) 2022 08 15

---

(111) M 2012 22226 R  
(151) 2012 01 31  
(732) Harrington Development Inc.  
Elvira Mendez Street, Vallarino bldg.,  
3rd Floor, Panama, Republic of Panama  
(141) 2022 08 15

---

(111) M 2012 22231 R  
(151) 2012 01 31  
(732) LTD "Cognac and Wine Factory Vaziani"  
Tamar Mepe Av. 6, 0112, Tbilisi, Georgia  
(141) 2022 08 15

---

(111) M 2012 22229 R  
(151) 2012 01 31  
(732) JSC "Lomisi"  
Vill. Natakhvari, 3308, Mrsheta, Georgia  
(141) 2022 08 15

---

(111) M 2012 22290 R  
(151) 2012 02 03  
(732) LTD "Natali"  
Vazha-Pshavela Av. 42, 0177, Tbilisi,  
Georgia  
(141) 2022 08 15

---

(111) M 2012 22228 R  
(151) 2012 01 31  
(732) JSC "Tskali Margebeli"  
Vill. Nabeghlavi, 4900, Chokhatauri Region,  
Georgia  
(141) 2022 08 15

---

(111) M 2012 22291 R  
(151) 2012 02 09  
(732) Detlefsen end Belk GmbH  
Hermann-Wuesthof-Ring 16, 21035 Hamburg,  
Germany  
(141) 2022 08 17

---

---

# CLASSIFICATION INDEXES

## INVENTIONS

### CONCORDANCE TABLE OF INTERNATIONAL CLASSIFICATION INDEX AND PUBLICATION NUMBERS

INTERNATIONAL CLASSIFICATION INDEXES (51)	NUMBER OF PUBLISHED APPLICATION (10)
A 24 D 3/14; A 61 K 38/44; A 61 K 7/00; A 61 L 2/00	AP 2022 15488 A
A 61 K 31/165; A 61 P 11/00; A 61 P 1/00; C 07 C 237/22; C 07 C 231/02	AP 2022 15511 A
A 61 K 31/437; A 61 P 35/00; C 07 D 471/04	AP 2022 15446 A
B 29 B 17/00; B 29 B 17/04; C 08 J 3/12; C 08 J 3/00; C 08 L 95/00; E 01 C 7/26	AP 2022 15770 A
B 61 B 7/00	AP 2022 15565 A
C 04 B 7/36	AP 2022 15578 A
C 07 D 231/40; C 07 D 401/12; C 07 D 401/14; C 07 D 403/12; C 07 D 403/14; C 07 D 405/12	AP 2022 15709 A
C 07 D 295/26; C 07 D 403/04; C 07 D 295/205; C 07 D 471/10; C 07 D 498/08	AP 2022 15088 A

### CONCORDANCE TABLE OF PUBLICATION NUMBERS AND INTERNATIONAL CLASSIFICATION INDEX

NUMBER OF PUBLISHED APPLICATION (10)	INTERNATIONAL CLASSIFICATION INDEXES (51)
AP 2022 15088 A	C 07 D 295/26; C 07 D 403/04; C 07 D 295/205; C 07 D 471/10; C 07 D 498/08
AP 2022 15446 A	A 61 K 31/437; A 61 P 35/00; C 07 D 471/04
AP 2022 15488 A	A 24 D 3/14; A 61 K 38/44; A 61 K 7/00; A 61 L 2/00
AP 2022 15511 A	A 61 K 31/165; A 61 P 11/00; A 61 P 1/00; C 07 C 237/22; C 07 C 231/02
AP 2022 15565 A	B 61 B 7/00
AP 2022 15578 A	C 04 B 7/36
AP 2022 15709 A	C 07 D 231/40; C 07 D 401/12; C 07 D 401/14; C 07 D 403/12; C 07 D 403/14; C 07 D 405/12
AP 2022 15770 A	B 29 B 17/00; B 29 B 17/04; C 08 J 3/12; C 08 J 3/00; C 08 L 95/00; E 01 C 7/26

**CONCORDANCE TABLE OF INTERNATIONAL CLASSIFICATION INDEX,  
PATENT NUMBERS AND PUBLICATION NUMBERS**

INTERNATIONAL CLASSIFICATION INDEX (51)	NUMBER OF PATENT (11)	NUMBER OF PUBLISHED APPLICATION (10)
A 61 K 31/427; A 61 K 31/433; A 61 K 31/4439	P 2022 7406 B	AP 2022 15303 A
A 61 K 31/565; A 61 P 15/18	P 2022 7407 B	AP 2022 15414 A
A 61 K 39/095; C 08 B 37/00; C 08 H 1/00; C 08 L 5/00	P 2022 7408 B	AP 2022 15229 A

**CONCORDANCE TABLE OF PATENT NUMBERS,  
PUBLICATION NUMBERS AND INTERNATIONAL CLASSIFICATION INDEX**

NUMBER OF PATENT (11)	NUMBER OF PUBLISHED APPLICATION (10)	INTERNATIONAL CLASSIFICATION INDEX (51)
P 2022 7406 B	AP 2022 15303 A	A 61 K 31/427; A 61 K 31/433; A 61 K 31/4439
P 2022 7407 B	AP 2022 15414 A	A 61 K 31/565; A 61 P 15/18
P 2022 7408 B	AP 2022 15229 A	A 61 K 39/095; C 08 B 37/00; C 08 H 1/00; C 08 L 5/00

**CONCORDANCE TABLE OF APPLICATION NUMBERS,  
PUBLICATION NUMBERS AND PATENTS**

NUMBER OF APPLICATION (21)	NUMBER OF PUBLISHED APPLICATION (10)	NUMBER OF PATENT (11)
AP 2018 15229	AP 2022 15229 A	P 2022 7408 B
AP 2018 15303	AP 2022 15303 A	P 2022 7406 B
AP 2019 15414	AP 2022 15414 A	P 2022 7407 B

## UTILITY MODELS

**CONCORDANCE TABLE OF INTERNATIONAL CLASSIFICATION INDEX  
AND PUBLICATION NUMBERS**

INTERNATIONAL CLASSIFICATION INDEXES (51)	NUMBER OF PUBLISHED APPLICATION (10)
A 61 M 1/10	AU 2022 15543 U
F 24 D 19/00; F 24 H 9/00	AU 2022 15765 U

CONCORDANCE TABLE OF PUBLICATION NUMBERS  
AND INTERNATIONAL CLASSIFICATION INDEX

NUMBER OF PUBLISHED APPLICATION (10)	INTERNATIONAL CLASSIFICATION INDEXES (51)
AU 2022 15543 U	A 61 M 1/10
AU 2022 15765 U	F 24 D 19/00; F 24 H 9/00

CONCORDANCE TABLE OF INTERNATIONAL CLASSIFICATION INDEX,  
PATENT NUMBERS AND PUBLICATION NUMBERS

INTERNATIONAL CLASSIFICATION INDEX (51)	NUMBER OF PATENT (11)	NUMBER OF PUBLISHED APPLICATION (10)
A 61 L 9/00	U 2022 2127 Y	AU 2022 15658 U
F 02 F 7/00	U 2022 2128 Y	AU 2022 15640 U

CONCORDANCE TABLE OF PATENT NUMBERS,  
PUBLICATION NUMBERS AND INTERNATIONAL CLASSIFICATION INDEX

NUMBER OF PATENT (11)	NUMBER OF PUBLISHED APPLICATION (10)	INTERNATIONAL CLASSIFICATION INDEX (51)
U 2022 2127 Y	AU 2022 15658 U	A 61 L 9/00
U 2022 2128 Y	AU 2022 15640 U	F 02 F 7/00

CONCORDANCE TABLE OF APPLICATION NUMBERS,  
PUBLICATION NUMBERS AND PATENTS

NUMBER OF APPLICATION (21)	NUMBER OF PUBLISHED APPLICATION (10)	NUMBER OF PATENT (11)
AU 2021 15640	AU 2022 15640 U	U 2022 2128 Y
AU 2021 15658	AU 2022 15658 U	U 2022 2127 Y

## TRADEMARKS

### CONCORDANCE TABLE OF REGISTRATION NUMBERS, APPLICATION NUMBERS, PUBLICATION NUMBERS AND BULLETIN NUMBERS

NUMBER OF REGISTRATION (111)	NUMBER OF APPLICATIONS (210)	NUMBER OF PUBLISHED APPLICATIONS (260)	NUMBER OF BULLETIN
1	2	3	4
M 2022 35746 R	AM 118484	–	16(595)2022
M 2022 35747 R	AM 118485	–	16(595)2022
M 2022 35748 R	AM 118486	–	16(595)2022
M 2022 35749 R	AM 118829	–	16(595)2022
M 2022 35750 R	AM 118482	–	16(595)2022
M 2022 35751 R	AM 118480	–	16(595)2022
M 2022 35752 R	AM 118481	–	16(595)2022
M 2022 35753 R	AM 118489	–	16(595)2022
M 2022 35754 R	AM 118487	–	16(595)2022
M 2022 35755 R	AM 118491	–	16(595)2022
M 2022 35756 R	AM 118921	–	16(595)2022
M 2022 35757 R	AM 118528	–	16(595)2022
M 2022 35758 R	AM 118529	–	16(595)2022
M 2022 35759 R	AM 118828	–	16(595)2022
M 2022 35760 R	AM 118515	–	16(595)2022
M 2022 35761 R	AM 118516	–	16(595)2022
M 2022 35762 R	AM 118517	–	16(595)2022
M 2022 35763 R	AM 118518	–	16(595)2022
M 2022 35764 R	AM 118519	–	16(595)2022
M 2022 35765 R	AM 118520	–	16(595)2022
M 2022 35766 R	AM 118495	–	16(595)2022
M 2022 35767 R	AM 118496	–	16(595)2022
M 2022 35768 R	AM 118497	–	16(595)2022
M 2022 35769 R	AM 118498	–	16(595)2022
M 2022 35770 R	AM 118499	–	16(595)2022
M 2022 35771 R	AM 118500	–	16(595)2022
M 2022 35772 R	AM 118501	–	16(595)2022
M 2022 35773 R	AM 118502	–	16(595)2022
M 2022 35774 R	AM 118503	–	16(595)2022
M 2022 35775 R	AM 118504	–	16(595)2022
M 2022 35776 R	AM 118505	–	16(595)2022
M 2022 35777 R	AM 118507	–	16(595)2022
M 2022 35778 R	AM 118508	–	16(595)2022
M 2022 35779 R	AM 118509	–	16(595)2022
M 2022 35780 R	AM 118510	–	16(595)2022
M 2022 35781 R	AM 118511	–	16(595)2022
M 2022 35782 R	AM 118512	–	16(595)2022
M 2022 35783 R	AM 118513	–	16(595)2022
M 2022 35784 R	AM 118514	–	16(595)2022
M 2022 35785 R	AM 118521	–	16(595)2022
M 2022 35786 R	AM 118522	–	16(595)2022
M 2022 35787 R	AM 118524	–	16(595)2022
M 2022 35788 R	AM 118525	–	16(595)2022
M 2022 35789 R	AM 118526	–	16(595)2022
M 2022 35790 R	AM 118527	–	16(595)2022
M 2022 35791 R	AM 118835	–	16(595)2022

1	2	3	4
M 2022 35792 R	AM 118493	–	16(595)2022
M 2022 35793 R	AM 118490	–	16(595)2022
M 2022 35794 R	AM 118506	–	16(595)2022
M 2022 35795 R	AM 118492	–	16(595)2022
M 2022 35796 R	AM 118494	–	16(595)2022
M 2022 35797 R	AM 118837	–	16(595)2022
M 2022 35798 R	AM 118929	–	16(595)2022
M 2022 35799 R	AM 118848	–	16(595)2022
M 2022 35800 R	AM 118863	–	16(595)2022
M 2022 35801 R	AM 118919	–	16(595)2022
M 2022 35802 R	AM 118926	–	16(595)2022
M 2022 35803 R	AM 111398	AM 2022 111398 A	2(581)2022
M 2022 35804 R	AM 111399	AM 2022 111399 A	2(581)2022
M 2022 35805 R	AM 111400	AM 2022 111400 A	2(581)2022
M 2022 35806 R	AM 112167	AM 2022 112167 A	8(587)2022
M 2022 35807 R	AM 112278	AM 2022 112278 A	1(580)2022
M 2022 35808 R	AM 112668	AM 2022 112668 A	3(582)2022
M 2022 35809 R	AM 112698	AM 2022 112698 A	4(583)2022
M 2022 35810 R	AM 112699	AM 2022 112699 A	4(583)2022
M 2022 35811 R	AM 113260	AM 2022 113260 A	3(582)2022
M 2022 35812 R	AM 113261	AM 2022 113261 A	3(582)2022
M 2022 35813 R	AM 113275	AM 2022 113275 A	2(581)2022
M 2022 35814 R	AM 113283	AM 2022 113283 A	2(581)2022
M 2022 35815 R	AM 113335	AM 2022 113335 A	2(581)2022
M 2022 35816 R	AM 113336	AM 2022 113336 A	2(581)2022
M 2022 35817 R	AM 113354	AM 2022 113354 A	2(581)2022
M 2022 35818 R	AM 113375	AM 2022 113375 A	5(584)2022
M 2022 35819 R	AM 113378	AM 2022 113378 A	3(582)2022
M 2022 35820 R	AM 13379	AM 2022 113379 A	2(581)2022
M 2022 35821 R	AM 113427	AM 2022 113427 A	4(583)2022
M 2022 35822 R	AM 113428	AM 2022 113428 A	4(583)2022
M 2022 35823 R	AM 113511	AM 2022 113511 A	2(581)2022
M 2022 35824 R	AM 113512	AM 2022 113512 A	2(581)2022
M 2022 35825 R	AM 113515	AM 2022 113515 A	2(581)2022
M 2022 35826 R	AM 113518	AM 2022 113518 A	2(581)2022
M 2022 35827 R	AM 113584	AM 2022 113584 A	3(582)2022
M 2022 35828 R	AM 113609	AM 2022 113609 A	3(582)2022
M 2022 35829 R	AM 113617	AM 2022 113617 A	2(581)2022
M 2022 35830 R	AM 113699	AM 2022 113699 A	3(582)2022
M 2022 35831 R	AM 113848	AM 2022 113848 A	4(583)2022
M 2022 35832 R	AM 113873	AM 2022 113873 A	3(582)2022
M 2022 35833 R	AM 113994	AM 2022 113994 A	5(584)2022
M 2022 35834 R	AM 113995	AM 2022 113995 A	5(584)2022
M 2022 35835 R	AM 113996	AM 2022 113996 A	5(584)2022
M 2022 35836 R	AM 113997	AM 2022 113997 A	5(584)2022
M 2022 35837 R	AM 113998	AM 2022 113998 A	5(584)2022
M 2022 35838 R	AM 114137	AM 2022 114137 A	5(584)2022
M 2022 35839 R	AM 114138	AM 2022 114138 A	5(584)2022
M 2022 35840 R	AM 114141	AM 2022 114141 A	4(583)2022
M 2022 35841 R	AM 114223	AM 2022 114223 A	2(581)2022
M 2022 35842 R	AM 114324	AM 2022 114324 A	6(585)2022
M 2022 35843 R	AM 114325	AM 2022 114325 A	5(584)2022
M 2022 35844 R	AM 114326	AM 2022 114326 A	5(584)2022
M 2022 35845 R	AM 114337	AM 2022 114337 A	7(586)2022
M 2022 35846 R	AM 114413	AM 2022 114413 A	5(584)2022
M 2022 35847 R	AM 114531	AM 2022 114531 A	7(586)2022

1	2	3	4
M 2022 35848 R	AM 114534	AM 2022 114534 A	8(587)2022
M 2022 35849 R	AM 114539	AM 2022 114539 A	7(586)2022
M 2022 35850 R	AM 114544	AM 2022 114544 A	7(586)2022
M 2022 35851 R	AM 114546	AM 2022 114546 A	7(586)2022
M 2022 35852 R	AM 114590	AM 2022 114590 A	8(587)2022
M 2022 35853 R	AM 114609	AM 2022 114609 A	7(586)2022
M 2022 35854 R	AM 114611	AM 2022 114611 A	8(587)2022
M 2022 35855 R	AM 114617	AM 2022 114617 A	7(586)2022
M 2022 35856 R	AM 114618	AM 2022 114618 A	7(586)2022
M 2022 35857 R	AM 114677	AM 2022 114677 A	8(587)2022
M 2022 35858 R	AM 114742	AM 2022 114742 A	8(587)2022
M 2022 35859 R	AM 114743	AM 2022 114743 A	8(587)2022
M 2022 35860 R	AM 114806	AM 2022 114806 A	8(587)2022
M 2022 35861 R	AM 114904	AM 2022 114904 A	8(587)2022
M 2022 35862 R	AM 114050	AM 2022 114050 A	4(583)2022
M 2022 35863 R	AM 114794	AM 2022 114794 A	9(588)2022
M 2022 35864 R	AM 114809	AM 2022 114809 A	8(587)2022
M 2022 35865 R	AM 114810	AM 2022 114810 A	8(587)2022
M 2022 35866 R	AM 115015	AM 2022 115015 A	9(588)2022
M 2022 35867 R	AM 115016	AM 2022 115016 A	9(588)2022
M 2022 35868 R	AM 118994	-	16(595)2022
M 2022 35869 R	AM 118727	-	16(595)2022
M 2022 35870 R	AM 118924	-	16(595)2022

**CONCORDANCE TABLE OF PUBLICATION NUMBERS  
AND APPLICATION NUMBERS**

NUMBER OF PUBLISHED APPLICATION (260)	NUMBER OF APPLICATION (210)	1	2
		1	2
AM 2022 115593 A	AM 115593	AM 2022 116309 A	AM 116309
AM 2022 115843 A	AM 115843	AM 2022 116310 A	AM 116310
AM 2022 116145 A	AM 116145	AM 2022 116311 A	AM 116311
AM 2022 116146 A	AM 116146	AM 2022 116312 A	AM 116312
AM 2022 116147 A	AM 116147	AM 2022 116319 A	AM 116319
AM 2022 116148 A	AM 116148	AM 2022 116320 A	AM 116320
AM 2022 116162 A	AM 116162	AM 2022 116326 A	AM 116326
AM 2022 116171 A	AM 116171	AM 2022 116329 A	AM 116329
AM 2022 116215 A	AM 116215	AM 2022 116330 A	AM 116330
AM 2022 116216 A	AM 116216	AM 2022 116402 A	AM 116402
AM 2022 116217 A	AM 116217	AM 2022 116405 A	AM 116405
AM 2022 116218 A	AM 116218	AM 2022 116407 A	AM 116407
AM 2022 116219 A	AM 116219	AM 2022 116408 A	AM 116408
AM 2022 116305 A	AM 116305	AM 2022 116413 A	AM 116413
AM 2022 116306 A	AM 116306	AM 2022 116435 A	AM 116435
		AM 2022 116528 A	AM 116528
		AM 2022 116542 A	AM 116542
		AM 2022 116552 A	AM 116552
		AM 2022 117318 A	AM 117318

CONCORDANCE TABLE OF INDEX OF GOODS AND/OR SERVICES  
AND APPLICATION NUMBERS

INDEX OF GOODS AND/OR SERVICES (511)	NUMBER OF PUBLISHED APPLICATIONS (260)	1	2
1	2		
1	AM 2022 116402 A	29	AM 2022 116319 A
1	AM 2022 116405 A	29	AM 2022 116320 A
3	AM 2022 116146 A	33	AM 2022 115593 A
4	AM 2022 116148 A	33	AM 2022 115843 A
4	AM 2022 116402 A	34	AM 2022 116552 A
4	AM 2022 116405 A	35	AM 2022 115593 A
5	AM 2022 116215 A	35	AM 2022 116148 A
5	AM 2022 116216 A	35	AM 2022 116162 A
5	AM 2022 116217 A	35	AM 2022 116171 A
5	AM 2022 116218 A	35	AM 2022 116326 A
5	AM 2022 116219 A	35	AM 2022 116329 A
5	AM 2022 116305 A	35	AM 2022 116402 A
5	AM 2022 116306 A	35	AM 2022 116405 A
5	AM 2022 116309 A	35	AM 2022 116542 A
5	AM 2022 116310 A	36	AM 2022 116171 A
5	AM 2022 116311 A	36	AM 2022 116407 A
5	AM 2022 116312 A	36	AM 2022 116542 A
5	AM 2022 116330 A	37	AM 2022 116148 A
5	AM 2022 116413 A	37	AM 2022 116402 A
5	AM 2022 116435 A	37	AM 2022 116405 A
9	AM 2022 116145 A	38	AM 2022 116147 A
9	AM 2022 116407 A	39	AM 2022 116162 A
16	AM 2022 116402 A	39	AM 2022 116542 A
16	AM 2022 116405 A	40	AM 2022 116408 A
25	AM 2022 116147 A	41	AM 2022 115593 A
25	AM 2022 116402 A	41	AM 2022 116147 A
25	AM 2022 116405 A	41	AM 2022 116402 A
29	AM 2022 116162 A	41	AM 2022 116405 A
		41	AM 2022 116528 A
		41	AM 2022 117318 A
		43	AM 2022 115593 A
		45	AM 2022 116171 A



CONCORDANCE TABLE OF INDEX OF GOODS AND/OR SERVICES  
AND NUMBERS OF TRADEMARKS REGISTERED ACCORDING  
TO THE ACCELERATED PROCEDURE

INDEX OF GOODS AND/OR SERVICES (511)	NUMBERS OF REGISTERED ACCORDING TO THE ACCELERATED PROCEDURE (111)
1	2
5	M 2022 35870 R
9	M 2022 35797 R
10	M 2022 35799 R
11	M 2022 35802 R
14	M 2022 35869 R
17	M 2022 35802 R
24	M 2022 35756 R
25	M 2022 35756 R
25	M 2022 35869 R
28	M 2022 35756 R
32	M 2022 35868 R
33	M 2022 35759 R
33	M 2022 35791 R
34	M 2022 35746 R
34	M 2022 35747 R
34	M 2022 35748 R
34	M 2022 35750 R
34	M 2022 35751 R
34	M 2022 35752 R
34	M 2022 35753 R
34	M 2022 35754 R
34	M 2022 35755 R
34	M 2022 35757 R
34	M 2022 35758 R
34	M 2022 35760 R
34	M 2022 35761 R
34	M 2022 35762 R
34	M 2022 35763 R
34	M 2022 35764 R
34	M 2022 35765 R
34	M 2022 35766 R
34	M 2022 35767 R
34	M 2022 35768 R
34	M 2022 35769 R
34	M 2022 35770 R
34	M 2022 35771 R
34	M 2022 35772 R
34	M 2022 35773 R
34	M 2022 35774 R
34	M 2022 35775 R
34	M 2022 35776 R
34	M 2022 35777 R
34	M 2022 35778 R
34	M 2022 35779 R
34	M 2022 35780 R
34	M 2022 35781 R
34	M 2022 35782 R
34	M 2022 35783 R

---

1	2
34	M 2022 35784 R
34	M 2022 35785 R
34	M 2022 35786 R
34	M 2022 35787 R
34	M 2022 35788 R
34	M 2022 35789 R
34	M 2022 35790 R
34	M 2022 35792 R
34	M 2022 35793 R
34	M 2022 35794 R
34	M 2022 35795 R
34	M 2022 35796 R
35	M 2022 35791 R
35	M 2022 35800 R
35	M 2022 35801 R
36	M 2022 35749 R
41	M 2022 35756 R
43	M 2022 35791 R
43	M 2022 35798 R
45	M 2022 35800 R
45	M 2022 35801 R

# OFFICIAL BULLETIN OF THE INDUSTRIAL PROPERTY

**INVENTIONS  
UTILITY MODELS  
DESIGNS  
TRADEMARKS**

## **16(595)**

EDITOR-IN-CHIEF: N. Bebrishvili

EDITOR-TRANSLATOR: E. Gabunia

PROOFREADER: A. Shixashvili

COMPUTER LAYOUT: M. Ordenidze  
K. Svanidze

[info@sakpatenti.gov.ge](mailto:info@sakpatenti.gov.ge)  
[www.sakpatenti.gov.ge](http://www.sakpatenti.gov.ge)