

# Official Bulletin of the Industrial Property

Inventions

Utility Models

Designs

Traademarks

Appellation of Origin of Good



საქართველოს ინტელექტუალური  
საკუთრების ეროვნული ცენტრი

**საქპატენტი**

**SAKPATENTI**

NATIONAL INTELLECTUAL PROPERTY  
CENTER OF GEORGIA

[www.sakpatenti.gov.ge](http://www.sakpatenti.gov.ge)

Date of Publication – 2021 09 27

**17(573)**

# INID CODES FOR IDENTIFICATION OF BIBLIOGRAPHIC DATA

## INVENTIONS, UTILITY MODELS

- (10) Number of publication for application, which has been examined
- (11) Number of patent and kind of document
- (21) Serial number of application
- (22) Date of filing of the application
- (23) Date of exhibition or the date of the earlier filing and the number of application, if any
- (24) Date from which patent may have effect
- (31) Number of priority application
- (32) Date of filing of priority application
- (33) Code of the country or regional organization allotting priority application number
- (44) Date of publication of application not granted, but examined and number of bulletin
- (45) Date of publication of registered document
- (51) International Patent Classification Index

- (54) Title of the invention
- (57) Abstract
- (60) Number of examined patent document granted by foreign patent office, date from which patent has effect and country code
- (62) Number of the earlier application and in case of divided application, date of filing an application
- (71) Name, surname and address of applicant (country code)
- (72) Name, surname of inventor (country code)
- (73) Name, surname and address of patent owner (country code)
- (74) Name, surname of representative or patent attorney
- (85) Date of commencement of the national phase of International Application
- (86) Number and date of filing of international application
- (87) Number and date of publication of international application
- (94) Calculated date of expiry of the SPC or the duration of the SPC

## DESIGNS

- (10) Number of publication for application
- (11) Number of patent and kind of document or number of registration
- (15) Date of registration/Date of patent renewal
- (18) Expected expiration date of patent or registration
- (21) Serial number of application
- (22) Date of filing of the application
- (23) Date of exhibition or the date of the earlier filing and the number of application, if any
- (24) Date from which patent may have effect
- (28) Number of designs included in the application
- (30) Data relating to priority (number of application, date of filing of application, two-letter code identifying the authority with whom the priority application was made)
- (31) Number of priority application
- (32) Date of filing of priority application
- (33) Code of the country or regional organization allotting priority application number
- (34) Two-letter code according to WIPO St.3 identifying the authority with which the priority application was made
- (44) Date of publication of design and number of bulletin (the first publication)
- (45) Date of publication of design registered by WIPO and number of bulletin

- (51) International Classification for designs (class and subclass of the Locarno Classification)
- (54) Title of the invention
- (55) Reproduction of the design
- (57) Description of characteristic features of the design including indication of colors
- (58) Date of recording of any kind of amendment in the Register
- (62) Number of the earlier application, registration and document number and if available the date of filing an application in case of divided application
- (71) Name, surname and address of applicant (country code)
- (72) Name, surname of creator (country code)
- (73) Name, surname and address of patent owner (country code)
- (74) Name, surname of representative or patent attorney
- (81) Contracting states concerned
  - II designated contracting states according to the 1960 Act
  - III designated contracting states according to the 1999 Act
- (85) Owner's permanent address
- (86) Owner's nationality
- (87) Owner's residence
- (88) State in which the owner has a real and effective industrial or commercial establishment

## TRADEMARKS

- (111) - Number of registration
- (151) - Date of registration
- (156) - Date of the renewal
- (181) - Expected expiration date of registration
- (186) - Renewal expiration date of registration
- (141) - Date of cancel of duration of the mark
- (210) - Serial number of application
- (220) - Date of filing of the application
- (230) - Data concerning exhibition
- (260) - Number of application, for which favorable decision of examination about registration has been taken (publication number)
- (310) - Number of the first application
- (320) - Date of filing of the first application
- (330) - Code, identifying national or regional Office where the first application was made
- (511) - International Classification of Goods and Services for the purposes of registration of trade marks and/or list of goods and/or services classified according thereto
- (526) - Disclaimer
- (531) - Description of figurative elements of Trade Marks according to the International Classification of the Figurative Elements of Marks

- (540) - Reproduction of Trade Mark
- (550) - Nature and kind of Trade Mark
- (551) - Indication to the effect that the mark is a collective mark, a certification mark or a guarantee mark
- (554) - Three-dimensional mark
- (580) - Date of recording of any kind changes in respect of applications or registrations
- (591) - Information concerning colors claimed
- (731) - Name and address of the applicant
- (732) - Name and address of the holder of the registration
- (740) - Name and address of the representative
- (750) - Addreses for correspondence
- (770) - Name and address of the previous applicant or holder in case of change in ownership
- (771) - Previous name and address of the applicant or holder in case of change in ownership
- (791) - Name and address of the licensee
- (793) - Indication of conditions and/or restrictions under the license (Type of license, number of license agreement, data of license, data of validity of license)
- (800) - Certain data relating to the international registration of Trade Marks under the Protocol Relating to Madrid Agreement (International registration number
- (852) - Partial cancellation of the list of goods and services
- (891) - Date of subsequent designation

## CODES FOR PUBLICATION IN BULLETIN

- (21) AP 0000 000000 - serial number of application for invention
- (10) AP 0000 0000 A - number of published application for invention (first publication)
- (11) P 0000 0000 B - number of patent for invention (second publication)
- (21) API 0000 000000 - number of application for imported patent
- (11) PI 0000 0000 A - number of imported patent (first publication)
- (21) AU 0000 000000 - serial number of application for utility model
- (10) AU 0000 000 U - number of published application for utility model (first publication)
- (11) U 0000 000 Y - number of patent for utility model (second publication)
- (21) AD 0000 000000 - serial number of application for design
- (10) AD 0000 000 S - number of published application for design (first publication)
- (11) D 0000 000 S - registered design

## INTERNATIONAL PATENT CLASSIFICATION FOR INVENTIONS AND UTILITY MODELS

- SECTION A - HUMAN NECESSITIES
- SECTION B - PERFORMING OPERATIONS; TRANSPORTING
- SECTION C - CHEMISTRY; METALLURGY
- SECTION D - TEXTILES; PAPER
- SECTION E - FIXED CONSTRUCTIONS
- SECTION F - MECHANICAL ENGINEERING; LIGHTING; HEATING; WEAPONS; BLASTING
- SECTION G - PHYSICS
- SECTION H - ELECTRICITY

- 
- M - Trade Mark
  - (210) AM 0000 000000 - Serial number of application;
  - (260) AAM 0000 00000 A - Publication number of application;
  - (111) M 0000 00000 R - Number of registration;
  - (111) MMM0000 00000 Rn - Number of renewals, in which n=1,2,3;
  - (111) M 0000 00000 R(P) - Number of registration under partial assignment of rights
-

# Official Bulletin of the Industrial Property

Inventions

Utility Models

Designs

Trademarks

Appellations of Origin of Good

# CONTENTS

<b>PUBLISHED TITLES OF PROTECTION</b> .....	3
<b>INVENTIONS</b>	
▪ APPLICATIONS APPROVED FOR GRANTING PATENT .....	4
▪ PATENTED INVENTIONS .....	6
<b>UTILITY MODELS</b>	
▪ APPLICATIONS APPROVED FOR GRANTING PATENT .....	8
▪ PATENTED UTILITY MODELS .....	10
<b>DESIGNS</b>	
▪ APPLICATION APPROVED FOR REGISTRATION .....	11
▪ REGISTERED DESIGN .....	12
▪ DESIGNS, WHICH HAVE BEEN REGISTERED WITH THE INTERNATIONAL BUREAU CLAIMING PRIORITY ON THE TERRITORY OF GEORGIA .....	13
<b>TRADEMARKS</b>	
▪ APPLICATIONS FILED UNDER THE NATIONAL PROCEDURE APPROVED FOR REGISTRATION .....	31
▪ REGISTERED TRADEMARKS .....	36
▪ TRADEMARKS REGISTERED ACCORDING TO THE ACCELERATED PROCEDURE .....	40
▪ INTERNATIONAL TRADEMARKS FOR WHICH A DECISION ON GRANTING PROTECTION IS TAKEN .....	42
▪ INTERNATIONAL TRADEMARKS PROTECTED IN GEORGIA .....	80
<b>APPELLATION OF ORIGIN OF GOOD</b>	
▪ AMENDMENTS MADE FOR THE REGISTER .....	87
<b>OFFICIAL NOTIFICATIONS</b>	
<b>INVENTIONS</b>	
▪ EXPIRATION OF PATENTS RESTORATION .....	88
▪ ABOLITION OF PATENTS WITH THE RIGHT TO RESTORE .....	88
▪ EXPIRATION OF TERM OF RESTORATION OF PATENTS .....	88
<b>UTILITY MODELS</b>	
▪ EXPIRATION OF PATENT RESTORATION .....	90
▪ ABOLITION OF PATENTS WITH THE RIGHT TO RESTORE .....	90
▪ EXPIRATION OF TERM OF RESTORATION OF PATENT .....	90
<b>TRADEMARKS</b>	
▪ RENEWAL OF REGISTRATIONS .....	91
▪ COMPLETE TRANSFER OF RIGHTS .....	95
▪ CHANGES OF NAMES AND/OR ADDRESSES OF OWNER .....	96
▪ CANCELLATION OF TRADEMARKS REGISTRATIONS .....	98
▪ REGISTRATION OF LICENSE AGREEMENTS .....	100
▪ INTERNATIONAL LICENSE AGREEMENTS .....	101
▪ CHANGE OF THE LIST OF GOODS AND/OR SERVICES OF TRADEMARK .....	101
<b>CLASSIFICATION INDEXES</b>	
INVENTIONS .....	102
UTILITY MODELS .....	103
DESIGNS .....	104
TRADEMARKS .....	106

## **PUBLISHED TITLES OF PROTECTION**

### **INVENTIONS**

- **APPLICATION APPROVED FOR GRANTING PATENT:**  
15480; 15121; 15348; 14774
- **PATENTED INVENTIONS:**  
7291-7298

### **UTILITY MODELS**

- **APPLICATIONS APPROVED FOR GRANTING PATENT:**  
15330; 15425; 15350
- **PATENTED UTILITY MODELS:**  
2096-2099

### **DESIGNS**

- **APPLICATION APPROVED FOR REGISTRATION:**  
1216
- **REGISTERED DESIGN:**  
905
- **DESIGNS, WHICH HAVE BEEN REGISTERED WITH THE INTERNATIONAL BUREAU CLAIMING PRIORITY ON THE TERRITORY OF GEORGIA:**  
215027; 212223; 212440; 212534; 212594; 212692; 212541

### **TRADEMARKS**

- **APPLICATIONS FILED UNDER THE NATIONAL PROCEDURE APPROVED FOR REGISTRATION:**  
104205\*; 110188; 110616, 110952; 111520; 111528, 111529; 111600; 111618, 111619; 111722; 111736; 111743; 111838; 111856; 111858; 111948-111950; 111959; 111961; 111974; 112062; 112077; 112085; 112092
- **REGISTERED TRADEMARKS:**  
34490-34510; 34513-34530
- **TRADEMARKS REGISTERED ACCORDING TO THE ACCELERATED PROCEDURE:**  
34486-34489; 34511, 34512
- **INTERNATIONAL TRADEMARKS FOR WHICH A DECISION ON GRANTING PROTECTIONS IS TAKEN:**  
110621; 110623-110625; 110636-110640; 110642-110645; 110740; 110815-110824; 110842, 110843; 110850; 110856; 110990, 110991; 110994; 111000-111003; 111017-111024; 111032; 111034; 111050; 111052-111054; 111093; 111097; 111099-111101; 111125, 111126; 111129-111131; 111180-111184; 111206-111208; 111235-111239; 111260-111262; 111264; 111308; 111310-111312; 111379, 111380; 111382; 111394-111397; 111488, 111489; 111627
- **INTERNATIONAL TRADEMARKS PROTECTED IN GEORGIA:**  
106553; 106895; 107221; 108534; 108902; 109246; 109395; 109397-109399; 109417; 109442; 109450-109455; 109457-109460; 109467-109473; 109477, 109478; 109491-109494; 109496; 109533-109537; 109543-109548; 109562-109567; 109577-109579; 109618-109621; 109634- 109636; 109687; 109689, 109690; 109718; 109725-109727; 109782; 109785; 109806-109808; 109816; 109821, 109822; 109885-109887; 109889; 109900, 109901; 109903-109907; 109909, 109910; 109984, 109985

### **APPELLATION OF ORIGIN OF GOOD**

KINDZMARAU LI

---

# INVENTIONS

## APPLICATIONS APPROVED FOR GRANTING PATENT

The decision can be appealed at the Chamber of Appeal of Sakpatenti within 3 months from the publication or at the Mtskheta District Court Administrative Cases Board (Address: №17, Samkhedro St., Mtskheta), within 1 month following the publication.

### PART A

#### A 23

- (10) AP 2021 15480 A (51) Int. Cl. (2006)  
A 23 C 9/13  
A 23 C 21/00  
(21) AP 2020 15480 (22) 2020 10 29  
(71) Giorgi Pkhakadze (GE)  
26<sup>th</sup> May St. 45, 4600, Kutaisi, Georgia (GE)  
(72) Giorgi Pkhakadze (GE)  
(54) METHOD FOR LACTIC ACID BEVERAGE  
PRODUCTION

(57) A method provides milk serum usage, and introducing therein vegetable milk prepared with soybean, amaranth, and seedling green buckwheat grains, then its homogenization, pasteurization, and cooling till coagulation temperature, adding kefir and yogurt traditional bacterial curd therein, introducing orange dietary nourishing cottage cheese as a stabilizer therein, coagulation, adding of syrop, mixing, homogenization, cooling, and bottling thereof.

Claims: 1 independent

---

#### A 61

- (10) AP 2021 15121 A (51) Int. Cl. (2006)  
A 61 K 31/424  
A 61 K 31/5365  
A 61 K 31/4985  
A 61 P 31/18  
C 07 D 498/16  
C 07 D 487/16  
(21) AP 2017 15121 (22) 2017 11 30  
(31) 62/429,470  
(32) 2016 12 02  
(33) US  
(71) Merck Sharp & Dohme Corp. (US)  
126 East Lincoln Ave. Rahway,  
NJ 07065-0907, USA (US)  
(72) ZHANG, Yonglian (US);  
MCCAULEY, John, A. (US);  
YU, Tao (US);  
GRAHAM, Thomas, H. (US)  
(74) Shalva Gvaramadze  
(85) 2019 06 27  
(86) PCT/US2017/063831, 2017 11 30

#### (54) TETRACYCLIC HETEROCYCLE COMPOUNDS USEFUL AS HIV INTEGRASE INHIBITORS

(57) Present invention relates to tetracyclic heterocycle compounds of formula (I),

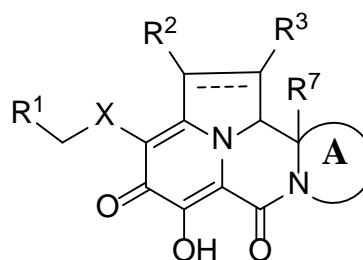

(I)

and pharmaceutical compositions; and usage therefor treating or preventing HIV infection, as well.

Claims: 11 independents

29 dependents

---

### PART B

#### B 61

- (10) AP 2021 15348 A (51) Int. Cl. (2006)  
B 61 H 1/00  
F 16 D 65/06  
(21) AP 2018 15348 (22) 2018 05 28  
(31) 2017138323  
(32) 2017 11 02  
(33) RU  
(71) Open Joint Stock Company  
"Ural Plant Of Auto-Textile Products" (RU)  
Ul. Plekhanova 64, Asbest, Sverdlovsk Rgn.,  
624269, Russian Federation (RU)  
(72) KUZMINYIKH, Andrey Germanovich (RU);  
ROMANENKO, Vitaliy Valerievich (RU)  
(74) Larisa Amirkhanyan  
(85) 2020 05 27  
(86) PCT/RU2018/000337, 2018 05 28  
(54) BRAKE SHOE FOR RAILROAD VEHICLE  
(57) Brake shoe for railroad vehicle comprises metal frame 2, polymer composite friction element 1, and metal insert 3. The depressions 4 are made on working and side surfaces of friction element, in the zone of interfacing therewith the insert.

Claims: 1 independent

Fig.: 2

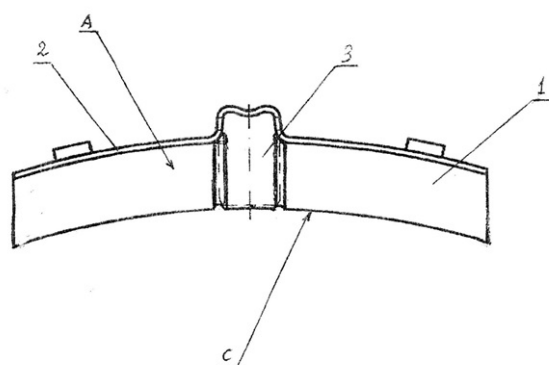

Fig. 1

Fig.: 15

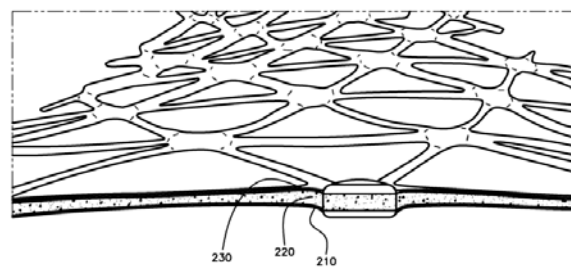

Fig. 7

## PART E

### E 02

(10) AP 2021 14774 A (51) Int. Cl. (2006)

E 02 D 29/02

E 02 D 17/20

(21) AP 2016 14774 (22) 2016 10 06

(31) 62/239.416

(32) 2015 10 09

(33) DK

(71) Tensar Corporation LLC (US)

2500 Northwinds Parkway Suite 500 Alpharetta,  
Georgia 30009, USA (US)

(72) TYAGI, Manoj Kumar (US);  
SHELTON, William Stanley (US)

(74) Tamaz Shilakadze

(85) 2018 05 03

(86) PCT/US2016/055768, 2016 10 06

(54) GEOGRID MADE FROM COEXTRUDED  
MULTILAYERED POLYMER

(57) Integral geogrid includes a plurality of interconnected, oriented strands having an array of openings therein that is produced from sheet starting material having starting thickness, at least 2mm, and consists of multilayer polymer material, wherefrom at least two are layers made of various materials, and simultaneously coextruded. The abundance of interconnected threads is oriented by post-textural stretching.

Claims: 7 independents

20 dependents

## PATENTED INVENTIONS

### PART A

#### A 47

- (11) P 2021 7298 B (51) Int. Cl. (2006)  
A 47 L 1/00  
E 06 B 7/02  
F 24 F 13/00
- (10) AP 2021 15271 A (44) 7(563)/2021  
(21) AP 2020 15271  
(22) 2020 02 04  
(24) 2020 02 04  
(73) Luka Pachkoria (GE)  
Sanapiro St. 2a, 0105, Tbilisi, Georgia (GE)  
(72) Luka Pachkoria (GE)  
(74) Shalva Gvaramadze  
(54) DEVICE FOR WINDOW AUTOMATIC  
CLEANING AND VENTILATION

#### A 61

- (11) P 2021 7297 B (51) Int. Cl. (2006)  
A 61 L 2/24
- (10) AP 2021 15415 A (44) 10(566)/2021  
(21) AP 2020 15415  
(22) 2020 08 21  
(24) 2020 08 21  
(73) Zaali Gogelia (GE)  
Sanapiro St. 2a, 0114, Tbilisi, Georgia (GE)  
(72) Zaali Gogelia (GE)  
(54) DESINFLECTION ROBOT

### PART C

#### C 12

- (11) P 2021 7291 B (51) Int. Cl. (2006)  
C 12 G 1/00  
C 12 N 1/16
- (10) AP 2021 15336 A (44) 10(566)/2021  
(21) AP 2020 15336  
(22) 2020 05 13  
(24) 2020 05 13  
(73) LLC "Restorator Group" (GE)  
N. Zhvania St. 28, app. 76, Tbilisi,  
Georgia (GE)  
(72) Nino Gagelidze (GE);  
Lia Amiranashvili (GE);  
Khatuna Varsimashvili (GE);

- Tinatin Sadunishvili (GE);  
Giorgi Kvesitadze (GE);  
Davit Bochorishvili (GE)  
(54) YEAST LOCAL GEORGIAN STRAIN  
GWL-01W FOR WHITE WINES  
PRODUCTION

- (11) P 2021 7292 B (51) Int. Cl. (2006)  
C 12 G 1/00  
C 12 N 1/16
- (10) AP 2021 15335 A (44) 10(566)/2021  
(21) AP 2020 15335  
(22) 2020 05 13  
(24) 2020 05 13  
(73) LLC "Restorator Group" (GE)  
N. Zhvania St. 28, app. 76, Tbilisi,  
Georgia (GE)  
(72) Lia Amiranashvili (GE);  
Nino Gagelidze (GE);  
Khatuna Varsimashvili (GE);  
Tinatin Sadunishvili (GE);  
Giorgi Kvesitadze (GE);  
Davit Bochorishvili (GE)  
(54) YEAST LOCAL GEORGIAN STRAIN  
GWL-01R FOR RED WINES PRODUCTION

- (11) P 2021 7293 B (51) Int. Cl. (2006)  
C 12 G 1/00  
C 12 N 1/16
- (10) AP 2021 15334 A (44) 10(566)/2021  
(21) AP 2020 15334  
(22) 2020 05 13  
(24) 2020 05 13  
(73) LLC "Restorator Group" (GE)  
N. Zhvania St. 28, app. 76, Tbilisi,  
Georgia (GE)  
(72) Nino Gagelidze (GE);  
Lia Amiranashvili (GE);  
Khatuna Varsimashvili (GE);  
Tinatin Sadunishvili (GE);  
Giorgi Kvesitadze (GE);  
Davit Bochorishvili (GE)  
(54) YEAST LOCAL GEORGIAN STRAIN  
GWC-08R FOR WHITE WINES  
PRODUCTION

- (11) P 2021 7294 B (51) Int. Cl. (2006)  
C 12 G 1/00  
C 12 N 1/16
- (10) AP 2021 15333 A (44) 10(566)/2021  
(21) AP 2020 15333  
(22) 2020 05 13



- 
- (24) 2020 05 13  
(73) LLC "Restorator Group" (GE)  
N. Zhvania St. 28, app. 76, Tbilisi,  
Georgia (GE)  
(72) Giorgi Kvesitadze (GE);  
Davit Bochorishvili (GE);  
Lia Amiranashvili (GE);  
Nino Gagelidze (GE);  
Khatuna Varsimashvili (GE);  
Tinatin Sadunishvili (GE)  
(54) YEAST LOCAL GEORGIAN STRAIN  
GWC-08R FOR RED WINES PRODUCTION
- 

## **PART F**

### **F 01**

- (11) P 2021 7295 B (51) Int. Cl. (2006)  
F 01 C 1/077  
F 01 C 1/18  
F 01 K 7/36  
F 01 K 13/00  
(10) AP 2021 15268 A (44) 10(566)/2021  
(21) AP 2018 15268  
(22) 2018 06 12  
(24) 2018 06 12  
(31) 102017000074290  
(32) 2017 07 03  
(33) IT  
(86) PCT/IB2018/054254, 2018 06 12  
(73) I.V.A.R. S.P.A. (IT)  
Via IV Novembre, 181, 25080 Prevalle (BS),  
Italy (IT)  
(72) OLIVOTTI, Sergio (IT)  
(74) Shalva Gvaramadze  
(54) HEAT MACHINE CONFIGURED FOR  
REALIZING HEAT CYCLES AND  
METHOD FOR REALIZING HEAT  
CYCLES BY MEANS OF SUCH  
HEAT MACHINE
- 

### **F 41**

- (11) P 2021 7296 B (51) Int. Cl. (2006)  
F 41 H 1/02  
(10) AP 2021 15326 A (44) 10(566)/2021  
(21) AP 2020 15326  
(22) 2020 05 01  
(24) 2020 05 01  
(73) Mikheil Kotishadze (GE)  
Nikea St., II Lane 6/5, 4600, Kutaisi,  
Georgia (GE)  
(72) Mikheil Kotishadze (GE)  
(54) ARMOR FOR BULLETPROOF VEST
-

# UTILITY MODELS

## APPLICATIONS APPROVED FOR GRANTING PATENT

The decision can be appealed at the Chamber of Appeal of Sakpatenti within 3 months from the publication or at the Mtskheta District Court Administrative Cases Board (Address: №17, Samkhedro St., Mtskheta), within 1 month following the publication.

### PART B

#### B 61

- (10) AU 2021 15330 U (51) Int. Cl. (2006)  
B 61 H 1/00  
F 16 D 65/06  
F 16 D 69/02
- (21) AU 2018 15330 (22) 2018 05 28  
(31) 2017137563  
(32) 2017 10 26  
(33) RU
- (71) Open Joint Stock Company "Ural Plant of Auto-Textile Products" (RU)  
Ul. Plekhanova 64, Asbest, Sverdlovsk Rgn., 624269, Russian Federation (RU)
- (72) ROMANENKO, Vitaliy Valerievich (RU);  
KUZMINYIKH, Andrey Germanovich (RU)
- (74) Larisa Amirkhanyan  
(85) 2020 05 08  
(86) PCT/RU2018/000339, 2018 05 28
- (54) BRAKE SHOE FOR RAILWAY VEHICLE  
(57) Brake shoe for railway vehicle comprises composite friction element, metal frame and cast-iron insert, working part mass whereof is from 59% to 90% of insert mass.  
Claims: 1 independent

### PART E

#### E 04

- (10) AU 2021 15425 U (51) Int. Cl. (2006)  
E 04 B 1/00
- (21) AU 2020 15425 (22) 2020 08 26
- (71) Roland Zhorzholiani (GE)  
Vill. Kochara, 0121, Ochamchire Region, Georgia (GE)
- (72) Roland Zhorzholiani (GE)
- (54) COASTLINE ANTI-LANDSLIDE FAST CONSTRUCTING WALL  
(57) Wall block has connecting rectangular parallelepiped-shaped componentry (2) having through-out holes, on front and rare walls (4, 5) edge ends of connecting componentry the extractions (6) are executed in opposite direction relative to each other. The

length of extractions is equal of block sidewall double thickness, and the height thereof is less than block height. Block connecting componentry are connected to passing along front and rare walls intermediate points the wall (1) having shape of rectangular parallelepiped or trapezoid. Additional connecting componentry are provided in the middle of block wall, as well. In accordance to execution variant thereof the intermediate transfer component (8) having triangular shape from upper view is provided between the wall passing along connecting componentry intermediate points and connecting componentry.

Claims: 1 independent  
2 dependents

Fig.: 3

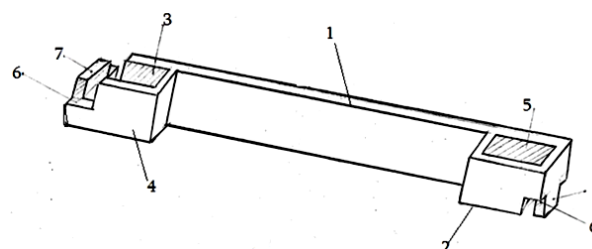

Fig. 1

### PART F

#### F 16

- (10) AU 2021 15350 U (51) Int. Cl. (2006)  
F 16 D 65/06
- (21) AU 2018 15350 (22) 2018 05 28  
(31) 2017138326  
(32) 2017 11 02  
(33) RU
- (71) Open Joint Stock Company "Ural Plant of Auto-Textile Products" (RU)  
Ul. Plekhanova 64, Asbest, Sverdlovsk Rgn., 624269, Russian Federation (RU)
- (72) KUZMINYIKH, Andrey Germanovich (RU);  
ROMANENKO, Vitaliy Valerievich (RU)
- (74) Larisa Amirkhanyan  
(85) 2020 05 27  
(86) PCT/RU2018/000336, 2018 05 28
- (54) BRAKE SHOE FOR RAILWAY VEHICLE

(57) Brake shoe for railroad vehicle comprises polymer composite friction element, metal frame, and cast-iron insert. The ratio between insert working part width and shoe back part width is:

$$b=(0,30\div 0,55)B$$

where  $b$  is insert working part width, and  $B$  is shoe back part width.

Claims: 1 independent

Fig.: 2

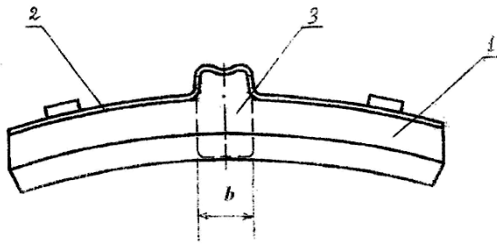

Fig. 1

**PATENTED UTILITY MODEL****PART A****A 61**

- 
- (11) U 2021 2099 Y (51) Int. Cl. (2006)  
A 61 K 9/08  
A 61 K 33/14  
A 61 K 31/045  
A 61 P 7/08  
(10) AU 2021 15282 U (44) 6(562)/2021  
(21) AU 2020 15282  
(22) 2020 02 17  
(24) 2020 02 17  
(73) GUMENUK, Mikola Ivanovich (UA)  
Vul. Klinichna 23-25, app. 173, 03110,  
Kyiv, Ukraine (UA)  
(72) GUMENUK, Mikola Ivanovich (UA)  
(74) Shalva Gvaramadze  
(54) INFUSION THERAPY DRAG
- 
- (11) U 2021 2098 Y (51) Int. Cl. (2006)  
A 61 K 31/045  
A 61 K 9/08  
A 61 K 33/14  
A 61 P 7/08  
(10) AU 2021 15283 U (44) 6(562)/2021  
(21) AU 2020 15283  
(22) 2020 02 17  
(24) 2020 02 17  
(73) GUMENUK, Mikola Ivanovich (UA)  
Vul. Klinichna 23-25, app. 173, 03110,  
Kyiv, Ukraine (UA)  
(72) GUMENUK, Mikola Ivanovich (UA)  
(74) Shalva Gvaramadze  
(54) METHOD FOR INFUSION THERAPY  
DRAG PREPARATION
- 
- (11) U 2021 2096 Y (51) Int. Cl. (2006)  
A 61 K 31/4985  
A 61 K 31/519  
A 61 P 15/10  
(10) AU 2021 15494 U (44) 10(566)/2021  
(21) AU 2020 15494  
(22) 2020 11 19  
(24) 2020 11 19  
(73) ATMA, Khaled (IL)  
Vill. Nahef, Israel (IL)  
(72) ATMA, Khaled (IL)  
(74) Khatuna Imnadze  
(54) THERAPEUTIC COMPOSITION FOR  
ERECTILE DYSFUNCTION TREATMENT
- 
- (11) U 2021 2097 Y (51) Int. Cl. (2006)  
A 61 N 5/06  
(10) AU 2021 15445 U (44) 10(566)/2021  
(21) AU 2020 15445  
(22) 2020 09 16  
(24) 2020 09 16  
(73) LEPL "Institute of Micro- and  
Nanoelectronics" (IMNE) (GE)  
Il. Chavchavadze Ave. 13, 0179, Tbilisi,  
Georgia (GE);  
Nugzar Dolidze (GE)  
Il. Chavchavadze Ave. 24, app. 21, 0179,  
Tbilisi, Georgia (GE);  
Aleksandre Jomarjidge (GE)  
Kavtaradze St. 38, app. 67, 0186, Tbilisi,  
Georgia (GE);  
Maia Dolidze (GE)  
Il. Chavchavadze Ave. 24, app. 21, 0179,  
Tbilisi, Georgia (GE);  
Amiran Bibilashvili (GE)  
A. Tsereteli Av. 97, app. 57, 0119, Tbilisi,  
Georgia (GE);  
Zurab Jibuti (GE)  
Gogebashvili St. 43, app. 27, 0179, Tbilisi,  
Georgia (GE)  
(72) Nugzar Dolidze (GE);  
Aleksandre Jomarjidge (GE);  
Maia Dolidze (GE);  
Amiran Bibilashvili (GE);  
Zurab Jibuti (GE)  
(74) Nugzar Dolidze  
(54) PHOTOTHERAPY DEVICE "LALI-1"
-

---

# DESIGNS

## APPLICATION APPROVED FOR REGISTRATION

The decision can be appealed at the Chamber of Appeal of Sakpatenti within 3 months from the publication or at the Mtskheta District Court Administrative Cases Board (Address: №17, Samkhedro str., Mtskheta), within 1 month following the publication.

- (10) AD 2021 1216 S      (51) 25-01  
(21) AD 2021 1216      (22) 2021 05 31  
(28) 1  
(71) Elguja Beridze (GE)  
Kvareli St. 131, 0148, Tbilisi, Georgia (GE)  
(72) Elguja Beridze (GE)  
(54) ARMATURE FIXATOR  
(55)

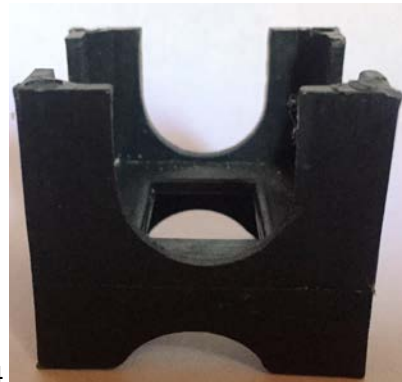

## REGISTERED DESIGN

- (11) D 2021 905 S      (51) 32-00  
(10) AD 2021 1190 S    (44) 2021 06 10 №10  
(21) AD 2020 1190  
(22) 2020 11 02  
(24) 2020 11 02  
(28) 1  
(18) 2025 11 02  
(73) LLC "Kartveli" (GE)  
    Kakheti Highway 110a, 0151, Isani-Samgori  
    District, Tbilisi, Georgia (GE)  
(72) Tornike Patarkatsishvili (GE)  
(74) Davit Dzamukashvili (GE)  
(54) GRAPHICAL SYMBOL
-

## DESIGNS, WHICH HAVE BEEN REGISTERED WITH THE INTERNATIONAL BUREAU CLAIMING PRIORITY ON THE TERRITORY OF GEORGIA

The decision can be appealed at the Chamber of Appeal of Sakpatenti within 3 months from the publication or at the Mtskheta District Court Administrative Cases Board (Address: №17, Samkhedro St., Mtskheta), within 1 month following the publication.

- (11) DM/215 027                      (51) 02-04  
 (15) 2021 05 03                      (44) 27/2021 (2021 07 09)  
 (22) 2021 05 03  
 (28) 3  
 (73) LOWA Sportschuhe GmbH  
       Hauptstr. 19, 85305 Jetzendorf (DE)  
 (85) DE  
 (86) DE  
 (87) DE  
 (88) DE  
 (89) DE  
 (81) II. MA III. AL, AM, AZ, BA, BN, BW, BZ, CH, EG, EM, GB, GE, GH, IL, IS, KG, KH, LI, LV, MC, MD, ME, MK, MN, MX, NA, NO, OA, OM, RS, RW, SG, SM, SR, TJ, TM, TN, TR, UA, WS  
 (72) MARCELLO TRIANNI  
       Poststraße 28A, 8274, Tägerwillen (CH)  
 (74) WEICKMANN & WEICKMANN PATENT- UND RECHTSANWÄLTE PARTMBB  
       Richard-Strauss Str.80, 81679 Munich (DE)  
 (54) 1. Shoe, 2. Shoe sole, 3. Shoe sole  
 (55)



1.1



2.1



3.1



3.2

- (11) DM/212 223 (51) 11-01  
(15) 2021 01 13 (44) 28/2021 (2021 07 16)  
(22) 2021 01 13  
(28) 6  
(73) HARRY WINSTON SA  
Chemin Du Tourbillon 8, 1228 Plan-les-Ouates (CH)  
(85) CH  
(86) CH  
(87) CH  
(88) CH  
(89) CH  
(81) II. MA III. AL, AM, AZ, BA, BZ, CA, CH, EM, GB, GE, KG, LI, MC, MD, ME, MK, MN, NO, OM, SG,  
TN, TR, UA  
(72) 1. Dominique RIVIERE  
C/o Harry Winston Inc. 718 Fifth Avenue, 10019, New York (US);  
2.-5. Delphine ABDOURAHIM  
C/o Harry Winston Inc. 718 Fifth Avenue, 10019, New York (US);  
6. Rie YATSUGI-KANG  
C/o Harry Winston Inc. 718 Fifth Avenue, 10019, New York (US)  
(74) The Swatch Group AG (The Swatch Group SA) (The Swatch Group Ltd.)  
Faubourg Du Lac 6, 2501 Biel/Bienne (CH)  
(54) 1. Necklace, 2. Necklace, 3. Necklace, 4. Finger ring, 5. Hair clip, 6. Pair of earrings  
(55)







1.5



1.6



1.7



1.8



2.1



2.2



2.3



2.4



2.5



2.6



2.7



2.8



3.1



3.2



3.3



3.4



3.5



3.6



3.7



3.8



4.1



4.2



4.3



4.4



4.5



4.6



4.7



4.8



5.1



5.2



5.3



5.4



5.5



5.6



5.7



6.1



6.2



6.3



6.4



6.5



6.6



6.7



6.8



- (11) DM/212 440 (51) 11-01  
 (15) 2021 01 21 (44) 29/2021 (2021 07 23)  
 (22) 2021 01 21  
 (28) 6  
 (73) HARRY WINSTON SA  
 Chemin Du Tourbillon 8, 1228 Plan-les-Ouates (CH)  
 (85) CH  
 (86) CH  
 (87) CH  
 (88) CH  
 (89) CH  
 (81) II. MA III. AL, AM, AZ, BA, BZ, CA, CH, EM, GB, GE, KG, LI, MC, MD, ME, MK, MN, NO, OM, SG,  
 TN, TR, UA  
 (72) 1-3; 5-6 Rie YATSUGI-KANG  
 C/o Harry Winston Inc. 718 Fifth Avenue, 10019, New York (US);  
 Delphine ABDOURAHIM  
 C/o Harry Winston Inc. 718 Fifth Avenue, 10019, New York (US)  
 (74) The Swatch Group AG (The Swatch Group SA) (The Swatch Group Ltd.)  
 Faubourg Du Lac 6, 2501 Biel/Bienne (CH)  
 (54) 1. Finger ring, 2. Finger ring, 3. Necklace, 4. Pair of earrings, 5. Pair of earrings, 6. Necklace  
 (55)





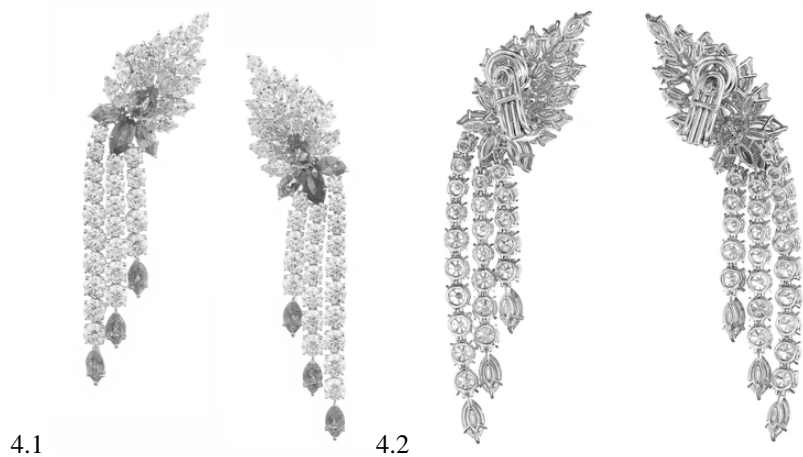

4.1

4.2

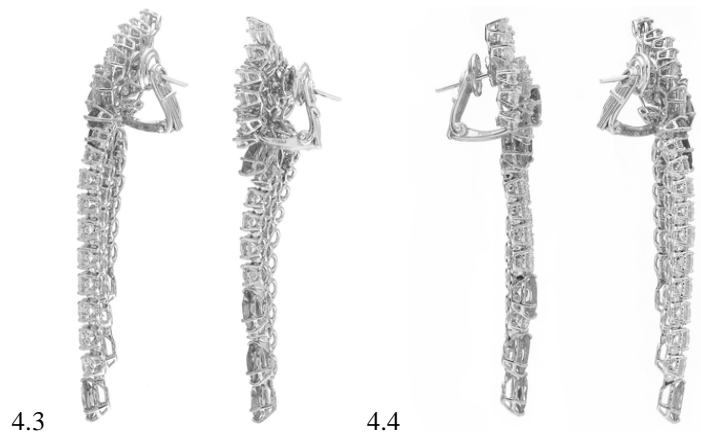

4.3

4.4



4.5

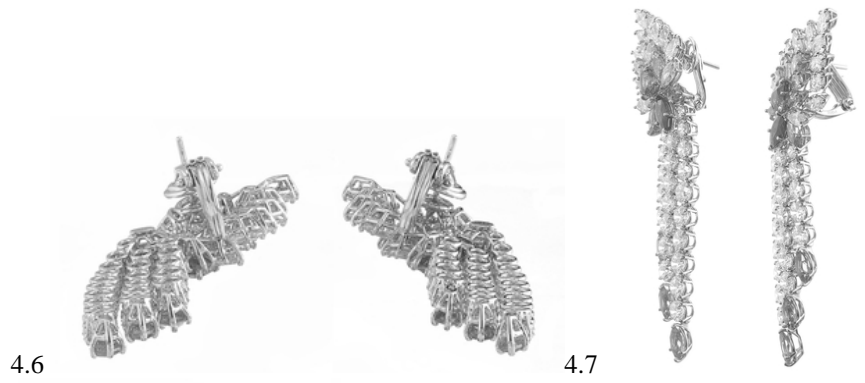

4.6

4.7

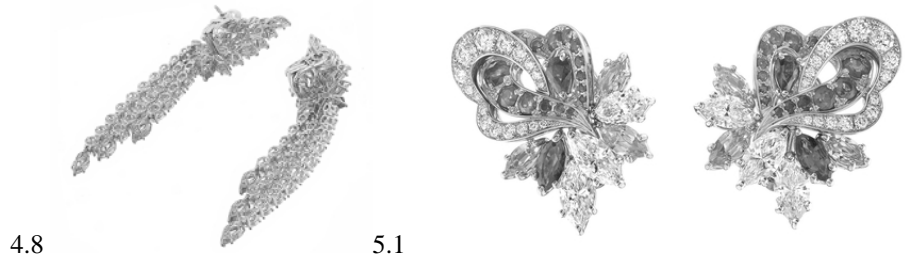

4.8

5.1



5.2



5.3



5.4



5.5



5.6



5.7



5.8



6.1



6.2



6.3



6.4



6.5



6.6



6.7



6.8



- (11) DM/212 534
- (15) 2021 01 28
- (22) 2021 01 28
- (28) 4
- (73) HARRY WINSTON SA  
Chemin Du Tourbillon 8, 1228 Plan-les-Ouates (CH)
- (85) CH
- (86) CH
- (87) CH
- (88) CH
- (89) CH
- (81) II. MA III. AL, AM, AZ, BA, BZ, CA, CH, EM, GB, GE, KG, LI, MC, MD, ME, MK, MN, NO, OM, SG, TN, TR, UA
- (72) 1; 4 Delphine ABDOURAHIM  
C/o Harry Winston Inc., 718 Fifth Avenue, 10019, New York (US)  
2 Rie YATSUGI-KANG  
C/o Harry Winston Inc., 718 Fifth Avenue, 10019, New York (US)  
3 Tobias WUEST  
C/o Harry Winston Inc., 718 Fifth Avenue, 10019, New York (US)
- (74) The Swatch Group AG (The Swatch Group SA) (The Swatch Group Ltd.)  
Faubourg Du Lac 6, 2501 Biel/Bienne (CH)
- (54) 1. Pair of earrings, 2. Bracelet, 3. Necklace, 4. Finger ring
- (55)

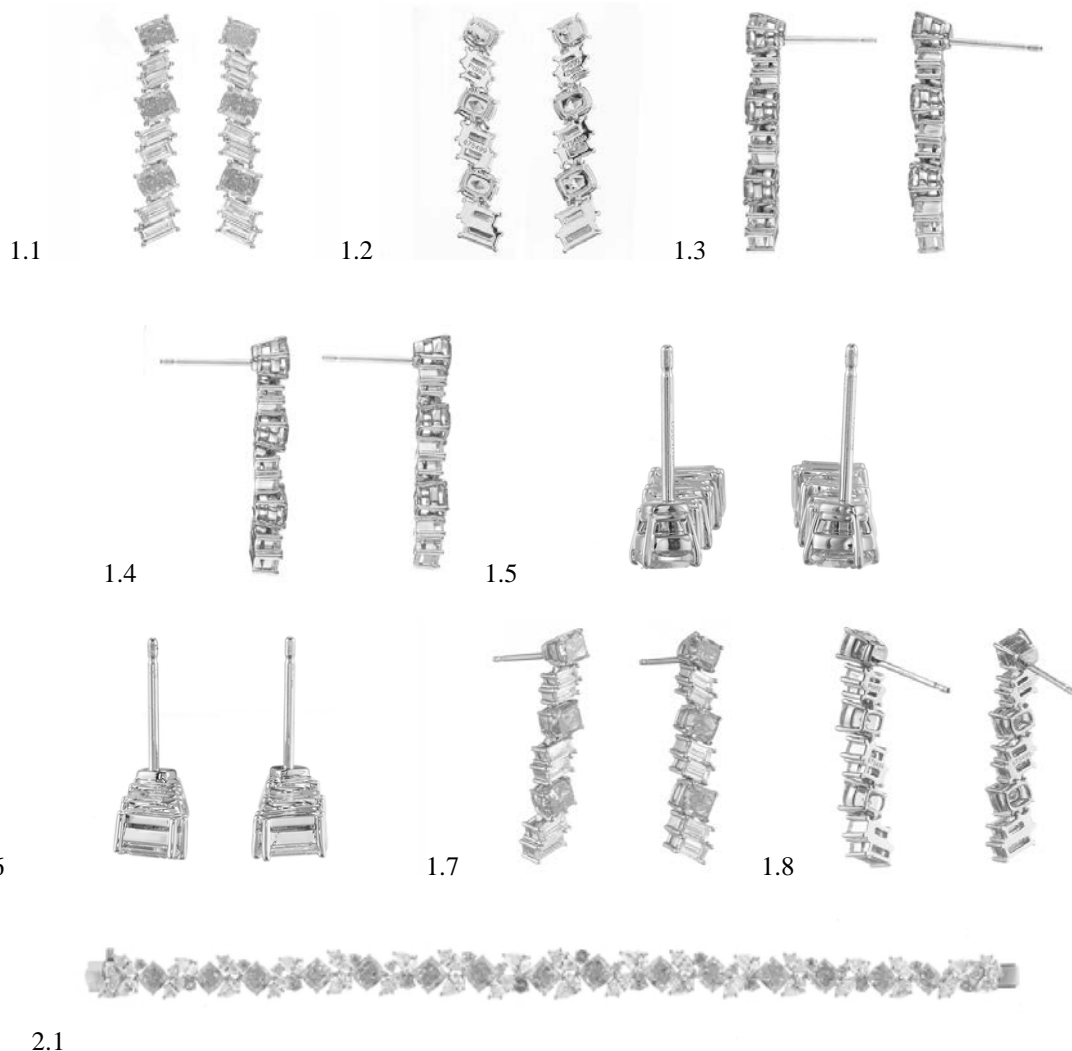



2.2



2.3



2.4



2.5



2.6

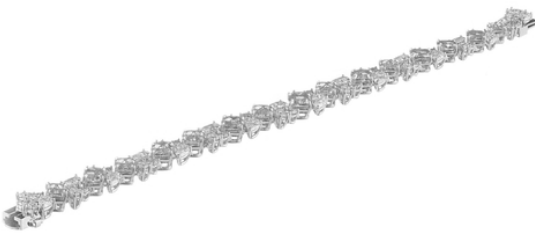

2.7



2.8



3.1



3.2



3.3



3.4



3.5



3.6



3.7



3.8

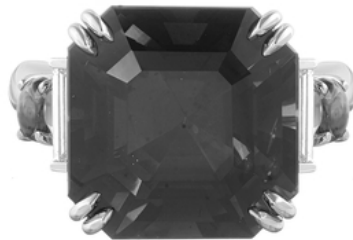

4.1



4.2



4.3



4.4



4.5



4.6



4.7



4.8

- (11) DM/212 594 (51) 10-02  
 (15) 2021 01 29 (44) 30/2021 (2021 07 30)  
 (22) 2021 01 29  
 (28) 1  
 (73) UNION Uhrenfabrik GmbH  
 Frühlingsweg 5, 01768 Glashütte (DE)  
 (85) DE, EM  
 (86) DE, EM  
 (87) DE, EM  
 (88) DE, EM  
 (89) DE  
 (81) II. MA III. AL, AM, AZ, BA, BZ, CH, EM, GB, GE, JP, KG, KR, LI, MC, MD, ME, MK, MN, NO,  
 OM, RU, SG, TN, TR, UA  
 (72) Renato Scarinzi  
 Les Plans Dessous 183a, 2534, Les Prés-d'Orvin (CH)  
 (74) The Swatch Group SA (The Swatch Group AG) (The Swatch Group Ltd.)  
 Faubourg Du Lac 6, 2501 Biel / Bienne (CH)  
 (54) 1. Wrist watch  
 (55)



1.1

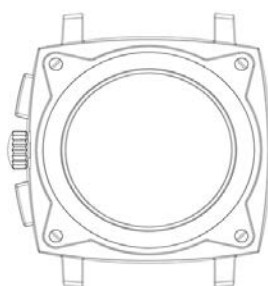

1.2

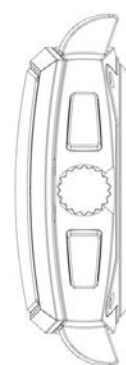

1.3



1.4



1.5



1.6



1.7



1.8

- (11) DM/212 692 (51) 10-02  
(15) 2021 01 25 (44) 30/2021 (2021 07 30)  
(22) 2021 01 25  
(28) 1  
(73) RADO UHREN AG (RADO WATCH CO. LTD.) (MONTRES RADO SA)  
Bielstrasse 45, 2543 Lengnau (CH)  
(85) –  
(86) CH  
(87) CH  
(88) –  
(89) CH  
(81) II. MA III. BA, CH, EM, GB, GE, NO, OM, SG, TN, TR, UA, VN  
(72) Tej Chauhan  
259 Acton Lane, W4 5DG, London (GB)  
(74) The Swatch Group AG  
Faubourg Du Lac 6, 2501 Biel (CH)  
(54) 1. Wristwatch  
(55)

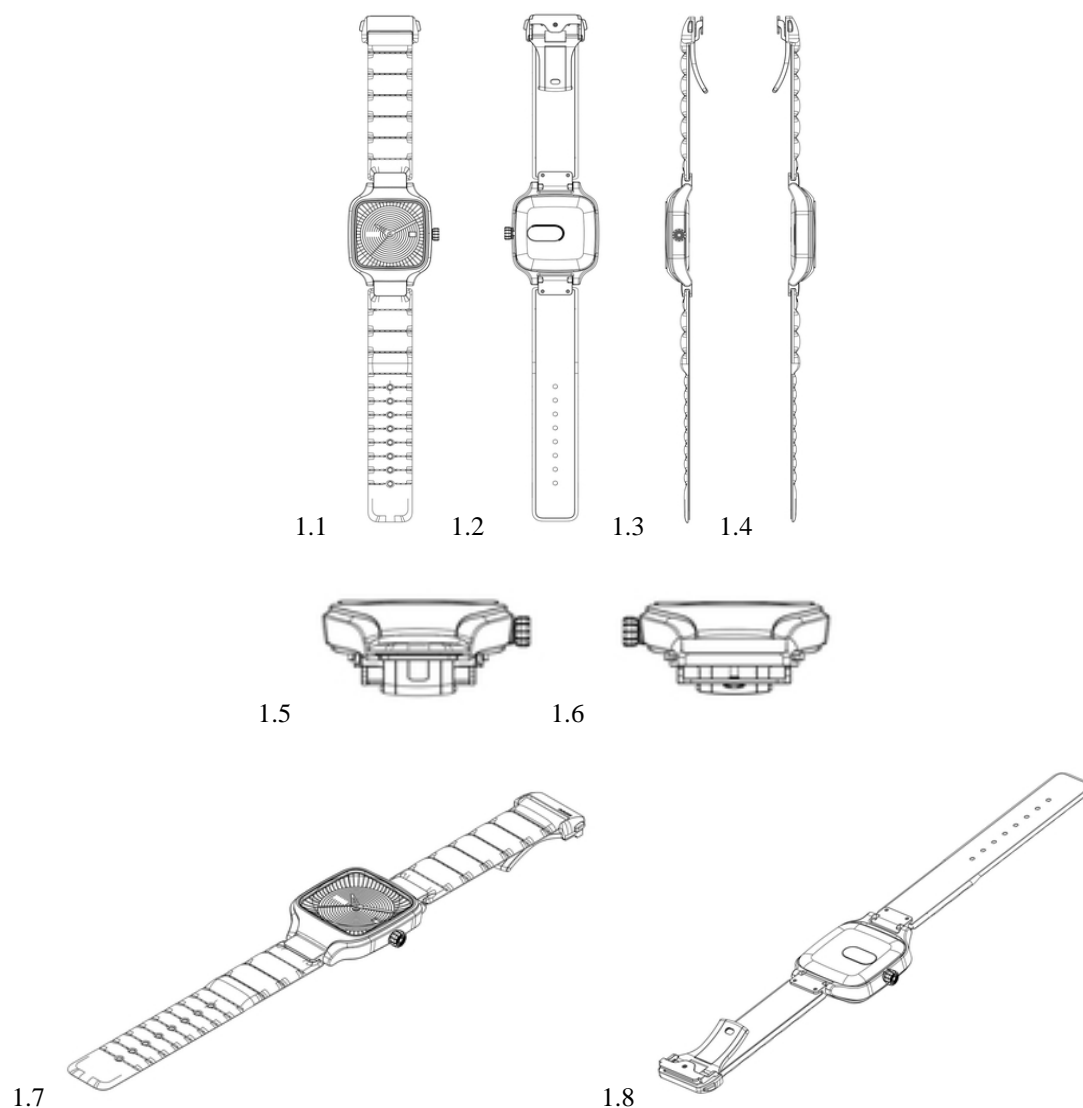

(11) DM/212 541

(51) 23-04

(15) 2021 01 25

(44) 30/2021 (2021 07 30)

(22) 2021 01 25

(28) 1

(73) FOREST WELL CO., LTD.

2-18-5-2 Higashiterao, Tsurumi-ku, Yokohama-shi, 230-0077 Kanagawa (JP)

(85) JP

(86) JP

(87) JP

(88) JP

(89) JP

(81) III. CA, CH, EM, GB, GE, KH, KR, MX, RU, SG, US, VN

(72) Takefumi SUGIURA

6th Floor, Kawaramachi-Naniwa Bldg., 4-6-15 Kawaramachi, Chuo-Ku, Osaka-shi, 541-0048 Osaka (JP)

Ryuhei MORII

C/o FOREST WELL CO.,LTD., 2-18-5-2 Higashiterao, Tsurumi-ku, Yokohama-shi, 230-0077,

Kanagawa (JP)

(54) 1. Air purifier

(55)

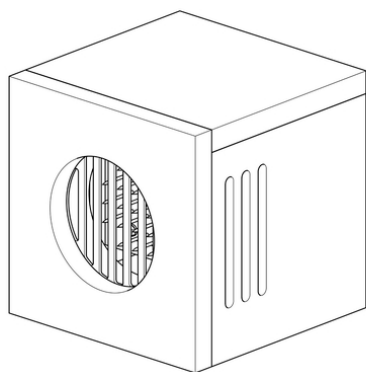

1.1

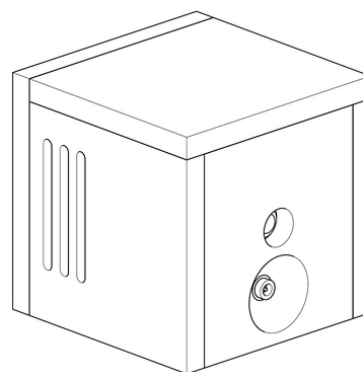

1.2

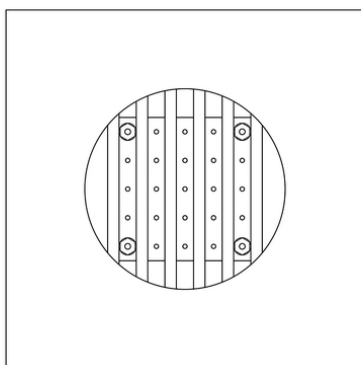

1.3

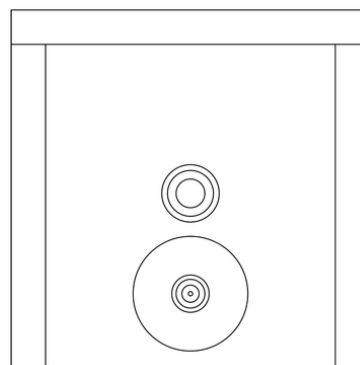

1.4

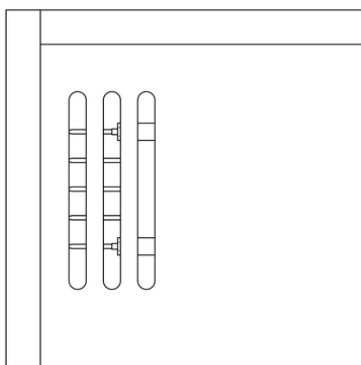

1.5

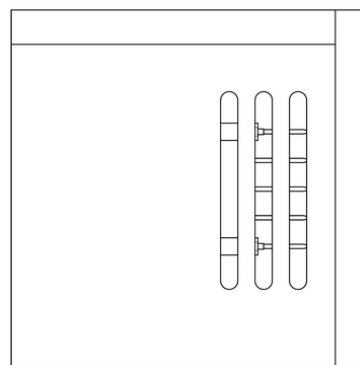

1.6

1.7

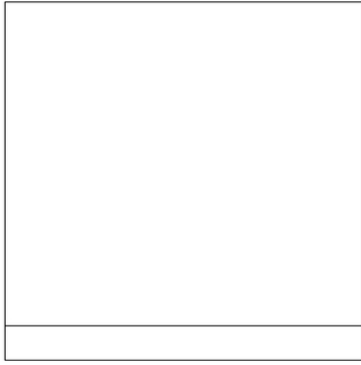

1.8

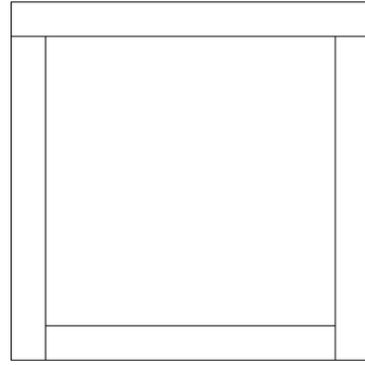



---

# TRADEMARKS

## APPLICATIONS FILED UNDER THE NATIONAL PROCEDURE APPROVED FOR REGISTRATION

The decision can be appealed at the Chamber of Appeal of Sakpatenti within 3 months from the publication or at the Mtskheta District Court Administrative Cases Board (Address: №17, Samkhedro St., Mtskheta), within 1 month following the publication.

(260) AM 2021 104205 A\*  
(210) AM 104205  
(220) 2020 02 17  
(731) LLC "Demasi"  
Right Coast, Surrounding Area of  
the 9 March Garden, Tbilisi, Georgia  
(740) Condrat Dimitrishvili  
(540)



(591) White, black, red  
(531) 26.04.01; 26.04.12; 26.04.24; 26.11.02;  
26.11.06; 26.11.12; 27.05.01; 28.19; 29.01.13  
(511) 35

---

(260) AM 2021 110188 A  
(210) AM 110188  
(220) 2021 03 11  
(731) LTD "Orient"  
Ak. Tsereteli Av. 13, app. 1, Tbilisi, Georgia  
(540)



(591) Golden, white  
(531) 05.03.04; 05.07.10; 19.09.02; 27.05.11;  
29.01.02  
(511) 29, 30, 32, 35

---

(260) AM 2021 110616 A  
(210) AM 110616  
(220) 2020 11 26  
(731) Philip Morris Products S.A.  
Quai Jeanrenaud 3, 2000 Neuchâtel,  
Switzerland

(740) Pavle Meipariani  
(540)

## GREEN ZING

(591) Black-white  
(511) 34

---

(260) AM 2021 110952 A  
(210) AM 110952  
(220) 2020 12 22  
(731) Ferrero Trading Lux S.A.  
16, Route de Trèves, L-2633 Senningerberg,  
Luxembourg  
(740) Giorgi Sarajishvili  
(540)



(591) White, green, brown  
(531) 05.03.14; 05.07.06; 27.05.01; 27.05.09;  
27.05.10; 29.01.12  
(526) GEORGIA  
(511) 31, 44

---

(260) AM 2021 111520 A  
(210) AM 111520  
(220) 2021 02 02  
(731) LLC "Alcoretail Group"  
Giorgi Mdivani St. 3a, Tbilisi, Georgia  
(740) Vakhtang Torotadze  
(540)



(591) FC9F97 pink, B41814 Bordeaux, 000000 black,  
FFFFFF white  
(531) 11.03.02; 26.11.12; 27.05.01; 28.19; 29.01.12  
(511) 33, 35

---

(260) AM 2021 111528 A  
 (210) AM 111528  
 (220) 2021 02 03  
 (731) JSC "Kazunion Holding"  
 Varketili – 3, II mcr., korp. 25a, app. 24,  
 0163, Tbilisi, Georgia



(591) White, orange, blue, yellow, sky-blue, light green  
 (531) 18.05.01; 18.05.03; 26.11.12; 27.05.01;  
 27.05.10; 29.01.14  
 (511) 35, 36

(260) AM 2021 111529 A  
 (210) AM 111529  
 (220) 2021 02 03  
 (731) Otar Chekurishvili  
 Tskneti Highway 23, app. 37, 0179, Tbilisi,  
 Georgia



(591) Black-white  
 (511) 33

(260) AM 2021 111600 A  
 (210) AM 111600  
 (220) 2021 02 09  
 (731) Shanghai Ramentalk E-Commerce Co., Ltd.  
 Room 2153, Bld. №2, Zixing Rd. № 588,  
 Minhang District, Shanghai, China  
 (740) Liliana Darakhvelidze  
 (540)



(591) Black-white  
 (531) 28.03  
 (511) 30, 35

(260) AM 2021 111618 A  
 (210) AM 111618  
 (220) 2021 02 11  
 (731) LLC "Qvevrula"  
 Vill. Tkemlovana, Chiatura, Georgia

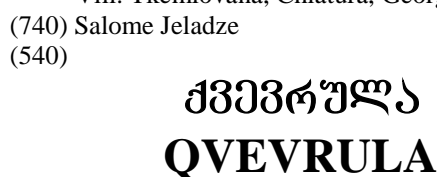

(591) Black, white, red, cornelian-red  
 (531) 25.01.10; 25.01.13; 26.04.14; 26.04.22;  
 26.04.24; 28.19; 29.01.15  
 (511) 33

(591) Black-white  
 (511) 33, 35

(260) AM 2021 111619 A  
 (210) AM 111619  
 (220) 2021 02 12  
 (731) LTD "Best Offer Group"  
 D. Aghmashenebeli St. 32, app. 34, 0154,  
 Batumi, Georgia



(591) White, dark blue  
 (531) 07.01.08; 07.01.24; 27.05.23; 29.01.04  
 (511) 35, 37

(260) AM 2021 111722 A  
 (210) AM 111722  
 (220) 2021 02 16  
 (731) Robert Okropilashvili  
 Tabukashvili St. 203/1, Kutaisi, Georgia  
 (540)

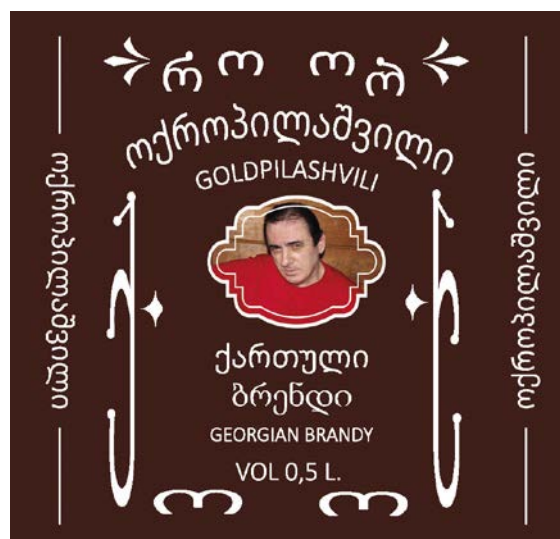

(591) Black, white, red, cornelian-red  
 (531) 25.01.10; 25.01.13; 26.04.14; 26.04.22;  
 26.04.24; 28.19; 29.01.15  
 (511) 33

- (260) AM 2021 111736 A  
 (210) AM 111736  
 (220) 2021 02 17  
 (731) Philip Morris Brands Sàrl  
 Quai Jeanrenaud 3, 2000 Neuchâtel,  
 Switzerland  
 (740) Pavle Meipariani  
 (540)



- (591) Black, golden  
 (531) 02.01.01; 26.04.02; 26.04.07; 26.04.22;  
 26.04.24; 27.05.01; 27.05.10; 27.05.24;  
 29.01.12  
 (511) 34

- (260) AM 2021 111743 A  
 (210) AM 111743  
 (220) 2021 02 18  
 (731) Tamar Chkhubianishvili  
 Z. Paliashvili St. 32, 0179, Tbilisi, Georgia  
 (540)



- (591) B3B1B1 grey, FBD4D4 pink  
 (531) 05.07.08; 27.05.01; 27.05.11; 29.01.01;  
 29.01.06; 29.01.12  
 (511) 30, 43

- (260) AM 2021 111838 A  
 (210) AM 111838  
 (220) 2021 02 19  
 (731) Aleksii Morchiladze  
 Chkondideli St. 22, 0180, Tbilisi, Georgia  
 (540)

## Yame

- (591) Black-white  
 (511) 29, 30, 31, 32, 35, 43

- (260) AM 2021 111856 A  
 (210) AM 111856  
 (220) 2021 02 23  
 (731) I/E Rustam Ibrahimov  
 Memed Abashidze St. 62, app. 14, 6010,  
 Batumi, Georgia  
 (540)



- (591) Red, white  
 (531) 11.03.03; 11.03.07; 26.04.02; 26.04.05;  
 26.04.16; 26.04.22; 26.04.24; 27.05.24; 28.19;  
 29.01.12  
 (511) 32

- (260) AM 2021 111858 A  
 (210) AM 111858  
 (220) 2021 02 23  
 (731) Bayer Aktiengesellschaft  
 Kaiser-Wilhelm-Allee, 51373 Leverkusen,  
 Germany  
 (740) Shalva Gvaramadze  
 (540)

## LUNA

- (591) Black-white  
 (511) 5

- (260) AM 2021 111948 A  
 (210) AM 111948  
 (220) 2021 03 01  
 (731) JSC "Gefa"  
 Ak. Beliashvili St. 142, 0159, Tbilisi,  
 Georgia  
 (740) Salome Jeladze  
 (540)

## MARKETDEPOT MD მარკეტდეპოტ მდ

- (591) Black-white  
 (511) 35, 44

- (260) AM 2021 111949 A  
 (210) AM 111949  
 (220) 2021 03 01  
 (731) JSC "Gefa"  
 Ak. Beliashvili St. 142, 0159, Tbilisi,  
 Georgia  
 (740) Salome Jeladze

(540)

**Broncho BENE**  
**ბრონქო ბენე**  
**Бронхо БЕНЕ**

(591) Black-white  
 (511) 5

(260) AM 2021 111950 A

(210) AM 111950

(220) 2021 03 01

(731) JSC "Gefa"

Ak. Beliashvili St. 142, 0159, Tbilisi, Georgia

(740) Salome Jeladze

(540)

**BENE Rest**  
**ბენე რესტო**  
**БЕНЕ РесТ**

(591) Black-white  
 (511) 5

(260) AM 2021 111959 A

(210) AM 111959

(220) 2021 03 02

(731) JSC "Medinserv"

D. Uznadze St. 76/Dgebuadze St. 1, 0102,  
 Tbilisi Georgia

(540)

**მედიინსერვი**

(591) 110F0F black-white  
 (511) 5, 9, 10, 35, 44

(260) AM 2021 111961 A

(210) AM 111961

(220) 2021 03 03

(310) 4679282

(320) 2020 09 04

(330) FR

(731) Sanofi Pasteur Inc.

One Discovery Drive, Swiftwater,  
 PA 18370, USA

(740) Shalva Gvaramadze

(540)

**KAYRINFA**

(591) Black-white  
 (511) 5

(260) AM 2021 111974 A

(210) AM 111974

(220) 2021 03 04

(731) LTD "Shenzhen Houshuxia Technology Co."

Rm 411, Block A, Weidonglong Business  
 Building, 2125 Meilong Road, Tsinghua  
 Community, Longhua Street, Longhua District,  
 Shenzhen, China

(740) Irakli Gvilia

(540)

**ACEFAST**

(591) Black-white

(531) 27.05.01; 27.05.10

(511) 9, 35

(260) AM 2021 112062 A

(210) AM 112062

(220) 2021 03 09

(731) LTD "Kvarlis Baga"

Il. Chavchavadze St. 13, Kvareli,  
 Georgia

(540)



(591) Black-white

(531) 01.03.01; 01.15.15; 03.04.02; 03.04.13;  
 03.07.03; 07.01.09; 11.03.02; 19.07.01;  
 19.07.12; 26.01.01; 26.01.04; 26.01.15;  
 26.01.16

(511) 29

(260) AM 2021 112077 A

(210) AM 112077

(220) 2021 03 09

(731) SC IP Limited

Charter Place, 23-27 Seaton Place, St Helier,  
 JE1 1JY, Jersey, United Kingdom

(740) Khatuna Imnadze

(540)



(591) Dark blue, beige

(531) 05.07.10; 07.03.01; 26.04.03; 27.05.01; 28.19;  
29.01.12

(511) 32, 33

(260) AM 2021 112085 A

(210) AM 112085

(220) 2021 03 11

(731) Paata Aroshidze

Vill. Tskhemliskhidi, Ozurgeti, Georgia

(540)

(591) 72434D brown, 0E7230 dark green,  
13A53D green, FC020F red

(531) 01.15.05; 26.13.25; 28.19; 29.01.13

(511) 29

(260) AM 2021 112092 A

(210) AM 112092

(220) 2021 03 11

(731) LLC "Sante GMT Products"

Kakheti Highway 10 km, 0182, Tbilisi,  
Georgia

(540)

როდესაც სასარგებლო  
გემრიელია

(591) Black-white

(511) 29

---

**REGISTERED TRADEMARKS**

(111) M 2021 34490 R  
(151) 2021 09 09  
(181) 2031 09 09  
(260) AM 2020 104328 A  
(220) 2020 08 11  
(732) JSC "Elit Electronix"  
Kazbegi Av. 24, 0160, Tbilisi, Georgia

---

(111) M 2021 34491 R  
(151) 2021 09 09  
(181) 2031 09 09  
(260) AM 2020 108231 A  
(220) 2020 05 15  
(732) LLC "Georgian Wine House"  
Vill. Zegaani, 1500, Gurjaani, Georgia

---

(111) M 2021 34492 R  
(151) 2021 09 09  
(181) 2031 09 09  
(260) AM 2020 108696 A  
(220) 2020 06 18  
(732) Giorgi Enriko Beridze  
T. Tabidze St. 10, Dead End I, 0108, Tbilisi,  
Georgia

---

(111) M 2021 34493 R  
(151) 2021 09 09  
(181) 2031 09 09  
(260) AM 2020 109035 A  
(220) 2020 07 13  
(732) LTD "K M C Wines"  
Dighomi, III qu., corp. 31, app. 57, Tbilisi,  
Georgia

---

(111) M 2021 34494 R  
(151) 2021 09 09  
(181) 2031 09 09  
(260) AM 2020 109118 A  
(220) 2020 07 20  
(732) LLC "Georgian Wines House"  
Vill. Zegaani, 1500, Gurjaani, Georgia

---

(111) M 2021 34495 R  
(151) 2021 09 09  
(181) 2031 09 09  
(260) AM 2020 109232 A  
(220) 2020 07 31  
(732) LLC "Georgian Wines House"  
Vill. Zegaani, 1500, Gurjaani, Georgia

---

(111) M 2021 34496 R  
(151) 2021 09 09  
(181) 2031 09 09  
(260) AM 2020 109298 A  
(220) 2020 08 05  
(732) LLC "Ideal Georgia"  
Pushkin St.56, 6000, Batumi, Georgia

---

(111) M 2021 34497 R  
(151) 2021 09 09  
(181) 2031 09 09  
(260) AM 2020 109300 A  
(220) 2020 08 05  
(732) LTD "Chemo Kargo"  
Tsoetne Dadiani St. 108/Kavtiskhevi St. 22,  
Gldani-Nadzaladevi District, Tbilisi, Georgia

---

(111) M 2021 34498 R  
(151) 2021 09 09  
(181) 2031 09 09  
(260) AM 2020 109772 A  
(220) 2020 09 17  
(732) Giorgi Kikabidze  
Il. Chavchavadze Av. 54a, 0179, Tbilisi,  
Georgia

---

(111) M 2021 34499 R  
(151) 2021 09 09  
(181) 2031 09 09  
(260) AM 2020 109852 A  
(220) 2020 09 24  
(732) Hyundai Motor Company  
12, Heolleung-ro, Seocho-gu, Seoul,  
Republic of Korea

---

(111) M 2021 34500 R  
(151) 2021 09 09  
(181) 2031 09 09  
(260) AM 2020 109916 A  
(220) 2020 09 25  
(732) Hyundai Motor Company  
12, Heolleung-ro, Seocho-gu, Seoul,  
Republic of Korea

---

(111) M 2021 34501 R  
(151) 2021 09 09  
(181) 2031 09 09  
(260) AM 2020 109918 A  
(220) 2020 09 25  
(732) Hyundai Motor Company

---

12, Heolleung-ro, Seocho-gu, Seoul,  
Republic of Korea

---

(111) M 2021 34502 R  
(151) 2021 09 09  
(181) 2031 09 09  
(260) AM 2020 109920 A  
(220) 2020 09 25  
(732) Hyundai Motor Company  
12, Heolleung-ro, Seocho-gu, Seoul,  
Republic of Korea

---

(111) M 2021 34503 R  
(151) 2021 09 09  
(181) 2031 09 09  
(260) AM 2020 110041 A  
(220) 2020 10 08  
(732) LLC "Momavlis Meghvineoba"  
(Winemaking of Future)  
Gldani, V mcr., corp. 5, app. 121, Tbilisi,  
Georgia

---

(111) M 2021 34504 R  
(151) 2021 09 09  
(181) 2031 09 09  
(260) AM 2020 110113 A  
(220) 2020 10 09  
(732) LTD "Neogas"  
Gazapkhuli St. 18, Vake-Saburtalo District,  
Tbilisi, Georgia

---

(111) M 2021 34505 R  
(151) 2021 09 09  
(181) 2031 09 09  
(260) AM 2020 110114 A  
(220) 2020 10 12  
(732) Toyota Jidosha Kabushiki Kaisha  
(also trading as Toyota Motor Corporation)  
1, Toiota-cho, Toiota-shi, Aichi-ken, Japan

---

(111) M 2021 34506 R  
(151) 2021 09 09  
(181) 2031 09 09  
(260) AM 2020 110132 A  
(220) 2020 10 15  
(732) Davit Tsetskhladze  
Airport Highway 85, Batumi, Georgia

---

(111) M 2021 34507 R  
(151) 2021 09 09  
(181) 2031 09 09  
(260) AM 2020 110220 A  
(220) 2020 10 21

(732) Toyota Jidosha Kabushiki Kaisha  
(also Trading as Toyota Motor Corporation)  
1, Toiota-cho, Toiota-shi, Aichi-ken, Japan

---

(111) M 2021 34508 R  
(151) 2021 09 09  
(181) 2031 09 09  
(260) AM 2020 110221 A  
(220) 2020 10 21  
(732) Toyota Jidosha Kabushiki Kaisha  
(also Trading as Toyota Motor Corporation)  
1, Toiota-cho, Toiota-shi, Aichi-ken, Japan

---

(111) M 2021 34509 R  
(151) 2021 09 09  
(181) 2031 09 09  
(260) AM 2020 110229 A  
(220) 2020 10 22  
(732) LTD "Kakhetian Traditional Winery"  
Tsintsadze St. 12, 0160, Tbilisi, Georgia

---

(111) M 2021 34510 R  
(151) 2021 09 09  
(181) 2031 09 09  
(260) AM 2020 110477 A  
(220) 2020 11 12  
(732) C.P. Merchandising Co., Ltd 313 C.P. Tower,  
Silom Road,  
Bangrak, Bangkok, 10500, Thailand

---

(111) M 2021 34513 R  
(151) 2021 09 17  
(181) 2031 09 17  
(260) AM 2020 106780 A  
(220) 2020 08 21  
(732) LTD "Lionidzis Zvari"  
Davit Aghmashenebeli Av. 39b, 2200, Telavi,  
Georgia

---

(111) M 2021 34514 R  
(151) 2021 09 17  
(181) 2031 09 17  
(260) AM 2020 109214 A  
(220) 2020 07 28  
(732) Mikheil Guliashvili  
Gldani II mcr., corp. 44, app. 19, Tbilisi,  
Georgia

---

(111) M 2021 34515 R  
(151) 2021 09 17  
(181) 2031 09 17  
(260) AM 2020 109222 A  
(220) 2020 07 29

(732) Sopiko Baghishvili  
Tsothe Dadiani St. 151, 0180, Tbilisi,  
Georgia

---

(111) M 2021 34516 R  
(151) 2021 09 17  
(181) 2031 09 17  
(260) AM 2020 109288 A  
(220) 2020 07 31  
(732) LTD "Kardenakhuli"  
Zghvisubani (Temka) III mcr., III qu.,  
corp. 52, app. 12, Tbilisi, Georgia

---

(111) M 2021 34517 R  
(151) 2021 09 17  
(181) 2031 09 17  
(260) AM 2020 109753 A  
(220) 2020 09 15  
(732) Captiva MVP Restaurant Partners LLC  
Suite 1, 4343 Anchor Plaza Parkway, Tampa,  
Florida, 33634, USA

---

(111) M 2021 34518 R  
(151) 2021 09 17  
(181) 2031 09 17  
(260) AM 2020 109826 A  
(220) 2020 09 21  
(732) Intel Corporation  
2200 Mission College Blvd, Santa Clara,  
California 95052, USA

---

(111) M 2021 34519 R  
(151) 2021 09 17  
(181) 2031 09 17  
(260) AM 2020 109934 A  
(220) 2020 09 29  
(732) LTD "Tural Group"  
Guramishvili St., Ozurgeti, Georgia

---

(111) M 2021 34520 R  
(151) 2021 09 17  
(181) 2031 09 17  
(260) AM 2020 110017 A  
(220) 2020 10 02  
(732) Discovery Communications LLC  
8403 Colesville Road, Silver Spring, Maryland  
20910, USA

---

(111) M 2021 34521 R  
(151) 2021 09 17  
(181) 2031 09 17  
(260) AM 2020 110033 A  
(220) 2020 10 06

(732) Eurodrug Laboratories B.V.  
Regulusweg 11, 2516 AC The Hague,  
Netherlands

---

(111) M 2021 34522 R  
(151) 2021 09 17  
(181) 2031 09 17  
(260) AM 2020 110045 A  
(220) 2020 10 08  
(732) Colgate-Palmolive Company  
Delaware Corporation  
300 Park Avenue, New York, NY 10022, USA

---

(111) M 2021 34523 R  
(151) 2021 09 17  
(181) 2031 09 17  
(260) AM 2020 110212 A  
(220) 2020 10 20  
(732) Varvara Strelkova  
Anna Politkovskaya St. 3, 37, app. 42, 0186,  
Tbilisi, Georgia

---

(111) M 2021 34524 R  
(151) 2021 09 17  
(181) 2031 09 17  
(260) AM 2020 110217 A  
(220) 2020 10 21  
(732) Dow AgroSciences LLC  
9330 Zionsville Road, Indianapolis, Indiana  
46268, USA

---

(111) M 2021 34525 R  
(151) 2021 09 17  
(181) 2031 09 17  
(260) AM 2020 110283 A  
(220) 2020 10 23  
(732) The Procter & Gamble Company  
One Procter & Gamble Plaza, Cincinnati,  
Ohio 45202, USA

---

(111) M 2021 34526 R  
(151) 2021 09 17  
(181) 2031 09 17  
(260) AM 2020 110359 A  
(220) 2020 10 30  
(732) LTD "Macro Tourism"  
V. Gorgasali St. 9, 0105, Tbilisi, Georgia

---

(111) M 2021 34527 R  
(151) 2021 09 17  
(181) 2031 09 17  
(260) AM 2020 110378 A  
(220) 2020 11 04



(732) Alibaba Group Holding Limited  
Fourth Floor, One Capital Place,  
P. O. Box 847, George Town,  
Grand Cayman, Cayman Islands

---

(111) M 2021 34528 R  
(151) 2021 09 17  
(181) 2031 09 17  
(260) AM 2020 110450 A  
(220) 2020 11 09  
(732) JSC "Kindzmarauli Corporation"  
Il. Chavchavadze St. 55, 4800, Kvareli,  
Georgia

---

(111) M 2021 34529 R  
(151) 2021 09 17  
(181) 2031 09 17  
(260) AM 2020 110538 A  
(220) 2020 11 18  
(732) Dimitri Vashakidze  
D. Guramishvili St. 33, 4600, Kutaisi,  
Georgia

---

(111) M 2021 34530 R  
(151) 2021 09 17  
(181) 2031 09 17  
(260) AM 2020 110611 A  
(220) 2020 11 26  
(732) LTD "Globalpharm"  
Almasiani St. 13a/Berbuti St. 8, 0171, Tbilisi,  
Georgia

---

## TRADEMARKS REGISTERED ACCORDING TO THE ACCELERATED PROCEDURE

The decision can be appealed at the Chamber of Appeal of Sakpatenti within 3 months from the publication.

(111) M 2021 34486 R  
 (151) 2021 09 06  
 (181) 2031 09 06  
 (210) AM 111879  
 (220) 2021 02 25  
 (732) LTD "Barbales Marani" (Barbale Cellar)  
 Vakhtang Gorgasali St. 19, Basement, 0105,  
 Krtsanisi District, Tbilisi, Georgia  
 (540)



(591) 0F0D0E black, A23234 bordeaux  
 (531) 01.03.01; 01.03.13; 01.03.15; 28.19; 29.01.12  
 (511) 33

(111) M 2021 34487 R  
 (151) 2021 09 06  
 (181) 2031 09 06  
 (210) AM 114321  
 (220) 2021 08 16  
 (732) LTD "Iveria"  
 Tevdore Mghvdeli St. 53, 0154, Tbilisi,  
 Georgia  
 (740) Zurab Bezhashvili  
 (540)



(591) 000000 black, white  
 (531) 05.03.04; 27.03.11; 28.05  
 (526) GEORGIA  
 (511) 33

(111) M 2021 34488 R  
 (151) 2021 09 06  
 (181) 2031 09 06  
 (210) AM 114341  
 (220) 2021 08 19  
 (732) US Smoke Free LLC  
 dba PUFF BAR branch in Georgia  
 Varketili Settlement, IV mkr., III qu., corp. 13,  
 app. 61, Samgori District, 0181, Tbilisi,  
 Georgia  
 (540)



(591) Black, red, blue, grey, green, orange, ivory  
 (531) 01.15.15; 19.07.09; 25.01.15; 25.01.19;  
 29.01.15  
 (511) 34, 35

(111) M 2021 34489 R  
 (151) 2021 09 07  
 (181) 2031 09 07  
 (210) AM 114318  
 (220) 2021 08 16  
 (732) LLC "Georgian Wheat"  
 Al. Tsulukidze St. 21, fl. 11, app. 33, Tbilisi,  
 Georgia

(740) Giorgi Taktakishvili  
(540)



(591) Black-white  
(531) 18.01.21; 27.05.01; 27.05.17; 28.19  
(511) 30

---

(111) M 2021 34511 R  
(151) 2021 09 10  
(181) 2031 09 10  
(210) AM 114240  
(220) 2021 08 12  
(732) LTD "Tsagveri"  
Borough Tsaghveri, 1212, Borjomi, Georgia  
(740) Davit Dzamukashvili  
(540)



(591) White, blue  
(531) 05.03.07; 27.05.01; 27.05.04; 27.05.09;  
27.05.10; 29.01.04  
(526) TSAGVERI  
(511) 5, 32

---

(111) M 2021 34512 R  
(151) 2021 09 10  
(181) 2031 09 10  
(210) AM 114407  
(220) 2021 08 24  
(732) Ana Iaseshvili  
Gldani, VII mcr., corp. 16, app. 80, Tbilisi,  
Georgia  
(540)

Mamy Bag

(591) Black-white  
(531) 27.05.01  
(511) 18

---

## INTERNATIONAL TRADEMARKS FOR WHICH A DECISION ON GRANTING PROTECTIONS IS TAKEN

The decision can be appealed at the Chamber of Appeal of Sakpatenti within 3 months from the publication or at the Mtskheta District Court Administrative Cases Board (Address: №17, Samkhedro St., Mtskheta), within 1 month following the publication.

(260) AM 2021 110621 A  
 (800) 1561415  
 (151) 2020 10 09  
 (891) 2020 10 09  
 (731) Cooper&Hunter International Corporation  
 3550 NW 113 Ct, Doral FL 33178, USA  
 (540)

### C&H

(591) Black, white  
 (511)  
 11 – Air conditioners; ventilators for air-conditioning installations and apparatus; air reheaters; electric radiators; electric fans; dehumidifiers; air purifiers; electric water heaters; electric drinking water dispensers; humidifiers; air conditioning apparatus and installations, fans being parts of air conditioning installations; filters for air conditioning; air refreshers, namely, air purifying apparatus.

(260) AM 2021 110623 A  
 (800) 1561469  
 (151) 2020 05 29  
 (891) 2020 05 29  
 (731) Aktsionernoe obshchestvo "Kaspi Bank"  
 ul. Nauryzbay batyra, d. 154A, 050013 Gorod Almaty, Kazakhstan  
 (540)



(591) White and red  
 (531) 02.07.10; 02.07.11; 04.05.05; 26.01.01;  
 26.01.14; 26.01.24; 26.04.10; 29.01.12  
 (511)  
 35 – Arranging subscriptions to telecommunication services for others; import-export agency services; commercial information agency services; advertising agency services; cost price analysis; rental of advertising space; business auditing; financial auditing; business intermediary services relating to the matching of

potential private investors with entrepreneurs needing funding; employment agency services; computerized file management; book-keeping; invoicing; demonstration of goods; transcription of communications [office functions]; opinion polling; market studies; business information; information and advice for consumers in the field of choosing products and services; business investigations; business research; marketing research; personnel recruitment; business management and organization consultancy; business organization consultancy; business management consultancy; personnel management consultancy; professional business consultancy; consultancy regarding public relations communication strategies; consultancy regarding advertising communication strategies; layout services for advertising purposes; marketing; marketing in the framework of software publishing; targeted marketing; business management of performing artists; business management of sports people; writing of resumes for others; scriptwriting for advertising purposes; news clipping services; updating and maintenance of information in registries; updating and maintenance of data in computer databases; updating of advertising material; word processing; online retail services for downloadable and pre-recorded music and movies; online retail services for downloadable ring tones; online retail services for downloadable digital music; organization of exhibitions for commercial or advertising purposes; arranging newspaper subscriptions for others; organization of fashion shows for promotional purposes; organization of trade fairs for commercial or advertising purposes; shop window dressing; development of advertising concepts; business appraisals; payroll preparation; data search in computer files for others; sponsorship search; administrative assistance in responding to calls for tenders; business management assistance; commercial or industrial management assistance; commercial intermediation services; providing business information via a web site; providing commercial and business contact information; provision of an online marketplace for buyers and sellers of goods and services; web indexing for commercial or advertising purposes; presentation of goods on communication media, for retail purpose; economic forecasting; auctioneering; retail services for works of art provided by art galleries; sales promotion for others; promotion of goods and services through sponsorship of sports events; production of teleshopping programmes; production of advertising films; office machines and equipment rental;

rental of advertising time on communication media; publicity material rental; rental of billboards [advertising boards]; rental of vending machines; rental of sales stands; rental of photocopying machines; publication of publicity texts; radio advertising; bill-posting; distribution of samples; dissemination of advertising matter; direct mail advertising; registration of written communications and data; writing of publicity texts; advertising; online advertising on a computer network; advertising by mail order; television advertising; document reproduction; compilation of statistics; compilation of information into computer databases; business inquiries; systemization of information into computer databases; advisory services for business management; negotiation of business contracts for others; negotiation and conclusion of commercial transactions for third parties; compiling indexes of information for commercial or advertising purposes; tax preparation; drawing up of statements of accounts; telemarketing services; psychological testing for the selection of personnel; wholesale of pharmaceutical, veterinary, hygiene products and medical supplies; retail sale of pharmaceutical, veterinary, hygiene products and medical supplies; interim business management; external administrative management for companies; business management of hotels; business management for freelance service providers; business project management services for construction projects; commercial administration of the licensing of the goods and services of others; business management of reimbursement programs for others; administration of consumer loyalty programs; administration of frequent flyer programs; administrative processing of purchase orders; public relations; competitive intelligence services; modelling for advertising or sales promotion; typing; market intelligence services; appointment reminder services [office functions]; web site traffic optimization; administrative services for the relocation of businesses; tax filing services; search engine optimization for sales promotion; appointment scheduling services [office functions]; gift registry services; price comparison services; pay per click advertising; secretarial services; procurement services for others [purchasing goods and services for other businesses]; shorthand; outsourcing services [business assistance]; telephone answering for unavailable subscribers; photocopying services; business efficiency expert services; media relations services; corporate communications services; rental of office equipment in co-working facilities; commercial lobbying services.

36 – Insurance underwriting; financial affairs, namely, monetary transactions, banking services, mortgage banking, financial services provided by banks or related institutions, lending against security, namely, real estate, loan financing services provided by credit institutions other than banks, such as cooperative credit

associations, independent financial companies; monetary affairs; real estate affairs; savings bank services.

(260) AM 2021 110624 A

(800) 1561495

(151) 2020 10 02

(891) 2020 10 02

(731) Apple Inc.

One Apple Park Way, Cupertino CA 95014, USA

(540)

## SensorKit

(591) Black, white

(531) 27.05.01

(511)

9 – Downloadable computer software used in developing other software applications.

(260) AM 2021 110625 A

(800) 1561496

(151) 2020 05 29

(891) 2020 05 29

(731) Aktsionernoe obshchestvo "Kaspi Bank"

ul. Nauryzbay batyra, d. 154A, 050013 Gorod Almaty, Kazakhstan

(540)



(591) White and red

(531) 26.04.05; 26.04.22; 27.05.24; 29.01.12

(511)

35 – Arranging subscriptions to telecommunication services for others; import-export agency services; commercial information agency services; advertising agency services; cost price analysis; rental of advertising space; business auditing; financial auditing; business intermediary services relating to the matching of potential private investors with entrepreneurs needing funding; employment agency services; computerized file management; book-keeping; invoicing; demonstration of goods; transcription of communications [office functions]; opinion polling; market studies; business information; information and advice for consumers in the field of choosing products and services; business investigations; business research; marketing research; personnel recruitment; business management and organization consultancy; business organization consultancy; business management consultancy; personnel management consultancy; professio-

nal business consultancy; consultancy regarding public relations communication strategies; consultancy regarding advertising communication strategies; layout services for advertising purposes; marketing; marketing in the framework of software publishing; targeted marketing; business management of performing artists; business management of sports people; writing of resumes for others; scriptwriting for advertising purposes; news clipping services; updating and maintenance of information in registries; updating and maintenance of data in computer databases; updating of advertising material; word processing; online retail services for downloadable and pre-recorded music and movies; online retail services for downloadable ring tones; online retail services for downloadable digital music; organization of exhibitions for commercial or advertising purposes; arranging newspaper subscriptions for others; organization of fashion shows for promotional purposes; organization of trade fairs for commercial or advertising purposes; shop window dressing; development of advertising concepts; business appraisals; payroll preparation; data search in computer files for others; sponsorship search; administrative assistance in responding to calls for tenders; business management assistance; commercial or industrial management assistance; commercial intermediation services; providing business information via a web site; providing commercial and business contact information; provision of an online marketplace for buyers and sellers of goods and services; web indexing for commercial or advertising purposes; presentation of goods on communication media, for retail purpose; economic forecasting; auctioneering; retail services for works of art provided by art galleries; sales promotion for others; promotion of goods and services through sponsorship of sports events; production of teleshopping programmes; production of advertising films; office machines and equipment rental; rental of advertising time on communication media; publicity material rental; rental of billboards [advertising boards]; rental of vending machines; rental of sales stands; rental of photocopying machines; publication of publicity texts; radio advertising; bill-posting; distribution of samples; dissemination of advertising matter; direct mail advertising; registration of written communications and data; writing of publicity texts; advertising; online advertising on a computer network; advertising by mail order; television advertising; document reproduction; compilation of statistics; compilation of information into computer databases; business inquiries; systemization of information into computer databases; advisory services for business management; negotiation of business contracts for others; negotiation and conclusion of commercial transactions for third parties; compiling indexes of information for commercial or advertising purposes; tax preparation; drawing up of statements of accounts; telemarketing services; psychological testing for the selection of personnel; wholesale of phar-

maceutical, veterinary, hygiene products and medical supplies; retail sale of pharmaceutical, veterinary, hygiene products and medical supplies; interim business management; external administrative management for companies; business management of hotels; business management for freelance service providers; business project management services for construction projects; commercial administration of the licensing of the goods and services of others; business management of reimbursement programs for others; administration of consumer loyalty programs; administration of frequent flyer programs; administrative processing of purchase orders; public relations; competitive intelligence services; modelling for advertising or sales promotion; typing; market intelligence services; appointment reminder services [office functions]; web site traffic optimization; administrative services for the relocation of businesses; tax filing services; search engine optimization for sales promotion; appointment scheduling services [office functions]; gift registry services; price comparison services; pay per click advertising; secretarial services; procurement services for others [purchasing goods and services for other businesses]; shorthand; outsourcing services [business assistance]; telephone answering for unavailable subscribers; photocopying services; business efficiency expert services; media relations services; corporate communications services; rental of office equipment in co-working facilities; commercial lobbying services.

36 – Insurance underwriting; financial affairs, namely, monetary transactions, banking services, mortgage banking, financial services provided by banks or related institutions, lending against security, namely, real estate, loan financing services provided by credit institutions other than banks, such as cooperative credit associations, independent financial companies; monetary affairs; real estate affairs; savings bank services.

---

(260) AM 2021 110636 A

(800) 1561714

(151) 2020 07 30

(891) 2020 07 30

(731) Eslami, Nikki

222 Sepulveda Blvd., Second Floor, El Segundo  
CA 90245, USA

(540)

## **WILD ELEMENTS**

(591) Black, white

(511)

3 – Cosmetic creams and preparations for skin care; non-medicated preparations for the care of skin, hair and scalp; baby wipes impregnated with cleaning preparations; deodorants and antiperspirants for personal use; antiperspirant soap; body wash for humans; make-up for the face and body; make-up kits comprised

of lipstick, lip gloss, eyeshadow, foundation; make-up removing tissues impregnated with make-up removing preparations; make-up removing milks, gels, lotions and creams; make-up sets; hair shampoo-conditioners; shaving creams; after shave lotions and creams; baby lotion, powder, shampoo and hair conditioner; cosmetics and make-up; cosmetics in the form of milks, lotions and emulsions; non-medicated hair care and hair styling preparations, namely, shampoo, hair conditioner, hair gel, hair masks, hair mousse, hair primer and heat protectant sprays; sun-tanning oils and lotions; sun-block creams, oils and lotions; toiletry bags sold filled with non-medicated toiletry preparations, namely, soap, shampoo, hair conditioner, hair gel, hair masks, hair mousse; non-medicated skin care preparations; non-medicated skin care preparations, namely, moisturizers, cleansers, cosmetic face masks, cosmetic foot masks, cosmetic hand masks, serum, creams, lotions, balms, gels, toners, scrubs, exfoliator and peels; fragrances; room fragrances; facial moisturizer with spf; sunscreen creams; sunscreen sprays; cosmetic sunscreen preparations; waterproof sunscreens; sunblock lotions; non-medicated skin care preparations, namely, creams, lotions, cleansers, masks and oils; eye cream; facial masks; non-medicated exfoliating preparations for the skin; facial cream; facial cleansers; face oil; facial moisturizers; essential oils for personal use; fragranced body creams, bath and body gels and body lotions; body cleansers and body washes; perfume; cologne; eau de toilette; aftershaves; all-purpose cleaners; glass cleaners; hand cleaners; powder cleaners for metals, ceramics and carpets; cleaner for cosmetic brushes; dish detergents; dishwasher detergents; laundry detergents; detergents for household use.

5 – Probiotic supplements; vitamin supplements; calcium supplements; food supplements; homeopathic supplements; mineral supplements; herbal supplements; prebiotic supplements; dietary supplements; nutritional supplements; protein supplements; enzyme dietary supplements; vitamins; dietary and nutritional supplements; all of the foregoing for human consumption; preparations for the relief of pain; allergy medications; acne medications; cold and flu treatment medications; herbal teas for medicinal purposes; medicinal tea; medicated sunscreens; therapeutic medicated bath preparations; antibacterial soap; antibacterial spray; antibacterial handwash; antibacterial wipes; antibacterial alcohol skin sanitizer gel; antibacterial detergents; antibacterial cleaners; insect repellants; insect repellent in the nature of a lamp oil; insect repellent in candle form; disinfectant bathroom cleaners; disinfectant soap; disinfectant liquid soaps; disinfectant toilet bowl cleaners; disinfectants; disinfecting wipes; disinfecting handwash; disinfectants for medical instruments; disinfectants for hygiene purposes; all-purpose disinfectants; disinfectants for sanitary purposes; disposable wipes impregnated with disin-

fecting chemicals or compounds therefor for use on counters, floors, kitchens, and bathrooms; sanitizing wipes; hand-sanitizing preparations; sanitizing preparations for household use; sanitizing preparations for hospital use; sanitizing preparations for use in institutional and industrial areas; laundry sanitizer tablets; spray sanitizers for personal use; antimicrobial handwash; antibacterial/antimicrobial tape for the purpose of destroying bacteria, mold and mildew; germicidal detergents; antibacterial detergents.

25 – Yoga pants; yoga shirts; yoga socks; headbands; athletic jackets; robes; bath robes; clothing and apparel, namely, shirts, blouses, pants, skirts, jackets, coats, blazers, leggings, sweaters, pajamas, swimwear, jumpsuits, rompers, caftans, shorts, scarves, wraps, capes; shoes; belts; footwear; headwear; riding boots; horse-riding pants; breeches; chaps.

36 – Charitable fundraising; charitable foundation services, namely, providing fundraising activities and/or funding for those working on projects related to the conservation of wildlife.

41 – Educational services, namely, conducting classes, educational courses, workshops and instructional outreach programs regarding the conservation of wildlife; entertainment services, namely, providing podcasts in the fields of beauty, fashion, travel, cooking, health and lifestyle; educational and entertainment services, namely, conducting educational seminars and conferences, and providing motivational and educational speakers in the field of health and wellness; entertainment services, namely, development, creation, and distribution of television shows; entertainment services, namely, development, creation, and distribution of videos in the fields of health and wellness and development, creation, production and post-production services of multimedia entertainment content; providing non-downloadable videos in the nature of television shows and multimedia entertainment content in the fields of beauty, fashion, travel, cooking, health and lifestyle via a website; entertainment services, namely, providing webcasts in the fields of beauty, fashion, travel, cooking, health and lifestyle via a website; magazine publishing; publishing of web magazines; online publication of electronic journals, namely, a group of blogs featuring information, advice, comments and tips about fashion and style, cooking and recipes, travel, entertainment, relationships and conscious living, and interior decoration.

(260) AM 2021 110637 A

(800) 1561731

(151) 2020 10 27

(891) 2020 10 27

(731) Pivovary Staropramen s.r.o.

Nádražní 43/84, CZ-150 00 Praha 5,  
Czech Republic



(540)

**PRAVHA**

(591) Black, white

(511)

32 – Beers; stout; lager; porter and ale; beer based beverages; mineral and aerated waters and other non-alcoholic drinks; fruit drinks and fruit juices; syrups and other preparations for making beverages.

(260) AM 2021 110638 A

(800) 1561886

(151) 2020 07 20

(891) 2020 07 20

(731) Euro Games Technology Ltd.

"Maritsa" Str., 4, "Vranya-Lozen-Triugulnika",  
BG-1151 Sofia, Bulgaria

(540)



(591) Blue, gray, yellow, gold, brown and orange

(531) 23.05.01; 27.05.04; 29.01.15

(511)

9 – Software; computer gaming software; computer software packages; computer operating system software; computer software, recorded; software drivers; virtual reality software; games software; entertainment software for computer games; computer programs for network management; operating computer software for main frame computers; monitors (computer hardware); computer hardware; apparatus for recording images; monitors (computer programs); computer game programs; computer programs for recorded games; apparatus for recording, transmission or reproduction of sound or images; communications servers [computer hardware]; electronic components for gambling machines; computer application software featuring games and gaming; computer software for the administration of on-line games and gaming; computer hardware for games and gaming; computer hardware and software for gambling, gambling machines, gambling games on the Internet and via telecommunication network.

28 – Gaming machines for gambling; chips for gambling; mah-jong; arcade games; gambling machines operating with coins, notes and cards; games; electronic games; parlor games; gaming chips; gaming tables; slot machines [gaming machines]; LCD game machines; slot machines and gaming devices; coin-operated amusement machines; roulette chips; poker chips; chips and dice [gaming equipment]; gaming equipment for casinos; roulette tables; gaming roulette wheels; casino games; amusement and gambling machines; coin-operated gaming machines and / or electronic coin-operated gaming machines with or without the possibility of gain; boxes for coin-operated machines, slot machines and gaming machines; electronic or

electro-technical gaming devices, amusement and gaming machines, including coin-operated machines; housings for coin-operated machines, gaming equipment, gaming machines, machines for gambling; electro-pneumatic and electrical gambling machines (slot machines).

41 – Gambling; entertainment services related to gambling; gaming services for entertainment purposes; casino, gaming and gambling services; training in the development of software systems; provision of equipment for gambling halls; providing casino equipment [gambling]; gaming machine entertainment services; providing casino facilities [gambling]; providing halls with gaming machines; amusement arcade services; games equipment rental; rental of gaming machines; providing amusement arcade services; rental of gaming machines with images of fruits; editing or recording of sounds and images; sound recording and video entertainment services; hire of sound reproducing apparatus; provision of gaming equipment for casinos; providing of casino facilities; online gambling services; provision of casino services; provision of gaming establishments, gaming halls, internet casinos, online gambling services.

(260) AM 2021 110639 A

(800) 1561896

(151) 2020 09 11

(891) 2020 09 11

(731) Zhejiang Dongyang DMEGC Chengji Electronics Co., Ltd.

Hengdian Industrial Area, Dongyang City,  
322100 Zhejiang Province, China

(540)



诚基

(591) Black, white

(531) 26.03.01; 26.03.12; 26.03.16; 26.13.25;

27.05.01; 28.03

(511)

7 – Generators of electricity; dynamos; machine tools for electronic industry; transmissions for machines; engine for manufacturing of batteries; driving motors, other than for land vehicles; motors, other than for land vehicles; motors, electric, other than for land vehicles; centrifugal machines; wind power generate electricity facilities.

9 – Sensor; wireless chargers; solar cells; monosilicon wafer; polysilicon wafer; silicon epitaxial wafer; solar panels; accumulators, electric; mobile phones; integrated circuits; magnetic materials and devices; circulators in the nature of electronic components.



(260) AM 2021 110640 A

(800) 1561924

(151) 2020 09 21

(891) 2020 09 21

(731) BayWa AG

Arabellastrasse 4, 81925 München, Germany

(540)

**DEXOLA**

(591) Black, white

(511)

1 – Chemicals for industrial, scientific, photographic, agricultural, horticultural and forestry purposes.

2 – Paints, varnishes, lacquers; preservatives against rust.

4 – Industrial oils and lubricants, in particular motor oils; fuels, including motor fuels.

(260) AM 2021 110642 A

(800) 1561942

(151) 2020 01 13

(891) 2020 01 13

(731) Obshchestvo s ogranichennoy otvetstvennostyu

"Nalchiksky molochny kombinat"

ul. Kirova, d. 294 A, g. Nalchik, RU-360000

Kabardino-Balkarskaya Respublika, Russian

Federation

(540)

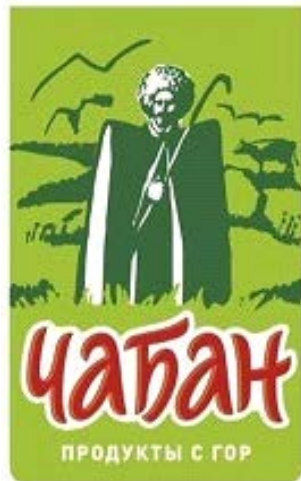

НАТУРАЛЬНЫЕ ПРОДУКТЫ  
ИЗ ПРИЭЛЬБРУСЬЯ

(591) Light green, dark green, ruby-red, orange-brown and white

(531) 02.01.04; 03.04.02; 26.04.04; 26.04.09;

26.04.14; 26.04.16; 26.04.24; 28.05; 29.01.13

(511)

29 – Apricots, processed; ajvar [preserved peppers]; anchovy, not live; peanuts, prepared; artichokes, preserved; albumen for culinary purposes; white of eggs; beans, preserved; soya beans, preserved, for food; ginger jam; laver, processed; edible birds' nests; peas, preserved; mushrooms, preserved; mushrooms, dried; game, not live; gelatine; fruit jellies; yolk of eggs; coconut fat; fruit-based snack food; raisins; caviar; eggplant paste; vegetable marrow paste; fish roe, prepared; yogurt; sauerkraut; kephir [milk beverage]; isinglass for food; milk shakes; arrangements of processed fruit; compotes; vegetables, tinned; fish, tinned; fruits, tinned; gherkins; shrimps, not live; prawns, not live; buttercream; croquettes; kumys [milk beverage]; margarine; marmalade; oils for food; peanut butter; cocoa butter for food; coconut oil for food; coconut butter; corn oil for food; sesame oil for food; linseed oil for culinary purposes; olive oil for food; palm oil for food; palm kernel oil for food; sunflower oil for food; colza oil for food; butter; shellfish, not live; almonds, ground; mussels, not live; milk; peanut milk for culinary purposes; almond milk for culinary purposes; rice milk for use as a milk substitute; condensed milk; soya milk being milk substitute; albumin milk; powdered milk; fish meal for human consumption; vegetable mousses; fish mousses; fruit pulp; milk beverages, milk predominating; vegetables, preserved; vegetables, cooked; vegetables, dried; potato fritters; olives, preserved; lobsters, not live; flavoured nuts; candied nuts; coconut, desiccated; nuts, prepared; tomato paste; pectin for culinary purposes; pickles; jams; powdered eggs; milk products; fish-based foodstuffs; bean sprouts, processed; curd; bulgogi [Korean beef dish]; pollen prepared as foodstuff; cranberry compote; apple purée; crayfish, not live; crustaceans, not live; fish, preserved; fish, not live; salted fish; vegetable salads; fruit salads; sardines, not live; herrings, not live; seeds, prepared; sunflower seeds, prepared; whipped cream; cream [dairy products]; fat-containing mixtures for bread slices; smetana [sour cream]; vegetable juices for cooking; tomato juice for cooking; whey; cheese; tahini [sesame seed paste]; tofu; strained cheese; sea-cucumbers, not live; truffles, preserved; tuna, not live; oysters, not live; milk ferments for culinary purposes; rennet; fish fillets; dates; crystallized fruits; frozen fruits; fruit, preserved; fruit preserved in alcohol; fruit, stewed; hazelnuts, prepared; potato flakes; hummus [chickpea paste]; fruit peel; preserved garlic; processed garlic; lentils, preserved; lentils, prepared; potato chips; low-fat potato chips; soya chips; fruit chips; non-alcoholic eggnog; seaweed extracts for food; meat extracts; berries, preserved; eggs; snail eggs for consumption; qu-

ail eggs; duck eggs; yakitori; peanut milk [non-alcoholic beverage]; almond milk [beverage].

32 – Aperitifs, non-alcoholic; kvass [non-alcoholic beverage]; cocktails, non-alcoholic; lemonades; isotonic beverages; non-alcoholic honey-based beverages; rice-based beverages, other than milk substitutes; soya-based beverages, other than milk substitutes; whey beverages; protein-enriched sports beverages; non-alcoholic beverages flavoured with coffee; non-alcoholic beverages flavoured with tea; non-alcoholic fruit juice beverages; fruit nectars, non-alcoholic; orgeat; syrups for lemonade; syrups for beverages; smoothies; vegetable juices [beverages]; fruit juices; tomato juice [beverage]; cider, non-alcoholic.

35 – Computerized file management; market studies; business information; business management and organization consultancy; commercial intermediation services; auctioneering; business efficiency expert services.

43 – Accommodation bureau services [hotels, boarding houses]; rental of temporary accommodation; tourist home services; hotel services; snack-bar services; café services; cafeteria services; motel services; boarding house services; restaurant services; self-service restaurant services; canteen services; holiday camp services [lodging]; bar services; catering services for the provision of food and drink; food and drink catering.

(260) AM 2021 110643 A

(800) 1561978

(151) 2020 09 09

(891) 2020 09 09

(731) Shandong Jinyu Tire Co., Ltd.

No. 260, Qingken Road, Dawang Town,  
Guangrao County, Dongying City, Shandong  
Province, China

(540)



(591) Black, white

(531) 03.01.01; 03.01.21; 03.01.24

(511)

12 – Inner tubes for pneumatic tires [tyres]; solid tires for vehicle wheels; pneumatic tires [tyres]; inner tubes for bicycle tires; automobile tires [tyres].

(260) AM 2021 110644 A

(800) 1561986

(151) 2020 08 24

(891) 2020 08 24

(731) Shenzhen Hongzhe Intelligent System  
Engineering Co. Ltd.

Room 1203, Block C, Building 2, Software  
Industry Base, No.1003 Keyuan Road, Nanshan  
District, ShenZhen, 518000 Guangdong, China

(540)



(591) Black, white

(531) 27.05.01

(511)

9 – Network communication equipment; video screens; central processing units; cabinets for loudspeakers; computer software applications, downloadable; microphones; megaphones; cameras [photography]; audio- and video-receivers; data processing apparatus.

(260) AM 2021 110645 A

(800) 1562019

(151) 2020 09 17

(891) 2020 09 17

(731) Yongkang Geenew IMP & EXP CO., LTD.

Jiangnan Street, Ziwei South Road, 295 Second,  
No. 4, Yongkang, Zhejiang, China

(540)



(591) Black, white

(531) 27.05.17; 27.05.23

(511)

8 – Hair clippers for personal use, electric and non-electric; scissors; abrading instruments [hand instruments]; hand tools, hand-operated; flat irons; graving tools [hand tools]; sabres; tableware [knives, forks and spoons]; beard clippers, electric; curling tongs; agricultural implements, hand-operated; garden tools, hand-operated; manicure sets.

11 – Electric hair dryers; electric fans for personal use; lamps; germicidal lamps for purifying air; cooking utensils, electric; refrigerating apparatus and machines; water heaters; faucets; bath installations; water purifying apparatus and machines; pocket warmers.

(260) AM 2021 110740 A

(800) 1554241

(151) 2020 08 28

(891) 2020 11 19

(731) RADISSON HOSPITALITY BELGIUM  
BV/SRL

Avenue du Bourget 44, B-1130 Brussels, Belgium

(540)

## RADISSON INDIVIDUALS

(591) Black, white

(511)

43 – Hotel, bar and restaurant services; services for the reservation of rooms.

(260) AM 2021 110815 A

(800) 1564335

(151) 2020 06 24

(891) 2020 06 24

(731) TECHIIA HOLDING LIMITED

Vasili Michailidi, 9, CY-3026 Limassol,  
Cyprus

(540)



## WP Merchandise!

(591) Black, white

(531) 26.11.01; 26.11.11; 27.05.01; 27.05.22

(511)

16 – Printed matter, namely, photographs, drawing pads, pamphlets, booklets, greeting cards, musical greeting cards, graphic representations, graphic reproductions, printed publication, graphic prints, magazines, note books, calendars, paintings, framed or unframed, flyers, pictures, framed or unframed, periodicals, prospectuses, photographs printed; envelopes of paper or plastics, for packaging; stationery, namely, pads.

18 – Luggage and carrying bags, namely, leatherware travelling sets; backpacks; net bags for shopping; travelling bags; handbags; beach bags; bags for sports; bags for campers; suitcases; valises; umbrellas and parasols; business card cases; purses; pocket wallets.

25 – Clothing, namely; boas, breeches for wear, camisoles, cuffs, knitwear, embroidered clothing, stuff jackets, wet suits for water-skiing, shirt yokes, veils, ready-made linings, bibs, sleeved, not of paper, bibs, not of paper, waistcoats, hoods, pockets for clothing, kimonos, judo uniforms, karate uniforms, collars, suits, masquerade costumes, neckties, gaiters, bathing suits, leotards, jackets, leggings, liveries, wristbands, shirt fronts, mantillas, sleep masks, mittens, muffs, fur stoles, outerclothing, ready-made clothing, motorists' clothing, cyclists' clothing, clothing for gymnastics, clothing of leather, gabardines, jerseys, clothing of imitations of leather, paper clothing, beach clothes, overcoats, parkas, pelerines, sashes for wear, hairdressing capes, fingerless gloves, braces for clothing, pyjamas, bathing trunks, ascots, coats, headbands,

ponchos, belts, money belts, jumpers, pullovers, fishing vests, overalls, ski gloves, gloves, jumper dresses, sweaters, shirts, short-sleeve shirts, skirts, petticoats, skorts, sports jerseys, sports singlets, dresses, aprons, uniforms, tee-shirts, dressing gowns, bath robes, scarves, scarfs, trousers; footwear, namely; ankle boots, football shoes, valenki, wooden shoes, football boots, bath slippers, beach shoes, non-slipping devices for footwear, spats, fittings of metal for footwear, esparto shoes or sandals, galoshes, slippers, footwear uppers, half-boots, soles for footwear, sandals, bath sandals, boots for sport, gymnastic shoes, sports shoes, ski boots, boots, lace boots; headwear, namely, bandanas, berets, hats, paper hats, hat frames, cap peaks, visors being headwear, skull caps, top hats, caps being headwear; underclothing and lingerie, namely, bodies, brassieres, corselets, tights, slips, combinations, bodices, corsets, underwear, knickers, hosiery, stockings, sweat-absorbent stockings, garters, girdles, underpants, panties, boxer shorts.

28 – Games, toys and playthings, namely, gymnastic and sporting articles, bats for games, billiard cues, billiard balls, billiard tables, coin-operated billiard tables, bodyboards, punching bags, boxing gloves, rattles, building blocks, twirling batons, boomerangs, teddy bears, stationary exercise bicycles, golf bag trolleys, shuttlecocks, dumb-bells, chest expanders, darts, spinning tops, discuses for sports, slides, dominoes, swimming kickboards, surfboards, sailboards, spring boards, chessboards, draughtboards, drones, exercisers, ascenders, stuffed toys, novelty toys for parties, novelty toys for playing jokes, toy imitation cosmetics, toy vehicles, toy models, toy pistols, toy air pistols, toy robots, remote-controlled toy vehicles, toy figures, building games, golf clubs, ice skates, roller skates, in-line roller skates, rocking horses, flippers for diving, flippers for swimming, flying discs, dolls, dolls' clothes, dolls' houses, dolls' rooms, dolls' beds, scale model vehicles, balls for games, scale model kits, inflatable games for swimming pools, swimming pool air floats, knee guards [sports articles], elbow guards [sports articles], water wings, paragliders, pachinkos, plush toys, plush toys with attached comfort blanket, portable games and toys incorporating telecommunication functions, baseball gloves, golf gloves, gloves for games, body-building apparatus, machines for physical exercises, body-training apparatus, batting gloves, appliances for gymnastics, bowling apparatus and machinery, fencing masks, fencing gloves, skating boots with skates attached, bags especially designed for skis and surfboards functions; baseball gloves; golf gloves; gloves for games; body-building apparatus; machines for physical exercises; body-training apparatus; batting gloves (accessories for games); appliances for gymnastics; bowling apparatus and machinery; fencing masks; fencing gloves; skating boots with skates attached; bags especially designed for skis and surfboards.

35 – Advertising; administrative processing of purchase orders; administration of consumer loyalty programs; cost price analysis; web indexing for commercial or advertising purposes; negotiation of business contracts for others; market studies, opinion polling, demonstration of goods; providing business information via a web site; compilation of information into computer databases; commercial information agency services; providing commercial information and advice for consumers in the choice of products and services; commercial administration of the licensing of the goods and services of others; computerized file management; marketing; targeted marketing; marketing research; organization of exhibitions for commercial or advertising purposes; organization of fashion shows for promotional purposes; organization of trade fairs for commercial or advertising purposes; shop window dressing; procurement services for others (purchasing goods and services for other businesses); commercial intermediation services; search engine optimization for sales promotion; presentation of goods on communication media, for retail purposes; publication of publicity texts; radio advertising; pay per click advertising; outdoor advertising; advertising by mail order; online advertising on a computer network; bill-posting; distribution of samples; dissemination of advertising matter; systemization of information into computer databases; sales promotion for others; promotion of goods and services through sponsorship of sports events; production of advertising films; production of teleshopping programmes; television advertising; telemarketing services; negotiation and conclusion of commercial transactions for third parties; the bringing together, for the benefit of others, of a variety of goods (excluding the transport thereof), enabling customers to conveniently view and purchase those goods, such services may be provided by retail and wholesale stores or by means of electronic media, for example through web sites.

(260) AM 2021 110816 A

(800) 1564353

(151) 2020 06 09

(891) 2020 06 09

(731) YIWU HANHAO SANITARY WARES CO., LTD.

F4-19087 Yiwu International Trade City, Futian Street, Yiwu City, Jinhua City, Zhejiang, China

(540)

# VARTE

(591) Black, white

(531) 27.05.17

(511)

11 – Faucets; floor drains; mixer taps for water pipes; anti-splash tap nozzles for water heating installations; pipes [parts of sanitary installations]; hand drying ap-

paratus for washrooms; toilets; bath installations; flushing tanks; wash-hand bowls [parts of sanitary installations]; showers; level controlling valves in water tanks; toilet seats; flushing apparatus; urinals being sanitary fixtures; bathtubs; shower water heaters; irrigation sprinklers; regulating and safety accessories for water apparatus; heating device; water-pipes for sanitary installations; pressure water tanks; radiators; automatic watering installations; shower installations.

(260) AM 2021 110817 A

(800) 1564358

(151) 2020 10 15

(891) 2020 10 15

(731) Apple Inc.

One Apple Park Way, Cupertino CA  
95014, USA

(540)

## MAGSAFE

(591) Black, white

(511)

9 – Charging mats for use with computers, mobile telephones and smart watches; charging docks for use with computers, mobile telephones and smart watches; charging apparatus for use with computers, mobile telephones and smart watches; adapters for use with computers, mobile telephones and smart watches; mobile phone chargers; mobile phone charging cases; smart watch charger; wireless chargers; wireless charging cases for mobile phones; cases adapted for mobile phones; cell phone cases; cell phone covers; computer cases; accessories and parts for computers, mobile phones, and smartwatches; cases specially adapted for electronic equipment, namely, mobile phones, smartphones, cell phones, earphones, tablets, computers, and portable handheld devices.

(260) AM 2021 110818 A

(800) 1564432

(151) 2020 06 10

(891) 2020 06 10

(731) Lodestar Anstalt

Lova-Center, P.O. Box 1150, FL-9490 Vaduz,  
Liechtenstein

(540)

## HIGH ROLLER

(591) Black, white

(511)

3 – Non-medicated cosmetics; creams; gels; lotions; shampoo; non-medicated dentifrices; perfumery, essential oils; cleaning, polishing, scouring and abrasive preparations; non-medicated cosmetics containing cannabis or cannabis derivatives; creams containing cannabis or cannabis derivatives; gels containing cannabis or cannabis derivatives; lotions containing canna-

bis or cannabis derivatives; shampoo containing cannabis or cannabis derivatives; non-medicated dentifrices containing cannabis or cannabis derivatives; perfumery containing cannabis or cannabis derivatives; essential oils containing cannabis or cannabis derivatives; cleaning, polishing, scouring and abrasive preparations, all containing cannabis or cannabis derivatives.

5 – Medical and veterinary preparations; medical preparations for inhaling; sanitary preparations for medical purposes; dietetic food and substances adapted for medical or veterinary use; dietary supplements and nutritional supplements for human beings and animals; vitamin preparations; preparation for the relief of pain, for relaxation, for reducing stress and fatigue, for mood enhancement, for maintaining general health and well-being, for relieving anxiety, for relieving depression, as a sleep aid; plasters, materials for dressings; inhalants; medical marijuana, cannabis, cannabis oils and cannabis derivatives; food for medicinal and health purposes containing cannabis or cannabis derivatives; beverages for medicinal and health purposes containing cannabis or cannabis derivatives; dietary supplements and nutritional supplements containing cannabis or cannabis derivatives; medicated skincare products and cosmetics containing cannabis or cannabis derivatives; medical and veterinary preparations containing cannabis or cannabis derivatives; inhalants containing medical cannabis or cannabis derivatives; herbal teas with cannabis or cannabis derivatives as an ingredient.

29 – Preserved, frozen, dried and cooked fruits and vegetables; jellies, jams, compotes; eggs; milk, cheese, butter, peanut butter, yogurt and other milk products; oils and fats for food; preserved, frozen, dried and cooked fruits and vegetables all containing cannabis or cannabis derivatives; jellies, jams, compotes, all containing cannabis or cannabis derivatives; milk products containing or infused with cannabis or cannabis derivatives; oils and fats containing cannabis or cannabis derivatives for food purposes.

30 – Coffee, tea, cocoa and artificial coffee; tea substitutes; tea essences; non-medicated teas in bags; rice, pasta and noodles; tapioca and sago; flour and preparations made from cereals; bread, pastries and confectionery; chocolate; ice cream, sorbets and other edible ices; honey, treacle; seasonings, spices, preserved herbs; vinegar, sauces; ice [frozen water]; coffee, tea, cocoa and artificial coffee mixed with or containing cannabis or cannabis derivatives; pasta and noodles flavored with or containing cannabis or cannabis derivatives; tapioca and sago mixed with cannabis or cannabis derivatives; flour and preparations made from cereals, mixed with or containing cannabis or cannabis derivatives; bread, pastries and confectionery containing cannabis or cannabis derivatives; chocolate with cannabis or cannabis derivatives as an ingre-

dient; ice cream, sorbets and other edible ices with cannabis or cannabis derivatives as an ingredient; honey, treacle, flavored with cannabis or cannabis derivatives; seasonings, spices, preserved herbs all mixed or flavored with cannabis or cannabis derivatives; vinegar, sauces, all infused or flavored with cannabis or cannabis derivatives.

31 – Raw and unprocessed agricultural, horticultural and forestry products; raw and unprocessed grains and seeds; fresh fruits, vegetables, fresh herbs; dried herbs for decoration; foodstuffs for animals containing herbal extracts; natural plants and flowers; seedlings and seeds for planting; foodstuffs and beverages for animals; cannabis, unprocessed; unprocessed cannabis in its various forms, including live cannabis plants, cannabis seeds, fresh cannabis, dried cannabis, cannabis strains; foodstuff and beverages for animals containing, mixed or flavored with cannabis or cannabis derivatives.

32 – Beers; non-alcoholic beverages; mineral and aerated waters; fruit beverages and fruit juices; syrups and other non-alcoholic preparations for making beverages; carbonated soft drinks, and energy drinks; cannabis or cannabis derivatives infused beer; beer containing cannabis or cannabis derivatives as an ingredient; non-alcoholic beverages flavored or infused with cannabis or cannabis derivatives; mineral and aerated waters flavored or infused with cannabis or cannabis derivatives; fruit beverage and fruit juices containing cannabis or cannabis derivatives; energy drinks with cannabis or cannabis derivatives; beer and soft drinks, containing cannabis seed extract or mature cannabis stem extract.

33 – Alcoholic beverages, except beers; alcoholic preparations for making beverages; cocktail mixes, alcoholic energy drinks; cannabis or cannabis derivatives infused alcoholic beverages; alcoholic beverages containing cannabis or cannabis derivatives as an ingredient; alcoholic beverages flavored or infused with cannabis or cannabis derivatives; cocktail mixes with cannabis or cannabis derivatives; alcoholic energy drinks with cannabis or cannabis derivatives; alcoholic beverages including mixed drinks, containing cannabis seed extract or mature cannabis stem extract.

34 – Tobacco and tobacco substitutes; cigarettes and cigars; electronic cigarettes and oral vaporizers for smokers; smokers' articles; matches; chemical flavorings in liquid form used to refill electronic cigarette cartridges; cartridges for electronic cigarettes; non-medical preparations for inhaling; tobacco and tobacco substitutes containing or mixed with cannabis or cannabis derivatives; cigarettes and cigars with cannabis or cannabis derivatives, cannabis cigarettes; cannabis based products for smoking and inhaling; cannabis flavorings in liquid form used to refill electronic cigarette cartridges.

(260) AM 2021 110819 A

(800) 1564497

(151) 2020 07 20

(891) 2020 07 20

(731) Euro Games Technology Ltd.

"Maritsa" Str., 4, "Vranya-Lozen-Triugulnika",  
BG-1151 Sofia, Bulgaria

(540)

(591) Yellow, gold, brown, orange, green, red, gray,  
black and white

(531) 03.06.25; 27.05.04; 29.01.15

(511)

9 – Software; computer gaming software; computer software packages; computer operating system software; computer software, recorded; software drivers; virtual reality software; games software; entertainment software for computer games; computer programs for network management; operating computer software for main frame computers; monitors (computer hardware); computer hardware; apparatus for recording images; monitors (computer programs); computer game programs; computer programs for recorded games; apparatus for recording, transmission or reproduction of sound or images; communications servers [computer hardware]; electronic components for gambling machines; computer application software featuring games and gaming; computer software for the administration of on-line games and gaming; computer hardware for games and gaming; computer hardware and software for gambling, gambling machines, gambling games on the Internet and via telecommunication network.

28 – Gaming machines for gambling; chips for gambling; mah-jong; arcade games; gambling machines operating with coins, notes and cards; games; electronic games; parlor games; gaming chips; gaming tables; slot machines [gaming machines]; LCD game machines; slot machines and gaming devices; coin-operated amusement machines; roulette chips; poker chips; chips and dice [gaming equipment]; gaming equipment for casinos; roulette tables; gaming roulette wheels; casino games; amusement and gambling machines; coin-operated gaming machines and / or electronic coin-operated gaming machines with or without the possibility of gain; boxes for coin-operated machines, slot machines and gaming machines; electronic or electro-technical gaming devices, amusement and gaming machines, including coin-operated machines; housings for coin-operated machines, gaming equipment, gaming machines, machines for gambling; electro-pneumatic and electrical gambling machines (slot machines).

41 – Gambling; entertainment services related to gambling; gaming services for entertainment purposes; casino, gaming and gambling services; training in the development of software systems; provision of equipment for gambling halls; providing casino equipment [gambling]; gaming machine entertainment services; providing casino facilities [gambling]; providing halls with gaming machines; amusement arcade services; games equipment rental; rental of gaming machines; providing amusement arcade services; rental of gaming machines with images of fruits; editing or recording of sounds and images; sound recording and video entertainment services; hire of sound reproducing apparatus; provision of gaming equipment for casinos; providing of casino facilities; online gambling services; provision of casino services; provision of gaming establishments, gaming halls, internet casinos, online gambling services.

(260) AM 2021 110820 A

(800) 1564515

(151) 2020 08 28

(891) 2020 08 28

(731) "ArtGrand" Limited Liability Company  
vul. Zhurnalistiv, 9 ZH., m. Dnipro 49005,  
Ukraine

(540)



(591) Red and black

(531) 27.05.09; 27.05.17; 27.05.19; 27.05.22;  
29.01.12

(511)

27 – Wall hangings, not of textile; wallpaper; textile wallpaper.

(260) AM 2021 110821 A

(800) 1564550

(151) 2020 10 27

(891) 2020 10 27

(731) Individual'nyj predprinimatel' Zajtsev Dmitriy  
Petrovich  
nab. Obvodnogo kanala, d. 127, kv. 9,  
RU-190013 Sankt-Peterburg, Russian  
Federation

(540)

**СЛОПЛАСТ**  
**SLOPLAST**

(591) Black, white

(531) 28.05

(511)

16 – Albums; booklets; books; calendars; catalogues; graphic prints; graphic representations; graphic reproductions; newspapers; note books; pamphlets; pe-

riodicals; photo-engravings; photographs [printed]; posters; printed matter; printed publications; signboards of paper or cardboard; stationery.

17 – Asbestos fibers; compositions to prevent the radiation of heat; dielectrics [insulators]; insulating materials; insulating paper; non-conducting materials for retaining heat; plastic fibers, other than for textile use; plastic substances, semi-processed; substances for insulating buildings against moisture; synthetic resins, semi-processed; threads of plastic materials, other than for textile use.

19 – Angle irons, not of metal; artificial stone; building materials, not of metal; building panels, not of metal; buildings, not of metal; ceilings, not of metal; cladding, not of metal, for building; door frames, not of metal; duckboards, not of metal; floor tiles, not of metal; floors, not of metal; gates, not of metal; grog [fired refractory material]; linings, not of metal, for building; manufactured timber; refractory construction materials, not of metal; shuttering, not of metal, for concrete; skating rinks [structures], not of metal; wainscoting, not of metal; wall claddings, not of metal, for building; wall linings, not of metal, for building; wall tiles, not of metal; window frames, not of metal; wood veneers.

20 – Bottle racks; boxes of wood or plastic; counters [tables]; covers for clothing [wardrobe]; cupboards; dinner wagons [furniture]; display stands; doors for furniture; edgings of plastic for furniture; filing cabinets; furniture fittings, not of metal; furniture shelves; house numbers, not of metal, non-luminous; keyboards for hanging keys; labels of plastic; library shelves; meat safes; office furniture; plate racks; plugs [dowels], not of metal; racks [furniture]; school furniture; shelves for file cabinets; shelves for storage; shelving units; signboards of wood or plastics; stools; tables; tea carts; tool chests, not of metal, empty; wardrobes; window fittings, not of metal.

35 – Administrative processing of purchase orders; advertising; demonstration of goods; import-export agency services; market studies; marketing research; marketing services; organization of exhibitions and trade fairs for commercial or advertising purposes; organization of exhibitions for commercial or advertising purposes; presentation of goods on communication media, for retail purposes; procurement services for others [purchasing goods and services for other businesses]; professional business consultancy; providing business information; sales promotion for others; updating and maintenance of data in computer databases.

37 – Factory construction; airplane maintenance and repair; building of fair stalls and shops; construction; furniture maintenance; harbour construction; installation of doors and windows; masonry; painting or repair of signs; providing construction information; pro-

viding information relating to repairs; rental of construction equipment; repair or maintenance of automobiles; scaffolding; shipbuilding; strong-room maintenance and repair; swimming-pool maintenance; vehicle breakdown repair services; vehicle maintenance; vehicle service stations [refuelling and maintenance]; warehouse construction and repair.

40 – Custom assembling of materials for others; decontamination of hazardous materials; framing of works of art; paper treating; photographic printing; printing.

(260) AM 2021 110822 A

(800) 1564562

(151) 2020 02 27

(891) 2020 02 27

(731) KLEEMED AG

SHAFFHAUSERSTRASSE 63, CH-8152  
GLATTBRUGG, Switzerland

(540)

# Mioxselle

(591) Black, white

(531) 27.05.17

(511)

5 – Absorbent cotton; absorbent cotton; adjuvants for medical purposes; cooling sprays for medical purposes; acaricides; aconitine; alkaloids for medical purposes; albumin dietary supplements; alginates for pharmaceutical purposes; alginate dietary supplements; algicides; aldehydes for pharmaceutical purposes; amino acids for veterinary purposes; amino acids for medical purposes; analgesics; anaesthetics; antibacterial handwashes; antibiotics; anthelmintics; anti-uric preparations; antiseptics; antiseptic cotton; first-aid boxes, filled; aluminium acetate for pharmaceutical purposes; acetates for pharmaceutical purposes; cotton for medical purposes; germicides; bacterial poisons; biological preparations for medical purposes; biocides; bismuth subnitrate for pharmaceutical purposes; linseed meal for pharmaceutical purposes; flour for pharmaceutical purposes; decoctions for pharmaceutical purposes; vitamin preparations; mineral waters for medical purposes; hydrated chloral for pharmaceutical purposes; dietary fibre; charcoal for pharmaceutical purposes; astringents for medical purposes; gases for medical purposes; gallic acid for pharmaceutical purposes; guaiacol for pharmaceutical purposes; sexual stimulant gels; haematogen; haemoglobin; haemostatic pencils; herbicides; sanitary tampons; hydrastine; hydrastinine; mustard for pharmaceutical purposes; mustard oil for medical purposes; mustard plasters; glycerine for medical purposes; glycerophosphates; glucose for medical purposes; homogenized food adapted for medical purposes; hormones for medical purposes; mud for baths; medicinal mud; vulnerary sponges; rubber for



dental purposes; gamboge for medical purposes; gurun balsam for medical purposes; disinfectants; disinfectants for chemical toilets; disinfectants for hygiene purposes; deodorants for clothing and textiles; deodorants, other than for human beings or for animals; cedar wood for use as an insect repellent; detergents for medical purposes; digitalin; infant formula; diagnostic preparations for veterinary purposes; diagnostic preparations for medical purposes; diastase for medical purposes; dietary supplements for animals; royal jelly dietary supplements; glucose dietary supplements; pollen dietary supplements; dietary supplements with a cosmetic effect; linseed dietary supplements; linseed oil dietary supplements; acai powder dietary supplements; propolis dietary supplements; wheat germ dietary supplements; dietetic beverages adapted for medical purposes; dietetic substances adapted for medical use; dietetic foods adapted for medical purposes; yeast for pharmaceutical purposes; yeast dietary supplements; eucalyptus for pharmaceutical purposes; eucalyptol for pharmaceutical purposes; plant extracts for pharmaceutical purposes; herbal extracts for medical purposes; extracts of hops for pharmaceutical purposes; elixirs (pharmaceutical preparations); enzymes for veterinary purposes; enzymes for medical purposes; enzyme dietary supplements; enzyme preparations for medical purposes; esters for pharmaceutical purposes; cellulose esters for pharmaceutical purposes; ethers for pharmaceutical purposes; cellulose ethers for pharmaceutical purposes; febrifuges; gelatine for medical purposes; milking grease; greases for veterinary purposes; greases for medical purposes; nicotine gum for use as an aid to stop smoking; chewing gum for medical purposes; nervines; bunion pads; isotopes for medical purposes; immunostimulants; reagent paper for veterinary purposes; reagent paper for medical purposes; insecticides; Irish moss for medical purposes; iodine for pharmaceutical purposes; alkaline iodides for pharmaceutical purposes; iodides for pharmaceutical purposes; iodoform; casein dietary supplements; calomel (fungicide); gum for medical purposes; camphor for medical purposes; camphor oil for medical purposes; capsules for medicines; carbolineum (parasiticide); caustics for pharmaceutical purposes; caustic pencils; cachou for pharmaceutical purposes; quassia for medical purposes; quebracho for medical purposes; oxygen for medical purposes; acids for pharmaceutical purposes; oxygen baths; bone cement for surgical and orthopaedic purposes; fly glue; adhesive tapes for medical purposes; adhesives for dentures; cocaine; collagen for medical purposes; collodion for pharmaceutical purposes; compresses; chemical contraceptives; angostura bark for medical purposes; condurango bark for medical purposes; croton bark; mangrove bark for pharmaceutical purposes; myrobalan bark for pharmaceutical purposes; barks for pharmaceutical purposes; quinquina for medical purposes; rhubarb roots for pharmaceutical purposes; lint for medical purposes; collyrium; cream

of tartar for pharmaceutical purposes; creosote for pharmaceutical purposes; blood for medical purposes; depuratives; styptic preparations; dill oil for medical purposes; starch for dietetic or pharmaceutical purposes; biological tissue cultures for veterinary purposes; biological tissue cultures for medical purposes; cultures of microorganisms for medical or veterinary use; curare; dental lacquer; breast-nursing pads; milk sugar for pharmaceutical purposes; adhesive plasters; lecithin for medical purposes; lecithin dietary supplements; fly catching paper; medicines for alleviating constipation; medicines for human purposes; medicines for veterinary purposes; drugs for medical purposes; medicines for dental purposes; medicinal roots; medicated animal feed; medicinal tea; corn remedies; remedies for perspiration; remedies for foot perspiration; medicated toothpaste; medicated dentifrices; medicated hair lotions; medicated after-shave lotions; medicinal drinks; medicinal infusions; medicinal oils; medicated toiletry preparations; medicinal hair growth preparations; medicated eye-washes; medicinal herbs; liniments; liquorice for pharmaceutical purposes; lotions for veterinary purposes; lotions for pharmaceutical purposes; personal sexual lubricants; lupulin for pharmaceutical purposes; magnesia for pharmaceutical purposes; sunburn ointments; ointments for pharmaceutical purposes; frostbite salve for pharmaceutical purposes; gauze for dressings; massage candles for therapeutic purposes; dental impression materials; teeth filling material; medicinal alcohol; medicine cases, portable, filled; medical preparations for slimming purposes; melissa water for pharmaceutical purposes; menthol; almond milk for pharmaceutical purposes; dog washes (insecticides); animal washes (insecticides); cattle washes (insecticides); insecticidal veterinary washes; antibacterial soap; disinfectant soap; medicated soap; mineral food supplements; moulding wax for dentists; moleskin for medical purposes; powdered milk for babies; lacteal flour for babies; milk ferments for pharmaceutical purposes; sea water for medicinal bathing; mint for pharmaceutical purposes; vitamin supplement patches; nicotine patches for use as aids to stop smoking; scapulars for surgical purposes; vesicants; narcotics; linseed for pharmaceutical purposes; tincture of iodine; tinctures for medical purposes; nutraceutical preparations for therapeutic or medical purposes; fumigating sticks; fumigation preparations for medical purposes; cachets for pharmaceutical purposes; wart pencils; oil of turpentine for pharmaceutical purposes; opiates; opium; opodeldoc; mouthwashes for medical purposes; rat poison; poisons; stick liquorice for pharmaceutical purposes; paper for mustard plasters; mothproofing paper; parasiticides; pastilles for pharmaceutical purposes; pectin for pharmaceutical purposes; pepsins for pharmaceutical purposes; peptones for pharmaceutical purposes; dressings, medical; hydrogen peroxide for medical purposes; pearl powder for medical purposes; pesticides; antioxidant pills; tanning pills; appetite suppres-



sant pills; slimming pills; babies' diapers; diapers for pets; diapers for incontinence; babies' diaper-pants; blood plasma; by-products of the processing of cereals for dietetic or medical purposes; eyepatches for medical purposes; nutritional supplements; nutritive substances for microorganisms; bouillons for bacteriological cultures; pomades for medical purposes; powder of cantharides; pyrethrum powder; porcelain for dental prostheses; laxatives; bismuth preparations for pharmaceutical purposes; pre-filled syringes for medical purposes; haemorrhoid preparations; preparations for callouses; chilblain preparations; bath preparations for medical purposes; air deodorizing preparations; mothproofing preparations; preparations for reducing sexual activity; preparations for destroying dry rot fungus; larvae exterminating preparations; preparations for destroying mice; fly destroying preparations; slug exterminating preparations; preparations for destroying noxious animals; vermin destroying preparations; acne treatment preparations; preparations for the treatment of burns; lice treatment preparations (pediculicides); ophotherapy preparations; air purifying preparations; appetite suppressants for medical purposes; sterilizing preparations; soil-sterilizing preparations; contact lens cleaning preparations; aloe vera preparations for pharmaceutical purposes; preparations of trace elements for human and animal use; preparations of microorganisms for medical or veterinary use; preparations to facilitate teething; poultices; chemical conductors for electrocardiograph electrodes; food for babies; sanitary towels; purgatives; propolis for pharmaceutical purposes; protein dietary supplements; protein supplements for animals; asthmatic tea; corn rings for the feet; antiparasitic collars for animals; antiparasitic preparations; anticryptogamic preparations; leeches for medical purposes; radium for medical purposes; radioactive substances for medical purposes; diagnostic biomarker reagents for medical purposes; radiological contrast substances for medical purposes; insect repellents; insect repellent incense; repellents for dogs; digestives for pharmaceutical purposes; fish meal for pharmaceutical purposes; cod liver oil; castor oil for medical purposes; ergot for pharmaceutical purposes; solutions for contact lenses; solutions for removing adhesive plasters; mercurial ointments; sarsaparilla for medical purposes; lead water; sedatives; tissues impregnated with pharmaceutical lotions; serotherapeutic medicines; siccatives (drying agents) for medical purposes; serums; syrups for pharmaceutical purposes; sulfur sticks (disinfectants); turpentine for pharmaceutical purposes; soporifics; salts for mineral water baths; bath salts for medical purposes; smelling salts; potassium salts for medical purposes; mineral water salts; salts for medical purposes; sodium salts for medical purposes; malt for pharmaceutical purposes; malted milk beverages for medical purposes; semen for artificial insemination; alcohol for pharmaceutical purposes; alloys of precious metals for dental purposes; douching preparations for medi-

cal purposes; steroids; stem cells for veterinary purposes; stem cells for medical purposes; dental abrasives; dental amalgams; dental amalgams of gold; dental mastics; dental cements; strychnine; freeze-dried meat adapted for medical purposes; freeze-dried food adapted for medical purposes; sulfonamides (medicines); suppositories; therapeutic preparations for the bath; thermal water; thymol for pharmaceutical purposes; gentian for pharmaceutical purposes; tonics (medicines); smoking herbs for medical purposes; herbal teas for medicinal purposes; transplants (living tissues); pants, absorbent, for incontinence; sanitary panties; tobacco extracts (insecticides); pharmaceutical preparations; pharmaceutical preparations for treating dandruff; pharmaceutical preparations for skin care; pharmaceutical preparations for treating sunburn; lime-based pharmaceutical preparations; pharmaceuticals; phenol for pharmaceutical purposes; fennel for medical purposes; ferments for pharmaceutical purposes; enzyme preparations for veterinary purposes; phytotherapy preparations for medical purposes; formaldehyde for pharmaceutical purposes; phosphates for pharmaceutical purposes; fungicides; chemico-pharmaceutical preparations; chemical preparations for the diagnosis of pregnancy; chemical preparations for treating wheat blight; chemical preparations for treating phylloxera; chemical preparations for treating diseases affecting vine plants; chemical preparations for treating diseases affecting cereal plants; chemical preparations for treating mildew; chemical preparations for veterinary purposes; chemical preparations for medical purposes; chemical preparations for pharmaceutical purposes; chemical reagents for medical or veterinary purposes; quinine for medical purposes; chinoline for medical purposes; surgical implants comprised of living tissues; surgical glues; surgical dressings; diabetic bread adapted for medical use; chloroform; flowers of sulfur for pharmaceutical purposes; cement for animal hooves; medicated candies; crystallized rock sugar for medical purposes; sugar for medical purposes; medicated shampoos for pets; insecticidal animal shampoos; medicated shampoos; pediculicidal shampoos; medicated dry shampoos; panty liners (sanitary); jujube, medicated; jalap.

(260) AM 2021 110823 A

(800) 1564584

(151) 2020 06 18

(891) 2020 06 18

(731) MASTELLI S.R.L.

Via Bussana Vecchia 32, I-18038 SANREMO,  
IMPERIA, Italy

(540)

**HPT**

(591) Black, white

(511)

3 – Astringents for cosmetic purposes; balms, other than for medical purposes; gel eye patches for cosmetic purposes; cosmetics; cosmetic creams; lotions for cosmetic purposes; beauty masks; oils for cosmetic purposes; pomades for cosmetic purposes; cosmetic preparations for baths; collagen preparations for cosmetic purposes; phytocosmetic preparations; cosmetic preparations for skin care; cakes of toilet soap; soap; cosmetics containing polynucleotides.

5 – Acetates for pharmaceutical purposes; acids for pharmaceutical purposes; chemical preparations for pharmaceutical purposes; chemical preparations for medical purposes; ethers for pharmaceutical purposes; phosphates for pharmaceutical purposes; medicines for human purposes; enzyme preparations for medical purposes; nutraceutical preparations for therapeutic or medical purposes; pharmaceutical preparations; chemico-pharmaceutical preparations; pharmaceuticals; polynucleotides for pharmaceutical purposes.

10 – Orthopaedic joint implants; artificial orthopaedic implants; orthopaedic articles; orthopaedic appliances; artificial limbs; orthopaedic belts; knee bandages, orthopaedic; biodegradable bone fixation implants; surgical implants comprised of artificial materials; injectors for medical purposes; hypodermic syringes; syringes for medical purposes.

(260) AM 2021 110824 A

(800) 1564633

(151) 2020 10 29

(891) 2020 10 29

(731) DAIMLER AG

Mercedesstraße 120, 70372 Stuttgart,  
Germany

(540)

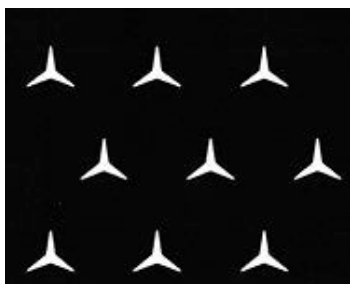

(591) Black, white

(531) 01.01.01; 01.01.05; 01.01.08; 25.07.01;  
26.04.05; 26.04.13; 26.04.24

(511)

12 – Vehicles; apparatus for locomotion by land, air or water; parts and fittings for vehicles.

28 – Games; toys; video game apparatus; interactive gaming chairs for video games; appliances for gymnastics; sporting articles [except for skis and snowboards]; decorations for Christmas trees.

37 – Vehicle repair, maintenance, refuelling and recharging.

(260) AM 2021 110842 A

(800) 830824

(151) 2004 06 07

(891) 2020 11 20

(731) Santen SAS

1 rue Pierre Fontaine, Bâtiment Genavenir IV,  
F-91000 Evry, France

(540)

## CATIONORM

(591) Black, white

(511)

5 – Pharmaceutical and veterinary products; hygienic products for medicine; chemical preparations for medical or pharmaceutical purposes, chemical preparations for veterinary purposes, eye drops, serums, ophthalmic emulsions, chemical-pharmaceutical preparations, lotions for pharmaceutical or veterinary use; tissues impregnated with pharmaceutical lotions; medicines for human purposes; medicines for veterinary purposes; therapeutic preparations.

(260) AM 2021 110843 A

(800) 917877

(151) 2007 02 08

(891) 2020 11 10

(731) Sarantis Slovakia s.r.o.

Nitrianska 100, SK-920 27 Hlohovec, Slovakia

(540)

## INDULONA

(591) Black, white

(511)

3 – Cosmetics.

(260) AM 2021 110850 A

(800) 1432006

(151) 2018 02 12

(891) 2020 10 30

(731) "4KRAFT" SPÓŁKA Z OGRANICZONĄ  
ODPOWIEDZIALNOŚCIĄ

ul. Tatrzńska 1/5, PL-60-413 Poznań, Poland

(540)

## kk Kinderkraft

(591) Black, white

(511)

12 – Prams; safety seats for children, for vehicles; pedal bicycles; inner tubes for pneumatic tyres; inner tubes for bicycle tyres; vehicle tires; tubeless tyres for bicycles; fitted footmuffs for prams; bicycle brakes; bicycle handlebars; bicycle horns; bicycle wheels; baskets adapted for bicycles; casters for trolleys [ve-

hicles]; side view mirrors for vehicles; fitted pushchair mosquito nets; bicycle kickstands; push scooters [vehicles]; bicycle tyres; bicycle pedals; pumps for bicycle tyres; bicycle frames; saddlebags adapted for bicycles; bags adapted for pushchairs; tricycles; valve stems for vehicle tires; repair outfits for inner tubes; audible warning systems for bicycles.

20 – Furniture; cushions; mattresses; bouncer chairs for babies; infant walkers; chairs for babies; playpens for babies; chests of drawers; moses baskets; seats; cots for babies; bassinets; beds; bumper guards for cots, other than bed linen; bed bases; bedding, except linen; bottle racks; valet stands; book rests [furniture]; trolleys for computers [furniture]; tables; lockers; stools; washstands [furniture]; mats for infant playpens; baby changing mats; sleeping pads; baby changing platforms; chests for toys; high chairs for babies; coatstands; dinner wagons [furniture]; wardrobes; step stools.

35 – Retail and wholesale of the following goods: alarms, acoustic alarms, air analysis apparatus, thermostats, computer software applications, downloadable, audiovisual teaching apparatus, gauges, readers [data processing equipment], light-emitting diodes [LED], camcorders, protective helmets for sports, measuring spoons, video telephones, smartwatches, electrical adapters, rulers [measuring instruments], microphones, monitors [computer programs], monitors [computer hardware], sound recording carriers, head guards for sports, audio- and video- receivers, wearable activity trackers, temperature indicators, meteorological instruments, observation instruments, weight measuring instruments, measuring apparatus, radios, car radios, respirators for filtering air, headphones, telephone receivers, intercommunication apparatus, baby monitors, teaching apparatus, breathing NOTIFICATION (continued) apparatus, except for artificial respiration, sound recording apparatus, video baby monitors, scales with body mass analysers, baby scales, walkie-talkies, prams, safety seats for children, for vehicles, pedal bicycles, inner tubes for pneumatic tyres, inner tubes for bicycle tyres, vehicle tires, tubeless tyres for bicycles, fitted footmuffs for prams, bicycle brakes, bicycle ndlebars, bicycle horns, bicycle wheels, baskets adapted for bicycles, casters for trolleys [vehicles], side view mirrors for vehicles, fitted pushchair mosquito nets, bicycle kickstands, push scooters [vehicles], bicycle tyres, bicycle pedals, pumps for bicycle tyres, bicycle frames, saddlebags adapted for bicycles, bags adapted for pushchairs, tricycles, valve stems for vehicle tires, repair outfits for inner tubes, audible warning systems for bicycles, vanity cases, not fitted, pouch baby carriers, rucksacks, reins for guiding children, bags, school bags, harnesses, valises, suitcases with wheels, bags for campers, furniture, cushions, mattresses, babies bouncing chairs, infant walkers, chairs for babies, playpens for babies, chests of drawers, moses baskets, seats, cots for ba-

bies, bassinets, beds, bumper guards for cots, other than bed linen, bed bases, bedding, except linen, bottle racks, valet stands, book rests [furniture], trolleys for computers [furniture], tables, lockers, stools, washstands [furniture], mats for infant playpens, baby changing mats, sleeping pads, baby changing platforms, chests for toys, high chairs for babies, coatstands, dinner wagons [furniture], wardrobes, step stools, drinking bottles for sports, comb cases, wash bags for carrying toiletries, heaters for feeding bottles, non-electric, cosmetic utensils, glasses [receptacles], isothermic bags, baby baths, portable, flasks, bottles.

(260) AM 2021 110856 A

(800) 1558673

(151) 2020 08 14

(891) 2020 11 23

(731) Drunk Elephant, LLC

3700 Newport Boulevard, Suite 301,  
Newport Beach CA 92663, USA

(540)



(591) Black, white

(531) 03.02.01; 03.02.24

(511)

3 – Beauty masks; beauty serums; eye cream; facial cleansers; facial masks; lip balm; non-medicated skin care preparations; skin cleansers; skin masks; skin moisturizer; cleansing bars; face and body beauty creams; face and body lotions; face powder; facial oils; gels for cosmetic purposes; moisturizing creams; skin bronzer; skin care kits comprised of an assortment of non-medicated skin care preparations; sunscreen; sun-screen preparations; make-up removing preparations; anti-aging cream; deodorant for personal use; cosmetic preparations for the hair and scalp; non-medicated preparations for the care of skin, hair and scalp; hair shampoo; hair conditioner; hair detangling preparations; non-medicated preparations for the care of hair and scalp.

(260) AM 2021 110990 A

(800) 1566102

(151) 2020 07 31

(891) 2020 07 31

(731) LabConnect, LLC

2304 Silverdale Drive, Suite 100, Johnson City  
TN 37601, USA

(540)

**YOUR CONNECTION TO  
CONFIDENCE**

(591) Black, white

(511)

35 – Clinical trials project management services, namely, business management in the field of clinical trials featuring information management services; laboratory testing project management services, namely, business management in the field of laboratory testing projects featuring information management services; employment staffing services in the fields of pharmaceutical research and development, laboratory testing and diagnostics.

42 – Medical laboratory services; scientific laboratory services; medical laboratories; laboratory research services; medical and scientific laboratory services, namely, laboratory services to support clinical trials; consulting services in the fields of pharmaceutical research and development, laboratory testing, and diagnostics; providing temporary use of non-downloadable computer software for tracking clinical trials and individual specimen samples; software as a service (SaaS) services featuring software for use in capturing, storing, sharing, transmitting and displaying data in the field of conducting clinical trials; hosting web portals in the field of scientific research via clinical trials.

(260) AM 2021 110991 A

(800) 1566140

(151) 2020 11 10

(891) 2020 11 10

(731) Apple Inc.

One Apple Park Way, Cupertino CA 95014,  
USA

(540)

**SF SYMBOLS**

(591) Black, white

(511)

9 – Downloadable computer software used in developing other software applications; downloadable computer software used in creating, developing, generating, displaying, and printing computer software user interfaces, menus, toolbars, navigation bars, and graphics.

(260) AM 2021 110994 A

(800) 1566197

(151) 2020 11 04

(891) 2020 11 04

(731) Bausch Health Ireland Limited

Citywest Business Campus, 3013 Lake Drive,  
Dublin 24, Ireland

(540)

**SmartCurve**

(591) Black, white

(511)

9 – Scleral lenses for correction of keratoconus and irregular cornea.

(260) AM 2021 111000 A

(800) 1566261

(151) 2020 08 10

(891) 2020 08 10

(731) KARACA EŞARÇILIK SANAYİ VE  
TİCARET LİMİTED ŞİRKETİ

Rüstempaşa Mahallesi, Saka Mehmet Çeşmesi,  
Sokak No:23 Eminönü Fatih; İSTANBUL,  
Turkey

(540)

**KRC**

(591) Black, white

(531) 27.05.17

(511)

25 – Headscarves, scarfs, head wraps.

(260) AM 2021 111001 A

(800) 1566276

(151) 2020 10 20

(891) 2020 10 20

(731) Nıbykan Golden Pharma GmbH

Bettinastraße 30, 60325 Frankfurt am Main,  
Germany

(540)

**NIBY & AN**

(591) Black, green

(531) 27.05.01; 27.05.09; 29.01.12

(511)

5 – Dietary supplements for humans; dietetic foods adapted for medical purposes; materials for dressings; medical and surgical dressings; dietary supplements for humans not for medical purposes; nutritional supplements; nutritional supplements for medical purposes; dietary supplements consisting of vitamins; liquid food supplements.

10 – Medical equipment.

35 – Wholesale services in relation to dietary supplements; retail services in relation to dietary supplements; retail services relating to food; wholesale services in relation to dietetic goods; retail or wholesale services for pharmaceutical, veterinary and sanitary

preparations and medical supplies; wholesale services in relation to foods.

(260) AM 2021 111002 A

(800) 1566351

(151) 2020 08 14

(891) 2020 08 14

(731) Industrial Innovation Group SARL

16 Rue de la Pélisserie, CH-1204 Genève,

Switzerland

(540)

## HEMPORAMA

(591) Black, white

(511)

4 – Industrial oils and greases, waxes; lubricants; dust absorbing, wetting and binding compositions; fuels and lighting fuel; candles and wicks for lighting.

5 – Pharmaceutical products, medical and veterinary preparations; hygienic products for medical purposes; dietetic substances and foodstuffs for medical or veterinary use, food for babies; food supplements for humans and animals; plasters, materials for dressings; material for dental fillings and dental impressions; disinfectants; products for destroying vermin; fungicides, herbicides.

6 – Common metals and their alloys, ores; building materials of metal; transportable buildings of metal; non-electric cables and wires of metal; small items of metal hardware; containers of metal for storage or transport; safes.

19 – Non-metallic building materials; non-metallic rigid pipes for building; asphalt, pitch, tar and bitumen; transportable buildings not of metal; monuments not of metal.

31 – Unprocessed and non-transformed agricultural, aquacultural, horticultural and forestry products; unprocessed and raw grains and seeds; raw hemp seeds; hemp seed meal for animal consumption; hemp straw (raw material); fresh fruits and vegetables, fresh aromatic herbs; natural plants and flowers; bulbs, seedlings and seeds; live animals; food products and beverages for animals; malt.

35 – Advertising; commercial business management; commercial administration; office functions; the bringing together, for the benefit of others, of a variety of goods (excluding the transport thereof) in retail and/or wholesale stores, as well as in mail-order catalogs and on websites enabling customers to conveniently view and purchase said goods.

39 – Transport; packaging and storage of merchandise; travel organization.

40 – Treatment of materials; recycling of trash and waste; air purification and water treatment; printing services; food and beverage preservation.

41 – Education; training; entertainment; sporting and cultural activities.

42 – Scientific and technological services as well as research and design services relating thereto; industrial analysis, industrial research and industrial design services; quality control and authentication services; design and development of computers and software.

(260) AM 2021 111003 A

(800) 1566402

(151) 2020 08 11

(891) 2020 08 11

(731) Majuro Holding Limited

Spyrou Kyprianou 20, CY-1075 Nicosia,

Cyprus

(540)



(591) Gold, green

(531) 01.15.15; 26.13.25; 29.01.12

(511)

36 – Insurance; insurance consultancy; financial affairs; monetary affairs; real estate affairs; life insurance, travel insurance, vehicle insurance, household insurance and accident insurance; insurance services relating to life; travel insurance services; vehicle insurance services, household insurance services; accident insurance services; insurance information; insurance claim settlements; processing of insurance claims; insurance investigations; estimation and financial management of insurance claims; endowment insurance services; appraisals for insurance purposes; advisory services relating to insurance contracts; administration of insurance portfolios; evaluation (financial -) [insurance, banking, real estate]; insurance underwriting and appraisals and assessment for insurance purposes; provision of information relating to insurance and financial services.

(260) AM 2021 111017 A

(800) 1566704

(151) 2020 10 26

(891) 2020 10 26

(731) TERAPIA S.A.

Str. Fabricii nr. 124, jud. Cluj, Cluj-Napoca,

Romania

(540)

## FARINGOSEPT RAPID

(591) Black, white

(511)

5 – Pharmaceutical, medical and veterinary preparations; dietary and nutritional supplements; sanitary preparations for medical purposes; dietetic substances adapted for medical use, food for babies; plasters; ma-

terials for dressings; material for stopping teeth, dental wax; disinfectants; preparations for destroying vermin; fungicides, herbicides.

35 – Advertising; promotion activities; business management; business administration; office functions.

(260) AM 2021 111018 A

(800) 1566722

(151) 2020 10 19

(891) 2020 10 19

(731) TERAPIA S.A.

Str. Fabricii nr. 124, jud. Cluj, Cluj-Napoca,  
Romania

(540)

## FARINGO INTENSIV

(591) Black, white

(511)

5 – Pharmaceutical and veterinary products; dietary and nutritional supplements; sanitary preparations for medical purposes; dietetic substances adapted for medical use, food for babies; plasters; materials for dressings; material for stopping teeth, dental wax; disinfectants; preparations for destroying vermin; fungicides, herbicides.

35 – Advertising; promotion activities; business management; business administration; office functions.

(260) AM 2021 111019 A

(800) 1566755

(151) 2020 07 30

(891) 2020 07 30

(731) Nafoods Group Joint Stock Company

No. 47 Nguyen Canh Hoan Street, Quan Bau  
Ward, Vinh City, Nghe An Province, Viet Nam

(540)



(591) Red, yellow, brown and white

(531) 24.09.02; 27.05.07; 27.05.09; 27.05.10;  
27.05.17; 29.01.13

(511)

29 – Dried fruits; dried or processed seeds; frozen fruits.

30 – Tea; coffee.

31 – Raw cashew nuts; fresh fruits.

32 – Concentrated fruit juice.

(260) AM 2021 111020 A

(800) 1566777

(151) 2020 11 10

(891) 2020 11 10

(731) Apple Inc.

One Apple Park Way, Cupertino CA  
95014, USA

(540)

## HOMEPOD MINI

(591) Black, white

(511)

9 – Audio speakers, amplifiers and receivers; digital audio players; sound reproducing apparatus; voice recording and recognition apparatus; microphones; radios, radio transmitters, and radio receivers; wireless communication devices for voice or data transmission; computer hardware for playing, organizing, downloading, transmitting, manipulating and reviewing audio files and media files; electronic devices capable of providing access to the Internet and for the sending, receiving, and storing of digital data; voice-controlled smart audio speakers with virtual personal assistant capabilities; audio speakers controlled by mobile applications; personal digital assistant; electronic voice command and recognition and remote control devices for controlling and monitoring consumer electronics devices, lighting, appliances, thermostats, heating and air conditioning systems, alarm and home security and surveillance systems, smoke and carbon monoxide detectors, door and window locks and latches, and home automation systems.

(260) AM 2021 111021 A

(800) 1566780

(151) 2020 11 27

(891) 2020 11 27

(731) Lightbox Jewelry Ltd

20 Carlton House Terrace, London  
SW1Y 5AN, United Kingdom

(540)

## LIGHTBOX

(591) Black, white

(511)

14 – Precious metals and their alloys; badges of precious metal; ingots of precious metal; boxes of precious metal; ornaments of precious metal; jewellery including precious stones, diamonds, synthetic stones; precious stones; diamonds; synthetic stones; horological and chronometric instruments including watches, pocket watches and clocks.

35 – Retail and wholesale services, advertising and marketing services all in the field of precious metals and their alloys, badges of precious metal, ingots of precious metal, boxes of precious metal, ornaments of precious metal, jewellery including precious stones, diamonds, synthetic stones, horological and chrono-



metric instruments including watches, pocket watches and clocks.

(260) AM 2021 111022 A

(800) 1566834

(151) 2020 10 28

(891) 2020 10 28

(731) DONGGUAN BENSON AUTOMOBILE GLASS CO., LTD.

Ludong Village, Humen Town, Dongguan City, Guangdong Province, China

(540)

**SOLAR REFLEX**

(591) Black, white

(531) 27.05.01

(511)

12 – Clutches for land vehicles; rearview mirrors; windshield; windscreens; doors for vehicles; windows for vehicles; horns for vehicles; turn signals for vehicles; anti-glare devices for vehicles.

(260) AM 2021 111023 A

(800) 1566937

(151) 2020 11 24

(891) 2020 11 24

(731) UAB "VILNIAUS DEGTINĖ"

Panerių g. 47, Vilnius, Lithuania

(540)



(591) White, grey, brown and black

(531) 02.03.02; 02.03.11; 02.03.15; 03.03.15; 19.07.01; 19.07.10; 27.05.09; 29.01.14

(511)

33 – Alcoholic beverages, except beer.

(260) AM 2021 111024 A

(800) 1566956

(151) 2020 11 23

(891) 2020 11 23

(731) Phoenix Biotechnology INC.

8626 Tesoro Drive, Suite 801, San Antonio TX 78217, USA

(540)

**SERRATIVIR**

(591) Black, white

(511)

5 – Nutraceuticals for use as a dietary supplement.

(260) AM 2021 111032 A

(800) 1567114

(151) 2020 10 09

(891) 2020 10 09

(731) L. Gobbi S.R.L.

Via Bartolomeo Bosco, 57, I-16121 GENOVA (GE), Italy

(540)



(591) Black, pantone color 348c, white

(531) 05.03.13; 05.03.15; 14.05.01; 14.05.03; 26.01.03; 26.01.18; 26.11.12; 27.05.21; 29.01.13

(511)

1 – Chemicals for use in agriculture, horticulture and forestry, fertilizers, fertilizing preparations, plant growth regulating preparations.

(260) AM 2021 111034 A

(800) 1567141

(151) 2020 11 27

(891) 2020 11 27

(731) Ningbo Fulman Communication Technology Co., Ltd.

No.98, Yuanzhong Road, Economic Development Zone, Xiangshan County, Ningbo, Zhejiang, China

(540)

**VENTION**

(591) Black, white

(531) 27.05.01

(511)

9 – Branch boxes [electricity]; audio- and video-receivers; batteries, electric; network communication apparatus; selfie sticks [hand-held monopods]; electric plugs; microphones; switchboards; audio interfaces; digital photo frames; covers for smartphones; cases for smartphones; protective films adapted for smartphones; virtual reality headsets; headphones; covers for electric outlets; rechargeable electric batteries; smartphones; battery chargers; cabinets for loudspeakers.

(260) AM 2021 111050 A

(800) 1244271

(151) 2015 02 26

(891) 2020 10 23

(731) Farmak International Holding GmbH  
Mariahilferstrasse 136, A-1150 Wien, Austria

(540)

**Кейвер**

(591) Black, white

(531) 28.05

(511)

5 – Pharmaceutical preparations; medicines for human purposes; medicinal products used for the pathology of the musculoskeletal system, included in this class.

(260) AM 2021 111052 A

(800) 1337435

(151) 2016 12 23

(891) 2020 10 23

(731) Farmak International Holding GmbH  
Mariahilferstrasse 136, A-1150 Wien, Austria

(540)

**Эстецифин**

(591) Black, white

(531) 28.05

(511)

5 – Pharmaceutical preparations; medicines for human purposes; medicines for use in dermatology; pharmaceutical preparations for skin care.

(260) AM 2021 111053 A

(800) 1386835

(151) 2017 08 09

(891) 2020 10 07

(731) DOĞRU BEBE GİYİM TEKSTİL, SANAYİ VE TİCARET LİMİTED ŞİRKETİ  
Duaçınarı Mahallesi Ordu Sokak No:4 Z/I,  
Yıldırım, Bursa, Turkey

(540)

**NECİX'S**

(591) Black, white

(511)

25 – Clothing, including underwear and outer clothing, other than special purpose protective clothing; socks, mufflers [clothing], shawls, bandanas, scarves, belts [clothing]; footwear, shoes, slippers, sandals; headgear, hats, caps with visors, berets, caps [headwear], skull caps.

(260) AM 2021 111054 A

(800) 1404628

(151) 2018 02 23

(891) 2020 11 30

(731) OrientSwiss SA  
Rue Caroline 15 A, c/o Mehrzad Khoi,  
CH-1003 Lausanne, Switzerland

(540)

(591) Black, white

(531) 18.01.19; 27.05.10

(511)

9 – E-commerce software and application software for mobile telephones enabling users to carry out commercial transactions by electronic means via a global computer network.

35 – Online sales services, namely, operating online marketplaces for sellers and buyers of goods and services; online sales services in which sellers present goods and services offered for sale and purchase or calls for tender via the Internet in order to facilitate the sale of goods and services by others via a computer network; advertising, promotional and marketing services via the Internet; provision of space on web sites for advertising goods and services.

38 – Telecommunication services, namely electronic transmission of data and information; electronic messaging; provision of electronic display boards and chat rooms online for transmission of messages among computer users concerning the trading and sale of goods and services via a global computer network.

(260) AM 2021 111093 A

(800) 1567393

(151) 2020 08 05

(891) 2020 08 05

(731) Otkrytoe aktsionernoe obshchestvo "Minskiy



molochny zavod N°1"  
ul. Vokzalnaya 11, 223034 Zaslavl, Minskiy  
rayon, Belarus

(540)



# TEMPLIER

(591) Black, white

(531) 03.01.22; 03.03.17; 24.01.15; 27.05.01

(511)

29 – Milk and milk products; yogurt; kephir; buttermilk; curd; kumys; whey; milk beverages, milk predominating; cream [dairy products]; whipped cream; ryazhenka [fermented baked milk]; cheese; cottage cheese; smetana; curd snacks; butter; margarine; rennet.

(260) AM 2021 111097 A

(800) 1567540

(151) 2020 08 03

(891) 2020 08 03

(731) Limited Liability Partnership "Litro"

Dostyk Avenue 43, Medeu district, Almaty city  
A25D9H3, Kazakhstan

(540)

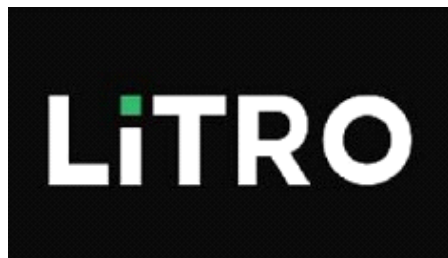

(591) White, green and black

(531) 26.04.22; 26.04.24; 27.05.24; 29.01.13

(511)

37 – Vehicle maintenance; vehicle breakdown repair services; motor vehicle maintenance and repair; vehicle greasing; vehicle service stations [refuelling and maintenance]; machinery installation, maintenance and repair; vehicle cleaning.

(260) AM 2021 111099 A

(800) 1567580

(151) 2020 07 13

(891) 2020 07 13

(731) KURLAR DALGIÇ POMPA SANAYİ VE  
TİCARET LİMİTED ŞİRKETİ

Osmangazi Mah. 2648.Sokak; No:7 1/2  
Esenyurt, İstanbul, Turkey

(540)

# KURLAR

(591) Dark blue and red

(531) 27.05.01; 29.01.12

(511)

7 – Machines, machine tools and industrial robots for processing and shaping wood, metals, glass, plastics and minerals, 3D printers; construction machines and robotic mechanisms (machines) for use in construction: bulldozers, diggers (machines), excavators, road construction and road paving machines, drilling machines, rock drilling machines, road sweeping machines; lifting, loading and transmission machines and robotic mechanisms (machines) for lifting, loading and transmission purposes: elevators, escalators and cranes; machines and robotic mechanisms (machines) for use in agriculture and animal breeding, machines and robotic mechanisms (machines) for processing cereals, fruits, vegetables and food; machines for preparing and processing beverages; engines and motors, other than for land vehicles, parts and fittings therefor: hydraulic and pneumatic controls for engines and motors, brakes other than for vehicles, brake linings for engines, crankshafts, gearboxes, other than for land vehicles, gearboxes, other than for land vehicles, cylinders for engines, pistons for engines, turbines, not for land vehicles, filters for engines and motors, oil, air and fuel filters for land vehicle engines, exhausts for land vehicle engines, exhaust manifolds for land vehicle engines, engine cylinders for land vehicles, engine cylinder heads for land vehicles, pistons for land vehicle engines, carburetors for land vehicles, fuel conversion apparatus for land vehicle engines, injectors for land vehicle engines, fuel economisers for land vehicle engines, pumps for land vehicle engines, valves for land vehicle engines, starter motors for land vehicles, dynamos for land vehicle engines, sparking plugs for land vehicle engines; machines for mounting and detaching tires; alternators, current generators, electric generators, current generators operated with solar energy; painting machines, automatic spray guns for paint, electric, hydraulic and pneumatic punching machines and guns, electric adhesive tape dispensers (machines), electric guns for compressed gas or liquid spraying machines, electric hand drills, electric hand saws, electric jigsaw machines, spiral machines, compressed air machines, compressors (machines), vehicle washing installations, robotic mechanisms (machines) with the abovementioned functions; electric and gas-operated welding apparatus, electric arc welding apparatus, electric soldering apparatus, electric arc cutting apparatus, electrodes for welding machines, industrial robots (machines) with the abovementioned functions; printing machines; packaging machines, filling, plugging and sealing machines, labellers (machines), sorting machines, industrial robots (machines)

nes) with the abovementioned functions, electric packing machines for plugging and sealing of plastics; machines for textile processing, sewing machines, industrial robots (machines) with the abovementioned functions; pumps [machines], compressed air pumps, fuel dispensing pumps for service stations, self-regulating fuel pumps; electric kitchen machines for chopping, grinding, crushing, mixing and mincing food-stuff, washing machines, laundry washing machines, dishwashers, spin driers (not heated), electric cleaning machines for cleaning floors, carpets or floorings, vacuum cleaners and parts thereof; automatic vending machines; galvanizing and electroplating machines; electric door openers and closers; gaskets for engines and motors.

(260) AM 2021 111100 A

(800) 1567631

(151) 2020 11 25

(891) 2020 11 25

(731) Josh Rosebrook Skin and Hair Care  
41945 Boardwalk ste B, Palm Desert  
CA 92211, USA

(540)

## JOSH ROSEBROOK

(591) Black, white

(511)

3 – Aromatic body care products, namely, body lotion, shower gel, cuticle cream, shampoo, conditioner, non-medicated lip balm, soap, body polish, body and foot scrub and non-medicated foot cream; Cosmetic preparations for body care; Cosmetic preparations for skin renewal.

(260) AM 2021 111101 A

(800) 1567641

(151) 2020 09 03

(891) 2020 09 03

(731) Egis Gyógyszergyár Zrt.  
Keresztúri út 30-38., H-1106 Budapest,  
Hungary

(540)

## SUPRANOSE

(591) Black, white

(511)

5 – Pharmaceutical preparations for human use; dietic substances adapted for medical use; vitamin compositions, mineral food supplements, dietary supplements.

(260) AM 2021 111125 A

(800) 1568316

(151) 2020 11 10

(891) 2020 11 10

(731) Bausch + Lomb Ireland Limited  
3013 Lake Drive, Citywest Business Campus,  
Dublin 24, Ireland

(540)

## EQUALENS

(591) Black, white

(511)

9 – Contact lenses.

(260) AM 2021 111126 A

(800) 1568321

(151) 2020 09 03

(891) 2020 09 03

(731) Egis Gyógyszergyár Zrt.  
Keresztúri út 30-38, H-1106 Budapest,  
Hungary

(540)

## WOMANCE

(591) Black, white

(511)

5 – Pharmaceutical preparations for human use; dietic substances adapted for medical use; vitamin compositions, mineral food supplements, dietary supplements; sanitary preparations for medical purposes.

(260) AM 2021 111129 A

(800) 1568356

(151) 2020 07 20

(891) 2020 07 20

(731) "Beluga Brands", LLC  
Proletarskaya street, 40A, 112, Zvenigorog city,  
RU-143180 Moscow region, Russian  
Federation

(540)



(591) Black, white

(531) 03.03.01; 03.03.15; 03.03.24; 26.01.01;  
26.01.15; 26.01.18; 26.01.24; 27.05.09;  
27.05.11

(511)

33 – Wine; piquette.

(260) AM 2021 111130 A

(800) 1568372

(151) 2020 07 20

(891) 2020 07 20

(731) Euro Games Technology Ltd.

"Maritsa" Str., 4, "Vranya-Lozen-Triugulnika",  
BG-1151 Sofia, Bulgaria

(540)

(591) Yellow, gold, pink, brown, white, red, orange,  
green, purple and black(531) 09.07.25; 22.03.21; 27.05.11; 27.07.04;  
29.01.15

(511)

9 – Software; computer gaming software; computer software packages; computer operating system software; computer software, recorded; software drivers; virtual reality software; games software; entertainment software for computer games; computer programs for network management; operating computer software for main frame computers; monitors (computer hardware); computer hardware; apparatus for recording images; monitors (computer programs); computer game programs; computer programs for recorded games; apparatus for recording, transmission or reproduction of sound or images; communications servers [computer hardware]; electronic components for gambling machines; computer application software featuring games and gaming; computer software for the administration of on-line games and gaming; computer hardware for games and gaming; computer hardware and software for gambling, gambling machines, gambling games on the Internet and via telecommunication network.

28 – Gaming machines for gambling; chips for gambling; mah-jong; arcade games; gambling machines operating with coins, notes and cards; games; electronic games; parlor games; gaming chips; gaming tables; slot machines [gaming machines]; LCD game machines; slot machines and gaming devices; coin-operated amusement machines; roulette chips; poker chips; chips and dice [gaming equipment]; gaming equipment for casinos; roulette tables; gaming roulette wheels; casino games; amusement and gambling machines; coin-operated gaming machines and / or electronic coin-operated gaming machines with or without the possibility of gain; boxes for coin-operated machines, slot machines and gaming machines; electronic or electro-technical gaming devices, amusement and gaming machines, including coin-operated machines; housings for coin-operated machines, gaming equipment, gaming machines, machines for gambling; electro-pneumatic and electrical gambling machines (slot machines).

41 – Gambling; entertainment services related to gambling; gaming services for entertainment purposes; casino, gaming and gambling services; training in the development of software systems; provision of equipment for gambling halls; providing casino equipment [gambling]; gaming machine entertainment services; providing casino facilities [gambling]; providing halls with gaming machines; amusement arcade services; games equipment rental; rental of gaming machines; providing amusement arcade services; rental of gaming machines with images of fruits; editing or recording of sounds and images; sound recording and video entertainment services; hire of sound reproducing apparatus; provision of gaming equipment for casinos; providing of casino facilities; online gambling services; provision of casino services; provision of gaming establishments, gaming halls, internet casinos, online gambling services.

(260) AM 2021 111131 A

(800) 1568405

(151) 2020 10 30

(891) 2020 10 30

(731) Limited Liability Company "Pharm Aid Ltd"

Daev per., 20, et. 5, of. 517, RU-107045

Moscow, Russian Federation

(540)

# РОТА-В-ЭЙД

(591) Black, white

(531) 28.05

(511)

5 – Vaccines; vaccines for the prevention of rotavirus; pharmaceuticals; medicinal preparations; medicines; pharmaceutical preparations; pharmaceutical products.

(260) AM 2021 111180 A

(800) 1568848

(151) 2020 08 19

(891) 2020 08 19

(731) Zakrytoe aktsionernoe obshchestvo "Myasnaya galereya"

ul. Poliny Osipenko, d. 65, of. 10, RU-600009  
Vladimir, Russian Federation

(540)



(591) Dark orange, yellow, light orange, black and white

(531) 03.07.17; 08.07.04; 28.05; 29.01.14  
 (526) Element ®, word "PITSTSA (ПИЦЦА)".  
 (511)  
 30 – Pizzas.

43 – Services for providing food and drink; food and drink catering; café services; cafeteria services; canteen services; restaurant services; self-service restaurant services; snack-bar services; bar services; food sculpting.

(260) AM 2021 111181 A  
 (800) 1568850  
 (151) 2020 11 11  
 (891) 2020 11 11  
 (731) CL Cosmetic GmbH  
 Renntalstraße 14, 74360 Ilsfeld, Germany  
 (540)



(591) Black, white  
 (531) 26.04.04; 26.04.18; 26.04.24; 26.11.12;  
 27.05.24  
 (511)  
 3 – Body and beauty-care preparations, perfumery, essential oils, soaps, dentifrices.  
 5 – Medicines, pharmaceutical and sanitary preparations, dietetic foodstuffs adapted for medical use, food-stuff supplements adapted for medical use, plasters and materials for dressings.

(260) AM 2021 111182 A  
 (800) 1568869  
 (151) 2020 07 09  
 (891) 2020 07 09  
 (731) GRATIS İÇ VE DIŞ TİCARET ANONİM  
 ŞİRKETİ  
 Levent Mah., Yapı Kredi Plaza C Blok,  
 Cömert Sok 1C Kat.5, Beşiktaş, İstanbul,  
 Turkey  
 (540)



(591) Black, white, purple  
 (531) 26.01.02; 26.01.20; 27.05.01; 29.01.13

(511)  
 8 – Forks, spoons, knives and non-electric cutters, slicers, peelers for kitchen use, including those made of precious metals; side arms and blades (weapons); tools and apparatus included in this class for personal beauty care use; tools and apparatus included in this class for shaving, epilation, manicure and pedicure, electric hand implements for straightening and curling hair, scissors; hand-operated [non-electric] hand tools included in this class for the repair of machines, apparatus and vehicles and for use in construction, agriculture, horticulture and forestry, none of them being power tools; electric or non-electric irons; steam irons; tool handles made of any kind of material.

18 – Unworked or semi-worked leather and animal skins, imitations of leather, stout leather, leather used for linings; goods made of leather, imitations of leather or other materials, designed for carrying items, included in this class; bags, wallets, boxes and trunks made of leather or stout leather; keycases, trunks [luggage], suitcases; umbrellas; parasols; sun umbrellas; walking sticks; whips; harness; saddlery; stirrups; straps of leather (saddlery).

21 – Hand-operated non-electric cleaning instruments and appliances, brushes, other than paintbrushes, steel wool for cleaning, sponges for cleaning, steel wool for cleaning, cloths of textile for cleaning, gloves for dishwashing, non-electric polishing machines for household purposes, brooms for carpets, mops; toothbrushes, electric toothbrushes, dental floss, shaving brushes, hair brushes, combs; non-electric household or kitchen utensils, included in this class, [other than forks, knives, spoons], services [dishes], pots and pans, bottle openers, flower pots, drinking straws, non-electric cooking utensils; ironing boards and shaped covers therefor, drying racks for washing, clothes drying hangers; cages for household pets, indoor aquariums, vivariums and indoor terrariums for animals and plant cultivation; ornaments and decorative goods of glass, porcelain, earthenware or clay, included in this class, namely statues, figurines and vases and trophies made of these materials; mouse traps, insect traps, electric devices for attracting and killing flies and insects, fly catchers, fly swatters; perfume burners, perfume sprayers, perfume vaporizers, electric or non-electric make-up removing appliances, powder puffs, toilet cases; nozzles for sprinkler hose, nozzles for watering cans, watering devices, garden watering cans; unworked or semi-worked glass, except building glass, mosaics of glass and powdered glass for decoration, except for building, glass wool other than for insulation or textile use.

(260) AM 2021 111183 A  
 (800) 1568871  
 (151) 2020 10 29  
 (891) 2020 10 29

(731) Premier Beverages P.B. Limited  
Amathountos, 50E, PEARL BUILDING,  
3rd floor, Flat/Office 1, CY-4532 Agios  
Tychonas Limassol, Cyprus

(540)



(591) Black, white, green

(531) 26.13.25; 27.05.10; 27.05.17; 27.05.24;  
29.01.13

(511)

32 – Non-alcoholic beverages; mineral and aerated waters; beverages based on fruit and fruit juices; syrups and other preparations without alcohol for making beverages; non-alcoholic aperitifs; carbonated water; lithia waters; seltzer water; soda water; waters [beverages]; mineral waters [beverages]; table waters; kvass; non-alcoholic cocktails; lemonades; isotonic beverages; non-alcoholic honey-based beverages; protein-enriched sports beverages; soft drinks; non-alcoholic coffee-flavored beverages; non-alcoholic tea-flavored beverages; non-alcoholic fruit juice beverages; energy drinks; fruit nectars; orgeat; powders for effervescing beverages; sarsaparilla [non-alcoholic beverage]; syrups for lemonade; syrups for beverages; mixed fruit or vegetable beverages [smoothies]; tomato juices [beverages]; apple juices; vegetable juices [beverages]; fruit juices; non-alcoholic preparations for making beverages; preparations for making aerated water; pastilles for effervescing beverages; sherbets [beverages]; non-alcoholic fruit extracts; non-alcoholic essences for making beverages.

35 – Advertising; demonstration of goods; sales promotion for third parties; procurement services for others [purchasing goods and services for other businesses]; retail sale services; wholesale services; retail services provided on websites on the Internet.

(260) AM 2021 111184 A

(800) 1568893

(151) 2020 11 09

(891) 2020 11 09

(731) ERIGON AKTIENGESELLSCHAFT

Wuhrstrasse 14, FL-9490 Vaduz,

Liechtenstein

(540)

## KOKTEBEL

(591) Black, white

(511)

33 – Alcoholic beverages, except beer; brandy; wine; whisky; vodka; gin; liqueurs; alcoholic beverages containing fruit; bitters; piquette; rum; cider; fruit extracts, alcoholic.

(260) AM 2021 111206 A

(800) 1569137

(151) 2020 11 24

(891) 2020 11 24

(731) Richter Gedeon Nyrt.

Gyömrői út 19-21, H-1103 Budapest, Hungary

(540)

## EMBIDON

(591) Black, white

(511)

5 – Pharmaceutical preparations.

(260) AM 2021 111207 A

(800) 1569141

(151) 2020 11 24

(891) 2020 11 24

(731) Richter Gedeon Nyrt.

Gyömrői út 19-21, H-1103 Budapest, Hungary

(540)

## ZELBERUN

(591) Black, white

(511)

5 – Pharmaceutical preparations.

(260) AM 2021 111208 A

(800) 1569147

(151) 2020 11 24

(891) 2020 11 24

(731) Richter Gedeon Nyrt.

Gyömrői út 19-21, H-1103 Budapest, Hungary

(540)

## SURGALEX

(591) Black, white

(511)

5 – Pharmaceutical preparations.

(260) AM 2021 111235 A

(800) 1569835

(151) 2020 10 19

(891) 2020 10 19

(731) Aroma P. Draniak sp. j.

ul. Szkolna 46 A, PL-05-816 Michałowice,

Poland

(540)

## WILD TAN

(591) Black, white



(511)  
3 – Cosmetics and perfumery, sunscreen preparations, cosmetic oils, essential oils.

(260) AM 2021 111236 A  
(800) 1569841  
(151) 2020 01 17  
(891) 2020 01 17  
(731) ÇİKO TEKSTİL LİMİTED ŞİRKETİ  
MERKEZ MAH. İSTANBUL CAD., ÜSTEL  
PASAJI NO:40 BAĞCILAR, İSTANBUL,  
Turkey

(540)



(591) Orange and green  
(531) 18.03.02; 18.03.23; 27.05.01; 29.01.12  
(511)

25 – Clothing (outer clothing and underwear), knitwear (clothing), jeans, clothing of leather, namely leather coats, leather jackets, clothing of imitations of leather; track suits; shirts, jackets, denim jackets, trousers, skirts, blouses, bathing suits, beachwear; underwear; gloves, namely bicycle gloves, riding gloves; socks; shoes, boots, slippers, babies' shoes, sports shoes, namely football shoes, gymnastic shoes; iron fittings for shoes, soles for footwear, heelpieces for boots and shoes, stockings, overshoes; headgear, namely hats, caps; babies' jackets, bibs for children made of cloth; neckties, bow ties, shawls, scarves, collars (clothing), muffs, bandanas (neckerchiefs), wristbands (clothing); belts (clothing), money belts, suspenders.

35 – The bringing together, for the benefit of others, of a variety of goods, namely, clothing (outer clothing and underwear), knitwear (clothing), jeans, clothing of leather, namely leather coats, leather jackets, clothing of imitations of leather, track suits, shirts, jackets, denim jackets, trousers, skirts, blouses, bathing suits, beachwear, underwear, gloves, namely bicycle gloves, riding gloves, socks, shoes, boots, slippers, babies' shoes, sports shoes, namely football shoes, gymnastic shoes, iron fittings for shoes, soles for footwear, heelpieces for boots and shoes, stockings, overshoes, headgear, namely hats, caps, infant cloth diapers, babies' jackets, bibs for children made of cloth, neckties, bow ties, shawls, scarves, collars (clothing), muffs, bandanas (neckerchiefs), wristbands (clothing), belts (clothing), money belts, suspenders, ankle garters, enabling customers to conveniently view and

purchase those goods, such services may be provided by retail stores, wholesale outlets, by means of electronic media or through mail order catalogues.

(260) AM 2021 111237 A  
(800) 1569848  
(151) 2020 06 01  
(891) 2020 06 01  
(731) PREDO SAĞLIK ÜRÜNLERİ SANAYİ VE  
TİCARET ANONİM ŞİRKETİ  
2. Organize Sanayi Bölgesi Batı 4, Nolu Cadde  
No:2, Başpınar Şehitkamil, Gaziantep, Turkey  
(540)



(591) Red, white, yellow, green, blue and purple  
(531) 01.15.09; 01.15.15; 05.07.12; 05.07.22;  
11.01.01; 11.03.01; 11.03.18; 25.01.19;  
27.05.01; 29.01.15

(511)  
3 – Bleaching and cleaning preparations, detergents other than for use in manufacturing operations and for medical purposes, laundry bleach, fabric softeners for laundry use, stain removers, dishwasher detergents.

(260) AM 2021 111238 A  
(800) 1569852  
(151) 2020 08 03  
(891) 2020 08 03  
(731) Ivoclar Vivadent AG  
Bendererstrasse 2, FL-9494 Schaan,  
Liechtenstein  
(540)

## Ivotion

(591) Black, white  
(511)  
5 – Porcelain materials for use in dentistry; materials for the manufacture of dental impressions, models, crowns, bridges, inlays, prostheses, artificial teeth; materials for the characterization of teeth; materials for polishing teeth; dental waxes; dental filling materials; dental adhesive agents; protective varnishes for teeth; dental composites; dental cements; dental

adhesives; materials for repairing damaged teeth; opaque materials for dental use; fiber-reinforced synthetic materials for the manufacture of crowns, bridges, and pontics; synthetic materials for the fabrication of crowns, bridges, artificial teeth; wax material for the fabrication of crowns, bridges, artificial teeth; dental veneers; 3D printers for dental use, and parts thereof.

7 – Milling machines and grinding machines for dental use for the treatment of ceramics, metal and plastic materials, and parts thereof; milling and grinding tools for dental use as machine tools, and parts thereof; holding devices for machine tools and piece holders for milling and grinding machines for dental use; 3D printers for dental use, and parts thereof; accessories for 3D printers for dental use, included in this class.

9 – Software for dental use; scanners, apparatus for the processing of images, and devices for CAD-CAM-processing.

10 – Apparatus, devices, tools, and instruments for dental use; impression devices for dental use; registration devices for dental use; articulators for dental use; milling, grinding, and drilling instruments for dental use; artificial teeth; dental plates; dental crowns and bridges; polishing instruments for dental purposes; milling and grinding machines for dental use, and parts thereof; accessories for 3D printers for dental use, included in this class; polymerization apparatus for dental use; bite plates for dental use; impression trays for dental use, try-in bodies for dental use; denture frameworks; ingots made of wax, synthetic materials, metal or ceramic for the fabrication of crowns, bridges, inlays, prostheses, artificial teeth.

(260) AM 2021 111239 A

(800) 1569854

(151) 2020 09 01

(891) 2020 09 01

(731) QUANZHOU AUTO FURNITURE CO., LTD  
Under Lingrui Mountain, Lingshan Village,  
Tuzhai Town, Hui'an County, Quanzhou City,  
362000 Fujian Province, China

(540)

**Topower**

(591) Black, white

(531) 27.05.01; 27.05.02

(511)

20 – Signboards; containers, not of metal [storage, transport]; furniture; furniture fittings, not of metal; door fittings, not of metal; plastic drain elbow [valve]; decorations of plastic for foodstuffs; rattan products [excluding shoes, hats, mats and cushion]; pillows.

(260) AM 2021 111260 A

(800) 1570235

(151) 2020 12 03

(891) 2020 12 03

(731) Rosier S.A.

Route de Grandmetz 11A, B-7911 Moustier,  
Belgium

(540)



(591) Blue, yellow, white

(531) 26.11.06; 26.11.12; 26.13.25; 27.05.01;

29.01.12

(511)

1 – Fertilizers and chemical products for use in agriculture, horticulture and forestry; fertilizers; technical nitrogenous products; nitrogenous fertilizers; raw materials for fertilizers; mineral fertilizers; chemical additives for soil; ammonia; ammonium nitrate; urea [fertilizer]; nitric acid.

(260) AM 2021 111261 A

(800) 599765

(151) 1993 03 15

(891) 2020 12 16

(731) WOLF OIL CORPORATION N.V.

Georges Gilliotstraat 52, B-2620 Hemiksem,  
Belgium

(540)

**PENNOL**

(591) Black, white

(531) 27.05.01; 27.05.17

(511)

1 – Antifreeze and antifreeze compositions.

3 – Cleaning, polishing, degreasing and abrasive preparations; soaps; rust-removing products.

4 – Industrial oils and greases; lubricants; products for binding dust; fuels (including motor spirit) and illuminants.

(260) AM 2021 111262 A

(800) 996724

(151) 2009 02 16

(891) 2020 12 18

(731) Wilkinson Sword GmbH

Schützenstraße 110, 42659 Solingen, Germany

(540)

**WILKINSON SWORD  
HYDRO**

(591) Black, white  
(511)  
8 – Razors, razor blades, hair trimmers, hair clippers.

(260) AM 2021 111264 A  
(800) 1430390  
(151) 2018 06 19  
(891) 2020 12 22  
(731) BANCA SELLA HOLDING S.P.A.  
Piazza Gaudenzio Sella, 1, I-13900 Biella,  
Italy

(540)

**Sella**

(591) Black, white  
(531) 27.05.17  
(511)  
36 – Insurance; financial affairs; monetary affairs; real estate affairs; accident insurance underwriting; installment loans; arranging letting of real estate; brokerage; credit agencies; real estate agency; real estate brokerage; debt collection agencies; insurance brokerage; financial customs brokerage services; insurance underwriting; banking; real-estate valuations; charitable fund raising; mutual funds; capital investment; surety services; currency trading and exchange services; issuance of travelers' checks; clearing, clearing-houses (financial); safe deposit services; organization of collections; loans (financing); financial assessment (insurance, banking, real estate); trusteeships; financing services; financial management; lending against securities; real estate management; apartment house management; fire insurance underwriting; rental of apartments; medical insurance; marine insurance underwriting; mortgage banking; savings bank services; credit leasing; stocks and bonds brokerage; life insurance underwriting; financial analysis; check [cheque] verification; financial advice; insurance consultancy; processing of payments in relation to credit cards; processing of debit card payments; electronic funds transfer; financial information; insurance information; issuance of tokens of value; deposit of valuables; issuance of credit cards; retirement payment services; financial sponsorship; online banking; lending against security; provident fund services; stock-broking; debt advisory services; arranging finance for construction projects; providing financial information via a web site; fund investments; brokerage services for stocks and bonds; current account facilities.

(260) AM 2021 111308 A  
(800) 1570961  
(151) 2020 12 15  
(891) 2020 12 15  
(731) Shandong Taishan Ruibao Composite Material Co., Ltd.

North side of Yuema River, west side of No.4 Road, Leling City, 100085 Shandong Province, China

(540)



(591) Black, white  
(531) 03.01.16; 26.13.25; 27.05.17  
(511)

12 – Cars; electric vehicles; oars; boats; motor buses; automobiles; launches; motor coaches; bicycles; seaplanes; bicycle handlebars; bicycle brakes; bicycle wheel rims; pushchairs; bicycle cranks; bicycle wheel spokes; wheelchairs; dress guards for bicycles; bicycle saddles; mopeds; bicycle frames; electric bicycles; tricycles.

(260) AM 2021 111310 A  
(800) 1570990  
(151) 2020 12 03  
(891) 2020 12 03  
(731) Rosier S.A.  
Route de Grandmetz 11A, B-7911 Moustier,  
Belgium

(540)



(591) Blue, light blue, white  
(531) 05.03.13; 07.01.08; 07.01.24; 26.11.01;  
26.11.12; 27.05.17; 29.01.04

(511)  
1 – Fertilizers and chemical products for use in agriculture, horticulture and forestry; fertilizers; technical nitrogenous products; nitrogenous fertilizers; raw materials for fertilizers; mineral fertilizers; chemical additives for soil; ammonia; ammonium nitrate; urea [fertilizer]; nitric acid.

(260) AM 2021 111311 A  
(800) 1570992  
(151) 2020 12 03  
(891) 2020 12 03  
(731) Rosier S.A.  
Route de Grandmetz 11A, B-7911 Moustier,  
Belgium

(540)





(591) Black, white  
 (531) 01.15.15; 26.11.01; 26.11.12; 27.05.17;  
 29.01.04

(511)  
 1 – Fertilizers and chemical products for use in agriculture, horticulture and forestry; fertilizers; technical nitrogenous products; nitrogenous fertilizers; raw materials for fertilizers; mineral fertilizers; chemical additives for soil; ammonia; ammonium nitrate; urea [fertilizer]; nitric acid.

(260) AM 2021 111312 A

(800) 1571006

(151) 2020 09 23

(891) 2020 09 23

(731) Obshchestvo s ogranichennoi, otvetstvennostiu "ZIL-AiPi"  
 ul. Avtozavodskaya, d. 23, korp. 15.; etazh 9,  
 chast komnaty 23; RU-115280 Moscow,  
 Russian Federation

(540)

**ЗиЛ**

(591) Black, white

(531) 28.05

(511)

7 – Drums [parts of machines]; reels [parts of machines]; camshafts for vehicle engines; valves [parts of machines]; crank shafts; fans for motors and engines; bellows [parts of machines]; exhausts for motors and engines; mufflers for motors and engines; cylinder heads for engines; driving motors, other than for land vehicles; propulsion mechanisms, other than for land vehicles; motors, other than for land vehicles; injectors for engines; carburettors; crankcases for machines, motors and engines; valves being parts of machines; cowlings [parts of machines]; machine wheels; piston segments; compressors [machines]; compressors for refrigerators; gear boxes, other than for land vehicles; housings [parts of machines]; machine flywheels; machine wheelwork; feeders [parts of machines]; clutches, other than for land vehicles; pumps [machines]; pumps [parts of machines, engines or motors]; axles for machines; chucks [parts of machines]; exhaust manifold for engines; gears, other than for land vehicles; reduction gears, other than for land vehicles; pneumatic controls for machines, motors and engines; hangers [parts of machines]; anti-friction bearings for machines; roller bearings; self-oiling bearings; bearings for transmission shafts; ball-bearings; pistons [parts of machines or engines]; shock absorber plungers [parts of machines]; pistons for engines; pistons for cylinders; catalytic converters; torque converters, other than for land vehicles; fuel conversion apparatus for internal combustion engines; springs [parts of machines]; radiators [cooling] for motors and engines; regulators [parts of machines]; pressure regulators [parts of machines]; speed governors for motors

and engines; speed governors for machines; belts for machines; belts for motors and engines; sparking plugs for internal combustion engines; brake segments, other than for vehicles; shaft couplings [machines]; stands for machines; machine tools; starters for motors and engines; stators [parts of machines]; machine tool holders; couplings, other than for land vehicles; transmissions for machines; transmissions, other than for land vehicles; turbines, other than for land vehicles; turbocompressors; connecting rods for machines, motors and engines; joints [parts of engines]; igniting devices for internal combustion engines; anti-pollution devices for motors and engines; control mechanisms for machines, engines or motors; filters being parts of machines or engines; journals [parts of machines]; driving chains, other than for land vehicles; transmission chains, other than for land vehicles; cylinders for motors and engines; cylinders for machines; pulleys [parts of machines]; brushes [parts of machines]; brushes, electrically operated [parts of machines]; ejectors; fuel economisers for motors and engines; motors, electric, other than for land vehicles.

11 – Defrosters for vehicles; beverage cooling apparatus; refrigerating apparatus and machines; freezers; heating and cooling apparatus for dispensing hot and cold beverages; refrigerating display cabinets; coils [parts of distilling, heating or cooling installations]; cool boxes, electric; refrigerating chambers; air conditioners for vehicles; light bulbs for directional signals for vehicles; refrigerating appliances and installations; ice machines and apparatus; cooling appliances and installations; anti-glare devices for vehicles [lamp fittings]; cooling installations for water; cooling installations for liquids; ventilation [air-conditioning] installations for vehicles; cooling installations and machines; air cooling apparatus; vehicle headlights; headlights for automobiles; refrigerators; refrigerators, cooling apparatus and freezers for medical storage purposes; refrigerating cabinets.

12 – Motor buses; motor coaches; camping cars; cars; refrigerated vehicles; caravans; shock absorbers for automobiles; suspension shock absorbers for vehicles; luggage carriers for vehicles; bumpers for automobiles; vehicle bumpers; brake shoes for vehicles; tailboard lifts [parts of land vehicles]; transmission shafts for land vehicles; bicycles; valves for vehicle tires; hoods for vehicles; lug nuts for vehicle wheels; lorries; trucks with a crane feature incorporated; horns for vehicles; treads for vehicles [tractor type]; doors for vehicles; bicycle motors; motorcycle engines; engines for land vehicles; driving motors for land vehicles; brake discs for vehicles; vehicle bonnet pins; rearview mirrors; hoods for vehicle engines; crankcases for land vehicle components, other than for engines; vehicle wheels; steering wheels for automobiles; brake pads for automobiles; hub caps; side cars; brake linings for vehicles; gear boxes for land vehicles; bands for wheel hubs; caps for vehicle fuel tanks; automo-

bile bodies; tipping bodies for lorries; bodies for vehicles; propulsion mechanisms for land vehicles; motorcycles; rubbish trucks; clutches for land vehicles; upholstery for vehicles; rims for vehicle wheels; windows for vehicles; engine mounts for land vehicles; axles for vehicles; headlight wipers; ashtrays for automobiles; head-rests for vehicle seats; vehicle running boards; cup holders for vehicles; air bags [safety devices for automobiles]; torque converters for land vehicles; anti-glare devices for vehicles; sun-blinds adapted for automobiles; trailers for transporting bicycles; balance weights for vehicle wheels; shock absorbing springs for vehicles; reduction gears for land vehicles; safety belts for vehicle seats; security harness for vehicle seats; vehicle suspension springs; rudders; vehicle joysticks; push scooters [vehicles]; brake segments for vehicles; luggage nets for vehicles; vehicle seats; mobility scooters; non-motorized scooters [vehicles]; remotely controlled land vehicles for transport; electric vehicles; tricycles; windscreens; windshields wipers; hubs for vehicle wheels; couplings for land vehicles; brakes for vehicles; torsion bars for vehicles; tractors; transmissions for land vehicles; military vehicles for transport; trailers [vehicles]; turbines for land vehicles; signal arms for vehicles; rowlocks; vans [vehicles]; automobile chains; bicycle chains; motorcycle chains; driving chains for land vehicles; transmission chains for land vehicles; undercarriages for vehicles; automobile chassis; vehicle chassis; connecting rods for land vehicles, other than parts of motors and engines; axle journals; tow trucks; motors, electric, for land vehicles.

28 – Toy vehicles; toys; toy mobiles; toy models; scale model kits [toys]; scale model vehicles; remote-controlled toy vehicles; toy figures.

---

(260) AM 2021 111379 A

(800) 1571821

(151) 2020 12 15

(891) 2020 12 15

(731) Richter Gedeon Nyrt.

Gyömrői út 19-21, H-1103 Budapest, Hungary

(540)

## ЗЕЛБЕРУН

(591) Black, white

(531) 28.05

(511)

5 – Pharmaceutical preparations.

---

(260) AM 2021 111380 A

(800) 1571836

(151) 2020 12 15

(891) 2020 12 15

(731) Richter Gedeon Nyrt.

Gyömrői út 19-21, H-1103 Budapest,  
Hungary

(540)

## ГУМЕТРИСИН

(591) Black, white

(531) 28.05

(511)

5 – Pharmaceutical preparations.

---

(260) AM 2021 111382 A

(800) 1571855

(151) 2020 11 20

(891) 2020 11 20

(731) Perani & Partners S.p.A.

Piazza Armando Diaz 7, I-20123 Milano MI,  
Italy

(540)

## DILS

(591) Black, white

(511)

36 – Real estate procurement for others; acquisition of land to be let; estate agency; accommodation bureau services [apartments]; real estate management; apartment house management; assisting in the acquisition of real estate; real estate consultancy; provision of finance for real estate development; providing real estate information relating to property and land; property portfolio management; rental of real estate and property; rent collection; real estate agency services relating to the purchase and sale of buildings; real estate consultancy; real estate management; commercial real estate agency services; real estate trustee services; rental of real estate; agencies or brokerage for renting of buildings; agencies or brokerage for leasing or renting of land.

---

(260) AM 2021 111394 A

(800) 1541566

(151) 2020 06 05

(891) 2020 12 21

(731) Samsung Electronics Co., Ltd.

129, Samsung-ro, Yeongtong-gu, Suwon-si,  
Gyeonggi-do, Republic of Korea

(540)

## Jetbot

(591) Black, white

(511)

7 – Robotic vacuum cleaners.

---

(260) AM 2021 111395 A  
 (800) 1547418  
 (151) 2020 07 14  
 (891) 2021 01 07  
 (731) Gilbarco Inc.  
 7300 West Friendly Avenue, Greensboro  
 NC 27410, USA

(540)

## AMPS2GO

(591) Black, white  
 (511)  
 9 – Battery charging devices for motor vehicles; charging stations for electric vehicles.

(260) AM 2021 111396 A  
 (800) 1548868  
 (151) 2020 07 14  
 (891) 2021 01 07  
 (731) Gilbarco Inc.  
 7300 West Friendly Avenue, Greensboro  
 NC 27410, USA

(540)

## EVERSE

(591) Black, white  
 (511)  
 9 – Downloadable software in the nature of a mobile application for finding electric vehicle charging stations, checking real-time availability of electric vehicle charging stations, getting navigational directions to charging stations, paying for and starting a charging session, reviewing an electric vehicle charging session in real-time, contacting customer service, and for registering, reviewing information and data from, and managing an electric vehicle charging account for electric vehicle chargers.

(260) AM 2021 111397 A  
 (800) 1561108  
 (151) 2020 10 20  
 (891) 2020 12 07  
 (731) Josera GmbH & Co. KG  
 Industriegebiet Süd, 63924 Kleinheubach,  
 Germany

(540)

## josi

(591) Black, white  
 (511)  
 31 – Animal feed preparations.

(260) AM 2021 111488 A  
 (800) 1572859  
 (151) 2020 10 22  
 (891) 2020 10 22  
 (731) R-Pharm, Joint Stock Company  
 Berzarina street, 19, bld. 1, RU-123154  
 Moscow, Russian Federation

(540)

## P-KOBI

(591) Black, white  
 (531) 28.05  
 (511)  
 5 – Acaricides; aconitine; alkaloids for medical purposes; alginates for pharmaceutical purposes; algicides; aldehydes for pharmaceutical purposes; dental amalgams of gold; dental amalgams; amino acids for veterinary purposes; amino acids for medical purposes; analgesics; anaesthetics; antibiotics; antiseptics; medicine cases, portable, filled; first-aid boxes, filled; aluminium acetate for pharmaceutical purposes; acetates for pharmaceutical purposes; germicides; balms for medical purposes; bandages for dressings; diagnostic biomarker reagents for medical purposes; biocides; bromine for pharmaceutical purposes; paper for mustard poultices; fly catching paper; reagent paper for veterinary purposes; reagent paper for medical purposes; mothproof paper; petroleum jelly for medical purposes; vaccines; oxygen baths; antiseptic cotton; aseptic cotton; absorbent wadding; wadding for medical purposes; cotton for medical purposes; dietetic substances adapted for medical use; radiological contrast substances for medical purposes; nutritive substances for microorganisms; radioactive substances for medical purposes; bismuth subnitrate for pharmaceutical purposes; melissa water for pharmaceutical purposes; sea water for medicinal bathing; mineral waters for medical purposes; thermal water; dietary fiber; molding wax for dentists; gases for medical purposes; guaiacol for pharmaceutical purposes; sexual stimulant gels; hematogen; hemoglobin; hydrastine; hydrastinine; glycerine for medical purposes; glycerophosphates; glucose for medical purposes; gentian for pharmaceutical purposes; hormones for medical purposes; mustard for pharmaceutical purposes; mustard poultices; mud for baths; medicinal sediment [mud]; gamboge for medical purposes; gurjun balsam for medical purposes; disinfectants; air deodorising preparations; deodorants, other than for human beings or for animals; deodorants for clothing and textiles; diastase for medical purposes; digitalin; mineral food supplements; nutritional supplements; albumin dietary supplements; dietary supplements for animals; yeast dietary supplements; alginate dietary supplements; glucose dietary supplements; casein dietary supplements; lecithin dietary supplements; flaxseed oil dietary supplements; propolis dietary supplements; protein dietary supplements; protein supplements for animals; royal jelly dietary supplements; pollen dietary supplements; wheat germ dietary supplements; flaxse-

ed dietary supplements; enzyme dietary supplements; yeast for pharmaceutical purposes; gelatine for medical purposes; cod liver oil; isotopes for medical purposes; immunostimulants; insecticides; iodine for pharmaceutical purposes; iodides for pharmaceutical purposes; alkaline iodides for pharmaceutical purposes; iodoform; calomel [fungicide]; cream of tartar for pharmaceutical purposes; tartar for pharmaceutical purposes; camphor for medical purposes; capsules for medicines; cachets for pharmaceutical purposes; hemostatic pencils; wart pencils; caustic pencils; carbolineum [parasiticide]; caustics for pharmaceutical purposes; cachou for pharmaceutical purposes; quassia for medical purposes; quebracho for medical purposes; oxygen for medical purposes; gallic acid for pharmaceutical purposes; acids for pharmaceutical purposes; adhesives for dentures; surgical glues; stem cells for veterinary purposes; stem cells for medical purposes; cocaine; collagen for medical purposes; collodion for pharmaceutical purposes; corn rings for the feet; candy, medicated; angostura bark for medical purposes; barks for pharmaceutical purposes; cedar wood for use as an insect repellent; condurango bark for medical purposes; croton bark; mangrove bark for pharmaceutical purposes; myrobalan bark for pharmaceutical purposes; cinchona for medical purposes; medicated animal feed; medicinal roots; rhubarb roots for pharmaceutical purposes; lint for medical purposes; starch for dietetic or pharmaceutical purposes; creosote for pharmaceutical purposes; blood for medical purposes; cultures of microorganisms for medical or veterinary use; curare; dental lacquer; liquorice for pharmaceutical purposes; lactose for pharmaceutical purposes; candy for medical purposes; sticking plasters; medicines for alleviating constipation; adhesive bands for medical purposes; lecithin for medical purposes; lotions for veterinary purposes; medicated hair lotions; lotions for pharmaceutical purposes; medicated after-shave lotions; personal sexual lubricants; lupulin for pharmaceutical purposes; magnesia for pharmaceutical purposes; liniments; ointments for pharmaceutical purposes; sunburn ointments; mercurial ointments; frostbite salve for pharmaceutical purposes; gauze for dressings; medicinal oils; mustard oil for medical purposes; camphor oil for medical purposes; castor oil for medical purposes; oil of turpentine for pharmaceutical purposes; dill oil for medical purposes; dental mastics; dental abrasives; dental impression materials; teeth filling material; dressings, medical; surgical dressings; drugs for medical purposes; medicines for veterinary purposes; serotherapeutic medicines; medicines for human purposes; medicines for dental purposes; menthol; medicinal drinks; moleskin for medical purposes; almond milk for pharmaceutical purposes; powdered milk for babies; royal jelly for pharmaceutical purposes; milk ferments for pharmaceutical purposes; Irish moss for medical purposes; meal for pharmaceutical purposes; flaxseed meal for pharmaceutical purposes; fish meal for phar-

maceutical purposes; fly catching adhesives; antibacterial soap; disinfectant soap; medicated soap; lyophilized meat adapted for medical purposes; mint for pharmaceutical purposes; dietetic beverages adapted for medical purposes; malted milk beverages for medical purposes; narcotics; medicinal infusions; tincture of iodine; eucalyptol for pharmaceutical purposes; tinctures for medical purposes; opium; opodeldoc; decoctions for pharmaceutical purposes; antiparasitic collars for animals; cotton sticks for medical purposes; stick liquorice for pharmaceutical purposes; sulfur sticks [disinfectants]; lozenges for pharmaceutical purposes; medicated dentifrices; pectin for pharmaceutical purposes; pepsins for pharmaceutical purposes; peptones for pharmaceutical purposes; hydrogen peroxide for medical purposes; pesticides; food for babies; leeches for medical purposes; blood plasma; eyepatches for medical purposes; poultices; compresses; scapulars for surgical purposes; babies' napkins; diapers for pets; diapers for incontinence; bunion pads; breast-nursing pads; pomades for medical purposes; powder of cantharides; pyrethrum powder; anti-uric preparations; bacterial preparations for medical and veterinary use; bacteriological preparations for medical and veterinary use; balsamic preparations for medical purposes; albuminous preparations for medical purposes; biological preparations for veterinary purposes; biological preparations for medical purposes; veterinary preparations; bismuth preparations for pharmaceutical purposes; vitamin preparations\*; diagnostic preparations for veterinary purposes; diagnostic preparations for medical purposes; bath preparations for medical purposes; therapeutic preparations for the bath; hemorrhoid preparations; preparations for callouses; lice treatment preparations [pediculicides]; acne treatment preparations; preparations to facilitate teething; preparations for the treatment of burns; fumigation preparations for medical purposes; organotherapy preparations; air purifying preparations; bronchodilating preparations; preparations for reducing sexual activity; sterilising preparations; soil-sterilising preparations; corn remedies; pharmaceutical preparations for treating dandruff; preparations for destroying noxious animals; weedkillers; preparations for destroying dry rot fungus; larvae exterminating preparations; fly destroying preparations; preparations for destroying mice; slug exterminating preparations; vermin destroying preparations; pharmaceutical preparations for skin care; contact lens cleaning preparations; preparations of microorganisms for medical or veterinary use; lime-based pharmaceutical preparations; styptic preparations; medicated eye-washes; medicinal hair growth preparations; nutraceutical preparations for therapeutic or medical purposes; opiates; anticryptogamic preparations; aloe vera preparations for pharmaceutical purposes; preparations of trace elements for human and animal use; sulfonamides [medicines]; pharmaceutical preparations; pharmaceutical preparations for treating sunburn; enzyme preparations for

veterinary purposes; enzyme preparations for medical purposes; phytotherapy preparations for medical purposes; chemico-pharmaceutical preparations; chemical preparations for veterinary purposes; chemical preparations for the diagnosis of pregnancy; chemical preparations for medical purposes; chemical preparations for treating wheat smut; chemical preparations for treating diseases affecting vine plants; chemical preparations for treating mildew; chemical preparations for treating phyloxera; chemical preparations for pharmaceutical purposes; chilblain preparations; mothproofing preparations; collyrium; Goulard water; chemical conductors for electrocardiograph electrodes; albuminous foodstuffs for medical purposes; dietetic foods adapted for medical purposes; by-products of the processing of cereals for dietetic or medical purposes; homogenised food adapted for medical purposes; lyophilized food adapted for medical purposes; pharmaceuticals; sanitary pads;; panty liners [sanitary]; propolis for pharmaceutical purposes; pearl powder for medical purposes; radium for medical purposes; hydrated chloral for pharmaceutical purposes; solvents for removing adhesive plasters; vaginal washes for medical purposes; solutions for use with contact lenses; chemical reagents for medical or veterinary purposes; gum for medical purposes; rubber for dental purposes; chewing gum for medical purposes; insect repellents; insect repellent incense; repellents for dogs; tissues impregnated with pharmaceutical lotions; sarsaparilla for medical purposes; sugar for medical purposes; asthmatic tea; fumigating pastilles; suppositories; flaxseed for pharmaceutical purposes; tobacco-free cigarettes for medical purposes; siccatives [drying agents] for medical purposes; syrups for pharmaceutical purposes; turpentine for pharmaceutical purposes; milking grease; greases for veterinary purposes; greases for medical purposes; lacteal flour for babies; infant formula; soporifics; bicarbonate of soda for pharmaceutical purposes; bath salts for medical purposes; salts for mineral water baths; salts for medical purposes; potassium salts for medical purposes; sodium salts for medical purposes; smelling salts; mineral water salts; malt for pharmaceutical purposes; semen for artificial insemination; alcohol for pharmaceutical purposes; medicinal alcohol; alloys of precious metals for dental purposes; ergot for pharmaceutical purposes; cooling sprays for medical purposes; antibacterial handwashes; adjuvants for medical purposes; astringents for medical purposes; anthelmintics; disinfectants for hygiene purposes; disinfectants for chemical toilets; douching preparations for medical purposes; appetite suppressants for medical purposes; medical preparations for slimming purposes; parasiticides; mouthwashes for medical purposes; febrifuges; depuratives; animal washes [insecticides]; detergents for medical purposes; cattle washes [insecticides]; dog washes [insecticides]; insecticidal veterinary washes; vesicants; evacuants; remedies for perspiration; remedies for foot perspiration; chemical con-

traceptives; antiparasitic preparations; tranquilizers; laxatives; tonics [medicines]; medicated toiletry preparations; digestives for pharmaceutical purposes; nervines; media for bacteriological cultures; steroids; strychnine; serums; tanning pills; appetite suppressant pills; slimming pills; jujube, medicated; antioxidant pills; menstruation tampons; vulnerary sponges; thymol for pharmaceutical purposes; biological tissue cultures for veterinary purposes; biological tissue cultures for medical purposes; smoking herbs for medical purposes; medicinal herbs; transplants [living tissues]; surgical implants comprised of living tissues; pants, absorbent, for incontinence; sanitary pants; babies' napkin-pants; charcoal for pharmaceutical purposes; fennel for medical purposes; porcelain for dental prostheses; phenol for pharmaceutical purposes; enzymes for veterinary purposes; enzymes for medical purposes; ferments for pharmaceutical purposes; formic aldehyde for pharmaceutical purposes; phosphates for pharmaceutical purposes; fungicides; quinine for medical purposes; chinoline for medical purposes; diabetic bread adapted for medical use; chloroform; flowers of sulfur for pharmaceutical purposes; cement for animal hooves; bone cement for surgical and orthopedic purposes; dental cements; medicinal tea; herbal teas for medicinal purposes; insecticidal animal shampoos; medicated shampoos; medicated shampoos for pets; pediculicidal shampoos; medicated dry shampoos; pre-filled syringes for medical purposes; eucalyptus for pharmaceutical purposes; herbal extracts for medical purposes; plant extracts for pharmaceutical purposes; tobacco extracts [insecticides]; extracts of hops for pharmaceutical purposes; elixirs [pharmaceutical preparations]; ethers for pharmaceutical purposes; esters for pharmaceutical purposes; cellulose esters for pharmaceutical purposes; cellulose ethers for pharmaceutical purposes; rat poison; poisons; bacterial poisons; jalap.

35 – Arranging subscriptions to telecommunication services for others; import-export agency services; commercial information agency services; publicity agency services; cost price analysis; rental of advertising space; business auditing; business intermediary services relating to the matching of potential private investors with entrepreneurs needing funding; employment agency services; computerized file management; accounting; invoicing; demonstration of goods; transcription of communications [office functions]; opinion polling; market studies; business information; commercial information and advice for consumers in the choice of products and services; business investigations; business research; marketing research; personnel recruitment; business management and organization consultancy; business organization consultancy; consultancy regarding public relations communication strategies; business management consultancy; personnel management consultancy; professional business consultancy; consultancy regarding advertising com-

munication strategies; layout services for advertising purposes; marketing; business management of performing artists; business management of sports people; writing of résumés for others; scriptwriting for advertising purposes; news clipping services; updating and maintenance of information in registries; updating and maintenance of data in computer databases; updating of advertising material; word processing; organization of exhibitions for commercial or advertising purposes; arranging newspaper subscriptions for others; organization of fashion shows for promotional purposes; organization of trade fairs for commercial or advertising purposes; shop window dressing; development of advertising concepts; business appraisals; payroll preparation; data search in computer files for others; sponsorship search; business management assistance; commercial or industrial management assistance; commercial intermediation services; providing business information via a web site; provision of commercial and business contact information; provision of an online marketplace for buyers and sellers of goods and services; web indexing for commercial or advertising purposes; presentation of goods on communication media, for retail purposes; economic forecasting; auctioneering; retail services for pharmaceutical, veterinary and sanitary preparations and medical supplies; sales promotion for others; production of tele-shopping programs; production of advertising films; office machines and equipment rental; rental of advertising time on communication media; publicity material rental; rental of billboards [advertising boards]; rental of vending machines; rental of sales stands; rental of photocopying machines; publication of publicity texts; radio advertising; bill-posting; distribution of samples; dissemination of advertising matter; direct mail advertising; registration of written communications and data; writing of publicity texts; publicity; online advertising on a computer network; advertising by mail order; television advertising; document reproduction being photocopying services; compilation of statistics; compilation of information into computer databases; business inquiries; systemization of information into computer databases; advisory services for business management; negotiation of business contracts for others; negotiation and conclusion of commercial transactions for third parties; compiling indexes of information for commercial or advertising purposes; tax preparation; drawing up of statements of accounts; telemarketing services; psychological testing for the selection of personnel; outsourced administrative management for companies; business management of hotels; business management for freelance service providers; business project management services for construction projects; commercial administration of the licensing of the goods and services of others; business management of reimbursement programs for others; administration of consumer loyalty programs; administration of frequent flyer programs; administrative processing of purchase orders; public

relations; modelling for advertising or sales promotion; typing; appointment reminder services [office functions]; web site traffic optimisation; administrative services for the relocation of businesses; tax filing services; search engine optimisation for sales promotion; appointment scheduling services [office functions]; price comparison services; pay per click advertising; secretarial services; procurement services for others [purchasing goods and services for other businesses]; shorthand; outsourcing services [business assistance]; telephone answering for unavailable subscribers; photocopying services; business efficiency expert services.

(260) AM 2021 111489 A

(800) 1572863

(151) 2020 10 22

(891) 2020 10 22

(731) R-Pharm, Joint Stock Company

Berzarina street, 19, bld. 1, RU-123154

Moscow, Russian Federation

(540)



(591) White and green

(531) 24.15.01; 26.04.01; 26.04.11; 28.05; 29.01.12

(511)

5 – Acaricides; aconitine; alkaloids for medical purposes; alginates for pharmaceutical purposes; algicides; aldehydes for pharmaceutical purposes; dental amalgams of gold; dental amalgams; amino acids for veterinary purposes; amino acids for medical purposes; analgesics; anaesthetics; antibiotics; antiseptics; medicine cases, portable, filled; first-aid boxes, filled; aluminium acetate for pharmaceutical purposes; acetates for pharmaceutical purposes; germicides; balms for medical purposes; bandages for dressings; diagnostic biomarker reagents for medical purposes; biocides; bromine for pharmaceutical purposes; paper for mustard poultices; fly catching paper; reagent paper for veterinary purposes; reagent paper for medical purposes; mothproof paper; petroleum jelly for medical purposes; vaccines; oxygen baths; antiseptic cotton; aseptic cotton; absorbent wadding; wadding for medical purposes; cotton for medical purposes; dietetic substances adapted for medical use; radiological contrast substances for medical purposes; nutritive substances for microorganisms; radioactive substances for medical purposes; bismuth subnitrate for phar-

maceutical purposes; melissa water for pharmaceutical purposes; sea water for medicinal bathing; mineral waters for medical purposes; thermal water; dietary fiber; molding wax for dentists; gases for medical purposes; guaiacol for pharmaceutical purposes; sexual stimulant gels; hematogen; hemoglobin; hydrastine; hydrastinine; glycerine for medical purposes; glycerophosphates; glucose for medical purposes; gentian for pharmaceutical purposes; hormones for medical purposes; mustard for pharmaceutical purposes; mustard poultices; mud for baths; medicinal sediment [mud]; gamboge for medical purposes; gurjun balsam for medical purposes; disinfectants; air deodorising preparations; deodorants, other than for human beings or for animals; deodorants for clothing and textiles; diastase for medical purposes; digitalin; mineral food supplements; nutritional supplements; albumin dietary supplements; dietary supplements for animals; yeast dietary supplements; alginate dietary supplements; glucose dietary supplements; casein dietary supplements; lecithin dietary supplements; flaxseed oil dietary supplements; propolis dietary supplements; protein dietary supplements; protein supplements for animals; royal jelly dietary supplements; pollen dietary supplements; wheat germ dietary supplements; flaxseed dietary supplements; enzyme dietary supplements; yeast for pharmaceutical purposes; gelatine for medical purposes; cod liver oil; isotopes for medical purposes; immunostimulants; insecticides; iodine for pharmaceutical purposes; iodides for pharmaceutical purposes; alkaline iodides for pharmaceutical purposes; iodoform; calomel [fungicide]; cream of tartar for pharmaceutical purposes; tartar for pharmaceutical purposes; camphor for medical purposes; capsules for medicines; cachets for pharmaceutical purposes; hemostatic pencils; wart pencils; caustic pencils; carbolineum [parasiticide]; caustics for pharmaceutical purposes; cachou for pharmaceutical purposes; quassia for medical purposes; quebracho for medical purposes; oxygen for medical purposes; gallic acid for pharmaceutical purposes; acids for pharmaceutical purposes; adhesives for dentures; surgical glues; stem cells for veterinary purposes; stem cells for medical purposes; cocaine; collagen for medical purposes; collodion for pharmaceutical purposes; corn rings for the feet; candy, medicated; angostura bark for medical purposes; barks for pharmaceutical purposes; cedar wood for use as an insect repellent; condurango bark for medical purposes; croton bark; mangrove bark for pharmaceutical purposes; myrobalan bark for pharmaceutical purposes; cinchona for medical purposes; medicated animal feed; medicinal roots; rhubarb roots for pharmaceutical purposes; lint for medical purposes; starch for dietetic or pharmaceutical purposes; creosote for pharmaceutical purposes; blood for medical purposes; cultures of microorganisms for medical or veterinary use; curare; dental lacquer; liquorice for pharmaceutical purposes; lactose for pharmaceutical purposes; candy for medical purposes; sticking plas-

ters; medicines for alleviating constipation; adhesive bands for medical purposes; lecithin for medical purposes; lotions for veterinary purposes; medicated hair lotions; lotions for pharmaceutical purposes; medicated after-shave lotions; personal sexual lubricants; lupulin for pharmaceutical purposes; magnesia for pharmaceutical purposes; liniments; ointments for pharmaceutical purposes; sunburn ointments; mercurial ointments; frostbite salve for pharmaceutical purposes; gauze for dressings; medicinal oils; mustard oil for medical purposes; camphor oil for medical purposes; castor oil for medical purposes; oil of turpentine for pharmaceutical purposes; dill oil for medical purposes; dental mastics; dental abrasives; dental impression materials; teeth filling material; dressings, medical; surgical dressings; drugs for medical purposes; medicines for veterinary purposes; serotherapeutic medicines; medicines for human purposes; medicines for dental purposes; menthol; medicinal drinks; moleskin for medical purposes; almond milk for pharmaceutical purposes; powdered milk for babies; royal jelly for pharmaceutical purposes; milk ferments for pharmaceutical purposes; Irish moss for medical purposes; meal for pharmaceutical purposes; flaxseed meal for pharmaceutical purposes; fish meal for pharmaceutical purposes; fly catching adhesives; antibacterial soap; disinfectant soap; medicated soap; lyophilized meat adapted for medical purposes; mint for pharmaceutical purposes; dietetic beverages adapted for medical purposes; malted milk beverages for medical purposes; narcotics; medicinal infusions; tincture of iodine; eucalyptol for pharmaceutical purposes; tinctures for medical purposes; opium; opodeldoc; decoctions for pharmaceutical purposes; antiparasitic collars for animals; cotton sticks for medical purposes; stick liquorice for pharmaceutical purposes; sulfur sticks [disinfectants]; lozenges for pharmaceutical purposes; medicated dentifrices; pectin for pharmaceutical purposes; pepsins for pharmaceutical purposes; peptones for pharmaceutical purposes; hydrogen peroxide for medical purposes; pesticides; food for babies; leeches for medical purposes; blood plasma; eyepatches for medical purposes; poultices; compresses; scapulars for surgical purposes; babies' napkins; diapers for pets; diapers for incontinence; bunion pads; breast-nursing pads; pomades for medical purposes; powder of cantharides; pyrethrum powder; anti-uric preparations; bacterial preparations for medical and veterinary use; bacteriological preparations for medical and veterinary use; balsamic preparations for medical purposes; albuminous preparations for medical purposes; biological preparations for veterinary purposes; biological preparations for medical purposes; veterinary preparations; bismuth preparations for pharmaceutical purposes; vitamin preparations; diagnostic preparations for veterinary purposes; diagnostic preparations for medical purposes; bath preparations for medical purposes; therapeutic preparations for the bath; hemorrhoid preparations; preparations for ca-

llouses; lice treatment preparations [pediculicides]; acne treatment preparations; preparations to facilitate teething; preparations for the treatment of burns; fumigation preparations for medical purposes; organotherapy preparations; air purifying preparations; bronchodilating preparations; preparations for reducing sexual activity; sterilising preparations; soil-sterilising preparations; corn remedies; pharmaceutical preparations for treating dandruff; preparations for destroying noxious animals; weedkillers; preparations for destroying dry rot fungus; larvae exterminating preparations; fly destroying preparations; preparations for destroying mice; slug exterminating preparations; vermin destroying preparations; pharmaceutical preparations for skin care; contact lens cleaning preparations; preparations of microorganisms for medical or veterinary use; lime-based pharmaceutical preparations; styptic preparations; medicated eye-washes; medicinal hair growth preparations; nutraceutical preparations for therapeutic or medical purposes; opiates; anticryptogamic preparations; aloe vera preparations for pharmaceutical purposes; preparations of trace elements for human and animal use; sulfonamides [medicines]; pharmaceutical preparations; pharmaceutical preparations for treating sunburn; enzyme preparations for veterinary purposes; enzyme preparations for medical purposes; phytotherapy preparations for medical purposes; chemico-pharmaceutical preparations; chemical preparations for veterinary purposes; chemical preparations for the diagnosis of pregnancy; chemical preparations for medical purposes; chemical preparations for treating wheat smut; chemical preparations for treating diseases affecting vine plants; chemical preparations for treating mildew; chemical preparations for treating phylloxera; chemical preparations for pharmaceutical purposes; chilblain preparations; mothproofing preparations; collyrium; Goulard water; chemical conductors for electrocardiograph electrodes; albuminous foodstuffs for medical purposes; dietetic foods adapted for medical purposes; by-products of the processing of cereals for dietetic or medical purposes; homogenised food adapted for medical purposes; lyophilized food adapted for medical purposes; pharmaceuticals; sanitary pads; panty liners [sanitary]; propolis for pharmaceutical purposes; pearl powder for medical purposes; radium for medical purposes; hydrated chloral for pharmaceutical purposes; solvents for removing adhesive plasters; vaginal washes for medical purposes; solutions for use with contact lenses; chemical reagents for medical or veterinary purposes; gum for medical purposes; rubber for dental purposes; chewing gum for medical purposes; insect repellents; insect repellent incense; repellents for dogs; tissues impregnated with pharmaceutical lotions; sarsaparilla for medical purposes; sugar for medical purposes; asthmatic tea; fumigating pastilles; suppositories; flaxseed for pharmaceutical purposes; tobacco-free cigarettes for medical purposes; siccatives [drying agents] for medical purposes; syrups for

pharmaceutical purposes; turpentine for pharmaceutical purposes; milking grease; greases for veterinary purposes; greases for medical purposes; lacteal flour for babies; infant formula; soporifics; bicarbonate of soda for pharmaceutical purposes; bath salts for medical purposes; salts for mineral water baths; salts for medical purposes; potassium salts for medical purposes; sodium salts for medical purposes; smelling salts; mineral water salts; malt for pharmaceutical purposes; semen for artificial insemination; alcohol for pharmaceutical purposes; medicinal alcohol; alloys of precious metals for dental purposes; ergot for pharmaceutical purposes; cooling sprays for medical purposes; antibacterial handwashes; adjuvants for medical purposes; astringents for medical purposes; anthelmintics; disinfectants for hygiene purposes; disinfectants for chemical toilets; douching preparations for medical purposes; appetite suppressants for medical purposes; medical preparations for slimming purposes; parasiticides; mouthwashes for medical purposes; febrifuges; depuratives; animal washes [insecticides]; detergents for medical purposes; cattle washes [insecticides]; dog washes [insecticides]; insecticidal veterinary washes; vesicants; evacuants; remedies for perspiration; remedies for foot perspiration; chemical contraceptives; antiparasitic preparations; tranquilizers; laxatives; tonics [medicines]; medicated toiletry preparations; digestives for pharmaceutical purposes; nervines; media for bacteriological cultures; steroids; strychnine; serums; tanning pills; appetite suppressant pills; slimming pills; jujube, medicated; antioxidant pills; menstruation tampons; vulnerary sponges; thymol for pharmaceutical purposes; biological tissue cultures for veterinary purposes; biological tissue cultures for medical purposes; smoking herbs for medical purposes; medicinal herbs; transplants [living tissues]; surgical implants comprised of living tissues; pants, absorbent, for incontinence; sanitary pants; babies' napkin-pants; charcoal for pharmaceutical purposes; fennel for medical purposes; porcelain for dental prostheses; phenol for pharmaceutical purposes; enzymes for veterinary purposes; enzymes for medical purposes; ferments for pharmaceutical purposes; formic aldehyde for pharmaceutical purposes; phosphates for pharmaceutical purposes; fungicides; quinine for medical purposes; chinoline for medical purposes; diabetic bread adapted for medical use; chloroform; flowers of sulfur for pharmaceutical purposes; cement for animal hooves; bone cement for surgical and orthopedic purposes; dental cements; medicinal tea; herbal teas for medicinal purposes; insecticidal animal shampoos; medicated shampoos; medicated shampoos for pets; pediculicidal shampoos; medicated dry shampoos; pre-filled syringes for medical purposes; eucalyptus for pharmaceutical purposes; herbal extracts for medical purposes; plant extracts for pharmaceutical purposes; tobacco extracts [insecticides]; extracts of hops for pharmaceutical purposes; elixirs [pharmaceutical preparations]; ethers for pharmaceuti-



cal purposes; esters for pharmaceutical purposes; cellulose esters for pharmaceutical purposes; cellulose ethers for pharmaceutical purposes; rat poison; poisons; bacterial poisons; jalap.

35 – Arranging subscriptions to telecommunication services for others; import-export agency services; commercial information agency services; publicity agency services; cost price analysis; rental of advertising space; business auditing; business intermediary services relating to the matching of potential private investors with entrepreneurs needing funding; employment agency services; computerized file management; accounting; invoicing; demonstration of goods; transcription of communications [office functions]; opinion polling; market studies; business information; commercial information and advice for consumers in the choice of products and services; business investigations; business research; marketing research; personnel recruitment; business management and organization consultancy; business organization consultancy; consultancy regarding public relations communication strategies; business management consultancy; personnel management consultancy; professional business consultancy; consultancy regarding advertising communication strategies; layout services for advertising purposes; marketing; business management of performing artists; business management of sports people; writing of résumés for others; scriptwriting for advertising purposes; news clipping services; updating and maintenance of information in registries; updating and maintenance of data in computer databases; updating of advertising material; word processing; organization of exhibitions for commercial or advertising purposes; arranging newspaper subscriptions for others; organization of fashion shows for promotional purposes; organization of trade fairs for commercial or advertising purposes; shop window dressing; development of advertising concepts; business appraisals; payroll preparation; data search in computer files for others; sponsorship search; business management assistance; commercial or industrial management assistance; commercial intermediation services; providing business information via a web site; provision of commercial and business contact information; provision of an online marketplace for buyers and sellers of goods and services; web indexing for commercial or advertising purposes; presentation of goods on communication media, for retail purposes; economic forecasting; auctioneering; retail services for pharmaceutical, veterinary and sanitary preparations and medical supplies; sales promotion for others; production of teleshopping programs; production of advertising films; office machines and equipment rental; rental of advertising time on communication media; publicity material rental; rental of billboards [advertising boards]; rental of vending machines; rental of sales stands; rental of photocopying machines; publication of publicity texts; radio adverti-

sing; bill-posting; distribution of samples; dissemination of advertising matter; direct mail advertising; registration of written communications and data; writing of publicity texts; publicity; online advertising on a computer network; advertising by mail order; television advertising; compilation of statistics; compilation of information into computer databases; business inquiries; systemization of information into computer databases; advisory services for business management; negotiation of business contracts for others; negotiation and conclusion of commercial transactions for third parties; compiling indexes of information for commercial or advertising purposes; tax preparation; drawing up of statements of accounts; telemarketing services; psychological testing for the selection of personnel; outsourced administrative management for companies; business management of hotels; business management for freelance service providers; business project management services for construction projects; commercial administration of the licensing of the goods and services of others; business management of reimbursement programs for others; administration of consumer loyalty programs; administration of frequent flyer programs; administrative processing of purchase orders; public relations; modelling for advertising or sales promotion; typing; appointment reminder services [office functions]; web site traffic optimisation; administrative services for the relocation of businesses; tax filing services; search engine optimisation for sales promotion; appointment scheduling services [office functions]; price comparison services; pay per click advertising; secretarial services; procurement services for others [purchasing goods and services for other businesses]; shorthand; outsourcing services [business assistance]; telephone answering for unavailable subscribers; photocopying services; business efficiency expert services.

---

(260) AM 2021 111627 A

(800) 1574335

(151) 2020 12 08

(891) 2020 12 08

(731) Limited Liability Company, "Pharm Aid Ltd"

Daev per., 20, et. 5, of. 517; RU-107045

Moscow, Russian Federation

(540)

## ROTA-V-AID

(591) Black, white

(531) 24.17.01; 27.05.01

(511)

5 – Vaccines; vaccines for the prevention of rotavirus; pharmaceuticals; medicinal preparations; medicines; pharmaceutical preparations; pharmaceutical products.

---

---

**INTERNATIONAL TRADEMARKS PROTECTED IN GEORGIA**

(260) AM 2021 106553 A  
(800) 1508273  
(151) 2019 12 05  
(181) 2029 12 05  
(891) 2019 12 05  
(511) 09, 42

---

(260) AM 2021 109397 A  
(800) 1545082  
(151) 2020 06 02  
(181) 2030 06 02  
(891) 2020 06 02  
(511) 05

---

(260) AM 2021 106895 A  
(800) 1511418  
(151) 2019 12 16  
(181) 2029 12 16  
(891) 2019 12 16  
(511) 35

---

(260) AM 2021 109398 A  
(800) 1545220  
(151) 2020 01 28  
(181) 2030 01 28  
(891) 2020 01 28  
(511) 33

---

(260) AM 2021 107221 A  
(800) 1515243  
(151) 2019 06 20  
(181) 2029 06 20  
(891) 2019 06 20  
(511) 12

---

(260) AM 2021 109399 A  
(800) 1545225  
(151) 2020 07 10  
(181) 2030 07 10  
(891) 2020 07 10  
(511) 09

---

(260) AM 2021 108534 A  
(800) 1533544  
(151) 2019 06 20  
(181) 2029 06 20  
(891) 2019 06 20  
(511) 07, 09, 12, 35, 36, 37, 42, 45

---

(260) AM 2021 109417 A  
(800) 1545817  
(151) 2020 05 25  
(181) 2030 05 25  
(891) 2020 05 25  
(511) 11, 37

---

(260) AM 2021 108902 A  
(800) 1538283  
(151) 2020 04 13  
(181) 2030 04 13  
(891) 2020 04 13  
(511) 25

---

(260) AM 2021 109442 A  
(800) 1545966  
(151) 2020 05 12  
(181) 2030 05 12  
(891) 2020 05 12  
(511) 05, 30, 32

---

(260) AM 2021 109246 A  
(800) 1542687  
(151) 2019 12 31  
(181) 2029 12 31  
(891) 2019 12 31  
(511) 03

---

(260) AM 2021 109450 A  
(800) 1546021  
(151) 2020 05 15  
(181) 2030 05 15  
(891) 2020 05 15  
(511) 05

---

(260) AM 2021 109395 A  
(800) 1545029  
(151) 2020 05 20  
(181) 2030 05 20  
(891) 2020 05 20  
(511) 10

---

(260) AM 2021 109451 A  
(800) 1546029  
(151) 2020 05 09  
(181) 2030 05 09  
(891) 2020 05 09  
(511) 03, 05

---

(260) AM 2021 109452 A  
(800) 1546051  
(151) 2020 04 08  
(181) 2030 04 08  
(891) 2020 04 08  
(511) 07, 09, 11

---

(260) AM 2021 109453 A  
(800) 1546061  
(151) 2020 05 18  
(181) 2030 05 18  
(891) 2020 05 18  
(511) 09, 28

---

(260) AM 2021 109454 A  
(800) 1546084  
(151) 2020 06 12  
(181) 2030 06 12  
(891) 2020 06 12  
(511) 01, 02, 04

---

(260) AM 2021 109455 A  
(800) 1546096  
(151) 2020 07 07  
(181) 2030 07 07  
(891) 2020 07 07  
(511) 14, 18, 24, 25, 35

---

(260) AM 2021 109457 A  
(800) 1546189  
(151) 2020 07 01  
(181) 2030 07 01  
(891) 2020 07 01  
(511) 31

---

(260) AM 2021 109458 A  
(800) 1546206  
(151) 2020 06 04  
(181) 2030 06 04  
(891) 2020 06 04  
(511) 45

---

(260) AM 2021 109459 A  
(800) 1546318  
(151) 2020 01 31  
(181) 2030 01 31  
(891) 2020 01 31  
(511) 25, 32, 33, 35, 38, 41, 43

---

(260) AM 2021 109460 A  
(800) 1546374  
(151) 2020 06 19  
(181) 2030 06 19

(891) 2020 06 19  
(511) 09, 38, 41, 42

---

(260) AM 2021 109467 A  
(800) 1546559  
(151) 2020 06 18  
(181) 2030 06 18  
(891) 2020 06 18  
(511) 05

---

(260) AM 2021 109468 A  
(800) 1546560  
(151) 2020 06 18  
(181) 2030 06 18  
(891) 2020 06 18  
(511) 05

---

(260) AM 2021 109469 A  
(800) 1546583  
(151) 2020 06 02  
(181) 2030 06 02  
(891) 2020 06 02  
(511) 33

---

(260) AM 2021 109470 A  
(800) 1546666  
(151) 2020 07 07  
(181) 2030 07 07  
(891) 2020 07 07  
(511) 33

---

(260) AM 2021 109471 A  
(800) 1546677  
(151) 2020 06 02  
(181) 2030 06 02  
(891) 2020 06 02  
(511) 29, 30, 31

---

(260) AM 2021 109472 A  
(800) 1546686  
(151) 2020 06 18  
(181) 2030 06 18  
(891) 2020 06 18  
(511) 05

---

(260) AM 2021 109473 A  
(800) 1546719  
(151) 2020 05 22  
(181) 2030 05 22  
(891) 2020 05 22  
(511) 33

---

(260) AM 2021 109477 A  
 (800) 1546769  
 (151) 2020 06 02  
 (181) 2030 06 02  
 (891) 2020 06 02  
 (511) 29, 30

---

(260) AM 2021 109478 A  
 (800) 1546777  
 (151) 2020 06 02  
 (181) 2030 06 02  
 (891) 2020 06 02  
 (511) 30, 35

---

(260) AM 2021 109491 A  
 (800) 1546968  
 (151) 2020 07 16  
 (181) 2030 07 16  
 (891) 2020 07 16  
 (511) 30, 35

---

(260) AM 2021 109492 A  
 (800) 1546976  
 (151) 2020 02 24  
 (181) 2030 02 24  
 (891) 2020 02 24  
 (511) 06

---

(260) AM 2021 109493 A  
 (800) 1546978  
 (151) 2020 07 16  
 (181) 2030 07 16  
 (891) 2020 07 16  
 (511) 30, 35

---

(260) AM 2021 109494 A  
 (800) 819780  
 (151) 2003 11 30  
 (181) 2023 11 30  
 (891) 2020 07 30  
 (511) 11

---

(260) AM 2021 109496 A  
 (800) 1544160  
 (151) 2020 06 23  
 (181) 2030 06 23  
 (891) 2020 07 31  
 (511) 05

---

(260) AM 2021 109533 A  
 (800) 1547263  
 (151) 2020 04 17  
 (181) 2030 04 17

(891) 2020 04 17  
 (511) 29, 30, 32, 35, 43

---

(260) AM 2021 109534 A  
 (800) 1547296  
 (151) 2020 04 29  
 (181) 2030 04 29  
 (891) 2020 04 29  
 (511) 28, 41

---

(260) AM 2021 109535 A  
 (800) 1547308  
 (151) 2020 06 02  
 (181) 2030 06 02  
 (891) 2020 06 02  
 (511) 30

---

(260) AM 2021 109536 A  
 (800) 1547339  
 (151) 2020 06 02  
 (181) 2030 06 02  
 (891) 2020 06 02  
 (511) 29, 30, 31, 32

---

(260) AM 2021 109537 A  
 (800) 1547356  
 (151) 2020 04 24  
 (181) 2030 04 24  
 (891) 2020 04 24  
 (511) 01, 02, 03, 05, 35

---

(260) AM 2021 109543 A  
 (800) 1547386  
 (151) 2020 05 20  
 (181) 2030 05 20  
 (891) 2020 05 20  
 (511) 05, 44

---

(260) AM 2021 109544 A  
 (800) 1547396  
 (151) 2020 03 05  
 (181) 2030 03 05  
 (891) 2020 03 05  
 (511) 29, 30, 35, 37, 40, 43

---

(260) AM 2021 109545 A  
 (800) 1547411  
 (151) 2020 06 18  
 (181) 2030 06 18  
 (891) 2020 06 18  
 (511) 12, 28

---

(260) AM 2021 109546 A  
(800) 1547453  
(151) 2020 07 16  
(181) 2030 07 16  
(891) 2020 07 16  
(511) 10

---

(260) AM 2021 109547 A  
(800) 1547458  
(151) 2020 05 28  
(181) 2030 05 28  
(891) 2020 05 28  
(511) 04

---

(260) AM 2021 109548 A  
(800) 1547478  
(151) 2020 06 09  
(181) 2030 06 09  
(891) 2020 06 09  
(511) 09

---

(260) AM 2021 109562 A  
(800) 1547785  
(151) 2020 05 11  
(181) 2030 05 11  
(891) 2020 05 11  
(511) 07, 11

---

(260) AM 2021 109563 A  
(800) 1547817  
(151) 2020 07 08  
(181) 2030 07 08  
(891) 2020 07 08  
(511) 05, 16, 44

---

(260) AM 2021 109564 A  
(800) 1547828  
(151) 2019 12 04  
(181) 2029 12 04  
(891) 2019 12 04  
(511) 06, 19, 40, 42

---

(260) AM 2021 109565 A  
(800) 897173  
(151) 2006 08 31  
(181) 2026 08 31  
(891) 2020 07 28  
(511) 09

---

(260) AM 2021 109566 A  
(800) 1012285  
(151) 2009 07 20  
(181) 2029 07 20

(891) 2020 08 06  
(511) 25

---

(260) AM 2021 109567 A  
(800) 1013623  
(151) 2009 08 05  
(181) 2029 08 05  
(891) 2020 07 23  
(511) 29

---

(260) AM 2021 109577 A  
(800) 1357585  
(151) 2016 12 08  
(181) 2026 12 08  
(891) 2020 08 12  
(511) 01, 09, 11

---

(260) AM 2021 109578 A  
(800) 1364927  
(151) 2016 12 08  
(181) 2026 12 08  
(891) 2020 08 12  
(511) 09, 10, 11

---

(260) AM 2021 109579 A  
(800) 1423377  
(151) 2018 07 23  
(181) 2028 07 23  
(891) 2020 07 22  
(511) 03

---

(260) AM 2021 109618 A  
(800) 1548075  
(151) 2020 07 16  
(181) 2030 07 16  
(891) 2020 07 16  
(511) 30

---

(260) AM 2021 109619 A  
(800) 1548109  
(151) 2020 06 17  
(181) 2030 06 17  
(891) 2020 06 17  
(511) 33

---

(260) AM 2021 109620 A  
(800) 1548116  
(151) 2020 03 04  
(181) 2030 03 04  
(891) 2020 03 04  
(511) 05, 35

---

(260) AM 2021 109621 A  
 (800) 1548127  
 (151) 2020 04 07  
 (181) 2030 04 07  
 (891) 2020 04 07  
 (511) 12

---

(260) AM 2021 109634 A  
 (800) 1548373  
 (151) 2020 02 14  
 (181) 2030 02 14  
 (891) 2020 02 14  
 (511) 03, 09, 14, 16, 18

---

(260) AM 2021 109635 A  
 (800) 1548393  
 (151) 2020 07 29  
 (181) 2030 07 29  
 (891) 2020 07 29  
 (511) 12

---

(260) AM 2021 109636 A  
 (800) 1548405  
 (151) 2020 07 21  
 (181) 2030 07 21  
 (891) 2020 07 21  
 (511) 03

---

(260) AM 2021 109687 A  
 (800) 1549165  
 (151) 2020 05 13  
 (181) 2030 05 13  
 (891) 2020 05 13  
 (511) 31

---

(260) AM 2021 109689 A  
 (800) 1549212  
 (151) 2020 04 28  
 (181) 2030 04 28  
 (891) 2020 04 28  
 (511) 05

---

(260) AM 2021 109690 A  
 (800) 1549215  
 (151) 2020 04 28  
 (181) 2030 04 28  
 (891) 2020 04 28  
 (511) 05

---

(260) AM 2021 109718 A  
 (800) 1549900  
 (151) 2020 05 28  
 (181) 2030 05 28

(891) 2020 05 28  
 (511) 35, 36, 42

---

(260) AM 2021 109725 A  
 (800) 1439615  
 (151) 2018 09 07  
 (181) 2028 09 07  
 (891) 2020 07 29  
 (511) 35

---

(260) AM 2021 109726 A  
 (800) 1514703  
 (151) 2019 11 07  
 (181) 2029 11 07  
 (891) 2020 08 05  
 (511) 03, 35, 41, 44

---

(260) AM 2021 109727 A  
 (800) 1538276  
 (151) 2019 12 27  
 (181) 2029 12 27  
 (891) 2020 07 24  
 (511) 30, 43

---

(260) AM 2021 109782 A  
 (800) 1550258  
 (151) 2020 05 29  
 (181) 2030 05 29  
 (891) 2020 05 29  
 (511) 09, 28, 41

---

(260) AM 2021 109785 A  
 (800) 1550309  
 (151) 2020 06 25  
 (181) 2030 06 25  
 (891) 2020 06 25  
 (511) 16, 18, 29, 30, 31, 32, 35, 39, 40, 42, 43

---

(260) AM 2021 109806 A  
 (800) 1551085  
 (151) 2020 05 07  
 (181) 2030 05 07  
 (891) 2020 05 07  
 (511) 09, 20, 36, 42

---

(260) AM 2021 109807 A  
 (800) 1551107  
 (151) 2020 06 02  
 (181) 2030 06 02  
 (891) 2020 06 02  
 (511) 09, 28, 41

---

(260) AM 2021 109808 A  
(800) 1551139  
(151) 2020 08 04  
(181) 2030 08 04  
(891) 2020 08 04  
(511) 09, 42

---

(260) AM 2021 109816 A  
(800) 1190940  
(151) 2013 07 22  
(181) 2023 07 22  
(891) 2020 08 20  
(511) 01, 16, 17, 19

---

(260) AM 2021 109821 A  
(800) 1457305  
(151) 2019 02 05  
(181) 2029 02 05  
(891) 2020 08 28  
(511) 29, 30

---

(260) AM 2021 109822 A  
(800) 1458365  
(151) 2018 11 28  
(181) 2028 11 28  
(891) 2020 08 14  
(511) 12

---

(260) AM 2021 109885 A  
(800) 1551814  
(151) 2020 06 12  
(181) 2030 06 12  
(891) 2020 06 12  
(511) 05

---

(260) AM 2021 109886 A  
(800) 1551904  
(151) 2020 05 29  
(181) 2030 05 29  
(891) 2020 05 29  
(511) 09, 28, 41

---

(260) AM 2021 109887 A  
(800) 1551933  
(151) 2020 06 30  
(181) 2030 06 30  
(891) 2020 06 30  
(511) 32

---

(260) AM 2021 109889 A  
(800) 1551942  
(151) 2020 08 13  
(181) 2030 08 13

(891) 2020 08 13  
(511) 05

---

(260) AM 2021 109900 A  
(800) 1552427  
(151) 2020 08 14  
(181) 2030 08 14  
(891) 2020 08 14  
(511) 29, 30, 31, 32

---

(260) AM 2021 109901 A  
(800) 1552436  
(151) 2020 03 11  
(181) 2030 03 11  
(891) 2020 03 11  
(511) 17, 19, 35

---

(260) AM 2021 109903 A  
(800) 1241072  
(151) 2015 02 06  
(181) 2025 02 06  
(891) 2020 09 04  
(511) 32

---

(260) AM 2021 109904 A  
(800) 1284427  
(151) 2015 10 01  
(181) 2025 10 01  
(891) 2020 09 10  
(511) 01, 19, 21, 27

---

(260) AM 2021 109905 A  
(800) 1325927  
(151) 2016 06 16  
(181) 2026 06 16  
(891) 2020 09 07  
(511) 17, 19

---

(260) AM 2021 109906 A  
(800) 1361261  
(151) 2017 05 24  
(181) 2027 05 24  
(891) 2020 07 02  
(511) 09

---

(260) AM 2021 109907 A  
(800) 1391040  
(151) 2017 11 08  
(181) 2027 11 08  
(891) 2020 08 19  
(511) 05

---

(260) AM 2021 109909 A  
(800) 1477381  
(151) 2019 02 15  
(181) 2029 02 15  
(891) 2020 06 25  
(511) 05

---

(260) AM 2021 109910 A  
(800) 1550359  
(151) 2020 07 17  
(181) 2030 07 17  
(891) 2020 09 10  
(511) 05

---

(260) AM 2021 109984 A  
(800) 1552830  
(151) 2020 07 22  
(181) 2030 07 22  
(891) 2020 07 22  
(511) 16, 39

---

(260) AM 2021 109985 A  
(800) 1552841  
(151) 2020 07 28  
(181) 2030 07 28  
(891) 2020 07 28  
(511) 36, 38, 42

---



---

# **APPELLATION OF ORIGIN OF GOOD**

## **AMENDMENTS MADE FOR THE REGISTER OF**

### **PDO WINE "KINDZMARAUЛИ"**

(Registration №787; Date of Registration: 30.03.2006)

In accordance with the Order №7350/06 of 8.09.2021 made by the Head of Department of Trademarks, Geographical Indications and Designs of the LEPL National Intellectual Property Center of Georgia – Sakpatenti, the amendments are made in the Specifications of Production for the PDO Wine "Kindzmarauli" registered in the LEPL National Intellectual Property Center of Georgia – Sakpatenti.

Said information, according to the Law of Georgia on Appellations of Origins and Geographical Indications of Goods shall be published in the Official Bulletin of Industrial Property of Georgia, and in one central and one local newspaper.

Notes and additional information shall be sent to the Ministry of Environmental Protection and Agriculture of Georgia for study within 3 months after publication.

If no additional information is received by Sakpatenti concerning these materials within 3 months, the published data about PDO Wine "Kindzmarauli" shall be reflected in the State Register of Appellations of Origin and Geographical Indications.

#### **PARAGRAPHS 5 AND 9 OF THE SPECIFICATIONS SHALL BE AMENDED AND FORMED AS FOLLOWS:**

##### **5. VINE VARIETIES**

Wine "Kindzmarauli" shall be produced with the grapes of vine varieties Saperavi and Saperavi Budeshuri harvested in the Micro-zone Kindzmarauli, and usage of other vine varieties is prohibited.

##### **9. GRAPE PROCESSING, WINEMAKING AND BOTTLING**

The grapes for the production of the PDO Wine "Kindzmarauli" shall be harvested only from the vineyards situated in the Micro-zone Kindzmarauli.

Grapes processing and winemaking are permitted only within the Kakheti zone, and bottling – outside the zone, as well, but in the territory of Georgia.

At that, withdrawal of: grapes from the Micro-zone Kindzmarauli for the processing, and wine from the Kakheti vinery zone for bottling is permitted only under strict accounting and control conditions.

Wine "Kindzmarauli" shall be produced by incomplete alcoholic fermentation of must. Only operations, materials and substances permitted by the Legislation of Georgia shall be used during "Kindzmarauli" production.

Marketing of Wine "Kindzmarauli" shall be allowed only packed in the consumer containers.

---

**OFFICIAL NOTIFICATIONS**  
**INVENTIONS**  
**EXPIRATION OF PATENTS RESTORATION**

(21) AP 2016 14609  
(11) P 2020 7127 B  
(73) Ecole Polytechnique Federale de Lausanne (EPFL)  
(54) 2-HOMOPIPERAZINE-1-YL-4H-1,3-BENZOTHIAZINE-4-ONE DERIVATIVES AND PROCESS FOR  
THE PREPARATION OF 2-(HOMO)PIPERAZINE 1,3-BENZOTHIAZINE-4-ONE HYDROCHLORIDES  
DATE OF CANCELLATION OF PATENT: 2021 03 23  
THE TERM OF RESTORATION OF PATENT: 2021 09 27

---

(21) AP 2019 15162  
(11) P 2020 7180 B  
(73) Gia Megrelishvili  
(54) SEWERAGE DOUBLE PIPE  
DATE OF CANCELLATION OF PATENT: 2021 08 05  
THE TERM OF RESTORATION OF PATENT: 2021 09 27

---

**ABOLITION OF PATENTS WITH THE RIGHT TO RESTORE**

(21) AP 2011 12365  
(11) P 2014 6073 B  
(73) Elguja Bakhtadze  
(54) METHOD OF SOAP PRODUCTION  
DATE OF CANCELLATION OF PATENT: 2021 09 09  
THE TERM OF RESTORATION OF PATENT: 2022 09 09

---

(21) AP 2011 13039  
(11) P 2015 6262 B  
(73) FMC Corporation  
(54) FUNGICIDAL PYRAZOLES AND THEIR MIXTURES  
DATE OF CANCELLATION OF PATENT: 2021 09 01  
THE TERM OF RESTORATION OF PATENT: 2022 09 01

---

**EXPIRATION OF TERM OF RESTORATION OF PATENTS**

(21) AP 2006 10602  
(11) P 2010 5044 B  
(73) Takeda Pharmaceutical Company Limited  
(54) 1-HETEROCYCLYSULFONYL, 2-AMINOMETHYL, 5-(HETERO-) ARYL SUBSTITUTED  
1-H-PYRROLE DERIVATIVES AS ACID SECRETION INHIBITORS  
DATE OF CANCELLATION OF PATENT: 2020 08 29  
THE TERM OF RESTORATION OF PATENT VALIDITY HAS EXPIRED: 2021 08 29

---

(21) AP 2008 11754  
(11) P 2012 5540 B  
(73) HYGEN SIA  
(54) METHOD FOR COMPRESSING GASEOUS FUEL FOR FUELLING VEHICLE AND DEVICE FOR IMPLEMENTATION THEREOF  
DATE OF CANCELLATION OF PATENT: 2020 09 09  
THE TERM OF RESTORATION OF PATENT VALIDITY HAS EXPIRED: 2021 09 09

---

(21) AP 2014 13562  
(11) P 2016 6463 B  
(73) Georgian Technical University  
(54) METHOD FOR PLANTING STOCK AND PLANTATION BIOACTIVATION  
DATE OF CANCELLATION OF PATENT: 2020 08 29  
THE TERM OF RESTORATION OF PATENT VALIDITY HAS EXPIRED: 2021 08 29

---

(21) AP 2013 13760  
(11) P 2017 6789 B  
(73) Tracon Pharmaceuticals Inc.  
(54) ANTIBODY FORMULATIONS AND USES THEREOF  
DATE OF CANCELLATION OF PATENT: 2020 09 05  
THE TERM OF RESTORATION OF PATENT VALIDITY HAS EXPIRED: 2021 09 05

---

## UTILITY MODELS EXPIRATION OF PATENT RESTORATION

(21) AU 2015 13890  
(11) U 2016 1912 Y  
(73) Konstantine Maghradze;  
Nugzar Joglidze  
(54) COMPOSITION FOR BAKERY FOR PANCREATIC DIABETIC DIETARY MEAL  
DATE OF CANCELLATION OF PATENT: 2021 07 17  
THE TERM OF RESTORATION OF PATENT: 2021 09 27

---

## ABOLITION OF PATENTS WITH THE RIGHT TO RESTORE

(21) AU 2018 14834  
(11) U 2020 2050 Y  
(73) Simon Baramidze;  
Avtandil Bitsadze  
(54) DEVICE FOR OBTAINING AIR AND/OR WATER FOR NATURAL OR ARTIFICIAL RESERVOIR  
DATE OF CANCELLATION OF PATENT: 2021 07 17  
THE TERM OF RESTORATION OF PATENT: 2022 07 17

---

(21) AU 2019 15177  
(11) U 2021 2064 Y  
(73) LTD "Geo Mulch"  
(54) EXCLUSIVE TECHNOLOGY FOR ECOLOGICALLY PURE "BIOORGANIC MULCH" PRODUCTION  
DATE OF CANCELLATION OF PATENT: 2021 08 26  
THE TERM OF RESTORATION OF PATENT: 2022 08 26

---

## EXPIRATION OF TERM OF RESTORATION OF PATENT

(21) AU 2017 14575  
(11) U 2018 1986 Y  
(73) Elguja Shengelia  
(54) METHOD FOR ART EDITION PRODUCTION  
DATE OF CANCELLATION OF PATENT: 2020 08 18  
THE TERM OF RESTORATION OF PATENT VALIDITY HAS EXPIRED: 2021 08 18

---

---

# TRADEMARKS

## RENEWAL OF REGISTRATIONS

(111) M 2001 14054 R2  
(156) 2001 10 10  
(186) 2031 10 10  
(732) Ajinomoto Co., Inc.  
15-1, Kyobashi, 1-Chome, Chuo-ku, Tokyo,  
Japan

---

(111) M 2001 13978 R2  
(156) 2001 09 11  
(186) 2031 09 11  
(732) Kriter Brut de Brut  
Route de Challanges, 21200 Beaune, France

---

(111) M 2001 14071 R2  
(156) 2001 10 18  
(186) 2031 10 18  
(732) The Gillette Company LLC  
One Gillette Park, Boston, Massachusetts  
02127, USA

---

(111) M 2001 14072 R2  
(156) 2001 10 18  
(186) 2031 10 18  
(732) The Gillette Company LLC  
One Gillette Park, Boston, Massachusetts  
02127, USA

---

(111) M 2001 14073 R2  
(156) 2001 10 18  
(186) 2031 10 18  
(732) The Gillette Company LLC  
One Gillette Park, Boston, Massachusetts  
02127, USA

---

(111) M 2001 14133 R2  
(156) 2001 11 19  
(186) 2031 11 19  
(732) The Gillette Company LLC  
One Gillette Park, Boston, Massachusetts  
02127, USA

---

(111) M 2001 13985 R2  
(156) 2001 09 11  
(186) 2031 09 11  
(732) Nirma Chemical Works Private Limited  
Nirma house, Ashram Road, Ahmedabad  
380009, India

---

(111) M 2001 14191 R2  
(156) 2001 12 13  
(186) 2031 12 13  
(732) Deutsche Telekom AG  
Friedrich-Ebert-Allee 140, 53113 Bonn,  
Germany

---

(111) M 2001 14177 R2  
(156) 2001 12 13  
(186) 2031 12 13  
(732) Deutsche Telekom AG  
Friedrich-Ebert-Allee 140, 53113 Bonn,  
Germany

---

(111) M 2011 21734 R1  
(156) 2011 09 12  
(186) 2031 09 12  
(732) HP Hewlett Packard Group LLC  
11445 Compaq Center Drive West,  
Houston, Texas 77070, USA

---

(111) M 2011 21353 R1  
(156) 2011 04 06  
(186) 2031 04 06  
(732) JSC "Liberty Bank"  
Il. Chavchavadze Av. 74, 0162, Tbilisi,  
Georgia

---

(111) M 2011 21286 R1  
(156) 2011 03 15  
(186) 2031 03 15  
(732) JSC "Liberty Bank"  
Il. Chavchavadze Av. 74, 0162, Tbilisi,  
Georgia

---

(111) M 2011 21287 R1  
(156) 2011 03 15  
(186) 2031 03 15  
(732) JSC "Liberty Bank"  
Il. Chavchavadze Av. 74, 0162, Tbilisi,  
Georgia

---

(111) M 2011 21288 R1  
(156) 2011 03 15  
(186) 2031 03 15  
(732) JSC "Liberty Bank"  
Il. Chavchavadze Av. 74, 0162, Tbilisi,  
Georgia

---

(111) M 2011 21196 R1  
 (156) 2011 02 25  
 (186) 2031 02 25  
 (732) Anadolu Efes biracilik ve Malt Sanayi Anonim  
 Sirketi  
 Fatih Sultan Mehmet Mah. Balkan Cad.  
 Buyaka E Blok No: 58/24 Umraniye Istanbul,  
 Turkey

---

(111) M 2011 21289 R1  
 (156) 2011 03 15  
 (186) 2031 03 15  
 (732) JSC "Liberty Bank"  
 Il. Chavchavadze Av. 74, 0162, Tbilisi,  
 Georgia

---

(111) M 2011 21290 R1  
 (156) 2011 03 15  
 (186) 2031 03 15  
 (732) JSC "Liberty Bank"  
 Il. Chavchavadze Av. 74, 0162, Tbilisi,  
 Georgia

---

(111) M 2011 21291 R1  
 (156) 2011 03 15  
 (186) 2031 03 15  
 (732) JSC "Liberty Bank"  
 Il. Chavchavadze Av. 74, 0162, Tbilisi,  
 Georgia

---

(111) M 2011 21292 R1  
 (156) 2011 03 15  
 (186) 2031 03 15  
 (732) JSC "Liberty Bank"  
 Il. Chavchavadze Av. 74, 0162, Tbilisi,  
 Georgia

---

(111) M 2011 21293 R1  
 (156) 2011 03 15  
 (186) 2031 03 15  
 (732) JSC "Liberty Bank"  
 Il. Chavchavadze Av. 74, 0162, Tbilisi,  
 Georgia

---

(111) M 2011 21294 R1  
 (156) 2011 03 15  
 (186) 2031 03 15  
 (732) JSC "Liberty Bank"  
 Il. Chavchavadze Av. 74, 0162, Tbilisi,  
 Georgia

---

(111) M 2011 21295 R1  
 (156) 2011 03 15  
 (186) 2031 03 15  
 (732) JSC "Liberty Bank"  
 Il. Chavchavadze Av. 74, 0162, Tbilisi,  
 Georgia

---

(111) M 2011 21296 R1  
 (156) 2011 03 15  
 (186) 2031 03 15  
 (732) JSC "Liberty Bank"  
 Il. Chavchavadze Av. 74, 0162, Tbilisi,  
 Georgia

---

(111) M 2011 21298 R1  
 (156) 2011 03 15  
 (186) 2031 03 15  
 (732) JSC "Liberty Bank"  
 Il. Chavchavadze Av. 74, 0162, Tbilisi,  
 Georgia

---

(111) M 2011 21299 R1  
 (156) 2011 03 15  
 (186) 2031 03 15  
 (732) JSC "Liberty Bank"  
 Il. Chavchavadze Av. 74, 0162, Tbilisi,  
 Georgia

---

(111) M 2011 21480 R1  
 (156) 2011 05 16  
 (186) 2031 05 16  
 (732) MET-Rx Substrate Technology Inc.  
 2100 Smithtown Avenue, Ronkonkoma,  
 New York 11779, USA

---

(111) M 2011 21481 R1  
 (156) 2011 05 16  
 (186) 2031 05 16  
 (732) Natur's Bounty (NY) Inc.  
 2100 Smithtown Avenue, Ronkonkoma,  
 New York 11779, USA

---

(111) M 2011 21795 R1  
 (156) 2011 09 19  
 (186) 2031 09 19  
 (732) Solgar Holdings Inc.  
 2100 Smithtown Avenue, Ronkonkoma,  
 New York 11779, USA

---

(111) M 2011 21796 R1  
(156) 2011 09 19  
(186) 2031 09 19  
(732) Solgar Holdings Inc.  
2100 Smithtown Avenue, Ronkonkoma,  
New York 11779, USA

---

(111) M 2011 21726 R1  
(156) 2011 08 23  
(186) 2031 08 23  
(732) Emirates Telecommunications Group  
Company (Etisalat Group) PJSC  
Etisalat taueri, p.o. boqs 3838 abu dabi,  
United Arab Emirates

---

(111) M 2011 21727 R1  
(156) 2011 08 23  
(186) 2031 08 23  
(732) Emirates Telecommunications Group  
Company (Etisalat Group) PJSC  
Etisalat taueri, p.o. boqs 3838 abu dabi,  
United Arab Emirates

---

(111) M 2011 21763 R1  
(156) 2011 09 16  
(186) 2031 09 16  
(732) JSC "Liberty Bank"  
Il. Chavchavadze Av. 74, 0162, Tbilisi,  
Georgia

---

(111) M 2011 21764 R1  
(156) 2011 09 16  
(186) 2031 09 16  
(732) JSC "Liberty Bank"  
Il. Chavchavadze Av. 74, 0162, Tbilisi,  
Georgia

---

(111) M 2011 21942 R1  
(156) 2011 10 28  
(186) 2031 10 28  
(732) Anhui Jianghuai Automobile Co., Ltd.  
№176 Dongliu Road, Hefei City,  
Anhui Province, China

---

(111) M 2011 22149 R1  
(156) 2011 12 29  
(186) 2031 12 29  
(732) BR IP Holder LLC  
130 Royall Street, Suite 300, P.O. Box 9141,  
Canton, Massachusetts 02021, USA

---

(111) M 2011 22150 R1  
(156) 2011 12 29  
(186) 2031 12 29  
(732) BR IP Holder LLC  
130 Royall Street, Suite 300, P.O. Box 9141,  
Canton, Massachusetts 02021, USA

---

(111) M 2011 22151 R1  
(156) 2011 12 29  
(186) 2031 12 29  
(732) BR IP Holder LLC  
130 Royall Street, Suite 300, P.O. Box 9141,  
Canton, Massachusetts 02021, USA

---

(111) M 2011 22152 R1  
(156) 2011 12 29  
(186) 2031 12 29  
(732) BR IP Holder LLC  
130 Royall Street, Suite 300, P.O. Box 9141,  
Canton, Massachusetts 02021, USA

---

(111) M 2011 21978 R1  
(156) 2011 11 17  
(186) 2031 11 17  
(732) JSC "Liberty Bank"  
Il. Chavchavadze Av. 74, 0162, Tbilisi,  
Georgia

---

(111) M 2011 21979 R1  
(156) 2011 11 17  
(186) 2031 11 17  
(732) JSC "Liberty Bank"  
Ilia Tchavtchavadze ave. 74, 0162, Tbilisi,  
Georgia

---

(111) M 2011 21980 R1  
(156) 2011 11 17  
(186) 2031 11 17  
(732) JSC "Liberty Bank"  
Il. Chavchavadze Av. 74, 0162, Tbilisi,  
Georgia

---

(111) M 2012 22326 R1  
(156) 2012 02 24  
(186) 2032 02 24  
(732) Toyota Jidosha Kabushiki Kaisha  
(also trading as Toyota Motor Corporation)  
1, Toyota-Cho, Toyota-Shi, Aichi-Ken, Japan

---

(111) M 2012 22336 R1  
(156) 2012 02 24  
(186) 2032 02 24  
(732) Toyota Jidosha Kabushiki Kaisha  
(also trading as Toyota Motor Corporation)  
1, Toyota-Cho, Toyota-Shi, Aichi-Ken, Japan

---

(111) M 2011 21809 R1  
(156) 2011 09 22  
(186) 2031 09 22  
(732) Tengiz Apkhaidze  
Panaskerteli St. 16, app. 32, 0194, Tbilisi,  
Georgia

---

(111) M 2011 21903 R1  
(156) 2011 10 21  
(186) 2031 10 21  
(732) Tengiz Apkhaidze  
Panaskerteli St. 16, app. 32, 0194, Tbilisi,  
Georgia

---

(111) M 2011 22114 R1  
(156) 2011 12 23  
(186) 2031 12 23  
(732) LTD "Suntrade"  
Varketili-3, IIIa mcr., korp. 340, app. 8,  
0163, Tbilisi, Georgia

---



## COMPLETE TRANSFER OF RIGHTS

(111) M 2021 34113 R  
 (732) LTD "Glavspirtprom"  
 Lilo Settlement 51, Samgori District, Tbilisi  
 Georgia

(770) LTD "Iveria"  
 Tevdore Mghvdeli St. 53, 0154, Tbilisi  
 Georgia  
 (580) 2021 09 10

(111) M 2004 15742 R  
 (732) Merz Consumer Care GmbH  
 Eckenheimer Landstr. 100 60318 Frankfurt  
 am Main, Germany  
 (770) Merz Pharma GmbH & CO. KgaA  
 Eckenheimer Landstrasse 100, 60318  
 Frankfurt am Main, Germany  
 (580) 2021 08 11

(111) M 1996 2786 R  
 (732) Hormel Foods Corporation  
 1 Hormel Place, Austin, Minnesota  
 55912, USA  
 (770) Kraft Foods Group Brands LLC  
 200 East Randolph Street, Chicago,  
 Illinois 60601, USA  
 (580) 2021 09 13

(111) M 2014 24711 R  
 (732) Tillotts Pharma AG  
 Baslerstrasse 15, CH-4310 Rheinfelden,  
 Switzerland  
 (770) Astellas Pharma Europe B.V.  
 Sylviusweg 62, 2333 BE LEIDEN,  
 Netherlands  
 (580) 2021 08 23

(111) M 2015 25730 R  
 (732) LTD "Glavspirtprom"  
 Lilo Settlement 51, Samgori District, Tbilisi  
 Georgia  
 (770) LTD "Geo-Alco"  
 Lilo Settlement 51, Samgori District, Tbilisi  
 Georgia  
 (580) 2021 08 25

(111) M 2015 26085 R  
 (732) LTD "Glavspirtprom"  
 Lilo Settlement 51, Samgori District, Tbilisi  
 Georgia

(770) LTD "Geo-Alco"  
 Lilo Settlement 51, Samgori District, Tbilisi  
 Georgia  
 (580) 2021 08 25

(111) M 2016 27701 R  
 (732) Bayer Animal Health GmbH  
 Kaiser-Wilhelm-Allee 20, 51373 Leverkusen,  
 Germany  
 (770) Bayer Intellectual Property GmbH  
 Alfred-Nobel-Strasse 10, 40789 Monheim  
 am Rhein, Germany  
 (580) 2021 09 13

(111) M 2016 27702 R  
 (732) Bayer Animal Health GmbH  
 Kaiser-Wilhelm-Allee 20, 51373 Leverkusen,  
 Germany  
 (770) Bayer Intellectual Property GmbH  
 Alfred-Nobel-Strasse 10, 40789 Monheim  
 am Rhein, Germany  
 (580) 2021 09 10

(111) M 2016 27971 R  
 (732) Bayer Animal Health GmbH  
 Kaiser-Wilhelm-Allee 20, 51373 Leverkusen,  
 Germany  
 (770) Bayer Intellectual Property GmbH  
 Alfred-Nobel-Straße 10, 40789 Monheim  
 am Rhein, Germany  
 (580) 2021 09 10

(111) M 2016 27972 R  
 (732) Bayer Animal Health GmbH  
 Kaiser-Wilhelm-Allee 20, 51373 Leverkusen,  
 Germany  
 (770) Bayer Intellectual Property GmbH  
 Alfred-Nobel-Straße 10, 40789 Monheim  
 am Rhein, Germany  
 (580) 2021 09 10

(111) M 2018 30313 R  
 (732) Hormel Foods Corporation  
 1 Hormel Place, Austin, Minnesota 55912,  
 USA  
 (770) Kraft Foods Group Brands LLC  
 200 Ist Rendolf Strit, Chikago, Ilinois 60601,  
 USA  
 (580) 2021 09 13

(111) M 1997 7723 R  
(732) Bayer Animal Health GmbH  
Kaiser-Wilhelm-Allee 20, 51373 Leverkusen,  
Germany  
(770) Bayer Intellectual Property GmbH  
Alfred-Nobel-Strasse 10, 40789 Monheim  
am Rhein, Germany  
(580) 2021 09 13

---

## CHANGES OF NAMES AND/OR ADDRESS OF OWNERS

(111) M 1997 5615 R  
(732) GSK Consumer Healthcare SARL  
Route de L'Etlaz, 1197 Prangins, Switzerland  
(770) GSK Consumer Healthcare S.A.  
Route de L'Etlaz, 1197 Prangins, Switzerland  
(580) 2021 09 03

---

(111) M 1995 1114 R  
(732) Japan Tobacco Inc.  
1-1, Toranomom 4-chome, Minato-ku, Tokyo,  
Japan  
(770) Japan Tobacco Inc.  
2-2-1 Toranomom Minato-ku, Tokyo, Japan  
(580) 2021 08 25

---

(111) M 1995 1037 R  
(732) Japan Tobacco Inc.  
1-1, Toranomom 4-chome, Minato-ku, Tokyo,  
Japan  
(770) Japan Tobacco Inc.  
2-2-1 Toranomom Minato-ku, Tokyo, Japan  
(580) 2021 08 25

---

(111) M 2009 19736 R  
(732) British American Tobacco Exports Limited  
Globe House, 1 Water Street, London,  
WC2R 3LA, United Kingdom  
(770) British American Tobacco Western Europe  
Commercial Trading Limited  
Globe House, 1 Water Street, London,  
WC2R 3LA, United Kingdom  
(580) 2021 09 15

---

(111) M 2009 19737 R  
(732) British American Tobacco Exports Limited  
Globe House, 1 Water Street, London,  
WC2R 3LA, United Kingdom

(770) British American Tobacco Western Europe  
Commercial Trading Limited  
Globe House, 1 Water Street, London,  
WC2R 3LA, United Kingdom  
(580) 2021 09 15

---

(111) M 2007 17640 R  
(732) GSK Consumer Healthcare SARL  
Route de L'Etlaz, 1197 Prangins, Switzerland  
(770) GSK Consumer Healthcare S.A.  
Route de L'Etlaz, 1197 Prangins, Switzerland  
(580) 2021 09 03

---

(111) M 2007 17643 R  
(732) GSK Consumer Healthcare SARL  
Route de L'Etlaz, 1197 Prangins, Switzerland  
(770) GSK Consumer Healthcare S.A.  
Route de L'Etlaz, 1197 Prangins, Switzerland  
(580) 2021 09 03

---

(111) M 2007 17645 R  
(732) GSK Consumer Healthcare SARL  
Route de L'Etlaz, 1197 Prangins, Switzerland  
(770) GSK Consumer Healthcare S.A.  
Route de L'Etlaz, 1197 Prangins, Switzerland  
(580) 2021 09 03

---

(111) M 2007 17648 R  
(732) GSK Consumer Healthcare SARL  
Route de L'Etlaz, 1197 Prangins, Switzerland  
(770) GSK Consumer Healthcare S.A.  
Route de L'Etlaz, 1197 Prangins, Switzerland  
(580) 2021 09 03

---

(111) M 2007 18045 R  
(732) GSK Consumer Healthcare SARL  
Route de L'Etlaz, 1197 Prangins, Switzerland

(770) GSK Consumer Healthcare S.A.  
Route de L'Etlaz, 1197 Prangins, Switzerland  
(580) 2021 09 03

---

(111) M 2007 18091 R  
(732) GSK Consumer Healthcare SARL  
Route de L'Etlaz, 1197 Prangins, Switzerland  
(770) GSK Consumer Healthcare S.A.  
Route de L'Etlaz, 1197 Prangins, Switzerland  
(580) 2021 09 03

---

(111) M 2008 18742 R  
(732) GSK Consumer Healthcare SARL  
Route de L'Etlaz, 1197 Prangins, Switzerland  
(770) GSK Consumer Healthcare S.A.  
Route de L'Etlaz, 1197 Prangins, Switzerland  
(580) 2021 09 03

---

(111) M 2009 19498 R  
(732) GSK Consumer Healthcare SARL  
Route de L'Etlaz, 1197 Prangins, Switzerland  
(770) GSK Consumer Healthcare S.A.  
Route de L'Etlaz, 1197 Prangins, Switzerland  
(580) 2021 09 03

---

(111) M 2009 19820 R  
(732) GSK Consumer Healthcare SARL  
Route de L'Etlaz, 1197 Prangins, Switzerland  
(770) GSK Consumer Healthcare S.A.  
Route de L'Etlaz, 1197 Prangins, Switzerland  
(580) 2021 09 03

---

(111) M 2011 21114 R  
(732) Coors Brewing Company  
3939 W. Highland Boulevard, Milwaukee,  
Wisconsin 53208, USA  
(770) Coors Brewing Company  
1801 California Street, Suite 4600, Denver,  
Colorado 80202, USA  
(580) 2021 09 03

---

(111) M 2011 21196 R  
(732) Anadolu Efes biracilic ve Malt Sanayi Anonim  
Sirketi  
Fatih Sultan Mehmet Mah. Balkan Cad.  
Buyaka E Blok №58/24 Umraniye Istanbul,  
Turkey  
(770) Anadolu Efes biracilic ve Malt Sanayi Anonim  
Sirketi  
Bahcelievler mah. Adnan Kahveci Bulvari  
№5 Bahcelievler Istanbul, Turkey  
(580) 2021 08 23

---

(111) M 2011 21726 R  
(732) Emirates Telecommunications Group  
Company (Etisalat Group) PJSC  
Etisalat Taueri, p.o. boqs 3838 Abu Dabi,  
United Arab Emirates  
(770) Emirates Telecommunications Corporation  
Etisalat Taueri, p.o. boqs 3838 Abu Dabi,  
United Arab Emirates  
(580) 2021 08 20

---

(111) M 2011 21727 R  
(732) Emirates Telecommunications Group  
Company (Etisalat Group) PJSC  
Etisalat Taueri, p.o. boqs 3838 Abu Dabi,  
United Arab Emirates  
(770) Emirates Telecommunications Corporation  
Etisalat Taueri, p.o. boqs 3838 Abu Dabi,  
United Arab Emirates  
(580) 2021 08 20

---

## CANCELLATION OF TRADEMARKS REGISTRATION

---

(111) M 2001 13818 R

(151) 2001 03 08

(732) Nature America Inc.  
a New York USA Corporation  
75 Varick Street, New York,  
New York 10013, USA

(141) 2021 09 16

---

(111) M 2001 13799 R

(151) 2001 03 02

(732) Hewlett-Packard Development Company L.P.  
11445 Compaq Center Drive West, Houston,  
Texas 77070, USA

(141) 2021 09 13

---

(111) M 2001 13810 R

(151) 2001 03 02

(732) LTD "Standard Tobacco Incorporated"  
Abuseridze-Tbeli St. 13, 0120, Tbilisi,  
Georgia

(141) 2021 09 13

---

(111) M 2001 13811 R

(151) 2001 03 02

(732) LTD "Standard Tobacco Incorporated"  
Abuseridze-Tbeli St. 13, 0120, Tbilisi,  
Georgia

(141) 2021 09 13

---

(111) M 2001 13813 R

(151) 2001 03 02

(732) LTD "Standard Tobacco Incorporated"  
Abuseridze-Tbeli St. 13, 0120, Tbilisi,  
Georgia

(141) 2021 09 13

---

(111) M 2001 13814 R

(151) 2001 03 02

(732) LTD "Standard Tobacco Incorporated"  
Abuseridze-Tbeli St. 13, 0120, Tbilisi,  
Georgia

(141) 2021 09 13

---

(111) M 2001 13804 R

(151) 2001 03 02

(732) Corning Incorporated  
Haughton Park, City of Corning,  
State of New York 14831, USA

(141) 2021 09 13

---

(111) M 2001 13807 R

(151) 2001 03 02

(732) Alcon Inc.  
Rue Louis-d'Affry 6, CH-1701 Fribourg,  
Switzerland

(141) 2021 09 13

---

(111) M 2011 21223 R

(151) 2011 03 01

(732) Novartis AG  
4002 Basel, Switzerland

(141) 2021 09 09

---

(111) M 2011 21224 R

(151) 2011 03 01

(732) Novartis AG  
4002 Basel, Switzerland

(141) 2021 09 09

---

(111) M 2011 21226 R

(151) 2011 03 01

(732) Golden Brands Limited  
Arch. Makariou III, 284, Fortuna Court  
Block B, 2nd floor, P.C. 3105, Limassol,  
Cyprus

(141) 2021 09 09

---

(111) M 2011 21227 R

(151) 2011 03 01

(732) Golden Brands Limited  
Arch. Makariou III, 284, Fortuna Court  
Block B, 2nd floor, P.C. 3105, Limassol,  
Cyprus

(141) 2021 09 09

---

(111) M 2011 21228 R

(151) 2011 03 01

(732) Super-Max IPR Holdings AG  
c/o Schwerzmann Partners AG,  
Gotthardstrasse 31, 6300 Zug, Switzerland

(141) 2021 09 09

---

(111) M 2011 21229 R

(151) 2011 03 01

(732) Super-Max IPR Holdings AG  
c/o Schwerzmann Partners AG,  
Gotthardstrasse 31, 6300 Zug, Switzerland

(141) 2021 09 09

---

(111) M 2011 21231 R  
(151) 2011 03 01  
(732) Golden Brands Limited  
Arch. Makariou III, 284, Fortuna Court  
Block B, 2nd floor, P.C. 3105, Limassol,  
Cyprus  
(141) 2021 09 09

---

(111) M 2011 21232 R  
(151) 2011 03 01  
(732) The Coca-Cola Company  
One Coca-Cola Plaza, Atlanta, Georgia  
30313, USA  
(141) 2021 09 09

---

(111) M 2011 21233 R  
(151) 2011 03 01  
(732) Kakhaber Koberidze  
Constitution st. 48, 3700, Rustavi, Georgia  
(141) 2021 09 09

---

(111) M 2011 21234 R  
(151) 2011 03 01  
(732) LTD "AEA"  
Meunargia St. 71, app. 23, 0101, Tbilisi,  
Georgia  
(141) 2021 09 09

---

(111) M 2011 21235 R  
(151) 2011 03 01  
(732) LTD "AEA"  
Meunargia St. 71, app. 23, 0101, Tbilisi,  
Georgia  
(141) 2021 09 09

---

(111) M 2011 21236 R  
(151) 2011 03 01  
(732) Global Conquistadors S.A.  
Cuba Avenue №36-36, Po Box 0816-06748,  
Panama 5, Republic of Panama  
(141) 2021 09 09

---

## REGISTRATION OF LICENSE AGREEMENTS

(111) M 2015 26369 R  
(732) DD IP Holder LLC  
130 Royall Street, Canton, Massachusetts  
02021, USA

(791) Dunkin' Donuts Franchising LLC  
P.O. Box 9141, Canton MA 02021, USA

(793) №1659  
04 03 2021 For a period of validity of the mark  
Simple  
Class – 29, 30, 32, 43

---

(111) M 2015 26416 R  
(732) DD IP Holder LLC  
130 Royall Street, Canton, Massachusetts  
02021, USA

(791) Dunkin' Donuts Franchising LLC  
P.O. Box 9141, Canton MA 02021, USA

(793) №1665  
04 03 2021 For a period of validity of the mark  
Simple  
Class – 30, 43

---

(111) M 2015 26417 R  
(732) DD IP Holder LLC  
130 Royall Street, Canton, Massachusetts  
02021, USA

(791) Dunkin' Donuts Franchising LLC  
P.O. Box 9141, Canton MA 02021, USA

(793) №1660  
04 03 2021 For a period of validity of the mark  
Simple  
Class – 30, 32, 43

---

(111) M 2015 26418 R  
(732) DD IP Holder LLC  
130 Royall Street, Canton, Massachusetts  
02021, USA

(791) Dunkin' Donuts Franchising LLC  
P.O. Box 9141, Canton MA 02021, USA

(793) №1662  
04 03 2021 For a period of validity of the mark  
Simple  
Class – 43

---

(111) M 2015 26419 R  
(732) DD IP Holder LLC  
130 Royall Street, Canton, Massachusetts  
02021, USA

(791) Dunkin' Donuts Franchising LLC  
P.O. Box 9141, Canton MA 02021, USA

(793) №1664  
04 03 2021 For a period of validity of the mark  
Simple  
Class – 30

---

(111) M 2015 26436 R  
(732) DD IP Holder LLC  
130 Royall Street, Canton, Massachusetts  
02021, USA

(791) Dunkin' Donuts Franchising LLC  
P.O. Box 9141, Canton MA 02021, USA

(793) №1663  
04 03 2021 For a period of validity of the mark  
Simple  
Class – 43

---

(111) M 2015 26569 R  
(732) DD IP Holder LLC  
130 Royall Street, Canton, Massachusetts  
02021, USA

(791) Dunkin' Donuts Franchising LLC  
P.O. Box 9141, Canton MA 02021, USA

(793) №1661  
04 03 2021 For a period of validity of the mark  
Simple  
Class – 43

---

## INTERNATIONAL LICENSE AGREEMENTS

(800) 1217667  
(732) DD IP Holder LLC  
130 Royall Street, Canton, MA 02021, USA  
(791) Dunkin' Donuts Franchising LLC  
P.O. Box 9141, Canton MA 02021, USA  
(793) №1658  
Simple  
04 03 2021 For a period of validity of the mark  
Class – 30

---

(800) 1223017  
(732) DD IP Holder LLC  
P.O. Box 9141, Canton MA 02021, s88  
(791) Dunkin' Donuts Franchising LLC  
P.O. Box 9141, Canton MA 02021, USA  
(793) №1657  
Simple  
04 03 2021 For a period of validity of the mark  
Class – 30, 32

---

## CHANGE OF THE LIST OF GOODS AND/OR SERVICES OF TRADEMARK

(111) M 2003 15376 R  
(732) Betek Boya ve Kimya Sanayi A.S.  
Zümrütevler Mahallesi Ural Sokak No:38  
Maltepe 34852 Stamboli, Turkey  
(511) 2, 19, 35  
(580) 2021 07 09

---

---

# CLASSIFICATION INDEXES

## INVENTIONS

### CONCORDANCE TABLE OF INTERNATIONAL CLASSIFICATION INDEX AND PUBLICATION NUMBERS

INTERNATIONAL CLASSIFICATION INDEXES (51)	NUMBER OF PUBLISHED APPLICATION (10)
A 23 C 9/13; A 23 C 21/00	AP 2021 15480 A
A 61 K 31/424; A 61 K 31/5365; A 61 K 31/4985; A 61 P 31/18; C 07 D 498/16; C 07 D 487/16	AP 2021 15121 A
B 61 H 1/00; F 16 D 65/06	AP 2021 15348 A
E 02 D 29/02; E 02 D 17/20	AP 2021 14774 A

### CONCORDANCE TABLE OF PUBLICATION NUMBERS AND INTERNATIONAL CLASSIFICATION INDEX

NUMBER OF PUBLISHED APPLICATION (10)	INTERNATIONAL CLASSIFICATION INDEXES (51)
AP 2021 14774 A	E 02 D 29/02; E 02 D 17/20
AP 2021 15121 A	A 61 K 31/424; A 61 K 31/5365; A 61 K 31/4985; A 61 P 31/18; C 07 D 498/16; C 07 D 487/16
AP 2021 15348 A	B 61 H 1/00; F 16 D 65/06
AP 2021 15480 A	A 23 C 9/13; A 23 C 21/00

### CONCORDANCE TABLE OF INTERNATIONAL CLASSIFICATION INDEX, PATENT NUMBERS AND PUBLICATION NUMBERS

INTERNATIONAL CLASSIFICATION INDEX (51)	NUMBER OF PATENT (11)	NUMBER OF PUBLISHED APPLICATION (10)
A 47 L 1/00; E 06 B 7/02; F 24 F 13/00	P 2021 7298 B	AP 2021 15271 A
A 61 L 2/24	P 2021 7297 B	AP 2021 15415 A
C 12 G 1/00; C 12 N 1/16	P 2021 7291 B	AP 2021 15336 A
C 12 G 1/00; C 12 N 1/16	P 2021 7292 B	AP 2021 15335 A
C 12 G 1/00; C 12 N 1/16	P 2021 7293 B	AP 2021 15334 A
C 12 G 1/00; C 12 N 1/16	P 2021 7294 B	AP 2021 15333 A
F 01 C 1/077; F 01 C 1/18; F 01 K 7/36; F 01 K 13/00	P 2021 7295 B	AP 2021 15268 A
F 41 H 1/02	P 2021 7296 B	AP 2021 15326 A



**CONCORDANCE TABLE OF PATENT NUMBERS,  
PUBLICATION NUMBERS AND INTERNATIONAL CLASSIFICATION INDEX**

NUMBER OF PATENT (11)	NUMBER OF PUBLISHED APPLICATION (10)	INTERNATIONAL CLASSIFICATION INDEX (51)
P 2021 7291 B	AP 2021 15336 A	C 12 G 1/00; C 12 N 1/16
P 2021 7292 B	AP 2021 15335 A	C 12 G 1/00; C 12 N 1/16
P 2021 7293 B	AP 2021 15334 A	C 12 G 1/00; C 12 N 1/16
P 2021 7294 B	AP 2021 15333 A	C 12 G 1/00; C 12 N 1/16
P 2021 7295 B	AP 2021 15268 A	F 01 C 1/077; F 01 C 1/18; F 01 K 7/36; F 01 K 13/00
P 2021 7296 B	AP 2021 15326 A	F 41 H 1/02
P 2021 7297 B	AP 2021 15415 A	A 61 L 2/24
P 2021 7298 B	AP 2021 15271 A	A 47 L 1/00; E 06 B 7/02; F 24 F 13/00

**CONCORDANCE TABLE OF APPLICATION NUMBERS,  
PUBLICATION NUMBERS AND PATENTS**

NUMBER OF APPLICATION (21)	NUMBER OF PUBLISHED APPLICATION (10)	NUMBER OF PATENT (11)
AP 2018 15268	AP 2021 15268 A	P 2021 7295 B
AP 2020 15271	AP 2021 15271 A	P 2021 7298 B
AP 2020 15326	AP 2021 15326 A	P 2021 7296 B
AP 2020 15333	AP 2021 15333 A	P 2021 7294 B
AP 2020 15334	AP 2021 15334 A	P 2021 7293 B
AP 2020 15335	AP 2021 15335 A	P 2021 7292 B
AP 2020 15336	AP 2021 15336 A	P 2021 7291 B
AP 2020 15415	AP 2021 15415 A	P 2021 7297 B

## UTILITY MODELS

INTERNATIONAL CLASSIFICATION INDEXES (51)	NUMBER OF PUBLISHED APPLICATION (10)
B 61 H 1/00; F 16 D 65/06; F 16 D 69/02	AU 2021 15330 U
E 04 B 1/00	AU 2021 15425 U
F 16 D 65/06	AU 2021 15350 U

**CONCORDANCE TABLE OF PUBLICATION NUMBERS  
AND INTERNATIONAL CLASSIFICATION INDEX**

NUMBER OF PUBLISHED APPLICATION (10)	INTERNATIONAL CLASSIFICATION INDEXES (51)
AU 2021 15330 U	B 61 H 1/00; F 16 D 65/06; F 16 D 69/02
AU 2021 15350 U	F 16 D 65/06
AU 2021 15425 U	E 04 B 1/00

**CONCORDANCE TABLE OF INTERNATIONAL CLASSIFICATION INDEX,  
PATENT NUMBERS AND PUBLICATION NUMBERS**

INTERNATIONAL CLASSIFICATION INDEX (51)	NUMBER OF PATENT (11)	NUMBER OF PUBLISHED APPLICATION (10)
A 61 K 9/08; A 61 K 33/14; A 61 K 31/045; A 61 P 7/08	U 2021 2099 Y	AU 2021 15282 U
A 61 K 31/045; A 61 K 9/08; A 61 K 33/14; A 61 P 7/08	U 2021 2098 Y	AU 2021 15283 U
A 61 K 31/4985; A 61 K 31/519; A 61 P 15/10 A 61 N 5/06	U 2021 2096 Y U 2021 2097 Y	AU 2021 15494 U AU 2021 15445 U

**CONCORDANCE TABLE OF PATENT NUMBERS,  
PUBLICATION NUMBERS AND INTERNATIONAL CLASSIFICATION INDEX**

NUMBER OF PATENT (11)	NUMBER OF PUBLISHED APPLICATION (10)	INTERNATIONAL CLASSIFICATION INDEX (51)
U 2021 2096 Y	AU 2021 15494 U	A 61 K 31/4985; A 61 K 31/519; A 61 P 15/10
U 2021 2097 Y	AU 2021 15445 U	A 61 N 5/06
U 2021 2098 Y	AU 2021 15283 U	A 61 K 31/045; A 61 K 9/08; A 61 K 33/14; A 61 P 7/08
U 2021 2099 Y	AU 2021 15282 U	A 61 K 9/08; A 61 K 33/14; A 61 K 31/045; A 61 P 7/08

**CONCORDANCE TABLE OF APPLICATION NUMBERS,  
PUBLICATION NUMBERS AND PATENTS**

NUMBER OF APPLICATION (21)	NUMBER OF PUBLISHED APPLICATION (10)	NUMBER OF PATENT (11)
AU 2020 15282	AU 2021 15282 U	U 2021 2099 Y
AU 2020 15283	AU 2021 15283 U	U 2021 2098 Y
AU 2020 15445	AU 2021 15445 U	U 2021 2097 Y
AU 2020 15494	AU 2021 15494 U	U 2021 2096 Y

## DESIGNS

**CONCORDANCE TABLE OF INTERNATIONAL CLASSIFICATION INDEX  
AND PUBLICATION NUMBERS**

INTERNATIONAL CLASSIFICATION INDEXES (51)	NUMBER OF PUBLISHED APPLICATION (10)
25-01	AD 2021 1216 S

CONCORDANCE TABLE OF PUBLICATION NUMBERS  
AND INTERNATIONAL CLASSIFICATION INDEX

NUMBER OF PUBLISHED APPLICATION (10)	INTERNATIONAL CLASSIFICATION INDEXES (51)
AD 2021 1216 S	25-01

CONCORDANCE TABLE OF INTERNATIONAL CLASSIFICATION INDEX,  
NUMBERS OF REGISTRATION AND PUBLICATION NUMBERS

INTERNATIONAL CLASSIFICATION INDEX (51)	NUMBER OF REGISTRATION (11)	NUMBER OF PUBLISHED APPLICATION (10)
32-00	D 2021 905 S	AD 2021 1190 S

CONCORDANCE TABLE OF NUMBERS OF REGISTRATION,  
PUBLICATION NUMBERS AND INTERNATIONAL CLASSIFICATION INDEX

NUMBER OF REGISTRATION (11)	NUMBER OF PUBLISHED APPLICATION (10)	INTERNATIONAL CLASSIFICATION INDEX (51)
D 2021 905 S	AD 2021 1190 S	32-00

CONCORDANCE TABLE OF APPLICATION NUMBERS,  
PUBLICATION NUMBERS AND NUMBERS OF REGISTRATION

NUMBER OF APPLICATION (21)	NUMBER OF PUBLISHED APPLICATION (10)	NUMBER OF REGISTRATION (11)
AD 2020 1190	AD 2021 1190 S	D 2021 905 S

## TRADEMARKS

### CONCORDANCE TABLE OF REGISTRATION NUMBERS, APPLICATION NUMBERS, PUBLICATION NUMBERS AND BULLETIN NUMBERS

NUMBER OF REGISTRATION (111)	NUMBER OF APPLICATIONS (210)	NUMBER OF PUBLISHED APPLICATIONS (260)	NUMBER OF BULLETIN
M 2021 34486 R	AM 111879	–	17(573)2021
M 2021 34487 R	AM 114321	–	17(573)2021
M 2021 34488 R	AM 114341	–	17(573)2021
M 2021 34489 R	AM 114318	–	17(573)2021
M 2021 34490 R	AM 104328	AM 2021 104328 A	3(559)2021
M 2021 34491 R	AM 108231	AM 2021 108231 A	4(560)2021
M 2021 34492 R	AM 108696	AM 2021 108696 A	8(564)2021
M 2021 34493 R	AM 109035	AM 2021 109035 A	3(559)2021
M 2021 34494 R	AM 109118	AM 2021 109118 A	4(560)2021
M 2021 34495 R	AM 109232	AM 2021 109232 A	4(560)2021
M 2021 34496 R	AM 109298	AM 2021 109298 A	4(560)2021
M 2021 34497 R	AM 109300	AM 2021 109300 A	3(559)2021
M 2021 34498 R	AM 109772	AM 2021 109772 A	8(564)2021
M 2021 34499 R	AM 109852	AM 2021 109852 A	6(562)2021
M 2021 34500 R	AM 109916	AM 2021 109916 A	7(563)2021
M 2021 34501 R	AM 109918	AM 2021 109918 A	7(563)2021
M 2021 34502 R	AM 109920	AM 2021 109920 A	7(563)2021
M 2021 34503 R	AM 110041	AM 2021 110041 A	8(564)2021
M 2021 34504 R	AM 110113	AM 2021 110113 A	8(564)2021
M 2021 34505 R	AM 110114	AM 2021 110114 A	8(564)2021
M 2021 34506 R	AM 110132	AM 2021 110132 A	9(565)2021
M 2021 34507 R	AM 110220	AM 2021 110220 A	8(564)2021
M 2021 34508 R	AM 110221	AM 2021 110221 A	8(564)2021
M 2021 34509 R	AM 110229	AM 2021 110229 A	9(565)2021
M 2021 34510 R	AM 110477	AM 2021 110477 A	9(565)2021
M 2021 34511 R	AM 114240	–	17(573)2021
M 2021 34512 R	AM 114407	–	17(573)2021
M 2021 34513 R	AM 106780	AM 2021 106780 A	6(562)2021
M 2021 34514 R	AM 109214	AM 2021 109214 A	4(560)2021
M 2021 34515 R	AM 109222	AM 2021 109222 A	4(560)2021
M 2021 34516 R	AM 109288	AM 2021 109288 A	4(560)2021
M 2021 34517 R	AM 109753	AM 2021 109753 A	6(562)2021
M 2021 34518 R	AM 109826	AM 2021 109826 A	8(564)2021
M 2021 34519 R	AM 109934	AM 2021 109934 A	10(566)2021
M 2021 34520 R	AM 110017	AM 2021 110017 A	8(564)2021
M 2021 34521 R	AM 110033	AM 2021 110033 A	8(564)2021
M 2021 34522 R	AM 110045	AM 2021 110045 A	8(564)2021
M 2021 34523 R	AM 110212	AM 2021 110212 A	8(564)2021
M 2021 34524 R	AM 110217	AM 2021 110217 A	8(564)2021
M 2021 34525 R	AM 110283	AM 2021 110283 A	9(565)2021
M 2021 34526 R	AM 110359	AM 2021 110359 A	10(566)2021
M 2021 34527 R	AM 110378	AM 2021 110378 A	9(565)2021
M 2021 34528 R	AM 110450	AM 2021 110450 A	10(566)2021
M 2021 34529 R	AM 110538	AM 2021 110538 A	10(566)2021
M 2021 34530 R	AM 110611	AM 2021 110611 A	10(566)2021

**CONCORDANCE TABLE OF PUBLICATION NUMBERS  
AND APPLICATION NUMBERS**

NUMBER OF PUBLISHED APPLICATION (260)	NUMBER OF APPLICATION (210)	1	2
1	2		
AM 2021 104205 A*	AM 104205	AM 2021 111736 A	AM 111736
AM 2021 110188 A	AM 110188	AM 2021 111743 A	AM 111743
AM 2021 110616 A	AM 110616	AM 2021 111838 A	AM 111838
AM 2021 110952 A	AM 110952	AM 2021 111856 A	AM 111856
AM 2021 111520 A	AM 111520	AM 2021 111858 A	AM 111858
AM 2021 111528 A	AM 111528	AM 2021 111948 A	AM 111948
AM 2021 111529 A	AM 111529	AM 2021 111949 A	AM 111949
AM 2021 111600 A	AM 111600	AM 2021 111950 A	AM 111950
AM 2021 111618 A	AM 111618	AM 2021 111959 A	AM 111959
AM 2021 111619 A	AM 111619	AM 2021 111961 A	AM 111961
AM 2021 111722 A	AM 111722	AM 2021 111974 A	AM 111974
		AM 2021 112062 A	AM 112062
		AM 2021 112077 A	AM 112077
		AM 2021 112085 A	AM 112085
		AM 2021 112092 A	AM 112092

**CONCORDANCE TABLE OF INDEX OF GOODS AND/OR SERVICES  
AND APPLICATION NUMBERS**

INDEX OF GOODS AND/OR SERVICES (511)	NUMBER OF PUBLISHED APPLICATIONS (260)	1	2
1	2		
5	AM 2021 111858 A	32	AM 2021 112077 A
5	AM 2021 111949 A	33	AM 2021 111520 A
5	AM 2021 111950 A	33	AM 2021 111529 A
5	AM 2021 111959 A	33	AM 2021 111618 A
5	AM 2021 111961 A	33	AM 2021 111722 A
9	AM 2021 111959 A	33	AM 2021 112077 A
9	AM 2021 111974 A	34	AM 2021 110616 A
10	AM 2021 111959 A	34	AM 2021 111736 A
29	AM 2021 110188 A	35	AM 2021 104205 A*
29	AM 2021 111838 A	35	AM 2021 110188 A
29	AM 2021 112062 A	35	AM 2021 111520 A
29	AM 2021 112085 A	35	AM 2021 111528 A
29	AM 2021 112092 A	35	AM 2021 111600 A
30	AM 2021 110188 A	35	AM 2021 111618 A
30	AM 2021 111600 A	35	AM 2021 111619 A
30	AM 2021 111743 A	35	AM 2021 111838 A
30	AM 2021 111838 A	35	AM 2021 111948 A
31	AM 2021 110952 A	35	AM 2021 111959 A
31	AM 2021 111838 A	35	AM 2021 111974 A
32	AM 2021 110188 A	36	AM 2021 111528 A
32	AM 2021 111838 A	37	AM 2021 111619 A
32	AM 2021 111856 A	43	AM 2021 111743 A
		43	AM 2021 111838 A
		44	AM 2021 110952 A
		44	AM 2021 111948 A
		44	AM 2021 111959 A

CONCORDANCE TABLE OF INDEX OF GOODS AND/OR SERVICES  
AND NUMBERS OF TRADEMARKS REGISTERED ACCORDING  
TO THE ACCELERATED PROCEDURE

INDEX OF GOODS AND/OR SERVICES (511)	NUMBERS OF REGISTERED ACCORDING TO THE ACCELERATED PROCEDURE (111)
5	M 2021 34511 R
18	M 2021 34512 R
30	M 2021 34489 R
32	M 2021 34511 R
33	M 2021 34486 R
33	M 2021 34487 R
34	M 2021 34488 R
35	M 2021 34488 R

# **OFFICIAL BULLETIN OF THE INDUSTRIAL PROPERTY**

**INVENTIONS  
UTILITY MODELS  
DESIGNS  
TRADEMARKS  
APPELLATION OF ORIGIN OF GOOD**

## **17(573)**

EDITOR-IN-CHIEF: N. Bebrishvili

EDITOR-TRANSLATOR: E. Gabunia

PROOFREADER: A. Shikhashvili

COMPUTER LAYOUT: M. Ordenidze  
K. Svanidze

[info@sakpatenti.gov.ge](mailto:info@sakpatenti.gov.ge)  
[www.sakpatenti.gov.ge](http://www.sakpatenti.gov.ge)