

# Official Bulletin of the Industrial Property

Inventions

Utility Models

Designs

Traademarks

Appellations of Origin of Good



საქართველოს ინტელექტუალური  
საკუთრების ეროვნული ცენტრი

**საქპატენტი**

**SAKPATENTI**

NATIONAL INTELLECTUAL PROPERTY  
CENTER OF GEORGIA

[www.sakpatenti.gov.ge](http://www.sakpatenti.gov.ge)

Date of Publication – 2021 10 11

**18(574)**

# INID CODES FOR IDENTIFICATION OF BIBLIOGRAPHIC DATA

## INVENTIONS, UTILITY MODELS

- (10) Number of publication for application, which has been examined
- (11) Number of patent and kind of document
- (21) Serial number of application
- (22) Date of filing of the application
- (23) Date of exhibition or the date of the earlier filing and the number of application, if any
- (24) Date from which patent may have effect
- (31) Number of priority application
- (32) Date of filing of priority application
- (33) Code of the country or regional organization allotting priority application number
- (44) Date of publication of application not granted, but examined and number of bulletin
- (45) Date of publication of registered document
- (51) International Patent Classification Index

- (54) Title of the invention
- (57) Abstract
- (60) Number of examined patent document granted by foreign patent office, date from which patent has effect and country code
- (62) Number of the earlier application and in case of divided application, date of filing an application
- (71) Name, surname and address of applicant (country code)
- (72) Name, surname of inventor (country code)
- (73) Name, surname and address of patent owner (country code)
- (74) Name, surname of representative or patent attorney
- (85) Date of commencement of the national phase of International Application
- (86) Number and date of filing of international application
- (87) Number and date of publication of international application
- (94) Calculated date of expiry of the SPC or the duration of the SPC

## DESIGNS

- (10) Number of publication for application
- (11) Number of patent and kind of document or number of registration
- (15) Date of registration/Date of patent renewal
- (18) Expected expiration date of patent or registration
- (21) Serial number of application
- (22) Date of filing of the application
- (23) Date of exhibition or the date of the earlier filing and the number of application, if any
- (24) Date from which patent may have effect
- (28) Number of designs included in the application
- (30) Data relating to priority (number of application, date of filing of application, two-letter code identifying the authority with whom the priority application was made)
- (31) Number of priority application
- (32) Date of filing of priority application
- (33) Code of the country or regional organization allotting priority application number
- (34) Two-letter code according to WIPO St.3 identifying the authority with which the priority application was made
- (44) Date of publication of design and number of bulletin (the first publication)
- (45) Date of publication of design registered by WIPO and number of bulletin

- (51) International Classification for designs (class and subclass of the Locarno Classification)
- (54) Title of the invention
- (55) Reproduction of the design
- (57) Description of characteristic features of the design including indication of colors
- (58) Date of recording of any kind of amendment in the Register
- (62) Number of the earlier application, registration and document number and if available the date of filing an application in case of divided application
- (71) Name, surname and address of applicant (country code)
- (72) Name, surname of creator (country code)
- (73) Name, surname and address of patent owner (country code)
- (74) Name, surname of representative or patent attorney
- (81) Contracting states concerned
  - II designated contracting states according to the 1960 Act
  - III designated contracting states according to the 1999 Act
- (85) Owner's permanent address
- (86) Owner's nationality
- (87) Owner's residence
- (88) State in which the owner has a real and effective industrial or commercial establishment

## TRADEMARKS

- (111) - Number of registration
- (151) - Date of registration
- (156) - Date of the renewal
- (181) - Expected expiration date of registration
- (186) - Renewal expiration date of registration
- (141) - Date of cancel of duration of the mark
- (210) - Serial number of application
- (220) - Date of filing of the application
- (230) - Data concerning exhibition
- (260) - Number of application, for which favorable decision of examination about registration has been taken (publication number)
- (310) - Number of the first application
- (320) - Date of filing of the first application
- (330) - Code, identifying national or regional Office where the first application was made
- (511) - International Classification of Goods and Services for the purposes of registration of trade marks and/or list of goods and/or services classified according thereto
- (526) - Disclaimer
- (531) - Description of figurative elements of Trade Marks according to the International Classification of the Figurative Elements of Marks

- (540) - Reproduction of Trade Mark
- (550) - Nature and kind of Trade Mark
- (551) - Indication to the effect that the mark is a collective mark, a certification mark or a guarantee mark
- (554) - Three-dimensional mark
- (580) - Date of recording of any kind changes in respect of applications or registrations
- (591) - Information concerning colors claimed
- (731) - Name and address of the applicant
- (732) - Name and address of the holder of the registration
- (740) - Name and address of the representative
- (750) - Addreses for correspondence
- (770) - Name and address of the previous applicant or holder in case of change in ownership
- (771) - Previous name and address of the applicant or holder in case of change in ownership
- (791) - Name and address of the licensee
- (793) - Indication of conditions and/or restrictions under the license (Type of license, number of license agreement, data of license, data of validity of license)
- (800) - Certain data relating to the international registration of Trade Marks under the Protocol Relating to Madrid Agreement (International registration number)
- (852) - Partial cancellation of the list of goods and services
- (891) - Date of subsequent designation

## CODES FOR PUBLICATION IN BULLETIN

- (21) AP 0000 000000 - serial number of application for invention
- (10) AP 0000 0000 A - number of published application for invention (first publication)
- (11) P 0000 0000 B - number of patent for invention (second publication)
- (21) API 0000 000000 - number of application for imported patent
- (11) PI 0000 0000 A - number of imported patent (first publication)
- (21) AU 0000 000000 - serial number of application for utility model
- (10) AU 0000 000 U - number of published application for utility model (first publication)
- (11) U 0000 000 Y - number of patent for utility model (second publication)
- (21) AD 0000 000000 - serial number of application for design
- (10) AD 0000 000 S - number of published application for design (first publication)
- (11) D 0000 000 S - registered design

## INTERNATIONAL PATENT CLASSIFICATION FOR INVENTIONS AND UTILITY MODELS

- SECTION A - HUMAN NECESSITIES
- SECTION B - PERFORMING OPERATIONS; TRANSPORTING
- SECTION C - CHEMISTRY; METALLURGY
- SECTION D - TEXTILES; PAPER
- SECTION E - FIXED CONSTRUCTIONS
- SECTION F - MECHANICAL ENGINEERING; LIGHTING; HEATING; WEAPONS; BLASTING
- SECTION G - PHYSICS
- SECTION H - ELECTRICITY

- 
- M - Trade Mark
  - (210) AM 0000 000000 - Serial number of application;
  - (260) AAM 0000 00000 A - Publication number of application;
  - (111) M 0000 00000 R - Number of registration;
  - (111) MMM0000 00000 Rn - Number of renewals, in which n=1,2,3;
  - (111) M 0000 00000 R(P) - Number of registration under partial assignment of rights
-

# Official Bulletin of the Industrial Property

Inventions

Utility Models

Designs

Trademarks

Appellations of Origin of Good

# CONTENTS

<b>PUBLISHED TITLES OF PROTECTION</b> .....	3
<b>INVENTIONS</b>	
▪ APPLICATIONS APPROVED FOR GRANTING PATENT .....	4
▪ PATENTED INVENTIONS .....	7
<b>UTILITY MODELS</b>	
▪ APPLICATIONS APPROVED FOR GRANTING PATENT .....	10
▪ PATENTED UTILITY MODEL .....	11
<b>DESIGNS</b>	
▪ APPLICATION APPROVED FOR REGISTRATION .....	12
▪ REGISTERED DESIGN .....	13
▪ DESIGNS, WHICH HAVE BEEN REGISTERED WITH THE INTERNATIONAL BUREAU CLAIMING PRIORITY ON THE TERRITORY OF GEORGIA .....	14
<b>TRADEMARKS</b>	
▪ APPLICATIONS FILED UNDER THE NATIONAL PROCEDURE APPROVED FOR REGISTRATION .....	20
▪ REGISTERED TRADEMARKS .....	32
▪ TRADEMARKS REGISTERED ACCORDING TO THE ACCELERATED PROCEDURE .....	35
▪ INTERNATIONAL TRADEMARKS FOR WHICH A DECISION ON GRANTING PROTECTION IS TAKEN .....	38
▪ INTERNATIONAL TRADEMARKS PROTECTED IN GEORGIA .....	98
<b>APPELLATIONS OF ORIGIN OF GOOD</b>	
INTERNATIONAL APPELLATIONS OF ORIGIN OF GOOD .....	107
<b>OFFICIAL NOTIFICATIONS</b>	
<b>INVENTIONS</b>	
▪ EXPIRATION OF PATENT RESTORATION .....	108
▪ ABOLITION OF PATENT WITH THE RIGHT TO RESTORE .....	108
▪ CHANGE OF NAME AND/OR ADDRESS OF PATENTOWNER .....	108
<b>UTILITY MODEL</b>	
EXPIRATION OF TERM OF RESTORATION OF PATENT .....	108
<b>DESIGN</b>	
▪ EXTENSION OF DESIGN REGISTRATION .....	109
▪ CANCELLATION OF REGISTRATION OF DESIGN .....	109
▪ EXTENSION OF INTERNATIONAL DESIGNS REGISTRATION .....	109
▪ CANCELLATION OF REGISTRATION OF INTERNATIONAL DESIGNS .....	112
<b>TRADEMARKS</b>	
▪ RENEWAL OF REGISTRATIONS .....	114
▪ COMPLETE TRANSFER OF RIGHTS .....	116
▪ CHANGES OF NAMES AND/OR ADDRESSES OF OWNER .....	118
▪ CANCELLATION OF TRADEMARKS REGISTRATIONS .....	123
<b>CLASSIFICATION INDEXES</b>	
INVENTIONS .....	127
UTILITY MODELS .....	128
DESIGNS .....	129
TRADEMARKS .....	131

## **PUBLISHED TITLES OF PROTECTION**

### **INVENTIONS**

- **APPLICATION APPROVED FOR GRANTING PATENT:**  
15388; 15237; 15467; 14952; 15256
- **PATENTED INVENTIONS:**  
7299-7306

### **UTILITY MODELS**

- **APPLICATIONS APPROVED FOR GRANTING PATENT:**  
15374; 15359
- **PATENTED UTILITY MODEL:**  
2100

### **DESIGNS**

- **APPLICATION APPROVED FOR REGISTRATION:**  
1228
- **REGISTERED DESIGN:**  
906
- **DESIGNS, WHICH HAVE BEEN REGISTERED WITH THE INTERNATIONAL BUREAU CLAIMING PRIORITY ON THE TERRITORY OF GEORGIA:**  
212354; 212688; 212694; 212608

### **TRADEMARKS**

- **APPLICATIONS FILED UNDER THE NATIONAL PROCEDURE APPROVED FOR REGISTRATION:**  
10191, 110192; 111602; 111716; 111720; 111738; 111834; 111841; 111849-111854; 111859- 111861; 111869-111873; 111876; 111877; 111934-111938; 111942; 111944-111947; 111951; 111957; 111962-111964; 111966, 111967; 111970; 112044-112049; 112054; 112057; 112066, 112067; 112158; 112176; 112190; 112254, 112255; 112271; 112281; 112287; 112289, 112290; 112298, 112299; 112368-112373; 112472
- **REGISTERED TRADEMARKS:**  
34534; 34541-34570
- **TRADEMARKS REGISTERED ACCORDING TO THE ACCELERATED PROCEDURE:**  
34531-34533; 34535-34540; 34571-34575
- **INTERNATIONAL TRADEMARKS FOR WHICH A DECISION ON GRANTING PROTECTIONS IS TAKEN:**  
107015\*; 109645; 110726; 110802-110814; 110830-110839; 110855; 110857; 110892-110894; 110905-110913; 110920-110925; 110927, 110928; 110930; 110987; 110996-110999; 111004; 111016; 111026; 111051; 111058, 111059; 111098; 111122-111124; 111127; 111165; 111175-111179; 111200-111205; 111209; 111231; 111233, 111234; 111255-111259; 111293; 111296, 111297; 111303-111307; 111361; 111381; 111390, 111391; 111450; 111544, 111545
- **INTERNATIONAL TRADEMARKS PROTECTED IN GEORGIA:**  
106018; 106254; 108100; 108135; 108548; 108701; 108706; 109531, 109532; 109538- 109540; 109542; 109556-109561; 109581-109585; 109614-109617; 109622; 109627-109629; 109631-109633; 109638; 109642-109644; 109646-109649; 109683-109685; 109692; 109696; 109699; 109701-109703; 109705; 109711-109713; 109719; 109721, 109722; 109728; 109783; 109786-109788; 109803, 109804; 109809; 109814, 109815; 109818-109820; 109860-109865; 109869; 109893, 109894; 109902; 109908; 109965, 109966; 109968-109972; 109974, 109975; 109986, 109987; 110004-110007; 110049-110053; 110055-110060; 110072-110076; 110151, 110152; 110162-110165; 110240; 110251; 110326, 110327

### **APPELLATIONS OF ORIGIN OF GOOD**

1155; 1148

# INVENTIONS

## APPLICATIONS APPROVED FOR GRANTING PATENT

The decision can be appealed at the Chamber of Appeal of Sakpatenti within 3 months from the publication or at the Mtskheta District Court Administrative Cases Board (Address: №17, Samkhedro St., Mtskheta), within 1 month following the publication.

### PART A

#### A 01

(10) AP 2021 15388 A (51) Int. Cl. (2006)  
A 01 G 25/02  
C 02 F 1/14

(21) AP 2020 15388 (22) 2020 07 13

(71) Aleksandre Vashakidze (GE)  
L. Gudiashvili St. 27, 0181, Tskneti,  
Tbilisi, Georgia (GE);  
Giorgi Gakhokidze (GE)  
El. Andronikashvili St. 103, 0117,  
Tbilisi, Georgia (GE);  
Nugzar Meladze (GE)  
Bakhtrioni St., corp. 30, app. 41, 0194,  
Tbilisi, Georgia (GE)

(72) Aleksandre Vashakidze (GE);  
Giorgi Gakhokidze (GE);  
Nugzar Meladze (GE)

(54) METHOD FOR RECEIVING WATER  
 $H_3O_2$  CONTAINING FOURTH PHASE  
AND DEVICE FOR EXECUTING THEREOF

(57) A method for receiving water  $H_3O_2$  containing fourth phase provides to intake irrigation water from distilled water; at that, solar collector 6 is supplied with distilled water from a tank 2 with a pump 4 and a pipeline 5. Outlet pipeline area 7 disposed above solar collector is perforated to receive distilled water droplets into the solar collector, wherefrom glass cover is removed, and as a result thereof the distilled water is charged with whole spectrum of solar rays, simultaneously, charged with solar energy the water is heated up to 30-45°C, and as a result of this the water containing fourth phase is received.

Claims: 2 independents

Fig.: 1

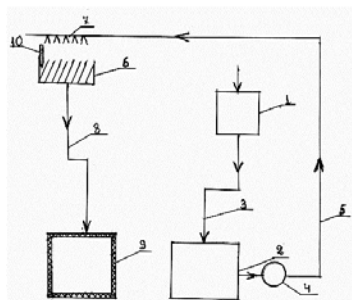

Fig. 1

#### A 23

(10) AP 2021 15237 A (51) Int. Cl. (2006)  
A 23 L 33/105  
A 61 Q 19/08

(21) AP 2017 15237 (22) 2017 12 15

(71) NAGAO, Tsukasa (JP)  
141-1 Kamiteru-cho, Nagahama-shi, 5260015  
Shiga, Japan (JP)

(72) NAGAO, Tsukasa (JP)

(74) Khatuna Imnadze

(85) 2019 12 16

(86) PCT/JP2017/045207, 2017 12 15

(54) ANTI-AGING HEALTH FOOD AND  
COSMETIC AND METHOD FOR  
PRODUCING GRAPESEED-DERIVED  
ANTI-AGING COMPONENT

(57) A method provides preparation of grapeseed-derived stimulating ingredient comprising health food and cosmetic.

Claims: 3 independents

1 dependent

Fig.: 5

#### A 61

(10) AP 2021 15467 A (51) Int. Cl. (2006)  
A 61 K 31/454  
A 61 P 29/00  
A 61 P 19/02  
A 61 P 17/06  
A 61 P 11/00

(21) AP 2018 15467 (22) 2018 03 06

(62) AP 2018 15309 2018 03 06

(31) 2017131435

(32) 2017 09 07

(33) RU

(71) Obschestvo s Ogranichennoi Otvetstvennostiyu  
"Pharmenterprises" (Ru)  
Skolkovo Innovation Centre, Bolshoj Blvd., 42,  
Bld. 1, Office 771, 772, 121205, Moscow,  
Russian Federation (RU)

(72) RYDLOVSKAYA, Anastasia Vladimirovna (RU);  
NEBOLSIN, Vladimir Evgenievich (RU)

(74) Shalva Gvaramadze

(85) 2020 10 12

(86) PCT/RU2018/000135, 2018 03 06

## (54) USE OF A GLUTARIMIDE DERIVATIVE TO TREAT DISEASES RELATED TO THE ABERRANT ACTIVITY OF CYTOKINES

(57) A remedy comprising 1-(2-(1H-imidazol-4-yl)ethyl)piperidine-2,6-dione as active ingredient is used at psoriasis prevention and/or treatment.

Claims: 2 independents

4 dependents

(10) AP 2021 14952 A (51) Int. Cl. (2006)  
 A 61 K 31/437  
 A 61 K 31/4375  
 A 61 K 31/444  
 A 61 K 31/4709  
 A 61 K 31/497  
 A 61 K 31/506  
 A 61 K 45/06  
 A 61 P 11/00  
 A 61 P 9/10  
 C 07 D 519/00  
 C 07 D 471/04

(21) AP 2017 14952 (22) 2017 05 08

(31) EP16168809.8

(32) 2016 05 09

(33) EP

(71) Bayer Aktiengesellschaft (DE)

Kaiser-Wilhelm-Allee 1, Leverkusen,  
51373, Germany (DE);

Bayer Pharma Aktiengesellschaft (DE)

Müllerstraße 178, Berlin, 13353, Germany (DE)

(72) TIMMERMANN, Andreas (DE);

ZUBOV, Dmitry (DE);

KÖLLING, Florian (DE);

BADOCK, Volker (DE);

MOOSMAYER, Dieter (DE);

SCHULZ, Alexander (DE);

BROCKSCHNIEDER, Damian (DE);

NEUBAUER, Thomas (DE);

SCHÄFER, Martina (DE);

TERJUNG, Carsten (DE);

LINDNER, Niels (DE);

MIYATAKE ONDOZABAL, Hideki (DE);

BIBER, Nicole (DE);

MOORE, Stephen (GB);

GERICKE, Kersten Matthias (DE);

MEDING, Jörg (DE);

MEIER, Heinrich (DE);

LUSTIG, Klemens (DE)

(74) Giorgi Kartvelishvili

(85) 2018 12 08

(86) PCT/EP2017/060900, 2017 05 08

(54) SUBSTITUTED 5,6,7,8-TETRAHYDRO  
 [1,2,4]TRIAZOLO[4,3-A]PYRIDINE-3  
 (2H)-ONES AND 2,5,6,7-TETRAHYDRO-  
 3H-PYRROLO[2,1-C][1,2,4]TRIAZOL-3-  
 ONES, AND USE THEREOF

(57) Compound of formula (I),

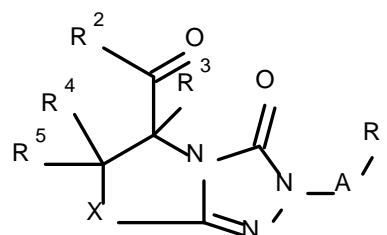

(I)

wherein values of A, X, R<sup>1</sup>, R<sup>2</sup>, R<sup>3</sup>, R<sup>4</sup>, R<sup>5</sup> substituents are provided in the claims, salts, solvates and salt solvates, and pharmaceutical compositions on the basis thereof, and usage thereof for the treatment of inflammatory pulmonary diseases, mainly, chronic obstructive pulmonary disease (COPD), emphysema of lungs, chronic bronchitis, etc.

Claims: 10 independents

13 dependents

Table: 5

Fig.: 7

(10) AP 2021 15256 A (51) Int. Cl. (2006)

A 61 K 31/5386

A 61 K 31/4995

A 61 P 25/00

A 61 P 11/00

C 07 D 498/08

C 07 D 471/08

(21) AP 2018 15256 (22) 2018 06 07

(31) 17176046.5; 17193252.8

(32) 2017 06 14; 2017 09 26

(33) EP; EP

(71) Bayer Aktiengesellschaft (DE)

Kaiser-Wilhelm-Allee, 51373 Leverkusen,  
Germany (DE);

Bayer Pharma Aktiengesellschaft (DE)

Müllerstraße 178, 13353 Berlin, Germany (DE)

(72) DELBECK, Martina (DE);

MÜLLER, Thomas (DE);

BECK-BROICHSITTER, Moritz (DE);

ALBUS, Udo (DE);

GEHRING, Doris (DE);

ROSENSTEIN, Björn (DE);

LINDNER, Niels (DE);

NICOLAI, Janine (DE);

HAHN, Michael (DE);

LUSTIG, Klemens (DE);

COLLINS, Karl (DE)

(74) Giorgi Kartvelishvili

(85) 2020 01 12

(86) PCT/EP2018/064977, 2018 06 07

(54) DIAZABICYCLIC SUBSTITUTED IMIDA-  
 ZOPYRIMIDINES AND THEIR USE FOR  
 THE TREATMENT OF BREATHING  
 DISORDERS

(57) Compound of formula (I),

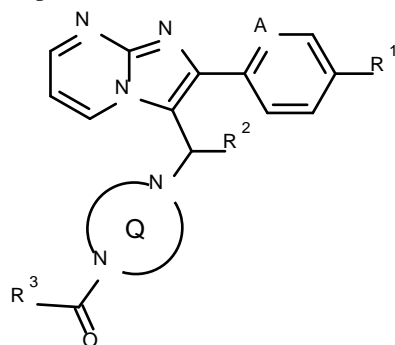

(I)

a method for producing thereof, the use thereof either alone or in combination for the treatment and/or prevention of diseases, as well as to their use for producing medicaments for the treatment of respiratory disorders, sleep-related respiratory disorders, obstructive and central sleep apnea and snoring.

Claims: 8 independents

7 dependents



# PATENTED INVENTIONS

## PART A

### A 01

- (11) P 2021 7299 B (51) Int. Cl. (2006)  
A 01 B 13/02  
A 01 B 49/02  
A 01 C 7/00
- (10) AP 2021 15395 A (44) 9(565)/2021  
(21) AP 2020 15395  
(22) 2020 07 20  
(24) 2020 07 20
- (73) Giorgi Kutelia (GE)  
Noste St. 7, 0101, Tbilisi, Georgia (GE);  
Jemal Katsitadze (GE)  
Ertso St. 4/4, app. 138, 0192, Tbilisi,  
Georgia (GE);  
Vladimer Miruashvili (GE)  
Dolidze St. 132, 0615, Tbilisi, Georgia (GE);  
Otar Karchava (GE)  
Giorgi Brtskinvale St. 41, app. 66, 1019,  
Tbilisi, Georgia (GE)
- (72) Giorgi Kutelia (GE);  
Jemal Katsitadze (GE);  
Vladimer Miruashvili (GE);  
Otar Karchava (GE)
- (54) PLASTIC MULCH LAYING MACHINE

### A 61

- (11) P 2021 7301 B (51) Int. Cl. (2006)  
A 61 K 31/519  
A 61 K 31/675  
A 61 K 31/55  
A 61 K 31/436  
A 61 K 31/4353  
A 61 K 31/407  
A 61 P 35/00
- (10) AP 2021 15006 A (44) 10(566)/2021  
(21) AP 2017 15006  
(22) 2017 07 21  
(24) 2017 07 21
- (31) 62/517,252; 62/464,554; 16306420.7;  
16180918.1
- (32) 2017 06 09; 2017 02 28; 2016 07 22;  
2016 10 28
- (33) US; US; EP; EP
- (86) PCT/EP2017/068453, 2017 07 21
- (73) Novartis AG (CH)  
Lichtstrasse 35, 4056 Basel, Switzerland (CH);  
Les Laboratoires Servier (FR)  
35, Rue de Verdun, 92284 Suresnes, Cedex,  
France (FR)

- (72) WEI, Andrew (AU);  
MOUJALLED, Donia (AU);  
POMILIO, Giovanna (AU);  
MARAGNO, Ana Leticia (FR);  
GENESTE, Olivier (FR);  
CLAPERON, Audrey (FR);  
MAACKKE, Heiko (CH);  
HALILOVIC, Ensar (US);  
PORTER, Dale (US);  
MORRIS, Erick (US);  
WANG, Youzhen (US);  
SANGHAVI, Sneha (US);  
MISTRY, Prakash (CH)
- (74) Tamaz Shilakadze
- (54) COMBINATION OF BCL-2 INHIBITOR  
AND MCL-1 INHIBITOR, USES AND  
PHARMACEUTICAL COMPOSITIONS  
THEREOF

## PART B

### B 66

- (11) P 2021 7303 B (51) Int. Cl. (2006)  
B 66 F 3/24
- (10) AP 2021 15375 A (44) 10(566)/2021  
(21) AP 2020 15375  
(22) 2020 06 21  
(24) 2020 06 21
- (73) Davit Loladze (GE)  
Paliashvili St. 37, 0179, Tbilisi, Georgia (GE)
- (72) Davit Loladze (GE)
- (54) FLAT FLEXIBLE JACK

## PART C

### C 01

- (11) P 2021 7302 B (51) Int. Cl. (2006)  
C 01 B 13/11
- (10) AP 2021 15372 A (44) 9(565)/2021  
(21) AP 2020 15372  
(22) 2020 06 17  
(24) 2020 06 17
- (73) Sopio Burjanadze (GE)  
Dighomi Massive, VI qu., corp. 5, app. 25,  
0159, Tbilisi, Georgia (GE);

- Jano Burjanadze (GE)  
 Dighomi Massive, VI qu., corp. 5, app. 25,  
 0159, Tbilisi, Georgia (GE);  
 Giorgi Burjanadze (GE)  
 Dighomi Massive, VI qu., corp. 5, app. 25,  
 0159, Tbilisi, Georgia (GE);  
 Giorgi Tsvitshivadze (GE)  
 R. Japaridze St. 1, Lane I, Dead End 3, 0179,  
 Tbilisi, Georgia (GE)
- (72) Sopio Burjanadze (GE);  
 Jano Burjanadze (GE);  
 Giorgi Burjanadze (GE);  
 Giorgi Tsvitshivadze (GE)
- (54) OZONE GENERATING SYSTEM

---

## C 02

- (11) P 2021 7300 B (51) Int. Cl. (2006)  
 C 02 F 1/00  
 C 09 K 8/05
- (10) AP 2021 15178 A (44) 8(564)/2021  
 (21) AP 2015 15178  
 (22) 2015 07 23  
 (24) 2015 07 23  
 (62) AP 2015 14447 2015 07 23  
 (31) 62/036,912; 62/103,668; 62/185,171  
 (32) 2014 08 13; 2015 01 15; 2015 06 26  
 (33) US; US; US  
 (86) PCT/US2015/041662, 2015 07 23  
 (73) Albemarle Corporation (US)  
 451 Florida St., Baton Rouge,  
 LA 70801-1765, USA (US)
- (72) LAMBETH, Gregory, H. (US);  
 GODAVARTHY, Srinivasa, S. (US);  
 NALEPA, Christopher, J. (US);  
 LIU, Yunqi (US);  
 COPPOLA, Kevin (US);  
 LOUWEN, Jacobus, N. (NL)
- (74) Tamar Kochlamazashvili
- (54) HIGH DENSITY AQUEOUS WELL  
 FLUIDS

## PART G

### G 01

- (11) P 2021 7304 B (51) Int. Cl. (2006)  
 G 01 T 1/00
- (10) AP 2021 15390 A (44) 10(566)/2021  
 (21) AP 2020 15390  
 (22) 2020 07 16  
 (24) 2020 07 16
- (73) I. Beritashvili Center Of Experimental  
 Biomedicine (IBCEB) (GE)  
 Gotua St. 14, 0160, Tbilisi, Georgia (GE)
- (72) Harry Grebenchuk (GE);  
 Mikheil Gogebashvili (GE);  
 Nazi Ivanishvili (GE);  
 Davit Nadareishvili (GE)
- (74) Harry Grebenchuk
- (54) METHOD FOR ESTIMATING AND  
 PREDICTING COMPLEX BIOLO-  
 GICAL EFFECTS OF RADON

---

### G 06

- (11) P 2021 7305 B (51) Int. Cl. (2006)  
 G 06 Q 30/02  
 G 06 Q 10/08
- (10) AP 2021 15376 A (44) 10(566)/2021  
 (21) AP 2018 15376  
 (22) 2018 11 14  
 (24) 2018 11 14  
 (31) PCT/EP2017/080735  
 (32) 2017 11 28  
 (33) EP  
 (86) PCT/EP2018/081255, 2018 11 14  
 (73) Sicpa Holding SA (CH)  
 Avenue de Florissant 41, 1008 Prilly,  
 Switzerland (CH)
- (72) MIYANO NETO, Roberto (BR);  
 PONTE SOARES, Marcos (CH)
- (74) Liliana Darakhvelidze
- (54) SYSTEM AND METHOD OF IDENTIFI-  
 CATION AND AUTHENTICATION FOR  
 TRACING AGRICULTURAL ASSETS,  
 IDENTIFICATION ELEMENT FOR  
 SECURE IDENTIFICATION OF  
 AGRICULTURAL ASSETS AND  
 CORRESPONDING COMPUTER  
 PROGRAMS

---

## PART H

### H 02

- (11) P 2021 7306 B (51) Int. Cl. (2006)  
H 02 J 3/38  
H 02 J 3/32
- (10) AP 2021 15266 A (44) 10(566)/2021  
(21) AP 2017 15266  
(22) 2017 06 29  
(24) 2017 06 29  
(86) PCT/ES2017/070472, 2017 06 29  
(73) Acciona Energía S. A. (ES)  
Av. Ciudad de la Innovacion 5, 31621,  
Sarriguren (Navarra), Spain (ES)
- (72) DE LA PARRA LAITA, Iñigo (ES);  
PADROS RAZQUIN, Asun (ES);  
ROJO OCHOA, Raquel (ES);  
MARCOS ALVAREZ, Javier (ES);  
GUELBENZU MICHELENA, Eugenio (ES);  
MARROYO PALOMO, Luis (ES);  
GARCIA SOLANO, Miguel (ES)
- (74) Liliana Darakhvelidze  
(85) 2020 01 29  
(86) PCT/ES2017/070472, 2017 06 29  
(54) METHOD FOR CONTROLLING POWER  
RAMPS WITH PREDICTION IN INTER-  
MITTENT POWER GENERATION  
PLANTS
-

---

# UTILITY MODELS

## APPLICATIONS APPROVED FOR GRANTING PATENT

The decision can be appealed at the Chamber of Appeal of Sakpatenti within 3 months from the publication or at the Mtskheta District Court Administrative Cases Board (Address: №17, Samkhedro St., Mtskheta), within 1 month following the publication.

### PART C

#### C 05

- (10) AU 2021 15374 U (51) Int. Cl. (2006)  
C 05 G 3/00
- (21) AU 2020 15374 (22) 2020 06 19
- (71) Giorgi Tsintskaladze (GE)  
A. Politkovskaya St. 31, Tbilisi, Georgia (GE);  
Marine Zautashvili (GE)  
Vazha-Pshavela Ave. 49, I qu., corp. 15, app. 6,  
Tbilisi, Georgia (GE);  
Teimuraz Kordzakhia (GE)  
Kyiv St. 6, Tbilisi, Georgia (GE);  
Tinatin Sharashenidze (GE)  
Nutsbidze Plateau, IV mcr., corp. 17, app. 126,  
Tbilisi, Georgia (GE);  
Manana Burjanadze (GE)  
Didi Dighomi, III mcr., corp. 3, app. 62, Tbilisi,  
Georgia (GE);  
Giorgi Antia (GE)  
Meliton and Andria Balanchivadze St. 22,  
app. 3, Tbilisi, Georgia (GE);  
Shota Rustaveli National Scientific Foundation  
of Georgia  
Merab Aleksidze St., II Lane 2, Tbilisi,  
Georgia (GE)
- (72) Giorgi Tsintskaladze (GE);  
Marine Zautashvili (GE);  
Teimuraz Kordzakhia (GE);  
Tinatin Sharashenidze (GE);  
Manana Burjanadze (GE);  
Giorgi Antia (GE)
- (54) COMPLEX PROLONGED ACTION ZEOLITE  
FERTILIZER PRODUCED WITH  
NANOTECHNOLOGY
- (57) Complex, prolonged action, multifunctional  
zeolite fertilizer containing ammonium dihydropho-  
sphate and potassium nitrate such as clinoptilolite, as  
well as iron, calcium, magnesium, molybdenum, bo-  
ron, zinc, manganese, copper, and sulfur ions in cer-  
tain correlation entered in zeolite e.g. Klinoptilolite  
structure on nano level.  
Claims: 1 independent
- 

#### C 12

- (10) AU 2021 15359 U (51) Int. Cl. (2006)  
C 12 G 3/025
- (21) AU 2020 15359 (22) 2020 06 07
- (71) Levan Tsirghvava (GE)  
Gurieli St. 13, 0186, Tbilisi, Georgia (GE)
- (72) Levan Tsirghvava (GE)
- (74) Pavle Meipariani
- (54) LOW ALCOHOL TONIC
- (57) A tonic contains wine, coffee beans/wine  
tincture, water/sugar solution or stevia or grape juice  
or concentrated grape juice, tartaric acid, carbon  
dioxide, drinking water, coffee, chocolate, cocoa,  
caramel, and natural flavors of cherry or orange or  
any combination thereof.  
Claims: 1 independents  
3 dependents
-

---

# PATENTED UTILITY MODEL

## PART A

### A 61

- (11) U 2021 2100 Y      (51) Int. Cl. (2006)  
  A 01 G 9/02
- (10) AU 2021 15563 U    (44) 10(566)/2021
- (21) AU 2021 15563
- (22) 2021 02 16
- (24) 2021 02 16
- (73) Giorgi Tsintsadze (GE)  
    Vasil Kakabadze St. 45, 0117, Tbilisi,  
    Georgia (GE)
- (72) Giorgi Tsintsadze (GE)
- (74) Khatuna Imnadze
- (54) POT ADAPTED FOR PLANT CULTIVATION
-

---

# DESIGNS

## APPLICATION APPROVED FOR REGISTRATION

The decision can be appealed at the Chamber of Appeal of Sakpatenti within 3 months from the publication or at the Mtskheta District Court Administrative Cases Board (Address: №17, Samkhedro str., Mtskheta), within 1 month following the publication.

(10) AD 2021 1228 S (51) 09-01

(21) AD 2021 1228

(22) 2021 06 25

(28) 1

(71) JSC "ARGO" (GE)

Lilo, Lochini Gorge (Plot 05/001), 0151, Tbilisi, Georgia (GE)

(72) Giorgi Nemsadze (GE)

(54) BOTTLE DESIGN

(55)



1.1



1.2



1.3



1.4



1.5

## REGISTERED DESIGN

- (11) D 2021 906 S      (51) 32-00  
(10) AD 2021 1199 S    (44) 2021 06 25 №11  
(21) AD 2021 1199  
(22) 2021 01 20  
(24) 2021 01 20  
(28) 5  
(18) 2026 01 20  
(73) Sopio Chkhaidze (GE)  
    Bidzina Baratashvili St. 14, 0105, Tbilisi,  
    Georgia (GE);  
    Elizaveta Chkhaidze (GE)  
    Bidzina Baratashvili St. 14, 0105, Tbilisi,  
    Georgia (GE)  
(72) Sopio Chkhaidze (GE);  
    Elizaveta Chkhaidze (GE)  
(74) Davit Dzamukashvili (GE)  
(54) GRAPHICAL SYMBOL
-

**DESIGNS, WHICH HAVE BEEN REGISTERED WITH THE INTERNATIONAL BUREAU CLAIMING PRIORITY ON THE TERRITORY OF GEORGIA**

The decision can be appealed at the Chamber of Appeal of Sakpatenti within 3 months from the publication or at the Mtskheta District Court Administrative Cases Board (Address: №17, Samkhedro St., Mtskheta), within 1 month following the publication.

- (11) DM/212 354
- (15) 2021 01 21
- (22) 2021 01 21
- (28) 1
- (73) OMEGA SA (OMEGA AG) (OMEGA LTD.)  
Jakob-Stämpfli-Strasse 96, 2502 BIEL/BIENNE (CH)
- (85) CH
- (86) CH
- (87) CH
- (88) CH
- (89) CH
- (81) II. MA III. AL, AM, AZ, BA, BZ, CH, EM, GB, GE, KG, LI, MC, MD, ME, MK, MN, NO, OM, SG,  
TN, TR, UA
- (72) Jean-Claude Monachon  
Rue Alice-de-Chambrier 1, 2022, Bevaix (CH)
- (74) The Swatch Group AG (The Swatch Group SA) (The Swatch Group Ltd.)  
6, Faubourg Du Lac, 2501 BIEL/BIENNE (CH)
- (54) 1. Watch
- (55)



1.1

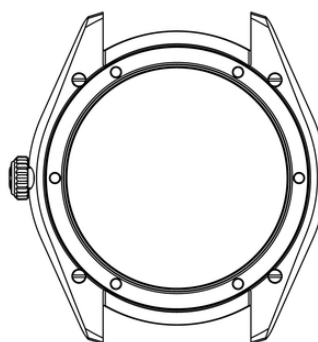

1.2

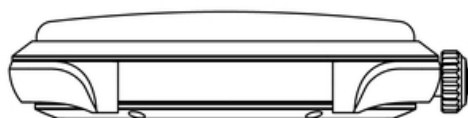

1.3

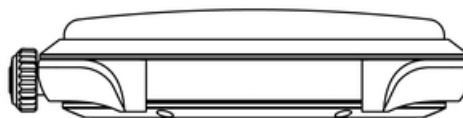

1.4



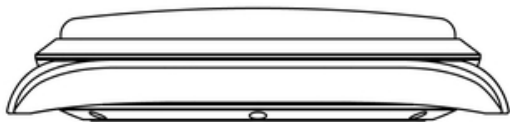

1.5

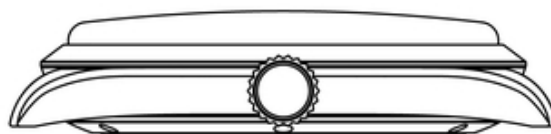

1.6



1.7

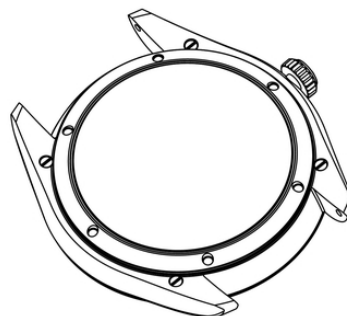

1.8

(11) DM/212 688

(51) 10-02

(15) 2021 01 29

(44) 30/2021 (2021 07 30)

(22) 2021 01 29

(28) 1

(73) OMEGA SA (OMEGA AG) (OMEGA LTD.)

Jakob-Stämpfli-Strasse 96, 2502 BIEL/BIENNE (CH)

(85) CH

(86) CH

(87) CH

(88) CH

(89) CH

(81) II. MA III. AL, AM, AZ, BA, BZ, CH, EM, GB, GE, KG, LI, MC, MD, ME, MK, MN, NO, OM, RU, SG, TN, TR, UA

(72) Jean-Claude Monachon

Rue Alice-de-Chambrier 1, 2022, Bevaix (CH)

(74) The Swatch Group AG (The Swatch Group SA) (The Swatch Group Ltd.)

6, Faubourg Du Lac, 2501 BIEL/BIENNE (CH)

(54) 1. Watch

(55)



1.1

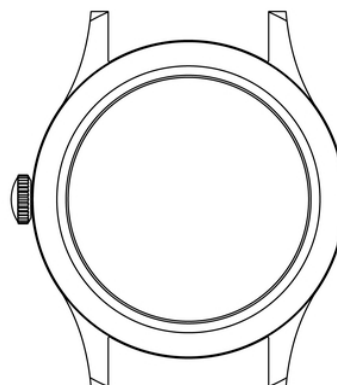

1.2

1.3



1.4

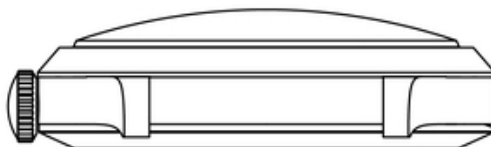

1.5

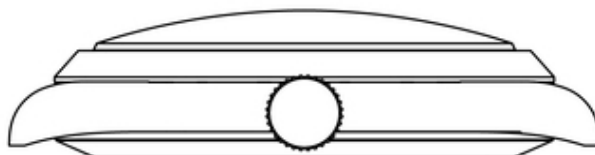

1.6

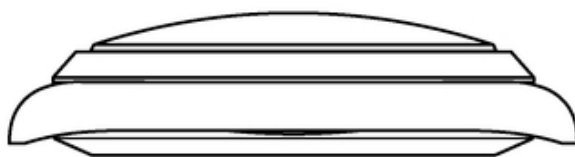

1.7

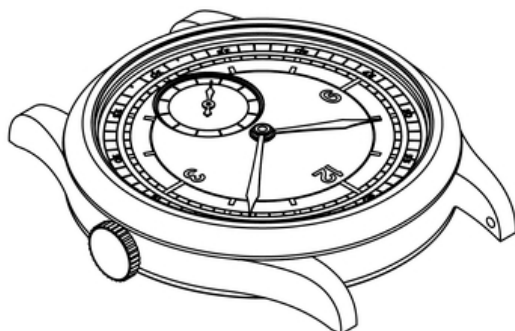

1.8

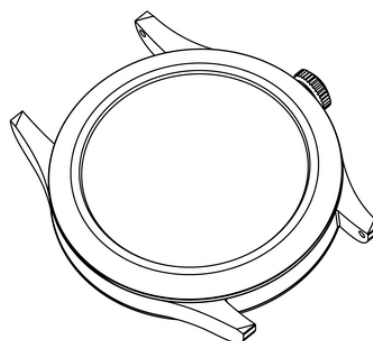

- (11) DM/212 694 (51) 10-07  
 (15) 2021 01 29 (44) 30/2021 (2021 07 30)  
 (22) 2021 01 29  
 (28) 1  
 (73) OMEGA SA (OMGA AG) (OMEGA LTD.)  
 Jakob-Stämpfli-Strasse 96, 2502 BIEL/BIENNE (CH)  
 (85) CH  
 (86) CH  
 (87) CH  
 (88) CH  
 (89) CH  
 (81) II. MA III. AL, AM, AZ, BA, BZ, CH, EM, GB, GE, KG, LI, MC, MD, ME, MK, MN, NO, OM, RU,  
 SG, TN, TR, UA  
 (72) Jean-Claude Monachon  
 Rue Alice-de-Chambrier 1, 2022, Bevaix (CH)  
 (74) The Swatch Group AG (The Swatch Group SA) (The Swatch Group Ltd.)  
 6, Faubourg Du Lac, 2501 BIEL/BIENNE (CH)  
 (54) 1. Watch dial  
 (55)



1.1



1.2



1.3



1.4

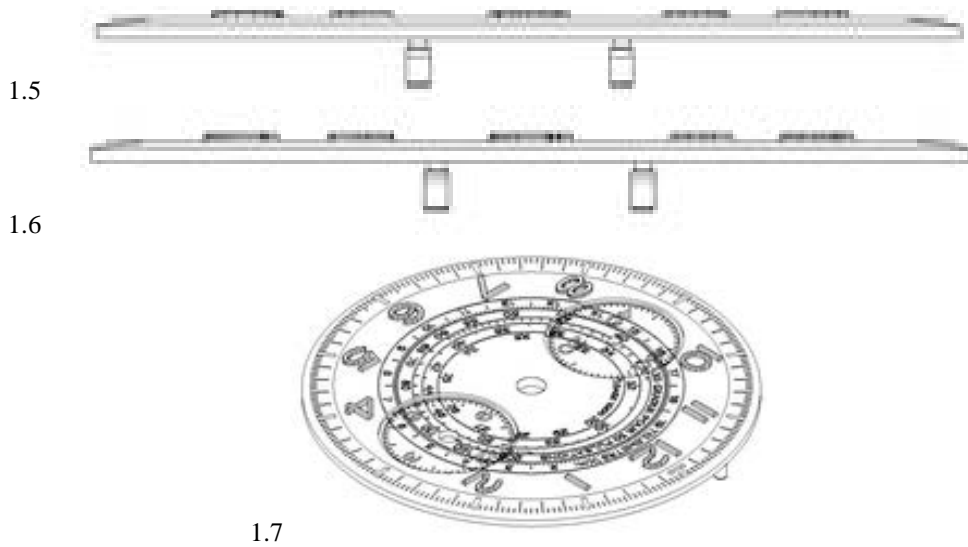

- (11) DM/212 608 (51) 10-02  
 (15) 2021 02 04 (44) 31/2021 (2021 08 06)  
 (22) 2021 02 04  
 (28) 1  
 (73) OMEGA SA (OMEGA AG) (OMEGA LTD.)  
 Jakob-Stämpfli-Strasse 96, 2502 BIEL/BIENNE (CH)  
 (85) CH  
 (86) CH  
 (87) CH  
 (88) CH  
 (89) CH  
 (81) II. MA III. AL, AM, AZ, BA, BZ, CH, EM, GB, GE, KG, LI, MC, MD, ME, MK, MN, NO, OM, RU,  
 SG, TN, TR, UA  
 (72) Jean-Claude Monachon  
 Rue Alice-de-Chambrier 1, 2022, Bevaix (CH)  
 (74) The Swatch Group AG (The Swatch Group SA) (The Swatch Group Ltd.)  
 6, Faubourg Du Lac, 2501 BIEL/BIENNE (CH)  
 (54) 1. Watch  
 (55)

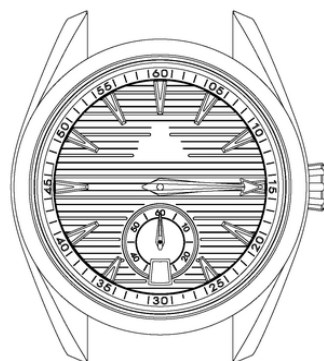

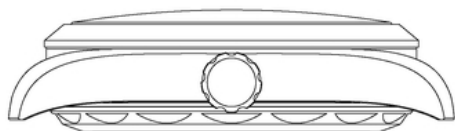

1.3

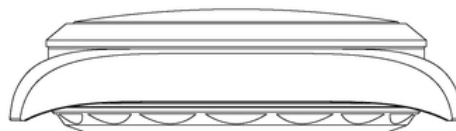

1.4

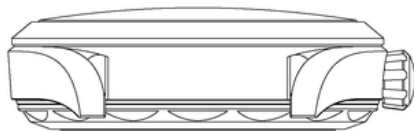

1.5

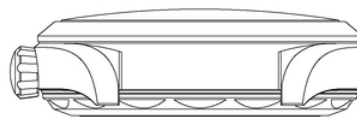

1.6



1.7

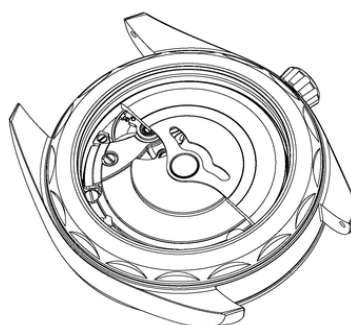

1.8

# TRADEMARKS

## APPLICATIONS FILED UNDER THE NATIONAL PROCEDURE APPROVED FOR REGISTRATION

The decision can be appealed at the Chamber of Appeal of Sakpatenti within 3 months from the publication or at the Mtskheta District Court Administrative Cases Board (Address: №17, Samkhedro St., Mtskheta), within 1 month following the publication.

(260) AM 2021 110191 A  
(210) AM 110191  
(220) 2021 03 18  
(731) JSC "Tbilisi Tobacco"  
Giorgi Nadareishvili St. 7, Tbilisi, Georgia  
(540)



(591) Blue, green, yellow, white  
(531) 10.01.05; 10.01.25; 19.03.03; 19.03.24; 28.19;  
29.01.15  
(526) Rio  
(511) 34

(260) AM 2021 110192 A  
(210) AM 110192  
(220) 2021 03 05  
(731) LTD "Danieli Winery"  
H. Abashidze St. 6, Saburtalo District, Tbilisi,  
Georgia  
(740) Darejan Oshoridze

(540)



(591) Golden, white, red, black  
(531) 05.03.04; 05.13.01; 05.13.06; 24.01.03;  
27.05.01; 27.05.11; 27.05.19; 29.01.14  
(511) 33

(260) AM 2021 111602 A  
(210) AM 111602  
(220) 2021 02 09  
(731) JSC "Gefa"  
Akaki Beliashvili St. 142, 0159, Tbilisi,  
Georgia  
(740) Salome Jeladze  
(540)

## SUPERPHARMACIA სუპერფარმაცია

(591) Black-white  
(511) 44

(260) AM 2021 111716 A  
(210) AM 111716  
(220) 2021 02 16  
(731) LTD "Smart Feed"  
14<sup>th</sup> St. II Lane 15, Vill. Gamarjveba, 1306,  
Gardabani, Georgia  
(540)



(591) Black, white, green, yellow, blue  
 (531) 03.04.02; 03.04.18; 03.07.03; 26.01.15;  
 26.01.21; 29.01.15  
 (511) 31

(260) AM 2021 111720 A  
 (210) AM 111720  
 (220) 2021 02 16  
 (731) Sánchez Romero Carvajal Jabugo S.A.  
 Fernan Caballero, 7, 11.500 Puerto de Santa  
 María, Cádiz, Spain  
 (740) Liliana Darakhvekidze  
 (540)

**CINCO JOTAS**

(591) Black-white  
 (511) 29

(260) AM 2021 111738 A  
 (210) AM 111738  
 (220) 2021 02 18  
 (731) LTD "Redmed"  
 Al. Kazbegi Av. 25, app. 41, Saburtalo  
 District, Tbilisi, Georgia  
 (540)

**რეადენ**

(591) White, red  
 (531) 27.05.01; 28.19; 29.01.01  
 (511) 9, 35, 38, 42, 44

(260) AM 2021 111834 A  
 (210) AM 111834  
 (220) 2021 02 19  
 (731) Zuffa LLC  
 6650 South Torrey Pines Drive, Las Vegas,  
 Nevada 89118, USA  
 (740) Tamaz Shilakadze  
 (540)

**ULTIMATE FIGHTING  
 CHAMPIONSHIP**

(591) Black-white  
 (511) 3, 8, 21

(260) AM 2021 111841 A  
 (210) AM 111841  
 (220) 2021 02 22  
 (731) JSC "Corporation Kindzmarauli"  
 Ilia Chavchavadze St. 55, 4800, Kvareli,  
 Georgia  
 (540)

**9999**

(591) Black-white  
 (511) 33, 35

(260) AM 2021 111849 A  
 (210) AM 111849  
 (220) 2021 02 23  
 (731) Gagi Gogolashvili  
 I. Mosashvili St. 6, 0162, Tbilisi, Georgia  
 (740) Nino Gasdeliani  
 (540)

**Intorio**

(591) Black-white  
 (511) 35

(260) AM 2021 111850 A  
 (210) AM 111850  
 (220) 2021 02 23  
 (731) Monge & C. S.P.A  
 Via Savigliano 31, 12030 Monasterolo  
 di Savigliano, Cuneo, Italy  
 (740) Shalva Gvaramadze  
 (540)

**Gemon**  
 HIGH PREMIUM QUALITY

(591) Black-white  
 (531) 27.05.01; 27.05.10  
 (511) 31

(260) AM 2021 111851 A  
 (210) AM 111851  
 (220) 2021 02 23  
 (731) Monge & C. S.P.A  
 Via Savigliano 31, 12030 Monasterolo  
 di Savigliano, Cuneo, Italy  
 (740) Shalva Gvaramadze  
 (540)

**Monge**  
 Natural Superpremium

(591) Black-white  
 (531) 01.01.05; 01.01.10; 27.05.01; 27.05.10;  
 27.05.17  
 (511) 31

(260) AM 2021 111852 A  
 (210) AM 111852  
 (220) 2021 02 23  
 (731) Monge & C. S.P.A  
 Via Savigliano 31, 12030 Monasterolo  
 di Savigliano, Cuneo, Italy  
 (740) Shalva Gvaramadze

(540)



(591) Black-white  
(531) 03.06.03; 27.05.02; 27.05.07  
(511) 31

(260) AM 2021 111853 A

(210) AM 111853

(220) 2021 02 23

(731) LTD "Gigi"

Shalva Nutsubidze Plateau, III mcr., I qu.,  
corp. 16, app. 4, Saburtalo District, Tbilisi,  
Georgia

(740) Tamar Matchavariani

(540)



(591) Red, yellow, green, orange, white  
(531) 05.03.13; 05.03.15; 05.03.16; 05.13.08;  
25.01.09; 25.01.10; 26.01.01; 26.01.24;  
29.01.15  
(511) 31, 35

(260) AM 2021 111854 A

(210) AM 111854

(220) 2021 02 23

(731) LTD "Gigi"

Shalva Nutsubidze Plateau, III mcr., I qu.,  
corp. 16, app. 4, Saburtalo District, Tbilisi,  
Georgia

(740) Tamar Matchavariani

(540)



(591) Red, yellow, green, orange, white  
(531) 05.03.13; 05.03.15; 05.03.16; 25.01.10;  
26.01.01; 26.01.24; 29.01.15  
(511) 31, 35

(260) AM 2021 111859 A

(210) AM 111859

(220) 2021 02 24

(731) LTD "GMP"

Vill. Ponichala 65, 0165, Tbilisi, Georgia

(740) Nugzar Ksovreli

(540)

ცინკოვიდო  
Цинковид  
ZincoviD

(591) Black-white

(511) 5

(260) AM 2021 111860 A

(210) AM 111860

(220) 2021 02 24

(731) LTD "GMP"

Vill. Ponichala 65, 0165, Tbilisi, Georgia

(740) Nugzar Ksovreli

(540)

ცინკუს-15  
Цинкус-15  
Zincus-15

(591) Black-white

(511) 5

(260) AM 2021 111861 A

(210) AM 111861

(220) 2021 02 24

(731) LTD "Icon Group"

Vill. Tsinsvla, Khelvachauri Region, Georgia

(540)



(591) White, blue, yellow

(531) 05.03.08; 05.03.17; 05.03.20; 27.05.01;  
27.05.10; 27.07.01; 27.07.21; 29.01.12

(511) 16, 23, 24, 31, 33, 35

(260) AM 2021 111869 A

(210) AM 111869

(220) 2021 02 24

(731) Bosnalijek d.d., Pharmaceutical and Chemical  
Industry, Joint Stock Company  
71000 Sarajevo, Jukićeva 53, Bosnia and  
Herzegovina



(740) Nino Bakhtadze  
(540)

## ENTEROFURYL

(591) Black-white  
(511) 5

(260) AM 2021 111870 A  
(210) AM 111870  
(220) 2021 02 24  
(731) Bosnalijek d.d., Pharmaceutical and Chemical Industry, Joint Stock Company  
71000 Sarajevo, Jukićeva 53, Bosnia and Herzegovina

(740) Nino Bakhtadze  
(540)

## FUNZOL

(591) Black-white  
(511) 5

(260) AM 2021 111871 A  
(210) AM 111871  
(220) 2021 02 25  
(731) Bosnalijek d.d., Pharmaceutical and Chemical Industry, Joint Stock Company  
71000 Sarajevo, Jukićeva 53, Bosnia and Herzegovina

(740) Nino Bakhtadze  
(540)

## LYSOBACT COMPLETE SPRAY

(591) Black-white  
(511) 5

(260) AM 2021 111872 A  
(210) AM 111872  
(220) 2021 02 25  
(731) Bosnalijek d.d., Pharmaceutical and Chemical Industry, Joint Stock Company  
71000 Sarajevo, Jukićeva 53, Bosnia and Herzegovina

(740) Nino Bakhtadze  
(540)

## LYSOBACT DUO

(591) Black-white  
(511) 5

(260) AM 2021 111873 A  
(210) AM 111873  
(220) 2021 02 25  
(731) Bosnalijek d.d., Pharmaceutical and Chemical Industry, Joint Stock Company  
71000 Sarajevo, Jukićeva 53, Bosnia and Herzegovina

(740) Nino Bakhtadze

(540)

## LYSOBACT SPRAY

(591) Black-white  
(511) 5

(260) AM 2021 111876 A  
(210) AM 111876  
(220) 2021 02 25  
(731) LTD "Rich Group"  
Vill. Mughanlo, Marneuli Region, Georgia

(540)

## Neosine

ნეოსინი

(591) Black-white  
(511) 5

(260) AM 2021 111877 A  
(210) AM 111877  
(220) 2021 02 25  
(731) Maia Tsiklauri  
Vill. Kvesheti, Dusheti Region, Georgia

(540)



(591) Yellow, light yellow, dark yellow, red  
(531) 05.05.16; 05.05.20; 29.01.12  
(511) 14, 21, 24, 25, 28, 40, 42

(260) AM 2021 111934 A  
(210) AM 111934  
(220) 2021 02 26  
(731) LTD "Impexpharm"  
On the right bank of the River Mtkvari, nearby  
The way to Bacteriophage, 0160, Tbilisi,  
Georgia

(740) Nugzar Ksovreli  
(540)

## Nidamicon

(591) Black-white  
(511) 5

(260) AM 2021 111935 A  
(210) AM 111935  
(220) 2021 02 26  
(731) LTD "Impexpharm"

On the right bank of the River Mtkvari, nearby  
the way to Bacteriophage, 0160, Tbilisi,  
Georgia

(740) Nugzar Ksovreli  
(540)

## Cliprim

(591) Black-white  
(511) 5

(260) AM 2021 111936 A  
(210) AM 111936  
(220) 2021 02 26  
(731) LTD "Impexpharm"

On the right bank of the River Mtkvari, nearby  
the way to bacteriophage, 0160, Tbilisi,  
Georgia

(740) Nugzar Ksovreli  
(540)

## Metaclogen

(591) Black-white  
(511) 5

(260) AM 2021 111937 A  
(210) AM 111937  
(220) 2021 02 26  
(731) Pati Kurt

Mahmudiye Mahallesi Tandoğan Caddesi 24.  
Sokak №24/A İnegöl, Bursa, Turkey

(740) Nino Bakhtadze  
(540)



(591) Black, white, red  
(531) 26.01.22; 26.07.03; 27.05.10; 27.05.17;  
29.01.13  
(511) 3, 14, 18, 25, 35

(260) AM 2021 111938 A  
(210) AM 111938  
(220) 2021 02 27

(731) Doğan Zarf Kağıt Ambalaj Sanayi Ve Ticaret  
Limited Şirketi  
Litros Yolu, 2. Matbaacılar Sitesi, 1 Bd 16,  
Topkapı, Zeytinburnu, Istanbul, Turkey

(740) Pavle Meipariani

(540)



ASILDOĞAN

(591) Yellow, orange, red, purple, white, black  
(531) 01.03.01; 01.03.08; 03.07.16; 27.05.01;  
29.01.13  
(511) 16

(260) AM 2021 111942 A  
(210) AM 111942  
(220) 2021 03 01  
(731) LLC "Barambo"  
Vill. Natakhtari, 3308, Mtskheta, Georgia  
(540)

## შოკობარი shokobari

(591) Black-white  
(511) 30

(260) AM 2021 111944 A  
(210) AM 111944  
(220) 2021 03 01  
(731) LTD "Nuvea Pharmaceutical"  
Chabua Amirejibi Highway 6, app. 96,  
0148, Tbilisi, Georgia  
(540)

## ადაზალ ნეო Adazal neo

(591) Black-white  
(511) 5

(260) AM 2021 111945 A  
(210) AM 111945  
(220) 2021 03 01  
(731) LTD "Nuvea Pharmaceutical"  
Chabua Amirejibi Highway 6, app. 96,  
0148, Tbilisi, Georgia  
(540)

## სოვერენი Соверен Soveren

(591) Black-white  
(511) 5

(260) AM 2021 111946 A  
 (210) AM 111946  
 (220) 2021 03 01  
 (731) LTD "Nuvea Pharmaceutical"  
 Chabua Amirejibi Highway 6, app. 96,  
 0148, Tbilisi, Georgia  
 (540)

**ჰეპა-ლაინი**  
**Гепа-лайн**  
**Gepa-Lain**

(591) Black-white  
 (511) 5

(260) AM 2021 111947 A  
 (210) AM 111947  
 (220) 2021 03 01  
 (731) LTD "Nuvea Pharmaceutical"  
 Chabua Amirejibi Highway 6, app. 96,  
 0148, Tbilisi, Georgia  
 (540)

**კატრარია**  
**Катрария**  
**Catraria**

(591) Black-white  
 (511) 5

(260) AM 2021 111951 A  
 (210) AM 111951  
 (220) 2021 03 02  
 (731) Space Exploration Technologies Corp.  
 1 Rocket Road, Hawthorne, California  
 90250, USA  
 (740) Tamaz Shilakadze  
 (540)

**STARLINK**

(591) Black-white  
 (511) 9, 38, 42

(260) AM 2021 111957 A  
 (210) AM 111957  
 (220) 2021 03 02  
 (731) L3Harris Technologies Inc.  
 (Delaware Corporation)  
 1025 West NASA Boulevard, Melbourne,  
 Florida 32919, USA  
 (740) Shalva Gvaramadze  
 (540)

**L3HARRIS**

(591) Black-white  
 (511) 9, 35, 37, 38, 42, 45

(260) AM 2021 111962 A  
 (210) AM 111962  
 (220) 2021 03 03  
 (310) 4679376  
 (320) 2020 09 04  
 (330) FR  
 (731) Sanofi Pasteur Inc.  
 One Discovery Drive, Swiftwater,  
 PA 18370, USA  
 (740) Shalva Gvaramadze  
 (540)

**HUGINFA**

(591) Black-white  
 (511) 5

(260) AM 2021 111963 A  
 (210) AM 111963  
 (220) 2021 03 03  
 (310) 4679372  
 (320) 2020 09 04  
 (330) FR  
 (731) Sanofi Pasteur Inc.  
 One Discovery Drive, Swiftwater,  
 PA 18370, USA  
 (740) Shalva Gvaramadze  
 (540)

**RESNYRVA**

(591) Black-white  
 (511) 5

(260) AM 2021 111964 A  
 (210) AM 111964  
 (220) 2021 03 03  
 (310) 4679360  
 (320) 2020 09 04  
 (330) FR  
 (731) Sanofi Pasteur Inc.  
 One Discovery Drive, Swiftwater,  
 PA 18370, USA  
 (740) Shalva Gvaramadze  
 (540)

**BEYFORTUS**

(591) Black-white  
 (511) 5

(260) AM 2021 111966 A  
 (210) AM 111966  
 (220) 2021 03 04  
 (310) 921633572; 921633793; 921633963;  
 921634340; 921634498; 921634790;  
 921634927; 921635079; 921635249;  
 921635370; 921635486; 921635613;  
 921635761; 921635834; 921636008;  
 921636091; 921636172; 921636261;  
 921636318; 921636342; 921636369;

921636393; 921636440; 921636482;  
 921636512; 921636571; 921636580;  
 921636636; 921636660; 921636687;  
 921636709; 921636725  
 (320) 2020 12 17  
 (330) BR  
 (731) General Motors LLC  
 300 Renaissance Center, City of Detroit, State  
 of Michigan 48265-3000, USA  
 (740) Giorgi Taktakishvili  
 (540)



(591) Black-white  
 (531) 26.04.01; 26.04.04; 26.04.18  
 (511) 1, 2, 3, 4, 6, 7, 8, 9, 11, 12, 14, 16, 17, 18,  
 20, 21, 22, 24, 25, 26, 27, 28, 34, 35, 36,  
 37, 38, 39, 40, 41, 42, 45

(260) AM 2021 111967 A  
 (210) AM 111967  
 (220) 2021 03 04  
 (731) Basmat Al Hayat Household Appliances  
 (L.L.C)  
 P. O. Box 5154 Dubai, United Arab Emirates  
 (740) Giorgi Taktakishvili  
 (540)



(591) Black-white  
 (531) 02.01.23; 04.05.02; 04.05.05; 27.03.01;  
 27.03.02; 27.05.01; 27.05.13  
 (511) 35, 39

(260) AM 2021 111970 A  
 (210) AM 111970  
 (220) 2021 03 04  
 (731) Ana Godabreidze  
 Politkovskaya St. 37, 0186, Tbilisi, Georgia  
 (540)



(591) Black-white  
 (511) 32, 33

(260) AM 2021 112044 A  
 (210) AM 112044  
 (220) 2021 03 05  
 (310) 18304283  
 (320) 2020 09 08  
 (330) EUIPO  
 (731) Sanofi Pasteur Inc.  
 One Discovery Drive, Swiftwater,  
 PA 18370, USA  
 (740) Shalva Gvaramadze  
 (540)

## EMRANVID

(591) Black-white  
 (511) 5

(260) AM 2021 112045 A  
 (210) AM 112045  
 (220) 2021 03 05  
 (310) 18304273  
 (320) 2020 09 08  
 (330) EUIPO  
 (731) Sanofi Pasteur Inc.  
 One Discovery Drive, Swiftwater,  
 PA 18370, USA  
 (740) Shalva Gvaramadze  
 (540)

## PAXMYRNA

(591) Black-white  
 (511) 5

(260) AM 2021 112046 A  
 (210) AM 112046  
 (220) 2021 03 05  
 (310) 18304259  
 (320) 2020 09 08  
 (330) EUIPO  
 (731) Sanofi Pasteur Inc.  
 One Discovery Drive, Swiftwater,  
 PA 18370, USA  
 (740) Shalva Gvaramadze  
 (540)

## VIDMAREVE

(591) Black-white  
 (511) 5

(260) AM 2021 112047 A  
 (210) AM 112047  
 (220) 2021 03 05  
 (310) 18305847  
 (320) 2020 09 11  
 (330) EUIPO  
 (731) Sanofi Pasteur Inc.  
 One Discovery Drive, Swiftwater,  
 PA 18370, USA  
 (740) Shalva Gvaramadze

(540)

**VIDPREVTYN**(591) Black-white  
(511) 5(260) AM 2021 112048 A  
(210) AM 112048  
(220) 2021 03 05  
(310) 18305830  
(320) 2020 09 11  
(330) EUIPO  
(731) Sanofi Pasteur Inc.  
One Discovery Drive, Swiftwater,  
PA 18370, USA  
(740) Shalva Gvaramadze  
(540)**VYDNECT**(591) Black-white  
(511) 5(260) AM 2021 112049 A  
(210) AM 112049  
(220) 2021 03 05  
(310) 18305841  
(320) 2020 09 11  
(330) EUIPO  
(731) Sanofi Pasteur Inc.  
One Discovery Drive, Swiftwater,  
PA 18370, USA  
(740) Shalva Gvaramadze  
(540)**VULTECVID**(591) Black-white  
(511) 5(260) AM 2021 112054 A  
(210) AM 112054  
(220) 2021 03 05  
(731) LTD "Odrex Software"  
Tashkenti St. Lane 4, app. 16, 0160, Tbilisi,  
Georgia  
(740) Giorgi Taktakishvili  
(540)**STEADYGAMES**(591) Green, black, white  
(531) 27.05.01; 29.01.12  
(511) 9, 28, 41, 42(260) AM 2021 112057 A  
(210) AM 112057  
(220) 2021 03 06  
(731) LLC "Alazani Winery"Demetre Tavdadebuli St. 3, 4800, Kvareli,  
Georgia(740) Giorgi Kartvelishvili  
(540)**FOUR SEASONS**(591) Black-white  
(511) 33(260) AM 2021 112066 A  
(210) AM 112066  
(220) 2021 03 09  
(310) 81417  
(320) 2020 09 11  
(330) JM  
(731) Mars Incorporated  
6885 Elm Street, Mclean, Virginia 22101, USA  
(740) Tamaz Shilakadze  
(540)(591) Blue, orange  
(531) 26.04.02; 26.04.22; 27.05.01; 27.05.10;  
29.01.12  
(511) 29, 30(260) AM 2021 112067 A  
(210) AM 112067  
(220) 2021 03 09  
(731) National Association of Realtors  
430 North Michigan Avenue, Chicago,  
Illinois, USA  
(740) Giorgi Taktakishvili  
(540)(591) Black-white  
(531) 26.04.01; 26.04.02; 26.04.05; 26.04.18;  
26.04.24; 27.05.01; 27.05.21; 27.05.24  
(511) 35, 36, 41(260) AM 2021 112158 A  
(210) AM 112158  
(220) 2021 03 12  
(731) JSC "Corporation Kindzmarauli"  
Chavchavadze St. 55, 4800, Kvareli, Georgia

(540)

შავი ა  
чёрная α  
black α

(591) Black-white  
(511) 33

(260) AM 2021 112176 A  
(210) AM 112176  
(220) 2021 03 16  
(731) LTD "Blox"  
Mukhran Machavariani St. 65, block a,  
app. 17, Tbilisi Georgia  
(540)



(591) C1976A golden, white  
(531) 26.04.03; 26.04.11; 27.05.01; 27.05.11; 28.19;  
29.01.12  
(511) 36, 37

(260) AM 2021 112190 A  
(210) AM 112190  
(220) 2021 03 17  
(731) Shalva Alelishvili  
Leselidze St. 21, 3700, Rustavi, Georgia  
(740) Shalva Aelilashvili  
(540)



(591) Brown  
(531) 03.04.01; 03.04.02; 03.04.13; 28.19  
(511) 33

(260) AM 2021 112254 A  
(210) AM 112254  
(220) 2021 03 19  
(731) LTD "4 Bros"  
1<sup>st</sup> St. 27, Vill. Velistsikhe, 1560, Gurjaani,  
Georgia  
(740) Khatuna Imnadze

(540)

სენატორი  
SENATOR  
СЕНАТОР

(591) Black-white  
(511) 29, 30, 35

(260) AM 2021 112255 A  
(210) AM 112255  
(220) 2021 03 19  
(731) LTD "4 Bros"  
1<sup>st</sup> St. 27, Vill. Velistsikhe, 1560, Gurjaani,  
Georgia  
(740) Khatuna Imnadze  
(540)

იმპერატორი  
IMPERATOR  
ИМПЕРАТОР

(591) Black-white  
(511) 29, 35

(260) AM 2021 112271 A  
(210) AM 112271  
(220) 2021 03 22  
(731) LTD "Mzetavi"  
Davit Jabadze St. 31, block b, app. 81, Gldani  
District, Tbilisi, Georgia  
(540)



Mzetavi

(591) Black-white  
(531) 05.07.10; 19.09.02; 25.01.05; 25.01.06;  
27.05.01; 27.05.09  
(511) 33, 35

(260) AM 2021 112281 A  
(210) AM 112281  
(220) 2021 03 23  
(731) Tearsience Inc.  
510 Cottonwood Drive, Milpitas,  
CA 95035, USA

(740) Giorgi Taktakishvili  
(540)

## LIPIVIEW

(591) Black-white  
(511) 9, 10

(260) AM 2021 112287 A  
(210) AM 112287  
(220) 2021 03 23  
(731) JSC "Gefa"

Akaki Belashvili St., 142, 0159, Tbilisi,  
Georgia

(740) Salome Jeladze  
(540)

## PHARMACIE DE BEAUTE ATTIRANCE ატირანს სილამაზის აპოთიკა

(591) Black-white  
(511) 3, 5, 35, 44

(260) AM 2021 112289 A  
(210) AM 112289  
(220) 2021 03 24  
(731) Tearsceince Inc.

510 Cottonwood Drive, Milpitas,  
CA 95035, USA

(740) Giorgi Taktakishvili  
(540)

## LIPIFLOW

(591) Black-white  
(511) 9, 10

(260) AM 2021 112290 A  
(210) AM 112290  
(220) 2021 03 24  
(731) Tearsceince Inc.

510 Cottonwood Drive, Milpitas,  
CA 95035, USA

(740) Giorgi Taktakishvili  
(540)

## LIPISCAN

(591) Black-white  
(511) 9, 10

(260) AM 2021 112298 A  
(210) AM 112298  
(220) 2021 03 24  
(731) LLC "Gitsa+"

Vazha-Pshavela Av. V qu., corp. 4, app. 71,  
0186, Vake District, Tbilisi, Georgia

(540)



(591) Grey, green  
(531) 03.11.11; 26.04.04; 26.04.09; 27.05.01; 28.19;  
29.01.12  
(511) 21, 28, 35

(260) AM 2021 112299 A  
(210) AM 112299  
(220) 2021 03 24  
(731) LTD "Shotas Marani"

Vill. Dzirageuli, 0400, Ambrolauri Region,  
Georgia

(740) Shota Metreveli  
(540)

## parvus cellar. პარვუს სელარ.

(591) Black-white  
(511) 33

(260) AM 2021 112368 A  
(210) AM 112368  
(220) 2021 03 26  
(731) Giorgi Dekanozishvili

Arsena St. 81, Settlement Tskneti, Tbilisi,  
Georgia

(540)



(591) Blue, golden  
(531) 19.09.01; 19.09.02; 24.01.03; 24.01.11;  
24.01.13; 24.01.17; 25.01.05; 29.01.12  
(511) 33

(260) AM 2021 112369 A  
 (210) AM 112369  
 (220) 2021 03 26  
 (731) LLC "Grand Candy"  
 31 May St., 0061, Yerevan, Armenia  
 (740) Giorgi Taktakishvili  
 (540)



(591) White, yellow, red, green, turquoise, brown, pink, grey, black  
 (531) 03.05.01; 03.05.24; 03.05.25; 29.01.15  
 (511) 30

(260) AM 2021 112370 A  
 (210) AM 112370  
 (220) 2021 03 26  
 (731) LLC "Grand Candy"  
 31 May St., 0061, Yerevan, Armenia  
 (740) Giorgi Taktakishvili  
 (540)



(591) White, yellow, red, green, terracotta, brown, beige, grey, black  
 (531) 03.05.03; 03.05.05; 03.05.24; 03.05.25; 29.01.15  
 (511) 30

(260) AM 2021 112371 A  
 (210) AM 112371  
 (220) 2021 03 26  
 (731) LLC "Grand Candy"

31 May St., 0061, Yerevan, Armenia  
 (740) Giorgi Taktakishvili  
 (540)



(591) White, yellow, red, green, sky-blue, coral, brown, beige, grey, black  
 (531) 03.04.01; 03.04.05; 03.04.24; 03.04.25; 29.01.15  
 (511) 30

(260) AM 2021 112372 A  
 (210) AM 112372  
 (220) 2021 03 26  
 (731) LLC "Grand Candy"  
 31 May St., 0061, Yerevan, Armenia  
 (740) Giorgi Taktakishvili  
 (540)



(591) White, yellow, red, green, sky-blue, golden, brown, beige, purple, pink, grey, black  
 (531) 02.05.03; 02.05.04; 02.05.23; 29.01.15  
 (511) 30

(260) AM 2021 112373 A  
 (210) AM 112373  
 (220) 2021 03 26  
 (731) LLC "Grand Candy"  
 31 May St., 0061, Yerevan, Armenia  
 (740) Giorgi Taktakishvili



(540)



(591) White, yellow, red, light brown, brown, dark brown, beige, grey, black

(531) 03.01.14; 29.01.15

(511) 30

---

(260) AM 2021 112472 A

(210) AM 112472

(220) 2021 04 02

(731) Toyota Jidosha Kabushiki Kaisha  
(also trading as Toyota Motor Corporation)  
1, Toiota-cho, Toiota-shi, Aichi-ken, Japan

(740) Tamar Kochlamazashvili

(540)

**COROLLA CROSS**

(591) Black-white

(531) 27.05.01

(511) 12

**REGISTERED TRADEMARKS**

(111) M 2021 34534 R  
(151) 2021 09 22  
(181) 2031 09 22  
(260) AM 2020 109303 A  
(220) 2020 08 06

(732) Allied Global Tobacco Limited  
Vei Qort Vesti, Iunion Roudi, Farnhami,  
GU9 7PT, Suri, United Kingdom

(111) M 2021 34541 R  
(151) 2021 09 28  
(181) 2031 09 28  
(260) AM 2020 109209 A  
(220) 2020 07 24

(732) Mariam Shengelia  
Politkovskaya St. 3, Tbilisi, Georgia;  
Ketevan Ratiani  
Politkovskaya St. 3, Tbilisi, Georgia

(111) M 2021 34542 R  
(151) 2021 09 28  
(181) 2031 09 28  
(260) AM 2020 109212 A  
(220) 2020 07 27

(732) LLC "Euomotors"  
Between Varketili 2 and Vazisubani Settlement,  
0163, Samgori District, Tbilisi, Georgia

(111) M 2021 34543 R  
(151) 2021 09 28  
(181) 2031 09 28  
(260) AM 2020 109355 A  
(220) 2020 08 10

(732) LTD "Chkviani"  
4000 Meskhi St. 9, 0183, Tbilisi, Georgia

(111) M 2021 34544 R  
(151) 2021 09 28  
(181) 2031 09 28  
(260) AM 2020 109356 A  
(220) 2020 08 10

(732) LLC "MGL GEORGIA"  
Pridon Khalvashi Av. 20, corp. A, app. 8,  
6010, Batumi, Georgia

(111) M 2021 34545 R  
(151) 2021 09 28  
(181) 2031 09 28  
(260) AM 2020 109588 A  
(220) 2020 08 28

(732) JSC "Kotekhi Winery"  
K. Koroghlishvili St. 38, 1500, Gurjaani, Georgia

(111) M 2021 34546 R  
(151) 2021 09 28  
(181) 2031 09 28  
(260) AM 2020 109589 A  
(220) 2020 08 28

(732) JSC "Kotekhi Winery"  
K. Koroghlishvili St. 38, 1500, Gurjaani, Georgia

(111) M 2021 34547 R  
(151) 2021 09 28  
(181) 2031 09 28  
(260) AM 2020 109590 A  
(220) 2020 08 28

(732) JSC "Kotekhi Winery"  
K. Koroghlishvili St. 38, 1500, Gurjaani, Georgia

(111) M 2021 34548 R  
(151) 2021 09 28  
(181) 2031 09 28  
(260) AM 2020 109675 A  
(220) 2020 09 10

(732) LTD "Midamo"  
Didi Kheivani St. 43, 0114, Tbilisi, Georgia

(111) M 2021 34549 R  
(151) 2021 09 28  
(181) 2031 09 28  
(260) AM 2020 109733 A  
(220) 2020 09 11

(732) Yadea Technology Group Co., LTD  
Dongsheng Road, Dacheng Industrial Zone,  
Anzhen Town, Xishan District, Wuxi City,  
Jiangsu Province, China

(111) M 2021 34550 R  
(151) 2021 09 28  
(181) 2031 09 28  
(260) AM 2020 109956 A  
(220) 2020 10 01

(732) LTD "IDS Borjomi Beverages Co.N.V."  
Pareraweg 45, Curaçao

(111) M 2021 34551 R  
(151) 2021 09 28  
(181) 2031 09 28  
(260) AM 2020 109958 A  
(220) 2020 10 01

---

(732) LTD "IDS Borjomi Beverages Co. N.V."  
Pareraweg 45, Curaçao

---

(111) M 2021 34552 R  
(151) 2021 09 28  
(181) 2031 09 28  
(260) AM 2020 110016 A  
(220) 2020 10 02

(732) LTD "IDS Borjomi Beverages Co. N.V."  
Pareraweg 45, Curaçao

---

(111) M 2021 34553  
(151) 2021 09 28  
(181) 2031 09 28  
(260) AM 2020 110196 A  
(220) 2020 10 16  
(732) Duracell Batteries BVBA  
Nijverheidslaan 7, 3220 Aarschot, Belgium

---

(111) M 2021 34554 R  
(151) 2021 09 28  
(181) 2031 09 28  
(260) AM 2020 110218 A  
(220) 2020 10 21  
(732) Dow AgroSciences LLC  
9330 Zionsville Rd., Indianapolis,  
IN 46268, USA

---

(111) M 2021 34555 R  
(151) 2021 09 28  
(181) 2031 09 28  
(260) AM 2020 110219 A  
(220) 2020 10 21  
(732) Dow AgroSciences LLC  
9330 Zionsville Rd., Indianapolis, IN 46268, USA

---

(111) M 2021 34556 R  
(151) 2021 09 28  
(181) 2031 09 28  
(260) AM 2020 110223 A  
(220) 2020 10 22  
(732) LTD "Aromaco"  
Ketevan Tsamebuli Av. 41/300 Aragveli 6,  
Ent. 1, Fl. 2, Isani District, Tbilisi, Georgia

---

(111) M 2021 34557 R  
(151) 2021 09 28  
(181) 2031 09 28  
(260) AM 2020 110226 A  
(220) 2020 10 22  
(732) Diamond Quest Limited  
OMC Chambers, P.O.Box 3152, Road Town,  
Tortola, Virgin Islands (British)

---

(111) M 2021 34558 R  
(151) 2021 09 28  
(181) 2031 09 28  
(260) AM 2020 110279 A  
(220) 2020 10 23  
(732) Biologische Heilmittel Heel GmbH  
Dr.-Reckeweg- Straße 2-4, D-76532  
Baden-Baden, Germany

---

(111) M 2021 34559 R  
(151) 2021 09 28  
(181) 2031 09 28  
(260) AM 2020 110280 A  
(220) 2020 10 23  
(732) Biologische Heilmittel Heel GmbH  
Dr.-Reckeweg-Straße 2-4, D-76532  
Baden-Baden, Germany

---

(111) M 2021 34560 R  
(151) 2021 09 28  
(181) 2031 09 28  
(260) AM 2020 110292 A  
(220) 2020 10 27  
(732) LLC "Lavapi"  
King Mirian St. 23, app. 61, 0159,  
Saburtalo District, Tbilisi, Georgia

---

(111) M 2021 34561 R  
(151) 2021 09 28  
(181) 2031 09 28  
(260) AM 2020 110505 A  
(220) 2020 11 13  
(732) H & M Hennes & Mauritz AB  
SE-106 38 Stockholm, Sweden

---

(111) M 2021 34562 R  
(151) 2021 09 28  
(181) 2031 09 28  
(260) AM 2020 110516 A  
(220) 2020 11 16  
(732) LLC "Impexpharm"  
Right Bank of the River Mtkvari (Kura)  
nearby Bacteriophage, 0160, Tbilisi,  
Georgia

---

(111) M 2021 34563 R  
(151) 2021 09 28  
(181) 2031 09 28  
(260) AM 2020 110603 A  
(220) 2020 11 24  
(732) Colgate-Palmolive Company  
Delaware Corporation  
300 Park Avenue, New York, NY 10022, USA

---

(111) M 2021 34564 R  
(151) 2021 09 28  
(181) 2031 09 28  
(260) AM 2020 110604 A  
(220) 2020 11 24  
(732) Pfizer Inc.  
235 East 42nd Street, New York, NY10017, USA

---

(111) M 2021 34570 R  
(151) 2021 09 29  
(181) 2031 09 29  
(260) AM 2020 110763 A  
(220) 2020 12 07  
(732) LTD "Pilgrim"  
Mukhran Machavariani St. 6b, app. 8, Saburtalo  
District, Tbilisi, Georgia

---

(111) M 2021 34565 R  
(151) 2021 09 28  
(181) 2031 09 28  
(260) AM 2020 110605 A  
(220) 2020 11 24  
(732) Novartis AG  
4002 Basel, Switzerland

---

(111) M 2021 34566 R  
(151) 2021 09 29  
(181) 2031 09 29  
(260) AM 2020 109374 A  
(220) 2020 08 12  
(732) Aleksi Morchiladze  
Chkondideli St. 22, 0180, Tbilisi, Georgia

---

(111) M 2021 34567 R  
(151) 2021 09 29  
(181) 2031 09 29  
(260) AM 2020 109587 A  
(220) 2020 08 28  
(732) LTD "Dugladze Wine Company"  
Orkhevi, Chantladze Blind End 8, 0109, Tbilisi,  
Georgia

---

(111) M 2021 34568 R  
(151) 2021 09 29  
(181) 2031 09 29  
(260) AM 2020 110035 A  
(220) 2020 10 07  
(732) Irakli Kiria  
G. Dzotsenidze St. 5, app. 29, 0183, Tbilisi,  
Georgia

---

(111) M 2021 34569 R  
(151) 2021 09 29  
(181) 2031 09 29  
(260) AM 2020 110481 A  
(220) 2020 11 12  
(732) Hsiang Lun International Corp.  
6f, №106, Chang-An W. Rd., Taipei, Taiwan,  
Province of China

---

## TRADEMARKS REGISTERED ACCORDING TO THE ACCELERATED PROCEDURE

The decision can be appealed at the Chamber of Appeal of Sakpatenti within 3 months from the publication.

(111) M 2021 34531 R  
(151) 2021 09 21  
(181) 2031 09 21  
(210) AM 114541  
(220) 2021 09 08  
(732) LLC "Elit Food"  
Mamuka Samakashvili St. 9, Tskaltubo,  
Georgia

(540)

კვბვა

(591) Black-white  
(511) 29

(111) M 2021 34532 R  
(151) 2021 09 21  
(181) 2031 09 21  
(210) AM 114596  
(220) 2021 09 13  
(732) JSC "Oppa"  
Al. Kazbegi Av. 5, 0160, Tbilisi,  
Georgia

(740) Giorgi Taktakishvili  
(540)



(591) Blue, sky-blue, yellow, green, grey, red, white, black  
(531) 15.01.24; 29.01.15  
(511) 9, 36

(111) M 2021 34533 R  
(151) 2021 09 21  
(181) 2031 09 21  
(210) AM 114597  
(220) 2021 09 13  
(732) JSC "Oppa"  
Al. Kazbegi Av. 5, 0160, Tbilisi,  
Georgia  
(740) Giorgi Taktakishvili

(540)



(591) Blue, sky-blue, orange, green, red, grey, white, black  
(531) 15.01.24; 15.01.25; 29.01.15  
(511) 9, 36

(111) M 2021 34535 R  
(151) 2021 09 22  
(181) 2031 09 22  
(210) AM 114612  
(220) 2021 09 15  
(732) LTD "Retail Group"  
Vill.Tserovani, Mtskheta, Georgia  
(540)



(591) BCFFF2 white, E58A44 orange, 5947CC blue  
(531) 02.09.01; 26.13.25; 28.19; 29.01.13  
(511) 30

(111) M 2021 34536 R  
(151) 2021 09 23  
(181) 2031 09 23  
(210) AM 114672  
(220) 2021 09 17  
(732) LLC "Askaneli Brothers"  
Kakheti Highway 110a, Samgori District,  
0198, Tbilisi, Georgia  
(740) Davit Dzamukashvili

(540)



(591) Lilac, white  
 (531) 26.04.02; 26.04.22; 26.04.24; 27.05.01;  
 27.05.24; 29.01.12  
 (511) 33

(111) M 2021 34537 R  
 (151) 2021 09 23  
 (181) 2031 09 23  
 (210) AM 114673  
 (220) 2021 09 17  
 (732) LLC "Askaneli Brothers"  
 Kakheti Highway 110a, Samgori District,  
 0198, Tbilisi, Georgia  
 (740) Davit Dزامukashvili  
 (540)



(591) Black, pink  
 (531) 26.04.22; 27.05.01; 29.01.12  
 (511) 33

(111) M 2021 34538 R  
 (151) 2021 09 23  
 (181) 2031 09 23  
 (210) AM 114688  
 (220) 2021 09 21  
 (732) Linda Kikolashvili  
 Ilia Chavchavadze Av. 12, app. 32, 0171,  
 Tbilisi, Georgia  
 (540)



(591) Golden, black, light pink, white  
 (531) 01.01.02; 01.01.10; 16.03.01; 27.03.15;  
 27.05.01; 27.05.17; 29.01.13  
 (511) 41

(111) M 2021 34539 R  
 (151) 2021 09 23  
 (181) 2031 09 23  
 (210) AM 114395  
 (220) 2021 08 20  
 (732) Revaz Tsirekidze  
 Tamarashvili St. 10, app. 43, 0177, Tbilisi,  
 Georgia

(540)

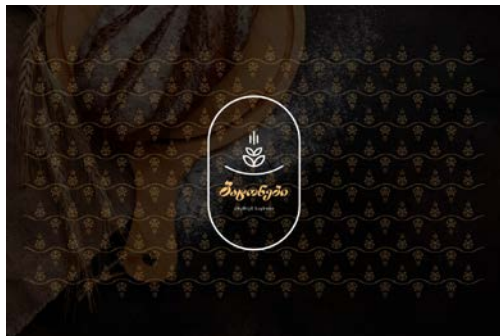

(591) Dark brown, brown, yellow, white, orange  
 (531) 05.07.02; 11.01.17; 25.03.03; 25.07.25; 28.19;  
 29.01.14  
 (511) 30, 43

(111) M 2021 34540 R  
 (151) 2021 09 28  
 (181) 2031 09 28  
 (210) AM 113701  
 (220) 2021 06 30  
 (732) Georgian Tobacco Production, LLC  
 Shota Rustaveli St. 9, app. 36, Marneuli,  
 Georgia  
 (740) Shalva Gvaramadze  
 (540)



(591) White, black, various tones of blue, lilac, sky-blue  
 (531) 02.03.17; 25.01.01; 27.05.01; 29.01.15  
 (511) 34

(111) M 2021 34571 R  
 (151) 2021 09 29  
 (181) 2031 09 29  
 (210) AM 114536  
 (220) 2021 09 07  
 (732) LLC "GT Motors"  
 Davit Aghmashenebeli Alley 155, 0131,  
 Saburtalo District, Tbilisi, Georgia  
 (540)

**ჯი-თი მოტორს**

(591) Black-white  
 (511) 12, 37

(111) M 2021 34572 R  
 (151) 2021 09 29  
 (181) 2031 09 29  
 (210) AM 114675  
 (220) 2021 09 17  
 (732) Nobel Ilac Sanayii Ve Ticaret Anonim  
 Sirketi Representative in Georgia  
 Liberty Square 4, 0105, Tbilisi, Georgia  
 (740) Tinatin Tskhvediani  
 (540)

**Hidroten**

**ჰიდროტენი**

(591) Black-white  
 (511) 5, 35

(111) M 2021 34573 R  
 (151) 2021 09 29  
 (181) 2031 09 29  
 (210) AM 114598  
 (220) 2021 09 13  
 (732) LTD "Deo"  
 Aleko Gbronidze St. 11, block "a", app. 28,  
 Gldani District, Tbilisi, Georgia  
 (540)

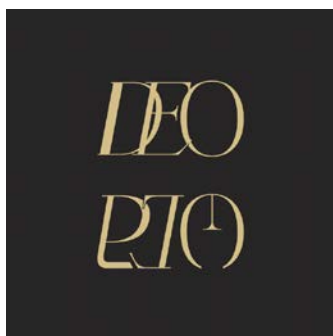

(591) Black, golden  
 (531) 26.04.02; 26.04.05; 26.04.22; 26.04.24;  
 27.05.01; 27.05.24; 28.19; 29.01.12  
 (511) 35, 44

(111) M 2021 34574 R  
 (151) 2021 09 29  
 (181) 2031 09 29  
 (210) AM 114683  
 (220) 2021 09 20  
 (732) Metro Avrasia Investment Georgia  
 Gogol St. 1, 6010, Batumi, Georgia  
 (540)

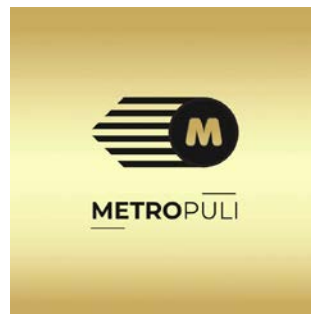

(591) 050000 black, FFD85B light golden,  
 C99724 dark golden  
 (531) 26.01.01; 26.01.18; 26.01.24; 26.11.03;  
 26.11.06; 26.11.08; 27.05.01; 27.05.10;  
 27.05.21; 29.01.12  
 (511) 36

(111) M 2021 34575 R  
 (151) 2021 10 04  
 (181) 2031 10 04  
 (210) AM 114680  
 (220) 2021 09 20  
 (732) TRC Franchisor Inc.  
 22 Sylvan Way, Parsippany, New Jersey  
 07054, USA  
 (740) Tamaz Shilakadze  
 (540)

**REGISTRY  
 COLLECTION HOTELS**

(591) Black-white  
 (511) 43

## INTERNATIONAL TRADEMARKS FOR WHICH A DECISION ON GRANTING PROTECTIONS IS TAKEN

The decision can be appealed at the Chamber of Appeal of Sakpatenti within 3 months from the publication or at the Mtskheta District Court Administrative Cases Board (Address: №17, Samkhedro St., Mtskheta), within 1 month following the publication.

(260) AM 2021 107015 A\*

(800) 1096614

(151) 2011 09 30

(891) 2019 12 23

(731) FARMEC SA

Str. Henri Barbusse no. 16, Cluj-Napoca,  
Romania

(540)

**GEROVITAL**

(591) Black, white

(511)

3 – Soaps; perfumery, essential oils, cosmetics, hair lotions; dentifrices.

(260) AM 2021 109645 A

(800) 1548698

(151) 2020 07 21

(891) 2020 07 21

(731) HANKOOK & COMPANY CO., LTD.

286, Pangyo-ro, Bundang-gu, Seongnam-si,  
Gyeonggi-do, Republic of Korea

(540)

**LAUFENN Z FIT EQ**

(591) Black, white

(531) 27.05.01

(511)

12 – Pneumatic tires; casings for pneumatic tires; inner tubes for pneumatic tires; solid tires for vehicle wheels; tires for vehicle wheels; valves for vehicle tires; motorcycle tires; inner tubes for automobile tires; automobile tires; tubeless tires for bicycles; inner tubes for bicycles, cycles; bicycle tires; spikes for tires; studs for tires; adhesive rubber patches for repairing inner tubes; repair outfits for inner tubes; tubular tires.

(260) AM 2021 110726 A

(800) 1563619

(151) 2020 06 30

(891) 2020 06 30

(731) Allergan, Inc.

2525 Dupont Drive, Irvine CA 92612, USA

(540)

**ALLERGAN  
AESTHETICS**

(591) Black, white

(526) AESTHETICS

(511)

3 – Non-medicated cosmetic and skincare preparations; skin cleansers; skin toners; facial skin lotions; skin moisturizers; anti-aging moisturizers; skin creams and beauty serums; anti-aging creams; eye creams and beauty serums; anti-wrinkle creams; hair texture cream and hair texture lotion; firming creams and lotions as cosmetic preparations; after sun creams; sun damage repair creams; age-retardant creams as anti-aging cream; age spot reducing creams; sunscreens as a type of sunscreen preparation; exfoliant creams; chemical skin peeling solutions as a type of non-medicated skin care preparation; body mist as non-medicated skin care preparation; body sprays; facial mist as non-medicated skin care preparation; facial spray; beauty masks; non-medicated cosmetics in the form of skin and face creams, gels, ointments, pastes, foams, lotions, sprays and waxes for non-medically treating glabellar lines, facial wrinkles, asymmetries and defects and conditions of the human skin.

10 – Surgical, medical, therapeutic and cosmetic instruments for treating glabellar lines, facial wrinkles, asymmetries and defects and conditions of the human skin, and for use in facial aesthetic surgery, facial aesthetic reconstruction, breast aesthetics, muscle stimulation, body contouring and ophthalmic related diseases and disorders; intra-uterine non-chemical contraceptive devices; medical diagnostic instruments for the analysis of body fluids; dermatological microdermabrasion apparatus, namely, instruments used for performing microdermabrasion of the skin and which deliver topical solutions to the skin during a procedure; cosmetic apparatus, namely, an electronic skin treatment device in the nature of a skin-resurfacing treatment device that combines exfoliation, extraction, and infusion of condition-specific serums to improve skin health, function and appearance; medical devices, namely, apparatus for tissue cooling, body shaping and contouring, and treatment of cellulite and soft tissue; medical devices used to destroy fat cells; medical devices, namely, therapeutic apparatus and instruments generating high frequency electromagnetic energy for use in muscle stimulation, treatment of cellulite and soft tissue, and sculpting, shaping and contouring of the body; medical devices, namely, medical apparatus and instruments generating high frequency electro-



magnetic energy for use in electrical muscle stimulation for medical purposes, treatment of cellulite, and treatment of soft tissue by means of electrical nerve stimulation for medical purposes; medical devices to facilitate the placement of cosmetic implants during surgical procedures; cell transfer apparatus, namely, graft harvesting instruments; medical injectors, namely, adipose tissue and medical fluid injectors; surgical and medical apparatus and instruments for use in processing adipose tissue; apparatus for the medical treatment of glabellar lines, facial wrinkles, asymmetries and defects and conditions of the human skin, namely, needles for the injection of hyaluronic acid formulations for medical purposes.

(260) AM 2021 110802 A

(800) 1563805

(151) 2020 10 01

(891) 2020 10 01

(731) Richter Gedeon Nyrt.

Gyömrői út 19-21, H-1103 Budapest, Hungary

(540)

## RYEQO

(591) Black, white

(511)

5 – Pharmaceutical preparations.

(260) AM 2021 110803 A

(800) 1563934

(151) 2020 10 05

(891) 2020 10 05

(731) Individual entrepreneur Matveev Alexandr

Vladimirovich

Prospect Mira, d. 33, kv. 28, Reutov,

RU-143960 Moscow Region, Russian

Federation

(540)

## SKYNAME

(591) Black, white

(511)

18 – Mountaineering sticks; slings for carrying infants; luggage tags; pocket wallets; saddlecloths for horses; business card cases; reins; reins for guiding children; sling bags for carrying infants; harness fittings; card holders [wallets]; parts of rubber for stirrups; chamois leather, other than for cleaning purposes; umbrellas; parasols; saddlery; frames for umbrellas or parasols; handbag frames; card cases [notecases]; cases of leather or leatherboard; valves of leather; whips; imitation leather; leather, unworked or semi-worked; leatherboard; casings, of leather, for springs; umbrella rings; hat boxes of leather; boxes of leather or leatherboard; boxes of vulcanized fiber; purses; chain mesh purses; fastenings for saddles; butts [parts of hides]; saddle trees; bags [envelopes,

pouches] of leather, for packaging; moleskin [imitation of leather]; travelling sets [leatherware]; knee-pads for horses; muzzles; halters; vanity cases, not fitted; furniture coverings of leather; clothing for pets; covers for animals; trimmings of leather for furniture; collars for animals; hiking sticks; conference folders; music cases; goldbeaters' skin; cat o' nine tails; leather leashes; pads for horse saddles; horseshoes; girths of leather; leathercloth; horse blankets; garment bags for travel; shoulder belts [straps] of leather; briefcases; traces [harness]; fur; randfels [Japanese school satchels]; haversacks; leather straps; straps for soldiers' equipment; harness straps; straps for skates; straps of leather [saddlery]; chin straps, of leather; stirrup leathers; umbrella handles; walking stick handles; suitcase handles; grips for holding shopping bags; rucksacks; travelling bags; riding saddles; net bags for shopping; umbrella or parasol ribs; stirrups; bags; bags for climbers; tool bags, empty; handbags; beach bags; saddlebags; compression cubes adapted for luggage; bags for sports; bags for campers; shopping bags; wheeled shopping bags; school satchels; pouch baby carriers; travelling trunks; nose bags [feed bags]; bridoons; walking sticks; umbrella sticks; walking stick seats; tefillin [phylacteries]; bits for animals [harness]; bridles [harness]; harness for animals; key cases; horse collars; suitcases; motorized suitcases; suitcases with wheels; valises; attaché cases; covers for horse saddles; umbrella covers; kid; curried skins; animal skins; cattle skins; leather cord; blinkers [harness]; labels of leather; game bags [hunting accessories].

28 – Arcade video game machines; video game machines; gaming machines for gambling; amusement machines, automatic and coin-operated; toy vehicles; swimming pools [play articles]; trampolines; novelty toys for parties; scratch cards for playing lottery games; starting blocks for sports; bodyboards; skating boots with skates attached; boomerangs; dolls' feeding bottles; tricycles for infants [toys]; stationary exercise bicycles; creels [fishing traps]; shuttlecocks; spinning tops [toys]; dumb-bells; gyroscopes and flight stabilizers for model aircraft; jigsaw puzzles; clay pigeons [targets]; punching bags; bite sensors [fishing tackle]; hang gliders; joysticks for video games; flying discs [toys]; discuses for sports; dolls' houses; dominoes; swimming kickboards; paddleboards; surfboards; spring boards [sports articles]; skateboards; sailboards; chessboards; checkerboards; drones [toys]; darts; Christmas trees of synthetic material; cups for dice; swimming jackets; ascenders [mountaineering equipment]; kites; needles for pumps for inflating balls for games; toys; toys for pets; stuffed toys; inflatable games for swimming pools; plush toys; toy mobiles; novelty toys for playing jokes; games; portable games and toys incorporating telecommunication functions; parlor games; board games; ring games; building games; toy imitation cosmetics; swimming pool

air floats; kaleidoscopes; bladders of balls for games; rosin used by athletes; edges of skis; trading cards for games; bingo cards; playing cards; fairground ride apparatus; reels for fishing; rocking horses; swings; yoga swings; skittles; skittles [games]; billiard cues; golf clubs; hockey sticks; baby gyms; seal skins [coverings for skis]; bells for Christmas trees; dolls' rooms; controllers for game consoles; controllers for toys; confetti; ice skates; roller skates; in-line roller skates; dice; paintball guns [sports apparatus]; ski bindings; dolls' beds; roulette wheels; fish hooks; building blocks [toys]; dolls; flippers for diving; flippers for swimming; swimming webs; rhythmic gymnastics ribbons; fishing lines; gut for fishing; bows for archery; skis; waterskis; roller skis; mah-jong; hunting game calls; puppets; masks [playthings]; carnival masks; theatrical masks; fencing masks; toy putty; matryoshka dolls; masts for sailboards; ball pitching machines; teddy bears; chalk for billiard cues; targets; electronic targets; toy models; scale model kits [toys]; scale model vehicles; kite reels; balls for games; artificial fishing bait; billiard table cushions; knee guards [sports articles]; billiard cue tips; elbow guards [sports articles]; backgammon games; pumps specially adapted for use with balls for games; dolls' clothes; fencing weapons; play tents; ski sticks for roller skis; ski sticks; twirling batons; paragliders; pachinkos; baseball gloves; boxing gloves; golf gloves; gloves for games; batting gloves [accessories for games]; fencing gauntlets; pinatas; toy pistols; toy air pistols; percussion caps [toys]; caps for pistols [toys]; toy dough; protective films adapted for screens for portable games; rattles [playthings]; horseshoe games; candle holders for Christmas trees; Christmas tree stands; sole coverings for skis; water wings; floats for fishing; portable games with liquid crystal displays; swimming belts; waist trimmer exercise belts; decoys for hunting or fishing; scent lures for hunting or fishing; archery implements; soap bubbles [toys]; divot repair tools [golf accessories]; billiard markers; video game consoles; handheld consoles for playing video games; protective paddings [parts of sports suits]; rackets; surfboard leashes; harness for sailboards; weight lifting belts [sports articles]; toy robots; sling shots [sports articles]; rollers for stationary exercise bicycles; harpoon guns [sports articles]; plush toys with attached comfort blanket; scooters [toys]; sleds [sports articles]; bob-sleighs; butterfly nets; landing nets for anglers; nets for sports; tennis nets; bite indicators [fishing tackle]; slot machines [gaming machines]; appliances for gymnastics; quoits; bar-bells; climbers' harness; fishing tackle; artificial snow for Christmas trees; snowshoes; snowboards; remote-controlled toy vehicles; clay pigeon traps; billiard tables; coin-operated billiard tables; tables for table tennis; strings for rackets; gut for rackets; golf bags, with or without wheels; cricket bags; golf bag carts; slides [playthings]; body-building apparatus; machines for physical exercises; men's athletic supporters [sports articles]; rods

for fishing; ornaments for Christmas trees, except illumination articles and confectionery; tennis ball throwing apparatus; conjuring apparatus; apparatus for games; bowling apparatus and machinery; toy figures; counters [discs] for games; chips for gambling; foosball tables; party poppers [party novelties]; Christmas crackers [party novelties]; bags especially designed for skis and surfboards; marbles for games; billiard balls; playing balls; play balloons; paintballs [ammunition for paintball guns] [sports apparatus]; snow globes; chess games; checkers [games]; poles for pole vaulting; paper party hats; shin guards [sports articles]; camouflage screens [sports articles]; chest expanders [exercisers].

(260) AM 2021 110804 A

(800) 1563947

(151) 2020 08 19

(891) 2020 08 19

(731) Noscat GmbH

Wallnerstraße 44, A-1010 Wien, Austria

(540)

## ARTRIGRAN

(591) Black, white

(511)

5 – Medicines, namely non-steroidal anti-inflammatory and anti-rheumatic drugs; food supplements for humans and animals; dietetic food and dietetic substances adapted for medical or veterinary use; mineral food supplements; vitamin preparations.

(260) AM 2021 110805 A

(800) 1564045

(151) 2020 07 14

(891) 2020 07 14

(731) TEKNOROT OTOMOTİV ÜRÜNLERİ SAN. VE TİC. A. Ş.

Huzur Mah. Cendere Cad. No: 114 B, Skyland  
İstanbul B Ofis Blok, 5. Kat, Ofis No: 85 P.K.,  
TR-34485 Sariyer İstanbul, Turkey

(540)



(591) Blue, green and white

(531) 26.11.12; 26.15.01; 27.05.01; 29.01.12

(511)

7 – Machines, machine tools and industrial robots for processing and shaping wood, metals, glass, plastics and minerals, 3D printers, construction machines and robotic mechanisms (machines) for use in construction, bulldozers, diggers (machines), excavators, road construction and road paving machines, drilling machines, rock drilling machines, road sweeping machi-

nes, lifting, loading and transmission machines and robotic mechanisms (machines) for lifting, loading and transmission purposes, elevators, escalators and cranes, machines and robotic mechanisms (machines) for use in agriculture and animal breeding, machines and robotic mechanisms (machines) for processing cereals, fruits, vegetables and food, machines for preparing and processing beverages, engines and motors, other than for land vehicles, parts and fittings therefor, hydraulic and pneumatic controls for engines and motors, brakes other than for vehicles, brake linings for engines, crankshafts, gearboxes, other than for land vehicles, gearboxes, cylinders for engines, pistons for engines, turbines, not for land vehicles, filters for engines and motors, oil, air and fuel filters for land vehicle engines, exhausts for land vehicle engines, exhaust manifolds for land vehicle engines, engine cylinders for land vehicles, engine cylinder heads for land vehicles, pistons for land vehicle engines, carburetors for land vehicles, fuel conversion apparatus for land vehicle engines, injectors for land vehicle engines, fuel economisers for land vehicle engines, pumps for land vehicle engines, valves for land vehicle engines, starter motors for land vehicles, dynamos for land vehicle engines, sparking plugs for land vehicle engines, bearings (parts of machines), roller or ball bearings, machines for mounting and detaching tires, alternators, current generators, electric generators, current generators operated with solar energy, painting machines, automatic spray guns for paint, electric, hydraulic and pneumatic punching machines and guns, electric adhesive tape dispensers (machines), electric guns for compressed gas or liquid spraying machines, electric hand drills, electric hand saws, electric jigsaw machines, spiral machines, compressed air machines, compressors (machines), vehicle washing installations, robotic mechanisms (machines) with the abovementioned functions, electric and gas-operated welding apparatus, electric arc welding apparatus, electric soldering apparatus, electric arc cutting apparatus, electrodes for welding machines, industrial robots (machines) with the abovementioned functions, printing machines, packaging machines, filling, plugging and sealing machines, labellers (machines), sorting machines, industrial robots (machines) with the abovementioned functions, electric packing machines for plugging and scaling of plastics, machines for textile processing, sewing machines, industrial robots (machines) with the abovementioned functions, pumps other than parts of machines or engines, fuel dispensing pumps for service stations, self-regulating fuel pumps, electric kitchen machines for chopping, grinding, crushing, mixing and mincing foodstuff, washing machines, laundry washing machines, dishwashers, spin driers (not heated), electric cleaning machines for cleaning floors, carpets or floorings, vacuum cleaners and parts thereof, automatic vending machines, galvanizing and electroplating machines, electric door openers and closers, gaskets for

engines and motors (terms too vague in the opinion of the International Bureau – Rule 13(2)(b) of the Regulations).

12 – Motor land vehicles, motorcycles, mopeds, engines and motors for land vehicles, clutches for land vehicles, transmissions, transmission belts and transmission chains for land vehicles, gearing for land vehicles, brakes, brake discs and brake linings for land vehicles, vehicle chassis, automobile bonnets, vehicle suspension springs, shock absorbers for automobiles, gearboxes for land vehicles, steering wheels for vehicles, rims for vehicle wheels, bicycles and their bodies, handlebars and mudguards for bicycles, vehicle bodies, tipping bodies for trucks, trailers for tractors, refrigerated bodies for land vehicles, trailer hitches for vehicles, vehicle seats, head-rests for vehicle seats, safety seats for children, for vehicles, seat covers for vehicles, vehicle covers (shaped), sun-blinds adapted for vehicles, direction signals and arms for direction signals for vehicles, windscreen wipers and wiper arms for vehicles, inner and outer tires for vehicle wheels, tubeless tires, tire-fixing sets comprised of tire patches and tire valves for vehicles, windows for vehicles, safety windows for vehicles, rearview mirrors and wing mirrors for vehicles, anti-skid chains for vehicles, luggage carriers for vehicles, bicycle and ski carriers for cars, saddles for bicycles or motorcycles, air pumps for vehicles, for inflating tires, anti-theft alarms for vehicles, horns for vehicles, safety belts for vehicle seats, air bags (safety devices for automobiles), baby carriages, wheelchairs, pushchairs, wheelbarrows, shopping carts, single or multi-wheeled wheelbarrows, shopping trolleys, grocery carts, handling carts, rail vehicles, locomotives, trains, trams, wagons, cable cars, chairlifts, vehicles for locomotion by water and their parts, other than their motors and engines, vehicles for locomotion by air and their parts, other than their motors and engines.

17 – Rubber, gutta-percha, gum, asbestos, mica and semi-finished synthetic goods made from these materials in the form of powder, bars, panels and foils included in this class, insulation, stopping and sealing materials, insulation paints, insulation fabrics, insulating tape and band, insulation covers for industrial machinery, joint sealant compounds for joints, gaskets, O-rings for sealing purposes (other than gaskets for motors, cylinders and washer for water taps), flexible pipes made from rubber and plastic, hoses made of plastic and rubber, including those used for vehicles, junctions for pipes of plastic and rubber, pipe jackets of plastic and rubber, hoses of textile material, junctions for pipes, not of metal, pipe jackets, not of metal, connecting hose for vehicle radiators, profile laths made of synthetic materials for vehicles for the purposes of decoration.

35 – Advertising, marketing and public relations, organization of exhibitions and trade fairs for commer-

cial or advertising purposes, design for advertising, provision of an online marketplace for buyers and sellers of goods and services, office functions, secretarial services, arranging newspaper subscriptions for others, compilation of statistics, rental of office machines, systemization of information into computer databases, telephone answering for unavailable subscribers, business management, business administration and business consultancy, accounting, commercial consultancy services, personnel recruitment, personnel placement, employment agencies, import-export agencies, temporary personnel placement services, auctioneering, the bringing together, for the benefit of others, of a variety of goods, namely, chemicals used in industry, science, photography, agriculture, horticulture and forestry, unprocessed artificial resins and unprocessed plastics, fire extinguishing compositions, adhesives not for medical, household and stationery purposes, paints, varnishes, lacquers, preservatives against rust, preservatives against deterioration of wood, thinners and binders for paints, pigments, preservatives for metals, shoe dyes, printing dyes and ink, toners (including filled toner cartridges), colorants for food, pharmaceuticals and beverages, raw natural resins, metals in foil and powder form for painters, decorators, printers and artists, bleaching and cleaning preparations, detergents other than for use in manufacturing operations and for medical purposes, laundry bleach, fabric softeners for laundry use, stain removers, dishwasher detergents, perfumery, non-medicated cosmetics, fragrances, deodorants for personal use and animals, soaps, dental care preparations, dentifrices, denture polishes, tooth whitening preparations, mouth washes, not for medical purposes, abrasive preparations, emery cloth, sandpaper, pumice stone, abrasive pastes, polishing preparations for leather, vinyl, metal and wood, polishes and creams for leather, vinyl, metal and wood, wax for polishing, industrial oils and greases, cutting fluids, dust absorbing, wetting and binding compositions, solid fuels, coal, firewood, liquid and gas fuels, petrol, diesel oil, liquified petroleum gas, natural gas, fuel oil and their non-chemical additives, candles, wicks, semi-finished wax, wax and paraffin for lighting purposes, electrical energy, pharmaceutical and veterinary preparations for medical purposes, chemical preparations for medical and veterinary purposes, chemical reagents for pharmaceutical and veterinary purposes, medicated cosmetics, dietary supplements for pharmaceutical and veterinary purposes, dietary supplements, nutritional supplements, medical preparations for slimming purposes, food for babies, herbs and herbal beverages adapted for medicinal purposes, dental preparations and articles, teeth filling material, dental impression material, dental adhesives and material for repairing teeth, sanitary preparations for medical use, hygienic pads, hygienic tampons, plasters, materials for dressings, diapers made of paper and textiles for babies, adults and pets, preparations for destroying vermin,

herbicides, fungicides, preparations for destroying rodents, deodorants, other than for human beings or for animals, air purifying preparations, air deodorising preparations, disinfectants, antiseptics, detergents for medical purposes, medicated soaps, disinfectant soaps, antibacterial hand lotions, ores of non-precious metal, common metals and their alloys and semi-finished products made of these materials, irons for construction, mats and stirrups of common metals for buildings, common metals in the form of plate, billet, slick, profile, sheet and sheeting, goods and materials of common metal used for storage, wrapping, packaging and sheltering purposes, containers of metal (storage, transport), buildings of metal, frames of metal for building, poles of metal for building, metal boxes, packaging containers of metal, aluminium foil, fences made of metal, guard barriers of metal, metal tubes, storage containers of metal, metal containers for the transportation of goods, ladders of metal, goods of common metal for filtering and sifting purposes, doors, windows, shutters, jalousies and their cases and fittings of metal, non-electric cables and wires of metal, ironmongery, small hardware of metal, screws of metal, nails, bolts of metal, nuts of metal, pegs of metal, flakes of metal, pitons of metal, metal chains, furniture casters of metal, fittings of metal for furniture, industrial metal wheels, door handles of metal, window handles of metal, hinges of metal, metal latches, metal locks, metal keys for locks, metal rings, metal pulleys, ventilation ducts, vents, vent covers, pipes, chimney caps, manhole covers, grilles of metal for ventilation, heating, sewage, telephone, underground electricity and air conditioning installations, metal panels or boards (non-luminous and non-mechanical) used for signalling, route showing, publicity purposes, signboards of metal, advertisement columns of metal, signaling panels of metal, non-luminous and non-mechanical traffic signs of metal, pipes of metal for transportation of liquids and gas, drilling pipes of metal and their metal fittings, valves of metal, couplings of metal for pipes, elbows of metal for pipes, clips of metal for pipes, connectors of metal for pipes, safes (strong boxes) of metal, metal railway materials, metal rails, metal railway ties, railway switches, bollards of metal, floating docks of metal, mooring buoys of metal, anchors, metal moulds for casting, other than machine parts, works of art made of common metals or their alloys, trophies of common metal, metal closures, bottle caps of metal, metal poles, metal pillars, scaffolding of metal, metal stakes, metal towers, metal pallets and metal ropes for lifting, loading and transportation purposes, metal hangers, tics, straps, tapes and bands used for load-lifting and load-carrying, wheel chocks made primarily of metal, metal profile laths for vehicles for the purposes of decoration, machines, machine tools and industrial robots for processing and shaping wood, metals, glass, plastics and minerals, 3D printers, construction machines and robotic mechanisms (machines) for use in construction,

bulldozers, diggers (machines), excavators, road construction and road paving machines, drilling machines, rock drilling machines, road sweeping machines, lifting, loading and transmission machines and robotic mechanisms (machines) for lifting, loading and transmission purposes, elevators, escalators and cranes, machines and robotic mechanisms (machines) for use in agriculture and animal breeding, machines and robotic mechanisms (machines) for processing cereals, fruits, vegetables and food, machines for preparing and processing beverages, engines and motors, other than for land vehicles, parts and fittings therefor, hydraulic and pneumatic controls for engines and motors, brakes other than for vehicles, brake linings for engines, crankshafts, gearboxes, other than for land vehicles, gearboxes, cylinders for engines, pistons for engines, turbines, not for land vehicles, filters for engines and motors, oil, air and fuel filters for land vehicle engines, exhausts for land vehicle engines, exhaust manifolds for land vehicle engines, engine cylinders for land vehicles, engine cylinder heads for land vehicles, pistons for land vehicle engines, carburetors for land vehicles, fuel conversion apparatus for land vehicle engines, injectors for land vehicle engines, fuel economisers for land vehicle engines, pumps for land vehicle engines, valves for land vehicle engines, starter motors for land vehicles, dynamos for land vehicle engines, sparking plugs for land vehicle engines, bearings (parts of machines), roller or ball bearings, machines for mounting and detaching tires, alternators, current generators, electric generators, current generators operated with solar energy, painting machines, automatic spray guns for paint, electric, hydraulic and pneumatic punching machines and guns, electric adhesive tape dispensers (machines), electric guns for compressed gas or liquid spraying machines, electric hand drills, electric hand saws, electric jigsaw machines, spiral machines, compressed air machines, compressors (machines), vehicle washing installations, robotic mechanisms (machines) with the abovementioned functions, electric and gas-operated welding apparatus, electric arc welding apparatus, electric soldering apparatus, electric arc cutting apparatus, electrodes for welding machines, industrial robots (machines) with the abovementioned functions, printing machines, packaging machines, filling, plugging and sealing machines, labellers (machines), sorting machines, industrial robots (machines) with the abovementioned functions, electric packing machines for plugging and sealing of plastics, machines for textile processing, sewing machines, industrial robots (machines) with the abovementioned functions, pumps other than parts of machines or engines, fuel dispensing pumps for service stations, self-regulating fuel pumps, electric kitchen machines for chopping, grinding, crushing, mixing and mincing foodstuff, washing machines, laundry washing machines, dishwashers, spin driers (not heated), electric cleaning machines for cleaning floors, carpets or floorings, vacuum cleaners

and parts thereof, automatic vending machines, galvanizing and electroplating machines, electric door openers and closers, gaskets for engines and motors, forks, spoons, knives and non-electric cutters, slicers, peelers for kitchen use, including those made of precious metals, side arms and blades (weapons), tools and apparatus included in this class for personal beauty care use, tools and apparatus included in this class for shaving, epilation, manicure and pedicure, electric hand implements for straightening and curling hair, scissors, hand-operated [non-electric] hand tools for the repair of machines, apparatus and vehicles and for use in construction, agriculture, horticulture and forestry, none of them being power tools, electric or non-electric irons, steam irons, handles for hand-operated hand tools, measurement apparatus and equipment including those for scientific, nautical, topographic, meteorologic, industrial and laboratory purposes, thermometers, not for medical purposes, barometers, ammeters, voltmeters, hygrometers, testing apparatus not for medical purposes, telescopes, periscopes, directional compasses, speed indicators, laboratory apparatus, microscopes, magnifying glasses, stills, binoculars, ovens and furnaces for laboratory experiments, apparatus for recording, transmission or reproduction of sound or images, cameras, photographic cameras, television apparatus, video recorders, CD and DVD players and recorders, MP3 players, computers, desktop computers, tablet computers, wearable technological devices (smart watches, wristbands, head-mounted devices), microphones, loudspeakers, earphones, telecommunications apparatus, apparatus for the reproduction of sound or images, computer peripheral devices, cell phones, covers for cell phones, telephone apparatus, computer printers, scanners [data processing equipment], photocopiers, magnetic and optic data carriers and computer software and programmes recorded thereto, downloadable and recordable electronic publications, encoded magnetic and optic cards, movies, tv series and video music clips recorded on magnetic, optical and electronic media, antennas, satellite antennas, amplifiers for antennas, parts of the aforementioned goods, ticket dispensers, automatic teller machines (ATM), electronic components used in the electronic parts of machines and apparatus, semi-conductors, electronic circuits, integrated circuits, chips [integrated circuits], diodes, transistors [electronic], magnetic heads for electronic apparatus, electronic locks, photocells, remote control apparatus for opening and closing doors, optical sensors, counters and quantity indicators for measuring the quantity of consumption, automatic time switches, clothing for protection against accidents, irradiation and fire, safety vests and life-saving apparatus and equipment, eyeglasses, sunglasses, optical lenses and cases, containers, parts and components thereof, apparatus and instruments for conducting, transforming, accumulating or controlling electricity, electric plugs, junction boxes [electricity], electric switches, circuit breakers,

fuses, lighting ballasts, battery starter cables, electrical circuit boards, electric resistances, electric sockets, transformers [electricity], electrical adapters, battery chargers, electric door bells, electric and electronic cables, batteries, electric accumulators, solar panels for production of electricity, alarms and anti-theft alarms, other than for vehicles, electric bells, signalling apparatus and instruments, luminous or mechanical signs for traffic use, fire extinguishing apparatus, fire engines, fire hose and fire hose nozzles, radar apparatus, sonars, night vision apparatus and instruments, decorative magnets, metronomes, surgical, medical, dental and veterinary apparatus and instruments, furniture especially made for medical purposes, artificial limbs and prostheses, medical orthopaedic article, corsets for medical purposes, orthopaedic shoes, elastic bandages and supportive bandages, surgical gowns and surgical sterile sheets, adult sexual aids, condoms, babies' bottles, babies' pacifiers, teats, teathers for babies, bracelets and rings for medical purposes, anti-rheumatism bracelets, anti-rheumatism rings, lighting installations, lights for vehicles and interior-exterior spaces, heating installations using solid, liquid or gas fuels or electricity, central heating boilers, boilers for heating installations, radiators [heating], heat exchangers, not parts of machines, stoves, kitchen stoves, solar thermal collectors [heating], steam, gas and fog generators, steam boilers, other than parts of machines, acetylene generators, oxygen generators, nitrogen generators, installations for air-conditioning and ventilating, cooling installations and freezers, electric and gas-powered devices, installations and apparatus for cooking, drying and boiling, cookers, electric cooking pots, electric water heaters, barbecues, electric laundry driers, hair driers, hand drying apparatus, sanitary installations, taps [faucets], shower installations, toilets [water-closets], shower and bathing cubicles, bath tubs, toilet seats, sinks, wash-hand basins [parts of sanitary installations], washers for water taps, stuffings (tap valves), water softening apparatus, water purification apparatus, water purification installations, waste water purification installations, electric bed warmers and electric blankets, not for medical use, electric pillow warmers, electric or non-electric footwarmers, hot water bottles, electrically heated socks, filters for aquariums and aquarium filtration apparatus, industrial type installations for cooking, drying and cooling purposes, pasteurizers and sterilizers, motor land vehicles, motorcycles, mopeds, engines and motors for land vehicles, clutches for land vehicles, transmissions, transmission belts and transmission chains for land vehicles, gearing for land vehicles, brakes, brake discs and brake linings for land vehicles, vehicle chassis, automobile bonnets, vehicle suspension springs, shock absorbers for automobiles, gearboxes for land vehicles, steering wheels for vehicles, rims for vehicle wheels, bicycles and their bodies, handlebars and mudguards for bicycles, vehicle bodies, tipping bodies

for trucks, trailers for tractors, frigorific bodies for land vehicles, trailer hitches for vehicles, vehicle seats, head-rests for vehicle seats, safety seats for children, for vehicles, seat covers for vehicles, vehicle covers (shaped), sun-blinds adapted for vehicles, direction signals and arms for direction signals for vehicles, windscreen wipers and wiper arms for vehicles, inner and outer tires for vehicle wheels, tubeless tire, tire-fixing sets comprised of tire patches and tire valves for vehicles, window's for vehicles, safety windows for vehicles, rearview mirrors and wing mirrors for vehicles, anti-skid chains for vehicles, luggage carriers for vehicles, bicycle and ski carriers for cars, saddles for bicycles or motorcycles, air pumps for vehicles, for inflating tires, anti-theft alarms for vehicles, horns for vehicles, safety belts for vehicle seats, air bags (safety devices for automobiles), baby carriages, wheelchairs, pushchairs, wheelbarrows, shopping carts, single or multi-wheeled wheelbarrows, shopping trolleys, grocery carts, handling carts, rail vehicles, locomotives, trains, trams, wagons, cable cars, chairlifts, vehicles for locomotion by water and their parts, other than their motors and engines, vehicles for locomotion by air and their parts, other than their motors and engines, firearms, air pistols (weapons), spring-loaded firearms, adapted cases and shoulder straps therefor, heavy weapons, mortars and rockets, fireworks, sprays for personal defence purposes, jewellery, imitation jewellery, gold, precious stones and jewellery made thereof, cufflinks, tie pins, statuettes and figurines of precious metal, clocks, watches and chronometrical instruments, chronometers and their parts, watch straps, trophies made of precious metal, rosaries, musical instruments and cases for musical instruments, paper and cardboard, paper and cardboard for packaging and wrapping purposes, cardboard boxes, paper towels, toilet paper, paper napkins, plastic materials for packaging and wrapping purposes, printing blocks and types, bookbinding material, printed publications, printed matter, books, magazines, newspapers, bill books, printed dispatch notes, printed vouchers, calendars, posters, photographs [printed], paintings, stickers [stationery], postage stamps, stationery, office stationery, instructional and teaching material [except furniture and apparatus], writing and drawing implements, artists' materials, paper products for stationery purposes, adhesives for stationery purposes, pens, pencils, erasers, adhesive tapes for stationery purposes, cardboard cartons [artists' materials], writing paper, copying paper, paper rolls for cash registers, drawing materials, chalkboards, painting pencils, watercolors [paintings], office requisites, paint rollers and paintbrushes for painting, rubber, gutta-percha, gum, asbestos, mica and semi-finished synthetic goods made from these materials in the form of powder, bars, panels and foils, insulation, stopping and sealing materials, insulation paints, insulation fabrics, insulating tape and band, insulation covers for industrial machinery, joint sealant compounds for

joints, gaskets, O-rings for sealing purposes (other than gaskets for motors, cylinders and washer for water taps), flexible pipes made from rubber and plastic, hoses made of plastic and rubber, including those used for vehicles, junctions for pipes of plastic and rubber, pipe jackets of plastic and rubber, hoses of textile material, junctions for pipes, not of metal, pipe jackets, not of metal, connecting hose for vehicle radiators, profile laths made of synthetic materials for vehicles for the purposes of decoration, unworked or semi-worked leather and animal skins, imitations of leather, stout leather, leather used for linings, goods made of leather, imitations of leather or other materials, designed for carrying items, bags, wallets, boxes and trunks made of leather or stout leather, keycases, trunks [luggage], suitcases, umbrellas, parasols, sun umbrellas, walking sticks, whips, harness, saddlery, stirrups, straps of leather (saddlery), sand, gravel, crushed stone, asphalt, bitumen, cement, gypsum, plaster, concrete, marble blocks for construction, building materials (as finished products) made of concrete, gypsum, clay, potters' clay, stone, marble, wood, plastics and synthetic materials for building, construction, road construction purposes, non-metallic buildings, non-metallic building materials, poles not of metal for power lines, barriers not of metal, natural and synthetic coatings in the form of panels and sheets, being building materials, bitumen cardboard coatings for roofing, bitumen coating for roofing, doors and windows of wood and synthetic materials, traffic signs not of metal, non-luminous and non-mechanical, for roads, monuments and statuettes of stone, concrete and marble, building glass, prefabricated swimming pools not of metal (structures), aquarium sand, furniture, made of any kind of material, mattresses, pillows, air mattresses and cushions, not for medical purposes, water beds, mirrors, beehives, artificial honeycombs and sections of wood for honeycombs, bouncing chairs for babies, playpens for babies, cradles, infant walkers, display boards, frames for pictures and paintings, identification plates, identification tags, nameplates, identification labels made of wood or synthetic materials, packaging containers of wood or plastics, casks for use in transportation or storage, barrels, storage drums, tanks, boxes, storage containers, transportation containers, chests, loading pallets and closures for the aforementioned goods, of wood or plastics, small hardware goods of wood or synthetic materials included in this class, furniture fittings, of wood or synthetic materials, opening and closing mechanisms of wood or synthetic materials, ornaments and decorative goods of wood, cork, reed, cane, wicker, horn, bone, ivory, whalebone, shell, amber, mother-of-pearl, meerschaum, beeswax, plastic or plaster namely figurines, holiday ornaments for walls, sculptures, trophies, baskets, fishing baskets, kennels, nesting boxes and beds for household pets, portable ladders and mobile boarding stairs of wood or synthetic materials, bamboo curtains, roller indoor blinds [for interiors],

slatted indoor blinds, strip curtains, bead curtains for decoration, curtain hooks, curtain rings, curtain tie-backs, curtain rods, non-metal wheel chocks, hand-operated non-electric cleaning instruments and appliances, brushes, other than paintbrushes, steel chips for cleaning, sponges for cleaning, steel wool for cleaning, cloths of textile for cleaning, gloves for dishwashing, non-electric polishing machines for household purposes, brooms for carpets, mops, toothbrushes, electric toothbrushes, dental floss, shaving brushes, hair brushes, combs, non-electric household or kitchen utensils, [other than forks, knives, spoons], services [dishes], pots and pans, bottle openers, flower pots, drinking straws, non-electric cooking utensils, ironing boards and shaped covers therefor, drying racks for washing, clothes drying hangers, cages for household pets, indoor aquariums, vivariums and indoor terrariums for animals and plant cultivation, ornaments and decorative goods of glass, porcelain, earthenware or clay namely statues, figurines, vases and trophies, mouse traps, insect traps, electric devices for attracting and killing flies and insects, fly catchers, fly swatters, perfume burners, perfume sprayers, perfume vaporizers, electric or non-electric make-up removing appliances, powder puffs, toilet cases, nozzles for sprinkler hose, nozzles for watering cans, watering devices, garden watering cans, unworked or semi-worked glass, except building glass, mosaics of glass and powdered glass for decoration, except for building, glass wool other than for insulation or textile use, ropes, strings, rope ladders, hammocks, fishing nets, tents, awnings, tarpaulins, sails, vehicle covers, not fitted, bags of textile, for packaging, padding and stuffing materials, except of rubber and plastics, including those of wool and cotton, textile fibers, raw spun fiber, glass fibers for textile use, yarns and threads for textile use, threads and yarns for sewing, embroidery and knitting, thread, elastic yams and threads for textile use, woven or non-woven textile fabrics, textile goods for household use, curtains, bed covers, sheets (textile), pillowcases, blankets, quilts, towels, tags, pennants, labels of textile, swaddling blankets, sleeping bags for camping, clothing, including underwear and outerclothing, other than special purpose protective clothing, socks, mufflers [clothing], shawls, bandanas, scarves, belts [clothing], footwear, shoes, slippers, sandals, headgear, hats, caps with visors, berets, caps [headwear], skull caps, laces and embroidery, guipures, festoons, ribbons (haberdashery), ribbons and braid, fastening tapes for clothing, cords for clothing, letters and numerals for marking linen, embroidered emblems, badges for wear, not of precious metal, shoulder pads for clothing, buttons for clothing, fasteners for clothing, eyelets for clothing, zippers, buckles for shoes and belts, fasteners, shoe and belt buckles, pins, other than jewellery, adhesive patches for decoration of textile articles, laces, needles, sewing needles, needles for sewing machines, needles for knitting and embroidery, boxes for needles, needle

cushions, artificial flowers, artificial fruits, hair pins, hair buckles, hair bands, decorative articles for the hair, not made of precious metal, wigs, hair extensions, electric or non-electric hair curlers, other than hand implements, carpets, rugs, mats, prayer rugs, linoleum, artificial turf, linoleum for covering floors, gymnasium mats, wallpaper, wall hangings not of textile, games and toys, arcade video game machines, game apparatus and machines for use with an external display screen and monitor, including those coin-operated, toys for animals, toys for outdoor playgrounds, parks and game parks, gymnastic and sporting articles, fishing tackle, artificial fishing hail, decoys for hunting and fishing, Christmas trees of artificial material, ornaments for Christmas trees, artificial snow for Christmas trees, rattles (playthings), novelties for parties, dances (party favors), paper party hats, meat, fish, poultry and game, processed meat products, dried pulses, soups, bouillon, processed olives, olive paste, milks of animal origin, milks of herbal origin, milk products, butter, edible oils, dried, preserved, frozen, cooked, smoked or salted fruits and vegetables, tomato paste, prepared nuts and dried fruits as snacks, hazelnut spreads and peanut butter, tahini (sesame seed paste), eggs and powdered eggs, potato chips, coffee, cocoa, coffee or cocoa based beverages, chocolate based beverages, pasta, stuffed dumplings, noodles, pastries and bakery products based on flour, desserts based on flour and chocolate, bread, simit [Turkish ring-shaped bagel covered with sesame seeds], poğaç [Turkish bagel], pita, sandwiches, katmer [Turkish pastry], pies, cakes, baklava [Turkish dessert based on dough coated with syrup], kadayıf [Turkish dessert based on dough], desserts based on dough coated with syrup, puddings, custard, kazandibi [Turkish pudding], rice pudding, keşkül [Turkish pudding], honey, bee glue for human consumption, propolis for food purposes, condiments for foodstuff, vanilla (flavoring), spices, sauces (condiments), tomato sauce, yeast, baking powder, flour, semolina, starch for food, sugar, cube sugar, powdered sugar, tea, ice tea, confectionery, chocolate, biscuits, crackers, wafers, chewing gums, ice-cream, edible ices, salt, cereal-based snack food, popcorn, crushed oats, corn chips, breakfast cereals, processed wheat for human consumption, crushed barley for human consumption, processed oats for human consumption, processed rye for human consumption, rice, molasses for food, agricultural and horticultural products, seeds, forestry products, live animals, fertilized eggs for hatching, plants, dried plants for decoration, fresh garden herbs, dried garden herbs for decoration, animal foodstuffs, malt not for human consumption, underlays for pets, cat litters, beers, preparations for making beer, mineral water, spring water, table water, soda water, fruit and vegetable juices, fruit and vegetable concentrates and extracts for making beverages, non-alcoholic soil drinks, energy drinks, protein-enriched sports beverages, alcoholic beverages (except beers), wines, raki [traditio-

nal Turkish alcoholic drink], whisky, liqueurs, alcoholic cocktails, tobacco, chewing tobacco, cigarettes, cigars, smokers' articles including those made of precious metals, pipes, mouthpieces for cigars and cigarettes, ashtrays, tobacco boxes, pocket apparatus for rolling cigarettes, cigarette paper, tobacco pipes, firestones, lighters for smokers, electronic cigarettes and their cartridges, matches, enabling customers to conveniently view and purchase those goods, such services may be provided by retail stores, wholesale outlets, by means of electronic media or through mail order catalogues (terms too vague in the opinion of the International Bureau – Rule 13(2)(b) of the Regulations).

37 – Construction services, rental of construction machines and equipment, cleaning services for buildings (interior and exterior), public areas, industrial premises, disinfecting, vermin exterminating services, other than for agriculture, rental of cleaning machines and equipment, vehicles service stations for land vehicles, maintenance, repair and refueling of land vehicles, vehicles service stations for marine vehicles, maintenance, repair and refueling of marine vehicles, repair and maintenance of air vehicles, upholstering, repair and restoration of furniture, installation, maintenance and repair of heating, cooling and sanitary installations, cleaning, care and repair of clothing, installation, maintenance and repair of industrial machines and equipment, office machines and equipment, communication apparatus, electric and electronic appliances, repair and maintenance of lifts, clock and watch repair, mining services and mining extraction, repair of shoes, bags and belts.

42 – Scientific and industrial analysis and research services, engineering, engineering and architectural design services, testing services for the certification of quality and standards, computer services, namely, computer programming, computer virus protection services, computer system design, creating, maintaining and updating websites for others, computer software design, updating and rental of computer software, providing search engines for the internet, hosting websites, computer hardware consultancy, rental of computer hardware, industrial design services, other than engineering, computer and architectural design; graphic arts designing, authenticating works of art (terms too vague in the opinion of the International Bureau – Rule 13(2)(b) of the Regulations).

(260) AM 2021 110806 A

(800) 1564086

(151) 2020 07 24

(891) 2020 07 24

(731) AROMATIKA LTD.

7-9 Nyzhniy Val str. Kyiv 04071,  
Ukraine



(540)

*My Brother's  
Shoes*

(591) Black, white

(531) 27.05.01

(511)

25 – Clothing, footwear, headgear.

(260) AM 2021 110807 A

(800) 1564141

(151) 2020 07 16

(891) 2020 07 16

(731) Egis Gyógyszergyár Zrt.

Keresztúri út 30-38., H-1106 Budapest,  
Hungary

(540)

**SKINSOLUTE**

(591) Black, white

(511)

3 – Cosmetics and cosmetic preparations.

5 – Human pharmaceutical preparations; dietetic substances adapted for medical use; dietary supplements; medicinal ointments; medicated skin creams; plasters, materials for dressings.

(260) AM 2021 110808 A

(800) 1564181

(151) 2020 08 12

(891) 2020 08 12

(731) Otkrytoe aktsionernoe obshchestvo

"Grodnenskaya tabachnaya fabrika "Neman"  
18, ul. Ordzhonikidze, 230771 Grodno, Belarus

(540)



(591) Black, white

(531) 04.03.01; 24.01.19; 25.12.01; 25.12.25;  
27.05.10; 27.05.24

(511)

34 – Tobacco; smokers' articles; matches; cigarettes.

(260) AM 2021 110809 A

(800) 1564185

(151) 2020 10 28

(891) 2020 10 28

(731) Kerry Luxembourg S.à.r.l.

17 rue Antoine Jans, L-1820 Luxembourg,  
Luxembourg

(540)

*DaVinci*  
GOURMET

(591) Black, white

(531) 27.05.01; 27.05.09

(511)

32 – Energy drinks; protein drinks; powdered mixes for making a frozen beverage; syrups for beverages; concentrates for making beverages; fruit-flavoured beverages.

(260) AM 2021 110810 A

(800) 1564190

(151) 2020 10 15

(891) 2020 10 15

(731) Closed Joint Stock Company "Sotex  
"PharmFirm"pos. Belikovo, d.11, selskoe poselenie,  
Bereznikovskoe, Sergievo-Posadsky,  
municipal district, RU-141345 Moscow  
region, Russian Federation

(540)

**HEMTRANIX**

(591) Black, white

(511)

5 – Mineral food supplements; medicated candies; medicated sweets; adhesive plasters; sticking plasters; medicines for human purposes; vitamin preparations; pharmaceutical preparations; suppositories; pre-filled syringes for medical purposes.

(260) AM 2021 110811 A

(800) 1564273

(151) 2020 04 02

(891) 2020 04 02

(731) Unidome Deutschland GmbH

Mainzer Straße 97, 65189 Wiesbaden, Germany

(540)

**UNIDOME**

(591) Black, white

(511)

19 – Building and construction materials and elements, not of metal; structural elements (non-met-

llic -) for use in building; construction elements of plastic; building materials of plastics material; building materials (non-metallic); structural components, not of metal, for buildings; concrete slabs; concrete parts; concrete floors; concrete panels; concrete beams; concrete formwork elements, not of metal, for concrete; slab panels, not of metal; prefabricated building components (non-metallic -); molds (non-metallic -) for concrete; woven fabrics (non-metallic -) for concrete; interlocking panels (non-metallic -) for building; non-metallic materials, for construction works; non-metal floor panels; slabs, not of metal, for building; plastic void-formers for construction.

(260) AM 2021 110812 A  
 (800) 1564292  
 (151) 2020 10 30  
 (891) 2020 10 30  
 (731) Beats Electronics, LLC  
 8600 Hayden Place, Culver City CA 90232, USA  
 (540)

## Beats Flex

(591) Black, white  
 (511)  
 9 – Earphones; microphones; audio cables; electric charging cables for use with headphones and earphones.

(260) AM 2021 110813 A  
 (800) 1564301  
 (151) 2020 10 28  
 (891) 2020 10 28  
 (731) Apple Inc.  
 One Apple Park Way, Cupertino CA 95014,  
 USA  
 (540)

## MAGSAFE CHARGER

(591) Black, white  
 (511)  
 9 – Charging mats for use with smartphones; charging apparatus for use with mobile telephones; wireless chargers for mobile telephones; mobile phone chargers.

(260) AM 2021 110814 A  
 (800) 1564313  
 (151) 2020 03 24  
 (891) 2020 03 24  
 (731) TLS GROUP SA  
 153-155 C, Rue du Kiem, L-8030 Strassen,  
 Luxembourg  
 (540)

**TLS**contact

(591) Pantone codes: Blue: 2145C/Orange: 165C  
 (531) 27.05.01; 27.05.17; 29.01.12  
 (511)

9 – Apparatus and instruments for conducting, distributing, transforming, accumulating, adjusting or controlling electric current, software, computer peripherals; biometric identification systems; printers for use with computers; modems, monitors (hardware); electronic agendas; integrated circuits; scientific apparatus (other than for medical purposes); nautical, surveying, photographic, cinematographic, optical, weighing, measuring, signaling, checking (supervision), life-saving and teaching apparatus and instruments; audiovisual and magnetic recording media; media for the transmission, reproduction and duplication of sound and/or images; recorded or blank data media; pre-recorded or blank video disks and video cassettes; pre-recorded or blank laser disks and laser cassettes; magnetic tape recorders; magnetic tape cassettes and recording discs; acoustic and audiovisual recordings; compact disks; videodisks; optical disks; CD-ROMs; DVD-roms; electronic cards; integrated circuit cards [smart cards]; encrypted magnetic cards; software for electronic games specifically designed for display on a television and/or a computer screen; magnetic encoders; electronic pens; computer programs; interactive televisual and/or audiovisual programs; downloadable databases, especially voice, data, text and sound databases and image banks; software for managing databases and particularly voice databases; audio and text data bank management software; image bank management software; software for electronic and automatic games specifically designed for display on a television and/or a computer screen; printed circuits; connectors for linking terminals or microcomputers to public and private networks; data communications software; diskettes; downloadable electronic publications; television apparatus; telephone apparatus; video telephones; cassette and compact disk players; optical readers; applications for portable telephones, computers and tablets; computer programs and software in the field of tourism; software applications for portable telephones, computers and tablets in the field of issuing visas and official documents; computer programs and software in the field of delivery of visas and official documents.

35 – Advertising, distribution of advertising materials (leaflets, prospectuses and samples); rental of advertising material; updating of advertising material; commercial and industrial company operational assistance; commercial information agencies; dissemination of advertisements; distribution of advertisements by mail; business consultancy, information or inquiries; targeting studies and consultancy in geo-marketing (marketing); administrative processing of address files (restructuring, deduplication, enrichment, geocoding); compilation and systemization of information into computer databases, telemarketing services; business

advice in connection with the negotiation and conclusion of commercial transactions on behalf of third parties; office functions; document reproduction; advice and organization in business affairs for diplomatic missions, embassies, consulates, air companies, associations, travel agencies, shops and commercial agencies; administrative services for the provision of duplicate birth and marriage certificates; administrative support related to the transmission and delivery of official documents, visas, passports and renewals of passports and visas, as well as advice relating thereto; administrative procedures for obtaining documents falling within the sovereign right of states or state institutions (such as visas, passports); administrative formalities with embassies to obtain documents, especially visas; administrative services for obtaining visas, travel documents and administrative authorizations in the field of business; provision of information and advice in the field of administrative procedures relating to obtaining visas, travel documents and administrative authorizations; conducting of administrative procedures with regards to competent authorities and consulates for the delivery of official documents; consulting, information or business inquiries in the field of tourism; retail sale services for computer software and computer programs; administrative and secretarial services through call centers; assistance with customer satisfaction analysis for industrial and commercial enterprises; business consultancy services and studies related to customer satisfaction analysis; organizing trade fairs for commercial purposes and administrative services related to obtaining entry tickets for these trade fairs; photocopying services; publication of advertising catalogs.

38 – Telecommunications, communications by computer terminals; communications via any kind of remote computing means; communications by fiber-optic networks; transmission and distribution of multimedia programs; electronic messaging services; services for the transmission of information by radio, telephone, telegraphy and telematics and teleinformatics, as well as by interactive videography, and in particular on terminals, computer peripherals or electronic and/or digital equipment, especially videophones, video telephones and videoconferencing equipment; sending and transmitting dispatches and messages; telex services; transmission of telegrams; information transmission services using a teletypewriter; transmission of information via computer communication networks; information transmission services via all means of communication and telecommunication designed for public information; computer communication services for the retrieval of information from databases; communication services via computer networks; transmission of information in the audiovisual, video and multimedia fields; transmission of information contained in data banks; computer-aided transmission of images and messages; distribution of audiovisual

and multimedia programs for interactive or other use; electronic communication services in the audiovisual, video and multimedia field; transmission of information via the Internet; transmission of information provided in the context of exclusive offers for clients benefiting from a program of specific services; telecommunication services for downloading digital data; provision of access to databases; sending notifications by SMS; providing access to application services and telecommunications networks for downloading computer applications, downloading applications for portable telephones and tablets, as well as for downloading software; telecommunication services for geopositioning; telecommunications services enabling the download of software and computer applications in the field of issuing visas and official documents; telecommunication for the downloading of computer software and applications in the field of the promotion of tourism.

42 – Computer programming, in particular in connection with procedures for delivering official documents; professional consultancy (unrelated to business operations), namely professional consultancy on computers; expertise in the field of computing, technical consulting and advice in the field of computing; computer breakdown research and diagnostic services; computing information; development (design) and updating of computer programs and software; hosting of web sites, in particular in connection with procedures for delivering official documents; rental of computers for technical research; design, development and maintenance of computer software and applications; computer and software design and development services in connection with procedures for the issue of official documents; computer programming in connection with the promotion of tourism; hosting of web sites in connection with the promotion of tourism; programming of software for electronic dictionaries and databases for language translation; providing temporary use of on-line non-downloadable software for language translation.

---

(260) AM 2021 110830 A  
 (800) 1564701  
 (151) 2020 05 29  
 (891) 2020 05 29  
 (731) Aktsionernoe obshchestvo "Kaspi Bank"  
 ul. Nauryzbay batyra, d. 154A, 050013  
 Gorod Almaty, Kazakhstan  
 (540)



(591) White and green

(531) 04.05.05; 26.01.01; 26.01.12; 26.01.18; 28.05; 29.01.12

(526) BONUS

(511)

35 – Arranging subscriptions to telecommunication services for others; import-export agency services; commercial information agency services; advertising agency services; cost price analysis; rental of advertising space; business auditing; financial auditing; business intermediary services relating to the matching of potential private investors with entrepreneurs needing funding; employment agency services; computerized file management; book-keeping; invoicing; demonstration of goods; transcription of communications [office functions]; opinion polling; market studies; business information; information and advice for consumers in the field of choosing products and services; business investigations; business research; marketing research; personnel recruitment; business management and organization consultancy; business organization consultancy; business management consultancy; personnel management consultancy; professional business consultancy; consultancy regarding public relations communication strategies; consultancy regarding advertising communication strategies; layout services for advertising purposes; marketing; marketing in the framework of software publishing; targeted marketing; business management of performing artists; business management of sports people; writing of resumes for others; scriptwriting for advertising purposes; news clipping services; updating and maintenance of information in registries; updating and maintenance of data in computer databases; updating of advertising material; word processing; online retail services for downloadable and pre-recorded music and movies; online retail services for downloadable ring tones; online retail services for downloadable digital music; organization of exhibitions for commercial or advertising purposes; arranging newspaper subscriptions for others; organization of fashion shows for promotional purposes; organization of trade fairs for commercial or advertising purposes; shop window dressing; development of advertising concepts; business appraisals; payroll preparation; data search in computer files for others; sponsorship search; administrative assistance in responding to calls for tenders; business management assistance; commercial or industrial management assistance; commercial intermediation services; providing business information via a web site; providing commercial and business contact information; provision of an online marketplace for buyers and sellers of goods and services; web indexing for commercial or advertising purposes; presentation of goods on communication media, for retail purpose; economic forecasting; auctioneering; retail services for works of art provided by art galleries; sales promotion for others; promotion of goods and services through sponsorship of sports events; producti-

on of teleshopping programmes; production of advertising films; office machines and equipment rental; rental of advertising time on communication media; publicity material rental; rental of billboards [advertising boards]; rental of vending machines; rental of sales stands; rental of photocopying machines; publication of publicity texts; radio advertising; bill-posting; distribution of samples; dissemination of advertising matter; direct mail advertising; registration of written communications and data; writing of publicity texts; advertising; online advertising on a computer network; advertising by mail order; television advertising; document reproduction; compilation of statistics; compilation of information into computer databases; business inquiries; systemization of information into computer databases; advisory services for business management; negotiation of business contracts for others; negotiation and conclusion of commercial transactions for third parties; compiling indexes of information for commercial or advertising purposes; tax preparation; drawing up of statements of accounts; telemarketing services; psychological testing for the selection of personnel; wholesale of pharmaceutical, veterinary, hygiene products and medical supplies; retail sale of pharmaceutical, veterinary, hygiene products and medical supplies; interim business management; external administrative management for companies; business management of hotels; business management for freelance service providers; business project management services for construction projects; commercial administration of the licensing of the goods and services of others; business management of reimbursement programs for others; administration of consumer loyalty programs; administration of frequent flyer programs; administrative processing of purchase orders; public relations; competitive intelligence services; modelling for advertising or sales promotion; typing; market intelligence services; appointment reminder services [office functions]; web site traffic optimization; administrative services for the relocation of businesses; tax filing services; search engine optimization for sales promotion; appointment scheduling services [office functions]; gift registry services; price comparison services; pay per click advertising; secretarial services; procurement services for others [purchasing goods and services for other businesses]; shorthand; outsourcing services [business assistance]; telephone answering for unavailable subscribers; photocopying services; business efficiency expert services; media relations services; corporate communications services; rental of office equipment in co-working facilities; commercial lobbying services.

36 – Insurance underwriting; financial affairs, namely, monetary transactions, banking services, mortgage banking, financial services provided by banks or related institutions, lending against security, namely, real estate, loan financing services provided by credit institutions other than banks, such as cooperative cre-

dit associations, independent financial companies; monetary affairs; real estate affairs; savings bank services.

---

(260) AM 2021 110831 A  
 (800) 1564710  
 (151) 2020 11 06  
 (891) 2020 11 06  
 (731) Apple Inc.  
 One Apple Park Way, Cupertino CA 95014,  
 USA  
 (540)

## SF HELLO

(591) Black, white  
 (511)  
 9 – Downloadable computer software for generating, displaying, and printing fonts.

---

(260) AM 2021 110832 A  
 (800) 1564731  
 (151) 2020 11 05  
 (891) 2020 11 05  
 (731) SK BIOPHARMACEUTICALS CO., LTD.  
 221, Pangyoyeok-ro, Bundang-gu, Seongnam-si, Gyeonggi-do, Republic of Korea  
 (540)

## ONTOZRY

(591) Black, white  
 (511)  
 5 – Pharmaceutical and veterinary preparations; pharmaceuticals; chemical preparations for pharmaceutical purposes; pharmaceutical preparations for the treatment of cancer; pharmaceutical preparations for the treatment of central nervous system [CNS] diseases; pharmaceutical preparations for the prevention of disorders of the nervous system; psychotropics; soporifics; pain relief preparations; pharmaceutical preparations for the treatment of diseases of the endocrine system; pharmaceutical preparations for treating metabolic disorders; pharmaceutical preparations for the treatment of multiple sclerosis; medicated preparations for skin treatment; pharmaceutical preparations for the treatment of musculoskeletal disorders; pharmaceutical preparations for preventing and treating seizure; pharmaceutical preparations for the treatment of cardiovascular disease; pills for dizziness symptoms treatment; pharmaceutical preparations for the prevention of disorders of the immune system; pharmaceutical preparations for the treatment of hormonal disorders; pharmaceutical products for treating respiratory diseases.

(260) AM 2021 110833 A  
 (800) 1564736  
 (151) 2020 11 06  
 (891) 2020 11 06  
 (731) Apple Inc.  
 One Apple Park Way, Cupertino CA 95014,  
 USA  
 (540)

## SF MONO

(591) Black, white  
 (511)  
 9 – Downloadable computer software for generating, displaying, and printing fonts.

---

(260) AM 2021 110834 A  
 (800) 1564738  
 (151) 2020 11 01  
 (891) 2020 11 01  
 (731) Guess? IP Holder L.P.  
 1444 South Alameda Street, Los Angeles  
 CA 90021, USA  
 (540)

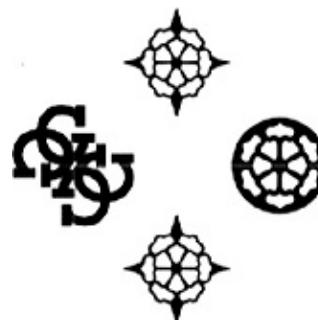

(591) Black, white  
 (531) 05.05.20; 26.05.04; 26.13.25; 27.05.22  
 (511)  
 3 – Fragrances, perfumes, colognes, cosmetics, body washes, hair and body lotions.

14 – Bracelets; earrings; horological and chronometric instruments and parts thereof; cuff links and tie clips; necklaces; rings; watchbands; wrist watches; watches; key rings of precious metal; jewelry.

18 – Athletic bags, backpacks, beach bags, carry-all bags, credit card cases, duffel bags, handbags, luggage, messenger bags, purses, satchels; textile, canvas, leather and reusable shopping bags; shoulder bags, sport bags; toiletry bags sold empty, tote bags, traveling bags, waist packs, wallets.

25 – Men's, women's, boys', girls' and infants' apparel, namely, underwear, footwear, swimwear, caps, headwear, pajamas, hosiery, gloves, belts, socks, shorts, t-shirts, sweatpants, sweatshirts, knit tops, skirts, pants, trousers, sweaters, jeans, dungarees, vests, coats, jackets, dresses, scarves, blouses, cardigans, gowns, golf shirts, jogging suits, turtlenecks, polo shirts; women's panties, bras, lingerie, tank tops, crop tops, bustiers,

camisoles, tap pants, rompers and teddies; infants' coveralls.

(260) AM 2021 110835 A

(800) 1564743

(151) 2020 07 03

(891) 2020 07 03

(731) Lodestar Anstalt

Lova-Center, P.O. Box 1150; FL-9490 Vaduz,

Liechtenstein

(540)

## HIGH FLIER

(591) Black, white

(511)

3 – Non-medicated cosmetics; cosmetic creams; cosmetic gels; lotions; shampoo; non-medicated dentifrices; perfumery, essential oils; cleaning, polishing, scouring and abrasive preparations; non-medicated cosmetics containing cannabis or cannabis derivatives; cosmetic creams containing cannabis or cannabis derivatives, cosmetic gels containing cannabis or cannabis derivatives; lotions containing cannabis or cannabis derivatives; shampoo containing cannabis or cannabis derivatives; non-medicated dentifrices containing cannabis or cannabis derivatives; perfumery containing cannabis or cannabis derivatives; essential oils containing cannabis or cannabis derivatives cleaning, polishing, scouring and abrasive preparations, all containing cannabis or cannabis derivatives.

5 – Medical and veterinary preparations; medical preparations for inhaling; sanitary preparations for medical purposes; dietetic food and substances adapted for medical or veterinary use; dietary supplements and nutritional supplements for human beings and animals, vitamin preparations; preparation for the relief of pain, for relaxation, for reducing stress and fatigue, for mood enhancement, for maintaining general health and well-being, for relieving anxiety, for relieving depression, as a sleep aid; plasters, materials for dressings; inhalants; medical marijuana, cannabis, cannabis oils and cannabis derivatives; food for medicinal and health purposes containing cannabis or cannabis derivatives; beverages for medicinal and health purposes containing cannabis or cannabis derivatives; dietary supplements and nutritional supplements containing cannabis or cannabis derivatives; medicated skincare products and cosmetics containing cannabis or cannabis derivatives; medical and veterinary preparations containing cannabis or cannabis derivatives; inhalants containing medical cannabis or cannabis derivatives; herbal teas with cannabis or cannabis derivatives as an ingredient; herbs extracts; dried cannabis buds for medical purposes.

29 – Preserved, frozen, dried and cooked fruits and vegetables; jellies, jams, compotes, eggs; milk, cheese, butter, peanut butter, yogurt and other milk pro-

ducts; oils and fats for food; preserved, frozen, dried and cooked fruits and vegetables all containing cannabis or cannabis derivatives, jellies, jams, compotes, all containing cannabis or cannabis derivatives, milk products containing or infused with cannabis or cannabis derivatives; oils and fats containing cannabis or cannabis derivatives for food purposes; oil made of cannabis or cannabis derivatives or cannabis extracts.

30 – Coffee, tea, cocoa and artificial coffee; tea substitutes; tea essences; non-medicated teas in bags; rice, pasta and noodles, tapioca and sago; flour and preparations made from cereals; bread, pastries and confectionery; chocolate, ice cream, sorbets and other edible ices; honey, treacle; seasonings, spices, preserved herbs; vinegar, sauces; ice [frozen water]; coffee, tea, cocoa and artificial coffee mixed with or containing cannabis or cannabis derivatives; pasta and noodles flavored with or containing cannabis or cannabis derivatives, tapioca and sago mixed with cannabis or cannabis derivatives; flour and preparations made from cereals, mixed with or containing cannabis or cannabis derivatives; bread, pastries and confectionery containing cannabis or cannabis derivatives; chocolate with cannabis or cannabis derivatives as an ingredient; ice cream, sorbets and other edible ices with cannabis or cannabis derivatives as an ingredient; honey, treacle, flavored with cannabis or cannabis derivatives; seasonings, spices, preserved herbs all mixed or flavored with cannabis or cannabis derivatives; vinegar, sauces, all infused or flavored with cannabis or cannabis derivatives.

31 – Raw and unprocessed agricultural, horticultural and forestry products; raw and unprocessed grains and seeds; fresh fruits, vegetables, fresh herbs, dried herbs for decoration; oil made of herbs; natural plants and flowers, seedlings and seeds for planting; foodstuffs and beverages for animals; cannabis; cannabis in its various forms including live cannabis plants, cannabis seeds fresh cannabis, cannabis strains; foodstuff and beverages for animals containing, mixed or flavored with cannabis or cannabis derivatives.

32 – Beers; non-alcoholic beverages; mineral and aerated waters; fruit beverages and fruit juices; syrups and other non alcoholic preparations for making beverages; carbonated soft drinks, and energy drinks; cannabis or cannabis derivatives infused beer; beer containing cannabis or cannabis derivatives as an ingredient; non-alcoholic beverages flavored or infused with cannabis or cannabis derivatives; mineral and aerated waters flavored or infused with cannabis or cannabis derivatives, fruit beverage and fruit juices containing cannabis or cannabis derivatives, energy drinks with cannabis or cannabis derivatives; beer and soft drinks, containing cannabis seed extract or mature cannabis stem extract.

33 – Alcoholic beverages, except beers, alcoholic preparations for making beverages; cocktail mixes, alco-

holic energy drinks, Cannabis or cannabis derivatives infused alcoholic beverages; alcoholic beverages containing cannabis or cannabis derivatives as an ingredient; alcoholic beverages flavored or infused with cannabis or cannabis derivatives; cocktail mixes with cannabis or cannabis derivatives; alcoholic energy drinks with cannabis or cannabis derivatives alcoholic beverages including mixed drinks, containing cannabis seed extract or mature cannabis stem extract.

34 – Tobacco and tobacco substitutes cigarettes and cigars; electronic cigarettes and oral vaporizers for smokers; smokers' articles; matches; chemical flavorings in liquid form used to refill electronic cigarette cartridges; cartridges for electronic cigarettes; non-medical preparations for inhaling; tobacco and tobacco substitutes containing or mixed with cannabis or cannabis derivatives; cigarettes and cigars with cannabis or cannabis derivatives; cannabis cigarettes; cannabis based products for smoking and inhaling; cannabis flavorings in liquid form used to refill electronic cigarette cartridges.

(260) AM 2021 110836 A

(800) 1564767

(151) 2019 06 26

(891) 2019 06 26

(731) ALVARO CETTO GAROLLO

Periferico Sur 7750, Colonia Santa María

Tequepexpan, Tlaquepaque, Jalisco, Mexico

(540)

**AGAVEN**

(591) Black, white

(511)

30 – Natural agave sweetener supplement.

(260) AM 2021 110837 A

(800) 1564783

(151) 2020 10 27

(891) 2020 10 27

(731) Kyochon F&B Co., Ltd.

78, Songsin-ro, Gasan-myeon, Chilgok-gun,

Gyeongsangbuk-do, Republic of Korea

(540)

**KYOCHON**

(591) Grey and Orange

(531) 26.11.12; 27.05.11; 29.01.12

(511)

29 – Preserved, dried and cooked fruit and vegetables; prepared side dishes consisting primarily of meat, fish, poultry or vegetable; tinned meat, fish, vegetables and fruits; packaged meats; meat, fish, poultry and game; meat, frozen; chicken; pork belly; pork; duck meat; beef; preserved meats and sausages; processed

eggs; smoked egg; dried meat; meat-based snack foods; prepared dishes consisting principally of meat; frozen appetizers consisting primarily of chicken; jellies for food; pre-packaged dinners consisting primarily of meat.

43 – Restaurants featuring home delivery; snack-bar services; tourist restaurant services; instant noodles restaurants; restaurant services; buffet restaurants; salad bars; western style restaurants; self-service cafeteria services; restaurant services in the framework of franchise; mobile restaurant services; Japanese restaurant services; traditional Korean tea cafes; food and drink catering by bakeries; Chinese restaurants; cafe and cafeteria services; fast-food restaurant services; street stalls serving light dishes (restaurant services); Korean restaurants; providing lunch box services in the framework of franchising.

(260) AM 2021 110838 A

(800) 1564801

(151) 2020 11 06

(891) 2020 11 06

(731) Apple Inc.

One Apple Park Way, Cupertino CA 95014,  
USA

(540)

**SF PRO**

(591) Black, white

(511)

9 – Downloadable computer software for generating, displaying, and printing fonts.

(260) AM 2021 110839 A

(800) 1564805

(151) 2020 07 17

(891) 2020 07 17

(731) Zakrytoe aktsionernoe obshchestvo

"Starodvorskie kolbasy"

ul. Poliny Osipenko, 41, RU-600009 Vladimir,  
Russian Federation

(540)



(591) White, burgundy, pink, orange, brown, light brown

(531) 08.05.03; 28.05; 29.01.15

(526) Symbol "R", the shape of the packaging (casing)  
(511)  
29 – Charcuterie.

(260) AM 2021 110855 A  
(800) 1547324  
(151) 2020 06 18  
(891) 2020 11 06  
(731) SISALPAY SPA  
Via Alessio Di Tocqueville, 13, I-20154  
MILANO (MI), Italy  
(540)

## MOONEY

(591) Black, white  
(511)  
36 – Real estate affairs; deposit of valuables; financial consultancy; financial sponsorship; insurance consultancy; safe deposit services; rental of apartments; rental of farms; real estate management; financial management; financial analysis; brokerage; mutual funds; issuance of travellers' checks; issuance of tokens of value; issuance of credit cards; online banking; brokerage of carbon credits; capital investment; rental of offices [real estate]; insurance brokerage; clearing [financial]; instalment loans; pawn brokerage; stock exchange quotations; actuarial services; savings bank services; financing services; provident fund services; business liquidation services [financial]; retirement payment services; mortgage banking; trusteeship; financial evaluation of standing timber; real estate appraisal; stamp appraisal; jewelry appraisal; art appraisal; antique appraisal; financial evaluation [insurance, banking, real estate]; repair costs evaluation [financial appraisal]; financial evaluation of wool; electronic funds transfer; insurance; financial affairs; monetary affairs; charitable fund raising; financial information; insurance information; organization of monetary collections; banking; credit bureaux; real estate agencies specialising in rentals; debt collection and recovery services; customs brokerage; real estate agencies; real estate management; accident insurance; fire insurance; health insurance; marine insurance; life insurance; charitable fund raising; safe deposit services; factoring; surety services; arranging letting of real estate; credit leasing; real estate brokerage; stocks and bonds brokerage; foreign currency exchange; fiscal valuation; financial loan services; rent collection; credit card services; charge card services; numismatic appraisals; check verification.

(260) AM 2021 110857 A  
(800) 1558724  
(151) 2020 08 14  
(891) 2020 11 23  
(731) Shiseido Americas Corporation  
10th Floor, 301 Route 17 North, Rutherford  
NJ 07070, USA  
(540)

## DRUNK ELEPHANT

(591) Black, white  
(511)  
3 – Beauty serums; non-medicated skin care preparations; skin moisturizer; sun block; beauty masks; eye cream; facial cleansers; facial masks; lip balm; skin cleansers; skin masks; cleansing bars; face and body beauty creams; face and body lotions; face powder; facial oils; gels for cosmetic purposes; moisturizing creams; skin bronzer; skin care kits comprised of an assortment of non-medicated skin care preparations; sunscreen preparations; make-up removing preparations; anti-aging cream; deodorant for personal use; cosmetic preparations for the hair and scalp; non-medicated preparations for the care of skin, hair and scalp; hair shampoo; hair conditioner; hair detangling preparations; non-medicated preparations for the care of hair and scalp.

(260) AM 2021 110892 A  
(800) 1564885  
(151) 2020 10 29  
(891) 2020 10 29  
(731) DAIMLER AG  
Mercedesstraße 120, 70372 Stuttgart, Germany  
(540)

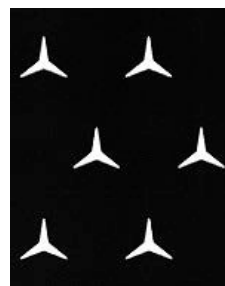

(591) Black, white  
(531) 01.01.01; 01.01.05; 01.01.08; 25.07.01;  
26.04.05; 26.04.13; 26.04.24  
(511)  
12 – Vehicles; apparatus for locomotion by land, air or water; parts and fittings for vehicles.  
28 – Games; toys; video game apparatus; interactive gaming chairs for video games; appliances for gymnastics; sporting articles [except for skis and snowboards]; decorations for Christmas trees.  
37 – Vehicle repair, maintenance, refuelling and recharging.



(260) AM 2021 110893 A

(800) 1564919

(151) 2020 10 06

(891) 2020 10 06

(731) AKCIJU SABIEDRĪBA "OLAINFARM", AS  
Rūpnīcu iela 5, Olaine, LV-2114 Olaines  
novads, Latvia

(540)

# OLAINFARM

(591) Black, white

(511)

1 – Chemicals for use in industry.

5 – Pharmaceutical and veterinary preparations.

(260) AM 2021 110894 A

(800) 1564954

(151) 2020 10 09

(891) 2020 10 09

(731) L. GOBBI S.R.L.  
Via Bartolomeo Bosco, 57, I-16121 GENOVA  
(GE), Italy

(540)

# *l.gobbi*

(591) Pantone color 348c

(531) 27.05.01; 29.01.03

(511)

1 – Chemicals for use in agriculture, horticulture and forestry, fertilizers, fertilizing preparations, plant growth regulating preparations.

(260) AM 2021 110905 A

(800) 1565281

(151) 2020 09 22

(891) 2020 09 22

(731) Obshchestvo s ogranichennoy otvetstvennostyu  
"BREND BOKS"  
prospect Lenina, d. 58A, et. 3, off. 17, Saransk,  
RU-430003 Republic of Mordovia,  
Russian Federation

(540)

# СВЕРКАЮЩИЙ ИНЕЙ

(591) Black, white

(531) 28.05

(511)

33 – Alcoholic beverages, except beer; aperitifs; ar-rack [arak]; brandy; wine; piquette; whisky; vodka; anisette [liqueur]; kirsch; gin; digesters [liqueurs and spirits]; cocktails; curacao; anise [liqueur]; liqueurs; pre-mixed alcoholic beverages, other than beer-based; alcoholic beverages containing fruit; spirits [bevera-

ges]; distilled beverages; mead [hydromel]; pepper-mint liqueurs; bitters; rum; sake; perry; cider; rice alcohol; alcoholic extracts; fruit extracts, alcoholic; alcoholic essences.

(260) AM 2021 110906 A

(800) 1565290

(151) 2020 07 23

(891) 2020 07 23

(731) Egis Gyógyszergyár Zrt.  
Keresztúri út 30-38., H-1106 Budapest,  
Hungary

(540)

# SILSEQ

(591) Black, white

(511)

3 – Cosmetics and cosmetic preparations.

5 – Human pharmaceutical preparations; dietetic substances adapted for medical use; dietary supplements; medicinal ointments; medicated skin creams; plasters, materials for dressings.

(260) AM 2021 110907 A

(800) 1565302

(151) 2020 08 12

(891) 2020 08 12

(731) Joint-stock company "AKKOND"  
Skladskoy proezd, d. 16, Cheboksary,  
RU-428022 Chuvash republic, Russian  
Federation

(540)



(591) White, yellow, blue, dark blue, black, red, pink, gray, green and dark green

(531) 01.15.14; 02.09.01; 03.07.06; 05.05.16;  
05.05.22; 26.11.03; 26.11.13; 28.05; 29.01.15

(511)

30 – Confectionery for decorating Christmas trees; pastries, including, cakes, crackers, cookies, biscuits, petit-beurre biscuits, gingerbread; almond confectionery, peanut confectionery, fruit confectionery, caramels [candy]; candies; fondants [confectionery], liquorice [confectionery], peppermint sweets, pastilles [confectionery], pralines, chocolate decorations for cakes; bread, chocolate.

(260) AM 2021 110908 A

(800) 1565323

(151) 2020 09 03

(891) 2020 09 03

(731) KHOROL INFANT NUTRITION FACTORY  
LLC17, Molodizhna Str., Khorol, Poltava region  
37800, Ukraine

(540)

**HAPPYLON**

(591) Black, white

(531) 27.05.01

(511)

5 – Infant formula; powdered milk for babies; lacteal  
flour for babies; food for babies.

(260) AM 2021 110909 A

(800) 1565344

(151) 2020 09 22

(891) 2020 09 22

(731) Obshchestvo s ogranichennoy otvetstvennostyu  
"BREND BOKS"off. 17, et. 3, d. 58A, prospect Lenina,  
RU-430003 Saransk, Republic of Mordovia,  
Russian Federation

(540)

**СОЛНЕЧНАЯ ДЕРЕВЕНЬКА**

(591) Black, white

(531) 28.05

(511)

33 – Alcoholic beverages, except beer; aperitifs; ar-  
rack [arak]; brandy; wine; piquette; whisky; vodka;  
gin; digesters [liqueurs and spirits]; cocktails; liqu-  
eurs; alcoholic beverages; alcoholic beverages contain-  
ing fruit; spirits [beverages]; distilled beverages; me-  
ad [hydromel]; peppermint liqueurs; bitters; rum; sa-  
ke; cider; rice alcohol; alcoholic extracts; fruit ex-  
tracts, alcoholic; alcoholic essences.

(260) AM 2021 110910 A

(800) 1565372

(151) 2020 08 14

(891) 2020 08 14

(731) Zudov Oleh Vasylovych

vul. Haharina, 1, s. Sofiiivska Borshchagivka,  
Kyievo-Sviatoshynskyi raion, Kyivska oblast  
02094, Ukraine

(540)



(591) Turquoise, black and white

(531) 26.11.03; 26.11.08; 26.11.09; 26.11.13;  
27.05.01; 29.01.13

(511)

11 – Apparatus and installations for heating, cooling,  
steam generating, drying, ventilating, water supply  
and sanitary purposes; steam accumulators; heat accu-  
mulators; hot air apparatus; air deodorizing apparatus;  
ionization apparatus for the treatment of air or water;  
air cooling apparatus; gas scrubbing apparatus; de-  
sicating apparatus; hand drying apparatus for wash-  
rooms; steam facial apparatus (saunas); heating and  
cooling apparatus for dispensing hot and cold beve-  
rages; air purifying apparatus and machines; under-  
floor heating apparatus and installations; germicidal  
lamps for purifying air; laundry room boilers; fans  
(air-conditioning); fans (parts of air-conditioning ins-  
tallations); electric fans for personal use; ventilation  
(air-conditioning) installations for vehicles; ventilati-  
on (air-conditioning) installations and apparatus; eva-  
porators; pressure water tanks; water conduits ins-  
tallations; water-pipes for sanitary installations; water  
intake apparatus; water heaters; gas lighters; gas con-  
densers, other than parts of machines; gas boilers; gas  
burners; deodorizing apparatus, not for personal use;  
chimney flues; flues for heating boilers; immersion  
heaters; humidifiers for central heating radiators; hu-  
midifiers; coils (parts of distilling, heating or cooling  
installations); heating apparatus; air conditioners for  
vehicles; taps for pipes and pipelines; mixer taps for  
water pipes; taps; radiator caps; ice machines and ap-  
paratus; freezers; air reheaters; stoves (heating appa-  
ratus); heating installations (water); heating installati-  
ons; heaters for vehicles; heating apparatus, electric;  
heating apparatus for solid, liquid or gaseous fuels;  
heating boilers; air dryers; steam boilers, other than  
parts of machines; cooling appliances and installati-  
ons; radiators (heating); radiators, electric; central  
heating radiators; sinks; heat regenerators; refrigera-  
tors; solar furnaces; solar thermal collectors (heating);  
air sterilizers; heat pumps; heat guns; heat exchangers,  
other than parts of machines; thermostatic valves  
(parts of heating installations); boiler pipes (tubes) for  
heating installations; bath installations; steam genera-  
ting installations; cooling installations for water; cool-  
ing installations for liquids; water distribution ins-  
tallations; air filtering installations; cooling installations  
and machines; hair dryers; filters for air conditioning;  
filters for drinking water; refrigerators; refrigerators,  
cooling apparatus and freezers for medical storage  
purposes; refrigerating apparatus and machines; refri-  
gerating containers; refrigerating chambers; refri-  
gerating display cabinets; refrigerating appliances and in-  
stallations; refrigerating cabinets.

(260) AM 2021 110911 A

(800) 1565415

(151) 2020 09 24

(891) 2020 09 24

(731) LLC TorgCity

Tatarskaya str., 1, lit. L, of. 303, Vladivostok,  
RU-690039 Primorskiy kray, Russian  
Federation

(540)



(591) Yellow, beige, brown, blue, red and white

(531) 03.09.01; 03.09.24; 26.07.25; 28.05; 29.01.15

(511)

29 – Beans, preserved; soya beans, preserved, for food; bouillon; fatty substances for the manufacture of edible fats; laver, preserved; sea-cucumbers, not live; mushrooms, preserved; jellies for food; edible fats; fish sausages; caviar; sauerkraut; kimchi; clams, not live; klipfish [salted and dried cod]; bouillon concentrates; fish cakes; onions, preserved; mussels, not live; fish mousses; vegetables, preserved; freeze-dried vegetables; frozen vegetables; vegetables, cooked; processed fern; fish paste; smoked fish products; frozen fish; smoked fish; pickled fish; vegetable salads; soups; vegetable soup preparations; tajine [prepared meat, fish or vegetable dish].

30 – Aromatic preparations for food; freeze-dried dishes with the main ingredient being pasta; freeze-dried dishes with the main ingredient being rice; sea water for cooking; seaweed [condiment]; mustard; ketchup [sauce]; condiments; tomato sauce; sauces [condiments].

31 – Fish spawn; fish meal for animal consumption.

(260) AM 2021 110912 A

(800) 1565551

(151) 2020 11 12

(891) 2020 11 12

(731) Rosier S.A.

Route de Grandmetz 11A, B-7911 Moustier,  
Belgium

(540)



(591) Black, white

(531) 26.01.01; 26.01.06; 26.01.24; 26.11.06

26.11.12; 27.05.01; 29.01.13

(511)

1 – Fertilizers and chemical products for use in agriculture, horticulture and forestry; soil fertilizers; technical nitrogenous products; nitrogenous fertilizers; raw materials for fertilizers; mineral fertilizers; chemical additives for soil; ammonia; ammonium nitrate; urea [fertilizer]; nitric acid.

(260) AM 2021 110913 A

(800) 1565619

(151) 2020 06 21

(891) 2020 06 21

(731) WEBUILD S.p.A.

Via dei Missaglia 97, I-20142 Milano, Italy

(540)



(591) Red and white

(531) 01.05.12; 27.05.01; 29.01.01

(511)

6 – Window fasteners of metal; windows of metal; telegraph posts of metal; metal cladding; street gutters of metal; structures and transportable buildings of metal; posts of metal for power lines; roofing plate of metal; shuttering of metal for concrete; portable metal levees; joists of metal; window stops of metal; door frames of metal; door stops of metal; water-pipes of metal; bridges [structures] of metal; steel masts; ducting conduit installations (non-electric -) of metal; barricades for highways (metal -); window casement bolts; safety doors of metal; roof coverings of metal; wall linings of metal for building; fittings of metal for windows; metal portable pier; doors of metal; buildings of metal; swimming pools [structures] of metal; check rails of metal for railways; wainscotting of metal; railway material of metal; road construction materials of metal; bollards (metal, non-luminous and non-mechanical -), for roads; tile floorings of metal; metal hardware; door bells of metal, non-electric; ladders of metal; monuments of metal; bars for metal railings; latches of metal; frameworks of metal; pre-fabricated houses of metal; pipes, tubes and hoses, and fittings therefor, including valves, of metal; copings of metal; ironwork for windows; door panels of metal; sluices [drains] of metal; tiles of metal for building; ironwork for doors; jalousies of metal; metal ventilation channels; architraves of metal; bridge bearings [construction materials] of metal; directional signage of metal for roads [non-luminous, non-mechanical]; outdoor blinds of metal; window frames of metal; platforms, prefabricated, of metal; door fittings of metal; crash barriers of metal; metal railings for bridges;

reinforcing materials of metal for building; steel buildings; fittings of metal for building; shutters of metal; steel sheets; roof flashing of metal; building and construction materials and elements of metal; buildings, transportable, of metal; unwrought or semi-wrought common metals; sills of metal; palings of metal; crash barriers of metal for roads; ceilings of metal; structural steels; lintels of metal; partitions of metal; materials of metal for railway construction; manhole covers of metal; duckboards of metal; door openers, non-electric; reinforcing materials, of metal, for concrete; building panels of metal; refractory construction materials of metal; gates of metal; beams of metal; sewer pipes of metal; door closers of metal, non-electric; door knockers of metal; display signs of metal [non-luminous, non-mechanical] for roads; common metals, unwrought or semi-wrought; cladding of metal for walls; window pulleys; doors, gates, windows and window coverings of metal; gully shafts of metal; door handles of metal; paving blocks of metal; slabs of metal for building; roofing of metal; runners of metal for sliding doors; roller blinds of steel; posts of metal; sheet piles of metal; roof gutters of metal; cornices of metal; latch bars of metal; safety scaffolding of metal; temporary bridges of metal; latticework of metal; pantiles of metal; building materials of metal; casement windows of metal; floors of metal.

19 – Bituminous products for building; rubble; trench drains [concrete drainage structures]; cements for building; asphalt paving; security glass for use in building; road signs, non-luminous and non-mechanical, not of metal; reinforced concrete; plaster; water-pipes, not of metal; roadways of non-metallic materials; asphalt; building timber; building stone; clay; window glass for building; building materials, not of metal; gravel; concrete; reinforcing materials, not of metal, for building; pillars, not of metal, for building; earth for bricks; road repair materials (non-metallic -); granite; parquet flooring; crash barriers, not of metal, for roads; casings (non-metallic -) for use in building or construction; marble; caissons for construction work under water; lime; tufa; portable signs [non-luminous, non-mechanical, non-metallic] for roads; planks of wood for building; coatings [building materials]; bridge bearings [construction materials] not of metal; porphyry [stone]; binding material for road repair; floor tiles, not of metal; asphalt [for building purposes]; common sheet glass for building; olivine for building; industrial concrete for use in civil engineering works; road asphalt; slag [building material]; raw chalk; concrete piles; tar; mortar for building; sandstone for building; wooden flooring; cladding materials (non-metallic -); building glass; roofing membranes; safety glass; stone; buildings, not of metal; safety doors, not of metal; bollards (fixed, non-metallic, non-luminous and non-mechanical -), for roads; barricades for highways (non-metallic -); cement slabs; woven mats (non-metallic -) for the protection of dikes against

erosion; channels of non-metallic materials for transmitting air for ventilation; temporary dams, not of metal; marble for construction; concrete beams; railway materials, non-metallic; hips for roofing; sluices [channels], not of metal; woven geotextile materials (non-metallic -) for protecting dikes against erosion; cement; sand, except foundry sand; bridges [structures] other than of metal; architraves of non-metallic materials; bitumen for use in road construction; concrete building materials; bitumen; insulating glass for building; portland cement; macadam; building and construction materials and elements, not of metal; doors, gates, windows and window coverings, not of metal; bricks; railway sleepers, not of metal; statues and works of art made of materials such as stone, concrete and marble, included in the class; materials, not of metal, for building and construction; structures and transportable buildings, not of metal; road coating materials; beams (non-metallic -) for building purposes.

37 – Rental of bulldozers; construction of motorways; maintenance of water purifying apparatus; installation of water pipes; installation of rainwater harvesting systems; harbour construction; demolition of buildings; carpentry services; beneath ground construction work relating to water supply pipes; cleaning of exterior airport runways; repair of water supply installations; road paving; construction consultancy; sanding; asphaltting; installation of water supply apparatus; construction of buildings; building project management [construction supervision]; cleaning of water tanks; constructing decks; custom construction of roads; communications infrastructure construction; roofing services; building, construction and demolition; security fencing (erection of -); maintenance of roads; repair and maintenance of building scaffolds, working and building platforms; advisory services relating to the maintenance of environmental control systems; beneath ground construction work relating to water supply mains; masonry; installation of security systems; installation of bridge expansion joints; factory construction; road construction; cleaning of culverts; road stripping; street sweeping services; underwater construction; plumbing installation, maintenance and repair; building of canal locks; power infrastructure construction; construction of dams; construction information; construction of foundations for roads; repair of canalization systems; construction of bridges; drilling of deep oil or gas wells; construction and maintenance services relating to water irrigation; drilling of wells; street cleaning; warehouse construction and repair; scaffolding; aviation infrastructure construction; installation of security and safety equipment; building sealing; marking of roads; oil well casing, tubing, and drill pipe installation; hydro-electric factory construction; installation of environmental control systems; rental of tools, plant and equipment for construction, demolition, cleaning and maintenance; ship-

building; installation of gas and water pipelines; installation of doors and windows; grout reinforcement for bridges; installation of rainwater drainage systems; mining extraction; construction of railways; demolition of bridges; maintenance and repair of security installations; maintenance and repair of road making machines; rail infrastructure construction; building of fair stalls and shops; construction of foundations for bridges; civil infrastructure construction; installation of environmental engineering systems; grout reinforcement for dams; water and oil well boring; construction of foundations for dams; advisory services relating to the repair of environmental control systems; boring of water wells; quarrying services; bricklaying; infrastructure construction; building insulating; building construction supervision; installation of hydropower systems; building maintenance and repair; services for the repair of canals; rental of construction equipment; extraction of natural resources; maintenance and repair of road making equipment; construction of airports; custom construction of bridges; installation of environmental protection systems; oil well drilling; rental of excavators; rental of building scaffolds, working and building platforms; maintaining and repair of rain channels; damp-proofing to existing buildings.

39 – Supply [transport] of water for domestic use; supply [transport] of water for industrial use; ground support freight handling services provided at airports; carriage of persons by urban rapid transit rail systems; water supplying; transportation information; services for the supply of water by pipeline; operating canal locks; storage; bridge operation; water distribution; physical storage of electronically stored data or documents; public utilities in the nature of supplying water; operation of locks and bridges used for transport purposes; supply of water by pipeline; operating toll roads; airline check-in services; supply [transport] of water through pipes; water distribution and supply; electricity distribution; distribution of energy; airport parking services; transportation logistics; transport by pipeline; provision of information relating to road traffic conditions; traffic information.

40 – Lead working; processing of fuel materials; metal stamping; gas production services; metal treating; electricity generating; stainless steel brushing services; processing of hydrocarbon derivatives; regeneration of water; sandblasting services; heat treatment and coating of steel; flame proofing; processing of plastics; silversmithing; water treatment and purification; generation of electricity from solar energy; treating [forging] of metal; steel cutting; recycling and waste treatment; material treatment information; fuel treatment services; treating [shaping] of metal; water purification; planing of materials; metal tempering; waste water treatment; production of hydroelectric power; pneumatic abrasion of surfaces; filtration services utilising gravel; processing of hydrocarbons; timber felling and processing; woodworking; proces-

sing of oil; treatment [washing] of coal; processing of chemicals and petrochemicals; water treating; wastewater treatment services in the field of water pollution control; buildings (fire-proofing to existing -); desalination of water; treatment of waste materials in the field of environmental pollution control; enamelling; oil well treatment; ceramic processing; treatment of hazardous substances; application of wear resistant coatings to engineering components; processing of tree barks; enamelling of metals; air and water conditioning and purification; cutting of metal; petrochemical refining services; shot blasting; stone crushing; soil, waste or water treatment services [environmental remediation services]; drilling of metals; energy production; blast treatment of a surface (services for the -); processing of rubber; ceramic glazing; fireproofing of existing structures; tin plating; treating [enamelling] of metal; heat treatment of metals; filtration services for the petroleum industry; filtration services for the parapetroleum industry; bevelling of glass; waste and/or water treatment services; generation of gas and electricity; abrasion; metalworking; soldering; processing of coal; treating [embossing] of metal; metallurgical processing; provision of information relating to chemical processing; treatment of hazardous liquids; processing of gas and oil; cutting of sheet glass; natural gas liquefaction services.

42 – Computer aided design services relating to architecture; computer aided design services relating to building projects; design services relating to real estate; engineering drawing; design and development of computer hardware; technical research relating to computers; design planning; design and development of wireless computer networks; industrial development services; design of engineered building systems; design of hotels; computer-aided engineering design and drawing services; design and development of operating software for accessing and using a cloud computing network; computer system analysis; drafting and development of photovoltaic systems; urban planning; energy auditing; research in the field of environmental conservation; developing and updating computer software; monitoring of computer systems by remote access; research relating to security; design of road networks; design of building interiors; environmental consultancy services; industrial design; design of buildings; environmental testing of vibration; development of computer systems; design services for architecture; planning [design] of multi-story office towers; advisory services relating to building design; office layout design services; environmental assessment services; research in the field of environmental protection; water quality control services; development of energy and power management systems; design and development of multimedia products; planning [design] of buildings; design and development of software for control, regulation and monitoring of solar energy systems; monitoring of water quality; consul-

tation services relating to interior design; landscape lighting design; water analysis; development and testing of computing methods, algorithms and software; website development services; technical design and planning of pipelines for gas, water and waste water; engineering and computer-aided engineering services; architectural design for exterior decoration; environmental testing; design services relating to interior decorating for offices; design of layouts for offices; architectural design services relating to exhibitions; services for the planning [design] of offices; services for the development of methods of testing; engineering design; interior and exterior design services; architectural design; architectural services for the design of industrial buildings; design services relating to civil engineering; providing technological information about environmentally-conscious and green innovations; engineering services for the design of structures; development of measuring and testing methods; scientific research; house design; architectural design for interior decoration; civil engineering planning services; design of monumental masonry; environmental monitoring of waste storage areas; technical consulting in the field of environmental engineering; conducting technical project studies; engineering consultancy relating to design; consultation in environment protection; consultancy in the field of energy-saving; preparation of reports relating to technical research; architectural services for the design of commercial buildings; technical research in the field of aeronautics; environmental monitoring services; development of computer platforms; computer assisted engineering design services; analysis of stream water quality; environmental hazard assessment; interior design services and information and advisory services relating thereto; design and development of computer software for logistics, supply chain management and e-business portals; advisory services relating to the safety of the environment; hosting web sites; design of industrial buildings; quality control; consultancy services relating to environmental planning; architectural services relating to the development of land; research in the field of building construction; technical project studies in the field of construction; construction engineering services [construction design]; advisory services relating to the planning of premises; engineering services; advisory services relating to research in the field of preventing environmental pollution; advisory services relating to design engineering; design of engineering works for the prevention of inundation of land by flood water; design services relating to residential property; shopping centre design; design services for the interior of buildings; design services relating to architecture; architectural design for town planning; development of testing methods; design of engineering works for the prevention of inundation of buildings by flood water; engineering design and consultancy; design of industrial plant; consultancy and information services relating to information technolo-

gy architecture and infrastructure; software development; design of office space; research and development of new products for others; product research and development services; research and development services in the field of engineering; computer-aided engineering design services; design and development of energy distribution networks; development of data bases; environmental monitoring of waste treatment areas; material testing; design of restaurants; design of health care buildings; development of computer programs recorded on data media (software) designed for use in construction and automated manufacturing (cad/cam); construction drafting; research relating to design; engineering services in the field of environmental technology; environmental testing services to detect contaminants in water; design and development of regenerative energy generation systems; design services for furniture; building design services; design of engineering works for flood prevention.

---

(260) AM 2021 110920 A

(800) 689629

(151) 1998 03 02

(891) 2020 11 30

(731) CANTINE BAVA S.P.A.

Strada Monferrato, 2, I-14023 COCCONATO  
D'ASTI, Italy

(540)

**BAVA**

(591) Black, white

(511)

33 – Alcoholic beverages (except beer).

---

(260) AM 2021 110921 A

(800) 915853

(151) 2007 02 06

(891) 2020 11 25

(731) WU, KUANG-JUNG

No. 7, Lane 1, Jhongsing Village, Hukou  
Township, Hsinchu County, Taiwan, China

(540)

**EVERGREEN**

(591) Black, white

(531) 27.05.01

(511)

12 – Tires for vehicle wheels; repair outfits for inner tubes; tires for bicycles, cycles.

---

(260) AM 2021 110922 A

(800) 938802

(151) 2007 05 29

(891) 2020 11 26

(731) L.CREDI-Peugler GmbH

Ridlerstraße 31, 80339 München, Germany

(540)

**L. CREDI**

(591) Black, white

(531) 27.05.01

(511)

14 – Leather key fobs.

18 – Bags of any kind, in particular made of leather or imitation leather; small leather goods, in particular purses, wallets, key wallets, empty cases for cosmetic utensils, pouches; suitcases, namely travel cases and travel bags; umbrellas; parasols.

25 – Belts for clothing.

(260) AM 2021 110923 A

(800) 1211026

(151) 2013 12 12

(891) 2020 11 24

(731) PM S.r.l.

Via G. Garibaldi, 16, VIGONOVO (VE), Italy

(540)

**PHILIPPE MODEL**

(591) Black, white

(511)

25 – Clothing, footwear, headgear; non-slipping devices for footwear; bandanas [neckerchiefs]; headbands [clothing]; stockings; sweat-absorbent stockings; bibs, not of paper; berets; overalls; boas [necklets]; tights; hosiery; bonnets; swimming caps; shower caps; boots; ankle boots; tips for footwear; garters; lace boots; collar protectors; camisoles; pants (Am.); bathing drawers; skull caps; bodices [lingerie]; hoods [clothing]; hat frames [skeletons]; belts [clothing]; money belts [clothing]; shawls; footmuffs, not electrically heated; pullovers; headgear; paper hats [clothing]; headgear; chasubles; socks; slippers; footwear; football boots; beach shoes; ski boots; sports shoes; shirts; short-sleeve shirts; tights; shoulder wraps; wetsuits for water-skiing; slippers [undergarments]; slippers [undergarments]; corsets; corsets; suits; swimming costumes; masquerade costumes; beachwear; ear muffs [clothing]; studs for football boots; ties; knickers; babies' pants [clothing]; dress shields; ready-made linings [parts of clothing]; sashes for wear; footwear uppers; shirt yokes; espadrilles; fur stoles; detachable collars; fittings of metal for footwear; sock suspenders; scarves; furs [clothing]; gabardines [clothing]; girdles; goloshes; ski gloves; gloves; waistcoats; gaiters; wimples; motorists' clothing; cyclists' clothing; clothing; top hats; rain suits; leg warmers; garters; garters; jumpers; skirts; skorts; petticoats; ascots; layettes [clothing]; leggings [trousers]; liveries; singlets; cuffs; muffs [clothing]; maniples; jackets; mantillas; sleep masks; mittens; miters [hats]; topcoats; parkas; dressing gowns; bath robes; pelerines; pelisses; shirt fronts;

pockets for clothing; pocket squares; ponchos; pullovers; pyjamas; gowns; pinafore dresses; wooden shoes; sandals; bath sandals; saris; sarongs; soles for footwear; soles for footwear; footwear; bath slippers; gymnastic shoes; sports shoes; trouser straps; underwear; sweat-absorbent underwear; brassieres; aprons [clothing]; heelpieces for footwear; heelpieces for stockings; heelpieces for footwear; tee-shirts; footwear uppers; togas; welts for footwear; knitwear [clothing]; turbans; uniforms; stuff jackets [clothing]; jackets [clothing]; fishing vests; ready-to-wear clothing; outerclothing; clothing for gymnastics; clothing of leather; clothing of imitations of leather; paper clothing; visors [headwear]; cap peaks; veils [clothing].

28 – Animal skins, hides; trunks and travelling bags; umbrellas and parasols; walking sticks; hat boxes of leather; cases, of leather or leatherboard; walking sticks; umbrella sticks; satchels; leatherboard; baggage; vanity cases (not fitted); coverings of skins [furs]; trimmings of leather for furniture; trunks [luggage]; baggage; briefcases; moleskin [imitation of leather]; umbrellas; parasols; animal skins, hides; walking stick handles; umbrella handles; suitcase handles; card cases [notecases]; briefcases; music cases; baggage; furniture coverings of leather; sling bags for carrying infants; casual bags; rucksacks; handbags; bags for campers; beach bags; gym bags; baggage; envelopes, of leather, for packaging; garment bags for travel; sling bags for carrying infants; travelling sets [leatherware]; baggage

(260) AM 2021 110924 A

(800) 1221143

(151) 2014 06 23

(891) 2020 11 17

(731) H & M Hennes & Mauritz AB  
SE-106 38 Stockholm, Sweden

(540)

**COS**

(591) Black, white

(531) 27.05.03

(511)

24 – Textiles and textile goods, not included in other classes; bed clothes; table cloths of textile; blankets; sheets, pillow cases, duvet covers; bed covers; throws; bed skirts; bed blankets; place mats; table cloths not of paper; oilcloth for use as tablecloths; table runners; table napkins of textile; linen for household purposes; bath towels and hand towels; tea cloths; curtains for showers; curtains; coverings of plastic for furniture; furniture coverings of textile; pillow shams; woven blankets; quilts filled with stuffing materials; dish towels for drying.

26 – False hair; hair curlers (other than hand implements); accessories for apparel, sewing articles and decorative textile articles; hair bands; slides (hair grips) not of precious metal; hair nets; barrettes (hair-slides); artificial flowers; badges for wear, not of precious metal; embroidery; lace; novelty buttons; ornamental novelty pins (not of precious metal), other than jewellery; tassels (fringes).

(260) AM 2021 110925 A

(800) 1269754

(151) 2015 03 13

(891) 2020 11 25

(731) THE CONCEPTUAL EYEWEAR, LDA

Rua Diogo Cão, numero 100 Freguesia de

Darque, P-4935-162 Viana do Castelo, Portugal

(540)



VAVA

(591) Black, white

(531) 26.11.11; 26.11.13; 27.05.22

(511)

9 – Eyewear; corrective eyewear; prescription eyewear; sports eyewear; protective eyewear; eyewear cases; sunglasses; sunglasses frames; clip-on sunglasses; frames for sunglasses; lenses for sunglasses; cases for sunglasses; straps for sunglasses; chains for sunglasses; frames for spectacles and sunglasses; optical lenses for use with sunglasses; optical glasses; cyclists' glasses; spectacle lenses; spectacles [glasses]; sun glasses; protective glasses; eye glasses; glasses cases; glasses frames; magnifying glasses; sports glasses; waling glasses; corrective glasses; opera glasses; theatre glasses; field-glasses; ski glasses; reading glasses; sight glasses [optical]; lenses for glasses; shooting glasses [optical]; lorgnettes [opera glasses]; frames for glasses; magnifying glasses [optics]; anti-glare glasses; children's eye glasses; cases adapted for glasses; eye glasses; spectacles; safety spectacles; 3D spectacles; protective spectacles; spectacles [optics]; polarizing spectacles; retainers for spectacles; bars for spectacles; frames for spectacles; cords for spectacles; anti-dazzle spectacles; lenses for spectacles; chains for spectacles; protective eyeglasses; frames for eyeglasses; eyeglasses; lenses for eyeglasses; glacier eyeglasses; lorgnette frames; spectacle frames; eyeglass frames; unmounted spectacle frames; monocles; anti-dazzle shades; pince-nez; pince-nez cases; pince-nez mountings; pince-nez cases; pince-nez cords; pince-nez chains; goggles; divers' goggles; sports goggles; diving goggles; snow goggles; ski goggles; safety go-

goggles; swim goggles; swimming goggles; protective goggles; scuba goggles; goggles for sports; goggles for sports; goggles for use in sports; lorgnette frames; contact lenses; contact lens cases; containers for contact lenses; holders for contact lenses; containers for contact lenses; cases adapted for contact lenses; carrying cases for contact lenses; blanks for contact lenses; lens cases; sunglass cases; eyeglass cases; spectacle cases; eyeglass cases; cases adapted for binoculars; cases especially made for photographic apparatus and instruments; spectacles; telephone earpieces; eyeglass shields; eyeglass chains; eyeglass cords; eyeglass lenses; eyeglass chains; safety glasses for protecting the eyes; lens blanks for eyesight correction; interchangeable lenses; optical lenses; optical lenses; spectacle lenses; magnifying lenses; ophthalmic lenses; glass ophthalmic lenses; objectives [lenses] optics; anti-reflective lenses; objectives [lenses] [optics]; correcting lenses [optics].

21 – Cloths for wiping spectacles; cloths for wiping eyeglasses; eyeglass cleaning cloths; cloths for wiping spectacles.

(260) AM 2021 110927 A

(800) 1435461

(151) 2018 09 27

(891) 2020 11 23

(731) Obschestvo s ogranichennoy otvetstvennost'yu "NL Kontinent"

ul. Yadrintsevskaya, d. 53/1, of. 1015,

RU-630099 Novosibirsk, Russian

Federation

(540)



(591) Green, yellow, orange, red and white

(531) 18.04.01; 18.04.11; 27.05.10; 29.01.15

(511)

5 – Acaricides; aconitine; alkaloids for medical purposes; alginates for pharmaceutical purposes; algicides; aldehydes for pharmaceutical purposes; dental amalgams of gold; dental amalgams; amino acids for veterinary purposes; amino acids for medical purposes; analgesics; anaesthetics; antibiotics; antiseptics; medicine cases, portable, filled; first-aid boxes, filled; aluminium acetate for pharmaceutical purposes; acetates for pharmaceutical purposes; germicides; balms for medical purposes; bandages for dressings; diagnostic biomarker reagents for medical purposes; biocides; bromine for pharmaceutical purposes; paper for mustard plasters; fly catching paper; reagent paper for



veterinary purposes; reagent paper for medical purposes; mothproofing paper; petroleum jelly for medical purposes; vaccines; oxygen baths; antiseptic cotton; aseptic cotton; absorbent cotton; wadding for medical purposes; cotton for medical purposes; dietetic substances adapted for medical use; radiological contrast substances for medical purposes; nutritive substances for microorganisms; radioactive substances for medical purposes; melissa water for pharmaceutical purposes; sea water for medicinal bathing; mineral waters for medical purposes; thermal water; dietary fiber; molding wax for dentists; gases for medical purposes; guaiacol for pharmaceutical purposes; sexual stimulant gels; hematogen; hemoglobin; hydrastine; hydrastinine; glycerine for medical purposes; glycerophosphates; glucose for medical purposes; gentian for pharmaceutical purposes; hormones for medical purposes; mustard for pharmaceutical purposes; mustard plasters; mud for baths; medicinal mud; gamboge for medical purposes; gurjun balsam for medical purposes; air deodorising preparations; deodorants, other than for human beings or for animals; deodorants for clothing and textiles; diastase for medical purposes; digitalin; mineral food supplements; nutritional supplements; albumin dietary supplements; dietary supplements for animals; yeast dietary supplements; alginate dietary supplements; glucose dietary supplements; casein dietary supplements; lecithin dietary supplements; linseed oil dietary supplements; propolis dietary supplements; protein dietary supplements; protein supplements for animals; royal jelly dietary supplements; pollen dietary supplements; wheat germ dietary supplements; linseed dietary supplements; enzyme dietary supplements; yeast for pharmaceutical purposes; gelatine for medical purposes; cod liver oil; isotopes for medical purposes; immunostimulants; insecticides; iodine for pharmaceutical purposes; iodides for pharmaceutical purposes; alkaline iodides for pharmaceutical purposes; iodoform; calomel [fungicide]; tartar for pharmaceutical purposes; camphor for medical purposes; capsules for medicines; cachets for pharmaceutical purposes; hemostatic pencils; wart pencils; caustic pencils; carbolineum [parasiticide]; caustics for pharmaceutical purposes; cachou for pharmaceutical purposes; quassia for medical purposes; quebracho for medical purposes; oxygen for medical purposes; gallic acid for pharmaceutical purposes; acids for pharmaceutical purposes; adhesives for dentures; surgical glues; stem cells for veterinary purposes; stem cells for medical purposes; cocaine; collagen for medical purposes; collodion for pharmaceutical purposes; corn rings for the feet; candy, medicated; angostura bark for medical purposes; barks for pharmaceutical purposes; cedar wood for use as an insect repellent; condurango bark for medical purposes; croton bark; mangrove bark for pharmaceutical purposes; myrobalan bark for pharmaceutical purposes; quinquina for medical purposes; medicated animal feed; medicinal roots; rhubarb roots for pharma-

ceutical purposes; lint for medical purposes; starch for dietetic or pharmaceutical purposes; creosote for pharmaceutical purposes; blood for medical purposes; cultures of microorganisms for medical or veterinary use; curare; dental lacquer; liquorice for pharmaceutical purposes; lactose for pharmaceutical purposes; candy for medical purposes; adhesive plasters; medicines for alleviating constipation; lecithin for medical purposes; lotions for veterinary purposes; medicated hair lotions; lotions for pharmaceutical purposes; medicated after-shave lotions; personal sexual lubricants; lupulin for pharmaceutical purposes; magnesia for pharmaceutical purposes; liniments; ointments for pharmaceutical purposes; sunburn ointments; mercurial ointments; frostbite salve for pharmaceutical purposes; gauze for dressings; medicinal oils; mustard oil for medical purposes; camphor oil for medical purposes; castor oil for medical purposes; oil of turpentine for pharmaceutical purposes; dill oil for medical purposes; dental mastics; dental abrasives; dental impression materials; teeth filling material; dressings, medical; surgical dressings; drugs for medical purposes; medicines for veterinary purposes; serotherapeutic medicines; medicines for human purposes; medicines for dental purposes; menthol; medicinal drinks; moleskin for medical purposes; almond milk for pharmaceutical purposes; powdered milk for babies; royal jelly for pharmaceutical purposes; milk ferments for pharmaceutical purposes; Irish moss for medical purposes; flour for pharmaceutical purposes; linseed meal for pharmaceutical purposes; fish meal for pharmaceutical purposes; fly glue; antibacterial soap; disinfectant soap; medicated soap; freeze-dried meat adapted for medical purposes; mint for pharmaceutical purposes; dietetic beverages adapted for medical purposes; malted milk beverages for medical purposes; narcotics; medicinal infusions; tincture of iodine; eucalyptol for pharmaceutical purposes; tinctures for medical purposes; opium; opodeldoc; decoctions for pharmaceutical purposes; antiparasitic collars for animals; stick liquorice for pharmaceutical purposes; sulfur sticks [disinfectants]; medicated dentifrices; pectin for pharmaceutical purposes; pepsins for pharmaceutical purposes; peptones for pharmaceutical purposes; hydrogen peroxide for medical purposes; pesticides; food for babies; leeches for medical purposes; blood plasma; eyepatches for medical purposes; poultices; compresses; scapulars for surgical purposes; babies' diapers; diapers for pets; diapers for incontinents; bunion pads; breast-nursing pads; pomades for medical purposes; powder of cantharides; pyrethrum powder; anti-uric preparations; bacterial preparations for medical and veterinary use; bacteriological preparations for medical and veterinary use; balsamic preparations for medical purposes; albuminous preparations for medical purposes; biological preparations for veterinary purposes; biological preparations for medical purposes; veterinary preparations; bismuth preparations for pharmaceutical purposes; vitamin prepara-

tions; diagnostic preparations for medical purposes; bath preparations for medical purposes; therapeutic preparations for the bath; hemorrhoid preparations; preparations for callouses; lice treatment preparations [pediculicides]; acne treatment preparations; preparations to facilitate teething; preparations for the treatment of burns; fumigation preparations for medical purposes; ootherapy preparations; air purifying preparations; bronchodilating preparations; preparations for reducing sexual activity; sterilising preparations; soil-sterilising preparations; corn remedies; pharmaceutical preparations for treating dandruff; preparations for destroying noxious animals; herbicides; preparations for destroying dry rot fungus; larvae exterminating preparations; fly destroying preparations; preparations for destroying mice; slug exterminating preparations; vermin destroying preparations; pharmaceutical preparations for skin care; contact lens cleaning preparations; preparations of microorganisms for medical or veterinary use; lime-based pharmaceutical preparations; medicated eye-washes; medicinal hair growth preparations; nutraceutical preparations for therapeutic or medical purposes; opiates; anticryptogamic preparations; aloe vera preparations for pharmaceutical purposes; preparations of trace elements for human and animal use; sulfonamides [medicines]; pharmaceutical preparations; pharmaceutical preparations for treating sunburn; enzyme preparations for veterinary purposes; enzyme preparations for medical purposes; phytotherapy preparations for medical purposes; chemico-pharmaceutical preparations; chemical preparations for veterinary purposes; chemical preparations for the diagnosis of pregnancy; chemical preparations for medical purposes; chemical preparations to treat wheat blight; vine disease treating chemicals; chemical preparations to treat mildew; chemical preparations for treating phylloxera; chemical preparations for pharmaceutical purposes; chilblain preparations; mothproofing preparations; collyrium; lead water; chemical conductors for electrocardiograph electrodes; albuminous foodstuffs for medical purposes; dietetic foods adapted for medical purposes; by-products of the processing of cereals for dietetic or medical purposes; homogenized food adapted for medical purposes; freeze-dried food adapted for medical purposes; pharmaceuticals; sanitary towels; panty liners [sanitary]; propolis for pharmaceutical purposes; pearl powder for medical purposes; radium for medical purposes; hydrated chloral for pharmaceutical purposes; solvents for removing adhesive plasters; vaginal washes for medical purposes; solutions for contact lenses; chemical reagents for medical or veterinary purposes; gum for medical purposes; rubber for dental purposes; chewing gum for medical purposes; insect repellents; insect repellent incense; repellents for dogs; tissues impregnated with pharmaceutical lotions; sarsaparilla for medical purposes; sugar for medical purposes; asthmatic tea; fumigating sticks; linseed for pharmaceutical purposes; tobacco-free cigarettes

for medical purposes; siccatives [drying agents] for medical purposes; syrups for pharmaceutical purposes; turpentine for pharmaceutical purposes; greases for veterinary purposes; greases for medical purposes; lacteal flour for babies; infant formula; soporifics; bicarbonate of soda for pharmaceutical purposes; bath salts for medical purposes; salts for mineral water baths; salts for medical purposes; potassium salts for medical purposes; sodium salts for medical purposes; smelling salts; mineral water salts; malt for pharmaceutical purposes; semen for artificial insemination; alcohol for pharmaceutical purposes; medicinal alcohol; alloys of precious metals for dental purposes; ergot for pharmaceutical purposes; cooling sprays for medical purposes; antibacterial handwashes; adjuvants for medical purposes; astringents for medical purposes; vermifuges; disinfectants for hygiene purposes; disinfectants for chemical toilets; douching preparations for medical purposes; appetite suppressants for medical purposes; medical preparations for slimming purposes; parasiticides; mouthwashes for medical purposes; febrifuges; depuratives; animal washes [insecticides]; detergents for medical purposes; cattle washes [insecticides]; dog washes [insecticides]; insecticidal veterinary washes; vesicants; purgatives; remedies for perspiration; remedies for foot perspiration; chemical contraceptives; antiparasitic preparations; laxatives; tonics [medicines]; medicated toiletry preparations; digestives for pharmaceutical purposes; nervines; media for bacteriological cultures; steroids; strychnine; serums; tanning pills; appetite suppressant pills; slimming pills; antioxidant pills; sanitary tampons; vulnerary sponges; thymol for pharmaceutical purposes; biological tissue cultures for veterinary purposes; biological tissue cultures for medical purposes; smoking herbs for medical purposes; medicinal herbs; surgical implants comprised of living tissues; pants, absorbent, for incontinents; sanitary panties; babies' diaper-pants; charcoal for pharmaceutical purposes; porcelain for dental prostheses; phenol for pharmaceutical purposes; enzymes for veterinary purposes; enzymes for medical purposes; ferments for pharmaceutical purposes; formic aldehyde for pharmaceutical purposes; phosphates for pharmaceutical purposes; fungicides; quinine for medical purposes; chinoline for medical purposes; diabetic bread adapted for medical use; chloroform; flowers of sulfur for pharmaceutical purposes; cement for animal hooves; bone cement for surgical and orthopaedic purposes; dental cements; medicinal tea; herbal teas for medicinal purposes; insecticidal animal shampoo; medicated shampoos; medicated shampoos for pets; pediculicidal shampoos; medicated dry shampoos; pre-filled syringes for medical purposes; eucalyptus for pharmaceutical purposes; herbal extracts for medical purposes; plant extracts for pharmaceutical purposes; tobacco extracts [insecticides]; extracts of hops for pharmaceutical purposes; elixirs [pharmaceutical preparations]; ethers for pharmaceutical purposes; esters

for pharmaceutical purposes; cellulose esters for pharmaceutical purposes; cellulose ethers for pharmaceutical purposes; rat poison; poisons; bacterial poisons; jalap; bismuth subnitrate for pharmaceutical purposes; fennel for medical purposes; transplants [living tissues]; jujube, medicated; sedatives; milking grease; suppositories; diagnostic preparations for veterinary purposes; pastilles for pharmaceutical purposes; cotton sticks for medical purposes; adhesive tapes for medical purposes; cream of tartar for pharmaceutical purposes; disinfectants.

29 – Ajvar [preserved peppers]; aloe vera prepared for human consumption; alginates for culinary purposes; anchovy, not live; peanuts, prepared; artichokes, preserved; albumen for culinary purposes; white of eggs; beans, preserved; soya beans, preserved, for food; bouillon; ginger jam; ham; fatty substances for the manufacture of edible fats; edible birds' nests; peas, preserved; mushrooms, preserved; guacamole [mashed avocado]; game, not live; gelatine; meat jellies; jellies for food; fruit jellies; yolk of eggs; coconut fat; bone oil for food; lard; suet for food; edible fats; fruit-based snack food; milk substitutes; charcuterie; raisins; caviar; eggplant paste; vegetable marrow paste; fish roe, processed; yogurt; galbi [grilled meat dish]; sauerkraut; kephir [milk beverage]; isinglass for food; clams, not live; potato-based dumplings; milk shakes; black pudding; onion rings; arrangements of processed fruit; compotes; meat, tinned; vegetables, tinned; fish, tinned; fruits, tinned; bouillon concentrates; gherkins; shrimps, not live; prawns, not live; buttercream; croquettes; silkworm chrysalis for human consumption; sweet corn, processed; kumys [milk beverage]; spiny lobsters, not live; lecithin for culinary purposes; salmon, not live; onions, preserved; margarine; marmalade; oils for food; peanut butter; cocoa butter for food; coconut oil for food; coconut butter; corn oil for food; sesame oil for food; olive oil for food; palm oil for food; palm kernel oil for food; sunflower oil for food; colza oil for food; butter; soya bean oil for food; shellfish, not live; almonds, ground; animal marrow for food; mussels, not live; milk; peanut milk; peanut milk for culinary purposes; coconut milk; coconut milk for culinary purposes; almond milk; almond milk for culinary purposes; oat milk; rice milk; rice milk for culinary purposes; albumin milk; condensed milk; soya milk; powdered milk; fish meal for human consumption; vegetable mousses; fish mousses; fruit pulp; meat; meat, preserved; freeze-dried meat; milk beverages, milk predominating; peanut milk-based beverages; coconut milk-based beverages; almond milk-based beverages; edible insects, not live; sausage casings, natural or artificial; vegetables, preserved; freeze-dried vegetables; vegetables, dried; vegetables, cooked; potato fritters; olives, preserved; lobsters, not live; flavored nuts; candied nuts; coconut, desiccated; nuts, prepared; tomato purée; liver pâté; pectin for culinary purposes; liver; pickles; jams;

powdered eggs; milk products; fish-based foodstuffs; prostokvasha [soured milk]; poultry, not live; bulgogi [Korean beef dish]; pollen prepared as foodstuff; cranberry compote; apple purée; crayfish, not live; crustaceans, not live; fish, preserved; fish, not live; salted fish; ryazhenka [fermented baked milk]; vegetable salads; fruit salads; bacon; sardines, not live; pork; herrings, not live; seeds, prepared; sunflower seeds, prepared; cream [dairy products]; whipped cream; vegetable-based cream; fat-containing mixtures for bread slices; smetana [sour cream]; lemon juice for culinary purposes; tomato juice for cooking; vegetable juices for cooking; salted meats; sausages; sausages in batter; hot dog sausages; preparations for making bouillon; preparations for making soup; nut-based spreads; tripe; soups; vegetable soup preparations; whey; cheese; tahini [sesame seed paste]; tofu; truffles, preserved; tuna, not live; oysters, not live; falafel; milk ferments for culinary purposes; rennet; dates; crystallized fruits; frozen fruits; fruit, preserved; fruit preserved in alcohol; fruit, stewed; hazelnuts, prepared; potato flakes; hummus [chickpea paste]; fruit peel; preserved garlic; lentils, preserved; potato chips; low-fat potato chips; fruit chips; non-alcoholic eggnog; seaweed extracts for food; meat extracts; escamoles [edible ant larvae, prepared]; berries, preserved; snail eggs for consumption; eggs; yakitori; sea-cucumbers, not live; fish fillets; extra virgin olive oil for food; linseed oil for food; corn dogs; kimchi [fermented vegetable dish].

30 – Vanilla flavorings for culinary purposes; flavorings, other than essential oils, for cakes; flavorings, other than essential oils, for beverages; coffee flavorings; food flavorings, other than essential oils; star aniseed; baozi [stuffed buns]; cereal bars; high-protein cereal bars; pancakes; noodle-based prepared meals; freeze-dried dishes with the main ingredient being pasta; freeze-dried dishes with the main ingredient being rice; buns; bread rolls; edible rice paper; edible paper; burritos; vanillin [vanilla substitute]; vareniki [stuffed dumplings]; waffles; vermicelli [noodles]; natural sweeteners; sausage binding materials; binding agents for ice cream; sea water for cooking; seaweed [condiment]; malt biscuits; cloves [spice]; mirror icing [mirror glaze]; cake frosting [icing]; glucose for culinary purposes; mustard; gluten additives for culinary purposes; yeast; thickening agents for cooking foodstuffs; leaven; rice-based snack food; cereal-based snack food; artificial coffee; vegetal preparations for use as coffee substitutes; dressings for salad; fruit jellies [confectionery]; candy decorations for cakes; confectionery for decorating Christmas trees; cakes; pastries; peanut confectionery; almond confectionery; pasta; ginger [spice]; frozen yogurt [confectionery ices]; cocoa; capers; caramels [candy]; curry [spice]; ketchup [sauce]; gimbap [Korean rice dish]; quiches; gluten prepared as foodstuff; flour-based dumplings; sweetmeats [candy]; liquorice [confectionery]; peppe-

rmint sweets; dulce de leche; cinnamon [spice]; coffee; unroasted coffee; starch for food; crackers; custard; hominy grits; semolina; oatmeal; crushed barley; groats for human food; ice cubes; corn, milled; corn, roasted; meat pies; turmeric; couscous [semolina]; noodles; ice for refreshment; ice, natural or artificial; edible ices; candy; rice cakes; mayonnaise; macarons [pastry]; macaroni; maltose; hominy; piccalilli; marinades; marzipan; honey; royal jelly; ice cream; bean meal; tapioca flour; potato flour; corn flour; nut flours; flour; wheat flour; soya flour; barley meal; dessert mousses [confectionery]; chocolate mousses; muesli; mint for confectionery; cocoa beverages with milk; coffee beverages with milk; coffee-based beverages; cocoa-based beverages; chamomile-based beverages; tea-based beverages; chocolate beverages with milk; chocolate-based beverages; infusions, not medicinal; crushed oats; husked oats; okonomiyaki [Japanese savory pancakes]; onigiri [rice balls]; nutmegs; chocolate-coated nuts; stick liquorice [confectionery]; pastilles [confectionery]; molasses for food; pâtés en croûte; pelmeni [dumplings stuffed with meat]; pepper; allspice; peppers [seasonings]; pesto [sauce]; cookies; petit-beurre biscuits; bibimbap [rice mixed with vegetables and beef]; pies; pizzas; meat gravies; fondants [confectionery]; popcorn; powders for making ice cream; baking powder; mustard meal; pralines; condiments; meat tenderizers for household purposes; cereal preparations; oat-based food; propolis; gingerbread; spices; petits fours [cakes]; puddings; cake powder; fruit coulis [sauces]; ravioli; ramen [Japanese noodle-based dish]; chewing gum; relish [condiment]; rice; instant rice; wheat germ for human consumption; spring rolls; sago; palm sugar; sugar; sesame seeds [seasonings]; linseed for culinary purposes [seasoning]; processed seeds for use as a seasoning; aniseed; agave syrup [natural sweetener]; confectionery; batter mixes for okonomiyaki [Japanese savory pancakes]; baking soda [bicarbonate of soda for cooking purposes]; malt for human consumption; salt for preserving foodstuffs; cooking salt; celery salt; sherbets [ices]; ham glaze; soya sauce; tomato sauce; sauces [condiments]; pasta sauce; spaghetti; seasonings; chocolate-based spreads; chocolate spreads containing nuts; preparations for stiffening whipped cream; rusks; breadcrumbs; sushi; sandwiches; tabbouleh; tacos; tapioca; tarts; dough; pastry dough; almond paste; rice pulp for culinary purposes; cake dough; garden herbs, preserved [seasonings]; chocolate decorations for cakes; vinegar; beer vinegar; ferments for pastes; halvah; bread; unleavened bread; chips [cereal products]; corn flakes; oat flakes; hot dog sandwiches; jiaozi [stuffed dumplings]; chicory [coffee substitute]; tea; iced tea; chutneys [condiments]; minced garlic [condiment]; cheeseburgers [sandwiches]; chow-chow [condiment]; saffron [seasoning]; chocolate; malt extract for food; essences for foodstuffs, except etheric essences and essential oils; husked barley; cream of tartar for culinary purposes;

flowers or leaves for use as tea substitutes; golden syrup; soya bean paste [condiment].

32 – Aperitifs, non-alcoholic; lithia water; seltzer water; soda water; waters [beverages]; aerated water; mineral water [beverages]; table waters; kvass [non-alcoholic beverage]; cocktails, non-alcoholic; beer-based cocktails; lemonades; non-alcoholic beverages; isotonic beverages; non-alcoholic honey-based beverages; rice-based beverages, other than milk substitutes; soya-based beverages, other than milk substitutes; aloe vera drinks, non-alcoholic; whey beverages; protein-enriched sports beverages; soft drinks; non-alcoholic beverages flavored with coffee; non-alcoholic beverages flavored with tea; non-alcoholic fruit juice beverages; fruit nectars, non-alcoholic; orgeat; beer; ginger beer; malt beer; powders for effervescing beverages; sarsaparilla [non-alcoholic beverage]; syrups for lemonade; syrups for beverages; smoothies; tomato juice [beverage]; cider, non-alcoholic; vegetable juices [beverages]; fruit juices; preparations for making aerated water; preparations for making liqueurs; preparations for making beverages; must; grape must, unfermented; beer wort; malt wort; pastilles for effervescing beverages; non-alcoholic fruit extracts; extracts of hops for making beer; essences for making beverages; sherbets [beverages].

35 – Arranging subscriptions to telecommunication services for others; import-export agency services; commercial information agency services; advertising agency services; cost price analysis; rental of advertising space; business auditing; business intermediary services relating to the matching of potential private investors with entrepreneurs needing funding; employment agency services; computerized file management; book-keeping; invoicing; demonstration of goods; transcription of communications [office functions]; opinion polling; market studies; business information; business investigations; business research; marketing research; personnel recruitment; business management and organization consultancy; business organization consultancy; business management consultancy; personnel management consultancy; professional business consultancy; layout services for advertising purposes; marketing; business management of performing artists; business management of sports people; writing of résumés for others; scriptwriting for advertising purposes; news clipping services; updating and maintenance of information in registries; updating and maintenance of data in computer databases; updating of advertising material; word processing; organization of exhibitions for commercial or advertising purposes; arranging newspaper subscriptions for others; organization of fashion shows for promotional purposes; organization of trade fairs for commercial or advertising purposes; shop window dressing; design of advertising materials; business appraisals; payroll preparation; data search in computer files for others; sponsorship search; business ma-

agement assistance; commercial or industrial management assistance; commercial intermediation services; providing business information via a web site; provision of commercial and business contact information; provision of an on-line marketplace for buyers and sellers of goods and services; web indexing for commercial or advertising purposes; economic forecasting; auctioneering; sales promotion for others; production of teleshopping programmes; production of advertising films; office machines and equipment rental; rental of advertising time on communication media; publicity material rental; rental of vending machines; rental of photocopying machines; publication of publicity texts; radio advertising; distribution of samples; dissemination of advertising matter; direct mail advertising; registration of written communications and data; writing of publicity texts; advertising; on-line advertising on a computer network; advertising by mail order; television advertising; document reproduction; compilation of statistics; compilation of information into computer databases; business inquiries; systemization of information into computer databases; advisory services for business management; negotiation of business contracts for others; negotiation and conclusion of commercial transactions for third parties; compiling indexes of information for commercial or advertising purposes; tax preparation; drawing up of statements of accounts; telemarketing services; psychological testing for the selection of personnel; business management of hotels; business management for freelance service providers; business project management services for construction projects; commercial administration of the licensing of the goods and services of others; business management of reimbursement programs for others; administration of consumer loyalty programs; administration of frequent flyer programs; administrative processing of purchase orders; public relations; modelling for advertising or sales promotion; typing; appointment reminder services [office functions]; relocation services for businesses; tax filing services; search engine optimization for sales promotion; appointment scheduling services [office functions]; price comparison services; secretarial services; procurement services for others [purchasing goods and services for other businesses]; shorthand; outsourcing services [business assistance]; telephone answering for unavailable subscribers; photocopying services; business efficiency expert services; commercial information and advice for consumers in the choice of products and services; pay per click advertising; web site traffic optimization; outsourced administrative management for companies; bill-posting; rental of sales stands; rental of signs for advertising purposes; wholesale services for pharmaceutical, veterinary and sanitary preparations and medical supplies; retail services for pharmaceutical, veterinary and sanitary preparations and medical supplies; presentation of goods on communication media, for retail purposes; consultancy regarding ad-

vertising communication strategies; consultancy regarding public relations communication strategies.

---

(260) AM 2021 110928 A  
 (800) 1472365  
 (151) 2019 03 01  
 (891) 2020 11 20  
 (731) Gollnest & Kiesel GmbH & Co. KG  
 Hauptstr. 13-16, 21514 Güster, Germany  
 (540)

**goki**

(591) Black, white  
 (511)  
 15 – Musical instruments; musical instruments accessories; parts and fittings for all the aforesaid goods, included in this class.

25 – Clothing, footwear, headgear.

28 – Games and playthings; gymnastic and sporting articles not included in other classes; decorations for Christmas trees.

---

(260) AM 2021 110930 A  
 (800) 1536309  
 (151) 2019 12 09  
 (891) 2020 11 24  
 (731) Vodafone Group Plc  
 Vodafone House, The Connection, Newbury,  
 Berkshire RG14 2FN, United Kingdom  
 (540)

**VODAFONE**

(591) Black, white  
 (511)  
 9 – Scientific, nautical, surveying, photographic, cinematographic, optical, weighing, measuring, signalling, checking [supervision], life-saving and teaching apparatus and instruments; apparatus and instruments for conducting, switching, transforming, accumulating, regulating or controlling electricity; apparatus for recording, transmission or reproduction of sound or images; magnetic data carriers, recording discs; compact discs, DVDs and other digital recording media; mechanisms for coin-operated apparatus; cash registers, calculating machines, data processing equipment, computers; computer software; telecommunications, telephonic and communications apparatus and instruments; radio telephones, mobile and fixed telephones; mobile phones; portable telecommunications apparatus; smartphones; cases for telephones; headsets for telephones; handheld, mobile and tablet computers; wearable electronic telecommunication and computing devices; data communication apparatus and instruments; digital voice signal processors; computer networking and data communications equipment; mobile data communications apparatus; data processing

systems; electronic databases; digital telephone platforms and software; computer hardware for telecommunications; telecommunication networks hardware; modems; network routers; broadband data interconnecting computer installations; decoders; set-top box apparatus including apparatus having an interactive viewing guide and/or a recorder for recording television and audio programmes; electrical and electronic apparatus for use in the reception of satellite, terrestrial or cable broadcasts; apparatus and instruments for the processing, transmission, storage, logging, reception and retrieval of data being in the form of encoded data, text, audio, graphic images or video or a combination of these formats; wireless handheld telecommunication units and devices, namely, tablets, wireless phones, mobile phones, smart phones, computers, portable telephones, video telephones, radios, smart watches, USB dongles, GPS trackers, wearable activity trackers, video cameras, cameras, personal digital assistants, handheld, mobile and tablet computers for the synchronisation, transmission, recordal, storage and manipulation of data and/or voice; remote controls for electric and electronic devices; personal digital assistants; electronic sensors including pedometers, altimeters and weighing scales; barcode and quick response code readers and scanners; audio and video recordings; electronic media for storing information, data, images and sound; digital media content (downloadable), including films, television programmes, radio programmes, videos, images, music, text, data, images, graphics and ringtones, provided from a computer database, the internet or other electronic network; satellite receiving and transmission apparatus and instruments; computer and video game software programs, including downloadable game programs; electronic publications (downloadable) provided online from computer databases, the internet or other electronic networks; machine readable data carriers; downloadable digital audio, video and data provided from a computer database, or the internet or other electronic network; battery chargers for use with telecommunications apparatus; batteries; battery backup power supply; peripheral equipment for televisions and computers; computers including laptop and notebook computers; electronic personal organisers; electronic and satellite navigational and positional apparatus and instruments including global positioning systems; desk or car mounted units incorporating a loud speaker which permits hands-free use of a telephone handset; in-car telephone handset cradles; teaching apparatus and instruments; metering apparatus; smart meters; blank and pre-recorded magnetic cards; cards containing microprocessors; telephone cards; encoded credit, debit and payment cards; encoded telephone credit cards; encoded cards; computer software, including computer software supplied from a computer database, the internet or other electronic network; data communications software; application software, including application software for mobile devi-

ces; downloadable computer software applications; computer software for wireless data communication; computer software and application software for the synchronisation, transmission and sharing of voice, data, calendar and content between one or more electronic devices, for purchasing applications, handheld electronic devices and for secure, encrypted purchases; operating system software; computer software for the streaming transmission and encryption and storage, of audio, video, graphics, text and data on and over communication networks; computer software to enable peer-to-peer networking and file sharing; search engine software; computer software for conducting and co-ordinating communications among computer users sharing information and audio data via electronic communications networks; software for interactive televisions; image and video editing software including software applications for use on mobile devices; software for the identification of persons; software for access control, video control and detecting the presence of persons; software for computer security, including antivirus, firewalls, antispyware, anti-spyware, web filtering; intrusion detection software; virtual private network software; computer software for receiving, processing, transmitting and displaying information relating to fitness, body fat, body mass index, sleep patterns, locations, attitude, weather and temperature; computer software for managing information regarding tracking, compliance and motivation with a health and fitness program; anti-theft devices not for vehicles; distance sensors being anti-collision sensors for vehicles, other than vehicle parts; devices and apparatus for locating movable property; apparatus for sending and receiving information from movable property; devices and apparatus for remote control of electrical apparatus and household appliances; alarm devices and installations, other than vehicle parts; satellite location and navigation systems; systems for the downloading and updating of computer software to and from electronic apparatus; electronic and biometric apparatus and installations for access control; electronic apparatus for identifying persons; closed circuit television systems; cameras, television cameras and video recorders for closed-circuit television; optical and photographic apparatus; electronic speedometers; electronic odometers; electronic tachometers; speed checking apparatus for vehicles; kilometre recorders for vehicles; electric or electronic sensors for vehicles, other than vehicle parts; electronic sensors; sirens; electric locks for vehicles; remote control apparatus; electronic keys for vehicles; electronic keyless remote controls for vehicle access devices; remote controls for starters of vehicles; remote control systems for the automatic operating of the locks of vehicle doors, boot, bonnet and roof; communication apparatus integrated into motorcycle helmets; GPS apparatus; GPS apparatus for vehicles for determining or signalling vehicle location, locations of site, travel routes, time, traffic conditions, presence of em-

emergency vehicles and hazard conditions; systems for communication networks between vehicles and road infrastructures; electronic equipment for detecting road markings; vehicle teleguidance systems and instruments; computer monitoring systems for blind spot and lane changing assistance; vehicle on-board computers; on-board electric, electronic and optical equipment for vehicles, namely, electric batteries, mileage recorders, radios for vehicles, on-board cameras, on-board electronic systems for providing driving and parking assistance in land vehicles, cruise controls for vehicles, displays for vehicles, audio speaker systems for vehicles, automatic indicators of low pressure in vehicle tyres, automatic vehicle speed control devices, autonomous driving control systems for vehicles, including for land vehicles; on-board electric, electronic and optical equipment for vehicles, including land vehicles, namely vehicle automatic driving control devices, smartphone battery chargers for use in vehicles, communications apparatus for vehicles, mobile phone connectors for vehicles, multi-camera systems for vehicles, vehicle navigation systems featuring interactive displays, radios for vehicles, temperature control apparatus [thermostats] for vehicles; on-board electric, electronic and optical equipment for vehicles, including land vehicles, namely ultrasonic object detectors for use on vehicles, on-board vehicle tracking apparatus, black boxes (data recorders) for land vehicles; on-board diagnostic computer apparatus and remote-controlled diagnostic computer apparatus for vehicles; computer systems for the downloading and updating of computer software to and from vehicles; electronic devices to detect and/or exchange data between a vehicle and a remote unit for security purposes; parking aids in the nature of electronic obstacle detection device sensors; parking assistance, namely, blind spot detection sensors; electronic apparatus for the control of car parking; pre-collision detection and collision avoidance systems, namely, on-board computers; in-vehicle touch screen computer systems; devices for remote location of vehicles; smart watchbands that communicate data to smartphones; downloadable software for promotional and demonstration purposes, for customised display screens on telecommunications apparatus; sim cards; telematics apparatus; telematics software; haptic sensors; haptic equipment and apparatus, namely tactile monitors, screens, electronic displays, switches, sensors, smart glasses and virtual or augmented reality glasses and headsets and holographic projectors; software for use with haptic sensors, equipment and apparatus; virtual reality software and hardware; augmented reality software and hardware; computer hardware modules for use with the Internet of Things [IoT]; computer hardware modules for use in electronic devices using the Internet of Things [IoT]; software for use in implementing the Internet of Things [IoT]; computer software and application software for connecting, operating, and managing networked devices, appliances, machinery

and systems in the Internet of Things (IoT); communications software; computer software and application software for secure, encrypted purchases; software for computer security, including antivirus, firewalls, antispam, anti-spyware, web filtering and intrusion detection software; customer support and customer service computer software and application software; voice command and recognition software, speech to text conversion software, and voice-enabled software applications; messaging software; personal assistant software; computer software for personal information management; computer software for use to connect and control Internet of Things (IoT) electronic devices; chatbot computer software and application software; computer software and application software in the field of artificial intelligence (AI); artificially intelligent chatbot computer software and application software for providing customer support and customer services; customer service chat robot software; humanoid robots with artificial intelligence; electronic apparatus incorporating artificial intelligence software; electronic controllers; electronic controllers to impart sensory feedback, namely, sounds and vibrations that are perceptible to the user; computer software for use in connection with the transmission of voice and data; computer software, and peripherals for personalised, interactive television (TV) programming and for use in displaying and manipulating visual media, graphic images, text, photographs, illustrations, digital animation, video clips, film footage and audio data, and for social networking; wireless controllers to monitor and control the functioning of other electronic devices; touchscreens; parental control software; communication network apparatus; networking apparatus; networking devices; e-commerce software; watches that communicate data to smartphones, namely smartwatches; safety devices for vehicles, namely, parts and fittings for vehicles for use as part of collision avoidance safety systems; devices for remote location of vehicles; collision avoidance safety systems for vehicles; steering apparatus, automatic, for vehicles; ethernet routers; wide area network [WAN] routers; wireless routers; computer network routers; computer network hubs, switches and routers; network servers; communications servers [computer hardware]; network access server hardware; ethernet adapters; ethernet cables; ethernet controllers; ethernet switches; ethernet transceivers; switches, electric; automatic switching apparatus for telecommunications; computer network switches; electronic encryption units; downloadable computer software for use in electronically trading, storing, sending, receiving, accepting, and transmitting digital currency, and managing digital currency payment and exchange transactions; interactive computer software and computer hardware for providing financial services online from a global computer network and the internet via computer terminals and mobile communication devices; electronic and com-

puter databases, namely, asset databases that can be shared and transmitted.

38 – Telecommunications; mobile and fixed telecommunication and telephone, satellite telecommunication, cellular telecommunication, radio and cellular telephone, radio facsimile, radio paging and radio communication services; voice transmission services; voice messaging and voicemail services; electronic mail services for data and voice; hire, leasing and rental of telecommunications, radio, radio telephone and radio facsimile apparatus; rental of telecommunication facilities; leasing of telephone circuits; communication of data by radio, telecommunications and by satellite; transmission and receiving by radio; communications services by satellite, television and/or radio; communication services in the nature of transmission and reception of voice; voice over IP services; telecommunication services via a global computer network or the Internet; telephone and mobile telephone message collection and transmission; delivery and reception of sound data and images; telephone communication services provided for hotlines and call centres; automated telephone call screening services; automated telephone voice message services; telephone communication services in the nature of automatic telephone answering services; personal numbering services (telephony services); rental of replacement telecommunications apparatus in the case of breakdown, loss or theft; provision of Internet services, namely Internet access services; Internet service provider (ISP) services; telecommunication of information (including web pages), computer programs and any other data; electronic mail services; provision of broadband services, namely wireless and fibre optic broadband communication services; wireless broadband communication services; providing Internet access via wireless broadband networks; providing Internet access via optical fibre broadband networks; wireless communication services; wireless telephony services; digital network telecommunications services; providing access to portals on the Internet; telecommunication services provided via Internet portal; provision of location based telecommunications services for telecommunications apparatus; provision of transfer of data via wireless application protocols [WAP], including those utilising a secure communications channel; provision of telecommunications information relating to or identifying telephone and telecommunications apparatus and instruments; telecommunications routing and junction services; electronic data interchange services; transfer of data by telecommunications; data streaming; streaming of digital media content, including films, television programmes, radio programmes, videos, music, text, data, images, graphics and ringtones, via the Internet or a telecommunications network; delivery of digital media content, including films, television programmes, radio programmes, videos, music, text, data, images, graphics and ringtones, via the

Internet or a telecommunications network; data transmission services; broadcasting services; data broadcasting services; broadcast or transmission of radio or television programmes; transmission of digital audio, video and multimedia content by telecommunications; electronic transmission of audio and video files via computer and other electronic communications networks; transmission of news and current affairs information; delivery of digital music by telecommunications; providing access to social networking websites; telecommunication services for the provision of video text, telexes and view data services, video communication services, interactive video text services; messaging services, namely, sending, receiving and forwarding messages in the form of text, audio, graphic images or video or a combination of these formats; unified messaging services; voicemail services; providing telecommunications connections to a global computer network or database; video conferencing services; video telephone services; providing telecommunications connections to the Internet or databases; computer aided transmission of messages, data and images; computer communication services; providing electronic conferencing services; providing and leasing access time to computer databases, computer bulletin boards, computer networks, interactive computer communications networks, electronic publications in various fields, merchandising and service catalogues and information and computerised research and reference materials; providing access to educational content, websites and portals; communication services for the remote control of electronic devices; provision of communications networks for systems of smart metering; communication services for the delivery of emergency messages and calls; electronic transmission of data and documents via computer terminals and electronic devices; signal transmission for electronic commerce via telecommunications systems and data communication systems; providing access to electronic communications networks and electronic databases; provision of communication facilities for the interchange of digital data; communication of data by means of telecommunications; transmission of data, including by audio-visual apparatus; transmission of sound, picture, video and data signals; providing access to databases; telecommunication services for data bank interconnection; electronic data exchange services; email data services; data broadcasting and communications services; providing third party users with access to telecommunication infrastructure; provision of information relating to telecommunications, providing electronic telecommunications connections; telecommunication gateway services; interactive telecommunications services; network telecommunication services; telecommunications consultancy services; telecommunications services for aircraft passengers; provision of access to the Internet in relation to electronic payment services including electronic fund transfer services and online transaction facilities; pro-



viding telecommunications connections and networks for use with the Internet of Things [IoT]; providing access to e-commerce platforms on the Internet; transmitting information resulting from traffic surveillance; provision of access to databases in relation to online address book, calendar and diary services; providing user access to data networks; transmission of digital data in the nature of user-generated digital media content; computer network access services provided by means of a metro Ethernet; electronic transmission of encrypted data; telecommunications services provided via fibre optic, wireless and cable networks.

(260) AM 2021 110987 A

(800) 1566042

(151) 2020 06 10

(891) 2020 06 10

(731) Tedi GmbH & Co. KG

Brackeler Hellweg 301, 44309 Dortmund,  
Germany

(540)



(591) Black, white

(531) 26.01.04; 26.01.19; 27.05.02; 27.05.17

(511)

1 – Manures; fire extinguishing compositions; chemical substances for preserving foodstuffs; tanning substances; adhesives used in industry; antifreeze; unexposed photographic films; chemicals used in horticulture; chemicals used in science; chemicals used in forestry; chemicals used in photography; chemicals used in industry; chemicals for use in agriculture; unprocessed plastics; tempering preparations; soldering preparations; carpet glue.

3 – Bleaching preparations and other substances for laundry use; cleaning, polishing, scouring and abrasive preparations; soaps; perfumery, essential oils, cosmetics, hair lotions; dentifrices; scouring solutions; preparations for cleaning waste pipes; make-up removing preparations; breath freshening sprays; eyebrow cosmetics; eyebrow pencils; bath salts, not for medical purposes; pumice stone; deodorants for personal use; scented wood; perfume water; shower gels; depilatory preparations; laundry blue; color-removing preparations; cosmetic kits; hair dye; hair spray; shampoo; body exfoliators; cosmetics; baths (cosmetic preparations for -); false nails; eyelashes (false -); lipstick; lotions for cosmetic purposes; make-up prepara-

tions; nail polish; nail care preparations; perfume; potpourris [fragrances]; polishing preparations; shaving preparations; fumigation preparations [perfumes]; joss sticks; windshield cleaning liquids; cleaning preparations for spectacles; polishing preparations; rust removers; abrasive paper; make-up preparations; make-up powder; emery paper; cosmetic masks; boot cream; shampoos for pets [non-medicated grooming preparations]; shampoo; wallpaper cleaning preparations; cotton wool for cosmetic purposes; cotton sticks for cosmetic purposes; fabric softener for laundry; incense; mascara; toothpaste.

4 – Industrial oils and greases, lubricants; lubricants; dust absorbing, wetting and binding compositions; candles and wicks for lighting; beeswax; methylated spirit; christmas lights [candles]; perfumed candles; dust removing preparations; firelighters; grease for leather; oils for the preservation of leather; perfumed candles; fuels (including motor spirit); lighting fuel.

5 – Pharmaceutical and veterinary preparations; sanitary preparations for medical purposes; sanitary preparations for medical purposes; dietetic substances adapted for medical use, food for babies; plasters, materials for dressings; material for stopping teeth, dental wax; disinfectants; preparations for destroying vermin; fungicides, herbicides; antiseptics; medicines for human purposes; aseptic cotton; babies' napkins of paper and cellulose (disposable); bath preparations for medical purposes; bandages for dressings; sanitary towels; deodorants other than for personal use; disinfectants for hygiene purposes; dietetic beverages adapted for medical purposes; febrifuges; fly catching paper; fly catching adhesives; fly destroying preparations; first-aid boxes (filled); adhesives for dentures; corn remedies; dog washes; insect repellents; capsules for medicines; germicides; compresses; solutions for contact lenses; lotions for pharmaceutical purposes; air fresheners [air deodorising preparations]; air purifying preparations; beverages adapted for medicinal purposes; medicinal infusions; medicinal hair growth preparations; menstruation bandages; mineral food supplements; mud for baths; mothproofing preparations; mouthwashes for medical purposes; antiparasitic collars for animals; pesticides; bunion pads; pharmaceutical preparations for skin care; rat poison; fumigating pastilles; contact lens cleaning preparations; medicine cases (portable) (filled); slug exterminating preparations; sunburn ointments; breast-nursing pads; animal washes [insecticides]; vermin destroying preparations; vitamin preparations; incontinence diapers.

6 – Common metals and their alloys; metal building materials; transportable buildings of metal; materials of metal for railway tracks; non-electric cables and wires of common metal; ironmongery, small items of metal hardware; pipes and tubes of metal; safes; ores; wire for aerials; fittings of metal for building; bolts of metal; busts of non-precious metal; wire rope; metal

pegs; wall plugs of metal; ice moulds of metal; badges of metal for vehicles; bottle closures of metal; insect screens of metal; tile floorings of metal; memorial plaques, of metal; cashboxes [metal or non-metal]; bells; tombs (monuments of metal for -); knobs of metal; metal hooks; handcuffs; house numbers of metal, non-luminous; chains for dogs; jealousies of metal; cable joints of metal, non-electric; metal clothes hooks; works of art of common metal; fittings of metal for furniture; identity plates of metal; keys of metal; rings of common metal for keys; screws of metal; safety cashboxes; metal ladders; metal stepladders; door handles of metal; latch bars of metal; door knockers; door bolts; bells for animals; cattle chains; bird baths [structures of metal]; padlocks; toolboxes of metal (empty); ferrules of metal.

7 – Automatic vending machines.

8 – Hand tools and implements (hand-operated); cutlery; side arms; razors; oyster openers; hatchets; pruning shears; fireplace bellows [hand tools]; gimlets [hand tools]; bits [hand tools]; crow bars; ceramic hob scrapers; daggers; can openers, non-electric; drills; electric irons; egg spoons; ice axes; fingernail polishers, electric or non-electric; depilation appliances, electric and non-electric; table forks; files [tools]; scaling knives; meat choppers; forks; pruning scissors; vegetable slicers; glazing irons; tool belts (holders); hammers [hand tools]; garden tools, hand-operated; lifting jacks, hand-operated; hand drills [hand tools]; rakes [hand tools]; planes; hunting knives; potato peelers; pruning knives; hand-operated jigsaws; spoons; machetes; manicure sets; graving tools [hand tools]; knives; nail files; nose and ear hair trimmers; egg slicers, non-electric; cheese slicers, non-electric; pedicure sets; pincers; pizza slicers; razor blades; saws [hand tools]; shovels [hand tools]; scissors; blade sharpening instruments; cutting tools [hand tools]; scythes; sickles; spatulas [hand tools]; spades; hoes [hand tools]; insecticide vaporisers (hand tools); soup ladles; pliers.

9 – Scientific, nautical, surveying, photographic, cinematographic, optical, weighing, measuring, signaling, checking (supervision), life-saving and teaching apparatus and instruments; apparatus and instruments for conducting, switching, transforming, accumulating, regulating or controlling electricity; apparatus for recording, transmitting or reproduction of sounds, images or data; magnetic data carriers, recording discs; mechanisms for coin-operated apparatus; cash registers, calculating machines and data processing equipment and computers; fire-extinguishing apparatus; answering machines; respirators for filtering air; eyeshades; films, exposed; flashlamps for cameras; letter scales; spectacles [optics]; spectacle cases; spectacle frames; spectacle lenses; compact disc players; cd boxes of paper; compact discs; computer keyboards; printers for computers; digital video disc players; batteri-

es, electric; theft prevention installations, electric; distance measuring apparatus; binoculars; telescopes; television apparatus; remote control devices; cinematographic apparatus; cameras; radiotelephony sets; recorded computer programs; computer programs [downloadable software]; altimeters; dog whistles; hydrometers; cassette players; knee-pads for workers; directional compasses; contact lenses; containers for contact lenses; headphones; laser pointers; loudspeakers; luminous signs; magnifying glasses; magnetic tapes; mouse [computer peripheral]; trackpads; cell phones; modems; monitors; teeth protectors; navigation apparatus for vehicles; power voltage regulator; notebook computers; optical data media; refrigerator magnets; radios; life vests; egg timers [sandglasses]; image scanning apparatus; commutators; signalling whistles; sirens; smart cards; sunglasses; voltmeters; games software; sports glasses; stands for photographic apparatus; plugs (current); control consoles (current); crash helmets; pocket calculators; telephones; testing apparatus none being for medical purposes; thermometers, not for medical purposes; sound recording carriers; transformers (current); usb card readers; videotapes; camcorders; video recorders; yardsticks; routers; projection screens.

10 – Veterinary apparatus and instruments; dental apparatus and instruments; artificial limbs; artificial teeth; artificial eyes; orthopedic articles; suture materials; feeding bottle receptacles; teething rings; sphygmomanometers; bandages, elastic; hearing aids; cases fitted for use by surgeons and doctors; condoms; stockings for varices; crutches; massage apparatus; gloves for massage; non-chemical contraceptives; dummies for babies; maternity belts; thermometers for medical purposes; anti-rheumatism rings; wrist braces for medical use.

11 – Apparatus for lighting, heating, steam generating, cooking, refrigerating, drying, ventilating, water supply and sanitary purposes; barbecues; lighting apparatus for vehicles; bed warmers; tanning apparatus [sun beds]; bread baking machines; ceiling lights; lights, electric, for Christmas trees; autoclaves, electric, for cooking; electric coffeepots; cooking utensils, electric; energy saving lamps; searchlights; flaming torches; bicycle lights; vehicle headlamps; friction lighters for igniting gas; gas burners; light bulbs; hair driers [dryers]; lanterns; hot air ovens; trouser pocket warmers; air conditioning installations; kilns; kitchen ranges; cooking rings; refrigerating containers; lighting lamps; lamp shades; chinese lanterns; lanterns for lighting; lava stones for barbecue grills; LED lights; luminous house numbers; glow sticks; strings of lights; light diffusers; air deodorising apparatus; baths (spa -) [vessels]; stoves [heating apparatus]; oil lamps; stoves; alcohol burners; fountains; electric torches; torches with batteries; pocket warmers; immersion heaters; water heaters; decorative water fountains; heat

regulating devices [valves] being parts of heating installations.

12 – Vehicles, except bicycles; apparatus for locomotion by land, air or water; trailer hitches for vehicles; inner tubes for bicycles, cycles; repair outfits for tyres, inner tubes; prams; pumps (air -) [vehicle accessories]; paddles for canoes; scooter; oars; sack trucks; safety seats for children, for vehicles; parts and fittings for vehicles, included in this class, other than bicycles.

13 – Firearms; ammunition and projectiles; explosives; fireworks; defence sprays.

14 – Precious metals and their alloys; jewellery, precious stones; horological and chronometric instruments; amulets [jewellery, jewelry (am.)]; pins; bracelets [jewellery, jewelry (am.)]; wristwatches; brooches [jewellery]; busts of precious metal; boxes of precious metal; clocks and watches, electric; necklaces [jewellery]; tie bars; tie pins; cuff links; lockets [jewellery]; earrings; rings [jewellery, jewelry (am.)]; jewel cases; stopwatches; watchstraps; housings for clocks and watches; wall clocks; alarm clocks.

15 – Musical instruments; flutes; guitars; gongs; castanets; electronic keyboards [musical instruments]; musical keyboard carrying cases; electric keyboards [musical instruments]; harmonicas; musical boxes; tambourines; drums [musical instruments]; iron xylophones.

16 – Paper cardboard; printed matter; bookbinding material; photographs; stationery; adhesives for stationery or household purposes; artists' materials; paint brushes; typewriters and office requisites (except furniture); instructional and teaching material (except apparatus); plastic materials for packaging (not included in other classes); printers' type; printing blocks; garbage bags of paper or of plastics; tear-off calendars; tissues of paper for removing make-up; rub down transfers; address stamps; folders for papers; document files [stationery]; scrapbooks; announcement cards (stationery); stickers [stationery]; desktop cabinets for stationery [office requisites]; mats for beer glasses; pictures and silhouettes for decorating windows; pencils; pads [stationery]; flowerpot covers of paper; booklets; paperweights; desk trays; writing paper; pamphlets; book binders; books; bookends; crayons; paper-clips; electric or non-electric pencil sharpeners; staple removers (office requisites); labels of paper or cardboard; flags of paper; figurines [statuettes] of papier mâché; bottle envelopes of paper or cardboard; bottle wrappers of paper or cardboard; correcting fluids [office requisites]; photographic albums; fountain pens; drinks crates made from paper; greeting cards; elastic bands for offices; manuals [handbooks]; hand labelling appliances; corkboard pins; calendars; record cards; catalogues; boxes for index files (office materials); scrapbook albums; adhesi-

ve tape rolls; adhesive glue sticks; sticky notes; chalk; ball pens; bibs of paper; bookmarkers; loose-leaf binders; canvas for painting; house painters' rollers; paintbrushes; painters' easels; modelling paste; rubbish bags of paper or plastic; record token cards; notebooks; paper-clips; oil paintings; parcel tape; paper handtowels; paper bags; boxes made of cardboard; notice boards; posters; rubber erasers; loose leaf paper; checkbook covers; signboards of paper or cardboard; writing and painting books; writing instruments; writing or drawing books; writing materials; writing boards; cyanoacrylates; sealing stamps; ink pads; pen; diaries; highlighting markers; ink erasers; tablecloths of paper; hygienic paper; place mats of paper; bags, envelopes, paper and polyethylene bags for wrapping (preparation of packages); wax crayons; permanent markers; sketch pads; drawing boards [painters' articles]; drawing sets; drawing instruments; drafting rulers; periodicals; compasses for drawing.

17 – Rubber, rubber and mica; plastics in extruded form for use in manufacture; packing, stopping and insulating materials; flexible tubes, not of metal; sealants for joints; anti-dazzle films for windows [tinted films]; insulating tapes; insulating gloves; insulating materials; adhesive strips, other than being office materials and not for medical or household purposes; impermeable materials for the purpose of retaining heat; packaging pouches, packaging wrappers and packaging bags of rubber; packaging materials (padding of rubber or plastics).

18 – Leather and imitation leather; animal skins, hides; trunks and travelling bags; combination walking sticks and umbrellas; saddlery; whips; harnesses; briefbags; slings for carrying infants; beach bags; wallets; bags for campers; attaché cases; portfolio cases [briefcases]; art portfolios [cases]; document cases of leather; net bags for shopping; shopping bags; wheeled shopping bags; purses; collars for animals; suitcases; handbags; dog collars; cases of leather or leatherboard; vanity cases, not fitted; traveling trunks; backpacks; satchels; key cases of imitation leather; key cases made of leather; credit card holders made of imitation leather; sport bags; dog blankets; reins for guiding children.

19 – Building materials (non-metallic); non-metallic rigid pipes for building; asphalt, pitch and bitumen; non-metallic transportable buildings; monuments, not of metal; insect screens not of metal; tile floorings, not of metal; gypsum; glass for buildings; gravestones; insect screens (non-metallic -) for doors; works of art of stone, concrete or marble; bird baths not of metal; aviaries, not of metal; cement; cement slabs.

20 – Mirrors (silvered glass); picture frames; furniture; ivory; whalebones; tortoiseshell; yellow amber; meerschaum; shelves for storage; display boards; cork memo boards; frames for display boards; bamboo curtains; benches [furniture]; closures for containers,

non-metallic; bed fittings, not of metal; flower-stands [furniture]; letter boxes, not of metal or masonry; library shelves; busts of wood, wax, plaster or plastic; containers, not of metal [storage, transport]; figurines [statuettes] of wood, wax, plaster or plastic; curtain hooks; curtain rings; poles for curtains; hand-held mirrors [toilet mirrors]; non-metal dog tags; cushions; clothes hangers and clothes hooks; mannequins and tailors' dummies; clothes stands; coral; baskets, not of metal; wickerwork; corks; scratching posts for cats; easy chairs; air mattresses, not for medical purposes; furniture fittings, not of metal; nesting boxes; notice boards of cork; bead curtains for decoration; racks; keyboards for hanging keys; covers for clothing [wardrobe]; chests for toys; seats; animal horns; tables; packaging containers of plastic; toolboxes of plastics, empty; wind chimes [decoration]; throw pillows; bird houses of metal.

21 – Household or kitchen utensils and containers (not of precious metal or coated therewith); combs and sponges; brushes (except paint brushes); brush-making materials; articles for cleaning purposes; steel-wool; unworked or semi-worked glass (except glass used in building); glassware, porcelain and earthenware included in this class; dustbins; brushes (dishwashing-); eyebrow brushes; mugs; painted glassware; brooms; beer mugs; flower pots; flower-pot covers, not of paper; cloth for washing floors; scrubbing brushes; frying pans; pins of metal (cooking -); watering can sprinklers; bread boards; bread bins; bread baskets for household purposes; ironing boards; flat-iron stands; toilet brushes; brushes; brushes, except paint brushes; busts of china, terra-cotta or glass; butter dishes; china ornaments; closures for pot lids; deodorising apparatus for personal use; shower squeegees; egg cups; buckets; jars (glass -) [carboys]; disposable table plates; toothbrushes, electric; cruets; chopsticks; bottle openers, electric and non-electric; mouse traps; skins of chamois for cleaning; window wipers; figurines (statuettes) of porcelain, terracotta or glass; hip flasks; flasks; bottles; fly swatters; ice cube molds; gardening gloves; containers for household or kitchen use; vegetable dishes; services (tableware); spice sets; watering cans; jars; glass bowls; mosaics of glass, not for building; powdered glass for decoration; glass stoppers; plungers for clearing blocked drains; hand-operated cleaning instruments; towel racks; household gloves; abrasive sponges for scrubbing the skin; insect traps; insulating flasks; coffee services; combs; pitchers; decanters; coasters, not of paper or textile; potato mashers; cheese-dish covers; dustpans; cookie jars; ceramics for household purposes; candlesticks; candle rings; garlic presses; cookery molds [moulds]; cooking pot sets; cooking pots; baskets for household purposes; corkscrews, electric and non-electric; cosmetic utensils; crystal [glassware]; cake moulds; kitchen containers; kitchen utensils; refrigerating bottles; isothermic bags; works of art, of porce-

lain, terra-cotta or glass; nest eggs, artificial; candlesticks; mouse traps; knife rests for the table; shakers; furniture dusters; mops; water apparatus for cleaning teeth and gums; chamber pots; nail brushes; heaters for feeding bottles (not electric); non-electric fruit presses for household purposes; non-electric stirrers; non-electric whisks for household purposes; non-electric grinders for household purposes; fruit cups; cups of paper or plastic; paper plates; perfume vaporizers; spatulas; pepper pots; plant syringes; picnic baskets (fitted -), including dishes; slabs; cookie [biscuit] cutters; polishing leather; porcelain ware; lunch boxes; cosmetic powder compacts; cleaning rags; cleaning tow; sprinklers; shaving brushes; rat traps; perfume burners; graters; cleaning rags; mixing spoons [kitchen utensils]; cocktail stirrers; salad bowls; salt shakers; spatulas for kitchen use; brushes for cleaning tanks and containers; basins [bowls]; beaters; signboards of porcelain or glass; cutting boards for the kitchen; basting spoons [cooking utensils]; shoe horns; boot brushes; shoe trees; dishes; pan-mats; sponges for household purposes; soap boxes; soap holders and soap dishes; soap dispensers; sieves [household utensils]; lazy susans; napkin rings; strainers; non-metal coin banks; nozzles for watering hose; dishwashing brushes; dusting cloths; feather brooms; soup bowls; trays for household purposes; tableware, other than knives, forks and spoons; cups; tea caddies; tea infusers; teapots; tea cosies; tea services [tableware]; pastry cutters; rolling pins, domestic; plates; carpet sweepers; carpet beaters [hand instruments]; crumb trays; toilet potties of plastic, portable; toilet roll holders; toilet roll dispensers; toilet sponges; pot lids; pots; pottery; tart scoops; baby baths, portable; funnels; drinking vessels; beverage glassware; straws for drinking; ironing board covers, shaped; saucers; vases; vacuum flasks; clothes-pegs; clothes drying racks; laundry drying racks; kettles, non-electric; toothbrushes; floss for dental purposes; toothpicks; toothpick holders; sugar bowls; shashlik skewers; dough scrapers; nutcrackers; broom handles of metal; sprinklers for watering flowers and plants.

22 – Ropes, string, nets, tents, awnings, tarpaulins, sails, sacks and bags (so far as included in this class); padding and stuffing materials, not of rubber, plastics, paper or cardboard; raw fibrous textile materials; car towing ropes; cords for hanging pictures; thread, not of metal, for wrapping or binding; strings; packaging string; vehicle covers, not fitted; feathers for stuffing upholstery; packing, of straw, for bottles; padding and stuffing materials; hammocks; awnings of plastic; awnings of textile; nets; sisal; rope ladders; tents.

23 – Yarns and threads, for textile use; spun cotton; cotton yarn; spools of yarn; thread of metal for embroidery; true hemp thread and yarn; jute thread and yarn; rayon thread and yarn; linen thread and yarn; sewing thread and yarn; silk yarn; wool yarn.

24 – Textiles and textile goods, included in this class; bed and table covers; napkins, of cloth, for removing make-up; bath linen, except clothing; bed linen; bed linen; cushion covers; shower curtains of textile or plastic; flags of textile or plastic; eiderdowns [down coverlets]; fleece blankets; curtains of textile or plastic; curtain holders of textile material; fabrics for textile use; linens; textile coasters; mattress covers; furniture coverings of plastic; furniture coverings of textile; mosquito nets; place mats, not of paper; travelling rugs [lap robes]; coverings for furniture; bed covers; labels of textile; face towels [made of textile materials]; towels of textile; textile napkins; handkerchiefs of textile; tablecloths, not of paper; table runners; textile napkins; tablecloths, not of paper; fitted toilet lid covers of fabric; bed sheets; bath mitts.

25 – Clothing; footwear; headgear; suits; eyemasks for sleeping purposes; layettes [clothing]; swimming costumes; bathing drawers; bathrobes; bathing caps; bath sandals; bandanas [neckerchiefs]; bikinis; leotards; brassieres; pocket squares; masquerade costumes; mittens; football boots; shoes for the garden; belts (money -) [clothing]; non-slipping devices for boots; rain boots; belts [clothing]; clothing for gymnastics; gymnastic shoes; scarves; gloves [clothing]; slippers; shirts; trousers; suspenders; hats; jackets [clothing]; caps [headwear]; pockets for clothing; corsets; costumes, father christmas costumes; neckties; bibs, not of paper; leather clothing; leggings; coats; robes; caps [headwear]; combinations [clothing]; slippers; sweaters; pyjamas; mackintoshes; sandals; neck scarves [mufflers]; sleepsuits; aprons [clothing]; ski boots; briefs; socks; sombreros; athletic shoes; boots; headbands [clothing]; g-strings; stockings; tights; sweaters; singlets; tee-shirts; mantles [clothing]; uniforms; pants; underwear.

26 – Lace and embroidery, ribbons and braid; buttons, hooks and eyes, pins and needles; artificial flowers; non-metallic badges; badges [buttons] (ornamental novelty -); cords for clothing; braids; snap fasteners; hair curlers, electrically-heated; sewing thimbles; heat adhesive patches for repairing textile articles; orsedew [trimmings for clothing]; gold embroidery; belt clasps; hair bands; bobby pins; hair pins; hair nets; bows for the hair; decorative articles for the hair; barrettes; false hair; toupees; tresses of hair; crochet hooks; hooks (haberdashery); trouser clips for cyclists; hat trimmings; dress fastenings; hook and pile fastening tapes; hook and loop fastener strips; artificial fruit; artificial garlands; needle cases; needle cushions; sewing boxes; sewing kits, without thread; hair curlers (other than hand implements), non-electric; zippers; buckles [clothing accessories]; shoe laces; shoe buckles; shoe fasteners; shoe trimmings; shoulder pads for clothing; pins, other than jewellery [jewellery (am.)]; embroidery; darning needles; knitting needles; monogram tabs for marking linen; letters for marking linen.

27 – Carpets for automobiles; bath mats; door mats; gymnasium mats; wallpaper; gymnasium mats; carpets; non-textile wall hangings; linoleum; floor coverings; matting; wallpaper of textile.

28 – Games and playthings; gymnastic and sporting articles, included in class 28; decorations for christmas trees; fishing equipment; rods for fishing; practical jokes (novelties); inflatable animals (toys); rattles [playthings]; building games; building blocks [toys]; billiard cue chalk; billiard balls; billiard cues; billiard tables; bingo cards; bodybuilding apparatus; bows for archery; boxing gloves; board games; christmas trees of synthetic material; ornaments for christmas trees, except illumination articles and confectionery; christmas tree stands; dominoes; kites; stationary exercise bike; costume masks; shuttlecocks; remote-controlled toy vehicles; parlour games; glass pebbles; bells for christmas trees; bar-bells; card games; candle holders for christmas trees; explosive bonbons [christmas crackers]; confetti; snow for christmas trees (artificial -); puppets; mobiles [toys]; marbles; easter eggs made from plastics; paddling pools (play articles); plush toys; dolls; dolls' beds; doll houses; dolls' clothes; puzzles; roller skates; chess games; swings; rocking horses; party favors; ice skates; snow globes; water wings; flippers for swimming; soap bubbles [toys]; skateboards; skis; balls for games; play money; card games; toys; toy vehicles; skipping ropes; teddy bears; safety whistles; scale model vehicles; water pistols; cups for dice; air mattresses (playthings); swimming jackets; paper hats.

29 – Meat, poultry and game; meat extracts; frozen, preserved, dried and cooked fruits and vegetables; jellies; jams, compotes; eggs, milk and milk products; edible oils and fats; stock; bouillon concentrates; tinned meat; broth concentrates; canned meat; fruit, preserved; fruit jellies; ready-to-eat nuts; vegetables, tinned [canned (am.)]; edible dried fungus; potato chips; compotes; marmalade; fruits, tinned [canned (am.)]; olives, preserved.

30 – Coffee, tea, cocoa, sugar, rice, tapioca, sago, coffee substitutes; bread, pastry and confectionery, edible ices; honey, treacles; yeast, baking powder, salt, mustard, vinegar, sauces (condiments), spices, ice; cakes (edible decorations for-); vinegar, sauces (condiments); pastries; fruit jellies [confectionery]; cereal-based snack food; cookies; biscuits; confectionery; liquorice [confectionery]; gingerbread; lollipops; marshmallows; marzipan; noodles; peppermint candy; popcorn; rice cakes; rice-based snack food; chocolate; snacks with a cereal base; confections; candy canes; confectionery for decorating Christmas trees; flour; preparations made from cereals.

31 – Agricultural, horticultural and forestry products and grains (not included in other classes); live animals; fresh fruits and vegetables; seeds, live plants and flowers; foodstuffs for animals; malt; flower

bulbs; christmas trees; edible chews for animals; grains for animal consumption; straw [forage]; dried branches; dog biscuits; cones (pine-); natural turf; nuts [fruits]; plants; sowing seeds; seedlings; sunflower; litter for animals; bird food.

32 – Beers; energy drinks; mineral and aerated waters and other non-alcoholic beverages; fruit beverages and fruit juices; syrups and other preparations for making beverages; aperitifs, non-alcoholic; powders and tablets for effervescing beverages; cocktails, non-alcoholic; isotonic drinks; lemonades; malt beer; vegetable juice; smoothies; sherbets [beverages]; tomato juice; cider (non-alcoholic); orange juice.

33 – Alcoholic beverages (except beers); fruit (alcoholic beverages containing -); pre-mixed alcoholic beverages, other than beer-based; alcoholic aperitifs; alcoholic cocktails; distilled beverages; bitters; sake; rum; brandy; spirits [beverages]; wine; sparkling wines; whisky; vodka; gin.

34 – Tobacco; smokers' articles; matches; ashtrays; lighters for smokers; gas containers for cigar lighters; pipe cleaners for tobacco pipes; pipe racks for tobacco pipes; matchboxes; tobacco jars; pipes; cigarettes; cigarette cases; cigarette filters; cigarette paper; cigars; cigar cutters; cigar boxes; humidors.

35 – Retail services, mail order trading (including online), relating to chemicals for industrial, scientific, photographic, agricultural purposes, horticulture and forestry, unprocessed artificial resins, unprocessed plastics, manure, fire extinguishing compositions, tempering and soldering preparations, chemical substances for preserving food-stuffs, tanning substances, adhesives used in industry, paints and lacquers, paint brushes, anticorrosive substances, wood preservatives, dye substances, stainers, raw natural resins, metals in foil and powder form for painters and decorators, printers and artists, detergents and cleaning products, cosmetics, cosmetics, perfumery and essential oils, dentifrices, shampoos, fuels and lighters, candles, and fats, pharmaceutical drugs, materials for dressings, fungicides, herbicides, pesticides, pharmaceutical and veterinary preparations, plasters, disinfectants, dietetic substances adapted for medical use, food for babies, building materials of metal, metal goods, namely baskets of metal, works of art of metal, figurines of metal, sculptures of metal, clothes hooks of metal, cans of metal, stirrups of metal, articles of metal hardware, safes, moneyboxes, machine tools for the treatment of materials and production, drilling machines, cleaning apparatus utilising steam, dynamod, fraises [milling machines], electric hand drills, hand-held tools, other than hand-operated, planning machines, coffee grinders, other than hand-operated, chains saws, electric glue gun, electric kitchen machines, waste disposers (machines), sewing machines, pepper mills, other than hand-operated, stirring machines, saw machines, cutting machines, paint sprayers, vacuum cleaners, bags

for vacuum cleaners, vacuum cleaner hoses, washing machine, sparking plugs for internal combustion engines, motors and engines, agricultural implements other than hand-operated, tools, gardening tools, cutlery, scissors, knives, shaving equipment, home appliances, electrical and electronic apparatus, namely smartphones, tablet computers, telecommunications apparatus and data processing apparatus, amusement apparatus, cameras, eyewear and eyeglass cases, computers, software, computer accessories, telephones, memory carriers, blank and pre-recorded CDs, DVDs, electric batteries, fire extinguishers, medical apparatus and instruments, contraceptive products, orthopedic articles, lamps and light bulbs, domestic electrical appliances, lighting devices, vehicles and vehicle accessories, fireworks, clocks, jewellery, musical instruments, books and journals, newspapers, stationery, scissors, office supplies, materials for packaging, instructional and teaching material, adhesives for stationery, stationery, goods of plastic, namely insulating materials, bags for packaging and packaging sleeves, drop cloths and sheeting, leather goods, namely handbags, document files, collars for animals, boxes, rucksacks, satchels, key cases and cases, suit cases, purses, cases, baskets, umbrellas and parasols, building materials, furniture and furnishings, objects d'art, decorative articles, household containers, household articles, household or kitchen utensils, food storage boxes, coathangers, crockery, glasses, cups, pots, cleaning appliances, ropes and cables, nets, yarns and threads, bed covers and table covers, hand towels, clothing, textile goods, shoes, headgear, haberdashery, buttons, artificial flowers, carpets and coverings, wall hangings, mats, games and playthings, decorations for christmas trees, gymnastic or sporting articles, novelties for parties, erotic articles, foodstuffs, agricultural, horticultural and forestry products, foodstuffs for animals, alcoholic beverages, non-alcoholic drinks, cigarettes, tobacco, smoker's articles and matches, tobacco products; advertising, marketing and promotional services; business assistance, management and administrative services; business analysis, research and information services; provision of on-line business and commercial information; providing business information via a website; auctioneering services; referral marketing services; arranging of collective buying; commercial assessment; arranging of competitions for advertising purposes; computerized on-line ordering services; price comparison services; procurement services, for others; arranging newspaper subscriptions for others; arranging subscriptions to reviews for others; arranging subscriptions to media packages for others; arranging subscriptions to telecommunication services for others; services rendered by a franchisor, namely, assistance in the running or management of industrial or commercial enterprises; provision of an on-line marketplace for buyers and sellers of goods and services; computerised stock ordering; negotiation and conclusion of commercial transactions for

third parties; negotiation and conclusion of commercial transactions for third parties; loyalty, incentive and bonus program services; arranging of trade fairs and exhibitions; search engine marketing services; advertising services provided via the internet; web site traffic optimization; search engine optimisation; pay-per-click advertising; online advertisements.

(260) AM 2021 110996 A  
 (800) 1566230  
 (151) 2020 10 14  
 (891) 2020 10 14  
 (731) Incyte Holdings Corporation  
 1801 Augustine Cut-Off, Wilmington  
 DE 19803, USA  
 (540)

## ABELURA

(591) Black, white  
 (511)  
 5 – Pharmaceutical preparations, namely, topical preparations for the treatment of dermatological disorders; topical preparations for the treatment of autoimmune disorders; topical preparations for the treatment of oncological disorders.

44 – Providing health information relating to dermatologic disorders, autoimmune disorders and oncological disorders: providing health information relating to dermatologic disorders, autoimmune disorders and oncological disorders via a website.

(260) AM 2021 110997 A  
 (800) 1566236  
 (151) 2020 10 21  
 (891) 2020 10 21  
 (731) Italgelatine S.p.A.  
 Strada Statale Alba Bra, 201, I-12069 Santa  
 Vittoria D'Alba (CN), Italy  
 (540)

# MiE.

(591) Black, white  
 (531) 24.17.02; 27.05.17  
 (511)  
 30 – Baked goods, confectionery, chocolate and deserts; processed grains, starches, and goods made thereof, baking preparations and yeasts; ice, ice creams, frozen yogurts and sorbets; sugars, natural sweeteners, sweet coatings and fillings, bee products; chocolates; confectionery; fruit jellies [confectionery]; sweets (candy), candy bars and chewing gum; sweetmeats [candy]; marshmallows; pastries, cakes, tarts and biscuits (cookies); cocoa based creams in the form of spreads.

(260) AM 2021 110998 A  
 (800) 1566240  
 (151) 2020 09 30  
 (891) 2020 09 30  
 (731) GIORGIO ARMANI S.P.A.  
 Via Borgonuovo, 11, I-20121 MILANO  
 (Milano), Italy  
 (540)



(591) Black, white  
 (531) 27.05.21  
 (511)  
 18 – Handbags; traveling bags; briefcases; leather briefcases; leather credit card holders; wallets; leather document briefcases; key-cases of leather and skins; purses; suit cases; cosmetic bags sold empty; gym bags; evening and shoulder bags for ladies; leather shopping bags; school bags; garment bags for travel; suit carriers for travel; shoe bags for travel; beach bags; diaper bags; backpacks; Boston bags; traveling trunks; duffel bags; overnight bags; carry-on bags; satchels; opera bags; vanity cases (not fitted); hides; cases and boxes made of leather; bags made of leather for packaging; leather straps; umbrellas; leather leashes; saddlery.

25 – Coats; jackets; trousers; skirts; tops; raincoats; overcoats; belts; braces for clothing; suits; stuff jackets; jumpers; jeans; dresses; cloaks; parkas; shirts; T-shirts; sweaters; underwear; baby-dolls being nightwear; bathrobes; bathing costumes; negligee; swim suits; dressing gowns; shawls; neckerchiefs; scarves; ties; neckties; sweat shirts; under shirts; polo shirts; body suits; shorts; combinations [clothing]; wedding dresses; stockings; socks; shoes; slippers; overshoes; galoshes; wooden clog; soles for footwear; footwear upper; boots; ski boots; snow boots; half boots; esparto shoes or sandals; sandals; bath sandals; gloves; mittens; hats and caps; visors (headwear).

(260) AM 2021 110999 A  
 (800) 1566247  
 (151) 2020 10 16  
 (891) 2020 10 16  
 (731) Incyte Holdings Corporation  
 1801 Augustine Cut-Off, Wilmington  
 DE 19803, USA  
 (540)

## ONUSUVA

(591) Black, white

(511)

5 – Pharmaceutical preparations, namely, topical preparations for the treatment of dermatological disorders; topical preparations for the treatment of autoimmune disorders; topical preparations for the treatment of oncological disorders.

44 – Providing health information relating to dermatologic disorders, autoimmune disorders and oncological disorders via a website.

(260) AM 2021 111004 A

(800) 1566404

(151) 2020 10 28

(891) 2020 10 28

(731) Ugreen Group Limited

4/F, Plant 6, 1F-6/F, Block 7, YuAn Zone,  
Gaofeng Community, Dalang Street, Longhua  
District, Shenzhen, Guangdong, China

(540)

# HiTune

(591) Black, white

(531) 27.05.01

(511)

9 – Data processing apparatus; computer peripheral devices; headsets; cables, electric; battery chargers; headphones; microphones; cabinets for loudspeakers; audio and video receivers; sound transmitting apparatus.

(260) AM 2021 111016 A

(800) 1566695

(151) 2020 10 26

(891) 2020 10 26

(731) Stockton (Israel) Ltd.

17 Hamefalsim St., Petach Tikva, Israel

(540)

# REGEV PRO

(591) Black, white

(511)

5 – Fungicides, herbicides, pesticides, insecticides and bactericides for agricultural use.

(260) AM 2021 111026 A

(800) 1566994

(151) 2020 11 19

(891) 2020 11 19

(731) Zakrytoe aktsionernoe obshchestvo "Myasnaya galereya"

ul. Poliny Osipenko, d. 65, of. 10,  
RU-600009 Vladimir, Russian Federation

(540)

# Ядрена Копоть

(591) Black, white

(531) 28.05

(511)

29 – Alginates for culinary purposes; anchovy, not live; peanuts, prepared; albumen for culinary purposes; white of eggs; beans, preserved; soya beans, preserved, for food; broth; ginger jam; fatty substances for the manufacture of edible fats; edible birds' nests; peas, preserved; mushrooms, preserved; game, not live; gelatine; meat jellies; jellies for food; fruit jellies; yolk of eggs; coconut fat; bone oil for food; lard; suet for food; edible fats; charcuterie; raisins; caviar; sauerkraut; isinglass for food; blood sausage; meat, canned; vegetables, canned; fish, canned; fruits, canned; broth concentrates; gherkins; shrimps, not live; buttercream; croquettes; silkworm chrysalis for human consumption; spiny lobsters, not live; salmon, not live; onions, preserved; margarine; marmalade; vegetable oils for food; peanut butter; cocoa butter for food; coconut oil for food; butter; mussels, not live; almonds, ground; animal marrow for food; mollusks, not live; milk; fish meal for human consumption; fruit pulp; meat; meat, preserved; vegetables, preserved; vegetables, dried; vegetables, cooked; potato fritters; olives, preserved; lobsters, not live; coconut, desiccated; nuts, prepared; tomato paste; liver pâté; pectin for culinary purposes; liver; pickles; jams; powdered eggs; products made from salted ham; milk products; fish-based foodstuffs; poultry, not live; pollen prepared as foodstuff; cranberry compote; apple purée; crustaceans, not live; fish, not live; fish, preserved; vegetable salads; fruit salads; bacon; sardines, not live; pork; herrings, not live; whipped cream; fat-containing mixtures for bread slices; tomato juice for cooking; vegetable juices for cooking; salted meats; sausages in batter; preparations for making bouillon; preparations for making soup; tripe; soups; vegetable soup preparations; cheese; tahini; tofu; sea-cucumbers, not live; truffles, preserved; tuna, not live; oysters, not live; rennet; fish fillets; dates; frosted fruits; frozen fruits; fruit, preserved; fruit preserved in alcohol; fruits, cooked; potato flakes; hummus; fruit peel; lentils, preserved; potato chips; fruit chips; seaweed extracts for food; meat extracts; snail eggs for consumption; eggs.

30 – Aromatic preparations for food; food flavorings, other than essential oils; star aniseed; biscuits; pancakes; buns; bread rolls; vanillin [vanilla substitute]; vanilla flavorings for foodstuffs; waffles; vermicelli; coffee flavorings; natural sweeteners; sausage binding materials; binding agents for edible ices; sea water for cooking; glucose for culinary purposes; mustard; thickening agents for cooking foodstuffs; artificial coffee; vegetal preparations for use as coffee substitutes; confectionery for decorating Christmas trees; cakes; pastries; peanut confectionery; almond confectionery; pasta; pasties; frozen yogurt [confectionery ices]; cocoa; capers; caramels [sweets]; gruel, with a milk base, for food; quiches; gluten prepared as foodstuff;



sweets; liquorice [confectionery]; peppermint sweets; coffee; unroasted coffee; starch for food; crackers; groats for human food; corn, milled; corn, roasted; meat pies; turmeric; couscous; farinaceous foods; noodles; ice for refreshment; ice, natural or artificial; edible ices; lollipops [confectionery]; rice cakes; maltose; fruit jellies [confectionery]; marzipan; custard; honey; royal jelly; ice cream; fruit ice cream; flour; muesli; mint for confectionery; cocoa beverages with milk; coffee beverages with milk; coffee-based beverages; tea-based beverages; chocolate beverages with milk; chocolate-based beverages; cocoa-based beverages; infusions, not medicinal; crushed oats; husked oats; nutmegs; pastilles [confectionery]; molasses for food; pepper; petits fours; cookies; pies; pizzas; fondants [confectionery]; popcorn; powders for making ice cream; pralines; condiments; meat tenderizers for household purposes; cereal preparations; food products consisting primarily of flour; oat-based food; starch-based food; bee glue; gingerbread; spices; puddings; cake powder; ravioli; chewing gum; rice; spring rolls; sugar; aniseed; cake dough; sugar confectionery; malt for human consumption; salt for preserving foodstuffs; cooking salt; celery salt; spaghetti; seasonings; preparations for stiffening whipped cream; rusks; breadcrumbs; sushi; sandwiches; yeast tablets for culinary purposes; tabbouleh; tacos; tapioca; almond paste; tortillas; fruit and berry cakes; sugar-based cake decorations; vinegar; ferments for pastes; halvah; bread; unleavened bread; chips [cereal products]; chicory [coffee substitute]; tea; iced tea; chocolate; malt extract for food; essences for foodstuffs, except etheric essences and essential oils; piccalilli; garden herbs, preserved [seasonings].

(260) AM 2021 111051 A  
 (800) 1264853  
 (151) 2015 07 14  
 (891) 2020 10 23  
 (731) Farmak International Holding GmbH  
 Mariahilferstrasse 136, A-1150 Wien, Austria  
 (540)

# Ровакор

(591) Black, white  
 (531) 28.05  
 (511)  
 5 – Pharmaceutical preparations; medicines for human purposes; medications used in cardiology.

(260) AM 2021 111058 A  
 (800) 1512798  
 (151) 2019 11 08  
 (891) 2020 12 08  
 (731) Arnold André GmbH & Co. KG  
 Moltkestraße 10-18, 32257 Bünde, Germany

(540)

# WTF!

(591) Black, white  
 (511)  
 34 – Raw tobacco; tobacco products, in particular cigars, cigarillos, cheroots, cigarettes, smoking tobacco, pipe tobacco, snuff tobacco and chewing tobacco; smokers' articles; matches; tobacco for hookahs; tobacco substitutes; tobacco replacement products in this class; herbs for smoking; hookahs, in particular shishas and bongs, and parts and accessories thereof, included in this class; electronic hookahs, in particular shishas and bongs.

(260) AM 2021 111059 A  
 (800) 1550672  
 (151) 2019 11 01  
 (891) 2020 09 28  
 (731) NINGBO LIAO COMMODITY CO., LTD.  
 Room 901, No. 88, Qianhe South Road,  
 Shounan Street, Yinzhou District, Ningbo,  
 Zhejiang, China

(540)

# Kleaner

(591) Black, white  
 (531) 04.05.05; 26.01.03; 27.03.02; 27.05.01  
 (511)  
 21 – Toilet brushes; steel wool for cleaning; brushes; brooms; rags [cloth] for cleaning; mops; sponges for household purposes; dusting cloths [rags]; gloves for household purposes; crumb-sweepers; door/window cleaners in the nature of a combination squeegee and scrubber.

(260) AM 2021 111098 A  
 (800) 1567566  
 (151) 2020 07 20  
 (891) 2020 07 20  
 (731) Euro Games Technology Ltd.  
 "Maritsa" Str., 4, "Vranya-Lozen-Triugulnika",  
 BG-1151 Sofia, Bulgaria  
 (540)



(591) Yellow, gold, red, black, gray, orange, purple and black  
 (531) 27.05.02; 27.05.03; 27.05.17; 29.01.15

(511)

9 – Computer software packages; computer operating system software; software drivers; virtual reality software; entertainment software for computer games; computer programs for network management; operating computer software for main frame computers; entertainment software for computer games; computer programs for network management; operating computer software for main frame computers; apparatus for recording images; monitors (computer programs); computer game programs; computer programs for recorded games; apparatus for recording, transmission or reproduction of sound or images; communications servers [computer hardware].

28 – Mah-jong; gaming tables; slot machines [gaming machines]; LCD game machines; chips and dice [gaming equipment]; electronic or electrotechnical gaming devices, amusement and gaming machines, including coin-operated machines.

41 – Training in the development of software systems; games equipment rental; rental of gaming machines; rental of gaming machines with images of fruits; editing or recording of sounds and images; sound recording and video entertainment services; hire of sound reproducing apparatus.

(260) AM 2021 111122 A

(800) 1568253

(151) 2020 09 18

(891) 2020 09 18

(731) "ROSAIMPEX" OOD

8, "Tsar Kaloyan" Str, BG-4000 Plovdiv,  
Bulgaria

(540)

## MEN'S MASTER

(591) Black, white

(511)

3 – Cosmetic kits; cosmetics; cleansing milk for toilet purposes; cosmetic soaps; cosmetic moisturisers; massage creams, not medicated; perfumed creams; scented body lotions and creams; washing creams; beauty balm creams; cosmetic lotions; baby suncreams; cosmetic creams and lotions; creamy face powder; body washes; cosmetics in the form of creams; aromatherapy creams; shower creams; cream soaps; sunblock; day creams; barrier creams; non-medicated creams; anti-wrinkle cream; nail cream; face creams for cosmetic use; skin cleansing cream; face cream (non-medicated -); body cream; anti-aging moisturizers; cosmetic hand creams; aftershave creams; aftershave moisturising cream; scented body creams; creams for firming the skin; dermatological creams [other than medicated]; hand and body butter; cold cream; sun-tanning creams and lotions; refill packs for skin care cream dispensers; after sun creams; age spot reducing creams; cosmetic creams for firming skin around

eyes; skin conditioning creams for cosmetic purposes; skin care creams, other than for medical use; hair creams; conditioning creams; hair protection creams; creams for fixing hair; hair care creams; depilatory creams; shaving cream; pre-shave creams; shaving sets, comprised of shaving cream and aftershave; shampoos; shampoo-conditioners; dry shampoos; body shampoos; shampoos; dandruff shampoo; suncare lotions; day lotion; cleansing lotions; bath lotion; shaving lotion; skin lotion; depilatory lotions; eye lotions; body lotions; hair lotions; sun tan lotion; hand lotion (non-medicated -); bath lotions (non-medicated-); lotions for beards.

5 – Pharmaceutical creams; medicated creams; hydrocortisone creams; therapeutic creams [medical]; night creams [medicated]; protective creams (medicated -); corn and callus creams; medicated skin creams; skin care creams for medical use; creams (medicated -) for the feet; body creams [medicated]; creams for dermatological use; acne creams [pharmaceutical preparations]; herbal creams for medical use; face cream (medicated -); medicated creams for the care of the feet; medicinal creams for the protection of the skin; hand creams for medical use; body creams for pharmaceutical use; skin care creams for medical use; creams (medicated -) for application after exposure to the sun; medicated shampoos; medicated lotions.

(260) AM 2021 111123 A

(800) 1568277

(151) 2020 09 28

(891) 2020 09 28

(731) SYNGENTA PARTICIPATIONS AG

Rosentalstrasse 67, CH-4058 Basel,  
Switzerland

(540)



(591) Black, white

(531) 05.03.15; 05.05.20; 27.05.07

(511)

1 – Active chemical ingredients for manufacture of fungicides, herbicides, insecticides, nematicides; chemical products intended for agriculture, horticulture and forestry; biostimulant products for plants; preparations for improving crops; preparations for fortifying plants; chemical and/or biological preparations for stress management in plants; plant growth regulating preparations; chemical preparations for seed treatment; additives other than for medical or veterinary purposes; genes of seeds for agricultural production.

5 – Preparations for destroying vermin; fungicides, herbicides, insecticides, nematicides.

16 – Packaging materials made of plastics, only for chemical products intended for agriculture; paper and cardboard; printed matter; sheets, films and bags of plastic materials for wrapping and packaging.

31 – Agricultural, horticultural and forestry products and grains, not included in other classes; seeds, plants, seedlings and other plants or seeds for propagation; fresh fruits and vegetables; seeds, natural plants and flowers; animal foodstuffs.

42 – Scientific and technological research services; all the aforesaid services in the field of agriculture, horticulture and forestry; computer platform as a service [PaaS] featuring computer software platforms for providing professional consultancy services in the field of agricultural, horticultural and forestry companies; application service provider (ASP) services, namely provision of a software application programming interface (API) to be used in drone management, control and monitoring; software as a service (SaaS) in the field of agricultural, horticultural and forestry companies; agricultural analysis services, namely, analysis of the state of crops and plants and agricultural fields, for the purpose of creating a recommendation for the application of agricultural chemicals and pesticides in a sustainable manner and with a field by field approach to improve the efficiency and sustainability of operations.

44 – Agricultural, horticultural and forestry services; services and advice regarding seed planting, plant cultivation and crop protection; provision of information and making available consultation and advisory services, all in the fields of agriculture, horticulture, forestry, wine growing, arboriculture, market gardening, fruit growing, seed planting, cultivation and seed protection.

---

(260) AM 2021 111124 A

(800) 1568310

(151) 2020 09 28

(891) 2020 09 28

(731) F.FAIGES, S.L.

C/ Comerç 51, E-43500 Tortosa, Tarragona,  
Spain

(540)

**GRAN OLIVO**

(591) Black, white

(531) 27.05.01

(511)

29 – Olive oil.

---

(260) AM 2021 111127 A

(800) 1568350

(151) 2020 07 20

(891) 2020 07 20

(731) Euro Games Technology Ltd.

"Maritsa" Str., 4, "Vranya-Lozen-Triugulnika",  
BG-1151 Sofia, Bulgaria

(540)

**10 CRYSTAL  
WISH**

(591) Yellow, gold, pink, brown and white

(531) 27.05.02; 27.07.02; 29.01.15

(511)

9 – Software; computer gaming software; computer software packages; computer operating system software; computer software, recorded; software drivers; virtual reality software; games software; entertainment software for computer games; computer programs for network management; operating computer software for main frame computers; monitors (computer hardware); computer hardware; apparatus for recording images; monitors (computer programs); computer game programs; computer programs for recorded games; apparatus for recording, transmission or reproduction of sound or images; communications servers [computer hardware]; electronic components for gambling machines; computer application software featuring games and gaming; computer software for the administration of on-line games and gaming; computer hardware for games and gaming; computer hardware and software for gambling, gambling machines, gambling games on the Internet and via telecommunication network.

28 – Gaming machines for gambling; chips for gambling; mah-jong; arcade games; gambling machines operating with coins, notes and cards; games; electronic games; parlor games; gaming chips; gaming tables; slot machines [gaming machines]; LCD game machines; slot machines and gaming devices; coin-operated amusement machines; roulette chips; poker chips; chips and dice [gaming equipment]; gaming equipment for casinos; roulette tables; gaming roulette wheels; casino games; amusement and gambling machines; coin-operated gaming machines and / or electronic coin-operated gaming machines with or without the possibility of gain; boxes for coin-operated machines, slot machines and gaming machines; electronic or electro-technical gaming devices, amusement and gaming machines, including coin-operated machines; housings for coin-operated machines, gaming equipment, gaming machines, machines for gambling; electro-pneumatic and electrical gambling machines (slot machines).

41 – Gambling; entertainment services related to gambling; gaming services for entertainment purposes; ca-

sino, gaming and gambling services; training in the development of software systems; provision of equipment for gambling halls; providing casino equipment [gambling]; gaming machine entertainment services; providing casino facilities [gambling]; providing halls with gaming machines; amusement arcade services; games equipment rental; rental of gaming machines; providing amusement arcade services; rental of gaming machines with images of fruits; editing or recording of sounds and images; sound recording and video entertainment services; hire of sound reproducing apparatus; provision of gaming equipment for casinos; providing of casino facilities; online gambling services; provision of casino services; provision of gaming establishments, gaming halls, internet casinos, online gambling services.

(260) AM 2021 111165 A

(800) 1568538

(151) 2020 10 28

(891) 2020 10 28

(731) CYBERMARCONI S.R.L.

VIA ALLA CASATA, 56C, I-38123 TRENTO  
(TN), Italy

(540)

**POLOMARCONI.IT**

(591) Black, white

(511)

9 – Antennas; satellite dishes; satellite antennas; television antennas; antennas for telecommunications networks; radio signal antennas; component parts for antennas; filters for antennas; antennas for wireless communications apparatus; antenna parameter measuring apparatus; zone plate antennas; masts for aerials; aerial combiners; aerial converters; magnetic wires; fuse wire; light conducting filaments [optical fibers]; antenna transmission wire; antenna positioners; aerial sockets; signal transmission apparatus; sound transmitting apparatus; radio receiving and transmitting apparatus; cables for optical signal transmission; cables for electrical signal transmission; satellite receiving and transmission apparatus and instruments; cables for electrical or optical signal transmission; satellite broadcast receiving and decoding apparatus and instruments; Global Positioning System [GPS] apparatus; Global Positioning System [GPS] receivers; Global Positioning System [GPS] transmitters; radio frequency adapters; radio frequency amplifiers; radio frequency receivers; radio frequency repeaters; radio frequency transmitters; filters for radio interference suppression; radio-frequency controlled locks; acoustic couplers; jump start cables; fiber optic couplings; electric apparatus for commutation; satellite navigational apparatus; transponders; radar apparatus; radar receivers; radar transmitters; radio and television antennas; couplers [data processing equipment]; frequency converters.

37 – Satellite dish installation and repair; antenna installation and repair; installation, maintenance and repair of catalytic converters; electric appliance installation and repair; telephone installation and repair; installation, maintenance and repair of telephone and communication equipment; installation, maintenance and repair of hardware for data communication networks; installation and maintenance of hardware for computer networks and Internet access; installation and maintenance of electronic apparatus (for others).

38 – Wireless broadcasting; rental of telecommunication apparatus; rental of radio transmission equipment; operation of satellite-to-earth receiver aerials; rental of radio transmission apparatus; rental of radio and television broadcasting installations; rental of telecommunication devices and equipment enabling connection to networks; electronic communications services; radio communications; providing telecommunications connections to a global computer network; information about telecommunication; communications by cellular phones; telecommunications routing and junction services; providing access to the Internet; telecommunication services; rental of telecommunication equipment (for others).

(260) AM 2021 111175 A

(800) 1568700

(151) 2020 10 27

(891) 2020 10 27

(731) Incyte Holdings Corporation

1801 Augustine Cut-Off, Wilmington  
DE 19803, USA

(540)



(591) Black, white

(531) 26.01.02; 26.03.04; 26.03.05

(511)

44 – Providing information relating to autoimmune disorders and oncological disorders, namely, providing information relating to diagnostic, prophylactic and therapeutic properties of pharmaceuticals, via a website.

(260) AM 2021 111176 A

(800) 1568782

(151) 2020 08 03

(891) 2020 08 03

(731) HANGZHOU FORTUNE GAS CRYOGENIC GROUP CO., LTD.

No.398, Xingqi Road, Yuhang Economic and Technological Development Zone, Yuhang District, Hangzhou, 311103 Zhejiang, China

(540)



(591) Black, white

(531) 26.03.23; 26.11.12; 27.05.01

(511)

7 – Gas separating installations; oxygen and nitrogen generators; rare gases extracting machines; gas converters for gas liquefaction; carbon dioxide processing machines; filters for cleaning cooling air and for engines; steam or oil separators; mineworking machines.

(260) AM 2021 111177 A

(800) 1568783

(151) 2020 08 19

(891) 2020 08 19

(731) Zakrytoe aktsionernoe obshchestvo "Myasnaya galereya"

ul. Poliny Osipenko, d. 65, of. 10, RU-600009 Vladimir, Russian Federation

(540)



(591) Yellow, black and white

(531) 03.07.17; 28.05; 29.01.13

(526) хрустящие КРЫЛЫШКИ

(511)

29 – Poultry and game; breaded chicken pieces; poultry, not live.

43 – Services for providing food and drink; food and drink catering; café services; cafeteria services; canteen services; restaurant services; self-service restaurant services; snack-bar services; bar services; rental

of chairs, tables, table linen, glassware; rental of tents; rental of cooking apparatus; food sculpting.

(260) AM 2021 111178 A

(800) 1568832

(151) 2020 10 23

(891) 2020 10 23

(731) Philip Morris Products S.A.

Quai Jeanrenaud 3, CH-2000 Neuchâtel, Switzerland

(540)



(591) Black, white

(531) 26.01.05; 26.04.05; 26.04.16; 26.04.18;

27.05.01; 27.05.09; 27.05.10

(511)

34 – Wired vaporizers for electronic cigarettes and electronic smoking devices; tobacco, raw or manufactured; tobacco products, including cigars, cigarettes, cigarillos, tobacco for roll-your-own cigarettes, pipe tobacco, chewing tobacco, snuff tobacco, kretek; snus; tobacco substitutes (not for medical purposes); smokers' articles, namely cigarette paper and tubes, cigarette filters, tobacco tins, cigarette cases and ashtrays, pipes, pocket apparatus for rolling cigarettes, lighters, matches; tobacco sticks, tobacco products for the purpose of being heated, electronic devices and their parts for the purpose of heating cigarettes or tobacco in order to release nicotine-containing aerosol for inhalation; liquid nicotine solutions for use in electronic cigarettes; electronic smoking devices; electronic cigarettes; electronic cigarettes as substitutes for traditional cigarettes; electronic devices for the inhalation of nicotine-containing aerosol; oral vaporizing devices for smokers, tobacco products and tobacco substitutes; smokers' articles for electronic cigarettes; parts and fittings for the aforesaid products included in this class; devices for extinguishing heated cigarettes and cigars as well as heated tobacco sticks; electronic rechargeable cigarette cases.

(260) AM 2021 111179 A  
 (800) 1568844  
 (151) 2020 07 20  
 (891) 2020 07 20  
 (731) Euro Games Technology Ltd.  
 "Maritsa" Str., 4, "Vranya-Lozen-Triugulnika",  
 BG-1151 Sofia, Bulgaria  
 (540)



(591) Yellow, gold, red, black and gray  
 (531) 27.05.03; 29.01.15  
 (511)

9 – Software; computer gaming software; computer software packages; computer operating system software; computer software, recorded; software drivers; virtual reality software; games software; entertainment software for computer games; computer programs for network management; operating computer software for main frame computers; monitors (computer hardware); computer hardware; apparatus for recording images; monitors (computer programs); computer game programs; computer programs for recorded games; apparatus for recording, transmission or reproduction of sound or images; communications servers [computer hardware]; electronic components for gambling machines; computer application software featuring games and gaming; computer software for the administration of on-line games and gaming; computer hardware for games and gaming; computer hardware and software for gambling, gambling machines, gambling games on the Internet and via telecommunication network.

28 – Gaming machines for gambling; chips for gambling; mah-jong; arcade games; gambling machines operating with coins, notes and cards; games; electronic games; parlor games; gaming chips; gaming tables; slot machines [gaming machines]; LCD game machines; slot machines and gaming devices; coin-operated amusement machines; roulette chips; poker chips; chips and dice [gaming equipment]; gaming equipment for casinos; roulette tables; gaming roulette wheels; casino games; amusement and gambling machines; coin-operated gaming machines and / or electronic coin-operated gaming machines with or without the possibility of gain; boxes for coin-operated machines, slot machines and gaming machines; electronic or electro-technical gaming devices, amusement and gaming machines, including coin-operated machines; housings for coin-operated machines, gaming equipment, gaming machines, machines for gambling; electro-pneumatic and electrical gambling machines (slot machines).

41 – Gambling; entertainment services related to gambling; gaming services for entertainment purposes; ca-

sino, gaming and gambling services; training in the development of software systems; provision of equipment for gambling halls; providing casino equipment [gambling]; gaming machine entertainment services; providing casino facilities [gambling]; providing halls with gaming machines; amusement arcade services; games equipment rental; rental of gaming machines; providing amusement arcade services; rental of gaming machines with images of fruits; editing or recording of sounds and images; sound recording and video entertainment services; hire of sound reproducing apparatus; provision of gaming equipment for casinos; providing of casino facilities; online gambling services; provision of casino services; provision of gaming establishments, gaming halls, internet casinos, online gambling services.

(260) AM 2021 111200 A  
 (800) 1569111  
 (151) 2020 11 24  
 (891) 2020 11 24  
 (731) Richter Gedeon Nyrt.  
 Gyömrői út 19-21, H-1103 Budapest, Hungary  
 (540)

## NESEPOD

(591) Black, white  
 (511)  
 5 – Pharmaceutical preparations.

(260) AM 2021 111201 A  
 (800) 1569113  
 (151) 2020 11 24  
 (891) 2020 11 24  
 (731) Richter Gedeon Nyrt.  
 Gyömrői út 19-21, H-1103 Budapest, Hungary  
 (540)

## RADIQTIN

(591) Black, white  
 (511)  
 5 – Pharmaceutical preparations.

(260) AM 2021 111202 A  
 (800) 1569123  
 (151) 2020 11 24  
 (891) 2020 11 24  
 (731) Richter Gedeon Nyrt.  
 Gyömrői út 19-21, H-1103 Budapest, Hungary  
 (540)

## NEXEDIN

(591) Black, white  
 (511)  
 5 – Gynecological pharmaceutical preparations.

(260) AM 2021 111203 A  
 (800) 1569129  
 (151) 2020 11 24  
 (891) 2020 11 24  
 (731) Richter Gedeon Nyrt  
 Gyömrői út 19-21, H-1103 Budapest, Hungary  
 (540)

## GRETELAN

(591) Black, white  
 (511)  
 5 – Pharmaceutical preparations.

(260) AM 2021 111204 A  
 (800) 1569132  
 (151) 2020 11 24  
 (891) 2020 11 24  
 (731) Richter Gedeon Nyrt.  
 Gyömrői út 19-21, H-1103 Budapest, Hungary  
 (540)

## ZEBOGAL

(591) Black, white  
 (511)  
 5 – Pharmaceutical preparations.

(260) AM 2021 111205 A  
 (800) 1569133  
 (151) 2020 10 09  
 (891) 2020 10 09  
 (731) SUBSIDIARY COMPANY "CONFECTIONE-  
 RY CORPORATION "ROSHEN"  
 prospect Nauky, bud. 1, korpus 1,  
 m. Kyiv 03039, Ukraine  
 (540)

## LACMI

(591) Black, white  
 (511)  
 30 – Caramels (candy); sponge cakes; sweetmeats  
 [candy]; sweets; confectionery; chocolate; sugar con-  
 fectionery; candies; cookies; pastries; crackers; waff-  
 les; pralines; cakes; biscuits; peanut confectionery;  
 almond confectionery.

(260) AM 2021 111209 A  
 (800) 1569155  
 (151) 2020 11 26  
 (891) 2020 11 26  
 (731) EGT Interactive  
 159 Tsarigradsko Shose Blvd., Fl. 10, BG-1784  
 Sofia, Bulgaria  
 (540)



(591) Black, white, dark blue, light blue  
 (531) 03.07.17; 03.13.10; 03.13.24; 22.05.19;  
 24.05.03; 27.05.03; 29.01.15  
 (511)  
 9 – Software; computer software, recorded; computer  
 software for the administration of on-line games and  
 gaming; computer application software featuring ga-  
 mes and gaming; betting software; gaming software  
 that generates or displays wager outcomes of gaming  
 machines.

28 – Gaming machines for gambling; games; slot ma-  
 chines [gaming machines].

41 – Providing of casino and gaming facilities; enter-  
 tainment services; betting services; interactive compu-  
 ter game services; on-line gaming services.

(260) AM 2021 111231 A  
 (800) 1569604  
 (151) 2020 10 19  
 (891) 2020 10 19  
 (731) Janssen Pharmaceutica NV  
 Turnhoutseweg 30, B-2340 Beerse, Belgium  
 (540)

## JCOVAV

(591) Black, white  
 (511)  
 5 – Vaccines.

(260) AM 2021 111233 A  
 (800) 1569769  
 (151) 2020 09 16  
 (891) 2020 09 16  
 (731) Panda Restaurant Group, Inc.  
 1683 Walnut Grove Avenue, Rosemead  
 CA 91770, USA  
 (540)



(591) Black, white  
 (531) 03.01.15; 03.01.24; 24.03.07; 24.03.13;  
 24.03.18; 24.17.02; 26.01.21; 27.01.12  
 (526) EXPRESS, CHINESE KITCHEN  
 (511)  
 43 – Restaurant services.

(260) AM 2021 111234 A  
 (800) 1569800  
 (151) 2020 10 30  
 (891) 2020 10 30  
 (731) Apple Inc.  
 One Apple Park Way, Cupertino CA 95014,  
 USA  
 (540)

## MAGSAFE

(591) Black, white  
 (511)  
 18 – Leather cases; leather wallets; leather credit card cases; leather key cases; leather pouches.

(260) AM 2021 111255 A  
 (800) 1570200  
 (151) 2020 11 24  
 (891) 2020 11 24  
 (731) Richter Gedeon Nyrt.  
 Gyömrői út 19-21, H-1103 Budapest, Hungary  
 (540)

## CASTANID

(591) Black, white  
 (511)  
 5 – Pharmaceutical preparations.

(260) AM 2021 111256 A  
 (800) 1570215  
 (151) 2020 11 24  
 (891) 2020 11 24  
 (731) Richter Gedeon Nyrt.  
 Gyömrői út 19-21, H-1103 Budapest, Hungary  
 (540)

## GLANDURIT

(591) Black, white  
 (511)  
 5 – Pharmaceutical preparations.

(260) AM 2021 111257 A  
 (800) 1570220  
 (151) 2020 11 24  
 (891) 2020 11 24  
 (731) Richter Gedeon Nyrt.  
 Gyömrői út 19-21, H-1103 Budapest, Hungary  
 (540)

## CABERTYN

(591) Black, white  
 (511)  
 5 – Pharmaceutical preparations.

(260) AM 2021 111258 A  
 (800) 1570230  
 (151) 2020 10 16  
 (891) 2020 10 16  
 (731) Richter Gedeon Nyrt.  
 Gyömrői út 19-21., H-1103 Budapest, Hungary  
 (540)

## PIЭKO

(591) Black, white  
 (531) 28.05  
 (511)  
 5 – Pharmaceutical preparations.

(260) AM 2021 111259 A  
 (800) 1570232  
 (151) 2020 11 24  
 (891) 2020 11 24  
 (731) Richter Gedeon Nyrt.  
 Gyömrői út 19-21, H-1103 Budapest, Hungary  
 (540)

## NETERENT

(591) Black, white  
 (511)  
 5 – Pharmaceutical preparations.

(260) AM 2021 111293 A  
 (800) 1570610  
 (151) 2020 07 22  
 (891) 2020 07 22  
 (731) SARPEN DAMITIMCILIK ANONİM  
 ŞİRKETİ  
 2. Cadde No:7, Organize Sanayi Bölgesi,  
 Akhisar – Manisa, Turkey  
 (540)

## BEYOĞLU RAKI

(591) Red  
 (531) 27.05.10; 29.01.01  
 (526) RAKI  
 (511)  
 33 – Raki [traditional Turkish alcoholic drink].

(260) AM 2021 111296 A  
 (800) 1570767  
 (151) 2020 09 29  
 (891) 2020 09 29  
 (731) Ropetrans AG  
 c/o Garaventa AG, Birkenstrasse 47, CH-6343  
 Rotkreuz, Switzerland



(540)



(591) Blue and white

(531) 15.01.25; 15.07.01; 15.07.03; 15.07.09;  
15.07.17; 29.01.12

(511)

12 – Cable cars, funiculars, suspended railways and aerial conveyors; telfer railways [cable cars]; suspension arms for telfer railways [cable cars]; funicular carriages; rolling stock for funicular railways; cars for cable transport installations; ski lifts; vehicles, cable cars, funiculars, suspended railways, aerial conveyors and funicular carriages for transporting passengers and goods; driving motors, provision and parking systems for transport and conveying systems as well as for track installations, including railway systems, and vehicles as well as driving equipment; funicular carriages, funicular cabins, passenger compartments, seats for lifts; cable and rail transport apparatus and installations; fittings and accessories (not included for other classes) for vehicles, cable cars, funiculars, suspended railways, aerial conveyors and funicular carriages, namely, hoods for passenger compartments, seats for chairlifts, transport platforms (transport equipment) and vehicles as well as driving equipment, trailer couplings, tension shafts, anti-dazzle devices, brake segments, brake linings, brakes, brake shoes, chassis as well as rail systems, and for vehicles as well as driving equipment; trucks of metal or mainly of metal; bogies for transport carriages and platforms; bogies for chairlift seats; car cabins, carriages and bodies, shock absorbers, bumpers, torsion shafts, support springs, running boards, windows, vehicle wheels, vehicle seats, armrests and headrests as well as covers for vehicle seats, doors, hoods, housings for vehicle fittings (except housings for motors and engines) gear sets, vans, railway carriage couplings, flanging walls, motors and engines for land vehicles, turbines for land vehicles, buffers for rail vehicles and for funiculars, axles, hubcaps; vehicle fittings, cable cars, funiculars, suspended railways, aerial conveyors and funicular carriages, namely, skid chains, reduction gears, alarm apparatus for reversing, windshield wipers, protection sheets, braiders, rails, coils, rollers, pulleys, cables, seats for suspended railways, chairlift seats, ski crossings, windshields, sun visors; suspension devices, roller mechanisms, ski carriers, undercarriages for vehicles, tipping devices for railway carriages; driving motors for land vehicles.

(260) AM 2021 111297 A

(800) 1570770

(151) 2020 11 10

(891) 2020 11 10

(731) Apple Inc.

One Apple Park Way, Cupertino CA 95014,  
USA

(540)

(591) Black, white

(531) 05.07.13; 05.07.23

(511)

9 – Downloadable and recorded computer software; downloadable and recorded computer software for processing, facilitating, verifying, and authenticating mobile payments and contactless transactions with retailers, merchants, and vendors via wearable and mobile devices; downloadable and recorded computer software for use in searching, transmitting, receiving, storing, accessing, finding, organizing and viewing geographic location information and providing content based on location; downloadable and recorded computer software for application development; downloadable and recorded computer software development tools; downloadable and recorded computer software used in developing other software applications; downloadable and recorded application programming interface (API) software; downloadable and recorded software development kits (SDK); downloadable and recorded computer software to maintain and operate a computer system; downloadable and recorded computer operating software.

(260) AM 2021 111303 A

(800) 1570841

(151) 2020 11 19

(891) 2020 11 19

(731) Limited Liability Company "NEARMEDIC  
PHARMA"ul. Koroleva, 4, office 402, RU-249030  
Obninsk, Kaluzhskaya oblast, Russian  
Federation

(540)

(591) Black, white

(531) 28.05

(511)

5 – Pharmaceuticals; medical preparations; medicines for human purposes; analgesics; anti-inflammatory pharmaceutical preparations; pharmaceutical preparations and medicines for the treatment of respiratory system; pharmaceutical preparations and medicines for the treatment of sore throat; medical solutions for the treatment of sore throat; medical lozenges for the

treatment of sore throat; medical drops for the treatment of sore throat; medical tablets for the treatment of sore throat; pharmaceuticals in the form of anti-inflammatory sprays; pharmaceuticals in the form of antibacterial sprays; medicines in the form of oral sprays; cooling sprays for medical purposes; chemical preparations for medical purposes; chemical preparations for pharmaceutical purposes; antiseptics; antifungal pharmaceutical preparations; antifungal medicines; antimicrobial pharmaceuticals; pharmaceutical preparations and substances with anaesthetic properties, including for topical application; mouthwashes for medical purposes; medicated toothpaste.

42 – Research and development of new products for others; scientific research, including in the field of medicine and pharmacology; clinical trials.

44 – Medical services; pharmacy advice; medical assistance; therapy services.

---

(260) AM 2021 111304 A

(800) 1570844

(151) 2020 11 17

(891) 2020 11 17

(731) Limited Liability Company "R.S.V.P."

Turchaninov Lane, 2A, floor A1, room. I,  
room 11, RU-119034 Moscow, Russian  
Federation

(540)

**R.S.V.P**

WE CREATE YOUR STORY

(591) Black, white

(531) 24.17.02; 26.11.01; 26.11.08; 27.05.09;  
27.05.10; 27.05.11

(511)

35 – Advertising; business management; business administration; office functions.

41 – Education; providing of training; entertainment; sporting and cultural activities.

---

(260) AM 2021 111305 A

(800) 1570915

(151) 2020 10 22

(891) 2020 10 22

(731) OXYGENTRACK LLC

1209 Orange Street, Wilmington DE 19801,  
USA

(540)

**TIME TO WALK OR  
PUSH**

(591) Black, white

(511)

38 – Transmission and streaming of data, images, music, audio, video, and multimedia by means of telecommunications networks; subscription transmission and streaming services of data, images, music, audio, video, and multimedia by means of telecommunications networks; video-on-demand transmission services; peer-to-peer photo sharing services, namely, electronic transmission of music, audio, video, and multimedia among Internet users; providing access to websites, databases, electronic bulletin boards, on-line forums, directories, music, and video and audio programs on the Internet.

41 – Educational services; fitness and exercise instruction, training, and consultation; providing fitness and exercise classes; providing information about fitness and exercise via a website; production of podcasts, presentation and distribution of films and of sound and video recordings, production or distribution of television programs with entertainment content; providing ongoing audio, video, podcast, and webcast programs; providing non-downloadable entertainment, music, informational, reality, documentary, current events, and arts and culture programming; entertainment information.

42 – Providing temporary use of online non-downloadable computer software; providing temporary use of online non-downloadable computer software for use in connection with fitness and exercise; hosting a website for the uploading, storing, sharing, viewing, and posting of images, audio, videos, podcasts, and multimedia content; hosting websites and computer applications featuring entertainment, music, informational, reality, documentary, current events, and arts and culture programming.

---

(260) AM 2021 111306 A

(800) 1570948

(151) 2020 10 26

(891) 2020 10 26

(731) BYD COMPANY LIMITED

No.1, Yan'an Road, Kuichong Street,  
Dapeng New District, Shenzhen, China

(540)

**FleetLink**

(591) Black, white

(531) 27.05.01

(511)

9 – Data processing apparatus; computer software, recorded; computer programs, downloadable; computer software applications, downloadable; rearview cameras for vehicles; batteries, electric, for vehicles; radios; computer peripheral devices; cases especially made for photographic apparatus and instruments; none

of the aforesaid relating to or being for use in the maritime sector.

(260) AM 2021 111307 A  
 (800) 1570950  
 (151) 2020 10 29  
 (891) 2020 10 29  
 (731) GREE ELECTRIC APPLIANCES, INC.,  
 OF ZHUHAI  
 Jinji West Road, Qianshan, Zhuhai,  
 519070 Guangdong, China

(540)

## KINGHOME

(591) Black, white  
 (511)

7 – Compressors [machines]; compressors for refrigerators; electric kitchen blenders for home use; electric juicers; electric food processors; washing machines for laundry; wringing machines for laundry; dishwashers; vacuum cleaners; electric motors other than for land vehicles; electric coffee grinders; electric meat choppers for home use; food waste disposers.

9 – Cell phones; interactive touch screen terminals; integrated circuits; data processing apparatus; downloadable applications for cell phones; remote controls for home use; electrical adapters; batteries; capacitors; electric switches; electronic chips; electric sockets; electric wires; electric cables; electric locks; computer software (recorded); face recognition equipment.

11 – Refrigerators; freezers; air conditioners; ventilation [air-conditioning] installations and apparatus; radiators, electric; laundry dryers, electric; fans [air-conditioning]; air dehumidifiers for home use; air purifying apparatus; extractor hoods for kitchen use; water heaters for the use of washing (gas or electrical heating); electric water heaters; electromagnetic induction cookers for household purposes; electric drinking water dispensers; electric kettles for home use; air humidifiers for home use; electric rice cookers; air dryers; air sterilizers; electric hair dryers; electric dish sterilizers; solar energy water heaters; bathroom air heaters; gas burners; microwave ovens for household purposes; water purification installations; electric egg boilers for household purposes; bread toasters; electric coffee machines; bakers' ovens for household use; electric slow-cookers; lighting installations; ice machines; electric wine cellars.

(260) AM 2021 111361 A  
 (800) 1571403  
 (151) 2020 11 26  
 (891) 2020 11 26  
 (731) GuangDong OPPO Mobile  
 Telecommunications Corp., Ltd. No.18  
 Haibin Road, Wusha, Chang'an, Dongguan,  
 Guangdong, China

(540)

## Marisilicon

(591) Black, white  
 (531) 27.05.01  
 (511)  
 9 – Chips [integrated circuits]; printed circuits.

(260) AM 2021 111381 A  
 (800) 1571842  
 (151) 2020 08 20  
 (891) 2020 08 20  
 (731) VIENNA INSURANCE GROUP AG Wiener  
 Versicherung Gruppe  
 Schottenring 30, A-1010 Wien, Austria

(540)

## tick2safe

(591) Black, white  
 (511)

36 – Insurance management services; administration of financial affairs; financial management of insurance plans; financial management of pre-paid health care plans; financial management of insurance claims; financial management of group insurance plans; life insurance agencies; financial data analysis; financial evaluation and analysis relating to insurance; financial feasibility studies relating to insurance; retail financing services; financial consultancy and insurance consultancy; insurance consultancy; insurance underwriting consultancy; travel insurance; real estate insurance services; insurance services relating to holiday travels and accommodation; life insurance; motor insurance brokerage; financial services relating to insurance; financial services relating to the insurance of motor vehicles; consulting and information concerning insurance; personal insurance services relating to the supply of legal services; consultancy and brokerage services relating to vehicle insurance; consultancy and brokerage services relating to health insurance; consultancy and brokerage services relating to home insurance; consultancy and brokerage services relating to travel insurance; claim adjustment for non-life insurance; consultancy and brokerage services relating to accident insurance; consultancy and brokerage services relating to life insurance; health insurance; accident insurance; home contents insurance; insurance services relating to motor vehicles; property insurance underwriting; insurance information; advisory services relating to life insurance; insurance brokerage; insurance services; insurance agencies; insurance agency and brokerage; insurance services relating to real estate; insurance underwriting; insurance services relating to property; insurance brokerage for property; insurance services relating to holiday accommodation; providing insurance information; financial services rendered by insurance companies; insurance services

relating to mechanical breakdown; insurance services for the protection of drivers; insurance services relating to the loss of personal possessions; life assurance brokerage; insurance services relating to the theft of personal possessions; insurance brokerage consultancy and information; insurance services relating to cancelled bookings for holidays; insurance services for the provision of emergency cash; computerised processing of insurance claims; provision of insurance premium quotations; insurance premium rate computing; computerised information services relating to insurance; insurance services relating to life; financial advisory services relating to life assurance.

(260) AM 2021 111390 A

(800) 1303695

(151) 2016 05 02

(891) 2020 12 31

(731) Coupang Corp.

18th Floor (Sincheon-dong), 570 Songpa-daero,  
Songpa-gu, Seoul, Republic of Korea

(540)

## COUPANG

(591) Black, white

(511)

35 – Advertising; providing recommendations of products and services to consumers for commercial purposes; providing computerized online ordering services for others featuring a wide variety of consumer, business, and industrial products; online trading services, namely, business evaluation relating to online buyers and sellers; dissemination of advertising of goods and services of others via local and global computer networks; advice in the field of business management and marketing; business administration and office work; retail department store services; retail services provided by hypermarkets; online comprehensive shopping mall services; business intermediary services relating to mail order selling by electric communication; commercial information and advice for consumers (consumer advice shop); contracts for the purchase and sale of goods for others; business intermediary services for the sale and purchase of goods and services; mediations for the purchase and sale of goods; evaluations relating to commercial matters; business appraisals and evaluations in business matters; providing of product information; dissemination of advertisements; providing of business information; presentation of goods on communication media, for retail purposes; administrative processing of purchase orders; demonstration of goods; providing commercial information relating to consumers, companies, industrial products and services; providing databases about advertisement of goods and services; providing commercial, advertising and business database of goods and services; procurement of contracts for the purchase and sale of goods and services; online retail

store services featuring toys [playthings]; online retail store services featuring books; online retail store services featuring pushchairs; online retail store services featuring babies' napkins [diapers]; online retail store services featuring baby food; online retail store services featuring baby wipes for cosmetic use; online retail store services featuring furniture for babies; online retail store services featuring baby food made from agricultural products; online retail store services featuring baby food made from aquatic products; online retail store services featuring baby food made from livestock products; online retail store services featuring cosmetic preparations for baths; online retail store services featuring bath sponges; online retail store services featuring bath linen [except clothing]; online retail store services featuring cleaning preparations; online retail store services featuring under garments; online retail store services featuring footwear; online retail store services featuring bags; online retail store services featuring watches; online retail store services featuring eyeglasses; online retail store services featuring cosmetics; online retail store services featuring perfumery; online retail store services featuring make-up; online retail store services featuring pet food; online retail store services featuring sporting articles [other than golf articles/climbing articles]; online retail store services featuring downloadable magazines; online retail store services featuring downloadable books; online retail store services featuring downloadable newspapers; online retail store services featuring downloadable periodicals; online retail store services featuring electric audio and visual apparatus and instruments; online retail store services featuring smart phones; online retail store services featuring telephone sets; online retail store services featuring computer hardware and computer peripheral devices; online retail store services featuring printers and their parts; online retail store services featuring televisions; online retail store services featuring electric humidifiers for household use; online retail store services featuring electric refrigerators; online retail store services featuring electric heating and cooling systems for household purposes; online retail store services featuring preserved/frozen/dried and cooked fruits and vegetables; online retail store services featuring instant or pre-cooked soup; online retail store services featuring dried cooked-rice; online retail store services featuring nutraceuticals for use as dietary supplements; online retail store services featuring health functional food mainly based on jujube; online retail store services featuring health supplement food mainly based on deer antlers; online retail store services featuring health supplement food based on dried fish and shellfish; online retail store services featuring fresh fruits and vegetables; online retail store services featuring grains [cereals]; online retail store services featuring fish and shellfish [live]; online retail store services featuring fresh seaweeds; online retail store services featuring meat; online retail store services

featuring eggs; online retail store services featuring milk; online retail store services featuring interior decoration fabrics; online retail store services featuring interior textile window blinds; online retail store services featuring vacuum cleaners for household purposes; online retail store services featuring laundry washing machines for household use; online retail store services featuring household shears; online retail store services featuring containers for household use; online retail store services featuring gloves for protection against accidents; online retail store services featuring helmets; online retail store services featuring protective clothing; online retail store services featuring safety goggles; online retail store services featuring maternity belts; online retail store services featuring sanitary preparations being toiletries; online retail store services featuring sanitary preparations for medical use; online retail store services featuring sanitary masks for medical purposes; online retail store services featuring sanitary apparatus and installations; online retail store services featuring sanitary vinyl bags; online retail store services featuring pharmaceutical and veterinary preparations; online retail store services featuring masks for medical purposes; online retail store services featuring necklaces; online retail store services featuring rings [jewelry]; online retail store services featuring jewelry ornaments; online retail store services featuring cuff links; online retail store services featuring decorative articles for the hair; online retail store services featuring clothing; online retail store services featuring headwear; online retail store services featuring belts for clothing.

(260) AM 2021 111391 A  
 (800) 1369835  
 (151) 2017 05 03  
 (891) 2021 01 06  
 (731) TAIZHOU CITY CHUNFENG MACHINERY, CO., LTD.  
 Block C-10-10.; Jiutang Feiqi Yantian, No. 24  
 Batang Road, Sanjia Street, Jiaojiang District,  
 Taizhou City; Zhejiang Province, China

(540)

 The logo for Pandora, featuring a stylized 'P' with a circular element inside, followed by the word 'Pandora' in a cursive script font.

(591) Black, white  
 (531) 27.05.01  
 (511)

7 – Weeding machines; spraying machines; agricultural machines; sowers [machines]; agricultural implements other than hand-operated; moulds, being parts of machines for processing plastics; dynamos; pumps [machines]; washing apparatus.

8 – Abrading instruments [hand instruments]; agricultural implements, hand-operated; fruit pickers [hand tools]; plant parasite killing apparatus; grafting tools [hand tools]; insecticide sprayers [hand tools]; garden tools, hand-operated; syringes for spraying insecticides; scraping tools [hand tools].

(260) AM 2021 111450 A  
 (800) 1571969  
 (151) 2020 11 10  
 (891) 2020 11 10  
 (731) Kiperman Vera Viktorovna  
 ul. Sovkhoznaya, 4A, kv. 134, Khimki,  
 RU-141406 Moskovskaya oblast',  
 Russian Federation

(540)

 The logo for VERA, featuring a large, stylized black 'V' shape on the left, and the word 'VERA' in a bold, sans-serif font to its right.

(591) Black, white  
 (531) 27.05.01; 27.05.09; 27.05.10; 27.05.17;  
 27.05.21

(511)

3 – Amber [perfume]; aromatics [essential oils]; air fragrancings preparations; cake flavorings [essential oils]; flavorings for beverages [essential oils]; food flavorings [essential oils]; breath freshening sprays; balms, other than for medical purposes; lip glosses; polishing stones; petroleum jelly for cosmetic purposes; cotton wool for cosmetic purposes; sachets for perfuming linen; adhesives for cosmetic purposes; scented water; toilet water; depilatory wax; mustache wax; creams for leather; polishing wax; massage gels, other than for medical purposes; heliotropine; dental bleaching gels; geraniol; make-up; deodorants for pets; deodorants for human beings or for animals; depilatory preparations; scented wood; perfumes; greases for cosmetic purposes; volcanic ash for cleaning; perfumery; decorative transfers for cosmetic purposes; ionone [perfumery]; eyebrow pencils; cosmetic pencils; adhesives for affixing false eyelashes; adhesives for affixing false hair; hair conditioners; quillaia bark for washing; corundum [abrasive]; beard dyes; cosmetic dyes; laundry glaze; polishing creams; cosmetic creams; skin whitening creams; hair spray; nail polish; hair lotions; lotions for cosmetic purposes; after-shave lotions; beauty masks; oils for perfumes and scents; oils for cosmetic purposes; oils for toilet purposes; essential oils; essential oils of cedarwood; essential oils of lemon; essential oils of citron; oils for cleaning purposes; bergamot oil; gaultheria oil; jasmine oil; lavender oil; almond oil; rose oil; oil of turpentine for degreasing; cleaning chalk; almond milk

for cosmetic purposes; cleansing milk for toilet purposes; musk [perfumery]; soap; deodorant soap; shaving soap; soap for brightening textile; cakes of toilet soap; antiperspirant soap; soap for foot perspiration; almond soap; mint for perfumery; cosmetic kits; nail art stickers; false nails; eau de Cologne; bases for flower perfumes; joss sticks; non-medicated dentifrices; pumice stone; lipstick cases; hydrogen peroxide for cosmetic purposes; breath freshening strips; teeth whitening strips; lipsticks; pomades for cosmetic purposes; shaving preparations; cosmetic preparations for baths; bath preparations, not for medical purposes; hair straightening preparations; hair waving preparations; smoothing preparations [starching]; color-removing preparations; leather bleaching preparations; polishing preparations; denture polishes; mouthwashes, not for medical purposes; cosmetic preparations for slimming purposes; starch glaze for laundry purposes; eye-washes, not for medical purposes; lacquer-removing preparations; make-up removing preparations; nail care preparations; cleaning preparations; preparations for cleaning dentures; collagen preparations for cosmetic purposes; laundry preparations; aloe vera preparations for cosmetic purposes; sunscreen preparations; color-brightening chemicals for household purposes [laundry]; shining preparations [polish]; make-up powder; diamantine [abrasive]; stain removers; nail varnish removers; vaginal washes for personal sanitary or deodorant purposes; scouring solutions; false eyelashes; tissues impregnated with cosmetic lotions; tissues impregnated with make-up removing preparations; safrol; potpourris [fragrances]; bath salts, not for medical purposes; bleaching salts; fumigation preparations [perfumes]; preservatives for leather [polishes]; astringents for cosmetic purposes; eyebrow cosmetics; make-up preparations; sun-tanning preparations [cosmetics]; hair dyes; neutralizers for permanent waving; cosmetic preparations for eyelashes; cosmetic preparations for skin care; cosmetics; cosmetics for animals; mascara; cleansers for intimate personal hygiene purposes, non medicated; detergents, other than for use in manufacturing operations and for medical purposes; degreasers, other than for use in manufacturing processes; bleaching preparations [decolorants] for cosmetic purposes; toiletry preparations; antiperspirants [toiletries]; phytocosmetic preparations; talcum powder, for toilet use; cotton swabs for cosmetic purposes; terpenes [essential oils]; henna [cosmetic dye]; shampoos; shampoos for animals [non-medicated grooming preparations]; shampoos for pets [non-medicated grooming preparations]; dry shampoos; sandpaper; herbal extracts for cosmetic purposes; extracts of flowers [perfumes]; ethereal essences; badian essence; mint essence [essential oil].

4 – Wax for lighting; perfumed candles; Christmas tree candles; candles.

5 – Air deodorising preparations.

(260) AM 2021 111544 A

(800) 1572932

(151) 2020 10 28

(891) 2020 10 28

(731) Sanhe Laserconn Tech Co., Ltd.

G#5F, Yian Industrial Park, Maikeshan

Clothing Company East, Outer Ring Road

South, Yanjiao Development Zone, Sanhe,

Langfang City, 065201 Hebei Province, China

(540)

## vilase

(591) Black, white

(511)

3 – Cosmetic; sandcloth / abrasive cloth; perfumery for cosmetics; beauty masks; incense; facial cleanser; cosmetics for animals; preparations to make the leaves of plants shiny; stain removers; denture polishes.

8 – Beard clippers; hand implements for hair curling; razors, electric or non-electric; hair clippers for personal use, electric and non-electric; depilation appliances, electric and non-electric; eyelash curlers; electric hair clippers; crimping irons; curling tongs; electric razors.

10 – Esthetic massage apparatus; physiotherapy apparatus; suture material; vibromassage apparatus; medical apparatus and instruments; ultrasonic apparatus for medical purposes; dental apparatus, electric; lasers for medical purposes; gloves for massage; abdominal corsets.

(260) AM 2021 111545 A

(800) 1572949

(151) 2020 09 28

(891) 2020 09 28

(731) AKCIONERNOE OBSHCHESTVO

"MILAGRE BIO"

ul. Dostoevskogo 1, pom. 1, office 6, Stupino,

RU-142802 Moscow region, Russian

Federation

(540)

## IZUMI

(591) Black, white

(531) 27.05.01

(511)

3 – Non-medicated cosmetics and toiletry preparations; non-medicated dentifrices; perfumery, essential oils; bleaching preparations and other substances for laundry use; cleaning, polishing, scouring and abrasive preparations; abrasives; amber [perfume]; descaling preparations for household purposes; antistatic preparations for household purposes; aromatics [essential oils]; air fragrancing preparations; cake flavorings [essential oils]; flavorings for beverages [essential oils]; food flavorings [essential oils]; breath freshening sprays; canned pressurized air for cleaning and

dusting purposes; balms, other than for medical purposes; basma [cosmetic dye]; lip glosses; nail glitter; polishing stones; abrasive paper; emery paper; polishing paper; petroleum jelly for cosmetic purposes; shoe polish; cobblers' wax; cotton wool for cosmetic purposes; cotton wool impregnated with make-up removing preparations; sachets for perfuming linen; drying agents for dishwashing machines; adhesives for cosmetic purposes; scented water; Javelle water; lavender water; micellar water; toilet water; wax for parquet floors; floor wax; non-slipping wax for floors; depilatory wax; mustache wax; tailors' wax; creams for leather; polish for furniture and flooring; shoemakers' wax; polishing wax; massage gels, other than for medical purposes; heliotropine; dental bleaching gels; geraniol; make-up; deodorants for pets; deodorants for human beings or for animals; depilatory preparations; air fragrance reed diffusers; scented wood; perfumes; non-slipping liquids for floors; windshield cleaning liquids; greases for cosmetic purposes; volcanic ash for cleaning; perfumery; decorative transfers for cosmetic purposes; ionone [perfumery]; shaving stones [astringents]; smoothing stones; eyebrow pencils; cosmetic pencils; silicon carbide [abrasive]; carbides of metal [abrasives]; alum stones [astringents]; tripoli stone for polishing; adhesives for affixing false eyelashes; adhesives for affixing false hair; hair conditioners; quillaia bark for washing; corundum [abrasive]; beard dyes; colorants for toilet purposes; cosmetic dyes; body paint for cosmetic purposes; laundry starch; laundry glaze; shoe cream; polishing creams; cosmetic creams; skin whitening creams; polishing rouge; incense; hair spray; nail polish; liquid latex body paint for cosmetic purposes; hair lotions; lotions for cosmetic purposes; after-shave lotions; beauty masks; oils for perfumes and scents; oils for cosmetic purposes; oils for toilet purposes; essential oils; essential oils of cedarwood; essential oils of lemon; essential oils of citron; oils for cleaning purposes; bergamot oil; gaultheria oil; jasmine oil; lavender oil; almond oil; rose oil; oil of turpentine for degreasing; whitening; cleaning chalk; almond milk for cosmetic purposes; cleansing milk for toilet purposes; musk [perfumery]; soap; deodorant soap; shaving soap; soap for brightening textile; cakes of toilet soap; antiperspirant soap; soap for foot perspiration; almond soap; mint for perfumery; cosmetic kits; emery; gel eye patches for cosmetic purposes; nail art stickers; false nails; eau de Cologne; bases for flower perfumes; joss sticks; pastes for razor strops; dentifrices; pumice stone; lipstick cases; hydrogen peroxide for cosmetic purposes; breath freshening strips; teeth whitening strips; abrasive cloth; glass cloth [abrasive cloth]; lipsticks; pomades for cosmetic purposes; shaving preparations; cosmetic preparations for baths; bath preparations, not for medical purposes; hair straightening preparations; hair waving preparations; laundry soaking preparations; grinding preparations; smoothing preparations [starching]; color-removing preparations; leather blea-

ching preparations; polishing preparations; denture polishes; mouthwashes, not for medical purposes; cosmetic preparations for slimming purposes; starch glaze for laundry purposes; preparations to make the leaves of plants shiny; eye-washes, not for medical purposes; fabric softeners for laundry use; laundry bleach; dry-cleaning preparations; paint stripping preparations; lacquer-removing preparations; make-up removing preparations; floor wax removers [scouring preparations]; varnish-removing preparations; rust removing preparations; nail care preparations; cleaning preparations; preparations for cleaning dentures; wall-paper cleaning preparations; preparations for unblocking drain pipes; chemical cleaning preparations for household purposes; collagen preparations for cosmetic purposes; bleaching preparations [decolorants] for household purposes; laundry preparations; aloe vera preparations for cosmetic purposes; sunscreen preparations; color-brightening chemicals for household purposes [laundry]; breath freshening preparations for personal hygiene; shining preparations [polish]; make-up powder; diamantine [abrasive]; stain removers; nail varnish removers; vaginal washes for personal sanitary or deodorant purposes; scouring solutions; false eyelashes; antistatic dryer sheets; baby wipes impregnated with cleaning preparations; colour run prevention laundry sheets; tissues impregnated with cosmetic lotions; tissues impregnated with make-up removing preparations; safrol; massage candles for cosmetic purposes; laundry blueing; turpentine for degreasing; potpourris [fragrances]; bleaching soda; washing soda, for cleaning; bath salts, not for medical purposes; bleaching salts; fumigation preparations [perfumes]; preservatives for leather [polishes]; ammonia [volatile alkali] [detergent]; astringents for cosmetic purposes; eyebrow cosmetics; make-up preparations; sun-tanning preparations [cosmetics]; hair dyes; neutralizers for permanent waving; cosmetic preparations for eyelashes; cosmetic preparations for skin care; shoe wax; cosmetics; cosmetics for children; cosmetics for animals; mascara; cleansers for intimate personal hygiene purposes, non medicated; do-uching preparations for personal sanitary or deodorant purposes [toiletries]; detergents, other than for use in manufacturing operations and for medical purposes; degreasers, other than for use in manufacturing processes; bleaching preparations [decolorants] for cosmetic purposes; toiletry preparations; antiperspirants [toiletries]; phytocosmetic preparations; talcum powder, for toilet use; cotton swabs for cosmetic purposes; terpenes [essential oils]; emery cloth; cloths impregnated with a detergent for cleaning; henna [cosmetic dye]; shampoos; shampoos for animals [non-medicated grooming preparations]; shampoos for pets [non-medicated grooming preparations]; dry shampoos; sandpaper; soda lye; herbal extracts for cosmetic purposes; extracts of flowers [perfumes]; ethereal essences; badian essence; mint essence [essential oil]; tooth whitening preparations; preparations for clea-

ning teeth; cosmetics and cosmetic preparations; non-medicated skin care preparations; non-medicated preparations for the care of skin, hair and scalp; cosmetic products in the form of aerosols for skin care; teeth cleaning lotions; tissues impregnated with cosmetics; cleaning pads impregnated with cosmetics; cleaning pads impregnated with toilet preparations; body washes; hair sprays and hair gels; cosmetic skin fresheners; sanitary preparations being toiletries; lotions for beards; non-medicated bath preparations; shower preparations; cosmetics in the form of lotions; cosmetics in the form of milks, lotions and emulsions; cosmetic preparations for the face and body; cosmetic hair dressing preparations; cosmetic preparations for the care of mouth and teeth; cosmetic facial care preparations; skin cleansers; facial cleansers; cleansing preparations for personal use; hand cleaning preparations; cosmetic preparations; skin moisturizers; moisturizing preparations [cosmetic]; hair moisturizers; liquid dentifrices; breath fresheners, not for medical purposes; anti-cavity mouth rinses, not for medical purposes; breath fresheners in the form of chew sticks made from birchwood extracts.

5 – Pharmaceuticals, medical and veterinary preparations; sanitary preparations for medical purposes; dietetic food and substances adapted for medical or veterinary use, food for babies; dietary supplements for human beings and animals; plasters, materials for dressings; material for dental fillings and dental impressions; disinfectants; preparations for destroying noxious animals; fungicides, herbicides; acaricides; aconitine; alkaloids for medical purposes; alginates for pharmaceutical purposes; algicides; aldehydes for pharmaceutical purposes; dental amalgams of gold; dental amalgams; amino acids for veterinary purposes; amino acids for medical purposes; analgesics; anaesthetics; antibiotics; antiseptics; medicine cases, portable, filled; first-aid boxes, filled; aluminium acetate for pharmaceutical purposes; acetates for pharmaceutical purposes; germicides; oxygen cylinders, filled, for medical purposes; balms for medical purposes; bandages for dressings; diagnostic biomarker reagents for medical purposes; biocides; bracelets impregnated with insect repellent; bromine for pharmaceutical purposes; paper for mustard plasters; fly catching paper; reagent paper for veterinary purposes; reagent paper for medical purposes; mothproofing paper; petroleum jelly for medical purposes; vaccines; oxygen baths; antiseptic cotton; aseptic cotton; absorbent cotton; wadding for medical purposes; cotton for medical purposes; dietetic substances adapted for medical use; radiological contrast substances for medical purposes; nutritive substances for microorganisms; radioactive substances for medical purposes; bismuth subnitrate for pharmaceutical purposes; melissa water for pharmaceutical purposes; sea water for medicinal bathing; mineral waters for medical purposes; thermal water; dietary fiber; molding wax for dentists; gases

for medical purposes; guaiacol for pharmaceutical purposes; massage gels for medical purposes; sexual stimulant gels; hematogen; hemoglobin; hydrastine; hydrastinine; glycerine for medical purposes; glycerophosphates; glucose for medical purposes; gentian for pharmaceutical purposes; hormones for medical purposes; mustard for pharmaceutical purposes; mustard plasters; mud for baths; medicinal mud; contraceptive sponges; gamboge for medical purposes; gurjun balsam for medical purposes; air deodorizing preparations; deodorants, other than for human beings or for animals; deodorants for clothing and textiles; diastase for medical purposes; digitalin; vitamin supplement patches; mineral food supplements; nutritional supplements; albumin dietary supplements; dietary supplements for animals; yeast dietary supplements; alginate dietary supplements; glucose dietary supplements; casein dietary supplements; lecithin dietary supplements; linseed oil dietary supplements; propolis dietary supplements; protein dietary supplements; protein supplements for animals; royal jelly dietary supplements; pollen dietary supplements; wheat germ dietary supplements; linseed dietary supplements; acai powder dietary supplements; dietary supplements with a cosmetic effect; enzyme dietary supplements; yeast for pharmaceutical purposes; gelatine for medical purposes; cod liver oil; isotopes for medical purposes; immunostimulants; insecticides; iodine for pharmaceutical purposes; iodides for pharmaceutical purposes; alkaline iodides for pharmaceutical purposes; iodoform; calomel [fungicide]; cream of tartar for pharmaceutical purposes; tartar for pharmaceutical purposes; camphor for medical purposes; capsules for medicines; cachets for pharmaceutical purposes; capsules made of dendrimer-based polymers, for pharmaceuticals; hemostatic pencils; wart pencils; caustic pencils; carbolineum [parasiticide]; caustics for pharmaceutical purposes; cachou for pharmaceutical purposes; quassia for medical purposes; quebracho for medical purposes; oxygen for medical purposes; gallic acid for pharmaceutical purposes; acids for pharmaceutical purposes; adhesives for dentures; surgical glues; stem cells for veterinary purposes; stem cells for medical purposes; cocaine; collagen for medical purposes; collodion for pharmaceutical purposes; corn rings for the feet; cannabis for medical purposes; medicated sweets; angostura bark for medical purposes; barks for pharmaceutical purposes; cedar wood for use as an insect repellent; condurango bark for medical purposes; croton bark; mangrove bark for pharmaceutical purposes; myrobalan bark for pharmaceutical purposes; quinquina for medical purposes; medicated animal feed; medicinal roots; rhubarb roots for pharmaceutical purposes; lint for medical purposes; starch for dietetic or pharmaceutical purposes; creosote for pharmaceutical purposes; blood for medical purposes; cultures of microorganisms for medical or veterinary use; curare; dental lacquer; liquorice for pharmaceutical purposes; lactose for pharmaceutical purposes; ad-



hesive plasters; medicines for alleviating constipation; adhesive tapes for medical purposes; lecithin for medical purposes; lotions for veterinary purposes; medicated hair lotions; lotions for pharmaceutical purposes; medicated after-shave lotions; personal sexual lubricants; lupulin for pharmaceutical purposes; magnesia for pharmaceutical purposes; liniments; ointments for pharmaceutical purposes; sunburn ointments; mercurial ointments; frostbite salve for pharmaceutical purposes; gauze for dressings; medicinal oils; mustard oil for medical purposes; camphor oil for medical purposes; castor oil for medical purposes; oil of turpentine for pharmaceutical purposes; dill oil for medical purposes; dental mastics; dental abrasives; dental impression materials; teeth filling material; dressings, medical; surgical dressings; drugs for medical purposes; medicines for veterinary purposes; serotherapeutic medicines; medicines for human purposes; medicines for dental purposes; menthol; medicinal drinks; moleskin for medical purposes; almond milk for pharmaceutical purposes; powdered milk for babies; royal jelly for pharmaceutical purposes; milk ferments for pharmaceutical purposes; Irish moss for medical purposes; flour for pharmaceutical purposes; linseed meal for pharmaceutical purposes; fish meal for pharmaceutical purposes; fly glue; antibacterial soap; disinfectant soap; medicated soap; freeze-dried meat adapted for medical purposes; mint for pharmaceutical purposes; dietetic beverages adapted for medical purposes; malted milk beverages for medical purposes; injectable dermal fillers; bone void fillers comprised of living tissues; narcotics; medicinal infusions; tincture of iodine; eucalyptol for pharmaceutical purposes; tinctures for medical purposes; opium; opodeldoc; decoctions for pharmaceutical purposes; antiparasitic collars for animals; cotton sticks for medical purposes; stick liquorice for pharmaceutical purposes; sulfur sticks [disinfectants]; pastilles for pharmaceutical purposes; medicated dentifrices; pectin for pharmaceutical purposes; pepsins for pharmaceutical purposes; peptones for pharmaceutical purposes; hydrogen peroxide for medical purposes; pesticides; food for babies; leeches for medical purposes; blood plasma; nicotine patches for use as aids to stop smoking; eyepatches for medical purposes; poultices; compresses; scapulars for surgical purposes; babies' diapers; diapers for pets; swim diapers, reusable, for babies; swim diapers, disposable, for babies; diapers for incontinence; diaper changing mats, disposable, for babies; bunion pads; breast-nursing pads; pomades for medical purposes; powder of cantharides; pyrethrum powder; anti-uric preparations; bacterial preparations for medical and veterinary use; bacteriological preparations for medical and veterinary use; balsamic preparations for medical purposes; albuminous preparations for medical purposes; biological preparations for veterinary purposes; biological preparations for medical purposes; veterinary preparations; bismuth preparations for pharmaceutical purposes; vitamin prepara-

tions; diagnostic preparations for veterinary purposes; diagnostic preparations for medical purposes; douching preparations for medical purposes; bath preparations for medical purposes; therapeutic preparations for the bath; hemorrhoid preparations; preparations for callouses; lice treatment preparations [pediculicides]; acne treatment preparations; preparations to facilitate teething; preparations for the treatment of burns; fumigation preparations for medical purposes; opotherapy preparations; air purifying preparations; bronchodilating preparations; preparations for reducing sexual activity; sterilising preparations; soil-sterilising preparations; corn remedies; pharmaceutical preparations for treating dandruff; herbicides; preparations for destroying dry rot fungus; larvae exterminating preparations; fly destroying preparations; preparations for destroying mice; slug exterminating preparations; vermin destroying preparations; pharmaceutical preparations for skin care; contact lens cleaning preparations; preparations of microorganisms for medical or veterinary use; lime-based pharmaceutical preparations; styptic preparations; medicated eye-washes; medicinal hair growth preparations; nutraceutical preparations for therapeutic or medical purposes; opiates; anticryptogamic preparations; aloe vera preparations for pharmaceutical purposes; preparations of trace elements for human and animal use; sulfonamides [medicines]; pharmaceutical preparations; pharmaceutical preparations for treating sunburn; enzyme preparations for veterinary purposes; enzyme preparations for medical purposes; phytotherapy preparations for medical purposes; chemico-pharmaceutical preparations; chemical preparations for veterinary purposes; chemical preparations for the diagnosis of pregnancy; chemical preparations for medical purposes; chemical preparations for treating diseases affecting cereal plants; chemical preparations for treating wheat blight; chemical preparations for treating diseases affecting vine plants; chemical preparations for treating mildew; chemical preparations for treating phylloxera; chemical preparations for pharmaceutical purposes; chilblain preparations; mothproofing preparations; collyrium; lead water; chemical conductors for electrocardiograph electrodes; albuminous foodstuffs for medical purposes; dietetic foods adapted for medical purposes; by-products of the processing of cereals for dietetic or medical purposes; homogenized food adapted for medical purposes; freeze-dried food adapted for medical purposes; pharmaceuticals; sanitary towels; panty liners [sanitary]; propolis for pharmaceutical purposes; pearl powder for medical purposes; radium for medical purposes; hydrated chloral for pharmaceutical purposes; solvents for removing adhesive plasters; vaginal washes for medical purposes; solutions for contact lenses; chemical reagents for medical or veterinary purposes; gum for medical purposes; rubber for dental purposes; chewing gum for medical purposes; nicotine gum for use as an aid to stop smoking; insect repellents; insect repellent incense;

repellents for dogs; tissues impregnated with pharmaceutical lotions; sarsaparilla for medical purposes; sugar for medical purposes; crystallized rock sugar for medical purposes; asthmatic tea; fumigating sticks; massage candles for therapeutic purposes; suppositories; linseed for pharmaceutical purposes; tobacco-free cigarettes for medical purposes; siccatives [drying agents] for medical purposes; syrups for pharmaceutical purposes; turpentine for pharmaceutical purposes; milking grease; greases for veterinary purposes; greases for medical purposes; lacteal flour for babies; infant formula; soporifics; bicarbonate of soda for pharmaceutical purposes; bath salts for medical purposes; salts for mineral water baths; salts for medical purposes; potassium salts for medical purposes; sodium salts for medical purposes; smelling salts; mineral water salts; malt for pharmaceutical purposes; semen for artificial insemination; alcohol for pharmaceutical purposes; medicinal alcohol; alloys of precious metals for dental purposes; ergot for pharmaceutical purposes; cooling sprays for medical purposes; antibacterial handwashes; adjuvants for medical purposes; astringents for medical purposes; vermifuges; disinfectants for hygiene purposes; disinfectants for chemical toilets; appetite suppressants for medical purposes; medical preparations for slimming purposes; parasiticides; mouthwashes for medical purposes; febrifuges; depuratives; animal washes [insecticides]; detergents for medical purposes; cattle washes [insecticides]; dog washes [insecticides]; insecticidal veterinary washes; vesicants; purgatives; remedies for perspiration; remedies for foot perspiration; chemical contraceptives; antiparasitic preparations; sedatives; laxatives; tonics [medicines]; medicated toiletry preparations; digestives for pharmaceutical purposes; nervines; media for bacteriological cultures; steroids; headache relief sticks; strychnine; serums; tanning pills; appetite suppressant pills; slimming pills; jujube, medicated; antioxidant pills; sanitary tampons; vulnerary sponges; thymol for pharmaceutical purposes; biological tissue cultures for veterinary purposes; biological tissue cultures for medical purposes; smoking herbs for medical purposes; medicinal herbs; transplants [living tissues]; surgical implants comprised of living tissues; pants, absorbent, for incontinence; sanitary panties; babies' diaper-pants; charcoal for pharmaceutical purposes; fennel for medical purposes; porcelain for dental prostheses; phenol for pharmaceutical purposes; enzymes for veterinary purposes; enzymes for medical purposes; ferments for pharmaceutical purposes; formic aldehyde for pharmaceutical purposes; phosphates for pharmaceutical purposes; fungicides; quinine for medical purposes; chinoline for medical purposes; diabetic bread adapted for medical use; chloroform; flowers of sulfur for pharmaceutical purposes; cement for animal hooves; bone cement for surgical and orthopaedic purposes; dental cements; medicinal tea; herbal teas for medicinal purposes; insecticidal animal shampoos; medicated shampoos; medicated

shampoos for pets; pediculicidal shampoos; medicated dry shampoos; pre-filled syringes for medical purposes; eucalyptus for pharmaceutical purposes; herbal extracts for medical purposes; plant extracts for pharmaceutical purposes; tobacco extracts [insecticides]; extracts of hops for pharmaceutical purposes; elixirs [pharmaceutical preparations]; ethers for pharmaceutical purposes; esters for pharmaceutical purposes; cellulose esters for pharmaceutical purposes; cellulose ethers for pharmaceutical purposes; rat poison; poisons; bacterial poisons; jalap.

21 – Combs and sponges; brushes, except paintbrushes; inflatable bath tubs for babies; bird baths; baby baths, portable; mop wringer buckets; buckets made of woven fabrics; whisks, non-electric, for household purposes; hair for brushes; horsehair for brush-making; heads for electric toothbrushes; large-toothed combs for the hair; combs for animals; abrasive sponges for scrubbing the skin; make-up sponges; sponges for household purposes; toilet sponges; toothpick holders; shaving brush stands; soap dispensers; toilet paper dispensers; plug-in diffusers for mosquito repellents; aromatic oil diffusers, other than reed diffusers, electric and non-electric; ironing boards; cutting boards for the kitchen; bread boards; washing boards; heat-insulated containers; chamois leather for cleaning; toothpicks; ceramics for household purposes; shaving brushes; make-up brushes; litter boxes for pets; material for brush-making; isothermic bags; confectioners' decorating bags [pastry bags]; saucepan scourers of metal; soap boxes; toilet cases; floss for dental purposes; droppers for cosmetic purposes; plates for diffusing aromatic oil; dripping pans; trays for household purposes; trays of paper, for household purposes; cosmetic utensils; toilet utensils; trouser presses; toothpaste tube squeezers; make-up removing appliances; powder compacts, empty; perfume vaporizers; powder puffs; foam toe separators for use in pedicures; combs; electric combs; cloth for washing floors; polishing cloths; cloths for cleaning; dusting cloths [rags]; furniture dusters; water apparatus for cleaning teeth and gums; flasks; comb cases; animal bristles [brushware]; pig bristles for brush-making; brushes; dishwashing brushes; ski wax brushes; brushes for cleaning tanks and containers; lamp-glass brushes; horse brushes; scrubbing brushes; toothbrushes; toothbrushes, electric; basting brushes; carpet sweepers; brushes for footwear; tar-brushes, long handled; toilet brushes; electric brushes, except parts of machines; eyebrow brushes; nail brushes; eyelash brushes; boxes for dispensing paper towels; household containers.

30 – Cereal preparations; cereal bars; high-protein cereal bars; waffles; malt biscuits; gluten additives for culinary purposes; cereal-based snack food; peanut confectionery; almond confectionery; fruit confectionery; mints for breath freshening; crackers; muesli; chewing gum; chewing gum for breath freshening;

gluten-free bread; chips [cereal products]; corn flakes; oat flakes.

44 – Hygienic and beauty care for human beings; medical services; public bath services for hygiene purposes; Turkish bath services; hospital services; depilatory waxing; health center services; nursing home services; hair implantation; medical advice for individuals with disabilities; pharmacy advice; aromatherapy services; animal-assisted therapy; manicuring; chiropractic; massage; medical testing; orthodontic services; artificial insemination services; palliative care; hair-dressing; body piercing; midwife services; veterinary assistance; dentistry services; medical assistance; preparation of prescriptions by pharmacists; medical equipment rental; rental of hair styling apparatus; rental of sanitary installations; rehabilitation for substance abuse patients; beauty salon services; sanatorium services; medical screening; blood bank services; health care; health counselling; tattooing; health spa services; human tissue bank services; visagists' services; convalescent home services; rest home services; medical clinic services; medical analysis services for diagnostic and treatment purposes provided by medical laboratories; home-visit nursing care; alternative medicine services; opticians' services; speech therapy; cosmetician services; in vitro fertilization services; services of a psychologist; sauna services; solarium services; telemedicine services; therapy services; nursing, medical; physical therapy; plastic surgery; hospice services.

---

---

**INTERNATIONAL TRADEMARKS PROTECTED IN GEORGIA**

(260) AM 2021 106018 A  
(800) 1501702  
(151) 2019 05 30  
(181) 2029 05 30  
(891) 2019 05 30  
(511) 35, 43

---

(260) AM 2021 106254 A  
(800) 1504950  
(151) 2019 10 15  
(181) 2029 10 15  
(891) 2019 10 15  
(511) 09, 09

---

(260) AM 2021 108100 A  
(800) 1528144  
(151) 2019 11 15  
(181) 2029 11 15  
(891) 2019 11 15  
(511) 01, 04

---

(260) AM 2021 108135 A  
(800) 1528315  
(151) 2019 12 23  
(181) 2029 12 23  
(891) 2019 12 23  
(511) 05

---

(260) AM 2021 108548 A  
(800) 1533934  
(151) 2020 04 27  
(181) 2030 04 27  
(891) 2020 04 27  
(511) 18, 25, 35

---

(260) AM 2021 108701 A  
(800) 1535917  
(151) 2020 05 15  
(181) 2030 05 15  
(891) 2020 05 15  
(511) 12

---

(260) AM 2021 108706 A  
(800) 1536081  
(151) 2020 03 26  
(181) 2030 03 26  
(891) 2020 03 26  
(511) 21

---

(260) AM 2021 109531 A  
(800) 1547160  
(151) 2020 04 20  
(181) 2030 04 20  
(891) 2020 04 20  
(511) 30

---

(260) AM 2021 109532 A  
(800) 1547178  
(151) 2020 05 20  
(181) 2030 05 20  
(891) 2020 05 20  
(511) 30

---

(260) AM 2021 109538 A  
(800) 1547357  
(151) 2020 05 20  
(181) 2030 05 20  
(891) 2020 05 20  
(511) 05, 44

---

(260) AM 2021 109539 A  
(800) 1547364  
(151) 2020 04 21  
(181) 2030 04 21  
(891) 2020 04 21  
(511) 09, 28

---

(260) AM 2021 109540 A  
(800) 1547367  
(151) 2020 02 17  
(181) 2030 02 17  
(891) 2020 02 17  
(511) 36, 38, 42

---

(260) AM 2021 109542 A  
(800) 1547383  
(151) 2020 05 20  
(181) 2030 05 20  
(891) 2020 05 20  
(511) 05, 44

---

(260) AM 2021 109556 A  
(800) 1547575  
(151) 2020 07 17  
(181) 2030 07 17  
(891) 2020 07 17  
(511) 30, 32

---

(260) AM 2021 109557 A  
(800) 1547617  
(151) 2020 05 14  
(181) 2030 05 14  
(891) 2020 05 14  
(511) 32

---

(260) AM 2021 109558 A  
(800) 1547663  
(151) 2020 07 14  
(181) 2030 07 14  
(891) 2020 07 14  
(511) 04

---

(260) AM 2021 109559 A  
(800) 1547675  
(151) 2020 03 31  
(181) 2030 03 31  
(891) 2020 03 31  
(511) 07

---

(260) AM 2021 109560 A  
(800) 1547709  
(151) 2020 07 23  
(181) 2030 07 23  
(891) 2020 07 23  
(511) 10

---

(260) AM 2021 109561 A  
(800) 1547750  
(151) 2020 05 18  
(181) 2030 05 18  
(891) 2020 05 18  
(511) 01, 11, 16, 17, 19, 20, 35, 39, 42

---

(260) AM 2021 109581 A  
(800) 1461109  
(151) 2019 02 25  
(181) 2029 02 25  
(891) 2020 06 30  
(511) 05, 10

---

(260) AM 2021 109582 A  
(800) 1470920  
(151) 2019 04 11  
(181) 2029 04 11  
(891) 2020 07 22  
(511) 03

---

(260) AM 2021 109583 A  
(800) 1485185  
(151) 2019 05 21  
(181) 2029 05 21  
(891) 2020 05 11  
(511) 09

---

(260) AM 2021 109584 A  
(800) 1512903  
(151) 2019 08 16  
(181) 2029 08 16  
(891) 2020 07 16  
(511) 29, 30

---

(260) AM 2021 109585 A  
(800) 1542309  
(151) 2020 05 19  
(181) 2030 05 19  
(891) 2020 07 28  
(511) 25

---

(260) AM 2021 109614 A  
(800) 1547918  
(151) 2020 07 09  
(181) 2030 07 09  
(891) 2020 07 09  
(511) 09

---

(260) AM 2021 109615 A  
(800) 1547925  
(151) 2020 07 01  
(181) 2030 07 01  
(891) 2020 07 01  
(511) 12

---

(260) AM 2021 109616 A  
(800) 1547969  
(151) 2020 08 05  
(181) 2030 08 05  
(891) 2020 08 05  
(511) 10

---

(260) AM 2021 109617 A  
(800) 1548029  
(151) 2020 03 11  
(181) 2030 03 11  
(891) 2020 03 11  
(511) 17

---

(260) AM 2021 109622 A  
 (800) 1548187  
 (151) 2020 05 29  
 (181) 2030 05 29  
 (891) 2020 05 29  
 (511) 06, 07, 09, 28, 35

---

(260) AM 2021 109638 A  
 (800) 1548515  
 (151) 2020 04 07  
 (181) 2030 04 07  
 (891) 2020 04 07  
 (511) 03, 08, 09, 12, 20

---

(260) AM 2021 109627 A  
 (800) 1548286  
 (151) 2020 05 29  
 (181) 2030 05 29  
 (891) 2020 05 29  
 (511) 08, 09, 16, 18

---

(260) AM 2021 109642 A  
 (800) 1548557  
 (151) 2020 06 27  
 (181) 2030 06 27  
 (891) 2020 06 27  
 (511) 05, 32, 35

---

(260) AM 2021 109628 A  
 (800) 1548290  
 (151) 2020 06 01  
 (181) 2030 06 01  
 (891) 2020 06 01  
 (511) 34

---

(260) AM 2021 109643 A  
 (800) 1548589  
 (151) 2020 07 23  
 (181) 2030 07 23  
 (891) 2020 07 23  
 (511) 09

---

(260) AM 2021 109629 A  
 (800) 1548298  
 (151) 2020 06 01  
 (181) 2030 06 01  
 (891) 2020 06 01  
 (511) 03

---

(260) AM 2021 109644 A  
 (800) 1548661  
 (151) 2020 07 08  
 (181) 2030 07 08  
 (891) 2020 07 08  
 (511) 09, 35, 38, 41, 42

---

(260) AM 2021 109631 A  
 (800) 1548349  
 (151) 2020 02 24  
 (181) 2030 02 24  
 (891) 2020 02 24  
 (511) 06, 07, 09, 17, 20, 35, 37, 39

---

(260) AM 2021 109646 A  
 (800) 1548782  
 (151) 2020 05 09  
 (181) 2030 05 09  
 (891) 2020 05 09  
 (511) 08

---

(260) AM 2021 109632 A  
 (800) 1548356  
 (151) 2020 05 29  
 (181) 2030 05 29  
 (891) 2020 05 29  
 (511) 35, 43

---

(260) AM 2021 109647 A  
 (800) 1548827  
 (151) 2020 05 25  
 (181) 2030 05 25  
 (891) 2020 05 25  
 (511) 07

---

(260) AM 2021 109633 A  
 (800) 1548366  
 (151) 2020 07 21  
 (181) 2030 07 21  
 (891) 2020 07 21  
 (511) 03

---

(260) AM 2021 109648 A  
 (800) 1548847  
 (151) 2020 03 31  
 (181) 2030 03 31  
 (891) 2020 03 31  
 (511) 07, 37

---

---

(260) AM 2021 109649 A  
(800) 1548878  
(151) 2020 05 12  
(181) 2030 05 12  
(891) 2020 05 12  
(511) 06, 07, 09, 17

---

---

(260) AM 2021 109701 A  
(800) 1549390  
(151) 2020 07 17  
(181) 2030 07 17  
(891) 2020 07 17  
(511) 01

---

---

(260) AM 2021 109683 A  
(800) 1549024  
(151) 2020 07 01  
(181) 2030 07 01  
(891) 2020 07 01  
(511) 05

---

---

(260) AM 2021 109702 A  
(800) 1549400  
(151) 2020 07 09  
(181) 2030 07 09  
(891) 2020 07 09  
(511) 01, 05, 09, 29, 40, 42

---

---

(260) AM 2021 109684 A  
(800) 1549071  
(151) 2020 06 22  
(181) 2030 06 22  
(891) 2020 06 22  
(511) 05, 29, 30, 32

---

---

(260) AM 2021 109703 A  
(800) 1549418  
(151) 2020 05 14  
(181) 2030 05 14  
(891) 2020 05 14  
(511) 05

---

---

(260) AM 2021 109685 A  
(800) 1549108  
(151) 2020 06 01  
(181) 2030 06 01  
(891) 2020 06 01  
(511) 07, 12

---

---

(260) AM 2021 109705 A  
(800) 1549431  
(151) 2020 03 31  
(181) 2030 03 31  
(891) 2020 03 31  
(511) 07, 37

---

---

(260) AM 2021 109692 A  
(800) 1549236  
(151) 2020 04 28  
(181) 2030 04 28  
(891) 2020 04 28  
(511) 05

---

---

(260) AM 2021 109711 A  
(800) 1549535  
(151) 2020 06 29  
(181) 2030 06 29  
(891) 2020 06 29  
(511) 05

---

---

(260) AM 2021 109696 A  
(800) 1549292  
(151) 2020 04 28  
(181) 2030 04 28  
(891) 2020 04 28  
(511) 05

---

---

(260) AM 2021 109712 A  
(800) 1549607  
(151) 2020 04 08  
(181) 2030 04 08  
(891) 2020 04 08  
(511) 05

---

---

(260) AM 2021 109699 A  
(800) 1549380  
(151) 2020 07 20  
(181) 2030 07 20  
(891) 2020 07 20  
(511) 34

---

---

(260) AM 2021 109713 A  
(800) 1549633  
(151) 2020 07 16  
(181) 2030 07 16  
(891) 2020 07 16  
(511) 09

---

(260) AM 2021 109719 A  
(800) 1549901  
(151) 2020 06 02  
(181) 2030 06 02  
(891) 2020 06 02  
(511) 06

---

(260) AM 2021 109788 A  
(800) 1550391  
(151) 2020 05 06  
(181) 2030 05 06  
(891) 2020 05 06  
(511) 01, 05, 09, 29, 40, 42

---

(260) AM 2021 109721 A  
(800) 725917  
(151) 1999 12 15  
(181) 2029 12 15  
(891) 2020 08 10  
(511) 39

---

(260) AM 2021 109803 A  
(800) 1550973  
(151) 2020 06 02  
(181) 2030 06 02  
(891) 2020 06 02  
(511) 09, 28, 41

---

(260) AM 2021 109722 A  
(800) 1042380  
(151) 2010 05 21  
(181) 2030 05 21  
(891) 2020 05 22  
(511) 09

---

(260) AM 2021 109804 A  
(800) 1551004  
(151) 2020 06 01  
(181) 2030 06 01  
(891) 2020 06 01  
(511) 03

---

(260) AM 2021 109728 A  
(800) 1542443  
(151) 2020 02 25  
(181) 2030 02 25  
(891) 2020 08 21  
(511) 05, 10

---

(260) AM 2021 109809 A  
(800) 1551157  
(151) 2020 06 02  
(181) 2030 06 02  
(891) 2020 06 02  
(511) 09, 28, 41

---

(260) AM 2021 109783 A  
(800) 1550265  
(151) 2020 04 22  
(181) 2030 04 22  
(891) 2020 04 22  
(511) 06, 07, 08, 09, 11, 12, 35

---

(260) AM 2021 109814 A  
(800) 1029459  
(151) 2009 12 02  
(181) 2029 12 02  
(891) 2020 08 31  
(511) 05

---

(260) AM 2021 109786 A  
(800) 1550312  
(151) 2020 05 06  
(181) 2030 05 06  
(891) 2020 05 06  
(511) 03, 05

---

(260) AM 2021 109815 A  
(800) 1068528  
(151) 2010 12 09  
(181) 2020 12 09  
(891) 2020 08 18  
(511) 33

---

(260) AM 2021 109787 A  
(800) 1550329  
(151) 2020 07 10  
(181) 2030 07 10  
(891) 2020 07 10  
(511) 44

---

(260) AM 2021 109818 A  
(800) 1383847  
(151) 2017 09 12  
(181) 2027 09 12  
(891) 2020 08 03  
(511) 34

---



(260) AM 2021 109819 A  
(800) 1417734  
(151) 2018 06 05  
(181) 2028 06 05  
(891) 2020 09 03  
(511) 33

---

(260) AM 2021 109820 A  
(800) 1435411  
(151) 2018 09 27  
(181) 2028 09 27  
(891) 2020 06 29  
(511) 05, 29, 30, 32

---

(260) AM 2021 109860 A  
(800) 1551419  
(151) 2020 08 13  
(181) 2030 08 13  
(891) 2020 08 13  
(511) 05

---

(260) AM 2021 109861 A  
(800) 1551434  
(151) 2020 07 30  
(181) 2030 07 30  
(891) 2020 07 30  
(511) 06, 11, 19, 20, 35, 37, 40, 42

---

(260) AM 2021 109862 A  
(800) 1551471  
(151) 2020 07 29  
(181) 2030 07 29  
(891) 2020 07 29  
(511) 12

---

(260) AM 2021 109863 A  
(800) 1551478  
(151) 2020 07 16  
(181) 2030 07 16  
(891) 2020 07 16  
(511) 33

---

(260) AM 2021 109864 A  
(800) 1551495  
(151) 2020 07 22  
(181) 2030 07 22  
(891) 2020 07 22  
(511) 33, 35

---

(260) AM 2021 109865 A  
(800) 1551500  
(151) 2020 08 11  
(181) 2030 08 11  
(891) 2020 08 11  
(511) 30

---

(260) AM 2021 109869 A  
(800) 1551554  
(151) 2020 07 10  
(181) 2030 07 10  
(891) 2020 07 10  
(511) 10

---

(260) AM 2021 109893 A  
(800) 1552010  
(151) 2020 02 21  
(181) 2030 02 21  
(891) 2020 02 21  
(511) 09

---

(260) AM 2021 109894 A  
(800) 1552067  
(151) 2020 07 20  
(181) 2030 07 20  
(891) 2020 07 20  
(511) 06, 07, 09, 11

---

(260) AM 2021 109902 A  
(800) 1126382  
(151) 2012 03 30  
(181) 2022 03 30  
(891) 2020 09 10  
(511) 29, 30, 32

---

(260) AM 2021 109908 A  
(800) 1408664  
(151) 2018 02 01  
(181) 2028 02 01  
(891) 2020 08 14  
(511) 33

---

(260) AM 2021 109965 A  
(800) 1552490  
(151) 2020 07 15  
(181) 2030 07 15  
(891) 2020 07 15  
(511) 05

---

(260) AM 2021 109966 A  
(800) 1552537  
(151) 2020 05 29  
(181) 2030 05 29  
(891) 2020 05 29  
(511) 09, 28, 41

---

(260) AM 2021 109968 A  
(800) 1552568  
(151) 2020 06 02  
(181) 2030 06 02  
(891) 2020 06 02  
(511) 09, 28, 41

---

(260) AM 2021 109969 A  
(800) 1552678  
(151) 2020 07 16  
(181) 2030 07 16  
(891) 2020 07 16  
(511) 03, 05

---

(260) AM 2021 109970 A  
(800) 1552693  
(151) 2020 07 21  
(181) 2030 07 21  
(891) 2020 07 21  
(511) 09

---

(260) AM 2021 109971 A  
(800) 1552695  
(151) 2020 07 21  
(181) 2030 07 21  
(891) 2020 07 21  
(511) 07

---

(260) AM 2021 109972 A  
(800) 1552711  
(151) 2020 07 01  
(181) 2030 07 01  
(891) 2020 07 01  
(511) 09

---

(260) AM 2021 109974 A  
(800) 1552732  
(151) 2020 06 05  
(181) 2030 06 05  
(891) 2020 06 05  
(511) 03, 05, 10, 44

---

(260) AM 2021 109975 A  
(800) 1552740  
(151) 2020 06 05  
(181) 2030 06 05  
(891) 2020 06 05  
(511) 03, 05, 10, 44

---

(260) AM 2021 109986 A  
(800) 1552865  
(151) 2020 05 29  
(181) 2030 05 29  
(891) 2020 05 29  
(511) 09, 28, 41

---

(260) AM 2021 109987 A  
(800) 1552932  
(151) 2020 04 23  
(181) 2030 04 23  
(891) 2020 04 23  
(511) 09, 12, 35, 36, 37, 38, 39, 41, 42, 43, 45

---

(260) AM 2021 110004 A  
(800) 1244819  
(151) 2014 12 18  
(181) 2024 12 18  
(891) 2020 08 24  
(511) 35

---

(260) AM 2021 110005 A  
(800) 1254383  
(151) 2015 01 26  
(181) 2025 01 26  
(891) 2020 08 24  
(511) 35

---

(260) AM 2021 110006 A  
(800) 1285520  
(151) 2015 10 01  
(181) 2025 10 01  
(891) 2020 09 10  
(511) 01, 02, 19, 21, 27

---

(260) AM 2021 110007 A  
(800) 1298535  
(151) 2016 04 07  
(181) 2026 04 07  
(891) 2020 08 24  
(511) 35

---

(260) AM 2021 110049 A  
(800) 1553435  
(151) 2020 07 27  
(181) 2030 07 27  
(891) 2020 07 27  
(511) 25, 35

---

(260) AM 2021 110057 A  
(800) 1553614  
(151) 2020 07 16  
(181) 2030 07 16  
(891) 2020 07 16  
(511) 30, 35

---

(260) AM 2021 110050 A  
(800) 1553444  
(151) 2020 08 17  
(181) 2030 08 17  
(891) 2020 08 17  
(511) 33

---

(260) AM 2021 110058 A  
(800) 1553627  
(151) 2020 06 02  
(181) 2030 06 02  
(891) 2020 06 02  
(511) 09, 28, 41

---

(260) AM 2021 110051 A  
(800) 1553496  
(151) 2020 07 24  
(181) 2030 07 24  
(891) 2020 07 24  
(511) 03, 05

---

(260) AM 2021 110059 A  
(800) 1553631  
(151) 2020 08 05  
(181) 2030 08 05  
(891) 2020 08 05  
(511) 10

---

(260) AM 2021 110052 A  
(800) 1553524  
(151) 2020 07 16  
(181) 2030 07 16  
(891) 2020 07 16  
(511) 30, 35

---

(260) AM 2021 110060 A  
(800) 1553639  
(151) 2020 06 02  
(181) 2030 06 02  
(891) 2020 06 02  
(511) 09, 28, 41

---

(260) AM 2021 110053 A  
(800) 1553548  
(151) 2020 07 22  
(181) 2030 07 22  
(891) 2020 07 22  
(511) 03, 05, 10, 21

---

(260) AM 2021 110072 A  
(800) 1554064  
(151) 2020 07 24  
(181) 2030 07 24  
(891) 2020 07 24  
(511) 11

---

(260) AM 2021 110055 A  
(800) 1553562  
(151) 2020 07 22  
(181) 2030 07 22  
(891) 2020 07 22  
(511) 03, 05, 10, 21

---

(260) AM 2021 110073 A  
(800) 1554076  
(151) 2020 09 15  
(181) 2030 09 15  
(891) 2020 09 15  
(511) 09

---

(260) AM 2021 110056 A  
(800) 1553590  
(151) 2020 09 09  
(181) 2030 09 09  
(891) 2020 09 09  
(511) 09

---

(260) AM 2021 110074 A  
(800) 1554124  
(151) 2020 05 27  
(181) 2030 05 27  
(891) 2020 05 27  
(511) 36, 37

---

(260) AM 2021 110075 A  
(800) 1554202  
(151) 2020 08 11  
(181) 2030 08 11  
(891) 2020 08 11  
(511) 30

---

(260) AM 2021 110165 A  
(800) 1555456  
(151) 2020 08 10  
(181) 2030 08 10  
(891) 2020 08 10  
(511) 30

---

(260) AM 2021 110076 A  
(800) 1554209  
(151) 2020 08 13  
(181) 2030 08 13  
(891) 2020 08 13  
(511) 09, 10

---

(260) AM 2021 110240 A  
(800) 1556310  
(151) 2020 07 29  
(181) 2030 07 29  
(891) 2020 07 29  
(511) 05

---

(260) AM 2021 110151 A  
(800) 1554911  
(151) 2020 05 07  
(181) 2030 05 07  
(891) 2020 05 07  
(511) 03, 05

---

(260) AM 2021 110251 A  
(800) 1556605  
(151) 2020 09 10  
(181) 2030 09 10  
(891) 2020 09 10  
(511) 09

---

(260) AM 2021 110152 A  
(800) 1554986  
(151) 2020 08 18  
(181) 2030 08 18  
(891) 2020 08 18  
(511) 30

---

(260) AM 2021 110326 A  
(800) 1557913  
(151) 2020 08 11  
(181) 2030 08 11  
(891) 2020 08 11  
(511) 42

---

(260) AM 2021 110162 A  
(800) 1555404  
(151) 2020 07 15  
(181) 2030 07 15  
(891) 2020 07 15  
(511) 30, 35

---

(260) AM 2021 110327 A  
(800) 1557924  
(151) 2020 06 02  
(181) 2030 06 02  
(891) 2020 06 02  
(511) 09, 28, 41

---

(260) AM 2021 110163 A  
(800) 1555418  
(151) 2020 07 06  
(181) 2030 07 06  
(891) 2020 07 06  
(511) 29, 30

---

(260) AM 2021 110164 A  
(800) 1555444  
(151) 2020 08 10  
(181) 2030 08 10  
(891) 2020 08 10  
(511) 33

---

---

**APPELLATIONS OF ORIGIN OF GOOD**  
**INTERNATIONAL APPELLATIONS OF ORIGIN OF GOOD**

(800) 1155  
(151) 2021 03 22  
(210) 3507  
(540)

**Figues de Djebba**

(731) Any fig producer of the Djebba imada of the Béja Governorate Tibbar delegation.  
The geographical area of Djebba imada of the Béja Governorate Tibbar delegation, Tunisia  
(511)  
29 – Figs.  
31 – Figs.

---

(800) 1148  
(151) 2020 01 13  
(210) 3508  
(540)

**Farsh e Dastbaft e Afshar e Tekab**

(731) Tekab Urban Handwoven Carpet Cooperative Company  
Tekab Region, Iran;  
Tekab Rural Handwoven Carpet Cooperative Company  
Tekab Region, Iran;  
Tekab Handwoven Carpet Weavers Union  
Tekab Region, Iran;  
West Azerbaijan Province Rural Handwoven Carpet Cooperative Companies Union  
Tekab Region, Iran  
(511)  
27 – Handmade Carpet.

---

---

**OFFICIAL NOTIFICATIONS**  
**INVENTIONS**  
**EXPIRATION OF PATENT RESTORATION**

(21) AP 2016 14154  
(11) P 2017 6726 B  
(73) Temur Maisuradze  
(54) POINT SWITCH  
DATE OF CANCELLATION OF PATENT: 2021 05 24  
THE TERM OF RESTORATION OF PATENT: 2021 10 11

---

**ABOLITION OF PATENT WITH THE RIGHT TO RESTORE**

(21) AP 2012 13226  
(11) P 2019 7052 B  
(73) Los Angeles Biomedical Research Center  
(54) HYR1-DERIVED COMPOSITIONS AND METHODS OF TREATMENT USING SAME  
DATE OF CANCELLATION OF PATENT: 2021 09 14  
THE TERM OF RESTORATION OF PATENT: 2022 09 14

---

**CHANGE OF NAME AND/OR ADDRESS OF PATENTOWNER**

(21) AP 2020 15415  
(11) P 2021 7297 B  
(54) DESINFACIION ROBOT  
NEW NAME AND NEW ADDRESS: Zaali Pachkoria (GE)  
Sanapiro St. 2a, 0114, Tbilisi, Georgia (GE)  
FORMER NAME AND FORMER ADDRESS: Zaali Gogelia (GE)  
Sanapiro St. 2a, 0114, Tbilisi, Georgia (GE)  
DATE OF REGISTRATION: 03 10 2021

---

**UTILITY MODEL**

**EXPIRATION OF TERM OF RESTORATION OF PATENT**

(21) AU 2015 13936  
(11) U 2017 1923 Y  
(73) Aleksandre Tsereteli;  
Enver Mdivani  
(54) METHOD FOR DIABETIC JAM PREPARATION  
DATE OF CANCELLATION OF PATENT: 2020 09 15  
THE TERM OF RESTORATION OF PATENT VALIDITY HAS EXPIRED: 2021 09 15

---

## DESIGNS

### EXTENSION OF DESIGN REGISTRATION

- (11) D 2017 712 S
  - (73) KYB Corporation (JP)  
World Trade Center Bldg., 4-1, Hamamatsu-Cho 2-Chome, Minato-Ku, Tokyo, Japan (JP)
  - (54) Box
  - (28) 2
  - (24) 2016 09 23
  - (18) 2026 09 23
  - (58) 2021 09 27
- 

### CANCELLATION OF REGISTRATION OF DESIGN

- (11) D 2016 691 S
  - (73) Mikheil Khukhashvili (GE)  
L. Asatiani St. 32, Tbilisi, Georgia (GE);  
Rally Saghinadze (GE)  
Tskneti St. I, app. 6, 0162, Tbilisi, Georgia (GE)
  - (54) LIGHTER FASTENER ON CIGARETTE BOX
  - (18) 2021 03 02
  - (58) 2021 09 20
- 

### EXTENSION OF INTERNATIONAL DESIGNS REGISTRATION

- (11) DM/68049
  - (73) SOREMARTEC S.A  
102, Drève de l'Arc-en-Ciel, B-6700 Arlon-Schoppach (BE)
  - (15) 2006 04 14
  - (24) 2006 04 14
  - (18) 2026 04 14
  - (28) 1
  - (28') 1
  - (54) Confectionery product, particularly praline
- 

- (11) DM/68373
  - (73) VOLKSWAGEN AKTIENGESELLSCHAFT  
38436 Wolfsburg (DE)
  - (15) 2006 10 20
  - (24) 2006 10 20
  - (18) 2026 10 20
  - (28) 10
  - (28') 10
  - (54) 1., 2., 5.-8. rear lights for vehicles; 3.-4. fog lamps for vehicles; 9.-10. headlamps for vehicles
-

(11) DM/75559  
(73) CHECKPOINT SYSTEMS INTERNATIONAL GMBH  
Ersheimer Strasse 69, 69434 Hirschhorn (EM)  
(15) 2011 02 15  
(24) 2011 02 15  
(18) 2026 02 15  
(28) 1  
(28') 1  
(54) Labeller

---

(11) DM/76606  
(73) MICROSOFT MOBILE OY  
Keilalahdentie 2-4, FI-02150 Espoo (FI) (EM)  
(15) 2011 08 22  
(24) 2011 08 22  
(18) 2026 08 22  
(28) 6  
(28') 6  
(54) Handsets

---

(11) DM/76787  
(73) ROLEX SA  
Rue François-Dussaud 3-5-7, CH-1211 Genève 26 (CH)  
(15) 2011 09 09  
(24) 2011 09 09  
(18) 2026 09 09  
(28) 5  
(28') 5  
(54) Watch bracelet, Watch dial, Watch dials, Wristwatch

---

(11) DM/92481  
(73) TISSOT SA (TISSOT AG) (TISSOT LTD)  
Chemin des Tourelles 17, CH-2400 Le Locle (CH)  
(15) 2016 09 09  
(24) 2016 09 09  
(18) 2026 09 09  
(28) 4  
(28') 4  
(54) Watch cases, Watch strap

---

(11) DM/92483  
(73) TISSOT SA (TISSOT AG) (TISSOT LTD)  
Chemin des Tourelles 17, CH-2400 Le Locle (CH)  
(15) 2016 09 12  
(24) 2016 09 12  
(18) 2026 09 12  
(28) 5  
(28') 5  
(54) Dials for timepieces, Watch case with strap

---



(11) DM/92535  
(73) ZIEHM IMAGING GMBH  
Donaustraße 31, 90451 Nürnberg (DE)  
(15) 2016 08 29  
(24) 2016 08 29  
(18) 2026 08 29  
(28) 2  
(28') 2  
(54) Flat-panel detector, Mobile X-ray device comprising integral flat-panel detector

---

(11) DM/92626  
(73) HARRY WINSTON SA  
Chemin du Tourbillon 8, CH-1228 Plan-les-Ouates (CH)  
(15) 2016 09 21  
(24) 2016 09 21  
(18) 2026 09 21  
(28) 3  
(28') 3  
(54) Pendants

---

(11) DM/92744  
(73) MILLENNIUM PHARMACEUTICALS INC.  
40 Landsdowne Street, Cambridge MA 02139 (US)  
(15) 2016 09 06  
(24) 2016 09 06  
(18) 2026 09 06  
(28) 1  
(28') 1  
(54) Medicine injector

---

(11) DM/93287  
(73) MAMUR TEKNOLOJİ SİSTEMLERİ SANAYİ ANONİM ŞİRKETİ  
Selimpaşa Sanayi Bölgesi, Merkez Mahallesi, 705. Cadde, 5008 Sokak, No:11, SILIVRI-İSTANBUL (TR)  
(15) 2016 07 29  
(24) 2016 07 29  
(18) 2026 07 29  
(28) 15  
(28') 3  
(54) Cooking stoves

---

(11) DM/93380  
(73) FREDERICK JOHN EIFFERT  
3 Balmoral Drive, Grantham NG31 8SY (GB)  
(15) 2016 08 22  
(24) 2016 08 22  
(18) 2026 08 22  
(28) 2  
(28') 2  
(54) Clock faces

---

(11) DM/94456  
(73) MOLINARI RAIL AG  
Merkurstrasse 25, CH-8400 Winterthur (CH)  
(15) 2016 11 04  
(24) 2016 11 04  
(18) 2026 11 04  
(28) 1

(28') 1  
(54) Anticlimber for locomotives

---

(11) DM/96898  
(73) DERNEK GRUP ELEKTRİK ELEKTRONİK DIŞ TİCARET VE SANAYİ LİMİTED ŞİRKETİ  
İstanbul Trakya Serbest Bölgesi, Ferhatpaşa SB Mahallesi, Sümbül Sokak, No: 5/41, Çatalca - İstanbul (TR)  
(15) 2016 08 04  
(24) 2016 08 04  
(18) 2026 08 04  
(28) 8  
(28') 8  
(54) Socket, Sockets, Switch, Switches

---

## CANCELLATION OF REGISTRATION OF INTERNATIONAL DESIGNS

(11) DM/69636  
(73) SWATCH AG (SWATCH SA) (SWATCH LTD.)  
Jakob-Stämpfli-Strasse 94, CH-2502 Biel/Bienne (CH)  
DATE OF CANCELLATION OF REGISTRATION: 2013 01 25  
(58) 2021 09 24

---

(11) DM/72333  
(73) SWATCH AG (SWATCH SA) (SWATCH LTD.)  
Jakob-Stämpfli-Strasse 94, CH-2502 Biel/Bienne (CH)  
DATE OF CANCELLATION OF REGISTRATION: 2019 09 23  
(58) 2021 09 24

---

(11) DM/73445  
(73) MICROSOFT MOBILE OY  
Keilalahdentie 2-4, FI-02150 Espoo (FI) (EM)  
DATE OF CANCELLATION OF REGISTRATION: 2020 03 25  
(58) 2021 09 24

---

(11) DM/74574  
(73) ALFRED KÄRCHER GMBH & CO. KG  
Alfred-Kärcher-Straße 28-40, 71364 Winnenden (DE)  
DATE OF CANCELLATION OF REGISTRATION: 2020 10 08  
(58) 2021 09 24

---

(11) DM/81732  
(73) VALENTINO S.P.A  
Via Turati, 16/18, I-20121 MILANO (EM)  
DATE OF CANCELLATION OF REGISTRATION: 2018 06 27  
(58) 2021 09 24

---

(11) DM/82168  
(73) SWATCH AG (SWATCH SA) (SWATCH LTD.)  
Jakob-Stämpfli-Strasse 94, CH-2502 Biel/Bienne (CH)  
DATE OF CANCELLATION OF REGISTRATION: 2018 11 04  
(58) 2021 09 24

---

(11) DM/84336  
(73) SCHREDER, SOCIÉTÉ ANONYME  
Rue de Lusambo 67, B-1190 Brussels (BX)  
DATE OF CANCELLATION OF REGISTRATION: 2019 09 04  
(58) 2021 09 24

---

---

## TRADEMARKS

### RENEWAL OF REGISTRATIONS

---

(111) M 2001 13868 R2

(156) 2001 05 29

(186) 2031 05 29

(732) Evyap Sabun Yag Gliserin Sanayi ve Ticaret  
Anonim Sirketi  
Sstanbul Deri Organize Sanayi Bölgesi Güderi  
Caddesi, N:1, X-1, Özel Parsel Tuzla İstanbul,  
Turkey

---

300 Park Avenue, New York,  
New York 10022, USA

---

(111) M 2011 21777 R1

(156) 2011 09 16

(186) 2031 09 16

(732) Albaugh Europe Sàrl  
Avenue Gratta-Paille 2, CH-1018 Lausanne,  
Switzerland

---

(111) M 2001 14076 R2

(156) 2001 10 18

(186) 2031 10 18

(732) Eli Lilly and Company  
Lilly Corporate Center, Indianapolis,  
Indiana 46285, USA

---

(111) M 2011 21814 R1

(156) 2011 09 29

(186) 2031 09 29

(732) LTD "Sales Force"  
Saburtalo St. 40, app. 56, 0160, Tbilisi,  
Georgia

---

(111) M 2001 14128 R2

(156) 2001 10 31

(186) 2031 10 31

(732) Monster Worldwide Inc.  
622 Third Avenue, New York,  
New York 10017, USA

---

(111) M 2011 21742 R1

(156) 2011 09 16

(186) 2031 09 16

(732) LTD "Globalpharm"  
Tamar Mepe Av. 7/13, 0112, Tbilisi, Georgia

---

(111) M 2001 14182 R2

(156) 2001 12 13

(186) 2031 12 13

(732) Wyeth Holdings LLC  
235 East 42nd Street, New York,  
NY 10017, USA

---

(111) M 2011 21743 R1

(156) 2011 09 16

(186) 2031 09 16

(732) LTD "Globalpharm"  
Tamar Mepe Av. 7/13, 0112, Tbilisi, Georgia

---

(111) M 2001 14063 R2

(156) 2001 10 18

(186) 2031 10 18

(732) Egidio Galbani S.r.l.  
Via Flavio Gioia 8, 20149 Milano, Italy

---

(111) M 2011 21790 R1

(156) 2011 09 19

(186) 2031 09 19

(732) Promod  
Chemin du Verseau 59700 Marq En Baroeul,  
France

---

(111) M 2001 14050 R2

(156) 2001 10 01

(186) 2031 10 01

(732) Egidio Galbani S.r.l.  
Via Flavio Gioia 8, 20149 Milano, Italy

---

(111) M 2012 22236 R1

(156) 2012 02 03

(186) 2032 02 03

(732) McDonald's International Property Company,  
Ltd., a corporation organized and existing  
under laws of the State of Delaware  
110 North Carpenter Street, Chicago, Illinois  
60607 USA

---

(111) M 2001 14144 R2

(156) 2001 11 19

(186) 2031 11 19

(732) Colgate-Palmolive Company,  
Delaware corporation

---

(111) M 2011 21823 R1  
(156) 2011 09 29  
(186) 2031 09 29  
(732) Hyundai Motor Company (a Korean limited liability company incorporated under the laws Republic of Korea)  
231, Yangjae-Dong, Seocho-Gu, Seoul,  
137-938, Republic of Korea

---

(111) M 2011 21824 R1  
(156) 2011 09 29  
(186) 2031 09 29  
(732) Hyundai Motor Company (a Korean limited liability company incorporated under the laws Republic of Korea)  
231, Yangjae-Dong, Seocho-Gu, Seoul,  
137-938, Republic of Korea

---

(111) M 2012 22240 R1  
(156) 2012 02 03  
(186) 2032 02 03  
(732) LTD "Geosteel"  
Davit Gareji 36, 3700, Rustavi, Georgia

---

(111) M 2011 22019 R1  
(156) 2011 11 30  
(186) 2031 11 30  
(732) Obshchestvo s ogranichennoi otvetstvennostiu "Almaz-m"  
1 Obydenskiy pereulok, 10 119034, Moscow,  
Russian Federation

---

(111) M 2012 22919 R1  
(156) 2012 08 30  
(186) 2032 08 30  
(732) McDonald's International Property Company, Ltd., a corporation organized and existing under the laws of the State of Delaware  
110 North Carpenter Street, Chicago, Illinois  
60607, USA

---

## COMPLETE TRANSFER OF RIGHTS

(111) M 2020 32270 R  
(732) Shenzhen Queeni Technology Co., Ltd.  
2nd Floor, Building A16, Silicon Valley  
Power, No. 416, Xuegang North Road, Qinghu  
Community, Longhua Street, Longhua District,  
Shenzhen, 518110, China  
(770) Toa Industry. CO., LTD.  
2-5-12 sotokanda chiyodaku Tokyo, Japan  
(580) 2021 09 01

---

(111) M 2021 34127 R  
(732) JSC "GEPHA"  
Akaki Beliashvili str. 142, 0159, Tbilisi,  
Georgia  
(770) JSC "Gefa"  
Akaki Beliashvili Str. 142, 0159, Tbilisi  
Georgia;  
LLC "Uein Enterprazis"  
Gldani, II mcr., corp. 28, app. 97, Tbilisi,  
Georgia  
(580) 2021 09 08

---

(111) M 1997 6731 R  
(732) Incanto Industries d.o.o.  
Maršala Tita 45, Čelarevo, 21413 Bačka  
Palanka, Serbia  
(770) Brooksburnett Investments LTD  
Sofias Tsirou 9, Toulla Court 3, 2nd  
Flat/Office 22, 3021, Limassol , Cyprus  
(580) 2021 09 17

---

(111) M 1998 10119 R  
(732) Briggs & Stratton LLC  
12301 West Wirth Street, Wauwatosa,  
WI 53222, USA  
(770) Briggs & Stratton Corporation  
12301 West Wirth Street, Wauwatosa,  
WI 53222, USA  
(580) 2021 09 06

---

(111) M 1998 10120 R  
(732) Briggs & Stratton LLC  
12301 West Wirth Street, Wauwatosa,  
WI 53222, USA  
(770) Briggs & Stratton Corporation  
12301 West Wirth Street, Wauwatosa,  
WI 53222, USA  
(580) 2021 09 06

---

(111) M 1999 12750 R  
(732) PF Consumer Healthcare 1 LLC, Corporation  
Service Company, a Delaware limited liability  
Company  
251 Little Falls Drive, Wilmington, Delaware  
19808, USA  
(770) Wyeth LLC  
235 East 42 nd Street, New York,  
NY 10017, USA  
(580) 2021 08 27

---

(111) M 1999 12427 R  
(732) PF Consumer Healthcare 1 LLC, Corporation  
Service Company, a Delaware limited liability  
Company  
251 Little Falls Drive, Wilmington, Delaware  
19808, USA  
(770) Wyeth LLC  
235 East 42 nd Street, New York,  
NY 10017, USA  
(580) 2021 08 27

---

(111) M 1999 12428 R  
(732) PF Consumer Healthcare 1 LLC, Corporation  
Service Company, a Delaware limited liability  
Company  
251 Little Falls Drive, Wilmington, Delaware  
19808, USA  
(770) Wyeth LLC  
235 East 42 nd Street, New York,  
NY 10017, USA  
(580) 2021 08 27

---

(111) M 1999 12515 R  
(732) PF Consumer Healthcare 1 LLC, Corporation  
Service Company, a Delaware limited liability  
Company  
251 Little Falls Drive, Wilmington, Delaware  
19808, USA  
(770) Wyeth LLC  
235 East 42 nd Street, New York,  
NY 10017, USA  
(580) 2021 08 27

---

(111) M 1999 12741 R  
(732) PF Consumer Healthcare 1 LLC, Corporation  
Service Company, a Delaware limited liability  
Company  
251 Little Falls Drive, Wilmington, Delaware  
19808, USA

(770) Wyeth LLC  
235 East 42 nd Street, New York,  
NY 10017, USA  
(580) 2021 08 27

---

(111) M 1999 12740 R  
(732) PF Consumer Healthcare 1 LLC, Corporation  
Service Company, a Delaware limited liability  
Company  
251 Little Falls Drive, Wilmington, Delaware  
19808, USA

(770) Wyeth LLC  
235 East 42 nd Street, New York,  
NY 10017, USA  
(580) 2021 08 27

---

(111) M 1996 3921 R  
(732) Pernod Ricard India Private Limited  
5th Floor, D-3, District Centre, Saket,  
New Delhi 110017, India

(770) Austin Nichols & CO., Incorporated  
250 Park Ave., 17th Floor, New York,  
NY 10177, USA  
(580) 2021 09 28

---

(111) M 2009 19153 R  
(732) Adelink Limited  
66 Kyriakou Matsi, 2409 Egkomi, Nicosia,  
Cyprus  
(770) Soira Investments Limited  
Kyriakou Matsi, 16, Eagle House, 6th floor,  
1082, Nicosia, Cyprus  
(580) 2021 09 16

---

(111) M 2009 19154 R  
(732) Adelink Limited  
66 Kyriakou Matsi, 2409 Egkomi, Nicosia,  
Cyprus  
(770) Soira Investments Limited  
Kyriakou Matsi, 16, Eagle House, 6th floor,  
1082, Nicosia, Cyprus  
(580) 2021 09 16

---

(111) M 2009 19155 R  
(732) Adelink Limited  
66 Kyriakou Matsi, 2409 Egkomi, Nicosia,  
Cyprus  
(770) Soira Investments Limited  
Kyriakou Matsi, 16, Eagle House, 6th floor,  
1082, Nicosia, Cyprus  
(580) 2021 09 16

---

(111) M 2009 19769 R  
(732) PF Consumer Healthcare 1 LLC, Corporation  
Service Company, a Delaware limited liability  
Company  
251 Little Falls Drive, Wilmington, Delaware  
19808, USA

(770) Wyeth LLC  
235 East 42 nd Street, New York,  
NY 10017, USA  
(580) 2021 08 27

---

(111) M 2009 19729 R  
(732) Adelink Limited  
66 Kyriakou Matsi, 2409 Egkomi, Nicosia,  
Cyprus  
(770) Soira Investments Limited  
Kyriakou Matsi, 16, Eagle House, 6th floor,  
1082, Nicosia, Cyprus  
(580) 2021 09 16

---

(111) M 2009 20114 R  
(732) Adelink Limited  
66 Kyriakou Matsi, 2409 Egkomi, Nicosia,  
Cyprus  
(770) Soira Investments Limited  
Kyriakou Matsi, 16, Eagle House, 6th floor,  
1082, Nicosia, Cyprus  
(580) 2021 09 16

---

(111) M 2014 25497 R  
(732) LTD "იდეგო გრუპი Idego Group"  
B. Khmelnitskiy St. 44a, corp. 4, app. 8,  
Isani-Samgori District, Tbilisi, Georgia  
(770) Iadon Kapanadze  
Gedevanishvili St. 10, 3300, Mtskheta,  
Georgia  
(580) 2021 09 16

---

(111) M 2017 29160 R  
(732) Adelink Limited  
66 Kyriakou Matsi, 2409 Egkomi, Nicosia,  
Cyprus  
(770) Soira Investments Limited  
Kyriakou Matsi, 16, eagle House, 6th floor,  
1082, Nicosia, Cyprus  
(580) 2021 09 16

---

## CHANGES OF NAMES AND/OR ADDRESS OF OWNERS

(111) M 2020 32438 R  
(732) Hiab AB  
c/o Cargotec Sweden AB , Box 1133, 164 22  
Kista, Sweden  
(770) Hiab AB  
Norra Vallgatan 64, SE-21122 Malmö,  
Sweden  
(580) 2021 09 01

---

(111) M 2019 30919 R  
(732) Japan Tobacco Inc.  
1-1, Toranomoni, 4-chome Minato-ku, Tokio,  
Japan  
(770) Japan Tobacco Inc.  
2-2-1, Toranomom, Minato-Ku, Tokyo, Japan  
(580) 2021 09 17

---

(111) M 2019 30975 R  
(732) Japan Tobacco Inc.  
1-1, Toranomom 4-chome, Minato-ku, Tokyo,  
Japan  
(770) Japan Tobacco Inc.  
2-2-1, Toranomom, Minato-Ku, Tokyo, Japan  
(580) 2021 09 17

---

(111) M 2019 31091 R  
(732) Japan Tobacco Inc.  
1-1, Toranomom 4-chome, Minato-ku, Tokyo,  
Japan  
(770) Japan Tobacco Inc.  
2-2-1, Toranomom, Minato-Ku, Tokyo, Japan  
(580) 2021 09 17

---

(111) M 2019 31092 R  
(732) Japan Tobacco Inc.  
1-1, Toranomom 4-chome, Minato-ku, Tokyo,  
Japan  
(770) Japan Tobacco Inc.  
2-2-1, Toranomom, Minato-Ku, Tokyo, Japan  
(580) 2021 09 17

---

(111) M 2019 31241 R  
(732) Japan Tobacco Inc.  
1-1, Toranomom 4-chome, Minato-ku, Tokyo,  
Japan  
(770) Japan Tobacco Inc.  
2-2-1, Toranomom, Minato-Ku, Tokyo, Japan  
(580) 2021 09 17

---

(111) M 2019 31856 R  
(732) Japan Tobacco Inc.  
1-1, Toranomom 4-chome, Minato-ku, Tokyo,  
Japan  
(770) Japan Tobacco Inc.  
2-2-1, Toranomom, Minato-Ku, Tokyo, Japan  
(580) 2021 09 17

---

(111) M 2020 32272 R  
(732) Japan Tobacco Inc.  
1-1, Toranomom 4-chome, Minato-ku, Tokyo,  
Japan  
(770) Japan Tobacco Inc.  
2-2-1, Toranomom, Minato-Ku, Tokyo, Japan  
(580) 2021 09 17

---

(111) M 2020 33502 R  
(732) Japan Tobacco Inc.  
1-1, Toranomom 4-chome, Minato-ku, Tokyo,  
Japan  
(770) Japan Tobacco Inc.  
2-2-1, Toranomom, Minato-Ku, Tokyo, Japan  
(580) 2021 09 17

---

(111) M 2020 32363 R  
(732) Japan Tobacco Inc.  
1-1, Toranomom 4-chome, Minato-ku, Tokyo,  
Japan  
(770) Japan Tobacco Inc.  
2-2-1, Toranomom, Minato-Ku, Tokyo, Japan  
(580) 2021 09 17

---

(111) M 2020 32364 R  
(732) Japan Tobacco Inc.  
1-1, Toranomom 4-chome, Minato-ku, Tokyo,  
Japan  
(770) Japan Tobacco Inc.  
2-2-1, Toranomom, Minato-Ku, Tokyo, Japan  
(580) 2021 09 17

---

(111) M 2020 32469 R  
(732) Japan Tobacco Inc.  
1-1, Toranomom 4-chome, Minato-ku, Tokyo,  
Japan  
(770) Japan Tobacco Inc.  
2-2-1, Toranomom, Minato-Ku, Tokyo, Japan  
(580) 2021 09 17

---



(111) M 2020 32506 R  
(732) Japan Tobacco Inc.  
1-1, Toranomoni, 4-chome Minato-ku, Tokio,  
Japan  
(770) Japan Tobacco Inc.  
2-2-1, Toranomom, Minato-Ku, Tokyo, Japan  
(580) 2021 09 17

---

(111) M 2020 32508 R  
(732) Japan Tobacco Inc.  
1-1, Toranomom 4-chome, Minato-ku, Tokyo,  
Japan  
(770) Japan Tobacco Inc.  
2-2-1, Toranomom, Minato-Ku, Tokyo, Japan  
(580) 2021 09 17

---

(111) M 2020 33092 R  
(732) Japan Tobacco Inc.  
1-1, Toranomom 4-chome, Minato-ku, Tokyo,  
Japan  
(770) Japan Tobacco Inc.  
2-2-1, Toranomom, Minato-Ku, Tokyo, Japan  
(580) 2021 09 20

---

(111) M 2001 13868 R  
(732) Evyap Sabun Yag Gliserin Sanayi ve Ticaret  
Anonim Sirketi  
stanbul Deri Organize Sanayi Bölgesi Güderi  
Caddesi, N:1, X-1, Özel Parsel Tuzla İstanbul,  
Turkey  
(770) Evyap Sabun Yag Gliserin Sanayi ve Ticaret  
Anonim Sirketi  
Ayazaga Cendere Yolu No.10/A 80670 Levent  
İstanbul, Turkey  
(580) 2021 09 20

---

(111) M 1996 3921 R  
(732) Austin Nichols & CO., Incorporated  
250 Park Ave., 17th Floor, New York,  
NY 10177, USA  
(770) Austin Nichols & CO., Incorporated  
401 Park Avenue, New York, NY 10016,  
USA  
(580) 2021 09 28

---

(111) M 1995 1122 R  
(732) Japan Tobacco Inc.  
1-1, Toranomom 4-chome, Minato-ku, Tokyo,  
Japan  
(770) Japan Tobacco Inc.  
2-2-1 Toranomom Minato-ku, Tokyo, Japan  
(580) 2021 09 17

---

(111) M 2005 16369 R  
(732) Shalva Gvaramadze  
Zaza Panaskertel-Tsitsishvili St., corp. 1,  
app. 10, 0160, Tbilisi, Georgia  
(770) Shalva Gvaramadze  
Bakhtrioni St., corp. 1, app. 10, 0160, Tbilisi,  
Georgia  
(580) 2021 09 09

---

(111) M 1995 1119 R  
(732) Japan Tobacco Inc.  
1-1, Toranomom 4-chome, Minato-ku, Tokyo,  
Japan  
(770) Japan Tobacco Inc.  
2-2-1 Toranomom Minato-ku, Tokyo, Japan  
(580) 2021 09 17

---

(111) M 1995 1123 R  
(732) Japan Tobacco Inc.  
1-1, Toranomom 4-chome, Minato-ku, Tokyo,  
Japan  
(770) Japan Tobacco Inc.  
2-2-1 Toranomom Minato-ku, Tokyo, Japan  
(580) 2021 09 17

---

(111) M 2008 18196 R  
(111) M 2005 16369 R  
(732) Shalva Gvaramadze  
Zaza Panaskertel-Tsitsishvili St., corp. 1,  
app. 10, 0160, Tbilisi, Georgia  
(770) Shalva Gvaramadze  
Bakhtrioni St., corp. 1, app. 10, 0160, Tbilisi,  
Georgia  
(580) 2021 09 09

---

(111) M 2009 19606 R  
(732) Japan Tobacco Inc.  
1-1, Toranomom 4-chome, Minato-ku, Tokyo,  
Japan  
(770) Japan Tobacco Inc.  
2-2-1, Toranomom, Minato-ku, Tokyo, Japan  
(580) 2021 09 17

---

(111) M 2010 20208 R  
(732) Japan Tobacco Inc.  
1-1, Toranomom 4-chome, Minato-ku, Tokyo,  
Japan  
(770) Japan Tobacco Inc.  
2-2-1, Toranomom, Minato-ku, Tokyo, Japan  
(580) 2021 09 17

---

(111) M 2010 20464 R  
(732) Japan Tobacco Inc.  
1-1, Toranomom 4-chome, Minato-ku, Tokyo,  
Japan  
(770) Japan Tobacco Inc.  
2-2-1, Toranomom, Minato-ku, Tokyo, Japan  
(580) 2021 09 17

---

(111) M 2010 21001 R  
(732) Japan Tobacco Inc.  
1-1, Toranomom 4-chome, Minato-ku, Tokyo,  
Japan  
(770) Japan Tobacco Inc.  
2-2-1, Toranomom, Minato-ku, Tokyo, Japan  
(580) 2021 09 17

---

(111) M 2011 21328 R  
(732) Japan Tobacco Inc.  
1-1, Toranomom 4-chome, Minato-ku, Tokyo,  
Japan  
(770) Japan Tobacco Inc.  
2-2-1, Toranomom, Minato-ku, Tokyo, Japan  
(580) 2021 09 17

---

(111) M 2010 20737 R  
(732) Japan Tobacco Inc.  
1-1, Toranomom 4-chome, Minato-ku, Tokyo,  
Japan  
(770) Japan Tobacco Inc.  
2-2-1, Toranomom, Minato-ku, Tokyo, Japan  
(580) 2021 09 17

---

(111) M 2011 22019 R  
(732) Obshchestvo s ogranichennoi otvetstvennostiu  
"Almaz-m"  
1 Obydenskiy pereulok, 10 119034, Moscow,  
Russian Federation  
(770) Obshchestvo s ogranichennoi otvetstvennostiu  
"Almaz-m"  
ul. Vokzalnaia, d. 53 143000, g. Odintsovo  
Moskovskaia obl., Russian Federation  
(580) 2021 09 17

---

(111) M 2010 21011 R  
(732) Japan Tobacco Inc.  
1-1, Toranomom 4-chome, Minato-ku, Tokyo,  
Japan  
(770) Japan Tobacco Inc.  
2-2-1, Toranomom, Minato-ku, Tokyo, Japan  
(580) 2021 09 17

---

(111) M 2011 21428 R  
(732) Japan Tobacco Inc.  
1-1, Toranomom 4-chome, Minato-ku, Tokyo,  
Japan  
(770) Japan Tobacco Inc.  
2-2-1, Toranomom, Minato-ku, Tokyo, Japan  
(580) 2021 09 17

---

(111) M 2012 22389 R  
(732) Japan Tobacco Inc.  
1-1, Toranomom 4-chome, Minato-ku, Tokyo,  
Japan  
(770) Japan Tobacco Inc.  
2-2-1, Toranomom, Minato-ku, Tokyo, Japan  
(580) 2021 09 17

---

(111) M 2012 22574 R  
(732) Japan Tobacco Inc.  
1-1, Toranomom 4-chome, Minato-ku, Tokyo,  
Japan  
(770) Japan Tobacco Inc.  
2-2-1, Toranomom, Minato-ku, Tokyo, Japan  
(580) 2021 09 17

---

(111) M 2013 24325 R  
(732) Japan Tobacco Inc.  
1-1, Toranomom 4-chome, Minato-ku, Tokyo,  
Japan  
(770) Japan Tobacco Inc.  
2-2-1, Toranomoni, Minato-ku, Tokio, Japan  
(580) 2021 09 17

---

(111) M 2014 24449 R  
(732) Japan Tobacco Inc.  
1-1, Toranomom 4-chome, Minato-ku, Tokyo,  
Japan  
(770) Japan Tobacco Inc.  
2-2-1, Toranomom Minato-ku, Tokyo, Japan  
(580) 2021 09 17

---

(111) M 2014 24483 R  
(732) Japan Tobacco Inc.  
1-1, Toranomom 4-chome, Minato-ku, Tokyo,  
Japan  
(770) Japan Tobacco Inc.  
2-2-1, Toranomom, Minato-ku, Tokyo, Japan  
(580) 2021 09 17

---

(111) M 2014 25401 R  
(732) Japan Tobacco Inc.  
1-1, Toranomom 4-chome, Minato-ku, Tokyo,  
Japan  
(770) Japan Tobacco Inc.  
2-2-1, Toranomom Minato-ku, Tokyo, Japan  
(580) 2021 09 17

---

(111) M 2014 24871 R  
(732) Japan Tobacco Inc.  
1-1, Toranomom 4-chome, Minato-ku, Tokyo,  
Japan  
(770) Japan Tobacco Inc.  
2-2-1, Toranomom Minato-ku, Tokyo, Japan  
(580) 2021 09 17

---

(111) M 2014 24938 R  
(732) Japan Tobacco Inc.  
1-1, Toranomom 4-chome, Minato-ku, Tokyo,  
Japan  
(770) Japan Tobacco Inc.  
2-2-1, Toranomom Minato-ku, Tokyo, Japan  
(580) 2021 09 17

---

(111) M 2014 25121 R  
(732) Japan Tobacco Inc.  
1-1, Toranomom 4-chome, Minato-ku, Tokyo,  
Japan  
(770) Japan Tobacco Inc.  
2-2-1, Toranomom, Minato-ku, Tokyo, Japan  
(580) 2021 09 17

---

(111) M 2015 25890 R  
(732) Japan Tobacco Inc.  
1-1, Toranomom 4-chome, Minato-ku, Tokyo,  
Japan  
(770) Japan Tobacco Inc.  
2-2-1 Toranomom Minato-ku, Tokyo, Japan  
(580) 2021 09 17

---

(111) M 2015 25891 R  
(732) Japan Tobacco Inc.  
1-1, Toranomom 4-chome, Minato-ku, Tokyo,  
Japan  
(770) Japan Tobacco Inc.  
2-2-1 Toranomom Minato-ku, Tokyo, Japan  
(580) 2021 09 17

---

(111) M 2016 27358 R  
(732) LTD "Shalvino"  
Zaza Panaskertel-Tsitsishvili St., corp. 1,  
app. 10, 0160, Tbilisi, Georgia

(770) LTD "Shalvino"  
Bakhrioni St., corp. 1, app. 10, 0160, Tbilisi,  
Georgia  
(580) 2021 09 09

---

(111) M 2016 27359 R  
(732) LTD "Shalvino"  
Zaza Panaskertel-Tsitsishvili St., corp. 1,  
app. 10, 0160, Tbilisi, Georgia  
(770) LTD "Shalvino"  
Bakhrioni St., corp. 1, app. 10, 0160, Tbilisi,  
Georgia  
(580) 2021 09 09

---

(111) M 2015 26025 R  
(732) Japan Tobacco Inc.  
1-1, Toranomom 4-chome, Minato-ku, Tokyo,  
Japan  
(770) Japan Tobacco Inc.  
2-2-1 Toranomom Minato-ku, Tokyo, Japan  
(580) 2021 09 17

---

(111) M 2015 26276 R  
(732) Japan Tobacco Inc.  
1-1, Toranomom 4-chome, Minato-ku, Tokyo,  
Japan  
(770) Japan Tobacco Inc.  
2-2-1 Toranomom, Minato-ku, Tokyo, Japan  
(580) 2021 09 17

---

(111) M 2015 26248 R  
(732) Japan Tobacco Inc.  
1-1, Toranomom 4-chome, Minato-ku, Tokyo,  
Japan  
(770) Japan Tobacco Inc.  
2-2-1 Toranomom, Minato-ku, Tokyo, Japan  
(580) 2021 09 17

---

(111) M 2016 27024 R  
(732) Japan Tobacco Inc.  
1-1, Toranomom 4-chome, Minato-ku, Tokyo,  
Japan  
(770) Japan Tobacco Inc.  
2-2-1 Toranomom Minato-ku, Tokyo, Japan  
(580) 2021 09 17

---

(111) M 2016 27025 R  
(732) japan tobacco Inc.  
1-1, Toranomom 4-chome, Minato-ku, Tokyo,  
Japan

(770) japan tobacco Inc.  
 2-2-1 Toranomom Minato-ku, Tokyo, Japan  
 (580) 2021 09 17

---

(111) M 2016 27886 R  
 (732) Japan Tobacco Inc.  
 1-1, Toranomoni, 4-chome Minato-ku, Tokio,  
 Japan  
 (770) Japan Tobacco Inc.  
 2-2-1, Toranomom, Minato-Ku, Tokyo, Japan  
 (580) 2021 09 17

---

(111) M 2016 27885 R  
 (732) Japan Tobacco Inc.  
 1-1, Toranomom 4-chome, Minato-ku, Tokyo,  
 Japan  
 (770) Japan Tobacco Inc.  
 2-2-1, Toranomom, Minato-Ku, Tokyo, Japan  
 (580) 2021 09 17

---

(111) M 2017 28040 R  
 (732) Japan Tobacco Inc.  
 1-1, Toranomoni, 4-chome Minato-ku, Tokio,  
 Japan  
 (770) Japan Tobacco Inc.  
 2-2-1, Toranomom, Minato-Ku, Tokyo, Japan  
 (580) 2021 09 17

---

(111) M 2017 28082 R  
 (732) Japan Tobacco Inc.  
 1-1, Toranomom 4-chome, Minato-ku, Tokyo,  
 Japan  
 (770) Japan Tobacco Inc.  
 2-2-1, Toranomom, Minato-Ku, Tokyo, Japan  
 (580) 2021 09 17

---

(111) M 2017 28314 R  
 (732) Japan Tobacco Inc.  
 1-1, Toranomoni, 4-chome Minato-ku, Tokio,  
 Japan  
 (770) Japan Tobacco Inc.  
 2-2-1, Toranomom, Minato-Ku, Tokyo, Japan  
 (580) 2021 09 17

---

(111) M 2017 28316 R  
 (732) Japan Tobacco Inc.  
 1-1, Toranomom 4-chome, Minato-ku, Tokyo,  
 Japan

(770) Japan Tobacco Inc.  
 2-2-1, Toranomom, Minato-Ku, Tokyo, Japan  
 (580) 2021 09 17

---

(111) M 2017 28493 R  
 (732) Japan Tobacco Inc.  
 1-1, Toranomom 4-chome, Minato-ku, Tokyo,  
 Japan  
 (770) Japan Tobacco Inc.  
 2-2-1, Toranomom, Minato-Ku, Tokyo, Japan  
 (580) 2021 09 17

---

(111) M 2017 28876 R  
 (732) Japan Tobacco Inc.  
 1-1, Toranomoni, 4-chome Minato-ku, Tokio,  
 Japan  
 (770) Japan Tobacco Inc.  
 2-2-1, Toranomom, Minato-Ku, Tokyo, Japan  
 (580) 2021 09 17

---

(111) M 2017 28877 R  
 (732) Japan Tobacco Inc.  
 1-1, Toranomom 4-chome, Minato-ku, Tokyo,  
 Japan  
 (770) Japan Tobacco Inc.  
 2-2-1, Toranomom, Minato-Ku, Tokyo, Japan  
 (580) 2021 09 17

---

(111) M 2017 28908 R  
 (732) Japan Tobacco Inc.  
 1-1, Toranomoni, 4-chome Minato-ku, Tokio,  
 Japan  
 (770) Japan Tobacco Inc.  
 2-2-1, Toranomom, Minato-Ku, Tokyo, Japan  
 (580) 2021 09 17

---

(111) M 2017 29136 R  
 (732) Japan Tobacco Inc.  
 1-1, Toranomom 4-chome, Minato-ku, Tokyo,  
 Japan  
 (770) Japan Tobacco Inc.  
 2-2-1, Toranomom, Minato-Ku, Tokyo, Japan  
 (580) 2021 09 17

---

(111) M 2018 30195 R  
 (732) Japan Tobacco Inc.  
 1-1, Toranomom 4-chome, Minato-ku, Tokyo,  
 Japan  
 (770) Japan Tobacco Inc.  
 2-2-1, Toranomoni, Minato-ku, Tokio, Japan  
 (580) 2021 09 17

---

(111) M 2018 30265 R  
 (732) Japan Tobacco Inc.  
 1-1, Toranomom 4-chome, Minato-ku, Tokyo,  
 Japan

(770) Japan Tobacco Inc.  
1-1, Toranomom 4-chome, Minato-ku, Tokyo,  
Japan  
(580) 2021 09 17

---

## CANCELLATION OF TRADEMARKS REGISTRATION

(111) M 1998 10931 R  
(151) 1998 09 23  
(732) ZHS IP Worldwide Sàrl  
Avenue Reverdil 14, 1260 Nyon, Switzerland  
(141) 2021 09 29 – Canceled by court decision  
(511) 33

---

(111) M 1998 10932 R  
(151) 1998 09 23  
(732) ZHS IP Worldwide Sàrl  
Avenue Reverdil 14, 1260 Nyon, Switzerland  
(141) 2021 09 29 – Canceled by court decision  
(511) 33

---

(111) M 2001 13831 R  
(151) 2001 03 21  
(111) M 2001 13831 R  
(151) 2001 03 21  
(732) LTD "N1 Liquor and Vodka Factory"  
Abuseridze-Tbeli St. 13, 0120, Tbilisi, Georgia  
(141) 2021 09 29

---

(111) M 2001 13828 R  
(151) 2001 03 21  
(732) Pogossiyan Semen Amayakovich  
Tavredyan 46, Erevan, Armenia  
(141) 2021 09 29

---

(111) M 2001 13829 R  
(151) 2001 03 21  
(732) Saray Biskuvi ve Gida Sanayi A.S.  
Organize Sanayi Bolgesi, Karaman, Turkey  
(141) 2021 09 29

---

(111) M 2001 13832 R  
(151) 2001 03 21  
(732) Takeda Pharmaceutical Company Limited  
1-1, Doshomachi 4-chome, Chuo-ku, Osaka,  
Japan  
(141) 2021 09 29

---

(111) M 2011 21302 R  
(151) 2011 03 24  
(732) Obshestvo s ogranichennoi otvetstvennostj  
"Coordinating Distribution Center "Efko-  
Kaskad"  
ul. Frunze, dom 4, Alekseevka, 309850,  
Belgorodskaya oblast, Russian Federation  
(141) 2021 10 04

---

(111) M 2011 21268 R  
(151) 2011 03 15  
(732) NED  
41 Avenue Gaston Roussel 93230  
Romainville, France  
(141) 2021 09 24

---

(111) M 2011 21283 R  
(151) 2011 03 15  
(732) LTD "Live"  
Barnov St. 126/a, 0179, Tbilisi, Georgia  
(141) 2021 09 23

---

(111) M 2011 21284 R  
(151) 2011 03 15  
(732) LTD "Live"  
Barnov St. 126/a, 0179, Tbilisi, Georgia  
(141) 2021 09 24

---

(111) M 2011 21238 R  
(151) 2011 03 14  
(732) PEIST Gastro Verwaltung GmbH  
Innere viener Strasse 19, 81667 munich,  
Germany  
(141) 2021 09 24

---

(111) M 2011 21239 R  
(151) 2011 03 14  
(732) Krewel Meuselbach GmbH  
Krewelstrasse 2, DE-53783 Eitorf, Germany  
(141) 2021 09 24

---

(111) M 2011 21240 R  
(151) 2011 03 14  
(732) Krewel Meuselbach GmbH  
Krewelstrasse 2, DE-53783 Eitorf, Germany  
(141) 2021 09 24

---

(111) M 2011 21241 R  
(151) 2011 03 14  
(732) Harrington Development Inc.  
Arango-Orillac Bldg. East 54 th street,  
Panama, Republic of Panama  
(141) 2021 09 24

---

(111) M 2011 21242 R  
(151) 2011 03 14  
(732) Harrington Development Inc.  
Arango-Orillac Bldg. East 54 th street,  
Panama, Republic of Panama  
(141) 2021 09 24

---

(111) M 2011 21243 R  
(151) 2011 03 14  
(732) LTD "Tentebi"  
Ir. Abashidze St. 41, 0179, Tbilisi, Georgia  
(141) 2021 09 24

---

(111) M 2011 21244 R  
(151) 2011 03 14  
(732) Zurabi Krizhanovski  
G. Tsabadze St. 4, app. 33, 0112, Tbilisi,  
Georgia  
(141) 2021 09 24

---

(111) M 2011 21245 R  
(151) 2011 03 14  
(732) British American Tobacco (Brands) Inc.  
(A Delaware corporation)  
251 Little Falls Drive, Suite 100, Wilmington,  
DE 19808-1674, USA  
(141) 2021 09 24

---

(111) M 2011 21246 R  
(151) 2011 03 14  
(732) LTD "ABC Pharmacy"  
Sanapiro St. 10a, 0108, Tbilisi, Georgia  
(141) 2021 09 24

---

(111) M 2011 21247 R  
(151) 2011 03 14  
(732) LTD "ABC Pharmacy"  
Sanapiro St. 10a, 0108, Tbilisi, Georgia

(141) 2021 09 24

---

(111) M 2011 21269 R  
(151) 2011 03 15  
(732) JSC "G-P-C"  
Marjanishvili St. 26, 0164, Tbilisi, Georgia  
(141) 2021 09 24

---

(111) M 2011 21270 R  
(151) 2011 03 15  
(732) JSC "G-P-C"  
Marjanishvili St. 26, 0164, Tbilisi, Georgia  
(141) 2021 09 24

---

(111) M 2011 21271 R  
(151) 2011 03 15  
(732) JSC "G-P-C"  
Marjanishvili St. 26, 0164, Tbilisi, Georgia  
(141) 2021 09 23

---

(111) M 2011 21273 R  
(151) 2011 03 15  
(732) JSC "G-P-C"  
Marjanishvili St. 26, 0164, Tbilisi, Georgia  
(141) 2021 09 24

---

(111) M 2011 21274 R  
(151) 2011 03 15  
(732) JSC ""G-P-C"  
Marjanishvili St. 26, 0164, Tbilisi, Georgia  
(141) 2021 09 23

---

(111) M 2011 21275 R  
(151) 2011 03 15  
(732) JSC "G-P-C"  
Marjanishvili St. 26, 0164, Tbilisi, Georgia  
(141) 2021 09 23

---

(111) M 2011 21276 R  
(151) 2011 03 15  
(732) JSC "G-P-C"  
Marjanishvili St. 26, 0164, Tbilisi, Georgia  
(141) 2021 09 24

---

(111) M 2011 21248 R  
(151) 2011 03 14  
(732) Harrington Development Inc.  
Arango-Orillac Bldg. East 54 th street,  
Republic of Panama  
(141) 2021 09 24

---

(111) M 2011 21252 R  
(151) 2011 03 14  
(732) Kraft Foods Danmark Intellectual Property  
ApS  
Ringager 2 A, 2, DK-2605 Brøndby, Denmark  
(141) 2021 09 24

---

(111) M 2011 21253 R  
(151) 2011 03 14  
(732) Harrington Development Inc.  
Arango-Orillac Bldg. East 54 th street,  
Republic of Panama  
(141) 2021 09 24

---

(111) M 2011 21254 R  
(151) 2011 03 14  
(732) Maia Kotrikadze  
Z. Gorgiladze St. 73, app.12, 6010, Batumi,  
Georgia  
(141) 2021 09 24

---

(111) M 2011 21307 R  
(151) 2011 03 24  
(732) Emzar Baladze  
Vaja-Fshavela St. 7, app.14, 6000, Batumi,  
Georgia  
(141) 2021 10 04

---

(111) M 2011 21310 R  
(151) 2011 03 24  
(732) Genzyme Corporation  
(a Massachusetts Corporation)  
500 Kendall Street, Cambridge, Massachusetts  
02142, USA  
(141) 2021 10 04

---

(111) M 2011 21311 R  
(151) 2011 03 24  
(732) McDonald's International Property Company,  
Ltd., a corporation organized and existing  
under the laws of the State of Delaware  
110 North Carpenter Street, Chicago, Illinois  
60607, USA  
(141) 2021 10 04

---

(111) M 2011 21315 R  
(151) 2011 03 24  
(732) British American Tobacco (Brands) Inc.  
(A Delaware corporation)  
251 Little Falls Drive, Suite 100, Wilmington,  
DE 19808-1674, USA  
(141) 2021 10 04

---

(111) M 2011 21316 R  
(151) 2011 03 24  
(732) Bristol-Myers Squibb Company  
a Delaware Corporation  
345 Park Avenue, New York, New York  
10154, USA  
(141) 2021 10 04

---

(111) M 2011 21260 R  
(151) 2011 03 14  
(732) LTD "Coffee House-Kenninghol"  
Kazbegi Av. 2, 0160, Tbilisi, Georgia  
(141) 2021 09 24

---

(111) M 2011 21279 R  
(151) 2011 03 15  
(732) Unilever N.V.  
Weena 455, 3013 AL Rotterdam, Netherlands  
(141) 2021 09 24

---

(111) M 2011 21318 R  
(151) 2011 03 24  
(732) Associazione Radio Maria  
Via Turati 7, 22036 Erba CO, Italy  
(141) 2021 10 04

---

(111) M 2011 21266 R  
(151) 2011 03 14  
(732) LTD "Zumer Georgia"  
Tsabadze Str. 8, 0112, Tbilisi, Georgia  
(141) 2021 09 24

---

(111) M 2011 21319 R  
(151) 2011 03 24  
(732) Dow AgroSciencesG LLC  
A Delaware Limited Liability Company  
9330 Zionsville Road, Indianapolis,  
Indiana 46268, USA  
(141) 2021 10 04

---

(111) M 2011 21297 R  
(151) 2011 03 15  
(732) JSC "Uniform"  
Vill. Teklati, 4112, Senaki district, Georgia  
(141) 2021 09 23

---

(111) M 2011 21323 R  
(151) 2011 03 24  
(732) LTD "Nergeta"  
I<sup>th</sup> Gujareti St. 88a, 0144, Tbilisi, Georgia  
(141) 2021 10 04

---

(111) M 2011 21327 R

(151) 2011 03 24

(732) Philip Morris Brands SARL

Quai Jeanrenaud 3, 2000 Neuchâtel,

Switzerland

(141) 2021 10 04

---

(111) M 2011 21300 R

(151) 2011 03 17

(732) Harrington Development Inc.

Elvira Mendez Street, Vallarino bldg.,

3rd Floor, Panama, Republic of Panama

(141) 2021 09 28

---



# CLASSIFICATION INDEXES

## INVENTIONS

### CONCORDANCE TABLE OF INTERNATIONAL CLASSIFICATION INDEX AND PUBLICATION NUMBERS

INTERNATIONAL CLASSIFICATION INDEXES (51)	NUMBER OF PUBLISHED APPLICATION (10)
A 01 G 25/02; C 02 F 1/14	AP 2021 15388 A
A 23 L 33/105; A 61 Q 19/08	AP 2021 15237 A
A 61 K 31/454; A 61 P 29/00; A 61 P 19/02; A 61 P 17/06; A 61 P 11/00	AP 2021 15467 A
A 61 K 31/437; A 61 K 31/4375; A 61 K 31/444; A 61 K 31/4709; A 61 K 31/497; A 61 K 31/506; A 61 K 45/06; A 61 P 11/00; A 61 P 9/10; C 07 D 519/00; C 07 D 471/04	AP 2021 14952 A
A 61 K 31/5386; A 61 K 31/4995; A 61 P 25/00; A 61 P 11/00; C 07 D 498/08; C 07 D 471/08	AP 2021 15256 A

### CONCORDANCE TABLE OF PUBLICATION NUMBERS AND INTERNATIONAL CLASSIFICATION INDEX

NUMBER OF PUBLISHED APPLICATION (10)	INTERNATIONAL CLASSIFICATION INDEXES (51)
AP 2021 14952 A	A 61 K 31/437; A 61 K 31/4375; A 61 K 31/444; A 61 K 31/4709; A 61 K 31/497; A 61 K 31/506; A 61 K 45/06; A 61 P 11/00; A 61 P 9/10; C 07 D 519/00; C 07 D 471/04
AP 2021 15237 A	A 23 L 33/105; A 61 Q 19/08
AP 2021 15256 A	A 61 K 31/5386; A 61 K 31/4995; A 61 P 25/00; A 61 P 11/00; C 07 D 498/08; C 07 D 471/08
AP 2021 15388 A	A 01 G 25/02; C 02 F 1/14
AP 2021 15467 A	A 61 K 31/454; A 61 P 29/00; A 61 P 19/02; A 61 P 17/06; A 61 P 11/00

### CONCORDANCE TABLE OF INTERNATIONAL CLASSIFICATION INDEX, PATENT NUMBERS AND PUBLICATION NUMBERS

INTERNATIONAL CLASSIFICATION INDEX (51)	NUMBER OF PATENT (11)	NUMBER OF PUBLISHED APPLICATION (10)
A 01 B 13/02; A 01 B 49/02; A 01 C 7/00	P 2021 7299 B	AP 2021 15395 A
A 61 K 31/675; A 61 K 31/55; A 61 K 31/436; A 61 K 31/4353; A 61 K 31/407 A 61 P 35/00	P 2021 7301 B	AP 2021 15006 A
B 66 F 3/24	P 2021 7303 B	AP 2021 15375 A
C 01 B 13/11	P 2021 7302 B	AP 2021 15372 A
C 02 F 1/00; C 09 K 8/05	P 2021 7300 B	AP 2021 15178 A
G 01 T 1/00	P 2021 7304 B	AP 2021 15390 A
G 06 Q 30/02; G 06 Q 10/08	P 2021 7305 B	AP 2021 15376 A
H 02 J 3/38; H 02 J 3/32	P 2021 7306 B	AP 2021 15266 A

**CONCORDANCE TABLE OF PATENT NUMBERS,  
PUBLICATION NUMBERS AND INTERNATIONAL CLASSIFICATION INDEX**

NUMBER OF PATENT (11)	NUMBER OF PUBLISHED APPLICATION (10)	INTERNATIONAL CLASSIFICATION INDEX (51)
P 2021 7299 B	AP 2021 15395 A	A 01 B 13/02; A 01 B 49/02; A 01 C 7/00
P 2021 7300 B	AP 2021 15178 A	C 02 F 1/00; C 09 K 8/05
P 2021 7301 B	AP 2021 15006 A	A 61 K 31/519; A 61 K 31/675; A 61 K 31/55; A 61 K 31/436; A 61 K 31/4353; A 61 K 31/407 A 61 P 35/00
P 2021 7302 B	AP 2021 15372 A	C 01 B 13/11
P 2021 7303 B	AP 2021 15375 A	B 66 F 3/24
P 2021 7304 B	AP 2021 15390 A	G 01 T 1/00
P 2021 7305 B	AP 2021 15376 A	G 06 Q 30/02; G 06 Q 10/08
P 2021 7306 B	AP 2021 15266 A	H 02 J 3/38; H 02 J 3/32

**CONCORDANCE TABLE OF APPLICATION NUMBERS,  
PUBLICATION NUMBERS AND PATENTS**

NUMBER OF APPLICATION (21)	NUMBER OF PUBLISHED APPLICATION (10)	NUMBER OF PATENT (11)
AP 2017 15006	AP 2021 15006 A	P 2021 7301 B
AP 2015 15178	AP 2021 15178 A	P 2021 7300 B
AP 2017 15266	AP 2021 15266 A	P 2021 7306 B
AP 2020 15372	AP 2021 15372 A	P 2021 7302 B
AP 2018 15376	AP 2021 15376 A	P 2021 7305 B
AP 2020 15375	AP 2021 15375 A	P 2021 7303 B
AP 2020 15390	AP 2021 15390 A	P 2021 7304 B
AP 2020 15395	AP 2021 15395 A	P 2021 7299 B

## UTILITY MODELS

INTERNATIONAL CLASSIFICATION INDEXES (51)	NUMBER OF PUBLISHED APPLICATION (10)
C 05 G 3/00	AU 2021 15374 U
C 12 G 3/025	AU 2021 15359 U

**CONCORDANCE TABLE OF PUBLICATION NUMBERS  
AND INTERNATIONAL CLASSIFICATION INDEX**

NUMBER OF PUBLISHED APPLICATION (10)	INTERNATIONAL CLASSIFICATION INDEXES (51)
AU 2021 15359 U	C 12 G 3/025
AU 2021 15374 U	C 05 G 3/00

CONCORDANCE TABLE OF INTERNATIONAL CLASSIFICATION INDEX,  
PATENT NUMBERS AND PUBLICATION NUMBERS

INTERNATIONAL CLASSIFICATION INDEX (51)	NUMBER OF PATENT (11)	NUMBER OF PUBLISHED APPLICATION (10)
A 01 G 9/02	U 2021 2100 Y	AU 2021 15563 U

CONCORDANCE TABLE OF PATENT NUMBERS,  
PUBLICATION NUMBERS AND INTERNATIONAL CLASSIFICATION INDEX

NUMBER OF PATENT (11)	NUMBER OF PUBLISHED APPLICATION (10)	INTERNATIONAL CLASSIFICATION INDEX (51)
U 2021 2100 Y	AU 2021 15563 U	A 01 G 9/02

CONCORDANCE TABLE OF APPLICATION NUMBERS,  
PUBLICATION NUMBERS AND PATENTS

NUMBER OF APPLICATION (21)	NUMBER OF PUBLISHED APPLICATION (10)	NUMBER OF PATENT (11)
AU 2021 15563	AU 2021 15563 U	U 2021 2100 Y

## DESIGNS

CONCORDANCE TABLE OF INTERNATIONAL CLASSIFICATION INDEX  
AND PUBLICATION NUMBERS

INTERNATIONAL CLASSIFICATION INDEXES (51)	NUMBER OF PUBLISHED APPLICATION (10)
09-01	AD 2021 1228 S

CONCORDANCE TABLE OF PUBLICATION NUMBERS  
AND INTERNATIONAL CLASSIFICATION INDEX

NUMBER OF PUBLISHED APPLICATION (10)	INTERNATIONAL CLASSIFICATION INDEXES (51)
AD 2021 1228 S	09-01

CONCORDANCE TABLE OF INTERNATIONAL CLASSIFICATION INDEX,  
NUMBERS OF REGISTRATION AND PUBLICATION NUMBERS

INTERNATIONAL CLASSIFICATION INDEX (51)	NUMBER OF REGISTRATION (11)	NUMBER OF PUBLISHED APPLICATION (10)
32-00	D 2021 906 S	AD 2021 1199 S

CONCORDANCE TABLE OF NUMBERS OF REGISTRATION,  
PUBLICATION NUMBERS AND INTERNATIONAL CLASSIFICATION INDEX

NUMBER OF REGISTRATION (11)	NUMBER OF PUBLISHED APPLICATION (10)	INTERNATIONAL CLASSIFICATION INDEX (51)
D 2021 906 S	AD 2021 1199 S	32-00

CONCORDANCE TABLE OF APPLICATION NUMBERS,  
PUBLICATION NUMBERS AND NUMBERS OF REGISTRATION

NUMBER OF APPLICATION (21)	NUMBER OF PUBLISHED APPLICATION (10)	NUMBER OF REGISTRATION (11)
AD 2021 1199	AD 2021 1199 S	D 2021 906 S

## TRADEMARKS

### CONCORDANCE TABLE OF REGISTRATION NUMBERS, APPLICATION NUMBERS, PUBLICATION NUMBERS AND BULLETIN NUMBERS

NUMBER OF REGISTRATION (111)	NUMBER OF APPLICATIONS (210)	NUMBER OF PUBLISHED APPLICATIONS (260)	NUMBER OF BULLETIN
1	2	3	4
M 2021 34531 R	AM 114541	–	18(574)2021
M 2021 34532 R	AM 114596	–	18(574)2021
M 2021 34533 R	AM 114597	–	18(574)2021
M 2021 34534 R	AM 109303	AM 109303 A	4(560)2021
M 2021 34535 R	AM 114612	–	18(574)2021
M 2021 34536 R	AM 114672	–	18(574)2021
M 2021 34537 R	AM 114673	–	18(574)2021
M 2021 34538 R	AM 114688	–	18(574)2021
M 2021 34539 R	AM 114395	–	18(574)2021
M 2021 34540 R	AM 113701	–	18(574)2021
M 2021 34541 R	AM 109209	AM 2021 109209 A	4(560)2021
M 2021 34542 R	AM 109212	AM 2021 109212 A	4(560)2021
M 2021 34543 R	AM 109355	AM 2021 109355 A	4(560)2021
M 2021 34544 R	AM 109356	AM 2021 109356 A	4(560)2021
M 2021 34545 R	AM 109588	AM 2021 109588 A	5(561)2021
M 2021 34546 R	AM 109589	AM 2021 109589 A	5(561)2021
M 2021 34547 R	AM 109590	AM 2021 109590 A	5(561)2021
M 2021 34548 R	AM 109675	AM 2021 109675 A	5(561)2021
M 2021 34549 R	AM 109733	AM 2021 109733 A	7(563)2021
M 2021 34550 R	AM 109956	AM 2021 109956 A	9(565)2021
M 2021 34551 R	AM 109958	AM 2021 109958 A	8(564)2021
M 2021 34552 R	AM 110016	AM 2021 110016 A	8(564)2021
M 2021 34553 R	AM 110196	AM 2021 110196 A	9(565)2021
M 2021 34554 R	AM 110218	AM 2021 110218 A	10(566)2021
M 2021 34555 R	AM 110219	AM 2021 110219 A	10(566)2021
M 2021 34556 R	AM 110223	AM 2021 110223 A	8(564)2021
M 2021 34557 R	AM 110226	AM 2021 110226 A	10(566)2021
M 2021 34558 R	AM 110279	AM 2021 110279 A	10(566)2021
M 2021 34559 R	AM 110280	AM 2021 110280 A	10(566)2021
M 2021 34560 R	AM 110292	AM 2021 110292 A	10(566)2021
M 2021 34561 R	AM 110505	AM 2021 110505 A	10(566)2021
M 2021 34562 R	AM 110516	AM 2021 110516 A	10(566)2021
M 2021 34563 R	AM 110603	AM 2021 110603 A	10(566)2021
M 2021 34564 R	AM 110604	AM 2021 110604 A	10(566)2021
M 2021 34565 R	AM 110605	AM 2021 110605 A	10(566)2021
M 2021 34566 R	AM 109374	AM 2021 109374 A	5(561)2021
M 2021 34567 R	AM 109587	AM 2021 109587 A	7(563)2021
M 2021 34568 R	AM 110035	AM 2021 110035 A	8(564)2021
M 2021 34569 R	AM 110481	AM 2021 110481 A	11(567)2021
M 2021 34570 R	AM 110763	AM 2021 110763 A	11(567)2021
M 2021 34571 R	AM 114536	–	18(574)2021
M 2021 34572 R	AM 114675	–	18(574)2021
M 2021 34573 R	AM 114598	–	18(574)2021
M 2021 34574 R	AM 114683	–	18(574)2021
M 2021 34575 R	AM 114680	–	18(574)2021

**CONCORDANCE TABLE OF PUBLICATION NUMBERS  
AND APPLICATION NUMBERS**

NUMBER OF PUBLISHED APPLICATION (260)	NUMBER OF APPLICATION (210)	1	2
1	2		
AM 2021 110191 A	AM 110191	AM 2021 111951 A	AM 111951
AM 2021 110192 A	AM 110192	AM 2021 111957 A	AM 111957
AM 2021 111602 A	AM 111602	AM 2021 111962 A	AM 111962
AM 2021 111716 A	AM 111716	AM 2021 111963 A	AM 111963
AM 2021 111720 A	AM 111720	AM 2021 111964 A	AM 111964
AM 2021 111738 A	AM 111738	AM 2021 111966 A	AM 111966
AM 2021 111834 A	AM 111834	AM 2021 111967 A	AM 111967
AM 2021 111841 A	AM 111841	AM 2021 111970 A	AM 111970
AM 2021 111849 A	AM 111849	AM 2021 112044 A	AM 112044
AM 2021 111850 A	AM 111850	AM 2021 112045 A	AM 112045
AM 2021 111851 A	AM 111851	AM 2021 112046 A	AM 112046
AM 2021 111852 A	AM 111852	AM 2021 112047 A	AM 112047
AM 2021 111853 A	AM 111853	AM 2021 112048 A	AM 112048
AM 2021 111854 A	AM 111854	AM 2021 112049 A	AM 112049
AM 2021 111859 A	AM 111859	AM 2021 112054 A	AM 112054
AM 2021 111860 A	AM 111860	AM 2021 112057 A	AM 112057
AM 2021 111861 A	AM 111861	AM 2021 112066 A	AM 112066
AM 2021 111869 A	AM 111869	AM 2021 112067 A	AM 112067
AM 2021 111870 A	AM 111870	AM 2021 112158 A	AM 112158
AM 2021 111871 A	AM 111871	AM 2021 112176 A	AM 112176
AM 2021 111872 A	AM 111872	AM 2021 112190 A	AM 112190
AM 2021 111873 A	AM 111873	AM 2021 112254 A	AM 112254
AM 2021 111876 A	AM 111876	AM 2021 112255 A	AM 112255
AM 2021 111877 A	AM 111877	AM 2021 112271 A	AM 112271
AM 2021 111934 A	AM 111934	AM 2021 112281 A	AM 112281
AM 2021 111935 A	AM 111935	AM 2021 112287 A	AM 112287
AM 2021 111936 A	AM 111936	AM 2021 112289 A	AM 112289
AM 2021 111937 A	AM 111937	AM 2021 112290 A	AM 112290
AM 2021 111938 A	AM 111938	AM 2021 112298 A	AM 112298
AM 2021 111942 A	AM 111942	AM 2021 112299 A	AM 112299
AM 2021 111944 A	AM 111944	AM 2021 112368 A	AM 112368
AM 2021 111945 A	AM 111945	AM 2021 112369 A	AM 112369
AM 2021 111946 A	AM 111946	AM 2021 112370 A	AM 112370
AM 2021 111947 A	AM 111947	AM 2021 112371 A	AM 112371
		AM 2021 112372 A	AM 112372
		AM 2021 112373 A	AM 112373
		AM 2021 112472 A	AM 112472

CONCORDANCE TABLE OF INDEX OF GOODS AND/OR SERVICES  
AND APPLICATION NUMBERS

INDEX OF GOODS AND/OR SERVICES (511)	NUMBER OF PUBLISHED APPLICATIONS (260)	1	2
1	2	12	AM 2021 111966 A
1	AM 2021 111966 A	12	AM 2021 112472 A
2	AM 2021 111966 A	14	AM 2021 111877 A
3	AM 2021 111834 A	14	AM 2021 111937 A
3	AM 2021 111937 A	14	AM 2021 111966 A
3	AM 2021 111966 A	16	AM 2021 111861 A
3	AM 2021 112287 A	16	AM 2021 111938 A
4	AM 2021 111966 A	16	AM 2021 111966 A
5	AM 2021 111859 A	17	AM 2021 111966 A
5	AM 2021 111860 A	18	AM 2021 111937 A
5	AM 2021 111869 A	18	AM 2021 111966 A
5	AM 2021 111870 A	20	AM 2021 111966 A
5	AM 2021 111871 A	21	AM 2021 111834 A
5	AM 2021 111872 A	21	AM 2021 111877 A
5	AM 2021 111873 A	21	AM 2021 111966 A
5	AM 2021 111876 A	21	AM 2021 112298 A
5	AM 2021 111934 A	22	AM 2021 111966 A
5	AM 2021 111935 A	23	AM 2021 111861 A
5	AM 2021 111936 A	24	AM 2021 111861 A
5	AM 2021 111944 A	24	AM 2021 111877 A
5	AM 2021 111945 A	24	AM 2021 111966 A
5	AM 2021 111946 A	25	AM 2021 111877 A
5	AM 2021 111947 A	25	AM 2021 111937 A
5	AM 2021 111962 A	25	AM 2021 111966 A
5	AM 2021 111963 A	26	AM 2021 111966 A
5	AM 2021 111964 A	27	AM 2021 111966 A
5	AM 2021 112044 A	28	AM 2021 111877 A
5	AM 2021 112045 A	28	AM 2021 111966 A
5	AM 2021 112046 A	28	AM 2021 112054 A
5	AM 2021 112047 A	28	AM 2021 112298 A
5	AM 2021 112048 A	29	AM 2021 111720 A
5	AM 2021 112049 A	29	AM 2021 112066 A
5	AM 2021 112287 A	29	AM 2021 112254 A
6	AM 2021 111966 A	29	AM 2021 112255 A
7	AM 2021 111966 A	30	AM 2021 111942 A
8	AM 2021 111834 A	30	AM 2021 112066 A
8	AM 2021 111966 A	30	AM 2021 112254 A
9	AM 2021 111738 A	30	AM 2021 112369 A
9	AM 2021 111951 A	30	AM 2021 112370 A
9	AM 2021 111957 A	30	AM 2021 112371 A
9	AM 2021 111966 A	30	AM 2021 112372 A
9	AM 2021 112054 A	30	AM 2021 112373 A
9	AM 2021 112281 A	31	AM 2021 111716 A
9	AM 2021 112289 A	31	AM 2021 111850 A
9	AM 2021 112290 A	31	AM 2021 111851 A
10	AM 2021 112281 A	31	AM 2021 111852 A
10	AM 2021 112289 A	31	AM 2021 111853 A
10	AM 2021 112290 A	31	AM 2021 111854 A
11	AM 2021 111966 A	32	AM 2021 111861 A
		33	AM 2021 111970 A
		33	AM 2021 110192 A
		33	AM 2021 111841 A

1	2
33	AM 2021 111861 A
33	AM 2021 111970 A
33	AM 2021 112057 A
33	AM 2021 112158 A
33	AM 2021 112190 A
33	AM 2021 112271 A
33	AM 2021 112299 A
33	AM 2021 112368 A
34	AM 2021 110191 A
34	AM 2021 111966 A
35	AM 2021 111738 A
35	AM 2021 111841 A
35	AM 2021 111849 A
35	AM 2021 111853 A
35	AM 2021 111854 A
35	AM 2021 111861 A
35	AM 2021 111937 A
35	AM 2021 111957 A
35	AM 2021 111966 A
35	AM 2021 111967 A
35	AM 2021 112067 A
35	AM 2021 112254 A
35	AM 2021 112255 A
35	AM 2021 112271 A
35	AM 2021 112287 A
35	AM 2021 112298 A
36	AM 2021 111966 A

1	2
36	AM 2021 112067 A
36	AM 2021 112176 A
37	AM 2021 111957 A
37	AM 2021 111966 A
37	AM 2021 112176 A
38	AM 2021 111738 A
38	AM 2021 111951 A
38	AM 2021 111957 A
38	AM 2021 111966 A
39	AM 2021 111966 A
39	AM 2021 111967 A
40	AM 2021 111877 A
40	AM 2021 111966 A
41	AM 2021 111966 A
41	AM 2021 112054 A
41	AM 2021 112067 A
42	AM 2021 111738 A
42	AM 2021 111877 A
42	AM 2021 111951 A
42	AM 2021 111957 A
42	AM 2021 111966 A
42	AM 2021 112054 A
44	AM 2021 111602 A
44	AM 2021 111738 A
44	AM 2021 112287 A
45	AM 2021 111957 A
45	AM 2021 111966 A

CONCORDANCE TABLE OF INDEX OF GOODS AND/OR SERVICES  
AND NUMBERS OF TRADEMARKS REGISTERED ACCORDING  
TO THE ACCELERATED PROCEDURE

INDEX OF GOODS AND/OR SERVICES (511)	NUMBERS OF REGISTERED ACCORDING TO THE ACCELERATED PROCEDURE (111)
5	M 2021 34572 R
9	M 2021 34532 R
9	M 2021 34533 R
12	M 2021 34571 R
29	M 2021 34531 R
30	M 2021 34535 R
30	M 2021 34539 R
33	M 2021 34536 R
33	M 2021 34537 R
34	M 2021 34540 R
35	M 2021 34572 R
35	M 2021 34573 R
36	M 2021 34532 R
36	M 2021 34533 R
36	M 2021 34574 R
37	M 2021 34571 R
41	M 2021 34538 R
43	M 2021 34539 R
43	M 2021 34575 R
44	M 2021 34573 R



# **OFFICIAL BULLETIN OF THE INDUSTRIAL PROPERTY**

**INVENTIONS  
UTILITY MODELS  
DESIGNS  
TRADEMARKS  
APPELLATIONS OF ORIGIN OF GOOD**

## **18(574)**

EDITOR-IN-CHIEF: N. Bebrishvili

EDITOR-TRANSLATOR: E. Gabunia

PROOFREADER: A. Shikhashvili

COMPUTER LAYOUT: M. Ordenidze  
K. Svanidze

[info@sakpatenti.gov.ge](mailto:info@sakpatenti.gov.ge)  
[www.sakpatenti.gov.ge](http://www.sakpatenti.gov.ge)