

Official Bulletin of the Industrial Property

Inventions

Utility Models

Designs

Trademarks



საქართველოს ინტელექტუალური
საკუთრების ეროვნული ცენტრი

საქპატენტი

SAKPATENTI

NATIONAL INTELLECTUAL PROPERTY
CENTER OF GEORGIA

www.sakpatenti.gov.ge

Date of Publication – 2021 11 10

20(576)

INID CODES FOR IDENTIFICATION OF BIBLIOGRAPHIC DATA

INVENTIONS, UTILITY MODELS

- (10) Number of publication for application, which has been examined
- (11) Number of patent and kind of document
- (21) Serial number of application
- (22) Date of filing of the application
- (23) Date of exhibition or the date of the earlier filing and the number of application, if any
- (24) Date from which patent may have effect
- (31) Number of priority application
- (32) Date of filing of priority application
- (33) Code of the country or regional organization allotting priority application number
- (44) Date of publication of application not granted, but examined and number of bulletin
- (45) Date of publication of registered document
- (51) International Patent Classification Index

- (54) Title of the invention
- (57) Abstract
- (60) Number of examined patent document granted by foreign patent office, date from which patent has effect and country code
- (62) Number of the earlier application and in case of divided application, date of filing an application
- (71) Name, surname and address of applicant (country code)
- (72) Name, surname of inventor (country code)
- (73) Name, surname and address of patent owner (country code)
- (74) Name, surname of representative or patent attorney
- (85) Date of commencement of the national phase of International Application
- (86) Number and date of filing of international application
- (87) Number and date of publication of international application
- (94) Calculated date of expiry of the SPC or the duration of the SPC

DESIGNS

- (10) Number of publication for application
- (11) Number of patent and kind of document or number of registration
- (15) Date of registration/Date of patent renewal
- (18) Expected expiration date of patent or registration
- (21) Serial number of application
- (22) Date of filing of the application
- (23) Date of exhibition or the date of the earlier filing and the number of application, if any
- (24) Date from which patent may have effect
- (28) Number of designs included in the application
- (30) Data relating to priority (number of application, date of filing of application, two-letter code identifying the authority with whom the priority application was made)
- (31) Number of priority application
- (32) Date of filing of priority application
- (33) Code of the country or regional organization allotting priority application number
- (34) Two-letter code according to WIPO St.3 identifying the authority with which the priority application was made
- (44) Date of publication of design and number of bulletin (the first publication)
- (45) Date of publication of design registered by WIPO and number of bulletin

- (51) International Classification for designs (class and subclass of the Locarno Classification)
- (54) Title of the invention
- (55) Reproduction of the design
- (57) Description of characteristic features of the design including indication of colors
- (58) Date of recording of any kind of amendment in the Register
- (62) Number of the earlier application, registration and document number and if available the date of filing an application in case of divided application
- (71) Name, surname and address of applicant (country code)
- (72) Name, surname of creator (country code)
- (73) Name, surname and address of patent owner (country code)
- (74) Name, surname of representative or patent attorney
- (81) Contracting states concerned
 - II designated contracting states according to the 1960 Act
 - III designated contracting states according to the 1999 Act
- (85) Owner's permanent address
- (86) Owner's nationality
- (87) Owner's residence
- (88) State in which the owner has a real and effective industrial or commercial establishment

TRADEMARKS

- (111) - Number of registration
- (151) - Date of registration
- (156) - Date of the renewal
- (181) - Expected expiration date of registration
- (186) - Renewal expiration date of registration
- (141) - Date of cancel of duration of the mark
- (210) - Serial number of application
- (220) - Date of filing of the application
- (230) - Data concerning exhibition
- (260) - Number of application, for which favorable decision of examination about registration has been taken (publication number)
- (310) - Number of the first application
- (320) - Date of filing of the first application
- (330) - Code, identifying national or regional Office where the first application was made
- (511) - International Classification of Goods and Services for the purposes of registration of trade marks and/or list of goods and/or services classified according thereto
- (526) - Disclaimer
- (531) - Description of figurative elements of Trade Marks according to the International Classification of the Figurative Elements of Marks

- (540) - Reproduction of Trade Mark
- (550) - Nature and kind of Trade Mark
- (551) - Indication to the effect that the mark is a collective mark, a certification mark or a guarantee mark
- (554) - Three-dimensional mark
- (580) - Date of recording of any kind changes in respect of applications or registrations
- (591) - Information concerning colors claimed
- (731) - Name and address of the applicant
- (732) - Name and address of the holder of the registration
- (740) - Name and address of the representative
- (750) - Addreses for correspondence
- (770) - Name and address of the previous applicant or holder in case of change in ownership
- (771) - Previous name and address of the applicant or holder in case of change in ownership
- (791) - Name and address of the licensee
- (793) - Indication of conditions and/or restrictions under the license (Type of license, number of license agreement, data of license, data of validity of license)
- (800) - Certain data relating to the international registration of Trade Marks under the Protocol Relating to Madrid Agreement (International registration number
- (852) - Partial cancellation of the list of goods and services
- (891) - Date of subsequent designation

CODES FOR PUBLICATION IN BULLETIN

- (21) AP 0000 000000 - serial number of application for invention
- (10) AP 0000 0000 A - number of published application for invention (first publication)
- (11) P 0000 0000 B - number of patent for invention (second publication)
- (21) API 0000 000000 - number of application for imported patent
- (11) PI 0000 0000 A - number of imported patent (first publication)
- (21) AU 0000 000000 - serial number of application for utility model
- (10) AU 0000 000 U - number of published application for utility model (first publication)
- (11) U 0000 000 Y - number of patent for utility model (second publication)
- (21) AD 0000 000000 - serial number of application for design
- (10) AD 0000 000 S - number of published application for design (first publication)
- (11) D 0000 000 S - registered design

INTERNATIONAL PATENT CLASSIFICATION FOR INVENTIONS AND UTILITY MODELS

- SECTION A - HUMAN NECESSITIES
- SECTION B - PERFORMING OPERATIONS; TRANSPORTING
- SECTION C - CHEMISTRY; METALLURGY
- SECTION D - TEXTILES; PAPER
- SECTION E - FIXED CONSTRUCTIONS
- SECTION F - MECHANICAL ENGINEERING; LIGHTING; HEATING; WEAPONS; BLASTING
- SECTION G - PHYSICS
- SECTION H - ELECTRICITY

-
- M - Trade Mark
 - (210) AM 0000 000000 - Serial number of application;
 - (260) AAM 0000 00000 A - Publication number of application;
 - (111) M 0000 00000 R - Number of registration;
 - (111) MMM0000 00000 Rn - Number of renewals, in which n=1,2,3;
 - (111) M 0000 00000 R(P) - Number of registration under partial assignment of rights
-

Official Bulletin of the Industrial Property

Inventions

Utility Models

Designs

Trademarks

CONTENTS

PUBLISHED TITLES OF PROTECTION	3
INVENTIONS	
▪ APPLICATIONS APPROVED FOR GRANTING PATENT	4
▪ PATENTED INVENTIONS	6
UTILITY MODEL	
▪ APPLICATION APPROVED FOR GRANTING PATENT	9
DESIGNS	
▪ APPLICATIONS APPROVED FOR REGISTRATION	10
▪ REGISTERED DESIGNS	11
▪ DESIGN REGISTERED ACCORDING TO THE ACCELERATED PROCEDURE	12
▪ DESIGNS, WHICH HAVE BEEN REGISTERED WITH THE INTERNATIONAL BUREAU CLAIMING PRIORITY ON THE TERRITORY OF GEORGIA	14
TRADEMARKS	
▪ APPLICATIONS FILED UNDER THE NATIONAL PROCEDURE APPROVED FOR REGISTRATION	25
▪ REGISTERED TRADEMARKS	36
▪ TRADEMARKS REGISTERED ACCORDING TO THE ACCELERATED PROCEDURE	39
▪ INTERNATIONAL TRADEMARKS FOR WHICH A DECISION ON GRANTING PROTECTION IS TAKEN	43
▪ INTERNATIONAL TRADEMARKS PROTECTED IN GEORGIA	97
OFFICIAL NOTIFICATIONS	
INVENTIONS	
▪ EXPIRATION OF PATENTS RESTORATION	104
▪ ABOLITION OF PATENTS WITH THE RIGHT TO RESTORE	104
▪ EXPIRATION OF TERM OF RESTORATION OF PATENTS	105
UTILITY MODELS	
▪ ABOLITION OF PATENTS WITH THE RIGHT TO RESTORE	106
▪ EXPIRATION OF TERM OF RESTORATION OF PATENTS	106
DESIGNS	
▪ EXTENSION OF DESIGN REGISTRATION	107
▪ EXTENSION OF INTERNATIONAL DESIGNS REGISTRATIONS	107
TRADEMARKS	
▪ RENEWAL OF REGISTRATIONS	113
▪ COMPLETE TRANSFER OF RIGHTS	115
▪ CHANGES OF NAMES AND/OR ADDRESSES OF OWNERS	118
▪ CANCELLATION OF TRADEMARKS REGISTRATIONS	121
CLASSIFICATION INDEXES	
INVENTIONS	125
UTILITY MODELS	128
DESIGNS	129
TRADEMARKS	131

PUBLISHED TITLES OF PROTECTION

INVENTIONS

- **APPLICATION APPROVED FOR GRANTING PATENTS:**
15380; 15385; 15242; 14672; 15582
- **PATENTED INVENTIONS:**
7309-7317

UTILITY MODEL

- **APPLICATION APPROVED FOR GRANTING PATENT:**
15590

DESIGNS

- **APPLICATION APPROVED FOR REGISTRATION:**
1225
- **REGISTERED DESIGNS:**
908-910
- **DESIGN REGISTERED ACCORDING TO THE ACCELERATED PROCEDURE:**
911
- **DESIGNS, WHICH HAVE BEEN REGISTERED WITH THE INTERNATIONAL BUREAU CLAIMING PRIORITY ON THE TERRITORY OF GEORGIA:**
215714; 214523; 212976; 215865; 215897; 215879

TRADEMARKS

- **APPLICATIONS FILED UNDER THE NATIONAL PROCEDURE APPROVED FOR REGISTRATION:**
111500; 111590; 112174; 112182; 112191; 112253; 112256; 112263; 112267; 112273-112275; 112279; 112282-112284; 112286; 112301, 112302, 112309; 112312; 112367; 112386, 112387; 112390; 112400, 112401; 112404; 112407; 112410; 112422; 112485; 112487, 112488; 112499; 112501; 112504, 112505; 112510; 112575, 112576; 112582, 112583; 112587; 112590; 112595; 112597; 112607; 112609, 112610; 112614-112616; 112622; 112628; 112685, 112686; 112690; 112696, 112697; 112713, 112714; 112716; 112719; 112721; 112738
- **REGISTERED TRADEMARKS:**
34644-34679
- **TRADEMARKS REGISTERED ACCORDING TO THE ACCELERATED PROCEDURE:**
34636-34643; 34679-34684
- **INTERNATIONAL TRADEMARKS FOR WHICH A DECISION ON GRANTING PROTECTIONS IS TAKEN:**
111254; 111265; 111298-111302; 111349-111355; 111384; 111386; 111456-111460; 111490; 111494; 111549; 111551; 111554; 111556; 111576; 111621; 111626; 111651; 111665, 111666; 111686, 111687; 111767, 111768; 111771, 111772; 111776; 111778; 111792-111800; 111807; 111809; 111811, 111812; 111814; 111822-111825; 111832; 111886; 111900; 111904; 111915-111917; 111919; 111980-111982; 111992-111994; 112000, 112001; 112004; 112011; 112014; 112016; 112018, 112019; 112022; 112030, 112031; 112111; 112121-112125; 112127, 112128; 112130-112132; 112197, 112198; 112202; 112219, 112220; 112226, 112227; 112229-112235; 112323; 112337, 112338; 112346-112352
- **INTERNATIONAL TRADEMARKS PROTECTED IN GEORGIA:**
107784; 107935; 109706; 109717; 109797, 109798; 109855; 109857-109859; 109875; 109880; 109883, 109884; 109890-109891, 109892; 109895, 109896; 109898; 109976-109979; 109982; 109988-109994; 110008-110010; 110047, 110048; 110061-110063; 110065, 110066; 110068-110071; 110083; 110087-110089; 110091; 110098; 110102; 110105; 110107-110109; 110149, 110150; 110159, 110160; 110174, 110175; 110235; 110238; 110262; 110265; 110268; 110312; 110341, 110342; 110347-110349; 110396; 110398, 110399; 110430; 110432-110435; 110495-110498; 110579-110581; 110617; 110619, 110620; 110651; 110654; 110656, 110657

INVENTIONS

APPLICATIONS APPROVED FOR GRANTING PATENT

The decision can be appealed at the Chamber of Appeal of Sakpatenti within 3 months from the publication or at the Mtskheta District Court Administrative Cases Board (Address: №17, Samkhedro St., Mtskheta), within 1 month following the publication.

PARTA

A 01

(10) AP 2021 15380 A (51) Int. Cl. (2006)
A 01 K 61/00

(21) AP 2020 15380 (22) 2020 06 25

(71) Omar Akhmetelashvili (GE)
I. Abashidze St. 61 app. 20, Tbilisi,
Georgia (GE);

Giorgi Gagua (GE)

Tashkent St. 5, app. 173, Rustavi,
Georgia (GE);

Ramaz Petremghvdlisshvili (GE)

Tibaani St. 72, Tbilisi, Georgia (GE)

(72) Omar Akhmetelashvili (GE);

Giorgi Gagua (GE);

Ramaz Petremghvdlisshvili (GE)

(54) AQUARIUM FISH COMPLEX
EXCITATING DEVICE

(57) Aquarium fish complex exciting device is disclosed. The device includes exciting holding tripod fastened onto aquarium wall, in a cavity whereof the complex exciting article – copper or wooden branch having 4-6 mm diameter and 18-20 mm length ended with soft rubber and floating on water surface is placed; at that, 12-volt bulb causing conditional reflex in fish is fixed onto the tripod.

Claims: 1 independent

Fig: 8

A 61

(10) AP 2021 15385 A (51) Int. Cl. (2006)
A 61 K 31/53

A 61 K 31/519

A 61 P 35/00

C 07 D 487/04

C 07 D 471/04

(21) AP 2018 15385 (22) 2018 12 13

(31) 201721044886; 201821024634;
201821040029

(32) 2017 12 13; 2018 07 02; 2018 10 23

(33) IN; IN; IN

(71) Lupin Limited (IN)

Kalpataru Inspire, 3rd Fl., Off Western Express

Highway Santacruz (East), Maharashtra

Mumbai 400055, India (IN)

(72) KULKARNI, Sanjeev, Anant (IN);
HAJARE, Anil, Kashiram (IN);
GUDADE, Ganesh, Bhausahab (IN);
SETHI, Sachin (IN);

GORE, Balasaheb, Arjun (IN);

SINDKHEDKAR, Milind, Dattatraya (IN);

KAMBOJ, Rajender, Kumar (IN);

TRYAMBAKE, Mahadeo, Bhaskar (IN);

PALLE, Venkata, P. (IN);

LAGAD, Dipak, Raychand (IN);

NAIR, Prathap, Sreedharan (IN);

KULKARNI, Chaitanya, Prabhakar (IN);

PAWAR, Chetan, Sanjay (IN)

(74) Larisa Amirkhanyan

(85) 2020 07 09

(86) PCT/IB2018/060015, 2018 12 13

(54) SUBSTITUTED BICYCLIC HETERO-
CYCLIC COMPOUNDS AS PRMT5
INHIBITORS

(57) Compound of general formula (I), stereoisomer
or pharmaceutically acceptable salt thereof,

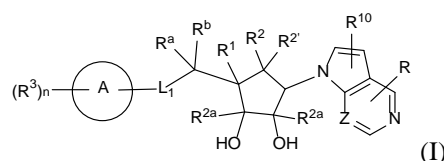

wherein values of A, R, R¹, R², R³, R^a, R^b, R^{2'}, R^{2a}, R¹⁰, Z, L₁ substitutes, and n variable are provided in the claims; pharmaceutical composition on the basis thereof, and their usage as PRMT5 inhibitor for drug preparation for the treatment of diseases, disorders, syndroms or conditions such as cancer, glioblastome multiforma, salivary gland cancer, pancreatic cancer, mantle zone lymphoma, non-Hodgkin's lymphomas, and diffuse large B-cell lymphoma, acute myeloid leukemia, etc.

Claims: 3 independent

14 dependent

Table: 22

(10) AP 2021 15242 A (51) Int. Cl. (2006)

A 61 K 31/519

A 61 K 31/5377

A 61 K 31/55

A 61 P 35/00

A 61 P 45/06

(21) AP 2018 15242 (22) 2018 06 21

(31) 62/523,389; 17189550.1

(32) 2017 06 22; 2017 09 06

(33) US; EP

(71) Novartis AG (CH)

Lichtstrasse 35, Basel, 4056, Switzerland (CH);

Les Laboratoires Servier (FR)

35, Rue de Verdun, Suresnes Cedex, 92284,

France (FR)

(72) WEI, Andrew (AU);

MOUJALLED, Donia (AU);

POMILIOO, Giovanna (AU);

GENESTE, Olivier (FR);

MARAGNO Ana-Leticia (FR)

(74) Tamaz Shilakadze

(85) 2019 12 20

(86) PCT/EP2018/066551, 2018 06 21

(54) COMBINATION OF MCL-1 INHIBITOR AND STANDARD OF CARE TREATMENT FOR HEMATOLOGIC CANCERS, USES AND ASSOCIATED PHARMACEUTICAL COMPOSITIONS

(57) Present invention relates to combination comprising Mcl-1 inhibitor (2R)-2-[[{(5Sa)-5-{3-chloro-2-methyl-4-[2-(4-methyl-piperazin-1-yl) ethoxy]phenyl} -6-(5-fluoranyl-furan-2-yl) thieno [2,3-d] pyrimidin-4-yl] oxy}-3-(2-[[1-(2,2,2-trifluoroethyl)-1H-pyrazol-5-yl] methoxy} phenyl) propionic acid or (2R)-2-[(5Sa)-5-{3-chloro-2-methyl-4-[2-(4-methyl-piperazin-1-yl) ethoxy] phenyl}-6-(4-fluoranyl-furan) thieno [2,3-d] pyrimidine-4-yl] oxy}-3-(2-[[2-(2-methoxyphenyl) pyrimidin-4-yl] methoxy} phenyl) propionic acid, and second anticancer agent; compositions and usage therefor the treatment of the AML patients, as well.

Claims: 5 independent

18 dependent

Fig: 6

(10) AP 2021 14672 A (51) Int. Cl. (2006)

A 61 K 39/39

(21) AP 2016 14672 (22) 2016 07 12

(31) 1512211,2; 1518375,9

(32) 2015 07 13; 2015 10 16

(33) GB; GB

(71) H. Lundbeck A/S (DK)

Ottoliavej 9, DK-2500 Valby, Denmark (DK)

(72) PEDERSEN, Jan, Torleif (DK);

ROSENQVIST, Nina (SE);

ABDUR-RASHEED ASUNI, Ayodeji (DK);

DÄCHSEL, Justus, Claus, Alfred (DE);

PEDERSEN, Lars, Østergaard (DK)

(74) Tamaz Shilakadze

(85) 2018 01 09

(86) PCT/EP2016/066470, 2016 07 12

(54) ANTIBODIES SPECIFIC FOR HYPERPHOSPHORYLATED TAU AND METHODS OF USE THEREOF

(57) Present invention relates to novel class of monoclonal antibodies specifically bound tau-protein

phosphorylated serine 396 residue (pS 396), and usage therefor the treatment of Alzheimer's disease and tauopathies.

Claims: 1 independent

1 dependent

Fig: 34

PARTE

E 02

(10) AP 2021 15582 A (51) Int. Cl. (2006)
E 02 B 9/04

(21) AP 2021 15582 (22) 2021 03 11

(71) Georgian Technical University (GE)

M. Kostava St. 77, Tbilisi, Georgia (GE);

Davit Gurgenedze (GE)

Ir. Abashidze St. 42, app. 57, Tbilisi, Georgia (GE);

Levan Klimiashvili (GE)

Ilia Chavchavadze Av. 11, app. 89, Tbilisi, Georgia (GE);

Giorgi Omsarashvili (GE)

Didi Dighomi, I mcr., G. Brtskinvale St. 41, app. 14, Tbilisi, Georgia (GE)

(72) Davit Gurgenedze (GE);

Levan Klimiashvili (GE);

Giorgi Omsarashvili (GE)

(54) WATERINTAKING CONSTRUCTION DISPOSED UNDER RIVERBED

(57) A construction includes watercollecting gallery 2 having an overlap executed as a waterintake having threelayered structure disposed on metallic grid 5; at that, gallery sidewalls 10 are formed with the gabions. The construction is equipped with additional waterintake 12 and wateroutlet 14 pipes, as well, wherein additional filtering componentry are disposed in front thereof. Three walls 15, 16, 17 formed with at least three various fractions of crushed-stone gabion system in front of waterintake pipe filtration component are additional waterintake tanks capable to inlet, outlet, and filter water between crushed-stone componentry of various fractions, and to direct water into waterintake pipe, as well.

Claims: 1 independent

Fig: 2

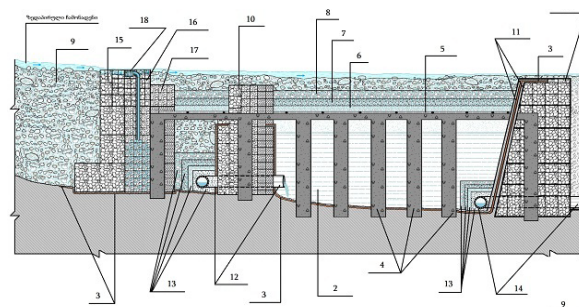

Fig. 2

PATENTED INVENTIONS

PART A

A 61

(11) P 2021 7312 B (51) Int. Cl. (2006)
 A 61 J 3/00
 A 61 M 5/178
 B 01 L 3/00
 B 01 L 3/14
 B 65 D 51/24
 F 26 B 5/04
 F 26 B 5/06

(10) AP 2021 14845 A (44) 12(568)/2021
 (21) AP 2017 14845
 (22) 2017 02 03
 (24) 2017 02 03
 (31) 62/292,119
 (32) 2016 02 05
 (33) US
 (86) PCT/US2017/016419, 2017 02 03
 (73) Tolmar International Limited (IE)
 10 Earlsfort Terrace, Dublin 2, DO2 T380,
 Ireland (IE)
 (72) MCCANN, Kevin, Stuart (US);
 BRINKMAN, Herbert, Robert (US);
 DOWNING, John, Milton (US)
 (74) Shalva Gvaramadze
 (54) VENTED COVER PLATE FOR AN
 ARRAY OF SYRINGES

(11) P 2021 7310 B (51) Int. Cl. (2006)
 A 61 K 45/06
 A 61 K 9/48
 A 61 K 31/616
 A 61 K 31/4422
 A 61 K 31/404
 A 61 K 31/138
 A 61 K 9/50

(10) AP 2021 14923 A (44) 12(568)/2021
 (21) AP 2017 14923
 (22) 2017 04 19
 (24) 2017 04 19
 (31) 1653502
 (32) 2016 04 20
 (33) FR
 (86) PCT/FR2017/050929, 2017 04 19
 (73) Les Laboratoires Servier (FR)
 35, Rue de Verdun, 92284 Suresnes, Cedex,
 France (FR)
 (72) FONKNECHTEN, Gilles (FR)
 (74) Tamaz Shilakadze

(54) PHARMACEUTICAL COMPOSITION
 COMPRISING BETA BLOCKER,
 CONVERTING ENZYME INHIBITOR
 AND ANTIHYPERTENSIVE OR NSAID

(11) P 2021 7316 B (51) Int. Cl. (2006)
 A 61 K 31/41
 A 61 P 25/28
 A 61 P 25/16
 A 61 P 25/02
 A 61 P 35/00
 A 61 P 37/00
 C 07 C 311/40
 C 07 D 207/333
 C 07 D 207/416
 C 07 D 213/40
 C 07 D 213/61
 C 07 D 213/64
 C 07 D 213/65
 C 07 D 213/74
 C 07 D 231/38
 C 07 D 231/56
 C 07 D 239/30
 C 07 D 263/32
 C 07 D 271/04
 C 07 D 275/02
 C 07 D 277/26
 C 07 D 277/34
 C 07 D 277/56
 C 07 D 213/60
 C 07 D 471/04
 C 07 D 233/61
 C 07 D 233/64
 C 07 D 249/10
 C 07 D 249/12
 C 07 D 249/14
 C 07 D 239/26
 C 07 D 405/06
 C 07 D 239/34
 C 07 D 239/42
 C 07 D 249/08
 C 07 D 213/85
 C 07 D 231/12
 C 07 D 231/14
 C 07 D 231/16
 C 07 D 231/18
 C 07 D 261/08
 C 07 D 233/68
 C 07 D 401/04
 C 07 D 235/06
 C 07 D 249/06
 C 07 D 233/16
 C 07 D 249/18
 C 07 D 249/20

C 07 D 403/04
 C 07 D 237/08
 C 07 D 405/04
 C 07 D 271/06
 (10) AP 2021 14943 A (44) 10(566)/2021
 (21) AP 2017 14943
 (22) 2017 04 26
 (24) 2017 04 26
 (31) 16167996.4
 (32) 2016 05 03
 (33) EP
 (86) PCT/EP2017/059882, 2017 04 26
 (73) Bayer Pharma Aktiengesellschaft (DE)
 Müllerstraße 13353 Berlin, Germany (DE)
 (72) MESCH, Stefanie (DE);
 WERNER, Stefan (DE);
 CLEVE, Arwed (DE);
 HARDAKER, Elizabeth (GB);
 BRÄUER, Nico (DE);
 HERBERT, Simon, Anthony (DE);
 DAHLLÖF, Henrik (SE);
 LISHCHYNSKYI, Anton (DE);
 KOCH, Markus (DE);
 OSMERS, Maren (DE)
 (74) Tamar Kochlamazashvili
 (54) AROMATIC SULFONAMIDE
 DERIVATIVES

(11) P 2021 7313 B (51) Int. Cl. (2006)
 A 61 K 31/137
 A 61 K 9/00
 A 61 K 31/197
 C 12 C 5/02
 (10) AP 2021 15301 A (44) 12(568)/2021
 (21) AP 2018 15301
 (22) 2018 08 22
 (24) 2018 08 22
 (31) 62/548,924
 (32) 2017 08 22
 (33) US
 (86) PCT/IB2018/056348, 2018 08 22
 (73) Euphoria Research And Development LTD (IL)
 Sderot Yoseftal 29, 5945602 Bat Yam,
 Israel (IL)
 (72) HAKIM, Daniel (IL)
 (74) Shalva Gvaramadze
 (54) ENRICHED ALCOHOLIC BEVERAGES

(11) P 2021 7317 B (51) Int. Cl. (2006)
 A 61 K 39/395
 A 61 K 35/04
 C 07 K 16/18
 C 07 K 16/28
 (10) AP 2021 14756 A (44) 13(569)/2021
 (21) AP 2016 14756
 (22) 2016 10 06
 (24) 2016 10 06

(31) 62/239,020
 (32) 2015 10 08
 (33) US
 (86) PCT/US2016/055750, 2016 10 06
 (73) Macrogenics Inc. (US)
 9704 Medical Center Drive, Rockville,
 MD 20850, USA (US)
 (72) VASSELLI, James (US);
 WIGGINTON, Jon, Marc (US);
 BONVINI, Ezio (US);
 KOENIG, Scott (US)
 (74) Shalva Gvaramadze
 (54) COMBINATION THERAPY FOR THE
 TREATMENT OF CANCER

PART B

B 60

(11) P 2021 7315 B (51) Int. Cl. (2006)
 B 60 T 1/06
 (10) AP 2021 15436 A (44) 13(569)/2021
 (21) AP 2020 15436
 (22) 2020 09 07
 (24) 2020 09 07
 (73) Ramzan Goytemirov (RU)
 Razdelnaya St. 13, Grozno, Russian
 Federation (RU)
 (72) Ramzan Goytemirov (RU)
 (74) Besik Kobakhidze
 (54) SLOWING VEHICLE BRAKE DEVICE

B 64

(11) P 2021 7314 B (51) Int. Cl. (2006)
 B 64 F 1/305
 E 04 B 1/94
 E 04 B 1/343
 (10) AP 2021 14882 A (44) 9(565)/2021
 (21) AP 2017 14882
 (22) 2017 02 13
 (24) 2017 02 13
 (31) P.416308
 (32) 2016 02 29
 (33) PL
 (86) PCT/PL2017/000008, 2017 02 13
 (73) Fimarc Bezpieczeństwo I Ochrona
 Przeciwpożarowa Biuro Ekspertyz,
 Doradztwa I Nadzoru (PL)
 Ul. Grabowa 9, Wiry, 62-051, Poland (PL)
 (72) MAŁKOWSKI, Zenon (PL)
 (74) Khatuna Imnadze
 (54) EMERGENCY ESCAPE TUNNEL

PART C**C 01**

- (11) P 2021 7309 B (51) Int. Cl. (2006)
C 01 B 31/08
C 10 B 53/02
- (10) AP 2021 15030 A (44) 8(564)/2021
- (21) AP 2019 15030
- (22) 2019 03 25
- (24) 2019 03 25
- (73) Iv. Javakhishvili Tbilisi State University
R. Agladze Institute Of Inorganic Chemistry
and Electrochemistry (GE)
E. Mindeli St. 11, 0186, Tbilisi, Georgia (GE)
- (72) Tamaz Marsagishvili (GE);
Grigor Tatishvili (GE);
Natela Ananiashvili (GE);
Manana Gachechiladze (GE);
Julieta Metreveli (GE);
Zurab Samkharadze (GE);
Elizaveta Tskhakaia (GE);
Nino Giorgadze (GE);
Marine Machavariani (GE);
Guram Megreli (GE)
- (54) METHOD FOR RECEIVING SORBENTS
FROM WASTE OF PLASTICS AND
CELLULOSE

- MOROZOV, Dmitriy Valentinovich (RU);
EKIMOVA, Victoria Mikhailovna (RU);
SOFRONOVA, Ekaterina Vladimirovna (RU);
USTYUGOV, Yakov Yurevich (RU)
- (74) Larisa Amirkhanyan
- (54) HIGH AFFINITY AND AGGREGATIVELY
STABLE ANTIBODIES ON BASIS OF
VARIABLE DOMAINS VL AND
DERIVATIVE VHH

C 07

- (11) P 2021 7311 B (51) Int. Cl. (2006)
C 07 K 16/24
C 07 K 16/18
C 12 N 15/13
A 61 K 39/395
- (10) AP 2021 14257 A (44) 12(568)/2021
- (21) AP 2015 14257
- (22) 2015 03 23
- (24) 2015 03 23
- (31) 2014138740
- (32) 2014 09 26
- (33) RU
- (86) PCT/RU2015/000163, 2015 03 23
- (73) Closed Joint Stock Company "Biocad" (RU)
Liter A, bld. 34, Svyazi St., Strelna,
Pwtrodvortsoviy District, St. Petersburg
198515 (RU)
- (72) ULITIN, Andrey Borisovich (RU);
EVDOKIMOV, Stanislav Rudolfovich (RU);
SOLOVIEV, Valeriy Vladimirovich (RU);
CHERNYH, Yulia Sergeevna (RU);
GONCHAROVA, Olga Vladimirovna (RU);
KORZHAVIN, Dmitriy Valerievich (RU);
CHERNOVSKAYA, Tatyana Veniaminovna (RU);
NEMANKIN, Timofey Aleksandrovich (RU);
IVANOV, Roman Alexeevich (RU);

UTILITY MODEL

APPLICATION APPROVED FOR GRANTING PATENT

The decision can be appealed at the Chamber of Appeal of Sakpatenti within 3 months from the publication or at the Mtskheta District Court Administrative Cases Board (Address: №17, Samkhedro St., Mtskheta), within 1 month following the publication.

PART B

B 21

(10) AU 2021 15590 U (51) Int. Cl. (2006)
B 21 D 5/14

(21) AU 2021 15590 (22) 2021 03 22

(71) Nia Natbiladze (GE)

Al. Kazbegi Ave. 1, app. 12, 0160, Tbilisi,

Georgia (GE);

Zaal Uplisashvili (GE)

Didgori St. 91, Vill. Dighomi, 0113, Tbilisi,

Georgia (GE);

Aleksandre Kavelashvili (GE)

Vill. Patriketi, Tskaltubo Region, Georgia (GE);

Murman Khachidze (GE)

K. Gamsakhurdia St. 38, Vill. Geguti 1,

Tskaltubo Region, Georgia (GE)

(72) Nia Natbiladze (GE);

Zaal Uplisashvili (GE);

Aleksandre Kavelashvili (GE);

Murman Khachidze (GE)

(54) BENDING SHEET METAL EQUIPMENT

(57) An equipment includes a column, a table 1, a drive, and vertical guide 2 fastened onto the column with a puanson 3 movable reciprocally therein. The equipment is equipped with actuating system including two cranked conrod mechanisms connected together, first wherefrom is connected to the drive, and another – to bending puanson, as well.

Claims: 1 independent

2 dependents

Fig: 1

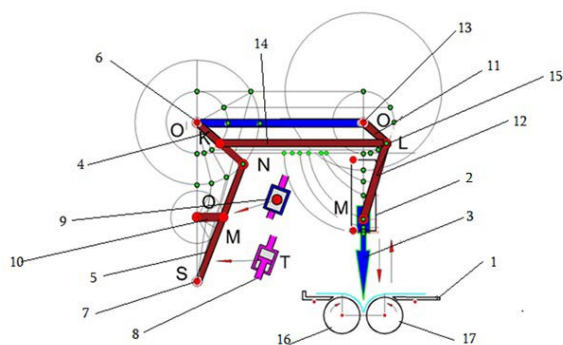

Fig. 1

DESIGNS

APPLICATION APPROVED FOR REGISTRATION

The decision can be appealed at the Chamber of Appeal of Sakpatenti within 3 months from the publication or at the Mtskheta District Court Administrative Cases Board (Address: №17, Samkhedro str., Mtskheta), within 1 month following the publication.

- (10) AD 2021 1225 S (51) 32-00
- (21) AD 2021 1225 (22) 2021 06 20
- (28) 4
- (71) LTD "Ninea" (GE)
Nino Zhvania St. 28, 0148, Tbilisi, Georgia (GE)
- (72) Sopio Chkhenkeli (GE)
- (54) 1.-4. GRAPHICAL SYMBOL
- (55)

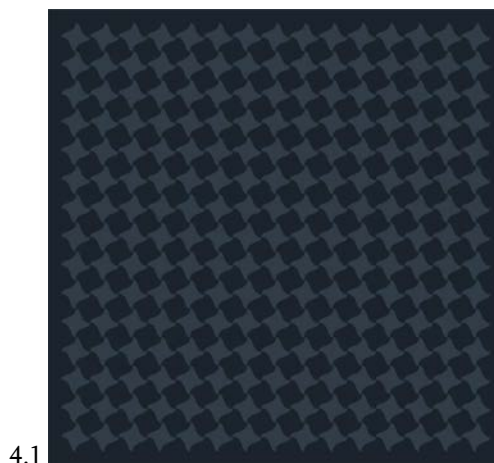
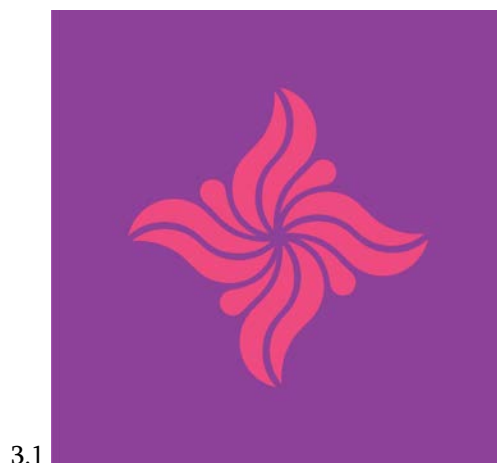
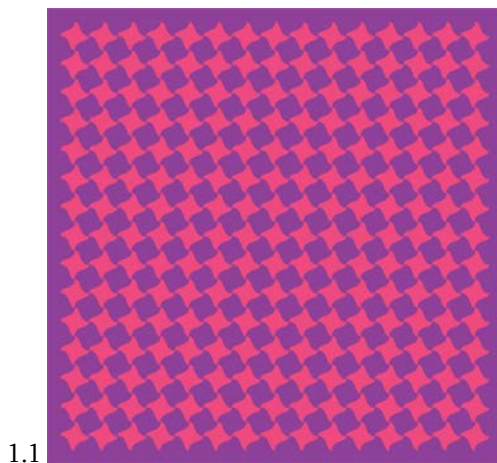

REGISTERED DESIGNS

(11) D 2021 909 S (51) 06-13
(10) AD 2021 1208 S (44) 2021 07 26 №13
(21) AD 2021 1208
(22) 2021 03 18
(24) 2021 03 18
(28) 1
(18) 2026 03 18
(73) Teimuraz Pachechyan (GE)
Bodbe Line 6, app. 6, 0144, Tbilisi,
Georgia (GE);
Roman Darchiashvili (GE)
Dighomi, II qu., corp 8b, app. 30, 0159, Tbilisi,
Georgia (GE)
(72) Teimuraz Pachechyan (GE);
Roman Darchiashvili (GE)
(54) GEORGIAN TABLECLOTH

(11) D 2021 908 S (51) 09-01
(10) AD 2021 1206 S (44) 2021 07 26 №13
(21) AD 2021 1206
(22) 2021 02 18
(24) 2021 02 18
(28) 3
(18) 2026 02 18
(73) Giorgi Zautashvili (GE)
D. Tavdadebuli St. 3, 4800, Kvareli,
Georgia (GE)
(72) Giorgi Zautashvili (GE)
(74) Giorgi Kartvelishvili (GE)
(54) 1.-3. BOTTLE

(11) D 2021 910 S (51) 09-01
(10) AD 2021 1210 S (44) 2021 07 26 №13
(21) AD 2021 1210
(22) 2021 03 20
(24) 2021 03 20
(28) 1
(18) 2026 03 20
(73) Giorgi Zautashvili (GE)
D. Tavdadebuli St. 3, 4800, Kvareli,
Georgia (GE)
(72) Giorgi Zautashvili (GE)
(74) Giorgi Kartvelishvili (GE)
(54) BOTTLE

DESIGN REGISTERED ACCORDING TO THE ACCELERATED PROCEDURE

The decision can be appealed at the Chamber of Appeal of Sakpatenti within 3 months from the publication.

- (11) D 2021 911 S (51) 21-01
- (21) AD 2021 1241 (22) 2021 10 13
- (24) 2021 10 13
- (28) 1
- (18) 2026 10 13
- (73) LTD "Chempions 111" (GE)
 Ilia Chavchavadze St. 29, fl. 5, 0179, Tbilisi, Georgia (GE)
- (72) Giga Ambokidze (GE)
- (74) Mariam Meskhi (GE)
- (54) GAME
- (55)

1.1



1.2



1.3

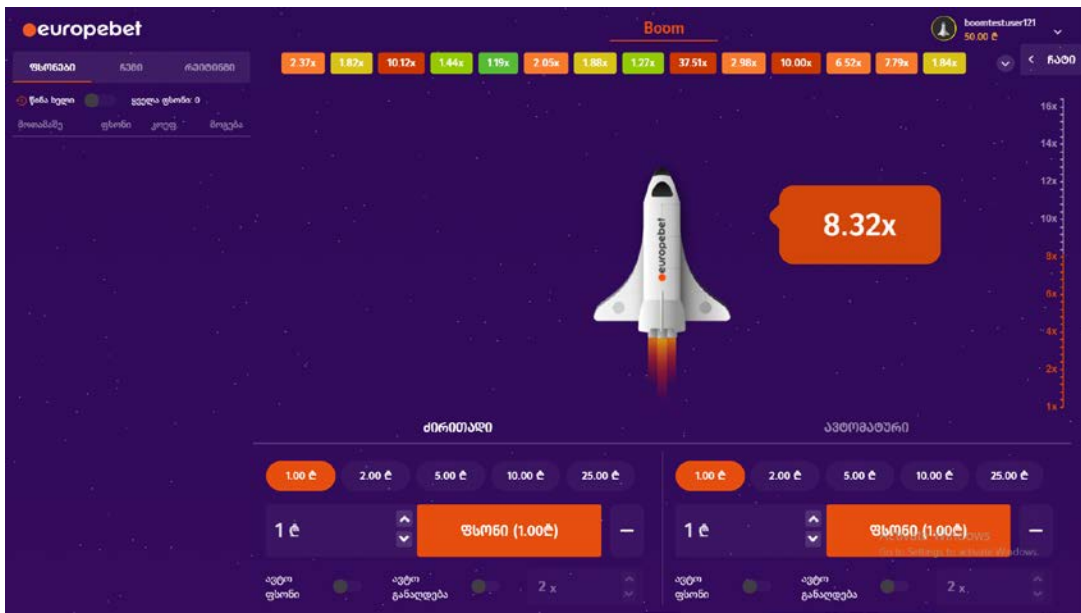

1.4



1.5

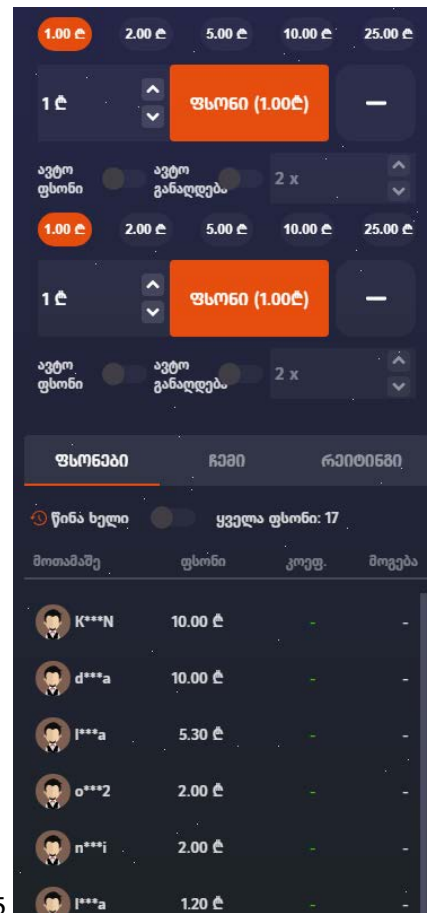

DESIGNS, WHICH HAVE BEEN REGISTERED WITH THE INTERNATIONAL BUREAU CLAIMING PRIORITY ON THE TERRITORY OF GEORGIA

The decision can be appealed at the Chamber of Appeal of Sakpatenti within 3 months from the publication or at the Mtskheta District Court Administrative Cases Board (Address: №17, Samkhedro St., Mtskheta), within 1 month following the publication.

- (11) DM/215 714
- (15) 2021 05 21
- (22) 2021 05 21
- (28) 1
- (30) No1: 02.12.2020; 008305122-0001; EM
- (73) BSH Hausgeräte GmbH
Carl-Wery-Str. 34, 81739 Munich (DE)
- (85) DE
- (86) DE
- (87) DE
- (88) DE
- (89) DE
- (81) II. MA III. AM, AZ, CA, CH, EG, GE, IL, JP, KG, KR, MN, NO, OM, RS, RU, SG, TJ, TN, TR, UA, US, VN
- (72) Dominik Meier
Nordendstr. 4a, 80799, Munich (DE);
Katja Gnielka
Brudermühlstr. 1, 81371, Munich (DE)
- (54) 1. Air purifier
- (55)

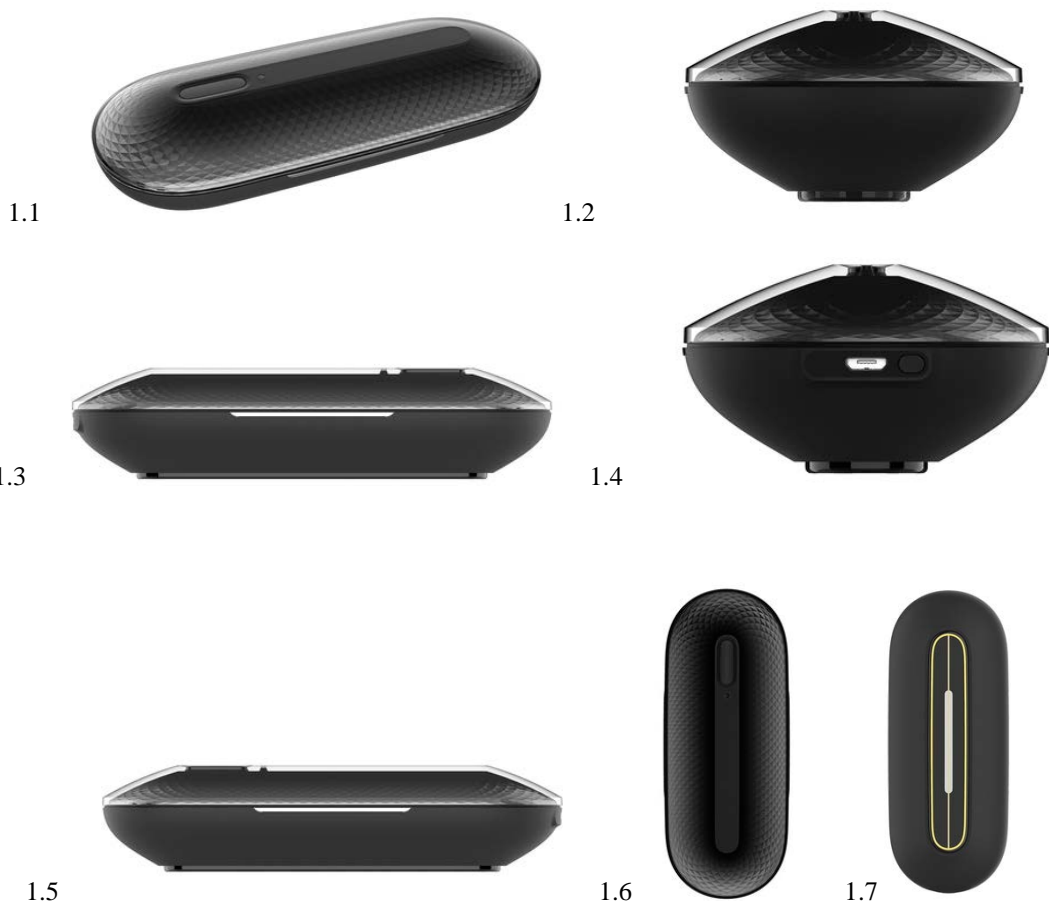

(11) DM/214 523

(51) 01-01

(15) 2021 02 25

(44) 34/2021 (2021 08 27)

(22) 2021 02 25

(28) 1

(73) Mie S.r.l.

Via Alba, 26, 12060 Barolo Barolo, CN (IT)

(85) –

(86) EM, IT

(87) IT

(88) EM

(89) EM

(81) II. MA, SN III. AL, AM, AZ, BA, CA, CH, EG, EM, GB, GE, IS, LI, MC, MD, ME, MK, NO, OM, RS, RU, SG, SR, TN, TR, UA, US

(72) Sandra Sandra

Via Francesco Crispi, 33, 12051, Alba, CN (IT)

(74) Buzzi, Notaro & Antonielli D'Oulx S.p.A. / Franco GALLAROTTI

Corso Vittorio Emanuele II, 6, 10123 Torino (IT)

(54) 1. Confectionery product

(55)

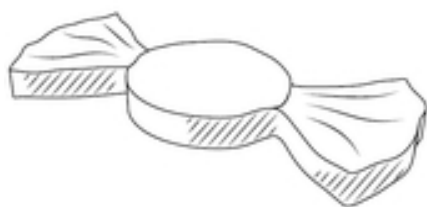

1.1

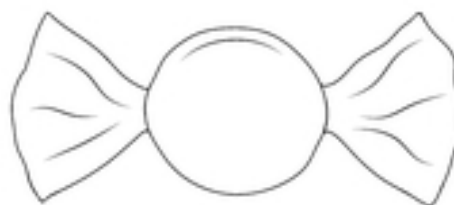

1.2

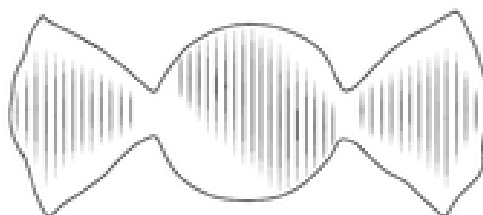

1.3



1.4



1.5



1.6



1.7

- (11) DM/212 976 (51) 10-07
 (15) 2021 02 24 (44) 34/2021 (2021 08 27)
 (22) 2021 02 24
 (28) 4
 (73) Montres Jaquet Droz SA (Montres Jaquet Droz AG) (Montres Jaquet Droz Ltd)
 Ilée Du Tourbillon 2, 2300 La Chaux-de-Fonds (CH)
 (85) –
 (86) CH
 (87) –
 (88) –
 (89) CH
 (81) II. MA III. AL, AM, AZ, BA, BZ, CH, EM, GB, GE, KG, LI, MC, MD, ME, MK, MN, NO, OM, SG,
 TN, TR, UA
 (72) 1-3 Yann Leiggenger
 La Recorne 54, 2300, La-Chaux-de-Fonds (CH);
 4 John Howe
 Rue De Port-Roulant 20, 2000, Neuchâtel (CH);
 Christian Lattmann
 Chemin Du Château-Neuf 17, 1125, Monnaz (CH)
 (74) The Swatch Group AG (The Swatch Group SA) (The Swatch Group Ltd)
 Faubourg Du Lac 6, 2501 Biel/Bienne (CH)
 (54) 1.-4. Watch dial
 (55)



1.1



1.2

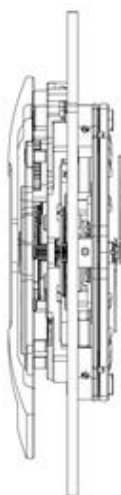

1.3



1.4



1.5



1.6



1.7

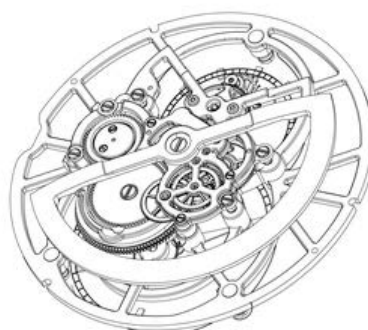

1.8



2.1



2.2



2.3



2.4



2.5



2.6



2.7

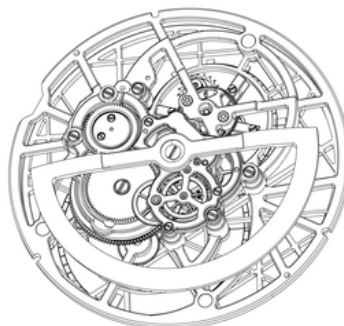

2.8



3.1



3.2

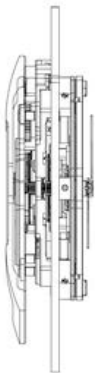

3.3

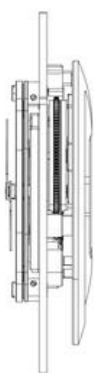

3.4



3.5

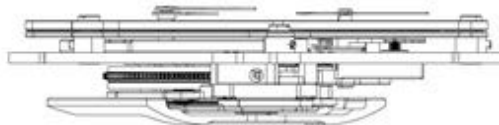

3.6

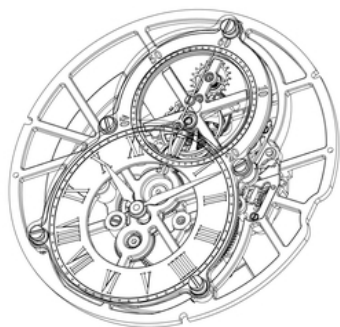

3.7

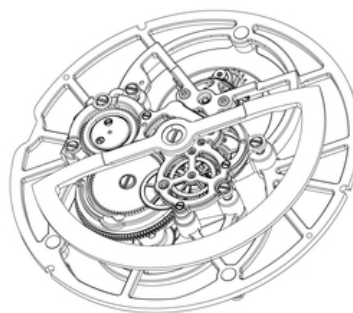

3.8



4.1



4.2

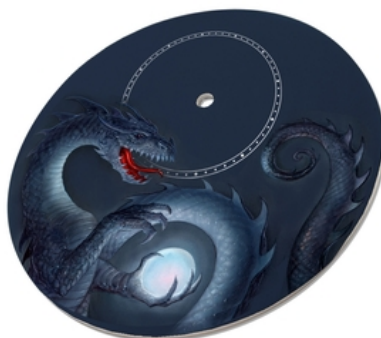

4.3

(11) DM/215 865

(51) 20-99

(15) 2021 07 29

(44) 34/2021 (2021 08 27)

(22) 2021 07 29

(28) 1

(73) ÜNTEL KABLOLARI SANAYİ VE TİCARET ANONİM ŞİRKETİ

Makine Organize Sanayi Bölgesi, 6.Cadde, No:4 Dilovası KOCAELİ (TR)

(85) –

(86) TR

(87) TR

(88) TR

(89) TR

(81) III. AL, AZ, BA, CA, CH, EG, EM, GB, GE, IL, JP, KG, KP, KR, MX, NO, OA, OM, RS, RU, SG, TJ, TM, TN, TR, UA, US, VN

(72) Ahmet Serkan Yapar

Kurtköy Mahallesi, Orhanlı Caddesi, Cihan Sokak, No: 31 E Blok, Kat: 1 ,Daire: 10, Pendik, İtatanbul (TR)

(74) DESTEK PATENT ANONİM ŞİRKETİ

Ruzi Plaza, Konak Mh. İzmir Yolu Cd, Kudret Sk. No: 20 D:Kat 6 Beşevler Nilüfer, 16110 BURSA (TR)

(54) 1. Mascot

(55)

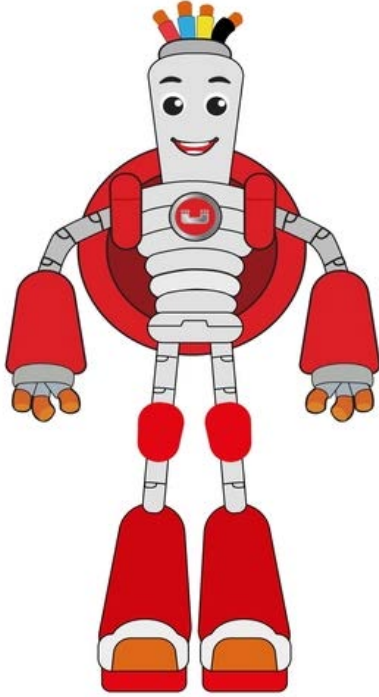

1.1

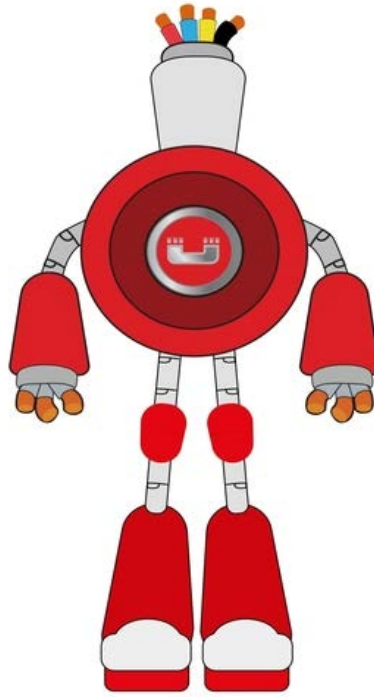

1.2

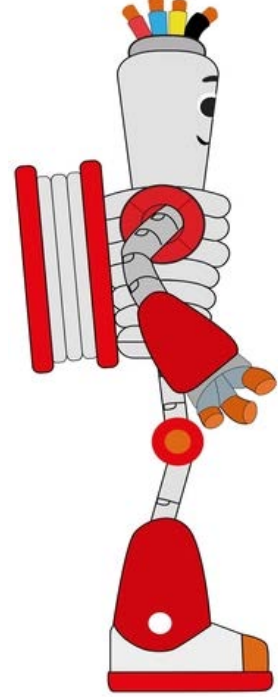

1.3

- (11) DM/215 897 (51) 21-01
 (15) 2021 06 29 (44) 34/2021 (2021 08 27)
 (22) 2021 06 29
 (28) 5
 (30) №1: 28.05.2021; 008556898-0001; EM; №2: 28.05.2021; 008556898-0002; EM; №3: 28.05.2021;
 008556898-0003; EM; №4: 28.05.2021; 008556898-0003; EM; №5: 28.05.2021; 008556898-0005; EM
 (73) AH License ApS
 Høgevej 19, 3400 Hillerød (DK)
 (85) –
 (86) DK
 (87) DK
 (88) –
 (89) DK
 (81) III. BA, CA, CH, EG, GB, GE, IL, IS, JP, KR, MK, MX, NO, OM, RS, RU, SG, TR, UA, US, VN
 (72) Henrik Larsen
 Gøgevænget 12 Gadevang, 3400, Hillerød (DK)
 (74) Elmann IPR
 Stockholmsgade 41, 2100 Copenhagen Ø (DK)
 (54) 1.-5. Construction set for children
 (55)

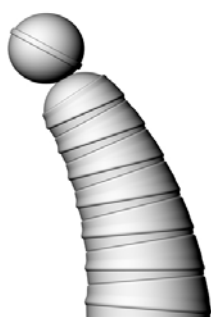

1.1



1.2



1.3



1.4



1.5

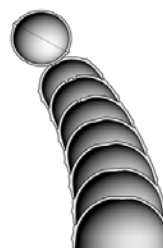

1.6



1.7



2.1



2.2



2.3

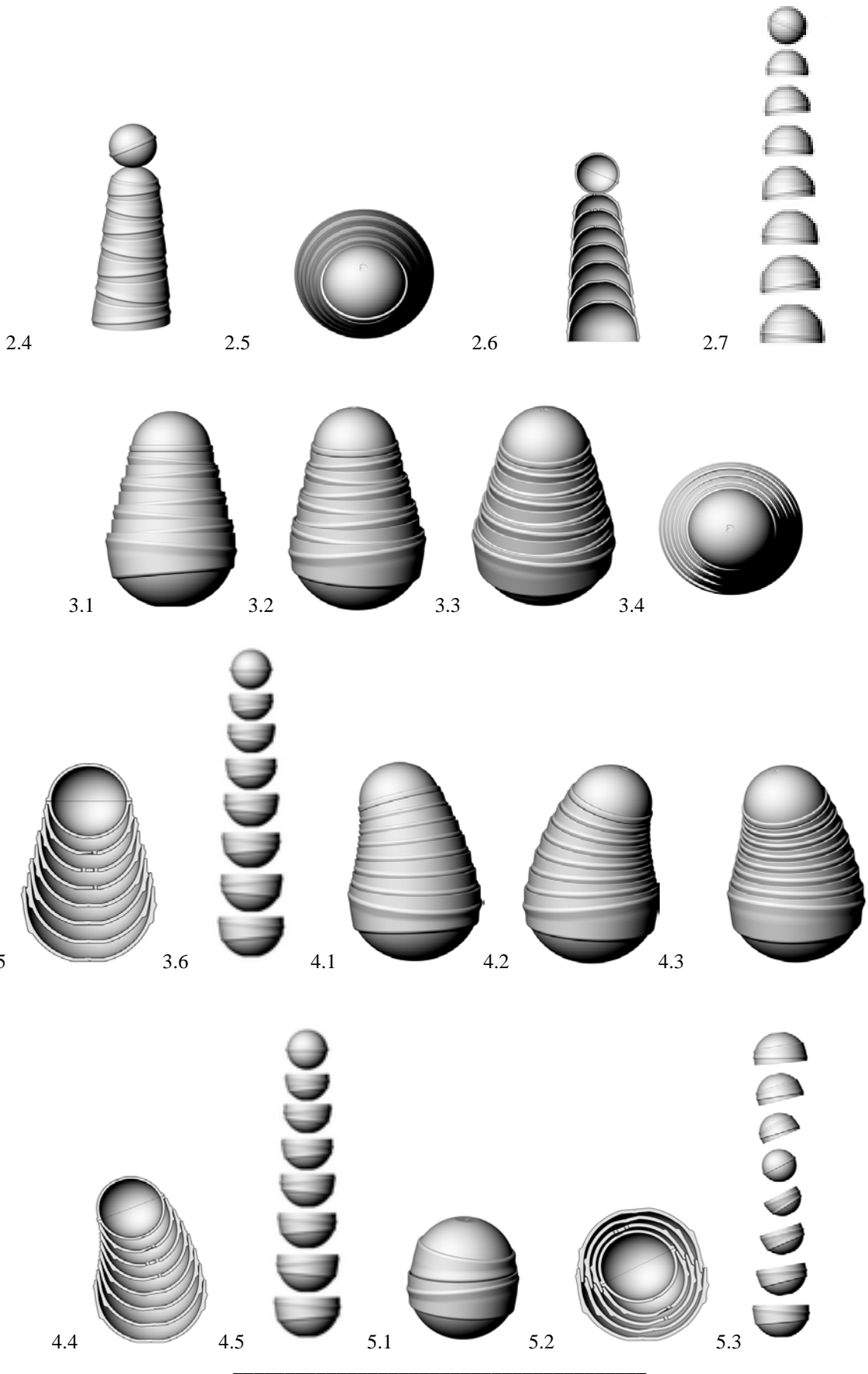

- (11) DM/215 879 (51) 24-04
 (15) 2021 06 29 (44) 34/2021 (2021 08 27)
 (22) 2021 06 29
 (28) 1
 (73) AH License ApS
 Høgevej 19, 3400 Hillerød (DK)
 (85) DK
 (86) DK
 (87) DK
 (88) DK
 (89) DK
 (81) III. BA, CA, CH, EG, EM, GB, GE, IL, IS, JP, KR, MK, MX, NO, OM, RS, RU, SG, TR, UA, US, VN
 (72) Henrik Larsen
 Gøgevænget 12 Gadevang, 3400, Hillerød (DK)
 (74) Elmann IPR
 Stockholmsgade 41, 2100 Copenhagen Ø (DK)
 (54) 1. Pacifier holder
 (55)

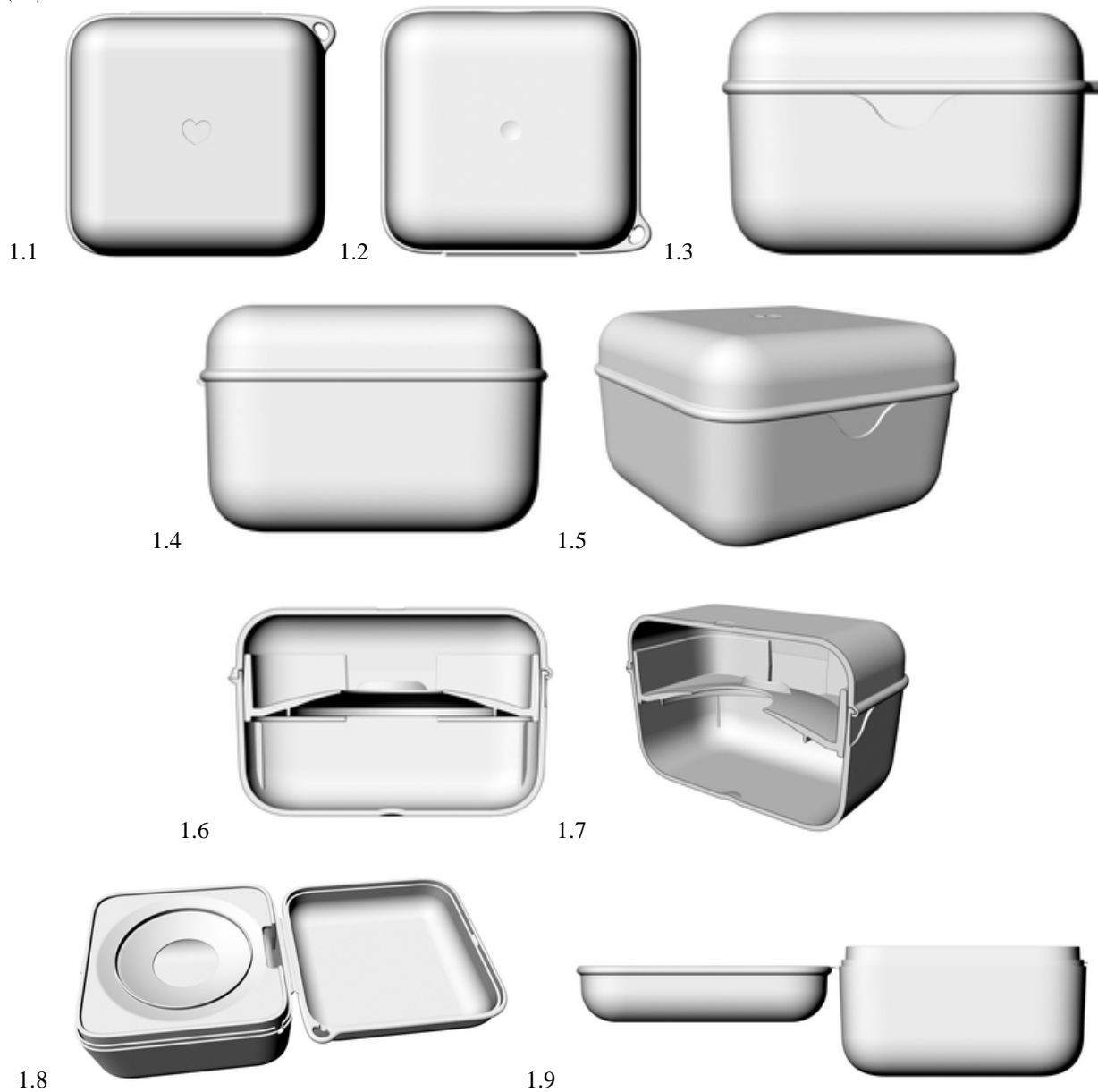

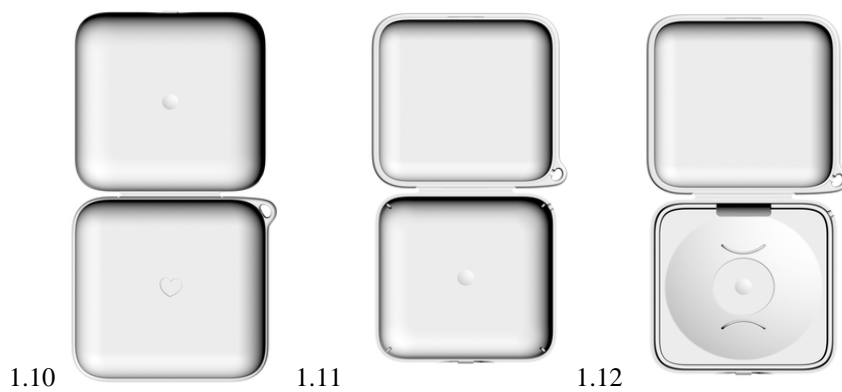

TRADEMARKS

APPLICATIONS FILED UNDER THE NATIONAL PROCEDURE APPROVED FOR REGISTRATION

The decision can be appealed at the Chamber of Appeal of Sakpatenti within 3 months from the publication or at the Mtskheta District Court Administrative Cases Board (Address: №17, Samkhedro St., Mtskheta), within 1 month following the publication.

(260) AM 2021 111500 A
(210) AM 111500
(220) 2021 01 29
(731) LTD "Marniskari"
Apakidze St. 11, Tbilisi, Georgia
(540)

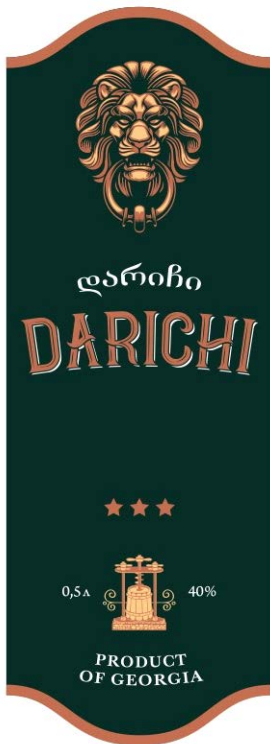

(591) Green, golden, white
(531) 03.01.01; 03.01.02; 03.01.16; 25.01.06;
25.01.10; 25.03.01; 25.03.03; 27.05.01;
27.05.24; 29.01.13
(526) Georgia
(511) 33

(260) AM 2021 111590 A
(210) AM 111590
(220) 2021 02 08
(731) Nino Orjaneli
Tianeti Highway 48a, 0107, Tbilisi,
Georgia

(540)

MAEMANI
მაემანი

(591) Brown
(531) 27.05.01
(511) 30

(260) AM 2021 112174 A
(210) AM 112174
(220) 2021 03 15
(731) LTD "Livin"
Ilia Chavchavadze Av. 47, Commercial
Space K-4, Tbilisi, Georgia
(540)



(591) Grey, black
(531) 26.04.02; 26.04.22; 27.05.01; 28.19
(511) 11, 20, 21, 35, 37, 43

(260) AM 2021 112182 A
(210) AM 112182
(220) 2021 03 16
(731) LTD "Vinery"
O. Khizanishvili St. 8, app. 66, 0167,
Tbilisi Georgia
(540)



(591) White, black, sky-blue, red
 (531) 05.05.04; 05.05.06; 05.05.20; 25.01.10;
 25.01.19; 26.04.02; 26.04.15; 26.04.22;
 27.05.01; 29.01.13
 (511) 33

(260) AM 2021 112191 A
 (210) AM 112191
 (220) 2021 03 18
 (731) LTD "Anticredit"
 Petre Iberi St. Lane 3, app. 50, 0179,
 Tbilisi Georgia
 (540)



(591) Black, green, white
 (531) 26.04.03; 26.04.19; 29.01.12
 (511) 45

(260) AM 2021 112253 A
 (210) AM 112253
 (220) 2021 03 19
 (731) Molson Canada 2005
 33 Carlingview Drive, Toronto, M9W 5E4,
 Canada
 (740) Liliana Darakhvelidze
 (540)

MOLSON CANADIAN

(591) Black-white
 (511) 32

(260) AM 2021 112256 A
 (210) AM 112256
 (220) 2021 03 19
 (731) S. C. Johnson & Son, Inc.
 1525 Howe Street, Racine, WI 53403-
 -2236, USA
 (740) Giorgi Taktakishvili
 (540)

OFF! DEFENSE

(591) Black-white
 (511) 5

(260) AM 2021 112263 A
 (210) AM 112263
 (220) 2021 03 21
 (731) Altunkaya İnşaat Nakliyat Gıda Ticaret
 Anonim Şirketi

4. Organize Sanayi Bölgesi, 83409,
 Nolu Cadde №8, Gaziantep, Turkey
 (740) Giorgi Meipariani
 (540)



(591) Sky-blue, black, blue, white
 (531) 02.09.04; 27.03.01; 27.03.02; 27.05.01;
 27.05.03; 29.01.13
 (511) 3, 5, 16

(260) AM 2021 112267 A
 (210) AM 112267
 (220) 2021 03 22
 (731) LTD "Restobro"
 Mikheil Tamarashvili Av. 13o, app. 163,
 Tbilisi Georgia
 (540)



(591) Black, white, yellow
 (531) 26.01.01; 26.01.12; 26.01.18; 26.04.02;
 26.04.10; 26.04.22; 26.04.24; 26.11.09;
 27.05.01; 27.05.17; 27.05.23; 29.01.13
 (511) 43

(260) AM 2021 112273 A
 (210) AM 112273
 (220) 2021 03 22
 (731) Enriko Beridze
 Tsitsishvili St. 18, Tbilisi, Georgia
 (740) Salome Jeladze
 (540)

AMBERO
ამბერო

(591) Black-white
 (511) 33

(260) AM 2021 112274 A
 (210) AM 112274
 (220) 2021 03 22
 (731) Compagnie Des Fromages & Richesmonts
 5 rue Chantecoq, 92800 Puteaux, France
 (740) Tamaz Shilakadze
 (540)

COEUR DE LION

(591) Black-white
(531) 27.05.01; 27.05.19
(511) 29

(260) AM 2021 112275 A
(210) AM 112275
(220) 2021 03 22
(731) Compagnie Des Fromages & Richesmonts
5 rue Chantecoq, 92800 Puteaux, France
(740) Tamaz Shilakadze
(540)

КЁР ДЕ ЛЬОН

(591) Black-white
(511) 29

(260) AM 2021 112279 A
(210) AM 112279
(220) 2021 03 23
(731) LTD "G-M-P"
Vill. Ponitchala 65, 0165, Tbilisi, Georgia
(740) Nugzar Ksovreli
(540)

დეტრი-დროპსი
Детри-Дропс
Detri-Drops

(591) Black-white
(511) 5

(260) AM 2021 112282 A
(210) AM 112282
(220) 2021 03 23
(731) Mariam Khanjaliashvili
Vill. Ruispiri, 2200, Telavi, Georgia
(540)



(591) Black, beige
(531) 05.03.04; 27.05.01; 28.19; 29.01.12
(526) ჭაბუკიანი, CHABUKIANI
(511) 33

(260) AM 2021 112283 A
(210) AM 112283
(220) 2021 03 23
(731) LLC "Elite Group"
Vekua St. 14, Gldani-Nadzaladevi
District, Tbilisi, Georgia
(540)

ატრიუმო
ATRIUM

(591) Black-white
(511) 35, 43

(260) AM 2021 112284 A
(210) AM 112284
(220) 2021 03 23
(731) LLC "Bolero & Company"
Kuchishvili St. 12-14-16, 0179, Tbilisi,
Georgia
(540)

ბუხარი
БУХАРИ
BUKHARI

(591) Black-white
(511) 33

(260) AM 2021 112286 A
(210) AM 112286
(220) 2021 03 23
(731) LTD "Mega Star"
Gamsakhurdia Av. 25, corp. 12, app. 45,
Tbilisi, Georgia
(540)



(591) Red, black, white
(531) 01.01.02; 26.04.01; 26.04.04; 26.04.18;
26.04.22; 26.04.24; 27.05.01; 27.05.21;
27.05.24; 29.01.13
(511) 21, 30

(260) AM 2021 112301 A
 (210) AM 112301
 (220) 2021 03 24
 (731) Qi Zhu
 №32, Hoichjou Stor, Jenan Neiborhud Komiti,
 Danbei Taun, Danyang, Jiangsu, 212300,
 China
 (740) Khatuna Imnadze
 (540)

KINGLION

(591) Black-white
 (531) 15.07.09; 15.07.21; 27.03.15; 27.05.01
 (511) 7

(260) AM 2021 112302 A
 (210) AM 112302
 (220) 2021 03 25
 (731) Vera Borisovna Zimnova
 Neishlotskiy Pereulok, Dom 11, corp. 1,
 app. 85, 197044, Saint Petersburg, Russian
 Federation
 (740) Liliana Darakhvelidze
 (540)



(591) White, lilac, green
 (531) 05.05.07; 05.13.01; 05.13.09; 27.05.01;
 29.01.05
 (511) 30, 43

(260) AM 2021 112309 A
 (210) AM 112309
 (220) 2021 03 25
 (731) Khairat Al Minafie CO for
 Transport & General Trading, Ltd
 27, boulevard Saborni, Varna 9000, Bulgaria
 (740) Liliana Darakhvelidze
 (540)

**BON FULL RICH
 INTERNATIONAL
 EUROPEAN**

(591) Black-white
 (511) 34

(260) AM 2021 112312 A
 (210) AM 112312
 (220) 2021 03 25
 (731) Toyota Jidosha Kabushiki Kaisha
 (also trading as Toyota Motor Corporation)
 1, Toyota-cho, Toyota-shi, Aichi-ken, Japan
 (740) Tamar Kotchlamazashvili
 (540)

TOYOTA BEYOND ZERO

(591) Black-white
 (531) 27.05.01
 (511) 12, 35, 39, 42

(260) AM 2021 112367 A
 (210) AM 112367
 (220) 2021 03 26
 (731) LTD "Alt-Info"
 Vazha-Pshavela Av., VII qu., corp. 7,
 app. 52, Tbilisi, Georgia
 (540)



ALT-INFO
www.alt-info.com

(591) Sky-blue, black, white
 (531) 26.01.01; 26.01.04; 27.05.01; 27.05.10;
 29.01.12
 (511) 16, 38, 41

(260) AM 2021 112386 A
 (210) AM 112386
 (220) 2021 03 29
 (731) Nitro-Kordex
 Vill. Tsintskaro, Tetrtskaro Region, Georgia
 (540)



(591) Red, blue, white
 (531) 26.02.07; 26.11.02; 26.11.12; 26.15.25;
 29.01.12
 (511) 13

(260) AM 2021 112387 A
 (210) AM 112387
 (220) 2021 03 29
 (731) LTD "Monolit Group"
 Chiatura St. 4/6, corp. 3, fl. 11, app. 66,
 0171, Saburtalo District, Tbilisi, Georgia
 (540)



(591) Sky-blue, blue
 (531) 07.01.12; 07.01.24; 26.04.09; 26.15.11;
 26.15.13; 29.01.04
 (511) 37

(260) AM 2021 112401 A
 (210) AM 112401
 (220) 2021 03 30
 (731) LTD "Monolit Group"
 Chiatura St. 4/6, corp. 3, fl. 11, app. 66,
 0171, Saburtalo District, Tbilisi, Georgia
 (540)



(591) 00ADE6 sky-blue, 007FAF light blue,
 005F90 dark blue
 (531) 07.01.12; 26.04.02; 26.04.09; 26.15.11;
 26.15.13; 29.01.04
 (511) 37

(260) AM 2021 112390 A
 (210) AM 112390
 (220) 2021 03 29
 (731) LTD "Biopolas"
 Noneshvili St. 65, 6000, Batumi, Georgia
 (740) Monika Kvaratskhelia
 (540)

ტრიალგინ
TRIALGIN
ТРИАЛГИН

(591) Black-white
 (511) 5

(260) AM 2021 112404 A
 (210) AM 112404
 (220) 2021 03 30
 (731) LTD "Askaneli Dzmebi"
 Kakheti Highway 110 a, 0198, Isani-Samgori
 District, Tbilisi, Georgia
 (740) Davit Dzamukashvili
 (540)

Anarekli
Анареккли

(591) Black-white
 (511) 33

(260) AM 2021 112400 A
 (210) AM 112400
 (220) 2021 03 30
 (310) 18316251
 (320) 2020 10 01
 (330) EUIPO
 (731) Philip Morris Brands Sàrl
 Quai Jeanrenaud 3, 2000 Neuchâtel,
 Switzerland
 (740) Pavle Meipariani
 (540)

AIR MIX  **FILTER**

(591) Black-white
 (531) 01.15.23; 27.05.01
 (511) 34

(260) AM 2021 112407 A
 (210) AM 112407
 (220) 2021 03 31
 (731) Ekaterine Gabashvili
 Varketili 3, IV mcr., corp. 417, app. 30, 0163,
 Samgori District, Tbilisi, Georgia
 (540)



(591) Black, white
 (531) 05.03.11; 05.03.13; 05.03.15; 05.03.17;
 05.03.20; 26.04.15; 26.04.22
 (511) 3

(260) AM 2021 112410 A
 (210) AM 112410
 (220) 2021 03 31
 (731) LTD "Good Market"
 Chabua Amirejibi Highway 6, app. 82, Vake
 District, Tbilisi, Georgia
 (540)



(591) FFFFFFF white, F90202 red, 212020 black
 (531) 05.03.11; 05.03.13; 05.03.15; 26.01.04;
 26.01.11; 26.07.05; 27.05.09; 27.05.10;
 27.05.24; 29.01.13
 (511) 35

(260) AM 2021 112422 A
 (210) AM 112422
 (220) 2021 04 01
 (731) Philip Morris Brands Sàrl
 Quai Jeanrenaud 3, 2000 Neuchâtel,
 Switzerland
 (740) Pavle Meipariani
 (540)

SOHO

(591) Black-white
 (511) 34

(260) AM 2021 112485 A
 (210) AM 112485
 (220) 2021 04 05
 (731) Tamaz Bekauri
 Otar Oniashvili St. 89, app. 2, 0160,
 Tbilisi Georgia
 (740) Zurab Bezhashvili
 (540)

**კოპისა
 Kopisa**

(591) Black-white
 (511) 33

(260) AM 2021 112487 A
 (210) AM 112487
 (220) 2021 04 05
 (731) LTD "Lilium"
 Shartava St. 39, 0160, Tbilisi,
 Georgia
 (740) Zurab Bezhashvili

(540)

(591) 000000 black
 (531) 27.05.01
 (511) 3, 44

(260) AM 2021 112488 A
 (210) AM 112488
 (220) 2021 04 05
 (731) Zurab Bezhashvili
 Vazha-Pshavela Av., VII qu., corp. 15, app. 9,
 0186, Tbilisi, Georgia
 (740) Zurab Bezhashvili
 (540)

Bezhashvil!

(591) DB1E48 red, 2C3B96 blue
 (531) 24.17.04; 27.05.01; 27.05.17; 29.01.12
 (511) 41, 45

(260) AM 2021 112499 A
 (210) AM 112499
 (220) 2021 04 07
 (731) LTD "Lynus & Co"
 Vill. Kazreti, Madneuli St. 10, Bolnisi,
 Georgia
 (540)



(591) Dark blue, white
 (531) 26.01.04; 26.01.19; 26.01.24; 27.05.22;
 27.05.24; 29.01.12
 (511) 7, 8

(260) AM 2021 112501 A
 (210) AM 112501
 (220) 2021 04 07
 (731) LTD "Hemaya"
 Vill. Krtsanisi, Gardabani Region, Georgia
 (740) Zaal Varsimashvili
 (540)

HEMAYA

(591) Black-white
 (511) 1

(260) AM 2021 112504 A
 (210) AM 112504
 (220) 2021 04 07
 (731) JSC "Ardi Insurance"
 Vazha-Psavela Av. 3, Tbilisi, Georgia
 (540)

ARDI

(591) White, black, 007A60 dark green
 (531) 26.04.01; 26.04.18; 26.04.24; 27.05.01;
 29.01.13
 (511) 19, 29, 35, 36, 37, 38, 39, 41, 42, 44, 45

(260) AM 2021 112505 A
 (210) AM 112505
 (220) 2021 04 08
 (731) LLC "International Masis Tabak"
 10 Hrant Vardanyan St., 0802 Masis, Ararat
 Region, Armenia
 (740) Giorgi Taktakishvili
 (540)



(591) Blue, golden, white, black
 (531) 05.03.01; 10.01.05; 10.01.10; 10.01.25;
 19.03.03; 19.03.25; 27.05.01; 28.19; 29.01.14
 (511) 34

(260) AM 2021 112510 A
 (210) AM 112510
 (220) 2021 04 08
 (731) LTD "Lynus & Co"
 Vill. Kazreti, Madneuli St. 10, Bolnisi,
 Georgia
 (540)



(591) Green, dark green, yellow
 (531) 26.04.02; 26.04.09; 26.04.22; 26.04.24;
 27.05.01; 27.05.11; 28.19; 29.01.12
 (511) 1, 7, 8, 11, 35

(260) AM 2021 112575 A
 (210) AM 112575
 (220) 2021 04 12
 (731) Swiss Pharma International AG
 Lindenstrasse 22, 8008 Zurich, Switzerland
 (740) Giorgi Taktakishvili
 (540)



(591) Yellow, sky-blue, pink, red, white, black,
 green
 (531) 19.03.03; 19.03.24; 25.05.01; 25.05.02;
 25.12.03; 27.05.01; 29.01.15
 (511) 5

(260) AM 2021 112576 A
 (210) AM 112576
 (220) 2021 04 12
 (731) PPG Industries Ohio Inc.
 3800 West 143rd St., Cleveland, Ohio, 44111,
 USA
 (740) Giorgi Taktakishvili
 (540)

DELTRON

(591) Black-white
 (511) 2

(260) AM 2021 112582 A
 (210) AM 112582
 (220) 2021 04 12
 (731) Guangzhou Hualiang Xinxing Electronic
 Manufacturing Co., Ltd
 №5-1, Industrial Road, Quanxi Village,
 Jianggao Town, Baiyun District, Guangzhou,
 Guangdong, China
 (740) Shalva Gvaramadze

(540)

KOLAV

(591) Black-white
 (531) 27.05.01; 27.05.17
 (511) 9

(260) AM 2021 112583 A

(210) AM 112583

(220) 2021 04 12

(731) Guangzhou Hualiang Xinxing Electronic
 Manufacturing Co., Ltd
 №5-1, Industrial Road, Quanxi Village,
 Jianggao Town, Baiyun District, Guangzhou,
 Guangdong, China

(740) Shalva Gvaramadze

(540)

LIGE

(591) Black-white
 (531) 27.05.01; 27.05.10; 27.05.17
 (511) 9

(260) AM 2021 112587 A

(210) AM 112587

(220) 2021 04 12

(731) Ketevan Giorgobiani
 Paliashvili St. 80a, Tbilisi, Georgia

(740) Roland Kitia

(540)



(591) Black-white
 (531) 26.01.05; 27.05.01; 27.05.24
 (511) 3, 35

(260) AM 2021 112590 A

(210) AM 112590

(220) 2021 04 13

(731) Ishihara Sangyo Kaisha LTD
 3-15, Edobori, 1-chome, Nishi-ku, Osaka,
 Japan

(740) Tamaz Shilakadze

(540)

KUSABI

(591) Black-white
 (511) 5

(260) AM 2021 112595 A

(210) AM 112595

(220) 2021 04 13

(731) Nuqul Brothers Company Limited
 P.O. Box 154, Amman, 11118, Jordan

(740) Liliana Darakhvelidze

(540)



(591) white, grey, black
 (531) 01.07.01; 01.07.06; 05.03.13; 24.01.15;
 26.11.12; 27.05.01; 27.05.24
 (511) 5

(260) AM 2021 112597 A

(210) AM 112597

(220) 2021 04 13

(731) Nuqul Brothers Company Limited
 P.O. Box 154, Amman, 11118, Jordan

(740) Liliana Darakhvelidze

(540)

**STERI
WASH**

(591) Black-white
 (531) 27.05.01; 27.05.09
 (511) 3

(260) AM 2021 112607 A

(210) AM 112607

(220) 2021 04 14

(731) LTD "Maqro"
 Kakhaveri St. 48, 6400, Batumi, Georgia

(540)



(591) 0C5458 swampy color, white
 (531) 01.15.23; 05.05.20; 26.13.25; 27.05.01;
 27.05.10; 27.05.24; 29.01.12
 (511) 20, 35

(260) AM 2021 112609 A
 (210) AM 112609
 (220) 2021 04 14
 (731) Nippon Soda Co., LTD
 2-1, Ohtemachi 2-chome, Chiyoda-ku, Tokyo,
 Japan
 (740) Tamaz Shilakadze
 (540)

NISSORUN

(591) Black-white
 (511) 5

(260) AM 2021 112610 A
 (210) AM 112610
 (220) 2021 04 14
 (731) LLC "Chateau Ozho"
 Vill. Sioni, Tianeti, Georgia
 (540)

ბერუნას მეღვინეობა
Beruna's Winery

(591) Black-white
 (511) 33, 35

(260) AM 2021 112614 A
 (210) AM 112614
 (220) 2021 04 14
 (731) Bridgestone Corporation
 1-1, Kyobashi 3-chome, Chuo-ku, Tokyo,
 Japan
 (740) Tamar Kotchlamazashvili
 (540)

R164

(591) Black-white
 (511) 12

(260) AM 2021 112615 A
 (210) AM 112615
 (220) 2021 04 14
 (731) Bridgestone Corporation
 1-1, Kyobashi 3-chome, Chuo-ku, Tokyo,
 Japan
 (740) Tamar Kotchlamazashvili
 (540)

R168

(591) Black-white
 (511) 12

(260) AM 2021 112616 A
 (210) AM 112616
 (220) 2021 04 14
 (731) Bridgestone Corporation
 1-1, Kyobashi 3-chome, Chuo-ku, Tokyo,
 Japan

(740) Tamar Kotchlamazashvili
 (540)

R192

(591) Black-white
 (511) 12

(260) AM 2021 112622 A
 (210) AM 112622
 (220) 2021 04 15
 (731) Giorgi Chkheidze
 Guram Panjikidze St. 22, Block "A", app. 12,
 Tbilisi Georgia
 (540)

ალექსაურო

(591) Black-white
 (511) 33, 35

(260) AM 2021 112628 A
 (210) AM 112628
 (220) 2021 04 16
 (731) H Group Construction
 Rustaveli St. 22, app. 30, Batumi, Georgia
 (540)



7th Heaven
 RESIDENCE

(591) Purple, golden
 (531) 03.07.01; 03.07.16; 27.05.01; 27.05.10;
 29.01.12
 (511) 37

(260) AM 2021 112685 A
 (210) AM 112685
 (220) 2021 04 19
 (731) Giorgi Khechuashvili
 Badri Shoshitaishvili Lane 6, app. 9, Tbilisi
 Georgia;
 Ekaterine Tskhadadze
 Guramishvili Av. 1, app. 10, Tbilisi, Georgia
 (540)



(591) Black-white
 (531) 06.01.01; 06.01.02; 06.01.04; 06.19.07
 (511) 33, 35

(260) AM 2021 112686 A
 (210) AM 112686
 (220) 2021 04 19
 (731) Giorgi Khechuashvili
 Badri Shoshitaishvili Lane 6, app. 9, Tbilisi
 Georgia;
 Ekaterine Tskhadadze
 Guramishvili Av. 1, app. 10, Tbilisi, Georgia
 (540)

ეკატერინე
Ekaterine

(591) Black-white
 (511) 33, 35

(260) AM 2021 112690 A
 (210) AM 112690
 (220) 2021 04 20
 (731) LTD "Seven Hills"
 Didi Dighomi, Giorgi Brtskinvale St. 23,
 app. 33, Vake-Saburtalo District, Tbilisi,
 Georgia
 (540)



(591) Blue, black, white
 (531) 26.01.01; 26.01.03; 26.01.20; 26.01.24;
 27.01.06; 29.01.13
 (511) 3, 16, 21, 40

(260) AM 2021 112696 A
 (210) AM 112696
 (220) 2021 04 20
 (731) LTD "Georgian Cosmetics"
 Vazha-Pshavela Av., VII qu., corp. 5b, app. 8,
 0186, Tbilisi, Georgia
 (540)



(591) Sky-blue, black, green
 (531) 01.15.15; 05.03.13; 27.05.01; 27.05.07;
 27.05.10; 29.01.13
 (511) 3

(260) AM 2021 112697 A
 (210) AM 112697
 (220) 2021 04 21
 (731) LLC "Elysee Food" (Elyseevskoe)
 Beri Gabriel Salosi Av. 165, app. 51, Tbilisi,
 Georgia
 (740) Giorgi Taktakishvili
 (540)



(591) Yellow, khaki color, sky-blue, blue
 (531) 25.01.09; 25.01.10; 25.01.25; 28.05; 29.01.13
 (511) 29, 30, 32, 33, 35

(260) AM 2021 112713 A
 (210) AM 112713
 (220) 2021 04 26
 (731) LTD "Lazieri"
 Peikrebi St. 12, Nadzaladevi District, Tbilisi,
 Georgia
 (540)



(591) Golden, white
 (531) 24.09.02; 24.09.03; 24.09.10; 24.09.11;
 24.09.24; 26.15.15; 26.15.25; 29.01.12
 (511) 20, 35

(260) AM 2021 112714 A
 (210) AM 112714
 (220) 2021 04 26
 (731) BMJ Industries FZ-LLC
 Al-Jazeera Al-Hamra, Ras Al Khaimah, UAE,
 United Arab Emirates
 (740) Tamaz Shilakadze

(540)



(591) Grey, white

(531) 26.04.02; 26.04.04; 26.04.22; 29.01.12

(511) 34

(260) AM 2021 112716 A

(210) AM 112716

(220) 2021 04 26

(731) BMJ Industries FZ-LLC

Al-Jazeera Al-Hamra, Ras-Al-Khaimah, UAE,
United Arab Emirates

(740) Tamaz Shilakadze

(540)



(591) Grey, white

(531) 26.04.02; 26.04.04; 26.04.22; 29.01.12

(511) 34

(260) AM 2021 112719 A

(210) AM 112719

(220) 2021 04 27

(731) Ty Inc.

280 Chestnut Avenue, Westmont, Illinois
60559, USA

(740) Tamaz Shilakadze

(540)

TEENIE BEANIE BOOS

(591) Black-white

(511) 28

(260) AM 2021 112721 A

(210) AM 112721

(220) 2021 04 27

(731) LTD "Agronom"

Bidzina Kvernadze St. 35, app. 56, 0171,
Tbilisi, Georgia

(540)

QLURE HAH
ქლურე ჰაჰ
KJIYPE XAX

(591) Black-white

(511) 5

(260) AM 2021 112738 A

(210) AM 112738

(220) 2021 04 29

(731) LTD "Georgian Wine and Alcoholic Beverage
Company"

Vill. Achinebuli, 2200, Telavi, Georgia

(540)

Wine is a relationship

(591) Black-white

(511) 33

REGISTERED TRADEMARKS

(111) M 2021 34644 R
(151) 2021 10 28
(181) 2031 10 28
(260) AM 2020 109611 A
(220) 2020 09 03

(732) LTD "Berika"
Ilia Chavchavadze Av., I Lane 6, app. 80,
Tbilisi, Georgia

(111) M 2021 34645 R
(151) 2021 10 28
(181) 2031 10 28
(260) AM 2020 109734 A
(220) 2020 09 11

(732) Philip Morris Products S.A.
Quai Jeanrenaud 3, 2000 Neuchâtel,
Switzerland

(111) M 2021 34646 R
(151) 2021 10 28
(181) 2031 10 28
(260) AM 2020 109735 A
(220) 2020 09 11

(732) Philip Morris Products S.A.
Quai Jeanrenaud 3, 2000 Neuchâtel,
Switzerland

(111) M 2021 34647 R
(151) 2021 10 28
(181) 2031 10 28
(260) AM 2020 109736 A
(220) 2020 09 11

(732) Philip Morris Products S.A.
Quai Jeanrenaud 3, 2000 Neuchâtel,
Switzerland

(111) M 2021 34648 R
(151) 2021 10 28
(181) 2031 10 28
(260) AM 2020 109737 A
(220) 2020 09 11

(732) Philip Morris Products S.A.
Quai Jeanrenaud 3, 2000 Neuchâtel,
Switzerland

(111) M 2021 34649 R
(151) 2021 10 28
(181) 2031 10 28
(260) AM 2020 109749 A
(220) 2020 09 14

(732) Philip Morris Products S.A.
Quai Jeanrenaud 3, 2000 Neuchâtel,
Switzerland

(111) M 2021 34650 R
(151) 2021 10 28
(181) 2031 10 28
(260) AM 2020 109775 A
(220) 2020 09 17

(732) LTD "Sandro & Company"
Vakhtang Gorgasali St. 37, app. 158,
0180, Tbilisi, Georgia

(111) M 2021 34651 R
(151) 2021 10 28
(181) 2031 10 28
(260) AM 2020 109776 A
(220) 2020 09 17

(732) Philip Morris Products S.A.
Quai Jeanrenaud 3, 2000 Neuchâtel,
Switzerland

(111) M 2021 34652 R
(151) 2021 10 28
(181) 2031 10 28
(260) AM 2020 109938 A
(220) 2020 09 30

(732) Compagnie Des Fromages & Richesmonts
5 rue Chantecoq, 92800 PUTEAUX, France

(111) M 2021 34653 R
(151) 2021 10 28
(181) 2031 10 28
(260) AM 2020 110015 A
(220) 2020 10 02

(732) Discovery Communications, LLC
8403 Colesville Road, Silver Spring, Maryland
20910, USA

(111) M 2021 34654 R
(151) 2021 10 28
(181) 2031 10 28
(260) AM 2020 110476 A
(220) 2020 11 12

(732) LLC "Alazani Winery"
Demetre Tavdadebuli St. 3, 4800, Kvareli,
Georgia

(111) M 2021 34655 R
(151) 2021 10 28
(181) 2031 10 28
(260) AM 2020 110539 A
(220) 2020 11 18
(732) Genzyme Corporation
50 Binney Street, Cambridge, MA 02142, USA

(111) M 2021 34656 R
(151) 2021 10 28
(181) 2031 10 28
(260) AM 2020 110606 A
(220) 2020 11 24
(732) Zhejiang Rifeshow Cosmetics Co., Ltd
No.67 Dashi Road, Fotang Town, Yiwu City,
Zhejiang, China

(111) M 2021 34657 R
(151) 2021 10 28
(181) 2031 10 28
(260) AM 2020 110671 A
(220) 2020 11 27
(732) Nutrimax
L. Ghoghoberidze St. 67b, 0165, Tbilisi,
Georgia

(111) M 2021 34658 R
(151) 2021 10 28
(181) 2031 10 28
(260) AM 2020 110672 A
(220) 2020 11 27
(732) Stereo App Limited
1 Dover Place, 5th Floor Ashford Commercial
Quarter, Ashford, Kent, TN23 1FB, United
Kingdom

(111) M 2021 34659 R
(151) 2021 10 28
(181) 2031 10 28
(260) AM 2020 110755 A
(220) 2020 12 07
(732) Hard Rock Limited
13-14 Esplanade, St. Helier, Jersey JE1 1EE,
Channel Islands, United Kingdom

(111) M 2021 34660 R
(151) 2021 10 28
(181) 2031 10 28
(260) AM 2020 110793 A
(220) 2020 12 11
(732) LTD "Rich Group"
Vill. Mughanlo, Marneuli Region, Georgia

(111) M 2021 34661 R
(151) 2021 10 28
(181) 2031 10 28
(260) AM 2020 110798 A
(220) 2020 12 11
(732) LTD "Rich Group"
Vill. Mughanlo, Marneuli Region, Georgia

(111) M 2021 34662 R
(151) 2021 10 28
(181) 2031 10 28
(260) AM 2020 110799 A
(220) 2020 12 11
(732) LTD "Rich Group"
Vill. Mughanlo, Marneuli Region, Georgia

(111) M 2021 34663 R
(151) 2021 10 28
(181) 2031 10 28
(260) AM 2020 110800 A
(220) 2020 12 11
(732) LTD "Rich Group"
Vill. Mughanlo, Marneuli Region, Georgia

(111) M 2021 34664 R
(151) 2021 10 28
(181) 2031 10 28
(260) AM 2020 110861 A
(220) 2020 12 12
(732) Shenzhen Quality Life Technology Co., Ltd
5th Fl., Block E, Huachuangda Technology
Park, No. 176 Hangcheng Avenue, Sanwei
Community, Hangcheng Sub-district, Baoan
District, Shenzhen, China

(111) M 2021 34665 R
(151) 2021 10 28
(181) 2031 10 28
(260) AM 2020 110864 A
(220) 2020 12 13
(732) LLC "Deutsche Product"
Marabda St. 34a, 0179, Tbilisi, Georgia

(111) M 2021 34666 R
(151) 2021 10 28
(181) 2031 10 28
(260) AM 2020 110866 A
(220) 2020 12 13
(732) LLC "Deutsche Product"
Marabda St. 34a, 0179, Tbilisi, Georgia

(111) M 2021 34667 R
(151) 2021 10 28
(181) 2031 10 28
(260) AM 2020 110867 A
(220) 2020 12 13
(732) LLC "Deutsche Product"
Marabda St. 34a, 0179, Tbilisi, Georgia

(111) M 2021 34668 R
(151) 2021 10 28
(181) 2031 10 28
(260) AM 2020 110873 A
(220) 2020 12 15
(732) JSC "Biopharm"
Gotua St. 3, 0160, Tbilisi, Georgia

(111) M 2021 34669 R
(151) 2021 10 28
(181) 2031 10 28
(260) AM 2020 110938 A
(220) 2020 12 18
(732) ADK Emotions Inc.
1-23-1 Toranomon, Minato-ku, Tokyo, Japan

(111) M 2021 34670 R
(151) 2021 10 28
(181) 2031 10 28
(260) AM 2020 110945 A
(220) 2020 12 21
(732) The Procter & Gamble Company
One Procter & Gamble Plaza, Cincinnati,
Ohio 45202, USA

(111) M 2021 34671 R
(151) 2021 10 28
(181) 2031 10 28
(260) AM 2020 110963 A
(220) 2020 12 22
(732) Shalva Merebashvili
Vakhtang Gorgasali St. 29, 2600, Kaspi,
Georgia

(111) M 2021 34672 R
(151) 2021 10 28
(181) 2031 10 28
(260) AM 2020 110969 A
(220) 2020 12 23
(732) JSC "Biopharm"
Gotua St. 3, 0160, Tbilisi, Georgia

(111) M 2021 34673 R
(151) 2021 10 28
(181) 2031 10 28
(260) AM 2020 110970 A
(220) 2020 12 23
(732) JSC "Biopharm"
Gotua St. 3, 0160, Tbilisi, Georgia

(111) M 2021 34674 R
(151) 2021 10 29
(181) 2031 10 29
(260) AM 2017 92160 A
(220) 2017 05 16
(732) Federal Treasury Enterprise "Sojuzplodoimport"
(FKP "Sojuzplodoimport")
Orlikov Pereulok, 1/11, Moscow, 107139,
Russian Federation

(111) M 2021 34675 R
(151) 2021 10 29
(181) 2031 10 29
(260) AM 2020 110131 A
(220) 2020 10 15
(732) Tengiz Bolghashvili
Atskuri St. 28, 0141, Tbilisi, Georgia

(111) M 2021 34676 R
(151) 2021 10 29
(181) 2031 10 29
(260) AM 2020 110869 A
(220) 2020 12 14
(732) LLC "M S Group"
Chirnakhuli St. 4, 0151, Tbilisi, Georgia

(111) M 2021 34677 R
(151) 2021 10 29
(181) 2031 10 29
(260) AM 2020 109833 A
(220) 2020 09 22
(732) Mariam Tsertsvadze
Panaskerteli St. 20a, Tbilisi, Georgia

(111) M 2021 34678 R
(151) 2021 10 29
(181) 2031 10 29
(260) AM 2020 110886 A
(220) 2020 12 17
(732) Ana Vakhtangishvili
Kojori Higway 45, Tsavkisi, Tbilisi, Georgia

TRADEMARKS REGISTERED ACCORDING TO THE ACCELERATED PROCEDURE

The decision can be appealed at the Chamber of Appeal of Sakpatenti within 3 months from the publication.

(111) M 2021 34636 R
(151) 2021 10 21
(181) 2031 10 21
(210) AM 114907
(220) 2021 10 08
(732) LTD "Kakhetian Traditional Winemaking"
S. Tsintsadze St. 12, Office 3/6, fl. 3, 0160,
Tbilisi, Georgia

(540)

ტერავინო

(591) Black-white
(511) 35, 43

(111) M 2021 34637 R
(151) 2021 10 22
(181) 2031 10 22
(210) AM 114620
(220) 2021 09 16
(732) LLC "Ori Nabiji"
Navtlughi St. 39-41, 0113, Isani District,
Tbilisi, Georgia

(540)



(591) White, red
(531) 26.04.02; 26.04.22; 26.04.24; 27.05.01;
27.05.11; 27.05.24; 29.01.12
(511) 32

(111) M 2021 34638 R
(151) 2021 10 22
(181) 2031 10 22
(210) AM 114621
(220) 2021 09 16
(732) LLC "Ori Nabiji"
Navtlughi St. 39-41, 0113, Isani District,
Tbilisi, Georgia

(540)



(591) Blue, red, white
(531) 01.15.03; 27.05.01; 27.05.08; 27.05.10;
29.01.13
(511) 32

(111) M 2021 34639 R
(151) 2021 10 26
(181) 2031 10 26
(210) AM 114989
(220) 2021 10 18
(732) LTD "Champions 111"
Ilia Chavchavadze Av. 29, fl. 5, 0179,
Tbilisi, Georgia
(740) Mariam Meskhi
(540)



(591) White, black, blue, golden, red
(531) 01.01.01; 01.01.09; 01.11.12; 18.05.01;
18.05.03; 18.05.10; 26.01.13; 26.01.16;
29.01.15
(511) 41

(111) M 2021 34640 R
 (151) 2021 10 26
 (181) 2031 10 26
 (210) AM 114991
 (220) 2021 10 18
 (732) Rituals International Trademarks B.V.
 Herengracht 539, 1017 BW Amsterdam,
 Netherlands
 (540)



(591) Black-white
 (531) 25.01.09; 25.01.10; 25.01.25; 26.04.01;
 26.04.05; 26.04.07; 26.04.12; 26.04.16;
 26.04.22; 26.04.24; 27.05.01; 27.05.24
 (511) 3, 4, 25, 35, 38

(111) M 2021 34641 R
 (151) 2021 10 26
 (181) 2031 10 26
 (210) AM 115010
 (220) 2021 10 19
 (732) LTD "Alco Group"
 Noah Zhordania St. 32, 3000, Marneuli,
 Georgia
 (540)



(591) Black, white, red, yellow, golden, green,
 brown
 (531) 05.03.15; 06.19.01; 06.19.05; 06.19.07;
 06.19.09; 11.03.01; 11.03.04; 11.03.14;
 25.03.01; 25.03.03; 27.05.01; 27.05.24;
 29.01.15
 (511) 30

(111) M 2021 34642 R
 (151) 2021 10 27
 (181) 2031 10 27
 (210) AM 115009
 (220) 2021 10 19
 (732) LLC "Kvareli Basement"
 Vill. Chikaani, 4800, Kvareli, Georgia
 (740) Khatuna Imnadze
 (540)



(591) White, brown, beige, yellow
 (531) 02.01.20; 05.07.10; 06.01.01; 06.01.02;
 06.01.04; 06.19.01; 06.19.07; 06.19.09;
 29.01.12
 (511) 33

(111) M 2021 34643 R
 (151) 2021 10 27
 (181) 2031 10 27
 (210) AM 114698
 (220) 2021 09 24
 (732) Hamlet Merabishvili
 Besiki St. 5, 0108, Tbilisi, Georgia

(540)



- (591) Black, white, green, golden
 (531) 06.19.07; 19.09.02; 24.07.15; 24.09.05;
 24.09.09; 25.01.19; 27.05.01; 27.05.10;
 29.01.13
 (526) რქაწითელი, RKATSITELI, PREMIUM
 GEORGIAN WINE, RKATSITELI,
 QVEVRI DRY WHITE WINE,
 750 ml, alc 13%

(511) 33

- (111) M 2021 34679 R
 (151) 2021 10 29
 (181) 2031 10 29
 (210) AM 115021
 (220) 2021 10 21
 (732) Gallaher Limited
 Members Hill, Brooklands Rd., Weybridge,
 Surrey KT13 0QU, United Kingdom
 (740) Shalva Gvaramadze
 (540)

SOBRANIE RICH

- (591) Black-white
 (511) 34

- (111) M 2021 34680 R
 (151) 2021 10 29
 (181) 2031 10 29
 (210) AM 115109
 (220) 2021 10 26
 (732) LTD "David"
 Patardzeuli Lane 40, Tbilisi,
 Georgia

(540)



- (591) Black, white, pink, yellow
 (531) 25.01.09; 25.01.10; 26.04.01; 26.04.22;
 26.04.24; 26.11.08; 27.05.01; 27.05.09;
 27.05.10; 27.05.11; 27.05.24; 29.01.13
 (511) 3

- (111) M 2021 34681 R
 (151) 2021 11 01
 (181) 2031 11 01
 (210) AM 115014
 (220) 2021 10 20
 (732) Tinatin Zaalishvili
 Vill. Kumisi, 1313, Gardabani, Georgia
 (740) Anna Romanchenko
 (540)



- (591) F49B00 golden, F5E255 yellow,
 FFED00 yellow, 1A1A18 black, FFFFFFFF
 white
 (531) 01.05.01; 24.09.01; 24.09.13; 27.05.01;
 27.05.04; 27.05.24; 29.01.12
 (511) 43

(111) M 2021 34682 R

(151) 2021 11 01

(181) 2031 11 01

(210) AM 115108

(220) 2021 10 26

(732) LTD "Alexandria"

Rapiel Agladze St. 11, app. 48, 0154,

Didube-Chughureti District, Tbilisi, Georgia

(740) Lasha Tsertsvadze

(540)

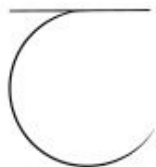

ALEXANDRIA

(591) FCFDFF white, 020202 black

(531) 27.05.01; 28.19

(511) 14

(111) M 2021 34683 R

(151) 2021 11 03

(181) 2031 11 03

(210) AM 114994

(220) 2021 10 18

(732) LLC "Kvareli Basement"

Vill. Chikaani, 4800, Kvareli, Georgia

(740) Khatuna Imnadze

(540)

ტერამანი

TERAMANI

ТЕРАМАНИ

(591) Black-white

(511) 33

(111) M 2021 34684 R

(151) 2021 11 03

(181) 2031 11 03

(210) AM 114918

(220) 2021 10 13

(732) LTD "Dale"

Kakheti Highway, app. 17, 0190, Isani

District, Tbilisi, Georgia

(540)



INTERNATIONAL TRADEMARKS FOR WHICH A DECISION ON GRANTING PROTECTIONS IS TAKEN

The decision can be appealed at the Chamber of Appeal of Sakpatenti within 3 months from the publication or at the Mtskheta District Court Administrative Cases Board (Address: №17, Samkhedro St., Mtskheta), within 1 month following the publication.

(260) AM 2021 111254 A
(800) 1570189
(151) 2020 07 30
(891) 2020 07 30
(731) Baxter S.r.l.
Via Trento 68, I-20821 Meda (MB), Italy
(540)

BAXTER

(591) Black, white
(511)
18 – Leather articles; leathers; leather goods; imitation leather goods; suitcases; trunks, harnesses and other saddlery; umbrellas.

(260) AM 2021 111265 A
(800) 1478790
(151) 2019 05 23
(891) 2020 10 28
(731) OLIMP LABORATORIES Sp. z o.o.
Pustynia 84 F, PL-39-200 Dębica, Poland
(540)

Olimp Labs

(591) Black, white
(511)
5 – Pharmaceutical and veterinary preparations, including in particular medicines for humans, adjuvants for medical purposes, medicaments in liquid form; ointments for pharmaceutical purposes, medicines for alleviating constipation, tranquillizers; laxatives, analgesics, medicated preparations for hair growth, medicinal herbs, hormones for medical purposes; dressings [medical], sanitary wear, bandages for dressings, gauze for dressings, gases for medical purposes, vulnerary sponges, adhesive bands for medical purposes; balms for medical purposes, therapeutic preparations for the bath, chemical and pharmaceutical preparations, bacteriological, bacterial and biological preparations for medical purposes, ferments for pharmaceutical and medical purposes, salts for mineral water baths; foodstuffs for infants, disinfectants, sanitary preparations for medical purposes.

(260) AM 2021 111298 A
(800) 1570779
(151) 2020 11 19
(891) 2020 11 19
(731) Limited Liability Company "NEARMEDIC PHARMA"
ul. Koroleva, 4, office 402, RU-249030
Obninsk, Kaluzhskaya oblast, Russian Federation
(540)

INLARTEKS

(591) Black, white
(531) 27.05.01
(511)
5 – Pharmaceuticals; medical preparations; medicines for human purposes; analgesics; anti-inflammatory pharmaceutical preparations; pharmaceutical preparations and medicines for the treatment of respiratory system; pharmaceutical preparations and medicines for the treatment of sore throat; medical solutions for the treatment of sore throat; medical lozenges for the treatment of sore throat; medical drops for the treatment of sore throat; medical tablets for the treatment of sore throat; pharmaceuticals in the form of anti-inflammatory sprays; pharmaceuticals in the form of antibacterial sprays; medicines in the form of oral sprays; cooling sprays for medical purposes; chemical preparations for medical purposes; chemical preparations for pharmaceutical purposes; antiseptics; anti-fungal pharmaceutical preparations; antifungal medicines; antimicrobial pharmaceuticals; pharmaceutical preparations and substances with anaesthetic properties, including for topical application; mouthwashes for medical purposes; medicated toothpaste.

42 – Research and development of new products for others; scientific research, including in the field of medicine and pharmacology; clinical trials.

44 – Medical services; pharmacy advice; medical assistance; therapy services.

(260) AM 2021 111299 A
(800) 1570810
(151) 2020 07 09
(891) 2020 07 09
(731) GRATIS İÇ VE DIŞ TİCARET ANONİM ŞİRKETİ
Levent Mah.Yapı Kredi Plaza, C Blok Cömert Sok 1C Kat.5, Beşiktaş, İstanbul, Turkey

(540)



(591) Black, white

(531) 02.09.01; 05.05.16; 05.05.20; 05.05.21;
25.01.25; 26.01.05; 26.01.18; 27.05.01

(511)

3 – Bleaching and cleaning preparations, detergents other than for use in manufacturing operations and for medical purposes, laundry bleach, fabric softeners for laundry use, stain removers, dishwasher detergents; perfumery; cosmetics; fragrances; deodorants for personal use and animals; soaps (except medicated soaps); dental care preparations: dentifrices, denture polishes, tooth whitening preparations, mouth washes, not for medical purposes; abrasive preparations; emery cloth; sandpaper; pumice stone; abrasive pastes; polishing preparations for leather, vinyl, metal and wood, polishes and creams for leather, vinyl, metal and wood, wax for polishing.

35 – Advertising, marketing and public relations; organization of exhibitions and trade fairs for commercial or advertising purposes, development of advertising concepts; provision of an online marketplace for buyers and sellers of goods and services; office functions; secretarial services; arranging newspaper subscriptions for others; compilation of statistics; rental of office machines; systemization of information into computer databases; telephone answering for unavailable subscribers; business management, business administration and business consultancy; accounting; commercial consultancy services; personnel recruitment, personnel placement, employment agencies, import-export agencies; temporary personnel placement services; auctioneering; the bringing together, for the benefit of others, of bleaching and cleaning preparations, detergents other than for use in manufacturing operations and for medical purposes, laundry bleach, fabric softeners for laundry use, stain removers, dishwasher detergents, perfumery, cosmetics, fragrances, deodorants for personal use and animals, soaps (except medicated soaps), dental care preparations: dentifrices, denture polishes, tooth whitening preparations, mouth washes, not for medical purposes, abrasive preparations, emery cloth, sandpaper, pumice stone, abrasive pastes, polishing preparations for leather, vinyl, metal and wood, polishes and creams for leather, vinyl, metal and wood, wax for polishing, pharmaceutical and veterinary preparations for medical purposes, chemical preparations for medical and veterinary purposes, chemical reagents for pharmaceutical and veterinary purposes, medicated cosmetics, dietary supple-

ments for pharmaceutical and veterinary purposes, dietary supplements, nutritional supplements for human beings and animals, medical preparations for slimming purposes, food for babies, herbs and herbal beverages adapted for medicinal purposes, dental preparations and articles (except instruments/devices): teeth filling material, dental impression material, dental adhesives and material for repairing teeth, sanitary preparations, hygienic pads, hygienic tampons, plasters, materials for dressings, diapers for adults and pets including those made of paper and textiles, preparations for destroying pest, vermin, fungicides, herbicides, deodorants, other than for human beings or for animals, air deodorising preparations, disinfectants, antiseptics, detergents for medical purposes, medicated soaps, disinfectant soaps, antibacterial hand lotions, excluding the transport thereof, enabling customers to conveniently view and purchase those goods, such services may be provided by retail stores, wholesale outlets, by means of electronic media or through mail order catalogues.

(260) AM 2021 111300 A

(800) 1570817

(151) 2020 05 20

(891) 2020 05 20

(731) Volkswagen Aktiengesellschaft

Berliner Ring 2, 38440 Wolfsburg, Germany

(540)

VEHIO

(591) Black, white

(511)

9 – Scientific, research, navigation, surveying, photographic, cinematographic, audiovisual, optical, weighing, measuring, signalling, detecting, testing, inspecting, life-saving and teaching apparatus and instruments; apparatus and instruments for conducting, switching, transforming, accumulating, regulating or controlling the distribution or use of electricity; apparatus and instruments for recording, transmitting, reproducing or processing sound, images or data; recorded and downloadable media, computer software, blank digital or analogue recording and storage media; information technology and audiovisual equipment; magnets, magnetizers and demagnetizers; apparatus, instruments and cables for electricity; optical devices, enhancers and correctors; electronic safety, security, protection and signaling devices; diving equipment; navigation, guidance, tracking, targeting and map making devices; measuring, detecting and monitoring instruments, indicators and controllers; automatic indicators of low pressure in vehicle tyres; mileage recorders for vehicles; scientific research and laboratory apparatus, educational apparatus and simulators; eyeglasses; eyeglass cases, binoculars, magnifying glasses [optics]; sunglasses; vehicle breakdown warning triangles; warning lamps for vehicles; batteries, electric and their parts, accumulators, electric and the-

ir parts, fuel cells and their parts, solar batteries; batteries, electric, for vehicles; chargers for batteries, electric; burglar alarms, fire alarms, smoke alarms, gas alarms; fire extinguishers; scales; spirit levels; compasses for measuring; rulers [measuring instruments], acid hydrometers, quantity indicators; electronic control devices and power supply apparatus for vehicle headlights and their parts; light-emitting diodes [LED], electronic power controllers; electric and electronic controllers, regulating apparatus and control instruments; simulators for the steering and control of vehicles; voltage regulators for vehicles; speed indicators; revolution counters; measuring apparatus and measuring instruments; life-saving apparatus and equipment, namely life-saving rafts, fire escapes, safety nets, safety tarpaulins, life belts, life buoys, life jackets; electrical fuses, relays, electric; lasers, not for medical purposes, laser pointers; remote control apparatus, remote controls; aerials; navigation apparatus for vehicles [on-board computers]; mobile telephones; telephone apparatus; television apparatus; video telephones; radios; directional compasses, navigating apparatus [compasses], navigational instruments; telematic apparatus; telematic terminal apparatus; magnetic, electronic and optical recording media, sound recording discs, compact discs, DVDs and other digital recording media, sound recording carriers, juke boxes, musical, compact discs [read-only memory], downloadable music files, headphones, loudspeakers, cabinets for loudspeakers, signs, luminous, compact disc players, DVD players, video telephones, phototelegraphy apparatus; projection apparatus, cameras [photography], films, exposed; film cameras, photocopyers, electronic translation apparatus (computers), electronic pocket translators; encoded magnetic cards, integrated circuit cards [smart cards], encoded telephone cards; coin-operated mechanisms; automated teller machines [ATM]; cash registers, calculating devices; data processing equipment; databases; computers; electronic agendas; facsimile machines; monitors [computer hardware] and monitors [computer programs]; computer peripheral devices; computer programs for use in the autonomous driving of vehicles; computer programs for use in the autonomous navigation of vehicles; computer programs for use in autonomous control of vehicles; computer programs, recorded and downloadable, especially for electronic data compilation; computer software platforms, computer software, downloadable; software; application software; pocket calculators; electronic publications, downloadable; downloadable image files; crash test dummies; microscopes; cables, electric; socket outlets; igniting apparatus, electric, for igniting at a distance; radiological apparatus for industrial purposes; head protection; electronic locks; electronic controllers and electronic control systems; security tokens [encryption devices]; electronic access control systems for interlocking doors; thermal imaging cameras; scales with body mass analysers; covers for tablet computers; black boxes [data

recorders]; digital weather stations; charging stations for electric vehicles; interactive touch screen terminals; smart rings; electric and electronic effects units for musical instruments; audio interfaces; equalizers [audio apparatus]; parking sensors for vehicles; teaching robots; humanoid robots with artificial intelligence; personal digital assistants [PDAs]; rearview cameras for vehicles; electric wire harnesses for automobiles; telecommunication apparatus in the form of jewellery; data gloves; parts and fittings of all aforesaid goods, included in this class.

35 – Retail and wholesale services in relation to vehicles, vehicle parts and accessories, motors and power units for land vehicles, chassis for land vehicles, vehicle bodies and tires for vehicle wheels; retail and wholesale services for mail order motor vehicles, vehicle parts and accessories, motors and power units for land vehicles, chassis for land vehicles, vehicle bodies and tires for vehicle wheels; retail and wholesale services via the Internet in relation to motor vehicles, vehicle parts and accessories, motors and power units for land vehicles, chassis for land vehicles, vehicle bodies and tires for vehicle wheels; retail and wholesale services of teleshopping consignments of motor vehicles, vehicle parts and accessories, motors and power units for land/farm vehicles, chassis for land/farm vehicles, vehicle bodies and tires for vehicle wheels; presentation, other than transport, of various motor vehicles, parts and accessories of motor vehicles, engines and power units for land vehicles, chassis for vehicles, bodies of vehicles and tires for vehicle wheels for third parties, in order to facilitate the inspection and purchase by consumers of those goods in a retail outlet; mediation of contracts for third parties on the purchase and sale of motor vehicles, motor vehicle parts and accessories, engines and powertrains for land vehicles, chassis for vehicles or vehicle bodies and tires for vehicle wheels; transportation fleet (business management of -) [for others]; commercial information and advice for consumers [consumer advice shop]; administrative processing of purchase orders; arranging of contracts for others for the buying and selling of goods; assistance, advisory services and consultancy with regard to business management; advertising; marketing; business management; business administration; clerical services; personnel management consultancy, business consultancy and advisory services, radio and television advertising, organization of trade fairs for commercial or advertising purposes, news clipping services; collection of data; data compilation for others; collating of data in computer databases; updating and maintenance of data in computer databases; systemization of information into computer databases; data search in computer files for others; registration of written communications and data; presentation of goods on communication media, for retail purposes; public relations; compiling indexes of information for commercial or advertising purposes; auctioneering; sales promotion for others; promotion of

goods and services through sponsorship of sports events; personnel recruitment; administrative services for the relocation of businesses; administrative processing of purchase orders; book-keeping; sponsorship search; consultancy and information relating to the above-mentioned services, included in this class.

38 – Telecommunication services; telecommunication; collection and delivery of messages by electronic mail; electronic message collection and transmission; news agency services; telecommunication services provided via Internet platforms and portals; providing access to information on the Internet; electronic exchange of messages via chat lines, chatrooms and Internet forums; rental of telecommunication equipment; broadcasting services; electronic transmission of messages (services for the -); information about telecommunication; providing user access to global computer networks; providing telecommunications connections to a global computer network; providing user access to computer programmes in data networks; providing Internet chatrooms; providing video conferencing services; wireless cellular phone services; computer aided transmission of messages and images; paging services [radio, telephone or other means of electronic communication], satellite transmission; telephone services; telephone exchange services; message sending; rental of telecommunication facilities; rental of message sending apparatus; rental of access time to global computer networks; providing access to databases; telematics services; telematic communication services; telematic data transmission and file transfer; information, consultancy and advisory services relating to telecommunications.

41 – Publishing and reporting; education, entertainment and sport services; translation and interpretation; providing of training; sporting and cultural activities; organisation and implementation of cultural and/or sporting events; provision of training and further training consultancy for the promotion of talent and young talent; presentation of live performances; conducting games on computer networks and the Internet; academies [education]; education information; organization of competitions [education or entertainment]; arranging and conducting of colloquia, conferences, congresses and symposiums; arranging and conducting of seminars; arranging and conducting workshops [training]; organization of exhibitions for cultural or educational purposes; coaching [training]; vocational retraining; organization of sports competitions; lending library services; publication of books; online publication of electronic books and journals; provision of a club [entertainment or education]; animal training; organization of lotteries; consultancy and information relating to the abovementioned services, included in this class.

42 – Information technology [IT] services, namely software development, programming and implementation, computer hardware development, hosting servi-

ces, software as a service [SaaS], and rental of software, rental of computer hardware and facilities, IT consultancy, advisory and information services, IT security, protection and restoration, data duplication and conversion services, data coding services, computer analysis and diagnostics, research and development and implementation of computers and computer systems, computer project management services, digital watermarks, computer technology consultancy services, technological services relating to computers, computer network services, updating the memory banks of computer systems, data migration services, updating websites for others, monitoring computer systems remotely; data encryption services; consultancy in the field of internet and data security; scientific and technological services; testing, authentication and quality control; design services; industrial analysis and research services; styling [industrial design]; development and research services for new products for third parties; provision of scientific information, advice and consultancy in relation to carbon offsetting; digitization of documents [scanning]; technical research; surveying; chemical research; biological research; weather forecasting; research in the field of physics; architectural services; fashion design; authenticating works of art; cloud seeding; software design for others; consultancy and information relating to the abovementioned services, included in this class.

(260) AM 2021 111301 A

(800) 1570818

(151) 2020 09 20

(891) 2020 09 20

(731) YİĞİTOĞLU KİMYA ANONİM ŞİRKETİ
NİSPETİYE MAHALLESİ, BAŞLIK SOKAK
M.M PLAZA NO:3, BEŞİKTAŞ / İSTANBUL,
Turkey

(540)

AGRON

(591) Black, white

(531) 27.05.01

(511)

16 – Paper and cardboard; paper and cardboard for packaging and wrapping purposes, cardboard boxes; paper towels; toilet paper; paper napkins; plastic materials for packaging and wrapping purposes; printing blocks and types; bookbinding material; printed publications; printed matter; books, magazines, newspapers, bill books, printed dispatch notes; printed vouchers, calendars; posters; photographs [printed]; paintings; stickers [stationery]; postage stamps; stationery, office stationery, instructional and teaching material [except furniture and apparatus]; writing and drawing implements; artists' materials; paper products for stationery purposes; adhesives for stationery purposes, pens, pencils, erasers, adhesive tapes for stationery purposes, cardboard cartons [artists' materials], wri-

ting paper, copying paper, paper rolls for cash registers, drawing materials, chalkboards, painting pencils, watercolors [paintings].

(260) AM 2021 111302 A

(800) 1570821

(151) 2020 07 09

(891) 2020 07 09

(731) GRATİS İÇ VE DIŞ TİCARET ANONİM
ŞİRKETİ

Levent Mah.Yapı Kredi Plaza, C Blok Cömert
Sok 1C Kat.5, Beşiktaş, İstanbul, Turkey

(540)

beaulis

(591) Black, white

(531) 27.05.17

(511)

3 – Bleaching and cleaning preparations, detergents other than for use in manufacturing operations and for medical purposes, laundry bleach, fabric softeners for laundry use, stain removers, dishwasher detergents; perfumery; cosmetics; fragrances; deodorants for personal use and animals; soaps (except medicated soaps); dental care preparations: dentifrices, denture polishes, tooth whitening preparations, mouth washes, not for medical purposes; abrasive preparations; emery cloth; sandpaper; pumice stone; abrasive pastes; polishing preparations for leather, vinyl, metal and wood, polishes and creams for leather, vinyl, metal and wood, wax for polishing.

5 – Pharmaceutical and veterinary preparations for medical purposes; chemical preparations for medical and veterinary purposes, chemical reagents for pharmaceutical and veterinary purposes, medicated cosmetics; dietary supplements for pharmaceutical and veterinary purposes; dietary supplements, nutritional supplements for human beings and animals; medical preparations for slimming purposes; food for babies; herbs and herbal beverages adapted for medicinal purposes; dental preparations and articles (except instruments/devices): teeth filling material, dental impression material, dental adhesives and material for repairing teeth; sanitary preparations; hygienic pads; hygienic tampons; plasters; materials for dressings; diapers for adults and pets including those made of paper and textiles; preparations for destroying pest, vermin; fungicides, herbicides; deodorants, other than for human beings or for animals; air deodorising preparations; disinfectants; antiseptics; detergents for medical purposes, medicated soaps, disinfectant soaps, antibacterial hand lotions.

35 – Advertising, marketing and public relations; organization of exhibitions and trade fairs for commercial or advertising purposes, development of advertising concepts; provision of an online marketplace for

buyers and sellers of goods and services; office functions; secretarial services; arranging newspaper subscriptions for others; compilation of statistics; rental of office machines; systemization of information into computer databases; telephone answering for unavailable subscribers; business management, business administration and business consultancy; accounting; commercial consultancy services; personnel recruitment, personnel placement, employment agencies, import-export agencies; temporary personnel placement services; auctioneering; the bringing together, for the benefit of others, of bleaching and cleaning preparations, detergents other than for use in manufacturing operations and for medical purposes, laundry bleach, fabric softeners for laundry use, stain removers, dishwasher detergents, perfumery, cosmetics, fragrances, deodorants for personal use and animals, soaps (except medicated soaps), dental care preparations: dentifrices, denture polishes, tooth whitening preparations, mouth washes, not for medical purposes, abrasive preparations, emery cloth, sandpaper, pumice stone, abrasive pastes, polishing preparations for leather, vinyl, metal and wood, polishes and creams for leather, vinyl, metal and wood, wax for polishing, pharmaceutical and veterinary preparations for medical purposes, chemical preparations for medical and veterinary purposes, chemical reagents for pharmaceutical and veterinary purposes, medicated cosmetics, dietary supplements for pharmaceutical and veterinary purposes, dietary supplements, nutritional supplements for human beings and animals, medical preparations for slimming purposes, food for babies, herbs and herbal beverages adapted for medicinal purposes, dental preparations and articles (except instruments/devices): teeth filling material, dental impression material, dental adhesives and material for repairing teeth, sanitary preparations, hygienic pads, hygienic tampons, plasters, materials for dressings, diapers for adults and pets including those made of paper and textiles, preparations for destroying pest, vermin, fungicides, herbicides, deodorants, other than for human beings or for animals, air deodorising preparations, disinfectants, antiseptics, detergents for medical purposes, medicated soaps, disinfectant soaps, antibacterial hand lotions, forks, spoons, knives and non-electric cutters, slicers, peelers for kitchen use, including those made of precious metals, side arms and blades (weapons), tools and apparatus included in this class for personal beauty care use: tools and apparatus included in this class for shaving, epilation, manicure and pedicure, electric hand implements for straightening and curling hair, scissors, hand-operated [non-electric] hand tools included in this class for the repair of machines, apparatus and vehicles and for use in construction, agriculture, horticulture and forestry, none of them being power tools, electric or non-electric irons, steam irons, tool handles made of any kind of material, surgical, medical, dental and veterinary apparatus and instruments, furniture especially made for medi-

cal purposes, artificial limbs and prostheses, medical orthopaedic articles: corsets for medical purposes, orthopaedic shoes, elastic bandages and supportive bandages, surgical gowns and surgical sterile sheets, adult sexual aids, condoms, babies' bottles, babies' pacifiers, teats, teethers for babies, bracelets and rings for medical purposes, bracelets and rings used to prevent rheumatism, jewellery, imitation jewellery, gold, precious stones and jewellery made thereof, cufflinks, tie pins, statuettes and figurines of precious metal, clocks, watches and chronometrical instruments, chronometers and their parts, watch straps, trophies of precious metal, rosaries, hand-operated non-electric cleaning instruments and appliances, brushes, other than paintbrushes, steel chips for cleaning, sponges for cleaning, steel wool for cleaning, cloths of textile for cleaning, gloves for dishwashing, non-electric polishing machines for household purposes, brooms for carpets, mops, toothbrushes, electric toothbrushes, dental floss, shaving brushes, hair brushes, combs, non-electric household or kitchen utensils, included in this class, [other than forks, knives, spoons], services [dishes], pots and pans, bottle openers, flower pots, drinking straws, non-electric cooking utensils, ironing boards and shaped covers therefor, drying racks for washing, clothes drying hangers, cages for household pets, indoor aquariums, vivariums and indoor terrariums for animals and plant cultivation, ornaments and decorative goods of glass, porcelain, earthenware or clay, included in this class, namely statues, figurines and vases and trophies made of these materials, mouse traps, insect traps, electric devices for attracting and killing flies and insects, fly catchers, fly swatters, perfume burners, perfume sprayers, perfume vaporizers, electric or non-electric make-up removing appliances, powder puffs, toilet cases, nozzles for sprinkler hose, nozzles for watering cans, watering devices, garden watering cans, unworked or semi-worked glass, except building glass, mosaics of glass and powdered glass for decoration, except for building, glass wool other than for insulation or textile use, beers, preparations for making beer, mineral water, spring water, table water, soda water, fruit and vegetable juices, fruit and vegetable concentrates and extracts for making beverages, non-alcoholic soft drinks, energy drinks, protein-rich beverages for athletes, excluding the transport thereof, enabling customers to conveniently view and purchase those goods, such services may be provided by retail stores, wholesale outlets, by means of electronic media or through mail order catalogues.

(260) AM 2021 111349 A

(800) 1571067

(151) 2020 10 28

(891) 2020 10 28

(731) DAIICHI SANKYO COMPANY, LIMITED
3-5-1, Nihonbashi Honcho, Chuo-ku,
Tokyo 103-8426, Japan

(540)



Daiichi-Sankyo

(591) Black, white

(531) 26.01.01; 26.01.03; 26.01.12; 26.02.05;
26.13.25; 27.05.01

(511)

10 – Surgical, medical, dental and veterinary apparatus, instruments and articles; diagnostic apparatus and instruments; apparatus for the regeneration of stem cells for medical purposes; prosthetic tissues for parietal use; prosthetic tissues for visceral use; prosthetic tissues for vascular use; medical apparatus for introducing pharmaceutical preparations into the human body; medical apparatus and instruments for use in treatment with cell preparations; medical apparatus and instruments for cell culture; pacifiers for babies; ice bag pillows for medical purposes; triangular bandages; supportive bandages; surgical catguts; feeding cups for medical purposes; dropping pipettes for medical purposes; teats; medical ice bags; medical ice bag holders; baby bottles; nursing bottles; finger guards for medical purposes; contraceptives, non-chemical; artificial tympanic membranes; prosthetics or fillings materials, not for dental use; medical apparatus and instruments; electric massage apparatus for household purposes; gloves for medical purposes; ear picks; esthetic massage apparatus for commercial use; urinals for medical purposes; bed pans.

(260) AM 2021 111350 A

(800) 1571071

(151) 2020 10 28

(891) 2020 10 28

(731) DAIICHI SANKYO COMPANY, LIMITED
3-5-1, Nihonbashi Honcho, Chuo-ku,
Tokyo 103-8426, Japan

(540)



(591) Blue, green, yellow

(531) 26.01.01; 26.01.03; 26.01.12; 26.02.05;
26.13.25; 29.01.13

(511)

10 – Surgical, medical, dental and veterinary apparatus, instruments and articles; diagnostic apparatus and instruments; apparatus for the regeneration of stem cells for medical purposes; prosthetic tissues for parietal use; prosthetic tissues for visceral use; prosthetic tissues for vascular use; medical apparatus for introducing pharmaceutical preparations into the human body; medical apparatus and instruments for use in treatment with cell preparations; medical apparatus and instruments for cell culture; pacifiers for babies; ice bag pillows for medical purposes; triangular bandages; supportive bandages; surgical catguts; feeding cups for medical purposes; dropping pipettes for medical purposes; teats; medical ice bags; medical ice bag holders; baby bottles; nursing bottles; finger guards for medical purposes; contraceptives, non-chemical; artificial tympanic membranes; prosthetics or fillings materials, not for dental use; medical apparatus and instruments; electric massage apparatus for household purposes; gloves for medical purposes; ear picks; esthetic massage apparatus for commercial use; urinals for medical purposes; bed pans.

(260) AM 2021 111351 A

(800) 1571100

(151) 2020 10 28

(891) 2020 10 28

(731) DAIICHI SANKYO COMPANY LIMITED

3-5-1, Nihonbashi Honcho, Chuo-ku,
Tokyo 103-8426, Japan

(540)



(591) Black, white

(531) 26.01.01; 26.01.03; 26.01.12; 26.02.05;
26.13.25; 27.05.01

(511)

10 – Surgical, medical, dental and veterinary apparatus, instruments and articles; diagnostic apparatus and instruments; apparatus for the regeneration of stem cells for medical purposes; prosthetic tissues for parietal use; prosthetic tissues for visceral use; prosthetic tissues for vascular use; medical apparatus for introducing pharmaceutical preparations into the human body; medical apparatus and instruments for use in treatment with cell preparations; medical apparatus and instruments for cell culture; pacifiers for babies; ice bag pillows for medical purposes; triangular bandages; supportive bandages; surgical catguts; feeding cups for medical purposes; dropping pipettes for medical purposes; teats; medical ice bags; medical ice bag holders; baby bottles; nursing bottles; finger guards for medical purposes; contraceptives, non-chemical; artificial tympanic membranes; prosthetics or fillings materials, not for dental use; medical apparatus

and instruments; electric massage apparatus for household purposes; gloves for medical purposes; ear picks; esthetic massage apparatus for commercial use; urinals for medical purposes; bed pans.

(260) AM 2021 111352 A

(800) 1571114

(151) 2020 10 26

(891) 2020 10 26

(731) BYD COMPANY LIMITED

No.1, Yan'an Road, Kuichong Street, Dapeng
New District, Shenzhen, China

(540)



(591) Black, white

(531) 18.01.07; 18.01.08; 26.11.22

(511)

9 – Data processing apparatus; computer software, recorded; computer programs, downloadable; computer software applications, downloadable; rearview cameras for vehicles; batteries, electric, for vehicles; radios; computer peripheral devices; cases especially made for photographic apparatus and instruments.

(260) AM 2021 111353 A

(800) 1571129

(151) 2020 09 10

(891) 2020 09 10

(731) HELIOS SRBIJA AD

Radovana Grkovića 24, 32300 Gornji
Milanovac, Serbia

(540)



(591) Gray and red

(531) 27.05.01; 27.05.04; 29.01.12

(511)

1 – Chemical products for use in the chemical industry for production of paints and lacquers; unprocessed artificial resins; adhesives for use in industry.

2 – Paints; varnishes; lacquers; preservatives against rust and against deterioration of wood; mordants; dyestuffs; Unprocessed natural resins; metals in foil and powder form for painters, decorators, printers and artists.

(260) AM 2021 111354 A
 (800) 1571162
 (151) 2020 10 29
 (891) 2020 10 29
 (731) GREE ELECTRIC APPLIANCES INC.,
 OF ZHUHAI
 Jinji West Road, Qianshan, Zhuhai, 519070
 Guangdong, China

(540)



(591) Black, white
 (531) 01.15.17; 26.05.04
 (511)

7 – Compressors [machines]; compressors for refrigerators; electric kitchen blenders for home use; electric juicers; electric food processors; washing machines for laundry; wringing machines for laundry; dishwashers; vacuum cleaners; electric motors other than for land vehicles; electric coffee grinders; electric meat choppers for home use; food waste disposers.

9 – Cell phones; interactive touch screen terminals; integrated circuits; data processing apparatus; downloadable applications for cell phones; remote controls for home use; electrical adapters; batteries; capacitors; electric switches; electronic chips; electric sockets; electric wires; electric cables; electric locks; computer software (recorded); face recognition equipment.

11 – Refrigerators; freezers; air conditioners; ventilation [air-conditioning] installations and apparatus; radiators, electric; laundry dryers, electric; fans [air-conditioning]; air dehumidifiers for home use; air purifying apparatus; extractor hoods for kitchen use; water heaters for the use of washing (gas or electrical heating); electric water heaters; electromagnetic induction cookers for household purposes; electric drinking water dispensers; electric kettles for home use; air humidifiers for home use; electric rice cookers; air dryers; air sterilizers; electric hair dryers; electric dish sterilizers; solar energy water heaters; bathroom air heaters; gas burners; microwave ovens for household purposes; water purification installations; electric egg boilers for household purposes; bread toasters; electric coffee machines; bakers' ovens for household use; electric slow-cookers; lighting installations; ice machines; electric wine cellars.

(260) AM 2021 111355 A
 (800) 1571167
 (151) 2020 08 20
 (891) 2020 08 20
 (731) TikTok Information Technologies UK Limited
 One London Wall, 6th Floor, London
 EC2Y 5EB, United Kingdom

(540)



(591) Black, Pantone colour 318C and Pantone colour 2040C

(531) 24.17.10; 26.13.25; 29.01.13

(511)

14 – Alarm clocks; badges of precious metal; boxes of precious metal; bracelets; earrings; jewellery; ornamental pins; shoe jewellery; tie clips; necklaces; watches; split rings of precious metal for keys; key rings; key chains.

16 – Bookmarks; printed matter; composing frames; drawing materials; desk mats; document holders; marking pens; school supplies; stationery; writing paper; table napkins of paper; paper; pencils; pictures; stands for pens and pencils; ink; teaching materials.

18 – Bags; bags for sports; boxes of leather or leatherboard; card cases; chain mesh purses; clothing for pets; handbags; net bags for shopping; suitcases; umbrellas; walking sticks; leather goods unworked or semi-worked, namely leather purses, leather cloths, leather bags, leather wallets, leather coin purses and leather briefcases.

18 – Bags; bags for sports; boxes of leather or leatherboard; card cases; chain mesh purses; clothing for pets; handbags; net bags for shopping; suitcases; umbrellas; walking sticks; leather goods unworked or semi-worked, namely leather purses, leather cloths, leather bags, leather wallets, leather coin purses and leather briefcases.

25 – Clothing, namely, shirts, t-shirts, jackets, sweaters, sweatshirts, vests, shorts, pants, bodysuits, cloth bibs, jerseys, pullovers, socks; headgear, namely, hats, caps, beanies, visors; beach shoes; belts; caps being headwear; bandanas [neckerchiefs]; gloves.

28 – Games; toys; board games; balls for games; body-building apparatus; archery implements; physical exercise machines; toy whistles; inflatable swimming pools; plastic race tracks; ice skates; Christmas tree ornaments, except illumination articles and confection-

nery; fishing tackle; twirling batons; camouflage screens [sports articles]; scratch cards for playing lottery games.

(260) AM 2021 111384 A

(800) 1571933

(151) 2020 11 26

(891) 2020 11 26

(731) SAMSUNG ELECTRONICS CO., LTD.

129, Samsung-ro, Yeongtong-gu, Suwon-si,
Gyeonggi-do, Republic of Korea

(540)

BESPOKE

(591) Black, white

(531) 27.05.09

(511)

7 – Robotic vacuum cleaners; dish washing machines; electric washing machines; vacuum cleaners; vacuum cleaner bags; outdoor air condensers for air conditioners.

11 – LED lamps; LED light bulbs; electric clothes management machines for household purposes; electric cooking ovens for household purposes; dehumidifiers for household use; air purifiers; filters for air purifiers; electric fans; air conditioners; electric refrigerators; electric ranges; electric laundry dryers; microwave ovens; cooktops.

(260) AM 2021 111386 A

(800) 1064109

(151) 2010 11 03

(891) 2020 12 31

(731) BEAUTY SUCCESS

1 rue des Lys, Parc d'activités Astier' Val,
F-24110 Saint-Astier, France

(540)

BEAUTY SUCCESS

(591) Black, white

(511)

3 – Soap, perfumery, essential oils, cosmetics, hair lotions.

5 – Pharmaceutical and parapharmaceutical products; sanitary products for medical purposes and for intimate hygiene; dietetic substances adapted for medical use; medical or sanitary disinfectants (other than soaps); dietetic beverages adapted for medical purposes.

38 – Transmission of information on the Internet and via data communications; telecommunications services, electronic messaging services on the Internet; transmission of commercial and/or advertising data on the Internet; transmission of information via electronic catalogs on the Internet; rental of access time to a database server center.

44 – Medical, sanitary and beauty care; hairdressing salons; manicuring; massage; clinics; plastic surgery.

(260) AM 2021 111456 A

(800) 1572247

(151) 2020 08 20

(891) 2020 08 20

(731) TikTok Information Technologies UK Limited

One London Wall, 6th Floor, London
EC2Y 5EB, United Kingdom

(540)



(591) Black, Pantone colour 318C and Pantone colour 2040C

(531) 24.17.10; 26.13.25; 27.05.13

(511)

9 – Software; application software; application software for smartphones; downloadable computer software applications; downloadable smart phone applications; covers for smartphones and mobile phones; cases for smartphones and mobile phones; protective cases for smartphones; selfie sticks used as smartphone accessories; holders adapted for smartphones; mobile phones; straps for smartphones; batteries; battery chargers; USB chargers (battery chargers); USB cables; earphones; headphones; headsets; protective films adapted for smartphones and mobile phones; other accessories designed for smartphones or mobile phones; fridge magnets; blank digital or analogue recording and storage media; decorative magnets; alarms; sunglasses; optical apparatus and instruments; video screens.

35 – Advertising and advertisement services; advertising agency services; on-line advertising on computer networks; pay per click advertising; preparing advertisements for others; dissemination of advertising matter; advertising through all public communication means; sales promotion for others; advice in the field of business management and marketing; presentation of goods on communication media, for retail purposes; search engine optimization services; provision and rental of advertising space on the internet; business advice and information services; assistance in management of business activities; commercial information agency services; providing business information via a website; personnel management consultancy services; updating and maintenance of data in computer databases; providing information relating to tax preparation and tax filing services; advertising; online advertising on a computer network.

-36 – Insurance; financial affairs; monetary affairs; real estate affairs; clearing and reconciling financial transactions via a global computer network; online banking services; financial services; credit card services, electronic payment services involving electronic processing and subsequent transmission of bill payment data, and providing insurance for financial transactions; funds transfer services; transmission of funds by electronic means for others; transfer of payments for others via the internet; financial services in the nature of electronic bill payment services; real estate management services; apartment management services; renting and leasing of real estate; real estate appraisal; real estate valuation; real estate financing; real estate investment; real estate brokerage services; housing agency services; actuarial services; real estate management and consultancy services; rent collection; rental of offices; capital investment services; financial evaluation services; financial and asset management services; insurance and financial services; financial services provided by telecommunication means; financial consultancy and advisory services; online banking; information services relating to finance and insurance, provided online from a computer database or the internet; antique appraisal; art appraisal; jewelry appraisal; used car appraisal; charitable fund raising; organizing of charitable collections; charitable collection services; online payment services; safe deposit services; arranging of finance for construction projects.

38 – Communications services provided over the internet; SMS message sending services; electronic message sending services; transmission of data from software applications via internet; providing user access to search engines; communication via virtual private networks [vpn]; electronic delivery of images and photographs via a global computer network; data transmission and telecommunication services; telecommunications services for providing access to data, sound or images; transmission of text, photos or video via a smartphone application; transmission of information via applications for smartphones; transmission, broadcasting and reception of audio, video, still and moving images, text and data; transfer of data via on-line services; peer-to-peer (p2p) sharing services; providing access to a video sharing portal; live video streaming services.

41 – Educational services; training services; providing video entertainment featuring music videos, via mobile devices online; provision of online electronic publications (not downloadable), via mobile devices; multimedia publishing of printed matter, books, magazines, journals, newspapers, newsletters, tutorials, maps, graphics, photographs, videos, music and electronic publications; electronic publication of information on-line; entertainment and amusement information via the internet; entertainment services; organization and presentation of shows, competitions, games,

concerts and entertainment events; arranging, organizing, conducting, and hosting social entertainment events; conducting educational conferences; publication of user generated content.

42 – Provision of software applications through a website; hosting on-line web facilities for others for sharing on-line content; hosting platforms on the internet; computer programming; computer software design; electronic data storage; software as a service (saas) services; cloud computing; hosting a website for the electronic storage of digital photographs and videos; hosting digital content on the internet; hosting multimedia entertainment content; hosting of multimedia and interactive applications; web site hosting services; business card design.

45 – Online social networking services; licensing of computer software; legal services; licensing of intellectual property.

(260) AM 2021 111457 A

(800) 1572260

(151) 2020 11 20

(891) 2020 11 20

(731) "KONTI-RUS" JOINT STOCK COMPANY
ul. Zolotaia, 13, Kursk, RU-305000
Kursk oblast, Russian Federation

(540)



(591) Light orange, brown, dark brown, light blue

(531) 05.03.13; 05.03.15; 05.03.16; 08.01.19;
19.03.24; 25.07.01; 26.05.04; 27.05.01;
29.01.13

(526) The images of candies.

(511)

30 – Confectionery.

(260) AM 2021 111458 A

(800) 1572261

(151) 2020 12 08

(891) 2020 12 08

(731) Apple Inc.

One Apple Park Way, Cupertino CA 95014,
USA

(540)



(591) The color(s) light blue, dark blue, white, black, and light brown is/are claimed as a feature of the mark

(531) 06.03.01; 06.03.02; 19.07.01; 19.07.10; 19.07.12; 19.07.20; 29.01.14

(511)

9 – Recorded and downloadable computer software for editing, organizing, encrypting, exporting, annotating, sharing, combining and converting documents and images.

(260) AM 2021 111459 A

(800) 1572278

(151) 2020 07 31

(891) 2020 07 31

(731) VIENNA INSURANCE GROUP AG Wiener Versicherung Gruppe
Schottenring 30, A-1010 Wien, Austria

(540)

(591) Blue and white

(531) 03.13.04; 03.13.24; 27.05.15; 27.05.17; 29.01.12

(511)

36 – Insurance management services; administration of financial affairs; financial management of insurance plans; financial management of pre-paid health care plans; financial management of insurance claims; financial management of group insurance plans; life insurance agencies; financial data analysis; financial evaluation and analysis relating to insurance; financial feasibility studies relating to insurance; retail financing services; financial consultancy and insurance consultancy; insurance consultancy; insurance underwriting consultancy; travel insurance; real estate insurance services; insurance services relating to holiday travels and accommodation; life insurance; motor insurance brokerage; financial services relating to insurance; financial services relating to the insurance of motor vehicles; consulting and information concerning insurance; personal insurance services relating to the supply of legal services; consultancy and brokerage services relating to vehicle insurance; consultancy and brokerage services relating to health insurance;

consultancy and brokerage services relating to home insurance; consultancy and brokerage services relating to travel insurance; claim adjustment for non-life insurance; consultancy and brokerage services relating to accident insurance; consultancy and brokerage services relating to life insurance; health insurance; accident insurance; home contents insurance; insurance services relating to motor vehicles; property insurance underwriting; insurance information; advisory services relating to life insurance; insurance brokerage; insurance services; insurance agencies; insurance agency and brokerage; insurance services relating to real estate; insurance underwriting; insurance services relating to property; insurance brokerage for property; insurance services relating to holiday accommodation; providing insurance information; financial services rendered by insurance companies; insurance services relating to mechanical breakdown; insurance services for the protection of drivers; insurance services relating to the loss of personal possessions; life insurance brokerage; insurance services relating to the theft of personal possessions; insurance brokerage consultancy and information; insurance services relating to cancelled bookings for holidays; insurance services for the provision of emergency cash; computerised processing of insurance claims; provision of insurance premium quotations; insurance premium rate computing; computerised information services relating to insurance; insurance services relating to life; financial advisory services relating to life assurance.

(260) AM 2021 111460 A

(800) 1572296

(151) 2020 12 08

(891) 2020 12 08

(731) Apple Inc.

One Apple Park Way, Cupertino CA 95014,
USA

(540)

APP CLIP

(591) Black, white

(511)

9 – Downloadable and recorded computer software; downloadable and recorded computer software for processing, facilitating, verifying, and authenticating mobile payments and contactless transactions with retailers, merchants, and vendors via wearable and mobile devices; downloadable and recorded computer software for use in searching, transmitting, receiving, storing, accessing, finding, organizing and viewing geographic location information and providing content based on location; downloadable and recorded computer software for application development; downloadable and recorded computer software development tools; downloadable and recorded computer software used in developing other software applications; downloadable and recorded application programming interface (API) software; downloadable and

recorded software development kits (SDK); downloadable and recorded computer software to maintain and operate a computer system; downloadable and recorded computer operating software.

(260) AM 2021 111490 A

(800) 1572868

(151) 2020 12 18

(891) 2020 12 18

(731) 40 Days For Life

4112 East 29th Street, Bryan TX 77802,
USA

(540)

40 DAYS FOR LIFE 365

(591) Black, white

(511)

41 – Charitable services, namely, providing educational materials in the nature of brochures and guides featuring information regarding the support of pro-life efforts in local communities; education services, namely, providing training programs in the field of organizing pro-life events that center on the issues of the sanctity of life and the rights of the preborn; organizing exhibitions for educational purposes in the field of defending the lives of the preborn and ending abortion; providing educational demonstrations in the field of pro-life activities, namely, defending and supporting the life of the preborn; providing educational mentoring services and programs in the field of pro-life support to expecting mothers.

(260) AM 2021 111494 A

(800) 1484943

(151) 2019 07 12

(891) 2021 01 08

(731) Japan Tobacco Inc.

1-1, Toranomon, 4-chome, Minato-ku, Tokyo,
Japan

(540)

STUDIO CAMEL

(591) Black, white

(511)

34 – Tobacco, raw or manufactured; smoking tobacco, pipe tobacco, rolling tobacco, chewing tobacco, snus; cigarettes, electronic cigarettes, cigars, cigarillos; snuff; smokers' articles included in class 34; cigarette paper, cigarette tubes and matches.

(260) AM 2021 111549 A

(800) 1573144

(151) 2020 10 06

(891) 2020 10 06

(731) Opel Automobile GmbH

Bahnhofplatz, 65423 Rüsselsheim,
Germany

(540)

PURE PANEL

(591) Black, white

(511)

12 – Motor vehicles, their parts and spare parts.

(260) AM 2021 111551 A

(800) 1573262

(151) 2020 12 03

(891) 2020 12 03

(731) ROSIER S.A., Société Anonyme

Route de Grandmetz 11bus A, B-7911
Frasnes-lez-Anvaing, Belgium

(540)

ROSAFERT

(591) Black, white

(511)

1 – Chemical products for use in agriculture, horticulture and forestry (with the exception of fungicides, herbicides and products for destroying vermin); soil fertilizers.

(260) AM 2021 111554 A

(800) 1573381

(151) 2020 12 11

(891) 2020 12 11

(731) G.R.Y.P.A.N.D. LTD

Lemesou 5, Eurosure Tower, CY-2112
Aglantzia, Lefkosia, Cyprus

(540)



(591) Black, white

(531) 05.01.03; 05.01.05; 05.01.16; 27.05.01

(511)

30 – Ice cream; pastries; non-medicated confectionery products; ice for refreshment; snack food products made from cereal flour; mixed flour for food; vanilla flavourings for culinary purposes; vanillin [vanilla substitute]; frozen yoghurt [confectionery ices]; malt biscuits; sherbets [ices]; cereal preparations; sugar, honey, treacle; confectionery; cocoa beverages with milk; caramels [candy]; coffee beverages with milk; marzipan; alimentary seasonings; chips [cereal products]; coated nuts [confectionery]; chocolate coated macadamia nuts; coffee-based beverages; chocolate beverages with milk; coffee and cocoa; waffles; quiches; dessert mousses [confectionery]; muesli; petit-beurre biscuits; cocoa-based beverages; custard; pies; chocolate-based beverages; crushed oats.

31 – Citrus fruit, fresh; almonds [fruits]; maize; edible sesame, unprocessed; malt; cereal seeds, unprocessed; coconuts; nuts [fruits]; chestnuts, fresh; barley; grains [cereals]; cocoa beans, raw; sowing seeds; peanuts, fresh; peanuts, unprocessed; fresh pistachio nuts; hazelnuts, fresh.

32 – Ginger beer; aperitifs, non-alcoholic; malt beer; sherbets [beverages]; table waters; isotonic beverages; cocktails, non-alcoholic; lemonades; mineral and aerated waters; soft drinks; cider, non-alcoholic; vegetable juices [beverages]; syrups for beverages; soda water; syrups for making beverages; syrups and other non-alcoholic preparations for making beverages.

43 – Canteen services; self-service cafeteria services; snack-bar services; café services; food and drink catering; restaurant services; bar and restaurant services; services for providing food.

(260) AM 2021 111556 A
(800) 1573399
(151) 2020 09 20
(891) 2020 09 20
(731) OXYGENTRACK LLC
1209 Orange Street, Wilmington DE 19801,
USA

(540)

TIME TO WALK

(591) Black, white
(511)

38 – Transmission and streaming of data, images, music, audio, video, and multimedia by means of telecommunications networks; subscription transmission and streaming services of data, images, music, audio, video, and multimedia by means of telecommunications networks; video-on-demand transmission services; peer-to-peer photo sharing services, namely, electronic transmission of music, audio, video, and multimedia among Internet users; providing access to websites, databases, electronic bulletin boards, on-line forums, directories, music, and video and audio programs on the Internet.

41 – Educational services; fitness and exercise instruction, training, and consultation; providing fitness and exercise classes; providing information on fitness and exercise via a website; production of podcasts, presentation and distribution of films and of sound and video recordings, production or distribution of television programs with entertainment content; providing ongoing audio, video, podcast, and webcast programs; providing non-downloadable entertainment, music, informational, reality, documentary, current events, and arts and culture programming; entertainment information.

42 – Providing temporary use of online non-downloadable computer software; providing temporary use of online non-downloadable computer software for use

in connection with fitness and exercise; hosting a website for the uploading, storing, sharing, viewing, and posting of images, audio, videos, podcasts, and multimedia content; hosting websites and computer applications featuring entertainment, music, informational, reality, documentary, current events, and arts and culture programming.

(260) AM 2021 111576 A
(800) 1513739
(151) 2019 07 09
(891) 2020 09 17
(731) Mykhailo Yudin
Hlazunova st., 3 ap. 1, Kyiv 01601, Ukraine

(540)

FORTOX[®]
ФОРТОКС[®]

(591) Black, white
(531) 27.05.01; 28.05
(511)

3 – Cosmetics, cosmetic preparations for skin care.

5 – Medicines for human purposes, drugs for medical purposes, pharmaceutical preparations, pharmaceutical preparations for skin care, pharmaceuticals, chemico-pharmaceutical preparations, chemical preparations for medical purposes, chemical preparations for pharmaceutical purposes.

(260) AM 2021 111621 A
(800) 1574217
(151) 2020 12 07
(891) 2020 12 07
(731) Supl.biz Limited Liability Company
Nakhimova ln, 12/1, off. 28, RU-634012
Tomsk, Russian Federation

(540)

Supl.biz

(591) Black, white
(531) 24.17.02; 27.05.01
(526) BIZ
(511)

35 – Import-export agency services; commercial information agency services; demonstration of goods; updating and maintenance of data in computer databases; providing business information via a web site; providing commercial and business contact information; web indexing for commercial or advertising purposes; sales promotion for others; dissemination of advertising matter; advertising; online advertising on a computer network; compilation of information into computer databases; systemization of information into computer databases; negotiation and conclusion of commercial transactions for third parties; search engine

optimization for sales promotion; price comparison services; outsourcing services [business assistance]; providing commercial information and advice for consumers in the choice of products and services; commercial intermediation services; provision of an on-line marketplace for buyers and sellers of goods and services; retail or wholesale services, including via a web site.

(260) AM 2021 111626 A
 (800) 1574332
 (151) 2020 07 20
 (891) 2020 07 20
 (731) Société des Produits Nestlé S.A.
 CH-1800 Vevey, Switzerland
 (540)



(591) Dark green, light green, beige, dark brown, red and white
 (531) 01.15.11; 11.03.01; 11.03.04; 11.03.20; 25.01.15; 27.05.09; 27.05.10; 27.05.11; 27.05.24; 28.05; 29.01.15
 (511)
 30 – Coffee, coffee extracts, coffee-based beverages; iced coffee.

(260) AM 2021 111651 A
 (800) 1575029
 (151) 2020 12 24
 (891) 2020 12 24
 (731) Beijing Vastdata Technology Co., Ltd.
 Room 01, 6 / F, SEAT B, Keda Tiangong Building, NO.30, Xueyuan Road, Haidian District, 100000 Beijing, China
 (540)

VASTDATA

(591) Black, white
 (531) 27.05.01
 (511)
 9 – Radios; computer memory devices; computer software applications, downloadable; meters; data processing apparatus; electronic notice boards; monitoring apparatus, electric; surveying apparatus and instruments; optical apparatus and instruments; integrated circuits.

(260) AM 2021 111665 A
 (800) 1575247
 (151) 2020 12 15
 (891) 2020 12 15
 (731) Apple Inc.
 One Apple Park Way, Cupertino CA 95014, USA
 (540)



(591) Purple, blue, and green
 (531) 02.07.23; 04.05.03; 29.01.13
 (511)
 9 – Downloadable computer software for accessing, browsing, managing, viewing, storing, and sharing files; computer software for keeping track of personal appointments, synchronizing and sharing calendar appointments with others, and providing automated reminders and event scheduling; computer software for searching, browsing, reviewing, downloading, sending, receiving, sharing, and viewing images and graphics; computer software for searching, browsing, reviewing, downloading, sharing, sampling, and playing electronic games and software applications; computer software for searching, browsing, reviewing, downloading, sharing, sampling, and playing live and pre-recorded audio, video, and multimedia content; computer software for searching, browsing, reviewing, downloading, sharing, sampling, and reading electronic books, newspapers, periodicals, and publications; computer software for personal information management; computer software for tracking the location of mobile digital electronic devices; computer software for use in accessing the Internet or other computer or communications networks.

(260) AM 2021 111666 A
 (800) 1575250
 (151) 2020 12 01
 (891) 2020 12 01
 (731) Joint-Stock Company "RUSSKY PRODUCT"
 Moskovskaya Str., 77, Detchino vlg.,
 Maloyaroslavetskiy region, RU-249080
 Kaluzhskaya area, Russian Federation
 (540)



(591) Light blue, white, dark yellow, green, light brown, beige, light green, yellow, milky white, light pink, red, burgundy, brown, gray, blue, orange, salad

(531) 02.07.12; 06.03.01; 06.19.01; 29.01.15

(511)

5 – Food for babies.

30 – Oatmeal; groats for human food; cereal preparations; oat-based food; chips [cereal products]; oat flakes; crushed oats; husked oats.

(260) AM 2021 111686 A

(800) 1462089

(151) 2019 03 04

(891) 2021 01 20

(731) MVH I, INC.

80-85 CHEVY CHASE ST, JAMAICA NY
11432, USA

(540)

MYLÉ

(591) Black, white

(511)

34 – Nicotine-based liquid, namely, liquid nicotine used to fill electronic cigarettes; cartridges, also known as pods, sold filled with liquid nicotine for electronic cigarettes; electronic cigarette liquids, namely, chemical flavorings in liquid form used to fill electronic cigarettes including filling electronic cartridges, also known as pods; cartridges, also known as pods, sold filled with chemical flavorings in liquid form for electronic cigarettes; electronic cigarettes; electronic smoking vaporizers, namely, electronic cigarettes; tobacco substitutes in liquid solution form other than for medical purposes for electronic cigarettes; smoker's and vaper's articles for electric and electronic cigarettes namely, cases for electronic cigarettes and electronic cigarette accessories and boxes for electronic cigarettes and electronic cigarette accessories.

(260) AM 2021 111687 A

(800) 1514854

(151) 2020 01 09

(891) 2021 01 13

(731) J. Choo Limited

10 Howick Place, London SW1P 1GW,
United Kingdom

(540)

I WANT CHOO

(591) Black, white

(531) 26.01.06; 27.05.19

(511)

3 – Soaps, bath gel, shower gel; perfumery, fragrances, eau de toilette, colognes, aftershave, perfumes in solid form; cosmetics, make-up, make-up preparations; essential oils, essential oils for personal use, bo-

dy oils, body lotion, body cream, moisturizing creams, deodorant for personal use, pre-shave and after-shave lotions; creams, gels and foam for shaving; hair lotions, hair conditioners, foot lotions; bath preparations not for medical purposes, balms not for medical purposes; nail care preparations, nail varnish, nail polish, nail varnish and nail polish removing preparations; talcum powder; sunscreen preparations; sun-tanning preparations; pumice stone; emery; dentifrices; shoe cream, shoe polish, shoe wax; cleaning and polishing preparations, including cleaning and polishing preparations for leather, footwear, handbags, sunglasses; room fragrance, room fragrancing preparations, aromatics for indoor use.

(260) AM 2021 111767 A

(800) 1575556

(151) 2020 12 15

(891) 2020 12 15

(731) Richter Gedeon Nyrt.

Gyömrői út 19-21, H-1103 Budapest, Hungary

(540)

КАСТАНИД

(591) Black, white

(531) 28.05

(511)

5 – Pharmaceutical preparations.

(260) AM 2021 111768 A

(800) 1575560

(151) 2020 12 15

(891) 2020 12 15

(731) Richter Gedeon Nyrt.

Gyömrői út 19-21, H-1103 Budapest, Hungary

(540)

БАВАРТИН

(591) Black, white

(531) 28.05

(511)

5 – Pharmaceutical preparations.

(260) AM 2021 111771 A

(800) 1575611

(151) 2020 11 04

(891) 2020 11 04

(731) PERFETTI VAN MELLE S.P.A.

Via XXV Aprile, 7, I-20020 Lainate (Milano),
Italy

(540)



(591) Black, white, purple, yellow, light blue
 (531) 28.05; 29.01.15
 (511)
 30 – Cocoa; coffee; cakes; caramels [sweets]; chewing gum; confectionery; sugar; pastries; liquorice [confectionery]; mints for breath freshening; lollipops [confectionery]; fruit jellies [confectionery].

(260) AM 2021 111772 A
 (800) 1575633
 (151) 2020 07 27
 (891) 2020 07 27
 (731) HEREHA VITALII VOLODYMYROVYCH
 7 house, Zavalivska st., Snyatyn city 78300,
 Ivano-Frankivska region, Ukraine
 (540)



(591) Black, white
 (531) 01.01.01; 01.01.10; 01.05.23; 02.05.06;
 02.05.23; 25.05.03; 26.05.01; 26.05.14;
 27.05.10
 (511)
 3 – Cleansing milk for toilet purposes, namely: baby wipes impregnated with cleaning preparations, wipes impregnated with cleaning preparations; cosmetics for children; tissues impregnated with cosmetic lotions; tissues impregnated with make-up removing preparations; antistatic preparations for household purposes, namely antistatic dryer sheets.

(260) AM 2021 111776 A
 (800) 1575761
 (151) 2020 10 02
 (891) 2020 10 02
 (731) Limited Liability Company «MedTechService»
 PO box 26, Irkutsk, RU-664020 Irkutsk region,
 Russian Federation
 (540)

Gmate

(591) Black, white
 (511)
 5 – Diagnostic biomarker reagents for medical purposes; biological preparations for medical purposes; diagnostic preparations for medical purposes.
 10 – Blood testing apparatus; testing apparatus for medical purposes; apparatus for use in medical analysis; body rehabilitation apparatus for medical purposes; physiotherapy apparatus; diagnostic apparatus for medical purposes; apparatus for DNA and RNA testing for medical purposes; gastroscopes; surgical imp-

lants comprised of artificial materials; temperature indicator labels for medical purposes; sphygmomanometers; sphygmotensimeters; arterial blood pressure measuring apparatus; pulse meters; esthetic massage apparatus; medical apparatus and instruments; orthodontic appliances; spirometers [medical apparatus]; tomographs for medical purposes; brain pacemakers.

(260) AM 2021 111778 A
 (800) 1575850
 (151) 2021 01 12
 (891) 2021 01 12
 (731) Burger King Corporation
 5707 Blue Lagoon Drive, Miami FL 33126,
 USA
 (540)



(591) Black, white
 (531) 08.01.06
 (511)
 9 – Downloadable mobile application software for obtaining restaurant information, online ordering of food and beverages for pickup and delivery, accessing a customer loyalty reward programme, including account and profile information, promotions, and reward status information.
 43 – Restaurant services; fast-food restaurant services; quick service restaurant services; providing prepared meals; preparation of food and meals for consumption on or off the premises.

(260) AM 2021 111792 A
 (800) 1576311
 (151) 2020 12 17
 (891) 2020 12 17
 (731) Kia Corporation
 12, Heolleung-ro, Seocho-gu, Seoul 06797,
 Republic of Korea
 (540)



(591) Black, white
 (531) 27.05.19
 (511)
 7 – Vending machines; lubricating pumps; drive devices for opening and closing vehicle doors; electric opening mechanisms for vehicle windows; pneumatic

transporters; automatic grappels for marine purposes; excavators; excavator parts; snow ploughs; apparatus for machining; taps [parts of machines, engines or motors]; sieves [machines or parts of machines]; chemical machines for industrial purposes; glass-working machines; painting machines and apparatus; packing machines; fuel pumps for land vehicle engines; exhaust pipes for land vehicles; pistons for land vehicle engines; liquefied fuel injectors for land vehicles; fuel injector parts for land and water vehicle engines; engines for marine vessels; aeroplane engines; aeronautic engines; automotive engine blocks; oil filters for automobile engines; fuel economisers for motors and engines; engines and motors for the generation of electricity; engines and motors for model vehicles, aircraft and boats; pumps for land vehicle engines; pumps as parts of machines, motors and engines; connecting rods for land vehicle engines; timing belts for engines for land vehicles; fan belts for land vehicle engines; speed change gears being parts of machines; speed change gears for ships or aircrafts; spring shock absorbers for machines; disc brakes being parts of machines; bearings for engines; vehicle washing machines; automatic parking installations; plastic processing machines; printing machines for manufacturing of three-dimensional products; starter motor; current generators for automobiles; ignition devices for motors of land vehicles; robots for machine tools; driving devices for robots; welding electrodes; electronic ignitions for vehicles.

(260) AM 2021 111793 A

(800) 1576320

(151) 2020 11 16

(891) 2020 11 16

(731) Suzhou 3Ctest Electronic Co., Ltd.

No.99 Emeishan Road, Suzhou New District,
Suzhou City, Jiangsu Province, China

(540)



(591) Black, white

(531) 26.13.25; 27.07.11

(511)

9 – Semiconductor testing apparatus; surveying apparatus and instruments; electrical measuring apparatus; transformers [electricity]; high-frequency apparatus; lasers for measuring purposes; high-frequency switching power supplies; electric switches; low-voltage power supplies; stabilized voltage supply.

(260) AM 2021 111794 A

(800) 1576328

(151) 2021 01 15

(891) 2021 01 15

(731) Apple Inc.

One Apple Park Way, Cupertino CA 95014,
USA

(540)

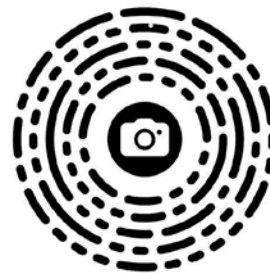

(591) Black, white

(531) 16.03.01; 26.01.05

(511)

9 – Downloadable and recorded computer software; downloadable and recorded computer software for processing, facilitating, verifying, and authenticating mobile payments and contactless transactions with retailers, merchants, and vendors via wearable and mobile devices; downloadable and recorded computer software for use in searching, transmitting, receiving, storing, accessing, finding, organizing and viewing geographic location information and providing content based on location; downloadable and recorded computer software for application development; downloadable and recorded computer software development tools; downloadable and recorded computer software used in developing other software applications; downloadable and recorded application programming interface (API) software; downloadable and recorded software development kits (SDK); downloadable and recorded computer software to maintain and operate a computer system; downloadable and recorded computer operating software.

(260) AM 2021 111795 A

(800) 1576342

(151) 2021 01 19

(891) 2021 01 19

(731) Apple Inc.

One Apple Park Way, Cupertino CA 95014, USA

(540)

MAGSAFE DUO CHARGER

(591) Black, white

(511)

9 – Charging mats for use with computers, mobile telephones and smart watches; charging apparatus for use with computers, mobile telephones and smart watches; wireless chargers for mobile phones, wireless chargers for smart watches.

(260) AM 2021 111796 A

(800) 1576374

(151) 2021 01 15

(891) 2021 01 15

(731) Apple Inc.

One Apple Park Way, Cupertino CA 95014,
USA

(540)



(591) Black, white

(531) 05.07.13; 16.03.01; 26.01.05; 26.04.04;
26.04.24

(511)

9 – Downloadable and recorded computer software; downloadable and recorded computer software for processing, facilitating, verifying, and authenticating mobile payments and contactless transactions with retailers, merchants, and vendors via wearable and mobile devices; downloadable and recorded computer software for use in searching, transmitting, receiving, storing, accessing, finding, organizing and viewing geographic location information and providing content based on location; downloadable and recorded computer software for application development; downloadable and recorded computer software development tools; downloadable and recorded computer software used in developing other software applications; downloadable and recorded application programming interface (API) software; downloadable and recorded software development kits (SDK); downloadable and recorded computer software to maintain and operate a computer system; downloadable and recorded computer operating software.

(260) AM 2021 111797 A

(800) 1576397

(151) 2021 01 18

(891) 2021 01 18

(731) Apple Inc.

One Apple Park Way, Cupertino CA 95014,
USA

(540)

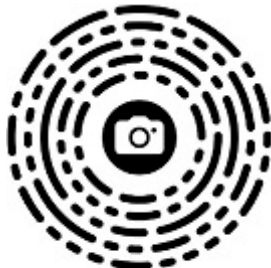

App Clip

(591) Black, white

(531) 05.07.13; 16.03.01; 26.01.05

(511)

9 – Downloadable and recorded computer software; downloadable and recorded computer software for

processing, facilitating, verifying, and authenticating mobile payments and contactless transactions with retailers, merchants, and vendors via wearable and mobile devices; downloadable and recorded computer software for use in searching, transmitting, receiving, storing, accessing, finding, organizing and viewing geographic location information and providing content based on location; downloadable and recorded computer software for application development; downloadable and recorded computer software development tools; downloadable and recorded computer software used in developing other software applications; downloadable and recorded application programming interface (API) software; downloadable and recorded software development kits (SDK); downloadable and recorded computer software to maintain and operate a computer system; downloadable and recorded computer operating software.

(260) AM 2021 111798 A

(800) 1576419

(151) 2021 01 07

(891) 2021 01 07

(731) Bayer Consumer Care AG

Peter Merian-Str. 84; CH-4052 Basel,
Switzerland

(540)

РелиБаланс

(591) Black, white

(531) 28.05

(511)

5 – Pharmaceutical products and medical preparations.

(260) AM 2021 111799 A

(800) 1576431

(151) 2020 12 15

(891) 2020 12 15

(731) Richter Gedeon Nyrt.

Gyömrői út 19-21, H-1103 Budapest, Hungary

(540)

БЛЭВАНДИКС

(591) Black, white

(531) 28.05

(511)

5 – Pharmaceutical preparations.

(260) AM 2021 111800 A

(800) 1576440

(151) 2021 01 07

(891) 2021 01 07

(731) Bayer Consumer Care AG

Peter Merian-Str. 84; CH-4052 Basel,
Switzerland

(540)

RELIEBALANCE

(591) Black, white

(511)

5 – Pharmaceutical products and medical preparations.

(260) AM 2021 111807 A

(800) 1576620

(151) 2020 12 30

(891) 2020 12 30

(731) Kroshnyi Ivan Vasylovych

vul. Shukhevycha, bud. 6/9, Novoyavorivsk,
Yavorivskiy r-n, Lvivska Obl. 81053, Ukraine

(540)



(591) Black, white

(531) 24.17.09; 27.05.10; 27.05.22

(511)

36 – Actuarial services; financial analysis; banking; stock brokerage services; stocks and bonds brokerage; brokerage of carbon credits; real estate brokerage; insurance brokerage; securities brokerage; brokerage; repair costs evaluation [financial appraisal]; issuance of travellers' cheques; issuance of credit cards; issuance of tokens of value; investment of funds; arranging finance for construction projects; preparation of quotes for cost estimation purposes; online banking; trusteeship; debt advisory services; electronic transfer of virtual currencies; electronic funds transfer; providing insurance information; providing financial information; providing financial information via a web site; safe deposit services; deposits of valuables; charitable fund raising; rent collection; capital investment; mortgage banking; apartment house management; real estate management; clearing, financial; insurance consultancy; stock exchange quotations; crowdfunding; pawnbrokerage; marine insurance underwriting; providing rebates at participating establishments of others through use of a membership card; loans [financing]; instalment loans; bail-bonding; exchanging money; processing of debit card payments; processing of credit card payments; real estate affairs; organization of monetary collections; rental of apartments; rental of real estate; rental of offices [real estate]; rental of offices for co-working; rental of farms; antique appraisal; stamp appraisal; real estate appraisal; numismatic appraisal; art appraisal; fiscal valuation; jewellery appraisal; cheque verification; lending against security; accommodation bureau services [apartments]; real estate agency services; credit bureau services; mutual funds; surety services; financing services; debt collection agency services; e-wallet payment services; savings bank services; provident fund services; insuran-

ce underwriting; accident insurance underwriting; fire insurance underwriting; life insurance underwriting; health insurance underwriting; factoring; financial management; financial management of reimbursement payments for others; financial consultancy; financial evaluation of development costs relating to the oil, gas and mining industries; financial evaluation of wood; financial evaluation of standing timber; financial valuation of intellectual property assets; financial appraisals in responding to calls for tenders; financial evaluation [insurance, banking, real estate]; financial sponsorship; financial research; financial exchange of virtual currency; financial customs brokerage services; hire-purchase financing; business liquidation services, financial; retirement payment services.

(260) AM 2021 111809 A

(800) 1576697

(151) 2020 11 05

(891) 2020 11 05

(731) CAGS TOBACCO TUTUN VE TUTUN
MAMULLERI SANAYI VE TICARET
ANONIM SIRKETIMaslak Mah., Sogutozu sok., Agaoglu Maslak
1453, T4Blok No:20U/B124, Sariyer, Istanbul,
Turkey

(540)

10BAK

(591) Black, white

(531) 27.05.01; 27.05.17; 27.07.01; 27.07.17

(511)

34 – Tobacco; chewing tobacco; hookah tobacco; cigarettes; cigars; cigarette cases; tobacco pipes; cigar holders; cigarette holders; smokers' mouthpieces for cigarettes, cigars, cigarette holders and cigar holders; cigarette rolling papers; ashtrays for smokers; humidors; pocket machines for rolling cigarettes; cigarette paper; firestones; lighters for smokers; matches.

(260) AM 2021 111811 A

(800) 1576773

(151) 2020 07 01

(891) 2020 07 01

(731) MIRZA INTERNATIONAL LIMITED
A-7, Mohan Co-operative Industrial area,
Mathura road, New Delhi-110044, India

(540)

MODE
REDTAPE LONDON

(591) Black, white

(531) 27.05.10

(526) LONDON

(511)
25 – Ready made garments and clothing; footwear and parts of footwear.

(260) AM 2021 111812 A
(800) 1576775
(151) 2020 11 10
(891) 2020 11 10
(731) SHENZHEN TCL NEW TECHNOLOGY CO., LTD.
9/F, Building D4, International E City, 1001 Zhongshan Park Road, Xili Street, Nanshan District, Shenzhen, Guangdong, China

(540)



(591) Black, white
(531) 15.07.01; 26.11.08; 27.03.15
(511)
9 – Data processing apparatus; computers; computer programs, downloadable; computer peripheral devices; tablet computers; interactive touch screen terminals; humanoid robots with artificial intelligence; downloadable software applications for mobile phones; computer software applications, downloadable; computer software platforms, recorded or downloadable; monitors [computer hardware]; electronic interactive whiteboards; integrated circuit cards [smart cards]; facial recognition apparatus; digital signs; cell phones; wearable activity trackers; television apparatus; loudspeakers; cabinets for loudspeakers; audio and video-receivers; sound transmitting apparatus; sound recording apparatus; sound reproduction apparatus; camcorders; headphone; microphones; virtual reality headsets; security surveillance robots; wearable video display monitors; portable media players; video projectors; audiovisual teaching apparatus; integrated circuits; chips [integrated circuits]; fluorescent screens; video screens; touch screen; remote controls; locks, electric; electric door bells.

(260) AM 2021 111814 A
(800) 1576825
(151) 2020 11 18
(891) 2020 11 18
(731) NINGBO DOOYA MECHANIC & ELECTRONIC TECHNOLOGY CO., LTD.
No.168, Shengguang Road, Luotuo Street, Zhenhai District, Ningbo, Zhejiang, China

(540)



(591) Black, white
(531) 27.05.01; 27.05.17
(511)
7 – Dynamos; wind turbines; transmissions for machines; mufflers for motors and engines; pneumatic transporters; elevating apparatus; universal joints [cardan joints]; filtering machines; curtain drawing devices, electrically operated; shredders [machines] for industrial use; shoe polishers, electric; electric door up-rolling machine; door closers, electric; door openers, electric.
9 – Electrified fences; resistances, electric; wind socks for indicating wind direction; inductors [electricity]; projection screens; remote control apparatus.

(260) AM 2021 111822 A
(800) 1357492
(151) 2016 12 01
(891) 2021 02 01
(731) SIGFOX
425 rue Jean Rostand, F-31670 LABEGE, France
(540)



(591) Black, gray
(531) 03.13.01; 26.01.02; 26.01.04; 26.01.06
(511)
9 – Scientific, nautical, surveying, photographic, cinematographic, optical, weighing, measuring, signaling, checking and control (inspection), life-saving (rescue) and educational apparatus and instruments, namely detection chips for scientific use, scientific measuring instruments in the form of conductivity meters, navigation apparatus for boats, surveying instruments, photographic apparatus, cameras (cinematographic apparatus), blank optical data media, optical cables, optical character readers, weighing instruments and apparatus, distance measuring apparatus, instruments for measuring the strength, signal bells, signal processors, transmitters of electronic signals, laser scanners for industrial monitoring (inspection), optical inspection apparatus, life rafts, life jackets, life preservers, children's educational software; apparatus for emitting, recording, transmitting or reproducing sound, data or images; magnetic data carriers, namely CD-Rs and DVD-Rs and blank recordables, blank CD-ROMs for sound or video recording, blank recordable optical discs; electronic data processing apparatus, computers, computer memories, modems, blank magnetic computer tapes, facsimile machines; magnetic or op-

tical media for computers, namely blank optical discs, blank magnetic discs; electric cables, blank digital optical discs, keyboards, printed circuits, printed circuit boards, integrated memory cards, electronic circuit cards, electronically encoded identification cards, computer software for database management, for use as a spreadsheet and for word processing; software packages, namely computer software for database management, for use as a spreadsheet, word processing and user manuals sold as a unit; computer terminals, video screens, printers for use with computers; electronic machines with screen and keyboard, namely electronic telephone sets with screen and keyboard, laptop computers; input or output carriers, namely blank magnetic and optical discs; apparatus for the collection, reading, storage, conversion, processing, inputting, broadcasting and transmission of data, information and signals, namely electronic card readers, RFID readers, blank digital storage media, frequency converters, converters for television and video, data processing apparatus, computer input devices, transmitting and receiving apparatus for radio and television broadcasting and for long-distance transmission; apparatus for transmission of communications, namely apparatus for transmitting data and signals by telephone, facsimile machine, telegraph, telex, cable, satellite or any communication media; telecommunication and radio communication apparatus, namely portable telephones and landlines, answering machines; media for recording and reproducing sound, images or signals, namely blank audio tapes, blank discs for computers, blank magnetic discs, blank optical discs; telecommunication transmitters and receivers, namely radio transmitters and receivers, wireless receivers and transmitters, telephone receivers, telecommunication transmitters.

38 – Telecommunications, namely the transmission of information accessible by any means of telecommunication; secure data transmission services by telecommunication; communications by computer terminals, communications by telephone; transmission of information by telephone, television and radio; transmission and reception of information via the Internet, satellite, cable, radio broadcasting and all means of communication; transmission of messages and encoded images; electronic data transmission services, particularly packet transmission of information and images, radio-paging and electronic mail services, electronic mailing and transmission of dispatches, and electronic exchange of data stored in databases accessible via telecommunication networks, namely computerized documents exchange and electronic exchange of information; information relating to telecommunications, namely telephone information services relating to telecommunications; telephone communication services, namely transfer of telephone calls; electronic messaging services, namely services for transmitting replies on an online interactive electronic service on a telecommunications network; electronic data trans-

mission, namely electronic information dissemination services for global communication networks or private or restricted-access networks; computer-aided electronic transmission of downloadable data, messages and images; provision of user access to global computer networks; provision of access to databases; provision of access to databases in the form of search engines; electronic messaging services on a telecommunication network; rental of telecommunication apparatus and installations; services provided by telecommunication consultants in the form of technical consulting and advice in the field of telecommunications; data transmission and reception services via telecommunications, namely transmission and receipt of data, signals, images and information processed by computers or by telecommunication apparatus; digital network telecommunications services, namely mobile telecommunications network services; digital network telecommunications services, namely definition of telecommunication networks; rental of access time to global computer networks, namely to a database server center.

(260) AM 2021 111823 A

(800) 1372394

(151) 2015 09 25

(891) 2021 01 26

(731) COOPERATIVA CERAMICA D'IMOLA S.C.
Via Vittorio Veneto, 13, I-40026 IMOLA
(BOLOGNA), Italy

(540)



(591) Black, white

(531) 26.04.02; 26.04.05; 26.04.22; 26.04.24;
26.11.08; 27.05.01; 27.05.10

(511)

19 – Tiles, not of metal, for building; floor tiles, not of metal; parquet flooring and parquet slabs; floors, not of metal; building stone; mosaics for building; ceilings, not of metal; duckboards, not of metal; luminous paving blocks; partitions, not of metal; non-metal coverings; non-metal roof coverings; wood panelling; signalling panels, non-luminous and non-mechanical, not of metal; marble; stones; cement slabs; building materials and components, not of metal; tiles; fire-proof tiles; translucent tiles (not of metal); ceramic tiles for flooring; ceramic tiles for paving; ceramic tiles for internal walls; ceramic tiles for external floors; ceiling tiles (non-metallic); tiles, not of metal, for building exteriors; building bricks, not of metal; facing bricks, not of metal; parquet flooring; parquet wood flooring; parquet floor boards; roofing tiles, not of metal; roof construction materials, not of metal; cla-

dding panels, not of metal, for roofs; covering panels, not of metal, for roofs; non-metal roof coverings; non-metallic roofing plates; veneers; pavements made of non-metallic materials; floorboard of non-metallic materials; flooring screeds; pavement screeds; flooring (non-metallic); paving cobblestones; paving blocks of non-metallic materials; paving stones; ceramic coverings for floor; non-metallic paving products; floors, not of metal; non-metallic flooring materials; paving blocks, not of metal; building panels, not of metal; wall panelling, not of metal; non-metallic cladding panels; non-metal floor panels; non-metallic interlocking panels for building; translucent building panels made from plastic materials; non-metallic waterproofing boards; signs, information and advertising displays, non-metallic, non-luminous and non-mechanical; non-metallic sidings; coatings (building materials); non-metallic facing bricks; cementitious waterproofing coatings; non-metallic wall claddings; wall panelling made of non-metallic materials; facing panels of non-metallic materials; non-metallic building slabs; fire burrs; non-metallic ceiling tiles; non-metallic ceiling panels; non-metallic cladding for ceilings; non-metal coverings for ceilings; signs made of plastic (non-luminous and non-mechanical); partitions, not of metal; screed coatings; building glass; figurines, statuettes of stone, concrete or marble included in this class; marble for building.

35 – Advertising; rental of advertising spaces; business research; conducting of marketing research; organization of trade fairs for commercial purposes; sponsorship search; business management; business administration; office functions; commercial or industrial management assistance; advertising agency services; demonstration of goods for promotional and advertising purposes; sales promotion for others; dissemination of advertising matter; distribution of samples; presentation of goods on communication media, for retail purposes; production of promotional films; shop window dressing; leasing of shop signs for advertising purposes; advertising for shop signs; business administration assistance; bill-posting (outdoor advertising); commercial information and advice for consumers (consumer advice shop); market research and surveys; conducting of marketing studies; negotiation and conclusion of commercial transactions for third parties; consultancy services related to human resources management; outsourcing services; business merchandising display services; products merchandising; public relations; import and export services; procurement services for others (purchasing goods and services for other business); arranging and conducting of events for promotional and advertising purposes; organization, promotion and execution of events, conferences and trade fairs for commercial and advertising purposes; promotional sponsorship of events.

(260) AM 2021 111824 A
(800) 1381552
(151) 2017 11 21
(891) 2021 01 28
(731) Immunomedics, Inc.
300 American Road, Morris Plains, NJ 07950,
USA

(540)

TRODELVY

(591) Black, white
(511)
5 – Pharmaceutical preparations.

(260) AM 2021 111825 A
(800) 1391463
(151) 2017 11 27
(891) 2021 01 20
(731) EPL SYSTEMS LTD
Gladstonos, 116, M. KYPRIANOU HOUSE,
3&4th floor, Limassol, CY-3032, Cyprus
(540)

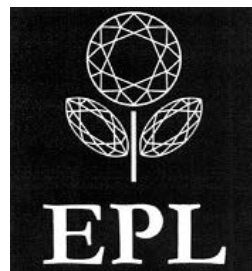

(591) White and black
(531) 05.05.20; 17.02.01; 17.02.02; 26.04.24
(511)

14 – Precious metals and their alloys, not included in other classes; jewellery, precious stones; horological and chronometric instruments; diamonds; bracelets [jewelry]; jewellery charms; brooches [jewelry]; cut diamonds; tie clips; cufflinks; clasps for jewelry; badges of precious metal; works of art of precious metal; jewelry; diamond jewelry; ivory jewelry; jewelry of yellow amber; cabochons; precious stones; semi-precious stones; rings [jewelry]; boxes of precious metal; presentation boxes for jewelry; medals; precious metals, unwrought or semi-wrought; earrings; figurines [statuettes] of precious metal; hat jewelry; watch chains; wristwatches; jewelry boxes; spinel [precious stones].

35 – Import-export agency services; demonstration of goods; organization of trade fairs for commercial or advertising purposes; sales promotion for others; commercial administration of the licensing of the goods and services of others; arranging and conducting of marketing events; commercial information and advice for consumers [consumer advice shop]; retail or wholesale services for automobiles; on-line ordering services; retail services provided by jewelry stores.

(260) AM 2021 111832 A
 (800) 1542049
 (151) 2020 06 05
 (891) 2021 01 21
 (731) PAION UK Limited

PAION UK Ltd, Unit D1, Brookmount Court,
 Kirkwood Road, CAMBRIDGE CB4 2QH,
 United Kingdom

(540)

BYFAVO

(591) Black, white

(511)

5 – Sedatives, anaesthetics, hypnotics, anxiolytics,
 muscle relaxants, anticonvulsants and analgesics.

(260) AM 2021 111886 A
 (800) 1576834
 (151) 2020 10 12
 (891) 2020 10 12
 (731) Entergamement, Inc.

5670 Wilshire Blvd., Suite 760; Los Angeles
 CA 90036, USA

(540)

U R HOLLYWOOD

(591) Black, white

(511)

41 – Entertainment services, namely, providing scripts for others to create videos, motion pictures, documentaries, and other entertainment works; entertainment services, namely, providing awards for videos, motion pictures, documentaries, and other entertainment works through nominations and voting through the internet; entertainment services, namely, providing live award ceremonies and red carpet events via the internet and in person; entertainment services, namely, providing an opportunity for amateur film makers to shoot and create videos, motion pictures, documentaries, and other entertainment works from supplied scripts or scripts written by amateur film makers and then submit them for potential awards for various categories; entertainment services, namely, providing the final nominees in each category with the means to be flown to California for a red carpet type of evening including the announcement of the winners in each category.

(260) AM 2021 111900 A
 (800) 1577360
 (151) 2020 12 31
 (891) 2020 12 31
 (731) De Rigo Vision S.p.A.

Zona Industriale Villanova 12, I-32013
 Longarone (BL), Italy

(540)



(591) Black, white

(531) 27.05.02; 27.05.22

(511)

9 – Optical apparatus and instruments namely spectacles, lens and spectacle frames, sunglasses, spectacle lenses, contact lenses, spectacle cases, parts and fittings for the aforesaid goods not included in other classes; polarizing spectacles; goggles; anti-glare glasses; corrective eyewear; eyeglass shields; cyclists' glasses; snow goggles; spectacle cords; prescription eyeglasses; bars for spectacles; children's eye glasses; spectacle chains; reading glasses; glacier eyeglasses; spectacle cases; goggles for sports; frames for spectacles and sunglasses; cords and chains for sunglasses; spectacle lenses.

(260) AM 2021 111904 A

(800) 1577426

(151) 2020 03 20

(891) 2020 03 20

(731) KOLIOS ANONYMI ETAIRIA-ELLINIKI
 VIOMICHANIA GALAKTOS
 DEKATO TETARTO (14o), HILIOMETRO
 ETHNIKIS ODOU, THESSALONIKIS –
 LAGKADA, GR-572 00 THESSALONIKI,
 Greece

(540)

KOLIÓS®
 THE GREEK DAIRY

GRILL & PAN | HALLOUMAKI

(591) Blue (PANTONE 2118 C)

(531) 24.17.25; 26.11.07; 27.05.01; 27.05.10;
 29.01.04

(511)

29 – Cheese complying with the specifications of the protected designation of origin 'Χαλλούμι/Hellim (Halloumi/Hellim)' (term considered too vague by the International Bureau – Rule 13 (2) (b) of the Regulations).

35 – Business representative services.

(260) AM 2021 111915 A

(800) 1577787

(151) 2020 11 06

(891) 2020 11 06

(731) TADIM GIDA MADDELERİ, SANAYİ VE
TİCARET ANONİM ŞİRKETİGebze Organize Sanayi Bölgesi; 1100. Sok.
No:1105 Çayırova; Kocaeli, Turkey

(540)

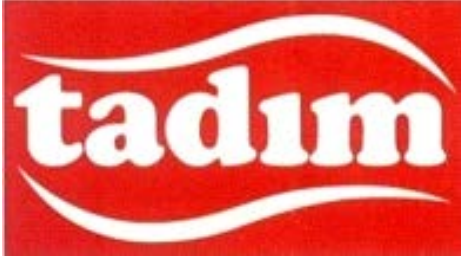

(591) Red, white

(531) 26.04.18; 26.11.13; 27.05.24; 29.01.12

(511)

30 – Cereal-based snack food, popcorn, crushed oats, corn chips, breakfast cereals, processed wheat for human consumption, crushed barley for human consumption, processed oats for human consumption, processed rye for human consumption, rice; rice, honey, puffed rice and oat-based bars with addition of peanuts, hazelnut, pistachio, groundnut, grape, almond, walnut, roasted sesame, dried nuts and dried fruits.

(260) AM 2021 111916 A

(800) 1577788

(151) 2020 07 24

(891) 2020 07 24

(731) D-MARKET ELEKTRONİK HİZMETLER
VE, TİCARET ANONİM ŞİRKETİKuştepe Mah., Mecidiyeköy Yolu Cad. No:12,
Trump Towers Kule 2 Kat:2,; Şişli; İstanbul,
Turkey

(540)

(591) Orange

(531) 27.05.01; 29.01.01

(511)

35 – Advertising, marketing and public relations; organization of exhibitions and trade fairs for commercial or advertising purposes; development of advertising concepts; provision of an online marketplace for buyers and sellers of goods and services; office functions; secretarial services; arranging newspaper subscriptions for others; compilation of statistics; rental of office machines; systemization of information into computer databases; telephone answering for unavailable subscribers; business management, business administration and business consultancy; accounting; commercial consultancy services; personnel recruit-

ment, personnel placement, employment agencies, import-export agencies; temporary personnel placement services; auctioneering; the bringing together, for the benefit of others, of a variety of goods, namely, chemicals used in industry, science, photography, agriculture, horticulture and forestry, manures and soils, unprocessed artificial resins and unprocessed plastics, fire extinguishing compositions, adhesives not for medical, household and stationery purposes, paints, varnishes, lacquers, preservatives against rust, preservatives against deterioration of wood, thinners and binders for paints, pigments, preservatives for metals, shoe dyes, printing dyes and ink, toners (including filled toner cartridges), colorants for food, pharmaceuticals and beverages, raw natural resins, metals in foil and powder form for painters, decorators, printers and artists, bleaching and cleaning preparations, detergents other than for use in manufacturing operations and for medical purposes, laundry bleach, fabric softeners for laundry use, stain removers, dishwasher detergents, perfumery, non-medicated cosmetics, fragrances, deodorants for personal use and animals, soaps, dental care preparations: dentifrices, denture polishes, tooth whitening preparations, mouth washes, not for medical purposes, abrasive preparations, emery cloth, sandpaper, pumice stone, abrasive pastes, polishing preparations for leather, vinyl, metal and wood, polishes and creams for leather, vinyl, metal and wood, wax for polishing, industrial oils and greases, cutting fluids, dust absorbing, wetting and binding compositions, solid fuels, coal, firewood, liquid and gas fuels, petrol, diesel oil, liquified petroleum gas, natural gas, fuel oil and their non-chemical additives, candles, wicks, semi-finished wax, wax and paraffin for lighting purposes, electrical energy, pharmaceutical and veterinary preparations for medical purposes, chemical preparations for medical and veterinary purposes, chemical reagents for pharmaceutical and veterinary purposes, medicated cosmetics, dietary supplements for pharmaceutical and veterinary purposes, dietary supplements, nutritional supplements, medical preparations for slimming purposes, food for babies, herbs and herbal beverages adapted for medicinal purposes, dental preparations and articles: teeth filling material, dental impression material, dental adhesives and material for repairing teeth, sanitary preparations for medical use, hygienic pads, hygienic tampons, plasters, materials for dressings, diapers made of paper and textiles for babies, adults and pets, preparations for destroying vermin, herbicides, fungicides, preparations for destroying rodents, deodorants, other than for human beings or for animals, air purifying preparations, air deodorising preparations, disinfectants, antiseptics, detergents for medical purposes, medicated soaps, disinfectant soaps, antibacterial hand lotions, ores of non-precious metal, common metals and their alloys and semi-finished products made of these materials, irons for construction, mats and stirrups of common metals for buildings, common metals in the

form of plate, billet, stick, profile, sheet and sheeting, goods and materials of common metal used for storage, wrapping, packaging and sheltering purposes, containers of metal (storage, transport), buildings of metal, frames of metal for building, poles of metal for building, metal boxes, packaging containers of metal, aluminium foil, fences made of metal, guard barriers of metal, metal tubes, storage containers of metal, metal containers for the transportation of goods, ladders of metal, goods of common metal for filtering and sifting purposes, doors, windows, shutters, jalousies and their cases and fittings of metal, non-electric cables and wires of metal, ironmongery, small hardware of metal, screws of metal, nails, bolts of metal, nuts of metal, pegs of metal, flakes of metal, pitons of metal, metal chains, furniture casters of metal, fittings of metal for furniture, industrial metal wheels, door handles of metal, window handles of metal, hinges of metal, metal latches, metal locks, metal keys for locks, metal rings, metal pulleys, ventilation ducts, vents, vent covers, pipes, chimney caps, manhole covers, grilles of metal for ventilation, heating, sewage, telephone, underground electricity and air conditioning installations, metal panels or boards (non-luminous and non-mechanical) used for signalling, route showing, publicity purposes, signboards of metal, advertisement columns of metal, signaling panels of metal, non-luminous and non-mechanical traffic signs of metal, pipes of metal for transportation of liquids and gas, drilling pipes of metal and their metal fittings, valves of metal, couplings of metal for pipes, elbows of metal for pipes, clips of metal for pipes, connectors of metal for pipes, safes (strong boxes) of metal, metal railway materials, metal rails, metal railway ties, railway switches, bollards of metal, floating docks of metal, mooring buoys of metal, anchors, metal moulds for casting, other than machine parts, works of art made of common metals or their alloys, trophies of common metal, metal closures, bottle caps of metal, metal poles, metal pillars, scaffolding of metal, metal stakes, metal towers, metal pallets and metal ropes for lifting, loading and transportation purposes, metal hangers, ties, straps, tapes and bands used for load-lifting and load-carrying, wheel chocks made primarily of metal, metal profile laths for vehicles for the purposes of decoration, machines, machine tools and industrial robots for processing and shaping wood, metals, glass, plastics and minerals, 3d printers, construction machines and robotic mechanisms (machines) for use in construction: bulldozers, diggers (machines), excavators, road construction and road paving machines, drilling machines, rock drilling machines, road sweeping machines, lifting, loading and transmission machines and robotic mechanisms (machines) for lifting, loading and transmission purposes: elevators, escalators and cranes, machines and robotic mechanisms (machines) for use in agriculture and animal breeding, machines and robotic mechanisms (machines) for processing cereals, fruits, vegetables and food, machines

for preparing and processing beverages, engines and motors, other than for land vehicles, parts and fittings therefor: hydraulic and pneumatic controls for engines and motors, brakes other than for vehicles, brake linings for engines, crankshafts, gearboxes, other than for land vehicles, gearboxes, cylinders for engines, pistons for engines, turbines, not for land vehicles, fillers for engines and motors, oil, air and fuel fillers for land vehicle engines, exhausts for land vehicle engines, exhaust manifolds for land vehicle engines, engine cylinders for land vehicles, engine cylinder heads for land vehicles, pistons for land vehicle engines, carburetors for land vehicles, fuel conversion apparatus for land vehicle engines, injectors for land vehicle engines, fuel economisers for land vehicle engines, pumps for land vehicle engines, valves for land vehicle engines, starter motors for land vehicles, dynamos for land vehicle engines, sparking plugs for land vehicle engines, bearings (parts of machines), roller or ball bearings, machines for mounting and detaching tires, alternators, current generators, electric generators, current generators operated with solar energy, painting machines, automatic spray guns for paint, electric, hydraulic and pneumatic punching machines and guns, electric adhesive tape dispensers (machines), electric guns for compressed gas or liquid spraying machines, electric hand drills, electric hand saws, electric jigsaw machines, spiral machines, compressed air machines, compressors (machines), vehicle washing installations, robotic mechanisms (machines) with the abovementioned functions, electric and gas-operated welding apparatus, electric arc welding apparatus, electric soldering apparatus, electric arc cutting apparatus, electrodes for welding machines, industrial robots (machines) with the abovementioned functions, printing machines, packaging machines, filling, plugging and sealing machines, labellers (machines), sorting machines, industrial robots (machines) with the abovementioned functions, electric packing machines for plugging and sealing of plastics, machines for textile processing, sewing machines, industrial robots (machines) with the abovementioned functions, pumps other than parts of machines or engines, fuel dispensing pumps for service stations, self-regulating fuel pumps, electric kitchen machines for chopping, grinding, crushing, mixing and mincing foodstuff, washing machines, laundry washing machines, dishwashers, spin driers (not heated), electric cleaning machines for cleaning floors, carpets or floorings, vacuum cleaners and parts thereof, automatic vending machines, galvanizing and electroplating machines, electric door openers and closers, gaskets for engines and motors, forks, spoons, knives and non-electric cutters, slicers, peelers for kitchen use, including those made of precious metals, side arms and blades (weapons), tools and apparatus for personal beauty care use: tools and apparatus for shaving, epilation, manicure and pedicure, electric hand implements for straightening and curling hair, scissors,

hand-operated [non-electric] hand tools for the repair of machines, apparatus and vehicles and for use in construction, agriculture, horticultural and forestry, none of them being power tools, electric or non-electric irons, steam irons, handles for hand-operated hand tools, measurement apparatus and equipment including those for scientific, nautical, topographic, meteorologic, industrial and laboratory purposes, thermometers, not for medical purposes, barometers, ammeters, voltmeters, hygrometers, testing apparatus not for medical purposes, telescopes, periscopes, directional compasses, speed indicators, laboratory apparatus, microscopes, magnifying glasses, stills, binoculars, ovens and furnaces for laboratory experiments, apparatus for recording, transmission or reproduction of sound or images, cameras, photographic cameras, television apparatus, video recorders, CD and DVD players and recorders, MP3 players, computers, desktop computers, tablet computers, wearable technological devices (smart watches, wristbands, head-mounted devices) microphones, loudspeakers, earphones, telecommunications apparatus, apparatus for the reproduction of sound or images, computer peripheral devices, cell phones, covers for cell phones, telephone apparatus, computer printers, scanners [data processing equipment], photocopiers, magnetic and optic data carriers and computer software and programmes recorded thereto, downloadable and recordable electronic publications, encoded magnetic and optic cards, movies, tv series and video music clips recorded on magnetic, optical and electronic media, antennas, satellite antennas, amplifiers for antennas, parts of the aforementioned goods, ticket dispensers, automatic teller machines (atm), electronic components used in the electronic parts of machines and apparatus, semiconductors, electronic circuits, integrated circuits, chips [integrated circuits], diodes, transistors [electronic], magnetic heads for electronic apparatus, electronic locks, photocells, remote control apparatus for opening and closing doors, optical sensors, counters and quantity indicators for measuring the quantity of consumption, automatic time switches, clothing for protection against accidents, irradiation and fire, safety vests and life-saving apparatus and equipment, eyeglasses, sunglasses, optical lenses and cases, containers, parts and components thereof, apparatus and instruments for conducting, transforming, accumulating or controlling electricity, electric plugs, junction boxes [electricity], electric switches, circuit breakers, fuses, lighting ballasts, battery starter cables, electrical circuit boards, electric resistances, electric sockets, transformers [electricity], electrical adapters, battery chargers, electric door bells, electric and electronic cables, batteries, electric accumulators, solar panels for production of electricity, alarms and anti-theft alarms, other than for vehicles, electric bells, signalling apparatus and instruments, luminous or mechanical signs for traffic use, fire extinguishing apparatus, fire engines, fire hose and fire hose nozzles, radar ap-

paratus, sonars, night vision apparatus and instruments, decorative magnets, metronomes, surgical, medical, dental and veterinary apparatus and instruments, furniture especially made for medical purposes, artificial limbs and prostheses, medical orthopaedic articles: corsets for medical purposes, orthopaedic shoes, elastic bandages and supportive bandages, surgical gowns and surgical sterile sheets, adult sexual aids, condoms, babies' bottles, babies' pacifiers, teethingers for babies, bracelets and rings for medical purposes, anti-rheumatism bracelets, anti-rheumatism rings, lighting installations, lights for vehicles and interior-exterior spaces, heating installations using solid, liquid or gas fuels or electricity, central heating boilers, boilers for heating installations, radiators [heating], heat exchangers, not parts of machines, stoves, kitchen stoves, solar thermal collectors [heating], steam, gas and fog generators, steam boilers, other than parts of machines, acetylene generators, oxygen generators, nitrogen generators, installations for air-conditioning and ventilating, cooling installations and freezers, electric and gas-powered devices, installations and apparatus for cooking, drying and boiling: cookers, electric cooking pots, electric water heaters, barbecues, electric laundry driers, hair driers, hand drying apparatus, sanitary installations, taps [faucets], shower installations, toilets [water-closets], shower and bathing cubicles, bath tubs, toilet seats, sinks, wash-hand basins [parts of sanitary installations], washers for water taps, stuffings (tap valves), water softening apparatus, water purification apparatus, water purification installations, waste water purification installations, electric bed warmers and electric blankets, not for medical use, electric pillow warmers, electric or non-electric footwarmers, hot water bottles, electrically heated socks, filters for aquariums and aquarium filtration apparatus, industrial type installations for cooking, drying and cooling purposes, pasteurizers and sterilizers, motor land vehicles, motorcycles, mopeds, engines and motors for land vehicles, clutches for land vehicles, transmissions, transmission belts and transmission chains for land vehicles, gearing for land vehicles, brakes, brake discs and brake linings for land vehicles, vehicle chassis, automobile bonnets, vehicle suspension springs, shock absorbers for automobiles, gearboxes for land vehicles, steering wheels for vehicles, rims for vehicle wheels, bicycles and their bodies, handlebars and mudguards for bicycles, vehicle bodies, tipping bodies for trucks, trailers for tractors, frigorific bodies for land vehicles, trailer hitches for vehicles, vehicle seats, head-rests for vehicle seats, safety seats for children, for vehicles, seat covers for vehicles, vehicle covers (shaped), sunblinds adapted for vehicles, direction signals and arms for direction signals for vehicles, windscreen wipers and wiper arms for vehicles, inner and outer tires for vehicle wheels, tubeless tires, tire-fixing sets comprised of tire patches and tire valves for vehicles, windows for vehicles, safety windows for vehicles, rear-

view mirrors and wing mirrors for vehicles, anti-skid chains for vehicles, luggage carriers for vehicles, bicycle and ski carriers for cars, saddles for bicycles or motorcycles, air pumps for vehicles, for inflating tires, anti-theft alarms for vehicles, horns for vehicles, safety belts for vehicle seats, air bags (safety devices for automobiles), baby carriages, wheelchairs, push-chairs, wheelbarrows, shopping carts, single or multi-wheeled wheelbarrows, shopping trolleys, grocery carts, handling carts, rail vehicles: locomotives, trains, trams, waggons, cable cars, chairlifts, vehicles for locomotion by water and their parts, other than their motors and engines, vehicles for locomotion by air and their parts, other than their motors and engines, firearms, air pistols (weapons), spring-loaded firearms, adapted cases and shoulder straps therefor, heavy weapons, mortars and rockets, fireworks, sprays for personal defence purposes, jewellery, imitation jewellery, gold, precious stones and jewellery made thereof, cufflinks, tie pins, statuettes and figurines of precious metal, clocks, watches and chronometrical instruments, chronometers and their parts, watch straps, trophies made of precious metal, rosaries, musical instruments and cases for musical instruments, paper and cardboard, paper and cardboard for packaging and wrapping purposes, cardboard boxes, paper towels, toilet paper, paper napkins, plastic materials for packaging and wrapping purposes, printing blocks and types, bookbinding material, printed publications, printed matter, books, magazines, newspapers, bill books, printed dispatch notes, printed vouchers, calendars, posters, photographs [printed], paintings, stickers [stationery], postage stamps, stationery, office stationery, instructional and teaching material [except furniture and apparatus], writing and drawing implements, artists' materials, paper products for stationery purposes, adhesives for stationery purposes, pens, pencils, erasers, adhesive tapes for stationery purposes, cardboard cartons [artists' materials], writing paper, copying paper, paper rolls for cash registers, drawing materials, chalkboards, painting pencils, watercolors [paintings], office requisites, paint rollers and paintbrushes for painting, rubber, gutta-percha, gum, asbestos, mica and semi-finished synthetic goods made from these materials in the form of powder, bars, panels and foils, insulation, stopping and sealing materials: insulation paints, insulation fabrics, insulating tape and band, insulation covers for industrial machinery, joint sealant compounds for joints, gaskets, o-rings for sealing purposes (other than gaskets for motors, cylinders and washer for water taps), flexible pipes made from rubber and plastic, hoses made of plastic and rubber, including those used for vehicles, junctions for pipes of plastic and rubber, pipe jackets of plastic and rubber, hoses of textile material, junctions for pipes, not of metal, pipe jackets, not of metal, connecting hose for vehicle radiators, profile laths made of synthetic materials for vehicles for the purposes of decoration, unworked or semi-worked leather

and animal skins, imitations of leather, stout leather, leather used for linings, goods made of leather, imitations of leather or other materials, designed for carrying items, bags, wallets, boxes and trunks made of leather or stout leather, keycases, trunks [luggage], suitcases, umbrellas, parasols, sun umbrellas, walking sticks, whips, harness, saddlery, stirrups, straps of leather (saddlery), sand, gravel, crushed stone, asphalt, bitumen, cement, gypsum, plaster, concrete, marble blocks for construction, building materials (as finished products) made of concrete, gypsum, clay, potters' clay, stone, marble, wood, plastics and synthetic materials for building, construction, road construction purposes, non-metallic buildings, non-metallic building materials, poles not of metal for power lines, barriers not of metal, natural and synthetic coatings in the form of panels and sheets, being building materials, bitumen cardboard coatings for roofing, bitumen coating for roofing, doors and windows of wood and synthetic materials, traffic signs not of metal, non-luminous and non-mechanical, for roads, monuments and statuettes of stone, concrete and marble, building glass, prefabricated swimming pools not of metal (structures), aquarium sand, furniture, made of any kind of material, mattresses, pillows, air mattresses and cushions, not for medical purposes, water beds, mirrors, beehives, artificial honeycombs and sections of wood for honeycombs, bouncing chairs for babies, playpens for babies, cradles, infant walkers, display boards, frames for pictures and paintings, identification plates, identification tags, nameplates, identification labels made of wood or synthetic materials, packaging containers of wood or plastics, casks for use in transportation or storage, barrels, storage drums, tanks, boxes, storage containers, transportation containers, chests, loading pallets and closures for the aforementioned goods, of wood or plastics, small hardware goods of wood or synthetic materials, furniture fittings, of wood or synthetic materials, opening and closing mechanisms of wood or synthetic materials, ornaments and decorative goods of wood, cork, reed, cane, wicker, horn, bone, ivory, whalebone, shell, amber, mother-of-pearl, meerschaum, beeswax, plastic or plaster namely figurines, holiday ornaments for walls, sculptures, trophies, baskets, fishing baskets, kennels, nesting boxes and beds for household pets, portable ladders and mobile boarding stairs of wood or synthetic materials, bamboo curtains, roller indoor blinds [for interiors], slatted indoor blinds, trip curtains, bead curtains for decoration, curtain hooks, curtain rings, curtain tie-backs, curtain rods, non-metal wheel chocks, hand-operated non-electric cleaning instruments and appliances, brushes, other than paintbrushes, steel chips for cleaning, sponges for cleaning, steel wool for cleaning, cloths of textile for cleaning, gloves for dishwashing, non-electric polishing machines for household purposes, brooms for carpets, mops, toothbrushes, electric toothbrushes, dental floss, shaving brushes, hair brushes, combs, non-electric house-

hold or kitchen utensils, [other than forks, knives, spoons], services [dishes], pots and pans, bottle openers, flower pots, drinking straws, non-electric cooking utensils, ironing boards and shaped covers therefor, drying racks for washing, clothes drying hangers, cages for household pets, indoor aquariums, vivariums and indoor terrariums for animals and plant cultivation, ornaments and decorative goods of glass, porcelain, earthenware or clay namely statues, figurines, vases, and trophies, mouse traps, insect traps, electric devices for attracting and killing flies and insects, fly catchers, fly swatters, perfume burners, perfume sprayers, perfume vaporizers, electric or non-electric make-up removing appliances, powder puffs, toilet cases, nozzles for sprinkler hose, nozzles for watering cans, watering devices, garden watering cans, unworked or semi-worked glass, except building glass, mosaics of glass and powdered glass for decoration, except for building, glass wool other than for insulation or textile use, ropes, strings, rope ladders, hammocks, fishing nets, tents, awnings, tarpaulins, sails, vehicle covers, not fitted, bags of textile for packaging, padding and stuffing materials, except of rubber and plastics, including those of wool and cotton, textile fibers, raw spun fiber, glass fibers for textile use, yarns and threads for textile use, threads and yarns for sewing, embroidery and knitting, thread, elastic yarns and threads for textile use, woven or non-woven textile fabrics, textile goods for household use, curtains, bed covers, sheets (textile), pillowcases, blankets, quilts, towels, flags, pennants, labels of textile, swaddling blankets, sleeping bags for camping, clothing, including underwear and outer clothing, other than special purpose protective clothing, socks, mufflers [clothing], shawls, bandanas, scarves, belts [clothing], footwear, shoes, slippers, sandals, headgear, hats, caps with visors, berets, caps [headwear], skull caps, laces and embroidery, guipures, festoons, ribbons (haberdashery), ribbons and braid, fastening tapes for clothing, cords for clothing, letters and numerals for marking linen, embroidered emblems, badges for wear, not of precious metal, shoulder pads for clothing, buttons for clothing, fasteners for clothing, eyelets for clothing, zippers, buckles for shoes and belts, fasteners, shoe and belt buckles, pins, other than jewellery, adhesive patches for decoration of textile articles, laces, needles, sewing needles, needles for sewing machines, needles for knitting and embroidery, boxes for needles, needle cushions, artificial flowers, artificial fruits, hair pins, hair buckles, hair bands, decorative articles for the hair, not made of precious metal, wigs, hair extensions, electric or non-electric hair curlers, other than hand implements, carpets, rugs, mats, prayer rugs, linoleum, artificial turf, linoleum for covering floors, gymnasium mats, wallpaper, wall hangings not of textile, games and toys, arcade video game machines, game apparatus and machines for use with an external display screen and monitor, including those coin-operated, toys for animals, toys for outdoor playgrounds,

parks and game parks, gymnastic and sporting articles, fishing tackle, artificial fishing bait, decoys for hunting and fishing, Christmas trees of artificial material, ornaments for Christmas trees, artificial snow for Christmas trees, rattles (playthings), novelties for parties, dances (party favors), paper party hats, meat, fish, poultry and game, processed meat products, dried pulses, soups, bouillon, processed olives, olive paste, milks of animal origin, milks of herbal origin, milk products, butter, edible oils, dried, preserved, frozen, cooked, smoked or salted fruits and vegetables, tomato paste, prepared nuts and dried fruits as snacks, hazelnut spreads and peanut butter, tahini (sesame seed paste), eggs and powdered eggs, potato chips, coffee, cocoa, coffee or cocoa based beverages, chocolate based beverages, pasta, stuffed dumplings, noodles, pastries and bakery products based on flour, desserts based on flour and chocolate, bread, simit [Turkish ring-shaped bagel covered with sesame seeds], poğaça [Turkish bagel], pita, sandwiches, katmer [Turkish pastry], pies, cakes, baklava [Turkish dessert based on dough coated with syrup], kadayif [Turkish dessert based on dough], desserts based on dough coated with syrup, puddings, custard, kazandibi [Turkish pudding], rice pudding, keşkül [Turkish pudding], honey, bee glue for human consumption, propolis for food purposes, condiments for foodstuff, vanilla (flavoring), spices, sauces (condiments), tomato sauce, yeast, baking powder, flour, semolina, starch for food, sugar, cube sugar, powdered sugar, tea, ice tea, confectionery, chocolate, biscuits, crackers, wafers, chewing gums, ice-cream, edible ices, salt, cereal-based snack food, popcorn, crushed oats, corn chips, breakfast cereals, processed wheat for human consumption, crushed barley for human consumption, processed oats for human consumption, processed rye for human consumption, rice, molasses for food, agricultural and horticultural product, seeds, forestry products, live animals, fertilized eggs for hatching, plants, dried plants for decoration, fresh garden herbs, dried garden herbs for decoration, animal foodstuffs, malt not for human consumption, underlays for pets, cat litters, beers, preparations for making beer, mineral water, spring water, table water, soda water, fruit and vegetable juices, fruit and vegetable concentrates and extracts for making beverages, non-alcoholic soft drinks, energy drinks, protein-enriched sports beverages, alcoholic beverages (except beers), wines, raki [traditional Turkish alcoholic drink], whisky, liqueurs, alcoholic cocktails, tobacco, chewing tobacco, cigarettes, cigars, smokers' articles including those made of precious metals: pipes, mouthpieces for cigars and cigarettes, ashtrays, tobacco boxes, pocket apparatus for rolling cigarettes, cigarette paper, tobacco pipes, firestones, lighters for smokers, electronic cigarettes and their cartridges, matches, enabling customers to conveniently view and purchase those goods, such services may be provided by retail stores, wholesale out-

lets, by means of electronic media or through mail order catalogues.

38 – Radio and television broadcasting services; telecommunication services; providing access to internet; news agencies.

42 – Scientific and industrial analysis and research services; engineering; engineering and architectural design services; testing services for the certification of quality and standards; computer services, namely, computer programming, computer virus protection services, computer system design, creating, maintaining and updating websites for others, computer software design, updating and rental of computer software, providing search engines for the internet, hosting websites, consultancy in the design and development of computer hardware, rental of computer hardware; industrial design services, other than engineering, computer and architectural design; graphic arts designing; authenticating works of art.

(260) AM 2021 111917 A

(800) 1577789

(151) 2021 01 13

(891) 2021 01 13

(731) Rotkäppchen-Mumm Sektkellereien GmbH
Sektellereistraße 5, 06632 Freyburg,
Germany

(540)



Rotkäppchen

(591) Black, white

(531) 03.07.17; 19.07.01; 24.01.09; 24.01.13;
24.01.18; 24.09.02; 24.09.11; 27.05.09;
27.05.10

(511)

32 – Non-alcoholic wines; non-alcoholic sparkling wines; de-alcoholized wines; de-alcoholized sparkling wines.

33 – Wines; sparkling wines.

(260) AM 2021 111919 A

(800) 1577800

(151) 2021 01 18

(891) 2021 01 18

(731) Apple Inc.
One Apple Park Way; Cupertino CA 95014,
USA

(540)



Apple App Clip

(591) Black, white

(531) 05.07.13; 16.03.01; 26.01.05

(511)

42 – Providing online non-downloadable application development software; providing online non-downloadable computer software development tools; providing online non-downloadable computer software used in developing other software applications; user authentication services using a software application; user authentication services using technology for e-commerce transactions; providing online information relating to computer technology, computer programming, and computer software.

(260) AM 2021 111980 A

(800) 1578034

(151) 2020 11 24

(891) 2020 11 24

(731) Mikasa Corporation

1, Kuchi, Asa-cho, Asakita-ku, Hiroshima-shi,
Hiroshima-ken 731-3362, Japan

(540)

MIKASA

(591) Black, white

(531) 01.01.02; 01.01.10; 27.05.07; 27.05.17

(511)

28 – Sports equipment; balls for sports; toys; volleyball nets; volleyball uprights; volleyball; basketball nets; basketball goals; cases for basketballs; cases for volleyballs; cases for sports balls; cases specially adapted for sports equipment; soccer balls; basketballs.

(260) AM 2021 111981 A

(800) 1578097

(151) 2021 01 25

(891) 2021 01 25

(731) Obschestvo s ogranichennoy otvetstvennost'yu
"NL Kontinent"
ul. Yadrntsevskaya, d. 53/1, of. 1015,
Novosibirsk, RU-630099 Novosibirskaya obl.,
Russian Federation

(540)



(591) Black, white

(531) 27.05.01; 27.05.09; 27.05.17; 27.05.19

(526) Coffee

(511)

30 – Coffee flavorings; coffee-flavored cereal bars; artificial coffee; vegetal preparations for use as coffee substitutes; coffee; unroasted coffee; coffee-flavored custard; coffee beverages with milk; coffee-based beverages; coffee-flavored chewing gum.

(260) AM 2021 111982 A

(800) 1578125

(151) 2020 12 19

(891) 2020 12 19

(731) Apple Inc.

One Apple Park Way, Cupertino CA 95014,
USA

(540)



(591) Blue, white, silver, green, yellow, orange, red, and purple

(531) 12.01.01; 12.01.25; 22.01.21; 25.07.03; 26.01.03; 26.01.10; 26.04.04; 26.04.08; 26.04.16; 29.01.15

(511)

9 – Downloadable computer software for presentation graphics, namely, software for generating, storing, retrieving, manipulating, altering and transmitting texts and graphics for use in presentations and utility programs for use therewith; downloadable computer software for accessing, viewing, annotating, storing, editing, downloading, displaying, sharing, and distributing electronic media, images, audio, video, data, information, and documents over the internet or other communications network.

(260) AM 2021 111992 A

(800) 1578382

(151) 2020 11 24

(891) 2020 11 24

(731) Insurance Public Joint Stock Company

"Ingosstrakh"

ul. Pyatnitskaya. 12, str.2, RU-115035 Moscow,
Russian Federation

(540)

INGOSSTRAKH

(591) Blue

(531) 27.05.01; 29.01.04

(511)

35 – Arranging subscriptions to telecommunication services for others; import-export agency services; commercial information agency services; advertising agency services; cost price analysis; rental of office equipment in co-working facilities; rental of advertising space; business auditing; financial auditing; business intermediary services relating to the matching of potential private investors with entrepreneurs needing funding; employment agency services; computerized file management; book-keeping; invoicing; demonstration of goods; transcription of communications [office functions]; opinion polling; market studies; providing business information; commercial information and advice for consumers in the choice of products and services; business investigations; business research; marketing research; personnel recruitment; business management and organization consultancy; business organization consultancy; business management consultancy; personnel management consultancy; professional business consultancy; consultancy regarding advertising communication strategies; consultancy regarding public relations communication strategies; layout services for advertising purposes; marketing; marketing in the framework of software publishing; targeted marketing; business management of performing artists; business management of sports people; writing of résumés for others; scriptwriting for advertising purposes; news clipping services; updating and maintenance of information in registries; updating and maintenance of data in computer databases; updating of advertising material; word processing; online retail services for downloadable and pre-recorded music and movies; online retail services for downloadable ring tones; online retail services for downloadable digital music; organization of exhibitions for commercial or advertising purposes; arranging newspaper subscriptions for others; organization of fashion shows for promotional purposes; organization of trade fairs for commercial or advertising purposes; shop window dressing; development of advertising concepts; business appraisals; payroll preparation; data search in computer files for others; sponsorship search; administrative assistance in responding to calls for tenders; business management assistance; commercial or industrial management assistance; commercial interme-

diation services; providing business information via a web site; providing commercial and business contact information; provision of an online marketplace for buyers and sellers of goods and services; web indexing for commercial or advertising purposes; presentation of goods on communication media, for retail purposes; media relations services; economic forecasting; auctioneering; wholesale services for pharmaceutical, veterinary and sanitary preparations and medical supplies; retail services for works of art provided by art galleries; retail services for pharmaceutical, veterinary and sanitary preparations and medical supplies; sales promotion for others; promotion of goods and services through sponsorship of sports events; production of teleshopping programmes; production of advertising films; office machines and equipment rental; rental of advertising time on communication media; publicity material rental; rental of billboards [advertising boards]; rental of vending machines; rental of sales stands; rental of photocopying machines; publication of publicity texts; radio advertising; billposting; distribution of samples; dissemination of advertising matter; direct mail advertising; registration of written communications and data; writing of publicity texts; advertising; online advertising on a computer network; outdoor advertising; advertising by mail order; television advertising; document reproduction being photocopying services; compilation of statistics; compilation of information into computer databases; business inquiries; systemization of information into computer databases; advisory services for business management; corporate communications services; negotiation of business contracts for others; negotiation and conclusion of commercial transactions for third parties; compiling indexes of information for commercial or advertising purposes; tax preparation; drawing up of statements of accounts; telemarketing services; interim business management; outsourced administrative management for companies; business management of hotels; business management for freelance service providers; business project management services for construction projects; commercial administration of the licensing of the goods and services of others; business management of reimbursement programs for others; administration of consumer loyalty programs; administration of frequent flyer programs; administrative processing of purchase orders; public relations; commercial lobbying services; competitive intelligence services; modelling for advertising or sales promotion; typing; market intelligence services; appointment reminder services [office functions]; web site traffic optimization; administrative services for the relocation of businesses; tax filing services; search engine optimization for sales promotion; appointment scheduling services [office functions]; gift registry services; price comparison services; pay per click advertising; secretarial services; procurement services for others [purchasing goods and services for other businesses]; shorthand; outsourcing services [business

assistance]; telephone answering for unavailable subscribers; photocopying services; business efficiency expert services.

36 – Credit bureau services; debt collection agency services; real estate agency services; financial analysis; rental of apartments; rental of offices for co-working; rental of real estate; rental of offices [real estate]; rental of offices for co-working; rental of farms; lease-purchase financing; savings bank services; accommodation bureau services [apartments]; rent collection; issuance of travelers' checks; issuance of credit cards; issuance of tokens of value; capital investment; insurance information; financial information; financial research; clearing, financial; insurance consultancy; financial consultancy; debt advisory services; stock exchange quotations; lending against security; business liquidation services, financial; brokerage; financial management; exchanging money; online banking; processing of debit card payments; processing of credit card payments; factoring; organization of monetary collections; arranging finance for construction projects; antique appraisal; jewelry appraisal; financial evaluation of standing timber; stamp appraisal; real estate appraisal; numismatic appraisal; art appraisal; financial evaluation of development costs relating to the oil, gas and mining industries; financial evaluation of wool; financial evaluation [insurance, banking, real estate]; financial appraisals in responding to calls for tenders; repair costs evaluation [financial appraisal]; electronic funds transfer; surety services; securities brokerage; real estate brokerage; brokerage of carbon credits; insurance brokerage; providing rebates at participating establishments of others through use of a membership card; loans [financing]; pawnbrokerage; providing financial information via a web site; check verification; investment of funds; charitable fund raising; stocks and bonds brokerage; financial sponsorship; mortgage banking; instalment loans; insurance underwriting; life insurance underwriting; health insurance underwriting; accident insurance underwriting; marine insurance underwriting; fire insurance underwriting; apartment house management; real estate management; financial management of reimbursement payments for others; actuarial services; banking; stock brokerage services; retirement payment services; bailbonding; trusteeship; provident fund services; financial customs brokerage services; mutual funds; financing services; safe deposit services; deposits of value-ables; fiscal valuation.

(260) AM 2021 111993 A

(800) 1578405

(151) 2020 11 20

(891) 2020 11 20

(731) Euro Games Technology Ltd.

4, "Maritsa" Str., "Vranya-Lozen-Triugulnika",
BG-1151 Sofia, Bulgaria

(540)



(591) Green, red, gold, blue, pink, yellow, purple, black, gray, white and orange

(531) 05.03.06; 05.07.22; 05.07.24; 26.04.04; 26.04.05; 26.04.16; 26.04.24; 29.01.15

(511)

9 – Software; computer gaming software; computer software packages; computer operating system software; computer software, recorded; software drivers; virtual reality software; games software; entertainment software for computer games; computer programs for network management; operating computer software for main frame computers; monitors (computer hardware); computer hardware; apparatus for recording images; monitors (computer programs); computer game programs; computer programs for recorded games; apparatus for recording, transmission or reproduction of sound or images; communications servers [computer hardware]; electronic components for gambling machines; computer application software featuring games and gaming; computer software for the administration of on-line games and gaming; computer hardware for games and gaming; hardware and software for gambling, gambling machines, gambling games on the Internet and via telecommunication network.

28 – Gaming machines for gambling; chips for gambling; mah-jong; arcade games; gambling machines operating with coins, notes and cards; games; electronic games; parlor games; gaming chips; gaming tables; slot machines [gaming machines]; LCD game machines; slot machines and gaming devices; coin-operated amusement machines; roulette chips; poker chips; chips and dice [gaming equipment]; equipment for casinos; roulette tables; gaming roulette wheels; casino games; automats and gambling machines; coin-operated machines and / or electronic coin-operated machines with or without the possibility of gain; boxes for coin-operated machines, slot machines and gaming machines; electronic or electrotechnical gaming devices, automats and machines, coin-operated machines; housings for coin-operated machines, gaming equipment, gaming machines, machines for gambling; electropneumatic and electrical gambling machines (slot machines).

41 – Gambling; services related to gambling; gaming services for entertainment purposes; casino, gaming and gambling services; training in the development of software systems; provision of equipment for gambling halls; providing casino equipment [gambling];

gaming machine entertainment services; providing casino facilities [gambling]; halls with gaming machines; amusement arcade services; games equipment rental; rental of gaming machines; providing amusement arcade services; rental of gaming machines with images of fruits; editing or recording of sounds and images; sound recording and video entertainment services; hire of sound reproducing apparatus; provision of gaming equipment for casinos; providing of casino facilities; online gambling services; casino management services; operation of gaming establishments, gaming halls, internet casinos, online gambling sites.

(260) AM 2021 111994 A

(800) 1578407

(151) 2020 11 25

(891) 2020 11 25

(731) ZHOU JAINGANG

Room 202, Unit 1, Building 3, Meitian Family House, No. 199 Zhongxing West Street, Xindu District, Xingtai City, 054000 Hebei Province, China

(540)



(591) Black, white

(531) 01.05.02; 01.05.05; 01.15.15; 27.05.17; 27.07.11

(511)

33 – Arrack [arak]; spirits [beverages]; digesters [liqueurs and spirits]; peppermint liqueurs; distilled beverages; whisky; alcoholic beverages, except beer; wine; baijiu [Chinese distilled alcoholic beverage]; cocktails.

(260) AM 2021 112000 A

(800) 1578582

(151) 2021 01 16

(891) 2021 01 16

(731) Kia Corporation

12, Heolleung-ro, Seocho-gu, Seoul 06797, Republic of Korea

(540)



Movement that inspires

(591) Black, white

(531) 27.05.01; 27.05.19

(511)

37 – Garage services for the maintenance and repair of motor vehicles; installation, maintenance and repair of batteries and accumulators; recharging of batteries and accumulators; laundering; vehicle battery char-

ging; vehicle battery replacement services; vehicle repair services; hydrogen gas refuelling service for vehicles; repair or maintenance of motor automobile parts; automobile cleaning and car washing; providing information relating to the repair or maintenance of automobiles; motor vehicle maintenance and repair; tuning of motor vehicles; repair of car accessories; maintenance of electrical plant; battery management; repair of braking devices; vehicle maintenance; rental of cleaning equipment.

(260) AM 2021 112001 A

(800) 1578583

(151) 2021 01 16

(891) 2021 01 16

(731) Kia Corporation

12, Heolleung-ro, Seocho-gu, Seoul 06797,
Republic of Korea

(540)



Movement that inspires

(591) Black, white

(531) 27.05.01; 27.05.19

(511)

12 – Mobility scooters; parachutes; tractors for agricultural purposes; robotic cars; motor trucks; electric motors for motor cars; automatic transport vehicles; driverless cars [autonomous cars]; civilian drones; buses; invalids' carriages; suspension shock absorbers for vehicles; electric drives for vehicles; sports cars; coach vans; parts and fittings for motorcycles; motorcycles; pushchairs; apparatus for locomotion by land, air or water; vehicles for locomotion by land, air, water or rail; land vehicles; rubber belts for land vehicles transmissions; motors and engines for land vehicles; brakes for land vehicles; couplings for land vehicles; driverless cars; automobiles; lane departure warning systems for automobiles; automobile tires; parts and fittings for automobiles; electrically operated scooters; electric cars; electric bicycles; electric wheelchairs; tractors; hybrid power scooters; wheelchairs.

(260) AM 2021 112004 A

(800) 1578604

(151) 2021 01 16

(891) 2021 01 16

(731) Kia Corporation

12, Heolleung-ro, Seocho-gu, Seoul 06797,
Republic of Korea

(540)



Movement that inspires

(591) Black, white

(531) 27.05.01; 27.05.19

(511)

35 – Auction services; advertising services; secretarial services; office functions; providing business and marketing information; organisation of exhibitions for commercial/promotional and publicity purposes; demonstration of goods; import-export agency services; wholesale store services featuring automobiles; retail store services featuring automobiles; retail store services featuring parts and fittings of automobiles; wholesale store services featuring parts and fittings of automobiles; rental of vending machines; business intermediary services relating to mail order by telecommunications; arranging subscriptions to information media; compilation of information into computer databases; retail store services featuring used automobiles; wholesale store services featuring used automobiles; providing information in the field of employment; sales promotion for others.

(260) AM 2021 112011 A

(800) 1578804

(151) 2020 09 08

(891) 2020 09 08

(731) KOÇAK ELEKTRONİK SANAYİ DİŞ
TİCARET LİMİTED ŞİRKETİ

Tahtakale Mh. Hasırcılar Cd., No:23/1 Fatih,
Istanbul, Turkey

(540)



(591) Blue

(531) 24.17.02; 27.05.01; 27.05.08; 29.01.04

(511)

9 – Apparatus for recording, transmission or reproduction of sound or images, cameras, photographic cameras, television apparatus, video recorders, CD and DVD players and recorders, MP3 players, computers, desktop computers, tablet computers, microphones, loudspeakers, earphones, telecommunications apparatus, apparatus for the reproduction of sound or images, computer peripheral devices, cell phones, covers for cell phones, phone cases, telephone apparatus, computer printers, scanners [data processing equipment], photocopiers, battery chargers, smartphone chargers, battery chargers for cell phones, portable charger for smart phones; magnetic and optical data carriers and computer software and programmes recorded thereto, downloadable and recordable electronic publications, encoded magnetic and optical cards; antennas, satellite antennas, amplifiers for antennas, parts of the aforementioned goods; electronic components used in the electronic parts of machines and apparatus, semi-conductors, electronic circuits, integrated circuits, chips [integrated circuits], diodes, transis-

tors [electronic], magnetic heads for electronic apparatus, electronic locks, photocells, remote control apparatus for opening and closing doors, optical sensors; eyeglasses, sunglasses, optical lenses and cases, containers, parts and components thereof; apparatus and instruments for conducting, transforming, accumulating or controlling electricity, electric plugs, junction boxes [electricity], electric switches, circuit breakers, fuses, lighting ballasts, battery starter cables, electrical circuit boards, electric resistances, electric sockets, transformers [electricity], electrical adapters, battery chargers, electric door bells, electric and electronic cables, batteries, electric accumulators.

(260) AM 2021 112014 A

(800) 1578929

(151) 2020 12 18

(891) 2020 12 18

(731) ONYX INTERNATIONAL INC.

Room 301, No.215, Qiaozhongzhong Road,
Liwán District, Guangzhou, Guangdong,
China

(540)

BOOX

(591) Black, white

(531) 27.05.01

(511)

9 – Electronic book readers; computer hardware; cell phones; neon signs; tablet computers; audiovisual teaching apparatus; computer programs, recorded; electronic tags for goods; covers for personal digital assistants [PDAs]; computer software applications, downloadable.

(260) AM 2021 112016 A

(800) 1578980

(151) 2020 09 29

(891) 2020 09 29

(731) BRAND GMBH + CO KG

Otto-Schott Straße 25, 97877 Wertheim,
Germany

(540)

BRAND

(591) Black, white

(531) 01.15.11; 19.11.07; 19.11.25; 26.13.25

(511)

7 – Automatic dispensing machines; semi-automated dispensing machines; semi-automated dispensing systems; robotic filling machines; robotic dispensing machines; robotic dispensing systems.

9 – Apparatus for scientific research and laboratories; laboratory apparatus and instruments; apparatus and instruments for physics; chemistry apparatus and instruments; scientific apparatus and instruments; automatic dosage apparatus; dosage dispensers; dosage dispensing apparatus; bottle top dispensers; manual, motorised and automated dosage dispensers, dispensing apparatus, bottle top dispensers; multiple dosage dispensers; burettes; burettes of glass; bottle topper burettes; manual, motorised, automated burettes, bottle top burettes; automated titration apparatus; titration apparatus; titration devices; replacement parts and accessories for automated dosage apparatus, dosage dispensers, dispensing apparatus; replacement parts and fittings for dose dispensing devices, namely rack holders, table stands and charging stations; replacement parts and accessories for bottle topper dispensers and bottle topper burettes, in particular dosing drain tubes, valves, bottle adapters, bottle holders, suction pipes, seals, ventilation plugs, dosing hoses, drying pipes, cylinder/piston actuation units, dosing pistons and dosing cylinders; pipettes; pipettors; pipetting instruments; pipetting units, single tube or multiple tube; piston stroke pipettes; single-channel or multi-channel hand-held piston-operated pipettes with or without air cushion; positive displacement pipettes; pipetting aids, in particular manual, motorised and automatic; liquid extraction apparatus, in particular bottle top liquid extraction apparatus; pipetting robots; pipetting aids, manual and motorised; pipette leak tightness testers; replacement parts and accessories for piston-operated pipettes, in particular single racks, table stands, rack holders, filters, battery packs, power supplies and charging stations; replacement parts and accessories for pipetting robots, in particular height adapters, single-channel or multi-channel pipetting modules, also being robotic tips, cooling and heating elements being fitted parts for pipetting modules, components for nanodosing; replacement parts and fittings for pipetting aids, in particular membrane filters, adapters, valves, bellows, cell pack, power suppliers; replacement parts and accessories for pipette leak tightness testers, in particular single-channel or multi-channel pipette adapters, filters, power suppliers; pycnometers, hydrometers, laboratory desiccator; laboratoryware; laboratory items of glass and/or plastic, namely reactor vessels, lids for reactor vessels, stands for reactor vessels, refrigerating containers for reactor vessels, PCR single vessels, PCR vessel strips made of several single vessels, with and without lids, PCR single lids and PCR lid strips, PCR plates, microtiter plate, receptacles for PCR vessels, strips and plates, PCR sealing films, deep-well plates; laboratory items of glass and/or plastic, namely cuvettes, cuvette stands, stirring tools, pi-

pette tips with and without filter, receptacles for pipette tips, dispenser-tips (pd-tips), reagent containers, containers for samples, volume measuring containers, measuring flasks with and without stoppers, graduated cylinders, mixing cylinders, tilt dispensers, bulb pipettes, graduated pipettes, supply bottles, oxygen tanks, centrifuge tubes, sedimentation cones, racks for sedimentation cones, sample tubes, disposal bags; laboratory items of glass and/or plastic, namely storage boxes, dispenser boxes, petri dishes, vaccination slings, test tubes, culture tubes, centrifuge tubes, PE stoppers, sample tubes, sedimentation tubes, dropping pipettes, pasteur pipettes, test tube frames, pipette bellows, counting chambers, microscope slides, slide boxes, staining troughs, spotting tiles, erlenmeyer flasks, evaporating dishes, watch glass; laboratory items of glass and/or plastic, namely mortars, funnels, filter crucibles, filter flasks, wash bottles, hoses, hose connectors, pinch valves, hose spigots, ground joint sleeves, ground sockets, stoppers, stirrers, magnetic stir bars, spatulas, forceps, measuring scoops, weighing dishes, storage bottles, wash bottles, dropper bottles, pulverising mills, sealing films; software and interfaces for use in laboratory automation, in particular for conducting, evaluating and presenting chemical and biochemical analyses and processes; software and interfaces for use in laboratory automation, in particular for simulations, virtual reality applications or augmented reality applications; software and interfaces for use in laboratory automation, in particular for the purpose of operation, control, operating, user communication, presentation, verification, calibration, adjustment, maintenance, repair, in particular for automated, semi-automated and/or robotic machines and systems, in particular dispensing machines, dispensing systems, bottle filling machines, pipetting installations, pipetting systems; software and interfaces for use in laboratory automation, in particular laboratory apparatus, laboratory instruments, consumables, industrial production facilities, mainly with dispensing technology; software for providing and administration of licences, in particular for software of the aforesaid areas of application and in connection with automated, semi-automated and/or robotic machines and systems, in particular dispensing machines, dosing systems, filling machines, pipetting installations, pipetting systems, and/or with laboratory apparatus, laboratory instruments, consumables, industrial production facilities, mainly with dispensing technology; laboratory apparatus and laboratory apparatus, namely robotic pipetting installations, robotic pipetting systems and pipetting robots; automated dosing dispenser systems; all the aforesaid products in particular for the use in scientific research and laboratories.

35 – Retailing and wholesaling relating to automated, semi-automated or robotic machines and systems, namely dispensing machines, dispensing systems, charging machines, pipetting installations, pipetting systems; retailing and wholesaling relating to apparatus

for use in scientific research and laboratories, in particular laboratory apparatus, laboratory instruments, automatic metering apparatus, replacement parts and accessories for automated dosage apparatus, dispensing apparatus, burettes, pipetting apparatus, replacement parts and accessories for pipetting apparatus, laboratory items of glass and/or plastic; retailing and wholesaling relating to software for use in laboratory automation, in particular software, integrated software packages and interfaces for laboratory apparatus, laboratory instruments, consumables, industrial production facilities, mainly with dispensing technology; computerised file management in connection with laboratory automation, in particular compiling, induction, systemization of information and data in databases, and/or in particular updating and maintenance of data in computer databases, mainly relating to software, integrated software packages and interfaces for use in laboratory automation, in particular for laboratory apparatus, laboratory instruments, consumables, industrial production facilities, mainly with dispensing technology.

37 – Installation, cleaning, repair and maintenance relating to automated or robotic machines and systems, namely dispensing machines, dispensing systems, filling machines, pipetting installations, pipetting systems; installation, cleaning, repair and maintenance relating to apparatus for use in scientific research and laboratories, in particular laboratory apparatus, laboratory instruments, automated dosage apparatus, replacement parts and accessories for automated dosage apparatus, dispensing apparatus, burettes, pipetting apparatus, replacement parts and accessories for apparatus, laboratory items of glass and/or plastic.

(260) AM 2021 112018 A

(800) 1578988

(151) 2021 01 18

(891) 2021 01 18

(731) Apple Inc.

One Apple Park Way, Cupertino CA 95014,
USA

(540)



Apple Clip

(591) gray, black and white

(531) 05.07.13; 16.01.11; 26.01.05

(511)

9 – Downloadable and recorded computer software; downloadable and recorded computer software for

processing, facilitating, verifying, and authenticating mobile payments and contactless transactions with retailers, merchants, and vendors via wearable and mobile devices; downloadable and recorded computer software for use in searching, transmitting, receiving, storing, accessing, finding, organizing and viewing geographic location information and providing content based on location; downloadable and recorded computer software for application development; downloadable and recorded computer software development tools; downloadable and recorded computer software used in developing other software applications; downloadable and recorded application programming interface (API) software; downloadable and recorded software development kits (SDK); downloadable and recorded computer software to maintain and operate a computer system; downloadable and recorded computer operating software.

42 – Providing online non-downloadable application development software; providing online non-downloadable computer software development tools; providing online non-downloadable computer software used in developing other software applications; user authentication services using a software application; user authentication services using technology for e-commerce transactions; providing online information relating to computer technology, computer programming, and computer software.

(260) AM 2021 112019 A

(800) 1579017

(151) 2020 12 29

(891) 2020 12 29

(731) Joint Stock Company "FABERLIC"

Nikopolskaya str., bld.4, RU-117403 Moscow,
Russian Federation

(540)

MY LOVELY BEST FRIENDS

(591) Black, white

(511)

31 – Algarovilla for animal consumption; anchovy, live; oranges, fresh; peanuts, fresh; artichokes, fresh; draff; beans, fresh; locust beans, raw; wreaths of natural flowers; grapes, fresh; algae, unprocessed, for human or animal consumption; fruit residue [marc]; dog biscuits; peas, fresh; buckwheat, unprocessed; mushroom spawn for propagation; mushrooms, fresh; trees; palm trees; turf, natural; unsawn timber; undressed timber; yeast for animal consumption; Christmas trees; edible chews for animals; live animals; menagerie animals; peanut cake for animals; oil cake; maize cake for cattle; rape cake for cattle; bagasses of cane [raw material]; cereal seeds, unprocessed; grains [cereals]; grains for animal consumption; lime for animal forage; fish spawn; vegetable marrows, fresh; cocoa be-

ans, raw; koi carp, live; chestnuts, fresh; quinoa, unprocessed; arrangements of fresh fruit; copra; raw barks; rough cork; animal foodstuffs; pet food; stall food for animals; bird food; strengthening animal forage; chicory roots; roots for animal consumption; nettles; groats for poultry; maize; shrubs; rose bushes; spiny lobsters, live; lemons, fresh; vine plants; salmon, live; onions, fresh; flower bulbs; leeks, fresh; olives, fresh; bran mash for animal consumption; shellfish, live; almonds [fruits]; mussels, live; peanut meal for animals; linseed meal for animal consumption; meal for animals; flax meal [fodder]; rice meal for forage; fish meal for animal consumption; straw mulch; beverages for pets; edible insects, live; oats; vegetables, fresh; cucumbers, fresh; lobsters, live; coconuts; kola nuts; bran; distillery waste for animal consumption; residue in a still after distillation; palms [leaves of the palm tree]; cuttle bone for birds; peppers [plants]; aromatic sand [litter] for pets; citrus fruit, fresh; litter for animals; mash for fattening livestock; unprocessed sweet corn ears [husked or unhusked]; animal fattening preparations; preparations for egg laying poultry; fishing bait, live; by-products of the processing of cereals, for animal consumption; seed germ for botanical purposes; poultry, live; wheat; pollen [raw material]; crayfish, live; crustaceans, live; seedlings; plants; aloe vera plants; plants, dried, for decoration; rhubarb, fresh; rice, unprocessed; rye; wheat germ for animal consumption; fish, live; lettuce, fresh; sardines, live; beet, fresh; herrings, live; seeds for planting; linseed for animal consumption; edible linseed, unprocessed; hay; coconut shell; bred stock; sanded paper [litter] for pets; malt for brewing and distilling; straw [forage]; straw litter; salt for cattle; trunks of trees; wood chips for the manufacture of wood pulp; litter peat; garden herbs, fresh; sea-cucumbers, live; sugarcane; truffles, fresh; tuna, live; squashes, fresh; oysters, live; fruit, fresh; hazelnuts, fresh; fodder; hops; flowers, natural; flowers, dried, for decoration; chicory, fresh; silkworms; garlic, fresh; lentils, fresh; pine cones; hop cones; spinach, fresh; juniper berries; berries, fresh; eggs for hatching, fertilized; silkworm eggs; barley.

(260) AM 2021 112022 A

(800) 1579053

(151) 2021 01 13

(891) 2021 01 13

(731) Enduristan GmbH

Kirchgasse 23, CH-8472 Seuzach, Switzerland

(540)

Enduristan

(591) Black, white

(511)

12 – Special boxes for motorcycles.

18 – Luggage.

(260) AM 2021 112030 A
 (800) 1579249
 (151) 2021 01 20
 (891) 2021 01 20
 (731) RAUCH Fruchtsäfte GmbH
 Langgasse 1, A-6830 Rankweil, Austria
 (540)



(591) Blue, yellow
 (531) 03.06.03; 27.03.03; 27.05.02; 27.05.03;
 27.05.17; 29.01.13
 (511)
 32 – Beers; shandy; waters; mineral and aerated waters; non-alcoholic beverages; juices; fruit beverages and fruit juices; cider (non-alcoholic); orange juice; nectars; fruit nectars; fruit nectar beverages; vegetable juice, vegetable beverages and vegetable juices [beverages]; vegetable juice beverages; syrups and other preparations for making beverages; energy drinks; energy drinks; lemonades; non-alcoholic beverages; non-alcoholic beverages, in particular fruit-flavoured beverages; smoothies; waters, in particular with fruit flavouring; syrups for beverages; fruit syrups and other non-alcoholic fruit preparations for making non-alcoholic beverages; non-alcoholic sparkling wine.

(260) AM 2021 112031 A
 (800) 1579286
 (151) 2020 08 31
 (891) 2020 08 31
 (731) Idemitsu Kosan Co., Ltd.
 2-1, Otemachi 1-chome, Chiyoda-ku,
 Tokyo 100-8321, Japan
 (540)



(591) Black, white
 (531) 02.01.01; 02.01.16; 02.01.23; 02.03.01;
 02.03.16; 02.03.23; 27.05.21; 29.01.12
 (511)
 4 – Solid lubricants; automotive lubricants; industrial lubricants; lubricants for ships; lubricants for metal working; lubricants for aircraft engines; all-purpose lubricants; lubricants for industrial machinery; grease for shoes and boots; leather preserving oil and grease; fuels; naphtha; biomass fuel; industrial oils; lubricating oils; lubricating greases; engine oils; motor oils;

gear oils; non-mineral oils and greases for industrial purposes [not for fuel]; waxes [raw material]; lubricants; industrial greases; industrial gasoline; cutting fluids; petroleum jelly; quenching oils; mould releasing oils; refrigeration oils; process oils.

(260) AM 2021 112111 A
 (800) 1579734
 (151) 2021 01 08
 (891) 2021 01 08
 (731) Anhui Anguo Fishing Tackle Co., Ltd.
 Bazhen Industrial Zone,; Chaohu City;
 Anhui Province, China
 (540)

KAIDAPRO

(591) Black, white
 (531) 27.05.01
 (511)
 28 – Artificial fishing bait; rods for fishing; landing nets for anglers; floats for fishing; fish hooks; decoys for hunting or fishing; fishing tackle; fishing lines; reels for fishing; creels [fishing traps].

(260) AM 2021 112121 A
 (800) 1580295
 (151) 2020 10 09
 (891) 2020 10 09
 (731) SR Brand AG
 Trunstrasse 4, CH-7247 Saas im Prättigau,
 Switzerland
 (540)

Skinrock

(591) Black, white
 (511)
 19 – Floor coverings of natural stone; veneer for floors made of natural stone; natural stone slabs; veneer for wall coverings made of natural stone; wall coverings not of metal; lining wall coverings, not of metal, for building.

37 – Installation of floor coverings; installation of wall coverings; restoration of floor coverings; restoration of wall coverings.

(260) AM 2021 112122 A
 (800) 1580375
 (151) 2020 12 30
 (891) 2020 12 30
 (731) Fashion Nova, LLC
 2801 E. 46th Street, Vernon CA 90058, USA
 (540)

FASHION NOVA

(591) Black, white
 (526) FASHION

(511)

18 – Tote bags and handbags, namely, purses, satchels, clutches, wristlet bags, shoulder bags; cross-body bags; fanny packs; sport bags and gym bags; messenger bags; duffle bags, mini bags; luggage; shoe bags for travel; weekend bags; overnight bags; travel bags; garment bags for travel; luggage tags; cosmetic cases sold empty; key cases; small leather goods, namely, wallets, and briefcase-type portfolios; credit card cases; coin purses.

(260) AM 2021 112123 A

(800) 1580389

(151) 2021 01 27

(891) 2021 01 27

(731) Limited Liability Company "Russian Mining Chemical Company"

Lyusinovskaya ul., d. 36, str. 1, et. 8,

RU-115093 Moskva, Russian Federation

(540)



(591) Green and its tinctures and black

(531) 01.15.09; 17.02.25; 26.05.04; 27.05.09; 29.01.12

(511)

1 – Bentonite; dolomite for industrial purposes; magnesium carbonate; flocculants; chemicals for use in forestry, except fungicides, herbicides, insecticides and parasiticides; magnesite; magnesium silicate; magnesium chloride; alkaline-earth metals; salts of alkaline-earth metals; salts [fertilizers]; talc [magnesium silicate]; fertilizers; horticultural chemicals, except fungicides, herbicides, insecticides and parasiticides; chemicals for industrial use; agricultural chemicals, except fungicides, herbicides, insecticides and parasiticides; chemical reagents, other than for medical or veterinary purposes.

(260) AM 2021 112124 A

(800) 1580418

(151) 2020 10 07

(891) 2020 10 07

(731) NAMMO AS

Enggata 37, N-2830 RAUFOSS, Norway

(540)



(591) Black, white

(531) 23.03.10; 27.05.08; 27.05.17

(511)

13 – Ammunition and associated parts and components, projectiles, rockets and associated parts and components, pyrotechnic mixtures for ammunition and rockets.

(260) AM 2021 112125 A

(800) 1580429

(151) 2020 12 28

(891) 2020 12 28

(731) FOREST WELL CO., LTD.

2-18-5-2 Higashiterao, Tsurumi-ku, Yokohama-shi, Kanagawa 230-0077, Japan

(540)



(591) Black, white, red

(531) 24.17.02; 27.05.01; 29.01.12

(511)

11 – Air purifiers with built-in ion generators; ion generating apparatus for air purifiers.

(260) AM 2021 112127 A

(800) 1580497

(151) 2020 12 18

(891) 2020 12 18

(731) Linak A/S

Smedevænget 8, Guderup, DK-6430 Nordborg, Denmark

(540)

LINAK

(591) Black, white

(511)

7 – Machine tools, power-operated tools; motors and engines, except for land vehicles; machine coupling and transmission components, except for land vehicles; agricultural implements, other than hand-operated hand tools; actuators for mechanisms; mechanical and electro-mechanical actuators; hydraulic actuators; linear actuators; linear actuators [mechanical], pneumatic actuators; pneumatic actuating apparatus; rotating actuators; rotary actuators; actuator systems; actuators for valves; actuators for use in wind turbines; actuators for automation of manufacturing processes; actuators integrated in feeding machines; actuators integrated in automatic feeding apparatus for livestock; actuators integrated in agricultural machines; actuators for outdoor power equipment, such as lawn mower blades and pull-type attachments for machine tools; drive units; telescopic guides; electric motors for actuators, lifting columns and actuator systems; electrical brakes for machines; actuating mechanisms for slats and pergolas and slats for shading installations; actuators for solar energy collectors for generating electricity; actuators for solar energy collectors for electricity generation; actuators for operating of valves; parts and accessories (not included in other classes) for the aforesaid goods; lifting platforms; lifting tables; lifting columns; linear actuators designed as lifting columns, linear actuators designed as

drive units for lifting columns; mechanical, electro-mechanical and electric lifting columns; robotic mechanisms for lifting; lifting and hoisting equipment, elevators and escalators; stairlifts; mobile stairs [motorised]; mechanical and hydraulic lifts; lifting apparatus; elevating apparatus; remotely controlled lifting machines; lifting chairs; parts and accessories (not included in other classes) for the aforesaid goods.

9 – Scientific, research, navigation, surveying, photographic, cinematographic, audio-visual, optical, weighing, measuring, signalling, detecting, testing, inspecting, life-saving and teaching apparatus and instruments; apparatus and instruments for conducting, switching, transforming, accumulating, regulating or controlling the distribution or use of electricity; apparatus and instruments for recording, transmitting, reproducing or processing sound, images or data; recorded and downloadable media, computer software, blank digital or analogue recording and storage media; computers and computer peripheral devices; electric actuators; linear actuators [electric]; electric actuator systems; frequency converters for actuators; peripherals adapted for use with computers and other smart devices; electric actuators for solar energy collectors for generating electricity; electric actuators for solar energy collectors for electricity generation; electric actuators for operating of valves; software for monitoring, analysing, controlling and running physical world operations; factory automation software; downloadable computer software for remote monitoring and analysis; computer software for controlling self-service terminals; interactive computer software for creating user manuals; software for movement controllers; machine learning software for healthcare; workout logging software; electric actuators for controlling apparatus for climate control; electric actuators integrated in monitors [computer hardware]; application software for controlling and monitoring actuators; downloadable applications for use with mobile devices; batteries for mobile devices; batteries for adjustable medical devices; multi battery chargers; battery chargers; adaptors (electricity); adapters for connection between media devices; USB adapters; application software for wireless devices; wireless remote controls for controlling actuators; wireless controllers to remotely monitor and control the function and status of other electrical, electronic, and mechanical devices or systems; operating panels; touch sensitive control panels; electric operating units; computer software for configuring actuators; security control apparatus; electronic or electric control modules and control boxes; electronic or electric junction boxes; electronic or electric end stops including switches for end stops; communication interface units for control boxes; AC/DC connector; sensors; electronic sensors; electric sensors; gyroscopic sensors; sensory software; object detecting sensors; intelligent motor control devices; health monitoring software; sensors for monitoring physical movements; measuring, detecting and

monitoring instruments, indicators and controllers; intelligent gateways for software defined storage; digital sensors; optical sensors; piezoelectric sensors; magnetic sensors; motion sensors for security lights; movement sensors; motion sensors, motion detectors; movement recognition software; electronic brakes for actuators; mounting brackets for actuators; mounting cords [electrical]; light-emitting diodes [LED]; weighing apparatus and instruments for weighing patients in hospital beds; computer software and computer hardware for testing, remotely monitoring, analyzing, fault and status reporting, maintaining and generating service data; electric, electronic and optical remote controls, hand controls and foot controls; switches, limit switches, electronic limit switches, safety limit switches (safety switches), circuit breakers, fault current breakers; fire alarms and moisture alarms; electrical and electronic circuits, potentiometers (variable electric resistances), antennas, electromagnetic coils, indicators (electric), temperature indications, speed indicators, pressure indicators, level indicators (instrument for determining the horizontal plane) tachometers, revolution counters, encoders including magnetic and optical encoders; extension cords and cables, plugs and plug connectors, and junctions and junction boxes; electric apparatus and instruments for automatic positioning devices; external power supply units [electric]; external power supply units [transformers]; power supply units (electric); external power supply units, batteries; scales with body mass analyzers; weighing scales for medical use; parts and accessories (not included in other classes) for the aforesaid goods.

10 – Surgical, medical, dental and veterinary apparatus and instruments; orthopaedic articles; massage apparatus; apparatus, devices and articles for nursing infants; actuators especially made as an integrated part of medical and surgical treatment apparatus and equipment; electrically operated massagers; sensor apparatus for medical use in diagnosis; patient monitoring sensors and alarms; dentists' armchairs; chairs especially made for medical use; sensor apparatus for medical use in monitoring the vital signs of patients; invalid lifts; patient lifters; actuators especially made for patient lifters; bed bases for beds especially made for medical purposes; beds specially made for medical purposes; tables for use in the treatment of patients; patient monitoring instruments; apparatus for monitoring vital signs; heart rate monitoring apparatus; heart signal monitors; incontinence bed pads; beds specially made for use by burn patients; patient examination tables; stair climbing machines for medical therapeutic use; lifting devices for aiding the disabled; lifting apparatus for the disabled; invalids' hoists; lifting chairs for the disabled; therapeutic and assistive devices adapted for the disabled; assistive devices adapted for the disabled; therapeutic devices adapted for the disabled; actuators especially made as integrated part of medical and surgical furniture including beds, couches and

treatment apparatus; parts and accessories (not included in other classes) for the aforesaid goods.

20 – Furniture; actuators especially made as an integrated part of height-adjustable tables; frames for tables with built-in actuators which are especially made; actuators integrated in height-adjustable store counters and check-out counters (store interior); frames for height-adjustable tables; height-adjustable desks; height-adjustable worktables; table legs; actuators especially made as integrated in height-adjustable kitchen furniture; actuators integrated in modular shelving [furniture]; actuators integrated in furniture, including adjustable beds, recliners [chairs] and sofas; fastening and anchoring devices (not of metal) for securing actuators to furniture including hospital furniture, office furniture and kitchen furniture; hospital beds; slatted bases for beds; mattress bases; bed rails; beds; adjustable beds; subframes for beds; bed frames; ladders and movable steps, non-metallic; furniture for the physically handicapped, namely, those of reduced mobility and invalids; feet for furniture; parts and accessories (not included in other classes) for the aforesaid goods.

(260) AM 2021 112128 A
(800) 1580542
(151) 2020 07 16
(891) 2020 07 16
(731) Trenkwalder Group AG
Lugeck 1-2, A-1010 Wien, Austria
(540)

trenkwalder

(591) Red
(531) 27.05.01; 29.01.01
(511)

35 – Employment agencies, especially hiring manpower; personnel selection using aptitude testing; outsourcing services [business assistance]; personnel management consultancy; personnel recruitment; personnel placement; personnel leasing; placement of staff; services of employment agencies; placement of temporary staff [employment agency]; recruitment of permanent staff; employment services for the procurement of medical and nursing staff.

41 – Training services; computer-based training; training services in the field of vocational training; training and further education; further education services; further education; organization of advanced training and further education courses; conducting of online seminars for training and further education; providing information relating to continuing education via the internet; vocational guidance; educational examination; distance learning courses; correspondence courses; know-how-transfer [training]; arranging and conducting of conferences; arranging and conducting of seminars; arranging and conducting of workshops.

42 – Computer and software development and design; software maintenance; web page design; scientific and technological services as well as research and design services relating thereto in the field of information technology.

(260) AM 2021 112130 A
(800) 1580549
(151) 2021 01 21
(891) 2021 01 21
(731) VITKO Oleksandr Mykolaiovych
vul. Horkoho, 110, kv. 44, Kyiv 03150, Ukraine
(540)



(591) Black, white
(531) 24.15.21; 25.07.03; 26.01.11; 26.07.25;
27.05.01

(511)
35 – Publicity; business management; business administration; administrative processing of purchase orders; administration of consumer loyalty programs; cost price analysis; accounting; negotiation of business contracts for others; market studies; opinion polling; invoicing; arranging subscriptions to telecommunication services for others; payroll preparation; tax preparation; demonstration of goods; business management assistance; commercial or industrial management assistance; economic forecasting; compilation of information into computer databases; compilation of statistics; business management for freelance service providers; business management of reimbursement programs for others; commercial administration of the licensing of the goods and services of others; computerized file management; personnel management consultancy; business management consultancy; marketing; marketing research; typing; provision of an online marketplace for buyers and sellers of goods and services; updating of advertising material; updating and maintenance of data in computer databases; updating and maintenance of information in registries; organization of exhibitions for commercial or advertising purposes; rental of advertising space; personnel recruitment; commercial information agency services; competitive intelligence services; layout services for advertising purposes; news clipping services; price comparison services; procurement services for others [purchasing goods and services for other businesses]; market intelligence services; photocopying services; gift registry services; import-export agency services; secretarial services; public relations; online retail services for downloadable digital music; online retail services for downloadable ring tones; online retail services for downloadable and pre-recorded music and movies; data search in computer files for others; presentation of goods on communication media, for retail

purposes; telephone answering for unavailable subscribers; office machines and equipment rental; rental of advertising time on communication media; direct mail advertising; outdoor advertising; pay per click advertising; online advertising on a computer network; dissemination of advertising matter; systemization of information into computer databases; compiling indexes of information for commercial or advertising purposes; sales promotion for others; promotion of goods and services through sponsorship of sports events; production of teleshopping programs; production of advertising films; television advertising; telemarketing services; negotiation and conclusion of commercial transactions for third parties; professional business consultancy.

38 – Telecommunications; providing access to databases; providing user access to global computer networks; providing internet chatrooms; providing online forums; providing telecommunications connections to a global computer network; providing telecommunication channels for teleshopping services; communications by fiber optic networks; communications by computer terminals; communications by cellular phones; video-on-demand transmission; transmission of greeting cards online; transmission of electronic mail; computer aided transmission of messages and images; transmission of telegrams; transmission of digital files; message sending; videoconferencing services; voice mail services; electronic bulletin board services [telecommunications services]; telecommunications routing and junction services; news agency services; teleconferencing services; streaming of data; rental of message sending apparatus; rental of modems; rental of telecommunication equipment; rental of telephones; rental of facsimile apparatus; rental of access time to global computer networks; radio communications; radio broadcasting; satellite transmission; television broadcasting; cable television broadcasting; communications by telegrams; communications by telephone; wireless broadcasting; facsimile transmission.

(260) AM 2021 112131 A

(800) 1580573

(151) 2020 09 10

(891) 2020 09 10

(731) Mul-T-Lock Technologies Ltd.

Mul-T-Lock Park, P.O.B. 637, Yavne, Israel

(540)

MTL

(591) Black, white

(511)

6 – Locks, security locks and lock goods, also including lock cylinders, mortise locks, padlocks, multi-point locks; keys and key blanks, bolts, locks bolts, padlock hasps, lock eases, safety chains, striking plates, split rings of common metal for keys, boxes, identity plates, king-pin locks, trailer hitch locks, ship-

ment container locks; safes, doors, windows, hinges and handles; panic handles; door closers not electric; emergency and panic devices for doors and windows, namely, metal security lock cylinders with emergency function; parts and accessories for all the aforesaid goods; articles for use by locksmiths in the repair and preparation of locks and keys, small items of metal hardware; rosettes for locks and for door handles; hardware for buildings; all the aforesaid goods being of metal or predominantly of metal; keys for locks and blanks for keys for locks, identity plates, safes of metal, parts and accessories therefor, all of the foregoing being non-electric and made of metal; metal security lock cylinders; rim lock, single point lock (SPL), industrial lock, all made of metal; metal door hardware, namely, keys and key cylinders; metal cylinders for compressed gas or liquids, sold empty; lock cylinders of metal; furniture locks, tubular locks, cylindrical locks, cylinder protectors, all made of metal; door closers made of metal, non-electric.

9 – Biometric, electric, electronic and electromechanical locks and lock goods; biometric and electronic lock cylinders; electric striking plates, door magnets, electronic keys, key cards, also including, electronic or magnetic access control cards and smart cards, and key card readers; biometric access control readers; units for programming locks, lock cylinders, keys, biometric sensors readers, key cards and key card readers; apparatus for measuring biomagnetic signals; biometric, electronic and magnetic sensors; apparatus and instruments for signaling and checking, also including checking and/or controlling people's movement within, entrance to and exit from buildings and through doors and gates and/or for use with locks; magnetic and electronic identity cards; computer software for biometric and magnetic data carriers; smart card readers; units for programming locks, lock cylinders, keys, key cards and key card readers; non-electric, door operators namely, electric installations for the remote control of industrial operations, electronic access control systems for interlocking doors; electric and electro mechanical door and window hardware; electronic and magnetic sensors; electric tags; RFID tags; radio-frequency controlled locks; electronic lock assemblies; electronically operated high security lock cylinders; electronic locks incorporating biometric iris and/or fingerprint scanners; electric locks; digital door locks; computer software and mobile applications for biometric, electric, electronic and electromechanical locks and lock goods; computer software and mobile applications for biometric and electronic lock cylinders; computer software and mobile applications for electric striking plates, door magnets, electronic keys, key cards, also including, electronic or magnetic access control cards and smart cards, and key card readers; computer software and mobile applications for biometric access control readers; computer software and mobile applications for units for programming locks, lock cylinders, keys, biometric sensors readers,

key cards and key card readers; computer software and mobile applications for measuring biomagnetic signals; computer software and mobile applications for biometric, electronic and magnetic sensors; computer software and mobile applications for signaling and checking, also including checking and/or controlling people's movement within, entrance to and exit from buildings and through doors and gates and/or for use with locks; computer software and mobile applications for magnetic and electronic identity cards; computer software and mobile applications for smart card readers; computer software and mobile applications for programming locks, lock cylinders, keys, key cards and key card readers; computer software and mobile applications for electromechanical and electro-hydraulic door openers, door closers and door operators; computer software and mobile applications for electric tags; computer software and mobile applications for rfid tags; computer software and mobile applications for radio-frequency controlled locks; computer software and mobile applications for electronically operated high security lock cylinders; computer software and mobile applications for electronic locks incorporating biometric iris and/or fingerprint scanners; computer software and mobile applications for electric locks; computer software and mobile applications for digital door locks; access control and alarm monitoring systems; electronic readers and controllers for controlling access to a premises; electronic access control systems for interlocking doors; magnetic locks and cylinders; magnetic locks and cylinders.

37 – Installation, maintenance and repair of doors; repair of door frames; door repair services; lock repair services; setup or repair of locks, cylinders and keys; installation, changing, replacement and repair of locks, cylinders and keys.

(260) AM 2021 112132 A

(800) 1580582

(151) 2020 12 17

(891) 2020 12 17

(731) Lockton, Inc.

444 W. 47th Street, Suite 900, Kansas City
MO 64112, USA

(540)

**UNCOMMONLY
INDEPENDENT**

(591) Black, white

(526) INDEPENDENT

(511)

36 – Insurance brokerage services; insurance and financial risk management services; insurance agency services; insurance information and consulting services; brokerage, insurance and financial risk management information and consulting in the field of emp-

loyee benefits concerning insurance and finance; brokerage, insurance and financial risk management information and consulting in the field of employee retirement plans concerning insurance and finance.

(260) AM 2021 112197 A

(800) 1580971

(151) 2020 12 25

(891) 2020 12 25

(731) WTM Establishment

Städtle 28, FL-9490 Vaduz, Liechtenstein

(540)



(591) Black, white

(531) 01.15.17; 06.19.05; 07.01.11; 24.13.01;
25.01.15; 27.05.10

(526) VODKA

(511)

33 – Vodka.

(260) AM 2021 112198 A

(800) 1581001

(151) 2020 12 07

(891) 2020 12 07

(731) ZHUHAI MEIDI EDUCATION

TECHNOLOGY COMPANY LIMITED

Room 202, 295 Yingyan North Road, Pingsha
Town, Zhuhai City, 519000 Guangdong
Province, China

(540)

dadi

(591) Black, white

(531) 27.05.01; 27.05.17

(511)

41 – Academies [education]; tuition; instruction services; nursery schools; coaching (training); tutoring service; bookmobile services; gymnastic instruction; providing sports facilities.

(260) AM 2021 112202 A

(800) 1581036

(151) 2021 01 28

(891) 2021 01 28

(731) Janssen Pharmaceutica NV

Turnhoutseweg 30, B-2340 Beerse, Belgium

(540)

БАЛВЕРСА

(591) Black, white

(531) 28.05

(511)

5 – Human pharmaceutical preparations.

(260) AM 2021 112219 A

(800) 1581453

(151) 2020 12 16

(891) 2020 12 16

(731) Zhongyi Rubber CO., LTD

East of Xinggong Road, South of Beiwaihuan Road, Dawang Town, Guangrao County, Dongying City, Shandong Province, China

(540)



(591) Black, white

(531) 02.01.20; 24.01.08; 24.01.09; 27.05.01

(511)

12 – Vehicle tires; automobile tires; inner tube for vehicle; solid tires for vehicles; bicycle pump; cart; repair outfits for inner tubes; hot air balloon; air pump for automobile; electric vehicle.

(260) AM 2021 112220 A

(800) 1581529

(151) 2020 11 24

(891) 2020 11 24

(731) Richter Gedeon Nyrt.

Gyömrői út 19-21, H-1103 Budapest, Hungary

(540)

SIRGALED

(591) Black, white

(511)

5 – Pharmaceutical preparations.

(260) AM 2021 112226 A

(800) 1581618

(151) 2021 01 07

(891) 2021 01 07

(731) MeiShang (GZ) Cosmetics Co., Ltd.

Room 3002, No. 146 Linhe Middle Road, Tianhe District, Guangzhou City, Guangdong Province, China

(540)

COŁORKEY

(591) Black, white

(531) 27.05.01

(511)

3 – Cleansing milk for toilet purposes; cleaning preparations; cosmetics; beauty masks; essential oils; perfumes; cosmetic kits; lotions for cosmetic purposes; oils for cosmetic purposes; cosmetic preparations for skin care.

(260) AM 2021 112227 A

(800) 1581649

(151) 2021 02 08

(891) 2021 02 08

(731) Public Joint Stock Company "Krasnyj

Octyabr"

ul. Malaya Krasnoselskaya, d. 7, str. 24,

RU-107140 Moscow, Russian Federation

(540)

ЧАРЛИ КЭМБЕР

(591) Black, white

(531) 28.05

(511)

30 – Confectionery for decorating Christmas trees; coffee flavorings; seasonings; cookies; candies; waffles; cocoa; coffee; cakes; capers; caramels [candies]; cereal preparations; chocolate; marzipan; condiments; confectionery; corn flakes; popcorn; ice cream; pancakes; fondants [confectionery]; cake dough; cocoa beverages with milk; coffee beverages with milk; molasses for food; honey; pies; pastries; petit-beurre biscuits; puddings; pralines; liquorice [confectionery]; sago; sherbets [ices]; tarts; edible ices; almond confectionery; peanut confectionery; oat flakes; chocolate mousses; dessert mousses [confectionery]; pesto; cereal bars.

(260) AM 2021 112229 A

(800) 1581664

(151) 2021 02 02

(891) 2021 02 02

(731) Limited Liability Company "SLADKIJ

ORESHEK"

d. Melechkino, stroenie 123, Solnechnogorsky

rayon, RU-141554 Moskovskaya oblast,

Russian Federation

(540)



(591) White, gray, yellow, orange, pink, raspberry, light green, blue, brown and dark brown

(531) 05.03.13; 05.07.06; 05.07.22; 19.03.24; 25.07.25; 29.01.15

(511)

30 – Aromatic preparations for food; vanilla flavorings for culinary purposes; flavorings, other than essential oils, for cakes; flavorings, other than essential oils, for beverages; coffee flavorings; food flavorings, other than essential oils; star aniseed; baozi; cereal bars; high-protein cereal bars; pancakes; savory pancakes; freeze-dried dishes with the main ingredient being pasta; freeze-dried dishes with the main ingredient being rice; noodle-based prepared meals; buns; bulgur; bread rolls; pains au chocolat; edible paper wafers; edible rice paper; edible paper; burritos; vanillin [vanilla substitute]; waffles; vermicelli; natural sweeteners; sausage binding materials; binding agents for ice cream; orange blossom water for culinary purposes; seawater for cooking; seaweed [condiment]; malt biscuits; cloves [spice]; mirror icing [mirror glaze]; cake frosting [icing]; glucose for culinary purposes; mustard; croutons; buckwheat, processed; gluten additives for culinary purposes; yeast; thickening agents for cooking foodstuffs; leaven; rice-based snack food; cereal-based snack food; artificial coffee; vegetal preparations for use as coffee substitutes; dressings for salad; fruit jellies [confectionery]; candy decorations for cakes; confectionery for decorating Christmas trees; cakes; pastries; peanut confectionery; almond confectionery; fruit confectionery; pasta; ground ginger; frozen yogurt [confectionery ices]; cocoa; cream of tartar for culinary purposes; capers; coffee capsules, filled; caramels [sweets]; curry [spice]; ketchup [sauce]; quinoa, processed; quiches; gluten prepared as foodstuff; flour-based dumplings; sweets; liquorice [confectionery]; peppermint sweets; mints for breath freshening; dulce de leche; cinnamon [spice]; coffee; unroasted coffee; starch for food; crackers; rice crackers; crème brûlée; custard; croissants; hominy grits; semolina; oatmeal; crushed barley; groats for human food; ice cubes; corn, milled; corn, roasted; meat pies; turmeric; couscous; laksa; noodles; soba noodles; udon noodles; ice for refreshment; ice, natural or artificial; edible ices; ice pops; potato-based flatbreads; rice cakes; mayonnaise; macarons; macaroni; maltose; hominy; piccalilli; marinades; marzipan; honey; miso; royal jelly; ice cream; bean meal; buckwheat flour; tapioca flour; potato flour; corn flour; nut flours; flour; wheat flour; soya flour; barley meal; dessert mousses [confectionery]; chocolate mousses; muesli; mint for confectionery; cocoa beverages with milk; coffee beverages with milk; coffee-based beverages; cocoa-based beverages; chamomile-based beverages; tea-based beverages; chocolate beverages with milk; chocolate-based beverages; infusions, not medicinal; nougat; crushed oats; husked oats; kimchi pancakes; onigiri; chocolate-coated nuts; nutmegs; stick liquorice [confectionery]; ginger paste [seasoning]; pastilles [confectionery]; molasses for food; pâtés en croûte; pelmeni; pepper; allspice; peppers [seasonings]; pesto; biscuits; coconut macaroons; petit-beurre biscuits; bibimbap [rice mixed with vegetables and beef]; pies;

pizzas; meat gravies; fondants [confectionery]; popcorn; powders for making ice cream; baking powder; mustard meal; pralines; condiments; meat tenderizers for household purposes; cereal preparations; oat-based food; propolis; profiteroles; gingerbread; spices; petits fours; puddings; rice pudding; cake powder; fruit coulis [sauces]; ravioli; ramen; chewing gum; chewing gum for breath freshening; relish [condiment]; rice; prepared rice rolled in seaweed; instant rice; wheat germ for human consumption; spring rolls; sago; sugar; crystallized rock sugar; palm sugar; sesame seeds [seasonings]; linseed for culinary purposes [seasoning]; processed seeds for use as a seasoning; aniseed; agave syrup [natural sweetener]; golden syrup; confectionery; savory pancake mixes; batter mixes; baking soda [bicarbonate of soda for cooking purposes]; malt for human consumption; salt for preserving foodstuffs; cooking salt; celery salt; sorbets [ices]; ham glaze; cranberry sauce [condiment]; soya sauce; tomato sauce; pasta sauce; sauces [condiments]; apple sauce [condiment]; spaghetti; seasonings; chocolate-based spreads; chocolate spreads containing nuts; preparations for stiffening whipped cream; shaved ice with sweetened red beans; rusks; breadcrumbs; sushi; sandwiches; tabbouleh; tacos; tamarind [condiment]; tapioca; tarts; dough; pastry dough; almond paste; rice pulp for culinary purposes; cake dough; tortillas; garden herbs, preserved [seasonings]; chocolate decorations for cakes; vinegar; beer vinegar; ferments for pastes; halvah; harissa [condiment]; bread; gluten-free bread; unleavened bread; corn flakes; oat flakes; chips [cereal products]; hot dog sandwiches; flowers or leaves for use as tea substitutes; jiaozi; chicory [coffee substitute]; tea; kelp tea; iced tea; chutneys [condiments]; minced garlic [condiment]; cheeseburgers [sandwiches]; chow-chow [condiment]; saffron [seasoning]; chocolate; malt extract for food; essences for foodstuffs, except etheric essences and essential oils; husked barley.

(260) AM 2021 112230 A

(800) 1581667

(151) 2020 09 30

(891) 2020 09 30

(731) Unipharm, Inc.

350 Fifth Avenue, Suite 6701, New York
NY 10118, USA

(540)

MELADREAM

(591) Black, white

(531) 27.05.01

(511)

3 – Non-medicated cosmetics and toiletry preparations; non-medicated dentifrices; perfumery, essential oils; bleaching preparations and other substances for laundry use; cleaning, polishing, scouring and abrasive preparations.

5 – Pharmaceuticals, medical and veterinary preparations; sanitary preparations for medical purposes; dietetic food and substances adapted for medical or veterinary use, food for babies; dietary supplements for human being and animals; plasters, materials for dressings; material for stopping teeth, dental wax; disinfectants; preparations for destroying vermin, fungicides, herbicides.

10 – Surgical, medical, dental and veterinary apparatus and instruments; artificial limbs, eyes and teeth; orthopaedic articles; suture materials; therapeutic and assistive devices adapted for persons with disabilities; massage apparatus; apparatus, devices and articles for nursing infants; sexual activity apparatus, devices and articles.

32 – Beers; non-alcoholic beverages; mineral and aerated waters; fruit beverages and fruit juices; syrups and other non-alcoholic preparations for making beverages.

(260) AM 2021 112231 A

(800) 1581669

(151) 2020 09 28

(891) 2020 09 28

(731) DECEUNINCK N.V.

Bruggesteeweg 360, B-8830 Hoogdele-Gits,
Belgium

(540)

deceuninck FRAMING THE FUTURE TOGETHER

(591) Black, white

(511)

19 – Films of plastic for use in building; building materials (non-metallic); non-metal windows; doors and gates, not of metal; non-metal window frames; window glass not for vehicles, not of metal; building glass, not of metal; fanlights (window flaps), not of metal; lintels (window lintels, door lintels), not of metal; roller shutters (external), not of metal and not of textile material; window shutters, not of metal; roller shutter boxes of plastic; transportable buildings not of metal, in particular conservatories (not of metal); reinforcing profiles, not of metal for hollow plastic profiles; pipes for building purposes, not of metal; profiles and panels [building materials], not of metal; doors, fencing, staircases, portals, cladding, walls, floors, ceiling, façades, foofings, roller shutters, roller shutter boxes, conservatories, all not made of metal; window frames, door frames and frame profiles, not of metal; claddings for doors and windows, not of metal; accessories for windows and doors, namely window sills, window shutters included in this class, not of metal; insect protection mesh, not of metal; ventilation elements being fittings for windows, doors, gates, not of metal; palisades; piles; all the aforesaid goods for building purposes and not of metal.

(260) AM 2021 112232 A

(800) 1581698

(151) 2020 01 27

(891) 2020 01 27

(731) adp Gauselmann GmbH

Merkur-Allee 1-15, 32339 Espelkamp,
Germany

(540)

BIG 5 ASIA

(591) Black, white

(511)

9 – Computer software; coin-operated mechanisms; computer and video games software; games software in particular for use on any computer platform, including electronic entertainment and games consoles; computer game programs; video games (software); computer games provided through a global computer network or supplied by means of multi-media electronic broadcast or through telecommunications or electronic transmission or via the internet; computer games, leisure and recreational software, video games and computer software, all being provided in the form of storage media; programs for operating electric and electronic apparatus for games, amusement and/or entertainment purposes; computer software for computer games on the internet; online games (software), in particular for online betting games, online prize games, online gambling games, online games of skill and online casino games; computer software in the form of an app for mobile devices and computers; calculating apparatus in coin-operated machines and parts for the aforesaid goods; electric, electronic, optical or automatic apparatus, for identifying data carriers, identity cards and credit cards, bank notes and coins; software in particular for casino and/or amusement arcade games, for gaming machines and/or slot machines each one with or without prize payouts; gaming software that generates or displays wager outcomes of gaming machines; operational computer games software; computer software for managing of games (game collection); computer programs for video games; computer video game software.

28 – Games; toys; gaming apparatus (including coin-operated apparatus); coin-operated arcade games (machines); games for amusement arcades (included in this class); coin-operated video gaming apparatus; video games apparatus adapted for use with external screens or monitors only; casino fittings, namely roulette tables, roulette wheels; coin-operated automatic gaming machines and gaming machines, in particular for gaming arcades, with or without a prize payout; electronic or electrotechnical gaming apparatus, automatic gaming machines, gaming machines, slot machines operated by coins, tokens, banknotes, tickets or by means of electronic, magnetic or biometric storage media, in particular for commercial use in casinos and amusement arcades, with or without a prize payout; automatic gaming machines and gaming machines, in

particular for commercial use in casinos and gaming arcades, with or without a prize payout; coin-operated gaming machines and/or electronic money-based gaming apparatus (machines), with or without prizes; housings adapted for gaming machines, gaming apparatus and automatic gaming machines, operated by means of coins, tokens, tickets or by means of electronic, magnetic or biometric storage media, in particular for commercial use in casinos and gaming arcades, with or without a prize payout; electronic games; electronic game entertainment apparatus and parts thereof; video output game machines; drawing apparatus for prize games and lotteries, draws or raffles; housings of metal, plastic and/or wood for coin-operated automatic amusement machines; apparatus for games (including video games), other than adapted for use with external screens or monitors only; electropneumatic and electric slot machines with pulling handles (gaming machines); gaming tables, in particular for table football, billiards, sliding games; flying discs (toys) and darts; gaming machines, namely, electric, electronic or electromechanical apparatus for bingo games, lotteries or video lottery games and for betting offices, connected or unconnected to a computer network; LCD games consoles; automatic gaming machines; all the aforesaid automatic machines operating in networks; apparatus and devices for accepting and storing money, being fittings for the aforesaid automatic machines, included in class 28; automatic lottery machines.

(260) AM 2021 112233 A

(800) 1581707

(151) 2021 01 21

(891) 2021 01 21

(731) AROMATIKA LTD.

7-9 Nyzhniy Val str., Kyiv 04071, Ukraine

(540)

AROMATIKA

(591) Black, white

(531) 27.05.01

(511)

31 – Raw and unprocessed agricultural, aquacultural, horticultural and forestry products; raw and unprocessed grains and seeds; foodstuffs and beverages for animals.

(260) AM 2021 112234 A

(800) 1581726

(151) 2020 11 23

(891) 2020 11 23

(731) Badoo Media Limited

332 Agiou Andreou Street, Patrician Chambers,
CY-3035 Limassol, Cyprus

(540)

badoo

(591) Black, white

(531) 27.05.01

(511)

9 – Computer software; application software for social networking services via internet; computer software platforms for social networking; computer application software for mobile phones; computer software for use as an application programming interface (api); instant messaging software; downloadable instant messaging software; mobile telephones; computer application software for mobile telephones; computer software to enable the transmission of photographs to mobile telephones; training guides in electronic format; downloadable applications; downloadable mobile applications; mobile application software; computer software for use as an application programming interface (api) to allow access to online services for competitions; computer game software playable via a social networking, business networking, social introduction, or dating applications; blog software; podcasts; mobile phone accessories; grips, stands and mounts for handheld electronic devices including mobile phones, tablets, sound players, video players, cameras, e-readers; protective mobile phone cases; adaptors; tablet cases; laptop cases; laptop bags; selfie sticks; headphones; earphone cases; portable power packs; speaker cases; portable speakers; mouse mats; computer mouse; microphones; headsets; memory sticks.

16 – Printed matter; postcards; greetings cards; stationery; pens; pencils; notebooks; gift bags; gift boxes; stickers; removable self-stick notes; notepads; beer mats.

18 – Luggage and carrying bags; umbrellas; purses; wallets; handbags; luggage tags; suitcases; rucksacks; backpacks; sports bags; school bags; shopping bags; tote bags; canvas bags; make up bags; cosmetic cases; flight bags; key pouches; leather bags; swim bags; shoe bags; pyjama bags; beach bags; vanity cases sold empty; parts and fittings for all the aforementioned goods.

25 – Clothing; headgear; footwear.

35 – Advertising, marketing and promotional services; business advice and consultancy; business management services; business management provided online from a computer database or the internet; business introductions, business networking services; online business introductions and online business networking services; location-based business introductions and location-based business networking services; business introductions and business networking services provided via a software application for portable electronic devices; hosting of exhibitions and networking events for business purposes; market research

services; compilation of advertisements for use as web pages on the internet; provision of space on websites for advertising goods and services; provision of space in mobile applications for advertising goods and services; opinion polling; writing of publicity texts; search engine optimisation; database management; collection of data; electronic data processing; compilation of data in computer databases; providing business information in the field of social media; providing marketing consulting in the field of social media; advertising and marketing services provided by means of social media; advertising and marketing services provided by means of blogging; business networking; information, advisory and consultancy services relating to all the aforesaid.

38 – Electronic transmission of data, messages, graphics, images and information; podcasting services; transmission of podcasts; peer-to-peer photo sharing services, namely, electronic transmission of digital photo files among internet users; providing access to computer, electronic and online databases; email and instant messaging services in connection with social networking, social introduction or dating; chat room services in connection with social networking, social introduction or dating; operating chat rooms in connection with social networking, social introduction or dating; providing access to online services relating to social networking, social introduction or dating; location-based transmission of information; audio, text and video broadcasting services over computer or other communication networks, including uploading, posting, displaying and electronically transmitting data, information, audio and video images; providing access to an online network service; information, advisory and consultancy services relating to all the aforesaid.

41 – Education; providing of training; entertainment; provision of entertainment via podcast; sporting and cultural activities; publishing services; information services relating to entertainment or education, provided on-line from a computer database or the internet; providing online games; providing on-line electronic publications (not downloadable); publication of electronic books and journals on-line; operating chat rooms; providing digital music (not downloadable) from mp3 internet web sites; writing services for blogs; information, advisory and consultancy services relating to all the aforesaid.

42 – Design and development of computer software in connection with social networking, social introduction or dating; design and development of computer software for the location-based transmission of information in connection with social networking, social introduction or dating; design, drawing and commissioned writing for the compilation of web sites; creating, maintaining and hosting the web sites of others; hosting of podcasts; design and development of computer hardware and software; application service provider ser-

vices; software as a service [saas]; providing search engines for the Internet; providing search engines for obtaining data via communications networks; computer services for the analysis of data; data mining; research in the field of social media; creation and maintenance of software for blogs; hosting of digital content, namely, on-line journals and blogs; providing temporary use of non-downloadable computer software for use in the creation and publication of on-line journals and blogs; information, advisory and consultancy services relating to all the aforesaid.

45 – Social introduction, social networking, professional introductions and dating services; concierge services; match making services; online dating, friendship, social introduction networking; internet based dating services; location-based social introduction, social networking, professional networking and dating services; social introduction, social networking and dating services provided via a software application for portable electronic devices including mobile phones and tablet computers; licensing of computer software and other technology; rental of clothing; personal wardrobe styling services; consulting in the field of personal relationships; consulting in the field of professional relationships; information, advisory and consultancy services relating to all the aforesaid.

(260) AM 2021 112235 A

(800) 1581762

(151) 2020 11 23

(891) 2020 11 23

(731) Badoo Media Limited

332 Agiou Andreou Street, Patrician Chambers,
CY-3035 Limassol, Cyprus

(540)

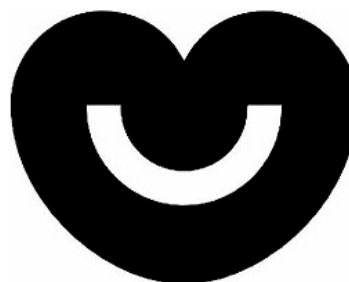

(591) Black, white

(531) 02.09.01; 26.13.25

(511)

9 – Computer software; application software for social networking services via internet; computer software platforms for social networking; computer application software for mobile phones; computer software for use as an application programming interface (api); instant messaging software; downloadable instant messaging software; mobile telephones; computer application software for mobile telephones; computer software to enable the transmission of photographs to mobile telephones; training guides in electronic format; downloadable applications; downloadable mobile ap-

plications; mobile application software; computer software for use as an application programming interface (api) to allow access to online services for competitions; computer game software playable via a social networking, business networking, social introduction, or dating applications; blog software; podcasts; mobile phone accessories; grips, stands and mounts for handheld electronic devices including mobile phones, tablets, sound players, video players, cameras, e-readers; protective mobile phone cases; adaptors; tablet cases; laptop cases; laptop bags; selfie sticks; headphones; earphone cases; portable power packs; speaker cases; portable speakers; mouse mats; computer mouse; microphones; headsets; memory sticks.

16 – Printed matter; postcards; greetings cards; stationery; pens; pencils; notebooks; gift bags; gift boxes; stickers; removable self-stick notes; notepads; beer mats.

18 – Luggage and carrying bags; umbrellas; purses; wallets; handbags; luggage tags; suitcases; rucksacks; backpacks; sports bags; school bags; shopping bags; tote bags; canvas bags; make up bags; cosmetic cases; flight bags; key pouches; leather bags; swim bags; shoe bags; pyjama bags; beach bags; vanity cases sold empty; parts and fittings for all the aforementioned goods.

25 – Clothing; headgear; footwear.

35 – Advertising, marketing and promotional services; business advice and consultancy; business management services; business management provided online from a computer database or the internet; business introductions, business networking services; online business introductions and online business networking services; location-based business introductions and location-based business networking services; business introductions and business networking services provided via a software application for portable electronic devices; hosting of exhibitions and networking events for business purposes; market research services; compilation of advertisements for use as web pages on the internet; provision of space on websites for advertising goods and services; provision of space in mobile applications for advertising goods and services; opinion polling; writing of publicity texts; search engine optimisation; database management; collection of data; electronic data processing; compilation of data in computer databases; providing business information in the field of social media; providing marketing consulting in the field of social media; advertising and marketing services provided by means of social media; advertising and marketing services provided by means of blogging; business networking; information, advisory and consultancy services relating to all the aforesaid.

38 – Electronic transmission of data, messages, graphics, images and information; podcasting services; transmission of podcasts; peer-to-peer photo sharing

services, namely, electronic transmission of digital photo files among internet users; providing access to computer, electronic and online databases; email and instant messaging services in connection with social networking, social introduction or dating; chat room services in connection with social networking, social introduction or dating; operating chat rooms in connection with social networking, social introduction or dating; providing access to online services relating to social networking, social introduction or dating; location-based transmission of information; audio, text and video broadcasting services over computer or other communication networks, including uploading, posting, displaying and electronically transmitting data, information, audio and video images; providing access to an online network service; information, advisory and consultancy services relating to all the aforesaid.

41 – Education; providing of training; entertainment; provision of entertainment via podcast; sporting and cultural activities; publishing services; information services relating to entertainment or education, provided on-line from a computer database or the internet; providing online games; providing on-line electronic publications (not downloadable); publication of electronic books and journals on-line; operating chat rooms; providing digital music (not downloadable) from mp3 internet web sites; writing services for blogs; information, advisory and consultancy services relating to all the aforesaid.

42 – Design and development of computer software in connection with social networking, social introduction or dating; design and development of computer software for the location-based transmission of information in connection with social networking, social introduction or dating; design, drawing and commissioned writing for the compilation of web sites; creating, maintaining and hosting the web sites of others; hosting of podcasts; design and development of computer hardware and software; application service provider services; software as a service [saas]; providing search engines for the Internet; providing search engines for obtaining data via communications networks; computer services for the analysis of data; data mining; research in the field of social media; creation and maintenance of software for blogs; hosting of digital content, namely, on-line journals and blogs; providing temporary use of non-downloadable computer software for use in the creation and publication of on-line journals and blogs; information, advisory and consultancy services relating to all the aforesaid.

45 – Social introduction, social networking, professional introductions and dating services; concierge services; match making services; online dating, friendship, social introduction networking; internet based dating services; location-based social introduction, social networking, professional networking and dating services; social introduction, social networking and

dating services provided via a software application for portable electronic devices including mobile phones and tablet computers; licensing of computer software and other technology; rental of clothing; personal wardrobe styling services; consulting in the field of personal relationships; consulting in the field of professional relationships; information, advisory and consultancy services relating to all the aforesaid.

(260) AM 2021 112323 A

(800) 1582418

(151) 2021 02 02

(891) 2021 02 02

(731) Siemens Healthcare GmbH

Henkestraße 127, 91052 Erlangen, Germany

(540)

MAGNETOM Free.RT

(591) Black, white

(511)

10 – Medical instruments and apparatus and parts therefor, in particular magnetic resonance imaging devices.

(260) AM 2021 112337 A

(800) 1583044

(151) 2021 02 05

(891) 2021 02 05

(731) WTW WHOLESALE TIRES & WHEELS, INC.

1144 W. Grove Avenue, Orange CA 92865, USA

(540)

GIOVANNA

(591) Black, white

(511)

12 – Tires; wheels.

(260) AM 2021 112338 A

(800) 1583053

(151) 2020 12 07

(891) 2020 12 07

(731) Tenz GmbH

Hohlstrasse 44, CH-8004 Zürich, Switzerland

(540)

Tenz

(591) Black, white

(511)

30 – Coffee, tea, cocoa and coffee substitutes; rice, pasta, noodles, Momo (purse-shaped) and Shapaley (purse-shaped); tapioca and sago; flour and preparations made from cereals; bread, pastry and confectionery; chocolate; ice cream, sherbets and other edible ices; sugar, honey, golden syrup; yeast, baking-powder; salt, seasonings, spices, preserved herbs; vine-

gars, sauces, chili sauce, chili powder and other condiments; ice for refreshment.

32 – Beers; non-alcoholic beverages; mineral and aerated waters; fruit beverages and fruit juices; syrups and other preparations without alcohol for making beverages.

43 – Services for providing food and beverages; temporary accommodation.

(260) AM 2021 112346 A

(800) 1583128

(151) 2021 01 27

(891) 2021 01 27

(731) LLC TorgCity

Tatarskaya str., 1, lit. L, of. 303, Vladivostok, RU-690039 Primorskiy kray, Russian Federation

(540)

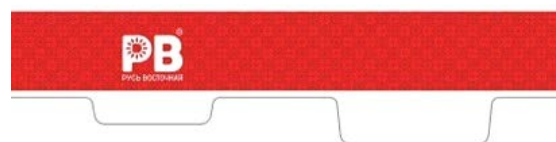

(591) Red, dark red, white, beige and gray

(531) 01.03.02; 26.04.02; 26.04.12; 26.04.13;

26.04.18; 26.11.01; 26.11.11; 28.05; 29.01.13

(511)

30 – Vanilla flavorings for culinary purposes; flavorings, other than essential oils, for cakes; flavorings, other than essential oils, for beverages; coffee flavorings; food flavorings, other than essential oils; star aniseed; baozi; cereal bars; high-protein cereal bars; pancakes; noodle-based prepared meals; freeze-dried dishes with the main ingredient being pasta; freeze-dried dishes with the main ingredient being rice; buns; bulgur; bread rolls; edible rice paper; edible paper; burritos; vanillin [vanilla substitute]; vareniki [stuffed dumplings]; waffles; vermicelli; natural sweeteners; sausage binding materials; binding agents for ice cream; sea water for cooking; seaweed [condiment]; malt biscuits; cloves [spice]; mirror icing [mirror glaze]; cake frosting [icing]; glucose for culinary purposes; mustard; croûtons; buckwheat, processed; gluten additives for culinary purposes; dressings for salad; yeast; thickening agents for cooking foodstuffs; leaven; rice-based snack food; cereal-based snack food; artificial coffee; vegetal preparations for use as coffee substitutes; zefir [confectionery]; fruit jellies [confectionery]; candy decorations for cakes; confectionery for decorating Christmas trees; cakes; pastries; peanut confectionery; almond confectionery; pasta; ginger [spice]; frozen yogurt [confectionery ices]; cocoa; cream of tartar for culinary purposes; capers; caramels [sweets]; curry [spice]; ketchup [sauce]; prepared rice rolled in seaweed; quinoa, processed; quiches; gluten prepared as foodstuff; flour-based dumplings; sweets; liquorice [confectionery]; peppermint sweets; mints

for breath freshening; dulce de leche; cinnamon [spice]; coffee; unroasted coffee; starch for food; crackers; custard; hominy grits; semolina; oatmeal; crushed barley; groats for human food; ice cubes; corn, milled; corn, roasted; meat pies; turmeric; couscous; noodles; ice for refreshment; ice, natural or artificial; edible ices; lollipops; rice cakes; mayonnaise; macarons; macaroni; maltose; hominy; piccalilli; marinades; marzipan; honey; miso; royal jelly; ice cream; bean meal; buckwheat flour; tapioca flour; potato flour; corn flour; nut flours; flour; wheat flour; soya flour; barley meal; dessert mousses [confectionery]; chocolate mousses; muesli; mint for confectionery; cocoa beverages with milk; coffee beverages with milk; coffee-based beverages; cocoa-based beverages; chamomile-based beverages; tea-based beverages; chocolate beverages with milk; chocolate-based beverages; infusions, not medicinal; crushed oats; husked oats; savory pancakes; onigiri; ramen; jiaozi; nutmegs; chocolate-coated nuts; stick liquorice [confectionery]; pastilles [confectionery]; molasses for food; pâtés en croûte; pelmeni; pepper; allspice; peppers [seasonings]; pesto; biscuits; petit-beurre biscuits; bibimbap [rice mixed with vegetables and beef]; pies; pizzas; meat gravies; fondants [confectionery]; popcorn; powders for making ice cream; baking powder; mustard meal; pralines; aromatic preparations for food; condiments; meat tenderizers for household purposes; cereal preparations; oat-based food; propolis; gingerbread; spices; petits fours; rice pudding; puddings; cake powder; fruit coulis [sauces]; ravioli; chewing gum; chewing gum for breath freshening; relish [condiment]; rice; instant rice; wheat germ for human consumption; spring rolls; sago; palm sugar; sugar; sesame seeds [seasonings]; linseed for culinary purposes [seasoning]; processed seeds for use as a seasoning; aniseed; agave syrup [natural sweetener]; golden syrup; confectionery; baking soda [bicarbonate of soda for cooking purposes]; malt for human consumption; salt for preserving foodstuffs; cooking salt; celery salt; sorbets [ices]; ham glaze; cranberry sauce [condiment]; soya sauce; tomato sauce; apple sauce [condiment]; sauces [condiments]; pasta sauce; mayonnaise sauces; spaghetti; seasonings; chocolate-based spreads; chocolate spreads containing nuts; preparations for stiffening whipped cream; rusks; bread-crumbs; sushi; sandwiches; rice crackers; tabbouleh; tacos; tapioca; tarts; dough; pastry dough; almond paste; rice pulp for culinary purposes; cake dough; tortillas; garden herbs, preserved [seasonings]; chocolate decorations for cakes; vinegar; beer vinegar; ferments for pastes; halvah; bread; unleavened bread; chips [cereal products]; corn flakes; oat flakes; hot dog sandwiches; flowers or leaves for use as tea substitutes; chicory [coffee substitute]; tea; iced tea; chutneys [condiments]; minced garlic [condiment]; cheeseburgers [sandwiches]; chow-chow [condiment]; saffron [seasoning]; chocolate; malt extract for food; essences for foodstuffs, except etheric essences and essential

oils; husked barley; buckwheat porridge with beef; pearl-barley porridge with beef; rice porridge with beef; buckwheat porridge with pork; pearl-barley porridge with pork; rice porridge with pork.

31 – Algarovilla for animal consumption; anchovy, live; oranges, fresh; peanuts, fresh; artichokes, fresh; draff; beans, fresh; locust beans, raw; wreaths of natural flowers; grapes, fresh; algae, unprocessed, for human or animal consumption; fruit residue [marc]; dog biscuits; peas, fresh; mushroom spawn for propagation; mushrooms, fresh; trees; palm trees; turf, natural; unsawn timber; undressed timber; yeast for animal consumption; Christmas trees; edible chews for animals; live animals; menagerie animals; peanut cake for animals; oil cake; maize cake for cattle; rape cake for cattle; bagasses of cane [raw material]; cereal seeds, unprocessed; grains [cereals]; grains for animal consumption; lime for animal forage; fish spawn; vegetable marrows, fresh; cocoa beans, raw; potatoes, fresh; chestnuts, fresh; arrangements of fresh fruit; copra; raw barks; rough cork; animal foodstuffs; pet food; stall food for animals; bird food; strengthening animal forage; chicory roots; roots for animal consumption; nettles; groats for poultry; maize; edible sesame, unprocessed; shrubs; rose bushes; spiny lobsters, live; lemons, fresh; vine plants; salmon, live; onions, fresh; flower bulbs; leeks, fresh; olives, fresh; bran mash for animal consumption; shellfish, live; almonds [fruits]; mussels, live; peanut meal for animals; linseed meal for animal consumption; meal for animals; flax meal [fodder]; rice meal for forage; fish meal for animal consumption; straw mulch; beverages for pets; edible insects, live; oats; vegetables, fresh; cucumbers, fresh; lobsters, live; nuts, unprocessed; coconuts; kola nuts; bran; distillery waste for animal consumption; residue in a still after distillation; palms [leaves of the palm tree]; cuttle bone for birds; peppers [plants]; aromatic sand [litter] for pets; citrus fruit, fresh; litter for animals; mash for fattening livestock; unprocessed sweet corn ears [husked or unhusked]; animal fattening preparations; preparations for egg laying poultry; fishing bait, live; by-products of the processing of cereals, for animal consumption; seed germ for botanical purposes; poultry, live; wheat; pollen [raw material]; crayfish, live; crustaceans, live; seedlings; plants; aloe vera plants; plants, dried, for decoration; rhubarb, fresh; rice, unprocessed; rye; wheat germ for animal consumption; fish, live; lettuce, fresh; sardines, live; beet, fresh; herrings, live; seeds for planting; linseed for animal consumption; edible linseed, unprocessed; hay; coconut shell; bred stock; sanded paper [litter] for pets; malt for brewing and distilling; straw [forage]; straw litter; salt for cattle; trunks of trees; wood chips for the manufacture of wood pulp; litter peat; garden herbs, fresh; sea-cucumbers, live; sugarcane; truffles, fresh; tuna, live; squashes, fresh; oysters, live; fruit, fresh; hazelnuts, fresh; fodder; hops; flowers, natural; flowers, dried, for decoration; chicory, fresh; silkworms; garlic,

fresh; lentils, fresh; pine cones; hop cones; spinach, fresh; juniper berries; berries, fresh; eggs for hatching, fertilized; silkworm eggs; barley.

32 – Aperitifs, non-alcoholic; lithia water; seltzer water; soda water; waters [beverages]; aerated water; mineral water [beverages]; table waters; kvass; cocktails, non-alcoholic; beer-based cocktails; lemonades; non-alcoholic beverages; isotonic beverages; non-alcoholic honey-based beverages; rice-based beverages, other than milk substitutes; soya-based beverages, other than milk substitutes; aloe vera drinks, non-alcoholic; whey beverages; protein-enriched sports beverages; soft drinks; non-alcoholic beverages flavored with coffee; non-alcoholic beverages flavored with tea; non-alcoholic fruit juice beverages; fruit nectars, non-alcoholic; orgeat; beer; ginger beer; malt beer; powders for effervescing beverages; sarsaparilla [non-alcoholic beverage]; syrups for lemonade; syrups for beverages; smoothies; tomato juice [beverage]; cider, non-alcoholic; vegetable juices [beverages]; fruit juices; preparations for making aerated water; malt extracts for making liquors; preparations for making beverages; must; grape must, unfermented; beer wort; malt wort; pastilles for effervescing beverages; sherbets [beverages]; non-alcoholic fruit extracts; extracts of hops for making beer; non-alcoholic essences for making beverages.

(260) AM 2021 112347 A

(800) 1583196

(151) 2021 02 11

(891) 2021 02 11

(731) APPLE INC.

One Apple Park Way, Cupertino CA 95014,
USA

(540)

APPLE WATCH SE

(591) Black, white

(511)

9 – Personal digital assistants; electronic personal organizers; digital audio players; remote controls for controlling smartphones and cameras; wearable activity trackers; smartwatches; electronic communication apparatus, namely, wearable digital electronic devices for sending and receiving of text, data, audio, image, and video files; personal electronic devices used to track fitness goals and statistics.

(260) AM 2021 112348 A

(800) 1583201

(151) 2021 02 12

(891) 2021 02 12

(731) HOLISTIC HEALTH, INC.

9070 GLEANNLOCH FOREST DRIVE,
SUITE 100, SPRING TX 77379, USA

(540)



(591) Black, white

(531) 26.05.01; 26.05.18; 27.05.01

(511)

25 – Clothing, namely, t-shirts, tank tops, shirts, long-sleeved shirts, shorts, pants, jackets, athletic apparel, namely, pullover hoodies, sweatshirts, jogging pants, leggings, hats and caps, and windbreakers.

(260) AM 2021 112349 A

(800) 1583247

(151) 2020 03 18

(891) 2020 03 18

(731) EFE AYAKKABI PAZARLAMA SAN. İTH.
İHR. LTD. ŞTİ.

Akçaburgaz Mahallesi Akçaburgaz, Caddesi
No:28 Kıraç, Esenyurt Bağcılar, İstanbul,
Turkey

(540)



(591) Black, white

(531) 27.05.01; 27.05.09

(511)

10 – Surgical, medical, dental and veterinary apparatus and instruments; furniture especially made for medical purposes; artificial limbs and prostheses; medical orthopaedic articles; corsets for medical purposes, orthopaedic shoes, elastic bandages and supportive bandages; surgical gowns and surgical sterile sheets; adult sexual aids; condoms; babies' bottles; babies' pacifiers; teats; teethers for babies.

25 – Clothing, including underwear and outerclotthing; other than special purpose protective clothing; socks, mufflers [clothing], shawls, bandanas, scarves, belts [clothing]; footwear, shoes, slippers, sandals; headgear, hats, caps with visors, berets, caps [headwear]; skull caps.

(260) AM 2021 112350 A

(800) 1583271

(151) 2020 08 27

(891) 2020 08 27

(731) Otkrytoe aktsionernoe obshchestvo

"Upravlyayushchaya kompaniya holdinga,

"Belkommunmash"

ul. Perekhodnaya, d.64B-2, 220070 Minsk,

Belarus

(540)



(591) Dark blue, lettuce green and dark grey

(531) 26.11.08; 27.05.10; 27.05.11; 27.05.22;
29.01.12

(526) HOLDING

(511)

12 – Vehicles, including electric vehicles; motor buses; trolleybuses; tramcars; electrobuses; bodies for vehicles; vehicles for locomotion by land and rail; bogies for railway cars; railway couplings; cars for transportation; sprinkling trucks.

37 – Construction; installation services; rebuilding machines that have been worn or partially destroyed; vehicle maintenance; motor vehicle maintenance and repair; repair of trolleybuses, tramcars, electrobuses; maintenance and servicing of trolleybuses, tramcars, electrobuses; vehicle polishing; painting of automobiles [repair].

(260) AM 2021 112351 A

(800) 1583281

(151) 2021 01 27

(891) 2021 01 27

(731) Limited Liability Company "Russian Mining Chemical Company"

Lyusinovskaya ul., d. 36, str. 1, et. 8,

RU-115093 Moskva, Russian Federation

(540)



(591) Azure and its tinctures and black

(531) 01.15.09; 17.02.04; 26.13.25; 27.05.09;
29.01.12

(511)

1 – Bentonite; dolomite for industrial purposes; magnesium carbonate; flocculants; chemicals for use in forestry, except fungicides, herbicides, insecticides and parasiticides; magnesite; magnesium silicate; magnesium chloride; alkaline-earth metals; salts [fertilizers]; salts [chemical preparations]; salts of alkaline-earth metals; talc [magnesium silicate]; fertilizers; fertilizers for agriculture; soil conditioning preparations; horticultural chemicals, except fungicides, herbi-

cides, insecticides and parasiticides; chemicals for industrial purposes; agricultural chemicals, except fungicides, herbicides, insecticides and parasiticides.

(260) AM 2021 112352 A

(800) 1583292

(151) 2020 11 19

(891) 2020 11 19

(731) MISSONI S.P.A.

VIA LUIGI ROSSI, 52, I-21040 SUMIRAGO

(VARESE), Italy

(540)



(591) Black, white

(531) 26.01.02; 26.01.18; 27.05.01

(511)

3 – Perfumes; toilet water; scented water; perfumed soap; soaps for body care; deodorants for personal use [perfumery]; essential oils for personal use; potpourris [fragrances]; body lotions; shower gel; bath foam; bath oils; bath pearls; shaving balms; shaving creams; aftershave lotions; cosmetic pencils; foundation; face powder; talcum powder; blusher; lipsticks; eyeshadow; mascara; under-eye enhancers; concealers for spots and blemishes; eyeliner; lip glosses; skin cleansing creams; skin cleansing lotions; sunscreen preparations; tissues impregnated with cosmetic lotions; decorative transfers for cosmetic purposes; nail polish; beauty masks; facial scrubs; face creams for cosmetic purposes; body creams; sachets for perfuming linen; make-up; make-up removing preparations; beauty care preparations; lipstick cases; cotton sticks for cosmetic purposes; cotton pads for removing make-up; cosmetic slimming preparations; creams for cellulite reduction; hair rinses; hair lighteners; hair conditioners; hair shampoos; hair lotions; hair dyes; hair waving preparations; hair styling preparations; non-medicated cosmetics and toiletry preparations; non-medicated dentifrices; shoe polish; laundry preparations; laundry bleach.

9 – Eyewear; smartglasses; eyeglasses; sunglasses; anti-glare glasses; goggles for sports; swim goggles; sports eyewear; eyewear cases; eyeglass and sunglass cases; eyeglass and sunglass lenses; eyeglass and sunglass frames; eyeglass and sunglass chains; eyeglass cords; spectacle straps; spectacle lanyards; pince-nez; cases for pince-nez; chains for pince-nez; cords for pince-nez; frames for pince-nez; correcting lenses [optics]; sleeves for laptops; carrying cases adapted for computers; mouse pads; cell phone straps; lanyards [straps] for cellular phones; covers for tablet

computers; cases adapted for cellular phones; cases for smartphones; electronic book reader covers; cellular phone cases made of leather or imitations of leather; cellular phone covers made of cloth or textile materials; covers for cellular phones; headsets for cellular phones; earphones for cellular phones; selfie sticks [hand-held monopods]; holders for mobile telephones; headphones; CD player cases; music and video player cases; personal computer cases; photographic camera cases; magnetic key cards; binocular cases; musical juke boxes; decorative magnets; magic lanterns; holograms; optical discs; diving suits; divers' masks; ear plugs for divers; time clocks [time recording devices]; smartwatches; protective helmets; protective footwear; protective masks; clothing for protection against injury; GPS navigation devices.

14 – Precious metals; gold; silver; palladium; jewellery; jewels; precious stones; semi-precious stones; jade; natural pearls; gems; sapphires; diamonds; rubies; emeralds; topaz; costume jewellery; bracelets; ankle bracelets; necklaces; chokers; bangles; jewel chains; jewellery rings; jewellery brooches; tie pins; pendants; earrings; tiaras; tie clips; ornamental pins; medallions; diadems; coins; cuff links; clasps for jewellery; key tags of plastic; key rings; lanyards for holding keys; key fobs of precious metals; threads of precious metal being jewellery; precious metal trophies; medals; boxes of precious metal; jewel cases; works of art of precious metal; charms for jewellery; statuettes of precious metal; shoe ornaments of precious metal; hat ornaments of precious metal; beads for making jewellery; badges of precious metal; cabochons; amulets [jewelry]; spinel [precious stones]; cloisonné jewellery; ornaments [jewelry]; chronometers; chronoscopes; wrist watches; pocket watches; watches; chronographs for use as watches; watch chains; watch cases; watch glasses; watch clasps; watch bands; wall clocks; master clocks; table clocks; alarm clocks; clockworks; movements for clocks and watches; watch springs; cases for clock- and watchmaking; watch parts; clocks and parts therefor; sundials.

18 – Leather, unworked or semi-worked; furs sold in bulk; bags; handbags; shoulder bags; beach bags; clutch bags; all purpose sports bags; overnight bags; leather shopping bags; textile shopping bags; chain mesh purses; carry-on bags; barrel bags; wheeled bags; travelling bags; attaché cases; carrying cases for documents; evening purses [handbags]; satchels; cosmetic cases sold empty; school knapsacks; rucksacks; briefcases; briefcase-type portfolios; purses; wallets; felt pouches; duffle bags; overnight suitcases; day-packs; hip bags; fur; furniture coverings of leather; shoe bags for travel; boxes of leather or leatherboard; collars for dogs; travelling trunks; garment bags for travel; hat boxes for travel; luggage; suitcases; umbrellas; walking sticks; travelling cases of leather; key cases; name card cases; leather straps; saddlery; whips; harnesses.

25 – Formal wear; suits; dresses; leather pants; leather jackets; leisure wear; combinations [clothing]; night-wear; shirts; blouses; tee-shirts; skirts; trousers; jeans; leggings [leg warmers]; shorts; hosiery; clothing of imitations of leather; knitwear [clothing]; sports jerseys; undershirts; sweaters; sweatshirts; hooded sweatshirts; sweat pants; fleece vests; quilted vests; jackets [clothing]; suit jackets; wind-resistant jackets; coats; overcoats; raincoats; cardigans; bermuda shorts; anoraks; fur stoles; bathing suits; pareus; bath robes; underpants; panties, shorts and briefs; garters; brassieres; tights; stockings; socks; neckties; ascots; scarves; belts [clothing]; money belts [clothing]; suspenders; gloves [clothing]; ear muffs [clothing]; babies' pants; layettes [clothing]; vests; track suits; blousons; dance costumes; ski suits; knickers; leisure shoes; boots; shoes; dress shoes; leather shoes; beach shoes; sneakers; sports shoes; pumps [footwear]; moccasins; slippers; sandals; fittings of metal for footwear; footwear uppers; insoles for footwear; tips for footwear; welts for footwear; hats; small hats; berets; visors [headwear]; headbands [clothing].

35 – Retail or wholesale services, also on-line, for fragrances, air fragrancing preparations, perfumery, perfumes, toilet water, perfumed soaps, personal deodorants, essential oils for personal use, potpourri, body lotions, shower gel, bubble bath, bath oils, bath pearls, shaving balms, shaving cream, aftershave, cosmetic pencils, foundation, face powder, talcum powders, rouges, lipsticks, eye make-up, eyeshadows, mascaras, skin cleansing cream, skin cleansing lotion, sun screen preparations, tissues impregnated with cosmetic lotions, decorative transfers and skin jewels for cosmetic purposes, nail polish, beauty masks, facial scrubs, face creams, body creams, hair shampoo, hair lotion, lipstick cases, toiletry preparations; retail or wholesale services, also on-line, for eyewear, spectacle cords, spectacle frames, spectacle lenses, eyewear cases, protective eyewear and component parts thereof, sports eyewear, eyeglasses, sunglasses, anti-glare glasses, eyeglass and sunglass cases, eyeglass and sunglass frames, eyeglass and sunglass chains, eyeglass and sunglass cords, sleeves for laptops, covers for tablet computers, cases for smartphones, protective covers for smartphones; retail or wholesale services, also on-line, for bracelets, ankle bracelets, earrings, necklaces being jewelry, rings being jewelry, pendants, jewelry brooches, jewelry chains, medallions, cufflinks, tie clips, jewelry, costume jewelry, decorative boxes made of precious metal, jewelry cases, gold, unwrought or beaten, silver, unwrought or beaten, threads of precious metal being jewelry, jewelry hat pins, pins being jewelry, tiaras, charms for jewellery, key chains, split rings of precious metal for keys, watch cases, watch bands, wrist watches, clocks, chronometers, precious stones; retail or wholesale services, also on-line, for handbags, shoulder bags, beach bags, clutch bags, all purpose sports bags, overnight bags, canvas shopping bags, leather shopping bags,

mesh shopping bags, shopping bags with wheels attached, textile shopping bags, travelling bags, attaché cases, card cases being note cases, hip bags, cosmetic cases sold empty, school knapsacks, rucksacks, briefcases, purses, pocket wallets, leather wallets, coin holders in the nature of wallets, name card cases, credit card cases, key cases of leather or imitation leather, key cases, carrying cases for documents, overnight suitcases, luggage, pouches of leather, boxes of leather or leathertoard, labels of leather, luggage label holders, satchels, briefcase-type portfolios, garment bags for travel, leather and imitations of leather, animal skins and hides, all-purpose carrying bags, clothing for animals, leather, unworked or semi-worked, furs sold in bulk, travelling trunks, suitcases, umbrellas, parasols, walking sticks, dog collars, whips, retail or wholesale services, also on-line, for underwear, nightwear, neckwear, hosiery, loungewear, dressing gowns, bath robes, bathing suits, formal wear, namely, gowns, tuxedos, dinner jackets, leisure suits, leggings, shorts, business wear, namely, suit jackets, wind resistant jackets, denim jackets, sweat pants, tank tops, combinations for clothing, gloves as clothing, cardigans, sports jerseys, sweaters, socks, stockings, tights, trousers, leg warmers, skirts, jackets being clothing, jerkins, shirts, vests, tracksuits, blouses, jeans, panties, bermuda shorts, sweatshirts, hooded sweatshirts, suits, dresses, overcoats, anoraks, coats, blousons, rainwear, belts for clothing, money belts, suspenders, infant wear, dance costumes, clothing for children, namely, pants, shorts, shirts, trousers, skirts, T-shirts, sweatshirts, jackets and jumpers, beachwear, skiwear, shoes, boots, ski boots, snowboard boots, moccasins, sneakers, sandals, slippers, leisure shoes, dress shoes, leather shoes, beach shoes, sports shoes, pumps as footwear, soles for footwear, tips for footwear, welts for footwear, hats, cap peaks, knitted caps, golf caps, caps with visors; presentation of goods on communication media, for retail purposes providing commercial information and advice for consumers in the choice of products and services; sales promotion for others; outsourcing services [business assistance]; procurement services for others [purchasing goods and services for other businesses]; demonstration of goods; shop window dressing; sponsorship search; providing business information; organization of fashion shows for promotional and commercial purposes; modelling for advertising or sales promotion; administrative processing of purchase orders; organization of events, exhibitions, fairs and shows for commercial, promotional and advertising purposes; commercial administration of the licensing of the goods and services of others; publication of publicity materials and texts; business consultancy, management, planning and supervision; commercial intermediation services; business networking; business development; marketing; marketing analysis; advisory services relating to marketing; organization, operation and supervision of loyalty and incentive schemes; dis-

tribution and dissemination of advertising matter; distribution of samples for advertising purposes; publication of printed matter for advertising purposes; publication of publicity materials on-line; input and compilation of information into computer databases; compilation of statistical information; computerized file management; on-line ordering services; services rendered by a franchisor, namely assistance in the running or management of commercial enterprises, business advisory services relating to the establishment and operation of franchises; auctioneering; bookkeeping; public relations; product merchandising; business auditing; personnel placement and recruitment; advertising; business management; business administration; office functions.

INTERNATIONAL TRADEMARKS PROTECTED IN GEORGIA

(260) AM 2021 107784 A
(800) 1523564
(151) 2020 02 20
(181) 2030 02 20
(891) 2020 02 20
(511) 07, 09, 09

(260) AM 2021 107935 A
(800) 1525203
(151) 2019 11 27
(181) 2029 11 27
(891) 2019 11 27
(511) 01, 05, 05

(260) AM 2021 109706 A
(800) 1549438
(151) 2020 07 16
(181) 2030 07 16
(891) 2020 07 16
(511) 30, 35

(260) AM 2021 109717 A
(800) 1549742
(151) 2020 07 14
(181) 2030 07 14
(891) 2020 07 14
(511) 09

(260) AM 2021 109797 A
(800) 1550715
(151) 2020 07 03
(181) 2030 07 03
(891) 2020 07 03
(511) 08, 20, 21, 24, 25, 35

(260) AM 2021 109798 A
(800) 1550769
(151) 2020 07 23
(181) 2030 07 23
(891) 2020 07 23
(511) 33

(260) AM 2021 109855 A
(800) 1551244
(151) 2020 06 02
(181) 2030 06 02
(891) 2020 06 02
(511) 09, 28, 41

(260) AM 2021 109857 A
(800) 1551299
(151) 2020 08 18
(181) 2030 08 18
(891) 2020 08 18
(511) 10

(260) AM 2021 109858 A
(800) 1551348
(151) 2020 07 17
(181) 2030 07 17
(891) 2020 07 17
(511) 01

(260) AM 2021 109859 A
(800) 1551385
(151) 2020 07 22
(181) 2030 07 22
(891) 2020 07 22
(511) 10, 16

(260) AM 2021 109875 A
(800) 1551628
(151) 2020 05 29
(181) 2030 05 29
(891) 2020 05 29
(511) 09, 28, 41

(260) AM 2021 109880 A
(800) 1551712
(151) 2020 07 07
(181) 2030 07 07
(891) 2020 07 07
(511) 03

(260) AM 2021 109883 A
(800) 1551755
(151) 2020 03 31
(181) 2030 03 31
(891) 2020 03 31
(511) 06, 07

(260) AM 2021 109884 A
(800) 1551779
(151) 2020 06 23
(181) 2030 06 23
(891) 2020 06 23
(511) 30

(260) AM 2021 109890 A
 (800) 1551978
 (151) 2020 01 09
 (181) 2030 01 09
 (891) 2020 01 09
 (511) 05

(260) AM 2021 109977 A
 (800) 1552752
 (151) 2020 08 18
 (181) 2030 08 18
 (891) 2020 08 18
 (511) 02, 19

(260) AM 2021 109891 A
 (800) 1552000
 (151) 2020 08 04
 (181) 2030 08 04
 (891) 2020 08 04
 (511) 09, 42

(260) AM 2021 109978 A
 (800) 1552754
 (151) 2020 08 18
 (181) 2030 08 18
 (891) 2020 08 18
 (511) 10

(260) AM 2021 109892 A
 (800) 1552005
 (151) 2020 08 04
 (181) 2030 08 04
 (891) 2020 08 04
 (511) 35, 39, 41

(260) AM 2021 109979 A
 (800) 1552762
 (151) 2020 08 18
 (181) 2030 08 18
 (891) 2020 08 18
 (511) 02, 19

(260) AM 2021 109895 A
 (800) 1552180
 (151) 2020 06 30
 (181) 2030 06 30
 (891) 2020 06 30
 (511) 09

(260) AM 2021 109982 A
 (800) 1552783
 (151) 2020 07 14
 (181) 2030 07 14
 (891) 2020 07 14
 (511) 12

(260) AM 2021 109896 A
 (800) 1552190
 (151) 2020 06 20
 (181) 2030 06 20
 (891) 2020 06 20
 (511) 24

(260) AM 2021 109988 A
 (800) 1552973
 (151) 2020 08 18
 (181) 2030 08 18
 (891) 2020 08 18
 (511) 10

(260) AM 2021 109898 A
 (800) 1552264
 (151) 2020 07 15
 (181) 2030 07 15
 (891) 2020 07 15
 (511) 09

(260) AM 2021 109989 A
 (800) 1553011
 (151) 2020 05 22
 (181) 2030 05 22
 (891) 2020 05 22
 (511) 36

(260) AM 2021 109976 A
 (800) 1552744
 (151) 2020 05 07
 (181) 2030 05 07
 (891) 2020 05 07
 (511) 32, 33

(260) AM 2021 109990 A
 (800) 1553033
 (151) 2020 07 28
 (181) 2030 07 28
 (891) 2020 07 28
 (511) 10

(260) AM 2021 109991 A
(800) 1553056
(151) 2020 08 20
(181) 2030 08 20
(891) 2020 08 20
(511) 30

(260) AM 2021 110047 A
(800) 1553365
(151) 2020 09 02
(181) 2030 09 02
(891) 2020 09 02
(511) 03

(260) AM 2021 109992 A
(800) 1553131
(151) 2020 02 27
(181) 2030 02 27
(891) 2020 02 27
(511) 36

(260) AM 2021 110048 A
(800) 1553391
(151) 2020 06 03
(181) 2030 06 03
(891) 2020 06 03
(511) 28

(260) AM 2021 109993 A
(800) 1553160
(151) 2020 08 28
(181) 2030 08 28
(891) 2020 08 28
(511) 10

(260) AM 2021 110061 A
(800) 1553683
(151) 2020 07 15
(181) 2030 07 15
(891) 2020 07 15
(511) 08, 09

(260) AM 2021 109994 A
(800) 1553178
(151) 2020 05 04
(181) 2030 05 04
(891) 2020 05 04
(511) 03, 05

(260) AM 2021 110062 A
(800) 1553711
(151) 2020 09 09
(181) 2030 09 09
(891) 2020 09 09
(511) 09

(260) AM 2021 110008 A
(800) 1365758
(151) 2017 05 04
(181) 2027 05 04
(891) 2020 09 16
(511) 12, 35, 36, 37

(260) AM 2021 110063 A
(800) 1553717
(151) 2020 07 28
(181) 2030 07 28
(891) 2020 07 28
(511) 03

(260) AM 2021 110009 A
(800) 1430868
(151) 2018 03 19
(181) 2028 03 19
(891) 2020 08 14
(511) 07

(260) AM 2021 110065 A
(800) 1553798
(151) 2020 07 24
(181) 2030 07 24
(891) 2020 07 24
(511) 03, 05

(260) AM 2021 110010 A
(800) 1528394
(151) 2020 04 01
(181) 2030 04 01
(891) 2020 09 14
(511) 08

(260) AM 2021 110066 A
(800) 1553812
(151) 2020 08 27
(181) 2030 08 27
(891) 2020 08 27
(511) 05

(260) AM 2021 110068 A
(800) 1553851
(151) 2020 07 17
(181) 2030 07 17
(891) 2020 07 17
(511) 09, 35, 41

(260) AM 2021 110069 A
(800) 1553912
(151) 2020 07 16
(181) 2030 07 16
(891) 2020 07 16
(511) 30, 35

(260) AM 2021 110070 A
(800) 1553945
(151) 2020 05 01
(181) 2030 05 01
(891) 2020 05 01
(511) 34

(260) AM 2021 110071 A
(800) 1554005
(151) 2020 07 01
(181) 2030 07 01
(891) 2020 07 01
(511) 09, 28

(260) AM 2021 110083 A
(800) 1554369
(151) 2020 07 27
(181) 2030 07 27
(891) 2020 07 27
(511) 09, 16, 18, 25, 35

(260) AM 2021 110087 A
(800) 1554468
(151) 2020 06 09
(181) 2030 06 09
(891) 2020 06 09
(511) 03, 06, 07, 09, 11, 12, 14, 16, 18, 20, 21, 24, 25,
27, 28, 35, 36, 37, 39, 41, 43

(260) AM 2021 110088 A
(800) 1554469
(151) 2020 06 08
(181) 2030 06 08
(891) 2020 06 08
(511) 18

(260) AM 2021 110089 A
(800) 1554546
(151) 2020 08 12
(181) 2030 08 12
(891) 2020 08 12
(511) 06, 12

(260) AM 2021 110091 A
(800) 1554560
(151) 2020 05 06
(181) 2030 05 06
(891) 2020 05 06
(511) 01, 09, 37

(260) AM 2021 110098 A
(800) 1554799
(151) 2020 08 27
(181) 2030 08 27
(891) 2020 08 27
(511) 07, 11, 37

(260) AM 2021 110102 A
(800) 622789
(151) 1994 03 26
(181) 2024 03 26
(891) 2020 09 17
(511) 01

(260) AM 2021 110105 A
(800) 1068957
(151) 2011 02 10
(181) 2021 02 10
(891) 2020 08 24
(511) 35

(260) AM 2021 110107 A
(800) 1471941
(151) 2019 05 08
(181) 2029 05 08
(891) 2020 09 08
(511) 28

(260) AM 2021 110108 A
(800) 1511186
(151) 2019 12 13
(181) 2029 12 13
(891) 2020 08 26
(511) 33

(260) AM 2021 110109 A
(800) 1523856
(151) 2020 02 10
(181) 2030 02 10
(891) 2020 08 17
(511) 05

(260) AM 2021 110235 A
(800) 1556108
(151) 2020 09 02
(181) 2030 09 02
(891) 2020 09 02
(511) 30

(260) AM 2021 110149 A
(800) 1554885
(151) 2020 05 07
(181) 2030 05 07
(891) 2020 05 07
(511) 03, 10

(260) AM 2021 110238 A
(800) 1556165
(151) 2020 09 15
(181) 2030 09 15
(891) 2020 09 15
(511) 09, 16, 18

(260) AM 2021 110150 A
(800) 1554888
(151) 2020 08 03
(181) 2030 08 03
(891) 2020 08 03
(511) 12

(260) AM 2021 110262 A
(800) 1557068
(151) 2020 06 12
(181) 2030 06 12
(891) 2020 06 12
(511) 03, 05, 29, 30, 32

(260) AM 2021 110159 A
(800) 1555369
(151) 2020 07 09
(181) 2030 07 09
(891) 2020 07 09
(511) 06, 20, 32, 33, 34, 35, 41, 43

(260) AM 2021 110265 A
(800) 1557164
(151) 2020 09 30
(181) 2030 09 30
(891) 2020 09 30
(511) 12

(260) AM 2021 110160 A
(800) 1555373
(151) 2020 08 14
(181) 2030 08 14
(891) 2020 08 14
(511) 09, 16, 41

(260) AM 2021 110268 A
(800) 1370445
(151) 2017 05 12
(181) 2027 05 12
(891) 2020 10 02
(511) 01, 03, 05

(260) AM 2021 110174 A
(800) 1555916
(151) 2020 08 11
(181) 2030 08 11
(891) 2020 08 11
(511) 37

(260) AM 2021 110312 A
(800) 1557500
(151) 2020 06 17
(181) 2030 06 17
(891) 2020 06 17
(511) 02

(260) AM 2021 110175 A
(800) 1555918
(151) 2020 06 18
(181) 2030 06 18
(891) 2020 06 18
(511) 03, 05, 10, 16, 35

(260) AM 2021 110341 A
(800) 1558394
(151) 2020 06 24
(181) 2030 06 24
(891) 2020 06 24
(511) 12

(260) AM 2021 110342 A
(800) 1558395
(151) 2020 09 17
(181) 2030 09 17
(891) 2020 09 17
(511) 09, 18, 34, 35, 37, 41

(260) AM 2021 110430 A
(800) 587028
(151) 1991 12 20
(181) 2021 12 20
(891) 2020 10 16
(511) 07, 08

(260) AM 2021 110347 A
(800) 1099808
(151) 2011 11 04
(181) 2021 11 04
(891) 2020 10 01
(511) 20, 27

(260) AM 2021 110432 A
(800) 1355045
(151) 2017 04 12
(181) 2027 04 12
(891) 2020 10 16
(511) 21

(260) AM 2021 110348 A
(800) 1133111
(151) 2012 07 30
(181) 2022 07 30
(891) 2020 09 25
(511) 05

(260) AM 2021 110433 A
(800) 1386615
(151) 2017 06 21
(181) 2027 06 21
(891) 2020 10 16
(511) 07, 08, 09

(260) AM 2021 110349 A
(800) 1244241
(151) 2015 02 17
(181) 2025 02 17
(891) 2020 09 25
(511) 05

(260) AM 2021 110434 A
(800) 1396907
(151) 2017 10 02
(181) 2027 10 02
(891) 2020 09 24
(511) 03

(260) AM 2021 110396 A
(800) 1558672
(151) 2020 09 24
(181) 2030 09 24
(891) 2020 09 24
(511) 30

(260) AM 2021 110435 A
(800) 1406251
(151) 2018 01 18
(181) 2028 01 18
(891) 2020 10 12
(511) 35

(260) AM 2021 110398 A
(800) 1558710
(151) 2020 07 24
(181) 2030 07 24
(891) 2020 07 24
(511) 29, 31

(260) AM 2021 110495 A
(800) 1560077
(151) 2020 10 02
(181) 2030 10 02
(891) 2020 10 02
(511) 29, 30, 32

(260) AM 2021 110399 A
(800) 1558730
(151) 2020 07 15
(181) 2030 07 15
(891) 2020 07 15
(511) 09, 11, 12, 35, 36, 37, 39

(260) AM 2021 110496 A
(800) 1560091
(151) 2020 07 13
(181) 2030 07 13
(891) 2020 07 13
(511) 25

(260) AM 2021 110497 A
(800) 1560172
(151) 2020 07 31
(181) 2030 07 31
(891) 2020 07 31
(511) 11

(260) AM 2021 110620 A
(800) 1561398
(151) 2020 07 10
(181) 2030 07 10
(891) 2020 07 10
(511) 05

(260) AM 2021 110498 A
(800) 1560256
(151) 2020 09 18
(181) 2030 09 18
(891) 2020 09 18
(511) 09

(260) AM 2021 110651 A
(800) 1562179
(151) 2020 10 14
(181) 2030 10 14
(891) 2020 10 14
(511) 09

(260) AM 2021 110579 A
(800) 1561164
(151) 2020 09 23
(181) 2030 09 23
(891) 2020 09 23
(511) 16

(260) AM 2021 110654 A
(800) 1562449
(151) 2020 09 14
(181) 2030 09 14
(891) 2020 09 14
(511) 38

(260) AM 2021 110580 A
(800) 1561168
(151) 2020 04 21
(181) 2030 04 21
(891) 2020 04 21
(511) 05

(260) AM 2021 110656 A
(800) 1562500
(151) 2020 09 14
(181) 2030 09 14
(891) 2020 09 14
(511) 38

(260) AM 2021 110581 A
(800) 1561185
(151) 2020 10 05
(181) 2030 10 05
(891) 2020 10 05
(511) 29, 30, 32

(260) AM 2021 110657 A
(800) 1562510
(151) 2020 07 09
(181) 2030 07 09
(891) 2020 07 09
(511) 03, 05, 16, 21

(260) AM 2021 110617 A
(800) 1561367
(151) 2020 10 16
(181) 2030 10 16
(891) 2020 10 16
(511) 33

(260) AM 2021 110619 A
(800) 1561380
(151) 2020 06 04
(181) 2030 06 04
(891) 2020 06 04
(511) 35, 36

OFFICIAL NOTIFICATIONS
INVENTIONS
EXPIRATION OF PATENTS RESTORATION

(21) AP 2018 14895
(11) P 2020 7120 B
(73) Gocha Kurdadze
(54) METHOD FOR SILICO MANGANESE PRODUCTION
DATE OF CANCELLATION OF PATENT: 2021 10 05
THE TERM OF RESTORATION OF PATENT: 2021 11 10

(21) AP 2002 6666
(11) P 2004 3355 B
(73) Otkrytoe Aktsionernoje Obshchestvo "Nizhegorodskij Khimiko-Farmatsevticheskij Zavod"
(54) PHARMACEUTICAL COMPOSITION POSSESSING ANTIMYCOTIC ACTIVITY AND METHOD OF ITS PRODUCTION
DATE OF CANCELLATION OF PATENT: 2020 10 28
THE TERM OF RESTORATION OF PATENT: 2021 11 10

(21) AP 2004 8568
(11) P 2006 4003 B
(73) Nizhegorodski Khimiko-Farmatsevticheskij Zavod OAO "Nizhpharm"
(54) AGENT FOR TREATMENT OF ARTICULATION DISEASE
DATE OF CANCELLATION OF PATENT: 2020 12 29
THE TERM OF RESTORATION OF PATENT: 2021 11 10

ABOLITION OF PATENTS WITH THE RIGHT TO RESTORE

(21) AP 2007 11265
(11) P 2012 5568 B
(73) Takeda Pharmaceutical Company Limited
(54) METASTIN DERIVATIVES AND USE THEREOF
DATE OF CANCELLATION OF PATENT: 2021 10 24
THE TERM OF RESTORATION OF PATENT: 2022 10 24

(21) AP 2011 12424
(11) P 2013 5740 B
(73) Allied Global Tobacco Limited
(54) CIGARETTE WITHOUT FILTER
DATE OF CANCELLATION OF PATENT: 2021 10 24
THE TERM OF RESTORATION OF PATENT: 2022 10 24

(21) AP 2011 13092
(11) P 2015 6303 B
(73) Reforcetech LTD
(54) REINFORCEMENT BAR AND METHOD FOR MANUFACTURING SAME
DATE OF CANCELLATION OF PATENT: 2021 10 21
THE TERM OF RESTORATION OF PATENT: 2022 10 21

(21) AP 2011 13096
(11) P 2014 6208 B
(73) Manetech A.S.
(54) ORGANIC FERTILIZER AND METHOD OF ITS PRODUCTION
DATE OF CANCELLATION OF PATENT: 2021 10 17
THE TERM OF RESTORATION OF PATENT: 2022 10 17

(21) AP 2014 13602
(11) P 2015 6404 B
(73) Merab Lekveishvili
(54) DRUG FOR TREATMENT OF CONDITIONS RELATED TO OXIDATIVE STRESS
DATE OF CANCELLATION OF PATENT: 2021 10 20
THE TERM OF RESTORATION OF PATENT: 2022 10 20

(21) AP 2016 14761
(11) P 2020 7142 B
(73) Arven Ilac Sanayi Ve Ticaret A.S.
(54) BLISTER FOR INHALABLE FORMULATION OF TIOTROPIUM BROMIDE
DATE OF CANCELLATION OF PATENT: 2021 10 21
THE TERM OF RESTORATION OF PATENT: 2022 10 21

EXPIRATION OF TERM OF RESTORATION OF PATENTS

(21) AP 2010 12649
(11) P 2016 6504 B
(73) Millennium Pharmaceuticals Inc.;
Amgen British Columbia
(54) ANTI-GCC ANTIBODY MOLECULES AND RELATED COMPOSITIONS AND METHODS
DATE OF CANCELLATION OF PATENT: 2020 10 22
THE TERM OF RESTORATION OF PATENT VALIDITY HAS EXPIRED: 2021 10 22

(21) AP 2010 12707
(11) P 2017 6604 B
(73) Institut National De La Santé Et De La Recherché Médicale (INSERM);
Centre National De La Recherché Scientifique;
Les Laboratoires Servier
(54) MONOCLONAL ANTIBODIES TO PROGASTRIN AND THEIR USES
DATE OF CANCELLATION OF PATENT: 2020 10 15
THE TERM OF RESTORATION OF PATENT VALIDITY HAS EXPIRED: 2021 10 15

(21) AP 2010 13723
(11) P 2019 6956 B
(73) Millennium Pharmaceuticals Inc.;
Amgen British Columbia
(54) ANTI-GCC ANTIBODY MOLECULES AND RELATED COMPOSITIONS AND METHODS
DATE OF CANCELLATION OF PATENT: 2020 10 22
THE TERM OF RESTORATION OF PATENT VALIDITY HAS EXPIRED: 2021 10 22

(21) AP 2015 13972
(11) P 2018 6831 B
(73) LEPL "Shota Rustaveli National Science Foundation";

LEPL "I. Javakhishvili Tbilisi State University";
Guram Khitiri;
Ioseb Chikvaidze
(54) METHOD FOR PIPELINE SEDIMENTATION WASTE-FREE UTILIZATION
DATE OF CANCELLATION OF PATENT: 2020 10 23
THE TERM OF RESTORATION OF PATENT VALIDITY HAS EXPIRED: 2021 10 23

(21) AP 2016 14294
(11) P 2018 6835 B
(73) Ilia Kherodinashvili
(54) METHOD FOR CITY OR VILLAGE COMMUNITY GAS SUPPLEMENT
DATE OF CANCELLATION OF PATENT: 2020 10 07
THE TERM OF RESTORATION OF PATENT VALIDITY HAS EXPIRED: 2021 10 07

(21) AP 2016 14795
(11) P 2020 7085 B
(73) Karatzis S.A. Industrial & Hotelier Enterprises
(54) RASCHEL MACHINE, NET AND USE OF THE RASCHEL MACHINE TO PRODUCE A NET
DATE OF CANCELLATION OF PATENT: 2020 10 13
THE TERM OF RESTORATION OF PATENT VALIDITY HAS EXPIRED: 2021 10 13

UTILITY MODELS

ABOLITION OF PATENTS WITH THE RIGHT TO RESTORE

(21) AU 2015 13963
(11) U 2017 1919 Y
(73) LEPL "Institute of Pharmacochimistry of TSMU";
LEPL "Tbilisi State Medical University"
(54) GEL FOR ELECTROTHERAPY
DATE OF CANCELLATION OF PATENT: 2021 10 16
THE TERM OF RESTORATION OF PATENT: 2022 10 16

(21) AU 2019 15191
(11) U 2021 2081 Y
(73) Zhiuli Keadze
(54) ANODE FOR RECEIVING ELECTORILYSIS MAGNESIUM DIOXIDE
DATE OF CANCELLATION OF PATENT: 2021 10 10
THE TERM OF RESTORATION OF PATENT: 2022 10 10

EXPIRATION OF TERM OF RESTORATION OF PATENTS

(21) AU 2013 13255
(11) U 2016 1885 Y
(73) Givi Papava;
Eldar Gugava;
Nora Dokhtashvili;

Nunu Maisuradze;
Nazi Gelashvili;
Marina Gurgenishvili;
Ketevan Papava;
Nanuli Khotenashvili;
Riva Liparteliani

(54) METHOD FOR NITROGEN FERTILIZER PRODUCTION OF PROLONGED ACTIVITY
DATE OF CANCELLATION OF PATENT: 2020 10 04
THE TERM OF RESTORATION OF PATENT VALIDITY HAS EXPIRED: 2021 10 04

(21) AU 2018 14904

(11) U 2019 2024 Y

(73) Davit Gogoli

(54) ELECTROLYTE FOR PLATING OF ZINC-BISMUT-MANGANESE ALLOY COATING

DATE OF CANCELLATION OF PATENT: 2020 10 15

THE TERM OF RESTORATION OF PATENT VALIDITY HAS EXPIRED: 2021 10 15

DESIGNS

EXTENSION OF DESIGN REGISTRATION

(11) D 2017 706 S

(73) Giorgi Bidzinashvili (GE)

D. Uznadze St. 91 a, app. 1, 0102, Tbilisi, Georgia (GE)

(54) DOOR WITH FRAME, DOOR WITH FRAME AND SLUICE, DOOR WITH FRAME AND LATTICE,
SAFE

(28) 4

(24) 2016 11 01

(18) 2026 11 01

(58) 2021 10 21

EXTENSION OF INTERNATIONAL DESIGNS REGISTRATIONS

(11) DM/68209

(73) SWATCH AG (SWATCH SA) (SWATCH LTD.)

94, Rue Jakob Stämpfli, CH-2502 BIENNE (CH)

(15) 2006 10 10

(24) 2006 10 10

(18) 2026 10 10

(28) 1

(28') 1

(54) Wristwatch

(11) DM/68217

(73) ENDURA AG (ENDURA SA) (ENDURA LTD.)

Längfeldweg 119, CH-2504 Biel-Bienne (CH)

(15) 2006 10 03

(24) 2006 10 03

(18) 2026 10 03
(28) 2
(28') 2
(54) Watch cases

(11) DM/68251
(73) SWATCH AG (SWATCH SA) (SWATCH LTD.)
94, Rue Jakob Stämpfli, CH-2502 BIENNE (CH)
(15) 2006 10 20
(24) 2006 10 20
(18) 2026 10 20
(28) 1
(28') 1
(54) Watch bracelet

(11) DM/68346
(73) HENKEL KOMMANDITGESELLSCHAFT AUF AKTIEN
Henkelstrasse 67, 40589 Düsseldorf (DE)
(15) 2006 10 11
(24) 2006 10 11
(18) 2026 10 11
(28) 2
(28') 2
(54) Bottles

(11) DM/68348
(73) LÉON HATOT SA (LÉON HATOT AG) (LÉON HATOT LTD.)
Viaduktstrasse 30, CH-2500 BIEL/BIENNE (CH)
(15) 2006 10 31
(24) 2006 10 31
(18) 2026 10 31
(28) 5
(28') 5
(54) Jewelry, including necklace (1), pendants (2, 3), ring (4), earrings (5)

(11) DM/68358
(73) OMEGA SA (OMEGA AG) (OMEGA LTD.)
Jakob-Stämpfli-Strasse 96, CH-2502 Biel/Bienne (CH)
(15) 2006 10 31
(24) 2006 10 31
(18) 2026 10 31
(28) 1
(28') 1
(54) Wristwatch

(11) DM/68361
(73) SWATCH AG (SWATCH SA) (SWATCH LTD.)
94, Rue Jakob Stämpfli, CH-2502 BIENNE (CH)
(15) 2006 10 31
(24) 2006 10 31
(18) 2026 10 31
(28) 1

(28') 1
(54) Wristwatch

(11) DM/68431
(73) STUDER & CO. AG
DISTILLERIE, Möslì 1, Postfach 179, CH-6182 Escholzmatt (CH)
(15) 2006 12 20
(24) 2006 12 20
(18) 2026 12 20
(28) 1
(28') 1
(54) Bottle with mountain inside

(11) DM/76901
(73) SWATCH AG (SWATCH SA) (SWATCH LTD.)
Jakob-Stämpfli-Strasse 94, CH-2502 BIEL/BIENNE (CH)
(15) 2011 10 05
(24) 2011 10 05
(18) 2026 10 05
(28) 1
(28') 1
(54) Watch case

(11) DM/76902
(73) BLANCPAIN SA
Le Rocher 12, CH-1348 LE BRASSUS (CH)
(15) 2011 10 05
(24) 2011 10 05
(18) 2026 10 05
(28) 12
(28') 12
(54) Dial, Watchband, Watchband clasp, Watch case, Watch hands, Wristwatch

(11) DM/76984
(73) ETA SA MANUFACTURE HORLOGÈRE SUISSE
CH-2540 Grenchen (CH)
(15) 2011 10 20
(24) 2011 10 20
(18) 2026 10 20
(28) 1
(28') 1
(54) Display unit

(11) DM/76994
(73) RADO UHREN AG (RADO WATCH CO. LTD.) (MONTRES RADO SA)
Bielstrasse 45, CH-2543 Lengnau (CH)
(15) 2011 10 21
(24) 2011 10 21
(18) 2026 10 21
(28) 2
(28') 2
(54) Wristwatches

(11) DM/77310
(73) KVADRA D.O.O.
Pustodol Začretski 19G, HR-49223 Sveti Kri Začretje (HR)
(15) 2011 12 15
(24) 2011 12 15
(18) 2026 12 15
(28) 1
(28') 1
(54) Rotating sofa bed

(11) DM/77438
(73) SOCIÉTÉ DES PRODUITS NESTLÉ S.A.
CH-1800 Vevey (CH)
(15) 2011 10 11
(24) 2011 10 11
(18) 2026 10 11
(28) 1
(28') 1
(54) Bouillon tablet

(11) DM/78027
(73) ANATEC
13, chemin du Levant, F-01210 FERNEY VOLTAIRE (FR)
(15) 2011 09 14
(24) 2011 09 14
(18) 2026 09 14
(28) 1
(28') 1
(54) Baiting boat for fishing

(11) DM/91939
(73) SAVERGLASS
3 rue de la Gare, F-60960 FEUQUIERES (FR)
(15) 2016 07 06
(24) 2016 07 06
(18) 2026 07 06
(28) 1
(28') 1
(54) Bottle

(11) DM/91940
(73) SAVERGLASS
3 rue de la Gare, F-60960 FEUQUIERES (FR)
(15) 2016 07 11
(24) 2016 07 11
(18) 2026 07 11
(28) 1
(28') 1
(54) Bottle

(11) DM/92120
(73) FCA ITALY S.P.A.
Corso Giovanni Agnelli, 200, I-10135 TORINO (EM)
(15) 2016 07 28

(24) 2016 07 28
(18) 2026 07 28
(28) 1
(28') 1
(54) Scale model car

(11) DM/92121
(73) FCA ITALY S.P.A.
Corso Giovanni Agnelli, 200, I-10135 TORINO (EM)
(15) 2016 07 28
(24) 2016 07 28
(18) 2026 07 28
(28) 1
(28') 1
(54) Car

(11) DM/92729
(73) SAVERGLASS
3 rue de la Gare, F-60960 FEUQUIERES (FR)
(15) 2016 09 27
(24) 2016 09 27
(18) 2026 09 27
(28) 1
(28') 1
(54) Bottle

(11) DM/92995
(73) THE SWATCH GROUP MANAGEMENT SERVICES AG (THE SWATCH GROUP MANAGEMENT SERVICES SA) (THE SWATCH GROUP MANAGEMENT SERVICES LTD.)
Seevorstadt 6, CH-2502 BIEL/BIENNE (CH)
(15) 2016 10 14
(24) 2016 10 14
(18) 2026 10 14
(28) 17
(28') 3
(54) Watch, Watch case, Watch cases with bracelets, Watch case with bracelet, Watch dial, Watch dials, Watches

(11) DM/93052
(73) TORUŃSKIE ZAKŁADY MATERIAŁÓW OPATRUNKOWYCH, SPÓŁKA AKCYJNA
Żółkiewskiego 20/26, PL-87-100 Toruń (PL)
(15) 2016 10 12
(24) 2016 10 12
(18) 2026 10 12
(28) 6
(28') 6
(54) Packaging for babies' diapers

(11) DM/93182
(73) ETA SA MANUFACTURE HORLOGÈRE SUISSE
Schild-Rust-Strasse 17, CH-2540 Grenchen (CH)
(15) 2016 10 14
(24) 2016 10 14
(18) 2026 10 14
(28) 31

(28') 30
(54) Wristwatches

(11) DM/93206
(73) TISSOT SA (TISSOT AG) (TISSOT LTD)
Chemin des Tourelles 17, CH-2400 Le Locle (CH)
(15) 2016 10 28
(24) 2016 10 28
(18) 2026 10 28
(28) 1
(28') 1
(54) Watch case

(11) DM/93235
(73) HAMILTON INTERNATIONAL AG (HAMILTON INTERNATIONAL SA)
(HAMILTON INTERNATIONAL LTD)
Mattenstrasse 149, CH-2503 Biel/Bienne (CH)
(15) 2016 10 28
(24) 2016 10 28
(18) 2026 10 28
(28) 2
(28') 2
(54) Watch, Watch case

(11) DM/93410
(73) MONTRES BREGUET S.A.
Place de la Tour 23, CH-1344 L'ABBAYE (CH)
(15) 2016 10 20
(24) 2016 10 20
(18) 2026 10 20
(28) 5
(28') 5
(54) Watch, Watch hands

(11) DM/94608
(73) YILDIZ HOLDİNG ANONİM ŞİRKETİ
Kısıklı Mahallesi Çeşme Çıkmaızı Sokak No:6/1, Üsküdar (TR)
(15) 2016 03 16
(24) 2016 03 16
(18) 2026 03 16
(28) 4
(28') 4
(54) Ornamentation for t-shirts

TRADEMARKS

RENEWAL OF REGISTRATIONS

(111) M 2001 13991 R2

(156) 2001 09 11

(186) 2031 09 11

(732) Avaya Inc.

2605 Meridian Parkway, Suite 200, Durham,
North Carolina 27713, USA

(111) M 2011 21759 R1

(156) 2011 09 16

(186) 2031 09 16

(732) Aldo Group Internartional AG

Schochenmuhlerstrasse 6, 6340 Baar,
Switzerland

(111) M 2001 13993 R2

(156) 2001 09 11

(186) 2031 09 11

(732) Avaya Inc.

2605 Meridian Parkway, Suite 200, Durham,
North Carolina 27713, USA

(111) M 2011 21760 R1

(156) 2011 09 16

(186) 2031 09 16

(732) Aldo Group Internartional AG

Schochenmuhlerstrasse 6, 6340 Baar,
Switzerland

(111) M 2002 14359 R2

(156) 2002 03 27

(186) 2032 03 27

(732) Richter Gedeon Nyrt.

1103 Budapest, Gyömrői út 19-21, Hungary

(111) M 2012 22316 R1

(156) 2012 02 24

(186) 2032 02 24

(732) Novartis AG

4002 Basel, Switzerland

(111) M 2011 21423 R1

(156) 2011 04 27

(186) 2031 04 27

(732) Seagate Technology LLC

47488 Kato Road, Fremont, CA 94538, USA

(111) M 2011 21927 R1

(156) 2011 10 28

(186) 2031 10 28

(732) Orion Corporation

30-10 munbae-dongi, yongsan-ku, Seoul,
Republic of Korea

(111) M 2011 22031 R1

(156) 2011 12 07

(186) 2031 12 07

(732) Bayer HealthCare LLC

100 Bayer Boulevard, P.O. Box 915,
07981-0915 Whippany, NJ, USA

(111) M 2011 21928 R1

(156) 2011 10 28

(186) 2031 10 28

(732) Orion Corporation

30-10 munbae-dongi, yongsan-ku, Seoul,
Republic of Korea

(111) M 2011 21876 R1

(156) 2011 10 17

(186) 2031 10 17

(732) World Medicine Limited

Commonwealth Trust Limited, Drake
Chambers, Tortola, Virgin Islands (British)

(111) M 2011 21929 R1

(156) 2011 10 28

(186) 2031 10 28

(732) Orion Corporation

30-10 munbae-dongi, yongsan-ku, Seoul,
Republic of Korea

(111) M 2012 22315 R1

(156) 2012 02 24

(186) 2032 02 24

(732) Novartis AG

4002 Basel, Switzerland

(111) M 2011 21943 R1

(156) 2011 10 28

(186) 2031 10 28

(732) LTD "Kumisi XXI"

Baratashvili St. 2, 0105, Tbilisi, Georgia

(111) M 2011 21946 R1
(156) 2011 10 28
(186) 2031 10 28
(732) Fashion Division S.A.
Lugar do Espido, Via Norte, 4470-177 Maia,
Portugal

(111) M 2011 21947 R1
(156) 2011 10 28
(186) 2031 10 28
(732) Fashion Division S.A.
Lugar do Espido, Via Norte, 4470-177 Maia,
Portugal

(111) M 2011 21982 R1
(156) 2011 11 17
(186) 2031 11 17
(732) Diners Club International Ltd.
2500 Lake Cook Road, Riverwoods,
Illinois 60015, USA

(111) M 2011 21983 R1
(156) 2011 11 17
(186) 2031 11 17
(732) Discover Financial Services
2500 Lake Cook Road, Riverwoods,
IL 60015, USA

(111) M 2011 22043 R1
(156) 2011 12 07
(186) 2031 12 07
(732) Bayer Consumer Care AG
Peter Merian-Str. 84, 4052 Basel,
Switzerland

(111) M 2011 22044 R1
(156) 2011 12 07
(186) 2031 12 07
(732) The Coca-Cola Company, a Corporate of the
State of Delaware
One Coca-Cola Plaza, Atlanta, Georgia
30313, USA

(111) M 2011 22045 R1
(156) 2011 12 07
(186) 2031 12 07
(732) The Coca-Cola Company
One Coca-Cola Plaza, Atlanta,
Georgia 30313, USA

(111) M 2012 22346 R1
(156) 2012 02 24
(186) 2032 02 24
(732) Philip Morris Brands S.A.R.L.
Quai Jeanrenaud 3, CH-2000 Neuchatel,
Switzerland

(111) M 2012 22369 R1
(156) 2012 02 24
(186) 2032 02 24
(732) Netflix Inc., a corporation of Delaware
100 Winchester Circle, Los-Gatos,
California 95032, USA

(111) M 2012 22433 R1
(156) 2012 03 16
(186) 2032 03 16
(732) Toyota Jidosha Kabushiki Kaisha
(also trading as Toyota Motor
Corporation)
1, Toyota-Cho, Toyota-Shi, Aichi-Ken, Japan

(111) M 2011 22054 R1
(156) 2011 12 13
(186) 2031 12 13
(732) The Coca-Cola Company
One Coca-Cola Plaza, Atlanta,
Georgia 30313, USA

(111) M 2011 22121 R1
(156) 2011 12 27
(186) 2031 12 27
(732) The Coca-Cola Company
One Coca-Cola Plaza, Atlanta,
Georgia 30313, USA

COMPLETE TRANSFER OF RIGHTS

-
- | | |
|---|---|
| <p>(111) M 1999 11835 R
(732) Puig France
65-67 avenue des Champs-Elysées,
75008 Paris, France
(770) Puig Holdings France
65-67 Avenue des Champs Elysées,
75008 Paris, France
(580) 2021 09 10</p> <hr/> | <p>(111) M 1997 7368 R
(732) Puig France
65-67 avenue des Champs-Elysées,
75008 Paris, France
(770) Puig Holdings France
65-67 Avenue des Champs Elysées,
75008 Paris, France
(580) 2021 09 10</p> <hr/> |
| <p>(111) M 1999 11835 R
(732) Puig Holdings France
65-67 Avenue des Champs Elysées,
75008 Paris, France
(770) Puig France, Societe par Actions
Simplifíee
65-67 Avenue des Champs Elysées,
75008 Paris, France
(580) 2021 09 10</p> <hr/> | <p>(111) M 2004 15508 R
(732) Nordmark Farma Gmbh
Pinnauallee 4, 25436 Uetersen, Germany
(770) Nordmark Arzneimittel Holding GmbH &
Co. KG
Pinnauallee 4, 25436 Uetersen, Germany
(580) 2021 10 27</p> <hr/> |
| <p>(111) M 1998 10671 R
(732) Puig France
65-67 avenue des Champs-Elysées,
75008 Paris, France
(770) Puig Holdings France
65-67 Avenue des Champs Elysées,
75008 Paris, France
(580) 2021 09 10</p> <hr/> | <p>(111) M 2006 16814 R
(732) LTD "EliseyFood"
Beri Gabriel Salosi Av. 165, app. 51, Tbilisi,
Georgia
(770) LTD "TM "Eliseevskie"
Krilatskaya St., dom. 5, komnata 21, 121552,
Moskow, Russian Federation
(580) 2021 10 11</p> <hr/> |
| <p>(111) M 1998 10671 R
(732) Puig Holdings France
65-67 Avenue des Champs Elysées,
75008 Paris, France
(770) Puig France, Societe par Actions
Simplifíee
65-67 Avenue des Champs Elysées,
75008 Paris, France
(580) 2021 09 10</p> <hr/> | <p>(111) M 2006 16815 R
(732) LTD "EliseyFood"
Beri Gabriel Salosi Av. 165, app. 51, Tbilisi,
Georgia
(770) LTD "TM "Eliseevskie"
Krilatskaya St., dom. 5, komnata 21, 121552,
Moskow, Russian Federation
(580) 2021 10 11</p> <hr/> |
| <p>(111) M 1997 7368 R
(732) Puig Holdings France
65-67 Avenue des Champs Elysées,
75008 Paris, France
(770) Puig France, Societe par Actions
Simplifíee
65-67 Avenue des Champs Elysées,
75008 Paris, France
(580) 2021 09 10</p> <hr/> | <p>(111) M 1998 8314 R
(732) Puig Holdings France
65-67 Avenue des Champs Elysées,
75008 Paris, France
(770) Puig France, Societe par Actions
Simplifíee
65-67 Aveniu De Shanz-elize,
75008 Parizi, France
(580) 2021 09 10</p> <hr/> |
| <p>(111) M 1997 7368 R
(732) Puig Holdings France
65-67 Avenue des Champs Elysées,
75008 Paris, France
(770) Puig France, Societe par Actions
Simplifíee
65-67 Avenue des Champs Elysées,
75008 Paris, France
(580) 2021 09 10</p> <hr/> | <p>(111) M 1998 8314 R
(732) Puig France
65-67 avenue des Champs-Elysées,
75008 Paris, France</p> |
-

(770) Puig Holdings France
65-67 Avenue des Champs Elysées,
75008 Paris, France
(580) 2021 09 10

(111) M 1996 2700 R
(732) Tos S.r.l.
Largo Maurizio Vitale 1, I-10152 Torino,
Italy

(770) Sebago International Limited
4th Floor Willow House, Cricket Square
P.O. Box 268 Grand Cayman KYI-1104,
Cayman Islands
(580) 2021 10 28

(111) M 1996 2702 R
(732) Tos S.r.l.
Largo Maurizio Vitale 1, I-10152 Torino,
Italy

(770) Sebago International Limited
44th Floor Willow House, Cricket Square
P.O. Box 268 Grand Cayman KYI-1104,
Cayman Islands
(580) 2021 10 28

(111) M 2014 25534 R
(732) LLC "Unimmed Group Corp."
Giorgi Saakadze's descent, 6,
Commercial space, 11, Tbilisi, Georgia
(770) LLC "Lady Helsqea"
Akaki Gakhokidze str. 2-4, Yuri Gagarin
St. 5, Office Space 6, Saburtalo District,
Tbilisi, Georgia
(580) 2021 10 22

(111) M 1997 7131 R
(732) Puig Holdings France
65-67 Avenue des Champs Elysées,
75008 Paris, France
(770) Puig France, Societe par Actions Simplifíee
65-67 Avenue des Champs Elysées,
75008 Paris, France
(580) 2021 09 10

(111) M 1997 7131 R
(732) Puig France
65-67 avenue des Champs-Elysées,
75008 Paris, France
(770) Puig Holdings France
65-67 Avenue des Champs Elysées,
75008 Paris, France
(580) 2021 09 10

(111) M 1997 7132 R
(732) Puig Holdings France
65-67 Avenue des Champs Elysées,
75008 Paris, France

(770) Puig France, Societe par Actions
Simplifíee
65-67 Avenue des Champs Elysées,
75008 Paris, France
(580) 2021 09 10

(111) M 1997 7132 R
(732) Puig France
65-67 avenue des Champs-Elysées,
75008 Paris, France
(770) Puig Holdings France
65-67 Avenue des Champs Elysées,
75008 Paris, France
(580) 2021 09 10

(111) M 1998 9333 R
(732) Puig France
65-67 avenue des Champs-Elysées,
75008 Paris, France
(770) Puig Holdings France
65-67 Avenue des Champs Elysées,
75008 Paris, France
(580) 2021 09 10

(111) M 1998 9333 R
(732) Puig Holdings France
65-67 Avenue des Champs Elysées,
75008 Paris, France
(770) Puig France, Societe par Actions
Simplifíee
65-67 Avenue des Champs Elysées,
75008 Paris, France
(580) 2021 09 10

(111) M 1998 9337 R
(732) Puig Holdings France
65-67 Avenue des Champs Elysées,
75008 Paris, France
(770) Puig France, Societe par Actions
Simplifíee
65-67 Avenue des Champs Elysées,
75008 Paris, France
(580) 2021 09 10

(111) M 1998 9337 R
(732) Puig France
65-67 avenue des Champs-Elysées,
75008 Paris, France
(770) Puig Holdings France

65-67 Avenue des Champs Elysées,
75008 Paris, France
(580) 2021 09 10

(770) Puig Holdings France
65-67 Avenue des Champs Elysées,
75008 Paris, France
(580) 2021 09 10

(111) M 2016 27534 R
(732) Holland & Barrett Interneshnl Limited
Samuel Ryder House, Barling Way,
Eliot Park, Nuneaton, Warwickshire,
CV10 7RH, United Kingdom
(770) Holland & Barrett Retail Limited
Samuel Ryder House, Barling Way,
Eliot Park, Nuneaton, Warwickshire,
CV10 7RH, United Kingdom
(580) 2021 11 02

(111) M 2017 28555 R
(732) Nordmark Pharma Gmbh
Pinnauallee 4, 25436 Uetersen, Germany
(770) Nordmark Arzneimittel Holding GmbH &
Co. KG
Pinnauallee 4, 25436 Uetersen, Germany
(580) 2021 10 27

(111) M 2016 27204 R
(732) LTD "Biopolaus"
Noneshvili St. 65, 6000, Batumi, Georgia
(770) LTD "Pharmaceutical House +"
Lvovi St. 92, Tbilisi, Georgia
(580) 2021 10 22

(111) M 2016 27205 R
(732) LTD "Biopolaus"
Noneshvili St. 65, 6000, Batumi, Georgia
(770) LTD "Pharmaceutical House +"
Lvovi St. 92, Tbilisi, Georgia
(580) 2021 10 22

(111) M 1998 8501 R
(732) Puig Holdings France
65-67 Avenue des Champs Elysées,
75008 Paris, France
(770) Puig France, Societe par Actions Simpliffee
65-67 Avenue des Champs Elysées,
75008 Paris, France
(580) 2021 09 10

(111) M 1998 8501 R
(732) Puig France
65-67 avenue des Champs-Elysées,
75008 Paris, France

CHANGES OF NAMES AND/OR ADDRESS OF OWNERS

(111) M 2020 32214 R
(732) Kia Corporation
12, Heolleung-ro, Seocho-gu, Seoul 06797,
Republic of Korea
(770) Kia Motors Korporeishen
12, Heolleung-ro, Seocho-gu, Seoul,
Republic of Korea
(580) 2021 10 26

(111) M 2020 32215 R
(732) Kia Corporation
12, Heolleung-ro, Seocho-gu, Seoul 06797,
Republic of Korea
(770) Kia Motors Corporation
12, Heolleung-ro, Seocho-gu, Seoul,
Republic of Korea
(580) 2021 10 26

(111) M 2020 32284 R
(732) Kia Corporation
12, Heolleung-ro, Seocho-gu, Seoul 06797,
Republic of Korea
(770) Kia Motors Corporation
12, Heolleung-ro, Seocho-gu, Seoul 06797,
Republic of Korea
(580) 2021 10 26

(111) M 2020 32285 R
(732) Kia Corporation
12, Heolleung-ro, Seocho-gu, Seoul 06797,
Republic of Korea
(770) Kia Motors corporation
12, Heolleung-ro, Seocho-gu, Seoul 06797,
Republic of Korea
(580) 2021 10 26

(111) M 2020 32286 R
(732) Kia Corporation
12, Heolleung-ro, Seocho-gu, Seoul 06797,
Republic of Korea
(770) Kia Motors Corporation
12, Heolleung-ro, Seocho-gu, Seoul 06797,
Republic of Korea
(580) 2021 10 26

(111) M 2020 32287 R
(732) Kia Corporation
12, Heolleung-ro, Seocho-gu, Seoul 06797,
Republic of Korea
(770) Kia Motors Corporation
12, Heolleung-ro, Seocho-gu, Seoul 06797,
Republic of Korea

(580) 2021 10 26

(111) M 2019 32149 R
(732) Kia Corporation
12, Heolleung-ro, Seocho-gu, Seuli 06797,
Republic of Korea
(770) Kia Motors Corporation
12, Heolleung-ro, Seocho-gu, Seoul,
Republic of Korea
(580) 2021 10 26

(111) M 2019 32150 R
(732) Kia Corporation
12, Heolleung-ro, Seocho-gu, Seoul 06797,
Republic of Korea
(770) Kia Motors Corporation
12, Heolleung-ro, Seocho-gu, Seoul,
Republic of Korea
(580) 2021 10 26

(111) M 2019 32151 R
(732) Kia Corporation
12, Heolleung-ro, Seocho-gu, Seoul 06797,
Republic of Korea
(770) Kia Motors Corporation
12, Heolleung-ro, Seocho-gu, Seoul,
Republic of Korea
(580) 2021 10 26

(111) M 2019 32152 R
(732) Kia Corporation
12, Heolleung-ro, Seocho-gu, Seoul 06797,
Republic of Korea
(770) Kia Motors Corporation
12, Heolleung-ro, Seocho-gu, Seoul,
Republic of Korea
(580) 2021 10 26

(111) M 2019 32153 R
(732) Kia Corporation
12, Heolleung-ro, Seocho-gu, Seoul 06797,
Republic of Korea
(770) Kia Motors Corporation
12, Heolleung-ro, Seocho-gu, Seoul,
Republic of Korea
(580) 2021 10 26

(111) M 2020 32327 R
(732) Kia Corporation
12, Heolleung-ro, Seocho-gu, Seoul 06797,
Republic of Korea

(770) Kia Motors Corporation
12, Heolleung-ro, Seocho-gu, Seoul,
Republic of Korea
(580) 2021 10 26

(111) M 2020 33491 R
(732) Kia Corporation
12, Heolleung-ro, Seocho-gu, Seoul 06797,
Republic of Korea
(770) Kia Motors Corporation
12, Heolleung-ro, Seocho-gu, Seoul,
Republic of Korea
(580) 2021 10 26

(111) M 2021 33833 R
(732) Kia Corporation
12, Heolleung-ro, Seocho-gu, Seoul 06797,
Republic of Korea
(770) Kia Motors Corporation
12, Heolleung-ro, Seocho-gu, Seoul,
Republic of Korea
(580) 2021 10 26

(111) M 1999 11449 R
(732) Kia Corporation
12, Heolleung-ro, Seocho-gu, Seoul 06797,
Republic of Korea
(770) Kia Motors Corporation
231 Yangjae-dong, Seocho-gu, Seoul,
Republic of Korea
(580) 2021 10 26

(111) M 2000 13383 R
(732) Kia Corporation
12, Heolleung-ro, Seocho-gu, Seoul 06797,
Republic of Korea
(770) Kia Motors Corporation
231, Yangjae-dong, Seocho-gu, Seoul,
Republic of Korea
(580) 2021 10 26

(111) M 2001 13991 R
(732) Avaya Inc.
2605 Meridian Parkway, Suite 200, Durham,
North Carolina 27713, USA
(770) Avaya Inc.
4655 Great America Parkway, Santa Clara,
California 95054, USA
(580) 2021 10 28

(111) M 2001 13993 R
(732) Avaya Inc.
2605 Meridian Parkway, Suite 200, Durham,
North Carolina 27713, USA

(770) Avaya Inc.
4655 Great America Parkway, Santa Clara,
California 95054, USA
(580) 2021 10 28

(111) M 2003 14937 R
(732) Kellogg Europe Trading Limited
3 Dublin Airport Central (DAC), Dublin
Airport, Dublin, K67X4X5, Ireland
(770) Kellogg Europe Trading Limited
Suite 3, One Earlsfort Centre, Lower Hatch
Street Dublin 2, Ireland
(580) 2021 10 21

(111) M 2004 15508 R
(732) Nordmark Arzneimittel Holding
GmbH & Co.KG
Pinnuallee 4, 25436 Uetersen, Germany
(770) Nordmark Arzneimittel GmbH & Co. KG
Pinnuallee 4, D-25436 Uetersen, Germany
(580) 2021 10 27

(111) M 2007 17598 R
(732) Kia Corporation
12, Heolleung-ro, Seocho-gu, Seoul 06797,
Republic of Korea
(770) Kia Motors Corporation
12 Heolleung-ro, Seocho-gu, Seoul,
Republic of Korea
(580) 2021 10 26

(111) M 2007 18017 R
(732) Kia Corporation
12, Heolleung-ro, Seocho-gu, Seoul 06797,
Republic of Korea
(770) Kia Motors Corporation
12, Heolleung-ro, Seocho-gu, Seuli,
Republic of Korea
(580) 2021 10 26

(111) M 2010 20468 R
(732) Kia Corporation
12, Heolleung-ro, Seocho-gu, Seoul 06797,
Republic of Korea
(770) Kia Motors Corporation
231 Yangjae-dong, Seocho-gu, Seoul
137-938, Republic of Korea
(580) 2021 10 26

(111) M 2010 20648 R
(732) Kia Corporation
12, Heolleung-ro, Seocho-gu, Seoul 06797,
Republic of Korea
(770) Kia Motors Corporation

12, Heolleung-ro, Seocho-gu, Seoul,
Republic of Korea
(580) 2021 10 26

(111) M 2010 20663 R
(732) Kia Corporation
12, Heolleung-ro, Seocho-gu, Seoul 06797,
Republic of Korea
(770) Kia Motors Corporation
231 Yangjae-dong, Seocho-gu, Seoul
137-938, Republic of Korea
(580) 2021 10 26

(111) M 1996 2700 R
(732) Sebago International Limited
4th Floor Willow House, Cricket Square
P.O. Box 268 Grand Cayman KYI-1104,
Cayman Islands
(770) Sebago International Limited
9341 Courtland Drive NE, Rockford,
MI 49351, USA
(580) 2021 10 28

(111) M 1996 2702 R
(732) Sebago International Limited
44th Floor Willow House, Cricket Square
P.O. Box 268 Grand Cayman KYI-1104,
Cayman Islands
(770) Sebago International Limited
9341 Courtland Drive NE, Rockford,
MI 49351, USA
(580) 2021 10 28

(111) M 2011 22031 R
(732) Bayer HealthCare LLC
100 Bayer Boulevard, P.O. Box 915,
07981-0915 Whippany, NJ, USA
(770) Bayer HealthCare LLC
100 Bayer Road, Pittsburgh, Pennsylvania
15205, USA
(580) 2021 10 22

(111) M 2012 22760 R
(732) Teijin Limited
2-4, Nakanoshima 3-chome, Kita-ku, Osaka,
Japan
(770) Teijin Limited
6-7, Minamihommachi 1-chome, Chuo-ku,
Osaka, Japan
(580) 2021 11 01

(111) M 2015 25731 R
(732) Kia Corporation
12, Heolleung-ro, Seocho-gu, Seoul 06797,
Republic of Korea
(770) Kia Motors Corporation
231 Yangjae-dong, Seocho-gu, Seoul
Republic of Korea
(580) 2021 10 26

(111) M 2017 28208 R
(732) Kia Corporation
12, Heolleung-ro, Seocho-gu, Seoul 06797,
Republic of Korea
(770) Kia Motors Corporation
231 Yangjae-dong, Seocho-gu, Seoul
137-938, Republic of Korea
(580) 2021 10 26

(111) M 2017 28555 R
(732) Nordmark Arzneimittel Holding
GmbH & Co.KG
Pinnauallee 4, 25436 Uetersen, Germany
(770) Nordmark Arzneimittel GmbH & Co. KG
Pinnauallee 4, 25436 Uetersen, Germany
(580) 2021 10 27

(111) M 2017 29164 R
(732) Kia Corporation
12, Heolleung-ro, Seocho-gu, Seoul 06797,
Republic of Korea
(770) Kia Motors Corporation
12 Heolleung-ro, Seocho-gu, Seuli,
Republic of Korea
(580) 2021 10 26

(111) M 2018 30096 R
(732) Avaya Inc.
2605 Meridian Parkway, Suite 200,
Durham, North Carolina 27713, USA
(770) Avaya Inc.
4655 Great America Parkway, Santa Clara,
California 95054, USA
(580) 2021 10 28

(111) M 1998 10046 R
(732) Kia Corporation
12, Heolleung-ro, Seocho-gu, Seuli 06797,
Republic of Korea
(770) Kia Motors Corporation
12 Heolleung-ro, Seocho-gu, Seuli,
Republic of Korea
(580) 2021 10 26

CANCELLATION OF TRADEMARKS REGISTRATIONS

(111) M 2011 21388 R
(151) 2011 04 27
(732) Limited Liability Society "Weysialoglu-Yajil Gardashlary"
Vill. Siiaguti, Shareri Region, Azerbaijan
(141) 2021 11 04

(111) M 2011 21389 R
(151) 2011 04 27
(732) Limited Liability Society "Weysialoglu-Yajil Gardashlary"
Vill. Siiaguti, Shareri Region, Azerbaijan
(141) 2021 11 04

(111) M 2011 21390 R
(151) 2011 04 27
(732) Limited Liability Society "Weysialoglu-Yajil Gardashlary"
Vill. Siiaguti, Shareri Region, Azerbaijan
(141) 2021 11 04

(111) M 2011 21391 R
(151) 2011 04 27
(732) Limited Liability Society "Weysialoglu-Yajil Gardashlary"
Vill. Siiaguti, Shareri Region, Azerbaijan
(141) 2021 11 04

(111) M 2011 21392 R
(151) 2011 04 27
(732) Limited Liability Society "Weysialoglu-Yajil Gardashlary"
Vill. Siiaguti, Shareri Region, Azerbaijan
(141) 2021 11 04

(111) M 2011 21393 R
(151) 2011 04 27
(732) Limited Liability Society "Weysialoglu-Yajil Gardashlary"
Vill. Siiaguti, Shareri Region, Azerbaijan
(141) 2021 11 04

(111) M 2011 21394 R
(151) 2011 04 27
(732) Limited Liability Society "Weysialoglu-Yajil Gardashlary"
Vill. Siiaguti, Shareri Region, Azerbaijan
(141) 2021 11 04

(111) M 2011 21395 R
(151) 2011 04 27
(732) Limited Liability Society "Weysialoglu-Yajil Gardashlary"
Vill. Siiaguti, Shareri Region, Azerbaijan
(141) 2021 11 04

(111) M 2011 21396 R
(151) 2011 04 27
(732) Limited Liability Society "Weysialoglu-Yajil Gardashlary"
Vill. Siiaguti, Shareri Region, Azerbaijan
(141) 2021 11 04

(111) M 2011 21397 R
(151) 2011 04 27
(732) Limited Liability Society "Weysialoglu-Yajil Gardashlary"
Vill. Siiaguti, Shareri Region, Azerbaijan
(141) 2021 11 04

(111) M 2011 21398 R
(151) 2011 04 27
(732) Limited Liability Society "Weysialoglu-Yajil Gardashlary"
Vill. Siiaguti, Shareri Region, Azerbaijan
(141) 2021 11 04

(111) M 2011 21358 R
(151) 2011 04 13
(732) LTD "PR Office GE"
Mujirishvili St.7, 0103, Tbilisi, Georgia
(141) 2021 10 22

(111) M 2011 21359 R
(151) 2011 04 13
(732) Harrington Development Inc.
Arango-Orillac Bldg. East 54 th street,
Panama, Republic of Panama
(141) 2021 10 22

(111) M 2011 21401 R
(151) 2011 04 27
(732) Harrington Development Inc.
Elvira Mendez Street, Vallarino bldg.,
3rd Floor, Panama, Republic of Panama
(141) 2021 11 04

(111) M 2011 21402 R
 (151) 2011 04 27
 (732) Harrington Development Inc.
 Arango-Orillac Bldg. East 54 th street,
 Panama, Republic of Panama
 (141) 2021 11 04

Arango-Orillac Bldg. East 54 th street,
 Panama, Republic of Panama
 (141) 2021 11 04

(111) M 2011 21360 R
 (151) 2011 04 13
 (732) Harrington Development Inc.
 Arango-Orillac Bldg. East 54 th street,
 Panama, Republic of Panama
 (141) 2021 10 22

(111) M 2011 21410 R
 (151) 2011 04 27
 (732) Harrington Development Inc.
 Arango-Orillac Bldg. East 54 th street,
 Panama, Republic of Panama
 (141) 2021 11 04

(111) M 2011 21403 R
 (151) 2011 04 27
 (732) LTD "aversi-farma"
 Davit Agmashenebeli Ave.148/2, 0112,
 Tbilisi, Georgia
 (141) 2021 11 04

(111) M 2011 21411 R
 (151) 2011 04 27
 (732) LTD "A-B-C Pharmacy"
 Sanapiro St. 10a, 0108, Tbilisi, Georgia
 (141) 2021 11 04

(111) M 2011 21404 R
 (151) 2011 04 27
 (732) LTD "Aversi-Pharma"
 Davit Agmashenebeli Av.148/2, 0112,
 Tbilisi, Georgia
 (141) 2021 11 04

(111) M 2011 21412 R
 (151) 2011 04 27
 (732) Maia Kotrikadze
 Z. Gorgiladze St. 73, app. 12, 6010, Batumi,
 Georgia
 (141) 2021 11 04

(111) M 2011 21405 R
 (151) 2011 04 27
 (732) LTD "Aversi-Pharma"
 Davit Agmashenebeli Av.148/2, 0112,
 Tbilisi, Georgia
 (141) 2021 11 04

(111) M 2011 21362 R
 (151) 2011 04 13
 (732) Mars Incorporated
 6885 Elm Street, McLean, Virginia
 22101-3883, USA
 (141) 2021 10 22

(111) M 2011 21407 R
 (151) 2011 04 27
 (732) Harrington Development Inc.
 Arango-Orillac Bldg. East 54 th street,
 Panama, Republic of Panama
 (141) 2021 11 04

(111) M 2011 21413 R
 (151) 2011 04 27
 (732) Rain Pilve
 Metsa 27, 11616 Tallinn, Estonia
 (141) 2021 11 04

(111) M 2011 21408 R
 (151) 2011 04 27
 (732) Harrington Development Inc.
 Arango-Orillac Bldg. East 54 th street,
 Panama, Republic of Panama
 (141) 2021 11 04

(111) M 2011 21364 R
 (151) 2011 04 13
 (732) Henkel AG & Co. KgaA
 Henkelstrasse 67, 40589 Dusseldorf,
 Germany
 (141) 2021 10 22

(111) M 2011 21409 R
 (151) 2011 04 27
 (732) Harrington Development Inc.

(111) M 2011 21414 R
 (151) 2011 04 27
 (732) Milagro Food Industries Ltd.
 113 Bonner Hill Road, Kingston-upon-
 Thames, Surrey KT1 3HE, United Kingdom
 (141) 2021 11 04

(111) M 2011 21415 R
(151) 2011 04 27
(732) Milagro Food Industries Ltd.
113 Bonner Hill Road, Kingston-upon-
Thames, Surrey KT1 3HE, United Kingdom
(141) 2021 11 04

(111) M 2011 21416 R
(151) 2011 04 27
(732) Milagro Food Industries Ltd.
113 Bonner Hill Road, Kingston-upon-
Thames, Surrey KT1 3HE, United Kingdom
(141) 2021 11 04

(111) M 2011 21366 R
(151) 2011 04 13
(732) GlaxoSmithKline Trading Services
Limited
Currabinny, Carrigaline, County Cork, Ireland
(141) 2021 10 22

(111) M 2011 21421 R
(151) 2011 04 27
(732) JSC "Pivovarnya Moskow-Efes"
Ul. Podolskikh Kursantov, dom 15b,
RU-117546 Moskow, Russian Federation
(141) 2021 11 04

(111) M 2011 21367 R
(151) 2011 04 13
(732) GlaxoSmithKline Trading Services Limited
Currabinny, Carrigaline, County Cork,
Ireland
(141) 2021 10 22

(111) M 2011 21368 R
(151) 2011 04 13
(732) GlaxoSmithKline Trading Services Limited
Currabinny, Carrigaline, County Cork,
Ireland
(141) 2021 10 22

(111) M 2011 21381 R
(151) 2011 04 15
(732) LLC "Saga Impex"
Gamrekeli str. 19, 0160, Tbilisi, Georgia
(141) 2021 10 25

(111) M 2011 21422 R
(151) 2011 04 27
(732) JSC "Pivovarnya Moskow-Efes"
Ul. Podolskikh Kursantov, dom 15b,
RU-117546 Moskow, Russian Federation
(141) 2021 11 04

(111) M 2011 21424 R
(151) 2011 04 27
(732) Vakhtang Chikadze
Vazha-Pshavela Av., VI qu., corp. 17, app. 59,
0186, Tbilisi, Georgia
(141) 2021 11 04

(111) M 2011 21425 R
(151) 2011 04 27
(732) Elguja Gvilava
Petritsi St. 6, app. 62, 0131, Tbilisi, Georgia
(141) 2021 11 04

(111) M 2011 21372 R
(151) 2011 04 13
(732) Unilever IP Holdings B.V.
Weena 455, 3013 AL Rotterdam, Netherlands
(141) 2021 10 22

(111) M 2011 21373 R
(151) 2011 04 13
(732) JSC "Unipharm"
Vill. Teklati, 4112, Senaki District, Georgia
(141) 2021 10 22

(111) M 2011 21426 R
(151) 2011 04 27
(732) Amirani Baramidze
Rurua Str. 13, App. 11, 6000, Batumi, Georgia
(141) 2021 11 04

(111) M 2011 21375 R
(151) 2011 04 13
(732) LTD "Iveriapharma"
Vill Tskneti, Zone "B", 7, 0181, Tbilisi,
Georgia
(141) 2021 10 22

(111) M 2011 21376 R
(151) 2011 04 13
(732) ColgatE-Palmolive Company
300 Park Avenue, New York,
New York 10022, USA
(141) 2021 10 22

(111) M 2011 21377 R
(151) 2011 04 13
(732) LTD "Tbilisi Marani"
Z. Paliashvili St. 33, app. 6, 0179, Tbilisi,
Georgia
(141) 2021 10 22

(111) M 2011 21384 R
(151) 2011 04 15
(732) LTD "Iber-Info"
Vazha-Pshavela Av. 41, floor 4, 0177,
Tbilisi Georgia
(141) 2021 10 25

(111) M 2011 21386 R
(151) 2011 04 20
(732) LTD "Cognac and Wine Factory Vaziani"
Tamar Mepe Av. 6, 0112, Tbilisi, Georgia
(141) 2021 10 29

(111) M 2011 21387 R
(151) 2011 04 26
(732) LTD "Bagebi City Group"
Ilia Chavchavadze Av. 49b, 0162, Tbilisi,
Georgia
(141) 2021 11 03

(111) M 2018 30379 R
(151) 2018 11 02
(732) LLC "Glavator"
Vill. Dunta, 4000, Sachkhere District, Georgia
(141) 2021 10 21 - Canceled by Court Decision
(511) 30

CLASSIFICATION INDEXES

INVENTIONS

CONCORDANCE TABLE OF INTERNATIONAL CLASSIFICATION INDEX AND PUBLICATION NUMBERS

INTERNATIONAL CLASSIFICATION INDEXES (51)	NUMBER OF PUBLISHED APPLICATION (10)
A 01 K 61/00	AP 2021 15380 A
A 61 K 31/53; A 61 K 31/519; A 61 P 35/00; C 07 D 487/04; C 07 D 471/04	AP 2021 15385 A
A 61 K 31/519; A 61 K 31/5377; A 61 K 31/55; A 61 P 35/00; A 61 P 45/06	AP 2021 15242 A
A 61 K 39/39	AP 2021 14672 A
E 02 B 9/04	AP 2021 15582 A

CONCORDANCE TABLE OF PUBLICATION NUMBERS AND INTERNATIONAL CLASSIFICATION INDEX

NUMBER OF PUBLISHED APPLICATION (10)	INTERNATIONAL CLASSIFICATION INDEXES (51)
AP 2021 14672 A	A 61 K 39/39
AP 2021 15242 A	A 61 K 31/519; A 61 K 31/5377; A 61 K 31/55; A 61 P 35/00; A 61 P 45/06
AP 2021 15380 A	A 01 K 61/00
AP 2021 15385 A	A 61 K 31/53; A 61 K 31/519; A 61 P 35/00; C 07 D 487/04; C 07 D 471/04
AP 2021 15582 A	E 02 B 9/04

**CONCORDANCE TABLE OF INTERNATIONAL CLASSIFICATION INDEX,
PATENT NUMBERS AND PUBLICATION NUMBERS**

INTERNATIONAL CLASSIFICATION INDEX (51)	NUMBER OF PATENT (11)	NUMBER OF PUBLISHED APPLICATION (10)
A 61 J 3/00; A 61 M 5/178; B 01 L 3/00; B 01 L 3/14; B 65 D 51/24; F 26 B 5/04; F 26 B 5/06	P 2021 7312 B	AP 2021 14845 A
A 61 K 45/06; A 61 K 9/48; A 61 K 31/616; A 61 K 31/4422; A 61 K 31/404; A 61 K 31/138; A 61 K 9/50	P 2021 7310 B	AP 2021 14923 A
A 61 K 31/41; A 61 P 25/28; A 61 P 25/16; A 61 P 25/02; A 61 P 35/00; A 61 P 37/00; C 07 C 311/40; C 07 D 207/333; C 07 D 207/416; C 07 D 213/40; C 07 D 213/61; C 07 D 213/64; C 07 D 213/65; C 07 D 213/74; C 07 D 231/38; C 07 D 231/56; C 07 D 239/30; C 07 D 263/32; C 07 D 271/04; C 07 D 275/02; C 07 D 277/26; C 07 D 277/34; C 07 D 277/56; C 07 D 213/60; C 07 D 471/04; C 07 D 233/61; C 07 D 233/64; C 07 D 249/10; C 07 D 249/12; C 07 D 249/14; C 07 D 239/26; C 07 D 405/06; C 07 D 239/34; C 07 D 239/42; C 07 D 249/08; C 07 D 213/85; C 07 D 231/12; C 07 D 231/14; C 07 D 231/16; C 07 D 231/18; C 07 D 261/08; C 07 D 233/68; C 07 D 401/04; C 07 D 235/06; C 07 D 249/06; C 07 D 233/16; C 07 D 249/18; C 07 D 249/20; C 07 D 403/04; C 07 D 237/08; C 07 D 405/04; C 07 D 271/06	P 2021 7316 B	AP 2021 14943 A
A 61 K 31/137; A 61 K 9/00; A 61 K 31/197; C 12 C 5/02	P 2021 7313 B	AP 2021 15301 A
A 61 K 39/395; A 61 K 35/04; C 07 K 16/18; C 07 K 16/28	P 2021 7317 B	AP 2021 14756 A
B 60 T 1/06	P 2021 7315 B	AP 2021 15436 A
B 64 F 1/305; E 04 B 1/343; E 04 B 1/94	P 2021 7314 B	AP 2021 14882 A
C 01 B 31/08; C 10 B 53/02	P 2021 7309 B	AP 2021 15030 A
C 07 K 16/24; C 07 K 16/18; C 12 N 15/13; A 61 K 39/395	P 2021 7311 B	AP 2021 14257 A

**CONCORDANCE TABLE OF PATENT NUMBERS,
PUBLICATION NUMBERS AND INTERNATIONAL CLASSIFICATION INDEX**

NUMBER OF PATENT (11)	NUMBER OF PUBLISHED APPLICATION (10)	INTERNATIONAL CLASSIFICATION INDEX (51)
P 2021 7309 B	AP 2021 15030 A	C 01 B 31/08; C 10 B 53/02
P 2021 7310 B	AP 2021 14923 A	A 61 K 45/06; A 61 K 9/48; A 61 K 31/616; A 61 K 31/4422; A 61 K 31/404; A 61 K 31/138; A 61 K 9/50
P 2021 7311 B	AP 2021 14257 A	C 07 K 16/24; C 07 K 16/18; C 12 N 15/13; A 61 K 39/395
P 2021 7312 B	AP 2021 14845 A	A 61 J 3/00; A 61 M 5/178; B 01 L 3/00; B 01 L 3/14; B 65 D 51/24; F 26 B 5/04; F 26 B 5/06
P 2021 7313 B	AP 2021 15301 A	A 61 K 31/137; A 61 K 9/00; A 61 K 31/197; C 12 C 5/02
P 2021 7314 B	AP 2021 14882 A	B 64 F 1/305; E 04 B 1/343; E 04 B 1/94
P 2021 7315 B	AP 2021 15436 A	B 60 T 1/06
P 2021 7316 B	AP 2021 14943 A	A 61 K 31/41; A 61 P 25/28; A 61 P 25/16; A 61 P 25/02; A 61 P 35/00; A 61 P 37/00; C 07 C 311/40; C 07 D 207/333; C 07 D 207/416; C 07 D 213/40; C 07 D 213/61; C 07 D 213/64; C 07 D 213/65; C 07 D 213/74; C 07 D 231/38; C 07 D 231/56; C 07 D 239/30; C 07 D 263/32; C 07 D 271/04; C 07 D 275/02; C 07 D 277/26; C 07 D 277/34; C 07 D 277/56; C 07 D 213/60; C 07 D 471/04; C 07 D 233/61; C 07 D 233/64; C 07 D 249/10; C 07 D 249/12; C 07 D 249/14; C 07 D 239/26; C 07 D 405/06; C 07 D 239/34; C 07 D 239/42; C 07 D 249/08; C 07 D 213/85; C 07 D 231/12; C 07 D 231/14; C 07 D 231/16; C 07 D 231/18; C 07 D 261/08; C 07 D 233/68; C 07 D 401/04; C 07 D 235/06; C 07 D 249/06; C 07 D 233/16; C 07 D 249/18; C 07 D 249/20; C 07 D 403/04; C 07 D 237/08; C 07 D 405/04; C 07 D 271/06
P 2021 7317 B	AP 2021 14756 A	A 61 K 39/395; A 61 K 35/04; C 07 K 16/18; C 07 K 16/28

**CONCORDANCE TABLE OF APPLICATION NUMBERS,
PUBLICATION NUMBERS AND PATENTS**

NUMBER OF APPLICATION (21)	NUMBER OF PUBLISHED APPLICATION (10)	NUMBER OF PATENT (11)
AP 2017 14845	AP 2021 14845 A	P 2021 7312 B
AP 2017 14923	AP 2021 14923 A	P 2021 7310 B
AP 2017 14943	AP 2021 14943 A	P 2021 7316 B
AP 2018 15301	AP 2021 15301 A	P 2021 7313 B
AP 2016 14756	AP 2021 14756 A	P 2021 7317 B
AP 2020 15436	AP 2021 15436 A	P 2021 7315 B
AP 2017 14882	AP 2021 14882 A	P 2021 7314 B
AP 2019 15030	AP 2021 15030 A	P 2021 7309 B
AP 2015 014257	AP 2021 14257 A	P 2021 7311 B

UTILITY MODEL

INTERNATIONAL CLASSIFICATION INDEXES (51)	NUMBER OF PUBLISHED APPLICATION (10)
B 21 D 5/14	AU 2021 15590 U

**CONCORDANCE TABLE OF PUBLICATION NUMBERS
AND INTERNATIONAL CLASSIFICATION INDEX**

NUMBER OF PUBLISHED APPLICATION (10)	INTERNATIONAL CLASSIFICATION INDEXES (51)
AU 2021 15590 U	B 21 D 5/14

DESIGNS**CONCORDANCE TABLE OF INTERNATIONAL CLASSIFICATION INDEX
AND PUBLICATION NUMBERS**

INTERNATIONAL CLASSIFICATION INDEXES (51)	NUMBER OF PUBLISHED APPLICATION (10)
32-00	AD 2021 1225 S

**CONCORDANCE TABLE OF PUBLICATION NUMBERS
AND INTERNATIONAL CLASSIFICATION INDEX**

NUMBER OF PUBLISHED APPLICATION (10)	INTERNATIONAL CLASSIFICATION INDEXES (51)
AD 2021 1225 S	32-00

**CONCORDANCE TABLE OF INTERNATIONAL CLASSIFICATION INDEX,
NUMBERS OF REGISTRATION AND PUBLICATION NUMBERS**

INTERNATIONAL CLASSIFICATION INDEX (51)	NUMBER OF REGISTRATION (11)	NUMBER OF PUBLISHED APPLICATION (10)
06-13	D 2021 909 S	AD 2021 1208 S
09-01	D 2021 908 S	AD 2021 1206 S
09-01	D 2021 910 S	AD 2021 1210 S

**CONCORDANCE TABLE OF NUMBERS OF REGISTRATION,
PUBLICATION NUMBERS AND INTERNATIONAL CLASSIFICATION INDEX**

NUMBER OF REGISTRATION (11)	NUMBER OF PUBLISHED APPLICATION (10)	INTERNATIONAL CLASSIFICATION INDEX (51)
D 2021 908 S	AD 2021 1206 S	09-01
D 2021 909 S	AD 2021 1208 S	06-13
D 2021 910 S	AD 2021 1210 S	09-01

**CONCORDANCE TABLE OF APPLICATION NUMBERS,
PUBLICATION NUMBERS AND NUMBERS OF REGISTRATION**

NUMBER OF APPLICATION (21)	NUMBER OF PUBLISHED APPLICATION (10)	NUMBER OF REGISTRATION (11)
AD 2021 1206	AD 2021 1206 S	D 2021 908 S
AD 2021 1208	AD 2021 1208 S	D 2021 909 S
AD 2021 1210	AD 2021 1210 S	D 2021 910 S

**DESIGN REGISTERED ACCORDING TO THE ACCELERATED
PROCEDURE**

CONCORDANCE TABLE OF INTERNATIONAL CLASSIFICATION INDEX
AND PUBLICATION NUMBERS

INTERNATIONAL CLASSIFICATION INDEXES (51)	NUMBER OF REGISTRATION (11)
21-01	D 2021 911 S

CONCORDANCE TABLE OF PUBLICATION NUMBERS
AND INTERNATIONAL CLASSIFICATION INDEX

NUMBER OF REGISTRATION (11)	INTERNATIONAL CLASSIFICATION INDEXES (51)
D 2021 911 S	21-01

CONCORDANCE TABLE OF APPLICATION NUMBERS,
PUBLICATION NUMBERS AND PATENTS

NUMBER OF APPLICATION (21)	NUMBER OF REGISTRATION (11)
AD 2021 1241	D 2021 911 S

TRADEMARKS

CONCORDANCE TABLE OF REGISTRATION NUMBERS, APPLICATION NUMBERS, PUBLICATION NUMBERS AND BULLETIN NUMBERS

NUMBER OF REGISTRATION (111)	NUMBER OF APPLICATIONS (210)	NUMBER OF PUBLISHED APPLICATIONS (260)	NUMBER OF BULLETIN
1	2	3	4
M 2021 34636 R	AM 114907	–	20(576)2021
M 2021 34637 R	AM 114620	–	20(576)2021
M 2021 34638 R	AM 114621	–	20(576)2021
M 2021 34639 R	AM 114989	–	20(576)2021
M 2021 34640 R	AM 114991	–	20(576)2021
M 2021 34641 R	AM 115010	–	20(576)2021
M 2021 34642 R	AM 115009	–	20(576)2021
M 2021 34643 R	AM 114698	–	20(576)2021
M 2021 34644 R	AM 109611	AM 2021 109611 A	7(563)2021
M 2021 34645 R	AM 109734	AM 2021 109734 A	7(563)2021
M 2021 34646 R	AM 109735	AM 2021 109735 A	7(563)2021
M 2021 34647 R	AM 109736	AM 2021 109736 A	7(563)2021
M 2021 34648 R	AM 109737	AM 2021 109737 A	7(563)2021
M 2021 34649 R	AM 109749	AM 2021 109749 A	7(563)2021
M 2021 34650 R	AM 109775	AM 2021 109775 A	7(563)2021
M 2021 34651 R	AM 109776	AM 2021 109776 A	7(563)2021
M 2021 34652 R	AM 109938	AM 2021 109938 A	7(563)2021
M 2021 34653 R	AM 110015	AM 2021 110015 A	12(568)2021
M 2021 34654 R	AM 110476	AM 2021 110476 A	12(568)2021
M 2021 34655 R	AM 110539	AM 2021 110539 A	12(568)2021
M 2021 34656 R	AM 110606	AM 2021 110606 A	12(568)2021
M 2021 34657 R	AM 110671	AM 2021 110671 A	12(568)2021
M 2021 34658 R	AM 110672	AM 2021 110672 A	12(568)2021
M 2021 34659 R	AM 110755	AM 2021 110755 A	12(568)2021
M 2021 34660 R	AM 110793	AM 2021 110793 A	12(568)2021
M 2021 34661 R	AM 110798	AM 2021 110798 A	12(568)2021
M 2021 34662 R	AM 110799	AM 2021 110799 A	12(568)2021
M 2021 34663 R	AM 110800	AM 2021 110800 A	12(568)2021
M 2021 34664 R	AM 110861	AM 2021 110861 A	12(568)2021
M 2021 34665 R	AM 110864	AM 2021 110864 A	13(569)2021
M 2021 34666 R	AM 110866	AM 2021 110866 A	13(569)2021
M 2021 34667 R	AM 110867	AM 2021 110867 A	13(569)2021
M 2021 34668 R	AM 110873	AM 2021 110873 A	12(568)2021
M 2021 34669 R	AM 110938	AM 2021 110938 A	12(568)2021
M 2021 34670 R	AM 110945	AM 2021 110945 A	12(568)2021
M 2021 34671 R	AM 110963	AM 2021 110963 A	12(568)2021
M 2021 34672 R	AM 110969	AM 2021 110969 A	12(568)2021
M 2021 34673 R	AM 110970	AM 2021 110970 A	12(568)2021
M 2021 34674 R	AM 92160	AM 2021 92160 A	11(567)2021
M 2021 34675 R	AM 110131	AM 2021 110131 A	7(563)2021
M 2021 34676 R	AM 110869	AM 2021 110869 A	11(567)2021
M 2021 34677 R	AM 109833	AM 2021 109833 A	7(563)2021
M 2021 34678 R	AM 110886	AM 2021 110886 A	12(568)2021
M 2021 34679 R	AM 115021	–	20(576)2021
M 2021 34680 R	AM 115109	–	20(576)2021

1	2	3	4
M 2021 34681 R	AM 115014	–	20(576)2021
M 2021 34682 R	AM 115108	–	20(576)2021
M 2021 34683 R	AM 114994	–	20(576)2021
M 2021 34684 R	AM 114918	–	20(576)2021

CONCORDANCE TABLE OF PUBLICATION NUMBERS
AND APPLICATION NUMBERS

NUMBER OF PUBLISHED APPLICATION (260)	NUMBER OF APPLICATION (210)	1	2
1	2		
AM 2021 111500 A	AM 111500	AM 2021 112485 A	AM 112485
AM 2021 111590 A	AM 111590	AM 2021 112487 A	AM 112487
AM 2021 112174 A	AM 112174	AM 2021 112488 A	AM 112488
AM 2021 112182 A	AM 112182	AM 2021 112499 A	AM 112499
AM 2021 112191 A	AM 112191	AM 2021 112501 A	AM 112501
AM 2021 112253 A	AM 112253	AM 2021 112504 A	AM 112504
AM 2021 112256 A	AM 112256	AM 2021 112505 A	AM 112505
AM 2021 112263 A	AM 112263	AM 2021 112510 A	AM 112510
AM 2021 112267 A	AM 112267	AM 2021 112575 A	AM 112575
AM 2021 112273 A	AM 112273	AM 2021 112576 A	AM 112576
AM 2021 112274 A	AM 112274	AM 2021 112582 A	AM 112582
AM 2021 112275 A	AM 112275	AM 2021 112583 A	AM 112583
AM 2021 112279 A	AM 112279	AM 2021 112587 A	AM 112587
AM 2021 112282 A	AM 112282	AM 2021 112590 A	AM 112590
AM 2021 112283 A	AM 112283	AM 2021 112595 A	AM 112595
AM 2021 112284 A	AM 112284	AM 2021 112597 A	AM 112597
AM 2021 112286 A	AM 112286	AM 2021 112607 A	AM 112607
AM 2021 112301 A	AM 112301	AM 2021 112609 A	AM 112609
AM 2021 112302 A	AM 112302	AM 2021 112610 A	AM 112610
AM 2021 112309 A	AM 112309	AM 2021 112614 A	AM 112614
AM 2021 112312 A	AM 112312	AM 2021 112615 A	AM 112615
AM 2021 112367 A	AM 112367	AM 2021 112616 A	AM 112616
AM 2021 112386 A	AM 112386	AM 2021 112622 A	AM 112622
AM 2021 112387 A	AM 112387	AM 2021 112628 A	AM 112628
AM 2021 112390 A	AM 112390	AM 2021 112685 A	AM 112685
AM 2021 112400 A	AM 112400	AM 2021 112686 A	AM 112686
AM 2021 112401 A	AM 112401	AM 2021 112690 A	AM 112690
AM 2021 112404 A	AM 112404	AM 2021 112696 A	AM 112696
AM 2021 112407 A	AM 112407	AM 2021 112697 A	AM 112697
AM 2021 112410 A	AM 112410	AM 2021 112713 A	AM 112713
AM 2021 112422 A	AM 112422	AM 2021 112714 A	AM 112714
		AM 2021 112716 A	AM 112716
		AM 2021 112719 A	AM 112719
		AM 2021 112721 A	AM 112721
		AM 2021 112738 A	AM 112738

CONCORDANCE TABLE OF INDEX OF GOODS AND/OR SERVICES
AND APPLICATION NUMBERS

INDEX OF GOODS AND/OR SERVICES (511)	NUMBER OF PUBLISHED APPLICATIONS (260)	1	2
1	2		
1	AM 2021 112501 A	30	AM 2021 111590 A
1	AM 2021 112510 A	30	AM 2021 112286 A
2	AM 2021 112576 A	30	AM 2021 112302 A
3	AM 2021 112263 A	30	AM 2021 112697 A
3	AM 2021 112407 A	32	AM 2021 112253 A
3	AM 2021 112487 A	32	AM 2021 112697 A
3	AM 2021 112587 A	33	AM 2021 111500 A
3	AM 2021 112597 A	33	AM 2021 112182 A
3	AM 2021 112690 A	33	AM 2021 112273 A
3	AM 2021 112696 A	33	AM 2021 112282 A
5	AM 2021 112256 A	33	AM 2021 112284 A
5	AM 2021 112263 A	33	AM 2021 112404 A
5	AM 2021 112279 A	33	AM 2021 112485 A
5	AM 2021 112390 A	33	AM 2021 112610 A
5	AM 2021 112575 A	33	AM 2021 112622 A
5	AM 2021 112590 A	33	AM 2021 112685 A
5	AM 2021 112595 A	33	AM 2021 112686 A
5	AM 2021 112609 A	33	AM 2021 112697 A
5	AM 2021 112721 A	33	AM 2021 112738 A
7	AM 2021 112301 A	34	AM 2021 112309 A
7	AM 2021 112499 A	34	AM 2021 112400 A
7	AM 2021 112510 A	34	AM 2021 112422 A
8	AM 2021 112499 A	34	AM 2021 112505 A
8	AM 2021 112510 A	34	AM 2021 112714 A
9	AM 2021 112582 A	34	AM 2021 112716 A
9	AM 2021 112583 A	35	AM 2021 112174 A
11	AM 2021 112174 A	35	AM 2021 112283 A
11	AM 2021 112510 A	35	AM 2021 112312 A
12	AM 2021 112312 A	35	AM 2021 112410 A
12	AM 2021 112614 A	35	AM 2021 112504 A
12	AM 2021 112615 A	35	AM 2021 112510 A
12	AM 2021 112616 A	35	AM 2021 112587 A
13	AM 2021 112386 A	35	AM 2021 112607 A
16	AM 2021 112263 A	35	AM 2021 112610 A
16	AM 2021 112367 A	35	AM 2021 112622 A
16	AM 2021 112690 A	35	AM 2021 112685 A
19	AM 2021 112504 A	35	AM 2021 112686 A
20	AM 2021 112174 A	35	AM 2021 112697 A
20	AM 2021 112607 A	35	AM 2021 112713 A
20	AM 2021 112713 A	36	AM 2021 112504 A
21	AM 2021 112174 A	37	AM 2021 112174 A
21	AM 2021 112286 A	37	AM 2021 112387 A
21	AM 2021 112690 A	37	AM 2021 112401 A
28	AM 2021 112719 A	37	AM 2021 112504 A
29	AM 2021 112274 A	37	AM 2021 112628 A
29	AM 2021 112275 A	38	AM 2021 112367 A
29	AM 2021 112504 A	38	AM 2021 112504 A
29	AM 2021 112697 A	39	AM 2021 112312 A
		39	AM 2021 112504 A
		40	AM 2021 112690 A
		41	AM 2021 112367 A
		41	AM 2021 112488 A

1	2
41	AM 2021 112504 A
42	AM 2021 112312 A
42	AM 2021 112504 A
43	AM 2021 112174 A
43	AM 2021 112267 A
43	AM 2021 112283 A

1	2
43	AM 2021 112302 A
44	AM 2021 112487 A
44	AM 2021 112504 A
45	AM 2021 112191 A
45	AM 2021 112488 A
45	AM 2021 112504 A

**CONCORDANCE TABLE OF INDEX OF GOODS AND/OR SERVICES
AND NUMBERS OF TRADEMARKS REGISTERED ACCORDING
TO THE ACCELERATED PROCEDURE**

INDEX OF GOODS AND/OR SERVICES (511)	NUMBERS OF REGISTERED ACCORDING TO THE ACCELERATED PROCEDURE (111)
3	M 2021 34640 R
3	M 2021 34680 R
4	M 2021 34640 R
14	M 2021 34682 R
25	M 2021 34640 R
30	M 2021 34641 R
32	M 2021 34637 R
32	M 2021 34638 R
33	M 2021 34642 R
33	M 2021 34643 R
33	M 2021 34683 R
34	M 2021 34679 R
35	M 2021 34636 R
35	M 2021 34640 R
35	M 2021 34684 R
38	M 2021 34640 R
41	M 2021 34639 R
43	M 2021 34636 R
43	M 2021 34681 R

OFFICIAL BULLETIN OF THE INDUSTRIAL PROPERTY

**INVENTIONS
UTILITY MODEL
DESIGNS
TRADEMARKS**

20(576)

EDITOR-IN-CHIEF: N. Bebrishvili

EDITOR-TRANSLATOR: E. Gabunia

PROOFREADER: A. Shikhashvili

COMPUTER LAYOUT: M. Ordenidze
K. Svanidze

info@sakpatenti.gov.ge
www.sakpatenti.gov.ge