

Official Bulletin of the Industrial Property

Inventions

Utility Models

Designs

Trademarks



საქართველოს ინტელექტუალური
საკუთრების ეროვნული ცენტრი

საკპატი

SAKPATENTI

NATIONAL INTELLECTUAL PROPERTY
CENTER OF GEORGIA

www.sakpatenti.gov.ge

Date of Publication – 2021 11 25

21(577)

INID CODES FOR IDENTIFICATION OF BIBLIOGRAPHIC DATA

INVENTIONS, UTILITY MODELS

- (10) Number of publication for application, which has been examined
- (11) Number of patent and kind of document
- (21) Serial number of application
- (22) Date of filing of the application
- (23) Date of exhibition or the date of the earlier filing and the number of application, if any
- (24) Date from which patent may have effect
- (31) Number of priority application
- (32) Date of filing of priority application
- (33) Code of the country or regional organization allotting priority application number
- (44) Date of publication of application not granted, but examined and number of bulletin
- (45) Date of publication of registered document
- (51) International Patent Classification Index

- (54) Title of the invention
- (57) Abstract
- (60) Number of examined patent document granted by foreign patent office, date from which patent has effect and country code
- (62) Number of the earlier application and in case of divided application, date of filing an application
- (71) Name, surname and address of applicant (country code)
- (72) Name, surname of inventor (country code)
- (73) Name, surname and address of patent owner (country code)
- (74) Name, surname of representative or patent attorney
- (85) Date of commencement of the national phase of International Application
- (86) Number and date of filing of international application
- (87) Number and date of publication of international application
- (94) Calculated date of expiry of the SPC or the duration of the SPC

DESIGNS

- (10) Number of publication for application
- (11) Number of patent and kind of document or number of registration
- (15) Date of registration/Date of patent renewal
- (18) Expected expiration date of patent or registration
- (21) Serial number of application
- (22) Date of filing of the application
- (23) Date of exhibition or the date of the earlier filing and the number of application, if any
- (24) Date from which patent may have effect
- (28) Number of designs included in the application
- (30) Data relating to priority (number of application, date of filing of application, two-letter code identifying the authority with whom the priority application was made)
- (31) Number of priority application
- (32) Date of filing of priority application
- (33) Code of the country or regional organization allotting priority application number
- (34) Two-letter code according to WIPO St.3 identifying the authority with which the priority application was made
- (44) Date of publication of design and number of bulletin (the first publication)
- (45) Date of publication of design registered by WIPO and number of bulletin

- (51) International Classification for designs (class and subclass of the Locarno Classification)
- (54) Title of the invention
- (55) Reproduction of the design
- (57) Description of characteristic features of the design including indication of colors
- (58) Date of recording of any kind of amendment in the Register
- (62) Number of the earlier application, registration and document number and if available the date of filing an application in case of divided application
- (71) Name, surname and address of applicant (country code)
- (72) Name, surname of creator (country code)
- (73) Name, surname and address of patent owner (country code)
- (74) Name, surname of representative or patent attorney
- (81) Contracting states concerned
 - II designated contracting states according to the 1960 Act
 - III designated contracting states according to the 1999 Act
- (85) Owner's permanent address
- (86) Owner's nationality
- (87) Owner's residence
- (88) State in which the owner has a real and effective industrial or commercial establishment

TRADEMARKS

- (111) - Number of registration
- (151) - Date of registration
- (156) - Date of the renewal
- (181) - Expected expiration date of registration
- (186) - Renewal expiration date of registration
- (141) - Date of cancel of duration of the mark
- (210) - Serial number of application
- (220) - Date of filing of the application
- (230) - Data concerning exhibition
- (260) - Number of application, for which favorable decision of examination about registration has been taken (publication number)
- (310) - Number of the first application
- (320) - Date of filing of the first application
- (330) - Code, identifying national or regional Office where the first application was made
- (511) - International Classification of Goods and Services for the purposes of registration of trade marks and/or list of goods and/or services classified according thereto
- (526) - Disclaimer
- (531) - Description of figurative elements of Trade Marks according to the International Classification of the Figurative Elements of Marks

- (540) - Reproduction of Trade Mark
- (550) - Nature and kind of Trade Mark
- (551) - Indication to the effect that the mark is a collective mark, a certification mark or a guarantee mark
- (554) - Three-dimensional mark
- (580) - Date of recording of any kind changes in respect of applications or registrations
- (591) - Information concerning colors claimed
- (731) - Name and address of the applicant
- (732) - Name and address of the holder of the registration
- (740) - Name and address of the representative
- (750) - Addreses for correspondence
- (770) - Name and address of the previous applicant or holder in case of change in ownership
- (771) - Previous name and address of the applicant or holder in case of change in ownership
- (791) - Name and address of the licensee
- (793) - Indication of conditions and/or restrictions under the license (Type of license, number of license agreement, data of license, data of validity of license)
- (800) - Certain data relating to the international registration of Trade Marks under the Protocol Relating to Madrid Agreement (International registration number
- (852) - Partial cancellation of the list of goods and services
- (891) - Date of subsequent designation

CODES FOR PUBLICATION IN BULLETIN

- (21) AP 0000 000000 - serial number of application for invention
- (10) AP 0000 0000 A - number of published application for invention (first publication)
- (11) P 0000 0000 B - number of patent for invention (second publication)
- (21) API 0000 000000 - number of application for imported patent
- (11) PI 0000 0000 A - number of imported patent (first publication)
- (21) AU 0000 000000 - serial number of application for utility model
- (10) AU 0000 000 U - number of published application for utility model (first publication)
- (11) U 0000 000 Y - number of patent for utility model (second publication)
- (21) AD 0000 000000 - serial number of application for design
- (10) AD 0000 000 S - number of published application for design (first publication)
- (11) D 0000 000 S - registered design

INTERNATIONAL PATENT CLASSIFICATION FOR INVENTIONS AND UTILITY MODELS

- SECTION A - HUMAN NECESSITIES
- SECTION B - PERFORMING OPERATIONS; TRANSPORTING
- SECTION C - CHEMISTRY; METALLURGY
- SECTION D - TEXTILES; PAPER
- SECTION E - FIXED CONSTRUCTIONS
- SECTION F - MECHANICAL ENGINEERING; LIGHTING; HEATING; WEAPONS; BLASTING
- SECTION G - PHYSICS
- SECTION H - ELECTRICITY

-
- M - Trade Mark
 - (210) AM 0000 000000 - Serial number of application;
 - (260) AAM 0000 00000 A - Publication number of application;
 - (111) M 0000 00000 R - Number of registration;
 - (111) MMM0000 00000 Rn - Number of renewals, in which n=1,2,3;
 - (111) M 0000 00000 R(P) - Number of registration under partial assignment of rights
-

Official Bulletin of the Industrial Property

Inventions

Utility Models

Designs

Trademarks

CONTENTS

PUBLISHED TITLES OF PROTECTION	3
INVENTIONS	
▪ APPLICATIONS APPROVED FOR GRANTING PATENT	4
▪ PATENTED INVENTIONS	5
UTILITY MODELS	
▪ APPLICATIONS APPROVED FOR GRANTING PATENT	7
DESIGNS	
▪ APPLICATIONS APPROVED FOR REGISTRATION	8
▪ DESIGNS REGISTERED ACCORDING TO THE ACCELERATED PROCEDURE	10
▪ DESIGNS, WHICH HAVE BEEN REGISTERED WITH THE INTERNATIONAL BUREAU CLAIMING PRIORITY ON THE TERRITORY OF GEORGIA	13
TRADEMARKS	
▪ APPLICATIONS FILED UNDER THE NATIONAL PROCEDURE APPROVED FOR REGISTRATION	29
▪ REGISTERED TRADEMARKS	37
▪ TRADEMARKS REGISTERED ACCORDING TO THE ACCELERATED PROCEDURE	43
▪ INTERNATIONAL TRADEMARKS FOR WHICH A DECISION ON GRANTING PROTECTION IS TAKEN	46
▪ INTERNATIONAL TRADEMARKS PROTECTED IN GEORGIA	126
OFFICIAL NOTIFICATIONS	
INVENTIONS	
▪ EXPIRATION OF PATENTS RESTORATION	135
▪ ABOLITION OF PATENTS WITH THE RIGHT TO RESTORE	135
▪ EXPIRATION OF TERM OF RESTORATION OF PATENTS	137
▪ CHANGES OF NAME AND/OR ADDRESS OF PATENTOWNER	138
UTILITY MODELS	
▪ EXPIRATION OF PATENTS RESTORATION	139
▪ EXPIRATION OF TERM OF RESTORATION OF PATENT	139
DESIGNS	
▪ EXTENSION OF DESIGN REGISTRATION	140
▪ CANCELLATION OF DESIGNS REGISTRATION	140
TRADEMARKS	
▪ RENEWAL OF REGISTRATIONS	141
▪ COMPLETE TRANSFER OF RIGHTS	143
▪ CHANGES OF NAMES AND/OR ADDRESSES OF OWNERS	144
▪ CANCELLATION OF TRADEMARKS REGISTRATION	147
▪ REGISTRATION OF LICENSE AGREEMENT	147
CLASSIFICATION INDEXES	
INVENTIONS	148
UTILITY MODELS	150
DESIGNS	150
TRADEMARKS	152

OFFICIAL BULLETIN OF THE INDUSTRIAL PROPERTY

21(577)

**INVENTIONS
UTILITY MODELS
DESIGNS
TRADEMARKS**

DATE OF PUBLICATION: 2021 11 25

PUBLISHED TITLES OF PROTECTION

INVENTIONS

- **APPLICATIONS APPROVED FOR GRANTING PATENT:**
15561; 15628
- **PATENTED INVENTIONS:**
7318-7326

UTILITY MODELS

- **APPLICATIONS APPROVED FOR GRANTING PATENT:**
15659; 15487

DESIGNS

- **APPLICATIONS APPROVED FOR REGISTRATION:**
1237; 1221
- **DESIGNS REGISTERED ACCORDING TO THE ACCELERATED PROCEDURE:**
912-914
- **DESIGNS, WHICH HAVE BEEN REGISTERED WITH THE INTERNATIONAL BUREAU CLAIMING PRIORITY ON THE TERRITORY OF GEORGIA:**
213344; 213324; 216166; 215349; 216325, 216326

TRADEMARKS

- **APPLICATIONS FILED UNDER THE NATIONAL PROCEDURE APPROVED FOR REGISTRATION:**
109506; 110303; 110387; 111336; 111424; 111499; 111835, 111836; 112188; 112310; 112365; 112389; 112392; 112395, 112396; 112406; 112408; 112419; 112473; 112489, 112490; 112493; 112495; 112577, 112578; 112584; 112596; 112598; 112601-112606; 112608; 112626; 112672; 112674; 112701; 112720; 112725; 112727; 112729-112731; 112839; 112906; 112928, 112929
- **REGISTERED TRADEMARKS:**
34692-34721; 34726-34763
- **TRADEMARKS REGISTERED ACCORDING TO THE ACCELERATED PROCEDURE:**
34685-34691; 34722-34725
- **INTERNATIONAL TRADEMARKS FOR WHICH A DECISION ON GRANTING PROTECTIONS IS TAKEN:**
106330*; 106425*; 108800*; 109475*; 110154; 111055; 111143; 111316; 111356, 111357; 111387, 111388; 111392; 111461-111465; 111491-111493; 111495; 111560-111564; 111574; 111622-111625; 111637; 111639; 111653; 111655-111662; 111672; 111683- 111685; 111760; 111769, 111770; 111781; 111787-111791; 111803; 111808; 111810; 111815, 111816; 111826; 111888, 111889; 111896-111898; 111901-111903; 111905, 111906; 111908, 111909; 111918; 111920; 111922, 111923; 111978, 111979; 111983, 111984; 111989, 111990; 112005; 112007; 112009; 112012; 112015; 112017; 112021; 112032-112039; 112116; 112126; 112129; 112134, 112135; 112151; 112163; 112200; 112205; 112218; 112237; 112251, 112252; 112313, 112314; 112318; 112320; 112324; 112339; 112353-112355; 112357; 112435; 112445; 112467; 112786
- **INTERNATIONAL TRADEMARKS PROTECTED IN GEORGIA:**
107214; 107228; 107321; 108186; 109811; 109967; 110064; 110077-110080; 110085, 110086; 110090; 110106; 110148; 110155; 110157, 110158; 110161; 110166-110170; 110180; 110185- 110187; 110232, 110233; 110236, 110237; 110247; 110249; 110263, 110264; 110267; 110274- 110277; 110308-110310; 110343, 110344; 110354-110356; 110395; 110397; 110410-110412; 110425-110429; 110431; 110436, 110437; 110483; 110486-110489; 110499; 110575, 110576; 110582; 110591; 110598; 110646-110650; 110652, 110653; 110662; 110701-110706; 110716-110722; 110733-110738; 110853, 110854; 110901; 110903, 110904; 110985, 110986; 110988; 110992; 111040; 111042-111047

INVENTIONS

APPLICATIONS APPROVED FOR GRANTING PATENT

The decision can be appealed at the Chamber of Appeal of Sakpatenti within 3 months from the publication or at the Mtskheta District Court Administrative Cases Board (Address: №17, Samkhedro St., Mtskheta), within 1 month following the publication.

PARTA

A 61

(10) AP 2021 15561 A (51) Int. Cl. (2006)
A 61 K 36/00

(21) AP 2021 15561 (22) 2021 02 16

(71) BABRY, Oren (US)

15050 Sherman Way, №201, Van Nuys,
CA, 91356, USA (US)

(72) BABRY, Oren (US)

(74) Davit Dzumukashvili

(54) PHARMACEUTICAL COMPOSITION BASED
ON PLANT RAW MATERIALS

(57) Pharmaceutical composition includes pine (*Pinus*) needles and grape dry chacha extract dry powder, pharmaceutically acceptable additive, ginger (*Zingiber officinale*), green tea (*Camellia sinensis*), turmeric (*Curcuma Longa*), white/yellow mustard (*Brassica hirta*) seeds, white peper, pomegranate (*Punica granatum*) tree bark dry extracts, and pomegranate (*Punica granatum*) juice dry powder.

Claims: 2 independents

3 dependents

PART B

B 65

(10) AP 2021 15628 A (51) Int. Cl. (2006)
B 65 D 85/10

(21) AP 2021 15628 (22) 2021 05 13

(71) Niko Melikidze (GE)

Nutsubidze II Plateau, III qu., corp. 1, app. 10,
Tbilisi, Georgia (GE)

(72) Niko Melikidze (GE)

(54) PACKAGE FOR CYGARETTES

(57) A package includes: rectangular paralepyped-shaped outer box 6 having a bottom, and front 7, back 8 and side 9, 10 walls, and removable cover 13 connected to back wall by means of hinge 14, rectangular paralepyped-shaped inner dressing 1 including set of cygarettes 2. Inner dressing is close plastic on the bottom whereof the rectangular metallic plate 3 is placed, on whole perimeter whereof the weakened strength line 4 is executed; at that, it has a handle 5 in the

top to place inner dressing in inner box, and remove therefrom – outer box. A magnet 11 is placed removable on outer box bottom.

Claims: 1 independent

1 dependent

Fig.: 5

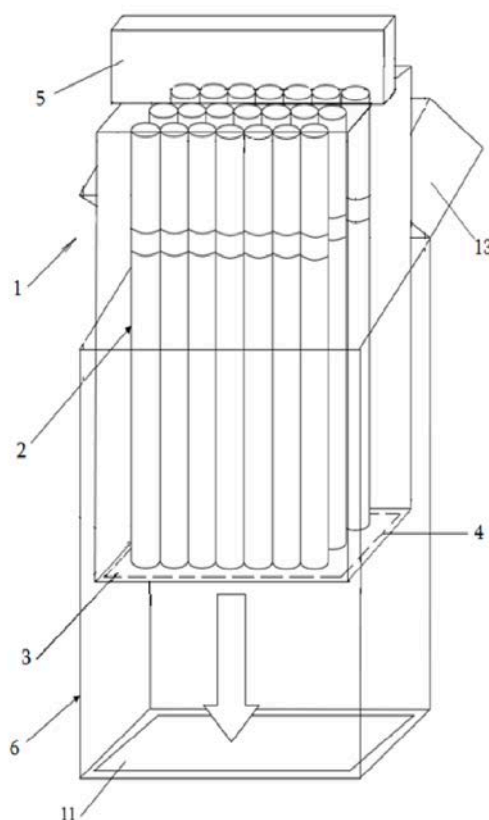

Fig. 4

PATENTED INVENTIONS

PART A

A 01

- (11) P 2021 7319 B (51) Int. Cl. (2006)
A 01 D 46/04
(10) AP 2021 15317 A (44) 10(566)/2021
(21) AP 2020 15317
(22) 2020 04 15
(24) 2020 04 15
(73) LEPL "Agriculture Scientific-Research
Center" (GE)
Marshal Gelovani Av. 6, Tbilisi, Georgia (GE)
(72) Nugzar Ebanoidze (GE);
Aleksandre Bekoshvili (GE);
Nodar Kekenadze (GE);
Giorgi Lezhava (GE)
(54) TEA BUSH PRUNING AND LOADING
COMBINED AGREGATE

- (11) P 2021 7320 B (51) Int. Cl. (2006)
A 01 D 46/04
(10) AP 2021 15357 A (44) 10(566)/2021
(21) AP 2020 15357
(22) 2020 06 04
(24) 2020 06 04
(73) LEPL "Agriculture Scientific-Research
Center" (GE)
Marshal Gelovani Ave. 6, Tbilisi, Georgia (GE)
(72) Aleksandre Bekoshvili (GE);
Marita Macharashvili (GE);
Nodar Kekenadze (GE);
Nugzar Ebanoidze (GE)
(54) COMBINED AGGREGATE FOR TEA
PLANTATIONS REHABILITATION

A 23

- (11) P 2021 7323 B (51) Int. Cl. (2006)
A 23 L 2/00
C 12 H 1/16
(10) AP 2021 15240 A (44) 12(568)/2021
(21) AP 2019 15240
(22) 2019 12 19
(24) 2019 12 19
(73) LTD "AQX" (GE)
Uznadze St. 111, app. 11, bld. 2, Didube
District, Tbilisi, Georgia (GE)
(72) Andrey Yurevich Kalachev (RU);
Artem Arturovich Balianko (RU);
Aleksandr Viktorovich Kolotsev (RU);
Andrey Vladimirovich Chentsov (RU)

- (74) Shalva Gvaramadze
(54) METHOD OF PREPARING OF BEVERAGE

A 61

- (11) P 2021 7318 B (51) Int. Cl. (2006)
A 61 K 31/496
A 61 K 31/4155
C 07 D 403/14
C 07 D 403/06
C 07 D 401/06
(10) AP 2021 15219 A (44) 10(566)/2021
(21) AP 2018 15219
(22) 2018 05 22
(24) 2018 05 22
(31) 62/510,213
(32) 2017 05 23
(33) US
(86) PCT/US2018/033959, 2018 05 22
(73) H. Lundbeck A/S (DK)
Ottiliavej 9, Valby, DK-2500, Denmark (DK)
(72) GRICE, Cheryl A. (US);
WIENER, John J. M. (US);
WEBER, Olivia D. (US);
DUNCAN, Katharine K. (US)
(74) Tamaz Shilakadze
(54) PYRAZOLE MAGL INHIBITORS

- (11) P 2021 7326 B (51) Int. Cl. (2006)
A 61 K 39/395
A 61 K 38/17
C 07 K 14/47
C 07 K 14/705
(10) AP 2021 14720 A (44) 10(566)/2021
(21) AP 2016 14720
(22) 2016 08 05
(24) 2016 08 05
(31) 62/202,772; 62/202,775; 62/202,779;
62/265,887; 62/276,801; 62/276,796;
62/346,414
(32) 2015 08 07; 2015 08 07; 2015 08 07;
2015 12 10; 2016 01 08; 2016 01 08;
2016 06 06
(33) US; US; US; US; US; US; US; US
(86) PCT/US2016/045914, 2016 08 05
(73) ALX Oncology Inc. (US)
866 Malcolm Rd., Suite 100,
Burlingame, CA 94010 USA (US)
(72) GOODMAN, Corey (US);
SIM, Bang Janet (US);
KUO, Tracy Chia-Chien (US);
WAN, Hong (US);
DEMING, Laura (US);

PONS, Jaime (US);
KAUDER, Steven Elliot (US)
(74) Tamar Kochlamazashvili
(54) CONSTRUCTS HAVING A SIRP-ALPHA
DOMAIN OR VARIANT THEREOF

PART B

B 05

(11) P 2021 7325 B (51) Int. Cl. (2006)
B 05 D 3/00
C 09 D 7/40
C 09 D 137/00
(10) AP 2021 14598 A (44) 11(567)/2021
(21) AP 2017 14598
(22) 2017 09 29
(24) 2017 09 29
(31) 16191982.4
(32) 2016 09 30
(33) EP
(73) Daw SE (DE)
Roßdörfer Straße 50, 64372 Ober-Ramstadt,
Germany (DE)
(72) BRENER, Thomas (DE);
WEINHOLD, Petra (DE);
GROSKOPF, Jean (DE)
(74) Liliana Darakhvelidze
(54) AQUEOUS TREATMENT COMPOUND
FOR BUILDING WALLS, CEILINGS
OR FLOORS, STAINING OR PRIMING,
SUBSTRATE WITH COATING, AND
MASS USAGE FOR TREATMENT

B 61

(11) P 2021 7324 B (51) Int. Cl. (2006)
B 61 B 23/02
(10) AP 2021 15215 A (44) 10(566)/2021
(21) AP 2017 15215
(22) 2017 04 12
(24) 2017 04 12
(86) PCT/EP2017/058859, 2017 04 12
(73) Stadler Rheintal AG (CH)
Ernst-Stadler-Strasse 1, Bussnang, 9565,
Switzerland (CH)
(72) PAUKER, Juergen-M. (AT)
(74) Liliana Darakhvelidze
(54) BOARDING ASSEMBLY, RAILWAY
VEHICLE COMPRISING BOARDING
ASSEMBLY, AND METHOD FOR
PRODUCING RAILWAY VEHICLE

PART G

G 01

(11) P 2021 7321 B (51) Int. Cl. (2006)
G 01 J 3/00
(10) AP 2021 15404 A (44) 14(570)/2021
(21) AP 2020 15404
(22) 2020 08 04
(24) 2020 08 04
(73) LTD "National High Technology Center of
Georgia" (GE)
Kavtaradze St. 46, 0186, Vake District, Tbilisi,
Georgia (GE)
(72) Lamzira Parulava (GE);
Natia Mzareulishvili (GE)
(74) Tamar Liluashvili
(54) MASS-SPECTROMETRIC METHOD
FOR DETERMINATION OF CARBON-13
ISOTOPE ATOMIC FRACTION DIRECTLY
IN SALICYLIC ACID

(11) P 2021 7322 B (51) Int. Cl. (2006)
G 01 J 3/00
(10) AP 2021 15403 A (44) 14(570)/2021
(21) AP 2020 15403
(22) 2020 08 04
(24) 2020 08 04
(73) LTD "National High Technology Center of
Georgia" (GE)
Kavtaradze St. 46, 0186, Vake District, Tbilisi,
Georgia (GE)
(72) Lamzira Parulava (GE);
Vakhtang Ugrekhelidze (GE)
(74) Tamar Liluashvili
(54) METHOD FOR DETERMINATION OF
OXYGEN-17 ISOTOPE ATOMIC FRACTION
IN MOLECULAR OXYGEN

UTILITY MODELS

APPLICATIONS APPROVED FOR GRANTING PATENT

The decision can be appealed at the Chamber of Appeal of Sakpatenti within 3 months from the publication or at the Mtskheta District Court Administrative Cases Board (Address: №17, Samkhedro St., Mtskheta), within 1 month following the publication.

PART A

A 61

- (10) AU 2021 15659 U (51) Int. Cl. (2006)
A 61 K 9/20
A 61 K 35/76
A 61 K 36/00
- (21) AU 2021 15659 (22) 2021 06 10
- (71) G. Eliava Institute Of Bacteriophages,
Microbiology And Virusology (GE)
Gotua St. 3, 0160, Tbilisi, Georgia (GE);
Lasha Bakuridze (GE)
Davit Ghmashenebeli Alley 12th km-s, 0159,
Tbilisi, Georgia (GE);
Marine Goderdzishvili (GE)
Kalistrate Kutateladze St. 22, 0160,
Tbilisi, Georgia (GE);
Irine Chkonia (GE)
Gotua St. 22, 0160, Tbilisi, Georgia (GE);
Ia Kusradze (GE)
Gotua St. 3, 0160, Tbilisi, Georgia (GE)
- (72) Lasha Bakuridze (GE);
Nora Kirtadze (GE);
Salome Barbakadze (GE);
Nino Tatrishvili (GE);
Teona Dvalidze (GE);
Natia Karumidze (GE);
Marine Goderdzishvili (GE);
Irine Chkonia (GE);
Ia Kusradze (GE)
- (54) SUCKING HEALING FORM AGAINST
INFECTIONS OF UPPER RESPIRATORY
TRACT AND MOUTH CAVITY
- (57) Sucking healing form contains mixture of
specific phagolysates against of taphylococcus aure-
us, Staphylococcus epidermidis, Streptococcus mitis,
Streptococcus pyogenes, Streptococcus oralis,
Enterococcus faecium, Enterococcus faecalis, and E.
coli, and combination of eucalyptus oil or dry sage
extract, and sage oil, as active ingredients; and
menthol, gelatin, sucrose, modified Kellenberger
synthetic soil, isomalt, and a dye, not necessarily – as
additional ingredients.
Claims: 1 independent
9 dependents
-

PART C

C 04

- (10) AU 2021 15487 U (51) Int. Cl. (2006)
C 04 B 35/32
H 01 L 39/00
- (21) AU 2020 15487 (22) 2020 11 09
- (71) Nikoloz Margiani (GE)
Vazha-Pshavela Av., IV qu., corp. 4, app. 27,
0186, Tbilisi, Georgia (GE);
Giorgi Mumladze (GE)
Politkovskaya St. 47, app. 91, 0186, Tbilisi,
Georgia (GE);
Vakhtangi Zhghamadze (GE)
Varketili 3, I mcr., corp. 3, app. 108, 0163,
Tbilisi, Georgia (GE);
Iamze Kvartskhava (GE)
Demetre Tavdadebuli St. 7, app. 27, 4400, Poti,
Georgia (GE);
Natia Margiani (GE)
Vazha-Pshavela Av., IV qu., corp. 4, app. 27,
0186, Tbilisi, Georgia (GE);
Nino Mumladze (GE)
Politkovskaya St. 47, app. 91, 0186, Tbilisi,
Georgia (GE)
- (72) Nikoloz Margiani (GE);
Giorgi Mumladze (GE);
Vakhtangi Zhghamadze (GE);
Iamze Kvartskhava (GE);
Natia Margiani (GE);
Nino Mumladze (GE)
- (54) COBALT BASED THERMOELECTRIC
POTTERY
- (57) Cobalt based thermoelectric pottery containing
oxides: Bi₂O₃, CaO, Co₃O₄, additionally contains
Pb(BO₂)₂, as well, with the following ratio of
componentry (in mass%):
Bi₂O₃ – 60.50 ÷ 62.45;
CaO – 15.50 ÷ 15.60;
Co₃O₄ – 18.90 ÷ 19.00;
Pb(BO₂)₂ – 3.10 ÷ 5.10.
Claims: 1 independent
-

DESIGNS

APPLICATIONS APPROVED FOR REGISTRATION

The decision can be appealed at the Chamber of Appeal of Sakpatenti within 3 months from the publication or at the Mtskheta District Court Administrative Cases Board (Address: №17, Samkhedro str., Mtskheta), within 1 month following the publication.

- (10) AD 2021 1237 S (51) 15-07
(21) AD 2021 1237 (22) 2021 08 20
(28) 1
(71) Giorgi Tsabolashvili (GE)
Mukhiani, I mcr., corp. B, app. 404, 0172, Tbilisi, Georgia (GE)
(72) Giorgi Tsabolashvili (GE)
(54) BOTTLE-SHAPED REFRIGERATOR
(55)



1.1

1.2

1.3

- (10) AD 2021 1221 S (51) 20-02
(21) AD 2021 1221 (22) 2021 06 10
(28) 1
(71) LTD "MOSEIRNE DAPA" (WALKING BLACKBOARD) (GE)
Ts. Dadiani St. 34, corp. 13, app. 7, 0180, Tbilisi, Georgia (GE)
(72) Merab Makharadze (GE)
(54) ADVERTISING BLACKBOARD
(55)



1.1

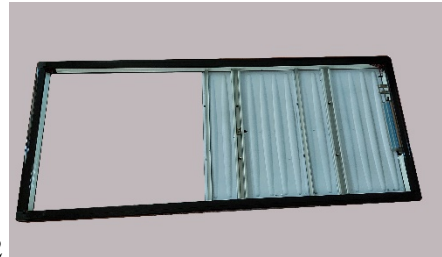

1.2

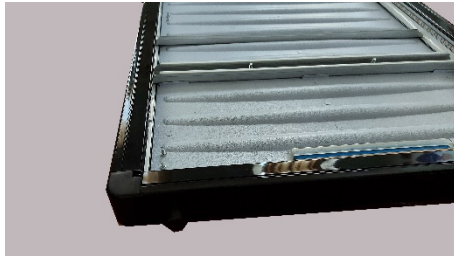

1.3

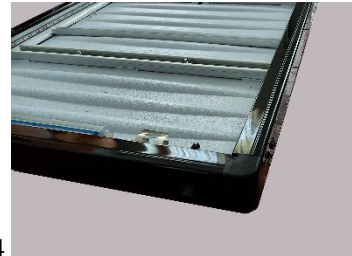

1.4



1.5

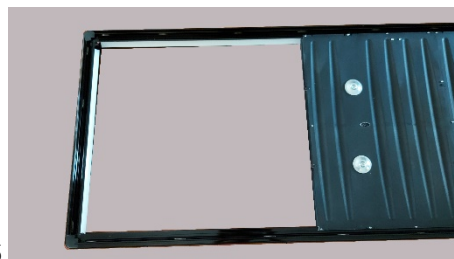

1.6

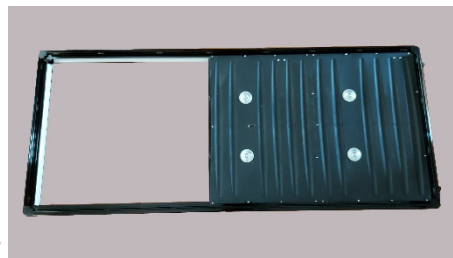

1.7

DESIGNS REGISTERED ACCORDING TO THE ACCELERATED PROCEDURE

The decision can be appealed at the Chamber of Appeal of Sakpatenti within 3 months from the publication.

- (11) D 2021 912 S (51) 09-01
(21) AD 2021 1243 (22) 2021 10 18
(24) 2021 10 18
(28) 1
(18) 2026 10 18
(73) LTD "Kvareli Cellar" (GE)
 Vill. Chikaani, 4800, Kvareli, Georgia (GE)
(72) Otar Tabatadze (GE)
(74) Khatuna Imnadze (GE)
(54) BOTTLE WITH LABEL
(55)

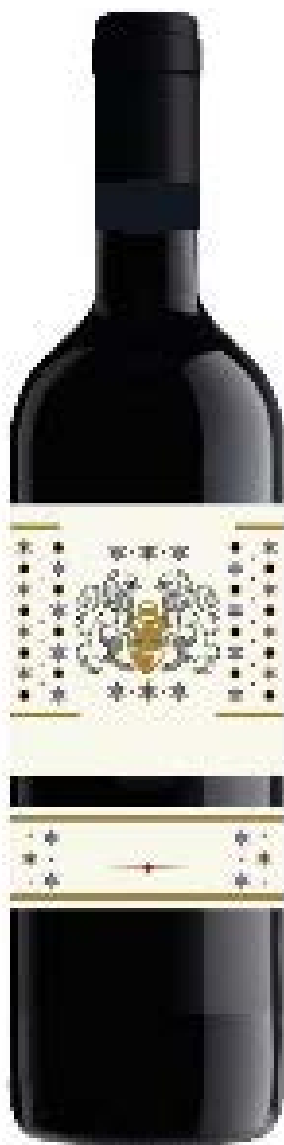

1.1

- (11) D 2021 913 S (51) 19-08
- (21) AD 2021 1245 (22) 2021 10 18
- (24) 2021 10 18
- (28) 3
- (18) 2026 10 18
- (73) LTD "Kvareli Cellar" (GE)
Vill. Chikaani, 4800, Kvareli, Georgia (GE)
- (72) Otar Tabatadze (GE)
- (74) Khatuna Imnadze (GE)
- (54) 1.-3. LABEL
- (55)



1.1

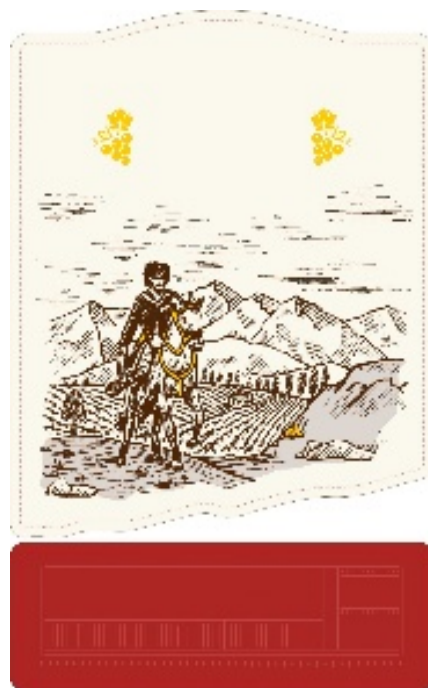

2.1



3.1

- (11) D 2021 914 S (51) 25-03
- (21) AD 2021 1249 (22) 2021 11 05
- (24) 2021 11 05
- (28) 1
- (18) 2026 11 05
- (73) Akaki Paichadze (GE)
Tashkent St. 17, app. 22, 0160, Tbilisi, Georgia (GE)
- (72) Akaki Paichadze (GE)
- (74) Shalva Gvaramadze (GE)
- (54) DATA CENTER MODULE BUILDING DESIGN
- (55)



1.1



1.2



1.3



1.4

DESIGNS, WHICH HAVE BEEN REGISTERED WITH THE INTERNATIONAL BUREAU CLAIMING PRIORITY ON THE TERRITORY OF GEORGIA

The decision can be appealed at the Chamber of Appeal of Sakpatenti within 3 months from the publication or at the Mtskheta District Court Administrative Cases Board (Address: №17, Samkhedro St., Mtskheta), within 1 month following the publication.

- (11) DM/213 344 (51) 11-01
 (15) 2021 03 01 (44) 35/2021 (2021 09 03)
 (22) 2021 03 01
 (28) 11
 (73) HARRY WINSTON SA
 Chemin Du Tourbillon 8, 1228 Plan-les-Ouates (CH)
 (85) CH
 (86) CH
 (87) CH
 (88) CH
 (89) CH
 (81) II. MA III. AL, AM, AZ, BA, BZ, CA, CH, EM, GB, GE, KG, LI, MC, MD, ME, MK, MN, NO, OM, SG, TN, TR, UA
 (72) 1; 9-11 Rie YATSUGI-KANG
 C/o Harry Winston Inc. 718 Fifth Avenue, 10019, New York (US);
 2-4 Dominique RIVIERE
 C/o Harry Winston Inc. 718 Fifth Avenue, 10019, New York (US);
 5-6 Delphine ABDOURAHIM
 C/o Harry Winston Inc. 718 Fifth Avenue, 10019, New York (US);
 7-8 Dominique RIVIERE
 C/o Harry Winston Inc. 718 Fifth Avenue, 10019, New York (US)
 (74) The Swatch Group AG (The Swatch Group SA) (The Swatch Group Ltd.)
 Faubourg Du Lac 6, 2501 Biel/Bienne (CH)
 (54) 10. Necklace, 11. Pair of earrings, 1.-2. Finger ring, 3. Necklace, 4.-8. Pair of earrings, 9. Bracelet
 (55)



1.1



1.2



1.3



1.4



1.5



1.6



1.7



1.8



2.1



2.2



2.3



2.4



2.5



2.6



2.7



2.8



3.1



3.2



3.3



3.4



3.5



3.6



3.7



3.8



4.1



4.2



4.3



4.4

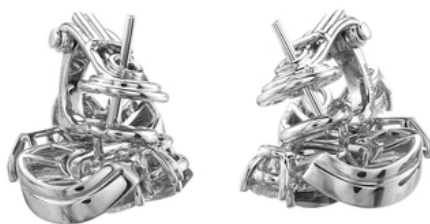

4.5



4.6



4.7



4.8



5.1



5.2



5.3



5.4



5.5



5.6



5.7



5.8

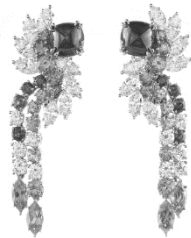

6.1



6.2



6.3



6.4



6.5



6.6



6.7

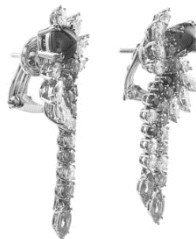

6.8



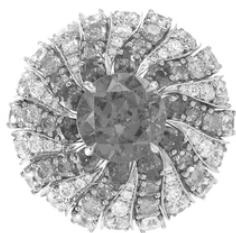

7.1

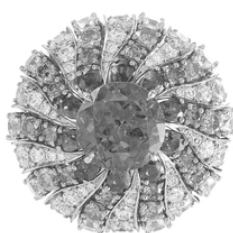

7.2



7.3



7.4



7.5



7.6



7.7

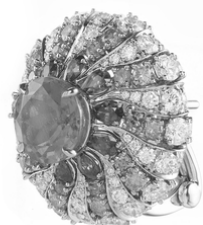

7.8

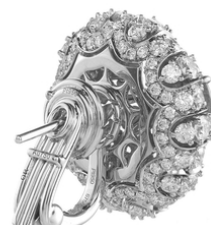

8.1



8.2



8.3



8.4



8.5

8.6



8.7

8.8



9.1



9.2



9.3



9.4



9.5

9.6



9.7



9.8



10.1



10.2



10.3



10.4



10.5



10.6



10.7



10.8



11.1



11.2



11.3



11.4



11.5



11.6



11.7



11.8

- (11) DM/213 324 (51) 09-01
 (15) 2021 03 11 (44) 37/2021 (2021 09 17)
 (22) 2021 03 11
 (28) 1
 (30) No1: 15.10.2020; 008203343-0003; EM
 (73) MONCLER S.P.A.
 VIA STENDHAL, 47, 20144 MILANO (IT)
 (85) EM
 (86) IT
 (87) IT
 (88) EM, IT
 (89) EM
 (81) III. GE, MD, MX, SG, UA
 (72) Mitha DE BHARAT ALNOOR
 32 RUE DES VIGNOLES, 75020, PARIS (FR)
 (74) MODIANO & PARTNERS
 Via Meravigli 16, 20123 MILANO (IT)
 (54) 1. Perfume bottle
 (55)

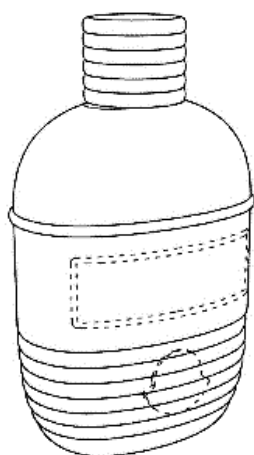

1.1

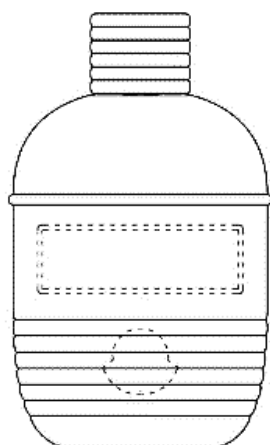

1.2

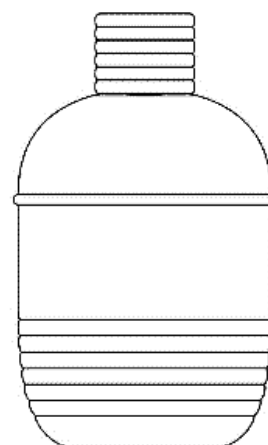

1.3

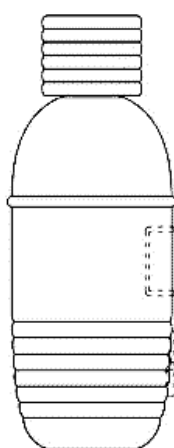

1.4

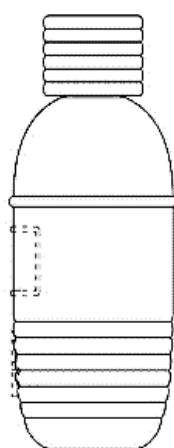

1.5

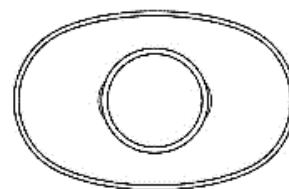

1.6

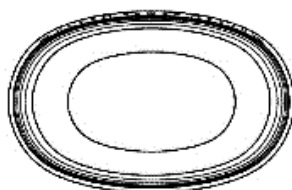

1.7

- (11) DM/216 166
- (15) 2021 08 31
- (22) 2021 08 31
- (28) 1
- (73) Lev Yosypovych RABENKO
Vul. Olesia Honchara, Bud. 26-28, Kv. 67, 01054 Kyiv (UA)
- (85) UA
- (86) UA
- (87) UA
- (88) UA
- (89) UA
- (81) III. AZ, BG, DE, EM, GB, GE, HR, IL, KR, NO, RO, UA, US, VN
- (72) Lev Yosypovych RABENKO
Vul. Olesia Honchara, Bud. 26-28, Kv. 67, 01054 Kyiv (UA)
- (74) Alexey Goriainov
P.O. Box 57, P.O. 210, 04210 Kyiv (UA)
- (54) 1. Ship
- (55)

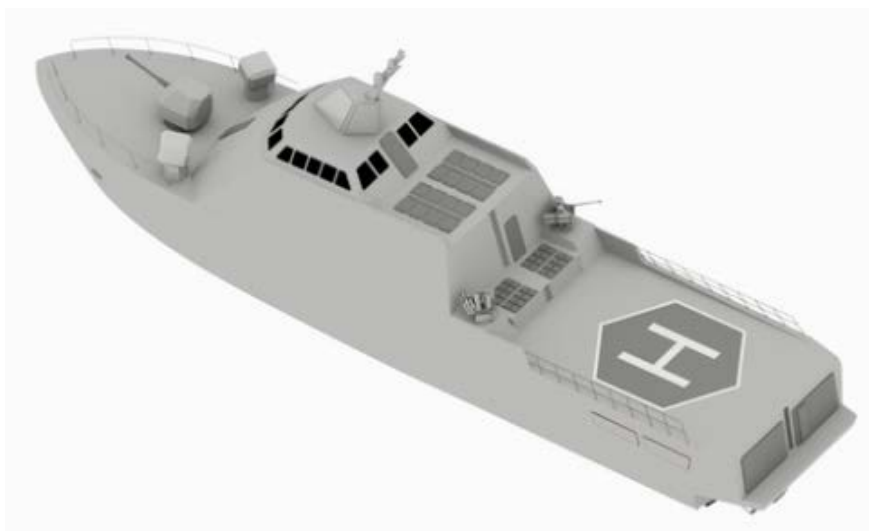

1.1

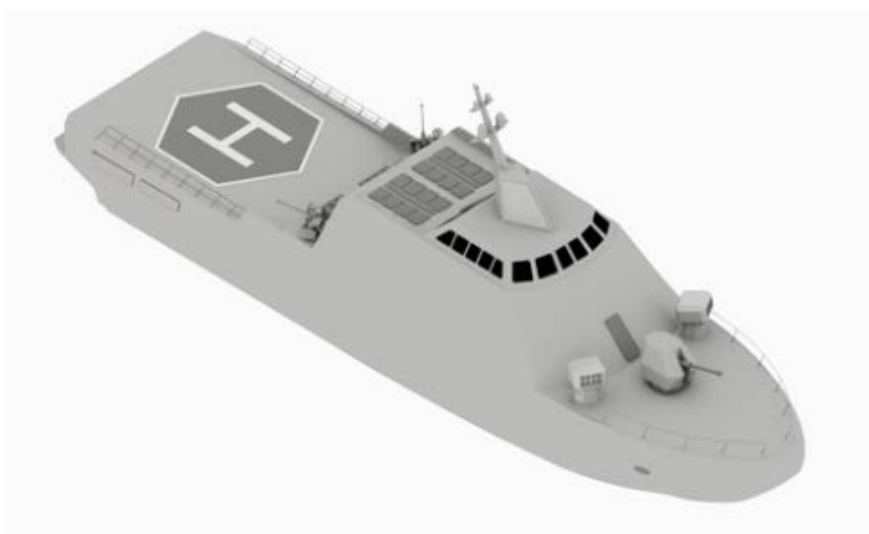

1.2

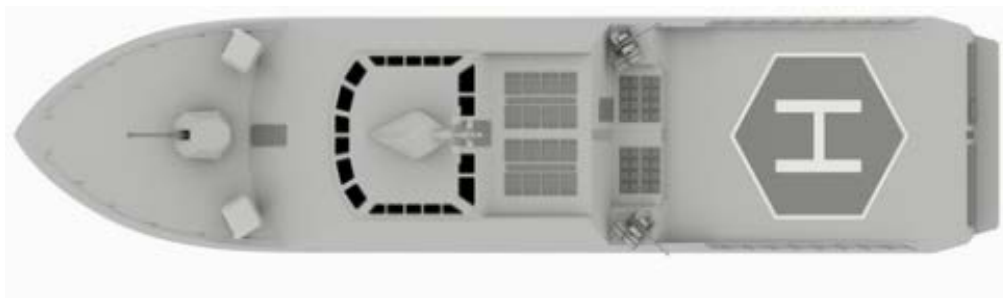

1.3

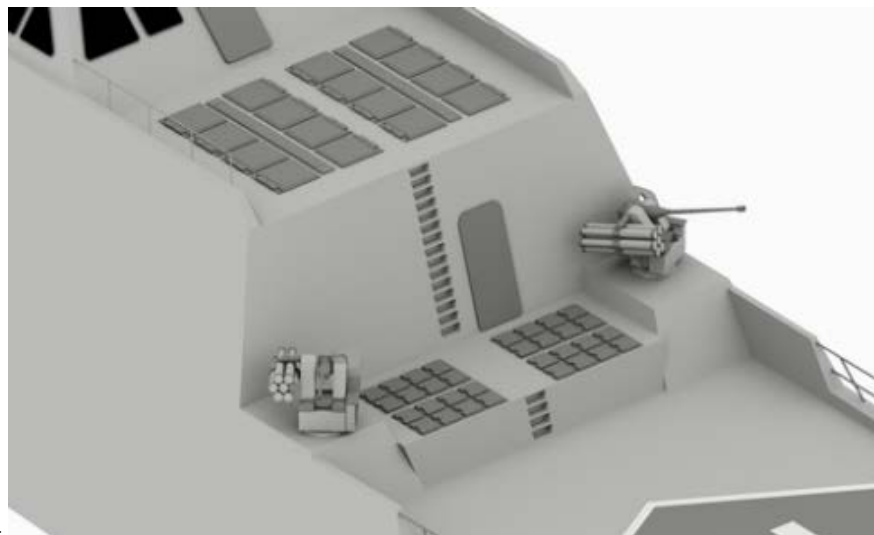

1.4



1.5

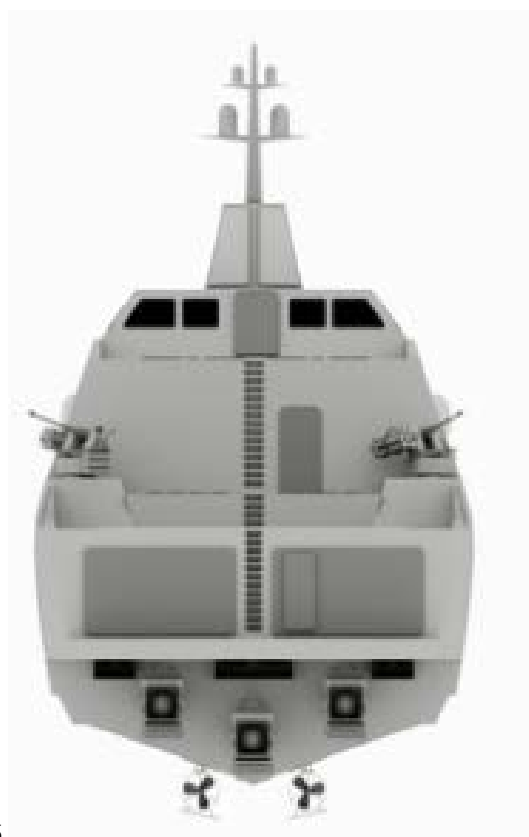

1.6

- (11) DM/215 349
- (15) 2021 03 17
- (22) 2021 03 17
- (28) 1
- (73) FEATHER COMPANY LTD.
40 Larch Street, Suite 201, P3E 5M7 Sudbury, ON (CA)
- (85) CA
- (86) CA
- (87) CA
- (88) CA
- (89) CA
- (81) III. AM, AZ, GE, IL, IS, OA
- (72) Jason RAINVILLE
3316 St. Laurent Street, P0M 1L0, Chelmsford, ON (CA);
Dominic COBALLE
2201 Reeves Crescent, K1H 7H3, Ottawa, ON (CA);
Patrick LEHOUX
284 David Street, P3E 1T8, Sudbury, ON (CA);
Mitch THOMPSON
496 Telstar Avenue, P3E 5K8, Sudbury, ON (CA)
- (74) MBM INTELLECTUAL PROPERTY LAW LLP
275 Slater Street, 14th Floor, K1P 5H9 Ottawa, ON (CA)
- (54) 1. Inhaler
- (55)

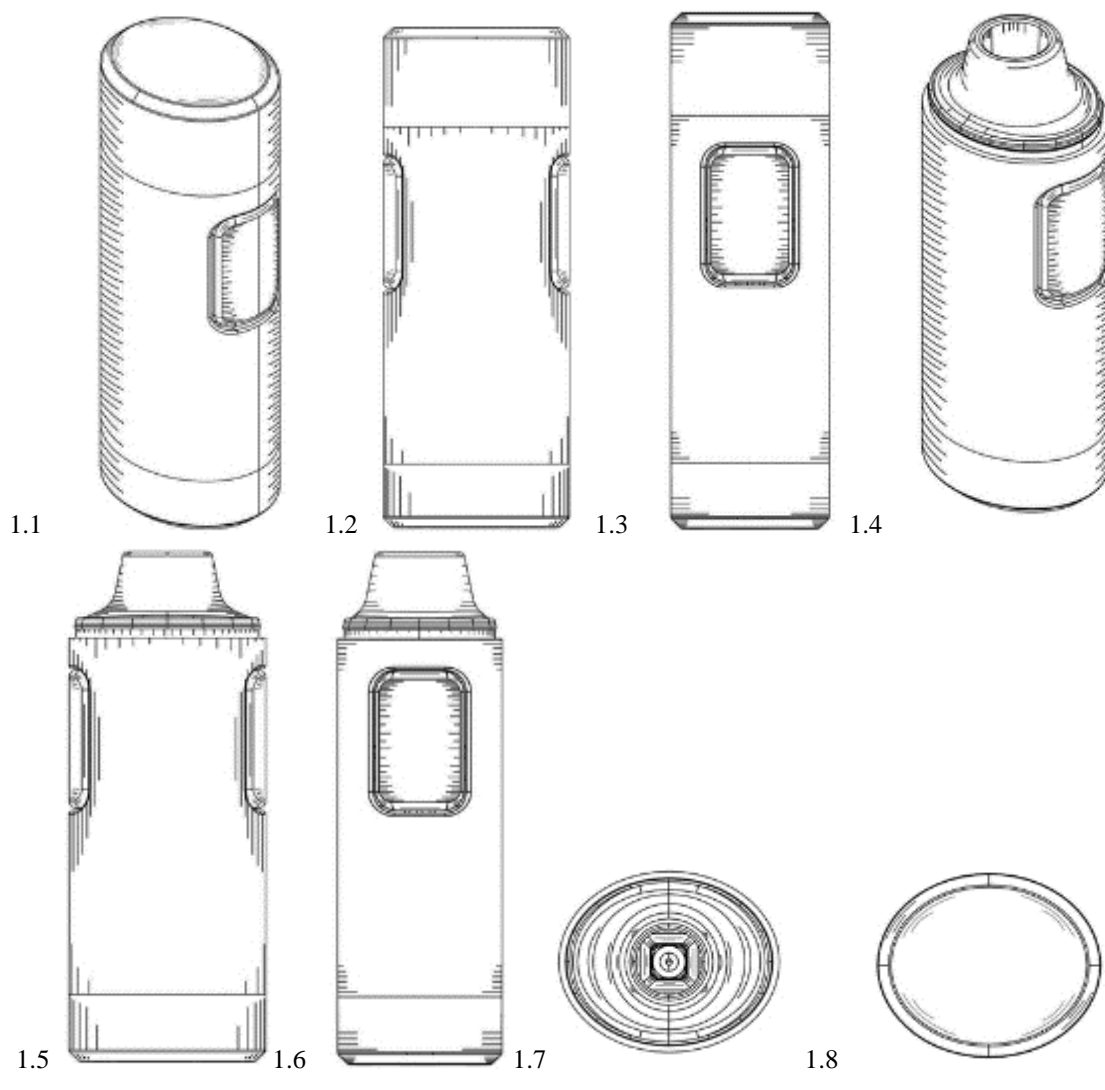

- (11) DM/216 325 (51) 02-04
 (15) 2021 09 02 (44) 38/2021 (2021 09 24)
 (22) 2021 09 02
 (28) 1
 (73) Valentino S.p.A
 Via Turati 16/18, I-20121 Milano (EM)
 (85) –
 (86) EM, IT
 (87) EM, IT
 (88) EM, IT
 (89) EM
 (81) III. AZ, EM, GB, GE, JP, KG, KR, RU, TJ, TR, UA, US
 (72) Pierpaolo PICCIOLI
 C/o VALENTINO S.p.A. Via Turati, 16/18, I-20121, Milano (IT)
 (74) Jacobacci & Partners/ Salvatore Giovanni Pennacchio
 Via Senato, 8, I-20121 Milano (IT)
 (54) 1. Boot
 (55)



- (11) DM/216 326 (51) 03-01
(15) 2021 09 01 (44) 38/2021 (2021 09 24)
(22) 2021 09 01
(28) 3
(73) Valentino S.p.A
Via Turati 16/18, I-20121 Milano (IT) (86) EM (EM)
(85) –
(86) EM, IT
(87) EM, IT
(88) EM, IT
(89) EM
(81) III. AZ, EM, GB, GE, JP, KG, KR, RU, TJ, TR, UA
(72) Pierpaolo PICCIOLI
C/o VALENTINO S.p.A. Via Turati, 16/18, I-20121, Milano (IT)
(74) Jacobacci & Partners/ Matteo Mozzi
Via Senato, 8, I-20121 Milano (IT)
(54) 1.-3. Bag
(55)

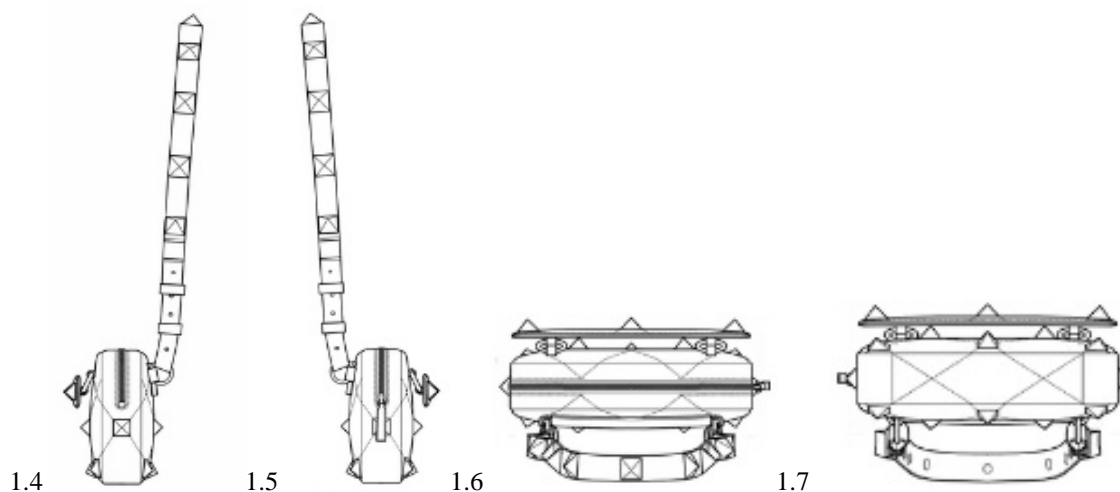
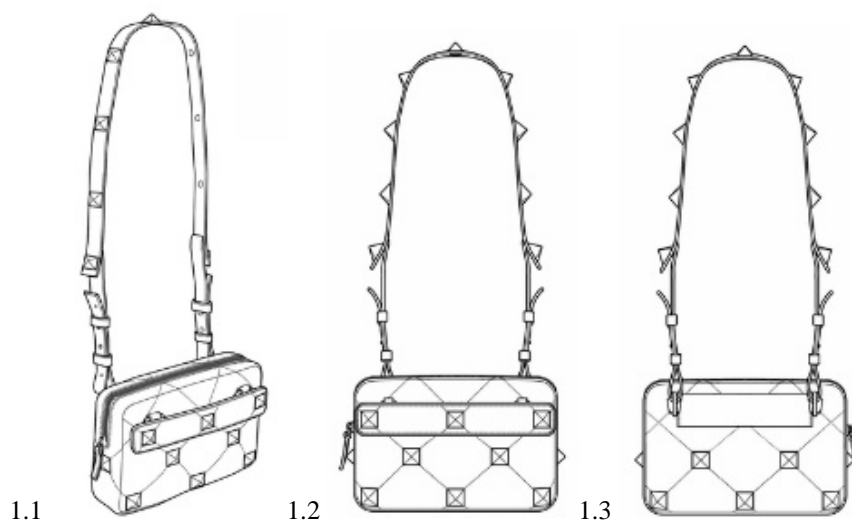

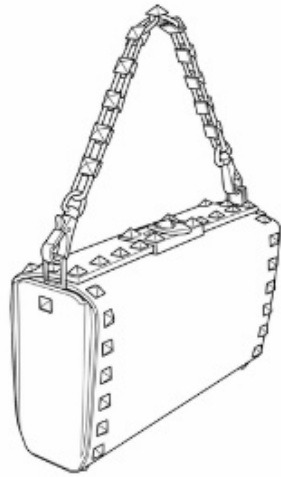

2.1

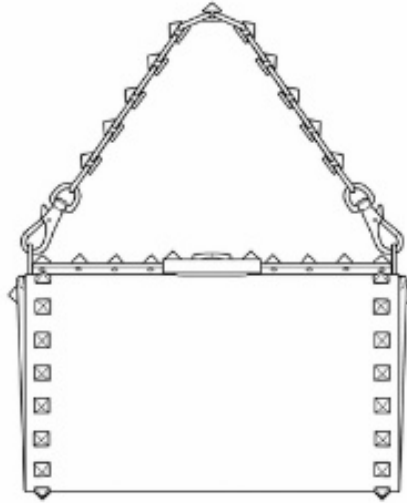

2.2

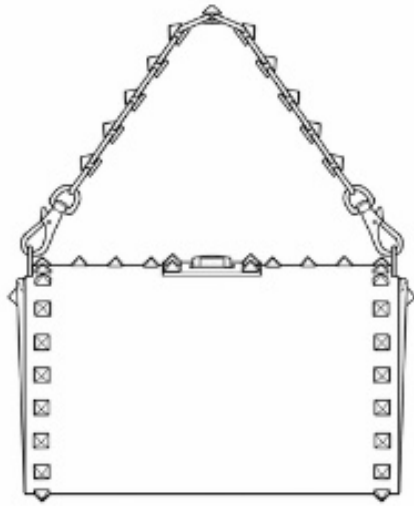

2.3



2.4



2.5

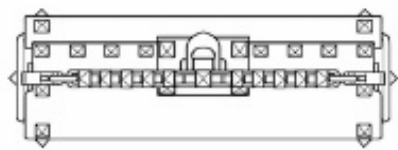

2.6



2.7



3.1

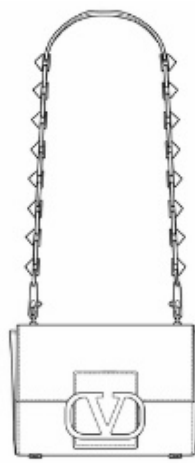

3.2



3.3



TRADEMARKS

APPLICATIONS FILED UNDER THE NATIONAL PROCEDURE APPROVED FOR REGISTRATION

The decision can be appealed at the Chamber of Appeal of Sakpatenti within 3 months from the publication or at the Mtskheta District Court Administrative Cases Board (Address: №17, Samkhedro St., Mtskheta), within 1 month following the publication.

(260) AM 2021 109506 A
(210) AM 109506
(220) 2021 04 12
(731) Demasi
Nearby March 9 Garden,
Old Tbilisi District, 0105, Tbilisi, Georgia
(540)

რადიანტი
Radiant

(591) Black-white
(511) 37

(260) AM 2021 110303 A
(210) AM 110303
(220) 2020 10 29
(731) GP Global Mag LLC
National Industries Park, Dubai, United Arab
Emirates
(740) Merab Kvimsadze
(540)

MAG
Lubricants
inside Engineering

(591) Black-white
(531) 27.05.01; 27.05.09; 27.05.10
(511) 4

(260) AM 2021 110387 A
(210) AM 110387
(220) 2021 05 04
(731) LLC "Growgrow"
Anastasia Eristavi-Khoshtaria St. 1, 0108,
Tbilisi, Georgia
(540)



(591) Phosphorous green, black
(531) 26.01.01; 26.01.03; 26.01.21; 26.01.22;
26.01.24; 27.05.22; 27.05.24; 27.05.25; 28.19;
29.01.12
(511) 35

(260) AM 2021 111336 A
(210) AM 111336
(220) 2021 01 21
(731) Holland & Barrett Interneshnl Limited
Samuel Ryder House, Barling Way, Eliot Park,
Nuneaton, Warwickshire, CV10 7RH, United
Kingdom
(740) Merab Kvimsadze
(540)

ჰოლანდ ბარეტ

(591) Green, dark green, white
(531) 05.07.08; 05.07.23; 27.05.01; 27.05.24; 28.19;
29.01.12
(511) 35

(260) AM 2021 111424 A
(210) AM 111424
(220) 2021 01 26
(731) LLC "Mr. Georgia"
Agaraki St. 30, 4100, Senaki, Georgia
(540)



(591) 0F0D0D black, 2B2222 grey, white
(531) 24.09.02; 24.09.05; 24.09.10; 26.01.01;
26.01.03; 26.01.16; 26.01.20; 27.05.01;
27.05.09; 27.05.24
(526) Georgia
(511) 41

(260) AM 2021 111499 A
 (210) AM 111499
 (220) 2021 01 29
 (731) LLC "Metekhi Ceramics"
 Vill. Metekhi, Kaspi, Georgia
 (540)



(591) Red, orange, black, terracota
 (531) 27.05.01; 27.05.22; 29.01.13
 (526) Metekhi
 (511) 19, 35, 37, 39

(260) AM 2021 111835 A
 (210) AM 111835
 (220) 2021 02 19
 (731) LLC "Alcoholic Beverages Factory"
 Vill. Martkopi, Vaziani Settlement 1320,
 Gardabani, Georgia
 (540)



(591) Black-white
 (531) 07.01.08; 27.05.10; 28.05
 (526) Tiflits
 (511) 32, 33

(260) AM 2021 111836 A
 (210) AM 111836
 (220) 2021 02 19
 (731) LLC "Alcoholic Beverages Factory"
 Vill. Martkopi, Vaziani Settlement 1320,
 Gardabani, Georgia
 (540)



(591) Black-white
 (531) 05.03.04; 26.01.15; 27.05.10; 27.05.22
 (526) Tbilisi, მარანი
 (511) 32

(260) AM 2021 112188 A
 (210) AM 112188
 (220) 2021 03 17
 (731) LLC "Alcoholic Beverages Factory"
 Vill. Martkopi, Vaziani Settlement 1320,
 Gardabani, Georgia
 (540)



(591) 000000 black-white
 (531) 07.01.01; 28.05
 (526) Kakheti
 (511) 32, 33

(260) AM 2021 112310 A
 (210) AM 112310
 (220) 2021 03 25
 (731) Khairat Al Minafie CO for Transport and
 General Trading Ltd.
 27, boulevard Saborni, Varna 9000, Bulgaria
 (740) Liliana Darakhvelidze
 (540)

VAN ROYALS

(591) Black-white
 (511) 34

(260) AM 2021 112365 A
 (210) AM 112365
 (220) 2021 03 26
 (731) JSC "Georgian Beer Company"
 Vill. Saguramo, 3311, Mtskheta, Georgia
 (540)

დრაფტ შოპი draft shop

(591) Black-white
 (511) 35, 43

(260) AM 2021 112389 A
 (210) AM 112389
 (220) 2021 03 29
 (731) LTD "Biopolus"
 Nonshvili St. 65, 6000, Batumi, Georgia
 (740) Monica Kvaratskhelia
 (540)

ლუმინალ-ბიო LUMINAL-BIO ЛУМИНАЛ-БИО

(591) Black-white
(511) 5

(260) AM 2021 112392 A
(210) AM 112392
(220) 2021 03 29
(731) LTD "Biopolus"
Noneshvili St. 65, 6000, Batumi, Georgia
(740) Monica Kvaratskhelia
(540)

ტრავისალ-ბიო
TRAVISAL-BIO
ТРАВИСАЛ-БИО

(591) Black-white
(511) 5

(260) AM 2021 112395 A
(210) AM 112395
(220) 2021 03 29
(731) LTD "Biopolus"
Noneshvili St. 65, 6000, Batumi, Georgia
(740) Monica Kvaratskhelia
(540)

სლეპექსონ
SLEEPERXON
СЛЕПЕКСОН

(591) Black-white
(511) 5

(260) AM 2021 112396 A
(210) AM 112396
(220) 2021 03 29
(731) LTD "Biopolus"
Noneshvili St. 65, 6000, Batumi, Georgia
(740) Monica Kvaratskhelia
(540)

უნიპროქტი
UNIPROCT
УНИПРОКТ

(591) Black-white
(511) 5

(260) AM 2021 112406 A
(210) AM 112406
(220) 2021 03 30
(731) JSC "Corporation Kindzmarauli"
Iia Chavchavadze St. 55, 4800, Kvareli,
Georgia

(540)

ილიას მამული
Усадьба Илья
Иля's Estate

(591) Black-white
(511) 33, 43

(260) AM 2021 112408 A
(210) AM 112408
(220) 2021 03 31
(731) LTD "Aisi"
Varketili 3, I mcr., corp. 28, app. 26, 0163,
Tbilisi, Georgia
(540)



(591) Red, yellow, green, blue, sky-blue, brown
(531) 26.01.01; 26.01.06; 26.01.19; 29.01.15
(511) 1, 2, 3, 4

(260) AM 2021 112419 A
(210) AM 112419
(220) 2021 04 01
(731) Yiwu Finder Import & Export Co., LTD
Shop 19846, 19847, 19848, 19849, Section 2,
International Trade City, Futian District, Yiwu
City, Zhejiang Province, China
(740) Shalva Gvaramadze
(540)

FINDER

(591) Black-white
(531) 27.05.01; 27.05.11; 27.05.17
(511) 7

(260) AM 2021 112473 A
(210) AM 112473
(220) 2021 04 04
(731) Irakli Shevardnadze
Vazha-Pshavela Av. 20, 1160, Saburtalo,
Tbilisi, Georgia

(540)



(591) 493F35 black, A63137 bordeaux,
7DABA2 sky-blue, E3C69C ivory
(531) 25.05.02; 26.11.12; 27.05.23; 28.19; 29.01.14
(511) 14, 15, 16, 18, 20, 21, 24, 25, 26, 27, 28, 32, 34,
35, 39

(260) AM 2021 112489 A
(210) AM 112489
(220) 2021 04 06
(731) JSC "Bank of Georgia"
Gagarin St. 29a, 0160, Tbilisi, Georgia
(740) Giorgi Taktakishvili
(540)



(591) Red, yellow, orange, white, brown, black
(531) 02.01.04; 02.01.07; 02.01.15; 02.01.22;
02.01.23; 02.01.27; 07.01.18; 13.01.17;
13.01.25; 27.05.01; 29.01.13
(511) 35, 36, 41

(260) AM 2021 112490 A
(210) AM 112490
(220) 2021 04 06
(731) JSC "Bank of Georgia"
Gagarin St. 29a, 0160, Tbilisi, Georgia
(740) Giorgi Taktakishvili
(540)



(591) Orange, red, yellow, white, brown, black
(531) 02.01.04; 02.01.22; 02.01.23; 02.01.27;
19.01.11; 27.05.01; 29.01.14
(511) 35, 36, 41

(260) AM 2021 112493 A
(210) AM 112493
(220) 2021 04 06
(731) JSC "Bank of Georgia"
Gagarin St. 29a, 0160, Tbilisi, Georgia
(740) Giorgi Taktakishvili
(540)



(591) Red, yellow, orange, white, brown, black
(531) 02.01.04; 02.01.15; 02.01.23; 02.01.27;
07.01.18; 13.01.17; 19.01.11; 29.01.14
(511) 35, 36, 41

(260) AM 2021 112495 A
(210) AM 112495
(220) 2021 04 06
(731) LTD "Biopolus"
Noneshvili St. 65, 6000, Batumi, Georgia
(740) Monica Kvaratskhelia
(540)

გლუტაქსანო Glutaxan Глутаксан

(591) Black-white
(511) 5

(260) AM 2021 112577 A
(210) AM 112577
(220) 2021 04 12
(731) Johnson & Johnson
One Johnson & Johnson Plaza,
New Brunswick, New Jersey 08933, USA
(740) Giorgi Taktakishvili
(540)

SMART RINSE

(591) Black-white
(511) 5

(260) AM 2021 112578 A
(210) AM 112578
(220) 2021 04 12
(731) Johnson & Johnson
One Johnson & Johnson Plaza,
New Brunswick, New Jersey 08933, USA

(740) Giorgi Taktakishvili
(540)

LISTERINE SMART RINSE

(591) Black-white
(511) 5

(260) AM 2021 112584 A
(210) AM 112584
(220) 2021 04 12
(731) LTD "lever-Design"
Vazha-Pshavela Av., VII qu. corp. 1a, app. 90,
0186, Vake-Saburtalo District, Tbilisi, Georgia
(740) Giorgi Ghvinjilia
(540)



(591) 727376 grey, FEBF2C yellow
(531) 07.03.11; 27.05.01; 27.05.10; 27.05.17;
29.01.13
(511) 11, 37

(260) AM 2021 112596 A
(210) AM 112596
(220) 2021 04 13
(731) JSC "Georgian Beer Company"
Vill. Saguramo, 3311, Mtskheta, Georgia
(540)



(591) white, red, black
(531) 03.07.01; 03.07.16; 24.01.15; 27.05.01; 28.19;
29.01.13
(526) ზედაზღენი
(511) 32

(260) AM 2021 112598 A
(210) AM 112598
(220) 2021 04 13
(731) Anhui Jianghuai Automobile Group Corp., Ltd
№176 Dongliu Road, Hefei City, Anhui
Province, China

(740) Giorgi Kartvelishvili
(540)



(591) Red, white, black
(531) 14.07.09; 27.05.01; 27.05.09; 27.05.10;
29.01.12
(511) 37

(210) AM 2021 112601 A
(210) AM 112601
(220) 2021 04 14
(731) JSC "Mineral-Chemical Company "EuroChem"
Dubininskaya St., house 53, building 6,
Moscow, 115054, Russian Federation
(740) Giorgi Taktakishvili
(540)



(591) Blue, white
(531) 26.03.04; 26.03.23; 26.04.03; 26.04.10;
27.05.01; 29.01.12
(511) 1, 4, 5, 6, 19, 25, 30, 31, 35, 37, 39, 42, 44

(260) AM 2021 112602 A
(210) AM 112602
(220) 2021 04 14
(731) JSC "Mineral-Chemical Company "EuroChem"
Dubininskaya St., house 53, building 6,
Moscow, 115054, Russian Federation
(740) Giorgi Taktakishvili
(540)



(591) Blue, white
(531) 26.03.04; 26.03.23; 26.04.03; 26.04.10; 28.05;
29.01.12
(511) 1, 4, 5, 6, 19, 25, 30, 31, 35, 37, 39, 42, 44

(260) AM 2021 112603 A
(210) AM 112603
(220) 2021 04 14
(731) JSC "Mineral-Chemical Company "EuroChem"
Dubininskaya St., house 53, building 6,
Moscow, 115054, Russian Federation

(740) Giorgi Taktakishvili
(540)



(591) Blue, white
(531) 26.03.04; 26.03.23; 26.04.03; 26.04.10;
27.05.01; 29.01.12
(511) 1, 4, 5, 6, 19, 25, 30, 31, 35, 37, 39, 42, 44

(260) AM 2021 112604 A
(210) AM 112604
(220) 2021 04 14
(731) JSC "Mineral-Chemical Company "EuroChem"
Dubininskaya St., house 53, building 6,
Moscow, 115054, Russian Federation
(740) Giorgi Taktakishvili
(540)



EUROCHEM

(591) Blue, white
(531) 26.03.04; 26.03.23; 26.04.03; 26.04.10;
27.05.01; 29.01.12
(511) 1, 4, 5, 6, 19, 25, 30, 31, 35, 37, 39, 42, 44

(260) AM 2021 112605 A
(210) AM 112605
(220) 2021 04 14
(731) JSC "Mineral-Chemical Company "EuroChem"
Dubininskaya St., house 53, building 6,
Moscow, 115054, Russian Federation
(740) Giorgi Taktakishvili
(540)



ЕВРОХИМ

(591) Morengo, grey, sky-blue, white
(531) 26.03.04; 26.03.23; 26.04.03; 26.04.10; 28.05;
29.01.13
(511) 1, 4, 5, 6, 19, 25, 30, 31, 35, 37, 39, 42, 44

(260) AM 2021 112606 A
(210) AM 112606
(220) 2021 04 14
(731) JSC "Mineral-Chemical Company "EuroChem"
Dubininskaya St., house 53, building 6,
Moscow, 115054, Russian Federation

(740) Giorgi Taktakishvili
(540)



EUROCHEM

(591) Morengo, sky-blue, white
(531) 26.03.23; 26.04.03; 26.04.10; 29.01.13
(511) 1, 4, 5, 6, 19, 25, 30, 31, 35, 37, 39, 42, 44

(260) AM 2021 112608 A
(210) AM 112608
(220) 2021 04 14
(731) LTD "Boran Construction"
Kandelaki St. 8, app. 56, Tbilisi, Georgia
(540)

KINDWINE

(591) Black-white
(511) 33

(260) AM 2021 112626 A
(210) AM 112626
(220) 2021 04 15
(731) Levan Kobaladze
Brothers Zubalashvili St. 2, app. 1, 0108,
Tbilisi, Georgia
(540)



(591) Black, golden, sky-blue, pink
(531) 02.07.02; 02.07.05; 02.07.16; 24.17.15;
24.17.21; 29.01.14
(511) 5

(260) AM 2021 112672 A
(210) AM 112672
(220) 2021 04 16
(731) LTD "Imuno"
Zugdidi St. 36, Chkhorotsku, Georgia
(740) Giorgi Taktakishvili
(540)

იმუნი
IMUNO
ИМУНО

(591) Black-white
(511) 29, 30, 32

(260) AM 2021 112674 A
(210) AM 112674
(220) 2021 04 16
(731) Grindeks As
Krustpils Iela 53, Riga, 1057, Latvia
(740) Khatuna Imnadze
(540)

კაპსიკაძი

(591) Black-white
(511) 3, 5

(260) AM 2021 112701 A
(210) AM 112701
(220) 2021 04 21
(731) JSC "Georgian Beer Company"
Vill. Saguramo, 3311, Mtskheta, Georgia
(540)



(591) Light yellow, golden, light blue, dark blue
(531) 26.01.01; 26.01.04; 26.01.06; 26.01.16;
26.01.21; 26.01.22; 28.19; 29.01.13
(511) 32

(260) AM 2021 112720 A
(210) AM 112720
(220) 2021 04 27
(731) I/E Anna Koshkelishvili
Razmadze St. 52, fl. 5, app. 21, 0179, Vake
District, Tbilisi, Georgia
(540)



(591) E21616 red, black, white
(531) 26.04.16; 26.04.22; 26.04.24; 26.13.01;
26.13.25; 27.05.01; 27.05.10; 27.05.24;
29.01.13
(511) 3, 35

(260) AM 2021 112725 A
(210) AM 112725
(220) 2021 04 28
(731) Merck Sharp & Dohme Corp.
One Merck Drive, Whitehouse Station,
New Jersey 08889, USA
(740) Tamaz Shilakadze
(540)

JEMPZIM

(591) Black-white
(511) 5

(260) AM 2021 112727 A
(210) AM 112727
(220) 2021 04 29
(731) S. C. Johnson & Son Inc.
1525 Howe Street, Racine, WI 53403-
2236, USA
(740) Giorgi Taktakishvili
(540)



(591) Black-white
(531) 01.15.15; 24.03.01; 24.03.07; 24.03.11;
24.03.18; 26.01.01; 26.01.04; 26.01.21;
26.11.12; 26.11.22
(511) 3, 4, 5

(260) AM 2021 112729 A
(210) AM 112729
(220) 2021 04 29
(731) Dell Inc.
One Dell Way, Round Rock, Texas
78682, USA
(740) Giorgi Taktakishvili
(540)

DELL EMC

(591) Black-white
(511) 9, 37, 42

(260) AM 2021 112730 A
 (210) AM 112730
 (220) 2021 04 29
 (731) Colgate-Palmolive Company
 Delaware Corporation
 300 Park Avenue, New York, New York
 10022, USA

(740) Tamaz Shilakadze
 (540)

CUSHION CLEAN

(591) Black-white
 (511) 21

(260) AM 2021 112731 A
 (210) AM 112731
 (220) 2021 04 29
 (731) Colgate-Palmolive Company
 Delaware Corporation
 300 Park Avenue, New York, New York
 10022, USA

(740) Tamaz Shilakadze
 (540)

COLGATE EASY COMFORT

(591) Black-white
 (511) 21

(260) AM 2021 112839 A
 (210) AM 112839
 (220) 2021 05 06
 (310) 81977
 (320) 2020 11 16
 (330) JM
 (731) Marriott Worldwide Corporation
 10400 Fernwood Road, Bethesda, Maryland,
 20817, USA
 (740) Tamaz Shilakadze
 (540)

(591) Black-white
 (531) 26.11.01; 26.11.13; 27.05.21
 (511) 35, 36, 43

(260) AM 2021 112906 A
 (210) AM 112906
 (220) 2021 05 11
 (731) Merck Sharp & Dohme Corp.
 One Merck Drive, Whitehouse Station,
 New Jersey 08889, USA

(740) Tamaz Shilakadze
 (540)

LYFNUA

(591) Black-white
 (511) 5

(260) AM 2021 112928 A
 (210) AM 112928
 (220) 2021 05 13
 (731) LTD "Draft"
 Uznadze Sr. 111, app. 11, (bld. 2),
 Tbilisi, Georgia
 (740) Eka Khartsivadze
 (540)

(591) White, red
 (531) 24.15.01; 27.05.01; 27.05.07; 27.05.10;
 29.01.12
 (511) 35, 41, 45

(260) AM 2021 112929 A
 (210) AM 112929
 (220) 2021 05 13
 (731) JSC "Smart Retail"
 Ilia Chavchavadze Av. 74b, Vake District,
 Tbilisi, Georgia
 (540)



(591) Orange, black, white, sky-blue
 (531) 03.05.03; 27.05.01; 27.05.10; 27.05.24; 28.19;
 29.01.13
 (511) 30, 35, 43

REGISTERED TRADEMARKS

(111) M 2021 34692 R (151) 2021 11 12 (181) 2031 11 12 (260) AM 2020 109948 A (220) 2020 09 30 (732) LLC "Maidan Group" Kote Abkhazi St. 44, Tbilisi, Georgia	One Coca-Cola Plaza, Atlanta, GA 30313, USA
(111) M 2021 34693 R (151) 2021 11 12 (181) 2031 11 12 (260) AM 2020 109950 A (220) 2020 09 30 (732) LLC "Maidan Group" Kote Abkhazi St. 44, Tbilisi, Georgia	(111) M 2021 34698 R (151) 2021 11 12 (181) 2031 11 12 (260) AM 2020 110199 A (220) 2020 10 19 (732) Kraft Foods Schweiz Holding GmbH Chollerstrasse 4, Zug 6300, Switzerland
(111) M 2021 34694 R (151) 2021 11 12 (181) 2031 11 12 (260) AM 2020 109951 A (220) 2020 09 30 (732) LLC "Maidan Group" Kote Abkhazi St. 44, Tbilisi, Georgia	(111) M 2021 34699 R (151) 2021 11 12 (181) 2031 11 12 (260) AM 2020 110286 A (220) 2020 10 26 (732) Millennium & Copthorne International Limited 9 Raffles Place, №12-01 Republic Plaza, Singapore, 048619, Singapore
(111) M 2021 34695 R (151) 2021 11 12 (181) 2031 11 12 (260) AM 2020 109952 A (220) 2020 09 30 (732) LLC "Maidan Group" Kote Abkhazi St. 44, Tbilisi, Georgia	(111) M 2021 34700 R (151) 2021 11 12 (181) 2031 11 12 (260) AM 2020 110375 A (220) 2020 11 04 (732) Tearscience Inc. 510 Cottonwood Drive, Milipitas, CA 95035, USA
(111) M 2021 34696 R (151) 2021 11 12 (181) 2031 11 12 (260) AM 2020 110031 A (220) 2020 10 06 (732) Lasha Bakuridze Janashia St. 30/55, 0179, Tbilisi, Georgia; Aliosha Bakuridze L. Sharashidze St. 2/4, app. 41, 0179, Tbilisi, Georgia	(111) M 2021 34701 R (151) 2021 11 12 (181) 2031 11 12 (260) AM 2020 110439 A (220) 2020 11 06 (732) Abercrombie & Fitch Europe Sagl Via Moree, 6850 Mendrisio, Switzerland
(111) M 2021 34697 R (151) 2021 11 12 (181) 2031 11 12 (260) AM 2020 110040 A (220) 2020 10 08 (732) Honist Ti Inc.	(111) M 2021 34702 R (151) 2021 11 12 (181) 2031 11 12 (260) AM 2020 110447 A (220) 2020 11 06 (732) Gizo Akhvlediani Zghvisubani Settlement, III mcr., III qu., corp. 45, app. 45 (Forever Temka Settlement, III mcr., III qu.), Tbilisi, Georgia

(111) M 2021 34703 R
(151) 2021 11 12
(181) 2031 11 12
(260) AM 2020 110448 A
(220) 2020 11 06
(732) Gizo Akhvlediani
Zghvisubani Settlement, III mcr., III qu.,
corp. 45, app. 45 (Forever Temka Settlement,
III mcr., III qu.), Tbilisi, Georgia

(111) M 2021 34704 R
(151) 2021 11 12
(181) 2031 11 12
(260) AM 2020 110453 A
(220) 2020 11 09
(732) Tribe Hotel Group Pty LTD
443-449 Toorak Rd, TOORAK, VIC 3142,
Australia

(111) M 2021 34705 R
(151) 2021 11 12
(181) 2031 11 12
(260) AM 2020 110520 A
(220) 2020 11 17
(732) Bear Electric Appliance Co., Ltd
№5-2-1 Fu'an Industrial Park, Leliu Town,
Shunde, Foshan City, Guangdong, China

(111) M 2021 34706 R
(151) 2021 11 12
(181) 2031 11 12
(260) AM 2020 110608 A
(220) 2020 11 25
(732) Callison Green Technology FZE
Jebel Ali Fri Zon, P.o. Box 261687, Dubai,
United Arab Emirates

(111) M 2021 34707 R
(151) 2021 11 12
(181) 2031 11 12
(260) AM 2020 110686 A
(220) 2020 12 01
(732) Bayer Aktiengesellschaft
Kaiser-Wilhelm-Allee, 51373 Leverkusen,
Germany

(111) M 2021 34708 R
(151) 2021 11 12
(181) 2031 11 12
(260) AM 2020 110688 A
(220) 2020 12 01
(732) LLC "G-M-P"
Vill. Ponichala 65, 0165, Tbilisi, Georgia

(111) M 2021 34709 R
(151) 2021 11 12
(181) 2031 11 12
(260) AM 2020 110696 A
(220) 2020 12 03
(732) JSC "Kotekhi-Gurjaani Wine Factory"
K. Koroghlishvili St. 38, 1500, Gurjaani,
Georgia

(111) M 2021 34710 R
(151) 2021 11 12
(181) 2031 11 12
(260) AM 2020 110753 A
(220) 2020 12 07
(732) LTD "Amber Trade"
Mukhran Machavariani St. 6b, app. 8,
Saburtalo District, Tbilisi, Georgia

(111) M 2021 34711 R
(151) 2021 11 12
(181) 2031 11 12
(260) AM 2020 110776 A
(220) 2020 12 08
(732) ASAP International Sdn Bhd
№1 Jalan Sitar 33/6, Seksyen 33, Shah Alam,
Selangor, 40400, Malaysia

(111) M 2021 34712 R
(151) 2021 11 12
(181) 2031 11 12
(260) AM 2020 110780 A
(220) 2020 12 09
(732) LLC "Winery Khareba"
Davit Aghmashenebeli Alley 170a, 0131,
Tbilisi Georgia

(111) M 2021 34713 R
(151) 2021 11 12
(181) 2031 11 12
(260) AM 2020 110860 A
(220) 2020 12 11
(732) LLC "Askaneli Winery & Distillery"
Kakheti Highway 110a, 0190, Samgori district,
Tbilisi, Georgia

(111) M 2021 34714 R
(151) 2021 11 12
(181) 2031 11 12
(260) AM 2020 110881 A
(220) 2020 12 16
(732) LLC "Libo Group"
D. Guramishvili Av. 84, 0141, Tbilisi, Georgia

(111) M 2021 34715 R (151) 2021 11 12 (181) 2031 11 12 (260) AM 2020 110890 A (220) 2020 12 17 (732) "IDS Borjomi Beverages Co.N.V." Pareraweg 45, Curaçao	(220) 2021 01 13 (732) LLC "My.Ge" Shalva Nutsubidze St. 129 A, fl. 4, 0186, Tbilisi, Georgia
(111) M 2021 34716 R (151) 2021 11 12 (181) 2031 11 12 (260) AM 2020 110891 A (220) 2020 12 17 (732) "IDS Borjomi Beverages Co.N.V." Pareraweg 45, Curaçao	(111) M 2021 34726 R (151) 2021 11 19 (181) 2031 11 19 (260) AM 2020 109955 A (220) 2020 10 01 (732) LLC "Georgian Wine House" Vill. Zegaani, 1500, Gurjaani, Georgia
(111) M 2021 34717 R (151) 2021 11 12 (181) 2031 11 12 (260) AM 2020 110950 A (220) 2020 12 22 (732) LTD "Lermont" Lermontov St. 10, 0105, Tbilisi, Georgia	(111) M 2021 34727 R (151) 2021 11 19 (181) 2031 11 19 (260) AM 2020 110021 A (220) 2020 10 05 (732) LLC "Georgian Wine House" Vill. Zegaani, 1500, Gurjaani, Georgia
(111) M 2021 34718 R (151) 2021 11 12 (181) 2031 11 12 (260) AM 2020 110951 A (220) 2020 12 22 (732) LTD "Lermont" Lermontov St. 10, 0105, Tbilisi, Georgia	(111) M 2021 34728 R (151) 2021 11 19 (181) 2031 11 19 (260) AM 2020 110137 A (220) 2020 10 15 (732) LTD "Artline Wings" Seaside Square, 6000, Batumi, Georgia
(111) M 2021 34719 R (151) 2021 11 12 (181) 2031 11 12 (260) AM 2020 110964 A (220) 2020 12 22 (732) LTD "Kartveli" Kakheti Highway 110a, 0151, Tbilisi, Georgia	(111) M 2021 34729 R (151) 2021 11 19 (181) 2031 11 19 (260) AM 2020 110138 A (220) 2020 10 15 (732) LTD "Artline Wings" Seaside Square, 6000, Batumi, Georgia
(111) M 2021 34720 R (151) 2021 11 12 (181) 2031 11 12 (260) AM 2021 111280 A (220) 2021 01 13 (732) LLC "My.Ge" Shalva Nutsubidze St. 129 A, fl. 4, 0186, Tbilisi, Georgia	(111) M 2021 34730 R (151) 2021 11 19 (181) 2031 11 19 (260) AM 2020 110139 A (220) 2020 10 15 (732) LTD "Artline Wings" Seaside Square, 6000, Batumi, Georgia
(111) M 2021 34721 R (151) 2021 11 12 (181) 2031 11 12 (260) AM 2021 111281 A	(111) M 2021 34731 R (151) 2021 11 19 (181) 2031 11 19 (260) AM 2020 110287 A (220) 2020 10 26 (732) Otar Tsikarishvili

Balanchivadze St. 10, app. 18, 3700, Rustavi, Georgia	(732) Daewoong Co., LTD. 244, Galmachi-ro, Jungwon-gu, Seongnam-si, Gyeonggi-do, Republic of Korea
(111) M 2021 34732 R (151) 2021 11 19 (181) 2031 11 19 (260) AM 2020 110299 A (220) 2020 10 28 (732) LTD "Easy" Medea Chakhava St. 9, 1st fl., Office Space 1, 0177, Vake District, Tbilisi, Georgia	(111) M 2021 34738 R (151) 2021 11 19 (181) 2031 11 19 (260) AM 2020 110692 A (220) 2020 12 03 (732) LTD "Krinti" Madneuli St. 10, Kazreti, Bolnisi, Georgia
(111) M 2021 34733 R (151) 2021 11 19 (181) 2031 11 19 (260) AM 2020 110300 A (220) 2020 10 28 (732) LTD "Easy" Medea Chakhava St. 9, 1st fl., Office Space 1, 0177, Vake District, Tbilisi, Georgia	(111) M 2021 34739 R (151) 2021 11 19 (181) 2031 11 19 (260) AM 2020 110694 A (220) 2020 12 03 (732) Abdi İbrahim İlaç Sanayi ve Ticaret Anonim Şirketi Reşitpaşa Mahallesi Eski Büyükdere Caddesi №4 34467 Maslak Sarıyer İstanbul, Turkey
(111) M 2021 34734 R (151) 2021 11 19 (181) 2031 11 19 (260) AM 2020 110363 A (220) 2020 11 02 (732) LTD "Belus" Melikishvili St. / Parnavaz Mepe St. 43/101, 6010, Batumi, Georgia	(111) M 2021 34740 R (151) 2021 11 19 (181) 2031 11 19 (260) AM 2020 110695 A (220) 2020 12 03 (732) Abdi İbrahim İlaç Sanayi ve Ticaret Anonim Şirketi Reşitpaşa Mahallesi Eski Büyükdere Caddesi №4 34467 Maslak Sarıyer İstanbul, Turkey
(111) M 2021 34735 R (151) 2021 11 19 (181) 2031 11 19 (260) AM 2020 110470 A (220) 2020 11 10 (732) Daewoong Co., LTD. 244, Galmachi-ro, Jungwon-gu, Seongnam-si, Gyeonggi-do, Republic of Korea	(111) M 2021 34741 R (151) 2021 11 19 (181) 2031 11 19 (260) AM 2020 110750 A (220) 2020 12 07 (732) LEPL "Georgian Mediators Association" Ipolite Khvichia St. 19, app. 12, 0160, Tbilisi, Georgia
(111) M 2021 34736 R (151) 2021 11 19 (181) 2031 11 19 (260) AM 2020 110471 A (220) 2020 11 10 (732) Daewoong Co., LTD. 244, Galmachi-ro, Jungwon-gu, Seongnam-si, Gyeonggi-do, Republic of Korea	(111) M 2021 34742 R (151) 2021 11 19 (181) 2031 11 19 (260) AM 2020 110751 A (220) 2020 12 07 (732) LTD "Nail Club" Nearly near Nutsbidze St. 77, Plot 01/216) /Nutsbidze St. 77, fl. 1, Commercial Area, Tbilisi, Georgia
(111) M 2021 34737 R (151) 2021 11 19 (181) 2031 11 19 (260) AM 2020 110472 A (220) 2020 11 10	

(111) M 2021 34743 R (151) 2021 11 19 (181) 2031 11 19 (260) AM 2020 110766 A (220) 2020 12 07 (732) LLC "Pilgrim" Mukhran Machavariani St. 6b, app. 8, Saburtalo District, Tbilisi, Georgia	(111) M 2021 34749 R (151) 2021 11 19 (181) 2031 11 19 (260) AM 2020 111068 A (220) 2020 12 28 (732) LLC "Paragraph Tabor Resorts" Ilia Chavchavadze Av. 37m, Tbilisi, Georgia
(111) M 2021 34744 R (151) 2021 11 19 (181) 2031 11 19 (260) AM 2020 110797 A (220) 2020 12 11 (732) LTD "Rich Group" Vill. Mughanlo, Marneuli Region, Georgia	(111) M 2021 34750 R (151) 2021 11 19 (181) 2031 11 19 (260) AM 2020 111070 A (220) 2020 12 28 (732) LLC "Paragraph Tabor Resorts" Ilia Chavchavadze Av. 37m, Tbilisi, Georgia
(111) M 2021 34745 R (151) 2021 11 19 (181) 2031 11 19 (260) AM 2020 110942 A (220) 2020 12 19 (732) China Tobacco Zhejiang Industrial Co., Ltd №77 Zhongshan Nan Road, Hangzhou City, Zhejiang Province, China	(111) M 2021 34751 R (151) 2021 11 19 (181) 2031 11 19 (260) AM 2020 111071 A (220) 2020 12 28 (732) LLC "Paragraph Tabor Resorts" Ilia Chavchavadze Av. 37m, Tbilisi, Georgia
(111) M 2021 34746 R (151) 2021 11 19 (181) 2031 11 19 (260) AM 2020 110953 A (220) 2020 12 22 (732) LTD "Krinti" Madneuli St. 10, Kazreti, Bolnisi, Georgia	(111) M 2021 34752 R (151) 2021 11 19 (181) 2031 11 19 (260) AM 2020 111072 A (220) 2020 12 28 (732) LLC "Paragraph Tabor Resorts" Ilia Chavchavadze Av. 37m, Tbilisi, Georgia
(111) M 2021 34747 R (151) 2021 11 19 (181) 2031 11 19 (260) AM 2020 110980 A (220) 2020 12 24 (732) LTD "Clintech" Chitadze St. 6/505, Tbilisi, Georgia	(111) M 2021 34753 R (151) 2021 11 19 (181) 2031 11 19 (260) AM 2021 111152 A (220) 2021 01 04 (732) LTD "PARK GIDA" 5th Ubani, St. 46a, 6200, Vill. Khutsubani, Kobuleti Municipality, Georgia
(111) M 2021 34748 R (151) 2021 11 19 (181) 2031 11 19 (260) AM 2020 111067 A (220) 2020 12 28 (732) LLC "Medi Club Georgia" Tashkent St. 22a, 0160, Tbilisi, Georgia	(111) M 2021 34754 R (151) 2021 11 19 (181) 2031 11 19 (260) AM 2021 111268 A (220) 2021 01 08 (732) Davit Mchedlidze N. Zhvania St. 28, app. 76, 0179, Tbilisi, Georgia

(111) M 2021 34755 R
(151) 2021 11 19
(181) 2031 11 19
(260) AM 2021 111283 A
(220) 2021 01 14
(732) KTM AG

Stallhofner Straße 3, Mattighofen,
5230, Austria

(111) M 2021 34756 R
(151) 2021 11 19
(181) 2031 11 19
(260) AM 2021 111317 A
(220) 2021 01 15
(732) KTM AG

Stallhofner Straße 3, Mattighofen,
5230, Austria

(111) M 2021 34757 R
(151) 2021 11 19
(181) 2031 11 19
(260) AM 2021 111318 A
(220) 2021 01 15
(732) Giorgi Kikabidze

Ilia Chavchavadze Av. 54a, 0179, Tbilisi,
Georgia

(111) M 2021 34758 R
(151) 2021 11 19
(181) 2031 11 19
(260) AM 2021 111319 A
(220) 2021 01 15
(732) Giorgi Kikabidze

Ilia Chavchavadze Av. 54a, 0179, Tbilisi,
Georgia

(111) M 2021 34759 R
(151) 2021 11 19
(181) 2031 11 19
(260) AM 2021 111323 A
(220) 2021 01 18
(732) AstraZeneca UK Limited

1 Francis Crick Avenue, Cambridge
Biomedical Campus, Cambridge,
CB2 0AA, United Kingdom

(111) M 2021 34760 R
(151) 2021 11 19
(181) 2031 11 19
(260) AM 2021 111325 A
(220) 2021 01 18
(732) LTD "My Building"

Nutsbidze Plateau, IV mcr., corp. 17,
app. 75, Vake District, Tbilisi, Georgia

(111) M 2021 34761 R
(151) 2021 11 19
(181) 2031 11 19
(260) AM 2021 111326 A
(220) 2021 01 18

(732) LTD "B-G-I Advisory Service Georgia"
Rustaveli Av. 18, 0108, Tbilisi, Georgia

(111) M 2021 34762 R
(151) 2021 11 19
(181) 2031 11 19
(260) AM 2021 111333 A
(220) 2021 01 20

(732) LLC "Information Communications
Systems"
Al. Kazbegi Av. 9a, Tbilisi, Georgia

(111) M 2021 34763 R
(151) 2021 11 19
(181) 2031 11 19
(260) AM 2021 111410 A
(220) 2021 01 25

(732) LLC "Online Molly"
V. Barnov/Tarkhnishvili St. 49/29, app. 6,
Tbilisi, Georgia

TRADEMARKS REGISTERED ACCORDING TO THE ACCELERATED PROCEDURE

The decision can be appealed at the Chamber of Appeal of Sakpatenti within 3 months from the publication.

(111) M 2021 34685 R
(151) 2021 11 08
(181) 2031 11 08
(210) AM 114674
(220) 2021 09 17
(732) LLC "Kindzmarauli Marani"
Vill. Gavazi, Kvareli, Georgia
(540)



(591) Swamp green, white, morengo, beige, crimson
(531) 06.19.01; 06.19.07; 06.19.16; 27.05.01; 28.19;
29.01.15
(526) KINDZMARAU LI
(511) 33

(111) M 2021 34686 R
(151) 2021 11 08
(181) 2031 11 08
(210) AM 115207
(220) 2021 10 29
(732) LLC "Daily"
Kakheti Highway, bld. 17, 0190, Tbilisi,
Georgia
(540)



(591) FEFEFE white, 5FBB51 light green,
3E4095 blue, 00AFEF sky-blue,
08AD5B green, ED3237 red,
F58634 orange, FFCC29 yellow
(531) 05.07.13; 08.01.01; 08.05.01; 08.05.02;
08.05.25; 11.03.02; 26.04.09; 26.04.16;
26.04.22; 26.04.24; 27.05.01; 27.05.24;
29.01.15
(511) 29, 30, 32

(111) M 2021 34687 R
(151) 2021 11 08
(181) 2031 11 08
(210) AM 114993
(220) 2021 10 18
(732) LLC "Kvareli Cellar"
Vill. Chikaani, 4800, Kvareli, Georgia
(740) Khatuna Imnadze
(540)

ლეგენდა გუდაური
LEGENDA GUDAURI
ЛЕГЕНДА ГУДАУРИ

(591) Black-white
(526) გუდაური, GUDAURI, ГУДАУРИ
(511) 33

(111) M 2021 34688 R
(151) 2021 11 08
(181) 2031 11 08
(210) AM 115218
(220) 2021 11 02
(732) LLC "Iber-Info"
Vazha-Pshavela Av. 41, fl. 4, 0177, Tbilisi,
Georgia
(540)

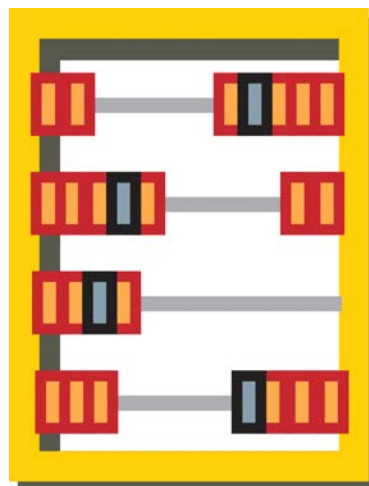

(591) Orange, yellow, black, white, red, sky-blue
(531) 17.05.04; 29.01.15
(511) 9, 35

(111) M 2021 34689 R
 (151) 2021 11 11
 (181) 2031 11 11
 (210) AM 115303
 (220) 2021 11 05
 (732) Tariel Eliashvili
 Kazbegi Av. 24g, app. 30, Tbilisi, Georgia
 (540)

NAPOLI

NAPOLI



(591) White, black, grey, metallic, golden
 (531) 26.04.01; 26.04.09; 26.04.14; 27.05.01;
 27.05.15; 27.05.17; 29.01.13
 (511) 34

(111) M 2021 34690 R
 (151) 2021 11 12
 (181) 2031 11 12
 (210) AM 115224
 (220) 2021 11 03
 (732) Novartis AG
 4002 Basel, Switzerland
 (740) Shalva Gvaramadze
 (540)

KIENDRA

(591) Black-white
 (511) 5

(111) M 2021 34691 R
 (151) 2021 11 12
 (181) 2031 11 12
 (210) AM 115335
 (220) 2021 11 09
 (732) LLC "Deutsche Immunologics"
 Tskaro St. 1a, Kojori Borough,
 Mtatsminda District, Tbilisi,
 Georgia



(591) Sky-blue, grey
 (531) 01.13.15; 27.05.01; 27.05.10; 29.01.04
 (511) 5

(111) M 2021 34722 R
 (151) 2021 11 16
 (181) 2031 11 16
 (210) AM 115098
 (220) 2021 10 22
 (732) LLC "Gorgio International Holding"
 Vill. Khashmi, Sagarejo, Georgia
 (540)



(591) EABE6B beige, FF0000 red,
 000000 black, FFFFFFF white
 (531) 01.03.02; 03.01.01; 03.01.02; 03.01.17;
 03.01.20; 03.01.22; 09.01.07; 09.01.10;
 24.01.05; 24.01.07; 24.01.13; 24.01.15;
 24.09.01; 24.09.13; 25.01.19; 26.01.01;
 26.01.13; 26.01.15; 26.01.21; 29.01.14
 (526) Georgian State Soat of Arms
 (511) 35, 42

(111) M 2021 34723 R
 (151) 2021 11 17
 (181) 2031 11 17
 (210) AM 115332
 (220) 2021 11 09
 (732) Inmusic Brands Inc.
 200 Scenic View Drive, Cumberland, 02864,
 USA, Rhode Island, USA
 (740) Giorgi Batlidze

(540)

The logo for RANE consists of the word "RANE" in a bold, black, sans-serif font. The letters are contained within a thick black rectangular border that has a slightly irregular, hand-drawn appearance.

(591) FFFFFFF white, 0C0000 black
(531) 27.01.02; 27.05.01; 27.05.11
(511) 9

(111) M 2021 34724 R

(151) 2021 11 18

(181) 2031 11 18

(210) AM 115236

(220) 2021 11 04

(732) LLC "Osecorp"

Vill. Mashavera, 1700, Dmanisi Region,
Georgia

(540)

The logo for OSECORP features a circular emblem on the left containing a compass rose with eight points. To the right of the emblem, the word "OSECORP" is written in a bold, black, sans-serif font.

(591) Black-white

(531) 01.01.01; 01.01.02; 01.01.10; 01.01.12;
26.01.01; 26.01.04; 27.05.01

(511) 35, 42

(111) M 2021 34725 R

(151) 2021 11 19

(181) 2031 11 19

(210) AM 115403

(220) 2021 11 12

(732) LTD "Dzala"

Gotua St. 3, 0160, Tbilisi, Georgia

(740) Giorgi Taktakishvili

(540)

The logo for GlyPerA features the word "GlyPerA" in a bold, sans-serif font. The letters "GlyPer" are in a teal color, and the letter "A" is in red.

(591) Turquoise, red

(531) 27.05.01; 27.05.17; 29.01.12

(511) 5

INTERNATIONAL TRADEMARKS FOR WHICH A DECISION ON GRANTING PROTECTIONS IS TAKEN

The decision can be appealed at the Chamber of Appeal of Sakpatenti within 3 months from the publication or at the Mtskheta District Court Administrative Cases Board (Address: №17, Samkhedro St., Mtskheta), within 1 month following the publication.

(260) AM 2021 106330 A*
 (800) 1498030
 (151) 2019 09 13
 (891) 2019 09 13
 (731) "Saratov-Lavr" obshchestvo s ogranichennoj
 otvetstvennost'yu
 Arbatskaya str., 28, RU-410053 Saratov,
 Russian Federation
 (540)



(591) Brown, yellow and white
 (531) 02.01.01; 02.01.16; 05.13.01; 05.13.08;
 05.13.11; 26.01.02; 26.01.14; 26.01.19; 28.05;
 29.01.13

(511)
 30 – Aromatic preparations for food; flavorings [flavourings], other than essential oils, for cakes; star aniseed; biscuits; pancakes; buns; bread rolls; vanillin [vanilla substitute]; waffles; vermicelli [noodles]; coffee flavorings; natural sweeteners; sausage binding materials; binding agents for ice cream; sea water for cooking; glucose for culinary purposes; mustard; thickening agents for cooking foodstuffs; artificial coffee; vegetal preparations for use as coffee substitutes; confectionery for decorating Christmas trees; cakes; pastries; peanut confectionery; almond confectionery; pasta; pies; frozen yogurt [confectionery ices]; cocoa; cocoa mixes; cocoa powder; cocoa extracts for human consumption; capers; caramels [candy]; gruel, with a milk base, for food; quiches; gluten prepared as food-stuff; sweetmeats [candy]; liquorice [confectionery]; peppermint sweets; coffee; unroasted coffee; starch for food; crackers; groats for human food; corn, milled; corn, roasted; meat pies; couscous [semolina]; noodles; ice for refreshment; ice, natural or artificial; edible ices; candy; rice cakes; maltose; marzipan; custard; honey; royal jelly; ice cream; sorbets [ices]; meal; muesli; mint for confectionery; cocoa beverages with milk; coffee beverages with milk; coffee-based beverages; tea-based beverages; chocolate beverages with milk; chocolate-based beverages; cocoa-based

beverages; infusions, not medicinal; crushed oats; husked oats; nutmegs; pastilles [confectionery]; molasses for food; pepper; petits fours [cakes]; cookies; pizzas; fondants [confectionery]; popcorn; powders for making ice cream; pralines; condiments; meat tenderizers for household purposes; cereal preparations; oat-based food; propolis; gingerbread; spices; puddings; cake powder; ravioli; chewing gum for breath freshening; rice; spring rolls; sugar; aniseed; cake batter; confectionery; malt for human consumption; salt for preserving foodstuffs; cooking salt; celery salt; spaghetti; seasonings; preparations for stiffening whipped cream; rusks; breadcrumbs; sushi; sandwiches; yeast; tabbouleh; tacos; tapioca; almond paste; tortillas; fruit cakes; candy decorations for cakes; vinegar; ferments for pastes; halvah; bread; unleavened bread; chips [cereal products]; chicory [coffee substitute]; tea; iced tea; chocolate; malt extract for food; essences for foodstuffs, except etheric essences and essential oils; turmeric.

(260) AM 2021 106425 A*
 (800) 1498572
 (151) 2019 09 13
 (891) 2019 09 13
 (731) "Saratov-Lavr" obshchestvo s ogranichennoj
 otvetstvennost'yu
 Arbatskaya str., 28, RU-410053 Saratov,
 Russian Federation
 (540)



(591) Burgundy, light brown and black
 (531) 05.13.08; 26.01.02; 26.01.15; 26.01.18;
 27.01.12; 28.05; 29.01.12

(511)
 30 – Vanilla flavorings for culinary purposes; flavorings, other than essential oils, for cakes; flavorings, other than essential oils, for beverages; coffee flavorings; food flavorings, other than essential oils; star aniseed; baozi [stuffed buns]; cereal bars; high-protein cereal bars; pancakes; noodle-based prepared meals;

freeze-dried dishes with the main ingredient being pasta; freeze-dried dishes with the main ingredient being rice; buns; bulgur; bread rolls; edible rice paper; edible paper; burritos; vanillin [vanilla substitute]; vareniki [stuffed dumplings]; waffles; vermicelli [noodles]; natural sweeteners; sausage binding materials; binding agents for ice cream; sea water for cooking; seaweed [condiment]; malt biscuits; cloves [spice]; mirror icing [mirror glaze]; cake frosting [icing]; glucose for culinary purposes; mustard; croûtons; buckwheat, processed; gluten additives for culinary purposes; yeast; thickening agents for cooking foodstuffs; leaven; rice-based snack food; cereal-based snack food; artificial coffee; vegetal preparations for use as coffee substitutes; dressings for salad; zephyr [confectionery]; fruit jellies [confectionery]; candy decorations for cakes; confectionery for decorating Christmas trees; cakes; pastries; peanut confectionery; almond confectionery; pasta; ginger [spice]; frozen yogurt [confectionery ices]; cocoa; cream of tartar for culinary purposes; capers; caramels [candy]; curry [spice]; ketchup [sauce]; gimbap [Korean rice dish]; kimchi-jeon [fermented vegetable pancakes]; quinoa, processed; quiches; gluten prepared as foodstuff; flour-based dumplings; sweetmeats [candy]; liquorice [confectionery]; peppermint sweets; mints for breath freshening; dulce de leche; cinnamon [spice]; coffee; unroasted coffee; starch for food; crackers; custard; hominy grits; semolina; oatmeal; crushed barley; groats for human food; ice cubes; corn, milled; corn, roasted; meat pies; turmeric; couscous [semolina]; noodles; soba noodles; udon noodles; ice for refreshment; ice, natural or artificial; edible ices; candy; rice cakes; lomper [potato-based flatbread]; mayonnaise; macarons [pastry]; macaroni; maltose; hominy; piccalilli; marinades; marzipan; honey; soya bean paste [condiment]; royal jelly; ice cream; bean meal; buckwheat flour; tapioca flour; potato flour; corn flour; nut flours; flour; wheat flour; soya flour; barley meal; dessert mousses [confectionery]; chocolate mousses; muesli; mint for confectionery; cocoa beverages with milk; coffee beverages with milk; coffee-based beverages; cocoa-based beverages; chamomile-based beverages; tea-based beverages; chocolate beverages with milk; chocolate-based beverages; infusions, not medicinal; crushed oats; husked oats; okonomiyaki [Japanese savory pancakes]; onigiri [rice balls]; nutmegs; chocolate-coated nuts; stick liquorice [confectionery]; pastila [confectionery]; pastilles [confectionery]; molasses for food; pâtés en croûte; pelmeni [dumplings stuffed with meat]; pepper; allspice; peppers [seasonings]; pesto [sauce]; cookies; petit-beurre biscuits; bibimbap [rice mixed with vegetables and beef]; pies; pizzas; meat gravies; fondants [confectionery]; popcorn; powders for making ice cream; baking powder; mustard meal; pralines; aromatic preparations for food; condiments; meat tenderizers for household purposes; cereal preparations; oat-based food; propolis; gingerbread; spices; petits fours [cakes]; rice pudding; puddings; cake po-

uder; fruit coulis [sauces]; ravioli; ramen [Japanese noodle-based dish]; chewing gum for breath freshening; chewing gum; relish [condiment]; rice; instant rice; wheat germ for human consumption; spring rolls; sago; palm sugar; sugar; sesame seeds [seasonings]; linseed for culinary purposes [seasoning]; processed seeds for use as a seasoning; aniseed; agave syrup [natural sweetener]; golden syrup; confectionery; batter mixes for okonomiyaki [Japanese savory pancakes]; baking soda [bicarbonate of soda for cooking purposes]; malt for human consumption; salt for preserving foodstuffs; cooking salt; celery salt; sherbets [ices]; ham glaze; cranberry sauce [condiment]; soya sauce; tomato sauce; apple sauce [condiment]; sauces [condiments]; pasta sauce; spaghetti; seasonings; chocolate-based spreads; chocolate spreads containing nuts; preparations for stiffening whipped cream; shaved ice with sweetened red beans; rusks; breadcrumbs; sushi; senbei [rice crackers]; sandwiches; tabbouleh; tacos; tapioca; tarts; dough; pastry dough; almond paste; rice pulp for culinary purposes; cake dough; tortillas; garden herbs, preserved [seasonings]; chocolate decorations for cakes; vinegar; beer vinegar; ferments for pastes; halvah; unleavened bread; bread; chips [cereal products]; corn flakes; oat flakes; hot dog sandwiches; flowers or leaves for use as tea substitutes; jiaozi [stuffed dumplings]; chicory [coffee substitute]; tea; iced tea; chutneys [condiments]; minced garlic [condiment]; cheeseburgers [sandwiches]; chow-chow [condiment]; saffron [seasoning]; chocolate; malt extract for food; essences for foodstuffs, except etheric essences and essential oils; husked barley.

(260) AM 2021 108800 A*

(800) 1537234

(151) 2019 12 27

(891) 2019 12 27

(731) GALERİ KRİSTAL TURİZM İNŞAAT
PAZARLAMA VE TİCARET ANONİM
ŞİRKETİ
Havaalanı Yolu 11 Km., Serik Cad. No.371,
Altınova Kepez, Antalya, Turkey

(540)



(591) Blue

(531) 01.01.05; 01.01.10; 01.15.21; 24.17.02;
24.17.25; 27.05.09; 27.05.10

(511)

43 – Temporary accommodation; day-nurseries (crèches); reservation of temporary accommodation; hotel,

motel, boarding house, camp services: hotel, motel, boarding house, holiday/camp, tourist homes services, reservation: child care services, retirement homes services, orphanage services; rental of transportable buildings; services of animal nursing homes; boarding for animals, providing shelter for animals, care of pet.

(260) AM 2021 109475 A*

(800) 1546730

(151) 2020 07 16

(891) 2020 07 16

(731) "My Republic" LLC

Pokhodny pr. 14, floor/premises/office
5/II/No.5 RU-125373 Moscow, Russian
Federation

(540)



(591) White and red

(531) 26.04.04; 26.04.05; 27.05.01; 27.05.24;
29.01.12

(511)

16 – Fountain pens; aquarelles; watercolors [paintings]; albums; almanacs; document laminators for office use; mimeograph apparatus and machines; atlases; posters; banknotes; banners of paper; paper bows, other than haberdashery or hair decorations; name badges [office requisites]; table linen of paper; tickets; baggage claim check tags of paper; forms, printed; announcement cards [stationery]; glitter for stationery purposes; note books; pads [stationery]; drawing pads; wristbands for the retention of writing instruments; pamphlets; booklets; paper; paper sheets [stationery]; waxed paper; paper for medical examination tables; paper for recording machines; paper for radiograms; papers for painting and calligraphy; electrocardiograph paper; drawer liners of paper, perfumed or not; wood pulp paper; carbon paper; copying paper [stationery]; parchment paper; writing paper; rice paper; luminous paper; toilet paper; wrapping paper; filter paper; washi; blotters; newsletters; rollers for typewriters; house painters' rollers; composing sticks; modelling wax, not for dental purposes; signboards of paper or cardboard; sewing patterns; bunting of paper; newspapers; electrotypes; hectographs; modelling clay; polymer modelling clay; terrestrial globes; drawing sets; engravings; slate pencils; pencil leads; document holders [stationery]; pencil holders; chalk holders; holders for cheque books; holders for stamps [seals]; page holders; name badge holders [office requisites]; diagrams; table runners of paper; engraving plates; writing slates; blackboards; galley racks [printing]; drawing boards; advertisement boards of paper or cardboard; duplicators; punches [office requisites]; cream containers of paper; magazines [periodicals];

money clips; clips for name badge holders [office requisites]; tags for index cards; pen clips; bookmarks; etching needles; tracing needles for drawing purposes; periodicals; printed publications; paper shredders for office use; graphic representations; credit card imprints, non-electric; graining combs; drawing instruments; calendars; tracing paper; tracing cloth; tracing patterns; gums [adhesives] for stationery or household purposes; lithographic stones; ink stones [ink reservoirs]; pencils; pencil lead holders; charcoal pencils; pictures; transfers [decalcomanias]; paintings [pictures], framed or unframed; cardboard; wood pulp board [stationery]; hat boxes of cardboard; cards; index cards [stationery]; geographical maps; paper tapes and cards for the recordal of computer programmes; trading cards, other than for games; perforated cards for jacquard looms; catalogues; spools for inking ribbons; covers of paper for flower pots; paintbrushes; painters' brushes; writing brushes; typewriter keys; glue for stationery or household purposes; isinglass for stationery or household purposes; gluten [glue] for stationery or household purposes; starch paste [adhesive] for stationery or household purposes; printing blocks; books; manifolds [stationery]; comic books; drawing pins; cigar bands; envelopes [stationery]; boxes of paper or cardboard; cases for stamps [seals]; paint boxes for use in schools; correcting fluids [office requisites]; printed coupons; stencils [stationery]; French curves; paper ribbons, other than haberdashery or hair decorations; typewriter ribbons; barcode ribbons; gummed tape [stationery]; adhesive bands for stationery or household purposes; correcting tapes [office requisites]; inking ribbons; adhesive tapes for stationery or household purposes; self-adhesive tapes for stationery or household purposes; square rulers for drawing; drawing rulers; flyers; absorbent sheets of paper or plastic for foodstuff packaging; humidity control sheets of paper or plastic for foodstuff packaging; viscose sheets for wrapping; sheets of reclaimed cellulose for wrapping; plastic bubble packs for wrapping or packaging; steel letters; type [numerals and letters]; lithographs; letter trays; paint trays; architects' models; postage stamps; plastics for modelling; graphic prints; modelling materials; teaching materials [except apparatus]; sealing compounds for stationery purposes; adhesives [glues] for stationery or household purposes; stuffing of paper or cardboard; bookbinding material; packing [cushioning, stuffing] materials of paper or cardboard; packaging material made of starches; filtering materials of paper; tablemats of paper; addressing machines; pencil sharpening machines, electric or non-electric; bookbinding apparatus and machines [office equipment]; typewriters, electric or non-electric; paper creasers [office requisites]; franking machines for office use; chalk for lithography; writing chalk; tailors' chalk; marking chalk; spray chalk; bags [envelopes, pouches] of paper or plastics, for packaging; garbage bags of paper or of plastics; plastic bags for pet waste disposal; painters' easels;

hand-rests for painters; printing sets, portable [office requisites]; bibs of paper; bibs, sleeved, of paper; stickers [stationery]; finger-stalls [office requisites]; writing cases [stationery]; cords for bookbinding; paper knives [letter openers]; printed sheet music; numbering apparatus; bottle envelopes of paper or cardboard; sealing wafers; covers [stationery]; passport holders; plastic cling film, extensible, for palletization; embroidery designs [patterns]; handwriting specimens for copying; oleographs; musical greeting cards; greeting cards; postcards; etchings; conical paper bags; paper bags for use in the sterilization of medical instruments; bags for microwave cooking; palettes for painters; ink sticks; pantographs [drawing instruments]; loose-leaf binders; files [office requisites]; folders for papers; papier mâché; pastels [crayons]; modelling paste; pen cases; pen wipers; office perforators; pens [office requisites]; nibs of gold; nibs; steel pens; drawing pens; song books; seals [stamps]; sealing stamps; clipboards; address plates for addressing machines; handkerchiefs of paper; plastic film for wrapping; desk mats; trays for sorting and counting money; coasters of paper; bookends; stamp stands; mats for beer glasses; stands for pens and pencils; photograph stands; obliterating stamps; inking pads; stamp pads; binding strips [bookbinding]; towels of paper; inking sheets for document reproducing machines; inking sheets for duplicators; bookbinding cloth; gummed cloth for stationery purposes; printers' blankets, not of textile; portraits; paperweights; writing cases [sets]; inkstands; office requisites, except furniture; writing materials; writing instruments; drawing materials; school supplies [stationery]; adhesive tape dispensers [office requisites]; hand labelling appliances; printed matter; lithographic works of art; prospectuses; printed timetables; ledgers [books]; printers' galleys; indexes; paper cutters [office requisites]; rubber erasers; elastic bands for offices; T-squares for drawing; graphic reproductions; retractable reels for name badge holders [office requisites]; penholders; marking pens [stationery]; tissues of paper for removing make-up; paper wipes for cleaning; dental tray covers of paper; face towels of paper; place mats of paper; tablecloths of paper; paper clasps; document files [stationery]; scrapers [erasers] for offices; paperclips; staples for offices; erasing products; biological samples for use in microscopy [teaching materials]; histological sections for teaching purposes; figurines of papier mâché; steatite [tailor's chalk]; writing board erasers; composing frames [printing]; sealing wax; arithmetical tables; placards of paper or cardboard; writing or drawing books; fabrics for bookbinding; stationery; pencil sharpeners, electric or non-electric; transparencies [stationery]; stencil plates; stencils for decorating food and beverages; cardboard tubes; Indian inks; moisteners [office requisites]; moisteners for gummed surfaces [office requisites]; squares for drawing; chart pointers, non-electronic; bottle wrappers of paper or cardboard; envelope sealing machines for

offices; sealing machines for offices; vignetting apparatus; apparatus for mounting photographs; stapling presses [office requisites]; manuals [handbooks]; statuettes of papier mâché; paper coffee filters; flags of paper; silver paper; molds for modelling clays [artists' materials]; photo-engravings; photographs [printed]; stencil cases; canvas for painting; chromolithographs [chromos]; animation cels; compasses for drawing; numbers [type]; artists' watercolor saucers; ink; correcting ink [heliography]; inkwells; blueprints; stencils; erasing shields; balls for ball-point pens; desktop cabinets for stationery [office requisites]; printing type; address stamps; stamps [seals]; shields [paper seals]; prints [engravings]; labels of paper or cardboard.

20 – Picture frame brackets; bumper guards for cots, other than bed linen; reels, not of metal, non-mechanical, for flexible hoses; pulleys of plastics for blinds; bolts, not of metal; casks of wood for decanting wine; mooring buoys, not of metal; casks, not of metal; barrels, not of metal; identification bracelets, not of metal; sideboards; busts of wood, wax, plaster or plastic; costume stands; bolsters; fans for personal use, non-electric; work benches; vice benches [furniture]; valet stands; coatstands; clothes hangers; shoulder poles [yokes]; screws, not of metal; display stands; showcases [furniture]; newspaper display stands; jewelry organizer displays; collars, not of metal, for fastening pipes; comb foundations for beehives; signboards of wood or plastics; loading gauge rods, not of metal, for railway wagons; nuts, not of metal; covers for clothing [wardrobe]; shoe pegs, not of metal; nesting boxes; coffins; doors for furniture; curtain holders, not of textile material; pegs [pins], not of metal; divans; door closers, not of metal, non-electric; kennels for household pets; birdhouses; keyboards for hanging keys; display boards; plugs [dowels], not of metal; containers, not of metal, for liquid fuel; troughs, not of metal, for mixing mortar; oil drainage containers, not of metal; packaging containers of plastic; indoor window blinds [furniture]; indoor window blinds of paper; indoor window blinds of woven wood; indoor window blinds of textile; flower-stands [furniture]; curtain tie-backs; clips, not of metal, for cables and pipes; binding screws, not of metal, for cables; clips of plastic for sealing bags; rivets, not of metal; imitation tortoiseshell; locks, not of metal, for vehicles; padlocks, other than electronic, not of metal; locks, other than electric, not of metal; bead curtains for decoration; door bolts, not of metal; bottle closures, not of metal; closures, not of metal, for containers; latches, not of metal; mirrors [looking glasses]; hand-held mirrors [toilet mirrors]; registration plates, not of metal; bamboo; scratching posts for cats; animal claws; animal hooves; coral; meerschaum; whalebone, unworked or semi-worked; stag antlers; tortoiseshell; shells; horn, unworked or semi-worked; animal horns; rattan; corozo; plaited straw, except matting; wickerwork; hampers [baskets] for the transport of items; works of art of wood, wax, plaster or plastic;

cabinet work; reeds [plaiting materials]; settees; jerry-cans, not of metal; curtain rods; index cabinets [furniture]; reels of wood for yarn, silk, cord; drain traps [valves] of plastic; water-pipe valves of plastic; valves, not of metal, other than parts of machines; staves of wood; plastic keys; plastic key cards, not encoded and not magnetic; mats for infant playpens; saw horses; bed casters, not of metal; furniture casters, not of metal; brush mountings; chopping blocks [tables]; wind chimes [decoration]; door bells, not of metal, non-electric; bottle caps, not of metal; cradles; tent pegs, not of metal; curtain rings; split rings, not of metal, for keys; chests of drawers; console tables; containers, not of metal [storage, transport]; floating containers, not of metal; lecterns; dog kennels; bakers' bread baskets; baskets, not of metal; moses baskets; bottle casings of wood; tool boxes, not of metal, empty; faucets, not of metal, for casks; armchairs; hair-dressers' chairs; deck chairs; beds; hospital beds; waterbeds, not for medical purposes; bedsteads of wood; air beds, not for medical purposes; cots for babies; edgings of plastic for furniture; brackets, not of metal, for furniture; screw tops, not of metal, for bottles; table tops; sash fasteners, not of metal, for windows; hooks, not of metal, for clothes rails; curtain hooks; clothes hooks, not of metal; bag hangers, not of metal; beds for household pets; nesting boxes for household pets; ladders of wood or plastics; playpens for babies; mannequins; mattresses; air mattresses, not for medical purposes; camping mattresses; sleeping mats; furniture; furniture of metal; inflatable furniture; office furniture; school furniture; mobiles [decoration]; door knockers, not of metal; shoe dowels, not of metal; curtain rails; runners, not of metal, for sliding doors; legs for furniture; feet for furniture; house numbers, not of metal, non-luminous; barrel hoops, not of metal; door stops, not of metal or rubber; window stops, not of metal or rubber; moldings for picture frames; bed bases; plastic ramps for use with vehicles; furniture partitions of wood; freestanding partitions [furniture]; mother-of-pearl, unworked or semi-worked; ambroid plates; identity plates, not of metal; loading pallets, not of metal; handling pallets, not of metal; transport pallets, not of metal; mirror tiles; head-rests [furniture]; trays, not of metal; stakes, not of metal, for plants or trees; trestles [furniture]; magazine racks; book rests [furniture]; stands for calculating machines; flower-pot pedestals; baby changing mats; pet cushions; pillows; cushions; head support cushions for babies; anti-roll cushions for babies; air cushions, not for medical purposes; air pillows, not for medical purposes; head positioning pillows for babies; removable mats or covers for sinks; racks [furniture]; library shelves; shelves for file cabinets; furniture shelves; shelves for storage; wood ribbon; straw edgings; towel stands [furniture]; hat stands; bathtub grab bars, not of metal; cask stands, not of metal; inflatable publicity objects; counters [tables]; bedding, except linen; corks for bottles; corks; stoppers, not of glass, metal

or rubber; sealing caps, not of metal; stair rods; standing desks; embroidery frames; dispensers for dog waste bags, fixed, not of metal; towel dispensers, fixed, not of metal; picture frames; sections of wood for beehives; crucifixes of wood, wax, plaster or plastic, other than jewelry; tanks, not of metal nor of masonry; fodder racks; curtain rollers; door handles, not of metal; knobs, not of metal; fishing baskets; writing desks; bath seats for babies; seats of metal; benches [furniture]; vats, not of metal; honeycombs; sofas; bungs, not of metal; statues of wood, wax, plaster or plastic; statuettes of wood, wax, plaster or plastic; oyster shells; silvered glass [mirrors]; shelving units; ambroid bars; umbrella stands; gun racks; carts for computers [furniture]; lap desks; dressing tables; washstands [furniture]; tables; typing desks; drafting tables; massage tables; tables of metal; wall-mounted baby changing platforms; saw benches [furniture]; desks; portable desks; tea carts; dinner wagons [furniture]; steps [ladders], not of metal; step stools, not of metal; chairs [seats]; high chairs for babies; shower chairs; chests, not of metal; placards of wood or plastics; stools; footstools; crates; trolleys [furniture]; straw plaits; mobile boarding stairs, not of metal, for passengers; straw mattresses; decorations of plastic for foodstuffs; beehives; bathroom vanities [furniture]; door fasteners, not of metal; window fasteners, not of metal; funerary urns; window closers, not of metal, non-electric; door openers, not of metal, non-electric; window openers, not of metal, non-electric; winding spools, not of metal, non-mechanical, for flexible hoses; figurines of wood, wax, plaster or plastic; hand-held flagpoles, not of metal; door fittings, not of metal; coffin fittings, not of metal; bed fittings, not of metal; furniture fittings, not of metal; window fittings, not of metal; infant walkers; garment covers [storage]; stuffed animals; stuffed birds; hinges, not of metal; chaise longues; poles, not of metal; screens [furniture]; filing cabinets; medicine cabinets; plate racks; meat safes; bookcases; wardrobes; cupboards; window pulleys, not of metal; bamboo curtains; slatted indoor blinds; screens for fireplaces [furniture]; labels of plastic; yellow amber; lockers; chests for toys; tool chests, not of metal, empty; boxes of wood or plastic; letter boxes, not of metal or masonry; bottle racks.

21 – Pressure cookers, non-electric; indoor aquaria; wine aerators; buckets; cookie jars; candle jars [holders]; china ornaments; dishes; paper plates; vegetable dishes; saucers; mugs; boxes for sweets; bottles; demijohns; busts of porcelain, ceramic, earthenware, terra-cotta or glass; vases; epergnes; fruit cups; inflatable bath tubs for babies; bird baths; baby baths, portable; plungers for clearing blocked drains; waffle irons, non-electric; diaper disposal pails; coolers [ice pails]; mop wringer buckets; buckets made of woven fabrics; whisks, non-electric, for household purposes; cooking skewers of metal; towel rails and rings; stretchers for clothing; hair for brushes; horsehair for brush-making; birdcages; funnels; candle warmers, electric and non-

electric; carpet beaters [hand instruments]; signboards of porcelain or glass; candle extinguishers; heads for electric toothbrushes; flower pots; chamber pots; glue-pots; cruets; decanters; large-toothed combs for the hair; combs for animals; tea cosies; abrasive sponges for scrubbing the skin; make-up sponges; sponges for household purposes; toilet sponges; sponge holders; stands for portable baby baths; toothpick holders; soap holders; table napkin holders; holders for flowers and plants [flower arranging]; tea bag rests; shaving brush stands; toilet paper holders; soap dispensers; toilet paper dispensers; plug-in diffusers for mosquito repellents; aromatic oil diffusers, other than reed diffusers, electric and non-electric; ironing boards; cutting boards for the kitchen; bread boards; washing boards; crushers for kitchen use, non-electric; strainers for household purposes; smoke absorbers for household purposes; containers for household or kitchen use; kitchen containers; glass jars [carboys]; heat-insulated containers; heat-insulated containers for beverages; thermally insulated containers for food; glass flasks [containers]; closures for pot lids; chamois leather for cleaning; toothpicks; ceramics for household purposes; majolica; works of art of porcelain, ceramic, earthenware, terra-cotta or glass; kitchen grinders, non-electric; cleaning instruments, hand-operated; cabarets [trays]; stew-pans; couscous cooking pots, non-electric; covers, not of paper, for flower pots; shaving brushes; make-up brushes; cages for household pets; baking mats; ladles for serving wine; polishing leather; hot pots, not electrically heated; glass bulbs [receptacles]; shoe trees; napkin rings; poultry rings; rings for birds; disposable aluminium foil containers for household purposes; coin banks; piggy banks; bread baskets for household purposes; baskets for household purposes; waste paper baskets; feeding troughs; pet feeding bowls, automatic; mangers for animals; lunch boxes; tea caddies; washtubs; earthenware saucepans; mess-tins; cauldrons; coffee percolators, non-electric; coffeepots, non-electric; coffee grinders, hand-operated; fused silica [semi-worked product], other than for building; beer mugs; tankards; rat traps; pot lids; aquarium hoods; butter-dish covers; dish covers; cheese-dish covers; reusable silicone food covers; buttonhooks; reusable ice cubes; pitchers; perfume burners; watering cans; fly traps; insect traps; ice cream scoops; mixing spoons [kitchen utensils]; basting spoons [cooking utensils]; pie servers; spatulas for kitchen use; litter boxes for pets; butter dishes; material for brush-making; polishing materials for making shiny, except preparations, paper and stone; tablemats, not of paper or textile; noodle machines, hand-operated; lint removers, electric or non-electric; pasta makers, hand-operated; polishing apparatus and machines, for household purposes, non-electric; pepper mills, hand-operated; mills for household purposes, hand-operated; feather-dusters; brooms; isothermic bags; confectioners' decorating bags [pastry bags]; bowls [basins]; pet feeding bowls; mo-

saics of glass, not for building; dishcloths; saucepan scourers of metal; soap boxes; mouse traps; cooking pot sets; nozzles for watering cans; pouring spouts; wine pourers; cake decorating tips and tubes; nozzles for watering hose; fitted picnic baskets, including dishes; toilet cases; floss for dental purposes; fiberglass thread, other than for textile use; cookie [biscuit] cutters; pastry cutters; sprinklers; syringes for watering flowers and plants; egg yolk separators; cotton waste for cleaning; wool waste for cleaning; cleaning tow; cold packs for chilling food and beverages; chopsticks; cocktail stirrers; food steamers, non-electric; pepper pots; oven mitts; animal grooming gloves; gloves for household purposes; car washing mitts; polishing gloves; gardening gloves; pestles for kitchen use; droppers for household purposes; wine-tasting pipettes; droppers for cosmetic purposes; plates for diffusing aromatic oil; plates to prevent milk boiling over; dripping pans; trays for household purposes; trays of paper, for household purposes; lazy susans; heaters for feeding bottles, non-electric; candelabra [candlesticks]; trivets [table utensils]; coasters, not of paper or textile; grill supports; menu card holders; knife rests for the table; flat-iron stands; egg cups; abrasive pads for kitchen purposes; scouring pads; drinking troughs; serving ladles; powdered glass for decoration; pottery; pots; cooking pots; painted glassware; tableware, other than knives, forks and spoons; porcelain ware; earthenware; crystal [glassware]; cosmetic utensils; toilet utensils; trouser presses; toothpaste tube squeezers; tortilla presses, non-electric [kitchen utensils]; deodorizing apparatus for personal use; cruet sets for oil and vinegar; make-up removing appliances; spice sets; apparatus for wax-polishing, non-electric; bottle openers, electric and non-electric; glove stretchers; bootjacks; crumb trays; tie presses; potholders; clothes-pegs; glass stoppers; powder compacts, empty; perfume vaporizers; powder puffs; dusting apparatus, non-electric; foam toe separators for use in pedicures; clothing stretchers; combs; electric combs; grills [cooking utensils]; sifters [household utensils]; drinking horns; shoe horns; candle drip rings; broom handles; salad bowls; place mats, not of paper or textile; beverage urns, non-electric; sugar bowls; beaters, non-electric; egg separators, non-electric, for household purposes; services [dishes]; coffee services [tableware]; liqueur sets; tea services [tableware]; cooking mesh bags, other than for microwaves; sieves [household utensils]; cinder sifters [household utensils]; tea strainers; wine-tasting siphons; siphon bottles for carbonated water; rolling pins, domestic; frying pans; squeegees [cleaning instruments]; steel wool for cleaning; currycombs; blenders, non-electric, for household purposes; scoops for household purposes; fruit presses, non-electric, for household purposes; drinking straws; salt cellars; drinking vessels; vessels of metal for making ices and iced drinks; refrigerating bottles; bulb basters; cups of paper or plastic; glasses [receptacles]; drinking glasses; statues of porcelain, ceramic,

earthenware, terra-cotta or glass; figurines of porcelain, ceramic, earthenware, terra-cotta or glass; glass for vehicle windows [semi-finished product]; plate glass [raw material]; opal glass; glass, unworked or semi-worked, except building glass; opaline glass; glass incorporating fine electrical conductors; enamelled glass, not for building; glass wool, other than for insulation; vitreous silica fibers, other than for textile use; fiberglass, other than for insulation or textile use; mortars for kitchen use; portable cool boxes, non-electric; soup bowls; drying racks for laundry; rotary washing lines; tajines, non-electric; basins [receptacles]; table plates; disposable table plates; graters for kitchen use; insulating flasks; indoor terrariums [plant cultivation]; indoor terrariums [vivariums]; roller tubes for peeling garlic; cloth for washing floors; polishing cloths; cloths for cleaning; dusting cloths [rags]; furniture dusters; aerosol dispensers, not for medical purposes; wax-polishing appliances, non-electric, for shoes; water apparatus for cleaning teeth and gums; electric devices for attracting and killing insects; watering devices; utensils for household purposes; kitchen utensils; cooking utensils, non-electric; coffee filters, non-electric; flasks; hip flasks; drinking bottles for sports; boot trees; molds [kitchen utensils]; egg poachers; cake moulds; ice cube molds; cookery moulds; deep fryers, non-electric; comb cases; bread bins; fly swatters; teapots; kettles, non-electric; cups; garlic presses [kitchen utensils]; ironing board covers, shaped; tea infusers; decorative glass spheres; mops; mop wringers; cocktail shakers; cosmetic spatulas; corkscrews, electric and non-electric; animal bristles [brushware]; pig bristles for brush-making; brushes; dishwashing brushes; ski wax brushes; brushes for cleaning tanks and containers; lamp-glass brushes; horse brushes; scrubbing brushes; toothbrushes; toothbrushes, electric; basting brushes; carpet sweepers; brushes for footwear; tar-brushes, long handled; toilet brushes; electric brushes, except parts of machines; eyebrow brushes; nail brushes; eyelash brushes; nutcrackers; ice tongs; salad tongs; sugar tongs; decanter tags; nest eggs, artificial; boxes for dispensing paper towels; dustbins; window-boxes; boxes of glass.

(260) AM 2021 110154 A
 (800) 1555080
 (151) 2020 07 15
 (891) 2020 07 15
 (731) CAYAGO TEC GmbH
 Benzstraße 10, 32108 Bad Salzuflen, Germany
 (540)



The logo for SEABOB BEACH features a stylized wave graphic above the brand name. 'SEABOB' is written in a bold, italicized, sans-serif font, and 'BEACH' is written below it in a similar but slightly smaller font.

(591) Black, white
 (531) 26.11.03; 26.11.13; 27.05.01

(511)
 7 – Motors, drive units and engines, other than for land vehicles; machine coupling and transmission components (except for land vehicles).

9 – Scientific, nautical, surveying, photographic, cinematographic, optical, weighing, measuring, signalling, checking (supervision), life-saving and teaching apparatus and instruments; apparatus and instruments for conducting, switching, transforming, accumulating, regulating or controlling electricity; apparatus for recording, transmission or reproduction of sound or images; magnetic data carriers, compact discs, DVDs and other digital recording media; calculating machines, data processing hardware, computers; computer software; remote control devices; storage batteries; chargers for electric batteries; charging stations for electric vehicles; commutation (electric apparatus for -).

12 – Apparatus for locomotion by land, air or water; motorised water sports apparatus, namely means of transport on/under water; boats; parts and fittings for water vehicles, in particular load weights; wall and/or floor holders, in particular for motorised water sports apparatus, luggage for motorised water sports apparatus, propellers, hulls for water sports apparatus; control devices for boats, house claddings for the aforesaid water sports apparatus; transport devices, namely automotive trailers; handling carts.

18 – Casual bags; leather and imitation leather; luggage; carrying cases; all-purpose carrying bags; saddlery.

25 – Clothing; footwear; headgear.

(260) AM 2021 111055 A
 (800) 1433146
 (151) 2018 06 18
 (891) 2020 10 23
 (731) Farmak International Holding GmbH
 Mariahilferstrasse 136, A-1150 Wien,
 Austria
 (540)

ОГРАНИЯ

(591) Black, white
 (531) 28.05
 (511)
 5 – medicines for human purposes; drugs for treating the nervous system; antiepileptic medicines.

(260) AM 2021 111143 A
 (800) 1549781
 (151) 2020 04 24
 (891) 2020 12 11
 (731) FRATELLI DYNASTY LIMITED
 306 Victoria House, Victoria, Mahe,
 Seychelles

(540)



(591) Black, white

(531) 26.04.22; 26.04.24; 27.05.24

(511)

33 – Alcoholic beverages, except beer; brandy; wine; whisky; vodka; cocktails; liqueurs; rum; spirits [beverages].

(260) AM 2021 111316 A

(800) 1501160

(151) 2019 09 28

(891) 2020 10 12

(731) PERUZE RENKLİER

Kilicaslan Mahallesi Sivas, Bulvari No:74/2
Melikgazi, Kayseri, Turkey

(540)



(591) Black, white

(531) 01.15.11; 11.03.04; 26.04.01; 26.04.05;
26.04.17; 26.04.18; 26.04.24; 27.03.15;
27.05.24; 27.07.24

(511)

30 – Coffee; coffee-based beverages; coffee beverages with milk; coffee flavorings; artificial coffee; baking powder; bread; aromatic preparations for food; chocolate; chocolate-based beverages; chocolate-based spreads; chocolate beverages with milk; chocolate mousses; chocolate spreads containing nuts; cocoa; cocoa-based beverages; cocoa beverages with milk; tea; tea-based beverages; cheeseburgers (sandwiches); cookies; corn flakes; flour; frozen yogurt (confectionery ices); honey; ice cream; ice cubes; iced tea; ice, natural or artificial; halvah; macaroni; macaroons (pastry); noodles; oat-based food; oat flakes; oatmeal; pancakes; pasta; pastries; pasta sauce; pizzas; popcorn; potato flour; sandwiches; sago; sea water for cooking; spaghetti; spices; sugar; tacos; tarts; thickening agents for cooking foodstuffs; tomato sauce; tortillas; vanillin (vanilla substitute); vegetal preparations for use as coffee substitutes; waffles; agave syrup (natural sweetener); allspice; cakes; gluten additives for culinary purposes; pies; puddings.

32 – Beers; beer-based cocktails; mineral and aerated waters; table waters; soda water; lemonades; non-alcoholic beverages; non-alcoholic beverages flavored

with coffee; non-alcoholic beverages flavored with tea; non-alcoholic fruit juice beverages; non-alcoholic fruit extracts; non-alcoholic preparations for making beverages; cocktails, non-alcoholic; fruit juices; fruit nectars, non-alcoholic; vegetable juices (beverages); energy drinks; isotonic beverages; protein-enriched sports beverages.

(260) AM 2021 111356 A

(800) 1571169

(151) 2020 12 10

(891) 2020 12 10

(731) Swinkels Family Brewers N.V.

De Stater 1, NL-5737 RV Lieshout,
Netherlands

(540)



(591) White and several shades of blue and grey

(531) 17.05.21; 24.01.03; 24.01.15; 29.01.12

(511)

32 – Beer; non-alcoholic drinks; mineral and aerated waters; fruit beverages and fruit juices; syrups and other preparations for making beverages [non-alcoholic]; alcohol-free beer; non-alcoholic malt beverages; brewery products [beers].

(260) AM 2021 111357 A

(800) 1571231

(151) 2020 10 15

(891) 2020 10 15

(731) ROYAL ARMENIA JV LTD

Davtashen 2nd Block 268, 0054 Yerevan,
Armenia

(540)



(591) Purple, red, white

(531) 02.07.23; 05.07.27; 06.01.02; 07.05.05;
22.05.10; 25.01.15; 25.07.01; 27.05.10;
29.01.14

(526) ARMENIA, ®, GROUND COFFEE,
100% ARABICA

(511)
30 – Ground coffee.

(260) AM 2021 111387 A

(800) 1117057

(151) 2012 04 12

(891) 2020 12 08

(731) "Delta Medical Promotions AG"
Oetenbachgasse 26, CH-8001 Zurich,
Switzerland

(540)

EkoBIOL

(591) Black, white

(531) 27.05.01; 27.05.10

(511)

3 – Color (colour) brightening chemicals for household purposes (laundry); laundry glaze; shining preparations (polish); petroleum jelly for cosmetic purposes; bath salts, not for medical purposes; laundry preparations; bleaching salts; cloths impregnated with a detergent for cleaning; disinfectant soap; deodorant soap; laundry soaking preparations; color-removing preparations; cakes of toilet soap; medicated soap; almond soap; detergents other than for use in manufacturing operations and for medical purposes; soap; soap for foot perspiration; antiperspirant soap; oils for cleaning purposes; stain removers; laundry bleach; dry-cleaning preparations; antiperspirants (toiletries); talcum powder, for toilet use; cleaning preparations; scouring solutions.

(260) AM 2021 111388 A

(800) 1147977

(151) 2012 12 24

(891) 2020 12 08

(731) "Delta Medical Promotions AG"
Oetenbachgasse 26, CH-8001 Zurich,
Switzerland

(540)

ЭкоБИОЛ

(591) Black, white

(531) 28.05

(511)

3 – Color- brightening chemicals for household purposes [laundry]; laundry glaze; shining preparations [polish]; petroleum jelly for cosmetic purposes; bath salts, not for medical purposes; laundry preparations; bleaching salts; cloths impregnated with a detergent for cleaning; disinfectant soap; deodorant soap; laun-

dry soaking preparations; color-removing preparations; cakes of toilet soap; medicated soap; almond soap; detergents other than for use in manufacturing operations and for medical purposes; soap; soap for foot perspiration; antiperspirant soap; oils for cleaning purposes; stain removers; laundry bleach; dry-cleaning preparations; antiperspirants [toiletries]; talcum powder, for toilet use; cleaning preparations; scouring solutions.

(260) AM 2021 111392 A

(800) 1412700

(151) 2018 04 16

(891) 2020 12 21

(731) MOPRIA ALLIANCE, INC.
5000 Executive Parkway, Suite 302
San Ramon CA 94583, USA

(540)



(591) The color(s) black, green, light blue, blue, red, yellow and magenta is/are claimed as a feature of the mark

(531) 25.07.06; 26.01.01; 27.05.01; 29.01.15

(511)

9 – Downloadable software for mobile phones and portable devices, namely, software for wireless printing; printers and multifunction electronic devices for use in copying, printing, scanning and/or transmitting documents and images.

38 – Telecommunication services, namely, transmission of data by wireless communication networks for printing.

42 – Computer software development in the field of mobile applications and technology; computer software consultancy services, namely, in the field of wireless printing; development of standards for computer software development.

(260) AM 2021 111461 A

(800) 1572302

(151) 2020 07 31

(891) 2020 07 31

(731) VIENNA INSURANCE GROUP AG Wiener
Versicherung Gruppe
Schottenring 30, A-1010 Wien, Austria

(540)

Selfsurance

(591) Black, white

(511)

36 – Insurance management services; administration of financial affairs; financial management of insurance plans; financial management of pre-paid health care plans; financial management of insurance claims; financial management of group insurance plans; life insurance agencies; financial data analysis; financial evaluation and analysis relating to insurance; financial feasibility studies relating to insurance; retail financing services; financial consultancy and insurance consultancy; insurance consultancy; insurance underwriting consultancy; travel insurance; real estate insurance services; insurance services relating to holiday travels and accommodation; life insurance; motor insurance brokerage; financial services relating to insurance; financial services relating to the insurance of motor vehicles; consulting and information concerning insurance; personal insurance services relating to the supply of legal services; consultancy and brokerage services relating to vehicle insurance; consultancy and brokerage services relating to health insurance; consultancy and brokerage services relating to home insurance; consultancy and brokerage services relating to travel insurance; claim adjustment for non-life insurance; consultancy and brokerage services relating to accident insurance; consultancy and brokerage services relating to life insurance; health insurance; accident insurance; home contents insurance; insurance services relating to motor vehicles; property insurance underwriting; insurance information; advisory services relating to life insurance; insurance brokerage; insurance services; insurance agencies; insurance agency and brokerage; insurance services relating to real estate; insurance underwriting; insurance services relating to property; insurance brokerage for property; insurance services relating to holiday accommodation; providing insurance information; financial services rendered by insurance companies; insurance services relating to mechanical breakdown; insurance services for the protection of drivers; insurance services relating to the loss of personal possessions; life assurance brokerage; insurance services relating to the theft of personal possessions; insurance brokerage consultancy and information; insurance services relating to cancelled bookings for holidays; insurance services for the provision of emergency cash; computerised processing of insurance claims; provision of insurance premium quotations; insurance premium rate computing; computerised information services relating to insurance; insurance services relating to life; financial advisory services relating to life assurance.

(260) AM 2021 111462 A

(800) 1572303

(151) 2020 09 03

(891) 2020 09 03

(731) REANİMA KOZMETİK TİCARET LİMİTED ŞİRKETİ

Cihangir Mahallesi Petrol Ofisi Caddesi,
Şehit Kom. Onbaşı Uğur Hancı Sokak No:5,
Avcılar, İstanbul, Turkey

(540)

Réanima

(591) Black, white

(531) 27.05.01

(511)

3 – Bleaching and cleaning preparations, perfumery, cosmetics, fragrances, deodorants for personal use, soaps, dental care preparations, polishing preparations for leather, vinyl, metal and wood.

5 – Dental preparations and articles, sanitary preparations for medical use, hygienic pads, hygienic tampons, plasters, materials for dressings, preparations for destroying vermin, fungicides, herbicides, deodorants, other than for human beings or for animals, air purifying preparations, air deodorising preparations, disinfectants, antiseptics, detergents for medical purposes, pharmaceutical preparations for medical purposes, chemical preparations for medical purposes, chemical reagents for pharmaceutical purposes, dietary supplements for pharmaceutical purposes, dietary supplements, medical preparations for slimming purposes, food for babies, herbs and herbal beverages adapted for medicinal purposes.

(260) AM 2021 111463 A

(800) 1572305

(151) 2020 12 07

(891) 2020 12 07

(731) Apple Inc.

One Apple Park Way, Cupertino CA 95014,
USA

(540)

APP CLIP CODE

(591) Black, white

(511)

9 – Downloadable and recorded computer software; downloadable and recorded computer software for processing, facilitating, verifying, and authenticating mobile payments and contactless transactions with retailers, merchants, and vendors via wearable and mobile devices; downloadable and recorded computer software for use in searching, transmitting, receiving, storing, accessing, finding, organizing and viewing geographic location information and providing content based on location; downloadable and recorded computer software for application development; downloadable and recorded computer software development tools; downloadable and recorded computer software used in developing other software applications; downloadable and recorded application programming interface (API) software; downloadable and recorded software development kits (SDK);

downloadable and recorded computer software to maintain and operate a computer system; downloadable and recorded computer operating software.

(260) AM 2021 111464 A

(800) 1572307

(151) 2020 07 31

(891) 2020 07 31

(731) VIENNA INSURANCE GROUP AG, Wiener
Versicherung Gruppe
Schottenring 30, A-1010 Wien, Austria

(540)

Beesafe

(591) Black, white

(511)

36 – Insurance management services; administration of financial affairs; financial management of insurance plans; financial management of pre-paid health care plans; financial management of insurance claims; financial management of group insurance plans; life insurance agencies; financial data analysis; financial evaluation and analysis relating to insurance; financial feasibility studies relating to insurance; retail financing services; financial consultancy and insurance consultancy; insurance consultancy; insurance underwriting consultancy; travel insurance; real estate insurance services; insurance services relating to holiday travels and accommodation; life insurance; motor insurance brokerage; financial services relating to insurance; financial services relating to the insurance of motor vehicles; consulting and information concerning insurance; personal insurance services relating to the supply of legal services; consultancy and brokerage services relating to vehicle insurance; consultancy and brokerage services relating to health insurance; consultancy and brokerage services relating to home insurance; consultancy and brokerage services relating to travel insurance; claim adjustment for non-life insurance; consultancy and brokerage services relating to accident insurance; consultancy and brokerage services relating to life insurance; health insurance; accident insurance; home contents insurance; insurance services relating to motor vehicles; property insurance underwriting; insurance information; advisory services relating to life insurance; insurance brokerage; insurance services; insurance agencies; insurance agency and brokerage; insurance services relating to real estate; insurance underwriting; insurance services relating to property; insurance brokerage for property; insurance services relating to holiday accommodation; providing insurance information; financial services rendered by insurance companies; insurance services relating to mechanical breakdown; insurance services for the protection of drivers; insurance services relating to the loss of personal possessions; life assurance brokerage; insurance services relating to the theft of personal possessions; insurance brokerage consultancy and information; insurance services relating to can-

celled bookings for holidays; insurance services for the provision of emergency cash; computerised processing of insurance claims; provision of insurance premium quotations; insurance premium rate computing; computerised information services relating to insurance; insurance services relating to life; financial advisory services relating to life assurance.

(260) AM 2021 111465 A

(800) 1572328

(151) 2020 08 14

(891) 2020 08 14

(731) Industrial Innovation Group SARL
16 Rue de la Pélisserie, CH-1204 Genève,
Switzerland

(540)



(591) Black, white

(531) 01.15.15; 05.03.13; 05.03.15; 26.01.05;
26.01.15; 27.05.01

(511)

1 – Chemicals used in industry, science, photography, as well as in agriculture, horticulture and forestry; unprocessed artificial resins, unprocessed plastics; fire extinguishing and fire prevention compositions; tempering and soldering preparations; materials for tanning leather and animal skins; adhesives for use in industry; mastics and other filler pastes; compost, manures, fertilizing products; biological preparations for use in industry and science.

2 – Paints, varnishes, lacquers; preservatives against rust and against deterioration of wood; colorants, dyes; printing inks, marking inks and engraving inks; Unprocessed natural resins; metals in foil and powder form for painting, decoration, printing and works of art.

3 – Non-medicated toiletry preparations and cosmetic products; non-medicated dentifrices; perfumery products, essential oils; bleaching preparations and other substances for laundry use; cleaning, polishing, degreasing and abrasive preparations.

5 – Veterinary preparations; hygienic products for medicine; dietetic substances and foodstuffs for medical or veterinary use, food for babies; food supplements for humans and animals; plasters, materials for dressings; material for dental fillings and dental impressions; disinfectants; products for destroying vermin; fungicides, herbicides.

10 – Surgical, medical, dental and veterinary apparatus and instruments; artificial limbs, eyes and teeth;

orthopedic articles; suture material; therapeutic and assistance devices designed for people with disabilities; massage apparatus; apparatus, devices and articles for child care.

16 – Paper and cardboard; printing products (printed matter); bookbinding material; photographs; stationery and office requisites, excluding furniture; adhesives for stationery or household purposes; drawing material and material for artists; paintbrushes; instructional or teaching material; sheets, films and bags of plastic materials for wrapping and packaging; printing type, printing blocks.

17 – Rubber, gutta-percha, gum, asbestos, mica being unprocessed or semi-processed and substitutes of all these materials; plastic materials and resins in extruded form used in manufacturing operations; packing, stopping and insulating materials; flexible pipes not of metal.

18 – Leather and imitations of leather; animal skins; luggage and transport bags; umbrellas and parasols; walking sticks; whips, harness and saddlery; collars, leashes and clothing for animals.

19 – Non-metallic building materials; non-metallic rigid pipes for building; asphalt, pitch, tar and bitumen; transportable buildings not of metal; monuments not of metal.

22 – Ropes and strings; nets; tents and tarpaulins; awnings of textile or synthetic materials; sails; bags for the transport and storage of merchandise in bulk; padding and stuffing materials, excluding paper, cardboard, rubber or plastic materials; raw fibrous textile materials and their substitutes.

23 – Threads for textile use.

24 – Textiles and substitutes thereof; household linen; curtains of textile or plastic.

25 – Clothing, footwear, headwear.

27 – Carpets, rugs, mats and matting, linoleum and other materials for covering existing floors; wall hangings not of textile.

34 – Tobacco and tobacco substitutes; cigarettes and cigars; electronic cigarettes and oral sprays for smokers; smokers' articles; matches.

35 – Advertising; commercial business management; commercial administration; office functions; the bringing together, for the benefit of others, of a variety of goods (excluding the transport thereof) in retail and/or wholesale stores, as well as in mail-order catalogs and on websites enabling customers to conveniently view and purchase said goods.

39 – Transport; packaging and storage of merchandise; travel organization.

40 – Treatment of materials; recycling of trash and waste; air purification and water treatment; printing services; food and beverage preservation.

41 – Education; training; entertainment; sporting and cultural activities.

42 – Scientific and technological services as well as research and design services relating thereto; industrial analysis, industrial research and industrial design services; quality control and authentication services; design and development of computers and software.

(260) AM 2021 111491 A

(800) 1572875

(151) 2020 07 24

(891) 2020 07 24

(731) HONOR MACHINERY CO., PTE. LTD.

10 Anson Road, # 44-12 International Plaza,
Singapore 079903, Singapore

(540)

RICOTA

(591) Black, white

(511)

6 – Unwrought or semi-wrought common metals; pipes of metal; sleeves [metal hardware]; fittings of metal for building; railway material of metal; bands of metal for tying-up purposes; clips of metal for cables and pipes; small hardware of metal; buckles of common metal [hardware]; nails; fittings of metal for furniture; non-electric door bells of metal; locks of metal, other than electric; padlocks; keys of metal; safes [strong boxes]; vice claws of metal; tool chests of metal, empty; labels of metal; bells for animals; rods of metal for welding; anchors; identification bracelets of metal; weather- or wind- vanes of metal; tree protectors of metal; traps for wild animals; works of art of common metal; iron ores; monuments of metal; angle irons of metal; props of metal; elbows of metal for pipes; junctions of metal for pipes; valves of metal, other than parts of machines; reinforcing materials of metal for pipes; collars of metal for fastening pipes; staircases of metal; buildings, transportable, of metal; fences of metal; building materials of metal; scaffolding of metal; steel wire; ropes of metal; wall plugs of metal; screws of metal; hinges of metal; hooks [metal hardware]; pulleys of metal, other than for machines.

7 – Agricultural machines; lawnmowers [machines]; aerating pumps for aquaria; forage harvesters; milking machines; electric hair clipping machines for animals; woodworking machines; saws [machines]; corrugated paperboard making machines; machines for making diaper-pants of paper; printing machines; looms; sizing machines; tea processing machines; electromechanical food preparation machines; tobacco processing machines; leather-working machines; stitching machines; bicycle assembling machines; brick making machines; engraving machines; machines for making electric batteries; cord making machines; enamel making machines; machines for making bulbs; packaging machines; machines for making coal briquettes; electric kitchen machines; washing machines [laundry];

centrifugal mills; gluing machines; glass-working machines; fertilizers making machines; electromechanical machines for chemical industry; mine borers; cutters [machines]; oil-well pumping machines; mixing machines; disintegrators; cranes [lifting and hoisting apparatus]; pneumatic hammers; trimming machines; foundry machines; metalworking machines; steam engines; igniting devices for internal combustion engines; wind-powered installations for generating electricity; machines for making needles; machines for making zippers; stands for machines; cutting machines; machines for making wires and cables; tools [parts of machines]; machines and apparatus for polishing [electric]; drilling heads [parts of machines]; hand-held tools, other than hand-operated; power-operated angle grinders; machines for the manufacture of electronic components; machines for the production of electronic instruments; machines for use in the manufacture of electronic instruments; machines for use in the manufacture of electronic parts; machines for washing electronic components in chemicals; machines for washing electronic components in solvents; machines for the production of optical apparatus; machines for separating gas; paint spraying machines; dynamos; motors, other than for land vehicles; pumps [machines]; valves [parts of machines]; compressed air machines; pneumatic cylinder (part of machines); propulsion mechanisms, other than for land vehicles; bearings [parts of machines]; belts for machines; electric welding machines; electric machines and apparatus for cleaning; high pressure washers; vacuum cleaners; filter presses; electric shoe polishers; electroplating machines; electric door openers.

8 – Abrading instruments [hand instruments]; hand-operated agricultural implements; hand-operated garden tools; instruments and tools for skinning animals; harpoons; manicure sets; bits [parts of hand tools]; perforating tools [hand tools]; riveters [hand tools]; hand-operated lifting jacks; hand-operated guns for the extrusion of mastics; graving tools [hand tools]; trowels for mason; secateurs; sabres; table cutlery [knives, forks and spoons]; handles for hand-operated hand tools; hand-operated hand tools.

9 – Downloadable computer software programs for data management, for on-line shopping and for processing electronic payments to and from others; counters; apparatus to check franking; counterfeit coin detectors; ticket dispensers; voting machines; apparatus for scanning the retina for the security identification of persons; biometric identification apparatus; photocopyers [photographic, electrostatic, thermic]; weighing apparatus and instruments; measuring apparatus; electronic notice boards; navigational instruments; electronic video surveillance apparatus; cameras [photography]; surveying apparatus and instruments; levels [instruments for determining the horizontal]; speed checking apparatus for vehicles; pressure measuring apparatus; chemistry apparatus and instruments;

electric measuring devices; lasers, not for medical purposes; optical apparatus and instruments; materials for electricity mains [wires, cables]; semi-conductors; electronic chip cards; condensers [capacitors]; electric switches; electric couplings; electric plugs; control panels [electricity]; covers for electric outlets; video screens; remote control apparatus; optical fibers [light conducting filaments]; heat regulating apparatus; lightning rods; electrolyzers; fire extinguishing apparatus; radiological apparatus for industrial purposes; protection devices for personal use against accidents; clothing for protection against accidents, irradiation and fire; protective masks; gloves for protection against accidents; knee-pads for workers; electric theft prevention installations; electric locks; eyeglasses; electric batteries; chargers for electric batteries; animated cartoons; safety boots for industrial use; electric sockets; industrial contactor starters, electrical; ear plugs for divers; electric locks; biometric fingerprint door locks; industrial endoscope cameras; rearview cameras for vehicles; sensor; alarms; cabinets for loudspeakers; printers for use with computers; mobile power supplies, namely rechargeable batteries; tachographs; bathroom scales; remote control apparatus; computer network switches; computer network bridges; Internet router; radio receivers and transmitters; radio signal tuners; electric door bells; interphones; video phones; video monitor; air analysis apparatus; wireless routers; measures; rulers [measuring instruments]; tape measures.

11 – Electric lamps; lighting apparatus and installations; lighting tubes; lights for vehicles; germicidal lamps for purifying air; curling lamps; oil lamps; cooking apparatus and installations; lava rocks for use in barbecue grills; cooling appliances and installations; air purifying apparatus and machines; fans [air-conditioning]; electric hair dryers; electric heating apparatus; apparatus for producing fog; taps; pipes [parts of sanitary installations]; automatic watering installations; bath installations; sanitary apparatus and installations; water purification installations; electric radiators; lighters; light bulbs; searchlights; electric torches; refrigerating appliances and installations; air-conditioning installations; water purifying apparatus and machines; pocket warmers; air purifier for household purposes; electric water purifier for household purposes; humidifiers for household purposes; electric kettles; extractor hoods for kitchens; gas burners; heat guns; cocks for pipes and pipelines; disinfectant apparatus; electrically heated clothing.

35 – Advertising; online advertising on a computer network; business management assistance; organization of exhibitions for commercial or advertising purposes; commercial administration of the licensing of the goods and services of others; import-export agency services; sales promotion for others; procurement services for others [purchasing goods and services for other businesses]; personnel management consultan-

cy; relocation services for businesses; systemization of information into computer databases; office machines and equipment rental; book-keeping; rental of vending machines; sponsorship search; rental of sales stands; retail services for pharmaceutical, veterinary and sanitary preparations and medical supplies; wholesale services for pharmaceutical, veterinary and sanitary preparations and medical supplies; employment agency; commercial information agency services; marketing; provision of an online marketplace for buyers and sellers of goods and services.

(260) AM 2021 111492 A

(800) 1128353

(151) 2012 06 18

(891) 2020 11 25

(731) Farmak International Holding GmbH

Mariahilferstrasse 136, A-1150 Wien, Austria

(540)

ЭВКАЗОЛИН
EUCAZOLIN

(591) Black, white

(531) 28.05

(511)

5 – Medicines for human purposes.

(260) AM 2021 111493 A

(800) 1471179

(151) 2019 04 02

(891) 2020 12 10

(731) Jose Bay e.U.

DC Tower, Tür 2, 30. Stock, Donau-City-Straße
7, A-1220 Wien, Austria

(540)

Jobchain

(591) Black, white

(511)

9 – Computer software; software for mobile phones; mobile software; software for smartphones; business intelligence software; financial management software; databases (electronic); database server software; databases; computer database servers; database engines; interactive databases; databases.

42 – Certification of data via blockchain; data storage via blockchain; computer software design; software engineering; software development; design of information systems relating to finance; maintenance of data bases; development of data bases.

(260) AM 2021 111495 A

(800) 1540337

(151) 2020 06 09

(891) 2020 12 29

(731) RVL PHARMACEUTICALS, INC.

400 CROSSING BOULEVARD,
BRIDGEWATER NJ 08807, USA

(540)

UPNEEQ

(591) Black, white

(511)

5 – Ophthalmic pharmaceutical preparations.

(260) AM 2021 111560 A

(800) 1573644

(151) 2020 11 10

(891) 2020 11 10

(731) SP-LOGISTICS HOLDINGS LTD

Fitzroy House, Crown Street, Ipswich
IP1 3LG, United Kingdom

(540)



(591) Blue, white

(531) 01.05.24; 26.01.02; 27.03.12; 29.01.04

(511)

35 – Business management of logistics and clinical trials supply chains (by all modes of transport); tracking, tracing and control of inventory through computerized business systems for management of all types of logistics, transportation, warehousing and clinical trials; clinical trials logistics analytics and forecasting including utilization of big data.

36 – Customs brokerage.

39 – Delivery of goods including pharmaceuticals, medical equipment, materials for clinical trials; passenger transport; packaging and warehousing services; storage of goods including pharmaceuticals, medical equipment, materials for clinical trials; arranging the storage and arranging transportation of goods including pharmaceuticals, medical equipment, advanced therapy, other materials for clinical trials; packaging and storage services; packaging and labeling of goods.

42 – Scientific investigations for medical purposes; scientific research in the field of pharmacy; scientific and technological services and research and design relating thereto; industrial analysis and research services; conducting clinical trials; providing medical and scientific research information in the field of pharmaceuticals and clinical trials; computer progra-

mming; development of computer platforms including for clinical trials logistics, telemedicine, advance therapy; information technology [IT] consultancy; quality assurance and quality control consultancy; software as a service [SaaS].

44 – Hospital services; telemedicine services; dentistry, optometry and mental health services; medical clinic services and medical analysis services for diagnostic and treatment purposes provided by medical laboratories, such as x-ray examinations and taking of blood samples; therapy services, for example, physiotherapy and speech therapy; pharmacy advice and preparation of prescriptions by pharmacists; blood bank and human tissue bank services; convalescent home and rest home services.

(260) AM 2021 111561 A

(800) 1573655

(151) 2020 10 13

(891) 2020 10 13

(731) STADA Arzneimittel AG

Stadastr. 2-18, 61118 Bad Vilbel, Germany

(540)

VIRUSTAD

(591) Black, white

(511)

5 – Pharmaceuticals, medical and veterinary preparations; medicine; sanitary preparations for medical purposes; nasal rinse, nasal sprays; solutions for inhalation, gargling and nasal rinsing; dietetic food and substances adapted for medical or veterinary use, food for babies; dietary supplements for human beings and animals; plasters, materials for dressings; material for stopping teeth, dental wax; disinfectants; vermin destroying preparations; fungicides, herbicides.

10 – Inhalers; medical devices and apparatus; aerosol dispensers for medical purposes, containers for medicines, nebulisers for medical purposes.

(260) AM 2021 111562 A

(800) 1573748

(151) 2020 12 15

(891) 2020 12 15

(731) SOCIETE BIC

14 rue Jeanne d'Asnières, F-92110 CLICHY, France

(540)

DJEEP

(591) Black, white

(511)

34 – Lighters for smokers (not of precious metal); smokers' articles (not of precious metal).

(260) AM 2021 111563 A

(800) 1573762

(151) 2020 12 14

(891) 2020 12 14

(731) JOINT STOCK COMPANY "FATS AND OIL INTEGRATED WORKS"

UL. TITOVA 27, RU-620085

EKATERINBURG, SVERDLOVSKAYA

OBLAST, Russian Federation

(540)



(591) White, light blue, blue, dark blue and green

(531) 02.09.01; 25.01.15; 25.05.02; 26.01.03;

26.01.14; 26.01.24; 28.05; 29.01.13

(511)

30 – Mayonnaise; mayonnaise sauce.

(260) AM 2021 111564 A

(800) 1573821

(151) 2020 10 30

(891) 2020 10 30

(731) STADA Arzneimittel AG

Stadastr. 2-18, 61118 Bad Vilbel, Germany

(540)

ВируПротект ШТАДА

(591) Black, white

(531) 28.05

(511)

5 – Pharmaceutical preparations; medical and veterinary preparations; medicine; sanitary preparations for medical purposes; nasal rinsing, nasal sprays; solutions for nasal inhalation, gargling and rinsing; dietetic food and substances adapted for medical or veterinary use, food for babies; dietary supplements for humans and animals; plasters, materials for dressings; material for stopping teeth and dental wax; disinfectants; preparations for destroying vermin; fungicides, herbicides.

10 – Inhalers; medical devices and apparatus; aerosol dispensers for medical purposes; containers for administering pharmaceuticals, vaporizers for medical purposes.

(260) AM 2021 111574 A
 (800) 1411753
 (151) 2018 04 16
 (891) 2020 12 21
 (731) MOPRIA ALLIANCE, INC.
 5000 Executive Parkway, Suite 302,
 San Ramon CA 94583, USA

(540)

MOPRIA

(591) Black, white

(511)

9 – Downloadable software for mobile phones, portable devices, software for wireless printing; printers and multifunction electronic devices for use in copying, printing, scanning and/or transmitting documents and images.

38 – Telecommunication services, namely, transmission of data by wireless communication networks for printing.

42 – Computer software development in the field of mobile applications and technology; computer software consultancy services, namely, in the field of wireless printing; development of standards for computer software development.

(260) AM 2021 111622 A
 (800) 1574246
 (151) 2020 11 13
 (891) 2020 11 13
 (731) B.H. Lizenz GmbH
 Rosemeyerstraße 14, 44139 Dortmund, Germany

(540)



(591) Black, white

(531) 26.13.01; 27.05.01; 27.05.09

(511)

32 – Beer and non-alcoholic beverages; soft drinks; preparations for making beverages.

(260) AM 2021 111623 A
 (800) 1574284
 (151) 2020 11 30
 (891) 2020 11 30
 (731) "Sonkei" Limited Liability Company
 ul. Profsoyuznaya, d. 40/42, pom. 18-18a,
 Kazan, RU-420111 Republic of Tatarstan,
 Russian Federation

(540)

Sonkei

(591) Black, white

(531) 27.05.01

(511)

3 – Abrasives; amber [perfume]; descaling preparations for household purposes; antistatic preparations for household purposes; aromatics [essential oils]; air fragrancing preparations; cake flavorings [essential oils]; flavorings for beverages [essential oils]; food flavourings [essential oils]; breath freshening sprays; canned pressurized air for cleaning and dusting purposes; balms, other than for medical purposes; basma [cosmetic dye]; lip glosses; nail glitter; polishing stones; abrasive paper; emery paper; polishing paper; petroleum jelly for cosmetic purposes; shoe polish; cobblers' wax; cotton wool for cosmetic purposes; sachets for perfuming linen; drying agents for dish-washing machines; adhesives for cosmetic purposes; scented water; Javelle water; lavender water; toilet water; wax for parquet floors; floor wax; non-slipping wax for floors; depilatory wax; mustache wax; creams for leather; polish for furniture and flooring; shoemakers' wax; polishing wax; tailors' wax; massage gels, other than for medical purposes; heliotropine; dental bleaching gels; geraniol; make-up; deodorants for pets; deodorants for human beings or for animals; depilatories; air fragrance reed diffusers; scented wood; perfumes; non-slipping liquids for floors; windshield cleaning liquids; greases for cosmetic purposes; volcanic ash for cleaning; perfumery; decorative transfers for cosmetic purposes; ionone [perfumery]; shaving stones [astringents]; smoothing stones; eyebrow pencils; cosmetic pencils; silicon carbide [abrasive]; carbides of metal [abrasives]; alum stones [astringents]; Tripoli stone for polishing; adhesives for affixing false eyelashes; adhesives for affixing false hair; hair conditioners; quillaia bark for washing; corundum [abrasive]; beard dyes; colorants for toilet purposes; cosmetic dyes; laundry starch; laundry glaze; shoe cream; polishing creams; cosmetic creams; skin whitening creams; polishing rouge; incense; hair spray; nail polish; hair lotions; lotions for cosmetic purposes; after-shave lotions; beauty masks; oils for cleaning purposes; oils for perfumes and scents; oils for cosmetic purposes; oils for toilet purposes; essential oils; essential oils of cedarwood; essential oils of lemon; essential oils of citron; bergamot oil; gaultheria oil; jasmine oil; lavender oil; almond oil; rose oil; oil of turpentine for degreasing; whitening; cleaning chalk; almond milk for cosmetic purposes; cleansing milk for toilet purposes; musk [perfumery]; soap; deodorant soap; shaving soap; soap for brightening textile; cakes of toilet soap; antiperspirant soap; soap for foot perspiration; almond soap; mint for perfumery; cosmetic kits; emery; gel eye patches for cosmetic purposes; nail art stickers; false nails; eau de Cologne; bases for flower perfumes; joss sticks; pastes for razor strops; toothpaste; pumice stone; lipstick cases; hydrogen peroxide for cosmetic purposes; breath freshening strips; teeth whitening strips; abrasive cloth; glass cloth [ab-

rasive cloth]; lipsticks; pomades for cosmetic purposes; breath freshening preparations for personal hygiene; shaving preparations; bath preparations, not for medical purposes; cosmetic preparations for baths; hair straightening preparations; hair waving preparations; laundry soaking preparations; grinding preparations; smoothing preparations [starching]; color-removing preparations; leather bleaching preparations; polishing preparations; denture polishes; mouthwashes, not for medical purposes; cosmetic preparations for slimming purposes; starch glaze for laundry purposes; preparations to make the leaves of plants shiny; eye-washes, not for medical purposes; fabric softeners for laundry use; laundry bleach; dry-cleaning preparations; paint stripping preparations; lacquer-removing preparations; make-up removing preparations; floor wax removers [scouring preparations]; varnish-removing preparations; rust removing preparations; nail care preparations; cleaning preparations; preparations for cleaning dentures; wallpaper cleaning preparations; preparations for unblocking drain pipes; chemical cleaning preparations for household purposes; collagen preparations for cosmetic purposes; bleaching preparations [decolorants] for household purposes; laundry preparations; aloe vera preparations for cosmetic purposes; sunscreen preparations; color-brightening chemicals for household purposes [laundry]; shining preparations [polish]; make-up powder; diamantine [abrasive]; stain removers; nail varnish removers; vaginal washes for personal sanitary or deodorant purposes; scouring solutions; false eyelashes; tissues impregnated with cosmetic lotions; tissues impregnated with make-up removing preparations; baby wipes impregnated with cleaning preparations; saffrol; massage candles for cosmetic purposes; laundry blueing; turpentine for degreasing; potpourris [fragrances]; bleaching soda; washing soda, for cleaning; bath salts, not for medical purposes; bleaching salts; fumigation preparations [perfumes]; preservatives for leather [polishes]; ammonia [volatile alkali] [detergent]; astringents for cosmetic purposes; eyebrow cosmetics; make-up preparations; sun-tanning preparations [cosmetics]; hair dyes; neutralizers for permanent waving; cosmetic preparations for eyelashes; cosmetic preparations for skin care; shoe wax; cosmetics for animals; cosmetics for children; mascara; detergents, other than for use in manufacturing operations and for medical purposes; cleansers for intimate personal hygiene purposes, non medicated; douching preparations for personal sanitary or deodorant purposes [toilettries]; degreasers, other than for use in manufacturing processes; bleaching preparations [decolorants] for cosmetic purposes; toiletry preparations; antiperspirants [toilettries]; phytocosmetic preparations; talcum powder, for toilet use; cotton sticks for cosmetic purposes; terpenes [essential oils]; emery cloth; cloths impregnated with a detergent for cleaning; henna [cosmetic dye]; shampoos; shampoos for animals [non-medicated grooming preparations]; shampoos for pets

[non-medicated grooming preparations]; dry shampoos; sandpaper; soda lye; herbal extracts for cosmetic purposes; extracts of flowers [perfumes]; ethereal essences; badian essence; mint essence [essential oil].

5 – Acaricides; aconitine; alkaloids for medical purposes; alginates for pharmaceutical purposes; algicides; aldehydes for pharmaceutical purposes; dental amalgams of gold; dental amalgams; amino acids for veterinary purposes; amino acids for medical purposes; analgesics; anaesthetics; antibiotics; antiseptics; medicine cases, portable, filled; first-aid boxes, filled; aluminium acetate for pharmaceutical purposes; acetates for pharmaceutical purposes; germicides; balms for medical purposes; bandages for dressings; diagnostic biomarker reagents for medical purposes; biocides; bracelets impregnated with insect repellent; bromine for pharmaceutical purposes; paper for mustard plasters; fly catching paper; reagent paper for veterinary purposes; reagent paper for medical purposes; mothproofing paper; petroleum jelly for medical purposes; vaccines; oxygen baths; antiseptic cotton; aseptic cotton; absorbent cotton; wadding for medical purposes; cotton for medical purposes; dietetic substances adapted for medical use; radiological contrast substances for medical purposes; nutritive substances for microorganisms; radioactive substances for medical purposes; bismuth subnitrate for pharmaceutical purposes; melissa water for pharmaceutical purposes; sea water for medicinal bathing; mineral waters for medical purposes; thermal water; dietary fiber; molding wax for dentists; gases for medical purposes; guaiacol for pharmaceutical purposes; sexual stimulant gels; hematogen; hemoglobin; hydrastine; hydrastinine; glycerine for medical purposes; glycerophosphates; glucose for medical purposes; gentian for pharmaceutical purposes; hormones for medical purposes; mustard for pharmaceutical purposes; mustard plasters; mud for baths; medicinal mud; gamboge for medical purposes; gurjun balsam for medical purposes; disinfectants; deodorants, other than for human beings or for animals; air deodorising preparations; deodorants for clothing and textiles; diastase for medical purposes; digitalin; vitamin supplement patches; mineral food supplements; nutritional supplements; albumin dietary supplements; dietary supplements for animals; yeast dietary supplements; alginate dietary supplements; glucose dietary supplements; casein dietary supplements; lecithin dietary supplements; linseed oil dietary supplements; propolis dietary supplements; protein dietary supplements; protein supplements for animals; royal jelly dietary supplements; pollen dietary supplements; wheat germ dietary supplements; linseed dietary supplements; acai powder dietary supplements; dietary supplements with a cosmetic effect; enzyme dietary supplements; yeast for pharmaceutical purposes; gelatine for medical purposes; cod liver oil; isotopes for medical purposes; immunostimulants; insecticides; iodine for pharmaceutical purposes; iodides for pharmaceutical purposes;

alkaline iodides for pharmaceutical purposes; iodoform; calomel [fungicide]; cream of tartar for pharmaceutical purposes; tartar for pharmaceutical purposes; camphor for medical purposes; capsules for medicines; cachets for pharmaceutical purposes; capsules made of dendrimer-based polymers, for pharmaceuticals; hemostatic pencils; wart pencils; caustic pencils; carbolineum [parasiticide]; caustics for pharmaceutical purposes; cachou for pharmaceutical purposes; quassia for medical purposes; quebracho for medical purposes; oxygen for medical purposes; gallic acid for pharmaceutical purposes; acids for pharmaceutical purposes; adhesives for dentures; surgical glues; stem cells for veterinary purposes; stem cells for medical purposes; cocaine; collagen for medical purposes; collodion for pharmaceutical purposes; corn rings for the feet; medicated candies; angostura bark for medical purposes; barks for pharmaceutical purposes; cedar wood for use as an insect repellent; condurango bark for medical purposes; croton bark; mangrove bark for pharmaceutical purposes; myrobalan bark for pharmaceutical purposes; quinquina for medical purposes; medicated animal feed; medicinal roots; rhubarb roots for pharmaceutical purposes; lint for medical purposes; starch for dietetic or pharmaceutical purposes; creosote for pharmaceutical purposes; blood for medical purposes; cultures of microorganisms for medical or veterinary use; curare; dental lacquer; liquorice for pharmaceutical purposes; lactose for pharmaceutical purposes; crystallized rock sugar for medical purposes; adhesive plasters; medicines for alleviating constipation; adhesive tapes for medical purposes; lecithin for medical purposes; lotions for veterinary purposes; medicated hair lotions; lotions for pharmaceutical purposes; medicated after-shave lotions; personal sexual lubricants; lupulin for pharmaceutical purposes; magnesia for pharmaceutical purposes; liniments; frostbite salve for pharmaceutical purposes; ointments for pharmaceutical purposes; sunburn ointments; mercurial ointments; gauze for dressings; medicinal oils; mustard oil for medical purposes; camphor oil for medical purposes; castor oil for medical purposes; oil of turpentine for pharmaceutical purposes; dill oil for medical purposes; dental mastics; dental abrasives; dental impression materials; teeth filling material; dressings, medical; surgical dressings; drugs for medical purposes; medicines for veterinary purposes; serotherapeutic medicines; medicines for human purposes; medicines for dental purposes; menthol; medicinal drinks; moleskin for medical purposes; almond milk for pharmaceutical purposes; powdered milk for babies; royal jelly for pharmaceutical purposes; milk ferments for pharmaceutical purposes; irish moss for medical purposes; flour for pharmaceutical purposes; linseed meal for pharmaceutical purposes; fish meal for pharmaceutical purposes; fly glue; antibacterial soap; disinfectant soap; medicated soap; freeze-dried meat adapted for medical purposes; mint for pharmaceutical purposes; dietetic beverages

adapted for medical purposes; malted milk beverages for medical purposes; injectable dermal fillers; narcotics; medicinal infusions; tincture of iodine; eucalyptol for pharmaceutical purposes; tinctures for medical purposes; opium; opodeldoc; decoctions for pharmaceutical purposes; antiparasitic collars for animals; cotton sticks for medical purposes; stick liquorice for pharmaceutical purposes; sulfur sticks [disinfectants]; pastilles for pharmaceutical purposes; medicated toothpaste; pectin for pharmaceutical purposes; pepsins for pharmaceutical purposes; peptones for pharmaceutical purposes; hydrogen peroxide for medical purposes; pesticides; food for babies; leeches for medical purposes; blood plasma; nicotine patches for use as aids to stop smoking; eyepatches for medical purposes; poultices; compresses; scapulars for surgical purposes; babies' diapers; diapers for pets; diapers for incontinence; breast-nursing pads; bunion pads; pomades for medical purposes; powder of cantharides; pyrethrum powder; chilblain preparations; mothproofing preparations; anti-uric preparations; bacterial preparations for medical and veterinary use; bacteriological preparations for medical and veterinary use; balsamic preparations for medical purposes; albuminous preparations for medical purposes; biological preparations for veterinary purposes; biological preparations for medical purposes; veterinary preparations; bismuth preparations for pharmaceutical purposes; vitamin preparations; diagnostic preparations for veterinary purposes; diagnostic preparations for medical purposes; douching preparations for medical purposes; bath preparations for medical purposes; therapeutic preparations for the bath; hemorrhoid preparations; preparations for callouses; lice treatment preparations [pediculicides]; acne treatment preparations; preparations to facilitate teething; preparations for the treatment of burns; fumigation preparations for medical purposes; opotherapy preparations; air purifying preparations; bronchodilating preparations; preparations for reducing sexual activity; sterilising preparations; soil-sterilising preparations; corn remedies; pharmaceutical preparations for treating dandruff; preparations for destroying noxious animals; preparations for destroying noxious plants; preparations for destroying dry rot fungus; larvae exterminating preparations; fly destroying preparations; preparations for destroying mice; slug exterminating preparations; vermin destroying preparations; pharmaceutical preparations for skin care; contact lens cleaning preparations; lime-based pharmaceutical preparations; preparations of microorganisms for medical or veterinary use; styptic preparations; medicated eye-washes; medicinal hair growth preparations; nutraceutical preparations for therapeutic or medical purposes; opiates; anticryptogamic preparations; aloe vera preparations for pharmaceutical purposes; preparations of trace elements for human and animal use; sulfonamides [medicines]; pharmaceutical preparations; pharmaceutical preparations for treating sunburn; enzyme preparations for

veterinary purposes; enzyme preparations for medical purposes; phytotherapy preparations for medical purposes; chemico-pharmaceutical preparations; chemical preparations for veterinary purposes; chemical preparations for the diagnosis of pregnancy; chemical preparations for medical purposes; chemical preparations for treating diseases affecting cereal plants; chemical preparations for treating wheat blight; chemical preparations for treating diseases affecting vine plants; chemical preparations for treating mildew; chemical preparations for treating phylloxera; chemical preparations for pharmaceutical purposes; collyrium; lead water; chemical conductors for electrocardiograph electrodes; albuminous foodstuffs for medical purposes; dietetic foods adapted for medical purposes; by-products of the processing of cereals for dietetic or medical purposes; homogenized food adapted for medical purposes; freeze-dried food adapted for medical purposes; pharmaceuticals; sanitary towels; panty liners [sanitary]; propolis for pharmaceutical purposes; pearl powder for medical purposes; radium for medical purposes; solvents for removing adhesive plasters; hydrated chloral for pharmaceutical purposes; vaginal washes for medical purposes; solutions for contact lenses; chemical reagents for medical or veterinary purposes; gum for medical purposes; rubber for dental purposes; chewing gum for medical purposes; nicotine gum for use as an aid to stop smoking; insect repellents; insect repellent incense; repellents for dogs; tissues impregnated with pharmaceutical lotions; sarsaparilla for medical purposes; sugar for medical purposes; asthmatic tea; fumigating sticks; massage candles for therapeutic purposes; suppositories; linseed for pharmaceutical purposes; tobacco-free cigarettes for medical purposes; siccatives [drying agents] for medical purposes; syrups for pharmaceutical purposes; turpentine for pharmaceutical purposes; milking grease; greases for veterinary purposes; greases for medical purposes; lacteal flour for babies; infant formula; soporifics; bicarbonate of soda for pharmaceutical purposes; mineral water salts; bath salts for medical purposes; salts for mineral water baths; salts for medical purposes; potassium salts for medical purposes; sodium salts for medical purposes; smelling salts; malt for pharmaceutical purposes; semen for artificial insemination; alcohol for pharmaceutical purposes; medicinal alcohol; alloys of precious metals for dental purposes; ergot for pharmaceutical purposes; cooling sprays for medical purposes; digestives for pharmaceutical purposes; nervines; antibacterial handwashes; adjuvants for medical purposes; astringents for medical purposes; vermifuges; disinfectants for hygiene purposes; disinfectants for chemical toilets; appetite suppressants for medical purposes; medical preparations for slimming purposes; parasiticides; mouthwashes for medical purposes; febrifuges; depuratives; animal washes [insecticides]; detergents for medical purposes; cattle washes [insecticides]; dog washes [insecticides]; insecticidal veteri-

nary washes; vesicants; purgatives; chemical contraceptives; antiparasitic preparations; remedies for foot perspiration; sedatives; laxatives; tonics [medicines]; medicated toiletry preparations; media for bacteriological cultures; steroids; strychnine; serums; antioxidant pills; tanning pills; appetite suppressant pills; slimming pills; jujube, medicated; sanitary tampons; vulnery sponges; thymol for pharmaceutical purposes; biological tissue cultures for veterinary purposes; smoking herbs for medical purposes; medicinal herbs; transplants [living tissues]; surgical implants comprised of living tissues; babies' diaper-pants; pants, absorbent, for incontinence; sanitary panties; charcoal for pharmaceutical purposes; fennel for medical purposes; porcelain for dental prostheses; phenol for pharmaceutical purposes; enzymes for veterinary purposes; enzymes for medical purposes; ferments for pharmaceutical purposes; formic aldehyde for pharmaceutical purposes; phosphates for pharmaceutical purposes; fungicides; quinine for medical purposes; chinoline for medical purposes; diabetic bread adapted for medical use; chloroform; flowers of sulfur for pharmaceutical purposes; cement for animal hooves; bone cement for surgical and orthopaedic purposes; dental cements; medicinal tea; herbal teas for medicinal purposes; insecticidal animal shampoos; medicated shampoos; medicated shampoos for pets; pediculicidal shampoos; medicated dry shampoos; pre-filled syringes for medical purposes; eucalyptus for pharmaceutical purposes; herbal extracts for medical purposes; plant extracts for pharmaceutical purposes; tobacco extracts [insecticides]; extracts of hops for pharmaceutical purposes; elixirs [pharmaceutical preparations]; ethers for pharmaceutical purposes; esters for pharmaceutical purposes; cellulose esters for pharmaceutical purposes; cellulose ethers for pharmaceutical purposes; rat poison; poisons; bacterial poisons; jalap.

10 – Analysers for bacterial identification for medical purposes; cholesterol meters; blood testing apparatus; testing apparatus for medical purposes; anaesthetic apparatus; galvanic therapeutic appliances; apparatus for artificial respiration; apparatus for the treatment of deafness; physical exercise apparatus for medical purposes; body rehabilitation apparatus for medical purposes; dental apparatus and instruments; surgical apparatus and instruments; resuscitation apparatus; dental apparatus, electric; physiotherapy apparatus; bed vibrators; hot air therapeutic apparatus; diagnostic apparatus for medical purposes; traction apparatus for medical purposes; radiotherapy apparatus; microdermabrasion apparatus; fumigation apparatus for medical purposes; apparatus for the regeneration of stem cells for medical purposes; apparatus for DNA and RNA testing for medical purposes; apparatus and installations for the production of X-rays, for medical purposes; magnetic resonance imaging [MRI] apparatus for medical purposes; orthodontic appliances; radiological apparatus for medical purposes; X-ray

apparatus for medical purposes; hearing aids; nasal aspirators; hernia bandages; maternity belts; bandages, elastic; cupping glasses; biomagnetic rings for therapeutic or medical purposes; dental burs; acupressure bands; bracelets for medical purposes; anti-rheumatism bracelets; anti-nausea wristbands; feeding bottles; air cushions for medical purposes; vaporizers for medical purposes; hot air vibrators for medical purposes; vibromassage apparatus; gastroscopes; hemocytometers; glucometers; lice combs; surgical sponges; defibrillators; dialyzers; containers especially made for medical waste; clips, surgical; mirrors for dentists; mirrors for surgeons; probes for medical purposes; urethral probes; artificial teeth; acupuncture needles; suture needles; needles for medical purposes; orthopedic articles; pill crushers; biodegradable bone fixation implants; surgical implants comprised of artificial materials; inhalers; hydrogen inhalers; injectors for medical purposes; incubators for medical purposes; incubators for babies; obstetric apparatus; obstetric apparatus for cattle; electric acupuncture instruments; surgical cutlery; insufflators; endoscopy cameras for medical purposes; cannulae; droppers for medical purposes; dropper bottles for medical purposes; heart rate monitoring apparatus; heart pacemakers; catheters; catgut; draw-sheets for sick beds; enema apparatus for medical purposes; clips for dummies; artificial skin for surgical purposes; menstrual cups; teething rings; anti-rheumatism rings; compressors [surgical]; thermo-electric compresses [surgery]; abdominal corsets; corsets for medical purposes; crutches; dentists' armchairs; armchairs for medical or dental purposes; beds specially made for medical purposes; waterbeds for medical purposes; air beds for medical purposes; feeding bottle valves; love dolls [sex dolls]; lasers for medical purposes; lamps for medical purposes; curing lamps for medical purposes; quartz lamps for medical purposes; ultraviolet ray lamps for medical purposes; lancets; lenses [intraocular prostheses] for surgical implantation; spoons for administering medicine; masks for use by medical personnel; respiratory masks for artificial respiration; anaesthetic masks; therapeutic facial masks; gum massagers for babies; suture materials; childbirth mattresses; air mattresses for medical purposes; furniture especially made for medical purposes; water bags for medical purposes; douche bags; breast pumps; body fat monitors; body composition monitors; urinals being vessels; portable hand-held urinals; teeth protectors for dental purposes; temperature indicator labels for medical purposes; knee bandages, orthopedic; tips for crutches; finger guards for medical purposes; medical guidewires; pumps for medical purposes; thread, surgical; knives for surgical purposes; scissors for surgery; ambulance stretchers; stretchers, wheeled; boots for medical purposes; orthopedic footwear; clothing especially for operating rooms; compression garments; blankets, electric, for medical purposes; supports for flat feet; ophthalmometers; ophthalmos-

copies; cooling pads for first aid purposes; slings [supporting bandages]; gloves for massage; gloves for medical purposes; pessaries; saws for surgical purposes; ear picks; cooling patches for medical purposes; spittoons for medical purposes; plaster bandages for orthopedic purposes; supportive bandages; suspensory bandages; abdominal pads; heating cushions, electric, for medical purposes; cushions for medical purposes; pads for preventing pressure sores on patient bodies; air pillows for medical purposes; soporific pillows for insomnia; abdominal belts; galvanic belts for medical purposes; hypogastric belts; belts for medical purposes; orthopedic belts; umbilical belts; belts, electric, for medical purposes; condoms; aerosol dispensers for medical purposes; sphygmomanometers; pulse meters; esthetic massage apparatus; massage apparatus; veterinary apparatus and instruments; medical apparatus and instruments; urological apparatus and instruments; brushes for cleaning body cavities; patient hoists; appliances for washing body cavities; corn knives; incontinence sheets; sterile sheets, surgical; surgical drapes; hair prostheses; artificial eyes; artificial breasts; sets of artificial teeth; artificial limbs; artificial jaws; ice bags for medical purposes; toe separators for orthopaedic purposes; surgical bougies; orthodontic rubber bands; X-ray photographs for medical purposes; respirators for artificial respiration; surgical robots; ear trumpets; strait jackets; sex toys; scalpels; tongue scrapers; dummies for babies; feeding bottle teats; baby feeding pacifiers; receptacles for applying medicines; spirometers [medical apparatus]; vaginal syringes; implantable subcutaneous drug delivery devices; hearing protectors; contraceptives, non-chemical; orthopedic soles; stents; stethoscopes; operating tables; commode chairs; basins for medical purposes; bed pans; instrument cases for use by doctors; arch supports for footwear; ear plugs [ear protection devices]; thermal packs for first aid purposes; thermometers for medical purposes; tomographs for medical purposes; trocars; walking sticks for medical purposes; quad canes for medical purposes; drainage tubes for medical purposes; X-ray tubes for medical purposes; radium tubes for medical purposes; balling guns; protection devices against X-rays, for medical purposes; apparatus for acne treatment; filters for ultraviolet rays, for medical purposes; patient examination gowns; wheeled walkers to aid mobility; walking frames for disabled persons; cases fitted for medical instruments; stockings for varices; elastic stockings for surgical purposes; splints, surgical; tongue depressors for medical purposes; syringes for injections; syringes for medical purposes; hypodermic syringes; uterine syringes; urethral syringes; pins for artificial teeth; castrating pincers; forceps; robotic exoskeleton suits for medical purposes; radiology screens for medical purposes; electrodes for medical use; electrocardiographs; brain pacemakers.

16 – Fountain pens; watercolors [paintings]; albums; almanacs; document laminators for office use; mi-

meograph apparatus and machines; atlases; posters; banknotes; banners of paper; paper bows, other than haberdashery or hair decorations; name badges [office requisites]; table linen of paper; tickets; baggage claim check tags of paper; forms, printed; announcement cards [stationery]; glitter for stationery purposes; note books; pads [stationery]; drawing pads; wristbands for the retention of writing instruments; pamphlets; booklets; paper; paper sheets [stationery]; waxed paper; paper for medical examination tables; paper for recording machines; paper for radiograms; papers for painting and calligraphy; electrocardiograph paper; drawer liners of paper, perfumed or not; wood pulp paper; carbon paper; copying paper [stationery]; parchment paper; writing paper; rice paper; luminous paper; toilet paper; wrapping paper; filter paper; wash; blotters; newsletters; rollers for typewriters; house painters' rollers; composing sticks; modelling wax, not for dental purposes; signboards of paper or cardboard; sewing patterns; bunting of paper; newspapers; electrotypes; hectographs; modelling clay; polymer modelling clay; terrestrial globes; drawing sets; engravings; slate pencils; pencil leads; document holders [stationery]; pencil holders; chalk holders; holders for cheque books; holders for stamps [seals]; page holders; name badge holders [office requisites]; diagrams; table runners of paper; advertisement boards of paper or cardboard; engraving plates; writing slates; blackboards; galley racks [printing]; drawing boards; duplicators; punches [office requisites]; cream containers of paper; magazines [periodicals]; money clips; clips for name badge holders [office requisites]; tags for index cards; pen clips; bookmarkers; etching needles; tracing needles for drawing purposes; periodicals; printed publications; paper shredders for office use; graphic representations; credit card imprinters, non-electric; graining combs; drawing instruments; calendars; tracing paper; tracing cloth; tracing patterns; gums [adhesives] for stationery or household purposes; lithographic stones; ink stones [ink reservoirs]; pencils; pencil lead holders; charcoal pencils; pictures; transfers [decalcomanias]; paintings [pictures], framed or unframed; cardboard; wood pulp board [stationery]; hat boxes of cardboard; cards; index cards [stationery]; geographical maps; paper tapes and cards for the recordal of computer programmes; trading cards, other than for games; perforated cards for Jacquard looms; catalogues; spools for inking ribbons; covers of paper for flower pots; paintbrushes; painters' brushes; writing brushes; typewriter keys; glue for stationery or household purposes; gluten [glue] for stationery or household purposes; isinglass for stationery or household purposes; starch paste [adhesive] for stationery or household purposes; printing blocks; books; comic books; manifolds [stationery]; drawing pins; cigar bands; envelopes [stationery]; boxes of paper or cardboard; cases for stamps [seals]; paint boxes for use in schools; correcting fluids [office requisites]; printed coupons; stencils [stationery];

French curves; paper ribbons, other than haberdashery or hair decorations; typewriter ribbons; barcode ribbons; gummed tape [stationery]; adhesive bands for stationery or household purposes; correcting tapes [office requisites]; inking ribbons; adhesive tapes for stationery or household purposes; self-adhesive tapes for stationery or household purposes; square rulers for drawing; drawing rulers; flyers; absorbent sheets of paper or plastic for foodstuff packaging; humidity control sheets of paper or plastic for foodstuff packaging; viscose sheets for wrapping; sheets of reclaimed cellulose for wrapping; plastic bubble packs for wrapping or packaging; steel letters; type [numerals and letters]; lithographs; letter trays; paint trays; architects' models; postage stamps; plastics for modelling; graphic prints; modelling materials; teaching materials [except apparatus]; sealing compounds for stationery purposes; adhesives [glues] for stationery or household purposes; stuffing of paper or cardboard; bookbinding material; packing [cushioning, stuffing] materials of paper or cardboard; packaging material made of starches; filtering materials of paper; tablemats of paper; addressing machines; pencil sharpening machines, electric or non-electric; bookbinding apparatus and machines [office equipment]; typewriters, electric or non-electric; paper creasers [office requisites]; franking machines for office use; spray chalk; chalk for lithography; writing chalk; tailors' chalk; marking chalk; bags [envelopes, pouches] of paper or plastics, for packaging; garbage bags of paper or of plastics; plastic bags for pet waste disposal; painters' easels; hand-rests for painters; printing sets, portable [office requisites]; bibs of paper; bibs, sleeved, of paper; stickers [stationery]; finger-stalls [office requisites]; writing cases [stationery]; cords for bookbinding; paper knives [letter openers]; printed sheet music; numbering apparatus; bottle envelopes of paper or cardboard; sealing wafers; covers [stationery]; passport holders; plastic cling film, extensible, for palletization; embroidery designs [patterns]; handwriting specimens for copying; oleographs; musical greeting cards; greeting cards; postcards; etchings; conical paper bags; paper bags for use in the sterilization of medical instruments; bags for microwave cooking; palettes for painters; ink sticks; pantographs [drawing instruments]; files [office requisites]; folders for papers; loose-leaf binders; papier mâché; pastels [crayons]; modelling paste; pen cases; pen wipers; office perforators; pens [office requisites]; nibs of gold; nibs; steel pens; drawing pens; song books; seals [stamps]; sealing stamps; clipboards; address plates for addressing machines; handkerchiefs of paper; plastic film for wrapping; desk mats; trays for sorting and counting money; coasters of paper; bookends; stamp stands; mats for beer glasses; stands for pens and pencils; photograph stands; obliterating stamps; inking pads; stamp pads; binding strips [bookbinding]; towels of paper; inking sheets for document reproducing machines; inking sheets for duplicators;

bookbinding cloth; gummed cloth for stationery purposes; printers' blankets, not of textile; portraits; paperweights; writing cases [sets]; inkstands; office requisites, except furniture; writing materials; writing instruments; drawing materials; school supplies [stationery]; adhesive tape dispensers [office requisites]; hand labelling appliances; printed matter; lithographic works of art; prospectuses; printed timetables; ledgers [books]; printers' reglets; indexes; paper cutters [office requisites]; rubber erasers; elastic bands for offices; T-squares for drawing; graphic reproductions; retractable reels for name badge holders [office requisites]; penholders; marking pens [stationery]; tissues of paper for removing make-up; paper wipes for cleaning; dental tray covers of paper; face towels of paper; place mats of paper; table napkins of paper; tablecloths of paper; paper clasps; document files [stationery]; scrapers [erasers] for offices; paper-clips; staples for offices; erasing products; biological samples for use in microscopy [teaching materials]; histological sections for teaching purposes; figurines of papier mâché; statuettes of papier mâché; steatite [tailor's chalk]; writing board erasers; composing frames [printing]; sealing wax; arithmetical tables; placards of paper or cardboard; writing or drawing books; fabrics for bookbinding; stationery; pencil sharpeners, electric or non-electric; transparencies [stationery]; stencil plates; stencils for decorating food and beverages; cardboard tubes; Indian inks; moisteners [office requisites]; moisteners for gummed surfaces [office requisites]; squares for drawing; chart pointers, non-electronic; bottle wrappers of paper or cardboard; envelope sealing machines for offices; sealing machines for offices; vignetting apparatus; apparatus for mounting photographs; stapling presses [office requisites]; manuals [handbooks]; paper coffee filters; flags of paper; silver paper; molds for modelling clays [artists' materials]; photo-engravings; photographs [printed]; stencil cases; canvas for painting; chromolithographs [chromos]; animation cels; compasses for drawing; numbers [type]; artists' watercolor saucers; ink; correcting ink [heliography]; inkwells; blueprints; stencils; erasing shields; balls for ball-point pens; desktop cabinets for stationery [office requisites]; printing type; address stamps; stamps [seals]; shields [paper seals]; prints [engravings]; labels of paper or cardboard.

25 – Wimples; bandanas [neckerchiefs]; underwear; sweat-absorbent underwear; berets; overalls; boas [necklets]; teddies [underclothing]; boxer shorts; ankle boots; ski boots; boots for sports; breeches for wear; trousers; football shoes; brassieres; valenki [felted boots]; mittens; collars [clothing]; detachable collars; shirt yokes; veils [clothing]; gabardines [clothing]; galoshes; neckties; ascots; leggings [leg warmers]; gaiters; boot uppers; corselets; jerseys [clothing]; vests; sports jerseys; hosiery; heels; hoods [clothing]; hat frames [skeletons]; pockets for clothing; scarfs; caps being headwear; kimonos; visors being headwear; cap peaks; tights; slips [underclothing]; combi-

nations [clothing]; wet suits for water-skiing; bodices [lingerie]; corsets [underclothing]; suits; bathing suits; masquerade costumes; beach clothes; leotards; jackets [clothing]; stuff jackets [clothing]; fishing vests; leggings [trousers]; liveries; camisoles; sports singlets; cuffs; short-sleeve shirts; mantillas; coats; sleep masks; furs [clothing]; fingerless gloves; miters [hats]; muffs [clothing]; footmuffs, not electrically heated; bibs, not of paper; bibs, sleeved, not of paper; fur stoles; hairdressing capes; heel protectors for shoes; ear muffs [clothing]; socks; sweat-absorbent socks; footwear; beach shoes; sports shoes; clothing; clothing containing slimming substances; paper clothing; outerclothing; embroidered clothing; ready-made clothing; motorists' clothing; cyclists' clothing; clothing for gymnastics; clothing of imitations of leather; clothing of leather; waterproof clothing; uniforms; fittings of metal for footwear; maniples; overcoats; panties; knickers; parkas; pelerines; gloves [clothing]; ski gloves; pajamas; bathing trunks; shirt fronts; pocket squares; dresses; headbands [clothing]; garters; sock suspenders; stocking suspenders; ready-made linings [parts of clothing]; dress shields; soles for footwear; heelpieces for footwear; braces for clothing [suspenders]; half-boots; lace boots; ponchos; money belts [clothing]; girdles; belts [clothing]; layettes [clothing]; non-slipping devices for footwear; sweaters; pullovers; jumpers [pullovers]; heelpieces for stockings; welts for footwear; chasubles; shirts; wooden shoes; sandals; bath sandals; boots; jumper dresses; saris; sarongs; footwear uppers; inner soles; albs; bath slippers; togas; knitwear [clothing]; underpants; shoes; gymnastic shoes; slippers; skull caps; turbans; headwear; aprons [clothing]; judo uniforms; karate uniforms; tee-shirts; dressing gowns; bath robes; top hats; tips for footwear; stockings; sweat-absorbent stockings; shawls; paper hats [clothing]; shower caps; bathing caps; studs for football boots; hats; babies' pants [underwear]; trouser straps; pelisses; esparto shoes or sandals; skirts; skorts; petticoats.

28 – Arcade video game machines; video game machines; gaming machines for gambling; amusement machines, automatic and coin-operated; toy vehicles; swimming pools [play articles]; trampolines; novelty toys for parties; scratch cards for playing lottery games; starting blocks for sports; bodyboards; skating boots with skates attached; boomerangs; dolls' feeding bottles; tricycles for infants [toys]; stationary exercise bicycles; creels [fishing traps]; shuttlecocks; spinning tops [toys]; dumb-bells; gyroscopes and flight stabilizers for model aircraft; jigsaw puzzles; clay pigeons [targets]; punching bags; bite sensors [fishing tackle]; hang gliders; joysticks for video games; flying discs [toys]; discuses for sports; dolls' houses; dominoes; swimming kickboards; paddleboards; surfboards; spring boards [sports articles]; skateboards; sailboards; chessboards; checkerboards; drones [toys]; darts; Christmas trees of synthetic material; cups for dice; swimming jackets; ascenders [mountaineering

equipment]; kites; needles for pumps for inflating balls for games; toys; toys for pets; stuffed toys; inflatable games for swimming pools; plush toys; toy mobiles; novelty toys for playing jokes; games; building games; portable games and toys incorporating telecommunication functions; parlor games; board games; ring games; toy imitation cosmetics; swimming pool air floats; kaleidoscopes; bladders of balls for games; rosin used by athletes; edges of skis; trading cards for games; bingo cards; playing cards; fair-ground ride apparatus; reels for fishing; rocking horses; swings; yoga swings; surf skis; skittles; skittles [games]; billiard cues; golf clubs; hockey sticks; baby gyms; seal skins [coverings for skis]; bells for Christmas trees; dolls' rooms; controllers for game consoles; controllers for toys; confetti; ice skates; roller skates; in-line roller skates; dice; paintball guns [sports apparatus]; ski bindings; dolls' beds; roulette wheels; fish hooks; building blocks [toys]; dolls; flippers for diving; flippers for swimming; swimming webs; webbed gloves for swimming; rhythmic gymnastics ribbons; fishing lines; gut for fishing; bows for archery; skis; waterskis; roller skis; mah-jong; toy models; hunting game calls; marionettes; masks [playthings]; carnival masks; theatrical masks; fencing masks; toy putty; matryoshka dolls; masts for sailboards; ball pitching machines; teddy bears; chalk for billiard cues; targets; electronic targets; scale model kits [toys]; scale model vehicles; kite reels; balls for games; artificial fishing bait; billiard table cushions; knee guards [sports articles]; billiard cue tips; elbow guards [sports articles]; backgammon games; pumps specially adapted for use with balls for games; dolls' clothes; fencing weapons; play tents; ski poles for roller skis; ski poles; twirling batons; paragliders; pachinkos; baseball gloves; boxing gloves; golf gloves; gloves for games; batting gloves [accessories for games]; fencing gauntlets; piñatas; toy pistols; toy air pistols; percussion caps [toys]; caps for pistols [toys]; toy dough; protective films adapted for screens for portable games; rattles [playthings]; horseshoe games; candle holders for Christmas trees; Christmas tree stands; sole coverings for skis; water wings; floats for fishing; portable games with liquid crystal displays; swimming belts; waist trimmer exercise belts; decoys for hunting or fishing; scent lures for hunting or fishing; archery implements; soap bubbles [toys]; divot repair tools [golf accessories]; billiard markers; video game consoles; hand-held consoles for playing video games; protective paddings [parts of sports suits]; rackets; surfboard leashes; harness for sailboards; weight lifting belts [sports articles]; toy robots; sling shots [sports articles]; rollers for stationary exercise bicycles; harpoon guns [sports articles]; plush toys with attached comfort blanket; scooters [toys]; sleds [sports articles]; bob-sleighs; butterfly nets; landing nets for anglers; nets for sports; tennis nets; bite indicators [fishing tackle]; slot machines [gaming machines]; appliances for gymnastics; quoits; bar-bells; climbers'

harness; fishing tackle; artificial snow for Christmas trees; snowshoes; snowboards; remote-controlled toy vehicles; clay pigeon traps; billiard tables; coin-operated billiard tables; tables for table tennis; strings for rackets; gut for rackets; golf bag carts; golf bags, with or without wheels; cricket bags; slides [playthings]; body-building apparatus; machines for physical exercises; men's athletic supporters [sports articles]; rods for fishing; ornaments for Christmas trees, except lights, candles and confectionery; tennis ball throwing apparatus; conjuring apparatus; apparatus for games; bowling apparatus and machinery; toy figures; counters [discs] for games; chips for gambling; foosball tables; Christmas crackers [party novelties]; party poppers [party novelties]; bags especially designed for skis and surfboards; marbles for games; billiard balls; playing balls; play balloons; paintballs [ammunition for paintball guns] [sports apparatus]; snow globes; chess games; checkers [games]; poles for pole vaulting; paper party hats; shin guards [sports articles]; camouflage screens [sports articles]; chest expanders [exercisers].

35 – Arranging subscriptions to telecommunication services for others; import-export agency services; commercial information agency services; advertising agency services; cost price analysis; rental of office equipment in co-working facilities; rental of advertising space; business auditing; financial auditing; business intermediary services relating to the matching of potential private investors with entrepreneurs needing funding; employment agency services; computerized file management; book-keeping; invoicing; demonstration of goods; transcription of communications [office functions]; opinion polling; market studies; business information; providing commercial information and advice for consumers in the choice of products and services; business investigations; business research; marketing research; personnel recruitment; consultancy regarding advertising communication strategies; consultancy regarding public relations communication strategies; business management and organization consultancy; business organization consultancy; business management consultancy; personnel management consultancy; professional business consultancy; layout services for advertising purposes; marketing; marketing in the framework of software publishing; targeted marketing; business management of performing artists; business management of sports people; writing of résumés for others; scriptwriting for advertising purposes; news clipping services; updating and maintenance of information in registries; updating and maintenance of data in computer databases; updating of advertising material; word processing; online retail services for downloadable and pre-recorded music and movies; online retail services for downloadable ring tones; online retail services for downloadable digital music; organization of exhibitions for commercial or advertising purposes; arranging newspaper subscriptions for others; organization of

fashion shows for promotional purposes; organisation of trade fairs for commercial or advertising purposes; shop window dressing; business appraisals; payroll preparation; data search in computer files for others; sponsorship search; administrative assistance in responding to calls for tenders; business management assistance; commercial or industrial management assistance; commercial intermediation services; providing business information via a web site; providing commercial and business contact information; provision of an online marketplace for buyers and sellers of goods and services; web indexing for commercial or advertising purposes; presentation of goods on communication media, for retail purposes; media relations services; economic forecasting; auctioneering; wholesale services for pharmaceutical, veterinary and sanitary preparations and medical supplies; retail services for works of art provided by art galleries; retail services for pharmaceutical, veterinary and sanitary preparations and medical supplies; sales promotion for others; promotion of goods and services through sponsorship of sports events; production of teleshopping programmes; production of advertising films; office machines and equipment rental*; rental of advertising time on communication media; publicity material rental; rental of billboards [advertising boards]; rental of vending machines; rental of sales stands; rental of photocopying machines; publication of publicity texts; radio advertising; bill-posting; distribution of samples; dissemination of advertising matter; direct mail advertising; registration of written communications and data; writing of publicity texts; advertising; online advertising on a computer network; outdoor advertising; advertising by mail order; television advertising; compilation of information into computer databases; compilation of statistics; business inquiries; systemization of information into computer databases; advisory services for business management; corporate communications services; negotiation of business contracts for others; negotiation and conclusion of commercial transactions for third parties; compiling indexes of information for commercial or advertising purposes; tax preparation; drawing up of statements of accounts; telemarketing services; psychological testing for the selection of personnel; interim business management; outsourced administrative management for companies; business management of hotels; business management for freelance service providers; business project management services for construction projects; commercial administration of the licensing of the goods and services of others; business management of reimbursement programs for others; administration of consumer loyalty programs; administration of frequent flyer programs; administrative processing of purchase orders; public relations; commercial lobbying services; competitive intelligence services; modelling for advertising or sales promotion; typing; market intelligence services; appointment reminder services [office functions]; web site traffic

optimization; administrative services for the relocation of businesses; tax filing services; search engine optimization for sales promotion; appointment scheduling services [office functions]; gift registry services; price comparison services; pay per click advertising; secretarial services; procurement services for others [purchasing goods and services for other businesses]; shorthand; outsourcing services [business assistance]; telephone answering for unavailable subscribers; photocopying services; business efficiency expert services.

39 – Air transport; motor coach rental; boat rental; garage rental; rental of vehicle roof racks; aircraft rental; parking place rental; rental of electric wine cellars; rental of warehouses; rental of tractors; booking of seats for travel; travel reservation; transport reservation; towing; vehicle breakdown towing services; bottling services; water distribution; delivery of newspapers; message delivery; parcel delivery; delivery of goods; delivery of goods by mail order; flower delivery; replenishment of vending machines; launching of satellites for others; providing traffic information; providing transportation information; providing information relating to storage services; transportation logistics; rescue operations [transport]; arranging of cruises; arranging of passenger transportation services for others via an online application; arranging of transportation for travel tours; armored-car transport; hauling; carting; transport and storage of trash; transporting furniture; lighterage services; ferryboat transport; removal services; transport of travelers; guarded transport of valuables; bus transport; car transport; barge transport; boat transport; railway transport; marine transport; passenger transport; river transport; ambulance transport; streetcar transport; portering; refloating of ships; cash replenishment of automated teller machines; shipbrokerage; transport brokerage; freight brokerage [forwarding (Am.)]; providing driving directions for travel purposes; car rental; railway truck rental; rental of diving bells; rental of diving suits; rental of motor racing cars; rental of aircraft engines; railway coach rental; rental of wheelchairs; rental of storage containers; horse rental; rental of freezers; rental of navigational systems; refrigerator rental; vehicle rental; stevedoring; unloading cargo; electricity distribution; distribution of energy; packaging of goods; collection of recyclable goods [transport]; ice-breaking; piloting; water supplying; escorting of travellers; transport by pipeline; wrapping of goods; operating canal locks; car parking; chauffeur services; pleasure boat transport; car sharing services; courier services [messages or merchandise]; salvaging; salvage of ships; gift wrapping; underwater salvage; taxi transport; transport; transport services for sightseeing tours; luggage storage; franking of mail; freight [shipping of goods]; freighting; physical storage of electronically stored data or documents; boat storage; storage of goods; storage; freight forwarding.

(260) AM 2021 111624 A

(800) 1574299

(151) 2020 12 09

(891) 2020 12 09

(731) DAW SE

Roßdörfer Str. 50; 64372 Ober-Ramstadt,
Germany

(540)



(591) Black, white

(531) 03.02.01; 03.02.24; 20.01.05; 27.05.11;
27.05.24

(511)

2 – Paints, varnishes, lacquers, glazes, coatings, preservatives against rust; primers; colorants, dyestuffs, dye pastes, mordants; paint thickeners; fixatives for paints; siccatives for paints; raw natural resins; thinning and binding preparations for paints and lacquers; solvents for thinning paints; preparations for preserving wood, wood mordants and wood preserving oils; paints, including structuring paints; bactericidal and/or fungicidal paints; anti-corrosion preparations; protective preparations for metals; metals in foil and powder form for painters, decorators, printers and artists.

17 – Sealing, thermal protection and insulating materials; insulating paints, insulating varnishes, insulating fabrics, insulating plaster; substances for insulating buildings against moisture; artificial and synthetic resins (semi-finished products); fabrics in the form of parts for composite heat insulation systems; insulating tapes; heat insulators; insulating panels; grid mats of glass fiber fabric and/or plastics, in the form of parts for composite heat insulation systems; plastic films, other than for wrapping purposes; adhesive tapes and strips for building.

19 – Building materials, not of metal or mainly not of metal, in particular profile rails and corner irons, finishing profiles; adjusting and levelling parts, spacers for building, sills, all not of metal or mainly not of metal; natural and artificial stone; mortar (building materials); quartz; plaster [building materials]; coatings (building materials); wall and ceiling panels (not of metal or mainly not of metal, for building); fabric embedding compounds for building; fillers (building materials); fabrics for building, not of metal or mainly not of metal, in particular stabilising fabrics.

(260) AM 2021 111625 A

(800) 1574313

(151) 2020 12 09

(891) 2020 12 09

(731) DAW SE

Roßdörfer Str. 50; 64372 Ober-Ramstadt,
Germany

(540)

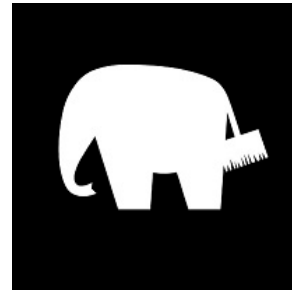

(591) Black, white

(531) 03.02.01; 20.01.05

(511)

2 – Paints, varnishes, lacquers, glazes, coatings, preservatives against rust; primers; colorants, dyestuffs, dye pastes, mordants; paint thickeners; fixatives for paints; siccatives for paints; raw natural resins; thinning and binding preparations for paints and lacquers; solvents for thinning paints; preparations for preserving wood, wood mordants and wood preserving oils; paints, including structuring paints; bactericidal and/or fungicidal paints; anti-corrosion preparations; protective preparations for metals; metals in foil and powder form for painters, decorators, printers and artists.

17 – Sealing, thermal protection and insulating materials; insulating paints, insulating varnishes, insulating fabrics, insulating plaster; substances for insulating buildings against moisture; artificial and synthetic resins (semi-finished products); fabrics in the form of parts for composite heat insulation systems; insulating tapes; heat insulators; insulating panels; grid mats of glass fiber fabric and/or plastics, in the form of parts for composite heat insulation systems; plastic films, other than for wrapping purposes; adhesive tapes and strips for building.

19 – Building materials, not of metal or mainly not of metal, in particular profile rails and corner irons, finishing profiles; adjusting and levelling parts, spacers for building, sills, all not of metal or mainly not of metal; natural and artificial stone; mortar (building materials); quartz; plaster [building materials]; coatings (building materials); wall and ceiling panels (not of metal or mainly not of metal, for building); fabric embedding compounds for building; fillers (building materials); fabrics for building, not of metal or mainly not of metal, in particular stabilising fabrics.

(260) AM 2021 111637 A

(800) 1574753

(151) 2020 09 29

(891) 2020 09 29

(731) Otkrytoe aktsionernoe obshchestvo "Belaruski Narodny Bank"
prosperkt Nezavisimosti, 87a, 220012 Minsk,
Belarus

(540)



(591) Gray, orange and black

(531) 24.17.01; 27.05.09; 27.05.10; 29.01.13

(511)

9 – Magnetic and optical data carriers, including credit and debit cards; identity cards, magnetic; magnetically encoded cards for data storage and data carriage; electronic multi-functional cards for financial services; integrated circuit cards [smart cards]; data processing apparatus, including magnetic and plastic card readers; readers [data processing equipment].

16 – Printed credit cards.

35 – Advertising / publicity; business management; business administration; providing business information; commercial information and advice for consumers; business investigations; marketing research; business management and organization consultancy; professional business consultancy; marketing; business management of performing artists; organization of exhibitions for commercial or advertising purposes; payroll preparation; business management assistance; commercial or industrial management assistance; publication of publicity texts; radio advertising; bill-posting; dissemination of advertising matter; direct mail advertising; advisory services for business management; public relations.

36 – Insurance underwriting; financial affairs; banking; savings bank services, issuance of tokens of value; capital investment; insurance information; providing financial information, insurance and financial consultancy, financial management; online banking; monetary affairs; financing services; exchanging money; financial evaluation [insurance, banking, real estate]; electronic funds transfer; financial sponsorship; issuance of credit and debit cards; processing of credit and debit card payments.

38 – Telecommunications.

41 – Arranging and conducting of exhibitions, presentations, colloquiums, congresses, conferences, concerts, workshops [training], seminars, symposiums, beauty contests, competitions [education or entertainment], and shows for cultural or educational purposes;

presentation of live performances and theatre productions; on-line publication of electronic books and journals; teaching, educational services; production of shows.

(260) AM 2021 111639 A

(800) 1574876

(151) 2020 09 25

(891) 2020 09 25

(731) Egis Gyógyszergyár Zrt.
Keresztúri út 30-38., H-1106 Budapest,
Hungary

(540)

REVEASOL

(591) Black, white

(511)

3 – Cosmetics and cosmetic preparations.

5 – Human pharmaceutical preparations; dietetic substances adapted for medical use; dietary supplements; medicinal ointments; medicated skin creams; plasters, materials for dressings.

(260) AM 2021 111653 A

(800) 1575081

(151) 2020 12 14

(891) 2020 12 14

(731) COMPAGNIE FINANCIERE ET DE
PARTICIPATIONS ROULLIER
27, avenue Franklin Roosevelt, F-35400
SAINT-MALO, France

(540)



(591) Black, white

(531) 05.03.11; 05.03.13; 26.01.03; 26.01.15;
27.05.09; 27.05.10

(511)

1 – Chemical products for use in agriculture, horticulture, forestry; mineral and/or organic products for use in industry, agriculture, horticulture and forestry; mineral and/or organic products consisting of natural elements for use in industry, agriculture, horticulture and forestry; soil fertilizers and conditioners; stimulants of the natural defenses of plants; ensilage agents; chemical and biological products for use in animal litter.

5 – Chemical and biological products with deodorizing or disinfecting properties for use in animal litter; food supplements for animals; food supplements for animals consisting of natural elements; fungicides.

31 – Foodstuffs for animals; foodstuffs for animals consisting of natural elements; mineral lick blocks and buckets for animal nutrition.

(260) AM 2021 111655 A
 (800) 1575123
 (151) 2021 01 05
 (891) 2021 01 05
 (731) DONGFENG MOTOR CORPORATION
 Special No.1 Dongfeng Road, Wuhan
 Economic & Technical, Development Zone
 Wuhan, 430056 Hubei Province, China

(540)

AVACOR

(591) Black, white

(531) 27.05.01

(511)

12 – Motor coaches; automobile chassis; automobile bodies; brake pads for automobiles; cars; lorries; motors, electric, for land vehicles; tires for vehicle wheels; clutches for land vehicles.

37 – Vehicle washing; motor vehicle maintenance and repair; vehicle polishing; vehicle battery replacement service; vehicle service stations [refuelling and maintenance]; tire balancing; rebuilding engines that have been worn or partially destroyed; vehicle maintenance; vehicle breakdown repair services; repair of rubber tires.

(260) AM 201 111656 A

(800) 1575177

(151) 2020 12 15

(891) 2020 12 15

(731) Richter Gedeon Nyrt.

Gyömrői út 19-21, H-1103 Budapest, Hungary

(540)

СОРПАТИН

(591) Black, white

(531) 28.05

(511)

5 – Pharmaceutical preparations.

(260) AM 2021 111657 A

(800) 1575178

(151) 2020 12 15

(891) 2020 12 15

(731) Richter Gedeon Nyrt.

Gyömrői út 19-21, H-1103 Budapest, Hungary

(540)

СТАКСТОН

(591) Black, white

(531) 28.05

(511)

5 – Pharmaceutical preparations.

(260) AM 2021 111658 A

(800) 1575179

(151) 2020 12 15

(891) 2020 12 15

(731) Richter Gedeon Nyrt.

Gyömrői út 19-21, H-1103 Budapest, Hungary

(540)

СУРГАЛЕКС

(591) Black, white

(531) 28.05

(511)

5 – Pharmaceutical preparations.

(260) AM 2021 111659 A

(800) 1575180

(151) 2020 12 15

(891) 2020 12 15

(731) Richter Gedeon Nyrt.

Gyömrői út 19-21, H-1103 Budapest, Hungary

(540)

ТРЕФУЛИС

(591) Black, white

(531) 28.05

(511)

5 – Pharmaceutical preparations.

(260) AM 2021 111660 A

(800) 1575181

(151) 2020 12 15

(891) 2020 12 15

(731) Richter Gedeon Nyrt.

Gyömrői út 19-21, H-1103 Budapest, Hungary

(540)

ТРЕССЕТИН

(591) Black, white

(531) 28.05

(511)

5 – Pharmaceutical preparations for gynecological purposes.

(260) AM 2021 111661 A

(800) 1575182

(151) 2020 12 15

(891) 2020 12 15

(731) Richter Gedeon Nyrt.

Gyömrői út 19-21, H-1103 Budapest, Hungary

(540)

ЗЕБОГАЛ

(591) Black, white

(531) 28.05

(511)

5 – Pharmaceutical preparations.

(260) AM 2021 111662 A
 (800) 1575185
 (151) 2021 01 05
 (891) 2021 01 05
 (731) Guangzhou Halei Commodity Co., Ltd.
 Plant A01, Yuanzhougang Village, Taiping
 Town, Conghua District, Guangzhou City,
 Guangdong Province, China

(540)



(591) Blue, green, white
 (531) 27.05.01; 27.05.21; 28.03; 29.01.12
 (511)

9 – Computers; holograms; digital signs; virtual reality headsets; chips [integrated circuits]; electrolyzers; smoke detectors; protective masks; spectacles; batteries, electric.

10 – Thermal packs for first aid purposes; gloves for medical purposes; surgical sponges; clothing especially for operating rooms; masks for use by medical personnel; sanitary masks for medical purposes; sterile sheets, surgical; bracelets for medical purposes; condoms; supportive bandages.

(260) AM 2021 111672 A
 (800) 1575352
 (151) 2020 12 21
 (891) 2020 12 21
 (731) Consorzio per la Tutela del Formaggio Grana Padano
 Via XXIV Giugno 8, Fraz. San Martino della Battaglia, I-25015 Desenzano del Garda (BS), Italy

(540)



(591) Black and yellow
 (531) 26.07.15; 26.13.25; 27.05.01; 29.01.12
 (551) Collective
 (511)
 29 – Cheese.

(260) AM 2021 111683 A
 (800) 881581
 (151) 2004 12 06
 (891) 2020 12 25
 (731) HOSHIZAKI CORPORATION
 3-16, Minamiyakata, Sakae-cho, Toyoake-shi
 Aichi 470-1194, Japan

(540)

HOSHIZAKI

(591) Black, white
 (531) 27.05.01
 (511)

11 – Set units of toilet bowl and seat, set units of bathroom, drying apparatus for chemical processing, recuperators for chemical processing, steamers for chemical processing, evaporators for chemical processing, distillers for chemical processing, heat exchangers for chemical processing, milk sterilizers, industrial furnaces, nuclear reactors, forage drying apparatus, industrial boilers, air purifying apparatus and machines for eliminating ethylene, air-conditioning apparatus for industrial purposes, industrial table-mounted electrical refrigerators and freezers, industrial thawing/refrigerating apparatus and machines, refrigerators for cooling beer mugs, electrical refrigerators for storing/cooling wine, industrial prefabricated electrical refrigerators, industrial prefabricated electrical ice storage freezers, industrial deep-freezers for food, industrial quick cooling refrigerators for food, electric freezers and refrigerators for industrial purposes, kitchen sinks with refrigerators for industrial purposes, electric showcase refrigerators and freezers, electric refrigerated display stands, table-mounted ice dispensers for industrial purposes, ice and chilled water dispensers for industrial purposes, electric water cooling apparatus for industrial purposes, refrigerating apparatus for use with cold salt water for perishable foods, table-top ice making machines with ice cream making function for industrial purposes, industrial ice making machines with packaging functions, ice machines, freezing machines and apparatus, clothes drying machines for industrial purposes (electric), industrial deep fryers, industrial rice cookers, industrial cooking pots, industrial roasters, industrial cooking ovens, industrial fryers with table (electric), industrial noodle boilers, industrial steamers for cooking, industrial cooking heaters, dish sterilizing machines for industrial use, cooking utensils sterilizing machines for industrial use, industrial draft beer dispensers with cooling function, industrial iced coffee dispensers, industrial coffee heaters, industrial juice dispensers, industrial iced aerated beverage dispensers, servers for shochu mixed with soda water, chilled sake servers, chilled beverage dispensers, soft ice cream servers, soft ice cream beverage servers, miso soup dispensers for industrial purposes, soup dispensers for industrial purposes, soup keeping heaters for industrial purposes, mineral water dispensers, aerated water dispensers, ice cream

dispensers for industrial purposes, beverage dispensers for industrial purposes, table ware dispensers for industrial purposes, heated table ware dispensers for industrial purposes, water-spraying industrial defrosting apparatus for thawing frozen foods, industrial vacuum defrosting apparatus for thawing frozen foods, storage device for promoting the maturation of foods by maintaining temperature, electric heating storage for industrial purposes, mobile wagon-type tea dispensers for industrial purposes, tea dispensers for industrial purposes, paper cup dispensers for supplying tea for industrial purposes, tap water faucets, level controlling valves for tanks, pipe line cocks, waste water treatment tanks for industrial purposes, septic tanks for industrial purposes, garbage incinerators, solar water heaters, industrial electric water purifying apparatus for purifying tap water by freezing and then melting, water electrolyzing apparatus and machines for industrial purposes, water purifying apparatus, electric lamps and other lighting apparatus, microwave ovens (cooking apparatus), electric coffee makers for household purposes, electric ice machines for household purposes, defrosting/refrigerating apparatus and machines for household purposes, electric freezers and refrigerators for household purposes, electric tea servers for household purposes, ice cream making machines for household purposes, household electric vacuum sealing machines for packaging purposes, water electrolyzing apparatus and machines for household purposes, household electric water purifying apparatus for purifying tap water by freezing and then melting, electric fryers with table for household use, electric deep fryers for household use, electric noodle boilers for household use, electric food steamers for household use, household electrothermic appliances, washers for water taps, gas water heaters for household use, non-electric cooking heaters for household purposes, kitchen worktops, kitchen sinks, industrial prefabricated electrical ice storage freezers, ice chests for household purposes (not for carrying with), ice-cooling refrigerators for household purposes, household tap water filters, bathtubs and the like, standing paper lanterns, portable paper lanterns, gas lamps, oil lamps, lamp chimneys, warming pans (non-electric), pocket warmers (non-electric), stick fuel for Japanese pocket warmers, hot water bottles for warming one's feet in bed, toilet stool units with a washing water squirter, disinfectant dispensers for toilet, toilet bowls, seatings for use with Japanese style toilet bowls, waste water treatment tanks for household use, septic tanks for household use, toilet ventilators (non-electric), heating or cooling packs filled with chemical substances ready to react when required, non-electric heating apparatus for household purposes; electric wine servers with cooling function, electric cocktail servers with cooling function.

(260) AM 2021 111684 A

(800) 1373004

(151) 2017 01 26

(891) 2020 12 25

(731) HOSHIZAKI CORPORATION

3-16, Minamiyakata, Sakae-cho, Toyoake-shi
Aichi 470-1194, Japan

(540)



(591) Blue, black and white

(531) 01.01.01; 01.01.05; 01.01.10; 03.07.08;

06.19.01; 06.19.19; 26.01.03; 26.01.15;

26.01.21; 29.01.13

(511)

7 – Metalworking machines and tools; industrial polishing machines for dishes of metal; construction machines and apparatus; loading-unloading machines and apparatus; conveyors for ice; chemical processing machines and apparatus; chemical processing machines and apparatus for composting kitchen garbage; food or beverage processing machines and apparatus; whipped cream making machines for industrial purposes; ice crushers for industrial purposes; coffee grinders for industrial purposes, other than hand-operated; aerated water making machines; meat slicers for industrial purposes; packaging or wrapping machines and apparatus; vacuum packaging machines; vending machines; vending machines for ice; vending machines for ionized alkaline water; electric washing machines; food mixing machines for commercial use; peeling machines for industrial purposes; cutting, chopping and slicing machines for industrial purposes; industrial magnetic stirrers for cooking; ice slicers for industrial purposes; dish washing machines; dishwashers for industrial purposes; cooking utensil washers for industrial purposes; dish conveyors for industrial dishwashers; automatic dish lifts for industrial dishwashers; dish storage wagons for use with industrial dishwashers; roast meat griddle washing machines for industrial purposes; electric wax-polishing machines; vacuum cleaners; waste compacting machines and apparatus; waste crushing machines; kitchen garbage crushing and disposing machines for industrial purposes; electric mixers for household purposes; electric ice slicers for household purposes; electric ice crushers for household purposes; household magnetic stirrers for cooking; electric vacuum packaging machines for household purposes.

11 – Drying apparatus for chemical processing; recuperators for chemical processing; steamers for chemical processing; evaporators for chemical processing; distillers for chemical processing; heat exchangers for chemical processing; boilers, other than parts of non-electric prime movers or engines; water heaters for industrial purposes; air-conditioning apparatus for industrial purposes; air purifying apparatus and machines for eliminating ethylene; industrial air purifiers; electric air deodorizing apparatus for industrial purposes; ventilating fans; freezing machines and apparatus; industrial table-mounted electrical refrigerators and freezers; industrial defrosting, refrigerating apparatus and machines; industrial refrigerators for cooling beer mugs; electrical refrigerators for storing, cooling wine for industrial purposes; industrial prefabricated electrical refrigerators; industrial prefabricated electrical ice storage freezers; industrial deep-freezers for food; industrial quick cooling refrigerators for food; electric freezers and refrigerators for industrial purposes; industrial quick refrigerating chambers for food; freezers for cold storage agents; kitchen sinks with refrigerators for industrial purposes; industrial electric refrigerators for temporary cold preservation of food; electric showcase refrigerators for ornamental plant with the automatic water electrolyzing function; electric showcase refrigerators and freezers for sushi; electric showcase refrigerators and freezers; electric refrigerated display stands with the automatic ice making function for chilled food and frozen food; ice and chilled water dispensers for industrial purposes; electric water cooling apparatus for industrial purposes; refrigerating apparatus for use with cold salt water for perishable foods; table-top ice making machines with ice cream making function for industrial purposes; industrial ice making machines with packaging functions; ice machines; ice making machines; industrial prefabricated electrical ice storage freezers; industrial cold cabinets for milk, electric; industrial cold cabinets for brown rice, electric; cooking apparatus and installations for industrial purposes; industrial dish drying machines; dish sterilizing machines for industrial use; industrial deep fryers; industrial rice cookers; industrial cooking pots; industrial roasters; industrial cooking ovens; industrial steam convection ovens; industrial electric fryers with table; industrial noodle boilers; industrial steamers for cooking; electromagnetic induction cookers for industrial purposes; industrial draft beer dispensers with cooling function; industrial iced coffee dispensers; industrial juice dispensers; industrial iced aerated beverage dispensers; industrial wine dispensers with cooling function; industrial cocktail dispensers with cooling functions; industrial chilled sake dispensers; industrial chilled beverage dispensers; mineral water dispensers for industrial purposes; aerated water dispensers for industrial purposes; beverage dispensers for industrial purposes; soft ice cream dispensers for industrial purposes; soft ice cream beverage dispensers for industrial purposes; ice cream

dispensers for industrial purposes; table-mounted ice dispensers for industrial purposes; miso soup dispensers for industrial purposes; soup dispensers for industrial purposes; soup heaters for maintaining soup temperature for industrial purposes; industrial coffee heaters; wall mounted tea dispensers for industrial purposes; mobile wagon-type tea dispensers for industrial purposes; tea dispensers for industrial purposes; paper cup dispensers as a component of tea dispenser for industrial purposes; water-spraying industrial defrosting apparatus for thawing frozen foods; industrial vacuum defrosting apparatus for thawing frozen foods; storage device for promoting the maturation of foods by maintaining temperature; food maturing and drying cabinets; electric heating storage for industrial purposes; electric cabinets used to control temperature and humidity for food preservation; cooking utensil sterilizing machines for industrial use; sterilizing and disinfection apparatus for cooking utensil for industrial purposes; tap water faucets; level controlling valves for tanks; pipe line cocks; water purifying apparatus; industrial electric water purifying apparatus for purifying tap water by freezing and then melting; water purifiers for industrial purposes; water electrolyzing apparatus and machines for industrial purposes; water sterilizers for swimming pool; electric lamps and other lighting apparatus; household electrothermic appliances; microwave ovens [cooking apparatus]; electric coffee makers for household purposes; electric ice machines for household purposes; defrosting, refrigerating apparatus and machines for household purposes; electric freezers and refrigerators for household purposes; electric tea servers for household purposes; water electrolyzing apparatus and machines for household purposes; household electric water purifying apparatus for purifying tap water by freezing and then melting; electric fryers with table for household use; electric deep fryers for household use; electric noodle boilers for household use; electric food steamers for household use; dish sterilizing machines for household use; washers for water taps; gas-fired water heaters; non-electric cooking heaters for household purposes; cooking tops; kitchen sinks; household tap-water filters; electric ice cream making machines for household purposes.

37 – Construction; construction of prefabricated electrical refrigerating warehouse for industrial purposes; installation of freezing machines and apparatus; repair or maintenance of loading-unloading machines and apparatus; repair, maintenance and servicing of ice conveying machines; maintenance by remote supervision of loading-unloading machines and apparatus; repair or maintenance of fire alarms; repair, maintenance and servicing of sprinkler systems for fire protection and sprinkler systems for disaster prevention; repair, maintenance and servicing of gas leak alarms, burglar alarms, alarm monitoring systems for disaster prevention and alarm systems for disaster prevention; maintenance by remote supervision of sprinkler sys-

tems for disaster prevention, alarm monitoring systems for disaster prevention, alarm systems for disaster prevention; repair or maintenance of air-conditioning apparatus for industrial purposes; burner maintenance or repair; repair or maintenance of boilers; pump repair or maintenance; repair or maintenance of freezing machines and apparatus; repair or maintenance of air purifying apparatus and machines for eliminating ethylene; repair or maintenance of electric air deodorizing apparatus for industrial purposes; repair or maintenance of ventilating fans; maintenance by remote supervision of air-conditioning apparatus for industrial purposes; repair or maintenance of water heaters for industrial purposes; repair or maintenance of industrial table-mounted electrical refrigerators and freezers, industrial electric defrosting, refrigerating apparatus and machines, industrial refrigerators for cooling beer mugs, electrical refrigerators for storing, cooling wine for industrial purposes, industrial prefabricated electrical refrigerators, industrial prefabricated electrical ice storage freezers, industrial deep-freezers for food, industrial quick cooling refrigerators for food, electric freezers and refrigerators for industrial purposes, industrial quick refrigerating chambers for food, freezers for cold storage agents; repair or maintenance of kitchen sinks with refrigerators for industrial purposes; repair or maintenance of industrial electric refrigerators for temporary cold preservation of food, electric showcase refrigerators for ornamental plant with the automatic water electrolyzing function, electric showcase refrigerators and freezers for sushi, electric showcase refrigerators and freezers, electric refrigerated display stands with the automatic ice making function for chilled food and frozen food; repair or maintenance of ice and chilled water dispensers for industrial purposes, electric water cooling apparatus for industrial purposes; repair or maintenance of refrigerating apparatus for use with cold salt water for perishable foods; repair or maintenance of tabletop ice making machines with ice cream making function for industrial purposes, industrial ice making machines with packaging functions, ice machines, ice making machines, industrial prefabricated electrical ice storage freezers; repair or maintenance of industrial cold cabinets for milk, industrial cold cabinets for brown rice; maintenance by remote supervision of freezing machines and apparatus; repair or maintenance of electronic machines and apparatus; repair or maintenance of computers; repair or maintenance of telecommunication machines and apparatus; maintenance by remote supervision of telecommunication machines and apparatus; repair or maintenance of consumer electrical appliances; repair or maintenance of dishwashers for household purposes; repair or maintenance of electric ice slicers for household purposes, electric ice crushers for household purposes, household magnetic stirrers for cooking, electric ice cream making machines for household purposes; repair or maintenance of microwave ovens [cooking apparatus],

electric coffee makers for household purposes, electric ice machines for household purposes, electric defrosting, refrigerating apparatus and machines for household purposes, electric freezers and refrigerators for household purposes, electric tea servers for household purposes, electric vacuum packaging machines for household purposes, water electrolyzing apparatus and machines for household purposes, household electric water purifying apparatus for purifying tap water by freezing and then melting, electric fryers with table for household use, electric deep fryers for household use, electric noodle boilers for household use, electric food steamers for household use, household electrothermic appliances; repair or maintenance of dish sterilizing machines for household use; repair or maintenance of electric lighting apparatus; repair or maintenance of measuring and testing machines and instruments; maintenance by remote supervision of measuring and testing machines and instruments; repair or maintenance of medical machines and apparatus; repair or maintenance of water disinfecting and sterilizing apparatus and machines for medical purposes, water electrolyzing apparatus and machines for medical purposes, medical instruments washing machines; maintenance by remote supervision of medical machines and apparatus; repair or maintenance of chemical processing machines and apparatus; repair or maintenance of chemical processing machines and apparatus for composting kitchen garbage; repair or maintenance of ozonisers and electrolyzers; repair or maintenance of metalworking machines and tools, industrial polishing machines for dish of metal; repair or maintenance of food or beverage processing machines and apparatus; repair or maintenance of whipped cream making machines for industrial purposes, ice crushers for industrial purposes, coffee grinders for industrial purposes, other than hand-operated, aerated water making machines, meat slicers for industrial purposes; maintenance by remote supervision of food or beverage processing machines and apparatus; repair or maintenance of packaging or wrapping machines and apparatus; repair or maintenance of vacuum packaging machines; maintenance by remote supervision of packaging or wrapping machines and apparatus; repair or maintenance of cooking apparatus and installations for industrial purposes; repair or maintenance of dish washing machines for industrial purposes; repair or maintenance of industrial deep fryers, industrial rice cookers, industrial cooking pots, industrial roasters, industrial cooking ovens, industrial steam convection ovens, industrial electric fryers with table, industrial noodle boilers, industrial steamers for cooking, electromagnetic induction cookers for industrial purposes; maintenance by remote supervision of cooking apparatus and installations for industrial purposes; repair or maintenance of dish washing machines for industrial purposes, dishwashers for industrial purposes, cooking utensil washers for industrial purposes; maintenance by remote supervision of dish washing machi-

nes for industrial purposes, dishwashers for industrial purposes, cooking utensil washers for industrial purposes; repair or maintenance of dish conveyors for industrial dishwashers, automatic dish lifts for industrial dishwashers, dish storage wagons for use with industrial dishwashers, roast meat griddle washing machines; repair or maintenance of food mixing machines for commercial use, peeling machines for industrial purposes, cutting, chopping and slicing machines for industrial purposes; repair or maintenance of industrial magnetic stirrers for cooking, ice slicers for industrial purposes; repair or maintenance of industrial draft beer dispensers with cooling function, industrial iced coffee dispensers, industrial juice dispensers, industrial iced aerated beverage dispensers, shochu mixed with soda water dispensers for industrial purposes, industrial wine dispensers with cooling function, industrial cocktail dispensers with cooling function, industrial chilled sake dispensers, industrial chilled beverage dispensers, mineral water dispensers for industrial purposes, aerated water dispensers for industrial purposes, beverage dispensers for industrial purposes; maintenance by remote supervision of beverage dispensers for industrial purposes; repair or maintenance of soft ice cream dispensers for industrial purposes, soft ice cream beverage dispensers for industrial purposes, ice cream dispensers for industrial purposes, table-mounted ice dispensers for industrial purposes; repair or maintenance of miso soup dispensers for industrial purposes, soup dispensers for industrial purposes, electric soup heaters for maintaining soup temperature for industrial purposes; repair or maintenance of industrial coffee heaters; repair or maintenance of wall mounted tea dispensers for industrial purposes, mobile wagon-type tea dispensers for industrial purposes, tea dispensers for industrial purposes; maintenance by remote supervision of tea dispensers for industrial purposes; repair or maintenance of industrial dish dispensers for use with beverage dispensers, industrial heated dish dispensers for use with beverage dispensers, paper cup dispensers as a component of tea dispenser for industrial purposes; repair or maintenance of water-spraying industrial defrosting apparatus for thawing frozen foods; maintenance by remote supervision of water-spraying industrial defrosting apparatus for thawing frozen foods; repair or maintenance of industrial vacuum defrosting apparatus for thawing frozen foods; maintenance by remote supervision of industrial vacuum defrosting apparatus for thawing frozen foods; repair or maintenance of storage device for promoting the maturation of foods by maintaining temperature; maintenance by remote supervision of storage device for promoting the maturation of foods by maintaining temperature; repair or maintenance of food maturing and drying cabinets; repair or maintenance of heated cabinets for cooked food, heated cabinets for dish and serving utensils, electric heating storage for industrial purposes; maintenance by remote supervision of heated cabinets for

cooked food, heated cabinets for dish and serving utensils, electric heating storage for industrial purposes; repair or maintenance of electric cabinets used to control temperature and humidity for food preservation; maintenance by remote supervision of electric cabinets used to control temperature and humidity for food preservation; repair or maintenance of industrial dish drying machines; maintenance by remote supervision of industrial dish drying machines; repair or maintenance of dish sterilizing machines for industrial use, cooking utensil sterilizing machines for industrial use, sterilizing and disinfection apparatus for cooking utensil for industrial purposes; maintenance by remote supervision of dish sterilizing machines for industrial use, cooking utensil sterilizing machines for industrial use, sterilizing and disinfection apparatus for cooking utensil for industrial purposes; repair or maintenance of industrial polishing machines for dish of metal; repair or maintenance of vending machines; repair or maintenance of vending machines for ice, vending machines for ionized alkaline water; maintenance by remote supervision of vending machines; repair or maintenance of water purifying apparatus; repair or maintenance of industrial electric water purifying apparatus for purifying tap water by freezing and then melting, water purifiers for industrial purposes, water electrolyzing apparatus and machines for industrial purposes; maintenance by remote supervision of water electrolyzing apparatus and machines for industrial purposes and water purifying apparatus; repair or maintenance of water sterilizers for swimming pool; repair or maintenance of water pipes; repair or maintenance of waste compacting machines and apparatus; repair or maintenance of waste crushing machines; repair or maintenance of kitchen garbage crushing and disposing machines for industrial purposes; maintenance by remote supervision of kitchen garbage crushing and disposing machines for industrial purposes; repair or maintenance of meal serving wagons with warming and cooling functions, meal serving wagons with heating function, and meal serving wagons, all for use in hotels, plant cafeterias and hospitals; maintenance by remote supervision of meal serving wagons with heating function, meal serving wagons with warming and cooling functions; furniture restorations; cabinet repair; repair of kitchen furniture; repair or maintenance of gas-fired water heaters; repair or maintenance of non-electric cooking heaters for household purposes; repair or maintenance of cooking pots and pans; repair of ice slicers [other than household electrothermic appliances and food or beverage processing machines and apparatus]; sterilization of medical apparatus and instruments; rental of electric flat irons for household purposes; rental of dish washing machines for industrial purposes; rental of dish drying machines for restaurants.

(260) AM 2021 111685 A
 (800) 1423974
 (151) 2018 08 15
 (891) 2020 12 18
 (731) Continental Reifen Deutschland GmbH
 Vahrenwalder Strasse 9, 30165 Hannover,
 Germany
 (540)

UltraContact

(591) Black, white
 (511)
 12 – Vehicle tires.

(260) AM 2021 111760 A
 (800) 1575526
 (151) 2020 12 15
 (891) 2020 12 15
 (731) Richter Gedeon Nyrt.
 Gyömrői út 19-21, H-1103 Budapest, Hungary
 (540)

ГИЛАДЕТ

(591) Black, white
 (531) 28.05
 (511)
 5 – Pharmaceutical preparations.

(260) AM 2021 111769 A
 (800) 1575562
 (151) 2020 12 15
 (891) 2020 12 15
 (731) Richter Gedeon Nyrt.
 Gyömrői út 19-21, H-1103 Budapest,
 Hungary
 (540)

ФИЛЕРОБ

(591) Black, white
 (531) 28.05
 (511)
 5 – Pharmaceutical preparations.

(260) AM 2021 111770 A
 (800) 1575597
 (151) 2020 12 30
 (891) 2020 12 30
 (731) Fashion Nova, LLC
 2801 E. 46th Street, Vernon CA 90058, USA
 (540)

FASHION NOVA

(591) Black, white
 (526) FASHION
 (511)
 14 – Jewelry.

(260) AM 2021 111781 A
 (800) 1575985
 (151) 2020 09 24
 (891) 2020 09 24
 (731) AKTSIONERNO DROUJESTVO "START"
 AD
 Rayon "Lozenets", Boulevard "Tcherni Vrah",
 32, VH. A., ET. 4, BG-1000 Sofia, Bulgaria
 (540)



(591) Black and white
 (531) 26.04.22; 26.04.24; 27.05.24
 (511)
 9 – Electric accumulators; electric accumulators for vehicles; starter accumulators, both sealed and maintenance-free, as well as accumulators with maintenance, which require regular electrolyte level checks, enabling the addition of distilled water; lead acid batteries for starting motor vehicles for loading and for loading heavy equipment, as well as for machines intended for road construction; conventional liquid batteries, in particular lead-calcium accumulators (PbCa, PbSn, PbCaAg) filled with a liquid electrolyte of sulfuric acid, of the accumulator type with addition of distilled water; AGM accumulators, including lead-calcium (PbCa) batteries with a glass-fiber blotter, impregnated with a liquid electrolyte of sulfuric acid, particularly of the maintenance-free battery type; GEL accumulators, including lead-calcium (PbCa) batteries, filled with an electrolyte solution in gel form, based on sulfuric acid mixed with silica powder; lead-acid accumulator batteries, in particular starter batteries, designed on the basis of "wet cells" of the so-called SLI (starting, lighting, ignition) type and of the deep-cycle and/or valve-regulated type (VRLA batteries); EFB accumulators for automatic starting of the engine, particularly designed for cars applying mainly the "start and stop" system without recuperation; accumulators for buses and coaches; batteries for automobile taxis and for vehicles for special use; batteries for farming equipment; batteries for railway-engine equipment; batteries for starting tourist cars; starter batteries for piston engines and/or auxiliary turbines, intended for the aviation industry, in particular nickel cadmium accumulators, nickel metal hydride accumulators, zinc silver accumulators, lithium ion (Li-Ion) accumulators and lithium polymer (LiPo) accumulators; lithium-iron-phosphate (LiFePO4) accumulator-type starter battery; lithium-ion accumulator batteries for scooters and motorcycles; stationary batteries intended for telecommunications for emergency power for telephone exchanges, for equipment for the transmission of messages and voice data, for mobile and fixed communication systems, for radio and television systems and for transmitters and relay stations; storage batteries for UPS systems, intended for power

plants, industrial sites, production companies, data storage centers, hospitals, banks and shopping centers, signalling and navigation systems; stationary batteries intended for working in harsh conditions with high working temperatures, for hybrid and cyclic applications in remote sites and in areas of frequent power cuts; batteries for storing energy from renewable energy sources; cyclic application batteries intended for use in AGM technology; traction accumulators; semi-traction batteries for sites requiring a constant and durable power supply; special batteries for use in tanks and armored vehicles, in compliance with NATO standards; batteries for use in motor boats, river boats, campers, pleasure boats and caravans; accumulators intended in particular for golf carts; accumulator boxes; battery jars; anode batteries; acidimeters for batteries; high-voltage batteries; batteries for lighting; batteries for pocket lamps; electric accumulators for vehicles; electric cells (batteries); batteries for electronic cigarettes; galvanic batteries; plates for batteries, including, grids for batteries; solar batteries; solar panels for electricity production; charging stations for electric vehicles; battery chargers; apparatus for charging electric accumulators; chargers for electronic cigarettes.

(260) AM 2021 111787 A
 (800) 1576188
 (151) 2020 12 04
 (891) 2020 12 04
 (731) Obschestvo s ogranichennoy, otvetstvennostyu "STUDEX"
 Dmitrovskoe shosse, d. 100,; str. 2, of. 3274;
 RU-127247 Moscow, Russian Federation

(540)

My First Earring
 by STUDEX

(591) Black, white
 (531) 27.05.09
 (511)
 8 – Ear-piercing apparatus; ear-piercing instruments.
 10 – Medical ear-piercing apparatus, including medical instruments for ear-piercing with disposable cartridge.
 14 – Ear studs.

(260) AM 2021 111788 A
 (800) 1576223
 (151) 2020 10 27
 (891) 2020 10 27
 (731) Egis Gyógyszergyár Zrt.
 Keresztúri út 30-38, H-1106 Budapest, Hungary

(540)

PRODERMOLON

(591) Black, white
 (511)
 3 – Cosmetics and cosmetic preparations.
 5 – Human pharmaceutical preparations; dietetic substances adapted for medical use; dietary supplements; medicinal ointments; medicated skin creams; plasters, materials for dressings.

(260) AM 2021 111789 A
 (800) 1576239
 (151) 2020 12 09
 (891) 2020 12 09
 (731) ROLEX SA
 3-5-7 rue François-Dussaud, CH-1211
 Genève 26, Switzerland

(540)

TRIPLOCK

(591) Black, white
 (511)
 14 – Timepieces, namely, watches, wrist-watches, component parts for timepieces and accessories for timepieces not included in other classes, clocks and other chronometric instruments, chronometers, chronographs (timepieces), watch bands, dials (timepieces), boxes and cases for timepieces and jewelry, watch movements and their parts; jewelry, jewelry items; precious stones and semi-precious stones; precious metals and their alloys; pins (jewelry).

(260) AM 2021 111790 A
 (800) 1576250
 (151) 2020 10 27
 (891) 2020 10 27
 (731) Egis Gyógyszergyár Zrt.
 Keresztúri út 30-38, H-1106 Budapest, Hungary

(540)

VIVASOLUTE

(591) Black, white
 (511)
 3 – Cosmetics and cosmetic preparations.
 5 – Human pharmaceutical preparations; dietetic substances adapted for medical use; dietary supplements; medicinal ointments; medicated skin creams; plasters, materials for dressings.

(260) AM 2021 111791 A
 (800) 1576303
 (151) 2020 07 07
 (891) 2020 07 07
 (731) PPF a.s.
 Evropská 2690/17, CZ-160 41 Praha 6,
 Dejvice, Czech Republic

(540)

Yettel.

(591) Black, white

(531) 24.17.02; 27.05.17

(511)

9 – Scientific, nautical, surveying, photographic, cinematographic apparatus and instruments; optical apparatus and instruments for weighing, measuring, signaling, checking (supervision), life-saving included in this class and teaching apparatus and instruments; apparatus for controlling, switching, transforming, accumulating, regulating or controlling of electric current; apparatus for sound or image recording, conversion, transmission or reproduction; magnetic data media; optical data media; recording discs; SD cards; micro SD cards; USB flash drives; memory cards; hard drives; coin-operated mechanisms for vending machines and mechanisms for coin-operated apparatus; calculating machines; data-processing equipment and computers; sound and image transmitting apparatus; telecommunications apparatus; mobile telecommunications apparatus; mobile telecommunications kits; computer hardware; computer software; downloadable computer software; multimedia applications; PDA (personal digital assistant); pocket PCs; mobile telephones; laptops; telecommunications network devices; control software for telecommunications networks and telecommunications devices; video recorders; cameras; MP3 and MP4 players; electronic publications (downloadable); periodicals in electronic form; electronic databases and databases products; information and data in electronic form; information and data on carriers or in electronic form; data, information, computer and communication networks of all kinds; covers for smartphones and computers; protective films and cases adapted for smartphones and computers; parts and accessories for all the aforesaid goods; coin-operated mechanisms for vending machines.

16 – Printed matter; paper labels; printed forms; brochures; printed catalogues; printed manuals; printed reference; user manuals and other printed manuals; printed instructions for use and other documentation for computer, telecommunication and other technical equipment and apparatus.

35 – Advertising; advertisement and promotional activities; marketing; provision of advertising time to advertisers; advertising and commercial information services; providing an on-line commercial information directory on the Internet; on-line advertising; business intermediary services relating to advertising, publicity and promotional activities; business management assistance; business administration; office work; retail and wholesale service, online retail and wholesale services and intermediation related to scientific, nautical, surveying, photographic, cinematographic apparatus and instruments, optical apparatus and instruments

for weighing, measuring, signaling, checking (supervision), life-saving included in this class and teaching apparatus and instruments, apparatus for controlling, switching, transforming, accumulating, regulating or controlling of electric current, apparatus for sound or image recording, conversion, transmission or reproduction, magnetic data media, optical data media, recording discs, SD cards, micro SD cards, USB flash drives, memory cards, hard drives, mechanisms for coin-operated apparatus, calculating machines, data-processing equipment and computers, sound and image transmitting apparatus, telecommunications apparatus, mobile telecommunications apparatus, mobile telecommunications kits, computer hardware, computer software, downloadable computer software, multimedia applications, PDA (personal digital assistant), pocket PCs, mobile telephones, laptops, telecommunications network devices, control software for telecommunications networks and telecommunications devices, video recorders, cameras, MP3 and MP4 players, electronic publications (downloadable), periodicals in electronic form, electronic databases and databases products, information and data in electronic form, information and data recorded on carriers or in electronic, data, information, computer and communication networks of all kinds, covers for smartphones and computers, protective films and cases adapted for smartphones and computers, parts and accessories for all the aforesaid goods; online retail and wholesale services relating to scientific, nautical, surveying, photographic, cinematographic apparatus and instruments, optical apparatus and instruments for weighing, measuring, signaling, checking (supervision), life-saving and teaching apparatus and instruments, apparatus for controlling, switching, transforming, accumulating, regulating or controlling of electric current, apparatus for sound or image recording, conversion, transmission or reproduction, magnetic data media, optical data media, recording discs, SD cards, micro SD cards, USB flash drives, memory cards, hard drives, coin-operated mechanisms for vending machines and mechanisms for coin-operated apparatus, calculating machines, data-processing equipment and computers, sound and image transmitting apparatus, telecommunications apparatus, mobile telecommunications apparatus, mobile telecommunications kits, computer hardware, computer software, downloadable computer software, multimedia applications, PDA (personal digital assistant), pocket PCs, mobile telephones, laptops, telecommunications network devices, control software for telecommunications networks and telecommunications devices, video recorders, cameras, MP3 and MP4 players, electronic publications (downloadable), periodicals in electronic form, electronic databases and databases products, information and data in electronic form, information and data recorded on carriers or in electronic, data, information, computer and communication networks of all kinds, covers for smartphones and computers, pro-

protective films and cases adapted for smartphones and computers, parts and accessories for all the aforesaid goods; intermediation related to scientific, nautical, surveying, photographic, cinematographic apparatus and instruments, optical apparatus and instruments for weighing, measuring, signaling, checking (supervision), life-saving and teaching apparatus and instruments, apparatus for controlling, switching, transforming, accumulating, regulating or controlling of electric current, apparatus for sound or image recording, conversion, transmission or reproduction, magnetic data media, optical data media, recording discs, SD cards, micro SD cards, USB flash drives, memory cards, hard drives, coin-operated mechanisms for vending machines and mechanisms for coin-operated apparatus, calculating machines, data-processing equipment and computers, sound and image transmitting apparatus, telecommunications apparatus, mobile telecommunications apparatus, mobile telecommunications kits, computer hardware, computer software, downloadable computer software, multimedia applications, PDA (personal digital assistant), pocket PCs, mobile telephones, laptops, telecommunications network devices, control software for telecommunications networks and telecommunications devices, video recorders, cameras, MP3 and MP4 players, electronic publications (downloadable), periodicals in electronic form, electronic databases and databases products, information and data in electronic form, information and data recorded on carriers or in electronic, data, information, computer and communication networks of all kinds, covers for smartphones and computers, protective films and cases adapted for smartphones and computers, parts and accessories for all the aforesaid goods; computerized data processing; systematization of information into computer databases; market research and market analysis; promotion by electronic means, including by means of Internet search engines; consultancy in the field of Internet marketing; rental of advertising space; dissemination of advertising matter; opinion polling, collection, classification, updating and arrangement of data and administration and operation of databases with marketing information; providing business information, including via the Internet; cable or other forms of data transmission; information, consultancy and advisory services in relation to the aforesaid services in this class; professional business research services, in particular in the field of market research and product research for others.

36 – Banking; factoring; financing services, hire-purchase financing; financial analysis; financial evaluation (insurance, banking, real estate); financial information; financial consultancy; financial management; financial sponsorship; financial clearing houses; financial clearing; mortgage banking; investment of funds; capital investment; brokerage services; stocks and bonds brokerage; securities brokerage; online banking; insurance consultancy; providing financial information via a website, providing rebates at partici-

pating establishments of others through use of a membership card; loans (financing); installment loans; lending against security; financial research; insurance underwriting; fire insurance underwriting; accident insurance underwriting; health insurance underwriting; life insurance underwriting; surety services; insurance brokerage.

37 – Construction services relating to industrial, civil engineering, residential and civil works, construction, assembly, maintenance, repair and revisions of telecommunication, radio communication and data machines and equipment, service for domestic and foreign telecommunication and other equipment, installation, assembly, maintenance, repair and revisions of electrical machinery, apparatus and equipment, installation, assembly, maintenance, repair and revisions of measuring and control equipment.

38 – Wireless broadcasting; electronic bulletin board services (telecommunication services); information about telecommunications; communication by fiber optic networks; communication by cellular phones; communication by computer terminals; online transmission of greeting cards online; paging (radio, telephone or other means of electronic communication); providing Internet chatrooms; providing online forums; providing access to databases; providing telecommunications connections to a global computer network; providing telecommunications channels for teshopping services; providing user access to global computer networks; rental of access time to global computer networks; rental of fax machines; rental of modems; rental of message transmission equipment; rental of telephones; rental of telecommunications equipment; rental of telecommunication apparatus and installations; digital file transmission; electronic mail transmission; facsimile transmission; telegram transmission; video on demand transmission; computer-aided transmission of messages and images; radio communication; radio broadcasting, satellite transmission; voice mail services; news agency services; telecommunications routing and junction services; streaming of data; communication by telephone; telephone services; communication by telegraph; telegraph services; teleconferencing services; television broadcasting; telex services; videoconferencing services; cable television broadcasting; messaging, communications (telecommunications); network telecommunication services; mobile telecommunications services; telecommunications portal services; Internet portal services; mobile telecommunications network services; consulting services in the field of telecommunications; mobile telecommunications and data communication services; fixed line telecommunications services; broadband telecommunications access services; broadband services; broadcasting services, television broadcasting services, broadcasting services relating to IP / TV or based on IP / TV, IP / TV access services; television transmission services provided via the Internet

Protocol technology including IP / TV, television and IP / TV; Internet access services; services of e-mail, text and multimedia messages, services relating to the provision of access to computer networks, in particular the assurance, provision and rental of access time to data networks and databases, in particular to the Internet; the provision of access to computer databases and communication services relating thereto; ancillary, supportive and assistance services in the field of telecommunications and telecommunications equipment; operation of networks, especially telecommunications and data networks; expert advisory and consultancy services in the field of telecommunications and data communication services; information, consultancy and advisory services in relation to the aforesaid services in this class; rental of telecommunication apparatus; rental of apparatus for data transfer.

41 – Publishing; education and training; training services; entertainment; sports and cultural activities; interactive entertainment services, electronic and computer games services provided via any communication networks; entertainment and information services relating to the aforesaid services provided via telecommunications networks; news reporters services; television entertainment services; providing entertainment via television and IP/TV; information, consultancy and advisory services relating to the aforesaid services in this class.

42 – Development of databases; updating of computer software; computer system analysis; cloud computing; digitization of documents (scanning); electronic monitoring of personally identifying information to detect identity theft via the Internet; electronic monitoring of credit card activity to detect fraud via the Internet, off-site data backup; graphic design of promotional materials; hosting computer sites (web sites); installation of computer software; conversion of computer programs and data other than physical conversion; duplication of computer programs; recovery of computer data, unlocking smartphones; platform as a service (PaaS); computer programming; information technology (IT) consultancy; Internet security consultancy; consultancy in the design and development of computer hardware; web site design consultancy; computer technology consultancy; data encryption services; telecommunications technology consultancy; data security consultancy; computer security consultancy; providing information on computer technology and programming via a website; providing of outsource services in the field of information technology; rental of computer software; rental of computers and data processing equipment; rental of web servers; surveying, providing search engine for the Internet, server hosting; monitoring of computer systems for detecting unauthorized access or data breach; monitoring of computer systems to detect breakdowns; software as a service (SaaS); computer software design, computer system design; maintenance of computer software; de-

velopment of computer platforms; software development in the framework of software publishing; research in the field of telecommunications technology; monitoring of computer systems by remote access; scientific and technological services and research and development relating thereto; industrial analysis and research; research in the field of telecommunications; data services and telecommunication technology; designing, development and analysis of computer, telecommunication and data systems; planning and design services in the field of telecommunications equipment; rental of computers and data processing apparatus and installations; monitoring of telecommunication and data systems; technical consulting services in the field of information technology; computer technology and data technology; engineering services in the field of information, telecommunications and data technology; design and development of computer hardware and software; information technology consultancy services; computer programming services; IT programming services; recovery of computer data; consultancy in the design and development of computer hardware; computer software consultancy; backup and copying of computer programs; rental of computers; design, development and creation of computer software; installation and maintenance of computer software, updating of computer software; rental of computer software and hardware; conversion of data or documents from physical to electronic media; conversion of data and computer programs (not physical conversion); creating and maintaining websites for others; webhosting; information and advisory services relating to the aforesaid services in this class.

(260) AM 2021 111803 A

(800) 1576499

(151) 2020 11 24

(891) 2020 11 24

(731) Limited Liability Company "ORIMI"

15/4 plot, 1-st Mikrorayon Street, Sverdlov settlement, Vsevolozhsk district, RU-188682 Leningrad oblast, Russian Federation

(540)

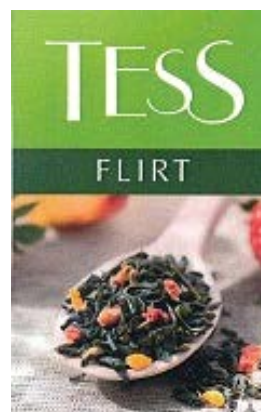

(591) Light green, white, dark green, green brown, beige, yellow, red, orange, gray, light gray

(531) 05.03.11; 05.03.16; 05.05.19; 05.05.23;
05.07.08; 11.01.02; 25.01.15; 27.05.09;
27.05.24; 29.01.15

(511)

30 – Tea including instant tea; flavored tea; tea with fruits, herbs, flowers, berries and other additives not for medicinal use; tea-based beverages; iced tea.

(260) AM 2021 111808 A

(800) 1576693

(151) 2020 11 26

(891) 2020 11 26

(731) FINCHIMICA S.P.A.

VIA LAZIO 13, I-25025 MANERBIO (BS),

Italy

(540)

AZOFIN

(591) Black, white

(511)

1 – Agricultural chemicals, except fungicides, herbicides, insecticides and parasiticides; plant strengthening preparations; chemicals used in industry, science and photography, as well as in agriculture, horticulture and forestry; synthetic resins, unprocessed; unprocessed plastics; manures; fire extinguishing compositions; tempering and soldering preparations; chemical substances for preserving foodstuffs; tanning substances; adhesives used in industry; chemically converted compound fertilizers; chemically treated peat for use in horticulture; manures; chemicals for use in agriculture; fertilisers and chemicals used in agriculture, horticulture and forestry; chemicals for use in agriculture; chemical adjuvants for use in agriculture; bacteriological preparations for use in agriculture; fertilisers, and chemicals used in agriculture, horticulture and forestry.

5 – Preparations for destroying vermin; insecticides; fungicides; herbicides; vermin destroying preparations; forestry (chemicals for -), [parasiticide]; parasiticides; pest control preparations and articles; antiparasitic preparations from chemical sources; antiparasitic preparations; fungicides; biological fungicides; fungicides; fungicides for horticultural use; fungicides for agricultural use; fungicides for killing vermin; forestry (chemicals for -), [herbicides]; biological herbicides.

(260) AM 2021 111810 A

(800) 1576714

(151) 2020 11 03

(891) 2020 11 03

(731) AHMET ERZURUMLUOĞLU

Sultantepe Mah.Susuzbağ Sok 5-1/ 10,

Üsküdar, İstanbul, Turkey

(540)



(591) Black, white, yellow

(531) 05.05.04; 05.05.20; 05.05.21; 05.07.01;

05.07.27; 26.13.25; 27.05.08; 27.05.11;

27.05.24; 29.01.13

(511)

25 – Underwear made of all kinds of materials, except those for protective purposes.

35 – Business management, business administration and business consultancy; accounting.

(260) AM 2021 111815 A

(800) 1081602

(151) 2011 05 20

(891) 2021 01 11

(731) KARMOD PREFABRIK YAPI

TEKNOLOJILERI INSAAT SANAYI VE

TICARET LIMITED SİRKETİ LIMITED

SİRKETİ

Orta Mah. Keban Sokak No:4, Orhanlı Tuzla

Istanbul, Turkey

(540)

Karmod

(591) Black, white

(531) 27.05.01; 27.05.17

(511)

6 – Common metals and their alloys; metal building materials; transportable buildings of metal; materials of metal for railway tracks; non-electric cables and wires of common metal; ironmongery, small items of metal hardware; pipes and tubes of metal; safes; goods of common metal not included in other classes; ores.

19 – Building materials (non-metallic); non-metallic rigid pipes for building; asphalt, pitch and bitumen; non-metallic transportable buildings; monuments, not of metal.

(260) AM 2021 111816 A

(800) 1086795

(151) 2011 05 26

(891) 2020 10 06

(731) Tovarishchestvo s ogranichennoy, otvetstvennostyu "Farmatsiya Universal" ul. Chaplina/Khalliulina, d. 71/66, 050000 g. Almaty, Kazakhstan

(540)



(591) Black, white

(531) 26.04.22

(511)

5 – Pharmaceutical preparations, biological preparations, vitamin preparations, medicinal preparations, remedies and substances; foodstuffs for medical use, nutritional supplements for medical use; pharmaceutical extracts, tinctures for medical use, elixirs (pharmaceutical preparations), medicinal infusions, syrups for pharmaceutical use, capsules for medicines; herbal teas, medicinal teas, medicinal herbs.

35 – Advertising, business management, including, advertising material (issuing, sending, dissemination, publishing, distribution of samples, exhibits), organization of exhibitions for commercial or advertising purposes, sales promotion for third parties (sale of goods via an intermediary, goods demonstrations, market studies), presentation of goods on all communication means for retail sales purposes, publishing of advertising texts, radio advertising, distribution of samples, dissemination of advertising materials (leaflets, prospectuses, printed matter, samples), advertising, on-line advertising on a computer network, advertising by mail order, television advertising, procurement services for third parties (purchasing goods and services for other businesses); all the services in this class relating to the goods in class 5.

39 – Transport; packaging and storage of goods, delivery of goods, packaging of goods, storage of goods; all the services in this class relating to the goods in class 5.

(260) AM 2021 111826 A

(800) 1398038

(151) 2018 01 10

(891) 2021 01 29

(731) Joint Stock Company Polyus Krasnoyarsk ul. Belinskogo, 2-B, g. p. Severo-Yeniseyskiy, Severo-Yeniseyskiy r-n, RU-663282 Krasnoyarsk Krai, Russian Federation

(540)



ПОЛЮС

(591) Yellow and gray

(531) 26.04.04; 26.04.09; 28.05; 29.01.13

(511)

1 – Antimony; antimony sulfide; gold salts; silver nitrate.

4 – Coal; coal briquettes.

6 – Silver solder; cobalt, raw; copper, unwrought or semi-wrought; badges of metal for vehicles; magnesium; common metals, unwrought or semi-wrought; ores of metal; nickel; packaging containers of metal; alloys of common metal; gold solder; boxes of common metal.

14 – Ingots of precious metals; jewelry; gold, unwrought or beaten; ornaments [jewelry]; alloys of precious metal; works of art of precious metal; silver, unwrought or beaten; badges of precious metal.

19 – Limestone; schists; granite; sandstone for building.

35 – Business management assistance; business inquiries; book-keeping; drawing up of statements of accounts; business management and organization consultancy; personnel management consultancy; business management consultancy; business efficiency expert services; business organization consultancy; computerized file management; payroll preparation; tax preparation; compilation of information into computer databases; systemization of information into computer databases; compilation of statistics; sponsorship search; provision of commercial and business contact information; negotiation and conclusion of commercial transactions for third parties; business project management services for construction projects; tax filing services; business management of reimbursement programs for others; commercial or industrial management assistance; outsourced administrative management for companies.

37 – Office machines and equipment installation, maintenance and repair; machinery installation, maintenance and repair; building construction supervision; warehouse construction and repair; factory construction; masonry; vehicle maintenance; construction information; quarrying services; drilling of wells; mining extraction; installation, maintenance and repair of computer hardware; construction consultancy; repair of power lines; construction.

38 – Communications by telephone; rental of telecommunication equipment; providing telecommunication connections to a global computer network; providing user access to global computer networks; providing access to databases.

39 – Transport and storage of trash; car transport; boat transport; railway transport; marine transport; passenger transport; river transport; stevedoring; electricity distribution; rental of warehouses; garage rental; parking place rental; freight forwarding; storage information; transportation information; rental of vehicle roof racks; distribution of energy; unloading cargo; transportation logistics.

40 – Water treating; gilding; metal treating; gold plating; grinding; timber felling and processing; recycling of waste and trash; recycling of waste; waste treatment [transformation]; production of energy; decontamination of hazardous materials; sorting of waste and recyclable material [transformation].

42 – Geological surveys; geological prospecting; geological research; research in the field of environmental protection.

(260) AM 2021 111888 A

(800) 1576898

(151) 2020 11 17

(891) 2020 11 17

(731) LIMITED LIABILITY COMPANY

"FOAMLIN"

Dmitrovskaya av., 60A, space XII, room 22,

Beskudnikovskiy municipal, district inner

territory of the city, RU-127474 Moscow,

Russian Federation

(540)



(591) Blue and light green

(531) 28.05; 29.01.12

(511)

1 – Combusting preparations [chemical additives to motor fuel]; adhesives for industrial purposes; salt for preserving, other than for foodstuffs; auxiliary fluids for use with abrasives; vulcanization accelerators; anti-frothing solutions for accumulators; acetates [chemicals]; acetate of cellulose, unprocessed; bacteriological preparations for acetification; acetic anhydride; acetone; acetylene; acetylene tetrachloride; acids; chemical condensation preparations; acid proof chemical compositions; finishing preparations for use in the manufacture of steel; actinium; additives, chemical, to drilling muds; additives, chemical, to motor fuel; detergent additives to gasoline; adhesive preparations for surgical bandages; water-softening preparations; gum tragacanth for industrial purposes; activated carbon; propellant gases for aerosols; reducing agents for use in photography; adhesives for billposting; agar-agar; agglutinants for concrete; agricultural chemicals, except fungicides, herbicides, insecticides and parasiticides; compositions for repairing inner tubes of tyres; albumin [animal or vegetable, raw material]; iodi-

sed albumen; malt albumen; albumenized paper; alkalis; caustic alkali; alkaline-earth metals; alcohol; ethyl alcohol; aldehydes; seaweeds [fertilizers]; chemical substances for preserving foodstuffs; chemical preparations for facilitating the alloying of metals; alumina; aluminium alum; aluminium hydrate; aluminium silicate; aluminium chloride; aluminium iodide; alum; soil conditioning preparations; americium; starch for industrial purposes; starch-liquifying chemicals [ungluing agents]; sal ammoniac; spirits of salt; ammoniacal salts; ammonia; ammonium aldehyde; ammonia alum; amyl acetate; amyl alcohol; anhydrous ammonia; anhydrides; animal charcoal; animal albumen [raw material]; anthranilic acid; anti-knock substances for internal combustion engines; antifreeze; anti-incrustants; antimony; antimony oxide; antimony sulfide; size for use in the textile industry; gum arabic for industrial purposes; glutinous tree-grafting preparations; tree cavity fillers [forestry]; silver salt solutions for silvering; argon; lead arsenate; arsenic; arsenious acid; astatine; fuel for nuclear reactors; engine-decarbonising chemicals; self-toning paper [photography]; textile-brightening chemicals; nitrogen; nitrous oxide; nitrogenous fertilisers; nitric acid; oenological bactericides [chemical preparations for use in wine making]; fixing baths [photography]; galvanizing baths; toning baths [photography]; soda ash; barium; baryta; baryta paper; barium compounds; substances for preventing runs in stockings; bases [chemical preparations]; chemicals, except pigments, for the manufacture of enamel; bauxite; bentonite; benzene-based acids; benzene derivatives; benzoic acid; benzoic sulfimide; saccharin; berkelium; concrete-aeration chemicals; concrete preservatives, except paints and oils; bichloride of tin; bichromate of potassium; bichromate of soda; beer-clarifying and preserving agents; biochemical catalysts; potassium dioxalate; manganese dioxide; bismuth; basic gallate of bismuth; moistening [wetting] preparations for use in bleaching; wax-bleaching chemicals; tan-wood; wood alcohol; wood pulp; wood vinegar [pyroligneous acid]; borax; boric acid for industrial purposes; drilling muds; brazing preparations; condensation-preventing chemicals; catechu; kainite; calcium cyanamide [fertilizer]; californium; plasticizers; rubber preservatives; carbonates; magnesium carbonate; carbon; carbon disulfide; carbonic acid; carbide; calcium carbide; lutetium [cassiopium]; catalysts; cellulose; paper pulp; viscose; cement [metallurgy]; fermium; ceramic glazings; cerium; salts from rare earth metals; caesium; ketones; animal carbon preparations; carbon for filters; bone charcoal; blood charcoal; coal saving preparations; cement for footwear; lime acetate; lime carbonate; lime chloride; chimney cleaners, chemical; leather-renovating chemicals; industrial chemicals; chemical preparations for scientific purposes, other than for medical or veterinary use; chemical reagents, other than for medical or veterinary purposes; moderating materials for nuclear reactors; fissionable chemical el-

ements; chemical substances for analyses in laboratories, other than for medical or veterinary purposes; chlorates; chlorine; hydrochlorates; hydrochloric acid; cholic acid; chromates; chrome alum; chromium oxide; chrome salts; chromic acid; mastic for leather; mastic for tires; cement for mending broken articles; cement-waterproofing chemicals, except paints; cement preservatives, except paints and oils; fluids for hydraulic circuits; grafting wax for trees; citric acid for industrial purposes; must-fining preparations; size for finishing and priming; adhesives for wallpaper; wine finings; collodion; salts for coloring metal; bate for dressing skins; flower preservatives; preservatives for use in the pharmaceutical industry; chemical preparations for use in photography; sensitized cloth for photography; photosensitive plates; corrosive preparations; currying preparations for leather; currying preparations for skins; cream of tartar for chemical purposes; crotonic aldehyde; cryogenic preparations; leather glues; leather-dressing chemicals; leather-impregnating chemicals; blue vitriol; curium; solutions for cyanotyping; cyanides [prussiates]; ferrocyanides; cymene; degreasing preparations for use in manufacturing processes; separating and unsticking [ungluing] preparations; oil-separating chemicals; degumming preparations; defoliant; mold-release preparations; polish removing substances; dehydrating preparations for industrial purposes; disincrustants; detergents for use in manufacturing processes; dextrin [size]; diagnostic preparations, other than for medical or veterinary purposes; diastase for industrial purposes; diazo paper; renovating preparations for phonograph records; distilled water; dolomite for industrial purposes; metal hardening preparations; dysprosium; acidulated water for recharging accumulators; glycerine for industrial purposes; heavy water; purification preparations; ion exchangers [chemicals]; flashlight preparations; fuel-saving preparations; reagent paper, other than for medical or veterinary purposes; antistatic preparations, other than for household purposes; salts for galvanic cells; opacifiers for enamel; opacifiers for glass; enamel-staining chemicals; photographic emulsions; emulsifiers; sensitized photographic plates; sizing preparations; fertilizers; enzyme preparations for industrial purposes; enzymes for industrial purposes; epoxy resins, unprocessed; gas purifying preparations; erbium; spirits of vinegar [dilute acetic acid]; test paper, chemical; esters; ethane; ethers; ethyl ether; glycol ether; methyl ether; sulfuric ether; stain-preventing chemicals for use on fabrics; europium; fire extinguishing compositions; flour for industrial purposes; iron salts; ferments for chemical purposes; ferrotype plates [photography]; fertilizing preparations; fireproofing preparations; compositions for threading; filtering preparations for the beverages industry; fissionable material for nuclear energy; fixing solutions [photography]; flowers of sulfur for chemical purposes; limestone hardening substances; fluorine; fluorospar compounds; hydrofluoric acid; graphite for in-

dustrial purposes; foundry binding substances; foundry molding preparations; additives, chemical, to insecticides; additives, chemical, to fungicides; formic acid; formic aldehyde for chemical purposes; fulling preparations for use in the textile industry; fulling preparations; francium; brake fluid; lamp black for industrial purposes; chemical preparations for smoking meat; gadolinium; gallnuts; gallic acid for the manufacture of ink; gallium; photographic paper; gallotannic acid; galvanizing preparations; gambier; protective gases for welding; solidified gases for industrial purposes; gelatine for photographic purposes; gelatine for industrial purposes; rock salt; getters [chemically active substances]; dry ice [carbon dioxide]; birdlime; glucosides; glycerides; glycol; fat-bleaching chemicals; fatty acids; grafting mastic for trees; guano; gurgun balsam for use in the manufacture of varnish; helium; holmium; hormones for hastening the ripening of fruit; horticultural chemicals, except fungicides, herbicides, insecticides and parasiticides; oils for the preservation of food; oils for preparing leather in the course of manufacture; oils for tanning leather; petroleum dispersants; oil dispersants; oil-bleaching chemicals; oil-purifying chemicals; humus; hydrates; carbonic hydrates; hydrazine; hydrogen; hypochlorite of soda; hyposulfites; textile-waterproofing chemicals; textile-impregnating chemicals; leather-waterproofing chemicals; iodine for chemical purposes; iodised salts; iodic acid; iodine for industrial purposes; isotopes for industrial purposes; kaolin; kieselgur; krypton; lactic acid; milk ferments for chemical purposes; lanthanum; preparations for preventing the tarnishing of lenses; lithia [lithium oxide]; lithium; masonry preservatives, except paints and oils; brickwork preservatives, except paints and oils; magnesite; magnesium chloride; manganate; mangrove bark for industrial purposes; glass-frosting chemicals; mercury; mercury salts; mercuric oxide; metalloids; salts of precious metals for industrial purposes; metal annealing preparations; methane; chemical preparations to prevent mildew; mineral acids; salts for industrial purposes; moistening [wetting] preparations for use in dyeing; naphthalene; neodymium; neon; neptunium; toxic gas neutralizers; chemical preparations to prevent wheat blight; uranium nitrate; sensitized plates for offset printing; oleic acid; olivine [silicate mineral]; gold salts; sorrel salt; oxalates; oxalic acid; oxygen for industrial purposes; hydrogen peroxide for industrial purposes; palladium chloride; nitrate paper; photometric paper; sensitized paper; litmus paper; pectin [photography]; perborate of soda; percarbonates; perchlorates; persulfates; persulfuric acid; phenol for industrial purposes; phosphates [fertilisers]; slag [fertilisers]; phosphatides; phosphorus; superphosphates [fertilisers]; blueprint paper; phosphoric acid; blueprint cloth; photographic developers; photographic sensitizers; picric acid; plastics, unprocessed; plastisols; lead acetate; lead oxide; plutonium; polonium; potato flour for industrial purposes; peat pots for horticultu-

re; potash; potassium; potash water; praseodymium; promethium; protactinium; protein [raw material]; pyrogalllic acid; quebracho for industrial purposes; synthetic resins, unprocessed; radioactive elements for scientific purposes; radon; radium for scientific purposes; refrigerants; by-products of the processing of cereals for industrial purposes; acrylic resins, unprocessed; rhenium; X-ray films, sensitized but not exposed; compositions for repairing tyres; rubidium; foundry sand; salicylic acid; saltpeter; samarium; sauce for preparing tobacco; soap [metallic] for industrial purposes; scandium; sebacic acid; salts [chemical preparations]; salt, raw; chromic salts; salts [fertilisers]; selenium; seed preserving substances; silicates; silicon; silicones; sodium; sulfides; welding chemicals; calcined soda; caustics for industrial purposes; caustic soda for industrial purposes; sodium salts [chemical compounds]; sulfur; bismuth subnitrate for chemical purposes; barytes; spinel [oxide mineral]; stearic acid; strontium; soot for industrial or agricultural purposes; liquids for removing sulfates from accumulators; sulfonic acids; sulfurous acid; sulfuric acid; sumac for use in tanning; chemicals for use in forestry, except fungicides, herbicides, insecticides and parasiticides; talc [magnesium silicate]; tan; tannin; tanning substances; calcium salts; tannic acid; tapioca flour for industrial purposes; tartar, other than for pharmaceutical purposes; tartaric acid; technetium; tellurium; surface-active chemical agents; terbium; glass-staining chemicals; preparations for preventing the tarnishing of glass; anti-tarnishing chemicals for windows; soil for growing; fuller's earth for use in the textile industry; rare earths; loam; carbon tetrachloride; tetrachlorides; moistening [wetting] preparations for use in the textile industry; thallium; thiocarbonyl; thulium; thorium; titanium dioxide for industrial purposes; titanite; toluol; peat [fertiliser]; preservatives for tiles, except paints and oils; tungstic acid; uranium; uranium oxide; water glass [soluble glass]; meat tenderizers for industrial purposes; chemical preparations to prevent diseases affecting vine plants; vinic alcohol; toning salts [photography]; vulcanizing preparations; witherite; xenon; ytterbium; yttrium; chlorides; sulfates; zirconia; preparations for stimulating cooking for industrial purposes; ammonia [volatile alkali] for industrial purposes; alkaline iodides for industrial purposes; alkaline metals; salts of alkaline metals; alkaloids; alginates for industrial purposes; aluminium acetate; starch paste [adhesive], other than for stationery or household purposes; ammonium salts; animal carbon; silver nitrate; color-brightening chemicals for industrial purposes; anti-sprouting preparations for vegetables; nitrates; adhesives for wall tiles; barium sulfate; chemicals for the manufacture of paints; methyl benzol; methyl benzene; bicarbonate of soda for chemical purposes; biological preparations, other than for medical or veterinary purposes; bleaching preparations [decolorants] for industrial purposes; sensitized films, unexposed; preparations of the distillation

of wood alcohol; brazing fluxes; soldering fluxes; bromine for chemical purposes; carbolineum for the protection of plants; flocculants; lecithin [raw material]; substrates for soil-free growing [agriculture]; cellulose esters for industrial purposes; casein for industrial purposes; cellulose derivatives [chemicals]; cellulose ethers for industrial purposes; bacterial preparations, other than for medical and veterinary use; bacteriological preparations, other than for medical and veterinary use; cultures of microorganisms, other than for medical and veterinary use; carbon black for industrial purposes; cinematographic films, sensitized but not exposed; cobalt oxide for industrial purposes; glue for industrial purposes; oils for currying leather; creosote for chemical purposes; compositions for the manufacture of phonograph records; preparations for the separation of greases; dispersions of plastics; solvents for varnishes; artificial sweeteners [chemical preparations]; water-purifying chemicals; emollients for industrial purposes; filtering materials of unprocessed plastics; filtering materials of chemical substances; filtering materials of mineral substances; filtering materials of vegetable substances; glucose for industrial purposes; gluten [glue], other than for stationery or household purposes; gums [adhesives] for industrial purposes; damp-proofing chemicals, except paints, for masonry; isinglass, other than for stationery, household or alimentary purposes; beer preserving agents; synthetic materials for absorbing oil; ceramic materials in particulate form, for use as filtering media; compost; compositions for the manufacture of technical ceramics; diatomaceous earth; mordants for metals; plant growth regulating preparations; descaling preparations, other than for household purposes; seawater for industrial purposes; preparations of trace elements for plants; camphor, for industrial purposes; chemical intensifiers for paper; chemical intensifiers for rubber; humus top dressing; magnetic fluid for industrial purposes; power steering fluid; transmission fluid; anti-boil preparations for engine coolants; ceramic compositions for sintering [granules and powders]; coolants for vehicle engines; radiator flushing chemicals; paste fillers for automobile body repair; electrophoresis gels; glaziers' putty; expanded clay for hydroponic plant growing [substrate]; wallpaper removing preparations; chemical additives for oils; oil cement [putty]; genes of seeds for agricultural production; stem cells, other than for medical or veterinary purposes; biological tissue cultures, other than for medical or veterinary purposes; fish meal fertilizers; enzyme preparations for the food industry; enzymes for the food industry; glucose for the food industry; lecithin for the food industry; lecithin for industrial purposes; pectin for the food industry; pectin for industrial purposes; cream of tartar for the food industry; cream of tartar for industrial purposes; alginates for the food industry; gluten for the food industry; gluten for industrial purposes; lactose for the food industry; lactose for industrial purposes; lactose [raw material];

milk ferments for the food industry; milk ferments for industrial purposes; casein for the food industry; sal ammoniac spirits; chemicals for the manufacture of pigments; preparations of microorganisms, other than for medical and veterinary use; potting soil; metal tempering preparations; glutamic acid for industrial purposes; tea extracts for use in the manufacture of pharmaceuticals; tea extracts for the food industry; organic digestate [fertilizer]; tea extracts for use in the manufacture of cosmetics; collagen for industrial purposes; silicon carbide [raw material]; adjuvants, other than for medical or veterinary purposes; vitamins for use in the manufacture of food supplements; vitamins for the food industry; antioxidants for use in manufacture; antioxidants for use in the manufacture of cosmetics; antioxidants for use in the manufacture of pharmaceuticals; antioxidants for use in the manufacture of food supplements; proteins for use in manufacture; proteins for use in the manufacture of food supplements; proteins for the food industry; ammonium nitrate; vitamins for use in the manufacture of pharmaceuticals; vitamins for use in the manufacture of cosmetics; flavonoids [phenolic compounds] for industrial purposes; thymol for industrial purposes; topsoil; transmission oil; polymer resins, unprocessed; chemical coatings for ophthalmic lenses; calomel [mercurous chloride]; animal manure; xylol; xylene; benzene; benzol; graphene; gypsum for use as a fertilizer.

10 – Abdominal belts; hypogastric belts; abdominal corsets; childbirth mattresses; hearing aids; ear trumpets; clips, surgical; needles for medical purposes; suture needles; pessaries; hot air therapeutic apparatus; hot air vibrators for medical purposes; draw-sheets for sick beds; incontinence sheets; catheters; radium tubes for medical purposes; teething rings; supportive bandages; splints, surgical; bandages, elastic; galvanic belts for medical purposes; X-ray apparatus for medical purposes; bed pans; basins for medical purposes; obstetric apparatus for cattle; feeding bottles; knives for surgical purposes; scalpels; boots for medical purposes; surgical bougies; spittoons for medical purposes; catgut; stretchers, wheeled; ambulance stretchers; orthopedic articles; trusses; arch supports for footwear; strait jackets; cannulae; gloves for medical purposes; appliances for washing body cavities; belts for medical purposes; maternity belts; orthopedic belts; dentists' armchairs; castrating pincers; heating cushions, electric, for medical purposes; orthopedic footwear; artificial teeth; surgical sponges; surgical apparatus and instruments; instrument cases for use by doctors; thread, surgical; anaesthetic apparatus; scissors for surgery; thermo-electric compresses [surgery]; compressors [surgical]; droppers for medical purposes; corn knives; esthetic massage apparatus; cushions for medical purposes; surgical cutlery; incubators for medical purposes; spoons for administering medicine; tongue scrapers; ear picks; dental burs; dental

apparatus and instruments; pins for artificial teeth; dentures; lancets; mirrors for dentists; finger guards for medical purposes; syringes for injections; drainage tubes for medical purposes; water bags for medical purposes; radiology screens for medical purposes; electrocardiographs; probes for medical purposes; pumps for medical purposes; blood testing apparatus; armchairs for medical or dental purposes; dropper bottles for medical purposes; forceps; galvanic therapeutic appliances; gloves for massage; gastroscopes; ice bags for medical purposes; hemocytometers; waterbeds for medical purposes; hypodermic syringes; abdominal pads; inhalers; injectors for medical purposes; soporific pillows for insomnia; urological apparatus and instruments; insufflators; enema apparatus for medical purposes; ultraviolet ray lamps for medical purposes; lasers for medical purposes; breast pumps; lamps for medical purposes; vaporizers for medical purposes; urinals being vessels; artificial jaws; anaesthetic masks; massage apparatus; medical apparatus and instruments; receptacles for applying medicines; cases fitted for medical instruments; artificial limbs; mirrors for surgeons; furniture especially made for medical purposes; obstetric apparatus; umbilical belts; ophthalmometers; ophthalmoscopes; hearing protectors; artificial skin for surgical purposes; tips for crutches; balling guns; condoms; sphygmomanometers; quartz lamps for medical purposes; apparatus and installations for the production of X-rays, for medical purposes; X-ray photographs for medical purposes; radiological apparatus for medical purposes; radiotherapy apparatus; resuscitation apparatus; X-ray tubes for medical purposes; protection devices against X-rays, for medical purposes; respirators for artificial respiration; apparatus for artificial respiration; saws for surgical purposes; artificial breasts; uterine syringes; vaginal syringes; stethoscopes; dummies for babies; supports for flat feet; apparatus for the treatment of deafness; suspensory bandages; suture materials; operating tables; trocars; urethral probes; urethral syringes; cupping glasses; veterinary apparatus and instruments; bed vibrators; vibromassage apparatus; artificial eyes; aerosol dispensers for medical purposes; air pillows for medical purposes; air cushions for medical purposes; air mattresses for medical purposes; syringes for medical purposes; elastic stockings for surgical purposes; stockings for varices; crutches; feeding bottle valves; feeding bottle teats; orthopedic soles; sterile sheets, surgical; beds specially made for medical purposes; electrodes for medical use; belts, electric, for medical purposes; physical exercise apparatus for medical purposes; incubators for babies; brushes for cleaning body cavities; dental apparatus, electric; testing apparatus for medical purposes; filters for ultraviolet rays, for medical purposes; fumigation apparatus for medical purposes; corsets for medical purposes; contraceptives, non-chemical; blankets, electric, for medical purposes; hair prostheses; knee bandages, orthopedic; lenses [intraocular prostheses]

for surgical implantation; pads for preventing pressure sores on patient bodies; physiotherapy apparatus; spirometers [medical apparatus]; thermometers for medical purposes; acupuncture needles; clothing especially for operating rooms; diagnostic apparatus for medical purposes; electric acupuncture instruments; heart pacemakers; invalids' hoists; masks for use by medical personnel; plaster bandages for orthopedic purposes; surgical drapes; surgical implants comprised of artificial materials; thermal packs for first aid purposes; commode chairs; defibrillators; dialyzers; medical guidewires; orthodontic appliances; traction apparatus for medical purposes; containers especially made for medical waste; slings [supporting bandages]; douche bags; love dolls [sex dolls]; microdermabrasion apparatus; body rehabilitation apparatus for medical purposes; pulse meters; stents; ear plugs [ear protection devices]; temperature indicator labels for medical purposes; walking frames for disabled persons; tomographs for medical purposes; apparatus for acne treatment; lice combs; quad canes for medical purposes; endoscopy cameras for medical purposes; heart rate monitoring apparatus; compression garments; sex toys; brain pacemakers; implantable subcutaneous drug delivery devices; biodegradable bone fixation implants; tongue depressors for medical purposes; nasal aspirators; teeth protectors for dental purposes; menstrual cups; respiratory masks for artificial respiration; orthodontic rubber bands; analysers for bacterial identification for medical purposes; apparatus for DNA and RNA testing for medical purposes; apparatus for the regeneration of stem cells for medical purposes; body fat monitors; body composition monitors; toe separators for orthopaedic purposes; anti-rheumatism bracelets; anti-rheumatism rings; bracelets for medical purposes; surgical robots; baby feeding pacifiers; anti-nausea wristbands; wheeled walkers to aid mobility; hydrogen inhalers; magnetic resonance imaging [MRI] apparatus for medical purposes; air beds for medical purposes; cooling patches for medical purposes; cooling pads for first aid purposes; portable hand-held urinals; walking sticks for medical purposes.

12 – Forklift trucks; railway couplings; couplings for land vehicles; aerial conveyors; air vehicles; hot air balloons; inner tubes for pneumatic tyres; repair outfits for inner tubes; air pumps [vehicle accessories]; suspension shock absorbers for vehicles; shock absorbing springs for vehicles; amphibious airplanes; non-skid devices for vehicle tires; anti-skid chains; headrests for vehicle seats; sprinkling trucks; trailer hitches for vehicles; motor buses; motor coaches; boats; trucks; automobile hoods; automobile chains; automobile chassis; reversing alarms for vehicles; aeroplanes; ferry boats; luggage carriers for vehicles; airships; tires for vehicle wheels; valves for vehicle tyres; flanges for railway wheel tyres; torsion bars for vehicles; ship hulls; boat hooks; steering gears for ships; disengaging gear for boats; inclined ways for boats; screw-

propellers for boats; oars; tipping bodies for lorries; mine cart wheels; bicycles; bicycle kickstands; bogies for railway cars; davits for boats; mudguards; two-wheeled trolleys; cars for cable transport installations; caissons [vehicles]; vehicle wheels; hoods for vehicle engines; hoods for vehicles; caravans; trailers [vehicles]; crankcases for land vehicle components, other than for engines; safety belts for vehicle seats; hubs for vehicle wheels; bicycle chains; wheelchairs; barges; launches; handling carts; hose carts; casting carriages; golf carts [vehicles]; vehicle chassis; rudders; rolling stock for funicular railways; rolling stock for railways; funnels for ships; treads for vehicles [tractor type]; tractors; mine cars; vehicle bumpers; buffers for railway rolling stock; hydraulic circuits for vehicles; bicycle handlebars; sleeping berths for vehicles; timbers [frames] for ships; bicycle tyres; gears for bicycles; bicycle brakes; bicycle mudguards; rims for bicycle wheels; bicycle cranks; bicycle motors; hubs for bicycle wheels; bicycle pedals; pumps for bicycle tires; spokes for bicycle wheels; bicycle wheels; bicycle saddles; motorcycle kickstands; gearing for land vehicles; dredgers [boats]; trolleys; motors, electric, for land vehicles; electric vehicles; clutches for land vehicles; safety seats for children, for vehicles; parachutes; casings for pneumatic tires; balance weights for vehicle wheels; space vehicles; spars for ships; axles for vehicles; axle journals; windshield wipers; dress guards for bicycles; luggage nets for vehicles; hub caps; vans [vehicles]; brakes for vehicles; bands for wheel hubs; refrigerated vehicles; refrigerated railway wagons; engines for land vehicles; skulls; seat covers for vehicles; portholes; seaplanes; hydroplanes; sleeping cars; locomotives; driving motors for land vehicles; railway carriages; vehicle running boards; transmissions for land vehicles; propulsion mechanisms for land vehicles; military vehicles for transport; jet engines for land vehicles; motorcycles; freewheels for land vehicles; water vehicles; ships; screws [propellers] for ships; paddles for canoes; windscreens; spikes for tires [tyres]; treads for retreading tyres; pneumatic tires [tyres]; pontoons; doors for vehicles; ski carriers for cars; delivery tricycles; pushchairs; stroller covers; pushchair hoods; screw-propellers; vehicle wheel spokes; spoke clips for wheels; ski lifts; vehicle suspension springs; dining cars; rearview mirrors; rims for vehicle wheels; motorcycle saddles; side cars; vehicle seats; sports cars; cleats [nautical]; chairlifts; rowlocks; tilting-carts; aircraft; undercarriages for vehicles; sleighs [vehicles]; tramcars; cable transport apparatus and installations; funiculars; telfer railways [cable cars]; tricycles; turbines for land vehicles; vehicles for locomotion by land, air, water or rail; adhesive rubber patches for repairing inner tubes; upholstery for vehicles; mopeds; windows for vehicles; cars; anti-theft devices for vehicles; tipping apparatus [parts of railway wagons]; yachts; aeronautical apparatus, machines and appliances; anti-glare devices for vehicles; automobile tyres; automobile bodies;

bumpers for automobiles; shock absorbers for automobiles; anti-theft alarms for vehicles; horns for vehicles; concrete mixing vehicles; inner tubes for bicycle tires; brake linings for vehicles; brake shoes for vehicles; gear boxes for land vehicles; wheelbarrows; carts; bicycle frames; bodies for vehicles; ejector seats for aircraft; vehicle covers [shaped]; driving chains for land vehicles; transmission chains for land vehicles; torque converters for land vehicles; signal arms for vehicles; funnels for locomotives; steering wheels for vehicles; saddle covers for bicycles; ambulances; tubeless tires for bicycles; reduction gears for land vehicles; brake segments for vehicles; air cushion vehicles; caps for vehicle fuel tanks; connecting rods for land vehicles, other than parts of motors and engines; tailboard lifts [parts of land vehicles]; security harness for vehicle seats; sun-blinds adapted for automobiles; transmission shafts for land vehicles; air bags [safety devices for automobiles]; baskets adapted for bicycles; motor homes; casters for trolleys [vehicles]; cleaning trolleys; fenders for ships; kick sledges; panniers adapted for bicycles; shopping trolleys; snowmobiles; remote control vehicles, other than toys; masts for boats; covers for vehicle steering wheels; spoilers for vehicles; headlight wipers; brake pads for automobiles; spare wheel covers; tilt trucks; cigar lighters for automobiles; brake discs for vehicles; saddlebags adapted for bicycles; bicycle bells; armored vehicles; engine mounts for land vehicles; military drones; canoes; civilian drones; side view mirrors for vehicles; fitted pushchair mosquito nets; vehicle joysticks; driverless cars [autonomous cars]; motor scooters; mobility scooters; ashtrays for automobiles; motorcycle chains; motorcycle frames; motorcycle handlebars; motorcycle engines; panniers adapted for motorcycles; solid tires for vehicle wheels; baby carriages; fitted footmuffs for prams; fitted footmuffs for pushchairs; tyre mousse inserts; bags adapted for pushchairs; remotely operated vehicles for underwater inspections; autonomous underwater vehicles for seabed inspections; bellows for articulated buses; electric bicycles; saddle covers for motorcycles; motor racing cars; robotic cars; camera drones; fishing trolleys; roll cage trolleys; lug nuts for vehicle wheels; clips adapted for fastening automobile parts to automobile bodies; rescue sleds; tow trucks; garbage trucks; trailers for transporting bicycles; bicycle trailers.

17 – Cellulose acetate, semi-processed; acrylic resins, semi-processed; asbestos safety curtains; rings of rubber; asbestos slate; watering hose; soundproofing materials; water-tight rings; balata; waterproof packings; rubber seals for jars; weatherstripping; padding materials of rubber or plastics; weatherstripping compositions; non-conducting materials for retaining heat; rubber, raw or semi-worked; rubber stoppers; clack valves of rubber; synthetic rubber; shock-absorbing buffers of rubber; flexible hoses, not of metal; insulating materials; compositions to prevent the radiation of heat; hoses of textile material; boiler composition

to prevent the radiation of heat; paper for electrical capacitors; cords of rubber; cotton wool for packing [caulking]; cylinder jointings; dielectrics [insulators]; asbestos sheets; ebonite; bark coverings for sound insulation; elastic threads, other than for textile use; clutch linings; caulking materials; expansion joint fillers; chemical compositions for repairing leaks; gas-kets; asbestos felt; insulating felt; vulcanized fiber; threads of plastic for soldering; brake lining materials, partly processed; insulating gloves; gutta-percha; insulating oil for transformers; insulating oils; sheets of regenerated cellulose, other than for wrapping; insulating paper; insulating fabrics; insulating varnish; substances for insulating buildings against moisture; foils of metal for insulating; insulating paints; slag wool [insulator]; mineral wool [insulator]; glass wool for insulation; latex [rubber]; canvas hose pipes; lute; pipe muffs, not of metal; sleeves of rubber for protecting parts of machines; sealant compounds for joints; mica, raw or partly processed; asbestos paper; plastic film, other than for wrapping; junctions, not of metal, for pipes; connecting hose for vehicle radiators; synthetic resins, semi-processed; washers of rubber or vulcanized fibre; bags [envelopes, pouches] of rubber, for packaging; asbestos coverings; asbestos fabrics; asbestos cloth; asbestos packing; valves of india-rubber or vulcanized fibre; viscose sheets, other than for wrapping; insulators for railway tracks; adhesive bands, other than stationery and not for medical or household purposes; fittings, not of metal, for compressed air lines; asbestos millboards; asbestos fibers; reinforcing materials, not of metal, for pipes; asbestos; self-adhesive tapes, other than stationery and not for medical or household purposes; stops of rubber; insulators for cables; threads of rubber, other than for textile use; carbon fibres, other than for textile use; plastic substances, semi-processed; insulators for electric mains; insulators; ebonite molds; packing [cushioning, stuffing] materials of rubber or plastics; plastic fibers [fibres], not for textile use; fiberglass for insulation; fiberglass fabrics for insulation; threads of plastic materials, other than for textile use; filtering materials of semi-processed foams of plastic; insulating tapes; floating anti-pollution barriers; rubber material for recapping tires; insulating plaster; plastic sheeting for agricultural purposes; foam supports for flower arrangements [semi-finished products]; liquid rubber; rubber solutions; anti-dazzle films for windows [tinted films]; insulating refractory materials; gum, raw or semi-worked; duct tapes; door stops of rubber; window stops of rubber; fittings, not of metal, for flexible pipes; fittings, not of metal, for rigid pipes; dock bumpers of rubber; filtering materials of semi-processed films of plastic.

19 – Advertisement columns, not of metal; alabaster glass; alabaster; asbestos cement; asbestos mortar; slate; roofing slates; slate powder; hips for roofing; silver sand; potters' clay; fire burrs; asphalt; asphalt paving; furrings of wood; balustrades, not of metal;

bitumen; tarred strips for building; huts; fair huts; roofing shingles; folding doors, not of metal; concrete; concrete building elements; bituminous products for building; wood, semi-worked; building timber; plywood; manufactured timber; wood for making household utensils; sawn timber; wood paving; wood veneers; veneer wood; wood panelling; cement; pitch; bricks; earth for bricks; binding agents for making briquettes; telephone booths, not of metal; caissons for construction work under water; limestone; roof gutters, not of metal; paperboard for building; bitumen paper for building; grog [fired refractory material]; fireclay; fireplace mantles, not of metal; framework, not of metal, for building; materials for making and coating roads; lime; mortar for building; plaster; chimneys, not of metal; fireproof cement coatings; cement slabs; cement posts; schists; partitions, not of metal; buildings, not of metal; building paper; building glass; cornices, not of metal; moldings, not of metal, for cornices; roof flashing, not of metal; angle irons, not of metal; windows, not of metal; doors, not of metal; manhole covers, not of metal; roof coverings, not of metal; raw chalk; quartz; stair-treads [steps], not of metal; gutter pipes, not of metal; water-pipes, not of metal; water-pipe valves, not of metal or plastic; scaffolding, not of metal; poles, not of metal, for power lines; branching pipes, not of metal; tomb or grave enclosures, not of metal; bituminous coatings for roofing; beams, not of metal; pigsties, not of metal; stables, not of metal; props, not of metal; grave slabs, not of metal; memorial plaques, not of metal; felt for building; foundry moulds, not of metal; cement for furnaces; cement for blast furnaces; stone; plate glass [windows] for building; clay; coal tar; granite; gravel; sandstone for building; sandstone pipes; gypsum [building material]; jalousies, not of metal; slag [building material]; clinker ballast; parquet floor boards; outdoor blinds, not of metal and not of textile; rocket launching platforms, not of metal; laths, not of metal; binding material for road repair; agglomerated cork for building; parquet flooring; stringers [parts of staircases], not of metal; lintels, not of metal; luminous paving blocks; macadam; monuments, not of metal; magnesia cement; buildings, transportable, not of metal; marble; glass granules for road marking; road marking sheets and strips of synthetic material; porches [structures], not of metal; masts [poles], not of metal; cask wood; mosaics for building; moldable wood; moldings, not of metal, for building; coatings [building materials]; wall claddings, not of metal, for building; flashing, not of metal, for building; olivine for building; shutters, not of metal; palisading, not of metal; fences, not of metal; sheet piles, not of metal; signalling panels, non-luminous and non-mechanical, not of metal; wall linings, not of metal, for building; skating rinks [structures], not of metal; perches; building stone; artificial stone; clinker stone; gravestones; tufa; works of stonemasonry; floors, not of metal; ceilings, not of metal; planks of wood for building; linings, not

of metal, for building; roofing tiles, not of metal; diving boards, not of metal; gates, not of metal; door panels, not of metal; telegraph posts, not of metal; chicken-houses, not of metal; joists, not of metal; platforms, prefabricated, not of metal; tanks of masonry; road coating materials; sills, not of metal; reeds for building; road signs, non-luminous and non-mechanical, not of metal; non-luminous and non-mechanical signs, not of metal; sand, except foundry sand; greenhouses, transportable, not of metal; silica [quartz]; silos, not of metal; statues of stone, concrete or marble; tar; terra-cotta [building material]; roofing, not of metal; tombs, not of metal; arbours [structures], not of metal; railway sleepers, not of metal; trellises, not of metal; rigid pipes, not of metal, for building; casement windows, not of metal; insulating glass for building; window glass, other than vehicle window glass; stained-glass windows; window glass for building; aviaries [structures], not of metal; scantlings [carpentry]; xylolith; mooring bollards, not of metal; floating docks, not of metal, for mooring boats; wainscotting, not of metal; aquaria [structures]; reinforcing materials, not of metal, for building; safety glass; works of art of stone, concrete or marble; bird baths [structures], not of metal; beacons, not of metal, non-luminous; swimming pools [structures], not of metal; building materials, not of metal; shuttering, not of metal, for concrete; bicycle parking installations, not of metal; paving blocks, not of metal; wood pulp board for building; busts of stone, concrete or marble; cabanas, not of metal; paint spraying booths, not of metal; posts, not of metal; window frames, not of metal; door frames, not of metal; greenhouse frames, not of metal; calcareous marl; chimney cowls, not of metal; tiles, not of metal, for building; floor tiles, not of metal; burial vaults, not of metal; chimney pots, not of metal; lengthening pieces, not of metal, for chimneys; chimney shafts, not of metal; paving slabs, not of metal; drain pipes, not of metal; drain traps [valves], not of metal or plastic; staircases, not of metal; building panels, not of metal; statuettes of stone, concrete or marble; tombs [monuments], not of metal; tombstone stelae, not of metal; crash barriers, not of metal, for roads; letter boxes of masonry; agglomerated bagasses of cane [building material]; penstock pipes, not of metal; aquarium gravel; aquarium sand; ducts, not of metal, for ventilating and air-conditioning installations; geotextiles; rubble; vinyl siding; insect screens, not of metal; roofing, not of metal, incorporating photovoltaic cells; duckboards, not of metal; refractory construction materials, not of metal; prefabricated houses [kits], not of metal; porphyry [stone]; street gutters, not of metal; turnstiles, not of metal; tombstone plaques, not of metal; wooden floor boards; tile floorings, not of metal; pantiles, not of metal; wall tiles, not of metal; slabs, not of metal, for building; rock crystal; armored doors, not of metal; enamelled glass, for building; pillars, not of metal, for building; brackets, not of metal, for building; cladding, not of

metal, for building; plastic landscape edgings; rubber bearings for seismic isolation of buildings; armour-plating, not of metal; flagpoles [structures], not of metal; swing doors, not of metal.

20 – Beehives; display boards; decorations of plastic for foodstuffs; yellow amber; stuffed animals; beds for household pets; nesting boxes for household pets; kennels for household pets; animal claws; curtain rings; silvered glass [mirrors]; cupboards; medicine cabinets; clips, not of metal, for cables and pipes; casks of wood for decanting wine; whalebone, unworked or semi-worked; bamboo; benches [furniture]; fishing baskets; playpens for babies; cradles; library shelves; reels of wood for yarn, silk, cord; bedsteads of wood; wood ribbon; corks for bottles; corks; bottle racks; embroidery frames; brush mountings; sideboards; animal horns; desks; office furniture; costume stands; comb foundations for beehives; sections of wood for beehives; furniture; taps, not of metal, for casks; index cabinets [furniture]; filing cabinets; imitation tortoiseshell; screens for fireplaces [furniture]; coffins; coffin fittings, not of metal; stag antlers; chairs [seats]; chaise longues; head-rests [furniture]; hat stands; loading pallets, not of metal; loading gauge rods, not of metal, for railway wagons; hinges, not of metal; display stands; dog kennels; coat hangers; shelves for file cabinets; armchairs; mannequins; containers, not of metal, for liquid fuel; chests of drawers; counters [tables]; containers, not of metal [storage, transport]; floating containers, not of metal; tables; coral; trays, not of metal; horn, unworked or semi-worked; corozo; bedding, except linen; cushions; mattresses; hooks, not of metal, for clothes rails; vats, not of metal; tea carts; drafting tables; towel dispensers, fixed, not of metal; divans; staves of wood; cabinet work; tortoiseshell; oyster shells; stakes, not of metal, for plants or trees; ladders of wood or plastics; mobile boarding stairs, not of metal, for passengers; school furniture; typing desks; placards of wood or plastics; nuts, not of metal; meerscham; removable mats or covers for sinks; packaging containers of plastic; curtain holders, not of textile material; beds; reels, not of metal, non-mechanical, for flexible hoses; winding spools, not of metal, non-mechanical, for flexible hoses; stair rods; work benches; racks [furniture]; nesting boxes; fans for personal use, non-electric; closures, not of metal, for containers; furniture fittings, not of metal; flower-stands [furniture]; flower-pot pedestals; fodder racks; gun racks; casks, not of metal; cask stands, not of metal; curtain rollers; meat safes; window fittings, not of metal; bed fittings, not of metal; door fittings, not of metal; chopping blocks [tables]; crates; covers for clothing [wardrobe]; registration plates, not of metal; furniture of metal; rattan; newspaper display stands; magazine racks; slatted indoor blinds; washstands [furniture]; hospital beds; bed casters, not of metal; latches, not of metal; lecterns; hampers [baskets] for the transport of items; coatstands; transport pallets, not of metal; handling

pallets, not of metal; steps [ladders], not of metal; furniture partitions of wood; furniture casters, not of metal; honeycombs; mobiles [decoration]; standing desks; mother-of-pearl, unworked or semi-worked; identity plates, not of metal; house numbers, not of metal, non-luminous; stuffed birds; pillows; air pillows, not for medical purposes; straw mattresses; plaited straw, except matting; straw plaits; straw edgings; bakers' bread baskets; umbrella stands; screens [furniture]; clothes hooks, not of metal; bead curtains for decoration; tent pegs, not of metal; table tops; doors for furniture; curtain rails; furniture shelves; edgings of plastic for furniture; tanks, not of metal nor of masonry; curtain rods; curtain hooks; curtain tie-backs; reeds [plaiting materials]; animal hooves; writing desks; locks, not of metal, for vehicles; seats of metal; sofas; settees; bed bases; valves, not of metal, other than parts of machines; statues of wood, wax, plaster or plastic; tables of metal; dressing tables; moldings for picture frames; shelves for storage; lockers; mirrors [looking glasses]; deck chairs; bolsters; trestles [furniture]; keyboards for hanging keys; plate racks; wickerwork; showcases [furniture]; air cushions, not for medical purposes; air mattresses, not for medical purposes; ambroid bars; ambroid plates; works of art of wood, wax, plaster or plastic; troughs, not of metal, for mixing mortar; chests, not of metal; vice benches [furniture]; barrels, not of metal; barrel hoops, not of metal; stands for calculating machines; bungs, not of metal; sealing caps, not of metal; screws, not of metal; rivets, not of metal; pegs [pins], not of metal; bolts, not of metal; bottle caps, not of metal; bottle closures, not of metal; identification bracelets, not of metal; dinner wagons [furniture]; busts of wood, wax, plaster or plastic; binding screws, not of metal, for cables; picture frames; picture frame brackets; massage tables; waterbeds, not for medical purposes; drain traps [valves] of plastic; plugs [dowels], not of metal; shells; stools; water-pipe valves of plastic; bottle casings of wood; statuettes of wood, wax, plaster or plastic; locks, other than electric, not of metal; hairdressers' chairs; poles, not of metal; baskets, not of metal; letter boxes, not of metal or masonry; mooring buoys, not of metal; garment covers [storage]; signboards of wood or plastics; trolleys [furniture]; bamboo curtains; chests for toys; high chairs for babies; infant walkers; inflatable publicity objects; plastic key cards, not encoded and not magnetic; mirror tiles; pulleys of plastics for blinds; saw horses; scratching posts for cats; shoulder poles [yokes]; carts for computers [furniture]; funerary urns; wind chimes [decoration]; indoor window blinds of woven wood; book rests [furniture]; pet cushions; indoor window blinds [furniture]; door handles, not of metal; hand-held mirrors [toilet mirrors]; mats for infant playpens; towel stands [furniture]; knobs, not of metal; wall-mounted baby changing platforms; baby changing mats; door bolts, not of metal; indoor window blinds of paper; indoor window blinds of textile; door bells, not of metal,

non-electric; freestanding partitions [furniture]; screw tops, not of metal, for bottles; door knockers, not of metal; saw benches [furniture]; inflatable furniture; step stools, not of metal; bathtub grab bars, not of metal; collars, not of metal, for fastening pipes; jewelry organizer displays; sleeping mats; split rings, not of metal, for keys; dispensers for dog waste bags, fixed, not of metal; door stops, not of metal or rubber; window stops, not of metal or rubber; sash fasteners, not of metal, for windows; window fasteners, not of metal; door fasteners, not of metal; tool boxes, not of metal, empty; tool chests, not of metal, empty; shelving units; bag hangers, not of metal; plastic keys; brackets, not of metal, for furniture; labels of plastic; console tables; bookcases; valet stands; jerrycans, not of metal; birdhouses; clips of plastic for sealing bags; bumper guards for cots, other than bed linen; boxes of wood or plastic; cots for babies; Moses baskets; legs for furniture; feet for furniture; wardrobes; footstools; shoe pegs, not of metal; shoe dowels, not of metal; crucifixes of wood, wax, plaster or plastic, other than jewellery; oil drainage containers, not of metal; air beds, not for medical purposes; camping mattresses; plastic ramps for use with vehicles; shower chairs; head support cushions for babies; anti-roll cushions for babies; head positioning pillows for babies; hand-held flagpoles, not of metal; stoppers, not of glass, metal or rubber.

21 – Drinking troughs; feeding troughs; steel wool for cleaning; washing boards; thermally insulated containers for food; carpet beaters [hand instruments]; glass bulbs [receptacles]; animal bristles [brushware]; poultry rings; nozzles for watering hose; watering devices; brushes; sprinklers; watering cans; bread baskets for household purposes; rings for birds; bird baths; brooms; carpet sweepers; glass flasks [containers]; Buckets; pails; basins [receptacles]; cooking pot sets; pouring spouts; currycombs; butter dishes; butter-dish covers; beer mugs; glass jars [carboys]; drinking vessels; heat-insulated containers for beverages; boxes for dispensing paper towels; soap boxes; tea caddies; bowls [basins]; demijohns; boot jacks; glass stoppers; corkscrews, electric and non-electric; decorative glass spheres; bottles; vacuum bottles; refrigerating bottles; bottle openers, electric and non-electric; cooking skewers of metal; nail brushes; toilet brushes; lamp-glass brushes; material for brush-making; hair for brushes; perfume burners; cruets; cabarets [trays]; birdcages; sifters [household utensils]; heat-insulated containers; decanters; menu card holders; stew-pans; saucepan scourers of metal; cinder sifters [household utensils]; ceramics for household purposes; fly swatters; cauldrons; brushes for footwear; horse brushes; mangers for animals; combs for animals; combs; cloths for cleaning; china ornaments; molds [kitchen utensils]; apparatus for wax-polishing, non-electric; cocktail shakers; glue-pots; glasses [receptacles]; drinking horns; cosmetic utensils; strainers for household purposes; fruit cups; knife rests for the tab-

le; closures for pot lids; pot lids; ironing board covers, shaped; tie presses; blenders, non-electric, for household purposes; sieves [household utensils]; crystal [glassware]; ice cube molds; polishing leather; cooking pots; scoops for household purposes; cookery moulds; cleaning instruments, hand-operated; tooth-picks; washtubs; plates to prevent milk boiling over; cutting boards for the kitchen; large-toothed combs for the hair; dusting apparatus, non-electric; flat-iron stands; powdered glass for decoration; toilet cases; toilet paper dispensers; soap dispensers; siphon bottles for aerated water; enamelled glass, not for building; shoe trees; funnels; spice sets; toilet sponges; sponge holders; furniture dusters; drying racks for laundry; buckets made of woven fabrics; comb cases; earthenware; holders for flowers and plants [flower arranging]; flower pots; whisks, non-electric, for household purposes; mops; frying pans; scrubbing brushes; fruit presses, non-electric, for household purposes; smoke absorbers for household purposes; mess-tins; glove stretchers; cake moulds; plate glass [raw material]; drinking bottles for sports; grills [cooking utensils]; grill supports; tar-brushes, long handled; powder puffs; glass, unworked or semi-worked, except building glass; insect traps; glass wool, other than for insulation; pots; vegetable dishes; liqueur sets; basting spoons [cooking utensils]; majolica; kitchen grinders, non-electric; utensils for household purposes; crumb trays; mosaics of glass, not for building; mills for household purposes, hand-operated; wool waste for cleaning; nest eggs, artificial; egg cups; opal glass; opaline glass; scouring pads; bread boards; fitted picnic baskets, including dishes; trouser presses; paper plates; rolling pins, domestic; electric combs; pie servers; wine-tasting pipettes; ironing boards; trays of paper, for household purposes; earthenware saucepans; nozzles for watering cans; pepper mills, hand-operated; pepper pots; polishing apparatus and machines, for household purposes, non-electric; polishing materials for making shiny, except preparations, paper and stone; porcelain ware; vases; soap holders; chamber pots; pottery; dustbins; powder compacts; coolers [ice pails]; graters for kitchen use; rat traps; containers for household or kitchen use; napkin rings; salad bowls; salt cellars; syringes for watering flowers and plants; services [dishes]; dishes; tea services [tableware]; table napkin holders; vessels of metal for making ices and iced drinks; saucers; shoe horns; soup bowls; eyebrow brushes; mouse traps; statues of porcelain, ceramic, earthenware, terra-cotta or glass; sugar bowls; epergnes; cups; clothing stretchers; teapots; buttonhooks; piggy banks; toilet utensils; beverage urns, non-electric; tableware, other than knives, forks and spoons; perfume vaporizers; glass incorporating fine electrical conductors; painted glassware; glass for vehicle windows [semi-finished product]; mugs; aerosol dispensers, not for medical purposes; works of art of porcelain, ceramic, earthenware, terra-cotta or glass; table plates; autocla-

ves, non-electric, for cooking; pressure cookers, non-electric; beaters, non-electric; heaters for feeding bottles, non-electric; shaving brushes; shaving brush stands; bobeches; boxes of glass; candy boxes; candelabra [candlesticks]; kettles, non-electric; tea infusers; toothbrushes; electric brushes, except parts of machines; busts of porcelain, ceramic, earthenware, terracotta or glass; covers, not of paper, for flower pots; coffee grinders, hand-operated; coffee services [tableware]; coffee filters, non-electric; coffee percolators, non-electric; coasters, not of paper or textile; abrasive pads for kitchen purposes; deep fryers, non-electric; portable cool boxes, non-electric; water apparatus for cleaning teeth and gums; chamois leather for cleaning; wax-polishing appliances, non-electric, for shoes; cheese-dish covers; baskets for household purposes; trays for household purposes; cotton waste for cleaning; dish covers; trivets [table utensils]; pitchers; kitchen containers; kitchen utensils; cooking utensils, non-electric; toothpick holders; toothbrushes, electric; deodorising apparatus for personal use; brushes for cleaning tanks and containers; signboards of porcelain or glass; sponges for household purposes; feather-dusters; dusting cloths [rags]; vitreous silica fibres, other than for textile use; fiberglass, other than for insulation or textile use; figurines of porcelain, ceramic, earthenware, terracotta or glass; fiberglass thread, other than for textile use; coffeepots, non-electric; tea strainers; flasks; gloves for household purposes; tankards; cruet sets for oil and vinegar; polishing gloves; candle extinguishers; baby baths, portable; cages for household pets; cloth for washing floors; dishwashing brushes; indoor terrariums [plant cultivation]; litter boxes for pets; fused silica [semi-worked product], other than for building; waffle irons, non-electric; bread bins; chopsticks; cleaning tow; clothes-pegs; cocktail stirrers; confectioners' decorating bags [pastry bags]; cookie [biscuit] cutters; cookie jars; cups of paper or plastic; drinking glasses; floss for dental purposes; gardening gloves; hot pots, not electrically heated; isothermic bags; lazy susans; lunch boxes; mixing spoons [kitchen utensils]; noodle machines, hand-operated; pastry cutters; plungers for clearing blocked drains; spatulas for kitchen use; abrasive sponges for scrubbing the skin; garlic presses [kitchen utensils]; disposable table plates; towel rails and rings; toilet paper holders; indoor aquaria; aquarium hoods; indoor terrariums [vivariums]; mop wringers; waste paper baskets; window-boxes; drinking straws; tea cosies; make-up removing appliances; electric devices for attracting and killing insects; baking mats; hip flasks; cosmetic spatulas; dripping pans; fly traps; candle jars [holders]; food steamers, non-electric; make-up sponges; crushers for kitchen use, non-electric; potholders; kitchen mitts; basting brushes; bulb basters; car washing mitts; make-up brushes; mop wringer buckets; tortilla presses, non-electric [kitchen utensils]; ski wax brushes; eyelash brushes; egg separators, non-electric, for household purposes; foam toe

separators for use in pedicures; plug-in diffusers for mosquito repellents; cold packs for chilling food and beverages; reusable ice cubes; tablemats, not of paper or textile; place mats, not of paper or textile; decanter tags; wine aerators; heads for electric toothbrushes; coin banks; lint removers, electric or non-electric; polishing cloths; pig bristles for brush-making; horsehair for brush-making; ice tongs; salad tongs; serving ladles; pestles for kitchen use; mortars for kitchen use; ice cream scoops; nutcrackers; sugar tongs; broom handles; ladles for serving wine; inflatable bath tubs for babies; stands for portable baby baths; tea bag rests; cake decorating tips and tubes; rotary washing lines; cooking mesh bags, other than for microwaves.

25 – Non-slipping devices for footwear; motorists' clothing; footwear; bath sandals; bath slippers; stockings; sweat-absorbent stockings; heelpieces for stockings; berets; overalls; boas [necklets]; caps being headwear; hosiery; boots; half-boots; tips for footwear; dress shields; braces for clothing [suspenders]; lace boots; collars [clothing]; neck scarves [mufflers]; camisoles; boxer shorts; skull caps; bodices [lingerie]; underwear; hoods [clothing]; hat frames [skeletons]; cap peaks; belts [clothing]; shawls; dressing gowns; sweaters; chasubles; socks; sock suspenders; garters; stocking suspenders; boot uppers; inner soles; shirts; shirt fronts; short-sleeve shirts; clothing; hats; fittings of metal for footwear; furs [clothing]; detachable collars; tights; wet suits for water-skiing; combinations [clothing]; sweat-absorbent underwear; corselets; suits; ready-made clothing; babies' pants [underwear]; ear muffs [clothing]; neckties; footwear uppers; gaiters; breeches for wear; trousers; cyclists' clothing; outerclothing; gloves [clothing]; ready-made linings [parts of clothing]; scarfs; sashes for wear; knitwear [clothing]; shirt yokes; esparto shoes or sandals; fur stoles; football shoes; top hats; gabardines [clothing]; corsets [underclothing]; girdles; galoshes; vests; trouser straps; wimples; gymnastic shoes; coats; waterproof clothing; leggings [leg warmers]; jerseys [clothing]; skirts; layettes [clothing]; liveries; sports jerseys; cuffs; aprons [clothing]; muffs [clothing]; maniples; fingerless gloves; miters [hats]; slippers; pelerines; pelisses; beach clothes; beach shoes; pockets for clothing; pajamas; dresses; wooden shoes; sandals; underpants; brassieres; overcoats; heelpieces for footwear; togas; welts for footwear; uniforms; stuff jackets [clothing]; jackets [clothing]; paper clothing; veils [clothing]; bathing caps; bathing trunks; bathing suits; bath robes; bibs, not of paper; soles for footwear; shoes; heels; sports shoes; footmuffs, not electrically heated; studs for football boots; boots for sports; headbands [clothing]; parkas; petticoats; ski boots; slippers [underclothing]; teddies [underclothing]; bandanas [neckerchiefs]; clothing for gymnastics; clothing of imitations of leather; clothing of leather; mantillas; masquerade costumes; saris; tee-shirts; turbans; ascots; shower caps; fishing vests; money belts [clothing]; pocket squares; paper hats [clothing]; sleep

masks; skorts; ponchos; sarongs; ski gloves; leggings [trousers]; jumper dresses; visors being headwear; panties; sports singlets; valenki [felted boots]; albs; ankle boots; sweat-absorbent socks; hairdressing capes; karate uniforms; judo uniforms; leotards; kimonos; bibs, sleeved, not of paper; headwear.

27 – Bath mats; floor coverings; artificial turf; gymnasium mats; mats; wallpaper; door mats; reed mats; carpets for automobiles; carpets; non-slip mats; wall hangings, not of textile; linoleum; carpet underlay; vinyl floor coverings; mats of woven rope for ski slopes; textile wallpaper; floor mats, fire-resistant, for fireplaces and barbecues; yoga mats; textile wallcoverings.

28 – Bladders of balls for games; artificial fishing bait; caps for pistols [toys]; toys for pets; ring games; Christmas trees of synthetic material; bows for archery; archery implements; edges of skis; swings; balls for games; play balloons; billiard table cushions; rocking horses; batting gloves [accessories for games]; dolls' feeding bottles; stationary exercise bicycles; billiard balls; chalk for billiard cues; billiard markers; skittles; marbles for games; toys; building blocks [toys]; bob-sleighs; Christmas crackers [party novelties]; skating boots with skates attached; candle holders for Christmas trees; playing balls; bowling apparatus and machinery; boxing gloves; gut for rackets; golf clubs; rods for fishing; kites; kite reels; targets; bells for Christmas trees; counters [discs] for games; building games; strings for rackets; machines for physical exercises; body-building apparatus; novelty toys for parties; shin guards [sports articles]; cricket bags; hockey sticks; checkers [games]; dice; chest expanders [exercisers]; discuses for sports; dominoes; chess games; chessboards; checkerboards; toy pistols; rollers for stationary exercise bicycles; landing nets for anglers; golf bags, with or without wheels; novelty toys for playing jokes; nets for sports; tennis nets; ski bindings; darts; floats for fishing; foosball tables; harpoon guns [sports articles]; gloves for games; cups for dice; bar-bells; fish hooks; rattles [playthings]; parlor games; games; clay pigeon traps; rackets; decoys for hunting or fishing; fishing tackle; fishing lines; dolls' beds; dolls' houses; puppets; dolls; theatrical masks; carnival masks; scale model vehicles; reels for fishing; flippers for swimming; creels [fishing traps]; swimming pools [play articles]; artificial snow for Christmas trees; quoits; roller skates; ice skates; seal skins [coverings for skis]; clay pigeons [targets]; surfboards; dolls' clothes; dolls' rooms; conjuring apparatus; skittles [games]; gut for fishing; sole coverings for skis; skis; tables for table tennis; spinning tops [toys]; sleds [sports articles]; backgammon games; scooters [toys]; shuttlecocks; toy air pistols; percussion caps [toys]; ornaments for Christmas trees, except illumination articles and confectionery; Christmas tree stands; billiard cues; billiard cue tips; billiard tables; coin-operated billiard tables; surf skis; sailboards;

hang gliders; apparatus for games; appliances for gymnastics; fencing weapons; fencing masks; fencing gauntlets; baseball gloves; climbers' harness; elbow guards [sports articles]; knee guards [sports articles]; toy mobiles; paragliders; protective paddings [parts of sports suits]; skateboards; slides [playthings]; spring boards [sports articles]; teddy bears; waterskis; golf gloves; bite indicators [fishing tackle]; bite sensors [fishing tackle]; board games; fairground ride apparatus; flying discs [toys]; horseshoe games; mah-jong; plush toys; soap bubbles [toys]; toy vehicles; twirling batons; butterfly nets; bags especially designed for skis and surfboards; harness for sailboards; jigsaw puzzles; masts for sailboards; paintball guns [sports apparatus]; paintballs [ammunition for paintball guns] [sports apparatus]; surfboard leashes; tennis ball throwing apparatus; starting blocks for sports; snow globes; weight lifting belts [sports articles]; bodyboards; bingo cards; divot repair tools [golf accessories]; hunting game calls; roulette wheels; in-line roller skates; piñatas; punching bags; remote-controlled toy vehicles; rosin used by athletes; snowshoes; sling shots [sports articles]; amusement machines, automatic and coin-operated; kaleidoscopes; playing cards; confetti; electronic targets; scent lures for hunting or fishing; camouflage screens [sports articles]; men's athletic supporters [sports articles]; snowboards; scale model kits [toys]; pachinkos; ascenders [mountaineering equipment]; gaming machines for gambling; slot machines [gaming machines]; paper party hats; swimming kickboards; chips for gambling; scratch cards for playing lottery games; stuffed toys; trampolines; poles for pole vaulting; water wings; swimming belts; swimming jackets; video game machines; portable games with liquid crystal displays; arcade video game machines; controllers for game consoles; toy models; toy figures; ball pitching machines; dumb-bells; masks [playthings]; matryoshka dolls; controllers for toys; golf bag carts; paddleboards; gyroscopes and flight stabilizers for model aircraft; joysticks for video games; protective films adapted for screens for portable games; drones [toys]; toy robots; needles for pumps for inflating balls for games; pumps specially adapted for use with balls for games; baby gyms; plush toys with attached comfort blanket; tricycles for infants [toys]; toy imitation cosmetics; swimming pool air floats; rhythmic gymnastics ribbons; party poppers [party novelties]; toy putty; toy dough; portable games and toys incorporating telecommunication functions.

35 – Business management assistance; business inquiries; bill-posting; import-export agency services; commercial information agency services; cost price analysis; dissemination of advertising matter; photocopying services; employment agency services; office machines and equipment rental; book-keeping; drawing up of statements of accounts; business auditing; business management and organization consultancy; personnel management consultancy; business management con-

sultancy; typing; demonstration of goods; direct mail advertising; commercial or industrial management assistance; document reproduction being photocopying services; updating of advertising material; distribution of samples; business efficiency expert services; auctioneering; market studies; business appraisals; business investigations; publicity material rental; business organization consultancy; publication of publicity texts; advertising; radio advertising; business research; public relations; shorthand; television advertising; transcription of communications [office functions]; shop window dressing; advertising agency services; advisory services for business management; modelling for advertising or sales promotion; marketing research; computerized file management; professional business consultancy; economic forecasting; organization of exhibitions for commercial or advertising purposes; business information; opinion polling; payroll preparation; personnel recruitment; administrative services for the relocation of businesses; rental of advertising space; sales promotion for others; secretarial services; tax preparation; telephone answering for unavailable subscribers; word processing; arranging newspaper subscriptions for others; advertising by mail order; business management of hotels; business management of performing artists; compilation of information into computer databases; systemization of information into computer databases; organization of trade fairs for commercial or advertising purposes; rental of photocopying machines; online advertising on a computer network; procurement services for others [purchasing goods and services for other businesses]; data search in computer files for others; rental of advertising time on communication media; news clipping services; rental of vending machines; psychological testing for the selection of personnel; price comparison services; presentation of goods on communication media, for retail purposes; commercial information and advice for consumers in the choice of products and services; arranging subscriptions to telecommunication services for others; administrative processing of purchase orders; commercial administration of the licensing of the goods and services of others; outsourcing services [business assistance]; invoicing; writing of publicity texts; compilation of statistics; layout services for advertising purposes; sponsorship search; organization of fashion shows for promotional purposes; production of advertising films; business management of sports people; marketing; telemarketing services; retail services for pharmaceutical, veterinary and sanitary preparations and medical supplies; rental of sales stands; provision of commercial and business contact information; search engine optimization for sales promotion; web site traffic optimization; pay per click advertising; commercial intermediation services; business management for freelance service providers; negotiation and conclusion of commercial transactions for third parties; updating and maintenance of data in computer databases;

business project management services for construction projects; providing business information via a web site; provision of an online marketplace for buyers and sellers of goods and services; development of advertising concepts; outsourced administrative management for companies; tax filing services; business management of reimbursement programs for others; rental of billboards [advertising boards]; writing of curriculum vitae for others; web indexing for commercial or advertising purposes; administration of frequent flyer programs; appointment scheduling services [office functions]; appointment reminder services [office functions]; administration of consumer loyalty programs; scriptwriting for advertising purposes; registration of written communications and data; updating and maintenance of information in registries; compiling indexes of information for commercial or advertising purposes; business intermediary services relating to the matching of potential private investors with entrepreneurs needing funding; production of tele-shopping programs; consultancy regarding public relations communication strategies; consultancy regarding advertising communication strategies; negotiation of business contracts for others; promotion of goods and services through sponsorship of sports events; competitive intelligence services; market intelligence services; financial auditing; online retail services for downloadable digital music; online retail services for downloadable ring tones; online retail services for downloadable and pre-recorded music and movies; wholesale services for pharmaceutical, veterinary and sanitary preparations and medical supplies; gift registry services; targeted marketing; interim business management; outdoor advertising; retail services for works of art provided by art galleries; administrative assistance in responding to calls for tenders; marketing in the framework of software publishing.

42 – Chemical analysis; analysis for oil-field exploitation; architectural services; bacteriological research; chemistry services; chemical research; architectural consultancy; construction drafting; technological research; oil-well testing; cosmetic research; design of interior decor; industrial design; packaging design; material testing; conducting technical project studies; geological surveys; oil-field surveys; engineering; meteorological information; land surveying; computer rental; computer programming; oil prospecting; research in the field of physics; mechanical research; textile testing; geological prospecting; geological research; authenticating works of art; calibration [measuring]; computer software design; updating of computer software; consultancy in the design and development of computer hardware; dress designing; graphic arts design; quality control; rental of computer software; research and development of new products for others; styling [industrial design]; underwater exploration; recovery of computer data; maintenance of computer software; computer system analysis; biological research; urban planning; surveying; computer

system design; vehicle roadworthiness testing; duplication of computer programs; conversion of data or documents from physical to electronic media; creating and maintaining web sites for others; hosting computer sites [web sites]; installation of computer software; cloud seeding; conversion of computer programs and data, other than physical conversion; computer software consultancy; rental of web servers; computer virus protection services; consultancy in the field of energy-saving; research in the field of environmental protection; providing search engines for the internet; digitization of documents [scanning]; handwriting analysis [graphology]; provision of scientific information, advice and consultancy in relation to carbon offsetting; quality evaluation of standing timber; quality evaluation of wool; monitoring of computer systems by remote access; water analysis; scientific laboratory services; energy auditing; web site design consultancy; software as a service [SaaS]; information technology [IT] consultancy; scientific research; server hosting; clinical trials; off-site data backup; electronic data storage; providing information on computer technology and programming via a web site; cartography services; cloud computing; outsource service providers in the field of information technology; technological consultancy; computer technology consultancy; telecommunications technology consultancy; weather forecasting; computer security consultancy; technical writing; interior design; unlocking of mobile phones; monitoring of computer systems to detect breakdowns; creating and designing website-based indexes of information for others [information technology services]; internet security consultancy; data security consultancy; data encryption services; monitoring of computer systems for detecting unauthorized access or data breach; electronic monitoring of personally identifying information to detect identity theft via the internet; electronic monitoring of credit card activity to detect fraud via the internet; software development in the framework of software publishing; platform as a service [PaaS]; exploration services in the field of the oil, gas and mining industries.

(260) AM 2021 111889 A
 (800) 1576915
 (151) 2020 11 17
 (891) 2020 11 17
 (731) Shogoro UEMURA
 route de Drize 3B, CH-1227 CAROUGE,
 Switzerland

(540)

IYASHI DÔME

(591) Black, white
 (511)
 11 – Saunas; sauna heaters; infrared lamps other than for medical use; infrared radiation sauna apparatus.

44 – Sauna services; infrared sauna services; rental of infrared sauna apparatus.

(260) AM 2021 111896 A
 (800) 1577168
 (151) 2021 01 15
 (891) 2021 01 15
 (731) Apple Inc.
 One Apple Park Way, Cupertino CA 95014,
 USA

(540)



(591) Black, white
 (531) 16.03.01; 26.01.05
 (511)

42 – Providing online non-downloadable application development software; providing online non-downloadable computer software development tools; providing online non-downloadable computer software used in developing other software applications; user authentication services using a software application; user authentication services using technology for e-commerce transactions; providing online information relating to computer technology, computer programming, and computer software.

(260) AM 2021 111897 A
 (800) 1577335
 (151) 2020 12 15
 (891) 2020 12 15
 (731) DAW SE
 Roßdörfer Str. 50, 64372 Ober-Ramstadt,
 Germany

(540)



(591) Black, violet, blue, green, yellow, orange, red
 (531) 03.02.01; 03.02.24; 26.04.05; 26.04.12;
 26.04.24; 26.11.07; 26.11.09; 29.01.15

(511)
 1 – Industrial chemicals; preservative and damp-proofing preparations for masonry, roofing tiles, cement and concrete, except paints and oils; artificial resins,

synthetic resins and unprocessed plastics; solvents (chemicals); solvents for varnishes and lacquers; adhesives used in industry; adhesives for wallpaper; adhesives used in building; filler for the treatment of subsurfaces for paints (not included in other classes).

2 – Paints; varnishes; lacquers; glazes; coatings; preservatives against rust; primers; colorants; dyestuffs; dye pastes; mordants; paint thickeners; fixatives for paints; siccatives for paints; raw natural resins; thinning and binding preparations for paints, lacquers and coatings; solvents for thinning paints; preparations for preserving wood; wood mordants and wood preserving oils; paints, including structuring paints; bactericidal and/or fungicidal paints; anti-corrosion preparations; protective preparations for metals; metals in foil and powder form for painters, decorators, printers and artists.

6 – Building materials of metal or mainly of metal; expanded pierced metal; wire cloths of metal or mainly of metal; adjusting and levelling parts of metal or mainly of metal for building purposes; screws, pins, and bolts (of metal or mainly of metal); spacers of metal or mainly of metal for building purposes; fixing anchors of metal or mainly of metal for building; sills of metal or mainly of metal; window sills of metal and components of metal for window sills.

7 – Machine tools, all for paint works and builder; hand-held tools, other than hand-operated, all for paint works and builder; mixing machines for paints, lacquers and coatings; compressed air guns for the extrusion of mastics; spray guns for paints, lacquers and plaster; painting machines, coating machines for lacquers and plaster.

8 – Hand tools and implements (hand-operated), all for painting; hand tools and implements (hand-operated), namely special-purpose tools and implements for facade claddings and coatings; hand-operated glueing apparatus, hand-operated stirring apparatus (tools), hand operated guns for the extrusion of mastics; hand-operated spray guns for applying sealing compounds; hand-operated spray guns for spraying paints, lacquers and plaster.

9 – Scientific, research, navigation, surveying, photographic, cinematographic, audiovisual, optical, weighing, measuring, signalling, detecting, testing, inspecting, life-saving and teaching apparatus and instruments; apparatus and instruments for conducting, switching, transforming, accumulating, regulating or controlling the distribution or use of electricity; apparatus and instruments for recording, transmitting, reproducing or processing sound, images or data; recorded and downloadable media; software; blank digital or analogue recording and storage media; computers and computer peripheral devices; mobile apps.

16 – Paper, cardboard; printed matter; catalogues; brochures; prospectuses; stickers (stationery); photo-

graphs; stationery; adhesives for stationery or household purposes; artists' materials; materials for painters and upholsterers, namely, paintbrushes, brushes, paint rollers, painters' rollers, paint trays, spin grid, paint and dirt protection paper; marking chalk; chalk holders; rulers; teaching materials (except apparatus); packaging materials; color and/or sample cards, color and/or sample fans, color and/or sample card collections, color and/or sample boards, color and/or sample board collections; colored paper.

17 – Sealing, thermal protection and insulating materials; insulating paints, insulating varnishes, insulating fabrics, insulating plaster; substances for insulating buildings against moisture; artificial and synthetic resins (semi-finished products); fabrics for building insulation; insulating tapes; heat insulators; insulating panels; grid mats of glass fiber fabric and/or plastics, in the form of parts for composite heat insulation systems; plastic films, other than for wrapping purposes; adhesive tapes and strips for building.

19 – Building materials, not of metal or mainly not of metal, in particular profile rails and corner irons, finishing profiles; adjusting and levelling parts, spacers for building, sills, all not of metal or mainly not of metal; natural and artificial stone; mortar (building materials); quartz; plaster [building materials]; coatings (building materials); wall and ceiling panels (not of metal or mainly not of metal, for building); fabric embedding compounds for building; fillers (building materials); fabrics for building, not of metal or mainly not of metal, in particular stabilising fabrics.

20 – Fixing materials (not of metal or mainly not of metal), in particular fixing anchors for building; bolts, plugs, pins, screws, nuts, not of metal or mainly not of metal.

24 – Textile wall hangings; non-woven fabrics; fabrics for textile use.

27 – Wall hangings (non-textile), even structuring in connection with paints; wallpaper; floor coverings.

35 – Advertising, marketing and sales promotion; business management; administrative services; commercial information and advice for consumers in the choice of products and services; import and export services, as well as wholesaling and retailing services, including via the Internet, in the fields of: chemicals, paints, machines, tools and metal hardware, construction articles, building materials, DIY articles and gardening articles, craft supplies, electric goods and electronic goods, sound recording carriers and data carriers; import and export services, as well as wholesaling and retailing services, including via the Internet, in the fields of: apparatus for sanitary purposes, printed matter, stationery, office requisites, furnishings and decorative articles, tents, awnings, wall hangings, agricultural products, horticultural products and forestry products.

37 – Painting, in particular tinting of paints; constructions; construction consultancy; building insulating; scaffolding; wallpapering; consultancy with regard to the use of paints, plasters and other coating materials in the construction industry.

39 – Transport; packaging and storage of goods; rental of units, silos and containers for storage and transport.

42 – Architectural services; consultancy in the field of energy-saving; architectural consultancy with regard to the interior and exterior color designing for buildings (buildings and constructions); IT services, namely development, programming, updating and implementation of software; hosting services, software as a service (SaaS) and rental of software; IT consultancy, advisory and information services; design services; software design and software development; consultancy relating to the aforesaid services.

(260) AM 2021 111898 A

(800) 1577352

(151) 2020 11 30

(891) 2020 11 30

(731) LORO PIANA S.p.A.

Corso Rolandi, 10, I-13017 Quaronia (VC),
Italy

(540)

JERSELY

(591) Black, white

(511)

24 – Textile material; textile fabrics for clothing and household furnishings; woven or knitted fabrics; non-woven textile fabrics; apparel fabrics; elastic woven material; silk (cloth); jersey (fabric); bed blankets; table covers; travelling rugs [lap robes]; loose covers for furniture; curtains of textile or plastic; linens; cushion covers; quilts; bed linen; bed sheets; hooded towels; towels of textile; face towels; guest towels of textile; beach towels; table linen; textile napkins; placemats of textile; labels of textile; upholstery fabrics; traced cloth for embroidery; fabric for footwear; lining fabric for footwear; linings [textile]; lingerie fabric; woven fabrics for furniture; wall hangings of textile; table linen; table mats of textile; table mats of textile; fabrics for textile use; sofa covers of textile.

(260) AM 2021 111901 A

(800) 1577362

(151) 2020 12 29

(891) 2020 12 29

(731) SHENZHEN GOTRON ELECTRONIC CO.,
LTD

518, 5F, R&D Building, Tsinghua Hi-Tech
Park, Hi-Tech Park(North), NanShan District,
Shenzhen, 518000 Guangdong Province,
China

(540)

uleFone

(591) Black, white

(531) 27.05.01

(511)

9 – Telephone; radiotelephony sets; notebook computers; computer software [recorded].

(260) AM 2021 111902 A

(800) 1577368

(151) 2021 01 20

(891) 2021 01 20

(731) CHINA ROAD & BRIDGE CORPORATION
Rm.1008, No. 88 C., Andingmenwai Avenue,
Dongcheng District, 100020 Beijing, China

(540)



(591) Black, white

(531) 26.04.03; 26.04.16; 26.04.18; 27.05.02

(511)

35 – Import-export agency services; auctioneering; sales promotion for others.

36 – Rental of real estate; real estate agency services; accommodation bureau services; real estate management; rental of apartments; apartment house management; real estate appraisal; real estate brokerage.

37 – Sanding; asphaltting; plumbing; pipeline construction and maintenance; harbour construction; pier breakwater building; underwater construction; underwater repair; building sealing; scaffolding; rental of construction equipment; rental of bulldozers; rental of excavators; construction; factory construction; warehouse construction and repair; masonry; demolition of buildings; damp-proofing [building]; plastering; underwater dredging; bricklaying; road paving.

41 – Educational services; academies [education]; teaching; tuition; educational examination; education information; boarding school education; instruction services; practical training [demonstration].

42 – Research and development of new products for others; conducting technical project studies; technological research; quality control; engineering; engineering drawing; architectural services; construction drafting; architectural consultancy; design of interior decor.

(260) AM 2021 111903 A

(800) 1577381

(151) 2020 12 28

(891) 2020 12 28

(731) Zubreeva Anastasiia Fyodorovna

ul. Kubanskaya nab., 31/1, kv. 333, Krasnodar,

RU-350000 Krasnodarskiy kray, Russian

Federation

(540)

(591) Black, white

(531) 27.05.01; 27.05.15

(511)

3 – Abrasives; amber [perfume]; descaling preparations for household purposes; antistatic preparations for household purposes; aromatics [essential oils]; air fragrancing preparations; cake flavorings [essential oils]; flavorings for beverages [essential oils]; food flavorings [essential oils]; breath freshening sprays; canned pressurized air for cleaning and dusting purposes; balms, other than for medical purposes; lip glosses; polishing stones; abrasive paper; emery paper; polishing paper; petroleum jelly for cosmetic purposes; shoe polish; cobblers' wax; cotton wool for cosmetic purposes; sachets for perfuming linen; drying agents for dishwashing machines; adhesives for cosmetic purposes; scented water; Javelle water; lavender water; toilet water; wax for parquet floors; floor wax; non-slipping wax for floors; depilatory wax; mustache wax; tailors' wax; creams for leather; polish for furniture and flooring; shoemakers' wax; polishing wax; massage gels, other than for medical purposes; heliotropine; dental bleaching gels; geraniol; make-up; deodorants for pets; deodorants for human beings or for animals; depilatory preparations; air fragrance reed diffusers; scented wood; perfumes; non-slipping liquids for floors; windshield cleaning liquids; greases for cosmetic purposes; volcanic ash for cleaning; perfumery; decorative transfers for cosmetic purposes; ionone [perfumery]; shaving stones [astringents]; smoothing stones; eyebrow pencils; cosmetic pencils; silicon carbide [abrasive]; carbides of metal [abrasives]; alum stones [astringents]; tripoli stone for polishing; adhesives for affixing false eyelashes; adhesives for affixing false hair; hair conditioners; quillaia bark for washing; corundum [abrasive]; beard dyes; colorants for toilet purposes; cosmetic dyes; laundry starch; laundry glaze; shoe cream; polishing creams; cosmetic creams; skin whitening creams; polishing rouge; incense; hair spray; nail polish;

hair lotions; lotions for cosmetic purposes; after-shave lotions; beauty masks; oils for perfumes and scents; oils for cosmetic purposes; oils for toilet purposes; essential oils; essential oils of cedarwood; essential oils of lemon; essential oils of citron; oils for cleaning purposes; bergamot oil; gaultheria oil; jasmine oil; lavender oil; almond oil; rose oil; oil of turpentine for degreasing; whitening; cleaning chalk; almond milk for cosmetic purposes; cleansing milk for toilet purposes; musk [perfumery]; soap; deodorant soap; shaving soap; soap for brightening textile; cakes of toilet soap; antiperspirant soap; soap for foot perspiration; almond soap; mint for perfumery; cosmetic kits; emery; nail art stickers; false nails; eau de Cologne; bases for flower perfumes; joss sticks; pastes for razor strops; dentifrices; pumice stone; lipstick cases; hydrogen peroxide for cosmetic purposes; breath freshening strips; teeth whitening strips; abrasive cloth; glass cloth [abrasive cloth]; lipsticks; pomades for cosmetic purposes; shaving preparations; cosmetic preparations for baths; bath preparations, not for medical purposes; hair straightening preparations; hair waving preparations; laundry soaking preparations; grinding preparations; smoothing preparations [starching]; color-removing preparations; leather bleaching preparations; polishing preparations; denture polishes; mouthwashes, not for medical purposes; cosmetic preparations for slimming purposes; starch glaze for laundry purposes; eye-washes, not for medical purposes; fabric softeners for laundry use; laundry bleach; dry-cleaning preparations; paint stripping preparations; lacquer-removing preparations; make-up removing preparations; floor wax removers [scouring preparations]; varnish-removing preparations; rust removing preparations; nail care preparations; cleaning preparations; preparations for cleaning dentures; wallpaper cleaning preparations; preparations for unblocking drain pipes; chemical cleaning preparations for household purposes; collagen preparations for cosmetic purposes; bleaching preparations [decolorants] for household purposes; laundry preparations; aloe vera preparations for cosmetic purposes; sunscreen preparations; color-brightening chemicals for household purposes [laundry]; breath freshening preparations for personal hygiene; shining preparations [polish]; make-up powder; diamantine [abrasive]; stain removers; nail varnish removers; vaginal washes for personal sanitary or deodorant purposes; scouring solutions; false eyelashes; tissues impregnated with cosmetic lotions; tissues impregnated with make-up removing preparations; safrol; massage candles for cosmetic purposes; laundry blueing; turpentine for degreasing; potpourris [fragrances]; bleaching soda; washing soda, for cleaning; bath salts, not for medical purposes; bleaching salts; fumigation preparations [perfumes]; preservatives for leather [polishes]; ammonia [volatile alkali] [detergent]; astringents for cosmetic purposes; eyebrow cosmetics; make-up preparations; sun-tanning preparations [cosmetics]; hair dyes; neutralizers

for permanent waving; cosmetic preparations for eye-lashes; cosmetic preparations for skin care; cosmetics; cosmetics for children; cosmetics for animals; mascara; cleansers for intimate personal hygiene purposes, non medicated; douching preparations for personal sanitary or deodorant purposes [toiletries]; detergents, other than for use in manufacturing operations and for medical purposes; degreasers, other than for use in manufacturing processes; bleaching preparations [decolorants] for cosmetic purposes; toiletry preparations; antiperspirants [toiletries]; phytocosmetic preparations; talcum powder, for toilet use; cotton swabs for cosmetic purposes; terpenes [essential oils]; emery cloth; cloths impregnated with a detergent for cleaning; henna [cosmetic dye]; shampoos; shampoos for animals [non-medicated grooming preparations]; shampoos for pets [non-medicated grooming preparations]; dry shampoos; sandpaper; soda lye; herbal extracts for cosmetic purposes; extracts of flowers [perfumes]; ethereal essences; badian essence; mint essence [essential oil].

(260) AM 2021 111905 A

(800) 1577436

(151) 2020 12 16

(891) 2020 12 16

(731) Sopro Bauchemie GmbH

Biebricher Straße 74, 65203 Wiesbaden,
Germany

(540)



(591) Black, grey, red, white

(531) 14.01.13; 14.05.02; 14.05.20; 26.11.22;
27.05.03; 27.05.09; 29.01.14

(511)

19 – Building materials (non-metallic), in particular with damping and insulating properties; building materials (non-metallic), namely hydraulic binding agents such as cement, lime, gypsum and as additives for binding and hardening concrete, mortar and stony-type building materials; building materials (non-metallic), namely hydraulic binding agents and mixtures composed thereof containing aggregates, pozzolanic materials (concrete admixtures) and/or chemical substances (concrete admixtures); mortar (building material); plaster (building material); screeds (building material); reinforcing fabrics (non-metallic) for building purposes; contact sludges (non-metallic) for building purposes; building materials, non-metallic, in the form of filling materials for building purposes for preparing surfaces made of concrete, mortar and other stony-ty-

pe building materials; silica sand for building purposes; bitumen; bituminous products for building; pipes, not of metal, for building purposes; concrete; concrete building elements; roof coverings, not of metal; bituminous coatings for roofing (except for sealing and insulating purposes); windows, not of metal; felts for building; gravel; sand for building purposes; prefabricated swimming pools (not of metal); prefabricated chimneys, not of metal; floor tiles, not of metal; tile floorings, not of metal; binding material for road repair; road coating materials.

37 – Construction services; providing information relating to building construction; providing online information relating to building construction; provision of construction information, in particular with respect to the field of application and use of building materials; on site project management relating to the construction of buildings; construction project management in the course of building construction (construction supervision); rental of building tools; rental of building materials; repair in the field of buildings above ground, underground engineering and completion of interiors; construction of interior accommodation.

41 – Provision of training courses; education and instruction services; organization of webinars and live-shows via internet; provision of training and education; developing, arranging, organizing and conducting of courses, tutorials, live-shows, tutorials for craftsmen, tutorials about construction materials and tiles for specialists, tutorials for planners and technical experts, lectures, certification courses and workshops (training); education, further education and further education, in particular also e-learning, computer-based training, web-based training with external persons via intranet and internet.

(260) AM 2021 111906 A

(800) 1577471

(151) 2020 12 18

(891) 2020 12 18

(731) Apple Inc.

One Apple Park Way, Cupertino CA 95014,
USA

(540)



(591) Red, orange, green, blue and white

(531) 20.05.07; 25.07.03; 26.04.04; 26.04.12;
26.15.25; 29.01.15

(511)

9 – Downloadable computer software for creating spreadsheets, tables, graphs, and charts, and for organizing, analyzing, and transmitting data, for home, education, business and developer use; downloadable computer software for accessing, viewing, annotating, storing, editing, downloading, displaying, sharing, and distributing electronic media, images, audio, video, data, information, and documents over the internet or other communications network.

(260) AM 2021 111908 A

(800) 1577546

(151) 2020 06 25

(891) 2020 06 25

(731) WORLDFORCE TEKNİK HIRDAVAT, OTO SERVİS EKİPMANLARI, SANAYİ VE TİCARET LİMİTED ŞİRKETİ
ARAP CAMİ MAH.; KERESTECİ FAZIL
SK.NO:16/2; BEYOĞLU/İSTANBUL, Turkey

(540)



(591) Red and white

(531) 01.05.23; 26.07.04; 27.05.24; 29.01.12

(511)

7 – Machines, machine tools and industrial robots for processing and shaping wood, metals, glass, plastics and minerals, 3D printers; construction machines and robotic mechanisms (machines) for use in construction: bulldozers, diggers (machines), excavators, road construction and road paving machines, drilling machines, rock drilling machines; road sweeping machines lifting, loading and transmission machines and robotic mechanisms (machines) for lifting, loading and transmission purposes: elevators, escalators and cranes; machines and robotic mechanisms (machines) for use in agriculture and animal breeding, machines and robotic mechanisms (machines) for processing cereals, fruits, vegetables and food; machines for preparing and processing beverages; engines and motors, other than for land vehicles, parts and fittings therefor; hydraulic and pneumatic controls for engines and motors, brakes other than for vehicles, brake linings for engines, rankshafts, gearboxes, other than for land vehicles, cylinders for engines, pistons for engines, turbines, not for land vehicles, filters for engines and motors, oil, air and fuel filters for land vehicle engines, exhausts for land vehicle engines, exhaust manifolds for land vehicle engines, engine cylinders for land vehicles, engine cylinder heads for land vehicles,

pistons for land vehicle engines, carburetors for land vehicles, fuel conversion apparatus for land vehicle engines, injectors for land vehicle engines, fuel economisers for land vehicle engines, pumps for land vehicle engines, valves for land vehicle engines, starter motors for land vehicles, dynamos for land vehicle engines, sparking plugs for land vehicle engines; bearings (parts of machines), roller or ball bearings; machines for mounting and detaching tires; alternators, current generators, electric generators, current generators operated with solar energy; painting machines, automatic spray guns for paint, electric, hydraulic and pneumatic punching machines and guns, electric adhesive tape dispensers (machines), electric guns for compressed gas or liquid spraying machines, electric hand drills, electric hand saws, electric jigsaw machines, spiral machines, compressed air machines, compressors (machines), vehicle washing installations, robotic mechanisms (machines) with the abovementioned functions; electric and gas-operated welding apparatus, electric arc welding apparatus, electric soldering apparatus, electric arc cutting apparatus, electrodes for welding machines, industrial robots (machines) with the abovementioned functions; printing machines; packaging machines, filling, plugging and sealing machines, labellers (machines), sorting machines, industrial robots (machines) with the abovementioned functions, electric packing machines for plugging and sealing of plastics; machines for textile processing, sewing machines, industrial robots (machines) with the abovementioned functions; electric pumps, fuel pumps and diffusion pumps, fuel dispensing pumps for service stations, self-regulating fuel pumps; electric kitchen machines for chopping, grinding, crushing, mixing and mincing foodstuff, washing machines, laundry washing machines, dishwashers, spin driers (not heated), electric cleaning machines for cleaning floors, carpets or floorings, vacuum cleaners and parts thereof; automatic vending machines; galvanizing and electroplating machines; electric door openers and closers; gaskets for engines and motors.

8 – Forks, spoons, knives and non-electric cutters, slicers, peelers for kitchen use, including those made of precious metals; side arms and blades (weapons); tools and apparatus included in this class for personal beauty care use; tools and apparatus included in this class for shaving, epilation, manicure and pedicure, electric hand implements for straightening and curling hair, scissors; hand-operated [non-electric] hand tools included in this class for the repair of machines, apparatus and vehicles and for use in construction, agriculture, horticulture and forestry, none of them being power tools; electric or non-electric irons; steam irons handles for hand-operated hand tools.

12 – Motor land vehicles, motorcycles, mopeds, engines and motors for land vehicles, clutches for land vehicles; transmissions, transmission belts and trans-

mission chains for land vehicles; gearing for land vehicles; brakes, brake discs and brake linings for land vehicles; vehicle chassis, automobile bonnets, vehicle suspension springs, shock absorbers for automobiles, gearboxes for land vehicles, steering wheels for vehicles, rims for vehicle wheels; bicycles and their bodies; handlebars and mudguards for bicycles; vehicle bodies; tipping bodies for trucks; trailers for tractors; frigorific bodies for land vehicles; trailer hitches for vehicles; vehicle seats, head-rests for vehicle seats, safety seats for children, for vehicles; seat covers for vehicles; vehicle covers (shaped); sun-blinds adapted for vehicles; direction signals and arms for direction signals for vehicles; windscreen wipers and wiper arms for vehicles; inner and outer tires for vehicle wheels; tubeless tires; tire-fixing sets comprised of tire patches and tire valves for vehicles; windows for vehicles, safety windows for vehicles, rearview mirrors and wing mirrors for vehicles; anti-skid chains for vehicles; luggage carriers for vehicles; bicycle and ski carriers for cars, saddles for bicycles or motorcycles; air pumps for vehicles, for inflating tires; anti-theft alarms for vehicles, horns for vehicles; safety belts for vehicle seats, air bags (safety devices for automobiles); baby carriages, wheelchairs, pushchairs; wheelbarrows; shopping carts; single or multi-wheeled wheelbarrows; shopping trolleys; grocery carts, handling carts; rail vehicles; locomotives; trains; trams; waggons; cable cars; chairlifts; vehicles for locomotion by water and their parts, other than their motors and engines; vehicles for locomotion by air and their parts, other than their motors and engines.

35 – Advertising, marketing and public relations; organization of exhibitions and trade fairs for commercial or advertising purposes; development of advertising concepts; provision of an online marketplace for buyers and sellers of goods and services; office functions; secretarial services; arranging newspaper subscriptions for others; compilation of statistics; rental of office machines; systemization of information into computer databases; telephone answering for unavailable subscribers; business management, business administration and business consultancy; accounting; commercial consultancy services; personnel recruitment, personnel placement, employment agencies, import-export agencies; temporary personnel placement services; auctioneering; the bringing together, for the benefit of others, of a variety of goods, namely, paints, varnishes, lacquers, preservatives against rust, preservatives against deterioration of wood, thinners and binders for paints, pigments, preservatives for metals, shoe dyes, printing dyes and ink, toners (including filled toner cartridges), colorants for food, pharmaceuticals and beverages, raw natural resins, metals in foil and powder form for painters, decorators, printers and artists, ores of non-precious metal, common metals and their alloys and semi-finished products made of these materials, irons for construction, mats and stirrups of common metals for buildings,

common metals in the form of plate, billet, stick, profile, sheet and sheeting, goods and materials of common metal used for storage, wrapping, packaging and sheltering purposes, containers of metal (storage, transport), buildings of metal, frames of metal for building, poles of metal for building, metal boxes, packaging containers of metal, aluminium foil, fences made of metal, guard barriers of metal, metal tubes, storage containers of metal, metal containers for the transportation of goods, ladders of metal, goods of common metal for filtering and sifting purposes, doors, windows, shutters, jalousies and their cases and fittings of metal, non-electric cables and wires of metal, ironmongery, small hardware of metal, screws of metal, nails, bolts of metal, nuts of metal, pegs of metal, flakes of metal, pitons of metal, metal chains, furniture casters of metal, fittings of metal for furniture, industrial metal wheels, door handles of metal, window handles of metal, hinges of metal, metal latches, metal locks, metal keys for locks, metal rings, metal pulleys, ventilation ducts, vents, vent covers, pipes, chimney caps, manhole covers, grilles of metal for ventilation, heating, sewage, telephone, underground electricity and air conditioning installations, metal panels or boards (non-luminous and non-mechanical) used for signaling, route showing, publicity purposes, signboards of metal, advertisement columns of metal, signaling panels of metal, non-luminous and non-mechanical traffic signs of metal, pipes of metal for transportation of liquids and gas, drilling pipes of metal and their metal fittings, valves of metal, couplings of metal for pipes, elbows of metal for pipes, clips of metal for pipes, connectors of metal for pipes, safes (strong boxes) of metal, metal railway materials, metal rails, metal railway ties, railway switches, bollards of metal, floating docks of metal, mooring buoys of metal, anchors, metal moulds for casting, other than machine parts, works of art made of common metals or their alloys, trophies of common metal, metal closures, bottle caps of metal, metal poles, metal pillars, scaffolding of metal, metal stakes, metal towers, metal pallets and metal ropes for lifting, loading and transportation purposes, metal hangers, ties, straps, tapes and bands used for load-lifting and load-carrying, wheel chocks made primarily of metal, metal profile laths for vehicles for the purposes of decoration, machines, machine tools and industrial robots for processing and shaping wood, metals, glass, plastics and minerals, 3d printers, construction machines and robotic mechanisms (machines) for use in construction, bulldozers, diggers (machines), excavators, road construction and road paving machines, drilling machines, rock drilling machines, road sweeping machines, lifting, loading and transmission machines and robotic mechanisms (machines) for lifting, loading and transmission purposes, elevators, escalators and cranes, machines and robotic mechanisms (machines) for use in agriculture and animal breeding, machines and robotic mechanisms (machines) for processing cereals,

fruits, vegetables and food, machines for preparing and processing beverages, engines and motors, other than for land vehicles, parts and fittings therefor, hydraulic and pneumatic controls for engines and motors, brakes other than for vehicles, brake linings for engines, crankshafts, gearboxes, other than for land vehicles, gearboxes, cylinders for engines, pistons for engines, turbines, not for land vehicles, filters for engines and motors, oil, air and fuel filters for land vehicle engines, exhausts for land vehicle engines, exhaust manifolds for land vehicle engines, engine cylinders for land vehicles, engine cylinder heads for land vehicles, pistons for land vehicle engines, carburetors for land vehicles, fuel conversion apparatus for land vehicle engines, injectors for land vehicle engines, fuel economisers for land vehicle engines, pumps for land vehicle engines, valves for land vehicle engines, starter motors for land vehicles, dynamos for land vehicle engines, sparking plugs for land vehicle engines, bearings (parts of machines), roller or ball bearings, machines for mounting and detaching tires, alternators, current generators, electric generators, current generators operated with solar energy, painting machines, automatic spray guns for paint, electric, hydraulic and pneumatic punching machines and guns, electric adhesive tape dispensers (machines), electric guns for compressed gas or liquid spraying machines, electric hand drills, electric hand saws, electric jigsaw machines, spiral machines, compressed air machines, compressors (machines), vehicle washing installations, robotic mechanisms (machines) with the the abovementioned functions, electric and gas-operated welding apparatus, electric arc welding apparatus, electric soldering apparatus, electric arc cutting apparatus, electrodes for welding machines, industrial robots (machines) with the abovementioned functions, printing machines, packaging machines, filling, plugging and sealing machines, labellers (machines), sorting machines, industrial robots (machines) with the abovementioned functions, electric packing machines for plugging and sealing of plastics, machines for textile processing, sewing machines, industrial robots (machines) with the abovementioned function, pumps other than parts of machines or engines, fuel dispensing pumps for service stations, self-regulating fuel pumps, electric kitchen machines for chopping, grinding, crushing, mixing and mincing foodstuff, washing machines, laundry washing machines, dishwashers, spin driers (not heated), electric cleaning machines for cleaning floors, carpets or floorings, vacuum cleaners and parts thereof, automatic vending machines, galvanizing and electroplating machines, electric door openers and closers, gaskets for engines and motors, forks, spoons, knives and non-electric cutters, slicers, peelers for kitchen use, including those made of precious metals, side arms and blades (weapons), tools and apparatus for personal beauty care use, tools and apparatus for shaving, epilation, manicure and pedicure, electric hand implements for straightening and

curling hair, scissors, hand-operated [non-electric] hand tools for the repair of machines, apparatus and vehicles and for use in construction, agriculture, horticulture and forestry, none of them being power tools, electric or non-electric irons, steam irons, handles for hand-operated hand tools, measurement apparatus and equipment including those for scientific, nautical, topographic, meteorologic, industrial and laboratory purposes, thermometers, not for medical purposes, barometers, ammeters, voltmeters, hygrometers, testing apparatus not for medical purposes, telescopes, periscopes, directional compasses, speed indicators, laboratory apparatus, microscopes, magnifying glasses, stills, binoculars, ovens and furnaces for laboratory experiments, apparatus for recording, transmission or reproduction of sound or images, cameras, photographic cameras, television apparatus, video recorders, CD and DVD players and recorders, MP3 players, computers, desktop computers, tablet computers, wearable technological devices (smart watches, wristbands, head-mounted devices) microphones, loudspeakers, earphones, telecommunications apparatus, apparatus for the reproduction of sound or images, computer peripheral devices, cell phones, covers for cell phones, telephone apparatus, computer printers, scanners [data processing equipment], photocopiers, magnetic and optic data carriers and computer software and programmes recorded thereto, downloadable and recordable electronic publications, encoded magnetic and optic cards, movies, tv series and video music clips recorded on magnetic, optical and electronic media, antennas, satellite antennas, amplifiers for antennas, parts of the aforementioned goods, ticket dispensers, automatic teller machines (ATM), electronic components used in the electronic parts of machines and apparatus, semi-conductors, electronic circuits, integrated circuits, chips [integrated circuits], diodes, transistors [electronic], magnetic heads for electronic apparatus, electronic locks, photocells, remote control apparatus for opening and closing doors, optical sensors, counters and quantity indicators for measuring the quantity of consumption, automatic time switches, clothing for protection against accidents, irradiation and fire, safety vests and life-saving apparatus and equipment, eyeglasses, sunglasses, optical lenses and cases, containers, parts and components thereof, apparatus and instruments for conducting, transforming, accumulating or controlling electricity, electric plugs, junction boxes [electricity], electric switches, circuit breakers, fuses, lighting ballasts, battery starter cables, electrical circuit boards, electric resistances, electric sockets, transformers [electricity], electrical adapters, battery chargers, electric door bells, electric and electronic cables, batteries, electric accumulators, solar panels for production of electricity, alarms and anti-theft alarms, other than for vehicles, electric bells, signalling apparatus and instruments, luminous or mechanical signs for traffic use, fire extinguishing apparatus, fire engines, fire hose and fire hose nozzles, ra-

dar apparatus, sonars, night vision apparatus and instruments, decorative magnet, metronomes, lighting installations, lights for vehicles and interior-exterior spaces, heating installations using solid, liquid or gas fuels or electricity, central heating boilers, boilers for heating installations, radiators [heating], heat exchangers, not parts of machines, stoves, kitchen stoves, solar thermal collectors [heating], steam, gas and fog generators, steam boilers, other than parts of machines, acetylene generators, oxygen generators, nitrogen generators, installations for air-conditioning and ventilating, cooling installations and freezers, electric and gas-powered devices, installations and apparatus for cooking, drying and boiling, cookers, electric cooking pots, electric water heaters, barbecues, electric laundry driers, hair driers, hand drying apparatus, sanitary installations, taps [faucets], shower installations, toilets [water-closets], shower and bathing cubicles, bath tubs, toilet seats, sinks, wash-hand basins [parts of sanitary installations], washers for water taps, stuffings (tap valves), water softening apparatus, water purification apparatus, water purification installations, waste water purification installations, electric bed warmers and electric blankets, not for medical use, electric pillow warmers, electric or non-electric footwarmers, hot water bottles, electrically heated socks, filters for aquariums and aquarium filtration apparatus, industrial type installations for cooking, drying and cooling purposes, pasteurizers and sterilizers, motor land vehicles, motorcycles, mopeds, engines and motors for land vehicles, clutches for land vehicles, transmissions, transmission belts and transmission chains for land vehicles, gearing for land vehicles, brakes, brake discs and brake linings for land vehicles, vehicle chassis, automobile bonnets, vehicle suspension springs, shock absorbers for automobiles, gearboxes for land vehicles, steering wheels for vehicles, rims for vehicle wheels, bicycles and their bodies, handlebars and mudguards for bicycles, vehicle bodies, tipping bodies for trucks, trailers for tractors, frigorific bodies for land vehicles, trailer hitches for vehicles, vehicle seats, head-rests for vehicle seats, safety seats for children, for vehicles, seat covers for vehicles, vehicle covers (shaped), sun-blinds adapted for vehicles, direction signals and arms for direction signals for vehicles, windscreen wipers and wiper arms for vehicles, inner and outer tires for vehicle wheels, tubeless tires, tire-fixing sets comprised of tire patches and tire valves for vehicles, windows for vehicles, safety windows for vehicles, rearview mirrors and wing mirrors for vehicles, anti-skid chains for vehicles, luggage carriers for vehicles, bicycle and ski carriers for cars, saddles for bicycles or motorcycles, air pumps for vehicles, for inflating tires, anti-theft alarms for vehicles, horns for vehicles, safety belts for vehicle seats, air bags (safety devices for automobiles), baby carriages, wheelchairs, pushchairs, wheelbarrows, shopping carts, single or multi-wheeled wheelbarrows, shopping trolleys, grocery carts,

handling carts, rail vehicles, locomotives, trains, trams, wagons, cable cars, chairlifts, vehicles for locomotion by water and their parts, other than their motors and engines, vehicles for locomotion by air and their parts, other than their motors and engines, ores of non-precious metal, common metals and their alloys and semi-finished products made of these materials, irons for construction, mats and stirrups of common metals for buildings, common metals in the form of plate, billet, stick, profile, sheet and sheeting, goods and materials of common metal used for storage, wrapping, packaging and sheltering purposes, containers of metal (storage, transport), buildings of metal, frames of metal for building, poles of metal for building, metal boxes, packaging containers of metal, aluminium foil, fences made of metal, guard barriers of metal, metal tubes, storage containers of metal, metal containers for the transportation of goods, ladders of metal, goods of common metal for filtering and sifting purposes, doors, windows, shutters, jalousies and their cases and fittings of metal, non-electric cables and wires of metal, ironmongery, small hardware of metal, screws of metal, nails, bolts of metal, nuts of metal, pegs of metal, flakes of metal, pitons of metal, metal chains, furniture casters of metal, fittings of metal for furniture, industrial metal wheels, door handles of metal, window handles of metal, hinges of metal, metal latches, metal locks, metal keys for locks, metal rings, metal pulleys, ventilation ducts, vents, vent covers, pipes, chimney caps, manhole covers, grilles of metal for ventilation, heating, sewage, telephone, underground electricity and air conditioning installations, metal panels or boards (non-luminous and non-mechanical) used for signaling, route showing, publicity purposes, signboards of metal, advertisement columns of metal, signaling panels of metal, non-luminous and non-mechanical traffic signs of metal, pipes of metal for transportation of liquids and gas, drilling pipes of metal and their metal fittings, valves of metal, couplings of metal for pipes, elbows of metal for pipes, clips of metal for pipes, connectors of metal for pipes, safes (strong boxes) of metal, metal railway materials, metal rails, metal railway ties, railway switches, bollards of metal, floating docks of metal, mooring buoys of metal, anchors, metal moulds for casting, other than machine parts, works of art made of common metals or their alloys, trophies of common metal, metal closures, bottle caps of metal, metal pole, metal pillars, scaffolding of metal, metal stakes, metal towers, metal pallets and metal ropes for lifting, loading and transportation purposes, metal hangers, ties, straps, tapes and bands used for load-lifting and load-carrying, wheel chocks made primarily of metal, metal profile laths for vehicles for the purposes of decoration enabling customers to conveniently view and purchase those goods, such services may be provided by retail stores, wholesale outlets, by means of electronic media or through mail order catalogues.

(260) AM 2021 111909 A

(800) 1577571

(151) 2020 09 30

(891) 2020 09 30

(731) Belarusian-German Joint Venture, "Santa Bremor", Limited Liability Company
ul. Katin Bor 106; 224004 g. Brest, Belarus

(540)



(591) Red and white

(531) 02.03.01; 25.01.15; 28.05; 29.01.12

(511)

29 – Meat, fish, poultry and game; meat extracts; preserved, dried and cooked fruits and vegetables; jellies, jams, compotes; eggs; milk and milk products; oils and fats for food; charcuterie; fermented milk products; cheese and cheese products; cottage cheese fritters, including cottage cheese casseroles and syrniki [cottage cheese pancakes]; milk-based beverages; anchovy, not live; salmon, not live; fish, not live; sardines, not live; herrings, not live; tuna, not live; fish fillets; fish-based foodstuffs; fish, tinned; fish mousses; fish, preserved; salted fish; seafood, processed, except fish; laver, preserved; shrimps, not live; prawns, not live; spiny lobsters, not live; shellfish, not live; mussels, not live; lobsters, not live; crayfish, not live; crustaceans, not live; oysters, not live; seaweed extracts for food; caviar; fish roe, processed; fish meal for human consumption; fruit and berries, processed or preserved; prepared fruit products; vegetables products, preserved; prepared vegetable dishes, including vegetable pancakes, vegetable-based dumplings, potato pancakes, cabbage rolls, vegetable salads; vegetable oils and fats for food; suet for food; fat-containing mixtures for bread slices.

30 – Coffee, tea, cocoa and artificial coffee; rice; tapioca and sago; flour and preparations made from cereals; bread, pastries and confectionery; ice cream; sugar, honey, treacle; yeast, baking-powder; salt; mustard; vinegar, sauces [condiments]; spices; ice for refreshment; flour and cereal products; dough and dough products; dough; pastry dough; cake dough; frozen yogurt [confectionery ices]; powders for making ice cream; frozen pastries and cakes; sorbets [ices]; shaved ice with sweetened red beans; edible ices; cereal-based culinary products; flour-based culinary products; boiled dough with filling; vareniki [stuffed dumplings]; pelmeni [dumplings stuffed with meat]; ravioli; culinary products from batter; pancakes; pies; pizzas; unleavened bread; sandwiches; hot dog sand-

wiches; cheeseburgers [sandwiches]; flour-based dumplings.

(260) AM 2021 111918 A

(800) 1577791

(151) 2020 07 27

(891) 2020 07 27

(731) "Eurasian Foods Corporation" Joint-Stock Company
Baizakov str., 69, 050026 Almaty city,
Kazakhstan

(540)

ИМПЕРИЯ СЫРА

(591) Black, white

(531) 28.05

(511)

29 – Ajvar [preserved peppers]; alginates for culinary purposes; peanuts, prepared; artichokes, preserved; albumen for culinary purposes; beans, preserved; soya beans, preserved, for food; bouillon; ginger jam; ham; peas, preserved; mushrooms, preserved; guacamole [avocado puree]; game, not live; gelatine; meat jellies; jellies for food; fruit jellies; lard; suet for food; leaven rennet; fruit-based snack food; milk substitutes; charcuterie; raisins; caviar; eggplant paste; vegetable marrow paste; fish roe, processed; yogurt; kefir [milk drink]; klipfish [salted and dried cod]; milk shakes; black pudding; onion rings; arrangements of processed fruit; compotes [dessert made of cooked fruit]; meat, tinned; vegetables, tinned; fish, tinned; fruits, tinned; bouillon concentrates; corn dogs (sausages in dough on sticks); gherkins; buttercream; croquettes; sweet corn, processed; kumys [milk drink]; lecithin for culinary purposes; onions, preserved; marmalade; almonds, ground; milk; peanut milk; peanut milk for culinary purposes; coconut milk; coconut milk for culinary purposes; almond milk; almond milk for culinary purposes; oat milk; rice milk; rice milk for culinary purposes; albumin milk; condensed milk; soya milk; powdered milk; vegetable mousses; fish mousses; fruit pulp; meat; meat, preserved; milk beverages, milk predominating; peanut milk-based beverages; coconut milk-based beverages; almond milk-based beverages; vegetables, preserved; freeze-dried vegetables; vegetables, dried; vegetables, cooked; potato fritters; olives, preserved; flavored nuts; candied nuts; coconut, desiccated; nuts, prepared; tomato puree; pressed fruit paste; liver pate; pectin for culinary purposes; liver; pickles; jams; powdered eggs; milk products; fish-based foodstuffs; curd [sour milk]; cranberry compote; mashed tomato; apple puree; fish, preserved; salted fish; soured milk [clarified milk of lactic acid fermentation]; vegetable salads; fruit salads; bacon; pork; seeds, prepared; sunflower seeds, prepared; cream [dairy products]; whipped cream; vegetable-based cream; smetana [sour cream]; lemon juice for culinary purposes; tomato juice for cooking; vegetable juices for

cooking; salted meats; sausages; sausages in batter; hot dog sausages; preparations for making bouillon; preparations for making soup; nut-based spreads; tripe; soups; vegetable soup preparations; whey; cheese; tahini [sesame seed paste]; tofu; truffles, preserved; falafel; milk ferments for culinary purposes; rennet; fish fillet; dates; crystallized fruits; frozen fruits; fruit, preserved; fruit preserved in alcohol; fruit, stewed; hazelnuts, prepared; potato flakes; hummus [paste of chickpeas]; fruit peel; preserved garlic; lentils, preserved; potato chips; low-fat potato chips; fruit chips; non-alcoholic eggnog; seaweed extracts for food; meat extracts; berries, preserved; fruit-based fillings.

43 – Accommodation bureau services [hotels, boarding houses]; rental of meeting rooms; tourist home services; hotel reservations; boarding house bookings; temporary accommodation reservations; hotel services; retirement home services; snack-bar services; café services; cafeteria services; motel services; boarding house services; restaurant services; self-service restaurant services; reception services for temporary accommodation [management of arrivals and departures]; food sculpting; canteen services; holiday camp services [lodging]; bar services; providing campground facilities; food and drink catering; washoku restaurant services; udon and soba restaurant services; day-nursery [crèche] services; decorating of food; cake decorating; information and advice in relation to the preparation of meals; personal chef services.

(260) AM 2021 111920 A

(800) 1577817

(151) 2020 11 20

(891) 2020 11 20

(731) Enes Seker

Auf Krummerück 32, 52078 Aachen, Germany

(540)



(591) Gold, pink, white

(531) 08.01.10; 08.01.25; 08.07.01; 24.09.02;
24.09.03; 24.09.05; 24.09.07; 27.03.15;
29.01.14

(511)

16 – Cardboard packaging boxes; packaging films for food; masking paper; packaging boxes [paper]; printed matter; paper napkins; promotional brochures; bags of paper for packaging; packaging materials; cardboard boxes; cardboard advertising signs; advertising signs of paper; boxes of paper; boxes of paper or cardboard; bags of plastic for packaging; wrapping paper; corrugated cardboard boxes; cardboard packa-

ging boxes; cardboard packing boxes; printed paper billboards; printed cardboard billboards; printed promotional materials.

(260) AM 2021 111922 A

(800) 1577877

(151) 2020 12 14

(891) 2020 12 14

(731) CHAO YANG LONGMARCH TYRE Co., Ltd
No.1 Xiangyang Road, Longcheng District,
Chaoyang, Liaoning, China

(540)

ROADLUX

(591) Black, white

(531) 27.05.01

(526) Road.

(511)

12 – Vehicle tires.

(260) AM 2021 111923 A

(800) 1577915

(151) 2020 08 26

(891) 2020 08 26

(731) JIANGSU AOGRAND GROUP INC.
205 ShuangGao Rd., QiQiao Ind.Park,
GaoChun, NanJing, Jiangsu Province,
China

(540)



(591) Black, white

(531) 01.15.07; 01.15.21; 27.05.02; 27.05.04;
27.05.08; 27.05.10

(511)

3 – Shampoos; laundry detergent; facial cleanser; bath lotions; toothpaste; soap; toilet waters; cakes of toilet soap; detergent.

(260) AM 2021 111978 A

(800) 1577955

(151) 2020 12 17

(891) 2020 12 17

(731) ZHEJIANG BOOU SANITARY WARE
CO., LTD.

Yuanquzhong Road, Fengjiang Street,
Luqiao District, Taizhou City, 318050
Zhejiang Province, China

(540)



(591) Red, white

(531) 01.05.02; 01.05.06; 01.05.24; 27.05.24;
29.01.12

(511)

11 – Light bulbs; heaters for baths; faucets; bath tubs; water closets; bath installations; water-pipes for sanitary installations; water conduits installations; cocks for pipes and pipelines; floor drains.

(260) AM 2021 111979 A

(800) 1578004

(151) 2020 12 22

(891) 2020 12 22

(731) HYTECK

25 rue de l'Ecole de Médecine, F-75006
PARIS, France

(540)

APOMA-3OH

(591) Black, white

(531) 28.05

(511)

3 – Perfumery products and perfumes; fragrances; eaux de toilette; aromatic extracts and essential oils; essential oils for aromatherapy use; suntanning oils; massage oils; cosmetic oils; oils for cosmetic use; do-it-yourself cosmetics; scented oils for the manufacture of cosmetics; vegetable oils for cosmetic use; essential oils for food flavorings; food flavorings (essential oils); vegetable butters for cosmetic use; cosmetics; cosmetic creams; soaps and gels; shower gels; aloe vera gel for cosmetic use; lip balms; hair care products; hair lotions; shampoos; hair conditioners; toiletries; Skin care preparations; exfoliants; care balms; face and body milks; make-up; facial foundation; nail polish; make-up removing products; deodorants; shaving and depilatory preparations; dentifrices; nail polish removers; incense; compositions for diffusers; wicks (impregnated) for the diffusion of the air freshener; extracts of flowers; household perfumes; air fragrancing preparations; tissues for cosmetic use; mineral water sprays for cosmetic use.

16 – Printing products (printed matter); printed matter; posters; information sheets; printed information sheets; news bulletins; leaflets; user instructions; printed recipe cards; printed tutorials; files (office requisites); recipe binders; books; recipe books; printed publications; pamphlets; catalogs; magazines; printed pe-

riodicals; booklets; newspapers; notebooks; writing or drawing books; notebooks; dictionaries; banners of paper; calendars; stickers; self-adhesive labels; labels of paper or cardboard; pictures; photographs; membership and loyalty cards of paper or cardboard; gift cards; printed information cards; printed advertisements; containers of cardboard or paper for packaging; packaging made of cardboard and paper; cardboard for packaging; wipes of paper; tissues of paper for removing make-up.

41 – Workshops and seminars in the field of cosmetics, do-it-yourself cosmetics, food supplements and aromatherapy products; courses for the manufacture of cosmetics, do-it-yourself cosmetics, food supplements and aromatherapy products; conducting conferences in the field of cosmetic products, do-it-yourself cosmetics, food supplements and aromatherapy products; editing and publishing books, magazines and other printed media in the fields of cosmetic products, do-it-yourself cosmetics, food supplements and aromatherapy products; editing and publication of cosmetic and aromatherapy recipes on printed media and in electronic format; editing electronic publications in the fields of cosmetic products, do-it-yourself cosmetics, food supplements and aromatherapy products; publishing the editorial content of sites accessible via a global computer network.

(260) AM 2021 111983 A

(800) 1578133

(151) 2020 07 28

(891) 2020 07 28

(731) Tobb Und Lojistik Yatırım Anonim Şirketi
ESKİŞEHİR YOL.KAT-DUMLUPINAR,
BLV.NO.252 TOBB İKİZ, KULELER
C KULE K.27, Çankaya Ankara, Turkey

(540)



(591) Black, white

(531) 26.04.05; 26.04.18; 26.04.24; 27.05.01;
27.05.10; 27.05.24; 29.01.04

(511)

35 – Office functions; secretarial services; arranging newspaper subscriptions for others; compilation of statistics; rental of office machines; systemization of information into computer databases; telephone answering for unavailable subscribers, advertising, marketing and public relations; organization of exhibitions and trade fairs for commercial or advertising purposes, business management, business administration and business consultancy; accounting; commercial consultancy services; personnel recruitment, personnel placement, employment agencies, import-export

agencies; temporary personnel placement services, auctioneering.

36 – Insurance services, financial and monetary affairs, real estate brokers, real estate agencies and real estate management, customs brokerage services.

39 – Car parking; garage rental; land, water and air transport services; rental of land, water or air vehicles; arranging of tours; travel reservation; issuing of tickets for travel; courier services (messages or merchandise), boat storage; transport and storage of trash; transport and storage of waste, storage, wrapping and packaging of goods, rescue operations for vehicles and goods, transport by pipeline, electricity distribution, water supplying.

42 – Industrial design services, other than engineering, computer and architectural design; graphic arts designing (other than designs for advertising purposes and designs for landscape), computer services, namely, computer programming, computer virus protection services, computer system design, creating, maintaining and updating websites for others, computer software design, updating and rental of computer software, providing search engines for the internet, hosting websites, consultancy in the design and development of computer hardware, rental of computer hardware, scientific and industrial analysis and research services; engineering; engineering and architectural design services; testing services for the certification of quality and standards, authenticating works of art.

(260) AM 2021 111984 A
(800) 1578146
(151) 2020 12 09
(891) 2020 12 09
(731) Metsä Tissue Oyj
Revontulenpuisto 2, FI-02100 Espoo,
Finland
(540)



(591) Green and white
(531) 05.03.11; 05.03.13; 05.03.14; 26.13.25;
27.05.24; 29.01.12
(511)

3 – Cleaning preparations; soaps; perfumery, essential oils, cosmetics, in particular wet wipes for hygienic and cosmetic purposes; hair lotions.

16 – Paper, cardboard, kitchen rolls (paper), toilet paper, napkins of paper, table cloths of paper, towels of paper, hand towels of paper, face towels of paper, paper wipes for cleaning, handkerchiefs of paper; pa-

per for drying and cleaning for use in service installations and in industry; wrapping and packaging materials made of paper and cardboard; printed matter; plastic materials for packaging (not included in other classes).

21 – Household or kitchen utensils and containers, in particular disposable tableware (other than knives, forks and spoons), holders, containers and dispensers for kitchen rolls, toilet paper, napkins and hand towels; articles for cleaning purposes, in particular soap dishes, soap boxes, soap dispensers, towels and cloths for cleaning.

28 – Games and playthings.

(260) AM 2021 111989 A
(800) 1578322
(151) 2020 12 25
(891) 2020 12 25
(731) Zhu Jing
Unit 1, Building 22, Liuqing Eighth District,
Beiyuan, Yiwu, Zhejiang, China
(540)



(591) Gray, white
(531) 27.05.01
(511)

7 – Scissors, electric; electric juicers; electric fruit juicers for household purposes; mixing machines; meat choppers [machines]; dust exhausting installations for cleaning purposes; washing machines [laundry]; vacuum cleaners; mills for household purposes, other than hand-operated; machines and apparatus for cleaning, electric.

8 – Electric irons; goffering irons; flat irons; electric steam irons.

11 – Hair dryers; cooking utensils, electric; radiators, electric; kettles, electric; heating apparatus; air sterilizers; microwave ovens [cooking apparatus]; disinfectant apparatus; heaters for baths; refrigerators.

(260) AM 2021 111990 A
(800) 1578324
(151) 2021 01 27
(891) 2021 01 27
(731) TAIZHOU FINGTEX SEWING MACHINE
CO., LTD.
Square A, Room 802, No.6, Building,
Zhonghuan Century Centre, Jiaojiang,
Taizhou, 318000 Zhejiang, China

(540)

sewing machine
Fingtex

(591) Black, white
(531) 26.01.01; 26.01.06; 26.01.24; 27.05.10
(526) Sewing machine.
(511)

7 – Sewing machines; ironing machines; hemming machines; stitching machines; pedal drives for sewing machines; overlock sewing machines; button attach machines; stand table for industrial sewing machines; cloth cutting machines.

(260) AM 2021 112005 A

(800) 1578657
(151) 2021 01 04
(891) 2021 01 04

(731) BAUSCH + LOMB IRELAND LIMITED
3013 Lake Drive, Citywest Business Campus,
Dublin 24, Ireland

(540)

VIZIDOR

(591) Black, white
(511)
5 – Pharmaceutical products; ophthalmic medicines; eye drops.

(260) AM 2021 112007 A

(800) 1578750
(151) 2021 01 21
(891) 2021 01 21

(731) Krzysztof Lipiński
Willowa 77, PL-32-085 Modlniczka,
Poland

(540)

Cherrypazzi

(591) Black, white
(511)
28 – Puzzles; puzzles [toys]; jigsaw puzzles.
35 – Online advertisements; sales promotion; advertising via electronic media and specifically the internet; online retail services relating to toys; internet marketing.

(260) AM 2021 112009 A

(800) 1578764
(151) 2020 12 11
(891) 2020 12 11

(731) Public Joint-Stock Company "Krasnyj Ocyabr"
ul. Malaya Krasnoselskaya, d. 7, str. 24,
RU-107140 Moscow, Russian Federation

(540)



(591) Brown, white, red, yellow, orange, beige
(531) 08.03.01; 25.01.19; 28.05; 29.01.15
(511)

30 – Waffles; confectionery for decorating Christmas trees; cakes; pancakes; pastries; peanut confectionery; almond confectionery; caramels; sweetmeats; liquorice [confectionery]; peppermint sweets; crackers; meat pies; fruit jellies [confectionery]; custard; mint for confectionery; lozenges [confectionery]; pies; fondants [confectionery]; pralines; gingerbread; cake dough; confectionery; rusks; almond paste; tarts; zephyr [confectionery]; halvah; bread; petits fours; biscuits; chocolate.

(260) AM 2021 112012 A

(800) 1578815
(151) 2020 10 14
(891) 2020 10 14

(731) "Group of companies "SKYMAX TECHNOLOGIES" LLP
Umbetbayev str., 192, Bostandyk District,
Almaty, Kazakhstan

(540)



(591) Red, grey and blue
(531) 27.05.10; 28.05; 29.01.13
(526) ГРУППА КОМПАНИЙ, КОМПАНИЯЛАР ТОБЫ, TECHNOLOGIES, ®
(511)

35 – Advertising; business management; market promotion and sales of products, including automatic telephone stations, conference systems with electronic voting and simultaneous translation functions, access control and time tracking systems, information display systems, electronic lock systems, locking systems, control systems for hotels, restaurants, SPA centers, interactive hotel television systems, airfield lighting equipment, meteorological equipment and automated weather stations, radar equipment, lighting equipment; consulting services related to the promotion and sale of products.

37 – Installation, assembly, repair and maintenance of equipment, including automatic telephone stations, conference systems with electronic voting and simultaneous translation functions, access control and time tracking systems, information display systems, electronic lock systems, locking systems, control systems for hotels, restaurants, SPA centers, interactive hotel television systems, airfield lighting equipment, meteorological equipment and automated weather stations, radar equipment, lighting equipment.

42 – Scientific and technological services and related research and development; industrial analysis and research services; development and improvement of computer hardware and software; exploring of technical projects, engineering.

(260) AM 2021 112015 A

(800) 1578956

(151) 2020 11 13

(891) 2020 11 13

(731) thyssenkrupp AG

ThyssenKrupp Allee 1, 45143 Essen, Germany

(540)

TK Elevator

(591) Black, white

(511)

7 – Elevators; platformlifts; lifting platforms for persons; electric motors for elevator doors; electric door openers for automatic lift doors; stairlifts; homelifts; mechanical escalators; mechanical moving walkways; passenger boarding bridges; structural machine parts of elevators, platformlifts, lifting platforms for persons, stairlifts, homelifts, mechanical escalators, mechanical moving walkways, passenger boarding bridges.

9 – Apparatus for recording, transmission and reproduction of sound and images; computers; electrical regulation and control systems and devices as well as electronic installations and devices for the automation of technology; interactive controls consoles and remote controls for the control, signal distribution, monitoring and visualisation of technological infrastructure; electrical regulation and control systems as well as electronic installations controlled by mobile apps; electrical and electronic devices for recording and controlling visitor streams; electronic control systems for access authorization; electrical, electronic and electrooptical sensors; sensors for controlling motors; sensors for system control; motion detectors; card readers; chip card management systems mainly consisting of identification cards (magnetic) and readers (data processing); virtual reality glasses; augmented reality glasses; all the aforementioned goods relating to elevators, platformlifts, passenger lifts, stairlifts, homelifts, mechanical escalators, mechanical moving walkways, passenger boarding bridges, visual docking guidance systems for airports and aircraft ground sup-

port equipment connectable to passenger boarding bridges; computer software and mobile applications for the control, maintenance, monitoring and optimisation of utilisation, monitoring of safety functions and detection and reporting of hazardous situations in relation to elevators, platformlifts, lifting platforms for people, stairlifts, homelifts, mechanical escalators, mechanical moving walks, passenger boarding bridges; computer software and mobile apps for the processing and evaluation of messages in the field of time recording, identification of persons, building automation, lighting control, climate control in relation to elevators, platformlifts, lifting platforms for persons, mechanical escalators, mechanical moving walks, passenger boarding bridges; computer software and mobile apps for telecommunications services, namely the transmission of voice, data, graphics, sound and video via broadband and wireless networks for elevator monitoring and control, for the provision of information and entertainment in elevator cabins and for enabling emergency calls from elevator cabins; computer software and mobile apps relating to elevators, platform lifts, passenger lifts, stairlifts, homelifts, mechanical escalators, mechanical moving walkways, passenger boarding bridges and aircraft ground support equipment connectable to passenger boarding bridges for virtual reality glasses and augmented reality glasses; visual docking guidance systems (visual devices and software) for airports; computer software and mobile apps to control and maintain visual docking guidance systems for airports; computer software and mobile apps to control and maintain aircraft ground support equipment connectable to passenger boarding bridges.

11 – Air generating equipment for ventilation; ventilation and air-conditioning equipment and systems, water supply systems; all the aforementioned goods connectable to passenger boarding bridges and for supporting aircrafts on the ground.

35 – Retail and wholesale services with elevators, platform lifts, passenger lifts, stairlifts, homelifts, mechanical escalators, mechanical moving walkways, passenger boarding bridges and software for elevators, stairlifts, homelifts, mechanical escalators, mechanical moving walkways and passenger boarding bridges.

37 – Construction of elevators, platformlifts, passenger lifts, automatic elevator doors, stairlifts, homelifts, mechanical escalators, mechanical moving walkways, passenger boarding bridges, visual docking guidance systems for airports, aircraft ground support systems connectable to passenger boarding bridges; installation of elevators, platformlifts, passenger lifts, automatic elevator doors, stairlifts, homelifts, mechanical escalators, mechanical moving walkways, passenger boarding bridges, visual docking guidance systems for airports, aircraft ground support systems connectable to passenger boarding bridges; repair, maintenance and renovation of elevators, platformlifts, passenger

lifts, automatic elevator doors, stairlifts, homelifts, mechanical escalators, mechanical moving walkways, passenger boarding bridges, visual docking guidance systems for airports, aircraft ground support equipment connectable to passenger boarding bridges.

42 – Scientific and technological services, research and related design services and industrial analysis, industrial research and industrial designer services; quality control and authentication services; engineering consultancy; technological consultancy services; consultancy services related to construction design; engineering design and consultancy; computer software design and development; mobile app design and development; consultancy services related to computer systems; computer software consultancy services; mobile app consultancy services; installation of software for access control as a service [ACaaS]; artificial intelligence platforms as software as a service [SaaS]; hosting of servers and software for access control as a service [ACaaS]; software as a service [SaaS]; all the above services relating to elevators, escalators, moving walkways, stairlifts, homelifts, passenger boarding bridges, visual docking guidance systems for airports, aircraft ground support equipment connectable to passenger boarding bridges.

(260) AM 2021 112017 A
(800) 1578981
(151) 2021 01 26
(891) 2021 01 26
(731) Baltika Breweries
6-th Verkhny pereulok, 3, RU-194292
Saint Petersburg, Russian Federation
(540)



(591) Dark blue, light blue, grey, blue and red
(531) 25.07.20; 25.07.25; 28.05; 29.01.13
(511)

32 – Aperitifs, non-alcoholic; barley wine [beer]; aerated water; lithia water; seltzer water; soda water; waters [beverages]; mineral water [beverages]; table waters; kvass; cocktails, non-alcoholic; beer-based cocktails; lemonades; non-alcoholic beverages; non-alcoholic dried fruit beverages; isotonic beverages; non-alcoholic honey-based beverages; rice-based beverages, other than milk substitutes; soya-based beverages, other than milk substitutes; aloe vera drinks, non-alcoholic; whey beverages; protein-enriched sports beverages; soft drinks; non-alcoholic beverages flavored with coffee; non-alcoholic beverages flavored with tea; non-alcoholic fruit juice beverages; ener-

gy drinks; fruit nectars, non-alcoholic; orgeat; beer; ginger beer; malt beer; powders for effervescing beverages; sarsaparilla [non-alcoholic beverage]; syrups for lemonade; syrups for beverages; smoothies; tomato juice [beverage]; cider, non-alcoholic; vegetable juices [beverages]; fruit juices; preparations for making aerated water; must; grape must, unfermented; beer wort; malt wort; pastilles for effervescing beverages; shandy; non-alcoholic fruit extracts; extracts of hops for making beer; non-alcoholic essences for making beverages; de-alcoholized beer; sherbets [beverages]; non-alcoholic preparations for making beverages; beer-based beverages.

(260) AM 2021 112021 A
(800) 1579047
(151) 2020 10 17
(891) 2020 10 17
(731) Philip Morris Products S.A.
Quai Jeanrenaud 3, CH-2000 Neuchâtel,
Switzerland
(540)

I IQOS

(591) Black, white
(511)
34 – Wired vaporizers for electronic cigarettes and electronic smoking devices; tobacco, raw or manufactured; tobacco products, including cigars, cigarettes, cigarillos, tobacco for roll-your-own cigarettes, pipe tobacco, chewing tobacco, snuff tobacco, kretek; snus; tobacco substitutes (not for medical purposes); smokers' articles, namely cigarette paper and tubes, cigarette filters, tobacco tins, cigarette cases and ashtrays, pipes, pocket apparatus for rolling cigarettes, lighters; matches; tobacco sticks, tobacco products for the purpose of being heated, electronic devices and their parts for the purpose of heating cigarettes or tobacco in order to release nicotine-containing aerosol for inhalation; liquid nicotine solutions for use in electronic cigarettes; electronic smoking devices; electronic cigarettes; electronic cigarettes as substitutes for traditional cigarettes; electronic devices for the inhalation of nicotine-containing aerosol; oral vaporizing devices for smokers, tobacco products and tobacco substitutes; smokers' articles for electronic cigarettes; parts and fittings for the aforesaid products included in this class; devices for extinguishing heated cigarettes and cigars as well as heated tobacco sticks; electronic rechargeable cigarette cases.

(260) AM 2021 112032 A
(800) 1579321
(151) 2020 10 15
(891) 2020 10 15
(731) ROYAL ARMENIA JV LTD
Davtashen 2nd Block 268, 0054 Yerevan,
Armenia

(540)



(591) Black, white, brown, yellow
 (531) 26.01.18; 26.04.03; 26.04.07; 26.11.09;
 27.01.01; 27.05.01; 29.01.14
 (526) ARMENIA, BRASILIA, GROUND COFFEE,
 ARABICA & ROBUSTA.
 (511)
 30 – Ground coffee produced from coffee beans of
 Brazilian origin.

(260) AM 2021 112033 A
 (800) 1579324
 (151) 2020 10 09
 (891) 2020 10 09
 (731) "CMT GROUP" LLC
 Absheron, AZ-0111 Ashagi Guzdek, Azerbaijan
 (540)



(591) Yellow, blue and white
 (531) 03.07.08; 26.01.15; 27.05.10; 29.01.13
 (526) Original paints
 (511)
 2 – Paints, varnishes, lacquers; preservatives against
 rust and against deterioration of wood; colorants, dy-
 es; inks for printing, marking and engraving; raw nat-
 ural resins; metals in foil and powder form for use in
 painting, decorating, printing and art.
 35 – Advertising; business management; business ad-
 ministration; office functions.

(260) AM 2021 112034 A
 (800) 1579344
 (151) 2021 01 08
 (891) 2021 01 08
 (731) Herbonis AG
 Rheinstrasse 30, CH-4302 Augst, Switzerland
 (540)

HERBONIS

(591) Black, white
 (511)
 5 – Pharmaceutical and veterinary products; dietary
 foods and substances for medical or veterinary use;
 food supplements for animals.
 31 – Animal feed and animal drinks.

(260) AM 2021 112035 A
 (800) 708770
 (151) 1999 01 16
 (891) 2021 02 17
 (731) Bayer Intellectual Property GmbH
 Alfred-Nobel-Straße 10, 40789 Monheim
 am Rhein, Germany
 (540)

REDIGO

(591) Black, white
 (511)
 1 – Chemical products for use in agriculture, horticul-
 ture and silviculture, seed dressing preparations (inc-
 luded in this class), fertilizers.
 5 – Preparations for weed and pest control, insecti-
 cides, herbicides, fungicides.

(260) AM 2021 112036 A
 (800) 919405
 (151) 2007 02 22
 (891) 2021 02 08
 (731) JNBY FINERY CO., LTD
 8/F, Unit 6, Tianmu Qingshui Commercial
 Center, Xihu District, HangZhou, Zhejiang
 Province, China
 (540)

CROQUIS

(591) Black, white
 (531) 27.05.17
 (511)
 25 – Clothing, for example, tee-shirts, coats; shoes;
 headgear for wear; socks; scarfs; neckties; gloves
 (clothing); girdles; leather belts (clothing); waterproof
 clothing.

(260) AM 2021 112037 A
 (800) 1407666
 (151) 2018 04 09
 (891) 2021 02 18
 (731) Khrisjoy S.r.l.
 Piazzale Biancamano, 2, I-20121 Milano,
 Italy
 (540)

KHRISJOY

(591) Black, white

(511)

18 – Suitcases; saddlery, whips and apparel for animals; toiletry bags; key cases; trunks [luggage]; vanity cases, not fitted; walking staffs; luggage; bags; work bags; evening handbags; bags for sports; travel baggage; book bags; purses; hat boxes of leather; handbags, purses and wallets; briefcases; collars for animals; folio cases; bags for umbrellas; umbrellas and parasols; briefcases [leather goods]; haversacks; shoulder belts; pocket wallets; rucksacks.

25 – Clothing; casualwear; thermally insulated clothing; leisurewear; clothing for gymnastics; sportswear; dresses; rainwear; bandanas [neckerchiefs]; bermuda shorts; caps [headwear]; nightwear; underwear; bikinis; suspenders; skull caps; footwear for men; footwear for women; wooden shoes; children's footwear; training shoes; breeches for wear; shirts; casual shirts; vest tops; headgear; sports caps and hats; capes; coats; cardigans; sports jackets; waist belts; flat caps; suits; cravats; headbands [clothing]; wrist warmers; sweatbands; kerchiefs [clothing]; sweat shirts; jackets [clothing]; men's and women's jackets, coats, trousers, vests; down jackets; overcoats; gilets; gloves including those made of skin, hide or fur; raincoats; denim jeans; sports jerseys; hosiery; mantles; trousers; casual trousers; sweatpants; coverups; polo shirts; sweaters; sandals; shoes; shawls; collar protectors for wear; boots; tee-shirts; uniforms; visors.

35 – Business advice and consultancy relating to franchising; business management advisory services related to franchising; business advertising services relating to franchising; provision of assistance [business] in the operation of franchises; assistance in business management within the framework of a franchise contract; advisory services (business -) relating to the establishment of franchises; business advisory services relating to the establishment and operation of franchises; trade marketing [other than selling]; advertising; business administration; business management; personnel management of sales personnel; clerical services; computerized on-line ordering services; arranging commercial transactions, for others, via online shops; mail order retail services connected with clothing accessories; arranging of buying and selling contracts for third parties; online retail store services relating to clothing; retail store services in the field of clothing; management of a retail enterprise for others; recruitment services for sales and marketing personnel; retail services connected with the sale of clothing and clothing accessories; electronic commerce services, namely, providing information about products via telecommunication networks for advertising and sales purposes.

(260) AM 2021 112038 A

(800) 1550852

(151) 2020 07 28

(891) 2021 02 11

(731) August Storck KG

Waldstraße 27, 13403 Berlin, Germany

(540)

Mamba FunPark

(591) Black, white

(511)

30 – Confectionery; chocolate; chocolate products; pastries; ice-cream; preparations for making the aforementioned goods, included in this class.

(260) AM 2021 112039 A

(800) 1568232

(151) 2020 11 19

(891) 2021 02 15

(731) FABITA S.R.L.

Contrada Serralta 49/A, I-60048

SERRA SAN QUIRICO, Italy

(540)



(591) Black, white

(531) 25.01.09; 26.04.05; 26.04.18

(511)

11 – Range hoods; exhaust hoods for kitchens; ventilation hoods; air conditioning installations; fans for air-conditioning apparatus; filters for air conditioning; fridge-freezers; electric refrigerators for household purposes; freezers; cooking rings; electric ranges; gas fires; induction cookers; cooking stoves; cooking ovens; gas cookers; microwave ovens [cooking apparatus]; cooking apparatus; electric coffee brewers.

(260) AM 2021 112116 A

(800) 1579910

(151) 2020 09 14

(891) 2020 09 14

(731) Apple Inc.

One Apple Park Way, Cupertino CA 95014, USA

(540)

Apple Music 1

(591) Black, white

(526) Music

(511)

41 – Arranging, organizing, conducting and presenting live music performances; providing non-downloadable playback of music in generated playlists via the internet and other communications networks; entertainment services, namely, curating songs for music playlists; production, distribution, and presentation of radio programs and sound recordings in the fields of entertainment news and music; providing ongoing podcasts in the fields of entertainment and music (terms too vague in the opinion of the International Bureau – Rule 13 (2) (b) of the Regulations); compiling and publishing music playlists; entertainment services, namely, providing streamed and downloadable audio and video content to users through a subscription service provided online via a communication network (terms too vague in the opinion of the International Bureau – Rule 13 (2) (b) of the Regulations); providing non-downloadable audio and video programming featuring entertainment and music; entertainment services, namely providing on-line non-downloadable music, interviews, live music performances and videos featuring musical artists, via a website.

(260) AM 2021 112126 A

(800) 1580479

(151) 2020 10 06

(891) 2020 10 06

(731) Owl In N.V., a limited liability company, organized and existing, under the laws of Curaçao Heelsumstraat 51, E-Commerce Park, Willemstad, Curaçao

(540)

BONS

(591) Black, white

(511)

38 – Telecommunications, particularly for online gaming and betting platforms.

41 – Entertainment services; gambling services; gaming services; betting services; organization of games and competitions; organization of competitions; conducting of competitions of the internet; arranging of competitions via the internet; providing online entertainment in the nature of game tournaments and (fantasy) sports leagues; providing information relating to sports and sports events; organization of sports tournaments; providing entertainment information, gambling information, gaming information, sports information and betting information from a website.

42 – Website design and software development, particularly for online gaming and betting platforms.

(260) AM 2021 112129 A

(800) 1580548

(151) 2020 10 06

(891) 2020 10 06

(731) Owl In N.V., a limited liability company, organized and existing under the laws of Curaçao Heelsumstraat 51, E-Commerce Park; Willemstad, Curaçao

(540)

BONS.COM

(591) Black, white

(511)

38 – Telecommunications, particularly for online gaming and betting platforms.

41 – Entertainment services; gambling services; gaming services; betting services; organization of games and competitions; organization of competitions; conducting of competitions of the internet; arranging of competitions via the internet; providing online entertainment in the nature of game tournaments and (fantasy) sports leagues; providing information relating to sports and sports events; organization of sports tournaments; providing entertainment information, gambling information, gaming information, sports information and betting information from a website.

42 – Website design and software development, particularly for online gaming and betting platforms.

(260) AM 2021 112134 A

(800) 1580602

(151) 2021 01 19

(891) 2021 01 19

(731) Ha-Be Betonchemie GmbH
Stüvestraße 39, 31785 Hameln,
Germany

(540)

PANTAFLOOR

(591) Black, white

(511)

1 – Chemical preparations for use in industry, namely additives for concrete and building materials relating to cement for improving the fresh and solid properties thereof; chemical preparations for use in industry, namely construction chemistry for concrete and cement-bound building materials for improving building material properties, in both the fresh and solid state.

(260) AM 2021 112135 A

(800) 1580617

(151) 2020 11 18

(891) 2020 11 18

(731) DICKIE-SPIELZEUG GmbH & Co. KG
Werkstraße 1, 90765 Fürth,
Germany

(540)



(591) Red and white

(531) 26.05.01; 26.05.18; 26.05.24; 26.11.02;
26.11.12; 27.05.09; 27.05.10; 27.05.24;
29.01.12

(511)

28 – Toys, in particular toy vehicles; toy cars; toy trains; toy buses; toy boats; toy airplanes; toy helicopters; toy tractors; toy excavators; toy cranes; toy fire engines; toy racing cars; toy motorcycles; toy roadways; toy houses; toy garages; toy figures; sets containing toy vehicles, toy roadways, toy gas stations, toy houses and/or toy garages; sets containing toy vehicles and toy figures; sets containing toy car racing rings and toy racing cars; toy remote controls; toy walkie-talkies; toys made of plastics; toys made of paper; toys made of metal; stuffed toys; games, in particular board games.

(260) AM 2021 112151 A

(800) 1365845

(151) 2017 05 09

(891) 2021 02 03

(731) GROUPE GO SPORT

17 avenue de la Falaise, F-38360 Sassenage,
France

(540)

WANABEE

(591) Black, white

(511)

18 – Mountaineering poles; rucksacks, sports bags, belt bags, shoe sacks, satchel bags, traveling bags, bags for climbers, bags for campers, beach bags, school bags, wallets, purses, wheeled shopping bags, handbags.

20 – Camping and hiking furniture, namely camp beds, folding and non-folding, tables and chairs, folding and non-folding, stools, folding and non-folding, armchairs, chairs, easy chairs; bedding (excluding linen), namely, mattresses, air mattresses, not for medical use; tent pegs not of metal.

22 – Tents; down (feathers); hammocks; ropes, strings, nets, tents, tarpaulins, sails.

25 – Clothing, sportswear, headgear, footwear, sports footwear, underclothing and underwear.

(260) AM 2021 112163 A

(800) 1579394

(151) 2020 12 30

(891) 2020 12 30

(731) Aktsionernoe obshchestvo "Moskovsky pivo-bezalkogolny kombinat "OCHAKOVO"
ul. Ryabinovaya, d. 44, RU-121471 MOSKVA,
Russian Federation

(540)



(591) Blue, gray, gray-blue, white, green, dark green, brown, beige, black, red and yellow

(531) 04.05.02; 04.05.04; 25.01.10; 25.01.17; 28.05;
29.01.15

(526) All numbers, symbols, pictograms, barcode, letters, words, except for "ХАЛЗАН", "РАСПРАВЬ СВОИ КРЫЛЬЯ", "Очаково", "ochakovo"

(511)

32 – Beer.

(260) AM 2021 112200 A

(800) 1581010

(151) 2021 01 15

(891) 2021 01 15

(731) OTCF S.A.

ul.Grottgera 30, PL-32-020 Wieliczka, Poland

(540)



ROBERT LEWANDOWSKI

(591) Black, white

(531) 27.05.01; 27.07.01

(511)

18 – School bags; rucksacks; backpacks; briefcases; school knapsacks; attaché cases; cases, of leather or leatherboard; cases of leather or leatherboard; garment bags for travel; bags (garment -) for travel; garment carriers; shopping bags; bags for sports; bum bags; shoulder bags; suitcases; handles (suitcase -); net bags for shopping; shoe bags; portmanteaus; trunks and travelling bags; haversacks; roller bags; bags for climbers; bags for campers; all-purpose athletic bags; carry-on bags; hiking rucksacks; pocket wallets.

25 – Beach shoes; beach clothes; underwear; sweat-absorbent underwear; bandanas [neckerchiefs]; jumpers; sweat shirts; hooded sweatshirts; football jer-

seys; track jackets; boots; shoes; football shoes; studs for football boots; lace boots; sports shoes; boots for sports; cap peaks; visors [headwear]; peaked headwear; wooden shoes; knitwear [clothing]; leggings [leg warmers]; rubbers [footwear]; millinery; rain hats; swimming trunks; overalls; pockets for clothing; shirts; short-sleeve shirts; casual shirts; singlets; jackets [clothing]; sports singlets; parkas; waterproof jackets; ski jackets; down jackets; rainproof jackets; stuff jackets [clothing]; sports jackets; windcheaters; leg warmers; underpants; babies' pants [underwear]; gymnastic shoes; football boots; athletic shoes; casual footwear; sneakers [footwear]; gloves [clothing]; belts [clothing]; combinations [clothing]; ear muffs [clothing]; hoods [clothing]; clothing of leather; clothing for gymnastics; clothing of imitations of leather; weatherproof clothing; money belts [clothing]; outer-clothing; cyclists' clothing; leisurewear; headgear; footwear; clothing; headbands [clothing]; headbands against sweating; sweatbands; caps [headwear]; infant-wear; loungewear; tee-shirts; scarfs; shawls; sweaters; swimsuits; skorts; skirts; sports pants; snow pants; cycling pants; jogging pants; tracksuit bottoms; waterproof pants; trousers; trunks (bathing -); sweat-absorbent socks; sports socks; sandals; bath sandals; fingerless gloves; half-boots; inner soles; vest tops; soles for footwear; bath robes; pelerines; slippers; bath slippers; topcoats; overcoats; footmuffs, not electrically heated; exercise wear; sportswear; denims [clothing]; jogging sets [clothing]; jogging tops.

(260) AM 2021 112205 A
 (800) 1581176
 (151) 2021 01 19
 (891) 2021 01 19
 (731) Ha-Be Betonchemie GmbH
 Stüvestraße 39, 31785 Hameln, Germany
 (540)

PANTARHOL

(591) Black, white
 (511)
 1 – Chemical preparations for use in industry, namely additives for concrete and building materials relating to cement for improving the fresh and solid properties thereof; chemical preparations for use in industry, namely construction chemistry for concrete and cement-bound building materials for improving building material properties, in both the fresh and solid state.

(260) AM 2021 112218 A
 (800) 1581430
 (151) 2021 01 11
 (891) 2021 01 11
 (731) SHENZHEN JINGWEIXIAN TECHNOLOGY CO., LTD
 Room 401, Floor 4, Block b, No. 1, Hantian Science and technology park, Ailian industry

park, Zhugushi road, Longcheng street, Longgang district, Shenzhen city, Guangdong Province, China

(540)

SKYCUT

(591) Black, white
 (531) 27.05.01
 (511)
 7 – Machines for processing plastics; computerized word cutting machines; engraving machines; punching machines; woodworking machines; printing machines; marking machines for industrial purposes.

(260) AM 2021 112237 A
 (800) 1581830
 (151) 2020 11 27
 (891) 2020 11 27
 (731) MEGINE INDUSTRIES SDN BHD
 B-05-02, The Vertical Business Suites 8,
 Jalan Kerinchi, Bangsar South, 59200
 WILAYAH PERSEKUTUAN, KUALA
 LUMPUR, Malaysia

(540)

Amadex

(591) Black, white
 (531) 03.13.24; 24.17.05; 27.05.01
 (511)
 10 – Compression gloves; disposable gloves for medical purposes; disposable gloves for surgical purposes; disposable gloves for veterinary purposes; examination gloves for medical purposes; gloves for dental purposes; gloves for massage; gloves for medical purposes; gloves for veterinary purposes; latex gloves for dental use; latex gloves for medical purposes; latex gloves for surgical purposes; massage gloves; surgical gloves.

(260) AM 2021 112251 A
 (800) 1495541
 (151) 2019 05 24
 (891) 2020 07 30
 (731) Ajmal Holdings & Investments Private Limited
 1, Cecil Court, 24, Mahakavi Bhusan Marg,
 Colaba, Mumbai 400 001, India
 (540)



(591) Black, white
 (531) 26.04.02; 26.04.05; 26.13.25; 28.01
 (511)
 3 – Attar (fragrances and perfumery); perfumery and cosmetics, included in this class.

(260) AM 2021 112252 A
 (800) 1580316
 (151) 2020 12 08
 (891) 2021 03 04
 (731) REHAU AG + Co
 Otto-Hahn-Str. 2, 95111 Rehau, Germany
 (540)

REHAU home

(591) Black, white
 (511)
 17 – Acrylic resins, semi-processed; adhesive bands, other than stationery and not for medical or household purposes; anti-glare films for windows [tinted films]; asbestos; asbestos cloth; asbestos coverings; asbestos fabrics; asbestos felt; asbestos fibres; asbestos millboards; asbestos packing; asbestos paper; asbestos safety curtains; asbestos sheets; asbestos slate; bags [envelopes, pouches] of rubber, for packaging; balata; bark coverings for sound insulation; boiler composition to prevent the radiation of heat; brake lining materials, partly processed; canvas hose pipes; carbon fibres, other than for textile use; caulking materials; cellulose acetate, semi-processed; chemical compositions for repairing leaks; clack valves of rubber; clutch linings; compositions to prevent the radiation of heat; cords of rubber; cotton wool for packing [caulking]; cylinder jointings; dielectrics [insulators]; dock bumpers of rubber; door stops of rubber; draught excluder strips; duct tapes; ebonite; ebonite moulds; elastic yarns, other than for textile use; expansion joint fillers; fibreglass fabrics for insulation; fibreglass for insulation; filtering materials of semi-processed films of plastic; filtering materials of semi-processed foams of plastic; fittings, not of metal, for compressed air lines; fittings, not of metal, for flexible pipes; fittings, not of metal, for rigid pipes; flexible hoses, not of metal; flexible pipes, not of metal; floating anti-pollution barriers; foam supports for flower arrangements [semi-finished products]; foil of regenerated cellulose, other than for wrapping; foils of metal for insulating; garden hoses; gaskets; glass wool for insulation; gum, raw or semi-worked; gutta-percha; hoses of textile material; insulating bands; insulating fabrics; insulating felt; insulating gloves; insulating materials; insulating oil for transformers; insulating oils; insulating paints; insulating paper; insulating plaster; insulating refractory materials; insulating varnish; insulators; insulators for cables; insulators for electric mains; insulators for railway tracks; junctions, not of metal, for pipes; latex [rubber]; liquid rubber; lute; mica, raw or partly processed; mineral wool [insulator]; non-conducting materials for retaining heat; packing [cushio-

ning, stuffing] materials of rubber or plastics; packing, stopping and insulating materials; padding materials of rubber or plastics; paper for electrical capacitors; pipe gaskets; pipe muffers, not of metal; pipes made of rubber for motor vehicles; plastic fibres, other than for textile use; plastic filaments for 3D printing; plastic film, other than for wrapping; plastic films for agricultural purposes; plastic substances, semi-processed; reinforcing materials, not of metal, for pipes; rings of rubber; rubber material for recapping tyres; rubber seals for jars; rubber sleeves for protecting parts of machines; rubber solutions; rubber stoppers; rubber, raw or semi-worked; sealant compounds for joints; self-adhesive tapes, other than stationery and not for medical or household purposes; shock-absorbing buffers of rubber; slag wool [insulator]; soundproofing materials; stops of rubber; substances for insulating buildings against moisture; synthetic resins, semi-processed; synthetic rubber; threads of plastic for soldering; threads of plastic materials, other than for textile use; threads of rubber, not for use in textiles; threads of rubber, other than for textile use; unprocessed and semi-processed rubber, gutta-percha, gum, asbestos, mica and substitutes for all these materials; valves of india-rubber or vulcanized fibre; viscose sheets, other than for wrapping; vulcanized fibre; washers of rubber or vulcanized fibre; waterproof packings; water-tight rings; weatherstripping compositions; window stops of rubber.

19 – Accordion doors, not of metal; advertisement columns, not of metal; agglomerated bagasses of cane [building material]; agglomerated cork for building; alabaster; alabaster glass; angle irons, not of metal; aquarium gravel; aquarium sand; aquaria [structures]; arbours [structures], not of metal; armoured doors, not of metal; armour-plating, not of metal; artificial stone; asbestos cement; asbestos mortar; asphalt; asphalt paving; asphalt, pitch, tar and bitumen; aviaries [structures], not of metal; aviaries, not of metal (structures); balustrades, not of metal; beacons, not of metal, non-luminous; bicycle parking installations, not of metal; binding agents for making briquettes; binding material for road repair; bird baths [structures], not of metal; bitumen; bitumen paper for building; bituminous coatings for roofing; bituminous products for building; brackets, not of metal, for building; branching pipes, not of metal; bricks; building glass; building materials, not of metal; building panels, not of metal; building paper; building stone; buildings, not of metal; buildings, transportable, not of metal; burial vaults, not of metal; busts of stone, concrete or marble; cabanas, not of metal; caissons for construction work under water; calcareous marl; casement windows, not of metal; cask wood; ceilings, not of metal; cement; cement for blast furnaces; cement for furnaces; cement posts; cement slabs; chicken-houses, not of metal; chimney cowls, not of metal; chimney pipes (not of metal); chimney pots, not of metal; chimneys, not of metal; cladding, not of metal, for building; clay;

clinker ballast; coal tar; coatings [building materials]; concrete; concrete building elements; cornices, not of metal; crash barriers, not of metal, for roads; diving boards, not of metal; door frames, not of metal; door panels, not of metal; doors, not of metal; drain pipes, not of metal; drain traps [valves], not of metal or plastic; duckboards, not of metal; ducts, not of metal, for ventilating and air-conditioning installations; earth for bricks; enamelled glass, for building; fair huts; felt for building; fences, not of metal; figurines of stone, concrete or marble; fire burrs; fireclay; fireplace mantles, not of metal; fireproof cement coatings; flagpoles [structures], not of metal; flashing, not of metal, for building; floating docks, not of metal, for mooring boats; floor tiles, not of metal; floors, not of metal; folding doors, not of metal; foundry moulds, not of metal; framework, not of metal, for building; furrings of wood; gates, not of metal; geotextiles; girders of non-metallic materials; glass granules for road marking; granite; grave slabs, not of metal; gravel; gravestones; greenhouse frames, not of metal; greenhouses, transportable, not of metal; gutter pipes, not of metal; gypsum [building material]; hips for roofing; huts; insect screens not of metal; insect screens, not of metal; insulating glass for building; jalousies, not of metal; joists, not of metal; laths, not of metal; latticework, not of metal; lengthening pieces, not of metal, for chimneys; letter boxes of masonry; lime; limestone; linings, not of metal, for building; lintels, not of metal; luminous paving blocks; macadam; magnesia cement; manhole covers, not of metal; manufactured timber; marble; masts [poles], not of metal; materials for making and coating roads; materials, not of metal, for building and construction; memorial plaques, not of metal; monuments, not of metal; mooring bollards, not of metal; mortar for building; mosaics for building; mouldable wood; mouldings, not of metal, for building; mouldings, not of metal, for cornices; non-luminous and non-mechanical signs, not of metal; non-metallic trellises; non-metallic paving slabs; non-metallic rigid pipes for building; olivine for building; outdoor blinds, not of metal and not of textile; paint spraying booths, not of metal; palings, not of metal; pantiles, not of metal; paperboard for building; parquet floor boards; parquet flooring; partitions, not of metal; paving blocks, not of metal; paving slabs, not of metal; penstock pipes, not of metal; perches; pigsties, not of metal; piles (non-metallic -); pilings, not of metal; pillars, not of metal, for building; pitch; planks of wood for building; plaster; plastic landscape edgings; plate glass [windows] for building; platforms, prefabricated, not of metal; plywood; porches [structures], not of metal; porphyry [stone]; posts, not of metal; posts, not of metal, for power lines; potters' clay; prefabricated fireplaces, not of metal; prefabricated houses [kits], not of metal; props, not of metal; quartz; railway sleepers, not of metal; raw chalk; reeds for building; refractory construction materials, not of metal; reinforcing materials, not of metal, for building;

rigid pipes, not of metal, for building; road coating materials; road marking sheets and strips of synthetic material; road signs, non-luminous and non-mechanical, not of metal; rock crystal; rocket launching platforms, not of metal; roof coverings, not of metal; roof flashing, not of metal; roof gutters, not of metal; roofing shingles; roofing slates; roofing tiles, not of metal; roofing, not of metal; roofing, not of metal, incorporating photovoltaic cells; rubber bearings for seismic isolation of buildings; rubble; safety glass; sand, except foundry sand; sandstone for building; sandstone pipes; sawn timber; scaffolding, non-metallic; scantlings [carpentry]; schists; shuttering, not of metal, for concrete; shutters, not of metal; signalling panels, non-luminous and non-mechanical, not of metal; silica [quartz]; sills, not of metal; silos, not of metal; silver sand; skating rinks [structures, not of metal]; skating rinks [structures], not of metal; slabs, not of metal, for building; slag [building material]; slag stone; slate; slate powder; stables, not of metal; stained-glass windows; staircases, not of metal; stair-treads [steps], not of metal; statues of stone, concrete or marble; stone; street gutters, not of metal; stringers [parts of staircases], not of metal; swimming pools [structures, not of metal]; swing doors, not of metal; tanks of masonry; tar; tarred strips for building; telegraph posts, not of metal; telephone booths, not of metal; terra-cotta [building material]; tile floorings, not of metal; tiles, not of metal, for building; tomb or grave enclosures, not of metal; tombs [monuments], not of metal; tombs, not of metal; tombstone plaques, not of metal; tombstone stelae, not of metal; tufa; turnstiles, not of metal; veneer wood; vinyl siding; wainscotting, not of metal; wall claddings, not of metal, for building; wall linings, not of metal, for building; wall tiles, not of metal; water-pipe valves, not of metal or plastic; water-pipes, not of metal; window casements, not of metal; window glass for building; window glass, other than vehicle window glass; windows, not of metal; wood for building; wood for making household utensils; wood paneling; wood paving; wood pulp board for building; wood veneers; wood, semi-worked; wooden floor boards; works of art of stone, concrete or marble; works of stonemasonry; xylolith.

20 – Air beds, not for medical purposes; air cushions, not for medical purposes; air mattresses, not for medical purposes; air pillows, not for medical purposes; ambroid bars; ambroid plates; animal claws; animal hooves; animal horns; anti-roll cushions for babies; armchairs; baby changing mats; bag hangers, not of metal; bakers' bread baskets; bamboo; bamboo curtains; barrels, not of metal; baskets, non-metallic; bassinets; bath seats for babies; bathtub grab bars, not of metal; bead curtains for decoration; bed bases; bed casters, not of metal; bed fittings, not of metal; bedding, except linen; beds; beds for household pets; bedsteads of wood; beehives; benches [furniture]; bins, not of metal; birdhouses; bolsters; bolts, not of metal; book rests [furniture]; bookcases; bottle caps, not of

metal; bottle casings of wood; bottle closures not of metal; bottle racks; boxes of wood or plastic; brackets, not of metal, for furniture; brush mountings; bumper guards for cots, other than bed linen; busts of wood, wax, plaster or plastic; cabinet work; camping mattresses; cask hoops, not of metal; cask stands, not of metal; casks of wood for decanting wine; casks, not of metal; chests for toys; chests of drawers; chopping blocks [tables]; clips of plastic for sealing bags; clips, not of metal, for cables and pipes; closures for containers, non-metallic; clothes hooks, not of metal; coat hangers; coathooks, not of metal; coatstands; coffin fittings, not of metal; collars, not of metal, for fastening pipes; comb foundations for beehives; console tables; containers, not of metal [storage, transport]; containers, not of metal, for liquid fuel; coral; corks; corks for bottles; corozo; costume stands; cots for babies; counters [tables]; covers for clothing [wardrobe]; crates; crucifixes of wood, wax, plaster or plastic, other than jewellery; cupboards; curtain holders, not of textile material; curtain hooks; curtain rails; curtain rings; curtain rods; curtain rollers; curtain tie-backs; cushions; deck chairs; decorations of plastic for foodstuffs; desks; dinner wagons [furniture]; dispensers for dog waste bags, fixed, not of metal; display boards; display cases; divans; dog kennels; door bells, not of metal, non-electric; door bolts, not of metal; door closers, not of metal, non-electric; door fasteners, not of metal; door fittings, not of metal; door handles, not of metal; door knockers, not of metal; door stops, not of metal or rubber; doors for furniture; dowels, not of metal; drafting tables; drain traps [valves] of plastic; dressing tables; edgings of plastic for furniture; embroidery frames; fans for personal use, non-electric; feet for furniture; figurines of wood, wax, plaster or plastic; filing cabinets; fishing baskets; floating containers, not of metal; flower-pot pedestals; flower-stands [furniture]; fodder racks; freestanding partitions [furniture]; funerary caskets; funerary urns; furniture; furniture casters, not of metal; furniture fittings, not of metal; furniture of metal; furniture partitions of wood; furniture shelves; furniture, mirrors, picture frames; garment covers [storage]; gun racks; hairdressers' chairs; hampers [baskets] for the transport of items; hand-held flagpoles, not of metal; hand-held mirrors [toilet mirrors]; handling pallets, not of metal; hat stands; head positioning pillows for babies; head support cushions for babies; head-rests [furniture]; high chairs for babies; hinges, not of metal; honeycombs; horn, unworked or semi-worked; hospital beds; hutches; identification bracelets, not of metal; imitation tortoiseshell; index cabinets [furniture]; indoor window blinds [furniture]; indoor window blinds of paper; indoor window blinds of textile; indoor window blinds of woven wood; infant walkers; inflatable furniture; inflatable publicity objects; jerrycans, not of metal; jewellery organizer displays; kennels for household pets; keyboards for hanging keys; knobs, not of metal; labels of plastic; ladders of wood or plastics;

lap desks; latches, not of metal; lecterns; legs for furniture; letter boxes, not of metal or masonry; library shelves; loading gauge rods, not of metal, for railway wagons; loading pallets, not of metal; lockers; locks, not of metal, for vehicles; locks, other than electric, not of metal; magazine racks; mannequins and tailors' dummies; massage tables; mats for infant playpens; mats, removable, for sinks; mattresses; meat safes; medicine cabinets; medicine chests; meerscham; mirror tiles; mirrors [looking glasses]; mobile boarding stairs, not of metal, for passengers; mobiles [decoration]; mooring buoys, non-metallic; moses baskets; mother-of-pearl, unworked or semi-worked; mouldings for picture frames; nameplates, not of metal; nesting boxes; nesting boxes for household pets; newspaper display stands; non-luminous house numbers, not of metal; non-metal cable clamps; non-metal pipe and cable clips; number plates, not of metal; nuts, not of metal; office furniture; oil drainage containers, not of metal; oyster shells; packaging containers of plastic; pet cushions; picture frame brackets; picture frames; pillows; pipes (clips, not of metal for-); placards of wood or plastics; plaited straw, except matting; plastic key cards, not encoded and not magnetic; plastic keys; plastic ramps for use with vehicles; plate racks; playpens for babies; plugs [dowels], not of metal; plugs, not of metal; poles, not of metal; portable desks; pulleys of plastics for blinds; racks [furniture]; rattan; reeds [plaiting materials]; reels of wood for yarn, silk, cord; reels, not of metal, non-mechanical, for flexible hoses; reservoirs, not of metal nor of masonry; rivets, not of metal; runners, not of metal, for sliding doors; sash fasteners, not of metal, for windows; saw benches [furniture]; saw horses; school furniture; scratching posts for cats; screens [furniture]; screens for fireplaces [furniture]; screw tops, not of metal, for bottles; screws, not of metal; sealing caps, not of metal; seats; seats of metal; sections of wood for beehives; settees; shells; shelves for file cabinets; shelves for storage; shelving units; shoe dowels, not of metal; shoe pegs, not of metal; shoulder poles [yokes]; shower chairs; sideboards; signboards of wood or plastics; silvered glass [mirrors]; slatted indoor blinds; sleeping pads; sofas; split rings, not of metal, for keys; stag antlers; stair rods; stakes, not of metal, for plants or trees; standing desks; stands for calculating machines; statues of wood, wax, plaster or plastic; staves of wood; step stools, not of metal; steps [ladders], not of metal; stools; stoppers, not of glass, metal or rubber; straw edgings; straw mattresses; straw plaits; stuffed animals; stuffed birds; table tops; tables; tables of metal; tanks, not of metal nor of masonry; taps, not of metal, for casks; tent pegs, not of metal; tool boxes, not of metal, empty; tool chests, not of metal, empty; tortoiseshell; towel dispensers, fixed, not of metal; towel stands [furniture]; transport pallets, not of metal; trays, not of metal; trestles [furniture]; trolleys [furniture]; trolleys for computers [furniture]; troughs, not of metal, for mixing mortar; typing

desks; umbrella stands; valet stands; valves, not of metal, other than parts of machines; vats, not of metal; vehicle number plates, not of metal; vice benches [furniture]; wall-mounted baby changing platforms; wardrobes; washstands [furniture]; waterbeds, not for medical purposes; water-pipe valves of plastic; whalebone, unworked or semi-worked; wickerwork; wind chimes [decoration]; winding spools, not of metal, non-mechanical, for flexible hoses; window fasteners, not of metal; window fittings, not of metal; window stops, not of metal or rubber; wood ribbon; workbenches; works of art of wood, wax, plaster or plastic; writing desks; yellow amber.

(260) AM 2021 112313 A

(800) 1582220

(151) 2020 09 14

(891) 2020 09 14

(731) Apple Inc.

One Apple Park Way, Cupertino CA 95014,
USA

(540)

The logo for Apple Music 1, featuring the Apple logo followed by the text "Music 1" in a bold, sans-serif font.

(591) Black, white

(531) 05.07.13; 05.07.23

(526) music

(511)

41 – Arranging, organizing, conducting and presenting live music performances; providing non-downloadable playback of music in generated playlists via the internet and other communications networks; entertainment services, namely, curating songs for music playlists; production, distribution, and presentation of radio programs and sound recordings in the fields of entertainment news and music; providing ongoing podcasts in the fields of entertainment and music; compiling and publishing music playlists; entertainment services, namely, providing streamed and downloadable audio and video content to users through a subscription service provided online via a communication network (term considered too vague by the International Bureau – Rule 13 (2) (b) of the Regulations); providing non-downloadable audio and video programming featuring entertainment and music; entertainment services, namely providing on-line non-downloadable music, interviews, live music performances and videos featuring musical artists, via a website.

(260) AM 2021 112314 A

(800) 1582239

(151) 2020 10 22

(891) 2020 10 22

(731) Apple Inc.

One Apple Park Way, Cupertino CA 95014,
USA

(540)

APPLE ONE

(591) Black, white

(511)

35 – Retail store and online retail store services featuring bundled subscription packages to online digital content and media services comprised of a music subscription service, a video-on-demand subscription service, a computer game subscription service, an electronic publication subscription service, a fitness streaming subscription service, and a personal file data storage subscription service; subscription services, namely, arranging subscriptions to text, data, image, audio, video, and multimedia content, provided via the Internet and other electronic and communications networks; subscription services, namely, arranging subscriptions to text, data, image, audio, video, and multimedia content, provided via the Internet and other electronic and communications networks, namely, arranging bundled entertainment subscription packages comprised of an online music subscription service, a video-on-demand subscription service, a computer game subscription service, an electronic publication subscription service, and a fitness streaming subscription service; arranging subscriptions to downloadable pre-recorded text, data, image, audio, video, and multimedia content for a fee or pre-paid subscription, via the Internet and other electronic and communications networks.

42 – Electronic data storage for a fee or pre-paid subscription; providing online non-downloadable software for use in connection with accessing, delivering, purchasing, and sharing bundled subscription packages to online digital content and media services comprised of a music subscription service, a video-on-demand subscription service, a computer game subscription service, an electronic publication subscription service, a fitness streaming subscription service, and a personal file data storage subscription service via a fee or pre-paid subscription; hosting an Internet portal allowing users to preview and download electronic books, publications, and other documents as part of a fee or pre-paid subscription.

(260) AM 2021 112318 A

(800) 1582367

(151) 2020 12 17

(891) 2020 12 17

(731) Kia Corporation

12, Heolleung-ro, Seocho-gu, Seoul 06797,
Republic of Korea

(540)

The Kia logo, consisting of a stylized, bold, black letter 'K'.

(591) Black, white

(531) 27.05.19; 27.05.22

(511)

39 – Vehicle leasing services; rental of GPS-equipped vehicles; rental car reservation; car transport and providing information relating thereto; providing information via the Internet relating to the leasing of automobiles; car rental, garage and parking space rental; vehicle rental; car sharing services; carpooling services; providing traffic information via computer communication networks; tracking of transport vehicles by computer (transport information); vehicle breakdown towing services; GPS navigation services; transport; rental of vehicles and apparatus for locomotion by air; rental of vehicle; vehicle transport; providing information relating to vehicle driving services; reservation services for vehicle rental; vehicle leasing services; vehicle towing services; rental of parking places and garages for vehicles; rental of vehicle equipment and accessories; rental of aircraft and vehicles; provision of information on the transportation of freight; rental of GPS-equipped vehicles; delivery of goods; transport of goods; courier services (messages or merchandise); technical advice relating to transportation logistics; air transport and storage of goods; supply chain logistics and reverse logistics services consisting of the storage, transportation and delivery of goods for others by air, rail, ship or truck; transportation and storage services relating to storage logistics, distribution logistics and returns logistics; logistics services consisting of the transportation, packaging, and storage of goods; transport and packaging of goods; providing traffic information; inspection of vehicles before transport; packaging and storage of goods; storage of energy and fuels; storage of aircraft; storage of watercraft, yachts, boats and water vehicles; provision of tourist travel information; physical storage of electronically-stored data; rental of diving bells and diving suits; transmission of oil or gas through pipelines; emergency automobile towing; providing road and traffic information; leasing of rental car; transport, delivery, packaging, and storage of goods; logistics services consisting of the storage, transportation and delivery of goods; storage, distribution and supply of energy and fuel; travel consultancy; travel arrangement; travel information; travel organization; travel advisory services; travel agency services; providing transportation information; providing information relating to car transport; conducting of sightseeing travel tours by automobiles; car rental; rental of diving suits; tracking of automobile fleets using electronic navigation and locating devices (transport information); physical storage of electronically stored data, documents, digital photographs, music, images, video, and computer games; towing and transportation of cars as part of vehicle breakdown services; vehicle sharing services; depot services for the storage of vehicles; packing, crating and warehousing services; packing of freight; rental of wheelchairs.

(260) AM 2021 112320 A

(800) 1582375

(151) 2021 01 20

(891) 2021 01 20

(731) MIRZA INTERNATIONAL LIMITED
a-7, mohan co-operative industrial area,
mathura road, new delhi-110044, India

(540)



(591) Black, white

(531) 03.07.17; 27.05.01

(511)

25 – Footwear; readymade garments and clothing; leather garments and leather belts; headgear.

(260) AM 2021 112324 A

(800) 1582624

(151) 2021 01 29

(891) 2021 01 29

(731) Bora Creations S.L.

11, Calle Velázquez (Pto. de Andratx),
E-07157 Andratx, Balearn, Spain

(540)

AFTER SHAPE

(591) Black, white

(511)

3 – Cosmetics; decorative cosmetics; non-medicated care products for eyebrow grooming; cosmetics; cooling pads for cosmetic purposes.

(260) AM 2021 112339 A

(800) 1583056

(151) 2020 08 18

(891) 2020 08 18

(731) DOĞRULAR EV ÜRÜNLERİ ANONİM
ŞİRKETİ

3. Organize Sanayi Bölgesi 7. Sokak, No:6,
Selçuklu, Konya, Turkey

(540)



(591) Black, white and red

(531) 26.04.12; 26.07.20; 27.05.01; 29.01.12

(526) ®

(511)

6 – Ores of non-precious metal; common metals and their alloys and semi-finished products made of these materials; irons for construction; mats and stirrups of common metals for buildings; common metals in the form of plate, billet, stick, profile, sheet and sheeting; goods and materials of common metal used for storage.

ge, wrapping, packaging and sheltering purposes, containers of metal (storage, transport), buildings of metal, frames of metal for building, poles of metal for building, metal boxes, packaging containers of metal, aluminum foil, fences made of metal, guard barriers of metal, metal tubes, storage containers of metal, metal containers for the transportation of goods, ladders of metal; doors, windows, shutters, jalousies and their cases and fittings of metal; non-electric cables and wires of metal; ironmongery; small hardware of metal; screws of metal; nails; bolts of metal; nuts of metal; pegs of metal; flakes of metal; pitons of metal; metal chains; furniture casters of metal; fittings of metal for furniture; door handles of metal; window handles of metal; hinges of metal; metal latches; metal locks; metal keys for locks; metal rings; metal pulleys; ventilation ducts, vents, vent covers, pipes, chimney caps, manhole covers, grilles of metal for ventilation, heating, sewage, telephone, underground electricity and air conditioning installations; metal panels or boards (non-luminous and non-mechanical) used for signalling, route showing, publicity purposes, signboards of metal, advertisement columns of metal, signaling panels of metal, non-luminous and non-mechanical traffic signs of metal; pipes of metal for transportation of liquids and gas, drilling pipes of metal and their metal fittings, valves of metal, couplings of metal for pipes, elbows of metal for pipes, clips of metal for pipes, connectors of metal for pipes; safes (strong boxes) of metal; metal railway materials, metal rails, metal railway ties, railway switches; bollards of metal, floating docks of metal, mooring buoys of metal, anchors; metal moulds for casting, other than machine parts; works of art made of common metals or their alloys, trophies of common metal; metal closures, bottle caps of metal; metal poles; metal pillars; metal stakes; metal pallets and metal ropes for lifting, loading and transportation purposes; metal hangers, ties, straps, tapes and bands used for load-lifting and load-carrying.

12 – Motor land vehicles, motorcycles, mopeds; engines and motors for land vehicles; clutches for land vehicles; transmissions, transmission belts and transmission chains for land vehicles; gearing for land vehicles; brakes, brake discs and brake linings for land vehicles; vehicle chassis, automobile bonnets, vehicle suspension springs, shock absorbers for automobiles, gearboxes for land vehicles, steering wheels for vehicles, rims for vehicle wheels; bicycles and their bodies; handlebars and mudguards for bicycles; vehicle bodies; tipping bodies for trucks; trailers for tractors; frigorific bodies for land vehicles; trailer hitches for vehicles; vehicle seats; head-rests for vehicle seats; safety seats for children, for vehicles; seat covers for vehicles; vehicle covers (shaped); sun-blinds adapted for vehicles; direction signals and arms for direction signals for vehicles; windscreen wipers and wiper arms for vehicles; inner and outer tires for vehicle wheels; tubeless tires; tire-fixing sets comprised of

tire patches and tire valves for vehicles; windows for vehicles, safety windows for vehicles, rearview mirrors and wing mirrors for vehicles; anti-skid chains for vehicles; luggage carriers for vehicles; bicycle and ski carriers for cars; saddles for bicycles or motorcycles; air pumps for vehicles, for inflating tires; anti-theft alarms for vehicles, horns for vehicles; safety belts for vehicle seats, air bags (safety devices for automobiles); baby carriages, wheelchairs, pushchairs; wheelbarrows; shopping carts; single or multi-wheeled wheelbarrows; shopping trolleys; grocery carts; handling carts; rail vehicles; locomotives; trains; trams; waggons; cable cars; chairlifts; vehicles for locomotion by water and their parts, other than their motors and engines; vehicles for locomotion by air and their parts, other than their motors and engines.

21 – Hand-operated non-electric cleaning instruments and appliances, brushes, other than paintbrushes, steel chips for cleaning, sponges for cleaning, steel wool for cleaning, cloths of textile for cleaning, gloves for dishwashing, non-electric polishing machines for household purposes, brooms for carpets, mops; toothbrushes, electric toothbrushes, dental floss, shaving brushes, hair brushes, combs; non-electric household or kitchen utensils, included in this class, [other than forks, knives, spoons], services [dishes], pots and pans, bottle openers, flower pots, drinking straws, non-electric cooking utensils; ironing boards and shaped covers therefor, drying racks for washing, clothes drying hangers; cages for household pets, indoor aquariums, vivariums and indoor terrariums for animals and plant cultivation; ornaments and decorative goods of glass, porcelain, earthenware or clay namely statues, figurines, vases and trophies; mouse traps, insect traps, electric devices for attracting and killing flies and insects, fly catchers, fly swatters; perfume burners, perfume sprayers, perfume vaporizers, electric or non-electric make-up removing appliances, powder puffs, toilet cases; nozzles for sprinkler hose, nozzles for watering cans, watering devices, garden watering cans; unworked or semi-worked glass, except building glass, mosaics of glass and powdered glass for decoration, except for building, glass wool other than for insulation or textile use.

(260) AM 2021 112353 A

(800) 1583324

(151) 2020 11 11

(891) 2020 11 11

(731) ALUCOIL, S.A.

C/ Ircio, Parcelas, 72-77, Polígono Industrial
Bayas Miranda de Ebro (Burgos) E-09200,
Spain

(540)



(591) Blue, red, yellow, white

(531) 26.04.03; 26.04.09; 26.04.24; 27.05.10;
27.05.17; 29.01.15

(511)

2 – Colorants, varnishes, preservatives against rust and deterioration of wood; dyestuffs; mordants; raw natural resins; metals in foil and powder form for painters, decorators, printers and artists; paints, lacquers for printing, lacquers for molds, lacquers as coating, coating for paints, lacquers and preservatives, printing pigments, metallic printing inks, silkscreen printing inks.

6 – Common metals and their alloys; building materials of metal; transportable buildings of metal; metallic materials for railway tracks; non-electric cables and wires of metal; ironmongery and small items of metal hardware; tubes of metal; safes [strong boxes]; ores of metal.

(260) AM 2021 112354 A

(800) 1225799

(151) 2014 07 10

(891) 2020 12 30

(731) GEN İLAÇ VE SAĞLIK ÜRÜNLERİ
SANAYİ VE TİCARET ANONİM ŞİRKETİ
Mustafa Kemal Mahallesi 2119., Sokak No:3
D:2-3, Çankaya, TR-06520 Ankara, Turkey

(540)



(591) Black, white

(531) 27.05.01

(511)

5 – Pharmaceutical and veterinary preparations for medical purposes; chemical preparations and chemical elements for pharmaceutical purposes.

(260) AM 2021 112355 A

(800) 1318501

(151) 2016 06 24

(891) 2021 01 12

(731) TERAPIA S.A.

Str. Fabricii nr.124, Cluj-Napoca, jud. Cluj,
Romania

(540)

ФарингоНатур

(591) Black, white

(531) 28.05

(511)

5 – Pharmaceutical and veterinary products; nutritive supplements; hygienic products for medical use, dietetic substances for medical use, food for babies, plasters and materials for dressings; materials for stopping teeth and dental wax; disinfectants; preparations for destroying vermin; fungicides, herbicides.

35 – Advertising; promotion activities; business management; business administration; office functions.

(260) AM 2021 112357 A

(800) 1338069

(151) 2017 01 30

(891) 2020 12 30

(731) GEN İLAÇ VE SAĞLIK ÜRÜNLERİ
SANAYİ VE TİCARET ANONİM ŞİRKETİ
Mustafa Kemal Mahallesi 2119., Sokak No:3
D:2-3, Çankaya, TR-06520 Ankara, Turkey

(540)

Modiogen

(591) Black, white

(531) 27.05.01; 27.05.17

(511)

5 – Pharmaceuticals, medical and veterinary preparations; sanitary preparations for medical purposes; dietetic food and substances adapted for medical or veterinary use, food for babies; dietary supplements for humans and animals; plasters, materials for dressings; material for stopping teeth, dental wax; disinfectants; preparations for destroying vermin; fungicides, herbicides.

(260) AM 2021 112435 A

(800) 1583746

(151) 2020 12 23

(891) 2020 12 23

(731) GIORGIO ARMANI S.P.A.

Via Borgonuovo, 11, I-20121 MILANO
(Milano), Italy

(540)

ARMANI

(591) Black, white

(511)

35 – Retail services for cosmetics, perfumery, candles, hand-operated hand tools and implements, cutlery, forks and spoons, razors, manicure implements, pedicure implements, spectacles, optical goods and cases for optical goods, electronic devices, telephones, smartwatches and covers for smartwatches, sensors for health purposes and heart rate monitoring apparatus, lighting apparatus and lamps, land vehicles, jewelry, timepieces, paper stationery, office stationery, bags, wallets, saddlery, furniture, kitchen utensils, utensils for household purposes, services [dishes], bath linen, bed linen, table linen, clothing, footwear, headwear, belts, buttons, zippers, buckles, carpets, floor coverings, wallpaper; the bringing together, for the benefit of others of games, toys, appliances, machines, devices and specific clothings for sports games, for sport and for physical exercises, bags and knapsacks for sporting articles, fruits and vegetables, jellies, jams, compotes, honey, edible oils, pastries, confectionery, chocolate, coffee, tea, natural plants and flowers, non-alcoholic beverages, alcoholic beverages, smokers' articles.

(260) AM 2021 112445 A

(800) 1584328

(151) 2021 02 17

(891) 2021 02 17

(731) Citizen Watch Company of America, Inc.

Empire State Building, 350 Fifth Avenue,
29th Floor, New York NY 10118, USA

(540)

AQUALUXX

(591) Black, white

(511)

14 – Horological and chronometric instruments; watches.

(260) AM 2021 112467 A

(800) 1567709

(151) 2020 10 29

(891) 2021 02 26

(731) Yiwu Dearbody Cosmetics Co., Ltd.

No. 86 Xiangyi Road, Yiting Town,
Yiwu City, Zhejiang, China

(540)

dear baby

(591) Black, white

(531) 27.05.01

(511)

3 – Shampoos; dentifrices; lipsticks; bath lotion; cosmetics; cleaning preparations; perfume; eyeshadow; lip balm.

(260) AM 2021 112786 A

(800) 1587990

(151) 2021 02 03

(891) 2021 02 03

(731) SHENZHEN IVPS TECHNOLOGY CO., LTD.

101, Building 69, Liantang Industrial Zone,
Tangwei Community, Fenghuang Street,
Guangming District, Shenzhen, 518107
Guangdong, China

(540)

SMOK

(591) Black, white

(511)

35 – Advertising; business management consultancy; organization of exhibitions for commercial or advertising purposes; marketing; sales promotion for others; personnel recruitment; updating and maintenance of data in computer databases; web indexing for commercial or advertising purposes; sponsorship search; presentation of goods on communication media, for retail purposes.

INTERNATIONAL TRADEMARKS PROTECTED IN GEORGIA

(260) AM 2021 107214 A
(800) 1515195
(151) 2019 10 02
(181) 2029 10 02
(891) 2019 10 02
(511) 01, 29, 30

(260) AM 2021 110077 A
(800) 1554210
(151) 2020 06 02
(181) 2030 06 02
(891) 2020 06 02
(511) 09, 28, 41

(260) AM 2021 107228 A
(800) 1515519
(151) 2019 12 04
(181) 2029 12 04
(891) 2019 12 04
(511) 29, 30, 31

(260) AM 2021 110078 A
(800) 1554239
(151) 2020 08 20
(181) 2030 08 20
(891) 2020 08 20
(511) 07, 09, 37

(260) AM 2021 107321 A
(800) 1516316
(151) 2019 12 04
(181) 2029 12 04
(891) 2019 12 04
(511) 29, 30

(260) AM 2021 110079 A
(800) 1554272
(151) 2020 09 03
(181) 2030 09 03
(891) 2020 09 03
(511) 03

(260) AM 2021 108186 A
(800) 1529649
(151) 2020 03 18
(181) 2030 03 18
(891) 2020 03 18
(511) 01, 04

(260) AM 2021 110080 A
(800) 1554296
(151) 2020 09 11
(181) 2030 09 11
(891) 2020 09 11
(511) 01, 02, 17

(260) AM 2021 109811 A
(800) 1551212
(151) 2020 06 02
(181) 2030 06 02
(891) 2020 06 02
(511) 28, 41

(260) AM 2021 110085 A
(800) 1554431
(151) 2020 06 09
(181) 2030 06 09
(891) 2020 06 09
(511) 03, 06, 09, 11, 12, 14, 16, 18, 20, 21, 24, 25, 27,
28, 35, 36, 37, 39, 41, 43

(260) AM 2021 109967 A
(800) 1552559
(151) 2020 08 04
(181) 2030 08 04
(891) 2020 08 04
(511) 35, 41

(260) AM 2021 110086 A
(800) 1554467
(151) 2020 07 17
(181) 2030 07 17
(891) 2020 07 17
(511) 01

(260) AM 2021 110064 A
(800) 1553761
(151) 2020 07 27
(181) 2030 07 27
(891) 2020 07 27
(511) 07

(260) AM 2021 110090 A
(800) 1554559
(151) 2020 07 13
(181) 2030 07 13
(891) 2020 07 13

(511) 12, 35, 37

(260) AM 2021 110106 A
(800) 1150215
(151) 2013 01 31
(181) 2023 01 31
(891) 2020 09 16
(511) 01, 05

(260) AM 2021 110148 A
(800) 1554851
(151) 2020 07 15
(181) 2030 07 15
(891) 2020 07 15
(511) 08, 09

(260) AM 2021 110155 A
(800) 1555093
(151) 2020 08 11
(181) 2030 08 11
(891) 2020 08 11
(511) 09

(260) AM 2021 110157 A
(800) 1555195
(151) 2020 08 24
(181) 2030 08 24
(891) 2020 08 24
(511) 09

(260) AM 2021 110158 A
(800) 1555245
(151) 2020 02 12
(181) 2030 02 12
(891) 2020 02 12
(511) 04, 05, 06, 07, 08, 09, 10, 11, 12, 14, 16, 18, 20,
21, 22, 24, 25, 26, 27, 28, 30, 34, 35, 36, 37, 38,
39, 42

(260) AM 2021 110161 A
(800) 1555396
(151) 2020 03 25
(181) 2030 03 25
(891) 2020 03 25
(511) 22

(260) AM 2021 110166 A
(800) 1555629
(151) 2020 08 06
(181) 2030 08 06
(891) 2020 08 06
(511) 25

(260) AM 2021 110167 A
(800) 1555644
(151) 2020 09 23
(181) 2030 09 23
(891) 2020 09 23
(511) 07, 09, 11

(260) AM 2021 110168 A
(800) 1555645
(151) 2020 09 16
(181) 2030 09 16
(891) 2020 09 16
(511) 03, 04

(260) AM 2021 110169 A
(800) 1555660
(151) 2020 09 14
(181) 2030 09 14
(891) 2020 09 14
(511) 33

(260) AM 2021 110170 A
(800) 1555685
(151) 2020 06 02
(181) 2030 06 02
(891) 2020 06 02
(511) 09, 28, 41

(260) AM 2021 110180 A
(800) 784245
(151) 2002 06 07
(181) 2022 06 07
(891) 2020 09 16
(511) 01, 05

(260) AM 2021 110185 A
(800) 1509110
(151) 2019 11 02
(181) 2029 11 02
(891) 2020 09 25
(511) 09, 35, 38, 41, 42

(260) AM 2021 110186 A
(800) 1543473
(151) 2020 02 18
(181) 2030 02 18
(891) 2020 08 26
(511) 37, 42

(260) AM 2021 110187 A
(800) 1549972
(151) 2019 07 31
(181) 2029 07 31
(891) 2020 09 17
(511) 09, 36, 42

(260) AM 2021 110263 A
(800) 1557097
(151) 2020 02 28
(181) 2030 02 28
(891) 2020 02 28
(511) 09, 36, 38, 39, 42

(260) AM 2021 110232 A
(800) 1556041
(151) 2020 07 29
(181) 2030 07 29
(891) 2020 07 29
(511) 05

(260) AM 2021 110264 A
(800) 1557160
(151) 2020 07 15
(181) 2030 07 15
(891) 2020 07 15
(511) 12

(260) AM 2021 110233 A
(800) 1556072
(151) 2020 08 10
(181) 2030 08 10
(891) 2020 08 10
(511) 12

(260) AM 2021 110267 A
(800) 1351037
(151) 2017 02 16
(181) 2027 02 16
(891) 2020 10 05
(511) 05

(260) AM 2021 110236 A
(800) 1556143
(151) 2020 08 11
(181) 2030 08 11
(891) 2020 08 11
(511) 30

(260) AM 2021 110274 A
(800) 1513976
(151) 2019 12 19
(181) 2029 12 19
(891) 2020 07 16
(511) 03

(260) AM 2021 110237 A
(800) 1556155
(151) 2020 06 23
(181) 2030 06 23
(891) 2020 06 23
(511) 06, 11

(260) AM 2021 110275 A
(800) 1522536
(151) 2020 02 10
(181) 2030 02 10
(891) 2020 07 02
(511) 07, 08, 09, 11, 14, 28, 35

(260) AM 2021 110247 A
(800) 1556550
(151) 2020 04 27
(181) 2030 04 27
(891) 2020 04 27
(511) 17

(260) AM 2021 110276 A
(800) 1533089
(151) 2020 04 24
(181) 2030 04 24
(891) 2020 10 07
(511) 05, 10

(260) AM 2021 110249 A
(800) 1556576
(151) 2020 07 29
(181) 2030 07 29
(891) 2020 07 29
(511) 09, 16, 18, 25, 35, 39

(260) AM 2021 110277 A
(800) 1544833
(151) 2020 06 23
(181) 2030 06 23
(891) 2020 10 07
(511) 05

(260) AM 2021 110308 A
(800) 1557353
(151) 2020 07 30
(181) 2030 07 30
(891) 2020 07 30
(511) 10

(260) AM 2021 110356 A
(800) 1544205
(151) 2020 06 05
(181) 2030 06 05
(891) 2020 09 14
(511) 34

(260) AM 2021 110309 A
(800) 1557376
(151) 2020 06 11
(181) 2030 06 11
(891) 2020 06 11
(511) 11, 16, 20, 21, 22, 24

(260) AM 2021 110395 A
(800) 1558665
(151) 2020 09 24
(181) 2030 09 24
(891) 2020 09 24
(511) 01, 04, 12, 16, 25, 35, 41

(260) AM 2021 110310 A
(800) 1557387
(151) 2020 07 31
(181) 2030 07 31
(891) 2020 07 31
(511) 03

(260) AM 2021 110397 A
(800) 1558679
(151) 2020 07 01
(181) 2030 07 01
(891) 2020 07 01
(511) 25

(260) AM 2021 110343 A
(800) 807427
(151) 2003 07 21
(181) 2023 07 21
(891) 2020 10 12
(511) 01, 05, 10

(260) AM 2021 110410 A
(800) 1559000
(151) 2020 07 29
(181) 2030 07 29
(891) 2020 07 29
(511) 19

(260) AM 2021 110344 A
(800) 833504
(151) 2004 08 02
(181) 2024 08 02
(891) 2020 09 30
(511) 01

(260) AM 2021 110411 A
(800) 1559001
(151) 2020 08 07
(181) 2030 08 07
(891) 2020 08 07
(511) 12

(260) AM 2021 110354 A
(800) 1456847
(151) 2019 02 21
(181) 2029 02 21
(891) 2020 09 29
(511) 09, 41

(260) AM 2021 110412 A
(800) 1559020
(151) 2020 08 25
(181) 2030 08 25
(891) 2020 08 25
(511) 35

(260) AM 2021 110355 A
(800) 1543526
(151) 2020 03 06
(181) 2030 03 06
(891) 2020 09 14
(511) 05

(260) AM 2021 110425 A
(800) 1559329
(151) 2020 09 23
(181) 2030 09 23
(891) 2020 09 23
(511) 28

(260) AM 2021 110426 A
(800) 1559333
(151) 2020 09 23
(181) 2030 09 23
(891) 2020 09 23
(511) 28

(260) AM 2021 110427 A
(800) 1559380
(151) 2020 10 08
(181) 2030 10 08
(891) 2020 10 08
(511) 02, 17, 19

(260) AM 2021 110428 A
(800) 1559423
(151) 2020 08 12
(181) 2030 08 12
(891) 2020 08 12
(511) 41

(260) AM 2021 110429 A
(800) 1559427
(151) 2020 09 04
(181) 2030 09 04
(891) 2020 09 04
(511) 11

(260) AM 2021 110431 A
(800) 1294008
(151) 2016 02 05
(181) 2026 02 05
(891) 2020 09 24
(511) 12, 37

(260) AM 2021 110436 A
(800) 1517142
(151) 2020 01 10
(181) 2030 01 10
(891) 2020 10 02
(511) 06, 42

(260) AM 2021 110437 A
(800) 1553270
(151) 2020 06 30
(181) 2030 06 30
(891) 2020 10 16
(511) 01, 03, 05

(260) AM 2021 110483 A
(800) 1559443
(151) 2020 10 07
(181) 2030 10 07
(891) 2020 10 07
(511) 05

(260) AM 2021 110486 A
(800) 1559488
(151) 2020 08 17
(181) 2030 08 17
(891) 2020 08 17
(511) 02, 16

(260) AM 2021 110487 A
(800) 1559493
(151) 2019 09 19
(181) 2029 09 19
(891) 2019 09 19
(511) 35, 40

(260) AM 2021 110488 A
(800) 1559499
(151) 2020 09 10
(181) 2030 09 10
(891) 2020 09 10
(511) 11

(260) AM 2021 110489 A
(800) 1559587
(151) 2020 04 27
(181) 2030 04 27
(891) 2020 04 27
(511) 05

(260) AM 2021 110499 A
(800) 460843
(151) 1981 05 28
(181) 2021 05 28
(891) 2020 10 28
(511) 33

(260) AM 2021 110575 A
(800) 1560815
(151) 2020 08 07
(181) 2030 08 07
(891) 2020 08 07
(511) 03, 35, 41, 44

(260) AM 2021 110576 A
(800) 1560895
(151) 2020 08 27
(181) 2030 08 27
(891) 2020 08 27
(511) 29, 30, 32

(260) AM 2021 110582 A
(800) 1561203
(151) 2020 09 29
(181) 2030 09 29
(891) 2020 09 29
(511) 10

(260) AM 2021 110591 A
(800) 1180570
(151) 2013 08 19
(181) 2023 08 19
(891) 2020 10 16
(511) 05

(260) AM 2021 110598 A
(800) 1515840
(151) 2019 11 25
(181) 2029 11 25
(891) 2020 10 05
(511) 09, 35, 38, 42

(260) AM 2021 110646 A
(800) 1562021
(151) 2020 10 22
(181) 2030 10 22
(891) 2020 10 22
(511) 09

(260) AM 2021 110647 A
(800) 1562125
(151) 2020 09 25
(181) 2030 09 25
(891) 2020 09 25
(511) 10

(260) AM 2021 110648 A
(800) 1562147
(151) 2020 09 25
(181) 2030 09 25
(891) 2020 09 25
(511) 12

(260) AM 2021 110649 A
(800) 1562153
(151) 2020 10 20
(181) 2030 10 20
(891) 2020 10 20
(511) 09, 42

(260) AM 2021 110650 A
(800) 1562170
(151) 2020 09 10
(181) 2030 09 10
(891) 2020 09 10
(511) 06, 11

(260) AM 2021 110652 A
(800) 1562356
(151) 2020 10 02
(181) 2030 10 02
(891) 2020 10 02
(511) 21, 33

(260) AM 2021 110653 A
(800) 1562421
(151) 2020 07 20
(181) 2030 07 20
(891) 2020 07 20
(511) 09, 28, 41

(260) AM 2021 110662 A
(800) 1296541
(151) 2016 01 25
(181) 2026 01 25
(891) 2020 10 26
(511) 25

(260) AM 2021 110701 A
(800) 1562702
(151) 2020 08 26
(181) 2030 08 26
(891) 2020 08 26
(511) 29, 30, 43

(260) AM 2021 110702 A
(800) 1562705
(151) 2020 06 18
(181) 2030 06 18
(891) 2020 06 18
(511) 03, 05

(260) AM 2021 110703 A
(800) 1562715
(151) 2020 06 18
(181) 2030 06 18
(891) 2020 06 18
(511) 03, 05

(260) AM 2021 110704 A
(800) 1562767
(151) 2020 09 21
(181) 2030 09 21
(891) 2020 09 21
(511) 06

(260) AM 2021 110705 A
(800) 1562779
(151) 2020 08 12
(181) 2030 08 12
(891) 2020 08 12
(511) 42

(260) AM 2021 110706 A
(800) 1562821
(151) 2020 07 17
(181) 2030 07 17
(891) 2020 07 17
(511) 09, 28, 41

(260) AM 2021 110716 A
(800) 1563206
(151) 2020 09 21
(181) 2030 09 21
(891) 2020 09 21
(511) 09

(260) AM 2021 110717 A
(800) 1563270
(151) 2020 03 27
(181) 2030 03 27
(891) 2020 03 27
(511) 11, 35

(260) AM 2021 110718 A
(800) 1563284
(151) 2020 09 15
(181) 2030 09 15
(891) 2020 09 15
(511) 01, 02, 04, 09, 16, 19, 28

(260) AM 2021 110719 A
(800) 1563298
(151) 2020 07 23
(181) 2030 07 23
(891) 2020 07 23
(511) 06, 07, 08, 09, 11, 12, 20, 21

(260) AM 2021 110720 A
(800) 1563398
(151) 2020 09 07
(181) 2030 09 07
(891) 2020 09 07
(511) 05, 10

(260) AM 2021 110721 A
(800) 1563462
(151) 2020 07 20
(181) 2030 07 20
(891) 2020 07 20
(511) 09, 28, 41

(260) AM 2021 110722 A
(800) 1563472
(151) 2020 09 22
(181) 2030 09 22
(891) 2020 09 22
(511) 33

(260) AM 2021 110733 A
(800) 1319161
(151) 2016 03 11
(181) 2026 03 11
(891) 2020 10 30
(511) 32

(260) AM 2021 110734 A
(800) 1328452
(151) 2016 07 11
(181) 2026 07 11
(891) 2020 10 06
(511) 05, 35, 39

(260) AM 2021 110735 A
(800) 1330042
(151) 2016 10 04
(181) 2026 10 04
(891) 2020 11 18
(511) 01, 02, 17, 19

(260) AM 2021 110736 A
(800) 1331068
(151) 2016 08 04
(181) 2026 08 04
(891) 2020 10 15
(511) 03

(260) AM 2021 110904 A
(800) 1565280
(151) 2020 08 12
(181) 2030 08 12
(891) 2020 08 12
(511) 03

(260) AM 2021 110737 A
(800) 1527679
(151) 2019 12 30
(181) 2029 12 30
(891) 2020 10 30
(511) 32

(260) AM 2021 110985 A
(800) 1566010
(151) 2020 09 14
(181) 2030 09 14
(891) 2020 09 14
(511) 25

(260) AM 2021 110738 A
(800) 1534953
(151) 2020 04 09
(181) 2030 04 09
(891) 2020 11 13
(511) 01, 16

(260) AM 2021 110986 A
(800) 1566021
(151) 2020 09 30
(181) 2030 09 30
(891) 2020 09 30
(511) 01, 05, 10

(260) AM 2021 110853 A
(800) 1523350
(151) 2020 01 20
(181) 2030 01 20
(891) 2020 11 24
(511) 01, 05

(260) AM 2021 110988 A
(800) 1566064
(151) 2020 09 30
(181) 2030 09 30
(891) 2020 09 30
(511) 18, 25

(260) AM 2021 110854 A
(800) 1529942
(151) 2020 01 20
(181) 2030 01 20
(891) 2020 11 24
(511) 01, 05

(260) AM 2021 110992 A
(800) 1566159
(151) 2020 10 22
(181) 2030 10 22
(891) 2020 10 22
(511) 43

(260) AM 2021 110901 A
(800) 1565156
(151) 2020 10 14
(181) 2030 10 14
(891) 2020 10 14
(511) 19

(260) AM 2021 111040 A
(800) 1567271
(151) 2020 07 30
(181) 2030 07 30
(891) 2020 07 30
(511) 29, 30, 31, 32

(260) AM 2021 110903 A
(800) 1565195
(151) 2020 09 25
(181) 2030 09 25
(891) 2020 09 25
(511) 18, 25, 35

(260) AM 2021 111042 A
(800) 1567340
(151) 2020 08 28
(181) 2030 08 28
(891) 2020 08 28
(511) 05, 10

(260) AM 2021 111043 A
(800) 899279
(151) 2006 03 23
(181) 2026 03 23
(891) 2020 11 30
(511) 03, 05

(260) AM 2021 111044 A
(800) 1023460
(151) 2009 11 18
(181) 2029 11 18
(891) 2020 10 23
(511) 05

(260) AM 2021 111045 A
(800) 1126216
(151) 2012 06 18
(181) 2022 06 18
(891) 2020 10 23
(511) 05

(260) AM 2021 111046 A
(800) 1131344
(151) 2012 06 18
(181) 2022 06 18
(891) 2020 10 23
(511) 05

(260) AM 2021 111047 A
(800) 1162946
(151) 2013 05 06
(181) 2023 05 06
(891) 2020 12 03
(511) 30

OFFICIAL NOTIFICATIONS

INVENTIONS

EXPIRATION OF PATENTS RESTORATION

(21) AP 2012 12880
(11) P 2014 6048 B
(73) Sopio Burjanadze
(54) CAVITATION-ELECTROLYSIS DEVICE FOR HYDROGEN GENERATION
DATE OF CANCELLATION OF PATENT: 2021 10 26
THE TERM OF RESTORATION OF PATENT: 2021 11 25

(21) AP 2012 12886
(11) P 2015 6362 B
(73) Guram Eristavi
(54) TURBINE OF HYDROPOWER PLANT WITHOUT DAM
DATE OF CANCELLATION OF PATENT: 2021 10 31
THE TERM OF RESTORATION OF PATENT: 2021 11 25

(21) AP 2002 6666
(11) P 2004 3355 B
(73) Otkrytoe Aktsionernoje Obshchestvo "Nizhegorodskij Khimiko-Farmatsevticheskiy Zavod"
(54) PHARMACEUTICAL COMPOSITION POSSESSING ANTIMYCOTIC ACTIVITY AND METHOD OF ITS PRODUCTION
DATE OF CANCELLATION OF PATENT: 2021 10 28
THE TERM OF RESTORATION OF PATENT: 2021 11 25

ABOLITION OF PATENTS WITH THE RIGHT TO RESTORE

(21) AP 2008 10961
(11) P 2012 5579 B
(73) Les Laboratoires Servier
(54) NOVEL CRYSTALLINE FORM VI OF AGOMELATINE, PREPARATION METHOD THEREOF AND PHARMACEUTICAL COMPOSITIONS CONTAINING SAME
DATE OF CANCELLATION OF PATENT: 2021 11 04
LIMITED DATE OF RESTORATION OF PATENT: 2022 11 04

(21) AP 2009 12240
(11) P 2013 5860 B
(73) Sunrise R&D Holdings LLC
(54) SYSTEMS OF INFLUENCE ON SHOPPERS AT FIRST MOMENT OF DECISION AT RETAIL ESTABLISHMENT
DATE OF CANCELLATION OF PATENT: 2021 11 02
LIMITED DATE OF RESTORATION OF PATENT: 2022 11 02

(21) AP 2009 12241
(11) P 2013 5861 B
(73) Sunrise R&D Holdings LLC
(54) METHODS OF INFLUENCE ON SHOPPERS AT FIRST MOMENT OF DECISION AT RETAIL ESTABLISHMENT
DATE OF CANCELLATION OF PATENT: 2021 11 02
LIMITED DATE OF RESTORATION OF PATENT: 2022 11 02

(21) AP 2012 12880
(11) P 2014 6048 B
(73) Sopio Burjanadze
(54) CAVITATION-ELECTROLYSIS DEVICE FOR HYDROGEN GENERATION
DATE OF CANCELLATION OF PATENT: 2021 10 26
LIMITED DATE OF RESTORATION OF PATENT: 2023 10 26

(21) AP 2012 12886
(11) P 2015 6362 B
(73) Guram Eristavi
(54) TURBINE OF HYDROPOWER PLANT WITHOUT DAM
DATE OF CANCELLATION OF PATENT: 2021 10 31
LIMITED DATE OF RESTORATION OF PATENT: 2023 10 31

(21) AP 2013 14156
(11) P 2020 7208 B
(73) Tillotts Pharma AG
(54) DELAYED RELEASE DRUG FORMULATION
DATE OF CANCELLATION OF PATENT: 2021 10 29
LIMITED DATE OF RESTORATION OF PATENT: 2022 10 29

(21) AP 2015 14494
(11) P 2020 7108 B
(73) Jenosaiens Farma
(54) SUBSTITUTED 2,4 DIAMINO-QUINOLINE AS NEW ANTICANCER AGENTS
DATE OF CANCELLATION OF PATENT: 2021 10 26
LIMITED DATE OF RESTORATION OF PATENT: 2022 10 26

(21) AP 2016 14798
(11) P 2021 7219 B
(73) Feltrim Pastoral Company Pty LTD
(54) APPARATUS FOR STORING ORGANIC MATERIAL
DATE OF CANCELLATION OF PATENT: 2021 10 27
LIMITED DATE OF RESTORATION OF PATENT: 2022 10 27

(21) AP 2013 14874
(11) P 2020 7119 B
(73) Tillotts Pharma AG
(54) A DELAYED RELEASE DRUG FORMULATION
DATE OF CANCELLATION OF PATENT: 2021 10 29
LIMITED DATE OF RESTORATION OF PATENT: 2022 10 29

(21) AP 2018 14915
(11) P 2020 7140 B
(73) Shota Gorjeladze;
Irakli Gorjeladze
(54) ROPEWAY
DATE OF CANCELLATION OF PATENT: 2021 11 02
LIMITED DATE OF RESTORATION OF PATENT: 2022 11 02

(21) AP 2002 6666
(11) P 2004 3355 B
(73) Otkrytoe Aktsionernoje Obshchestvo "Nizhegorodskij Khimiko-Farmatsevticheskij Zavod"
(54) PHARMACEUTICAL COMPOSITION POSSESSING ANTIMYCOTIC ACTIVITY AND METHOD OF ITS PRODUCTION
DATE OF CANCELLATION OF PATENT: 2021 10 28
LIMITED DATE OF RESTORATION OF PATENT: 2023 10 28

(21) AP 2004 9274
(11) P 2009 4701 B
(73) Interdigital Technology Corporation
(54) METHOD AND APPARATUS FOR PROCESSING DATA BLOCKS DURING SOFT HANDOVER
DATE OF CANCELLATION OF PATENT: 2021 11 02
LIMITED DATE OF RESTORATION OF PATENT: 2022 11 02

EXPIRATION OF TERM OF RESTORATION OF PATENTS

(21) AP 2008 10958
(11) P 2010 5092 B
(73) Meri Alania;
Nana Kavtaradze;
Aliosha Bakuridze;
Temur Ujmajuridze
(54) PREPARATION FOR TREATMENT OF PROSTATE ADENOMA
DATE OF CANCELLATION OF PATENT: 2020 11 03
THE TERM OF RESTORATION OF PATENT VALIDITY HAS EXPIRED: 2021 11 03

(21) AP 2009 12297
(11) P 2015 6391 B
(73) Unilin BVBA
(54) COMPOSED ELEMENT
DATE OF CANCELLATION OF PATENT: 2020 10 29
THE TERM OF RESTORATION OF PATENT VALIDITY HAS EXPIRED: 2021 10 29

(21) AP 2011 12427
(11) P 2014 6085 B
(73) Giorgi Tumanishvili;
Tengiz Nadiradze;
Tengiz Buchukuri;
Viktor Zviadauri;
Giorgi Tumanishvil

(54) BASEPLATE

DATE OF CANCELLATION OF PATENT: 2020 10 26

THE TERM OF RESTORATION OF PATENT VALIDITY HAS EXPIRED: 2021 10 26

(21) AP 2012 13483

(11) P 2019 6940 B

(73) Millennium Pharmaceuticals Inc.

(54) ADMINISTRATION D'UN INHIBITEUR D'ENZYME ACTIVANT NEDD8 ET AGENT
D'HYPOMÉTHYLATION

DATE OF CANCELLATION OF PATENT: 2020 11 02

THE TERM OF RESTORATION OF PATENT VALIDITY HAS EXPIRED: 2021 11 02

(21) AP 2013 13832

(11) P 2017 6717 B

(73) Valeria Research S.R.L.;

Gnosis S.P.A.

(54) FIBRINOLYTIC COMPOSITIONS COMPRISING BROMELAIN AND NATTOKINASE FOR
PREVENTION

AND TREATMENT OF PHLEBOTHROMBTIC STATES

DATE OF CANCELLATION OF PATENT: 2020 11 06

THE TERM OF RESTORATION OF PATENT VALIDITY HAS EXPIRED: 2021 11 06

(21) AP 2016 14315

(11) P 2018 6842 B

(73) Levan Nadaraeishvili

(54) NADAREISHVILI EQUIPMENT FOR POLYMERIC FILMS ZONAL GRADIENT OR HOMOGENIC
TENSION

DATE OF CANCELLATION OF PATENT: 2020 11 01

THE TERM OF RESTORATION OF PATENT VALIDITY HAS EXPIRED: 2021 11 01

(21) AP 2002 6667

(11) P 2004 3353 B

(73) Otkrytoe Aktsionernoje Obshchestvo "Nizhegorodskij Khimiko-Farmatsevticheskij Zavod"

(54) SOLID MEDICINAL FORM OF TERBINAFINE HYDROCHLORIDE

DATE OF CANCELLATION OF PATENT: 2020 10 28

THE TERM OF RESTORATION OF PATENT VALIDITY HAS EXPIRED: 2021 10 28

CHANGES OF NAME AND/OR ADDRESS OF PATENTOWNER

(21) AP 2004 8568

(11) P 2006 4003 B

(54) AGENT FOR TREATMENT OF ARTICULATION DISEASE

NEW NAME AND NEW ADDRESS: Joint-Stock Company " Nizhegorodskiy Chemical-Pharmaceutical
Plant" /JSC "NizhPharm"

Salganskaja 7, Nizhnij Novgorod, 03950, Russian Federation

"Nizhegorodskiy Chemical-Pharmaceutical Plant" /OJSC

FORMER NAME AND FORMER ADDRESS: "NizhPharm"

Salganskaja 7, Nizhnij Novgorod, 03950, Russian Federation

DATE OF REGISTRATION: 05 11 2021

UTILITY MODELS

EXPIRATION OF PATENTS RESTORATION

(21) AU 2016 14321

(11) U 2018 1964 Y

(73) Merab Diasamidze;

Merab Topchiashvili;

Zurab Suladze;

David Suladze

(54) METHOD FOR ARTICLE MANUFACTURE WITH WOOD- POLYMER COMPOSITE

DATE OF CANCELLATION OF PATENT: 2020 11 14

THE TERM OF RESTORATION OF PATENT: 2021 11 25

(21) AU 2018 14928

(11) U 2020 2030 Y

(73) Marine Nikolaishvili;

Tea Muselian;

Elene Giorgadze;

Natia Chkheidze

(54) THERAPEUTIC AGENT FOR TYPE II DIABETES

DATE OF CANCELLATION OF PATENT: 2020 11 20

THE TERM OF RESTORATION OF PATENT: 2021 12 10

EXPIRATION OF TERM OF RESTORATION OF PATENT

(21) AU 2016 14309

(11) U 2018 1963 Y

(73) Temur Chakhunashvili;

Teimuraz Rover;

Zhiuli Keadze;

Zinaida Vatsadze

(54) ELECTROLYTIC BATH FOR RECEIVING MANGANESE DIOXIDE

DATE OF CANCELLATION OF PATENT: 2020 10 27

THE TERM OF RESTORATION OF PATENT VALIDITY HAS EXPIRED: 2021 10 27

DESIGNS

EXTENSION OF DESIGN REGISTRATION

- (11) D 2016 684 S
 - (73) Z. Panaskertel-Tsitsishvili St. 11, app. 68, 0194, Tbilisi, Georgia (GE)
 - (54) GEORGIAN SQUARE TABLECLOT, GEORGIAN ROUND TABLECLOTH, GEORGIAN RUG-LIKE PAINTED LARGE TABLECLOTH, GEORGIAN RUG-LIKE PAINTED LARGE TABLECLOTH, GEORGIAN RUG-LIKE PAINTED SMALL TABLECLOTH
 - (28) 4
 - (24) 2015 11 06
 - (18) 2025 11 06
 - (58) 2021 11 15
-

CANCELLATION OF DESIGNS REGISTRATION

- (11) D 2016 682 S
 - (73) LTD "Aqua Georgia" (GE)
Dighomi, II qu., corp. 2, 0159, Tbilisi, Georgia (GE)
 - (54) BOTTLE
 - (18) 2021 04 15
 - (58) 2021 11 04
-

- (11) D 2016 680 S
 - (73) LTD Agroconsortium "Tserovani"
Vill. Tserovani, 3318, Mtskheta, Georgia (GE)
 - (54) SURFACE DECORATION
 - (18) 2021 04 22
 - (58) 2021 11 04
-

TRADEMARKS

RENEWAL OF REGISTRATIONS

(111) M 2001 14143 R2

(156) 2001 11 19

(186) 2031 11 19

(732) Nanjing Chervon Industry Co., Ltd
№159 Jiang-jun Road, Jiangning Economic
End Technical Development Zone, Nanjing
211106 P.R., China

(111) M 2001 14215 R2

(156) 2001 12 17

(186) 2031 12 17

(732) The Gillette Company LLC
One Gillette Park, Boston, Massachusetts
02127, USA

(111) M 2002 14252 R2

(156) 2002 01 08

(186) 2032 01 08

(732) YKK Corporation
1, Kanda Izumi-Cho, Chiyoda-Ku, Tokyo,
Japan

(111) M 2001 14218 R2

(156) 2001 12 17

(186) 2031 12 17

(732) The Gillette Company LLC
One Gillette Park, Boston, Massachusetts
02127, USA

(111) M 2002 14382 R2

(156) 2002 03 27

(186) 2032 03 27

(732) The Polo/Lauren Company L.P.
650 Medison Avenue, New York,
New York 10022, USA

(111) M 2011 21490 R1

(156) 2011 05 25

(186) 2031 05 25

(732) Russian Standard Intellectual Property
Holding AG
Boesch 37, 6331 Huenenberg, Switzerland;
ZAO "Roust Inc"
Pulkovskoe shosse, 52, litera A, p. Shushary,
196140, Saint-Petersburg, Russian Federation

(111) M 2011 21491 R1

(156) 2011 05 25

(186) 2031 05 25

(732) Russian Standard Intellectual Property
Holding AG
Boesch 37, 6331 Huenenberg, Switzerland;
ZAO "Roust Inc"
Pulkovskoe shosse, 52, litera A, p. Shushary,
196140, Saint-Petersburg, Russian Federation

(111) M 2011 21492 R1

(156) 2011 05 25

(186) 2031 05 25

(732) Russian Standard Intellectual Property
Holding AG
Boesch 37, 6331 Huenenberg, Switzerland;
ZAO "Roust Inc"
Pulkovskoe shosse, 52, litera A, p. Shushary,
196140, Saint-Petersburg, Russian Federation

(111) M 2011 21804 R1

(156) 2011 09 19

(186) 2031 09 19

(732) Russian Standard Intellectual Property
Holding AG
Boesch 37, 6331 Huenenberg, Switzerland;
ZAO "Roust Inc"
Pulkovskoe shosse, 52, litera A, p. Shushary,
196140, Saint-Petersburg, Russian Federation

(111) M 2011 21805 R1

(156) 2011 09 19

(186) 2031 09 19

(732) Russian Standard Intellectual Property
Holding AG
Boesch 37, 6331 Huenenberg, Switzerland;
ZAO "Roust Inc"
Pulkovskoe shosse, 52, litera A, p. Shushary,
196140, Saint-Petersburg, Russian Federation

(111) M 2011 21467 R1

(156) 2011 05 16

(186) 2031 05 16

(732) Russian Standard Intellectual Property
Holding AG
Boesch 37, 6331 Huenenberg, Switzerland;
ZAO "Roust Inc"
Pulkovskoe shosse, 52, litera A, p. Shushary,
196140, Saint-Petersburg, Russian Federation

(111) M 2011 21493 R1
(156) 2011 05 25
(186) 2031 05 25
(732) Russian Standard Intellectual Property Holding AG
Boesch 37, 6331 Huenenberg, Switzerland;
ZAO "Roust Inc"
Pulkovskoe shosse, 52, litera A, p. Shushary,
196140, Saint-Petersburg, Russian Federation

(111) M 2011 21494 R1
(156) 2011 05 25
(186) 2031 05 25
(732) ZAO "Roust Inc"
Pulkovskoe shosse, 52, litera A, p. Shushary,
196140, Saint-Petersburg, Russian Federation;
Russian Standard Intellectual Property Holding AG
Boesch 37, 6331 Huenenberg, Switzerland

(111) M 2011 21495 R1
(156) 2011 05 25
(186) 2031 05 25
(732) Russian Standard Intellectual Property Holding AG
Boesch 37, 6331 Huenenberg, Switzerland;
ZAO "Roust Inc"
Pulkovskoe shosse, 52, litera A, p. Shushary,
196140, Saint-Petersburg, Russian Federation

(111) M 2011 21496 R1
(156) 2011 05 25
(186) 2031 05 25
(732) Russian Standard Intellectual Property Holding AG
Boesch 37, 6331 Huenenberg, Switzerland;
ZAO "Roust Inc"
Pulkovskoe shosse, 52, litera A, p. Shushary,
196140, Saint-Petersburg, Russian Federation

(111) M 2011 21701 R1
(156) 2011 08 23
(186) 2031 08 23
(732) Bilim Ilac Sanayi ve Ticaret A.S.
Kaptanpaşa Mahallesi, Zincirlikuyu Caddesi,
N184 Beyoğlu, İstanbul, Turkey

(111) M 2012 22202 R1
(156) 2012 01 18
(186) 2032 01 18
(732) MedImmune LLC
One MedImmune Way, Gaithersburg,
MD 20878, USA

(111) M 2012 22203 R1
(156) 2012 01 18
(186) 2032 01 18
(732) MedImmune LLC
One MedImmune Way, Gaithersburg,
MD 20878, USA

(111) M 2011 22183 R1
(156) 2011 12 29
(186) 2031 12 29
(732) HMY Group
50 Route d'Auxerre, 89470 Monéteau,
France

(111) M 2012 22289 R1
(156) 2012 02 03
(186) 2032 02 03
(732) Syngenta Participations AG
Schwarzwaldallee 215, 4058 Basel,
Switzerland

(111) M 2012 22370 R1
(156) 2012 02 24
(186) 2032 02 24
(732) JSC "Sarajishvili"
Sarajishvili Ave. 4, 0153, Tbilisi, Georgia

(111) M 2012 22480 R1
(156) 2012 04 05
(186) 2032 04 05
(732) Toyota Jidosha Kabushiki Kaisha
(also trading as Toyota Motor Corporation)
1, Toyota-Cho, Toyota-Shi, Aichi-Ken,
Japan

(111) M 2012 22436 R1
(156) 2012 03 16
(186) 2032 03 16
(732) Brown-Forman Finland Ltd
Porkkalankatu 24, 00180 helsinki, Finland

(111) M 2011 22113 R1
(156) 2011 12 23
(186) 2031 12 23
(732) "Amber Beverage Group" SIA
Raņķa dambis 30 - 120, Riga, LV-1048,
Latvia

COMPLETE TRANSFER OF RIGHTS

(111) M 2021 34007 R
(732) Ltd "Brand Consulting Group"
Degtarnaia Str. 9, App. 31, 04071, Kiev,
Ukraine
(770) "Tfilisis Marani" LLC
Paliashvili St. 33, app. 6, 0179, Tbilisi,
Georgia
(580) 2021 09 22

(111) M 1997 6624 R
(732) New Naf naf
55 Chemin Latéral, F-93140 Bondy, France
(770) Naf Naf
6/10 Boulevard Foch, 93800 Epinay-Sur-
Seine, France
(580) 2021 11 02

(111) M 1997 4450 R
(732) Novartis AG
CH-4002 Basel, Switzerland
(770) Glaxo Group Limited
980 Great West Road, Brentford, Middlesex
TW8 9GS, United Kingdom
(580) 2021 11 11

(111) M 1997 6493 R
(732) Novartis AG
CH-4002 Basel, Switzerland
(770) Glaxo Group Limited
980 Great West Road, Brentford, Middlesex
TW8 9GS, United Kingdom
(580) 2021 11 11

(111) M 1997 4452 R
(732) Novartis AG
CH-4002 Basel, Switzerland
(770) Glaxo Group Limited
980 Great West Road, Brentford, Middlesex
TW8 9GS, United Kingdom
(580) 2021 11 11

(111) M 1996 1680 R
(732) Laboratoire Native
4 Rue Euler, F-75008 Paris, France
(770) L' Oreal
14 Rue Royale, 75008 Paris, France
(580) 2021 07 26

(111) M 2012 22202 R
(732) MedImmune LLC
One MedImmune Way, Gaithersburg,
MD 20878, USA
(770) AbbVie Inc.,
a corporation of the State of Delaware
1 N. Waukegan Road, North Chicago,
Illinois 60064, USA
(580) 2021 11 03

(111) M 2012 22203 R
(732) MedImmune LLC
One MedImmune Way, Gaithersburg,
MD 20878, USA
(770) AbbVie Inc.,
a Corporation of the State of Delaware
1 N. Waukegan Road, North Chicago,
Illinois 60064, USA
(580) 2021 11 03

CHANGES OF NAMES AND/OR ADDRESSES OF OWNERS

(111) M 1997 5269 R

(732) Maxell, Ltd

1 Koizumi, Oyamazaki, Oyamazaki-Cho,
Otokuni-Gun, Kyoto, Japan

(770) Maxell Holdings, Ltd

1 Koizumi, Oyamazaki, Oyamazaki-Cho,
Otokuni-Gun, Kyoto, Japan

(580) 2021 11 02

(111) M 2001 14007 R

(732) Evyap Sabun yag gliserin Sanayi ve

Ticaret Anonim sirketi

İstanbul Deri Organize Sanayi Bölgesi

Güderi Caddesi, №1, X-1, Özel Parsel

Tuzla İstanbul, Turkey

(770) Evyap Sabun yag gliserin Sanayi ve

Ticaret Anonim Sirketi

Ayazaga, Cendere Yolu №10/A 80670

Levent, Istanbul, Turkey

(580) 2021 11 10

(111) M 2010 20875 R

(732) Next Holdings Limited

Desford Road, Enderby, Leicester,

Leicestershire, LE19 4 AT, United Kingdom

(770) Next Group Plc

Desford Road, Enderby, Leicester,

Leicestershire, LE19 4AT, United Kingdom

(580) 2021 11 03

(111) M 2011 21490 R

(732) ZAO "Roust inc"

Pulkovskoe shosse, 52, litera A, p. Shushary,
196140, Saint-Petersburg, Russian Federation;
Russian Standard Intellectual Property
Holding AG

Boesch 37, 6331 Huenenberg, Switzerland

(770) ZAO "Roust inc"

Pulkovskoe shosse, 52, litera A, p. Shushary,
196140, Saint-Petersburg, Russian Federation;
Russian Standard Intellectual Property
Holding AG

Zugerstrasse 49, Postfach 2528, 6330 Cham,
Switzerland

(580) 2021 11 09

(111) M 2011 21491 R

(732) ZAO "Roust inc"

Pulkovskoe shosse, 52, litera A, p.Shushary,
196140, Saint-Petersburg, Russian Federation;

Russian Standard Intellectual Property
Holding AG

Boesch 37, 6331 Huenenberg, Switzerland

(770) ZAO "Roust inc"

Pulkovskoe shosse, 52, litera A, p.Shushary,
196140, Saint-Petersburg, Russian Federation;
Russian Standard Intellectual Property
Holding AG

Zugerstrasse 49, Postfach 2528, 6330 Cham,
Switzerland

(580) 2021 11 09

(111) M 2011 21492 R

(732) ZAO "Roust inc"

Pulkovskoe shosse, 52, litera A, p.Shushary,
196140, Saint-Petersburg, Russian Federation;
Russian Standard Intellectual Property
Holding AG

Boesch 37, 6331 Huenenberg, Switzerland

(770) ZAO "Roust inc"

Pulkovskoe shosse, 52, litera A, p. Shushary,
196140, Saint-Petersburg, Russian Federation;
Russian Standard Intellectual Property
Holding AG

Zugerstrasse 49, Postfach 2528, 6330 Cham,
Switzerland

(580) 2021 11 09

(111) M 2011 21804 R

(732) ZAO "Roust inc"

Pulkovskoe shosse, 52, litera A, p.Shushary,
196140, Saint-Petersburg, Russian Federation;
Russian Standard Intellectual Property
Holding AG

Boesch 37, 6331 Huenenberg, Switzerland

(770) ZAO "Roust inc"

Pulkovskoe shosse, 52, litera A, p. Shushary,
196140, Saint-Petersburg, Russian Federation;
Russian Standard Intellectual Property
Holding AG

Zugerstrasse 49, Postfach 2528, 6330 Cham,
Switzerland

(580) 2021 11 09

(111) M 2011 21805 R

(732) ZAO "Roust inc"

Pulkovskoe shosse, 52, litera A, p. Shushary,
196140, Saint-Petersburg, Russian Federation;
Russian Standard Intellectual Property
Holding AG

Boesch 37, 6331 Huenenberg, Switzerland

(770) ZAO "Roust inc"
Pulkovskoe shosse, 52, litera A, p. Shushary,
196140, Saint-Petersburg, Russian Federation;
Russian Standard Intellectual Property
Holding AG
Zugerstrasse 49, Postfach 2528, 6330 Cham,
Switzerland

(580) 2021 11 09

(111) M 2011 21467 R

(732) ZAO "ROUST INC"

Pulkovskoe shosse, 52, litera A, p. Shushary,
196140, Saint-Petersburg, Russian Federation;
Russian Standard Intellectual Property
Holding AG
Boesch 37, 6331 Huenenberg, Switzerland

(770) ZAO "ROUST INC"

Pulkovskoe shosse, 52, litera A, p. Shushary,
196140, Saint-Petersburg, Russian Federation;
Russian Standard Intellectual Property
Holding AG
Zugerstrasse 49, Postfach 2528, 6330 Cham,
Switzerland

(580) 2021 11 09

(111) M 2011 21493 R

(732) ZAO "Roust inc"

Pulkovskoe shosse, 52, litera A, p. Shushary,
196140, Saint-Petersburg, Russian Federation;
Russian Standard Intellectual Property
Holding AG
Boesch 37, 6331 Huenenberg, Switzerland

(770) ZAO "Roust inc"

Pulkovskoe shosse, 52, litera A, p. Shushary,
196140, Saint-Petersburg, Russian Federation;
Russian Standard Intellectual Property
Holding AG
Zugerstrasse 49, Postfach 2528, 6330 Cham,
Switzerland

(580) 2021 11 09

(111) M 2011 21494 R

(732) Russian Standard Intellectual Property
Holding AG

Boesch 37, 6331 Huenenberg, Switzerland;
ZAO "Roust inc"
Pulkovskoe shosse, 52, litera A, p. Shushary,
196140, Saint-Petersburg, Russian Federation

(770) Russian Standard Intellectual Property
Holding AG

Zugerstrasse 49, Postfach 2528, 6330 Cham,
Switzerland;
ZAO "Roust inc"
Pulkovskoe shosse, 52, litera A, p. Shushary,
196140, Saint-Petersburg, Russian Federation

(580) 2021 11 09

(111) M 2011 21495 R

(732) ZAO "Roust inc"

Pulkovskoe shosse, 52, litera A, p. Shushary,
196140, Saint-Petersburg, Russian Federation;
Russian Standard Intellectual Property
Holding AG
Boesch 37, 6331 Huenenberg, Switzerland

(770) ZAO "Roust inc"

Pulkovskoe shosse, 52, litera A, p. Shushary,
196140, Saint-Petersburg, Russian Federation;
Russian Standard Intellectual Property
Holding AG
Zugerstrasse 49, Postfach 2528, 6330 Cham,
Switzerland

(580) 2021 11 09

(111) M 2011 21496 R

(732) ZAO "Roust inc"

Pulkovskoe shosse, 52, litera A, p. Shushary,
196140, Saint-Petersburg, Russian Federation;
Russian Standard Intellectual Property
Holding AG
Boesch 37, 6331 Huenenberg, Switzerland

(770) ZAO "Roust inc"

Pulkovskoe shosse, 52, litera A, p. Shushary,
196140, Saint-Petersburg, Russian Federation;
Russian Standard Intellectual Property
Holding AG
Zugerstrasse 49, Postfach 2528, 6330 Cham,
Switzerland

(580) 2021 11 09

(111) M 2011 21701 R

(732) Bilim Ilac Sanayi ve Ticaret A.S.

Kaptanpaşa Mahallesi, Zincirlikuyu Caddesi,
N184 Beyoğlu, İstanbul, Turkey

(770) Bilim Ilac Sanayi ve Ticaret A.S.

Maslak Mahallesi Sümer Sokak. N4 Şişli,
İstanbul, Turkey

(580) 2021 11 08

(111) M 2011 21788 R

(732) Astellas Deutschland GmbH

Ridlerstrasse 57, D-80339, München,
Germany

(770) Astellas Deutschland GmbH

Georg Brauchle Ring 64-66, 80992
München, Germany

(580) 2021 09 17

(111) M 2011 21789 R
(732) Astellas Deutschland GmbH
Ridlerstrasse 57, D-80339, Munich,
Germany
(770) Astellas Deutschland GmbH
Georg Brauchle Ring 64-66, 80992
München, Germany
(580) 2021 09 17

(111) M 2011 21791 R
(732) Astellas Deutschland GmbH
Ridlerstrasse 57, D-80339, Munich,
Germany
(770) Astellas Deutschland GmbH
Georg Brauchle Ring 64-66, 80992
München, Germany
(580) 2021 09 17

(111) M 2011 22113 R
(732) "Amber Beverage Group" SIA
Raņķa dambis 30 - 120, Riga, LV-1048,
Latvia
(770) "Amber Beverage Group" SIA
A. Čaka iela 160, Rīga, LV-1012, Latvia
(580) 2021 11 01

CANCELLATION OF TRADEMARKS REGISTRATION

(111) M 2011 21429 R
(151) 2011 04 28
(732) Ministry of Culture and Monument Protection
of Georgia
Sanapiro St. 4, 0105, Tbilisi, Georgia
(141) 2021 11 10

(111) M 2011 21430 R
(151) 2011 05 10
(732) Harrington Development Inc.
Arango-Orillac Bldg. East 54 th street,
Republic of Panama
(141) 2021 11 18

(210) 75864
(800) 1027206
(540)

RANEX

(732) Smartwares Safety & Lighting B.V.
Jules Verneweg 87, NL-5015 BH Tilburg,
Netherlands
(511) List of Declared of Court Decision:
Class – 9

REGISTRATION OF LICENSE AGREEMENT

(111) M 2019 31041 R
(732) LTD "Georgian Cosmetics"
Vazha-Pshavela Av., VII qu., corp. 5b, app. 8, 0186, Tbilisi, Georgia
(791) LTD "Dariachangi"
Ateni St. 16, app. 67, Vake District, Tbilisi Georgia
(793) №1666
20 10 2021 – Sign for validity period
Exclusive
Class – 3

CLASSIFICATION INDEXES

INVENTIONS

CONCORDANCE TABLE OF INTERNATIONAL CLASSIFICATION INDEX AND PUBLICATION NUMBERS

INTERNATIONAL CLASSIFICATION INDEXES (51)	NUMBER OF PUBLISHED APPLICATION (10)
A 61 K 36/00	AP 2021 15561 A
B 65 D 85/10	AP 2021 15628 A

CONCORDANCE TABLE OF PUBLICATION NUMBERS AND INTERNATIONAL CLASSIFICATION INDEX

NUMBER OF PUBLISHED APPLICATION (10)	INTERNATIONAL CLASSIFICATION INDEXES (51)
AP 2021 15561 A	A 61 K 36/00
AP 2021 15628 A	B 65 D 85/10

CONCORDANCE TABLE OF INTERNATIONAL CLASSIFICATION INDEX, PATENT NUMBERS AND PUBLICATION NUMBERS

INTERNATIONAL CLASSIFICATION INDEX (51)	NUMBER OF PATENT (11)	NUMBER OF PUBLISHED APPLICATION (10)
A 01 D 46/04	P 2021 7319 B	AP 2021 15317 A
A 01 D 46/04	P 2021 7320 B	AP 2021 15357 A
A 23 L 2/00; C 12 H 1/16	P 2021 7323 B	AP 2021 15240 A
A 61 K 31/496; A 61 K 31/4155; C 07 D 403/14; C 07 D 403/06; C 07 D 401/06	P 2021 7318 B	AP 2021 15219 A
A 61 K 39/395; A 61 K 38/17; C 07 K 14/47; C 07 K 14/705	P 2021 7326 B	AP 2021 14720 A
B 05 D 3/00; C 09 D 7/40; C 09 D 137/00	P 2021 7325 B	AP 2021 14598 A
B 61 B 23/02	P 2021 7324 B	AP 2021 15215 A
G 01 J 3/00	P 2021 7321 B	AP 2021 15404 A
G 01 J 3/00	P 2021 7322 B	AP 2021 15403 A

**CONCORDANCE TABLE OF PATENT NUMBERS,
PUBLICATION NUMBERS AND INTERNATIONAL CLASSIFICATION INDEX**

NUMBER OF PATENT (11)	NUMBER OF PUBLISHED APPLICATION (10)	INTERNATIONAL CLASSIFICATION INDEX (51)
P 2021 7318 B	AP 2021 15219 A	A 61 K 31/496; A 61 K 31/4155; C 07 D 403/14; C 07 D 403/06; C 07 D 401/06
P 2021 7319 B	AP 2021 15317 A	A 01 D 46/04
P 2021 7320 B	AP 2021 15357 A	A 01 D 46/04
P 2021 7321 B	AP 2021 15404 A	G 01 J 3/00
P 2021 7322 B	AP 2021 15403 A	G 01 J 3/00
P 2021 7323 B	AP 2021 15240 A	A 23 L 2/00; C 12 H 1/16
P 2021 7324 B	AP 2021 15215 A	B 61 B 23/02
P 2021 7325 B	AP 2021 14598 A	B 05 D 3/00; C 09 D 7/40; C 09 D 137/00
P 2021 7326 B	AP 2021 14720 A	A 61 K 39/395; A 61 K 38/17; C 07 K 14/47; C 07 K 14/705

**CONCORDANCE TABLE OF APPLICATION NUMBERS,
PUBLICATION NUMBERS AND PATENTS**

NUMBER OF APPLICATION (21)	NUMBER OF PUBLISHED APPLICATION (10)	NUMBER OF PATENT (11)
AP 2017 14598	AP 2021 14598 A	P 2021 7325 B
AP 2016 14720	AP 2021 14720 A	P 2021 7326 B
AP 2017 15215	AP 2021 15215 A	P 2021 7324 B
AP 2018 15219	AP 2021 15219 A	P 2021 7318 B
AP 2019 15240	AP 2021 15240 A	P 2021 7323 B
AP 2020 15317	AP 2021 15317 A	P 2021 7319 B
AP 2020 15357	AP 2021 15357 A	P 2021 7320 B
AP 2020 15403	AP 2021 15403 A	P 2021 7322 B
AP 2020 15404	AP 2021 15404 A	P 2021 7321 B

UTILITY MODELS

INTERNATIONAL CLASSIFICATION INDEXES (51)	NUMBER OF PUBLISHED APPLICATION (10)
A 61 K 9/20; A 61 K 35/76; A 61 K 36/00	AU 2021 15659 U
C 04 B 35/32; H 01 L 39/00	AU 2021 15487 U

CONCORDANCE TABLE OF PUBLICATION NUMBERS AND INTERNATIONAL CLASSIFICATION INDEX

NUMBER OF PUBLISHED APPLICATION (10)	INTERNATIONAL CLASSIFICATION INDEXES (51)
AU 2021 15487 U	C 04 B 35/32; H 01 L 39/00
AU 2021 15659 U	A 61 K 9/20; A 61 K 35/76; A 61 K 36/00

DESIGNS

CONCORDANCE TABLE OF INTERNATIONAL CLASSIFICATION INDEX AND PUBLICATION NUMBERS

INTERNATIONAL CLASSIFICATION INDEXES (51)	NUMBER OF PUBLISHED APPLICATION (10)
15-07	AD 2021 1237 S
20-02	AD 2021 1221 S

CONCORDANCE TABLE OF PUBLICATION NUMBERS AND INTERNATIONAL CLASSIFICATION INDEX

NUMBER OF PUBLISHED APPLICATION (10)	INTERNATIONAL CLASSIFICATION INDEXES (51)
AD 2021 1221 S	20-02
AD 2021 1237 S	15-07

DESIGN REGISTERED ACCORDING TO THE ACCELERATED PROCEDURE

CONCORDANCE TABLE OF INTERNATIONAL CLASSIFICATION INDEX AND PUBLICATION NUMBERS

INTERNATIONAL CLASSIFICATION INDEXES (51)	NUMBER OF REGISTRATION (11)
09-01	D 2021 912 S
19-08	D 2021 913 S
25-03	D 2021 914 S

CONCORDANCE TABLE OF PUBLICATION NUMBERS AND INTERNATIONAL CLASSIFICATION INDEX

NUMBER OF REGISTRATION (11)	INTERNATIONAL CLASSIFICATION INDEXES (51)
D 2021 912 S	09-01
D 2021 913 S	19-08
D 2021 914 S	25-03

CONCORDANCE TABLE OF APPLICATION NUMBERS, PUBLICATION NUMBERS AND PATENTS

NUMBER OF APPLICATION (21)	NUMBER OF REGISTRATION (11)
AD 2021 1243	D 2021 912 S
AD 2021 1245	D 2021 913 S
AD 2021 1249	D 2021 914 S

TRADEMARKS

CONCORDANCE TABLE OF REGISTRATION NUMBERS, APPLICATION NUMBERS, PUBLICATION NUMBERS AND BULLETIN NUMBERS

NUMBER OF REGISTRATION (111)	NUMBER OF APPLICATIONS (210)	NUMBER OF PUBLISHED APPLICATIONS (260)	NUMBER OF BULLETIN
1	2	3	4
M 2021 34685 R	AM 114674	–	21(577)2021
M 2021 34686 R	AM 115207	–	21(577)2021
M 2021 34687 R	AM 114993	–	21(577)2021
M 2021 34688 R	AM 115218	–	21(577)2021
M 2021 34689 R	AM 115303	–	21(577)2021
M 2021 34690 R	AM 115224	–	21(577)2021
M 2021 34691 R	AM 115335	–	21(577)2021
M 2021 34692 R	AM 109948	AM 2021 109948 A	11(567)2021
M 2021 34693 R	AM 109950	AM 2021 109950 A	8(564)2021
M 2021 34694 R	AM 109951	AM 2021 109951 A	10(566)2021
M 2021 34695 R	AM 109952	AM 2021 109952 A	11(567)2021
M 2021 34696 R	AM 110031	AM 2021 110031 A	8(564)2021
M 2021 34697 R	AM 110040	AM 2021 110040 A	8(564)2021
M 2021 34698 R	AM 110199	AM 2021 110199 A	8(564)2021
M 2021 34699 R	AM 110286	AM 2021 110286 A	12(568)2021
M 2021 34700 R	AM 110375	AM 2021 110375 A	9(565)2021
M 2021 34701 R	AM 110439	AM 2021 110439 A	9(565)2021
M 2021 34702 R	AM 110447	AM 2021 110447 A	13(569)2021
M 2021 34703 R	AM 110448	AM 2021 110448 A	13(569)2021
M 2021 34704 R	AM 110453	AM 2021 110453 A	11(567)2021
M 2021 34705 R	AM 110520	AM 2021 110520 A	12(568)2021
M 2021 34706 R	AM 110608	AM 2021 110608 A	12(568)2021
M 2021 34707 R	AM 110686	AM 2021 110686 A	13(569)2021
M 2021 34708 R	AM 110688	AM 2021 110688 A	13(569)2021
M 2021 34709 R	AM 110696	AM 2021 110696 A	11(567)2021
M 2021 34710 R	AM 110753	AM 2021 110753 A	13(569)2021
M 2021 34711 R	AM 110776	AM 2021 110776 A	12(568)2021
M 2021 34712 R	AM 110780	AM 2021 110780 A	13(569)2021
M 2021 34713 R	AM 110860	AM 2021 110860 A	12(568)2021
M 2021 34714 R	AM 110881	AM 2021 110881 A	12(568)2021
M 2021 34715 R	AM 110890	AM 2021 110890 A	12(568)2021
M 2021 34716 R	AM 110891	AM 2021 110891 A	12(568)2021
M 2021 34717 R	AM 110950	AM 2021 110950 A	13(569)2021
M 2021 34718 R	AM 110951	AM 2021 110951 A	13(569)2021
M 2021 34719 R	AM 110964	AM 2021 110964 A	13(569)2021
M 2021 34720 R	AM 111280	AM 2021 111280 A	13(569)2021
M 2021 34721 R	AM 111281	AM 2021 111281 A	13(569)2021
M 2021 34722 R	AM 115098	–	21(577)2021
M 2021 34723 R	AM 115332	–	21(577)2021
M 2021 34724 R	AM 115236	–	21(577)2021
M 2021 34725 R	AM 115403	–	21(577)2021
M 2021 34726 R	AM 109955	AM 2021 109955 A	9(565)2021
M 2021 34727 R	AM 110021	AM 2021 110021 A	8(564)2021
M 2021 34728 R	AM 110137	AM 2021 110137 A	8(564)2021
M 2021 34729 R	AM 110138	AM 2021 110138 A	8(564)2021

1	2	3	4
M 2021 34730 R	AM 110139	AM 2021 110139 A	8(564)2021
M 2021 34731 R	AM 110287	AM 2021 110287 A	10(566)2021
M 2021 34732 R	AM 110299	AM 2021 110299 A	11(567)2021
M 2021 34733 R	AM 110300	AM 2021 110300 A	11(567)2021
M 2021 34734 R	AM 110363	AM 2021 110363 A	11(567)2021
M 2021 34735 R	AM 110470	AM 2021 110470 A	10(566)2021
M 2021 34736 R	AM 110471	AM 2021 110471 A	10(566)2021
M 2021 34737 R	AM 110472	AM 2021 110472 A	10(566)2021
M 2021 34738 R	AM 110692	AM 2021 110692 A	12(568)2021
M 2021 34739 R	AM 110694	AM 2021 110694 A	13(569)2021
M 2021 34740 R	AM 110695	AM 2021 110695 A	13(569)2021
M 2021 34741 R	AM 110750	AM 2021 110750 A	14(570)2021
M 2021 34742 R	AM 110751	AM 2021 110751 A	13(569)2021
M 2021 34743 R	AM 110766	AM 2021 110766 A	14(570)2021
M 2021 34744 R	AM 110797	AM 2021 110797 A	14(570)2021
M 2021 34745 R	AM 110942	AM 2021 110942 A	13(569)2021
M 2021 34746 R	AM 110953	AM 2021 110953 A	13(569)2021
M 2021 34747 R	AM 110980	AM 2021 110980 A	14(570)2021
M 2021 34748 R	AM 111067	AM 2021 111067 A	14(570)2021
M 2021 34749 R	AM 111068	AM 2021 111068 A	14(570)2021
M 2021 34750 R	AM 111070	AM 2021 111070 A	14(570)2021
M 2021 34751 R	AM 111071	AM 2021 111071 A	14(570)2021
M 2021 34752 R	AM 111072	AM 2021 111072 A	14(570)2021
M 2021 34753 R	AM 111152	AM 2021 111152 A	14(570)2021
M 2021 34754 R	AM 111268	AM 2021 111268 A	14(570)2021
M 2021 34755 R	AM 111283	AM 2021 111283 A	14(570)2021
M 2021 34756 R	AM 111317	AM 2021 111317 A	14(570)2021
M 2021 34757 R	AM 111318	AM 2021 111318 A	14(570)2021
M 2021 34758 R	AM 111319	AM 2021 111319 A	14(570)2021
M 2021 34759 R	AM 111323	AM 2021 111323 A	14(570)2021
M 2021 34760 R	AM 111325	AM 2021 111325 A	14(570)2021
M 2021 34761 R	AM 111326	AM 2021 111326 A	14(570)2021
M 2021 34762 R	AM 111333	AM 2021 111333 A	14(570)2021
M 2021 34763 R	AM 111410	AM 2021 111410 A	14(570)2021

CONCORDANCE TABLE OF PUBLICATION NUMBERS
AND APPLICATION NUMBERS

NUMBER OF PUBLISHED APPLICATION (260)	NUMBER OF APPLICATION (210)	1	2
1	2		
AM 2021 109506 A	AM 109506	AM 2021 112577 A	AM 112577
AM 2021 110303 A	AM 110303	AM 2021 112578 A	AM 112578
AM 2021 110387 A	AM 110387	AM 2021 112584 A	AM 112584
AM 2021 111336 A	AM 111336	AM 2021 112596 A	AM 112596
AM 2021 111424 A	AM 111424	AM 2021 112598 A	AM 112598
AM 2021 111499 A	AM 111499	AM 2021 112601 A	AM 112601
AM 2021 111835 A	AM 111835	AM 2021 112602 A	AM 112602
AM 2021 111836 A	AM 111836	AM 2021 112603 A	AM 112603
AM 2021 112188 A	AM 112188	AM 2021 112604 A	AM 112604
AM 2021 112310 A	AM 112310	AM 2021 112605 A	AM 112605
AM 2021 112365 A	AM 112365	AM 2021 112606 A	AM 112606
AM 2021 112389 A	AM 112389	AM 2021 112608 A	AM 112608
AM 2021 112392 A	AM 112392	AM 2021 112626 A	AM 112626
AM 2021 112395 A	AM 112395	AM 2021 112672 A	AM 112672
AM 2021 112396 A	AM 112396	AM 2021 112674 A	AM 112674
AM 2021 112406 A	AM 112406	AM 2021 112701 A	AM 112701
AM 2021 112408 A	AM 112408	AM 2021 112720 A	AM 112720
AM 2021 112419 A	AM 112419	AM 2021 112725 A	AM 112725
AM 2021 112473 A	AM 112473	AM 2021 112727 A	AM 112727
AM 2021 112489 A	AM 112489	AM 2021 112729 A	AM 112729
AM 2021 112490 A	AM 112490	AM 2021 112730 A	AM 112730
AM 2021 112493 A	AM 112493	AM 2021 112731 A	AM 112731
AM 2021 112495 A	AM 112495	AM 2021 112839 A	AM 112839
		AM 2021 112906 A	AM 112906
		AM 2021 112928 A	AM 112928
		AM 2021 112929 A	AM 112929

CONCORDANCE TABLE OF INDEX OF GOODS AND/OR SERVICES
AND APPLICATION NUMBERS

INDEX OF GOODS AND/OR SERVICES (511)	NUMBER OF PUBLISHED APPLICATIONS (260)	1	2
1	2	14	AM 2021 112473 A
1	AM 2021 112408 A	15	AM 2021 112473 A
1	AM 2021 112601 A	16	AM 2021 112473 A
1	AM 2021 112602 A	18	AM 2021 112473 A
1	AM 2021 112603 A	19	AM 2021 111499 A
1	AM 2021 112604 A	19	AM 2021 112601 A
1	AM 2021 112605 A	19	AM 2021 112602 A
1	AM 2021 112606 A	19	AM 2021 112603 A
2	AM 2021 112408 A	19	AM 2021 112604 A
3	AM 2021 112408 A	19	AM 2021 112605 A
3	AM 2021 112674 A	19	AM 2021 112606 A
3	AM 2021 112720 A	20	AM 2021 112473 A
3	AM 2021 112727 A	21	AM 2021 112473 A
4	AM 2021 110303 A	21	AM 2021 112730 A
4	AM 2021 112408 A	21	AM 2021 112731 A
4	AM 2021 112601 A	24	AM 2021 112473 A
4	AM 2021 112602 A	25	AM 2021 112473 A
4	AM 2021 112603 A	25	AM 2021 112601 A
4	AM 2021 112604 A	25	AM 2021 112602 A
4	AM 2021 112604 A	25	AM 2021 112603 A
4	AM 2021 112604 A	25	AM 2021 112604 A
4	AM 2021 112605 A	25	AM 2021 112605 A
4	AM 2021 112606 A	25	AM 2021 112606 A
4	AM 2021 112727 A	26	AM 2021 112473 A
5	AM 2021 112389 A	27	AM 2021 112473 A
5	AM 2021 112392 A	28	AM 2021 112473 A
5	AM 2021 112395 A	29	AM 2021 112672 A
5	AM 2021 112396 A	30	AM 2021 112601 A
5	AM 2021 112495 A	30	AM 2021 112602 A
5	AM 2021 112577 A	30	AM 2021 112603 A
5	AM 2021 112578 A	30	AM 2021 112604 A
5	AM 2021 112601 A	30	AM 2021 112605 A
5	AM 2021 112602 A	30	AM 2021 112606 A
5	AM 2021 112603 A	30	AM 2021 112672 A
5	AM 2021 112604 A	30	AM 2021 112929 A
5	AM 2021 112605 A	31	AM 2021 112601 A
5	AM 2021 112606 A	31	AM 2021 112602 A
5	AM 2021 112626 A	31	AM 2021 112603 A
5	AM 2021 112674 A	31	AM 2021 112604 A
5	AM 2021 112725 A	31	AM 2021 112605 A
5	AM 2021 112727 A	31	AM 2021 112606 A
5	AM 2021 112906 A	32	AM 2021 111835 A
6	AM 2021 112601 A	32	AM 2021 111836 A
6	AM 2021 112602 A	32	AM 2021 112188 A
6	AM 2021 112603 A	32	AM 2021 112473 A
6	AM 2021 112604 A	32	AM 2021 112596 A
6	AM 2021 112605 A	32	AM 2021 112672 A
6	AM 2021 112606 A	32	AM 2021 112701 A
7	AM 2021 112419 A	33	AM 2021 111835 A
9	AM 2021 112729 A	33	AM 2021 112188 A
11	AM 2021 112584 A	33	AM 2021 112406 A
		33	AM 2021 112608 A

1	2
34	AM 2021 112310 A
34	AM 2021 112473 A
35	AM 2021 110387 A
35	AM 2021 111336 A
35	AM 2021 111499 A
35	AM 2021 112365 A
35	AM 2021 112473 A
35	AM 2021 112489 A
35	AM 2021 112490 A
35	AM 2021 112493 A
35	AM 2021 112601 A
35	AM 2021 112602 A
35	AM 2021 112603 A
35	AM 2021 112604 A
35	AM 2021 112605 A
35	AM 2021 112606 A
35	AM 2021 112720 A
35	AM 2021 112839 A
35	AM 2021 112928 A
35	AM 2021 112929 A
36	AM 2021 112489 A
36	AM 2021 112490 A
36	AM 2021 112493 A
36	AM 2021 112839 A
37	AM 2021 109506 A
37	AM 2021 111499 A
37	AM 2021 112584 A
37	AM 2021 112598 A
37	AM 2021 112601 A
37	AM 2021 112602 A
37	AM 2021 112603 A
37	AM 2021 112604 A
37	AM 2021 112605 A

1	2
37	AM 2021 112606 A
37	AM 2021 112729 A
39	AM 2021 111499 A
39	AM 2021 112473 A
39	AM 2021 112601 A
39	AM 2021 112602 A
39	AM 2021 112603 A
39	AM 2021 112604 A
39	AM 2021 112605 A
39	AM 2021 112606 A
41	AM 2021 111424 A
41	AM 2021 112489 A
41	AM 2021 112490 A
41	AM 2021 112493 A
41	AM 2021 112928 A
42	AM 2021 112601 A
42	AM 2021 112602 A
42	AM 2021 112603 A
42	AM 2021 112604 A
42	AM 2021 112605 A
42	AM 2021 112606 A
42	AM 2021 112729 A
43	AM 2021 112365 A
43	AM 2021 112406 A
43	AM 2021 112839 A
43	AM 2021 112929 A
44	AM 2021 112601 A
44	AM 2021 112602 A
44	AM 2021 112603 A
44	AM 2021 112604 A
44	AM 2021 112605 A
44	AM 2021 112606 A
45	AM 2021 112928 A

CONCORDANCE TABLE OF INDEX OF GOODS AND/OR SERVICES
AND NUMBERS OF TRADEMARKS REGISTERED ACCORDING
TO THE ACCELERATED PROCEDURE

INDEX OF GOODS AND/OR SERVICES (511)	NUMBERS OF REGISTERED ACCORDING TO THE ACCELERATED PROCEDURE (111)
5	M 2021 34690 R
5	M 2021 34691 R
5	M 2021 34725 R
9	M 2021 34688 R
9	M 2021 34723 R
29	M 2021 34686 R
30	M 2021 34686 R
32	M 2021 34686 R
33	M 2021 34685 R
33	M 2021 34687 R
34	M 2021 34689 R
35	M 2021 34688 R
35	M 2021 34722 R
35	M 2021 34724 R
42	M 2021 34722 R
42	M 2021 34724 R

OFFICIAL BULLETIN OF THE INDUSTRIAL PROPERTY

**INVENTIONS
UTILITY MODEL
DESIGNS
TRADEMARKS**

21(577)

EDITOR-IN-CHIEF: N. Bebrishvili

EDITOR-TRANSLATOR: E. Gabunia

PROOFREADER: A. Shikhashvili

COMPUTER LAYOUT: M. Ordenidze
K. Svanidze

info@sakpatenti.gov.ge
www.sakpatenti.gov.ge