

# Official Bulletin of the Industrial Property

Inventions

Utility Models

Designs

Trademarks



საქართველოს ინტელექტუალური  
საკუთრების ეროვნული ცენტრი

**საქპატენტი**

**SAKPATENTI**

NATIONAL INTELLECTUAL PROPERTY  
CENTER OF GEORGIA

[www.sakpatenti.gov.ge](http://www.sakpatenti.gov.ge)

Date of Publication – 2021 12 10

**22(578)**

# INID CODES FOR IDENTIFICATION OF BIBLIOGRAPHIC DATA

## INVENTIONS, UTILITY MODELS

- (10) Number of publication for application, which has been examined
- (11) Number of patent and kind of document
- (21) Serial number of application
- (22) Date of filing of the application
- (23) Date of exhibition or the date of the earlier filing and the number of application, if any
- (24) Date from which patent may have effect
- (31) Number of priority application
- (32) Date of filing of priority application
- (33) Code of the country or regional organization allotting priority application number
- (44) Date of publication of application not granted, but examined and number of bulletin
- (45) Date of publication of registered document
- (51) International Patent Classification Index

- (54) Title of the invention
- (57) Abstract
- (60) Number of examined patent document granted by foreign patent office, date from which patent has effect and country code
- (62) Number of the earlier application and in case of divided application, date of filing an application
- (71) Name, surname and address of applicant (country code)
- (72) Name, surname of inventor (country code)
- (73) Name, surname and address of patent owner (country code)
- (74) Name, surname of representative or patent attorney
- (85) Date of commencement of the national phase of International Application
- (86) Number and date of filing of international application
- (87) Number and date of publication of international application
- (94) Calculated date of expiry of the SPC or the duration of the SPC

## DESIGNS

- (10) Number of publication for application
- (11) Number of patent and kind of document or number of registration
- (15) Date of registration/Date of patent renewal
- (18) Expected expiration date of patent or registration
- (21) Serial number of application
- (22) Date of filing of the application
- (23) Date of exhibition or the date of the earlier filing and the number of application, if any
- (24) Date from which patent may have effect
- (28) Number of designs included in the application
- (30) Data relating to priority (number of application, date of filing of application, two-letter code identifying the authority with whom the priority application was made)
- (31) Number of priority application
- (32) Date of filing of priority application
- (33) Code of the country or regional organization allotting priority application number
- (34) Two-letter code according to WIPO St.3 identifying the authority with which the priority application was made
- (44) Date of publication of design and number of bulletin (the first publication)
- (45) Date of publication of design registered by WIPO and number of bulletin

- (51) International Classification for designs (class and subclass of the Locarno Classification)
- (54) Title of the invention
- (55) Reproduction of the design
- (57) Description of characteristic features of the design including indication of colors
- (58) Date of recording of any kind of amendment in the Register
- (62) Number of the earlier application, registration and document number and if available the date of filing an application in case of divided application
- (71) Name, surname and address of applicant (country code)
- (72) Name, surname of creator (country code)
- (73) Name, surname and address of patent owner (country code)
- (74) Name, surname of representative or patent attorney
- (81) Contracting states concerned
  - II designated contracting states according to the 1960 Act
  - III designated contracting states according to the 1999 Act
- (85) Owner's permanent address
- (86) Owner's nationality
- (87) Owner's residence
- (88) State in which the owner has a real and effective industrial or commercial establishment

## TRADEMARKS

- (111) - Number of registration
- (151) - Date of registration
- (156) - Date of the renewal
- (181) - Expected expiration date of registration
- (186) - Renewal expiration date of registration
- (141) - Date of cancel of duration of the mark
- (210) - Serial number of application
- (220) - Date of filing of the application
- (230) - Data concerning exhibition
- (260) - Number of application, for which favorable decision of examination about registration has been taken (publication number)
- (310) - Number of the first application
- (320) - Date of filing of the first application
- (330) - Code, identifying national or regional Office where the first application was made
- (511) - International Classification of Goods and Services for the purposes of registration of trade marks and/or list of goods and/or services classified according thereto
- (526) - Disclaimer
- (531) - Description of figurative elements of Trade Marks according to the International Classification of the Figurative Elements of Marks

- (540) - Reproduction of Trade Mark
- (550) - Nature and kind of Trade Mark
- (551) - Indication to the effect that the mark is a collective mark, a certification mark or a guarantee mark
- (554) - Three-dimensional mark
- (580) - Date of recording of any kind changes in respect of applications or registrations
- (591) - Information concerning colors claimed
- (731) - Name and address of the applicant
- (732) - Name and address of the holder of the registration
- (740) - Name and address of the representative
- (750) - Addreses for correspondence
- (770) - Name and address of the previous applicant or holder in case of change in ownership
- (771) - Previous name and address of the applicant or holder in case of change in ownership
- (791) - Name and address of the licensee
- (793) - Indication of conditions and/or restrictions under the license (Type of license, number of license agreement, data of license, data of validity of license)
- (800) - Certain data relating to the international registration of Trade Marks under the Protocol Relating to Madrid Agreement (International registration number
- (852) - Partial cancellation of the list of goods and services
- (891) - Date of subsequent designation

## CODES FOR PUBLICATION IN BULLETIN

- (21) AP 0000 000000 - serial number of application for invention
- (10) AP 0000 0000 A - number of published application for invention (first publication)
- (11) P 0000 0000 B - number of patent for invention (second publication)
- (21) API 0000 000000 - number of application for imported patent
- (11) PI 0000 0000 A - number of imported patent (first publication)
- (21) AU 0000 000000 - serial number of application for utility model
- (10) AU 0000 000 U - number of published application for utility model (first publication)
- (11) U 0000 000 Y - number of patent for utility model (second publication)
- (21) AD 0000 000000 - serial number of application for design
- (10) AD 0000 000 S - number of published application for design (first publication)
- (11) D 0000 000 S - registered design

## INTERNATIONAL PATENT CLASSIFICATION FOR INVENTIONS AND UTILITY MODELS

- SECTION A - HUMAN NECESSITIES
- SECTION B - PERFORMING OPERATIONS; TRANSPORTING
- SECTION C - CHEMISTRY; METALLURGY
- SECTION D - TEXTILES; PAPER
- SECTION E - FIXED CONSTRUCTIONS
- SECTION F - MECHANICAL ENGINEERING; LIGHTING; HEATING; WEAPONS; BLASTING
- SECTION G - PHYSICS
- SECTION H - ELECTRICITY

- 
- M - Trade Mark
  - (210) AM 0000 000000 - Serial number of application;
  - (260) AAM 0000 00000 A - Publication number of application;
  - (111) M 0000 00000 R - Number of registration;
  - (111) MMM0000 00000 Rn - Number of renewals, in which n=1,2,3;
  - (111) M 0000 00000 R(P) - Number of registration under partial assignment of rights
-

# Official Bulletin of the Industrial Property

Inventions

Utility Models

Designs

Trademarks

# CONTENT

<b>PUBLISHED TITLES OF PROTECTION</b> .....	3
<b>INVENTIONS</b>	
▪ APPLICATIONS APPROVED FOR GRANTING PATENT .....	4
▪ PATENTED INVENTIONS .....	8
<b>UTILITY MODELS</b>	
▪ APPLICATION APPROVED FOR GRANTING PATENT .....	11
<b>DESIGNS</b>	
▪ APPLICATIONS APPROVED FOR REGISTRATION .....	12
▪ DESIGNS REGISTERED WITH INTERNATIONAL BUREAU CLAIMING PRIORITY ON THE TERRITORY OF GEORGIA .....	16
<b>TRADEMARKS</b>	
▪ APPLICATIONS FILED UNDER NATIONAL PROCEDURE APPROVED FOR REGISTRATION .....	30
▪ REGISTERED TRADEMARKS .....	40
▪ TRADEMARKS REGISTERED ACCORDING TO ACCELERATED PROCEDURE .....	43
▪ INTERNATIONAL TRADEMARKS FOR WHICH A DECISION ON GRANTING PROTECTION IS TAKEN .....	46
▪ INTERNATIONAL TRADEMARKS PROTECTED IN GEORGIA .....	112
<b>OFFICIAL NOTIFICATIONS</b>	
<b>INVENTIONS</b>	
▪ RESTORATION OF PATENTS .....	122
▪ ABOLITION OF PATENTS WITH THE RIGHT TO RESTORE .....	122
▪ EXPIRATION OF TERMS OF RESTORATION OF PATENTS.....	123
▪ EXPIRATION OF TERMS OF PATENTS .....	125
▪ CHANGES OF NAMES AND/OR ADDRESSES OF PATENT OWNER .....	125
<b>UTILITY MODELS</b>	
▪ ABOLITION OF PATENTS WITH THE RIGHT TO RESTORE.....	126
▪ EXPIRATION OF PATENTS RESTORATION .....	126
▪ TRANSFER OF RIGHTS .....	128
<b>DESIGNS</b>	
▪ EXTENSION OF TERMS OF INTERNATIONAL DESIGN REGISTRATION.....	128
▪ CANCELLATION OF INTERNATIONAL DESIGNS REGISTRATION.....	131
<b>TRADEMARKS</b>	
▪ EXTENSION OF TERMS OF REGISTRATION.....	132
▪ COMPLETE TRANSFER OF RIGHTS .....	134
▪ CHANGES OF NAMES AND/OR ADDRESSES OF TRADEMARK OWNER.....	135
▪ CANCELLATION OF TRADEMARKS REGISTRATION .....	136
<b>CLASSIFICATION INDEXES</b>	
INVENTIONS .....	139
UTILITY MODELS .....	141
DESIGNS .....	141
TRADEMARKS .....	143

# PUBLISHED TITLES OF PROTECTION

## INVENTIONS

- **APPLICATIONS APPROVED FOR GRANTING PATENT:**  
15141; 15351; 15353; 14983; 15411; 14363; 15458
- **PATENTED INVENTIONS:**  
7327-7334

## UTILITY MODELS

- **APPLICATION APPROVED FOR GRANTING PATENT:**  
15552

## DESIGNS

- **APPLICATIONS APPROVED FOR REGISTRATION:**  
1224; 1226; 1231; 1217
- **DESIGNS REGISTERED WITH INTERNATIONAL BUREAU CLAIMING PRIORITY ON THE TERRITORY OF GEORGIA:**  
2215968; 216019; 213318; 213220; 213338

## TRADEMARKS

- **APPLICATIONS FILED UNDER NATIONAL PROCEDURE APPROVED FOR REGISTRATION:**  
110201\*; 112185; 112585; 112666, 112667; 112670, 112671; 112677, 112678; 112707-112712; 112722-112724; 112732; 112835, 112836; 112909-112920; 113009; 113033, 113034; 113037, 113038; 113043-113045; 113048; 113105, 113106; 113108; 113111-113113; 113119; 113124; 113131, 113132; 113134; 113145; 113147; 113183, 113184; 113187, 113188; 113197, 113198; 113237
- **REGISTERED TRADEMARKS:**  
34780-34805
- **TRADEMARKS REGISTERED ACCORDING TO ACCELERATED PROCEDURE:**  
34764-34779
- **INTERNATIONAL TRADEMARKS FOR WHICH A DECISION ON GRANTING PROTECTIONS IS TAKEN:**  
108201; 110234; 110250\*; 110585\*; 111559; 111631; 111633; 111635, 111654; 111671; 111678; 111688; 111758, 111759; 111762-111766; 111782-111786; 111813; 111817-111821; 111887; 111890-111895; 111899; 111907; 111912-111914; 111985-111988; 111991; 111995- 111999; 112002, 112003; 112006; 112008; 112020; 112040, 112041; 112106, 112107; 112110; 112112-112115; 112117, 112118; 112120; 112133; 112141-112143; 112145-112150; 112152- 112155; 112201; 112203; 112212-112214; 112221-112225; 112238; 112240; 112246, 112247; 112249, 112250; 112317; 112325; 112341-112345; 112356; 112423; 112428-112434; 112527, 112528; 112530; 112532; 112534; 112556; 112642; 112650; 112745; 112784; 112804-112806
- **INTERNATIONAL TRADEMARKS PROTECTED IN GEORGIA:**  
106618; 107246; 107253; 107793; 108982; 109206, 109207; 109243; 109345, 109346; 110081; 110084; 110094; 110172, 110173; 110242-110245; 110248; 110254-110261; 110316; 110318-110325; 110331-110340; 110350; 110353; 110389-110393; 110400, 110401; 110403-110409; 110414-110419; 110421-110424; 110490-110493; 110553-110557; 110559-110564; 110568; 110570, 110571; 110574; 110578; 110586; 110589, 110590; 110592-110595; 110631-110635; 110641; 110655; 110658-110661; 110663, 110664; 110666; 110698; 110710-110712; 110723; 110725; 110727-110729; 110731; 110825-110827; 110900; 110902; 111005-111009; 111011, 111012; 111014

# INVENTIONS

## APPLICATIONS APPROVED FOR GRANTING PATENT

The decision can be appealed at the Chamber of Appeal of Sakpatenti within 3 months from the publication or at the Mtskheta District Court Administrative Cases Board (Address: №17, Samkhedro St., Mtskheta), within 1 month following the publication.

### PART A

#### A 61

- (10) AP 2021 15141 A (51) Int. Cl. (2006)  
A 61 K 31/415  
A 61 P 29/00  
C 07 D 241/12  
C 07 D 233/64  
C 07 D 333/38  
C 07 D 333/28  
C 07 D 231/56  
C 07 D 231/12  
C 07 D 333/58  
C 07 D 277/56  
C 07 D 213/56  
C 07 D 495/04
- (21) AP 2017 15141 (22) 2017 12 18  
(31) 16206750.8  
(32) 2016 12 23  
(33) EP  
(71) Bayer Pharma Aktiengesellschaft (DE)  
Müllerstraße 178, Berlin, 13353, Germany (DE)  
(72) SCHMIDT, Nicole (DE);  
ROTGERI, Andrea (DE);  
STIMSON, Christopher (GB);  
NAGEL, Jens (DE);  
GRÖTICKE, Ina (DE);  
RAUSCH, Alexandra (DE);  
KLAR, Jürgen (DE);  
DYRKS, Thomas (DE);  
DAVENPORT, Adam James (GB);  
BÄURLE, STEFAN (DE)  
(74) Tamar Kochlamazashvili  
(85) 2019 07 19  
(86) PCT/EP2017/083290, 2017 12 18  
(54) CARBOXYLIC ACID AROMATIC AMIDES  
AS ANTAGONISTS OF BRADYKININ B1  
RECEPTOR  
(57) Compound of formula (I),

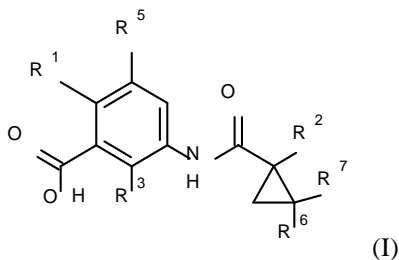

pharmaceutical compositions on the basis thereof, and their usage for the treatment or prophylactic of diseases.

Claims: 6 independents  
24 dependents  
Fig.: 16

- (10) AP 2021 15351 A (51) Int. Cl. (2006)  
A 61 K 31/437  
A 61 P 31/12  
C 07 D 513/04  
C 07 D 519/00
- (21) AP 2018 15351 (22) 2018 11 02  
(31) 17199687.9  
(32) 2017 11 02  
(33) EP  
(71) AICURIS GMBH & CO. KG (DE)  
Friedrich-Ebert-Straße 475 42117,  
Wuppertal, Germany (DE)  
(72) DONALD, Alastair (DE);  
URBAN, Andreas (DE);  
BONSMANN, Susanne (DE);  
WEGERT, Anita (DE);  
GREMMEN, Christiaan  
SPRINGER, Jasper (NL)  
(74) Tamaz Shilakadze  
(85) 2020 05 27  
(86) PCT/EP2018/000502, 2018 11 02  
(54) NOVEL, HIGHLY ACTIVE AMINO-  
THIAZOLE SUBSTITUTED INDOLE-2-  
CARBOXAMIDES ACTIVE AGAINST THE  
HEPATITIS B VIRUS (HBV)  
(57) Present invention relates to thiazolo[5,4-c] pyridine indole-2-carboxamides, hepatitis B virus (HBV) antagonist agents of formula (I)

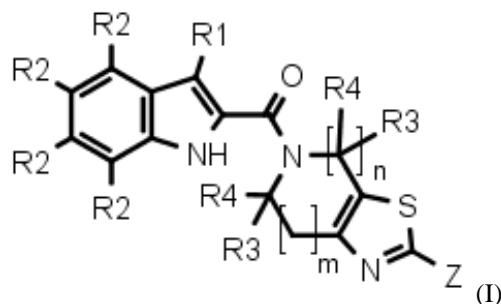

and pharmaceutical compositions containing them.

Claims: 5 independents  
3 dependents

(10) AP 2021 15353 A (51) Int. Cl. (2006)  
A 61 K 31/437  
A 61 P 31/12  
C 07 D 471/04  
C 07 D 471/18  
C 07 D 487/04  
C 07 D 519/00

(21) AP 2018 15353 (22) 2018 11 02

(31) 17199676.2

(32) 2017 11 02

(33) EP

(71) AICURIS GMBH & CO. KG (DE)

Friedrich-Ebert-Straße 475 42117,  
Wuppertal, Germany (DE)

(72) DONALD, Alastair (DE);

URBAN, Andreas (DE);

BONSMANN, Susanne (DE);

WEGERT, Anita (DE);

SPRINGER, Jasper (NL)

(74) Tamaz Shilakadze

(85) 2020 06 01

(86) PCT/EP2018/000503, 2018 11 02

(54) NOVEL, HIGHLY ACTIVE PYRAZOLO-  
PIPERIDINE SUBSTITUTED INDOLE-2-  
CARBOXAMIDES ACTIVE AGAINST THE  
HEPATITIS B VIRUS (HBV)

(57) Present invention relates to pyrazolo-piperidin  
substituted indole-2-carboxamides, active against he-  
patitis B virus (HBV) of common formula (I)

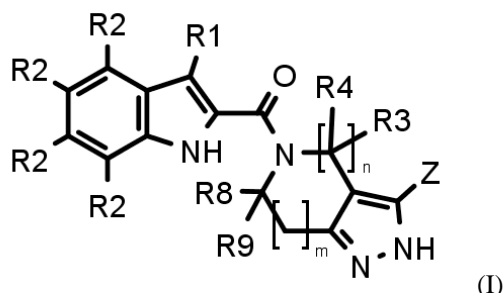

and pharmaceutical compositions containing them.

Claims: 5 independents

3 dependents

(10) AP 2021 14983 A (51) Int. Cl. (2006)  
A 61 K 39/00  
C 07 K 16/36

(21) AP 2017 14983 (22) 2017 06 12

(31) 62/349,888

(32) 2016 06 14

(33) US

(71) ADIMAB, LLC (US)

7 Lucent Drove Lebanon, NH 03766, USA (US);

MERCK SHARP & DOHME CORP. (US)

126 East Lincoln Avenue Rahway,

NJ 07065-0907, USA (US)

(72) MILLIGAN, James (US);

OLDHAM, Elizabeth (US);

CHEN, Zhu (US);

PRINZ, Bianka (US);

ELLSWORTH, Kenneth, P. (US);

SEIFFERT, Dietmar (US);

GANTI, Vaishnavi (US);

TABRIZIFARD, Mohammad (US)

(74) Shalva Gvaramadze

(85) 2019 01 10

(86) PCT/US2017/036940, 2017 06 12

(54) ANTI-COAGULATION FACTOR XI  
ANTIBODIES

(57) An invention relates to anticoagulation Factor  
XI  $\alpha$ FXI-18623p group antibodies useful for throm-  
boembolic disorders or diseases treatment.

Claims: 9 independents

9 dependents

Fig.: 17

## A 62

(10) AP 2021 15411 A (51) Int. Cl. (2006)  
A 62 C 2/06

(21) AP 2020 15411 (22) 2020 08 18

(71) Omar Lanchava (GE)

Panaskerteli St. 15a, app. 22, Tbilisi, Georgia  
(GE);

Giorgi Nozadze (GE)

Sea District, IV mcr., bld. 6, app. 37, 0178,  
Tbilisi, Georgia (GE);

Maradi Jangidze (GE)

Gldani, IV mcr., bld. 92a, app. 38, Tbilisi,  
Georgia (GE);

LEPL "GRIGOL TSULUKIDZE MINING  
INSTITUTE" (GE)

Mindeli St. 7, 0186, Tbilisi, Georgia (GE)

(72) Omar Lanchava (GE);

Giorgi Nozadze (GE);

Maradi Jangidze (GE)

(54) TRANSFORMABLE LIMIT SYSTEM TO  
LOCALIZE FIRES AND MINIMIZE LIFE-  
THREATENING CONSEQUENCES IN  
VEHICLE TUNNELS

(57) A system contains a number of partitions located  
in the tunnel, where each partition is executed as two  
independent sections A and B located on each other,  
and where each section has an ability to fully and par-  
tially open and close independently and periodically  
cross-section of tunnel, as required, so, that lower  
section B has rectangular tunnel cross-section bound-  
ary 10 placed in folded position in tunnel ceiling in  
across position, and has an ability to change position  
from across to vertical through the chain mechanism  
17 and 18, if required; at that, lower section of par-  
tition is equipped with airproof evacuation wounds 12  
for people evacuation from localized area of fire.

Claims: 1 independent

Fig.: 5

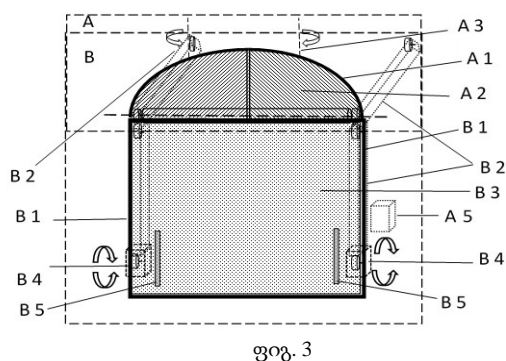

Fig. 3

**PART C****C 07**

(10) AP 2021 14363 A (51) Int. Cl. (2006)  
C 07 D 209/14  
C 07 D 209/16  
Z 61 K 31/4045  
Z 61 P 25/28

(21) AP 2015 14363 (22) 2015 07 03

(31) PA 2014 00369

(32) 2014 07 04

(33) DK

(71) H. LUNDBECK A/S (DK)

Ottoliavej 9, DK-2500 Valby, Denmark (DK)

(72) ANDERSEN, Kristine, Birklund (DK);

ROCK, Michael, Harold (DK);

DE DIEGO, Heidi, Lopez (DK);

THERKELSEN, Frans, Dennis (DK)

(74) Tamaz Shilakadze

(85) 2016 12 26

(86) PCT/EP2015/065176, 2015 07 03

(54) NOVEL POLYMORPHIC FORM OF N-[2-(6-FLUORO-LH-INDOL-3-YL)ETHYL]-3-(2,2,3,3-TETRAFLUOROPROPOXY) BENZYLAMINE HYDROCHLORIDE FOR THE TREATMENT OF ALZHEIMER'S

(57) Present invention relates to novel polymorphic form of N-[2-(6-fluoro-lh-indol-3-yl)ethyl]-3-(2,2,3,3-tetrafluoropropoxy)benzylamine hydrochloride, characterized with the following  $2\theta$  angles of X-ray powder diffractogram: 4.63, 6.94, 13.89, 17.26, and 19.97.

Claims: 12 independents

5 dependents

Fig.: 11

**PART F****F 01**

(10) AP 2021 15458 A (51) Int. Cl. (2006)

F 01 K 25/10

H 02 K 35/02

H 02 K 7/18

(21) AP 2019 15458 (22) 2019 02 07

(31) 2018-036840

(32) 2018 03 01

(33) JP

(71) KOBAYASHI, Takaitzu (JP)

3-16-33, Nekozone, Urayasu-si, Chiba 2790004, Japan (JP)

(72) KOBAYASHI, Takaitzu (JP)

(74) Shalva Gvaramadze

(85) 2020 09 28

(86) PCT/JP2019/004410, 2019 02 07

(54) WORKING MEDIUM PROPERTY DIFFERENCE POWER GENERATION SYSTEM AND WORKING MEDIUM PROPERTY DIFFERENCE POWER GENERATION METHOD THAT USES THE POWER GENERATION SYSTEM

(57) A system uses natural heat energy as a source of heat for the working medium and contains first working medium line (L1) that circulates first working medium (W1), first heat exchanger (1A), first thermal engine (2A), and a first power generator (3A), it is also equipped with second medium line (L2) that circulates second working medium (W2), second heat exchanger (1B), third working medium (W3) supply device (5) that supplies third working medium (W3) in mixing device (6) with second thermal engine (2B) and second power generator (3B). On both of downstream side of first thermal engine on first working medium line and a downstream side of second thermal engine on second working medium line the third heat exchanger (1C) is included. Also included is third working medium discharge device (10) for discharging third working medium to the third heat exchanger.

Claims: 2 independents

11 dependents

Fig.: 11



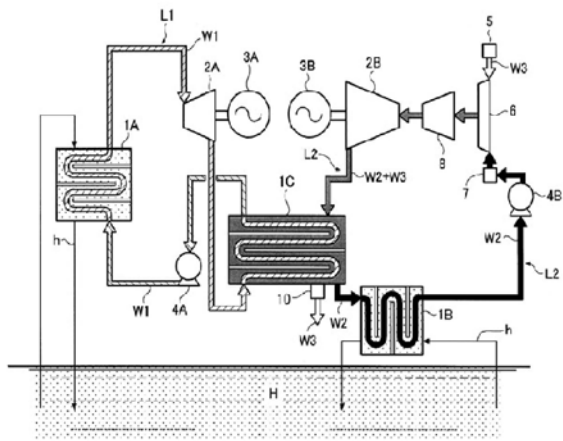

Fig. 1

## PATENTED INVENTIONS

### PART A

#### A 23

- (11) P 2021 7333 B (51) Int. Cl. (2006)  
A 23 C 21/06  
A 23 C 1/00  
C 13 K 5/00
- (10) AP 2021 15471 A (44) 14(570)/2021  
(21) AP 2020 15471  
(22) 2020 10 19  
(24) 2020 10 19
- (73) Shota Rukhadze (GE)  
Tabukashvili St. 92/52, 4600, Kutaisi,  
Georgia (GE);  
Megi Apridonidze (GE)  
Varlamishvili St. 9/10, 4600, Kutaisi,  
Georgia (GE);  
Andria Ghvinepadze (GE)  
Kazbegi St. 28, 4600, Kutaisi, Georgia (GE);  
Giorgi Pkhakadze (GE)  
26 May St. 45, 4600, Kutaisi, Georgia (GE);  
Gulnara Khetsuriani (GE)  
Rustaveli Ave. 120a, app. 42, 4600, Kutaisi,  
Georgia (GE);  
Maria Silagadze (GE)  
26 May St. 45, 4600, Kutaisi, Georgia (GE)
- (72) Shota Rukhadze (GE);  
Megi Apridonidze (GE);  
Andria Ghvinepadze (GE);  
Giorgi Pkhakadze (GE);  
Gulnara Khetsuriani (GE);  
Maria Silagadze (GE)
- (54) METHOD FOR MILK SUGAR (LACTOSE)  
PRODUCTION

- (11) P 2021 7334 B (51) Int. Cl. (2006)  
A 23 C 21/00
- (10) AP 2021 15514 A (44) 14(570)/2021  
(21) AP 2020 15514  
(22) 2020 12 09  
(24) 2020 12 09
- (73) Shota Rukhadze (GE)  
Tabukashvili St. 92/52, 4600, Kutaisi,  
Georgia (GE);  
Megi Apridonidze (GE)  
Varlamishvili St. 9/10, 4600, Kutaisi,  
Georgia (GE);  
Andria Ghvinepadze (GE)  
Kazbegi St. 28, 4600, Kutaisi, Georgia (GE);  
Giorgi Pkhakadze (GE)  
26 May St. 45, 4600, Kutaisi, Georgia (GE);  
Gulnara Khetsuriani (GE)

- Rustaveli Ave. 120a, app. 42, 4600, Kutaisi,  
Georgia (GE);  
Maria Silagadze (GE)  
26 May St. 45, 4600, Kutaisi, Georgia (GE)
- (72) Shota Rukhadze (GE);  
Megi Apridonidze (GE);  
Andria Ghvinepadze (GE);  
Giorgi Pkhakadze (GE);  
Gulnara Khetsuriani (GE);  
Maria Silagadze (GE)
- (54) METHOD FOR DIETARY BEVERAGE  
PRODUCTION ON MILK SERUM BASE

#### A 61

- (11) P 2021 7332 B (51) Int. Cl. (2006)  
A 61 K 31/4375  
A 61 P 13/00  
A 61 P 9/00  
C 07 D 471/04  
C 07 D 491/107
- (10) AP 2021 15045 A (44) 14(570)/2021  
(21) AP 2017 15045  
(22) 2017 09 06  
(24) 2017 09 06  
(31) 16188728.6; 16202509.2  
(32) 2016 09 14; 2016 12 06  
(33) EP; EP  
(86) PCT/EP2017/072339, 2017 09 06
- (73) Bayer Aktiengesellschaft (DE)  
Kaiser-Wilhelm-Allee 1, Leverkusen, 51373,  
Germany (DE);  
Bayer Pharma Aktiengesellschaft (DE)  
Müllerstraße 178, Berlin, 13353, Germany (DE)
- (72) BRECHMANN, Markus (US);  
WITTMER, Matthias, Beat (CH);  
FREUDENBERGER, Till (DE);  
MONDRITZKI, Thomas (DE);  
STRAUB, Alexander (DE);  
KULLMANN, Maximilian, Andreas (DE);  
MARQUARDT, Tobias (DE);  
VAKALOPOULOS, Alexandros (DE);  
TINEL, Hanna (DE);  
TELLER, Henrik (DE);  
BOULTADAKIS ARAPINIS, Melissa (DE)
- (74) Giorgi Kartvelishvili
- (54) 7-SUBSTITUTED 1-ARYL-  
NAPHTHYRIDINE-3-CARBOXYLIC ACID  
AMIDES AND USE THEREOF

- |   |  |  |  |
|---|--|--|--|
| <p>(11) P 2021 7329 B</p> <p>(10) AP 2021 15057 A</p> <p>(21) AP 2017 15057</p> <p>(22) 2017 09 29</p> <p>(24) 2017 09 29</p> <p>(31) 62/419,935; 62/402,838; 62/410,353; 62/415,409</p> <p>(32) 2016 11 09; 2016 09 30; 2016 10 19; 2016 10 31</p> <p>(33) US; US; US; US</p> <p>(86) PCT/US2017/054611, 2017 09 29</p> <p>(73) Vertex Pharmaceuticals Incorporated (US)<br/>50 Northern Avenue, Boston,<br/>MA 02210, USA (US)</p> <p>(72) MCCARTNEY, Jason (US);<br/>VAN GOOR, Fredrick (US);<br/>ANDERSON, Corey (US);<br/>FRIEMAN, Bryan A. (US);<br/>KRENITSKY, Paul John (US);<br/>MELILLO, Vito (US);<br/>KHATUYA, Haripada (US);<br/>CLEVELAND, Thomas (US);<br/>ZHANG, Beili (US);<br/>HUGHES, Robert M. (US);<br/>KESHAVARZ-SHOKRI, Ali (US);<br/>MCAULEY-AOKI, Rachel (US);<br/>TERMIN, Andreas P. (US);<br/>PIERRE, Fabrice Jean Denis (US);<br/>UY, Johnny (US);<br/>ABELA, Alexander Russell (US);<br/>BUSCH, Brett Bradley (US);<br/>SIESEL, David Andrew (US);<br/>ZHOU, Jinglan (US);<br/>HADIDA RUAH, Sara Sabina (US);<br/>BAEK, Minson (US);<br/>GROOTENHUIS, Peter (US);<br/>MILLER, Mark Thomas (US);<br/>ALCACIO, Timothy (US);<br/>JOSHI, Pramod Virupax (US);<br/>PARASELLI, Prasuna (US)</p> <p>(74) Aleksandre Gegechkori</p> <p>(54) MODULATOR OF CYSTIC FIBROSIS<br/>TRANSMEMBRANE CONDUCTANCE<br/>REGULATOR, PHARMACEUTICAL<br/>COMPOSITIONS, METHODS OF<br/>TREATMENT, AND PROCESS<br/>FOR MAKING THE MODULATOR</p> | <p>(51) Int. Cl. (2006)<br/>A 61 K 31/4439<br/>A 61 P 11/12<br/>C 07 D 498/14<br/>C 07 D 471/14<br/>C 07 D 401/14</p> <p>(44) 10(566)/2021</p> | <p>(11) P 2021 7327 B</p> <p>(10) AP 2021 15281 A</p> <p>(21) AP 2018 15281</p> <p>(22) 2018 08 28</p> <p>(24) 2018 08 28</p> <p>(31) 62/551,721</p> <p>(32) 2017 08 29</p> <p>(33) US</p> <p>(86) PCT/US2018/048372, 2018 08 28</p> <p>(73) Lundbeck La Jolla Research Center Inc. (US)<br/>10835 Rd. To the Cure, Suite 250, San Diego,<br/>CA 92121, (US)</p> <p>(72) GRICE, Cheryl A. (US);<br/>WEBER, Olivia D. (US);<br/>BUZARD, Daniel J. (US);<br/>SHAGHAFI, Michael B. (US);<br/>JONES, Todd K. (US)</p> <p>(74) Tamaz Shilakadze</p> <p>(54) SPIROCYCLE COMPOUNDS AND<br/>METHODS OF MAKING AND<br/>USING SAME</p> | <p>(51) Int. Cl. (2006)<br/>A 61 K 31/27<br/>A 61 K 31/438<br/>A 61 K 31/435<br/>C 07 D 403/04<br/>C 07 D 295/205<br/>C 07 D 471/10</p> <p>(44) 14(570)/2021</p> |
| <p>(11) P 2021 7328 B</p> <p>(10) AP 2021 14828 A</p> <p>(21) AP 2016 14828</p> <p>(22) 2016 12 12</p> <p>(24) 2016 12 12</p> <p>(31) 62/266,944</p> <p>(32) 2015 12 14</p> <p>(33) US</p> <p>(86) PCT/US2016/066060, 2016 12 12</p> <p>(73) Macrogenics Inc. (US)<br/>9704 Medical Center Drive, Rockville,<br/>MD 20850, USA (US)</p> <p>(72) JOHNSON, Leslie, S. (US)<br/>CHICHILI, Gurunadh, Reddy (US);<br/>SHAH, Kalpana (US);<br/>LA MOTTE-MOHS, Ross (US);<br/>MOORE, Paul, A. (US);<br/>BONVINI, Ezio (US);<br/>KOENIG, Scott (US)</p> <p>(74) Shalva Gvaramadze</p> <p>(54) BISPECIFIC MOLECULES HAVING<br/>IMMUNOREACTIVITY WITH PD-1<br/>AND CTLA-4, AND METHODS OF<br/>USE THEREOF</p>   | <p>(51) Int. Cl. (2006)<br/>A 61 K 39/395<br/>C 07 K 16/28<br/>C 07 K 16/30<br/>C 07 K 16/46</p> <p>(44) 14(570)/2021</p>                      |  |  |

**PART C**

(74) Shalva Gvaramadze  
(54) ANTI-TIGIT ANTIBODIES

---

C 07

- (11) P 2021 7330 B (51) Int. Cl. (2006)  
C 07 B 59/00  
C 07 D 295/145
- (10) AP 2021 14132 A (44) 10(566)/2021  
(21) AP 2014 14132  
(22) 2014 10 17  
(24) 2014 10 17  
(31) 14175612.2; 13004991.9  
(33) EP; EP  
(86) PCT/EP2014/002808, 2014 10 17  
(73) Deutsches Krebsforschungszentrum (DE)  
Im Neuenheimer Feld 280, 69120 Heidelberg,  
Germany (DE);  
Ruprecht-Karls-Universität Heidelberg (DE)  
Grabengasse 1, 69117 Heidelberg,  
Germany (DE)
- (72) EDER, Matthias (DE);  
KOPKA, Klaus (DE);  
SCHÄFER, Martin (DE);  
BAUDER-WÜST, Ulrike (DE);  
HABERKORN, Uwe (DE);  
EISENHUT, Michael (DE);  
MIER, Walter (DE);  
BENESOVA, Martina (CZ)
- (74) Shalva Gvaramadze  
(54) LABELED INHIBITORS OF PROSTATE  
SPECIFIC MEMBRANE ANTIGEN (PSMA),  
THEIR USE AS IMAGING AGENTS AND  
PHARMACEUTICAL AGENTS FOR THE  
TREATMENT OF PROSTATE CANCER
- 

- (11) P 2021 7331 B (51) Int. Cl. (2006)  
C 07 K 16/28  
A 61 K 39/395  
A 61 P 37/02  
A 61 K 39/00
- (10) AP 2021 14450 A (44) 13(569)/2021  
(21) AP 2015 14450  
(22) 2015 08 17  
(24) 2015 08 17  
(31) 62/126,733; 62/038,912  
(32) 2015 03 02; 2014 08 19  
(33) US; US  
(86) PCT/US2015/045447, 2015 08 17  
(73) MERCK SHARP & DOHME CORP. (US)  
126 EastLincoln Ave, Rahway, NJ 07065 – 0907,  
USA (US)
- (72) WILLIAMS, Sybil, M. G. (US);  
LAFACE, Drake (US);  
FAYADAT-DILMAN, Laurence (US);  
RAGHUNATHAN, Gopalan (US);  
LIANG, Linda (US);  
SEGHEZZI, Wolfgang (DE)
-

---

# UTILITY MODELS

## APPLICATION APPROVED FOR GRANTING PATENT

The decision can be appealed at the Chamber of Appeal of Sakpatenti within 3 months from the publication or at the Mtskheta District Court Administrative Cases Board (Address: №17, Samkhedro St., Mtskheta), within 1 month following the publication.

### PART A

#### A 21

(10) AU 2021 15552 U (51) Int. Cl. (2006)

A 21 D 10/04

A 21 C 1/00

(21) AU 2021 15552 (22) 2021 02 06

(71) Ramin Ghvaladze (GE)

Varketili 3, IV mcr., bld. 414, app. 165,  
0163, Tbilisi, Georgia (GE)

(72) Ramin Ghvaladze (GE)

(54) METHOD FOR DOUGH PRODUCTION FOR  
BAKING BREAD WITHOUT YEAST

(57) A method provides mixing of carbon dioxide gas/water solution, under the pressure of 5-10 bar, with white flour, and dough kneading under the pressure of 5-10 bar in dough kneading machine; then, making free the machine from the pressure, as a result whereof the carbon dioxide becomes free from the water, bubbles appear in the dough and it is puff. As gas pressure is more at dough preparation, as large bubbles are appear, and the dough is more puff. Sparkling water (water/carbon dioxide solution) addition onto the dough placed in the kneading machine can be provided by means of two methods: sparkling water is prepared in the separate machine, and then it is added into kneading machine, by one method, and water and gas are sprayed, under pressure of 5-10 bar, in the kneading machine, by another method.

Claims: 1 independent

---

---

# DESIGNS

## APPLICATIONS APPROVED FOR REGISTRATION

The decision can be appealed at the Chamber of Appeal of Sakpatenti within 3 months from the publication or at the Mtskheta District Court Administrative Cases Board (Address: №17, Samkhedro str., Mtskheta), within 1 month following the publication.

- (10) AD 2021 1224 S      (51) 06-10  
(21) AD 2021 1224      (22) 2021 06 15  
(28) 1  
(31) 202030779890.7  
(32) 2020 12 17  
(33) CN  
(71) SHAOXING KEQIAO DIWAN TEXTILE CO. LTD (CN)  
    Qingfeng Vill. Qianqing Town, Keqiao District, Shaoxing,  
    Zhejiang 312030, China (CN)  
(72) GUO, Zhen (CN)  
(74) Larisa Amirkhanyan (GE)  
(54) CURTAIN WITH TIEBACKS  
(55)

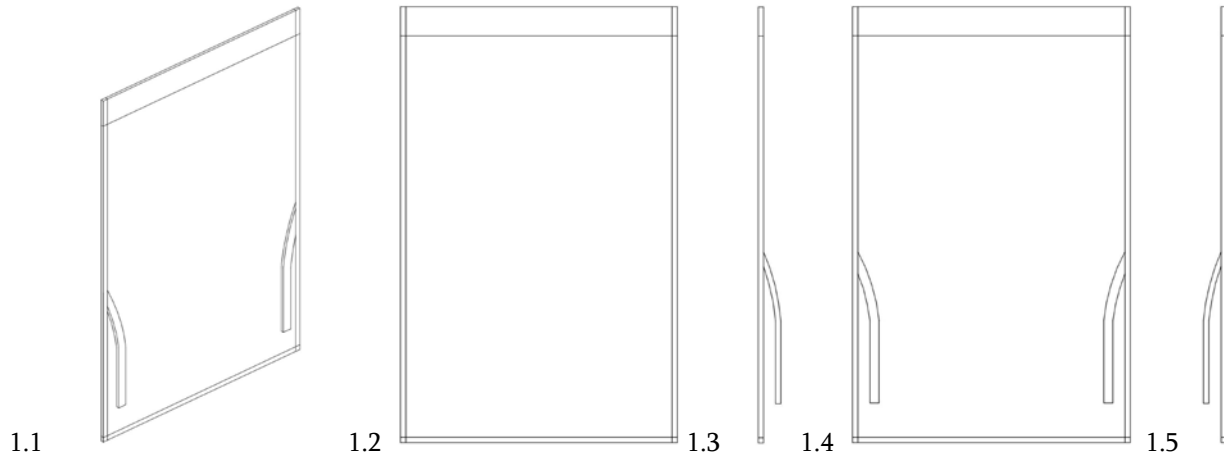

- (10) AD 2021 1226 S (51) 09-03  
 (21) AD 2021 1226 (22) 2021 06 20  
 (28) 3  
 (71) Zurab Mamulashvili (GE)  
 Al. Kazbegi Ave. 35 b, 0177, Tbilisi, Georgia (GE)  
 (72) Zurab Mamulashvili (GE)  
 (74) Zurab Mamulashvili (GE)  
 (54) 1. BOX FOR WOODY KNIFE; 2. BOX FOR WOODY FORK;  
 3. BOX FOR WOODY SPOON  
 (55)



(10) AD 2021 1231 S (51) 11-02  
(21) AD 2021 1231 (22) 2021 07 27  
(28) 2  
(71) LLC "ZARAPKHANA" (GE)  
Lublana St. 15, 0159, Tbilisi, Georgia (GE)  
(72) Tea Tetradze (GE)  
(54) 1.-2.COLLECTION KNIFE  
(55)



1.1



1.2



2.1



2.2



2.3

---



(10) AD 2021 1217 S (51) 12-08  
(21) AD 2021 1217 (22) 2021 05 31  
(28) 1  
(71) Zake Tkemaladze (GE)  
Zurab Chavchavadze St. 8/108, 4600, Kutaisi, Georgia (GE)  
(72) Zake Tkemaladze (GE)  
(54) AUTOMOBILE DESIGN  
(55)

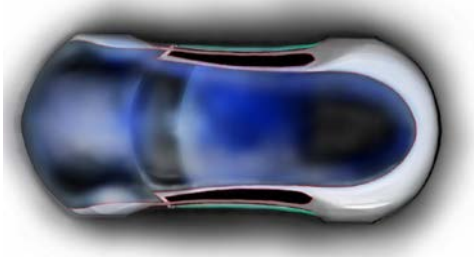

1.1

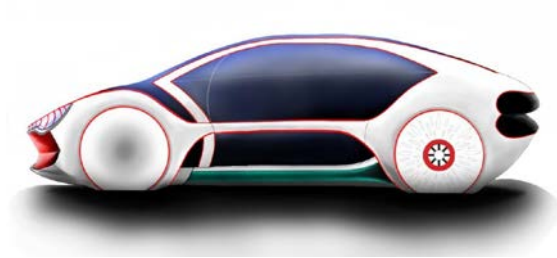

1.2



1.3



1.4

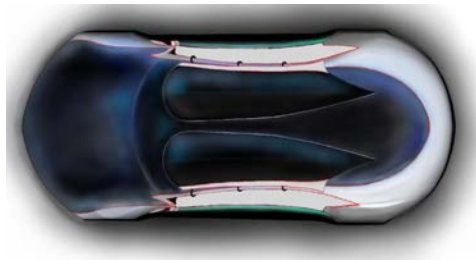

1.5

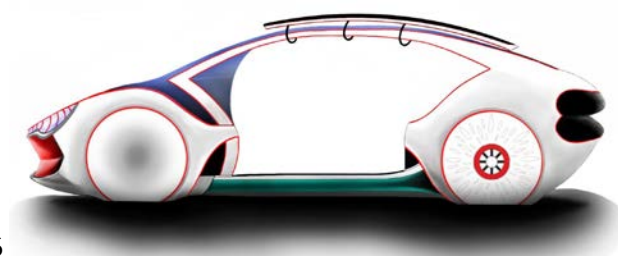

1.6

## DESIGNS REGISTERED WITH INTERNATIONAL BUREAU CLAIMING PRIORITY ON THE TERRITORY OF GEORGIA

The decision can be appealed at the Chamber of Appeal of Sakpatenti within 3 months from the publication or at the Mtskheta District Court Administrative Cases Board (Address: №17, Samkhedro St., Mtskheta), within 1 month following the publication.

- (11) DM/215 968 (51) 13-03  
 (15) 2021 05 31 (44) 35/2021 (2021 09 03)  
 (22) 2021 05 31  
 (28) 2  
 (73) Dernek Grup Elektrik Elektronik Dış Ticaret Ve Sanayi Limited Şirketi  
 İstanbul Trakya Serbest Bölgesi, Ferhatpaşa Sb Mahallesi, Sümbül Sokak, №5/41, Çatalca İstanbul (TR)  
 (85) TR  
 (86) TR  
 (87) TR  
 (88) TR  
 (89) TR  
 (81) III. AL, AM, AZ, BA, EM, GE, KG, ME, MK, NA, OA, RS, SY, TJ, UA  
 (72) Serhat Dernek  
 İstanbul Trakya Serbest Bölgesi, Ferhatpaşa Sb Mahallesi, Sümbül Sokak, №5/41, Çatalca, İstanbul (TR)  
 (74) Destek Patent Anonim Şirketi  
 Konak Mahallesi, İzmir Yolu Caddesi, Ruzi İş Merkezi Apt., No:95/1B TR-16110 Nilüfer, 16110  
 BURSA (TR)  
 (54) 1. Electric switch, 2. Electric outlet  
 (55)

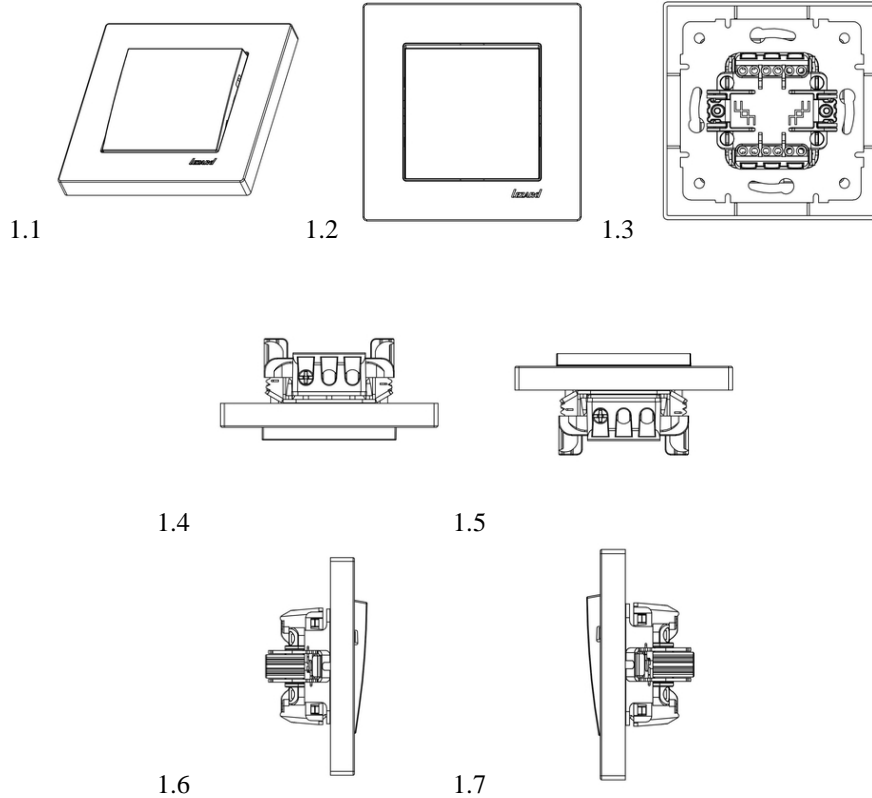

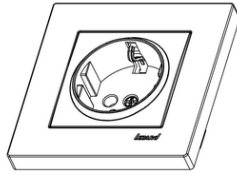

2.1

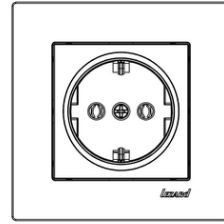

2.2

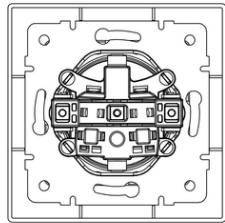

2.3

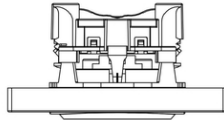

2.4

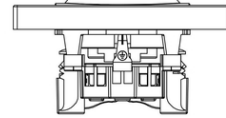

2.5

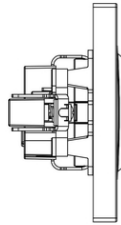

2.6

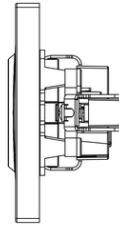

2.7

- (11) DM/216 019 (51) 14-03  
(15) 2021 08 19 (44) 35/2021 (2021 09 03)  
(22) 2021 08 19  
(28) 1  
(30) №1: 23.02.2021; 29771496; US  
(73) Apple Inc.  
One Apple Park Way, 95014 Cupertino, CA (US)  
(85) –  
(86) –  
(87) –  
(88) US  
(89) US  
(81) III. AL, AM, AZ, BA, BG, BN, BW, BX, BY, BZ, CA, CH, DE, DK, EE, EG, EM, ES, FI, FR, GB, GE, GH, HR, HU, IL, IS, JP, KG, KH, KP, KR, LI, LT, LV, MC, MD, ME, MK, MN, MX, NA, NO, OA, OM, PL, RO, RS, RU, RW, SG, SI, SM, SR, ST, SY, TJ, TM, TN, TR, UA, US, VN, WS  
(72) Eugene Antony Whang  
One Apple Park Way, Cupertino, CA (US);  
Clement Tissandier  
One Apple Park Way, Cupertino, CA (US);  
Joe Sung-Ho Tan  
One Apple Park Way, Cupertino, CA (US);  
Benjamin Andrew Shaffer  
One Apple Park Way, Cupertino, CA (US);  
Peter Russell-Clarke  
One Apple Park Way, Cupertino, CA (US);  
Nicolas Lylyk  
One Apple Park Way, Cupertino, CA (US);  
Duncan Robert Kerr  
One Apple Park Way, Cupertino, CA (US);  
Julian Jaede  
One Apple Park Way, Cupertino, CA (US);  
Richard P. Howarth  
One Apple Park Way, Cupertino, CA (US);  
M. Evans Hankey  
One Apple Park Way, Cupertino, CA (US);  
Jonathan Gomez Garcia  
One Apple Park Way, Cupertino, CA (US);  
Markus Diebel  
One Apple Park Way, Cupertino, CA (US);  
Clara Geneviève Marine Courtaigne  
One Apple Park Way, Cupertino, CA (US);  
Abidur Rahman Chowdhury  
One Apple Park Way, Cupertino, CA (US);  
Jeremy Bataillou  
One Apple Park Way, Cupertino, CA (US);  
Marine C. Bataille  
One Apple Park Way, Cupertino, CA (US);  
Anthony Michael Ashcroft  
One Apple Park Way, Cupertino, CA (US);  
Shota Aoyagi  
One Apple Park Way, Cupertino, CA (US);  
Bartley K. Andre  
One Apple Park Way, Cupertino, CA (US);  
Molly Anderson  
One Apple Park Way, Cupertino, CA (US);  
Jody Akana  
One Apple Park Way, Cupertino, CA (US)  
(74) Saidman DesignLaw Group  
LLC / George Raynal, 8601 Georgia Avenue Suite №603, 20910 Silver Spring, MD (US)

(54) 1. Remote control [wireless]  
(55)

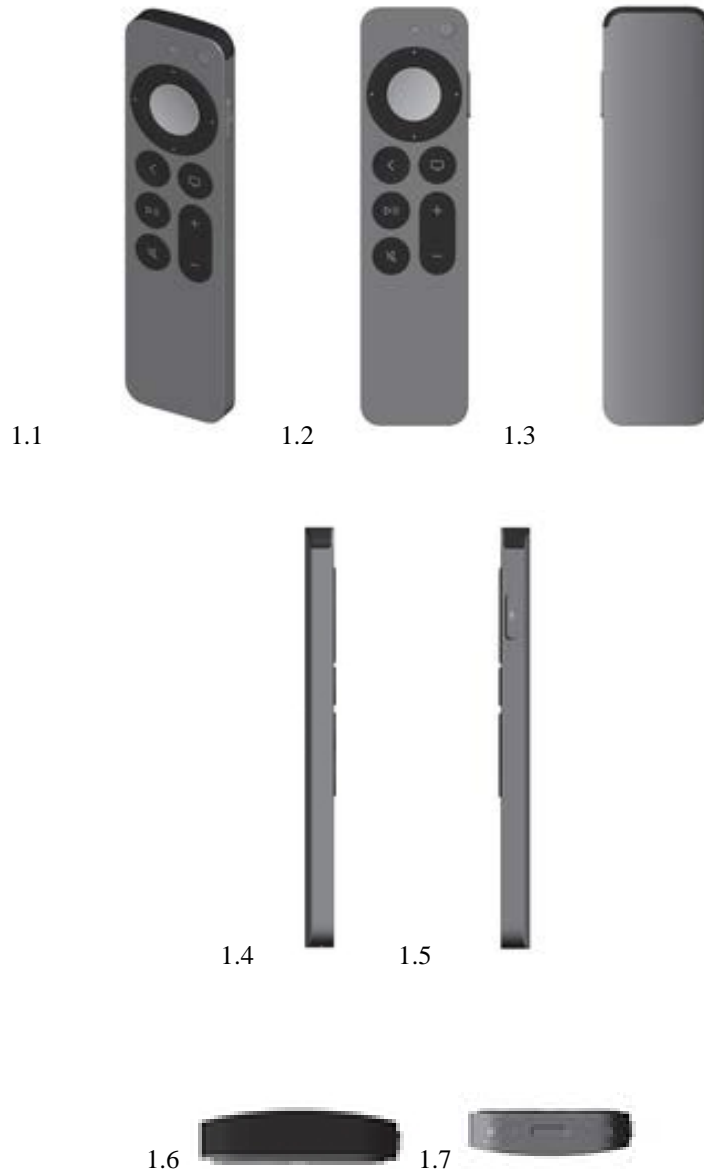

- (11) DM/213 318                   (51) 11-01
- (15) 2021 03 05                   (44) 36/2021 (2021 09 10)
- (22) 2021 03 05
- (28) 6
- (73) HARRY WINSTON SA  
    Chemin Du Tourbillon 8, 1228 Plan-les-Ouates (CH)
- (85) CH
- (86) CH
- (87) CH
- (88) CH
- (89) CH
- (81) II. MA III. AL, AM, AZ, BA, BZ, CA, CH, EM, GB, GE, KG, LI, MC, MD, ME, MK, MN, NO, OM, SG,  
    TN, TR, UA
- (72) 1-3 Tobias WUEST  
    C/o Harry Winston Inc., 718 Fifth Avenue, 10019, New York (US);  
    4-6 Delphine ABDOURAHIM  
    C/o Harry Winston Inc., 718 Fifth Avenue, 10019, New York (US)
- (74) The Swatch Group AG (The Swatch Group SA) (The Swatch Group Ltd)  
    Faubourg Du Lac 6, 2501 Biel/Bienne (CH)
- (54) 1.-2. Pair of earrings, 3. Finger ring, 4. Necklace, 5. Finger ring, 6. Pair of earrings
- (55)

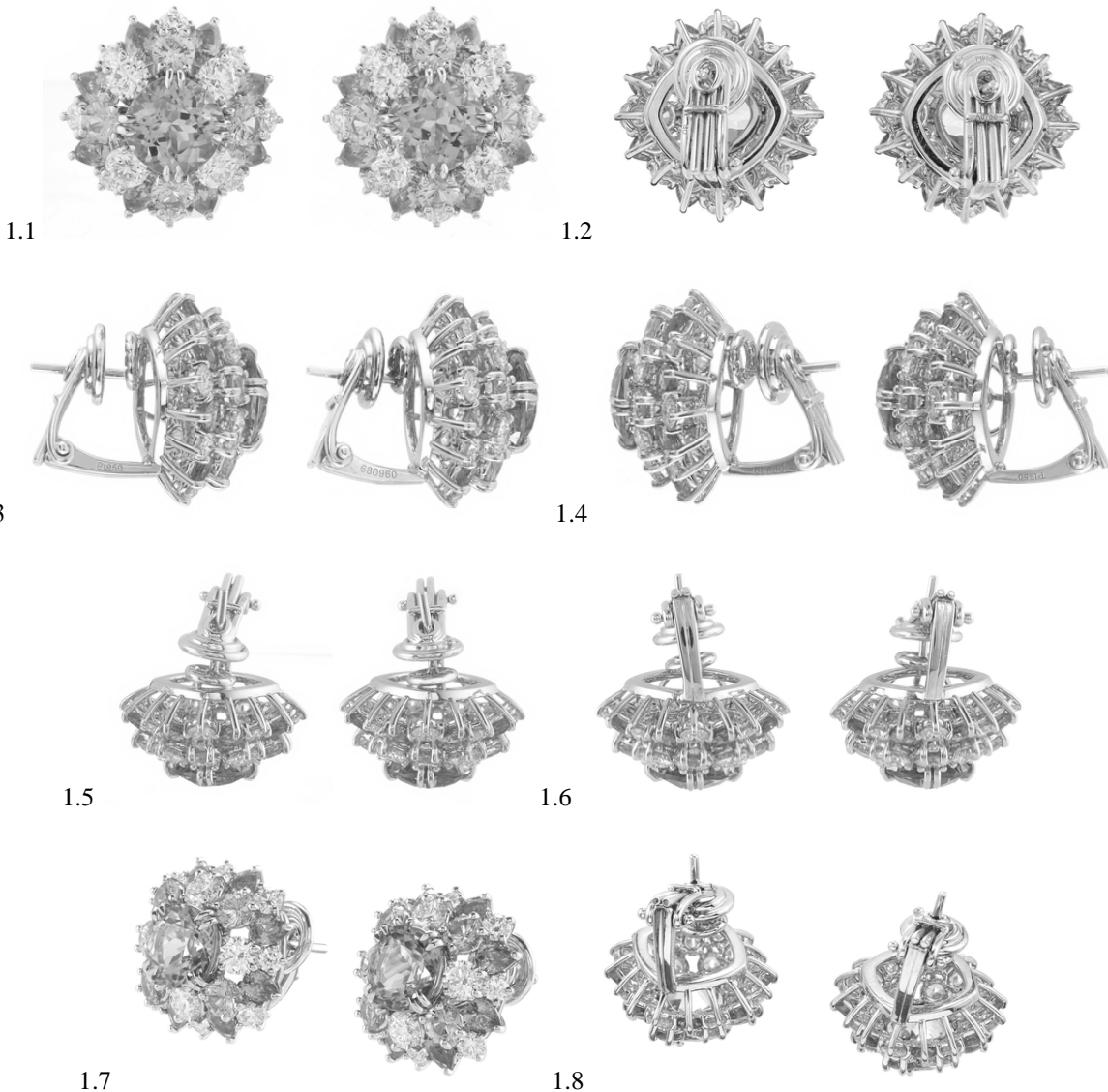

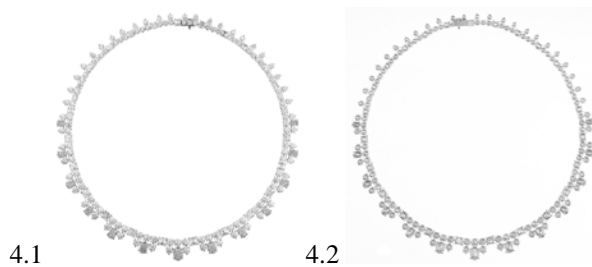



4.3



4.4



4.5



4.6



4.7



4.8



5.1



5.2



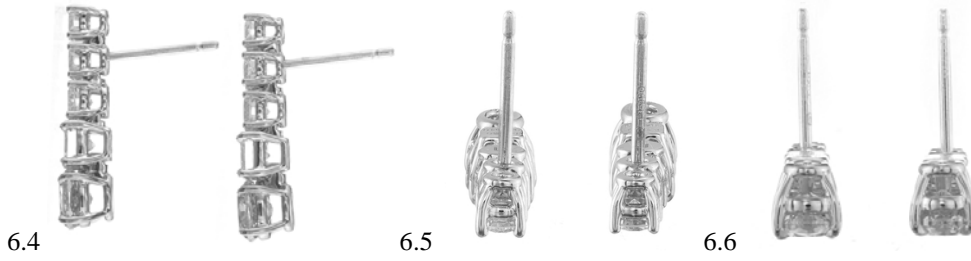

- (11) DM/213 220
- (15) 2021 03 11
- (22) 2021 03 11
- (28) 2
- (73) HARRY WINSTON SA  
Chemin Du Tourbillon 8, 1228 Plan-les-Ouates (CH)
- (85) CH
- (86) CH
- (87) CH
- (88) CH
- (89) CH
- (81) II. MA III. AL, AM, AZ, BA, BZ, CA, CH, EM, GB, GE, KG, LI, MC, MD, ME, MK, MN, NO, OM, SG, TN, TR, UA
- (72) 1 Tobias WUEST  
C/o Harry Winston Inc. 718 Fifth Avenue, 10019, New York (US);  
2 Delphine ABDOURAHIM  
C/o Harry Winston Inc. 718 Fifth Avenue, 10019, New York (US)
- (74) The Swatch Group AG (The Swatch Group SA) (The Swatch Group Ltd)  
Faubourg Du Lac 6, 2501 Biel/Bienne (CH)
- (54) 1.-2. Pair of earrings
- (55)

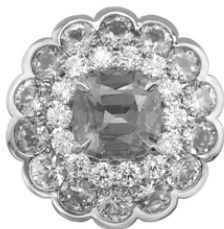

1.1



1.2



1.3



1.4



1.5



1.6



1.7



1.8





- (11) DM/213 338 (51) 11-01  
(15) 2021 03 19 (44) 38/2021 (2021 09 24)  
(22) 2021 03 19  
(28) 6  
(73) HARRY WINSTON SA  
Chemin Du Tourbillon 8, 1228 Plan-les-Ouates (CH)  
(85) CH  
(86) CH  
(87) CH  
(88) CH  
(89) CH  
(81) II. MA III. AL, AM, AZ, BA, BZ, CA, CH, EM, GB, GE, KG, LI, MC, MD, ME, MK, MN, NO, OM, SG, TN, TR, UA  
(72) 1. Delphine ABDOURAHIM  
C/o Harry Winston Inc. 718 Fifth Avenue, 10019, New York (US);  
2. Tobias WUEST  
C/o Harry Winston Inc. 718 Fifth Avenue, 10019, New York (US);  
3; 5-6 Rie YATSUGI-KANG  
C/o Harry Winston Inc. 718 Fifth Avenue, 10019, New York (US);  
4. Dominique RIVIERE  
C/o Harry Winston Inc. 718 Fifth Avenue, 10019, New York (US)  
(74) The Swatch Group AG (The Swatch Group SA) (The Swatch Group Ltd.)  
Faubourg Du Lac 6, 2501 Biel/Bienne (CH)  
(54) 1. Necklace, 2. Pair of earrings, 3.-5. Finger ring, 6. Pair of earrings  
(55)



1.1

1.2

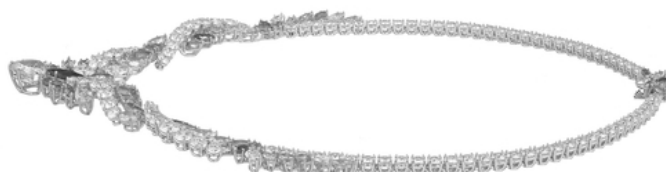

1.3



1.4



1.5



1.6



1.7



1.8



2.1



2.2



2.3



2.4



2.5



2.6



2.7



2.8



3.1





3.2



3.3



3.4



3.5



3.6



3.7



3.8



4.1



4.2



4.3



4.4



4.5



4.6



4.7



4.8



5.1



5.2



5.3



5.4



5.5



5.6



5.7



5.8



6.1



6.2



6.3



6.4



6.5



6.6



6.7



6.8



---

# TRADEMARKS

## APPLICATIONS FILED UNDER NATIONAL PROCEDURE APPROVED FOR REGISTRATION

The decision can be appealed at the Chamber of Appeal of Sakpatenti within 3 months from the publication or at the Mtskheta District Court Administrative Cases Board (Address: №17, Samkhedro St., Mtskheta), within 1 month following the publication.

(260) AM 2021 110201 A\*  
(210) AM 110201  
(220) 2020 10 19  
(731) LLC "Ori Nabiji"  
Navtlughi St. 39-41, 0113, Isani District,  
Tbilisi, Georgia  
(540)



(591) 721039 dark lilak  
(531) 28.19; 29.01.01  
(511) 32, 33

---

(260) AM 2021 112185 A  
(210) AM 112185  
(220) 2021 05 17  
(731) JSC "Faber"  
Davit Aghmashenebeli Av. 55/1, Tbilisi,  
Georgia  
(740) Giorgi Batlidze;  
Mariam Ghubianuri  
(540)



(591) Black-white  
(531) 27.05.01  
(511) 9, 25, 38, 42

---

(260) AM 2021 112585 A  
(210) AM 112585  
(220) 2021 04 12  
(731) LLC "Berketi-Design"  
Vazha-Pshavela Av., VII qu., bld. 1a,  
app. 90, 0186, Tbilisi, Georgia  
(740) Giorgi Ghvinjilia

(540)



(591) 299843 green  
(531) 27.05.01; 29.01.03  
(511) 37

---

(260) AM 2021 112666 A  
(210) AM 112666  
(220) 2021 04 16  
(731) LLC "Bolero & Company"  
Kuchishvili St. 12-14-16, 0179, Tbilisi, Georgia  
(540)

საამურა  
Saamura  
Саамура

(591) Black-white  
(511) 33

---

260) AM 2021 112667 A  
(210) AM 112667  
(220) 2021 04 16  
(731) LLC "Bolero & Company"  
Kuchishvili St. 12-14-16, 0179, Tbilisi, Georgia  
(540)

საბუდარა  
Sabudara  
Сабудара

(591) Black-white  
(511) 33

---



(260) AM 2021 112670 A  
 (210) AM 112670  
 (220) 2021 04 16  
 (731) LLC "Bolero & Company"  
 Kuchishvili St. 12-14-16, 0179, Tbilisi,  
 Georgia

(540)

**Секрет винокура**  
**სეკრეტ ვინოკურა**  
**Sekret Winokura**

(591) Black-white  
 (511) 33

(260) AM 2021 112671 A  
 (210) AM 112671  
 (220) 2021 04 16  
 (731) LLC "Bolero & Company"  
 Kuchishvili St. 12-14-16, 0179, Tbilisi,  
 Georgia

(540)

**კარიჭა**  
**Karicha**  
**Карича**

(591) Black-white  
 (511) 33

(260) AM 2021 112677 A  
 (210) AM 112677  
 (220) 2021 04 19  
 (731) The Procter & Gamble Company  
 One Procter & Gamble Plaza, Cincinnati,  
 Ohio 45202, USA

(740) Merab Kvimsadze  
 (540)

**ALWAYS ZZZ**

(591) Black-white  
 (531) 27.05.01  
 (511) 5

(260) AM 2021 112678 A  
 (210) AM 112678  
 (220) 2021 04 19  
 (731) The Procter & Gamble Company  
 One Procter & Gamble Plaza, Cincinnati,  
 Ohio 45202, USA

(740) Merab Kvimsadze  
 (540)

**COMFORTLOCK WINGS**

(591) Black-white

(531) 27.05.01  
 (511) 5

(260) AM 2021 112707 A  
 (210) AM 112707  
 (220) 2021 04 22  
 (731) Mohan Meakin Limited  
 Solan Brewery P. O. N173 214, Shimla Hills,  
 Himachal Pradesh, India  
 (740) Tamaz Shilakadze  
 (540)

**OLD MONK**

(591) Black-white  
 (511) 32

(260) AM 2021 112708 A  
 (210) AM 112708  
 (220) 2021 04 22  
 (731) Maxeon Solar Pte. LTD.  
 8 Marina Boulevard N05-02 Marina Bay  
 Financial Centre, 018981, Singapore  
 (740) Tamaz Shilakadze  
 (540)

**MAXEON**

(591) Black-white  
 (511) 9

(260) AM 2021 112709 A  
 (210) AM 112709  
 (220) 2021 04 23  
 (731) LTD "Barambo"  
 Vill. Natakhtari, 3308, Mtskheta, Georgia  
 (540)

**ბარემ**  
**barem**

(591) Black-white  
 (511) 30

(260) AM 2021 112710 A  
 (210) AM 112710  
 (220) 2021 04 23  
 (731) LLC "Rtvelisi"  
 R. Shmerling St. 19, 0131, Tbilisi, Georgia  
 (540)



(591) Black, golden  
 (531) 03.03.01; 03.03.24; 26.04.15; 26.04.24;  
 27.05.01; 27.05.24; 29.01.12  
 (511) 33, 35

(260) AM 2021 112711 A  
 (210) AM 112711  
 (220) 2021 04 23  
 (310) 81,805  
 (320) 2020 10 26  
 (330) JM  
 (731) INTEL CORPORATION  
 2200 Mission College Boulevard, Santa Clara,  
 California 95052, USA  
 (740) Tamaz Shilakadze  
 (540)

## ARC

(591) Black-white  
 (511) 9, 42

(260) AM 2021 112712 A  
 (210) AM 112712  
 (220) 2021 04 23  
 (310) 81,814  
 (320) 2020 10 26  
 (330) JM  
 (731) JNT Systems Inc.  
 1209 Orange Street, Wilmington, Delaware  
 19801, USA  
 (740) Tamaz Shilakadze  
 (540)

## HELIX

(591) Black-white  
 (511) 9, 42

(260) AM 2021 112722 A  
 (210) AM 112722  
 (220) 2021 04 28  
 (731) LTD "Cyclone"  
 Sulkhan Tsintsadze St. 58, Commercial Space  
 10, bld. B, entr. 3, fl. 1, 0160, Saburtalo  
 District, Tbilisi, Georgia  
 (740) Badri Niauri  
 (540)



(591) Blue, white  
 (531) 01.15.23; 01.15.24; 26.01.12; 26.15.01;  
 27.05.01; 28.19; 29.01.04  
 (511) 37

(260) AM 2021 112723 A  
 (210) AM 112723  
 (220) 2021 04 28  
 (731) Tab Gıda Sanayi ve Ticaret Anonim Şirketi  
 Emirhan Caddesi Atakule No:109, Dikilitaş  
 Beşiktaş İstanbul, Turkey  
 (740) Tamaz Shilakadze  
 (540)



(591) Black, white, red  
 (531) 02.01.11; 26.01.14; 29.01.13  
 (511) 29, 30, 35, 43

(260) AM 2021 112724 A  
 (210) AM 112724  
 (220) 2021 04 28  
 (731) Tab Gıda Sanayi ve Ticaret Anonim Şirketi  
 Emirhan Caddesi Atakule No:109, Dikilitaş  
 Beşiktaş İstanbul, Turkey  
 (740) Tamaz Shilakadze  
 (540)



(591) Black, white, brown, red  
 (531) 02.01.11; 26.01.14; 29.01.13  
 (511) 29, 30, 35, 43

(260) AM 2021 112732 A  
 (210) AM 112732  
 (220) 2021 04 29  
 (731) Gaba International Holding GmbH  
 Grabetsmattweg, Therwil 4106, Switzerland  
 (740) Tamaz Shilakadze  
 (540)



(591) Black-white

(531) 24.13.05; 24.13.13; 24.13.14; 26.04.04;  
26.04.24; 27.05.01; 27.05.24  
(511) 3, 5, 21

(260) AM 2021 112835 A  
(210) AM 112835  
(220) 2021 04 30  
(731) LTD "Nick-2007"  
E. Akhvlediani St., Lane 6, 0103, Tbilisi,  
Georgia  
(540)



(591) Sky-blue, blue  
(531) 06.01.01; 06.01.04; 26.01.01; 26.01.16;  
29.01.04  
(511) 6, 8, 22, 25, 28

(260) AM 2021 112836 A  
(210) AM 112836  
(220) 2021 05 04  
(731) Bosnalijek d.d., Pharmaceutical and Chemical  
Industry, Joint Stock Company  
71000 Sarajevo, Jukićeva 53, Bosnia and  
Herzegovina  
(740) Nino Bakhtadze  
(540)

## ENTEROHYDRON

(591) Black-white  
(511) 5

(260) AM 2021 112909 A  
(210) AM 112909  
(220) 2021 05 11  
(731) Alkaloid AD Skopje  
Blvd. Aleksandar Makedonski 12, Skopje,  
1000, The Republic  
of North Macedonia  
(740) Shalva Gvaramadze  
(540)

## БЛОКМАКС

(591) Black-white  
(511) 5

(260) AM 2021 112910 A  
(210) AM 112910  
(220) 2021 05 11  
(731) Alkaloid AD Skopje  
Blvd. Aleksandar Makedonski 12, Skopje,  
1000, The Republic of North Macedonia  
(740) Shalva Gvaramadze  
(540)

## МОКСИРАЛ

(591) Black-white  
(511) 5

(260) AM 2021 112911 A  
(210) AM 112911  
(220) 2021 05 11  
(731) Alkaloid AD Skopje  
Blvd. Aleksandar Makedonski 12, Skopje,  
1000, The Republic of North Macedonia  
(740) Shalva Gvaramadze

(540)

## СКОПРИЛ ПЛЮС

(591) Black-white  
(511) 5

(260) AM 2021 112912 A  
(210) AM 112912  
(220) 2021 05 11  
(731) Alkaloid AD Skopje  
Blvd. Aleksandar Makedonski 12, Skopje,  
1000, The Republic of North Macedonia  
(740) Shalva Gvaramadze  
(540)

## ТИРЕЗ

(591) Black-white  
(511) 5

(260) AM 2021 112913 A  
(210) AM 112913  
(220) 2021 05 11  
(731) Alkaloid AD Skopje  
Blvd. Aleksandar Makedonski 12, Skopje,  
1000, The Republic of North Macedonia  
(740) Shalva Gvaramadze  
(540)

## РОПУИДО

(591) Black-white  
(511) 5

(260) AM 2021 112914 A  
 (210) AM 112914  
 (220) 2021 05 11  
 (731) Alkaloid AD Skopje  
 Blvd. Aleksandar Makedonski 12, Skopje,  
 1000, The Republic of North Macedonia  
 (740) Shalva Gvaramadze  
 (540)

## СКОПРИЛ

(591) Black-white  
 (511) 5

(260) AM 2021 112915 A  
 (210) AM 112915  
 (220) 2021 05 11  
 (731) Alkaloid AD Skopje  
 Blvd. Aleksandar Makedonski 12, Skopje,  
 1000, The Republic of North Macedonia  
 (740) Shalva Gvaramadze  
 (540)

## ХЕФЕРОЛ

(591) Black-white  
 (511) 5

(260) AM 2021 112916 A  
 (210) AM 112916  
 (220) 2021 05 11  
 (731) Alkaloid AD Skopje  
 Blvd. Aleksandar Makedonski 12, Skopje,  
 1000, The Republic of North Macedonia  
 (740) Shalva Gvaramadze  
 (540)

## БРОНЛЕС

(591) Black-white  
 (511) 5

(260) AM 2021 112917 A  
 (210) AM 112917  
 (220) 2021 05 11  
 (731) Alkaloid AD Skopje  
 Blvd. Aleksandar Makedonski 12, Skopje,  
 1000, The Republic of North Macedonia  
 (740) Shalva Gvaramadze  
 (540)

## СТАВРА

(591) Black-white  
 (511) 5

(260) AM 2021 112918 A  
 (210) AM 112918  
 (220) 2021 05 11  
 (731) Alkaloid AD Skopje

Blvd. Aleksandar Makedonski 12, Skopje,  
 1000, The Republic of North Macedonia  
 (740) Shalva Gvaramadze  
 (540)

## ПАНЦЕФ

(591) Black-white  
 (511) 5

(260) AM 2021 112919 A  
 (210) AM 112919  
 (220) 2021 05 11  
 (731) Alkaloid AD Skopje  
 Blvd. Aleksandar Makedonski 12, Skopje,  
 1000, The Republic of North Macedonia  
 (740) Shalva Gvaramadze  
 (540)

## КАФФЕТИН ЛЕДИ

(591) Black-white  
 (511) 5

(260) AM 2021 112920 A  
 (210) AM 112920  
 (220) 2021 05 11  
 (731) Alkaloid AD Skopje  
 Blvd. Aleksandar Makedonski 12, Skopje,  
 1000, The Republic of North Macedonia  
 (740) Shalva Gvaramadze  
 (540)

## БУЛНЕКСО

(591) Black-white  
 (511) 5

(260) AM 2021 113009 A  
 (210) AM 113009  
 (220) 2021 05 14  
 (731) LTD "MS Group"  
 Chirnakhuli St. 4, 0151, Tbilisi,  
 Georgia  
 (540)



(591) Dark green, light green, orange  
 (531) 07.01.09; 27.05.01; 27.05.21; 28.19; 29.01.12  
 (511) 7, 8, 11, 21,35

(260) AM 2021 113033 A  
 (210) AM 113033  
 (220) 2021 05 18  
 (731) LTD "Tradezone"  
 Telavi St. 45a, app. 28, 0105, Tbilisi,  
 Georgia

(540)



(591) Contesa, white  
 (531) 01.05.05; 01.05.15; 01.17.02; 01.17.04;  
 01.17.07; 01.17.25  
 (511) 42

(260) AM 2021 113034 A  
 (210) AM 113034  
 (220) 2021 05 18  
 (731) LLC "Ni Estetic Georgia"  
 Vazha-Pshavela Av. 70a, 0186, Tbilisi, Georgia  
 (540)



(591) Golden, black  
 (531) 26.01.01; 26.01.18; 26.01.24; 26.04.10;  
 26.04.24; 27.05.01; 27.05.22; 29.01.12  
 (511) 44

(260) AM 2021 113037 A  
 (210) AM 113037  
 (220) 2021 05 19  
 (731) LTD "MS Group"  
 Chirnakhuli St. 4, 0151, Tbilisi, Georgia  
 (540)

CMYK: 25, 99, 97, 22



(591) Dark grey, bordeaux  
 (531) 26.04.01; 26.04.02; 26.04.03; 26.04.04;  
 26.04.09; 27.01.02; 27.05.01; 28.19; 29.01.12  
 (511) 7, 8, 11, 21

(260) AM 2021 113038 A  
 (210) AM 113038  
 (220) 2021 05 19  
 (731) LTD "Enso"  
 Varketili III, I qu., bld. A, Commercial Space,  
 Samgori District, Tbilisi, Georgia  
 (540)



(591) Orange, sky-blue, dark sky-blue, blue, white  
 (531) 19.11.04; 19.11.13; 27.05.01; 27.05.10;  
 29.01.13  
 (511) 11

(260) AM 2021 113043 A  
 (210) AM 113043  
 (220) 2021 05 20  
 (731) Philip Morris Brands Sàrl  
 Quai Jeanrenaud 3, 2000 Neuchâtel,  
 Switzerland  
 (740) Pavle Meipariani  
 (540)

## PHILIP MORRIS EXPERT BLUE

(591) Black-white  
 (511) 34

(260) AM 2021 113044 A  
 (210) AM 113044  
 (220) 2021 05 20  
 (731) Philip Morris Brands Sàrl  
 Quai Jeanrenaud 3, 2000 Neuchâtel,  
 Switzerland  
 (740) Pavle Meipariani  
 (540)

## PHILIP MORRIS EXPERT RED

(591) Black-white  
 (511) 34

(260) AM 2021 113045 A  
 (210) AM 113045  
 (220) 2021 05 20  
 (731) Zviad Adeishvili  
 Vill. Shuagora, 1907, Vani District, Georgia  
 (540)



(591) Black-white  
 (531) 05.07.10; 19.09.02; 27.05.01; 28.19  
 (511) 33

(260) AM 2021 113048 A  
 (210) AM 113048  
 (220) 2021 05 20  
 (731) LLC "TeleImedi"  
 Ak. Tsereteli Av. 140, Didube District,  
 Tbilisi, Georgia  
 (540)



(591) 3A6F77 turquoise, D0F9FF sky-blue  
 ECF7F9  
 (531) 02.01.08; 26.01.14  
 (511) 38, 41

(260) AM 2021 113105 A  
 (210) AM 113105  
 (220) 2021 05 23  
 (731) Jadran - Galenski Laboratorij d.d.  
 Svilno 20, 51000 Rijeka, Croatia  
 (740) Pavle Meipariani  
 (540)

**ACNECUTAN**

(591) Black-white  
 (511) 3, 5

(260) AM 2021 113106 A  
 (210) AM 113106  
 (220) 2021 05 23  
 (731) Jadran - Galenski Laboratorij d.d.  
 Svilno 20, 51000 Rijeka, Croatia  
 (740) Pavle Meipariani

(540)

**აკნეკუტან**

(591) Black-white  
 (511) 3, 5

(260) AM 2021 113108 A  
 (210) AM 113108  
 (220) 2021 05 24  
 (731) LLC "Ori Nabiji"  
 Navtlughi St. 39-41, 0113, Isani District,  
 Tbilisi, Georgia  
 (540)



(591) Dark Green  
 (531) 24.17.05; 24.17.07; 24.17.25; 29.01.03  
 (511) 16, 35

(260) AM 2021 113111 A  
 (210) AM 113111  
 (220) 2021 05 24  
 (731) Natela Abaishvili  
 G. Nizharadze St., I Lane, 12, Tbilisi, Georgia  
 (540)



(591) Green, white  
 (531) 09.01.01; 09.01.03; 09.05.01; 27.05.01;  
 27.05.02; 29.01.12  
 (511) 25, 41

(260) AM 2021 113112 A  
 (210) AM 113112  
 (220) 2021 05 24  
 (731) LLC "ch.ch.sh"  
 G. Eliozishvili St., bld. 13, app. 18, Gori,  
 Georgia  
 (540)

**ბეღელი**

(591) Black-white  
 (511) 35

(260) AM 2021 113113 A  
 (210) AM 113113  
 (220) 2021 05 24  
 (731) LTD "Georgian Theme"  
 Irakli Gamrekeli St. 35v, 0186, Tbilisi, Georgia  
 (540)



(554) Three-dimensional  
 (591) FFFFFFF yellow, brown, red, green, lilac, purple, white  
 (531) 07.01.01; 19.03.24; 29.01.15  
 (511) 28, 30

(260) AM 2021 113119 A  
 (210) AM 113119  
 (220) 2021 05 25  
 (731) Obshchestvo s ogranichennoy otvetstvennostyu  
 "Avtograf"  
 Ul. Butlerova, D. 17b, E. 2, Pom. XI, K. 69,  
 Of. 137, Moscow, 117342, Russian Federation  
 (740) Giorgi Taktakishvili  
 (540)

**GP HOTELS**

(591) Black-white  
 (511) 41, 43

(260) AM 2021 113124 A  
 (210) AM 113124  
 (220) 2021 05 25  
 (731) Ningbo Genin Industrial Co., LTD.  
 Room 536, Bld. 5, N22 Henghe Road, Beilun  
 District, Ningbo, Zhejiang Province, China  
 (740) Shalva Gvaramadze  
 (540)

***Victeche***

(591) Black-white  
 (531) 27.05.01; 27.05.17  
 (511) 7, 8

(260) AM 2021 113131 A  
 (210) AM 113131  
 (220) 2021 05 25  
 (731) NGK Spark Plug Co., LTD.  
 14-18 Takatsuji-cho, Mizuho-ku,  
 Nagoya City, 467-8525, Japan

(740) Tamaz Shilakadze  
 (540)

**NTK**

(591) Black-white  
 (531) 27.05.01; 27.05.17; 27.05.23  
 (511) 7

(260) AM 2021 113132 A  
 (210) AM 113132  
 (220) 2021 05 25  
 (731) NGK Spark Plug Co., LTD.  
 14-18 Takatsuji-cho, Mizuho-ku,  
 Nagoya City, 467-8525, Japan  
 (740) Tamaz Shilakadze  
 (540)



(591) Black-white  
 (531) 26.01.12; 26.01.18; 26.01.24; 27.05.01;  
 27.05.17; 27.05.23  
 (511) 7

(260) AM 2021 113134 A  
 (210) AM 113134  
 (220) 2021 05 26  
 (731) Idai Nature S.L.  
 Es/mosku, 10. Pol. Mas De Tous 46185  
 La Pobla De Valbona (Valencia), Spain  
 (740) Liliana Darakhvelidze  
 (540)

**idai**  
**Fertireg**

(591) Black, white, green, brown  
 (531) 26.13.25; 27.05.01; 27.05.10; 29.01.12  
 (511) 1, 5

(260) AM 2021 113145 A  
 (210) AM 113145  
 (220) 2021 05 27  
 (310) 9060,640  
 (320) 2020 12 04  
 (330) US



(731) ADP Inc.  
One ADP Boulevard, Roseland, New Jersey,  
07068, USA  
(740) Shalva Gvaramadze  
(540)

**ROLL**

(591) Black-white  
(511) 9

(260) AM 2021 113147 A  
(210) AM 113147  
(220) 2021 05 28  
(731) Colgate-Palmolive Company,  
Delaware Corporation  
300 Park Avenue, New York, New York 10022,  
USA  
(740) Tamaz Shilakadze  
(540)

**COLGATE**  
**ТЕХНОЛОГИЯ РЕМИН-**  
**ДЕМИН**

(591) Black-white  
(511) 3

(260) AM 2021 113183 A  
(210) AM 113183  
(220) 2021 05 28  
(731) LLC "Novator Pharma"  
Vill. Irganchai, 1707, Dmanisi, Georgia  
(540)

**KLORITOL**  
**КЛОРИТОЛ**  
**კლორიტოლი**

(591) Black-white  
(511) 5

(260) AM 2021 113184 A  
(210) AM 113184  
(220) 2021 05 28  
(731) LLC "Novator Pharma"  
Vill. Irganchai, 1707, Dmanisi, Georgia  
(540)

**MELOCSEVIN**  
**მელოქსევინი**  
**МЕЛОКСЕВИН**

(591) Black-white  
(511) 5

(260) AM 2021 113187 A  
(210) AM 113187  
(220) 2021 05 28  
(731) LLC "Novator Pharma"  
Vill. Irganchai, 1707, Dmanisi, Georgia  
(540)

**MOXIMERA**  
**მოქსიმერა**  
**МОКСИМЕРА**

(591) Black-white  
(511) 5

(260) AM 2021 113188 A  
(210) AM 113188  
(220) 2021 05 28  
(731) Full Fortune Intellectual Limited  
Rm 503 Wilson Hse 19-27 Wyndham St  
Central Hong Kong, Hong Kong  
(740) Merab Kvimsadze  
(540)

**HEY DUDE**

(591) Black-white  
(531) 27.05.01  
(511) 25

(260) AM 2021 113197 A  
(210) AM 113197  
(220) 2021 05 28  
(731) LTD "Helios Pharma"  
Ilia Chavchavadze Av. 17g, 0179, Tbilisi,  
Georgia  
(540)

**KASANORM**  
**კასანორმი**  
**КАСАНОРМ**

(591) Black-white  
(511) 5

(260) AM 2021 113198 A  
(210) AM 113198  
(220) 2021 05 28  
(731) LTD "Helios Pharma"  
Ilia Chavchavadze Av. 17g, 0179, Tbilisi,  
Georgia  
(540)

**PRE-LARGOVIT**  
**პრე-ლარგოვიტი**



## ПРЕ-ЛАРГОВИТ

(591) Black-white

(511) 5

---

(260) AM 2021 113237 A

(210) AM 113237

(220) 2021 06 01

(731) LTD "Semila"

Vazha-Pshavela Av. 39, app. 9, 6000, Batumi,  
Georgia

(540)



591) Green, blue, white

(531) 01.05.01; 01.05.05; 18.05.01; 19.13.22;  
27.05.01; 29.01.12

(511) 3, 25, 35

---

## REGISTERED TRADEMARKS

(111) M 2021 34780 R  
 (151) 2021 12 03  
 (181) 2031 12 03  
 (260) AM 2020 110029 A  
 (220) 2020 10 05

(732) Data Bezhuashvili  
 Petre Kavtaradze St. 28, app. 66, 0186, Tbilisi,  
 Georgia

(111) M 2021 34781 R  
 (151) 2021 12 03  
 (181) 2031 12 03  
 (260) AM 2020 110044 A  
 (220) 2020 10 08

(732) LTD "Gionik Group"  
 R. Margiani St. 32, 0186, Tbilisi, Georgia

(111) M 2021 34782 R  
 (151) 2021 12 03  
 (181) 2031 12 03  
 (260) AM 2020 110289 A  
 (220) 2020 10 26

(732) Akad General Trading (LLC)  
 Ofisi 1247, Abdu Salam Murad Al Ganahis  
 Sakutreba, Biznes Bei, Dubai, United Arab  
 Emirates

(111) M 2021 34783 R  
 (151) 2021 12 03  
 (181) 2031 12 03  
 (260) AM 2020 110290 A  
 (220) 2020 10 26

(732) Akad General Trading (LLC)  
 Ofisi 1247, Abdu Salam Murad Al Ganahis  
 Sakutreba, Biznes Bei, Dubai, United Arab  
 Emirates

(111) M 2021 34784 R  
 (151) 2021 12 03  
 (181) 2031 12 03  
 (260) AM 2020 110305 A  
 (220) 2020 10 29

(732) Philip Morris Products S.A.  
 Quai Jeanrenaud 3, 2000 Neuchâtel,  
 Switzerland

(111) M 2021 34785 R  
 (151) 2021 12 03  
 (181) 2031 12 03  
 (260) AM 2020 110358 A  
 (220) 2020 10 30

(732) LTD "Alko-Ge"  
 Artem Lusinyan St. 20, app. 7, 0144,  
 Tbilisi, Georgia

(111) M 2021 34786 R  
 (151) 2021 12 03  
 (181) 2031 12 03  
 (260) AM 2020 110443 A  
 (220) 2020 11 06

(732) Shenzhen Times Innovation Technology Co., Ltd  
 5th Floor, Building B, Baseus Intelligence  
 Park, No.2008, Xuegang Rd, Gangtuo  
 Community, Bantian Street, Longgang  
 District, Shenzhen City, Guangdong  
 Province, China

(111) M 2021 34787 R  
 (151) 2021 12 03  
 (181) 2031 12 03  
 (260) AM 2020 110451 A  
 (220) 2020 11 09

(732) Ketevan Lomaia  
 Gldani, III mcr., corp. 7a, 0167, Tbilisi,  
 Georgia

(111) M 2021 34788 R  
 (151) 2021 12 03  
 (181) 2031 12 03  
 (260) AM 2020 110465 A  
 (220) 2020 11 10

(732) Aeolus Tyre Co., LTD  
 No. 48 Jiaodong South Road Jiaozuo, Henan,  
 China

(111) M 2021 34789 R  
 (151) 2021 12 03  
 (181) 2031 12 03  
 (260) AM 2020 110466 A  
 (220) 2020 11 10

(732) Aeolus Tyre Co., LTD  
 No. 48 Jiaodong South Road Jiaozuo, Henan,  
 China

(111) M 2021 34790 R  
 (151) 2021 12 03  
 (181) 2031 12 03  
 (260) AM 2020 110467 A  
 (220) 2020 11 10

(732) Aeolus Tyre Co., LTD  
 No. 48 Jiaodong South Road Jiaozuo, Henan,

China	Gotua St. 3, 0160, Tbilisi, Georgia
(111) M 2021 34791 R (151) 2021 12 03 (181) 2031 12 03 (260) AM 2020 110468 A (220) 2020 11 10 (732) Aeolus Tyre Co., LTD No. 48 Jiaodong South Road Jiaozuo, Henan, China	(111) M 2021 34797 R (151) 2021 12 03 (181) 2031 12 03 (260) AM 2020 110977 A (220) 2020 12 24 (732) LLC "U Trust" Queen Ketevani Ave./Bochorma St. 50/18, Block "G" commercial space 5, 0144, Tbilisi, Georgia
(111) M 2021 34792 R (151) 2021 12 03 (181) 2031 12 03 (260) AM 2020 110469 A (220) 2020 11 10 (732) Aeolus Tyre Co., LTD No. 48 Jiaodong South Road Jiaozuo, Henan, China	(111) M 2021 34798 R (151) 2021 12 03 (181) 2031 12 03 (260) AM 2021 111158 A (220) 2021 01 06 (732) LTD "Agropharm" David Jokhadze St. 27, Vill. Tsavkisi, Mtatsminda district, Tbilisi, Georgia
(111) M 2021 34793 R (151) 2021 12 03 (181) 2031 12 03 (260) AM 2020 110545 A (220) 2020 11 19 (732) Luka Tsanava Niko Tskhvedadze St. 48, 0162, Tbilisi, Georgia	(111) M 2021 34799 R (151) 2021 12 03 (181) 2031 12 03 (260) AM 2021 111426 A (220) 2021 01 26 (732) Les Publications Condé Nast 3 avenue Hoche, Paris, 75008, France
(111) M 2021 34794 R (151) 2021 12 03 (181) 2031 12 03 (260) AM 2020 110615 A (220) 2020 11 26 (732) The British Broadcasting Corporation Broadcasting House, Portland Place, London W1A 1AA, United Kingdom	(111) M 2021 34800 R (151) 2021 12 03 (181) 2031 12 03 (260) AM 2021 111501 A (220) 2021 01 29 (732) LTD "Krinti" Madneuli St. 10, Vill. Kazreti, Bolnisi, Georgia
(111) M 2021 34795 R (151) 2021 12 03 (181) 2031 12 03 (260) AM 2020 110880 A (220) 2020 12 16 (732) Zurab Turtuseladze Vazisubani, IV mcr., II qu., corp. 3, app. 23, 0152, Tbilisi, Georgia	(111) M 2021 34801 R (151) 2021 12 03 (181) 2031 12 03 (260) AM 2021 111502 A (220) 2021 01 29 (732) LTD "Carat" Baku St. 20b, 0107, Tbilisi, Georgia
(111) M 2021 34796 R (151) 2021 12 03 (181) 2031 12 03 (260) AM 2020 110971 A (220) 2020 12 23 (732) JSC "Biopharm"	(111) M 2021 34802 R (151) 2021 12 03 (181) 2031 12 03 (260) AM 2021 111523 A (220) 2021 02 03 (732) LTD "Father & Son Cellar" Vill. Velistsikhe, 1500, Gurjaani, Georgia

(111) M 2021 34803 R  
(151) 2021 12 03  
(181) 2031 12 03  
(260) AM 2021 111532 A  
(220) 2021 02 04  
(732) LTD "Korida"  
7<sup>th</sup> Km Settlement, 4400, Poti, Georgia

---

(111) M 2021 34804 R  
(151) 2021 12 03  
(181) 2031 12 03  
(260) AM 2021 111533 A  
(220) 2021 02 04  
(732) Magda Churukba  
Vakhtang Bochorishvili St. 37b, 0171,  
Tbilisi, Georgia

---

(111) M 2021 34805 R  
(151) 2021 12 03  
(181) 2031 12 03  
(260) AM 2021 111535 A  
(220) 2021 02 04  
(732) LTD "Isurve"  
XV mcr. 13, app. 79, Rustavi, Georgia

---

**TRADEMARKS REGISTERED ACCORDING TO  
ACCELERATED PROCEDURE**

The decision can be appealed at the Chamber of Appeal of Sakpatenti within 3 months from the publication.

(111) M 2021 34764 R  
(151) 2021 11 26  
(181) 2031 11 26  
(210) AM 115401  
(220) 2021 11 12  
(732) LLC "Ori Nabiji"  
Navtlughi St. 39-41, 0113, Isani District,  
Tbilisi, Georgia  
(540)



(591) Black, grey  
(531) 19.07.01; 19.07.16  
(554) Three-dimensional  
(511) 32

(111) M 2021 34765 R  
(151) 2021 11 26  
(181) 2031 11 26  
(210) AM 113683  
(220) 2021 06 25  
(732) LTD "Askaneli Dzmebi"  
Kakheti Highway 110a, 0198, Tbilisi, Georgia  
(740) Davit Dzamukashvili  
(540)

**Pocket Wine**

(591) Black-white  
(511) 33

(111) M 2021 34766 R  
(151) 2021 11 26  
(181) 2031 11 26  
(210) AM 115320  
(220) 2021 11 08  
(732) GROUPE CANAL+

50 Rue Camille Desmoulins, 92863 Issy-Les-  
Moulineaux Cedex 9, France  
(740) Giorgi Taktakishvili  
(540)



(591) Black-white  
(531) 24.13.01; 24.17.05; 24.17.07; 26.04.02;  
26.04.16; 26.04.24; 27.05.24  
(511) 9, 16, 25, 28, 35, 38, 41, 42

(111) M 2021 34767 R  
(151) 2021 11 26  
(181) 2031 11 26  
(210) AM 115321  
(220) 2021 11 08  
(732) GROUPE CANAL+  
50 Rue Camille Desmoulins, 92863 Issy-Les-  
Moulineaux Cedex 9, France  
(740) Giorgi Taktakishvili  
(540)



(591) Black-white  
(531) 26.04.02; 26.04.22; 26.04.24; 27.05.01;  
27.05.19; 27.05.24  
(511) 9, 16, 35, 38, 41, 42

(111) M 2021 34768 R  
(151) 2021 12 01  
(181) 2031 12 01  
(210) AM 115509  
(220) 2021 11 22  
(732) LTD "Pinriva"  
Vill. Mukhattskaro, St. 3, 24a, Mtskheta,  
Georgia  
(540)



(591) 5650A1 blue, F0C019 yellow  
 (531) 26.02.07; 26.11.12; 27.05.01; 27.05.17;  
 29.01.12  
 (511) 36

(111) M 2021 34769 R  
 (151) 2021 12 02  
 (181) 2031 12 02  
 (210) AM 115313  
 (220) 2021 11 05  
 (732) HeidelbergCement Georgia, LLC  
 Al. Kazbegi Av. 21, 0160, Tbilisi, Georgia  
 (740) Giorgi Taktakishvili  
 (540)

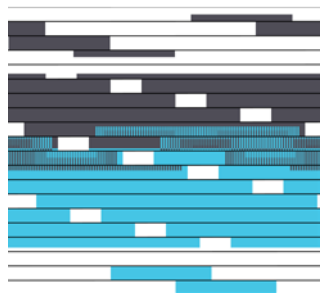

(591) Sky-blue, black  
 (531) 19.03.24; 26.04.02; 26.04.09; 29.01.12  
 (511) 19

111) M 2021 34770 R  
 (151) 2021 12 02  
 (181) 2031 12 02  
 (210) AM 115314  
 (220) 2021 11 05  
 (732) HeidelbergCement Georgia, LLC  
 Al. Kazbegi Av. 21, 0160, Tbilisi, Georgia  
 (740) Giorgi Taktakishvili  
 (540)

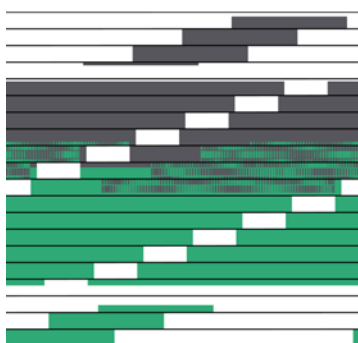

(591) Green, black  
 (531) 19.03.24; 26.04.02; 26.04.09; 29.01.12  
 (511) 19

(111) M 2021 34771 R  
 (151) 2021 12 02  
 (181) 2031 12 02  
 (210) AM 115315  
 (220) 2021 11 05  
 (732) HeidelbergCement Georgia, LLC  
 Al. Kazbegi Av. 21, 0160, Tbilisi, Georgia  
 (740) Giorgi Taktakishvili  
 (540)



(591) Yellow, black  
 (531) 26.04.09; 29.01.13  
 (511) 19

(111) M 2021 34772 R  
 (151) 2021 12 02  
 (181) 2031 12 02  
 (210) AM 115601  
 (220) 2021 11 30  
 (732) I/E Zurab Shervashidze  
 M. Lermontov St. 36/38, 6010, Batumi, Georgia  
 (540)



(591) White, 0A0909 black  
 (531) 03.01.01; 03.01.02; 03.01.20; 24.09.02;  
 24.09.12; 25.01.05  
 (511) 43

(111) M 2021 34773 R  
 (151) 2021 12 02  
 (181) 2031 12 02  
 (210) AM 115316  
 (220) 2021 11 05  
 (732) HeidelbergCement Georgia, LLC  
 Al. Kazbegi Av. 21, 0160, Tbilisi, Georgia  
 (740) Giorgi Taktakishvili

(540)



(591) Sky-blue, black  
 (531) 19.01.03; 19.01.11; 26.15.11; 26.15.13;  
 29.01.13  
 (554) Three-dimensional  
 (511) 19

(111) M 2021 34774 R  
 (151) 2021 12 02  
 (181) 2031 12 02  
 (210) AM 115317  
 (220) 2021 11 05  
 (732) HeidelbergCement Georgia, LLC  
 Al. Kazbegi Av. 21, 0160, Tbilisi, Georgia  
 (740) Giorgi Taktakishvili  
 (540)



(591) Green, black  
 (531) 19.01.03; 19.01.11; 26.15.11; 26.15.13;  
 29.01.13  
 (554) Three-dimensional  
 (511) 19

(111) M 2021 34775 R  
 (151) 2021 12 02  
 (181) 2031 12 02  
 (210) AM 115318  
 (220) 2021 11 05  
 (732) HeidelbergCement Georgia, LLC  
 Al. Kazbegi Av. 21, 0160, Tbilisi, Georgia  
 (740) Giorgi Taktakishvili  
 (540)



(591) Yellow, black  
 (531) 19.01.03; 19.01.11; 26.15.11; 26.15.13;  
 29.01.13  
 (554) Three-dimensional

(511) 19

(111) M 2021 34776 R  
 (151) 2021 12 03  
 (181) 2031 12 03  
 (210) AM 115438  
 (220) 2021 11 18  
 (732) Alex Plus  
 Hasan Lortkipanidze St. 39a, 6000, Batumi,  
 Georgia  
 (540)



(591) F9D818 golden  
 (531) 02.01.01; 02.01.23; 05.07.10; 11.03.02;  
 29.01.02  
 (511) 29, 33

(111) M 2021 34777 R  
 (151) 2021 12 03  
 (181) 2031 12 03  
 (210) AM 115592  
 (220) 2021 11 29  
 (732) LTD "Pinriva"  
 Vazha-Pshavela Av. 71, Office 33, fl. 6,  
 (Block 1), Tbilisi, Georgia  
 (540)



(591) 5650A1 ლურჯი, F0C019 ყვითელი  
 (531) 26.02.07; 26.11.12; 27.05.17; 29.01.12  
 (511) 36

(111) M 2021 34778 R  
 (151) 2021 12 03  
 (181) 2031 12 03  
 (210) AM 115595  
 (220) 2021 11 30  
 (732) Nobel Ilac Sanayii Ve Ticaret Anonim Sirketi  
 Representative in Georgia  
 Liberty Square 4, 0105, Tbilisi, Georgia

(740) Tinatin Tskhvediani  
(540)

**Vaxato**  
**ვაქსატო**

(591) Black-white  
(511) 5, 35

---

(111) M 2021 34779 R  
(151) 2021 12 03  
(181) 2031 12 03  
(210) AM 115603  
(220) 2021 11 30  
(732) Nobel Ilac Sanayii Ve Ticaret Anonim Sirketi  
Representative in Georgia  
Freedom Square 4, 0105, Tbilisi, Georgia  
(740) Tinatin Tskhvediani  
(540)

**NBL Fish Oil Jr.**  
**ნბლ ფიშ ოილ ჯრ.**

(591) Black-white  
(511) 5, 35

---



## INTERNATIONAL TRADEMARKS FOR WHICH A DECISION ON GRANTING PROTECTIONS IS TAKEN

The decision can be appealed at the Chamber of Appeal of Sakpatenti within 3 months from the publication or at the Mtskheta District Court Administrative Cases Board (Address: №17, Samkhedro St., Mtskheta), within 1 month following the publication.

(260) AM 2021 108201 A

(800) 1463570

(151) 2019 01 02

(891) 2020 04 20

(731) Wilhelmsen Ships Service AS

Strandveien 20, N-1366 Lysaker, Norway

(540)



(591) Black, white

(531) 26.01.01; 26.01.03; 26.01.24; 27.05.01;

27.05.07; 27.05.17

(511)

9 – Weighing, measuring, signalling, checking (supervision) apparatus and instruments, all being for use in relation to ropes and/or rope products, hereunder for recording, controlling, measuring, analyzing and providing information of their use, duration, tension, stretch and/or capacity; apparatus for recording, transmission or reproduction of images and data, all being for use in relation to ropes and/or rope products, hereunder for recording, controlling, measuring, analyzing and providing information of their use, duration, tension, stretch and/or capacity; data processing equipment, all being for use in relation to ropes and/or rope products, hereunder for recording, controlling, measuring, analyzing and providing information of their use, duration, tension, stretch and/or capacity; computer software, computer software applications and computer application software, all being for use in relation to ropes and/or rope products, hereunder for recording, controlling, measuring, analyzing and providing information of their use, duration, tension, stretch and/or capacity; sensors and sensor devices for use in or in relation to ropes and rope products, hereunder for recording, controlling, measuring, analyzing and providing information of their use, duration, tension, stretch and/or capacity; data transmitters and software systems for measuring tension and stretch of ropes.

42 – Scientific and technological services and research and design relating thereto, all being related to ropes and/or rope products, as well as to the development and design of such products with embedded sen-

sors for controlling, measuring and providing information of their use, duration, tension, stretch and/or capacity; industrial analysis and research services, all being related to ropes and rope products, as well as to the development and design of such products with embedded sensors for controlling, measuring and providing information of their use, duration, tension, stretch and/or capacity; design and development of computer software, computer software applications and computer application software, all for use in relation to ropes and rope products, hereunder for recording, controlling, measuring, analyzing and providing information of use, duration, tension, stretch and/or capacity of ropes and rope products, as well as for such products with embedded sensors for controlling, measuring and providing information of their use, duration, tension, stretch and/or capacity; design and development of sensors and sensor devices, all for use in or in relation to ropes and rope products, hereunder for controlling, measuring and providing information of their use, duration, tension, stretch and/or capacity; services related to analysis of data related to ropes and rope products, hereunder related to the use, duration, tension, stretch and/or capacity; services related to analysis of data related to measuring tension and stretch of ropes; installation of computer software for use in relation to ropes and rope products, hereunder for recording, controlling, measuring, analyzing and providing information of their use, duration, tension, stretch and/or capacity; rental of computer software, computer software applications and computer application software, all for use in relation to ropes and rope products, hereunder for recording, controlling, measuring, analyzing and providing information of their use, duration, tension, stretch and/or capacity.

(260) AM 2021 110234 A

(800) 1556088

(151) 2020 09 02

(891) 2020 09 02

(731) Limited liability company "Autoplastic"

Smirnova st., 74, RU-153000 Ivanovo,  
Russian Federation

(540)



(591) Black, white

(531) 26.05.03; 26.05.18; 27.05.17

(511)

17 – Insulators; insulating tapes; insulating bands; adhesive bands, other than stationery and not for medical or household purposes; adhesive tapes, other than stationery and not for medical or household purposes; self-adhesive tapes, other than stationery and not for medical or household purposes; soundproofing materials; insulating materials; insulating refractory materials; non-conducting materials for retaining heat; insulating plaster.

19 – Building materials, not of metal; construction materials, not of metal; wainscoting, not of metal.

(260) AM 2021 110250 A\*

(800) 1556591

(151) 2019 12 27

(891) 2019 12 27

(731) International Fruit Genetics, LLC

8224 Espresso Drive, Suite 2006 Bakersfield  
CA 93312, USA

(540)

## COTTON CANDY

(591) Black, white

(511)

30 – sorbets and other edible ices.

(260) AM 2021 110585 A\*

(800) 1561278

(151) 2020 08 04

(891) 2020 08 04

(731) Siemens Aktiengesellschaft

Werner-von-Siemens-Str. 1, 80333 München,  
Germany

(540)

## SENTRON

(591) Black, white

(511)

9 – apparatus and instruments for measuring, monitoring and analysing operating data from electric goods; data processing programs; mobile apps, including cloud apps.

(260) AM 2021 111559 A

(800) 1573626

(151) 2020 10 01

(891) 2020 10 01

(731) SARUHAN KİMYA VE TEMİZLİK  
ÜRÜNLERİ, SANAYİ TİCARET ANONİM  
ŞİRKETİ

Halkalı Merkez Mahallesi, Basın Ekspres  
Caddesi No: 39/2, Küçükçekmece, İstanbul,  
Turkey

(540)



(591) Black, blue, white

(531) 27.05.10; 27.05.17; 29.01.12

(511)

3 – Non-medicated cosmetics and toiletry preparations; non-medicated dentifrices; perfumery, essential oils.

5 – Pharmaceuticals and medical preparations; sanitary preparations for medical purposes; dietetic food and substances adapted for medical use, food for babies; dietary supplements for human beings; plasters, materials for dressings; material for stopping teeth, dental wax.

(260) AM 2021 111631 A

(800) 1574536

(151) 2020 09 22

(891) 2020 09 22

(731) Mediestetik s.r.o.

Senovazne namesti 23, CZ-110 00 Prague 1,  
Czech Republic

(540)

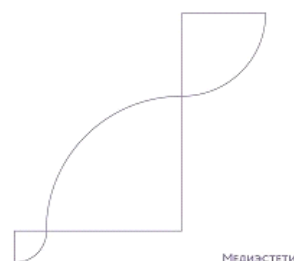

(591) Purple

(531) 26.13.25; 28.05; 29.01.05

(511)

44 – Public bath services for hygiene purposes; turkish bath services; hospital services; depilatory waxing; rehabilitation for substance abuse patients; health center services; nursing home services; hair implantation; pharmacy advice; cosmetician services; aromatherapy services; manicuring; chiropractic; massage; orthodontic services; artificial insemination services; hairdressing; midwife services; veterinary assis-

tance; dentistry services; medical assistance; preparation of prescriptions by pharmacists; medical equipment rental; rental of sanitation facilities; beauty salon services; sanatorium services; blood bank services; health care; health counselling; health counseling; tattooing; health spa services; aquaculture services; visagists' services; rest home services; medical clinic services; opticians' services; in vitro fertilization services; in vitro fertilisation services; services of a psychologist; sauna services; solarium services; telemedicine services; therapy services; nursing, medical; physical therapy; physiotherapy; plastic surgery; tree surgery; hospice services.

(260) AM 2021 111633 A

(800) 1574631

(151) 2020 11 10

(891) 2020 11 10

(731) GIORGIO ARMANI S.P.A.

Via Borgonuovo 11; I-20121 MILANO  
(Milano), Italy

(540)



(591) Black, white

(531) 27.05.13

(511)

18 – Handbags; traveling bags; briefcases; leather briefcases; leather credit card holders; wallets; leather document briefcases; leather key cases; purses; suitcases; cosmetic bags sold empty; sports bags; evening and shoulder bags for ladies; leather shopping bags; school bags; garment bags for travel; suit carriers for travel; shoe bags for travel; beach bags; diaper bags; backpacks; Boston bags; traveling trunks; duffel bags; overnight bags; carry-on bags; satchels; opera bags; vanity cases (not fitted); hides; cases and boxes made of leather; bags made of leather for packaging; leather straps; umbrellas; leather leashes; saddlery.

25 – Coats; jackets; trousers; skirts; tops; raincoats; overcoats; belts; braces for clothing; suits; stuff jackets; jumpers; jeans; dresses; cloaks; parkas; shirts; T-shirts; sweaters; underwear; babydolls being nightwear; bathrobes; bathing costumes; negligée; swim suits; dressing gowns; shawls; neckerchiefs; scarves; ties; neckties; sweat shirts; under shirts; polo shirts; body suits; shorts; combinations [clothing]; wedding dresses; stockings; socks; shoes; slippers; overshoes; galoshes; wooden clog; soles for footwear; footwear upper; boots; ski boots; snow boots; half boots; esparto shoes or sandals; sandals; bath sandals; gloves; mittens; hats and caps; visors (headwear).

(260) AM 2021 111635 A

(800) 1574708

(151) 2020 08 21

(891) 2020 08 21

(731) Obshchestvo s ogranichennoy otvetstvennostyu "SpectoCom"

ul. Volodko, d. 6/6, pom.12, 220007 g. Minsk,  
Belarus

(540)



(591) Black, white

(531) 02.09.04; 27.03.02; 27.05.09

(511)

9 – Monitoring apparatus, other than for medical purposes; personal video recorders [PVRs]; computer software, recorded; observation instruments; computer programs, recorded; computer programs, downloadable; interactive touch screen terminals; video recorders; data processing apparatus.

37 – Maintenance and repair services of data collection and storage terminals, and of personal video recorders; installation of monitoring apparatus, other than for medical purposes, personal video recorders [PVRs], observation instruments, interactive touch screen terminals, video recorders and data processing apparatus.

42 – Computer software consultancy; updating of computer software; software as a service [SaaS]; maintenance of computer software; computer software design; installation of computer software, recorded, computer programs, recorded and computer programs, downloadable.

(260) AM 2021 111654 A

(800) 1575109

(151) 2021 01 05

(891) 2021 01 05

(731) DONGFENG MOTOR CORPORATION

Special No.1 Dongfeng Road, Wuhan  
Economic & Technical; Development Zone  
Wuhan; 430056 Hubei Province, China

(540)



(591) Black, white

(531) 27.05.01

(511)

12 – Motor coaches; brake pads for automobiles; automobile chassis; automobile bodies; tires for vehicle wheels; cars; lorries; clutches for land vehicles; motors, electric, for land vehicles; suspension shock absorbers for vehicles.

37 – Motor vehicle maintenance and repair; vehicle breakdown repair services; vehicle washing; vehicle polishing; vehicle service stations [refuelling and maintenance]; vehicle maintenance; rebuilding engines that have been worn or partially destroyed; vehicle battery replacement service; tire balancing; repair of rubber tires.

(260) AM 2021 111671 A

(800) 1575309

(151) 2020 12 10

(891) 2020 12 10

(731) Limited liability company "Technopol"

Bakuninskaya street, 69, bld. 1, floor  
mezzanine1, section 1, room 16, office 10,  
RU-105082 Moscow, Russian Federation

(540)

## PowerTech

(591) Black, white

(511)

9 – Electronic publications, downloadable; electronic publications in the nature of training materials, manuals, reference books, downloadable; magnetic and optical media recorded, including with prerecorded teaching materials, manuals and reference books.

16 – Printed publications; printed matter; stationery; office stationery; instructional and teaching materials; manuals [handbooks]; printed guides; pamphlets; reference books; three-dimensional models for educational purposes; printed certificates; signs and badges made of paper or cardboard.

25 – Clothing, including tee-shirts; headwear, including caps, baseball caps.

28 – Building games; toy models; scale model kits [toys]; scale model vehicles; radio-controlled scale model vehicles; radio-controlled miniature aerial targets for sports; toy robots; matryoshka dolls.

41 – Education; providing of training; entertainment services; sporting and cultural activities; organization of competitions [education or entertainment]; providing recreation facilities; publication of texts, other than publicity texts; teaching; arranging and conducting of colloquiums; arranging and conducting of conferences; arranging and conducting of congresses; organization of exhibitions for cultural or educational purposes; practical training [demonstration]; arranging and conducting of seminars; arranging and conducting of symposiums; arranging and conducting of workshops [training]; providing online electronic publications, not downloadable; vocational guidance [education or training advice]; arranging and conducting of in-person educational forums; providing information, advice and consultation on all of the above services.

(260) AM 2021 111678 A

(800) 1575395

(151) 2020 11 24

(891) 2020 11 24

(731) "MY REPUBLIC" Ltd.

Pohodniy proezd, building 14, lev/place/room  
5/II/№5, RU-125373 Moscow, Russian  
Federation

(540)



(591) Green

(531) 05.05.20; 05.05.21; 27.05.01; 29.01.03

(511)

8 – Table forks; agricultural forks [hand tools]; rakes [hand tools]; cutlery; edge tools [hand tools]; garden tools, hand-operated; implements for decanting liquids [hand tools]; depilation appliances, electric and non-electric; ear-piercing apparatus; riveters [hand tools]; cutting tools [hand tools]; hand tools, hand-operated; pickaxes; mallets [hand instruments]; ladles [hand tools]; foundry ladles [hand tools]; diggers [hand tools]; spoons; table knives, forks and spoons for babies; table knives, forks and spoons of plastic; trowels [gardening]; shovels [hand tools]; hair clippers for personal use, electric and non-electric; swords; hammers [hand tools]; riveting hammers [hand tools]; mattocks; manicure sets; manicure sets, electric; pedicure sets; knives; vegetable knives; billhooks; cleavers; scissors; border shears; pruning shears; shearers [hand instruments]; vegetable slicers; kitchen mandolines; vegetable peelers [hand tools]; agricultural implements, hand-operated; stirring sticks for mixing paint; nail files; tweezers; dies [hand tools]; tool belts [holders]; hair braiders, electric; table cutlery [knives, forks and spoons]; hand implements for hair curling; vegetable choppers; money scoops; hackles [hand tools]; syringes for spraying insecticides; frames for handsaws; knife handles; handles for hand-operated hand tools; secateurs; silver plate [knives, forks and spoons]; scrapers [hand tools]; mortise chisels; axes; weeding forks [hand tools]; squares [hand tools]; razor cases; palette knives; spatulas [hand tools]; spatulas for use by artists; wine bottle foil cutters, hand-operated; bayonets; pliers; curling tongs; nail nippers; cuticle tweezers; eyelash curlers; nail clippers, electric or non-electric; cutters; cheese slicers, non-electric; vegetable spiralizers, hand-operated; fingernail polishers, electric or non-electric.

20 – Bumper guards for cots, other than bed linen; pulleys of plastics for blinds; bolts, not of metal; casks of wood for decanting wine; mooring buoys, not of metal; casks, not of metal; barrels, not of metal; iden-

tification bracelets, not of metal; valet stands; coat-stands; shoulder poles [yokes]; screws, not of metal; collars, not of metal, for fastening pipes; signboards of wood or plastics; nuts, not of metal; curtain holders, not of textile material; pegs [pins], not of metal; kennels for household pets; birdhouses; plugs [dowels], not of metal; troughs, not of metal, for mixing mortar; oil drainage containers, not of metal; packing containers of plastic; indoor window blinds [furniture]; clips of plastic for sealing bags; rivets, not of metal; bottle closures, not of metal; closures, not of metal, for containers; latches, not of metal; registration plates, not of metal; bamboo; wickerwork; hampers [baskets] for the transport of items; works of art of wood, wax, plaster or plastic; curtain rings; chests of drawers; console tables; containers, not of metal [storage, transport]; floating containers, not of metal; lecterns; bakers' bread baskets; baskets, not of metal; Moses baskets; bottle casings of wood; tool boxes, not of metal, empty; edgings of plastic for furniture; screw tops, not of metal, for bottles; hooks, not of metal, for clothes rails; curtain hooks; clothes hooks, not of metal; bag hangers, not of metal; beds for household pets; ladders of wood or plastics; playpens for babies; mannequins; air mattresses, not for medical purposes; camping mattresses; sleeping mats; office furniture; school furniture; legs for furniture; house numbers, not of metal, non-luminous; window stops, not of metal or rubber; plastic ramps for use with vehicles; freestanding partitions [furniture]; identity plates, not of metal; trestles [furniture]; racks [furniture]; furniture shelves; shelves for storage; bathtub grab bars, not of metal; counters [tables]; corks for bottles; stoppers, not of glass, metal or rubber; sealing caps, not of metal; embroidery frames; picture frames; tanks, not of metal nor of masonry; curtain rollers; door handles, not of metal; knobs, not of metal; bath seats for babies; vats, not of metal; bungs, not of metal; statues of wood, wax, plaster or plastic; drafting tables; wall-mounted baby changing platforms; portable desks; dinner wagons [furniture]; steps [ladders], not of metal; chairs [seats]; high chairs for babies; shower chairs; chests, not of metal; placards of wood or plastics; stools; trolleys [furniture]; decorations of plastic for foodstuffs; bathroom vanities [furniture]; window closers, not of metal, non-electric; window openers, not of metal, non-electric; door fittings, not of metal; bed fittings, not of metal; furniture fittings, not of metal; window fittings, not of metal; chaise longues; screens [furniture]; filing cabinets; medicine cabinets; plate racks; meat safes; slatted indoor blinds; screens for fireplaces [furniture]; labels of plastic; lockers; chests for toys; tool chests, not of metal, empty; boxes of wood or plastic; bottle racks; trays, not of metal; figurines of wood, wax, plaster or plastic; letter boxes, not of metal or masonry; step stools, not of metal.

21 – Indoor aquaria; wine aerators; buckets; cookie jars; china ornaments; dishes; paper plates; vegetable

dishes; saucers; mugs; boxes for sweets; bottles; demijohns; vases; epergnes; fruit cups; inflatable bath tubs for babies; bird baths; baby baths, portable; plungers for clearing blocked drains; waffle irons, non-electric; coolers [ice pails]; mop wringer buckets; buckets made of woven fabrics; whisks, non-electric, for household purposes; cooking skewers of metal; towel rails and rings; hair for brushes; funnels; carpet beaters [hand instruments]; signboards of porcelain or glass; candle extinguishers; flower pots; chamber pots; glue-pots; cruets; decanters; large-toothed combs for the hair; combs for animals; tea cosies; abrasive sponges for scrubbing the skin; make-up sponges; sponges for household purposes; toilet sponges; sponge holders; stands for portable baby baths; toothpick holders; soap holders; table napkin holders; holders for flowers and plants [flower arranging]; tea bag rests; shaving brush stands; toilet paper holders; soap dispensers; toilet paper dispensers; ironing boards; cutting boards for the kitchen; bread boards; washing boards; strainers for household purposes; smoke absorbers for household purposes; containers for household or kitchen use; kitchen containers; glass jars [carboys]; heat-insulated containers; heat-insulated containers for beverages; thermally insulated containers for food; glass flasks [containers]; closures for pot lids; chamois leather for cleaning; toothpicks; ceramics for household purposes; majolica; kitchen grinders, non-electric; cleaning instruments, hand-operated; cabarets [trays]; stew-pans; covers, not of paper, for flower pots; shaving brushes; birdcages; baking mats; ladles for serving wine; polishing leather; hot pots, not electrically heated; glass bulbs [receptacles]; napkin rings; poultry rings; rings for birds; coin banks; bread baskets for household purposes; baskets for household purposes; waste paper baskets; feeding troughs; pet feeding bowls, automatic; mangers for animals; lunch boxes; tea caddies; washtubs; earthenware saucepans; cauldrons; coffee percolators, non-electric; coffeepots, non-electric; coffee grinders, hand-operated; fused silica [semi-worked product], other than for building; beer mugs; tankards; rat traps; pot lids; aquarium hoods; butter-dish covers; dish covers; cheese-dish covers; reusable silicone food covers; buttonhooks; pitchers; perfume burners; watering cans; insect traps; mixing spoons [kitchen utensils]; basting spoons [cooking utensils]; pie servers; spatulas for kitchen use; litter boxes for pets; butter dishes; material for brush-making; polishing materials for making shiny, except preparations, paper and stone; tablemats, not of paper or textile; noodle machines, hand-operated; polishing apparatus and machines, for household purposes, non-electric; pepper mills, hand-operated; mills for household purposes, hand-operated; feather-dusters; brooms; isothermic bags; confectioners' decorating bags [pastry bags]; bowls [basins]; pet feeding bowls; mosaics of glass, not for building; dishcloths; saucepan scourers of metal; soap boxes; mouse traps; cooking pot sets; nozzles

for watering cans; pouring spouts; nozzles for watering hose; fitted picnic baskets, including dishes; toilet cases; floss for dental purposes; fiberglass thread, other than for textile use; cookie [biscuit] cutters; pastry cutters; sprinklers; syringes for watering flowers and plants; egg yolk separators; cotton waste for cleaning; wool waste for cleaning; cleaning tow; cold packs for chilling food and beverages; chopsticks; cocktail stirrers; pepper pots; gloves for household purposes; polishing gloves; gardening gloves; oven mitts; pestles for kitchen use; droppers for household purposes; plates to prevent milk boiling over; dripping pans; trays for household purposes; trays of paper, for household purposes; lazy susans; heaters for feeding bottles, non-electric; candelabra [candlesticks]; trivets [table utensils]; coasters, not of paper or textile; grill supports; menu card holders; knife rests for the table; flat-iron stands; egg cups; abrasive pads for kitchen purposes; scouring pads; drinking troughs; serving ladles; pottery; pots; cooking pots; painted glassware; tableware, other than knives, forks and spoons; porcelain ware; earthenware; crystal [glassware]; cosmetic utensils; toilet utensils; trouser presses; toothpaste tube squeezers; cruet sets for oil and vinegar; make-up removing appliances; spice sets; apparatus for wax-polishing, non-electric; bottle openers, electric and non-electric; glove stretchers; boot jacks; crumb trays; tie presses; clothes-pegs; glass stoppers; powder compacts, empty; perfume vaporizers; powder puffs; dusting apparatus, non-electric; foam toe separators for use in pedicures; combs; electric combs; grills [cooking utensils]; sifters [household utensils]; drinking horns; shoe horns; candle drip rings; broom handles; salad bowls; place mats, not of paper or textile; sugar bowls; beaters, non-electric; egg separators, non-electric, for household purposes; services [dishes]; coffee services [tableware]; liqueur sets; tea services [tableware]; cooking mesh bags, other than for microwaves; sieves [household utensils]; cinder sifters [household utensils]; tea strainers; siphon bottles for carbonated water; rolling pins, domestic; squeegees [cleaning instruments]; steel wool for cleaning; currycombs; blenders, non-electric, for household purposes; scoops for household purposes; fruit presses, non-electric, for household purposes; drinking straws; salt cellars; drinking vessels; vessels of metal for making ices and iced drinks; refrigerating bottles; cups of paper or plastic; glasses [receptacles]; drinking glasses; statues of porcelain, ceramic, earthenware, terra-cotta or glass; figurines of porcelain, ceramic, earthenware, terra-cotta or glass; glass for vehicle windows [semi-finished product]; plate glass [raw material]; opal glass; glass, unworked or semi-worked, except building glass; opaline glass; glass incorporating fine electrical conductors; glass wool, other than for insulation; vitreous silica fibers, other than for textile use; fiberglass, other than for insulation or textile use; portable cool boxes, non-electric; soup bowls; drying racks for laundry; rotary washing

lines; basins [receptacles]; table plates; disposable table plates; graters for kitchen use; insulating flasks; indoor terrariums [plant cultivation]; indoor terrariums [vivariums]; cloth for washing floors; polishing cloths; cloths for cleaning; dusting cloths [rags]; furniture dusters; aerosol dispensers, not for medical purposes; wax-polishing appliances, non-electric, for shoes; water apparatus for cleaning teeth and gums; electric devices for attracting and killing insects; watering devices; utensils for household purposes; kitchen utensils; cooking utensils, non-electric; diaper disposal pails; coffee filters, non-electric; flasks; hip flasks; drinking bottles for sports; boot trees; molds [kitchen utensils]; egg poachers; cake moulds; ice cube molds; cookery moulds; deep fryers, non-electric; comb cases; bread bins; fly swatters; teapots; kettles, non-electric; cups; ironing board covers, shaped; tea infusers; mops; mop wringers; cocktail shakers; cosmetic spatulas; corkscrews, electric and non-electric; animal bristles [brushware]; brushes; dishwashing brushes; brushes for cleaning tanks and containers; lamp-glass brushes; horse brushes; scrubbing brushes; toothbrushes; toothbrushes, electric; basting brushes; carpet sweepers; brushes for footwear; tar-brushes, long handled; toilet brushes; electric brushes, except parts of machines; eyebrow brushes; nail brushes; eyelash brushes; decanter tags; nest eggs, artificial; boxes for dispensing paper towels; dustbins; window-boxes; boxes of glass; busts of porcelain, ceramic, earthenware, terra-cotta or glass; clothing stretchers; wine-tasting pipettes; bulb basters.

(260) AM 2021 111688 A

(800) 1517194

(151) 2019 12 19

(891) 2021 01 22

(731) ALK-Abelló A/S

Bøge Allé 6-8, DK-2970 Hørsholm, Denmark

(540)

## OSIRIS

(591) Black, white

(511)

5 – Pharmaceutical and veterinary preparations for immunotherapeutic purposes; pharmaceutical and veterinary preparations for diagnosis, prevention and treatment of allergy, asthma, allergic rhinitis, rhinconjunctivitis, allergic asthma and respiratory allergic diseases, particularly sublingual preparations; diagnostic preparations for medical purposes, diagnostic reagents and diagnostic testing materials for medical use.

(260) AM 2021 111758 A  
(800) 1575521  
(151) 2020 12 15  
(891) 2020 12 15  
(731) Richter Gedeon Nyrt.  
Gyömrői út 19-21, H-1103 Budapest, Hungary  
(540)

**НЕТЕРЕНТ**

(591) Black, white  
(531) 28.05  
(511)  
5 – Pharmaceutical preparations.

---

(260) AM 2021 111759 A  
(800) 1575524  
(151) 2020 12 15  
(891) 2020 12 15  
(731) Richter Gedeon Nyrt.  
Gyömrői út 19-21, H-1103 Budapest, Hungary  
(540)

**ЛАДЕРТИН**

(591) Black, white  
(531) 28.05  
(511)  
5 – Pharmaceutical preparations.

---

(260) AM 2021 111762 A  
(800) 1575545  
(151) 2020 12 15  
(891) 2020 12 15  
(731) Richter Gedeon Nyrt.  
Gyömrői út 19-21, H-1103 Budapest, Hungary  
(540)

**КАБЕРТИН**

(591) Black, white  
(531) 28.05  
(511)  
5 – Pharmaceutical preparations.

---

(260) AM 2021 111763 A  
(800) 1575546  
(151) 2020 12 15  
(891) 2020 12 15  
(731) Richter Gedeon Nyrt.  
Gyömrői út 19-21, H-1103 Budapest, Hungary  
(540)

**ЭМБИДОН**

(591) Black, white  
(531) 28.05  
(511)  
5 – Pharmaceutical preparations.

---

(260) AM 2021 111764 A  
(800) 1575548  
(151) 2020 12 15  
(891) 2020 12 15  
(731) Richter Gedeon Nyrt.  
Gyömrői út 19-21, H-1103 Budapest, Hungary  
(540)

**ФРАДУКСИН**

(591) Black, white  
(531) 28.05  
(511)  
5 – Pharmaceutical preparations.

---

(260) AM 2021 111765 A  
(800) 1575549  
(151) 2020 12 15  
(891) 2020 12 15  
(731) Richter Gedeon Nyrt.  
Gyömrői út 19-21, H-1103 Budapest, Hungary  
(540)

**КУНДЕВИН**

(591) Black, white  
(531) 28.05  
(511)  
5 – Pharmaceutical preparations.

---

(260) AM 2021 111766 A  
(800) 1575554  
(151) 2020 12 15  
(891) 2020 12 15  
(731) Richter Gedeon Nyrt.  
Gyömrői út 19-21, H-1103 Budapest, Hungary  
(540)

**БАЛДОМИН**

(591) Black, white  
(531) 28.05  
(511)  
5 – Pharmaceutical preparations.

---

(260) AM 2021 111782 A  
(800) 1576122  
(151) 2020 12 28  
(891) 2020 12 28  
(731) S.C. Johnson & Son, Inc.  
1525 Howe Street, Racine, WI 53403-2236,  
USA  
(540)

**PURE HAPPINESS**

(591) Black, white  
(511)  
3 – Room or atmosphere perfumes; essential oils for the atmosphere; air fragranting preparations; air perfuming preparations; potpourri; incense.

---

4 – Candles; perfumed candles.

5 – Air purifying preparations; air sanitizing preparations; preparations for neutralizing odors; deodorants not for personal use; room or atmosphere deodorizers; carpet deodorizers; deodorizers for textiles.

(260) AM 2021 111783 A

(800) 1576150

(151) 2020 10 27

(891) 2020 10 27

(731) Egis Gyógyszergyár Zrt.

Keresztúri út 30-38, H-1106 Budapest, Hungary

(540)

## PLASOLUTE

(591) Black, white

(511)

3 – Cosmetics and cosmetic preparations.

5 – Human pharmaceutical preparations; dietetic substances adapted for medical use; dietary supplements; medicinal ointments; medicated skin creams; plasters, materials for dressings.

(260) AM 2021 111784 A

(800) 1576164

(151) 2020 12 15

(891) 2020 12 15

(731) The Skoll Fund

Suite 200, 250 University Avenue, Palo Alto  
CA 94301, USA

(540)

## SKOLL

(591) Black, white

(511)

36 – Philanthropic services concerning monetary donations.

(260) AM 2021 111785 A

(800) 1576171

(151) 2020 10 27

(891) 2020 10 27

(731) Egis Gyógyszergyár Zrt.

Keresztúri út 30-38, H-1106 Budapest, Hungary

(540)

## PLASEQ

(591) Black, white

(511)

3 – Cosmetics and cosmetic preparations.

5 – Human pharmaceutical preparations; dietetic substances adapted for medical use; dietary supplements; medicinal ointments; medicated skin creams; plasters, materials for dressings.

(260) AM 2021 111786 A

(800) 1576181

(151) 2020 09 28

(891) 2020 09 28

(731) NINGBO LIAO COMMODITY CO., LTD.

Room 901, No. 88, Qianhe South Road,  
Shouan Street, Yinzhou District, Ningbo,  
Zhejiang, China

(540)



(591) Black, white

(531) 01.15.05; 27.05.02; 27.05.07; 27.05.10;  
27.05.17

(511)

21 – Toilet brushes; steel wool for cleaning; brushes; brooms; cloths for cleaning; mops; sponges for household purposes; rags for cleaning; gloves for household purposes; window scrapers (domestic utensils) for cleaning purposes; trash cans; furniture dusters.

(260) AM 2021 111813 A

(800) 1576802

(151) 2020 12 11

(891) 2020 12 11

(731) Joint Stock Company "Yasnaya Polyana"

Odojevskoye shosse, 83, RU-300036 g. Tula,  
Russian Federation

(540)

## КАРАЧКИ

(591) Black, white

(531) 28.05

(511)

30 – Confectionery; caramels; chocolate; pralines; gingerbread; cookies; malt biscuits; waffles; ice cream; bread, pastries.

(260) AM 2021 111817 A

(800) 1155759

(151) 2012 10 17

(891) 2021 01 04

(731) GOLDIM spol. s r.o.

Michelská 18/12a, Michle, CZ-140 00 Praha 4,  
Czech Republic

(540)

## GOATTINY

(591) Black, white

(511)

5 – Food and beverages for infants, babies and small children, especially first stage and second stage powdered milk; milk for infants and babies; milk with ad-



ded albumin; milk for pharmaceutical use; cereal purees; milk and cereal purees; purees containing fruit and/or vegetables for infants and babies; food in jars for infants and babies; soups for infants and babies; fruit fillings, cereal fillings, fillings containing milk ingredients; meat fillings, vegetable fillings, fillings of meat and vegetables, mixed vegetable fillings and fruit fillings for infants, babies and small children; pastilles, tablets, capsules or gel capsules and gum for chewing containing curative ingredients; tea for infants, babies and small children; herbal teas for curative purposes; medicinal plants; medicinal plant extracts or syrups and preparations containing vitamins, minerals, trace elements and herbal extracts; beverages, food in granular form, beverage concentrates, dietetic beverages for medical purposes, milk and malt-based beverages for medical purposes, curative beverages; functional foods included in this class having positive health effects; nutraceutical, microbiotic, probiotic, prebiotic, symbiotic products and other food supplements for special human nutrition and for therapeutic purposes in the form of liquids, powders, granules, in tablets, in capsules and suppositories; preparations for diabetes patients, gluten-free, cholesterol-free, enriched with vitamins, minerals and trace elements; medicinal plants or extracts thereof intended for special diets and for medical purposes included in this class; sugar syrup containing curative ingredients; medicinal syrups; dietetic products for children and patients for medical purposes; nutritional or dietetic preparations with curative effects supplementing daily foods as instant food or stand-alone mixture, and consisting mainly of powdered milk or animal or vegetable protein substances and supplements of vitamins or minerals or trace elements or sugar; dietetic foodstuffs and/or dietary preparations and/or food supplements for therapeutic purposes made with albumin, fat, saccharides and/or fiber, containing supplements of vitamins, fatty acids, minerals, trace elements, functional substances, vegetable and/or animal oils and fats, for use alone or in combination, for medical use included in this class; preparations for diabetes patients; vitamins; vitamin and multivitamin preparations, minerals, mineral and multi-mineral preparations, trace elements as food supplements for medical use; albumin preparations derived from vegetable and animal products for medical use for human nutrition; lotions, creams and preparations for the bath for therapeutic purposes and particularly for babies and infants, pregnant and lactating women; food supplements and foodstuffs for special purposes included in this class (not for medical purposes) and containing substances of animal origin; food supplements made from animal products containing enzyme preparations and vitamin preparations; cereal-based food supplements included in this class (not for medical purposes); food supplements not for medical purposes (included in this class) and containing plant-based substances; food supplements not for medical purposes

made with albumin, probiotics, groceries and other biologically active ingredients.

29 – Milk, dairy products; dairy beverages made with goat milk in liquid, granulated and dried form supplemented with probiotic and/or prebiotic ingredients and/or symbiotic preparations, vegetable oils, vitamins, amino acids, albumin, minerals, trace elements, biologically active extracts, fruits, vegetables, medicinal plants and extracts thereof; milk beverages with a high milk content; whey; yogurts; kephir [milk beverage]; albumin-enriched milk; soya milk (milk substitute); goat's milk; albumin for human consumption; cheese and cheese foodstuffs; dried vegetables ; fruit, dried fruit, crushed fruit; pasteurized fruit and vegetable fillings; aspic; jams; jellies; albumin products and nutritional preparations and albumin products made from vegetable and animal products for human nutrition; foodstuffs included in this class for special nutrition for athletes or persons with high energy needs, particularly pregnant and lactating women; gelatinous products for special nutrition; dietetic oils; balanced nutrition preparations for specific diets including slimming diets made with vegetable and animal albumen, coenzymes containing fortified vitamins and/or minerals and/or trace elements and/or herbal extracts; dietetic preparations not for medical use containing albumin, probiotics, vitamins, minerals, edible oils and fats and other biologically active ingredients included in this class; soups.

30 – Beverages made with coffee, cocoa and chocolate and cocoa and coffee substitutes; prepared cereals for consumption in the form of bars, biscuits, mealy mixtures, muesli, breakfast cereals; purees, desserts, pastries and bakery products; cereal flakes and cereal preparations; cereal bars consisting mainly of cereals, muesli, nuts, fruits and/or sugar; products made with honey; confectionery with chocolate and without chocolate ; puree of buckwheat, rice, cereal, alone or with dairy products; foodstuffs for special nutrition purposes made with cereals; foodstuffs for weight treatment, for athletes' nutrition and for special property nutrition, containing vegetable substances included in this class, supplemented with mineral salts, trace elements, vitamins, saccharides, vegetable albumin, vegetable enzymes, vegetable coenzymes, probiotics, prebiotics, symbiotics, plant extracts and biologically active substances included in this class in the form of liquids, granules, powder, in tablets or capsules; appetite suppressing preparations included in this class (not for medical purposes); tea, tea concentrates, instant teas, tea powder; tea-based beverages, chocolate; Chocolate beverages; chocolate beverages with milk; cocoa; cocoa beverages; cocoa beverages with milk; cafés; coffee beverages; confectionery in the form of bars and instant desserts; soups made with cereal and starch; foodstuffs made with oats and other cereals; fibrous foodstuffs and muesli; desserts particularly puddings consisting mainly of sugar, cocoa, chocola-

te, chocolate and/or starch; desserts and puddings mainly consisting of sugar and chocolate, also with binding agents of any kind; finished products and ready-prepared cooked dishes made with cereals, rice, buckwheat and/or pasta; muesli consisting mainly of cereals, fruit, nuts and/or sugar; chewing gum; candy; ices; baked goods; confectionery; foodstuffs and dishes made with cereals for human consumption; pasta; honey; biscuits and cookies; desserts; lady fingers; biscuit bread; bars consisting primarily of fruits and cereals, muesli, cereals, nuts and/or sugar; children's desserts, particularly desserts consisting mainly of milk and/or fruit; desserts and puddings consisting mainly of milk and binding agents of any kind; desserts and puddings consisting mainly of fruits; herbs, crushed, ground or in the form of extracts with added vitamins, minerals, trace elements, bioflavonoids.

32 – Non-alcoholic beverages, particularly fruit juices; beverages made from fruit juice ; vegetable juices; ciders; fruit syrups and other non-alcoholic concentrates made with fruit and intended for making non-alcoholic beverages; fruit nectars; mineral waters; whey beverages; carbonated beverages; powders and granules for making beverages; lozenges and tablets for preparing carbonated beverages; beverages containing prepared milk substitutes and vegetable materials, included in this class.

(260) AM 2021 111818 A

(800) 1258845

(151) 2015 04 23

(891) 2020 12 30

(731) Société des Produits Nestlé S.A.

CH-1800 Vevey, Switzerland

(540)



(591) Black, white

(531) 03.07.20; 03.07.24

(511)

5 – Pharmaceutical and veterinary products; sanitary products for medical purposes; dietetic substances and foodstuffs for medical and clinical use; food and food substances for babies; foodstuffs and food substances for medical use for children and patients; foodstuffs and food substances for medical use for nursing mothers; nutritional and dietetic supplements for medical use; vitamin preparations, mineral-based preparations; dietetic confectionery products for medical use.

29 – Vegetables and potatoes (preserved, frozen, dried or cooked), fruit (preserved, frozen, dried or cooked), mushrooms (preserved, dried or cooked), meat, poul-

try, game, fish and seafood, all these goods in the form of extracts, soups, jellies, spreads, preserves, cooked, deep-frozen or dehydrated dishes; jams; eggs; milk, cream, butter, cheese and dairy products; milk substitutes; milk beverages where milk is predominating; milk-based desserts and cream-based desserts; yogurts; soya milk (milk substitute), preserved soya beans for human consumption; edible oils and fats; coffee and/or tea whiteners (cream substitutes); sausages; charcuterie, peanut butter; soups, concentrated soups, broths, stock cubes, bouillons, consommés (soups).

30 – Coffee, coffee extracts, coffee-based beverages and preparations; iced coffee; artificial coffee, artificial coffee extracts, artificial coffee-based beverages and preparations; chicory; tea, tea extracts, tea-based beverages and preparations; iced tea; malt-based preparations for human consumption; cocoa and cocoa-based beverages and preparations; chocolate, chocolate products, chocolate-based beverages and preparations; confectionery, sugar confectionery, candy; sugar; chewing gum not for medical use; natural sweeteners; bakery products, bread, yeast, pastries; biscuits, cakes, cookies, wafers, caramels, desserts (included in this class), puddings; edible ices, water ices, sherbets, frozen confectionery, frozen cakes, ice creams, frozen yogurts, powders and binding agents (included in this class) for making edible ices and/or water ices and/or sherbets and/or frozen confectionery and/or frozen cakes and/or ice creams and/or frozen yogurts; honey and honey substitutes; breakfast cereals, muesli, corn flakes, cereal bars, ready-to-eat cereals; cereal preparations; rice, pasta, noodles; food products based on rice, flour or cereals, also in the form of cooked dishes; pizzas; sandwiches; pasta and ready-to-bake cake dough preparations; sauces, soya sauce; tomato ketchup; flavoring or seasoning products for food; spices for food, condiments, salad dressings, mayonnaise; mustard; vinegar.

32 – Still waters, aerated or carbonated waters, treated waters, spring waters, mineral waters, flavored waters; fruit-flavored beverages and fruit-based beverages, fruit juices and vegetable juices, nectars, lemonades, soda water and other non-alcoholic beverages; syrups, extracts and essences and other preparations for making non-alcoholic beverages (excluding essential oils); beverages based on milk ferments; soya-based beverages; malt-based beverages; isotonic beverages.

(260) AM 2021 111819 A

(800) 1304812

(151) 2016 05 04

(891) 2021 01 20

(731) Obschestvo s ogranitchennoy otvetstvennostyu "KDV Nizhny Tagil"

Frunze str., bld. 83, Nizhny Tagil, RU-622022  
Sverdlovskaya oblast, Russian Federation

(540)

**БОН ТАЙМ**  
**BON TIME**

(591) Black, white

(531) 28.05

(511)

29 – Fruit jellies; fruits, tinned [canned (Am.)]; buttercream; croquettes; marmalade; nuts, prepared; whipped cream; crystallized fruits; fruit, preserved; fruit, stewed; potato flakes; potato chips; fruit chips.

30 – Aromatic preparations for food; food flavorings, other than essential oils; waffles; vermicelli [noodles]; cakes; pastries; peanut confectionery; almond confectionery; pasta; frozen yogurt [confectionery ices]; caramels [candy]; sweetmeats [candy]; crackers; couscous [semolina]; noodles; candy; custard; ice cream; muesli; pastilles [confectionery]; cookies; pies; fondants [confectionery]; condiments; gingerbread; cake dough; confectionery.

(260) AM 2021 111820 A

(800) 1328602

(151) 2015 12 23

(891) 2021 02 03

(731) GROUPE GO SPORT, Société Anonyme

17 Avenue de la Falaise, F-38360  
SASSENAGE, France

(540)



(591) Black, white

(531) 26.11.13; 29.01.13

(511)

9 – Protective helmets for cyclists and motorcyclists, spectacles for cyclists and motorcyclists, spectacle cases.

12 – Vehicles; apparatus for locomotion by land, air or water and especially cycles and bicycles; anti-theft devices for cycles; audible warning systems for cycles and bicycles (bells); kickstands for cycles and bicycles (parts thereof); tubeless tires for cycles; frames for cycles; chains for bicycles, cycles; inner tubes for cycles; brakes and brake fittings for all cycles and bicycles; cycle mudguards; handle bars for bicycles, cycles; saddles for all cycles and bicycles; saddle covers for cycles; bicycle rims; mudguards, guards for cycle, bi-

cycle and vehicle components (other than for engines); grips for cycles and bicycles; motors for cycles; pneumatic tires for cycles and bicycles; air pumps; bicycle pumps; pedals for cycles; special baskets for cycles and bicycles; luggage carriers for cycles and bicycles and fittings thereof; baby carriers for cycles and bicycles; wheels of all cycles and bicycles; wheel hubs of all vehicles, cycles and bicycles; bicycle spokes; saddlebags adapted for cycles; cranks for cycles; gears for cycles; tyres for bicycles, cycles.

25 – Clothing, sportswear and particularly clothing for cycling, headgear, footwear, footwear for sports and particularly footwear for cycling, underclothing and underwear; gloves.

(260) AM 2021 111821 A

(800) 1350701

(151) 2017 03 30

(891) 2021 02 03

(731) GROUPE GO SPORT

17 avenue de la Falaise, F-38360 Sassenage,  
France

(540)

**SCRAPPER**

(591) Black, white

(531) 27.05.01

(511)

9 – Protective helmets for cyclists and motorcyclists, spectacles for cyclists and motorcyclists, spectacle cases.

11 – Lighting apparatus and lamps for cycles; cycle lights; headlights for cycles.

12 – Vehicles; apparatus for locomotion by land, air or water and especially cycles and bicycles; electric land vehicles, and particularly electric bicycles; anti-theft devices for cycles; audible warning systems for cycles and bicycles (bells); kickstands for cycles (cycle parts); tubeless tires for cycles; cycle frames; chains for bicycles, cycles; inner tubes for cycles; brakes and brake fittings for all cycles and bicycles; mudguards for cycles; cycle handlebars; saddles for all cycles and bicycles; saddle covers for cycles; bicycle rims; mudguards, guards for cycle, bicycle and vehicle components (other than for engines); grips for cycles and bicycles; motors for cycles; pneumatic tires for cycles and bicycles; bicycle pumps; pedals for cycles; special baskets for cycles and bicycles; air pumps for cycles; luggage carriers for cycles; baby carriers for cycles; wheels of all cycles and bicycles; wheel hubs of all vehicles, cycles and bicycles; bicycle spokes; saddlebags adapted for cycles; cranks for cycles; gears for cycles; tyres for bicycles, cycles.

25 – Clothing, sportswear and particularly clothing for cycling, headgear, footwear, footwear for sports and

particularly footwear for cycling, underclothing and underwear; gloves.

(260) AM 2021 111887 A

(800) 1576894

(151) 2020 10 22

(891) 2020 10 22

(731) CHANGSHU TONGRUN, AUTO ACCESSORY CO., LTD.

New Longteng Industrial Park,; Changshu Economic Development Zone; Jiangsu Province, China

(540)



(591) Black, white

(531) 02.09.14; 27.05.03

(511)

7 – Jacks [machines]; lifting apparatus; hoisting cranes; elevators; hydraulic cylinders [parts of machines]; electric screwdrivers; hand-held hydraulic tools; capstans; loading ramps; rack and pinion jacks; truck jacks; lorry jacks; air pumps; hand-held hydraulic presses; automatic tire mounting apparatus; hydraulic conveyors; electric spanners; hand-held tools, other than hand-operated; elevating apparatus; cranes [lifting and hoisting apparatus]; pneumatic jacks; mechanical parking system with elevating apparatus; hydraulic controls for machines, motors and engines; hydraulic presses; compressed air machines.

(260) AM 2021 111890 A

(800) 1576925

(151) 2020 10 22

(891) 2020 10 22

(731) ŞÖLEN ÇİKOLATA GIDA SANAYİ VE TİCARET ANONİM ŞİRKETİ

4.Organize Sanayi Bölgesi, Nolu Cadde No:4, TR-83412 ŞEHİTKAMİL GAZIANTEP, Turkey

(540)

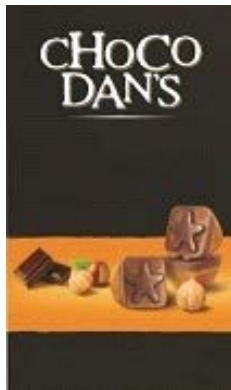

(591) Black, white, brown, beige, orange and green

(531) 01.01.01; 01.01.10; 05.07.06; 08.01.22;

26.04.02; 26.04.16; 26.04.18; 26.04.24;

27.05.03; 27.05.10; 27.05.11; 27.05.24;

29.01.15

(511)

30 – Pasta, stuffed dumplings, noodles; pastries and bakery products based on flour; desserts based on flour and chocolate; bread, simit [Turkish ring-shaped bagel covered with sesame seeds], poğaça [Turkish bagel], pita, sandwiches, katmer [Turkish pastry], pies, cakes, baklava [Turkish dessert based on dough coated with syrup]; kadayıf [Turkish dessert based on dough]; desserts based on dough coated with syrup; puddings, custard, kazandibi [Turkish pudding], rice pudding, keşkül [Turkish pudding]; honey, bee glue for human consumption, propolis for food purposes; condiments for foodstuff, vanilla (flavoring), spices, sauces (condiments), tomato sauce; yeast, baking powder; flour, semolina, starch for food; sugar, cube sugar, powdered sugar; tea, ice tea; confectionery, chocolate, biscuits, crackers, wafers; chewing gums; ice-cream, edible ices; salt; cereal-based snack food, popcorn, crushed oats, corn chips, breakfast cereals, processed wheat for human consumption, crushed barley for human consumption, processed oats for human consumption, processed rye for human consumption, rice; molasses for food.

(260) AM 2021 111891 A

(800) 1576948

(151) 2020 11 26

(891) 2020 11 26

(731) Incyte Holdings Corporation

1801 Augustine Cut-Off, Wilmington DE 19803, USA

(540)



(591) Black, white

(531) 27.01.01; 27.05.17; 27.05.21; 27.05.25

(511)

5 – Pharmaceutical preparations for the prevention and treatment of cancer.

44 – Providing healthcare information to patients and healthcare professionals regarding diseases, diagnosis and treatment of diseases via a website.

(260) AM 2021 111892 A  
 (800) 1576959  
 (151) 2020 12 14  
 (891) 2020 12 14  
 (731) Monus doo Beograd Zemun  
 Aleksandra Dubčeka 14, 11080  
 Zemun – Beograd, Serbia

(540)

## SPEAK EASY

(591) Black, white  
 (511)  
 16 – Printed matter and printed advertising materials concerning the following goods: tobacco, rolling tobacco, tobacco products, chewing tobacco, smokers' articles, tobacco filters, matches, cigarettes, cigars.

34 – Tobacco; rolling tobacco; tobacco products; chewing tobacco; smokers' articles, filters for tobacco; matches; cigarettes; cigars; rolling tobacco; tobacco products; chewing tobacco; smokers' articles; filters for tobacco; matches; cigarettes; cigars.

(260) AM 2021 111893 A  
 (800) 1576981  
 (151) 2020 11 18  
 (891) 2020 11 18  
 (731) NANJING MOGE NEW ENERGY CO., LTD  
 2nd Floor, Building 2, No. 605, Zhushan Road,  
 Science Park, Jiangning District, Nanjing,  
 211100 Jiangsu, China

(540)

**MOREGOSOLAR**

(591) Orange, gray  
 (531) 27.05.01; 29.01.12  
 (511)  
 9 – Solar batteries; photovoltaic cells; galvanic cells; inverters [electricity]; solar panels for power generation; plates for batteries; chip for integrated circuit; material for electricity mains [wires, cables].

(260) AM 2021 111894 A  
 (800) 1577005  
 (151) 2021 01 14  
 (891) 2021 01 14  
 (731) Zhejiang Konita New Materials CO., LTD  
 No. 929, Airport Avenue, Wenzhou Industrial  
 Park, Wenzhou, 325000 Zhejiang, China

(540)



(591) Blue, brown, green, gray, white  
 (531) 26.04.09; 27.05.10; 29.01.15  
 (511)  
 1 – Photosensitive plates; photographic developers; sensitized plates for offset printing; chemical preparations for use in photography; blueprint cloth; photographic sensitizers; photo development chemical composition; sensitized films, unexposed; sensitized photographic plates; spectrum sensitization board.

7 – Printing pattern plank; printing pattern roller; printing plates; matrices for use in printing; printing-down apparatus; foreign language moulding board; offset point machine; printing presses; zincography printing; photoengraving machines.

16 – Hectographs; printing type; printing blocks; mimeograph apparatus and machines; household ductor; engraved paper pattern; prints [engravings]; electrotypes; rotary stenograph.

(260) AM 2021 111895 A  
 (800) 1577121  
 (151) 2020 10 13  
 (891) 2020 10 13  
 (731) Melnikov Vladimir Vladimirovich  
 ul. 2-ya Volodarskogo, d. 1851, RU-344004  
 Rostov-na-Donu, Russian Federation

(540)

## Ready! Steady! Go!

(591) Black, white  
 (531) 27.05.01  
 (511)  
 3 – Non-medicated cosmetics and toiletry preparations; non-medicated dentifrices; perfumery, essential oils; bleaching preparations and other substances for laundry use; cleaning, polishing, scouring and abrasive preparations; abrasives; amber [perfume]; descaling preparations for household purposes; antistatic preparations for household purposes; aromatics [essential oils]; air fragrancing preparations; cake flavorings [essential oils]; cake flavourings [essential oils]; flavorings for beverages [essential oils]; flavourings for beverages [essential oils]; food flavourings [essential oils]; food flavorings [essential oils]; breath freshening sprays; canned pressurized air for cleaning and dusting purposes; balms, other than for medical purposes; basma [cosmetic dye]; lip glosses; nail glitter; polishing stones; abrasive paper; emery paper; polishing paper; petroleum jelly for cosmetic purposes; shoe polish; cobblers' wax; cotton wool for cosmetic purposes; cotton wool impregnated with make-up removing preparations; sachets for perfuming linen; drying agents for dishwashing machines; adhesives for cosmetic purposes; scented water; Javelle water; potassium hypochloride; lavender water; micellar water; toilet water; wax for parquet floors; floor wax; non-slipping wax for floors; depilatory wax; mustache

wax; moustache wax; tailors' wax; creams for leather; waxes for leather; polish for furniture and flooring; shoemakers' wax; polishing wax; massage gels, other than for medical purposes; heliotropine; dental bleaching gels; geraniol; make-up; deodorants for pets; deodorants for human beings or for animals; depilatory preparations; depilatories; air fragrance reed diffusers; scented wood; perfumes; non-slipping liquids for floors; windshield cleaning liquids; windscreen cleaning liquids; greases for cosmetic purposes; volcanic ash for cleaning; perfumery; decorative transfers for cosmetic purposes; ionone [perfumery]; shaving stones [astringents]; smoothing stones; eyebrow pencils; cosmetic pencils; silicon carbide [abrasive]; carbides of metal [abrasives]; alum stones [astringents]; tripoli stone for polishing; adhesives for affixing false eyelashes; adhesives for affixing false hair; hair conditioners; quillaia bark for washing; corundum [abrasive]; beard dyes; colorants for toilet purposes; cosmetic dyes; body paint for cosmetic purposes; laundry starch; starch for laundry purposes; laundry glaze; shoe cream; polishing creams; cosmetic creams; skin whitening creams; cream for whitening the skin; polishing rouge; jewellers' rouge; incense; hair spray; nail polish; nail varnish; liquid latex body paint for cosmetic purposes; hair lotions; lotions for cosmetic purposes; after-shave lotions; beauty masks; oils for perfumes and scents; oils for cosmetic purposes; oils for toilet purposes; essential oils; ethereal oils; essential oils of cedarwood; essential oils of lemon; essential oils of citron; oils for cleaning purposes; bergamot oil; gaultheria oil; jasmine oil; lavender oil; almond oil; rose oil; oil of turpentine for degreasing; whitening; cleaning chalk; almond milk for cosmetic purposes; cleansing milk for toilet purposes; musk [perfumery]; soap; deodorant soap; shaving soap; soap for brightening textile; cakes of toilet soap; cakes of soap; antiperspirant soap; soap for foot perspiration; almond soap; mint for perfumery; cosmetic kits; emery; gel eye patches for cosmetic purposes; nail art stickers; false nails; eau de Cologne; bases for flower perfumes; joss sticks; pastes for razor strops; toothpaste; pumice stone; lipstick cases; hydrogen peroxide for cosmetic purposes; breath freshening strips; teeth whitening strips; abrasive cloth; sandcloth; glass cloth [abrasive cloth]; lipsticks; pomades for cosmetic purposes; shaving preparations; cosmetic preparations for baths; bath preparations, not for medical purposes; hair straightening preparations; hair waving preparations; waving preparations for the hair; laundry soaking preparations; preparations for soaking laundry; grinding preparations; sharpening preparations; smoothing preparations [starching]; color-removing preparations; colour-removing preparations; leather bleaching preparations; polishing preparations; denture polishes; mouthwashes, not for medical purposes; cosmetic preparations for slimming purposes; starch glaze for laundry purposes; preparations to make the leaves of plants shiny; eye-washes, not for medical purposes;

fabric softeners for laundry use; laundry bleach; laundry bleaching preparations; dry-cleaning preparations; paint stripping preparations; lacquer-removing preparations; make-up removing preparations; floor wax removers [scouring preparations]; varnish-removing preparations; rust removing preparations; nail care preparations; cleaning preparations; preparations for cleaning dentures; wallpaper cleaning preparations; preparations for unblocking drain pipes; chemical cleaning preparations for household purposes; collagen preparations for cosmetic purposes; bleaching preparations [decolorants] for household purposes; laundry preparations; aloe vera preparations for cosmetic purposes; sunscreen preparations; color-brightening chemicals for household purposes [laundry]; colour-brightening chemicals for household purposes [laundry]; breath freshening preparations for personal hygiene; shining preparations [polish]; make-up powder; diamantine [abrasive]; stain removers; nail varnish removers; nail polish removers; vaginal washes for personal sanitary or deodorant purposes; scouring solutions; false eyelashes; antistatic dryer sheets; antistatic drier sheets; baby wipes impregnated with cleaning preparations; color run prevention laundry sheets; colour run prevention laundry sheets; tissues impregnated with cosmetic lotions; tissues impregnated with make-up removing preparations; safrol; massage candles for cosmetic purposes; laundry blueing; turpentine for degreasing; potpourris [fragrances]; bleaching soda; washing soda, for cleaning; bath salts, not for medical purposes; bleaching salts; fumigation preparations [perfumes]; preservatives for leather [polishes]; leather preservatives [polishes]; ammonia [volatile alkali] [detergent]; volatile alkali [ammonia] [detergent]; astringents for cosmetic purposes; eyebrow cosmetics; make-up preparations; sun-tanning preparations [cosmetics]; hair dyes; hair colorants; neutralizers for permanent waving; cosmetic preparations for eyelashes; cosmetic preparations for skin care; shoe wax; dentifrices; cosmetics; cosmetics for children; cosmetics for animals; mascara; cleansers for intimate personal hygiene purposes, non medicated; douching preparations for personal sanitary or deodorant purposes [toiletries]; detergents, other than for use in manufacturing operations and for medical purposes; degreasers, other than for use in manufacturing processes; bleaching preparations [decolorants] for cosmetic purposes; toiletry preparations; antiperspirants [toiletries]; phytocosmetic preparations; talcum powder, for toilet use; cotton sticks for cosmetic purposes; cotton swabs for cosmetic purposes; terpenes [essential oils]; emery cloth; cloths impregnated with a detergent for cleaning; henna [cosmetic dye]; shampoos; shampoos for animals [non-medicated grooming preparations]; shampoos for pets [non-medicated grooming preparations]; dry shampoos; sandpaper; glass paper; soda lye; herbal extracts for cosmetic purposes; extracts of flowers [perfumes]; ethereal essences; badian essence; mint essence [essential oil].



14 – Precious metals and their alloys; jewellery, precious and semi-precious stones; horological and chronometric instruments; agates; diamonds; amulets [jewellery]; amulets [jewelry]; anchors [clock- and watchmaking]; barrels [clock- and watchmaking]; bracelets [jewellery]; bracelets [jewelry]; bracelets made of embroidered textile [jewelry]; bracelets made of embroidered textile [jewellery]; watch bands; watch straps; straps for wristwatches; charms for key rings; charms for key chains; jewellery charms; jewelry charms; charms for jewellery; charms for jewelry; brooches [jewellery]; brooches [jewelry]; alarm clocks; pins [jewellery]; pins [jewelry]; ornamental pins; tie pins; jewellery hat pins; jewelry hatpins; beads for making jewelry; beads for making jewellery; pearls made of ambroid [pressed amber]; busts of precious metal; jewelry rolls; jewellery rolls; jet, unwrought or semi-wrought; jewelry findings; jewellery findings; key chains [split rings with trinket or decorative fob]; key rings [split rings with trinket or decorative fob]; retractable key chains; retractable key rings; pearls [jewellery]; pearls [jewelry]; copper tokens; tie clips; cuff links; clasps for jewelry; clasps for jewellery; badges of precious metal; gold, unwrought or beaten; cloisonne jewellery; cloisonne jewelry; works of art of precious metal; jewelry; jewellery; ivory jewelry; ivory jewellery; jewelry of yellow amber; jewellery of yellow amber; iridium; cabochons; precious stones; semiprecious stones; spun silver [silver wire]; necklaces [jewellery]; necklaces [jewelry]; split rings of precious metal for keys; rings [jewellery]; rings [jewelry]; boxes of precious metal; presentation boxes for jewellery; presentation boxes for jewelry; watch cases [parts of watches]; clock cases; pendulums [clock- and watchmaking]; medals; lockets [jewellery]; lockets [jewelry]; precious metals, unwrought or semi-wrought; movements for clocks and watches; clockworks; misbaha [prayer beads]; coins; gold thread [jewellery]; gold thread [jewelry]; threads of precious metal [jewellery]; wire of precious metal [jewellery]; threads of precious metal [jewelry]; wire of precious metal [jewelry]; silver thread [jewellery]; silver thread [jewelry]; olivine [gems]; peridot; osmium; palladium; platinum [metal]; chronometric instruments; watch springs; crucifixes of precious metal, other than jewellery; crucifixes of precious metal, other than jewelry; crucifixes as jewellery; crucifixes as jewelry; rhodium; ruthenium; stopwatches; silver, unwrought or beaten; earrings; ingots of precious metals; alloys of precious metal; statues of precious metal; figurines of precious metal; statuettes of precious metal; watch glasses; watch crystals; paste jewellery; watch hands; clock hands; ornaments of jet; shoe jewellery; shoe jewelry; hat jewellery; hat jewelry; presentation boxes for watches; chronographs [watches]; chronometers; chronoscopes; chains [jewellery]; chains [jewelry]; watch chains; dials [clock- and watchmaking]; atomic clocks; watches; sundials; clocks and watches, electric; control clocks [master clocks]; mas-

ter clocks; clocks; wristwatches; rosaries; chaplets; jewellery boxes; jewelry boxes; spinel [precious stones].

25 – Clothing, footwear, headwear; wimples; bandanas [neckerchiefs]; underwear; underclothing; sweat-absorbent underwear; sweat-absorbent underclothing; berets; overalls; smocks; boas [necklets]; teddies [underclothing]; bodies [underclothing]; boxer shorts; ankle boots; ski boots; boots for sports; breeches for wear; trousers; pants (Am.); football shoes; football boots; brassieres; adhesive bras; adhesive brassieres; valenki [felted boots]; mittens; collars [clothing]; detachable collars; shirt yokes; veils [clothing]; gabardines [clothing]; galoshes; goloshes; neckties; ascots; leggings [leg warmers]; leg warmers; gaiters; spats; boot uppers; corselets; jerseys [clothing]; vests; waistcoats; sports jerseys; hosiery; heels; hoods [clothing]; hat frames [skeletons]; pockets for clothing; scarfs; scarves; caps being headwear; kimonos; cap peaks; visors being headwear; slippers [underclothing]; combinations [clothing]; wet suits for water-skiing; bodices [lingerie]; corsets [underclothing]; suits; bathing suits; swimsuits; masquerade costumes; beach clothes; headscarfs; headscarves; leotards; jackets [clothing]; stuff jackets [clothing]; fishing vests; leggings [trousers]; liveries; camisoles; sports singlets; cuffs; wristbands [clothing]; short-sleeve shirts; mantillas; coats; sleep masks; furs [clothing]; fingerless gloves; miters [hats]; mitres [hats]; muffs [clothing]; footmuffs, not electrically heated; bibs, not of paper; bibs, sleeved, not of paper; fur stoles; hairdressing capes; heel protectors for shoes; ear muffs [clothing]; socks; sweat-absorbent socks; footwear; beach shoes; sports shoes; clothing; paper clothing; outerclothing; embroidered clothing; ready-made clothing; motorists' clothing; cyclists' clothing; clothing for gymnastics; clothing of imitations of leather; latex clothing; clothing of leather; waterproof clothing; clothing incorporating LEDs; uniforms; clothing containing slimming substances; fittings of metal for footwear; maniples; overcoats; topcoats; panties; knickers; parkas; pelerines; gloves [clothing]; ski gloves; pajamas; pyjamas; bathing trunks; bathing drawers; shirt fronts; pocket squares; dresses; headbands [clothing]; garters; sock suspenders; stocking suspenders; ready-made linings [parts of clothing]; dress shields; soles for footwear; heelpieces for footwear; braces for clothing [suspenders]; suspenders; half-boots; lace boots; ponchos; girdles; belts [clothing]; sashes for wear; money belts [clothing]; layettes [clothing]; non-slipping devices for footwear; sweaters; pullovers; jumpers [pullovers]; heelpieces for stockings; welts for footwear; chasubles; shirts; wooden shoes; sandals; bath sandals; boots; jumper dresses; pinafore dresses; saris; sarongs; footwear uppers; inner soles; albs; bath slippers; togas; knitwear [clothing]; underpants; shoes; gymnastic shoes; slippers; skull caps; turbans; headwear; aprons [clothing]; judo uniforms; karate uniforms; tee-shirts; rash guards; dressing gowns; bath

robes; top hats; tips for footwear; stockings; sweat-absorbent stockings; shawls; paper hats [clothing]; shower caps; bathing caps; neck gaiters; neck tube scarves; studs for football boots; hats; babies' pants [underwear]; trouser straps; gaiter straps; pelisses; esparto shoes or sandals; skirts; petticoats; skorts.

35 – Advertising; business management; business administration; office functions; arranging subscriptions to telecommunication services for others; import-export agency services; commercial information agency services; advertising agencies; publicity agencies; cost price analysis; rental of office equipment in co-working facilities; rental of advertising space; business auditing; financial auditing; business intermediary services relating to the matching of potential private investors with entrepreneurs needing funding; employment agency services; computerized file management; book-keeping; accounting; invoicing; demonstration of goods; transcription of communications [office functions]; opinion polling; market studies; business investigations; business research; marketing research; personnel recruitment; business management and organization consultancy; business organization consultancy; business management consultancy; personnel management consultancy; professional business consultancy; consultancy regarding advertising communication strategies; consultancy regarding public relations communication strategies; layout services for advertising purposes; marketing; marketing in the framework of software publishing; targeted marketing; business management of performing artists; business management of sports people; writing of resumes for others; writing of curriculum vitae for others; scriptwriting for advertising purposes; news clipping services; updating and maintenance of information in registries; updating and maintenance of data in computer databases; updating of advertising material; word processing; online retail services for downloadable and pre-recorded music and movies; online retail services for downloadable ring tones; online retail services for downloadable digital music; organization of exhibitions for commercial or advertising purposes; arranging newspaper subscriptions for others; organization of fashion shows for promotional purposes; organization of trade fairs; shop window dressing; business appraisals; payroll preparation; data search in computer files for others; sponsorship search; administrative assistance in responding to calls for tenders; administrative assistance in responding to requests for proposals [RFPs]; business management assistance; commercial or industrial management assistance; commercial intermediation services; providing business information; providing business information via a web site; providing commercial and business contact information; providing commercial information and advice for consumers in the choice of products and services; provision of an online marketplace for buyers and sellers of goods and services; providing user reviews for commercial or advertising purposes; web indexing

for commercial or advertising purposes; providing user rankings for commercial or advertising purposes; providing user ratings for commercial or advertising purposes; presentation of goods on communication media, for retail purposes; media relations services; economic forecasting; auctioneering; wholesale services for pharmaceutical, veterinary and sanitary preparations and medical supplies; retail services for works of art provided by art galleries; retail services for pharmaceutical, veterinary and sanitary preparations and medical supplies; sales promotion for others; promotion of goods and services through sponsorship of sports events; production of teleshopping programmes; production of teleshopping programs; production of advertising films; office machines and equipment rental; rental of advertising time on communication media; publicity material rental; rental of billboards [advertising boards]; rental of vending machines; rental of sales stands; rental of photocopying machines; consumer profiling for commercial or marketing purposes; publication of publicity texts; radio advertising; development of advertising concepts; bill-posting; distribution of samples; dissemination of advertising matter; direct mail advertising; registration of written communications and data; writing of publicity texts; publicity; online advertising on a computer network; outdoor advertising; advertising by mail order; television advertising; compilation of statistics; compilation of information into computer databases; business inquiries; systemization of information into computer databases; administrative services for medical referrals; advisory services for business management; corporate communications services; negotiation of business contracts for others; negotiation and conclusion of commercial transactions for third parties; compiling indexes of information for commercial or advertising purposes; tax preparation; drawing up of statements of accounts; telemarketing services; psychological testing for the selection of personnel; interim business management; outsourced administrative management for companies; business management of hotels; business management for freelance service providers; business project management services for construction projects; commercial administration of the licensing of the goods and services of others; business management of reimbursement programs for others; business management of reimbursement programmes for others; administration of consumer loyalty programs; administration of frequent flyer programs; administrative processing of purchase orders; administrative services for the relocation of businesses; public relations; commercial lobbying services; competitive intelligence services; modelling for advertising or sales promotion; typing; market intelligence services; appointment reminder services [office functions]; web site traffic optimization; web site traffic optimisation; tax filing services; search engine optimization for sales promotion; search engine optimisation for sales promotion; appointment scheduling services [office



functions]; retail services relating to bakery products; gift registry services; price comparison services; pay per click advertising; secretarial services; procurement services for others [purchasing goods and services for other businesses]; shorthand; outsourcing services [business assistance]; telephone answering for unavailable subscribers; telephone switchboard services; photocopying services; business efficiency expert services; retail or wholesale services for goods.

43 – Services for providing food and drink; temporary accommodation; accommodation bureau services [hotels, boarding houses]; rental of temporary accommodation; rental of meeting rooms; tourist home services; hotel reservations; boarding house bookings; temporary accommodation reservations; hotel services; retirement home services; snack-bar services; information and advice in relation to the preparation of meals; cafe services; cafeteria services; motel services; boarding house services; boarding for animals; rental of cooking apparatus; rental of chairs, tables, table linen, glassware; rental of lighting apparatus; rental of tents; rental of transportable buildings; rental of drinking water dispensers; restaurant services; self-service restaurant services; reception services for temporary accommodation [management of arrivals and departures]; food sculpting; canteen services; decorating of food; cake decorating; holiday camp services [lodging]; bar services; hookah lounge services; providing campground facilities; personal chef services; food and drink catering; washoku restaurant services; udon and soba restaurant services; day-nursery [crèche] services.

(260) AM 2021 111899 A  
(800) 1577357  
(151) 2020 07 20  
(891) 2020 07 20  
(731) LASSELSBERGER GmbH  
Wörth 1, A-3380 Pöchlarn, Austria  
(540)



(591) Blue (CMYK C=100 / M=50 / Y=0 / K=6, sRGB R=0 / G=100 / B=172, Pantone 2384 C, Pantone 3005 U, RAL 5017 Traffic blue); white (CMYK C=0 / M=0 / Y=0 / K=0, sRGB R=255 / G=255 / B=255, RAL 9003 Signal white)  
(531) 26.04.02; 26.04.05; 26.04.22; 27.05.24; 29.01.12  
(511)  
2 – Paints, in particular facade paints, colorants and dyes for industrial use, in particular for use in construction chemistry; paints; colorants; silicate paints; emulsion paints; primers (paints).

17 – Sealing compounds and filling compounds; insulating plaster; wall paints for insulation purposes; insulating fillings (insulating material); thermal insulating material; plastics for semi-finished products.

37 – Construction in the field of opencast mining, masonry, structural engineering, tiling work, maintenance of buildings and their modification or rather removal, in particular with regard to their renovation and additions; information relating to the aforesaid services, not included in other classes.

(260) AM 2021 111907 A  
(800) 1577528  
(151) 2020 08 21  
(891) 2020 08 21  
(731) Tarasenko Iryna  
Hvardiysiv Shyronintsiv St., 49G, apt. 53,  
Kharkiv 61170, Ukraine;  
Tarasenko Ihor  
Lypovetska St., 26, Skvyra, Kyiv region  
09001, Ukraine

(540)



(591) Black, white  
(531) 27.05.01  
(511)

30 – Flour and preparations made from cereals; bread; confectionery; baking powder; peanut confectionery; cereal bars; high-protein cereal bars; bean meal; pastries; flour confectionery; bread rolls; buns; oatmeal; oat flakes; oat-based food; cookies; rice-based snack food; cereal-based snack food; wheat germ for human consumption; potato flour; sugar confectionery; corn flour; corn flakes; confectionery for decorating Christmas trees; almond cookies; almond confectionery; muesli; crushed oats; husked oats; husked barley; quiches; chips (cereal products); unleavened bread; gingerbread; cake powder; wheat flour; fruit coulis [sauces]; soya flour; malt biscuits; rusks; breadcrumbs; petit-beurre biscuits; cakes; tarts; dough; cake batter; cake dough; pastry dough; crackers; barley meal; crushed barley.

(260) AM 2021 111912 A  
(800) 1577662  
(151) 2021 01 15  
(891) 2021 01 15  
(731) Apple Inc.  
One Apple Park Way, Cupertino CA 95014,  
USA

(540)



(591) Red and white

(531) 24.17.10; 26.04.04; 29.01.12

(511)

9 – Computer software application for access to audio, video, and multimedia content; computer software application for use in connection with an online music subscription service; computer software for use in playing, organizing, downloading, transmitting, manipulating, and reviewing audio and video files; computer software for use in the delivery, distribution and transmission of digital music and entertainment-related audio and video content; downloadable audio and video recordings featuring music, music performances, podcasts, radio programs, and music videos; computer software application for use in reviewing, storing, organizing, and playing live and pre-recorded audio, video, and multimedia content; magnetically encoded gift cards.

(260) AM 2021 111913 A

(800) 1577683

(151) 2020 11 30

(891) 2020 11 30

(731) AKZIONERNOE OBSHESTVO,  
"KERAMOGRAFITNIJ ZAVOD"  
Starositnenskoje Shosse, vl. 32, g. Stupino,  
RU-142800 Moscow region, Russian  
Federation

(540)

## COLISEUM

(591) Black, white

(511)

19 – Ceramic tiles; tiles of porcelain stoneware; ceramic slabs; porcelain stoneware slabs; non-metallic tiles; wall tiles, not of metal; wall tiles for bathrooms, not of metal; wall tiles for kitchens, not of metal.

(260) AM 2021 111914 A

(800) 1577686

(151) 2020 12 10

(891) 2020 12 10

(731) Toruńskie Zakłady Materiałów,  
Opatrunkowych, Spółka Akcyjna  
Żółkiewskiego 20/26; PL-87-100 Toruń,  
Poland

(540)

## seni

(591) Black, white

(511)

3 – Skin care products for incontinent persons.

5 – Disposable diapers for incontinent persons, disposable diaper-pants for incontinent persons, disposable underwear panties for incontinent persons, urological incontinence pads for men, anatomical urological incontinence pads for women.

10 – Bed pads for incontinent persons.

(260) AM 2021 111985 A

(800) 1578202

(151) 2019 06 11

(891) 2019 06 11

(731) ProXES GmbH

Stephanplatz 2, 31789 Hameln, Germany

(540)



(591) White, blue and grey

(531) 26.04.04; 26.04.05; 26.04.22; 27.05.10;  
29.01.13

(511)

7 – Machines, namely crushing, mixing, homogenising and de-aeration machines and mills for the food industry, the luxury foods, alcohol and tobacco industry, the paint and lacquer industries, and for the ceramic, chemical, pharmaceutical, cosmetic, textile and rubber industries; machine tools and tools therefore; parts and fittings for the aforesaid machines and machine tools, included in this class; machines and apparatus for producing, processing, treating and preparing of foodstuffs and beverages, and cosmetic, pharmaceutical and chemical bases, intermediates and end products, and parts and fittings for the aforesaid machines and apparatus, included in this class; machines and apparatus for the painting and varnishing, ceramic, chemical, pharmaceutical, cosmetic, textile and rubber industry, and for use for chemical and/or biological reactions and powder processing, and parts and fittings for the aforesaid machines and apparatus, included in this class; machines and apparatus for processing and treating, in particular for peeling, comminuting, cutting, chopping, crushing, pureeing, milling, separating, breaking, stirring, mixing, blending, kneading, beating, conching, homogenising, negative and positive pressure treating, aerating, dispersing, emulsifying and preparing of foodstuffs, and parts and fittings of the aforesaid machines and apparatus, included in this class; machines and apparatus for processing and treating, in particular for peeling, comminuting

ting, cutting, chopping, crushing, pureeing, milling, separating, breaking, stirring, mixing, blending, kneading, beating, conching, homogenising, negative and positive pressure treating, aerating, dispersing, emulsifying and preparing of cosmetic, pharmaceutical and chemical bases, intermediates and end products, and parts and fittings for the aforesaid machines and apparatus, included in this class; installations consisting of machines for manufacturing, treating, processing and preparing foodstuffs, food and beverages, and cosmetic, pharmaceutical and chemical raw materials, intermediate products and end products, and parts and fittings for the aforesaid installations, included in this class; feeding machines, dispensing machines, spraying machines, bottling machines, filling machines, decanting machines, settling machines, inserting machines, turning machines, packaging machines, pumps, mills, filtering machines, separators and centrifuges, included in this class, and parts and fittings for the aforesaid machines, included in this class; butchers' machines, bakery and patisserie machines, machines for the bread and baked goods industry, machines for the fish industry, machines for making prepared food (ready-to-cook, ready-to-bake, ready-to-infuse/ready-to-mix, ready-to-make or ready-to-eat) and delicatessen food, machines for the milk industry and machines for the confectionery and chocolate industry, and parts and fittings for the aforesaid machines, included in this class; food preparation machines, machines for making sauces, pastes, creams and spices, and electromechanical machines for cosmetics, pharmacy and chemical industry, and parts and fittings for the aforesaid machines, included in this class; electromechanical machines and apparatus for making foodstuffs and beverages for industrial kitchens and mass catering, included in this class, and parts and fittings for the aforesaid machines, included in this class; motors and engines (except for land vehicles); machine coupling and transmission components (except for land vehicles); agricultural implements other than hand-operated; heat exchangers (parts of machines); valves; replacement parts for all the aforesaid goods, included in this class.

9 – Apparatus and instruments for conducting, switching, transforming, accumulating, regulating, storing or controlling electricity; electronic and electric controls and computer hardware and software for control of machines and apparatus for producing, processing, treating and preparing of foodstuffs and beverages, and cosmetic, pharmaceutical and chemical bases, intermediates and end products, and installations therewith and consisting thereof; electronic and electric controls and computer hardware and software for control of machines and apparatus for the paint and lacquer, the ceramic, chemical, pharmaceutical, cosmetic, textile and rubber industries, and for use for chemical and/or biological reactions and powder processing; electronic and electric controls and computer hardware and software for control of cooking, heating,

cooling and other thermal treatment apparatus and equipment, warming, heating, cooking, refrigerating and freezing machines and apparatus, ovens, air conditioning apparatus, heat exchangers, heat accumulators, heat collectors, heat regenerators, heat generating apparatus, lighting installations, devices, apparatus, lamps, regulators and meters, and installations therewith and consisting thereof; electronic and electric controls and computer hardware and software for control of electromechanical machines and apparatus for preparing of foodstuffs and beverages for industrial kitchens and mass catering; electronic and electric controllers and computer hardware and software for controlling sterilising apparatus and sterilising installations, drying apparatus and installations, pasteurising apparatus and installations, steam generators, burners, humidifying installations and microwave ovens; energy regulators; apparatus and instruments for switching, transforming, accumulating, regulating or conducting energy; monitoring and control apparatus and systems consisting thereof for the status, operation and management of machines and apparatus for producing, processing, treating and preparing of foodstuffs and beverages, and cosmetic, pharmaceutical and chemical bases, intermediates and end products, comprising computer software, computer hardware, sensors, transmitters and receivers, included in this class; computer hardware and software for receiving, storing, processing, transmitting and display of data; computer hardware and software for monitoring and controlling the status, operation and management of machines and apparatus for producing, processing, treating and preparing of foodstuffs and beverages, and cosmetic, pharmaceutical and chemical bases, intermediates and end products, both on-site and remote, included in this class; fault recorders and fault storage devices for recording and storing of data resulting from monitoring and control of machines and apparatus for producing, processing, treating and preparing of foodstuffs and beverages, and cosmetic, pharmaceutical and chemical bases, intermediates and end products, included in this class; electric and electronic sensors for measuring data for monitoring and control of the status, operation and management of machines and apparatus for producing, processing, treating and preparing of foodstuffs and beverages, and cosmetic, pharmaceutical and chemical bases, intermediates and end products, included in this class; vibration sensors; electric sensors; gas sensors for measuring gas concentration; industrial calibration sensors; fluid sensors for measuring fluid characteristics; liquid level sensors; humidity sensors; flowability sensors; fluid resistance sensors; optical sensors; photoelectric sensors; pressure sensors; proximity sensors; sensors for determining conductivity, temperature, position, distance, speed and acceleration; timing sensors; ultrasound sensors; safety equipment for machines and apparatus for producing, processing, treating and preparing of foodstuffs and beverages, and cosmetic, phar-

maceutical and chemical bases, intermediates and end products, namely safety sensors and cameras; environmental monitoring systems, comprising meters and sensors for measuring pressure, moisture and temperature, and alarm and reporting functions; heat sinks and refrigerating apparatus for electronic and electric controls, control modules, apparatus, circuits and switches, and for measuring apparatus; temperature regulators for electronic and electric controllers, control modules, apparatus, circuits and switches, and for measuring apparatus; electric light regulators, electric light regulators and light meters; replacement parts for all the aforesaid goods, included in this class.

11 – Warming, heating, cooking, refrigerating and freezing machines and apparatus for producing, processing, treating and preparing of foodstuffs and beverages, and cosmetic, pharmaceutical and chemical bases, intermediates and end products, and parts and fittings for the aforesaid machines and apparatus, included in this class; installations, consisting of machines for warming, heating, cooking, refrigerating and freezing of foodstuffs and beverages, and cosmetic, pharmaceutical and chemical bases, intermediates and end products; warming, heating, cooking, refrigerating and freezing machines and apparatus for meat and sausage production, meat and sausage processing, vegetable processing, fruit processing, cereal processing, processing milk products, pastry and confectionery production, bread and baked goods production, and parts and fittings for the aforesaid machines and apparatus, included in this class; warming, heating, cooking, refrigerating and freezing machines and apparatus for fish processing and production of prepared food (ready-to-cook, ready-to-bake, ready-to-infuse/ready-to-mix, ready-to-make or ready-to-eat) and delicatessen food, confectionery and chocolate goods, food and foodstuff production, sauce, paste, cream and spice production, and production of cosmetics, pharmaceuticals and chemicals, and parts and fittings for the aforesaid machines and apparatus, included in this class; ovens for producing, processing, treating and preparing of foodstuffs and beverages, and cosmetic, pharmaceutical and chemical bases, intermediates and end products, and parts and fittings for the aforesaid machines and apparatus, included in this class; apparatus and equipment for cooking, heating, cooking and otherwise thermally treating foodstuffs and beverages, included in this class; sterilisers and sterilizing installations; drying apparatus and installations; pasteurisers; steam generating apparatus; burners; installations for humidifying; heat exchangers, other than parts of machines; heat accumulators; heat accumulators; heat regenerators; heat generating apparatus; microwaves; cool-

ing elements; coils as parts of cooling installations; cooling evaporators; heat sinks for refrigerating apparatus, ventilating apparatus and heating apparatus; cooling fans; commercial refrigeration units; industrial cooling installations; cooling tanks for furnaces; apparatus and installations for cooling gases and liquids; separators for removing condensation by refrigeration; refrigerating machines; refrigerant condensers; lighting devices, apparatus and lamps; computerised lighting installations, devices and apparatus; filters and colour filters for lighting; louvres for light deflection; diffusers being parts of lighting installations; reflectors for luminaires; suspension rails [not electrified] for electrical lighting fixtures; replacement parts for all the aforesaid goods, included in this class.

35 – Consultancy and preparation of expert opinions for commercial purposes using a process technology centre, business feasibility studies, consultancy and preparation of expert opinions for commercial purposes for product transfer, commercial scale-up, commercial analytics and product evaluation; commercial optimisation of existing processes and products, commercial development of new processes and products; commercial energy and resource management; commercial consultancy and support for procuring apparatus, machines, systems and plants; cost price analysis; business inquiries; business management and organization consultancy; business management consulting; procurement services for others [purchasing goods and services for other businesses]; professional business consulting; relocation services for businesses; development of usage concepts for manufacturing equipment from a professional business perspective (facility management); business investigation; compilation of statistics; drawing up of business expert reports; market research; marketing studies; opinion polling; business research; public relations services; organization of exhibitions for commercial or advertising purposes; business organisation consulting; organisational consultancy; organisational project management in the field of production, apparatus, machines, equipment and plants, logistics; outsourcing services [business assistance]; planning and monitoring of business developments with regard to organisational matters; presentation of companies on the Internet and other media; price comparison services; news clipping services; business consultancy and advisory services; business administration; organisation of trade fairs for commercial or advertising purposes; consumer consultancy; sales promotion for others; arranging of trading and economical contacts, also over the Internet; arranging commercial transactions for third parties, also within the framework of e-commerce; arranging of contracts for others for the buying and selling of goods; arranging of contracts, for others, for the providing of services; advertising; computerized file management; computerized file management; data search in computer files for others; systemization of information into computer databases; compilation of infor-

mation into computer databases; trading in, and negotiation of contracts relating to the purchase and sale of used apparatus, machines, equipment and plants, namely machines and apparatus for manufacturing, treating, processing and preparing foodstuffs, food and beverages, and cosmetic, pharmaceutical and chemical raw materials, intermediate products and end products, machines and apparatus for the painting and varnishing, ceramic, chemical, pharmaceutical, cosmetic, textile and rubber industry, and for use for chemical and/or biological reactions and powder processing, installations consisting of machines for manufacturing, treating, processing and preparing foodstuffs, food and beverages, and cosmetic, pharmaceutical and chemical raw materials, intermediate products and end products, apparatus and instruments for conducting, switching, transforming, accumulating, regulating or controlling electricity, apparatus and instruments for switching, converting, accumulating, regulating and controlling energy, warming, heating, cooking, refrigerating and freezing machines and apparatus for manufacturing, treating, processing and preparing foodstuffs, food and beverages, and cosmetic, pharmaceutical and chemical raw materials, intermediate products and end products, installations consisting of machines for warming, heating, cooking, refrigerating and freezing foodstuffs, food and beverages, and cosmetic, pharmaceutical and chemical raw materials, intermediate products and end products, and air conditioning apparatus and installations for manufacturing, treating, processing and preparing foodstuffs, food and beverages, and cosmetic, pharmaceutical and chemical raw materials, intermediate products and end products.

37 – Assembly, installation, inspection in the context of maintenance and repair, maintenance, repair and retrofitting of apparatus and installations for conducting, switching, transforming, accumulating, regulating or controlling electricity, and apparatus and instruments for switching, converting, accumulating, regulating and controlling energy; assembly, installation, inspection in the context of maintenance and repair, maintenance, repair and retrofitting of machines and apparatus for manufacturing, treating, processing and preparing foodstuffs, food and beverages, and cosmetic, pharmaceutical and chemical raw materials, intermediate products and end products, of installations consisting thereof and comprising the aforesaid, and machine tools and tools therefor; assembly, installation, inspection in the context of maintenance and repair, maintenance, repair and retrofitting of cooking, heating, refrigerating and other thermal treatment apparatus and equipment, warming, heating, cooking, refrigerating and freezing machines and apparatus, stoves (heating apparatus), air conditioning apparatus, heat exchangers, heat accumulators, heat collectors, heat regenerators, heat generating apparatus, lighting installations, devices, apparatus, lamps, regulators and light meters, and of installations consisting thereof

and comprising the aforesaid; assembly, installation, inspection in the context of maintenance and repair, maintenance, repair and retrofitting of sterilising apparatus and sterilising equipment, drying apparatus and equipment, pasteurising apparatus and equipment, steam generators, burners, humidifying equipment, and microwave ovens; assembly, installation, inspection in the context of maintenance and repair, maintenance, repair and retrofitting of electromechanical machines and apparatus for preparing foodstuffs and beverages for industrial kitchens and mass catering; assembly, installation, inspection in the context of maintenance and repair, maintenance, repair and retrofitting of feeding machines, dispensing machines, spraying machines, bottling machines, filling machines, decanting machines, settling machines, inserting machines, turning machines, packaging machines, pumps, mills, filtering machines, separators and centrifuges; assembly, installation, inspection in the context of maintenance and repair, maintenance, repair and retrofitting of butchers' machines, bakery and patisserie machines, machines for the bread and baked goods industry, machines for the fish industry, machines for making prepared food (ready-to-cook, ready-to-bake, ready-to-infuse/ready-to-mix, ready-to-make or ready-to-eat) and delicatessen food, machines for the milk industry, machines for the confectionery and chocolate industry, machines for manufacturing prepared food products; assembly, installation, inspection in the context of maintenance and repair, maintenance, repair and retrofitting of machines for manufacturing sauces, pastes, creams and spices, and machines for use in cosmetics, pharmacy and chemistry, and parts and fittings for the aforesaid machines; assembly, installation, inspection in the context of maintenance and repair, maintenance, repair and retrofitting of machines and apparatus for the painting and varnishing, ceramic, chemical, pharmaceutical, cosmetic, textile and rubber industry, and for use for chemical and/or biological reactions and powder processing; assembly, installation, inspection in the context of maintenance and repair, maintenance, repair and retrofitting of motors and engines, except for land vehicles, machine coupling and transmission components, except for land vehicles, agricultural implements, other than hand-operated, machine tools and tools therefor.

41 – Translation and interpretation; providing of training and further training, education, distance learning courses, correspondence courses, courses, training courses and workshops (training), including for conducting and assisting with IQ (installation qualification) and OQ (operational qualification), on site, in-house, mobile, in a training centre, online and via multimedia devices; coaching; consultancy in relation to and organisation, arranging and conducting of exhibitions for training and further training, and for educational purposes, colloquiums, conferences, congresses, seminars, courses, symposiums, training co-

urses and workshops (training); providing of non-downloadable electronic publications, including technical and operating instructions, magazines (periodicals) and books in electronic form, including on the Internet and on intranets; electronic desktop publishing; digital image processing (photograph editing) and digital writing and publication of texts, other than for advertising purposes; layout services, other than for advertising purposes; creating and editing of sound and video recordings and productions; writing of text, image and film documentation and reports, other than for advertising purposes; writing of technical and operating instructions.

42 – Engineering, technological services, technical analysis, research and development in the fields of mechanical engineering, electrical engineering, control technology, process technology, physics, foodstuff and food technology, chemistry, pharmacy, cosmetics, biology, bacteriology, hygiene, agriculture, horticulture, animal husbandry, sound insulation, product development, safety technology, design and software; creation, design, installation, commissioning, inspection, maintenance, repair and updating of software; technical consultancy and surveys using a process technology centre, engineering feasibility studies, technical product transfer, technical scale-up, technical analytics and product evaluation; technical optimisation of existing processes and products, technical development of new processes and products; provision of information concerning research and technical project studies relating to the use of natural energy; technical calibration; technical consultancy and assistance for procuring apparatus, machines, equipment and plants; technical customer service and support (consultancy); design, development, managing and maintenance of an online portal targeted at technical and/or economic issues for customers; preparation of technical reports and quality testing of products for certification purposes.

(260) AM 2021 111986 A

(800) 1578240

(151) 2021 01 15

(891) 2021 01 15

(731) Premier Beverages P.B. Limited

Amathountos, 50E, PEARL BUILDING,  
3rd floor, Flat/Office 1, Agios Tychonas,  
Limassol, CY-4532, Cyprus

(540)

"Max & Jack's"

(591) Black, white

(531) 27.05.01

(511)

32 – Beers; mineral and aerated waters; beverages based on fruit and fruit juices; syrups and other preparations for manufacturing beverages; isotonic bevera-

ges; kvass; energy drinks, other than for medical and dietetic use; non-alcoholic tonic beverages, including those containing caffeine, taurine, other than for medical and dietetic purposes.

33 – Alcoholic beverages with the exception of beers; ciders; mead [hydromel]; alcoholic malt beverages, excluding beers.

(260) AM 2021 111987 A

(800) 1578252

(151) 2020 11 25

(891) 2020 11 25

(731) Toruńskie Zakłady Materiałów Opatrunkowych  
Spółka Akcyjna

Żółkiewskiego 20/26, PL-87-100 Toruń, Poland

(540)



PANTY

(591) Black, white

(531) 24.07.01; 26.04.06; 26.04.07; 26.04.22;

26.04.24; 26.05.01; 26.05.22; 27.05.09

(511)

5 – Sanitary towels, panty liners.

(260) AM 2021 111988 A

(800) 1578274

(151) 2020 09 03

(891) 2020 09 03

(731) Egis Gyógyszergyár Zrt.

Keresztúri út 30-38., H-1106 Budapest,  
Hungary

(540)

**CELENIA**

(591) Black, white

(511)

3 – Cosmetics and cosmetic preparations.

5 – Human pharmaceutical preparations with the exception of food for babies; medicinal ointments; medicated skin creams, plasters, materials for dressings.



(260) AM 2021 111991 A

(800) 1578343

(151) 2020 12 15

(891) 2020 12 15

(731) Limited liability company "Telefonnye Sistemy"

ul. Bakuninskaya, 41, str. 1, pomesch./ kom. IA,  
/ 2, munitsipalny okrug Basmany vn.ter.g.,  
Moscow, RU-105082, Russian Federation

(540)



(591) White, red and gray

(531) 24.17.20; 25.05.25; 26.04.05; 26.04.12;

26.04.24; 27.05.09; 29.01.13

(511)

9 – Scientific, nautical, surveying, photographic, cinematographic, optical, weighing, measuring, signalling, checking [supervision], life-saving and teaching apparatus and instruments; apparatus and instruments for conducting, switching, transforming, accumulating, regulating or controlling electricity; apparatus for recording, transmission or reproduction of sound or images; magnetic data carriers, recording discs; compact discs, DVDs and other digital recording media; cash registers, calculating machines, data processing equipment, computers; software; fire extinguishing apparatus; DVD players; ticket dispensers; coin-operated musical automata [juke boxes]; answering machines; fire engines; accumulators, electric; accumulators, electric, for vehicles; actinometers; alidades; altimeters; ammeters; anemometers; anodes; antennas; anticathodes; apertometers [optics]; high-frequency apparatus; testing apparatus not for medical purposes; remote control apparatus; electro-dynamic apparatus for the remote control of railway points; electro-dynamic apparatus for the remote control of signals; monitoring apparatus, other than for medical purposes; sound recording apparatus; Global Positioning System [GPS] apparatus; distillation apparatus for scientific purposes; diffraction apparatus [microscopy]; air analysis apparatus; apparatus to check franking; sound transmitting apparatus; apparatus for fermentation [laboratory apparatus]; breathing apparatus for underwater swimming; breathing apparatus, except for artificial respiration; apparatus and installations for the production of X-rays, not for medical purposes; electric apparatus for commutation; intercommunication apparatus; stills for laboratory experiments; projection apparatus; radiological apparatus for industrial purposes; X-ray apparatus not for medical purposes; blueprint apparatus; flashing lights [luminous signals]; stereoscopic apparatus; telephone apparatus; facsimile machines; phototelegraphy apparatus; igniting apparatus, electric, for igniting at a distance; acid hydrometers; salinometers; acidimeters for batteries; aerome-

ters; beacons, luminous; battery jars; barometers; anode batteries; galvanic batteries; batteries for lighting; solar batteries; batteries, electric; balances [steelyards]; betatrons; binoculars; electronic tags for goods; magnetic tape units for computers; computer memory devices; fire hose nozzles; encoded identification bracelets, magnetic; safety tarpaulins; signalling buoys; life buoys; marking buoys; directional compasses; vacuum gauges; electrolyzers; variometers; verniers; scales; letter scales; weighbridges; precision balances; levelling staffs [surveying instruments]; camcorders; video cassettes; video telephones; video screens; viewfinders, photographic; electric plugs; electric sockets; plug connectors; micrometer screws for optical instruments; viscosimeters; circuit closers; wave-meters; voltmeters; switchboxes [electricity]; current rectifiers; gas testing instruments; gasometers [measuring instruments]; galvanometers; hands-free kits for telephones; heliographic apparatus; hygrometers; hydrometers; weights; peepholes [magnifying lenses] for doors; holograms; plotters; loudspeakers; sounding leads; plumb bobs; range finders; densimeters; densitometers; eyewear; detectors; smoke detectors; counterfeit coin detectors; transparencies [photography]; slide projectors; diaphragms [photography]; dictating machines; dynamometers; light-emitting diodes [LED]; floppy disks; disks, magnetic; optical discs; circular slide rules; disk drives for computers; juke boxes for computers; DNA chips; electronic notice boards; bullet-proof vests; life jackets; identification threads for electric wires; nose clips for divers and swimmers; locks, electric; bells [warning devices]; alarm bells, electric; electric door bells; signal bells; acoustic conduits; mirrors for inspecting work; road signs, luminous or mechanical; mechanical signs; signs, luminous; marine depth finders; probes for scientific purposes; buzzers; needles for record players; measures; pressure measuring apparatus; simulators for the steering and control of vehicles; inverters [electricity]; pressure indicators; temperature indicators; incubators for bacteria culture; measuring instruments; cosmographic instruments; mathematical instruments; levelling instruments; instruments containing eyepieces; surveying instruments; azimuth instruments; interfaces for computers; ionization apparatus not for the treatment of air or water; spark-guards; coaxial cables; fiber optic cables; cables, electric; calipers; slide calipers; screw-tapping gauges; calculating machines; pocket calculators; decompression chambers; cinematographic cameras; electronic pens [visual display units]; holders for electric coils; identity cards, magnetic; video game cartridges; encoded magnetic cards; riding helmets; protective helmets; carriers for dark plates [photography]; automated teller machines [ATM]; cathodes; spools [photography]; choking coils [impedance]; coils, electric; electromagnetic coils; cinematographic film, exposed; computer keyboards; solenoid valves [electromagnetic switches]; wire connectors [electricity]; electronic agen-

das; push buttons for bells; mouse pads; magnetic encoders; visors for helmets; collectors, electric; calibrating rings; protective suits for aviators; commutators; compact discs [audio-video]; compact discs [read-only memory]; comparators; marine compasses; laptop computers; notebook computers; condensers [capacitors]; contacts, electric; wind socks for indicating wind direction; branch boxes [electricity]; distribution boxes [electricity]; junction boxes [electricity]; battery boxes; cabinets for loudspeakers; diving suits; clothing for protection against fire; galena crystals [detectors]; reflecting discs for wear, for the prevention of traffic accidents; covers for electric outlets; logs [measuring instruments]; lasers, not for medical purposes; lactodensimeters; lactometers; vacuum tubes [radio]; darkroom lamps [photography]; thermionic tubes; amplifying tubes; flashlights [photography]; head cleaning tapes [recording]; magnetic tapes; videotapes; surveying chains; fire escapes; rulers [measuring instruments]; slide-rules; contact lenses; correcting lenses [optics]; optical lenses; optical condensers; sounding lines; electricity conduits; measuring spoons; magnifying glasses [optics]; thread counters; magnets; decorative magnets; crash test dummies; resuscitation mannequins [teaching apparatus]; mouse [computer peripheral]; pressure gauges; divers' masks; solderers' helmets; protective masks; materials for electricity mains [wires, cables]; voting machines; money counting and sorting machines; material testing instruments and machines; furniture especially made for laboratories; megaphones; portable media players; diaphragms [acoustics]; diaphragms for scientific apparatus; metal detectors for industrial or military purposes; metronomes; rules [measuring instruments]; carpenters' rules; dressmakers' measures; mechanisms for coin-operated apparatus; mechanisms for counter-operated apparatus; coin-operated mechanisms for television sets; shutter releases [photography]; micrometers; microprocessors; microscopes; microtomes; microphones; modems; lightning rods; monitors [computer hardware]; monitors [computer programs]; terminals [electricity]; junction sleeves for electric cables; teeth protectors; knee-pads for workers; headphones; surveyors' levels; sound recording carriers; optical data media; computer software, recorded; sheaths for electric cables; identification sheaths for electric wires; weighing machines; punched card machines for offices; life saving apparatus and equipment; shoes for protection against accidents, irradiation and fire; objectives [lenses] [optics]; lenses for astrophotography; egg-candlers; fire extinguishers; electrified fences; limiters [electricity]; clothing for protection against accidents, irradiation and fire; asbestos clothing for protection against fire; clothing especially made for laboratories; ozonisers [ozonators]; octants; eyepieces; ohmmeters; wrist rests for use with computers; spectacle frames; oscillographs; plumb lines; mirrors [optics]; spectacles; sunglasses; goggles for sports; signalling panels, luminous or mechanical;

radio pagers; pince-nez; electronic pocket translators; transmitters [telecommunication]; telephone transmitters; transmitters of electronic signals; switches, electric; periscopes; gloves for divers; gloves for protection against accidents; gloves for protection against X-rays for industrial purposes; asbestos gloves for protection against accidents; furnaces for laboratory use; pyrometers; planimeters; plane tables [surveying instruments]; plates for batteries; wafers for integrated circuits; printed circuit boards; compact disc players; cassette players; sound recording strips; X-ray films, exposed; films, exposed; life-saving rafts; laboratory trays; semi-conductors; polarimeters; fire pumps; measuring glassware; life belts; fuses; circuit breakers; converters, electric; telerupters; food analysis apparatus; diagnostic apparatus, not for medical purposes; distance recording apparatus; distance measuring apparatus; speed measuring apparatus [photography]; appliances for measuring the thickness of leather; apparatus for measuring the thickness of skins; speed checking apparatus for vehicles; teaching apparatus; time recording apparatus; hemline markers; apparatus and instruments for astronomy; navigational instruments; apparatus and instruments for physics; chemistry apparatus and instruments; measuring apparatus; measuring devices, electric; boiler control instruments; meteorological instruments; naval signalling apparatus; observation instruments; navigation apparatus for vehicles [on-board computers]; satellite navigational apparatus; regulating apparatus, electric; precision measuring apparatus; audio- and video-receivers; prisms [optics]; printers for use with computers; retorts' stands; apparatus for changing record player needles; drainers for use in photography; cleaning apparatus for sound recording discs; fire beaters; telescopic sights for firearms; test tubes; pressure indicator plugs for valves; magnetic wires; telegraph wires; telephone wires; wires, electric; conductors, electric; copper wire, insulated; fuse wire; computer programs, recorded; computer game software, recorded; computer software applications, downloadable; computer operating programs, recorded; record players; processors [central processing units]; rods for water diviners; electronic publications, downloadable; distribution consoles [electricity]; control panels [electricity]; radar apparatus; masts for wireless aerials; transmitting sets [telecommunication]; radios; vehicle radios; sprinkler systems for fire protection; frames for photographic transparencies; screens for photoengraving; walkie-talkies; voltage surge protectors; voltage regulators for vehicles; stage lighting regulators; light dimmers [regulators], electric; speed regulators for record players; cell switches [electricity]; washing trays [photography]; marking gauges [joinery]; time switches, automatic; relays, electric; safety restraints, other than for vehicle seats and sports equipment; X-ray photographs, other than for medical purposes; rheostats; respirators for filtering air; respiratory masks, other than for artificial respiration; retorts; refractome-



ters; refractors; grids for batteries; speaking tubes; horns for loudspeakers; saccharometers; optical fibers [light conducting filaments]; traffic-light apparatus [signalling devices]; dog whistles; signalling whistles; sextants; inductors [electricity]; safety nets; nets for protection against accidents; fire alarms; signals, luminous or mechanical; sirens; scanners [data processing equipment]; integrated circuit cards [smart cards]; connections for electric lines; couplings, electric; connectors [electricity]; sonars; sound locating instruments; lighting ballasts; resistances, electric; spectrograph apparatus; spectrometers; speed indicators; alcoholmeters; satellites for scientific purposes; protection devices for personal use against accidents; audiovisual teaching apparatus; radiotelegraphy sets; radiotelephony sets; spectacle lenses; anti-glare glasses; optical glass; personal stereos; stereoscopes; stands for photographic apparatus; fire boats; sulfometers; drying racks [photography]; spherometers; integrated circuits; printed circuits; counters; parking meters; kilometer recorders for vehicles; revolution counters; abacuses; egg timers [sandglasses]; taximeters; ear plugs for divers; tachometers; television apparatus; telegraphs [apparatus]; telescopes; teleprompters; teleprinters; cordless telephones; theodolites; thermometers, not for medical purposes; thermostats; thermostats for vehicles; crucibles [laboratory]; tone arms for record players; totalizers; transistors [electronic]; transponders; protractors [measuring instruments]; transformers [electricity]; step-up transformers; vehicle breakdown warning triangles; triodes; starter cables for motors; discharge tubes, electric, other than for lighting; capillary tubes; neon signs; X-ray tubes not for medical purposes; telephone receivers; gauges; quantity indicators; gasoline gauges; water level indicators; electric loss indicators; light-emitting electronic pointers; slope indicators; levels [instruments for determining the horizontal]; mercury levels; spirit levels; urinometers; amplifiers; particle accelerators; electric installations for the remote control of industrial operations; steering apparatus, automatic, for vehicles; balancing apparatus; video recorders; sound reproduction apparatus; invoicing machines; tape recorders; protection devices against X-rays, not for medical purposes; railway traffic safety appliances; data processing apparatus; oxygen transvasing apparatus; theft prevention installations, electric; film cutting apparatus; drying apparatus for photographic prints; optical character readers; centering apparatus for photographic transparencies; dosage dispensers; battery chargers; chargers for electric accumulators; acoustic alarms; sounding apparatus and machines; apparatus for editing cinematographic film; cathodic anti-corrosion apparatus; couplers [data processing equipment]; anti-theft warning apparatus; computer peripheral devices; anti-interference devices [electricity]; demagnetizing apparatus for magnetic tapes; acoustic couplers; alarms; fog signals, non-explosive; whistle alarms; adding machines; readers [data processing

equipment]; heat regulating apparatus; photocopiers [photographic, electrostatic, thermic]; bar code readers; downloadable ring tones for mobile phones; downloadable image files; downloadable music files; animated cartoons; filters [photography]; filters for respiratory masks; filters for ultraviolet rays, for photography; USB flash drives; magic lanterns; optical lamps; signal lanterns; cameras [photography]; glazing apparatus for photographic prints; shutters [photography]; darkrooms [photography]; photometers; flash-bulbs [photography]; enlarging apparatus [photography]; photovoltaic cells; containers for contact lenses; spectacle cases; containers for microscope slides; cases especially made for photographic apparatus and instruments; chromatography apparatus for laboratory use; chronographs [time recording apparatus]; laboratory centrifuges; cyclotrons; compasses for measuring; frequency meters; time clocks [time recording devices]; fire blankets; chips [integrated circuits]; jigs [measuring instruments]; pedometers; meteorological balloons; electrified rails for mounting spot lights; asbestos screens for firemen; fire hose; protective helmets for sports; cell phone straps; tripods for cameras; switchboards; distribution boards [electricity]; screens [photography]; workmen's protective face-shields; projection screens; radiology screens for industrial purposes; fluorescent screens; exposure meters [light meters]; ducts [electricity]; galvanic cells; epidiascopes; ergometers; armatures [electricity].

(260) AM 2021 111995 A

(800) 1578410

(151) 2020 12 17

(891) 2020 12 17

(731) ZHEJIANG BOOU SANITARY WARE CO., LTD.

Yuanquzhong Road, Fengjiang Street, Luqiao District, Taizhou City, 318050 Zhejiang Province, China

(540)



(591) Black, white

(531) 26.01.18; 29.01.01

(511)

11 – Light bulbs; heaters for baths; faucets; bath tubs; water closets; bath installations; water-pipes for sanitary installations; water conduits installations; cocks for pipes and pipelines; floor drains.

(260) AM 2021 111996 A  
 (800) 1578429  
 (151) 2021 01 08  
 (891) 2021 01 08  
 (731) BAUSCH & LOMB INCORPORATED  
 1400 N. Goodman Street, Rochester  
 NY 14609, USA

(540)



(591) The mark in use will be in the colours blue, navy, dark blue, light blue and white  
 (531) 25.12.03; 26.04.02; 26.04.16; 26.04.18; 26.04.24; 27.05.09; 27.05.24; 29.01.12  
 (511)  
 9 – Contact lenses.

(260) AM 2021 111997 A  
 (800) 1578492  
 (151) 2021 01 06  
 (891) 2021 01 06  
 (731) Lorenz Snack-World Holding GmbH  
 Adelheidstr. 4/5, 30171 Hannover, Germany  
 (540)

## Pomsticks

(591) Black, white  
 (511)  
 29 – Potato sticks.

(260) AM 2021 111998 A  
 (800) 1578508  
 (151) 2020 12 18  
 (891) 2020 12 18  
 (731) Beijing Sabine Technologies Co., Ltd.  
 12A-3B, 12F, Building B, Jia No. 28, Xinxu  
 Road, Haidian District, Beijing, China  
 (540)

## SABINETEK

(591) Black, white  
 (511)  
 9 – Downloadable mobile phone applications; computer software applications, downloadable; computer hardware; downloadable music files; downloadable image files; pedometers; time clocks [time recording devices]; electronic notice boards; cell phones; network communication equipment; headphones; sound transmitting apparatus; sound recording apparatus; microphones; video recorders; camcorders; audio mixers; audio interfaces; equalizers [audio apparatus]; portable media players; audio mixing apparatus; projection apparatus; measuring instruments; optical ap-

paratus and instruments; wires, electric; semi-conductors; integrated circuits; light-emitting diodes [LED]; regulating apparatus, electric; video screens; remote control apparatus; optical fibers [light conducting filaments]; batteries, electric.

(260) AM 2021 111999 A  
 (800) 1578522  
 (151) 2020 12 19  
 (891) 2020 12 19  
 (731) Apple Inc.  
 One Apple Park Way, Cupertino CA 95014,  
 USA  
 (540)



(591) Black, orange, silver and white  
 (531) 20.01.03; 24.17.25; 26.04.04; 26.04.12; 26.04.16; 29.01.14

(511)  
 9 – Downloadable computer software for creating, editing, transmitting and printing documents comprised of text and graphics and utility programs for use therewith; downloadable computer software for accessing, viewing, annotating, storing, editing, downloading, displaying, sharing, and distributing electronic media, images, audio, video, data, information, and documents over the internet or other communications network.

(260) AM 2021 112002 A  
 (800) 1578590  
 (151) 2021 01 27  
 (891) 2021 01 27  
 (731) TAIZHOU FIT GARMENT EQUIPMENT  
 CO., LTD.  
 Square B, Room 802, No.6, Building,  
 Zhonghuan Century Centre, Taizhou,  
 318000 Zhejiang, China

(540)

# FIT

(591) Black, white  
 (531) 27.05.01; 27.05.17; 27.05.23  
 (511)  
 7 – Sewing machines; ironing machines; hemming machines; overlock sewing machines; button attach

machines; edge sewing machines; cloth cutting machines; stand table for industrial sewing machines.

(260) AM 2021 112003 A

(800) 1578596

(151) 2020 12 10

(891) 2020 12 10

(731) TAIZHOU DISON MACHINERY CO., LTD.

No. 15 Canghe Road, Cangqianwang  
Country, Hongjia Subdistrict, Jiaojiang  
District, Taizhou City, 318000 Zhejiang  
Province, China

(540)

**DISON**  
— 迪松 —

(591) Black, white

(531) 27.05.11; 27.05.17; 28.03

(511)

7 – Sewing machines; pedal drives for sewing machines; stitching machines; hemming machines; ironing machines; lasts for shoes [parts of machines]; reels [parts of machines]; rotary steam presses, portable, for fabrics.

(260) AM 2021 112006 A

(800) 1578737

(151) 2021 01 25

(891) 2021 01 25

(731) Individual entrepreneur Tovstik Roman

Vladimirovich  
prospekt Vernadskogo, d. 94, korp. 2, kv. 2,  
RU-119571 Moskva, Russian Federation

(540)

TENX

(591) Black, white

(531) 27.05.10

(511)

3 – Abrasives; amber [perfume]; descaling preparations for household purposes; antistatic preparations for household purposes; aromatics [essential oils]; air fragrancing preparations; cake flavorings [essential oils]; flavorings for beverages [essential oils]; food flavorings [essential oils]; breath freshening sprays; canned pressurized air for cleaning and dusting purposes; balms, other than for medical purposes; lip glosses; polishing stones; abrasive paper; emery paper; polishing paper; petroleum jelly for cosmetic purposes; shoe polish; cobblers' wax; cotton wool for cos-

metic purposes; sachets for perfuming linen; drying agents for dishwashing machines; adhesives for cosmetic purposes; scented water; Javelle water; lavender water; toilet water; laundry wax; wax for parquet floors; floor wax; non-slipping wax for floors; depilatory wax; mustache wax; tailors' wax; creams for leather; polish for furniture and flooring; shoemakers' wax; polishing wax; massage gels, other than for medical purposes; heliotropine; dental bleaching gels; geraniol; make-up; deodorants for pets; deodorants for human beings or for animals; depilatory preparations; scented wood; perfumes; non-slipping liquids for floors; windshield cleaning liquids; greases for cosmetic purposes; volcanic ash for cleaning; perfumery; decorative transfers for cosmetic purposes; ionone [perfumery]; shaving stones [astringents]; smoothing stones; eyebrow pencils; cosmetic pencils; silicon carbide [abrasive]; carbides of metal [abrasives]; alum stones [astringents]; tripoli stone for polishing; adhesives for affixing false eyelashes; adhesives for affixing false hair; hair conditioners; quillaia bark for washing; corundum [abrasive]; beard dyes; colorants for toilet purposes; cosmetic dyes; laundry starch; laundry glaze; shoe cream; polishing creams; cosmetic creams; skin whitening creams; polishing rouge; incense; hair spray; nail polish; hair lotions; lotions for cosmetic purposes; after-shave lotions; beauty masks; oils for perfumes and scents; oils for cosmetic purposes; oils for toilet purposes; essential oils; essential oils of cedarwood; essential oils of lemon; essential oils of citron; oils for cleaning purposes; bergamot oil; gaultheria oil; jasmine oil; lavender oil; almond oil; rose oil; oil of turpentine for degreasing; whitening; cleaning chalk; almond milk for cosmetic purposes; cleansing milk for toilet purposes; musk [perfumery]; deodorant soap; shaving soap; soap for brightening textile; cakes of toilet soap; antiperspirant soap; soap for foot perspiration; soap; almond soap; mint for perfumery; cosmetic kits; emery; nail art stickers; false nails; eau de Cologne; bases for flower perfumes; joss sticks; pastes for razor strops; non-medicated dentifrices; pumice stone; lipstick cases; hydrogen peroxide for cosmetic purposes; breath freshening strips; teeth whitening strips; abrasive cloth; glass cloth [abrasive cloth]; lipsticks; pomades for cosmetic purposes; shaving preparations; cosmetic preparations for baths; bath preparations, not for medical purposes; hair straightening preparations; hair waving preparations; laundry soaking preparations; grinding preparations; smoothing preparations [starching]; color-removing preparations; leather bleaching preparations; polishing preparations; denture polishes; mouthwashes, not for medical purposes; cosmetic preparations for slimming purposes; starch glaze for laundry purposes; eye-washes, not for medical purposes; fabric softeners for laundry use; laundry bleach; dry-cleaning preparations; paint stripping preparations; lacquer-removing preparations; make-up removing preparations; floor wax removers [scouring preparations]; varnish-removing

preparations; rust removing preparations; nail care preparations; cleaning preparations; preparations for cleaning dentures; wallpaper cleaning preparations; preparations for unblocking drain pipes; collagen preparations for cosmetic purposes; laundry preparations; aloe vera preparations for cosmetic purposes; sunscreen preparations; color-brightening chemicals for household purposes [laundry]; shining preparations [polish]; make-up powder; diamantine [abrasive]; stain removers; nail varnish removers; vaginal washes for personal sanitary or deodorant purposes; scouring solutions; false eyelashes; tissues impregnated with cosmetic lotions; tissues impregnated with make-up removing preparations; safrol; laundry blueing; turpentine for degreasing; potpourris [fragrances]; bleaching soda; washing soda, for cleaning; bath salts, not for medical purposes; bleaching salts; fumigation preparations [perfumes]; preservatives for leather [polishes]; ammonia [volatile alkali] [detergent]; astringents for cosmetic purposes; eyebrow cosmetics; make-up preparations; sun-tanning preparations [cosmetics]; hair dyes; neutralizers for permanent waving; preparations to make the leaves of plants shiny; cosmetic preparations for eyelashes; cosmetic preparations for skin care; shoe wax; cosmetics; cosmetics for animals; mascara; cleansers for intimate personal hygiene purposes, non medicated; detergents, other than for use in manufacturing operations and for medical purposes; degreasers, other than for use in manufacturing processes; bleaching preparations [decolorants] for cosmetic purposes; antiperspirants [toiletries]; toiletry preparations; phytocosmetic preparations; talcum powder, for toilet use; cotton swabs for cosmetic purposes; terpenes [essential oils]; emery cloth; cloths impregnated with a detergent for cleaning; henna [cosmetic dye]; shampoos for animals [non-medicated grooming preparations]; shampoos for pets [non-medicated grooming preparations]; dry shampoos; shampoos; sandpaper; soda lye; herbal extracts for cosmetic purposes; extracts of flowers [perfumes]; ethereal essences; badian essence; mint essence [essential oil].

(260) AM 2021 112008 A  
(800) 1578760  
(151) 2021 01 12  
(891) 2021 01 12  
(731) Otis Elevator Company  
One Carrier Place, Farmington CT 06032,  
USA

(540)



(591) Black, white  
(531) 02.09.17; 26.01.01; 26.01.03; 26.01.14;  
26.01.24; 26.11.01; 26.11.07

(511)

11 – Cleaning and disinfecting appliances using ultraviolet light; ultraviolet lamps for cleaning, disinfecting and sanitisation purposes; air purifying ultraviolet lamps; air sterilising lighting installations; ultraviolet light sanitisation devices; ultraviolet light devices used to sanitize and disinfect the environment; germicidal lamps; germicidal lamps for purifying the air.

(260) AM 2021 112020 A

(800) 1579025

(151) 2021 01 13

(891) 2021 01 13

(731) GRINDEKS, akciju sabiedrība

Krustpils iela 53, LV-1057 Rīga, Latvia

(540)

Grindex



(591) Black, white

(531) 27.05.22

(511)

1 – Chemical preparations for use in the manufacture of pharmaceuticals; chemicals for use in the pharmaceutical industry.

3 – Cosmetics; functional cosmetics; cosmetic preparations for skin care.

5 – Pharmaceutical preparations; veterinary preparations; nutritional supplements; dietary supplements for humans; diagnostic preparations and materials; sanitary preparations for medical purposes; disinfectants and antiseptics; transdermal patches; adhesive tapes for medical purposes; vermin destroying preparations; fungicides; herbicides; vitamins and vitamin preparations.

35 – Advertising.

(260) AM 2021 112040 A

(800) 1573416

(151) 2020 12 02

(891) 2021 02 18

(731) GlaxoSmithKline Consumer Healthcare

Holdings (US) LLC

Corporation Service Center, 251 Little Falls

Drive, Wilmington DE 19808, USA

(540)



(591) The color(s) dark red, light red, dark orange, light orange, dark yellow, light yellow, light green, dark green, light blue, dark blue and purple is/are claimed as a feature of the mark

(531) 26.01.01; 26.01.06; 26.11.08; 29.01.15

(511)

5 – Dietary and nutritional supplements; vitamins.



(260) AM 2021 112041 A  
 (800) 1573504  
 (151) 2020 12 02  
 (891) 2021 02 17  
 (731) GlaxoSmithKline Consumer Healthcare  
 Holdings (US) LLC  
 Corporation Service Center, 251 Little Falls  
 Drive, Wilmington DE 19808, USA

(540)  

(591) The color(s) dark red, light red, dark orange, light orange, dark yellow, light yellow, light green, dark green, light blue, dark blue, purple and black is/are claimed as a feature of the mark  
 (531) 26.01.01; 26.11.08; 27.05.01; 29.01.15  
 (511)  
 5 – Dietary and nutritional supplements; vitamins.

(260) AM 2021 112106 A  
 (800) 1579689  
 (151) 2020 11 20  
 (891) 2020 11 20  
 (731) Euro Games Technology Ltd.  
 4, "Maritsa" Str., "Vranya-Lozen-Triugulnika",  
 BG-1151 Sofia, Bulgaria

(540)  

(591) Gold, red, purple, yellow and black  
 (531) 27.05.02; 27.05.03; 27.05.09; 27.05.10;  
 29.01.15

(511)  
 9 – Software; computer gaming software; computer software packages; computer operating system software; computer software, recorded; software drivers; virtual reality software; games software; entertainment software for computer games; computer programs for network management; operating computer software for main frame computers; monitors (computer hardware); computer hardware; apparatus for recording images; monitors (computer programs); computer game programs; computer programs for recorded games; apparatus for recording, transmission or reproduction of sound or images; communications servers [computer hardware]; electronic components

for gambling machines; computer application software featuring games and gaming; computer software for the administration of on-line games and gaming; computer hardware for games and gaming; hardware and software for gambling, gambling machines, gambling games on the Internet and via telecommunication network.

28 – Gaming machines for gambling; chips for gambling; mah-jong; arcade games; gambling machines operating with coins, notes and cards; games; electronic games; parlor games; gaming chips; gaming tables; slot machines [gaming machines]; LCD game machines; slot machines and gaming devices; coin-operated amusement machines; roulette chips; poker chips; chips and dice [gaming equipment]; equipment for casinos; roulette tables; gaming roulette wheels; casino games; automats and gambling machines; coin-operated machines and / or electronic coin-operated machines with or without the possibility of gain; boxes for coin-operated machines, slot machines and gaming machines; electronic or electrotechnical gaming devices, automats and machines, coin-operated machines; housings for coin-operated machines, gaming equipment, gaming machines, machines for gambling; electropneumatic and electrical gambling machines (slot machines).

41 – Gambling; services related to gambling; gaming services for entertainment purposes; casino, gaming and gambling services; training in the development of software systems; provision of equipment for gambling halls; providing casino equipment [gambling]; gaming machine entertainment services; providing casino facilities [gambling]; halls with gaming machines; amusement arcade services; games equipment rental; rental of gaming machines; providing amusement arcade services; rental of gaming machines with images of fruits; editing or recording of sounds and images; sound recording and video entertainment services; hire of sound reproducing apparatus; provision of gaming equipment for casinos; providing of casino facilities; online gambling services; casino management services; operation of gaming establishments, gaming halls, internet casinos, online gambling sites.

(260) AM 2021 112107 A  
 (800) 1579697  
 (151) 2021 01 19  
 (891) 2021 01 19  
 (731) Ha-Be Betonchemie GmbH  
 Stüvestraße 39, 31785 Hameln, Germany

(540)  

(591) Black, white  
 (511)

1 – Chemical preparations for use in industry, namely additives for concrete and building materials relating to cement for improving the fresh and solid properties

thereof; chemical preparations for use in industry, namely construction chemistry for concrete and cement-bound building materials for improving building material properties, in both the fresh and solid state.

(260) AM 2021 112110 A

(800) 1579723

(151) 2021 01 11

(891) 2021 01 11

(731) Anker Innovations Technology Co., Ltd.

Room 701, 7F Building 7, 1st Phase of Headquarters Building of, Changsha Zhongdian Software, Park Co., Ltd., No. 39 Jianshan Road, Changsha National High-Tech, Industrial Development Zone, China

(540)



(591) Black, white

(531) 01.15.03; 27.05.01; 27.05.17

(511)

9 – Electrical adapters; power adaptors; power adaptors for electric sockets of vehicle cigarette lighters; battery chargers; electric sockets; cell phones; USB (universal serial bus) cables; computer peripheral devices; portable media players; electric batteries.

(260) AM 2021 112112 A

(800) 1579793

(151) 2020 09 02

(891) 2020 09 02

(731) "Zavod Bulbash" Limited Liability Company

d. Vendelevo, 50, Petrishkovskiy s/s, 223037 Minskiy r-n, Minskaya obl., Belarus

(540)



(591) Blue, gold, gray, beige, white, shades of blue, shades of gray, shades of beige and shades of gold

(531) 19.07.02; 19.07.16; 29.01.13

(554) მოცულობითი

(526) "1", "№ 1" apart from the graphical design of these elements.

(511)

33 – Alcoholic beverages, except beer; aperitifs; ar-rack [arak]; brandy; wine; piquette; whisky; vodka; anisette [liqueur]; kirsch; gin; digesters [liqueurs and spirits]; cocktails, alcoholic; curacao; anise [liqueur]; liqueurs; pre-mixed alcoholic beverages, other than beer-based; alcoholic beverages containing fruit; spirits [beverages]; distilled beverages; mead [hydro-mel]; peppermint liqueurs; bitters; rum; sake; perry; cider; rice alcohol; alcoholic extracts; fruit extracts, alcoholic; alcoholic essences.

(260) AM 2021 112113 A

(800) 1579816

(151) 2020 12 09

(891) 2020 12 09

(731) Galderma Holding SA

Rue d'Entre-deux-Villes 10, CH-1814 La Tour-de-Peilz, Switzerland

(540)



(591) Black, white

(531) 26.01.06; 26.01.18

(511)

3 – Perfumery and beauty products, soaps, cosmetics, skin care, beauty and treatment products, creams and lotions for sensitive skin cleansing.

(260) AM 2021 112114 A

(800) 1579818

(151) 2021 02 09

(891) 2021 02 09

(731) Sany Group Co., Ltd.

Third Floor, SANY Administrative Center, SANY Industrial Park, Economic and Technological, Development Zone, Changsha, Hunan, China

(540)



(591) Black, white  
 (531) 26.01.01; 26.01.03; 26.01.12; 26.01.17;  
 26.13.25; 27.07.11

(511)  
 12 – Motor coaches; trucks; sport utility vehicles;  
 cars; vehicle wheels; trolley railways [cable cars];  
 wheelchairs; horse drawn carriages; automobile tires;  
 aerial conveyors; launches.

(260) AM 2021 112115 A  
 (800) 1579868  
 (151) 2020 12 28  
 (891) 2020 12 28  
 (731) Tovarystvo z obmezhenoiu vidpovidalnistiu  
 "Kompaniia "Liberti Ukraina"  
 vul. Kurenivska, 2 B, Kyiv 04073, Ukraine  
 (540)

caffè  
**DORATO**

(591) Black, white, gray  
 (531) 05.07.27; 27.03.11; 27.05.10  
 (511)  
 35 – Import-export agency services.

(260) AM 2021 112117 A  
 (800) 1579978  
 (151) 2020 12 14  
 (891) 2020 12 14  
 (731) CHAO YANG LONGMARCH TYRE Co., Ltd.  
 No.1 Xiangyang Road, Longcheng District,  
 Chaoyang, Liaoning, China  
 (540)

**SUPERCARGO**

(591) Black, white  
 (531) 27.05.02; 27.05.17  
 (526) SUPER", "CARGO  
 (511)  
 12 – Tires for vehicles.

(260) AM 2021 112118 A  
 (800) 1579985  
 (151) 2020 12 14  
 (891) 2020 12 14  
 (731) GOLDEN LADY COMPANY S.p.A.  
 VIA LEOPARDI 3/5, I-46043 CASTIGLIONE  
 DELLE STIVIERE (MN), Italy  
 (540)

**INFINYL**

(591) Black, white

(511)  
 22 – Raw textile fibers; natural fibers; acrylic fibers;  
 textile fibres; cotton fibers; yarn fibers; textile fila-  
 ments; silk fibers; hemp fibres; synthetic textile fila-  
 ments; non-woven textile fibres; raw fibrous textile;  
 synthetic fibers for textile use; raw textile fibers and  
 substitutes; semi-synthetic fibers [for textile use]; car-  
 bon fibres for textile use; glass fibres for textile use;  
 plastic fibres for textile use; vitreous silica fibres for  
 textile use; non-woven polymeric fibers for textile  
 use; fibres being partly prepared synthetic materials  
 for textile use.

23 – Yarn; spun thread and yarn.

24 – Textiles and substitutes for textiles; non-woven  
 fabrics; cloth; lap rugs; bed clothes and blankets; lin-  
 gerie fabric; bath linen, except clothing; linens; bed li-  
 nen; table linen; table linen, not of paper; table covers;  
 covers for cushions; pillow shams; protective loose  
 covers for mattresses and furniture; curtains of textile  
 or plastic; shower curtains of textile or plastic.

25 – Clothing; bathing suits; neckerchiefs; gloves  
 [clothing]; underwear; pyjamas; nightwear; shawls;  
 scarfs; stockings; socks; tights; footless tights; leg-  
 gings [leg warmers]; sock suspenders; stocking sus-  
 penders; leggings [trousers]; leotards.

27 – Carpets, rugs and mats; non-textile wall cover-  
 ings.

(260) AM 2021 112120 A  
 (800) 1580220  
 (151) 2020 10 16  
 (891) 2020 10 16  
 (731) Zakrytoe aktsionernoe obshchestvo  
 "Starodvorskie kolbasy"  
 ul. Poliny Osipenko, d. 41, of. 210,  
 RU-600009 Vladimir, Russian Federation  
 (540)

**Вязанка**

(591) Black, white  
 (531) 28.05  
 (511)  
 29 – Sea-cucumbers, not live; artichokes, preserved;  
 guacamole [mashed avocado]; curd; milk substitutes;  
 eggplant paste; vegetable marrow paste; galbi [grilled  
 meat dish]; potato-based dumplings; onion rings; ar-  
 rangements of processed fruit; corn dogs; sweet corn,  
 processed; extra virgin olive oil for food; soya bean  
 oil for food; peanut milk; peanut milk for culinary  
 purposes; coconut milk; coconut milk for culinary  
 purposes; almond milk; almond milk for culinary pur-  
 poses; oat milk; rice milk; rice milk for culinary pur-  
 poses; condensed milk; powdered milk; freeze-dried  
 meat; chicken nuggets; peanut milk-based beverages;  
 coconut milk-based beverages; almond milk-based  
 beverages; edible insects, not live; sausage casings,

natural or artificial; freeze-dried vegetables; flavored nuts; candied nuts; bulgogi [Korean beef dish]; tomato purée; ryazhenka [fermented baked milk]; sardelki [sausages]; vegetable-based cream; smetana [sour cream]; lemon juice for culinary purposes; hot dog sausages; nut-based spreads; falafel; hazelnuts, prepared; shpikachki [sausages]; escamoles [edible ant larvae, prepared]; berries, preserved; yakitori.

30 – Cream of tartar for culinary purposes; golden syrup; vanilla flavorings for culinary purposes; flavorings, other than essential oils, for cakes; flavorings, other than essential oils, for beverages; coffee flavorings; food flavorings, other than essential oils; star aniseed; baozi [stuffed buns]; cereal bars; high-protein cereal bars; pancakes; noodle-based prepared meals; freeze-dried dishes with the main ingredient being pasta; freeze-dried dishes with the main ingredient being rice; buns; bread rolls; edible rice paper; edible paper; burritos; vanillin [vanilla substitute]; vareniki [stuffed dumplings]; waffles; vermicelli; natural sweeteners; sausage binding materials; binding agents for ice cream; sea water for cooking; seaweed [condiment]; malt biscuits; cloves [spice]; mirror icing [mirror glaze]; cake frosting [icing]; glucose for culinary purposes; mustard; gluten additives for culinary purposes; yeast; thickening agents for cooking foodstuffs; leaven; rice-based snack food; cereal-based snack food; artificial coffee; vegetal preparations for use as coffee substitutes; dressings for salad; fruit jellies [confectionery]; candy decorations for cakes; confectionery for decorating Christmas trees; cakes; pastries; peanut confectionery; almond confectionery; pasta; ginger [spice]; frozen yogurt [confectionery ices]; cocoa; capers; caramels [sweets]; curry [spice]; ketchup [sauce]; bibimbap [Korean dish consisting primarily of cooked rice with added vegetables and beef]; quiches; gluten prepared as foodstuff; flour-based dumplings; sweets; liquorice [confectionery]; peppermint sweets; dulce de leche; cinnamon [spice]; coffee; unroasted coffee; starch for food; crackers; custard; hominy grits; semolina; oatmeal; crushed barley; groats for human food; ice cubes; corn, milled; corn, roasted; meat pies; turmeric; couscous; noodles; ice for refreshment; ice, natural or artificial; edible ices; candies; rice cakes; mayonnaise; macarons; macaroni; maltose; hominy; marinades; marzipan; honey; miso [seasoning]; royal jelly; ice cream; bean meal; tapioca flour; potato flour; corn flour; nut flours; flour; wheat flour; soya flour; barley meal; dessert mousses [confectionery]; chocolate mousses; muesli; mint for confectionery; cocoa beverages with milk; coffee beverages with milk; coffee-based beverages; cocoa-based beverages; chamomile-based beverages; tea-based beverages; chocolate beverages with milk; chocolate-based beverages; infusions, not medicinal; crushed oats; husked oats; okonomiyaki [Japanese savory pancakes]; onigiri [rice balls]; nutmegs; chocolate-coated nuts; stick liquorice [confectionery]; pastilles [confectionery]; molasses for food; pâtés en croûte; pelmeni

[dumplings stuffed with meat]; pepper; allspice; peppers [seasonings]; pesto [sauce]; cookies; petit-beurre biscuits; bibimbap [rice mixed with vegetables and beef]; pies; pizzas; meat gravies; fondants [confectionery]; popcorn; powders for making ice cream; baking powder; mustard meal; pralines; aromatic preparations for food; condiments; meat tenderizers for household purposes; cereal preparations; oat-based food; bee glue; gingerbread; spices; petits fours [cakes]; rice pudding; puddings; cake powder; fruit coulis [sauces]; ravioli; ramen [Japanese noodle-based dish]; chewing gum; relish [condiment]; rice; instant rice; wheat germ for human consumption; spring rolls; sago; sugar; palm sugar; sesame seeds [seasonings]; linseed for culinary purposes [seasoning]; processed seeds for use as a seasoning; aniseed; agave syrup [natural sweetener]; confectionery; batter mixes for okonomiyaki [Japanese savory pancakes]; baking soda [bicarbonate of soda for cooking purposes]; malt for human consumption; salt for preserving foodstuffs; cooking salt; celery salt; sherbets [ices]; ham glaze; soya sauce; tomato sauce; sauces [condiments]; pasta sauce; spaghetti; seasonings; chocolate-based spreads; chocolate spreads containing nuts; preparations for stiffening whipped cream; rusks; breadcrumbs; sushi; sandwiches; tabbouleh; tacos; tapioca; tarts; dough; pastry dough; almond paste; rice pulp for culinary purposes; cake dough; tortillas; garden herbs, preserved [seasonings]; chocolate decorations for cakes; vinegar; beer vinegar; ferments for pastes; halvah; bread; unleavened bread; chips [cereal products]; corn flakes; oat flakes; hot dog sandwiches; flowers or leaves for use as tea substitutes; jiaozi [stuffed dumplings]; chicory [coffee substitute]; tea; iced tea; chutneys [condiments]; chebureki [deep-fried pies]; minced garlic [condiment]; cheeseburgers [sandwiches]; chow-chow [condiment]; saffron [seasoning]; chocolate; malt extract for food; essences for foodstuffs, except etheric essences and essential oils; husked barley; piccalilli.

(260) AM 2021 112133 A

(800) 1580597

(151) 2021 01 21

(891) 2021 01 21

(731) VITKO Oleksandr Mykolaiovych  
vul. Horkoho, 110, kv. 44, Kyiv 03150,  
Ukraine

(540)

**SWEET.TV**

(591) Black, white

(531) 27.05.01

(511)

35 – Publicity; business management; business administration; administrative processing of purchase orders; administration of consumer loyalty programs; cost price analysis; accounting; negotiation of business contracts for others; market studies; opinion po-



ling; invoicing; arranging subscriptions to telecommunication services for others; payroll preparation; tax preparation; demonstration of goods; business management assistance; commercial or industrial management assistance; economic forecasting; compilation of information into computer databases; compilation of statistics; business management for freelance service providers; business management of reimbursement programs for others; commercial administration of the licensing of the goods and services of others; computerized file management; personnel management consultancy; business management consultancy; marketing; marketing research; typing; provision of an online marketplace for buyers and sellers of goods and services; updating of advertising material; updating and maintenance of data in computer databases; updating and maintenance of information in registries; organization of exhibitions for commercial or advertising purposes; rental of advertising space; personnel recruitment; commercial information agency services; layout services for advertising purposes; news clipping services; price comparison services; procurement services for others [purchasing goods and services for other businesses]; photocopying services; import-export agency services; secretarial services; public relations; data search in computer files for others; presentation of goods on communication media, for retail purposes; telephone answering for unavailable subscribers; office machines and equipment rental; rental of advertising time on communication media; direct mail advertising; pay per click advertising; online advertising on a computer network; dissemination of advertising matter; systemization of information into computer databases; compiling indexes of information for commercial or advertising purposes; sales promotion for others; production of teleshopping programs; production of advertising films; television advertising; telemarketing services; negotiation and conclusion of commercial transactions for third parties; professional business consultancy.

38 – Telecommunications; providing access to databases; providing user access to global computer networks; providing internet chatrooms; providing online forums; providing telecommunications connections to a global computer network; providing telecommunication channels for teleshopping services; communications by fiber optic networks; communications by computer terminals; communications by cellular phones; video-on-demand transmission; transmission of greeting cards online; transmission of electronic mail; computer aided transmission of messages and images; transmission of telegrams; transmission of digital files; message sending; videoconferencing services; voice mail services; electronic bulletin board services [telecommunications services]; telecommunications routing and junction services; news agency services; teleconferencing services; streaming of data; rental of message sending apparatus; rental of modems; rental of telecommunication equipment; rental of telepho-

nes; rental of facsimile apparatus; rental of access time to global computer networks; radio communications; radio broadcasting; satellite transmission; television broadcasting; cable television broadcasting; communications by telegrams; communications by telephone; wireless broadcasting; facsimile transmission.

---

(260) AM 2021 112141 A  
(800) 1580811  
(151) 2020 10 07  
(891) 2020 10 07  
(731) Tecomania Investments Limited  
1, Lampousas Street, CY-1095 Nicosia, Cyprus  
(540)

## BIOVEN

(591) Black, white  
(511)  
5 – Pharmaceutical and veterinary preparations; medicines for humans; bacterial and bacteriological preparations for medical or veterinary purposes; cultures of microorganisms for medical or veterinary purposes; preparations of microorganisms for medical or veterinary purposes; dietetic substances adapted for medical purposes; baby food; dietary supplements for humans or animals; germicides; biological preparations for medical purposes; immunomodulators and immunostimulants for medical purposes; antiseptics; antiviral drugs for medical purposes; pharmaceutical preparations for the treatment and prevention of infectious diseases; enzymes for medical purposes; enzyme preparations for medical purposes; anti-inflammatory preparations for medical purposes.

---

(260) AM 2021 112142 A  
(800) 1580846  
(151) 2021 01 19  
(891) 2021 01 19  
(731) Ha-Be Betonchemie GmbH  
Stüvestraße 39, 31785 Hameln, Germany  
(540)

## PANTAPOR

(591) Black, white  
(511)  
1 – Chemical preparations for use in industry, namely additives for concrete and building materials relating to cement for improving the fresh and solid properties thereof; chemical preparations for use in industry, namely construction chemistry for concrete and cement-bound building materials for improving building material properties, in both the fresh and solid state.

---

(260) AM 2021 112143 A  
 (800) 1580847  
 (151) 2021 01 13  
 (891) 2021 01 13  
 (731) FOREST WELL CO., LTD.  
 2-18-5-2 Higashiterao, Tsurumi-ku, Yokohama-  
 shi, Kanagawa 230-0077, Japan  
 (540)



(591) Black, white, red  
 (531) 24.17.02; 27.05.22; 29.01.12  
 (511)  
 11 – Air purifiers with built-in ion generators; ion generating apparatus for air purifiers; air purifiers; parts and accessories for air purifiers; air purifying apparatus and machines; parts and accessories for air purifying apparatus and machines; filters for air purifiers; air sterilisers; industrial air purifiers; electric air purifiers for household purposes.

(260) AM 2021 112145 A  
 (800) 1580866  
 (151) 2020 12 29  
 (891) 2020 12 29  
 (731) Shenzhen XN Electronics Co., Ltd  
 3/F, 3 Building, Yongtai Industrial Park,  
 599 Zhoushi Road, Jiuwei Community,  
 Hangcheng Street, Baoan District, Shenzhen,  
 518000 Guangdong, China  
 (540)



(591) Yellow, gray  
 (531) 01.01.15; 24.07.01; 24.07.23; 25.07.04;  
 29.01.12  
 (511)  
 9 – Cabinets for loudspeakers; audio- and video-receivers; loudspeakers; quantity indicators; batteries, electric; anti-theft warning apparatus.

(260) AM 2021 112146 A  
 (800) 1580893  
 (151) 2021 01 19  
 (891) 2021 01 19  
 (731) BASF SE  
 Carl-Bosch-Str. 38, Ludwigshafen am Rhein,  
 Germany



(591) Black, white  
 (531) 26.04.03; 26.04.09; 26.04.24  
 (511)  
 1 – Chemicals used in agriculture, horticulture and forestry, especially plant fortifying preparations, chemical or biological preparations for stress management in plants, plant growth regulating preparations, chemical preparations for the treatment of seeds, genes of seeds for agricultural production.  
 5 – Preparations for destroying and combating vermin; insecticides, fungicides, herbicides, pesticides.  
 31 – Agricultural, horticultural and forestry products, namely seeds, grains and vegetative parts of plants treated with pesticides or chemical or biological products, not included in other classes.

(260) AM 2021 112147 A  
 (800) 1580925  
 (151) 2020 12 02  
 (891) 2020 12 02  
 (731) Bogatyrev Vasily Alexandrovich  
 ul. Admiral Zhiltsov, 3 sq. 13, Ivanteevka,  
 RU-141280 Moscow region, Russian  
 Federation  
 (540)



(591) Black, white  
 (531) 27.05.01  
 (511)  
 34 – Flavorings, other than essential oils, for tobacco; flavorings, other than essential oils, for use in electronic cigarettes; gas containers for cigar lighters; absorbent paper for tobacco pipes; cigarette paper; lighters for smokers; tobacco substitutes, not for medical pur-

poses; tobacco substitutes containing nicotine, not for medical purposes; hookahs; tobacco pouches; books of cigarette papers; humidors; matchboxes; firestones; cigar cutters; cigar holders; cigarette holders; mouthpieces for cigarette holders; tips of yellow amber for cigar and cigarette holders; tobacco free nicotine pouches for oral administration, not for medical purposes; pouches containing tobacco substitutes with nicotine, for oral administration, not for medical purposes; ashtrays for smokers; spittoons for tobacco users; pipe racks for tobacco pipes; pipe cleaners for tobacco pipes; liquid solutions for use in electronic cigarettes; electronic cigarettes; cigarettes; cigarettes containing tobacco substitutes, not for medical purposes; cigari- llos; cigars; tobacco jars; match holders; matches; oral vaporizers for smokers; tobacco; chewing tobacco; snuff; snuff boxes; herbs for smoking; tobacco pipes; pocket machines for rolling cigarettes; cigarette fil- ters; wicks adapted for cigarette lighters; cigarette tips; cigar cases; cigarette cases.

(260) AM 2021 112148 A  
(800) 1114346  
(151) 2012 03 14  
(891) 2021 01 27  
(731) ETEX N.V.

PassPort Building, Luchthaven Brussel  
Nationaal, Gebouw 1K, B-1930 Zaventem,  
Belgium

(540)

## EQUITONE

(591) Black, white  
(511)

19 – Non-metal building materials; non-metal rigid pipes; non-metal transportable constructions; non-metal claddings for roofs, façades and walls, particularly roof tiles, slates, sheets (plates), panels and boards.

(260) AM 2021 112149 A  
(800) 1305115  
(151) 2016 05 02  
(891) 2021 02 03  
(731) GROUPE GO SPORT, Société Anonyme

17 Avenue de la Falaise, F-38360  
SASSENAGE, France

(540)

## ATHLITECH

(591) Black, white  
(511)

25 – Clothing, sportswear, headgear, footwear, sports footwear, underclothing and underwear.

28 – Gymnastic and sporting articles (except for mats) for use in physical training, football, basketball, hand- ball, volleyball, rugby, badminton, squash, tennis, table tennis, golf, athletics, running, water sports (swim-

ming, diving, boating, windsurfing, water skiing), mo- untain sports (skiing, snowboard, hiking, mountain climbing), horse riding, combat sports, rollerskating, skateboarding, cycling.

(260) AM 2021 112150 A  
(800) 1332354  
(151) 2016 08 19  
(891) 2021 02 22  
(731) MONGE & C. S.P.A.

Via Savigliano, 31, I-12030 MONASTEROLO  
DI SAVIGLIANO (CUNEO), Italy

(540)

**Monge**  
**VetSolution**

(591) Black, white

(531) 01.01.05; 01.01.10; 27.05.07; 27.05.09;  
27.05.10

(511)

31 – Animal foodstuffs.

(260) AM 2021 112152 A  
(800) 1427638  
(151) 2018 02 09  
(891) 2021 02 02  
(731) ALGOLOGIE

10 place des Victoires, F-75002 PARIS, France

(540)

**algologie**  
ARMOR • FRANCE

(591) Black, white

(531) 27.05.01; 27.05.09; 27.05.10

(511)

3 – Non-medicated cosmetics; plant-based cosmetics; cosmetics based on algae and marine active agents; cosmetics based on active ingredients from halophyte plants; cosmetics based on essential oils; saline prepara- tions for cosmetic use; seaweed extracts for cosme- tic use; marine extracts for cosmetic use; collagen pre- parations for cosmetic use; lotions for cosmetic use; tissues impregnated with cosmetic lotions; cosmetic creams; balm other than for medical use; pomades for cosmetic use; beauty masks; phytocosmetic preparati- ons; cleansing milk for toilet purposes; toilettries; anti- perspirants (toilettries); oils for cosmetic use; greases for cosmetic use; hygiene, beauty and toiletry pro- ducts and care products for the face and body; clean- sing milk for cosmetic purposes; cosmetic products for skin care; cosmetic products for hands; cosmetic products for feet; cosmetics for body care; scrubs for skin, body and face care; make-up removing products; wipes impregnated with make-up removing preparati-

ons; massage oils; massage gels other than for medical use; eye creams (not for medical use); eye lotions; cosmetics based on marine products; cosmetic preparations for slimming; cosmetic skin-tanning preparations; sunscreen preparations; bath preparations, not for medical use; cosmetic preparations for baths; bath salts not for medical use; perfumes; soaps; essential oils; perfumery product; fumigation products [perfumes]; deodorants [perfumery]; eau de Cologne; lavender water; scented water; eaux de toilette; oils for perfumes and scents; oils for toilet purposes; extracts of flowers [perfumes]; make-up products; lip glosses; false eyelashes; cosmetics for eyelashes; adhesives for affixing false eyelashes; eyebrow cosmetics; pencils for cosmetic use; eyebrow pencils; rose oil; nail polish; nail polish (varnish); nail polish removers; varnish-removing products; false nails; lipstick cases; make-up; eye shadows; mascara; cosmetic kits; false nails; make-up powder; lipstick; non-medicated hair lotions; hair lotions; hair care products; shampoos; hair conditioners; hair straightening preparations; hair waving preparations; hair dyes; hair sprays; hair fixatives; non-medicated dentifrices; preparations for mouthwashes (not for medical use); douching preparations for intimate hygiene, deodorant preparations or for sanitary purposes [toiletries]; bleaching preparations [decolorants] for cosmetic use; plant extracts for cosmetic use; depilatory products; decorative transfers for cosmetic use; astringents for cosmetic use.

(260) AM 2021 112153 A

(800) 1525213

(151) 2020 03 12

(891) 2021 02 23

(731) PEDIATRICA S.r.l.

Via A. Nicolodi, 28/A, I-57121 Livorno, Italy

(540)



(591) Black, white, gray

(531) 02.09.15; 04.05.02; 26.04.05; 26.04.10;  
26.04.18; 27.05.12

(511)

3 – Perfume; essential oils; cosmetic creams and lotions; detergents; body and facial creams [cosmetics]; cosmetics; hair care lotions; dentifrices; soaps; antiperspirants [toiletries].

5 – Pharmaceuticals; sanitary preparations for medical purposes; dietetic substances adapted for medical use; infant formula; vitamin supplements; plasters, materials for dressings; disinfectants; tranquillizers; sopor-

rifics; syrups for pharmaceutical purposes; analgesics; antipyretics; decongestants; antiseptics; antiparasitic preparations; beverages adapted for medicinal purposes; herbal teas for medicinal purposes; cold cream for medical use.

(260) AM 2021 112154 A

(800) 1525233

(151) 2020 03 12

(891) 2021 02 23

(731) PEDIATRICA S.r.l.

Via A. Nicolodi, 28/A, I-57121 Livorno, Italy

(540)



(591) Black, white, gray

(531) 02.09.15; 04.05.02; 26.04.04; 27.05.01

(511)

3 – Perfumes; ethereal oils; cosmetic creams and lotions; detergents; body and facial creams [cosmetics]; cosmetics; hair care lotions; dentifrices; soap; antiperspirants [toiletries].

5 – Pharmaceuticals; sanitary preparations for medical purposes; dietetic substances adapted for medical use; infant formula; vitamin supplements; plasters, materials for dressings; disinfectants; sedatives; soporifics; syrups for pharmaceutical purposes; analgesics; antipyretics; decongestants; antiseptics; antiparasitic preparations; medicinal drinks; herbal teas for medicinal purposes; cold cream for medical use.

(260) AM 2021 112155 A

(800) 1545844

(151) 2020 05 15

(891) 2020 12 02

(731) MAKYAJ KOZMETİK İNŞAAT SANAYİ VE TİCARET LİMİTED ŞİRKETİ

Hadımköy Bağlantı Yolu Akçaburgaz,

Mah. No:140 Esenyurt, İstanbul, Turkey

(540)



(591) Blue, red, white

(531) 24.13.09; 24.13.24; 24.13.25; 27.05.10;  
29.01.12

(511)

3 – Perfumery; non-medicated cosmetics; fragrances; deodorants for human beings or for animals; non-medicated soaps; dentifrices; denture polishes; tooth whi-

tening preparations; dental bleaching gels; mouthwashes, not for medical purposes.

(260) AM 2021 112201 A

(800) 1581011

(151) 2021 01 15

(891) 2021 01 15

(731) OTCF S.A.

ul.Grottgera 30, PL-32-020 Wieliczka, Poland

(540)



(591) Black, white

(531) 27.05.01; 27.05.23; 27.07.01

(511)

18 – School bags; rucksacks; backpacks; briefcases; school knapsacks; attaché cases; cases, of leather or leatherboard; cases of leather or leatherboard; garment bags for travel; bags (garment -) for travel; garment carriers; shopping bags; bags for sports; bum bags; shoulder bags; suitcases; handles (suitcase -); net bags for shopping; shoe bags; portmanteaus; trunks and travelling bags; haversacks; roller bags; bags for climbers; bags for campers; all-purpose athletic bags; carry-on bags; hiking rucksacks; pocket wallets.

25 – Beach shoes; beach clothes; underwear; sweat-absorbent underwear; bandanas [neckerchiefs]; jumpers; sweat shirts; hooded sweatshirts; football jerseys; track jackets; boots; shoes; football shoes; studs for football boots; lace boots; sports shoes; boots for sports; cap peaks; visors [headwear]; peaked headwear; wooden shoes; knitwear [clothing]; leggings [leg warmers]; rubbers [footwear]; millinery; rain hats; swimming trunks; overalls; pockets for clothing; shirts; short-sleeve shirts; casual shirts; singlets; jackets [clothing]; sports singlets; parkas; waterproof jackets; ski jackets; down jackets; rainproof jackets; stuff jackets [clothing]; sports jackets; windcheaters; leg warmers; underpants; babies' pants [underwear]; gymnastic shoes; football boots; athletic shoes; casual footwear; sneakers [footwear]; gloves [clothing]; belts [clothing]; combinations [clothing]; ear muffs [clothing]; hoods [clothing]; clothing of leather; clothing for gymnastics; clothing of imitations of leather; weatherproof clothing; money belts [clothing]; outerclothing; cyclists' clothing; leisurewear; headgear; footwear; clothing; headbands [clothing]; headbands against sweating; sweatbands; caps [headwear]; infantwear; loungewear; tee-shirts; scarfs; shawls; sweaters; swimsuits; skorts; skirts; sports pants; snow pants; cycling pants; jogging pants; tracksuit bottoms; waterproof pants; trousers; trunks (bathing -); sweat-absorbent socks; sports socks; sandals; bath sandals; fingerless gloves; half-boots; inner soles; vest tops; soles

for footwear; bath robes; pelerines; slippers; bath slippers; topcoats; overcoats; footmuffs, not electrically heated; exercise wear; sportswear; denims [clothing]; jogging sets [clothing]; jogging tops.

(260) AM 2021 112203 A

(800) 1581089

(151) 2020 04 30

(891) 2020 04 30

(731) TERRAVITA Spółka z o.o.

Szarych Szeregów 48, PL-60-462 Poznań, Poland

(540)



(591) Red

(531) 27.05.01; 27.05.17; 29.01.01

(511)

30 – Chocolate, candy, pralines, caramels, chocolate bars, chocolate cream, chocolate hazelnut cream, sweetmeats [candy], bakery goods, chocolate-coated crackers, cookies, confectionery, sweets for Christmas trees, coatings, compound chocolate, chocolates.

(260) AM 2021 112212 A

(800) 1581242

(151) 2020 12 17

(891) 2020 12 17

(731) Linak A/S

Smedevænget 8, Guderup, DK-6430 Nordborg, Denmark

(540)



(591) Blue and white

(531) 24.15.02; 24.15.13; 24.15.15; 26.04.04;

26.04.16; 26.04.24; 29.01.12

(511)

7 – Machine tools, power-operated tools; motors and engines, except for land vehicles; machine coupling and transmission components, except for land vehicles; agricultural implements, other than hand-operated hand tools; actuators for mechanisms; mechanical and electro-mechanical actuators; hydraulic actuators; linear actuators; linear actuators [mechanical]; pneumatic actuators; pneumatic actuating apparatus; rotating actuators; rotary actuators; actuator systems; actuators for valves; actuators for use in wind turbines; actuators for automation of manufacturing processes;

actuators integrated in feeding machines; actuators integrated in automatic feeding apparatus for livestock; actuators integrated in agricultural machines; actuators for outdoor power equipment, such as lawn mower blades and pull-type attachments for machine tools; drive units; telescopic guides; electric motors for actuators, lifting columns and actuator systems; electrical brakes for machines; actuating mechanisms for slats and pergolas and slats for shading installations; actuators for solar energy collectors for generating electricity; actuators for solar energy collectors for electricity generation; actuators for operating of valves; lifting platforms; lifting tables; lifting columns; linear actuators designed as lifting columns, linear actuators designed as drive units for lifting columns; mechanical, electro-mechanical and electric lifting columns; robotic mechanisms for lifting; lifting and hoisting equipment, elevators and escalators; stairlifts; mobile stairs [motorised]; mechanical and hydraulic lifts; lifting apparatus; elevating apparatus; remotely controlled lifting machines; lifting chairs; parts and accessories (not included in other classes) for the aforesaid goods.

9 – Scientific, research, navigation, surveying, photographic, cinematographic, audio-visual, optical, weighing, measuring, signalling, detecting, testing, inspecting, life-saving and teaching apparatus and instruments; apparatus and instruments for conducting, switching, transforming, accumulating, regulating or controlling the distribution or use of electricity; apparatus and instruments for recording, transmitting, reproducing or processing sound, images or data; recorded and downloadable media, computer software, blank digital or analogue recording and storage media; computers and computer peripheral devices; electric actuators; linear actuators [electric]; electric actuator systems; frequency converters for actuators; peripherals adapted for use with computers and other smart devices; electric actuators for solar energy collectors for generating electricity; electric actuators for solar energy collectors for electricity generation; electric actuators for operating of valves; software for monitoring, analysing, controlling and running physical world operations; factory automation software; downloadable computer software for remote monitoring and analysis; computer software for controlling self-service terminals; interactive computer software for creating user manuals; software for movement controllers; machine learning software for healthcare; workout logging software; electric actuators for controlling apparatus for climate control; electric actuators integrated in monitors [computer hardware]; application software for controlling and monitoring actuators; downloadable applications for use with mobile devices; batteries for mobile devices; batteries for adjustable medical devices; multi battery chargers; battery chargers; adaptors (electricity); adapters for connection between media devices; USB adapters; application software for wireless devices; wireless re-

mote controls for controlling actuators; wireless controllers to remotely monitor and control the function and status of other electrical, electronic, and mechanical devices or systems; operating panels; touch sensitive control panels; electric operating units; computer software for configuring actuators; security control apparatus; electronic or electric control modules and control boxes; electronic or electric junction boxes; electronic or electric end stops including switches for end stops; communication interface units for control boxes; AC/DC connector; sensors; electronic sensors; electric sensors; gyroscopic sensors; sensory software; object detecting sensors; intelligent motor control devices; health monitoring software; sensors for monitoring physical movements; measuring, detecting and monitoring instruments, indicators and controllers; intelligent gateways for software defined storage; digital sensors; optical sensors; piezoelectric sensors; magnetic sensors; motion sensors for security lights; movement sensors; motion sensors; motion detectors; movement recognition software; electronic brakes for actuators; mounting brackets for actuators; mounting cords [electrical]; light-emitting diodes [LED]; weighing apparatus and instruments for weighing patients in hospital beds; computer software and computer hardware for testing, remotely monitoring, analyzing, fault and status reporting, maintaining and generating service data; electric, electronic and optical remote controls, hand controls and foot controls; switches, limit switches, electronic limit switches, safety limit switches (safety switches), circuit breakers, fault current breakers; fire alarms and moisture alarms; electrical and electronic circuits, potentiometers (variable electric resistances), antennas, electromagnetic coils, indicators (electric), temperature indications, speed indicators, pressure indicators, level indicators (instrument for determining the horizontal plane) tachometers, revolution counters, encoders including magnetic and optical encoders; extension cords and cables, plugs and plug connectors, and junctions and junction boxes; electric apparatus and instruments for automatic positioning devices; external power supply units [electric]; external power supply units [transformers]; power supply units (electric); external power supply units, batteries; scales with body mass analyzers; weighing scales for medical use; parts and accessories (not included in other classes) for the aforesaid goods.

---

(260) AM 2021 112213 A  
 (800) 1581248  
 (151) 2020 08 31  
 (891) 2020 08 31  
 (731) Idemitsu Kosan Co., Ltd.  
 2-1, Otemachi 1-chome, Chiyoda-ku,  
 Tokyo 100-8321, Japan



(540)

idemitsu

(591) Gray

(531) 27.05.01

(511)

4 – Solid lubricants; automotive lubricants; industrial lubricants; lubricants for ships; lubricants for metal working; lubricants for aircraft engines; all-purpose lubricants; lubricants for industrial machinery; grease for shoes and boots; leather preserving oil and grease; fuels; naphtha; biomass fuel; industrial oils; lubricating oils; lubricating greases; engine oils; motor oils; gear oils; non-mineral oils and greases for industrial purposes [not for fuel]; waxes [raw material]; lubricants; industrial greases; industrial gasoline; cutting fluids; petroleum jelly; quenching oils; mould releasing oils; refrigeration oils; process oils.

(260) AM 2021 112214 A

(800) 1581257

(151) 2020 09 18

(891) 2020 09 18

(731) Apple Inc.

One Apple Park Way, Cupertino CA 95014,  
USA

(540)

**APPLE FITNESS+**

(591) Black, white

(526) FITNESS+

(511)

38 – Transmission of streamed music, audio, video, podcasts, voice, data, images, radio, and multimedia content by means of telecommunications networks; subscription transmission services of streamed music, audio, video, and multimedia content by means of telecommunications networks; Providing access to websites, databases, electronic bulletin boards, online forums, directories, music, podcasts, and audio and video content programs on the Internet by means of telecommunications networks; streaming audio material on the internet; radio broadcasting.

41 – Education and entertainment services, namely, an ongoing series featuring health, wellness, lifestyle, exercise, physical training, fitness instruction, guided workouts, and personal development provided through webcasts, podcasts, and broadcasts; audio production services, namely, creating and producing audiovisual and audio content in the fields of health, wellness, lifestyle, exercise, physical training, fitness instruction, guided workouts, and personal development; production of audio recordings; provision of educational information relating to health, wellness, lifestyle, exercise, physical training, fitness instruction, guided workouts, and personal development; entertainment

services, namely, providing video podcasts in the field of health and fitness (term considered too vague by the International Bureau – Rule 13 (2) (b) of the Regulations); entertainment services, namely, providing podcasts in the field of health and fitness (term considered too vague by the International Bureau – Rule 13 (2) (b) of the Regulations); personal fitness training services; conducting fitness classes; physical education services.

42 – Providing online non-downloadable software for use in connection with an online subscription service featuring audio, video, data, text, podcasts, webcasts, and multimedia content in the field of health, wellness, lifestyle, exercise, physical training, fitness instruction, guided workouts, and personal development; providing online non-downloadable software for use in generating customized recommendations of audio, video, data, text, podcasts, webcasts, and other multimedia content; providing search engines for obtaining data via the internet and other electronic communications networks; providing online non-downloadable software for use in playing, organizing, downloading, transmitting, manipulating, and reviewing audio files, video files, and media files; computer services, namely, creating computer network-based indexes of information, websites and resources available on global computer networks for others; providing information relating to computer hardware design or software provided on-line from a global computer network or the Internet; electronic data storage services; providing online non-downloadable software for use in the delivery, distribution and transmission of audio, video, data, text, podcasts, webcasts, and multimedia content in the field of health, wellness, lifestyle, exercise, physical training, fitness instruction, guided workouts, and personal development.

45 – Online social networking services provided via a social networking website.

(260) AM 2021 112221 A

(800) 1581534

(151) 2020 12 29

(891) 2020 12 29

(731) Limited liability company "Internet Solutions"  
Presnenskaya nab., d. 10, Pomeschenie I,  
et. 41, komn. 6, RU-123112 Moscow,  
Russian Federation

(540)



(591) White, blue and red  
 (531) 26.04.02; 26.04.12; 26.04.18; 26.04.24;  
 27.05.24; 29.01.13

(511)  
 43 – Accommodation bureau services [hotels, boarding houses]; rental of temporary accommodation; rental of meeting rooms; tourist home services; hotel reservations; boarding house bookings; temporary accommodation reservations; hotel services; retirement home services; snack-bar services; information and advice in relation to the preparation of meals; café services; cafeteria services; motel services; boarding house services; boarding for animals; rental of cooking apparatus; rental of chairs, tables, table linen, glassware; rental of lighting apparatus; rental of tents; rental of transportable buildings; rental of drinking water dispensers; restaurant services; self-service restaurant services; reception services for temporary accommodation [management of arrivals and departures]; food sculpting; canteen services; decorating of food; cake decorating; holiday camp services [lodging]; bar services; hookah lounge services; providing campground facilities; personal chef services; food and drink catering; washoku restaurant services; udon and soba restaurant services; day-nursery [crèche] services.

(260) AM 2021 112222 A  
 (800) 1581549  
 (151) 2021 01 15  
 (891) 2021 01 15  
 (731) Volkova Svetlana Gennadijevna  
 Kovrov per., 15, apt. 109, RU-109544 Moscow,  
 Russian Federation  
 (540)

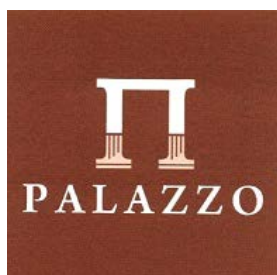

(591) White, brown and light brown.  
 (531) 07.05.06; 27.05.24; 29.01.13  
 (511)  
 16 – Aquarelles; albums; posters; forms, printed; pads [stationery]; drawing pads; loose-leaf binders; wristbands for the retention of writing instruments; pamphlets; booklets; paper; paper sheets [stationery]; waxed paper; wood pulp paper; carbon paper; parchment paper; writing paper; wrapping paper; papers for painting and calligraphy; signboards of paper or cardboard; newspapers; engravings; modelling clay; printed publications; periodicals; graphic representations; magazines [periodicals]; bookmarks; calendars; tracing paper; tracing cloth; tracing patterns; pencils;

pencil lead holders; charcoal pencils; pictures; paintings [pictures], framed or unframed; cardboard; wood pulp board [stationery]; catalogues; paintbrushes; painters' brushes; writing brushes; books; envelopes [stationery]; boxes of paper or cardboard; paint boxes for use in schools; paper tapes; absorbent sheets of paper or plastic for foodstuff packaging; postage stamps; plastics for modelling; modelling materials; teaching materials [except apparatus]; writing chalk; marking chalk; bags [envelopes, pouches] of paper or plastics, for packaging; painters' easels; hand-rests for painters; writing cases [stationery]; stickers [stationery]; covers [stationery]; embroidery designs [patterns]; oleographs; musical greeting cards; greeting cards; postcards; etchings; conical paper bags; palettes for painters; ink sticks; folders for papers; papier mâché; pastels [crayons]; modelling paste; drawing pens; stands for pens and pencils; photograph stands; portraits; writing materials; writing instruments; drawing materials; lithographic works of art; printed matter; prospectuses; printed timetables; graphic reproductions; document files [stationery]; steatite [tailor's chalk]; writing or drawing books; stationery; stencil plates; figurines of papier mâché; flyers; silver paper; canvas for painting; molds for modelling clays [artists' materials]; photo-engravings; photographs [printed]; labels, not of textile; prints [engravings].

(260) AM 2021 112223 A  
 (800) 1581562  
 (151) 2020 12 18  
 (891) 2020 12 18  
 (731) Yiwu Dingqi Hardware Firm  
 No. F4-19265, International Trade City, China  
 Commodity City, Yiwu City, Jinhua City,  
 Zhejiang Province, China

(540)

(591) Black, white  
 (531) 27.05.01  
 (511)  
 7 – Centrifugal pumps; pressure regulating valves being parts of machines; lubricating pumps; pumps [machines]; air pumps [garage installations]; vacuum pumps [machines]; compressed air pumps; suction pumps; cylinders being parts of machines; pressure valves [parts of machines]; chain saws; cutting machines; electric saws; tools [parts of machines]; glue guns, electric; electric hand drills; electric welding apparatus; welding torches; pneumatic drills, hand-held.  
 8 – Abrading instruments [hand instruments]; pickhammers; agricultural implements, hand-operated; knives; monkey wrenches; graving tools [hand tools]; pliers; mallets [hand instruments]; riveters [hand tools]; guns, hand-operated, for the extrusion of mastics.



(260) AM 2021 112224 A

(800) 1581590

(151) 2021 01 11

(891) 2021 01 11

(731) Japan Tobacco Inc.

1-1, Toranomom 4-chome, Minato-ku, Tokyo,  
Japan

(540)

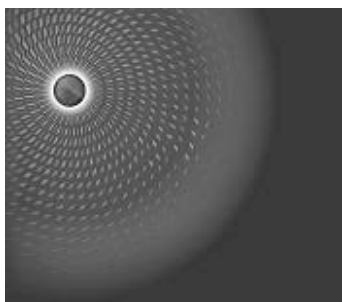

(591) Black, white

(531) 01.15.09; 25.07.08; 26.01.01; 26.01.05;  
26.15.01

(511)

34 – Tobacco, raw or manufactured; smoking tobacco, pipe tobacco, rolling tobacco, chewing tobacco, snus; cigarettes, electronic cigarettes, cigars, cigarettos; snuff; smokers' articles included in this class; cigarette paper, cigarette tubes and matches.

(260) AM 2021 112225 A

(800) 1581596

(151) 2020 10 05

(891) 2020 10 05

(731) "MY REPUPLIC" Ltd.

Pohodniy proezd, building 14, lev/place/room  
5/II/№5, RU-125373 Moscow, Russian  
Federation

(540)



(591) Yellow, light-yellow, beige, pink, brown, blue  
and white

(531) 01.01.02; 01.01.10; 04.01.02; 27.05.01;  
27.05.17; 29.01.15

(511)

8 – Carving forks; table forks; rakes [hand tools]; sculptors' chisels; cutlery; edge tools [hand tools]; garden tools, hand-operated; implements for decanting liquids [hand tools]; ear-piercing apparatus; cutting tools [hand tools]; hand tools, hand-operated; mallets [hand instruments]; ladles [hand tools]; foundry ladles [hand tools]; diggers [hand tools]; nail nippers; spoons; table knives, forks and spoons for babies; table

knives, forks and spoons of plastic; trowels [gardening]; shovels [hand tools]; hair clippers for personal use, electric and non-electric; hammers [hand tools]; mattocks; manicure sets; manicure sets, electric; pedicure sets; bits [hand tools]; air pumps, hand-operated; hand pumps; knives; fruit segmenters; vegetable knives; hobby knives [scalpels]; fruit corers; ceramic knives; bill-hooks; scissors; border shears; pruning shears; shearers [hand instruments]; agricultural implements, hand-operated; stirring sticks for mixing paint; emery boards; nail files; nail files, electric; tweezers; guns, hand-operated, for the extrusion of mastics; dies [hand tools]; tool belts [holders]; hair braiders, electric; table cutlery [knives, forks and spoons]; hand implements for hair curling; hackles [hand tools]; silver plate [knives, forks and spoons]; mortars for pounding [hand tools]; mitre boxes [hand tools]; hoop cutters [hand tools]; weeding forks [hand tools]; squares [hand tools]; irons [non-electric hand tools]; awls; choppers [knives]; swords; palette knives; spatulas [hand tools]; spatulas for use by artists; pliers; curling tongs; cuticle tweezers; eyelash curlers; nail clippers, electric or non-electric; cutters; fullers [hand tools]; egg slicers, non-electric; pizza cutters, non-electric; fingernail polishers, electric or non-electric.

10 – Maternity belts; bandages, elastic; cupping glasses; feeding bottles; air cushions for medical purposes; vibromassage apparatus; pill cutters; containers especially made for medical waste; clips for dummies; feeding bottle valves; spoons for administering medicine; furniture especially made for medical purposes; breast pumps; dummies for babies; feeding bottle teats; baby feeding dummies; receptacles for applying medicines; cases fitted for medical instruments; tongue depressors for medical purposes.

11 – Refrigerating containers; shower enclosures; toilet seats; ornamental fountains; thermo-pots, electric.

18 – Mountaineering sticks; slings for carrying infants; pocket wallets; reins for guiding children; sling bags for carrying infants; umbrellas; parasols; cases of leather or leatherboard; imitation leather; leather, unworked or semi-worked; hat boxes of leather; boxes of leather or leatherboard; purses; bags [envelopes, pouches] of leather, for packaging; moleskin [imitation of leather]; travelling sets [leatherware]; vanity cases, not fitted; hiking sticks; music cases; girths of leather; garment bags for travel; shoulder belts [straps] of leather; briefcases; randrels [Japanese school satchels]; haversacks; leather straps; straps for skates; straps of leather [saddlery]; umbrella handles; walking stick handles; suitcase handles; grips for holding shopping bags; rucksacks; travelling bags; net bags for shopping; bags; handbags; beach bags; saddlebags; compression cubes adapted for luggage; bags for sports; bags for campers; shopping bags; wheeled shopping bags; school satchels; pouch baby carriers; travelling trunks; nose bags [feed bags]; umbrella sticks; walking stick seats; key cases; suitcases; moto-

rized suitcases; suitcases with wheels; valises; attaché cases; umbrella covers; leather cord; labels of leather; boxes of vulcanized fiber.

20 – Bumper guards for cots, other than bed linen; pulleys of plastics for blinds; bolts, not of metal; barrels, not of metal; sideboards; busts of wood, wax, plaster or plastic; costume stands; bolsters; fans for personal use, non-electric; valet stands; coatstands; shoulder poles [yokes]; display stands; showcases [furniture]; signboards of wood or plastics; covers for clothing [wardrobe]; curtain holders, not of textile material; pegs [pins], not of metal; door closers, not of metal, non-electric; keyboards for hanging keys; display boards; packaging containers of plastic; binding screws, not of metal, for cables; clips of plastic for sealing bags; rivets, not of metal; bottle closures, not of metal; closures, not of metal, for containers; latches, not of metal; mirrors [looking glasses]; hand-held mirrors [toilet mirrors]; bamboo; wickerwork; works of art of wood, wax, plaster or plastic; settees; jerrycans, not of metal; curtain rods; plastic keys; mats for infant playpens; bed casters, not of metal; furniture casters, not of metal; brush mountings; wind chimes [decoration]; door bells, not of metal, non-electric; bottle caps, not of metal; cradles; tent pegs, not of metal; curtain rings; chests of drawers; containers, not of metal [storage, transport]; floating containers, not of metal; lecterns; baskets, not of metal; Moses baskets; bottle casings of wood; tool boxes, not of metal, empty; faucets, not of metal, for casks; deck chairs; beds; edgings of plastic for furniture; screw tops, not of metal, for bottles; hooks, not of metal, for clothes rails; curtain hooks; clothes hooks, not of metal; bag hangers, not of metal; ladders of wood or plastics; playpens for babies; mannequins; mattresses; air mattresses, not for medical purposes; camping mattresses; furniture of metal; office furniture; school furniture; door knockers, not of metal; curtain rails; legs for furniture; feet for furniture; door stops, not of metal or rubber; window stops, not of metal or rubber; moldings for picture frames; freestanding partitions [furniture]; stakes, not of metal, for plants or trees; trestles [furniture]; magazine racks; book rests [furniture]; flower-pot pedestals; baby changing mats; head support cushions for babies; anti-roll cushions for babies; air pillows, not for medical purposes; head positioning pillows for babies; racks [furniture]; library shelves; furniture shelves; shelves for storage; wood ribbon; straw edgings; towel stands [furniture]; hat stands; bathtub grab bars, not of metal; inflatable publicity objects; counters [tables]; bedding, except linen; corks for bottles; sealing caps, not of metal; tanks, not of metal nor of masonry; curtain rollers; door handles, not of metal; knobs, not of metal; bath seats for babies; seats of metal; benches [furniture]; vats, not of metal; statues of wood, wax, plaster or plastic; shelving units; umbrella stands; gun racks; dressing tables; tables of metal; wall-mounted baby changing platforms; steps [ladders], not of metal; chairs [seats];

high chairs for babies; shower chairs; chests, not of metal; placards of wood or plastics; stools; footstools; decorations of plastic for foodstuffs; door fittings, not of metal; bed fittings, not of metal; furniture fittings, not of metal; infant walkers; garment covers [storage]; chaise longues; screens [furniture]; bamboo curtains; slatted indoor blinds; labels of plastic; lockers; chests for toys; tool chests, not of metal, empty; boxes of wood or plastic; bottle racks; trays, not of metal; step stools, not of metal; figurines of wood, wax, plaster or plastic.

21 – Buckets; cookie jars; china ornaments; dishes; paper plates; vegetable dishes; saucers; mugs; boxes for sweets; bottles; demijohns; vases; epergnes; fruit cups; inflatable bath tubs for babies; baby baths, portable; waffle irons, non-electric; diaper disposal pails; coolers [ice pails]; whisks, non-electric, for household purposes; towel rails and rings; flower pots; chamber pots; cruets; decanters; sponge holders; stands for portable baby baths; toothpick holders; soap holders; table napkin holders; holders for flowers and plants [flower arranging]; tea bag rests; shaving brush stands; toilet paper holders; soap dispensers; toilet paper dispensers; cutting boards for the kitchen; bread boards; washing boards; strainers for household purposes; containers for household or kitchen use; kitchen containers; heat-insulated containers; heat-insulated containers for beverages; thermally insulated containers for food; glass flasks [containers]; closures for pot lids; toothpicks; works of art of porcelain, ceramic, earthenware, terra-cotta or glass; cleaning instruments, hand-operated; cabarets [trays]; stew-pans; covers, not of paper, for flower pots; basting brushes; baking mats; polishing leather; hot pots, not electrically heated; glass bulbs [receptacles]; napkin rings; poultry rings; coin banks; piggy banks; bread baskets for household purposes; baskets for household purposes; waste paper baskets; lunch boxes; tea caddies; washtubs; mess-tins; pot lids; aquarium hoods; butter-dish covers; dish covers; cheese-dish covers; reusable silicone food covers; pitchers; perfume burners; watering cans; ice cream scoops; mixing spoons [kitchen utensils]; basting spoons [cooking utensils]; pie servers; spatulas for kitchen use; butter dishes; pepper mills, hand-operated; isothermic bags; bowls [basins]; soap boxes; cooking pot sets; nozzles for watering cans; pouring spouts; cake decorating tips and tubes; nozzles for watering hose; fitted picnic baskets, including dishes; toilet cases; sprinklers; cold packs for chilling food and beverages; chopsticks; plates to prevent milk boiling over; dripping pans; trays for household purposes; lazy susans; heaters for feeding bottles, non-electric; candelabra [candlesticks]; trivets [table utensils]; coasters, not of paper or textile; knife rests for the table; flat-iron stands; egg cups; drinking troughs; serving ladles; pots; cooking pots; tableware, other than knives, forks and spoons; porcelain ware; crystal [glassware]; cosmetic utensils; toilet utensils; make-up removing appliances; spice sets; apparatus

for wax-polishing, non-electric; bottle openers, electric and non-electric; glove stretchers; clothes-pegs; glass stoppers; powder compacts, empty; combs; sifters [household utensils]; shoe horns; salad bowls; sugar bowls; beaters, non-electric; egg separators, non-electric, for household purposes; services [dishes]; coffee services [tableware]; tea services [tableware]; cooking mesh bags, other than for microwaves; sieves [household utensils]; tea strainers; squeegees [cleaning instruments]; currycombs; blenders, non-electric, for household purposes; scoops for household purposes; fruit presses, non-electric, for household purposes; drinking straws; salt cellars; drinking vessels; refrigerating bottles; cups of paper or plastic; glasses [receptacles]; drinking glasses; statues of porcelain, ceramic, earthenware, terra-cotta or glass; figurines of porcelain, ceramic, earthenware, terra-cotta or glass; mortars for kitchen use; portable cool boxes, non-electric; soup bowls; drying racks for laundry; basins [receptacles]; table plates; disposable table plates; insulating flasks; utensils for household purposes; kitchen utensils; cooking utensils, non-electric; flasks; molds [kitchen utensils]; egg poachers; cake moulds; ice cube molds; cookery moulds; deep fryers, non-electric; comb cases; bread bins; teapots; kettles, non-electric; cups; ironing board covers, shaped; tea infusers; mops; mop wringers; cocktail shakers; cosmetic spatulas; brushes; dishwashing brushes; brushes for cleaning tanks and containers; carpet sweepers; brushes for footwear; tar-brushes, long handled; toilet brushes; nail brushes; boxes for dispensing paper towels; dustbins; window-boxes; busts of porcelain, ceramic, earthenware, terra-cotta or glass; clothing stretchers; bulb basters.

24 – Frieze [cloth]; velvet; household linen; diapered linen; bath linen, except clothing; bed linen; table linen, not of paper; cot bumpers [bed linen]; buckram; fustian; sleeping bag liners; gauze [cloth]; damask; jersey [fabric]; drugget; shower curtains of textile or plastic; curtains of textile or plastic; net curtains; zephyr [cloth]; canvas for tapestry or embroidery; bolting cloth; baby buntings; furniture coverings of textile; fabrics for textile use; filtering materials of textile; wall hangings of textile; non-woven textile fabrics; plastic material [substitute for fabrics]; textile material; bivouac sacks being covers for sleeping bags; sleeping bags; sleeping bags for babies; pillowcases; bed blankets; brocades; diaper changing cloths for babies; handkerchiefs of textile; picnic blankets; travelling rugs [lap robes]; bed valances; curtain holders of textile material; bed covers; furniture coverings of plastic; towels of textile; cloth; hemp cloth; gummed cloth, other than for stationery purposes; printers' blankets of textile; door curtains; sheets [textile]; eiderdowns [down coverlets]; bath mitts; shrouds; glass cloths [towels]; cloths for removing make-up; face towels of textile; table napkins of textile; mosquito nets; calico; oilcloth for use as tablecloths; tablecloths, not of paper; billiard cloth; taffeta [cloth]; ticks [mattress

covers]; tick [linen]; fabric; lingerie fabric; jute fabric; fabric for footwear; ramie fabric; esparto fabric; rayon fabric; adhesive fabric for application by heat; linen cloth; hemp fabric; lining fabric for footwear; traced cloth for embroidery; chenille fabric; printed calico cloth; knitted fabric; cotton fabrics; silk fabrics for printing patterns; woollen cloth; elastic woven material; haircloth [sackcloth]; cheese cloth; tulle; flannel [fabric]; trellis [cloth]; covers for cushions; fitted toilet lid covers of fabric; covers [loose] for furniture; pillow shams; cheviots [cloth]; silk [cloth]; labels of textile.

27 – Artificial turf; yoga mats; floor mats, fire-resistant, for fireplaces and barbecues; carpets; carpets for automobiles; bath mats; non-slip mats; linoleum; wall hangings, not of textile; wallpaper; textile wallpaper; carpet underlay; vinyl floor coverings; floor coverings; textile wallcoverings; door mats; tatami mats; gymnasium mats.

28 – Swimming pools [play articles]; trampolines; novelty toys for parties; bodyboards; boomerangs; dolls' feeding bottles; tricycles for infants [toys]; shuttlecocks; spinning tops [toys]; dumb-bells; jigsaw puzzles; punching bags; flying discs [toys]; discs for sports; dolls' houses; playhouses for children; dominoes; swimming kickboards; paddleboards; surfboards; skateboards; sailboards; chessboards; checkerboards; drones [toys]; darts; Christmas trees of synthetic material; cups for dice; kites; toys; stuffed toys; inflatable games for swimming pools; plush toys; novelty toys for playing jokes; games; parlor games; board games; ring games; building games; toy imitation cosmetics; swimming pool air floats; kaleidoscopes; bladders of balls for games; trading cards for games; rocking horses; swings; yoga swings; skittles; skittles [games]; baby gyms; bells for Christmas trees; dolls' rooms; confetti; roller skates; dice; dolls' beds; building blocks [toys]; dolls; flippers for swimming; rhythmic gymnastics ribbons; puppets; masks [playthings]; carnival masks; toy putty; matryoshka dolls; teddy bears; targets; toy models; scale model kits [toys]; scale model vehicles; kite reels; balls for games; knee guards [sports articles]; elbow guards [sports articles]; pumps specially adapted for use with balls for games; dolls' clothes; play tents; batting gloves [accessories for games]; pinatas; toy pistols; toy air pistols; percussion caps [toys]; caps for pistols [toys]; toy dough; protective films adapted for screens for portable games; rattles [playthings]; horseshoe games; candle holders for Christmas trees; Christmas tree stands; water wings; swimming belts; soap bubbles [toys]; rackets; toy robots; plush toys with attached comfort blanket; scooters [toys]; sleds [sports articles]; butterfly nets; snowboards; toy vehicles; remote-controlled toy vehicles; ornaments for Christmas trees, except lights, candles and confectionery; conjuring apparatus; apparatus for games; toy figures; party poppers [party novelties]; Christmas crackers [party no-

velties]; marbles for games; playing balls; play balloons; chess games; checkers [games]; paper party hats; toy mobiles; flippers for diving; swimming webs.

35 – Cost price analysis; rental of advertising space; computerized file management; book-keeping; invoicing; demonstration of goods; transcription of communications [office functions]; opinion polling; market studies; business investigations; marketing research; layout services for advertising purposes; marketing; targeted marketing; news clipping services; updating and maintenance of information in registries; updating and maintenance of data in computer databases; updating of advertising material; word processing; organization of exhibitions for commercial or advertising purposes; arranging newspaper subscriptions for others; organization of fashion shows for promotional purposes; organization of trade fairs; shop window dressing; payroll preparation; data search in computer files for others; providing business information; providing business information via a web site; providing commercial and business contact information; providing commercial information and advice for consumers in the choice of products and services; providing user reviews for commercial or advertising purposes; web indexing for commercial or advertising purposes; providing user rankings for commercial or advertising purposes; auctioneering; sales promotion for others; publication of publicity texts; radio advertising; development of advertising concepts; distribution of samples; dissemination of advertising matter; direct mail advertising; registration of written communications and data; writing of publicity texts; advertising; online advertising on a computer network; billposting; advertising by mail order; television advertising; compilation of statistics; compilation of information into computer databases; business inquiries; systemization of information into computer databases; administration of consumer loyalty programs; administrative processing of purchase orders; gift registry services; procurement services for others [purchasing goods and services for other businesses]; provision of an online marketplace for buyers and sellers of goods and services.

(260) AM 2021 112238 A  
(800) 1581858  
(151) 2021 01 22  
(891) 2021 01 22  
(731) Open Joint Stock Company "Voronezhskaya Conditerskaya Fabrika"  
ul. Koltsovskaya, d. 40, RU-394030 Voronezh,  
Russian Federation  
(540)

# Шейк

(591) Black, white

(531) 28.05  
(511)  
30 – Confectionery; sweetmeats [candy]; boiled sweets; cookies; waffles; pastilles [confectionery].

(260) AM 2021 112240 A  
(800) 1582090  
(151) 2021 02 05  
(891) 2021 02 05  
(731) HOLISTIC HEALTH, INC.  
9070 GLEANNLOCH FOREST DRIVE,  
SUITE 100, Spring TX 77379, USA  
(540)

## TOTALFIT

(591) Black, white  
(511)  
25 – Clothing, namely, t-shirts, tank tops, shirts, long-sleeved shirts, shorts, pants, jackets, athletic apparel, namely, pullover hoodies, sweatshirts, jogging pants, leggings, hats and caps, and windbreakers.

(260) AM 2021 112246 A  
(800) 1066624  
(151) 2010 08 23  
(891) 2021 02 20  
(731) Obschestvo s ogranichennoy, otvetstvennost'yu  
"NL Kontinent"  
ul. Yadrintsevskaya, d. 53/1 of. 1015,  
RU-630099 Novosibirsk, Russian Federation  
(540)



## International

(591) Black, white  
(531) 01.05.02; 01.05.06; 27.05.10  
(526) International.  
(511)  
3 – Abrasives; adhesives for cosmetic purposes; breath freshening sprays; aromatics (essential oils); fabric softeners for laundry use; astringents for cosmetic purposes; cosmetic creams; polishing creams; shoe polish; shoemakers' wax; laundry wax; cosmetics; cosmetic preparations for eyelashes; eyebrow cosmetics; cosmetic pencils; washing soda, for cleaning; scouring solutions; floor wax removers; bleaching preparations (decolorants) for cosmetic purposes; dentifrices; depilatory preparations; deodorants for personal use; stain removers; scale removing preparations for household purposes; detergents other than for use in manufacturing operations and for medical purposes; toilet water; starch for laundry purposes; polish for furniture and flooring; make-up; greases for cos-

metic purposes; cleansing milk for toilet purposes; hair spray; nail polish; windshield cleaning liquids; lotions for cosmetic purposes; mascara; beauty masks; preparations for soaking laundry; cosmetic kits; neutralizers for permanent waving; perfumes; pomades for cosmetic purposes; potpourris; make-up powder; cosmetic preparations for baths; sunscreen preparations; hair waving preparations; polishing preparations; color-brightening chemicals for household purposes (laundry); antistatic preparations for household purposes; cosmetic preparations for skin care; make-up removing preparations; laundry glaze; make-up preparations; dry-cleaning preparations; perfumery; shaving preparations; toiletries; antiperspirants; grinding preparations; leather bleaching preparations; lacquer-removing preparations; color-removing preparations; rust removing preparations; nail care preparations; mouth washes, not for medical purposes; smoothing preparations; soap; shampoos; shampoos for pets; bath salts, not for medical purposes; tissues impregnated with cosmetic lotions; cosmetic dyes; hair dyes.

5 – Additives to fodder for medical purposes; albuminous foodstuffs for medical purposes; dietetic foods adapted for medical purposes; food for babies; starch for dietetic or pharmaceutical purposes; amino acids for medical purposes; analgesics; antibiotics; antiseptics; bath preparations, medicated; balms for medical purposes; biocides; dietetic beverages adapted for medical purposes; confectionery, medicated; mud for baths; medicinal mud; fumigating sticks; nutritional additives for medical purposes; antiseptic cotton; appetite suppressants for medical purposes; decoctions for pharmaceutical purposes; disinfectants for hygiene purposes; digestives for pharmaceutical purposes; drugs for medical purposes; mineral water for medical purposes; thermal water; elixirs (pharmaceutical preparations); enzymes for medical purposes; enzymes for veterinary purposes; lacteal flour for babies; ferments for pharmaceutical purposes; milk ferments for pharmaceutical purposes; royal jelly (for medical purposes); germicides; glucose for medical purposes; chewing gum for medical purposes; hematogen; medicinal herbs; medicinal oils; cod liver oil; medicinal infusions; milk of almonds for pharmaceutical purposes; yeast for pharmaceutical purposes; liniments; lotions for pharmaceutical purposes; nervines; diabetic bread; pomades for medical purposes; albuminous preparations for medical purposes; bacterial preparations for medical and veterinary use; bacteriological preparations for medical and veterinary use; biological preparations for medical purposes; biological preparations for veterinary purposes; chemical preparations for medical purposes; chemical preparations for pharmaceutical purposes; vitamin preparations; preparations of trace elements for human and animal use; medical preparations for slimming purposes; contact lens cleaning preparations; therapeutic preparations for the bath; chemico-pharmaceutical preparations; preparations for the treatment of burns; opotherapy

preparations; pharmaceutical preparations; pharmaceutical preparations for skin care; air purifying preparations; air freshening preparations; veterinary preparations; medicinal roots; salts for medical purposes; bath salts for medical purposes; serums; sanitary towels; tissues impregnated with pharmaceutical lotions; syrups for pharmaceutical purposes; dietetic substances adapted for medical use; milk sugar (lactose); mineral food-supplements; reducing tea for medical purposes; asthmatic tea; herbs teas for medicinal purposes.

9 – Couplings, electric; accumulators, electric; actinometers; aerometers; electronic agendas; stills for laboratory experiments; alcoholmeters; altimeters; flashlights; amplifiers; anodes; aerials; anticathodes; high-frequency apparatus; welding apparatus, electric; ionisation apparatus, not for the treatment of air; apparatus to check franking; heat regulating apparatus; electric arc cutting apparatus; diffraction apparatus (microscopy); apparatus for fermentation (laboratory apparatus); precision measuring apparatus; satellite navigational apparatus; navigation apparatus for vehicles (on-board computers); projection apparatus; slide projectors; radios; radiological apparatus for industrial purposes; electric arc welding apparatus; electric welding apparatus; television apparatus; remote control apparatus; heliographic apparatus; electro-dynamic apparatus for the remote control of signals; regulating apparatus, electric; measuring devices, electric; monitoring apparatus, electric; electrical apparatus for sealing plastics; electric apparatus for commutation; chemistry apparatus and instruments; optical apparatus and instruments; weighing apparatus and instruments; apparatus and instruments for physics; sounding apparatus and machines; cameras; air analysis apparatus; gas testing instruments; food analysis apparatus; testing apparatus not for medical purposes; sound reproduction apparatus; chargers for electric batteries; breathing apparatus, except for artificial respiration; railway traffic safety appliances; sound transmitting apparatus; data processing apparatus; make-up removing appliances, electric; diagnostic apparatus, not for medical purposes; distillation apparatus for scientific purposes; amusement apparatus adapted for use with an external display screen or monitor; sound recording apparatus; time recording apparatus; apparatus for games adapted for use with an external display screen or monitor; divers' apparatus; breathing apparatus for underwater swimming; teaching apparatus; stereoscopic apparatus; telephone apparatus; audiovisual teaching apparatus; apertometers (optics); hemline markers; optical goods; thermionic valves (radio); coin-operated musical automata; fire alarms; anti-theft warning apparatus; acoustic (sound) alarms; personal stereos; scales; barometers; fiber optic cables; cables, electric; cash registers; pocket calculators; cinematographic cameras; camcorders; ducts; encoded cards, magnetic; identity cards, magnetic; integrated circuit cards; video game cartridges;

headphones; protective helmets; protective helmets for sports; cathodes; photovoltaic cells; shoes for protection against accidents, irradiation and fire; juke boxes for computers; chronographs (time recording apparatus); printed circuits; integrated circuits; computer keyboards; flashing lights (luminous signals); collectors, electric; commutators; comparators; converters, electric; counters; acoustic conduits; speed checking apparatus for vehicles; retorts; acoustic couplers; copiers (data processing equipment); incubators for bacteria culture; electronic pens; measuring spoons; cyclotrons; densimeters; densitometers; animated cartoons; detectors; metal detectors for industrial or military purposes; distance measuring apparatus; circuit breakers; sound recording discs; compact discs (audio-video); floppy disks; optical discs; anti-interference devices (electricity); cathodic anti-corrosion apparatus; electric devices for attracting and killing insects; balancing apparatus; protection devices for personal use against accidents; steering apparatus, automatic, for vehicles; life saving apparatus and equipment; editing appliances for cinematographic films; distribution machines, automatic; ticket dispensers; dynamometers; telephone receivers; workmen's protective face-shields; projection screens; fluorescent screens; screens (photography); video screens; welding electrodes; galvanic cells; transmitters of electronic signals; transmitting sets (telecommunication); magnetic encoders; pressure indicators; tape recorders; test tubes; ergometers; electronic tags for goods; containers for contact lenses; spectacle cases; cases especially made for photographic apparatus and instruments; exposure meters (light meters); door closers, electric; flat irons, electric; soldering irons, electric; optical fibers (light conducting filaments); wires, electric; filters; frequency meters; furnaces for laboratory experiments; gloves for protection against accidents; galvanometers; eyeshades; gasometers; sprinkler systems for fire protection; loudspeakers; holograms; hydrometers; hygrometers; indicators (electricity); temperature indicators; speed indicators; armatures (electricity); inverters (electricity); theft prevention installations, electric; interfaces for computers; material testing instruments and machines; electric installations for the remote control of industrial operations; measuring instruments; observation instruments; printers for use with computers; navigational instruments; switches, electric; binoculars; optical lamps; signal lanterns; lasers, not for medical purposes; bar code readers; compact disc players; optical character readers; contact lenses; optical lenses; anti-glare glasses; spectacles (optics); sunglasses; goggles for sports; adding machines; calculating machines; money counting and sorting machines; dictating machines; weighing machines; word processors; video recorders; pressure gauges; protective masks; mechanisms for coin-operated apparatus; disk drives for computers; coin-operated mechanisms for television sets; computer memories; measures; measuring appa-

ratus; capacity measures; rules (measuring instruments); micrometers; microprocessors; microphones; microscopes; microtomes; egg-candlers; furniture especially made for laboratories; modems; monitors (computer hardware); levels (instruments for determining the horizontal); objectives [lenses] (optics); octants; eyepieces; ohmmeters; wavemeters; computers; notebook computers; ozonisers (ozonators); computer peripheral devices; acid hydrometers; lactometers; photocopiers; solar batteries; batteries, electric; pedometers; speaking tubes; radiotelephony sets; computer programs, recorded; computer programs (downloadable software); teeth protectors; electronic publications, downloadable; chips (integrated circuits); quantity indicators; radar apparatus; audio and video-receivers; current rectifiers; voltage regulators for vehicles; light dimmers (regulators), electric; refractometers; refractors; relays, electric; wrist rests for use with computers; rheostats; saccharometers; needles for record players; scanners (data processing equipment); locks, electric; signals, luminous or mechanical; sonars; sound locating instruments; mouse (data processing equipment); spectrograph apparatus; spectrosopes; spherometers; stereoscopes; sound recording carriers; optical data media; switchboards; electronic notice boards; control panels (electricity); distribution boards (electricity); tachometers; walkie-talkies; ear plugs; mouse pads; plotters; taximeters; facsimile machines; range finders; telerupters; portable telephones; theodolites; thermometers, not for medical purposes; thermostats; totalizers; record players; electronic pocket translators; transmitters (telecommunication); transformers; tripods for cameras; marking gauges; processors (central processing units); urinometers; vacuum gauges; verniers; measuring glassware; spectacle glasses; optical glass; glass covered with an electrical conductor; clothing for protection against accidents, irradiation and fire; anti-glare visors; voltmeters.

14 – Clock hands (clock and watch making); amulets (jewelry); anchors (clock and watch making); silver, unwrought or beaten; spun silver; rings (jewelry); barrels (clock and watch making); cloisonné jewellery; boxes of precious metal; bracelets (jewelry); watch straps; charms; brooches (jewelry); earrings; cuff links; busts of precious metal; dials (clock and watch making); chains (jewelry); watch chains; chronographs (watches); chronometers; stopwatches; chronoscopes; necklaces (jewelry); cases for watches; pins (jewelry); ornamental pins; tie pins; threads of precious metal (jewelry); silver thread; gold thread (jewelry); tie clips; atomic clocks; clocks and watches, electric; badges of precious metal; chronometrical instruments; iridium; jet, unwrought or semi-wrought; copper tokens; jewelry; ingots of precious metals; medals; medallions (jewelry); precious metals, unwrought or semi-wrought; coins; watches; wristwatches; movements for clocks and watches; olivine (gems); gold, unwrought or beaten; ornaments of jet;

osmium; palladium; ornaments (jewelry); jewelry of yellow amber; silver ornaments; ivory; shoe ornaments of precious metal; clocks; pearls made of ambroid; pearls (jewelry); semi-precious stones; precious stones; platinum (metal); rhodium; alarm clocks; ruthenium; statues of precious metal; figurines (statuettes) of precious metal; paste jewelry; watch glasses.

16 – Posters; albums; almanacs; document laminators for office use; office requisites, except furniture; stationery; atlases; stickers (stationery); boxes of cardboard or paper; pamphlets; calendars; cards; postcards; greeting cards; musical greeting cards; cardboard; cardboard articles; catalogues; rosaries; folders for papers; newsletters; printing blocks; glue for stationery or household purposes; conical paper bags; babies' diaper-pants of paper and cellulose, disposable; pencils; slate pencils; decalcomanias; paper shredders for office use; graphic prints; mats for beer glasses; inkstands; shields (paper seals); bottle wrappers of cardboard or paper; ink; signboards of paper or cardboard; envelopes (stationery); bottle envelopes of cardboard or paper; drawing squares; towels of paper; labels, not of textile; plastic bubble packs for wrapping or packaging; sheets of reclaimed cellulose for wrapping; viscose sheets for wrapping; index cards (stationery); forms, printed; writing materials; electrotypes; terrestrial globes; engravings; hectographs; printed matter; writing instruments; newspapers; correcting fluids (office requisites); lithographs; books; booklets; manuals; teaching materials (except apparatus); sealing compounds for stationery purposes; adhesives (glues) for stationery or household purposes; packaging material made of starches; handkerchiefs of paper; paper; silver paper; wrapping paper; filter paper; toilet paper; patterns for dressmaking; photographs; plastic film for wrapping; periodicals; paintbrushes; holders for checkbooks; advertisement boards of paper or cardboard; credit card imprinters, non-electric; erasing products; prospectuses; thumbtacks; ledgers (books); indexes; graphic representations; adhesive tapes for stationery or household purposes; garbage bags of paper or of plastics; bags (envelopes, pouches) of paper or plastics, for packaging; bags for microwave cooking; seals (stamps); tissues of paper for removing make-up; face towels of paper; fountain pens; holders for stamps (seals); tablecloths of paper; tickets; stamps (seals); transparencies (stationery).

21 – Deodorizing apparatus for personal use; aerosol dispensers, not for medical purposes; polishing apparatus and machines, for household purposes, non-electric; pressure cookers (autoclaves), non-electric; appliances for removing make-up, non-electric; food cooling devices containing heat exchange fluids, for household purposes; sprinklers; table plates; litter trays for pets; chopsticks; bird baths; baby baths, portable; mops; carpet sweepers; buckets; basins (receptacles); cocktail stirrers; cooking pot sets; shaving brushes;

lunch boxes; boxes of metal, for dispensing paper towels; bread bins; soap boxes; candy boxes; kettles, non-electric; tea infusers; bottles; insulating flasks; refrigerating bottles; cooking skewers, of metal; brush goods; brushes for footwear; toothbrushes; toothbrushes, electric; nail brushes; eyebrow brushes; toilet brushes; electric brushes, except parts of machines; dishwashing brushes; perfume burners; coffeepots, non-electric; cages for household pets; decanters; stew-pans; heaters for feeding bottles, non-electric; china ornaments; beer mugs; apparatus for wax-polishing, non-electric; wax-polishing appliances, non-electric, for shoes; hot pots, not electrically heated; baskets for domestic use; shoe horns; dish covers; crystal (glassware); jugs; toothpicks; plungers for clearing blocked drains; large-toothed combs for the hair; dusting apparatus, non-electric; trivets (table utensils); toilet paper dispensers; soap dispensers; water apparatus for cleaning teeth and gums; abrasive sponges for scrubbing the skin; sponges for household purposes; toilet sponges; currycombs; comb cases; earthenware; floss for dental purposes; coffee filters, non-electric; strainers for household purposes; flasks; gloves for household purposes; waffle irons, non-electric; goblets; cups of paper or plastic; drinking flasks for travellers; grills (cooking utensils); powder puffs; watering devices; cleaning instruments, hand-operated; bowls; toilet cases; fitted picnic baskets, including dishes; feeding troughs for animals; shakers; mills for domestic purposes, hand-operated; cookery molds; molds (kitchen utensils); bottle openers; glove stretchers; combs; coffee percolators, non-electric; insect traps; ironing boards; trays for domestic purposes; dishes; paper plates; frying pans; porcelain ware; soap holders; napkin holders; pottery; pots; flower pots; garlic presses (kitchen utensils); fruit presses, non-electric, for household purposes; ceramics for household purposes; garbage cans, powder compacts; crumb trays; drinking vessels; heat insulated containers for beverages; thermally insulated containers for food; containers for household or kitchen use; isothermic bags; salt cellars; clothes racks, for drying; spice sets; services (dishes); animal bristles (brushware); saucers; soup bowls; holders for flowers and plants (flower arranging); scouring pads; cups; clothing stretchers; boot jacks; corkscrews; cloths for cleaning; cosmetic utensils; kitchen utensils; cooking utensils, non-electric; utensils for household purposes; tableware, other than knives, forks and spoons; perfume vaporizers; vases; painted glassware; glasses (receptacles); birdcages.

25 – Bandanas (neckerchiefs); stockings; hosiery; boots; half-boots; braces for clothing; lace boots; collar protectors; bathing trunks; hoods (clothing); belts (clothing); sweaters; headgear for wear; socks; footwear; shirts; collars; tights; combinations (clothing); suits; bathing suits; beach clothes; ear muffs (clothing); neckties; sashes for wear; esparto shoes or sandals; fur stoles; furs (clothing); scarves; gloves (clot-

hing); waistcoats; spats; waterproof clothing; leggings; garters; skirts; petticoats; layettes; underwear; sweat-absorbent underclothing; singlets; muffs (clothing); coats; mantillas; overcoats; trousers; parkas; pelerines; dressing gowns; pelisses; pullovers; pajamas; frocks; sandals; inner soles; shoes; brassieres; tee-shirts; knitwear (clothing); uniforms; stuff jackets; jackets; clothing; ready-made clothing; outerclothing; clothing of leather; clothing of imitations of leather; paper clothing; cap peaks.

28 – Hang gliders; Christmas trees of synthetic material; bows for archery; fencing weapons; appliances for gymnastics; body-building apparatus; balls for games; climbers' harness; building blocks (toys); starting blocks for sports; body boards; skating boots with skates attached; playing balls; rods for fishing; golf clubs; bingo cards; kites; dolls' rooms; targets; hockey sticks; checkerboards; ornaments for christmas trees, except illumination articles and confectionery; dice; chessboards; chest expanders (exercisers); practical jokes (novelties); nets for sports; darts; harpoon guns (sports articles); gloves for games; cups for dice; rattles; counters (disks) for games; games; automatic coin-operated amusement machines; games other than those adapted for use with an external display screen or monitor; playing cards; building games; checkers; dominoes; chess games; board games; toys; toys for domestic pets; bowling apparatus and machinery; toy masks; fencing masks; mobiles (toys); scale model vehicles; novelties for parties, dances; flippers for swimming; paragliders; ice skates; roller skates; surf boards; skateboards; sailboards; roulette wheels; swimming pools (play articles); paintball guns (sports apparatus); toy pistols; dolls; knee guards (sports articles); elbow guards (sports articles); shin guards (sports articles); punching bags; jigsaw puzzles; skittles; billiard cues; rackets; protective paddings (parts of sports suits); golf bags, with or without wheels; skis; waterskis; surf skis; billiard tables; tables for table tennis; sleighs (sports articles); spring boards (sports articles); radio-controlled toy vehicles; shuttlecocks.

30 – Oat-based food; seasonings; rusks; biscuits; cocoa-based beverages; chocolate-based beverages; coffee-based beverages; tea-based beverages; sweetmeats; gruel, with a milk base, for food; cocoa; cocoa beverages with milk; coffee; coffee beverages with milk; breadcrumbs; chocolate; chocolate beverages with milk; condiments; confectionery; couscous (semolina); crackers; custard; ice cream; pancakes; turmeric for food; edible decorations for cakes; natural sweeteners; thickening agents for cooking foodstuffs; spices; flour for food; starch for food; ferments for pastes; chips; fondants (confectionery); cakes; gluten for food; groats for human food; halvah; infusions, not medicinal; popcorn; malt for human consumption; marzipan; mayonnaise; farinaceous foods; honey; muesli; bread; pastilles (confectionery); almond paste;

cake paste; pasta; pâté (pastries); meat pies; fruit jellies (confectionery); bread rolls; pizzas; baking powder; pralines; aromatic preparations for food; cereal preparations; cocoa products; flour-milling products; preparations for stiffening whipped cream; ravioli; rice; sandwiches; cooking salt; sorbets (ices); sugar; sushi; tapioca; tarts; tea; pies; vinegar.

32 – Aperitifs, non-alcoholic; beer; whey beverages; non-alcoholic fruit juice beverages; isotonic beverages; non-alcoholic beverages; cocktails, non-alcoholic; table waters; essences for making beverages; non-alcoholic fruit extracts; extracts of hops for making beer; fruit juices; vegetable juices (beverages); milk of almonds (beverage); lemonades; must; fruit nectars, non-alcoholic; orgeat; pastilles for effervescing beverages; preparations for making liqueurs; preparations for making mineral water; preparations for making beverages; preparations for making aerated water; powders for effervescing beverages; syrups for beverages.

35 – Bill-posting; import-export agencies; commercial information agencies; advertising agencies; business management assistance; commercial or industrial management assistance; cost price analysis; employment agencies; business management and organization consultancy; personnel management consultancy; professional business consultancy; publicity columns preparation; shop window dressing; demonstration of goods; distribution of samples; dissemination of advertising matter; business management of performing artists; business appraisals; tax preparation; marketing studies; efficiency experts; business management of hotels; computerized file management; business information; rental of advertising space; publicity material rental; rental of advertising time on communication media; updating of advertising material; organization of trade fairs for commercial or advertising purposes; organization of exhibitions for commercial or advertising purposes; payroll preparation; economic forecasting; publication of publicity texts; advertising; on-line advertising on a computer network; advertising by mail order; radio advertising; television advertising; marketing research; personnel recruitment; compilation of information into computer databases; public relations; business inquiries; document reproduction; photocopying; psychological testing for the selection of personnel; modelling for advertising or sales promotion; relocation services for businesses; news clipping services; secretarial services; arranging newspaper subscriptions for others; opinion polling; systemization of information into computer databases; word processing; transcription; book-keeping; auditing; auctioneering.

41 – Modeling for artists; night clubs; sport camp services; timing of sports events; health club services; physical education; animal training; teaching; videotaping; educational examination; providing on-line electronic publications, not downloadable; providing amu-



sement arcade services; practical training (demonstration); education information; entertainment information; recreation information; gaming; rental of audio equipment; rental of sound recordings; rental of sports equipment, except vehicles; electronic desktop publishing; providing sports facilities; organization of exhibitions for cultural or educational purposes; arranging and conducting of colloquiums; arranging and conducting of congresses; arranging and conducting of conferences; arranging and conducting of workshops; arranging and conducting of seminars; arranging and conducting of symposiums; arranging of beauty contests; organization of competitions (education or entertainment); operating lotteries; organization of sports competitions; vocational guidance (education or training advice); photography; party planning (entertainment); videotape film production; cinema presentations; publication of books; publication of electronic books and journals on-line; production of shows; publication of texts, other than publicity texts; scriptwriting services; photographic reporting; entertainer services; providing casino facilities (gambling); club services (entertainment or education); discotheque services; providing recreation facilities; news reporters services; recording studio services; translation; movie studios.

(260) AM 2021 112247 A  
 (800) 1135892  
 (151) 2012 10 08  
 (891) 2021 02 20  
 (731) Obschestvo s ogranichennoy otvetstvennost'yu "NL Kontinent"  
 ul. Yadrintsevskaya, d. 53/1 of. 1015,  
 RU-630099 Novosibirsk, Russian Federation  
 (540)



**International**

(591) Black, white  
 (531) 01.05.02; 27.05.10  
 (511)  
 29 – Albumen for culinary purposes; preserved beans; bouillon; fatty substances for the manufacture of edible fats; preserved mushrooms; game, not live; jellies for food; edible fats; charcuterie; meat, tinned [canned (am.)]; vegetables, tinned [canned (am.)]; fish, tinned [canned (am.)]; fruits, tinned [canned (am.)]; bouillon concentrates; butter cream; margarine; piccalilli; marmalade; coconut oil; butter; clams [not live]; milk; meat; preserved meat; preserved vegetables; dried vegetables; cooked vegetables; prepared nuts; tomato puree; liver pâté; liver; jams; cream [dairy products];

food products made from fish; poultry, not live; crayfish, not live; fish, not live; preserved fish; vegetable salads; fruit salads; bacon; fat-containing mixtures for bread slices; vegetable juices for cooking; salted meats; preparations for making bouillon; preparations for making soup; tripe; soups; cheese; tofu; crystallized fruits; frozen fruits; fruit, preserved; fruit, stewed; potato flakes; fruit peel; potato chips; fruit chips; eggs.

(260) AM 2021 112249 A  
 (800) 1457606  
 (151) 2018 12 03  
 (891) 2020 12 23  
 (731) EMSEY SAĞLIK HİZMETLERİ VE İŞLETMELERİ TURİZM OTELCİLİK TİCARET ANONİM LİMİTED ŞİRKETİ  
 Çamlık Mah. Selçuklu Cad. No:22, Kurtköy  
 Pendik, İSTANBUL, Turkey  
 (540)

**EMSEY HOSPITAL**

(591) Gold  
 (531) 27.05.01; 29.01.02  
 (526) HOSPITAL  
 (511)  
 44 – Medical services; veterinary services; hygienic and beauty care for human beings or animals; agriculture, horticulture and forestry services.

(260) AM 2021 112250 A  
 (800) 1495323  
 (151) 2019 05 24  
 (891) 2020 07 30  
 (731) AJMAL HOLDINGS & INVESTMENTS PRIVATE LIMITED  
 1, Cecil Court, 24, Mahakavi Bhusan Marg,  
 Colaba, Mumbai 400001, India  
 (540)



(591) Black, white  
 (531) 26.04.02; 26.04.05; 26.13.25  
 (511)  
 3 – Attar, perfumery and cosmetics all included in class 3.

(260) AM 2021 112317 A

(800) 1582357

(151) 2020 12 25

(891) 2020 12 25

(731) Egorov Alexey Vladimirovich

Simonova st., 12/9, 426, RU-194358

Saint-Petersburg, Russian Federation

(540)

**WO  
OM  
WCOM**

(591) Black, white

(531) 24.17.08; 27.05.01

(511)

5 – Dental amalgams of gold; acaricides; aconitine; alkaloids for medical purposes; alginates for pharmaceutical purposes; algicides; aldehydes for pharmaceutical purposes; dental amalgams; amino acids for veterinary purposes; amino acids for medical purposes; analgesics; anaesthetics; antibiotics; antiseptics; medicine cases, portable, filled; first-aid boxes, filled; aluminium acetate for pharmaceutical purposes; acetates for pharmaceutical purposes; germicides; oxygen cylinders, filled, for medical purposes; balms for medical purposes; bandages for dressings; diagnostic biomarker reagents for medical purposes; biocides; bracelets impregnated with insect repellent; bromine for pharmaceutical purposes; paper for mustard plasters; fly catching paper; reagent paper for veterinary purposes; reagent paper for medical purposes; moth-proofing paper; vaccines; oxygen baths; antiseptic cotton; absorbent cotton; wadding for medical purposes; cotton for medical purposes; dietetic substances adapted for medical use; radiological contrast substances for medical purposes; nutritive substances for microorganisms; radioactive substances for medical purposes; bismuth subnitrate for pharmaceutical purposes; melissa water for pharmaceutical purposes; sea water for medicinal bathing; mineral waters for medical purposes; thermal water; dietary fiber; molding wax for dentists; petroleum jelly for medical purposes; gases for medical purposes; guaiacol for pharmaceutical purposes; massage gels for medical purposes; sexual stimulant gels; hematogen; hemoglobin; hydrastine; hydrastinine; glycerine for medical purposes; glycerophosphates; glucose for medical purposes; gentian for pharmaceutical purposes; hormones for medical purposes; mustard for pharmaceutical purposes; mustard plasters; mud for baths; medicinal mud; contraceptive sponges; gamboge for medical purposes; gurjun balsam for medical purposes; disinfectants; air deodorising preparations; deodorants, other than for human beings or for animals; deodorants for clothing and textiles; diastase for medical purposes; digitalin; vitamin

supplement patches; mineral food supplements; nutritional supplements; albumin dietary supplements; dietary supplements for animals; yeast dietary supplements; alginate dietary supplements; glucose dietary supplements; casein dietary supplements; lecithin dietary supplements; linseed oil dietary supplements; propolis dietary supplements; protein dietary supplements; protein supplements for animals; royal jelly dietary supplements; pollen dietary supplements; wheat germ dietary supplements; linseed dietary supplements; acai powder dietary supplements; dietary supplements with a cosmetic effect; enzyme dietary supplements; yeast for pharmaceutical purposes; gelatine for medical purposes; cod liver oil; isotopes for medical purposes; immunostimulants; insecticides; iodine for pharmaceutical purposes; iodides for pharmaceutical purposes; alkaline iodides for pharmaceutical purposes; iodoform; cream of tartar for pharmaceutical purposes; tartar for pharmaceutical purposes; camphor for medical purposes; capsules for medicines; cachets for pharmaceutical purposes; capsules made of dendrimerbased polymers, for pharmaceuticals; hemostatic pencils; wart pencils; caustic pencils; carbolineum [parasiticide]; caustics for pharmaceutical purposes; cachou for pharmaceutical purposes; quassia for medical purposes; quebracho for medical purposes; oxygen for medical purposes; gallic acid for pharmaceutical purposes; acids for pharmaceutical purposes; adhesives for dentures; surgical glues; stem cells for veterinary purposes; stem cells for medical purposes; cocaine; collagen for medical purposes; collodion for pharmaceutical purposes; corn rings for the feet; cannabis for medical purposes; medicated candies; angostura bark for medical purposes; barks for pharmaceutical purposes; cedar wood for use as an insect repellent; condurango bark for medical purposes; croton bark; mangrove bark for pharmaceutical purposes; myrobalan bark for pharmaceutical purposes; quinquina for medical purposes; medicated animal feed; medicinal roots; rhubarb roots for pharmaceutical purposes; lint for medical purposes; starch for dietetic or pharmaceutical purposes; creosote for pharmaceutical purposes; blood for medical purposes; cultures of microorganisms for medical or veterinary use; curare; dental lacquer; liquorice for pharmaceutical purposes; lactose for pharmaceutical purposes; adhesive plasters; medicines for alleviating constipation; adhesive tapes for medical purposes; lecithin for medical purposes; lotions for veterinary purposes; medicated hair lotions; lotions for pharmaceutical purposes; medicated after-shave lotions; personal sexual lubricants; lupulin for pharmaceutical purposes; magnesia for pharmaceutical purposes; liniments; ointments for pharmaceutical purposes; sunburn ointments; mercurial ointments; frostbite salve for pharmaceutical purposes; gauze for dressings; medicinal oils; mustard oil for medical purposes; camphor oil for medical purposes; castor oil for medical purposes; oil of turpentine for pharmaceutical purposes; dill oil

for medical purposes; dental mastics; dental abrasives; dental impression materials; teeth filling material; dressings, medical; surgical dressings; drugs for medical purposes; medicines for veterinary purposes; serotherapeutic medicines; medicines for human purposes; medicines for dental purposes; menthol; medicinal drinks; moleskin for medical purposes; almond milk for pharmaceutical purposes; powdered milk for babies; royal jelly for pharmaceutical purposes; milk ferments for pharmaceutical purposes; Irish moss for medical purposes; flour for pharmaceutical purposes; linseed meal for pharmaceutical purposes; fish meal for pharmaceutical purposes; fly glue; antibacterial soap; disinfectant soap; medicated soap; freeze-dried meat adapted for medical purposes; mint for pharmaceutical purposes; dietetic beverages adapted for medical purposes; malted milk beverages for medical purposes; injectable dermal fillers; bone void fillers comprised of living tissues; narcotics; medicinal infusions; tincture of iodine; eucalyptol for pharmaceutical purposes; tinctures for medical purposes; opium; opodeldoc; decoctions for pharmaceutical purposes; antiparasitic collars for animals; stick liquorice for pharmaceutical purposes; sulfur sticks [disinfectants]; pastilles for pharmaceutical purposes; medicated toothpaste; pectin for pharmaceutical purposes; pepsins for pharmaceutical purposes; peptones for pharmaceutical purposes; hydrogen peroxide for medical purposes; pesticides; food for babies; leeches for medical purposes; blood plasma; nicotine patches for use as aids to stop smoking; eyepatches for medical purposes; poultices; compresses; scapulars for surgical purposes; babies' diapers; diapers for pets; swim diapers, reusable, for babies; swim diapers, disposable, for babies; diapers for incontinence; diaper changing mats, disposable, for babies; bunion pads; breast-nursing pads; pomades for medical purposes; powder of cantarides; pyrethrum powder; anti-uric preparations; bacterial preparations for medical and veterinary use; bacteriological preparations for medical and veterinary use; balsamic preparations for medical purposes; albuminous preparations for medical purposes; biological preparations for veterinary purposes; biological preparations for medical purposes; veterinary preparations; bismuth preparations for pharmaceutical purposes; vitamin preparations; diagnostic preparations for veterinary purposes; diagnostic preparations for medical purposes; douching preparations for medical purposes; bath preparations for medical purposes; therapeutic preparations for the bath; hemorrhoid preparations; preparations for callouses; lice treatment preparations [pediculicides]; acne treatment preparations; preparations to facilitate teething; preparations for the treatment of burns; fumigation preparations for medical purposes; ootherapy preparations; air purifying preparations; bronchodilating preparations; preparations for reducing sexual activity; sterilising preparations; soil-sterilising preparations; corn remedies; pharmaceutical preparations for treating dandruff; prepara-

tions for destroying noxious animals; herbicides; preparations for destroying dry rot fungus; larvae exterminating preparations; fly destroying preparations; preparations for destroying mice; slug exterminating preparations; vermin destroying preparations; pharmaceutical preparations for skin care; contact lens cleaning preparations; preparations of microorganisms for medical or veterinary use; lime-based pharmaceutical preparations; styptic preparations; medicated eyewashes; medicinal hair growth preparations; nutraceutical preparations for therapeutic or medical purposes; opiates; anticryptogamic preparations; aloe vera preparations for pharmaceutical purposes; preparations of trace elements for human and animal use; sulfonamides [medicines]; pharmaceutical preparations; pharmaceutical preparations for treating sunburn; enzyme preparations for veterinary purposes; enzyme preparations for medical purposes; phytotherapy preparations for medical purposes; chemico-pharmaceutical preparations; chemical preparations for veterinary purposes; chemical preparations for the diagnosis of pregnancy; chemical preparations for medical purposes; chemical preparations for treating diseases affecting cereal plants; chemical preparations for treating wheat blight; chemical preparations for treating diseases affecting vine plants; chemical preparations for treating mildew; chemical preparations for treating phyloxera; chemical preparations for pharmaceutical purposes; chilblain preparations; mothproofing preparations; collyrium; lead water; chemical conductors for electrocardiograph electrodes; albuminous foodstuffs for medical purposes; dietetic foods adapted for medical purposes; by-products of the processing of cereals for dietetic or medical purposes; homogenized food adapted for medical purposes; freeze-dried food adapted for medical purposes; pharmaceuticals; sanitary towels; panty liners [sanitary]; propolis for pharmaceutical purposes; pearl powder for medical purposes; radium for medical purposes; hydrated chloral for pharmaceutical purposes; solvents for removing adhesive plasters; vaginal washes for medical purposes; solutions for contact lenses; chemical reagents for medical or veterinary purposes; gum for medical purposes; rubber for dental purposes; chewing gum for medical purposes; nicotine gum for use as an aid to stop smoking; insect repellents; insect repellent incense; repellents for dogs; tissues impregnated with pharmaceutical lotions; sarsaparilla for medical purposes; sugar for medical purposes; crystallized rock sugar for medical purposes; asthmatic tea; fumigating sticks; massage candles for therapeutic purposes; suppositories; linseed for pharmaceutical purposes; tobaccofree cigarettes for medical purposes; siccatives [drying agents] for medical purposes; syrups for pharmaceutical purposes; turpentine for pharmaceutical purposes; milking grease; greases for veterinary purposes; greases for medical purposes; lacteal flour for babies; infant formula; soporifics; bicarbonate of soda for pharmaceutical purposes; bath salts for medical

purposes; salts for mineral water baths; salts for medical purposes; potassium salts for medical purposes; sodium salts for medical purposes; smelling salts; mineral water salts; malt for pharmaceutical purposes; semen for artificial insemination; alcohol for pharmaceutical purposes; medicinal alcohol; alloys of precious metals for dental purposes; ergot for pharmaceutical purposes; cooling sprays for medical purposes; antibacterial handwashes; adjuvants for medical purposes; astringents for medical purposes; vermifuges; disinfectants for hygiene purposes; disinfectants for chemical toilets; appetite suppressants for medical purposes; medical preparations for slimming purposes; parasiticides; mouthwashes for medical purposes; medicated dentifrices; febrifuges; depuratives; animal washes [insecticides]; detergents for medical purposes; cattle washes [insecticides]; dog washes [insecticides]; insecticidal veterinary washes; vesicants; purgatives; remedies for perspiration; remedies for foot perspiration; chemical contraceptives; antiparasitic preparations; sedatives; laxatives; tonics [medicines]; medicated toiletry preparations; digestives for pharmaceutical purposes; nervines; media for bacteriological cultures; steroids; headache relief sticks; strychnine; serums; tanning pills; appetite suppressant pills; slimming pills; jujube, medicated; antioxidant pills; sanitary tampons; vulnerary sponges; thymol for pharmaceutical purposes; biological tissue cultures for veterinary purposes; biological tissue cultures for medical purposes; smoking herbs for medical purposes; medicinal herbs; transplants [living tissues]; surgical implants comprised of living tissues; pants, absorbent, for incontinence; sanitary panties; babies' diaper-pants; charcoal for pharmaceutical purposes; fennel for medical purposes; porcelain for dental prostheses; phenol for pharmaceutical purposes; enzymes for veterinary purposes; enzymes for medical purposes; ferments for pharmaceutical purposes; formic aldehyde for pharmaceutical purposes; phosphates for pharmaceutical purposes; fungicides; quinine for medical purposes; chinoline for medical purposes; diabetic bread adapted for medical use; chloroform; flowers of sulfur for pharmaceutical purposes; cement for animal hooves; bone cement for surgical and orthopaedic purposes; dental cements; medicinal tea; herbal teas for medicinal purposes; insecticidal animal shampoos; medicated shampoos; medicated shampoos for pets; pediculicidal shampoos; medicated dry shampoos; pre-filled syringes for medical purposes; eucalyptus for pharmaceutical purposes; herbal extracts for medical purposes; plant extracts for pharmaceutical purposes; tobacco extracts [insecticides]; extracts of hops for pharmaceutical purposes; elixirs [pharmaceutical preparations]; ethers for pharmaceutical purposes; esters for pharmaceutical purposes; cellulose esters for pharmaceutical purposes; rat poison; poisons; bacterial poisons; jalap.

21 – Autoclaves, non-electric, for cooking; indoor aquaria; wine aerators; buckets; cookie jars; candle jars [holders]; china ornaments; dishes; paper plates; vegetable dishes; saucers; mugs; candy boxes; bottles; demijohns; busts of porcelain, ceramic, earthenware, terra-cotta or glass; vases; epergnes; fruit bowls; inflatable bath tubs for babies; bird baths; baby baths, portable; plungers for clearing blocked drains; waffle irons, non-electric; pails; diaper disposal pails; coolers [ice pails]; mop wringer buckets; buckets made of woven fabrics; whisks, non-electric, for household purposes; cooking skewers of metal; towel rails and rings; clothing stretchers; hair for brushes; horsehair for brush-making; birdcages; funnels; candle warmers, electric and non-electric; carpet beaters [hand instruments]; signboards of porcelain or glass; candle extinguishers; heads for electric toothbrushes; flower pots; chamber pots; glue-pots; cruets; decanters; large-toothed combs for the hair; combs for animals; tea cosies; abrasive sponges for scrubbing the skin; make-up sponges; sponges for household purposes; toilet sponges; sponge holders; stands for portable baby baths; toothpick holders; soap holders; table napkin holders; holders for flowers and plants [flower arranging]; tea bag rests; shaving brush stands; toilet paper holders; soap dispensers; toilet paper dispensers; plug-in diffusers for mosquito repellents; aromatic oil diffusers, other than reed diffusers, electric and non-electric; ironing boards; cutting boards for the kitchen use, non-electric; strainers for household purposes; smoke absorbers for household purposes; containers for household or kitchen use; kitchen containers; glass jars [carboys]; heat-insulated containers; heat-insulated containers for beverages; thermally insulated containers for food; glass flasks [containers]; closures for pot lids; chamois leather for cleaning; toothpicks; ceramics for household purposes; majolica; works of art of porcelain, ceramic, earthenware, terra-cotta or glass; kitchen grinders, non-electric; cleaning instruments, hand-operated; cabarets [trays]; stew-pans; couscous cooking pots, non-electric; covers, not of paper, for flower pots; shaving brushes; makeup brushes; basting brushes; cages for household pets; baking mats; ladles for serving wine; polishing leather; hot pots, not electrically heated; glass bulbs [receptacles]; shoe trees; napkin rings; poultry rings; rings for birds; disposable aluminium foil containers for household purposes; coin banks; piggy banks; bread baskets for household purposes; baskets for household purposes; waste paper baskets; feeding troughs; pet feeding bowls, automatic; mangers for animals; lunch boxes; tea caddies; washtubs; earthenware saucepans; mess-tins; coffee percolators, non-electric; coffeepots, nonelectric; coffee grinders, hand-operated; fused silica [semiworked product], other than for building; beer mugs; tankards; rat traps; pot lids; aquarium hoods; butter-dish covers; dish covers; cheese-dish covers; reusable silicone food covers; button-

hooks; reusable ice cubes; pitchers; perfume burners; watering cans; fly traps; insect traps; ice cream scoops; mixing spoons [kitchen utensils]; basting spoons [cooking utensils]; pie servers; cosmetic spatulas; spatulas for kitchen use; litter boxes for pets; butter dishes; material for brush-making; polishing materials for making shiny, except preparations, paper and stone; tablemats, not of paper or textile; noodle machines, hand-operated; lint removers, electric or nonelectric; pasta makers, hand-operated; polishing apparatus and machines, for household purposes, non-electric; pepper mills, hand-operated; mills for household purposes, hand-operated; feather-dusters; brooms; isothermic bags; confectioners' decorating bags [pastry bags]; bowls [basins]; pet feeding bowls; mosaics of glass, not for building; dishcloths; saucepan scourers of metal; soap boxes; mouse traps; cooking pot sets; nozzles for watering cans; pouring spouts; wine pourers; cake decorating tips and tubes; nozzles for watering hose; fitted picnic baskets, including dishes; toilet cases; floss for dental purposes; fiberglass thread, other than for textile use; cookie [biscuit] cutters; pastry cutters; sprinklers; syringes for watering flowers and plants; egg yolk separators; cotton waste for cleaning; wool waste for cleaning; cleaning tow; cold packs for chilling food and beverages; chopsticks; cocktail stirrers; food steamers, non-electric; pepper pots; oven mitts; animal grooming gloves; gloves for household purposes; car washing mitts; polishing gloves; gardening gloves; pestles for kitchen use; droppers for household purposes; wine-tasting pipettes; droppers for cosmetic purposes; plates for diffusing aromatic oil; plates to prevent milk boiling over; dripping pans; trays for household purposes; trays of paper, for household purposes; lazy susans; heaters for feeding bottles, non-electric; candelabra [candlesticks]; trivets [table utensils]; coasters, not of paper or textile; grill supports; menu card holders; knife rests for the table; flat-iron stands; egg cups; abrasive pads for kitchen purposes; scouring pads; drinking troughs; serving ladles; powdered glass for decoration; pottery; pots; cooking pots; painted glassware; tableware, other than knives, forks and spoons; porcelain ware; earthenware; crystal [glassware]; cosmetic utensils; trouser presses; toothpaste tube squeezers; tortilla presses, non-electric [kitchen utensils]; deodorising apparatus for personal use; cruet sets for oil and vinegar; make-up removing appliances; spice sets; apparatus for waxpolishing, non-electric; bottle openers, electric and non-electric; glove stretchers; boot-jacks; crumb trays; potholders; clothespegs; glass stoppers; powder compacts, empty; perfume vaporizers; powder puffs; dusting apparatus, non-electric; foam toe separators for use in pedicures; combs; electric combs; grills [cooking utensils]; sifters [household utensils]; drinking horns; shoe horns; bobeches; broom handles; salad bowls; place mats, not of paper or textile; beverage urns, nonelectric; sugar bowls; beaters, non-electric; egg separators, non-electric, for

household purposes; services [dishes]; coffee services [tableware]; liqueur sets; tea services [tableware]; cooking mesh bags, other than for microwaves; sieves [household utensils]; tea strainers; siphon bottles for aerated water; rolling pins, domestic; frying pans; squeegees [cleaning instruments]; steel wool for cleaning; currycombs; blenders, non-electric, for household purposes; scoops for household purposes; fruit presses, non-electric, for household purposes; drinking straws; salt cellars; drinking vessels; vessels of metal for making ices and iced drinks; bulb basters; cups of paper or plastic; glasses [receptacles]; drinking glasses; figurines of porcelain, ceramic, earthenware, terra-cotta or glass; statues of porcelain, ceramic, earthenware, terracotta or glass; glass for vehicle windows [semi-finished product]; plate glass [raw material]; opal glass; glass, unworked or semi-worked, except building glass; opaline glass; glass incorporating fine electrical conductors; enamelled glass, not for building; glass wool, other than for insulation; vitreous silica fibres, other than for textile use; fiberglass, other than for insulation or textile use; mortars for kitchen use; portable cool boxes, non-electric; soup bowls; drying racks for laundry; rotary washing lines; tagines, non-electric; basins [receptacles]; table plates; disposable table plates; graters for kitchen use; insulating flasks; indoor terrariums [plant cultivation]; indoor terrariums [vivariums]; roller tubes for peeling garlic; cloth for washing floors; polishing cloths; cloths for cleaning; dusting cloths [rags]; furniture dusters; aerosol dispensers, not for medical purposes; waxpolishing appliances, non-electric, for shoes; water apparatus for cleaning teeth and gums; electric devices for attracting and killing insects; watering devices; utensils for household purposes; kitchen utensils; cooking utensils, non-electric; coffee filters, non-electric; flasks; hip flasks; drinking bottles for sports; boot trees; molds [kitchen utensils]; egg poachers; cake moulds; ice cube moulds; cookery moulds; deep fryers, nonelectric; comb cases; bread bins; fly swatters; teapots; kettles, non-electric; cups; garlic presses [kitchen utensils]; ironing board covers, shaped; tea infusers; decorative glass spheres; mops; mop wringers; cocktail shakers; corkscrews, electric and non-electric; animal bristles [brushware]; pig bristles for brush-making; brushes; dishwashing brushes; ski wax brushes; brushes for cleaning tanks and containers; lamp-glass brushes; horse brushes; scrubbing brushes; toothbrushes; toothbrushes, electric; carpet sweepers; shoe brushes; tar-brushes, long handled; toilet brushes; electric brushes, except parts of machines; eyebrow brushes; nail brushes; eyelash brushes; nutcrackers; ice tongs; salad tongs; sugar tongs; decanter tags; nest eggs, artificial; boxes for dispensing paper towels; dustbins; window-boxes; boxes of glass.

---

(260) AM 2021 112325 A  
 (800) 1582640  
 (151) 2020 10 09  
 (891) 2020 10 09  
 (731) National Basketball Players Association  
 1133 Avenue of the Americas, 5th Floor,  
 New York NY 10036, USA  
 (540)



(591) Black, white  
 (531) 21.03.01; 26.01.05; 26.01.21; 26.01.24;  
 26.11.03; 26.11.13  
 (511)  
 9 – Downloadable computer game software for use on mobile phones; downloadable computer game software for home video game consoles; arcade games software; downloadable publications, electronic publications; internet licensed access software; video game software; social gaming software; virtual products, namely, virtual reality games, digital trading cards or tokens not used for currency; simulated management-style game software; computer and electronic accessories, namely computer keyboards, computer mice, and mouse pads; fantasy game software; case covers (smartphones, e-readers, tablets); mobile phone accessories, namely, mobile phone cases, mobile phone stands and cradles, mobile phone harnesses, mobile phone adapters, mobile phone chargers, headsets, mobile phone holsters, mobile phone clips, mobile phone charms and mobile phone straps; thumbles in the nature of adhesive home button covers namely, adhesive stickers for mobile phone home buttons; hands-free pad (smartphones, e-readers, tablets); electronics-charging bracelet accessories; carrying cases, holders and stands specifically adapted for use with portable and handheld mobile electronic devices; magnets; headphones; earbuds; speakers.  
 35 – Association services, namely, promoting the business interests of basketball players.  
 41 – Organization of community events for cultural purposes, sporting events, and cultural events; organization of sporting events and activities in the nature of basketball clinics, basketball games, professional basketball games and all-star basketball games; providing entertainment information about community events, sporting events, basketball clinics, and cultural events via a website; providing community outreach programs, namely, organizing, arranging and conducting community sporting events and cultural events

(260) AM 2021 112341 A  
 (800) 1583076  
 (151) 2020 11 20  
 (891) 2020 11 20  
 (731) SERUM INSTITUTE OF INDIA PRIVATE LIMITED  
 Sarosh Bhavan, 16-B/1, Dr. Ambedkar Road,  
 Pune-411001, Maharashtra, India  
 (540)

## COVOVAX

(591) Black, white  
 (531) 27.05.01  
 (511)  
 5 – Vaccine for human use.

(260) AM 2021 112342 A  
 (800) 1583082  
 (151) 2020 11 20  
 (891) 2020 11 20  
 (731) SERUM INSTITUTE OF INDIA PRIVATE LIMITED  
 Sarosh Bhavan, 16-B/1, Dr. Ambedkar Road,  
 Pune-411001, Maharashtra, India  
 (540)

## COVI SHIELD

(591) Black, white  
 (531) 27.05.01  
 (511)  
 5 – Vaccine for human use.

(260) AM 2021 112343 A  
 (800) 1583099  
 (151) 2020 11 20  
 (891) 2020 11 20  
 (731) SERUM INSTITUTE OF INDIA PRIVATE LIMITED  
 Sarosh Bhavan, 16-B/1, Dr. Ambedkar Road,  
 Pune-411001, Maharashtra, India  
 (540)

## SII COVAX

(591) Black, white  
 (531) 27.05.01; 27.05.17  
 (511)  
 5 – Vaccine for human use.

(260) AM 2021 112344 A  
 (800) 1583104  
 (151) 2021 01 30  
 (891) 2021 01 30  
 (731) Hanhui Pharmaceuticals Co., Ltd.  
 No. 2 Haizheng Road, Xukou Town, Fuyang  
 District, Hangzhou City, Zhejiang Province,  
 China

(540)

**Hanhui**

(591) Black, white

(511)

5 – Pharmaceutical preparations; chemico-pharmaceutical preparations; analgesics; drugs for medical purposes; capsules for pharmaceutical purposes; sedatives, tranquillizers; biological preparations for medical purposes; chemical preparations for pharmaceutical purposes; antibiotics; injection (medicines); tablets (medicines); bulk drugs; biochemical medicines; blood products; tinctures for medical purposes; diagnostic preparations for medical purposes; chemical reagents for medical or veterinary purposes; radium for medical purposes; radioactive substances for medical purposes; isotopes for medical purposes; radioactive medicines; oxygen baths; gases for medical purposes; oxygen for medical purposes; chemical conductors for electrocardiograph electrodes; semen for artificial insemination; disinfectants for hygiene purposes; disinfectants; solutions for contact lenses; contact lens cleaning preparations; media for bacteriological cultures; bouillons for bacteriological cultures; bacteriological culture mediums; nutritive substances for microorganisms; cultures of microorganisms for medical and veterinary use; disinfectant wipes; wadding for medical purposes; medicines for human purposes; food for babies.

(260) AM 2021 112345 A

(800) 1583122

(151) 2021 01 21

(891) 2021 01 21

(731) AROMATIKA LTD.

7-9 Nyzhniy Val str., Kyiv 04071, Ukraine

(540)

**AROMATIKA**

(591) Black, white

(531) 01.15.15; 05.03.14; 24.03.07; 26.01.15;  
27.05.01

(511)

31 – Raw and unprocessed agricultural, aquacultural, horticultural and forestry products; raw and unprocessed grains and seeds; foodstuffs and beverages for animals.

(260) AM 2021 112356 A

(800) 1318835

(151) 2016 06 22

(891) 2021 01 12

(731) TERAPIA S.A.

Str. Fabricii nr.124, Cluj-Napoca, jud. Cluj,  
Romania

(540)

**ФарингоТусів**

(591) Black, white

(531) 28.05

(511)

5 – Pharmaceutical and veterinary products; nutritive supplements; hygienic products for medical use, dietetic substances for medical use, food for babies, plasters and materials for dressings; materials for stopping teeth and dental wax; disinfectants; preparations for destroying vermin; fungicides, herbicides.

35 – Advertising; promotion activities; business management; business administration; office functions.

(260) AM 2021 112423 A

(800) 1583403

(151) 2020 12 07

(891) 2020 12 07

(731) MİNİK O PAZARLAMA DIŞ TİC. VE TUR.  
A.Ş.Ali Nihat Tarlan Caddesi, Kahraman Sokak  
Hoffman İş Merkezi, No:2 Kat:5 D:11  
Bostancı Kadıköy, İSTANBUL, Turkey

(540)



(591) Gray, light blue

(531) 27.05.01; 29.01.12

(511)

8 – Hand tools and implements, hand-operated; cutlery; side arms, except firearms; razors.

21 – Household or kitchen utensils and containers; cookware and tableware, except forks, knives and spoons; combs and sponges; brushes, except paintbrushes; brush-making materials; articles for cleaning purposes; unworked or semi-worked glass, except building glass; glassware, porcelain and earthenware.

25 – Clothing, footwear, headwear.

(260) AM 2021 112428 A

(800) 1583552

(151) 2021 01 22

(891) 2021 01 22

(731) ZHEJIANG GEELY HOLDING GROUP CO.,  
LTD.1760 Jiangling Road, Binjiang District,  
Hangzhou, Zhejiang, China



(540)

# aurobay

(591) Black, white  
(531) 27.05.01; 27.05.17  
(511)

9 – Smartphone software applications, downloadable; computer software applications, downloadable; navigation apparatus for vehicles [on-board computers]; audio- and video-receivers; measuring instruments; electronic control units for automobile; car batteries; simulators for the steering and control of vehicles; electronic key fobs being remote control apparatus; integrated circuits.

12 – Speed change gears for land vehicles; gear boxes for land vehicles; automobile engines; engines for land vehicles; motors, electric, for land vehicles; cars; electric vehicles; vehicles for locomotion by land, air, water or rail; upholstery for vehicles; clutches for land vehicles; torque converters for land vehicles; self-balancing electric scooters; propulsion mechanisms for land vehicles; couplings for land vehicles.

37 – Motor vehicle maintenance and repair; vehicle battery replacement service; vehicle breakdown repair services; vehicle greasing; vehicle battery charging; anti-rust treatment for vehicles; vehicle washing; re-reading of tires; vehicle service stations [refueling and maintenance]; reconditioning of automobiles.

(260) AM 2021 112429 A  
(800) 1583566  
(151) 2021 02 04  
(891) 2021 02 04  
(731) SOLEPHARM PHARMACEUTICALS, SIA  
Alkšņu iela 4, Jaunmārupe, LV-2166  
Mārupes nov., Latvia  
(540)

## SOLEFARIN

(591) Black, white  
(511)  
5 – Pharmaceuticals, medical and veterinary preparations.

(260) AM 2021 112430 A  
(800) 1583576  
(151) 2021 02 03  
(891) 2021 02 03  
(731) Siemens Healthcare GmbH  
Henkestraße 127, 91052 Erlangen,  
Germany  
(540)

## MAGNETOM Free

(591) Black, white

(511)

10 – Medical instruments and apparatus and parts therefor, in particular magnetic resonance imaging devices.

(260) AM 2021 112431 A  
(800) 1583594  
(151) 2021 01 25  
(891) 2021 01 25  
(731) E. REMY MARTIN & C°  
20 rue de la Société Vinicole, F-16100 Cognac,  
France  
(540)



(591) Black, white  
(531) 03.01.02; 05.05.02; 05.05.20; 19.07.01;  
19.07.12; 24.07.01; 24.07.23; 27.05.01;  
29.01.15  
(511) 33 – Alcoholic beverages, except beers.

(260) AM 2021 112432 A  
(800) 1583615  
(151) 2020 11 23  
(891) 2020 11 23  
(731) RIKHAB CHAND JAIN  
878a, master prithvi nath marg, karol bagh,  
delhi 110005, India  
(540)

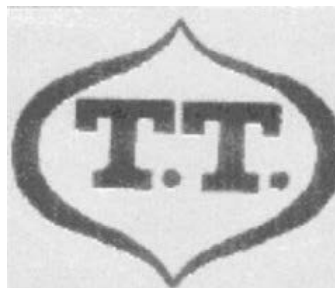

(591) Black, white  
(531) 26.13.25; 27.05.01; 27.05.23  
(511)  
25 – Clothing, footwear.



(260) AM 2021 112433 A

(800) 1583671

(151) 2020 10 22

(891) 2020 10 22

(731) Apple Inc.

One Apple Park Way, Cupertino CA 95014,  
USA

(540)



(591) Black, white

(531) 05.07.13; 05.07.23; 27.05.01

(511)

35 – Retail store and online retail store services featuring bundled subscription packages to online digital content and media services comprised of a music subscription service, a video-on-demand subscription service, a computer game subscription service, an electronic publication subscription service, a fitness streaming subscription service, and a personal file data storage subscription service; subscription services, namely, arranging subscriptions to text, data, image, audio, video, and multimedia content, provided via the Internet and other electronic and communications networks; subscription services, namely, arranging subscriptions to text, data, image, audio, video, and multimedia content, provided via the Internet and other electronic and communications networks, namely, arranging bundled entertainment subscription packages comprised of an online music subscription service, a video-on-demand subscription service, a computer game subscription service, an electronic publication subscription service, and a fitness streaming subscription service; arranging subscriptions to downloadable pre-recorded text, data, image, audio, video, and multimedia content for a fee or pre-paid subscription, via the Internet and other electronic and communications networks.

42 – Electronic data storage for a fee or pre-paid subscription; providing online non-downloadable software for use in connection with accessing, delivering, purchasing, and sharing bundled subscription packages to online digital content and media services comprised of a music subscription service, a video-on-demand subscription service, a computer game subscription service, an electronic publication subscription service, a fitness subscription service, an electronic publication subscription service, a fitness streaming subscription service, and a personal file data storage subscription service via a fee or pre-paid subscription; hosting an Internet portal allowing users to preview and download electronic books, publications, and other documents as part of a fee or pre-paid subscription.

(260) AM 2021 112434 A

(800) 1583737

(151) 2021 02 12

(891) 2021 02 12

(731) MYR GmbH

Eiermarkt 3c, 30938 Burgwedel, Germany

(540)



HEPCLUDEX

(591) Grey and white

(531) 26.01.03; 26.01.07; 26.01.08; 26.01.18;

27.05.01; 27.05.02; 27.05.09; 27.05.10

(511)

5 – Pharmaceutical and veterinary preparations; biological preparations for medical purposes; biological preparations for veterinary purposes; biochemical preparations for medical purposes; biochemical preparations for veterinary purposes; chemical preparations for medical purposes; chemical preparations for veterinary purposes; medicines for human purposes; medicines for veterinary purposes; pharmaceutical preparations for hepatic diseases or disorders; pharmaceutical preparations for hepatitis B; pharmaceutical preparations for hepatitis D; pharmaceutical preparations for dyslipidemia; pharmaceutical preparations for non-alcoholic steatohepatitis (NASH); pharmaceutical preparations for primary biliary cholangitis (PBC); pharmaceutical preparations for inflammatory diseases; pharmaceutical preparations for inflammatory diseases inhibiting sodium-taurocholate co-transporting polypeptide (NTCP); pharmaceutical preparations for metabolic diseases; and pharmaceutical preparations for metabolic diseases inhibiting sodium-taurocholate co transporting polypeptide (NTCP).

(260) AM 2021 112527 A

(800) 1584996

(151) 2020 12 17

(891) 2020 12 17

(731) Jose Bay e.U.

DC Tower, Donau-City-Straße 7/20.Stock,  
A-1220 Wien, Austria

(540)

## Jobchain

(591) Black, white

(511)

35 – Business analysis, research and information services; business assistance, management and administrative services; advertising, marketing and promotional services; analysis of business data; analysis of business information; analysis of business trends; analysis of marketing trends; analysis of business statistics; preparation of cost-price analyzes; information on commercial matters; information relating to fo-

reign trade; information relating to business matters; information relating to business statistics; information relating to commercial matters; information relating to joint ventures; information relating to the movement of goods; business and commercial information; business information relating to franchising; business information from a computer database or the internet; business information by means of computer terminals; business information via a global computer network or the internet; business information, including via the internet, the cable network or other forms of data transmission; commercial and business information [marketing or demographic information]; commercial information via the internet; commercial information; commercial and business information; business information or research and marketing; business information via computer databases; management information; business information inquiries in the field of social media; information on business statistics; information on commercial transactions; information on market statistics; online business and commercial information; information on the movement of goods; commercial and business information services; information on foreign trade; providing information in relation to business matters; business inquiries and inquiries; information and preparation of expert reports on companies and businesses; economic information for business purposes; evaluation of company statistics; benchmarking [business comparison services]; advice relating to business analysis; business advice and investigations; providing online comparisons of financial services; providing a directory of the websites of others for the facilitation of business transactions; providing business data in the form of mailing lists; providing business information via a web site; provision of statistical business information; provision of business related trade and business information; business evaluations and analyzes; computerized business information services; business evaluation of business opportunities; professional assessments in relation to business matters; evaluation of business opportunities with regard to business matters; business research; valuation of companies; business reviews of industrial establishments; business reviews of professional establishments; business evaluations for commercial establishments; computerized information relating to business management; computerized information on the evaluation of business options; computerized business information; computerized business research; statistical analysis and reporting services for business purposes; conducting business surveys; conducting online business management research; implementation of project studies for companies; conducting business studies; implementation of business project studies for companies; conducting statistical business studies; development and coordination of volunteer projects for charities; development of business feasibility studies; developing public opinion polls; preparation and compilation of business and com-

mercial reports and information; business investigations; preparation of business analyzes; cost-benefit analysis; preparation of market reports and studies; expert opinions relating to business matters; preparation of studies on internal corporate communication; creation of business feasibility studies; compilation of computerized business statistics; preparation of statistical business studies; preparation of strategic business analyzes; creation of sales analyzes; preparation of profitability studies related to companies; economic analysis for business purposes; preparation of economic studies for business purposes; creation of statistical company analyzes; preparation of reports for economic purposes; preparation of business surveys; preparation of cost analyzes; preparation of market reports and market studies; preparation of price offers for goods or services; creation of corporate project studies; economic forecasting and analysis for business purposes; preparation of business project studies; economic forecasting for business purposes; preparation of economic forecasts; providing information in the field of time management; providing of information relating to business matters; providing information relating to the comparison of hotel prices; providing of commercial and business information from online databases; providing information about goods for consumers via the internet; providing an on-line commercial information directory on the internet; providing business information directory services, via a global computer network; providing information relating to the updating and maintenance of data in databases; providing market information [information] in relation to index levels; providing market information in relation to trade reports; business statistical information relating to medical matters; provision of information on foreign trade; providing of business information; commercial information agency services; provision of information on commercial and business matters through agencies; commercial information for consumers; providing information on commercial matters; providing consumer product information relating to software; evaluation of business opportunities from a business perspective; business market research; business analysis services; annual report preparation; management analysis; business profit analysis; business information for companies; business information by means of global computer networks; business information services through agencies; business information; business information through the provision of computerized data; information and advice for consumers on the selection of products to buy; business record information through the provision of computerized data; information about the ranking of product sales; information and advisory services relating to tariffs; cost price analysis regarding waste disposal, removal, handling and recycling; marketing research; health care cost review; cost estimate [help with the management]; market research of new businesses; market research in commercial matters; mar-

ket research and business analysis; market research services; market studies; business research and information; business research and expertise; collection and systematization of business data; business research services; price analysis services; product sales information; business research; news clipping services; business analysis service; business appraisals; support and advice on company analysis; valuation for business purposes; appraisals in the business area; business appraisals; economic forecasting and analysis; compilation of business data; providing on-line commercial directory information services; compilation and analysis of information and data relating to business management; compilation and provision of price and statistical information from trade and industry; executive recruitment services; recruitment of temporary personnel; conducting personality tests for recruitment purposes; administrative data processing; conclusion and mediation of commercial transactions for others; administrative services relating to employer-sponsored health care plans; administrative services relating to employee benefits; administrative services relating to the placement of insurance agents; administrative services for medical referrals; administrative assistance in responding to calls for tenders; agency services for organizing business introductions; acquisition in business matters; updating and maintenance of information in registries; recruiting services from a model agency; business inquiries; outsourcing services in the nature of customer relationship management; outsourcing services in the field of business operations; outsourcing services in the nature of arranging service contracts for others; advice on preparing market reports; advice on the management of industrial companies, including the preparation of cost / income analyzes; business management advice relating to recruitment; advising the management on questions of personnel deployment; advice relating to business relocation; consultancy relating to search engine optimization; business advice and information; advisory services relating to business planning; consultancy services relating to the management of telephone call centers; providing user rankings for commercial or advertising purposes; providing user reviews for commercial or advertising purposes; inventory management services; operational planning within the framework of business consulting; operations and business management; auditing services; operations management; business assistance services; business assistance in setting up franchise companies; professional business assistance in the operation of franchise companies; business project management services for construction projects; business management of reimbursement programs for others; accounting for companies; office functions; office services; computerized secretarial services; services in the field of joint ventures [business consultancy]; office function services; business networking services; business establishment services [business consultancy]; econo-

mic consultancy services for businesses; business performance consultancy services; business management services rendered by theater agencies; implementation of corporate relocations; business inquiries; development of corporate strategies [business consulting]; development of concepts for the management of hospitals; development of corporate strategies; creation of auditory and visual product presentations for companies [marketing]; preparation of reports on company projects; preparation of business reports; business efficiency expert services; preparation of transport documents for third parties [office work]; preparation of annual financial statements for companies; preparation of market reports; creation of business documents; preparation of project studies relating to business matters; preparation of economic reports; running a company [for third parties]; business record keeping services; business documentation for others; business management services; management in the development of business areas; management of a vehicle fleet for others; management of an airline; management for authors and writers; business management for visitor attractions; business management, including marketing advice on demographic issues; management of shopping centers for others; business management for airlines; business management for soccer players; business management for shops; management for trading and service companies; business management for freelance service providers; business management of performing artists; business management of sports people; business management for actors; management for professional athletes; business management of car parking facilities; business management for musicians; management for models; business management for sports clubs; management for veterinary practices; business management for entertainers; business management for entertainment venues; business management for companies; management for insurance agencies and insurance brokers as an outsourced service; business management with regard to the procurement of orders; business management in the field of transport and delivery services; business management of hotels for others; business management relating to corporate takeovers; business management services relating to electronic commerce; business management and administration services; business management and business advisory services; airport management; management of retail stores; wholesale and retail business management; wholesale business management; management of trading companies [for third parties]; management of hotel resorts; business administration of hotels; business management of hotels; management of clinics for others; management of conference centers; management of hospitals; business management of restaurants; management of swimming pools; management of sports facilities [for third parties]; management of petrol stations [for third parties]; management of theaters; business management services; business contact brokerage; bu-

business planning and business strategy services [business consulting]; business planning; business project management; business audit services; business strategy and business planning services [business consulting]; business administration services relating to the processing of sales made on the internet; information and advice on the organization and management of companies; business information and advice; information on sales methods; interim business management; career networking services; commercial business support services; commercial management services; commercial administration of the licensing of the goods and services of others; commercial project management; life cycle costing for business purposes; business management for others; business project management for others; business process management and consultancy relating thereto; supply chain management services; market intelligence services; market information services; model booking services; business process redesign; online business networking services; operational business support for companies; organization and conducting of business meetings; organization of presentations for business purposes; human resource management and recruitment; organizational management; outsourced administrative management for companies; outsourcing services [business assistance]; recruitment and personnel management services; business succession planning as part of business consulting; planning of business appointments; strategic business planning; planning in the management of companies; planning in relation to business management, namely the search for business partners for mergers and acquisitions and for business start-ups; registration of written communications and data; registration of vehicle registrations and transfers of ownership; business planning services; business consulting; transcriptions in the medical field; business advice on business risks; business advice and organization relating to the introduction of new products; business advice and planning of marketing activities; corporate management [for third parties]; corporate governance planning; supervision of the management; corporate strategy planning; surveillance of business; monitoring sales volumes for others; business administration services; business administration services in the field of healthcare; business administration services in the field of transportation; mediation of business contacts; negotiation and conclusion of commercial transactions for third parties; arranging and handling of commercial transactions, for others, via telecommunication systems; negotiation of commercial transactions for performing artists as part of the management for artists; negotiation of advertising contracts; negotiating contracts with health care providers; negotiation of contracts for the purchase and sale of goods; negotiation of contracts through literary agents; negotiation of business contracts for others; negotiation and settlement of commercial transactions for others; business administration in the field of

transport and delivery; business administration of trading companies; mediation of commercial transactions; arranging commercial transactions for others; arranging of contact information in commercial and business matters; arranging contracts for the buying and selling of goods; commercial intermediation services; contract negotiations for commercial transactions for third parties [management]; administration of the business affairs of retail stores; management of the business affairs of franchise companies; administration of professional competence tests; administration of foreign business interests by a chamber of commerce to promote trade; management of professional, professional certificates; administration of foreign business interests by a chamber of commerce to promote commerce; administration for employee participation systems; administration for business appraisal; administration relating to business planning; management of employee retirement plans; administration of drug reimbursement programs and services; management of foreign business; management of exchange programs in the field of culture and education; administration of reimbursement programs for patients; management of business offices for others; business process management; commercial management; management of outpatient clinics; administration of business affairs; administration of hospitals; administrative services relating to hospital referrals; administrative services relating to the placement of general contractors; administrative services relating to medical expenses; administrative services relating to online registration for academic courses; administrative services relating to courses at academic institutions; administrative services relating to residential property investments; management of competitions for advertising purposes; business administration; management of employee benefit plans; management of plans with statutory health insurance physicians; management of marketing activities; management of company payrolls for others; management of customer business relationships; management of membership programs; competitive intelligence services; administrative services relating to customs clearance; compilation of methods for compiling business statistics; provision of commercial and business contact information via the internet; conducting online auctions; rental of advertising space on-line; on-line advertising on computer communication networks; online advertising on a computer network; bookkeeping for pension funds.

---

(260) AM 2021 112528 A

(800) 1584998

(151) 2021 01 13

(891) 2021 01 13

(731) GEOX S.P.A.

Via Feltrino Centro 16, I-31044

MONTEBELLUNA FRAZIONE BIADENE

(TV), Italy

(540)

**SPHERICA**

(591) Black, white

(511)

25 – Clothing, footwear, headgear; coats; overcoats; jackets [clothing]; heavy jackets; blousons; blazers; cardigans; dresses; combinations [clothing]; sweat-shirts; belts [clothing]; ready-made linings [parts of clothing]; heelpieces for footwear; tips for footwear; welts for footwear; shoe straps; protective metal members for shoes and boots; inner soles; non-slip-ping devices for footwear; shoe inserts for non-ortho-pedic purposes; footwear uppers; waterproof clothing; clothing of imitations of leather; clothing of leather; motorists' clothing; cyclists' clothing; clothing for gymnastics; suits; jumper dresses; berets; galoshes; skull caps; boots for sports; stockings; socks; breeches for wear; hats; belts [clothing]; money belts [clothing]; fittings of metal for footwear; boot uppers; stuff jackets [clothing]; mittens; ready-made clothing; knit-wear [clothing]; jerseys [clothing]; pelerines; slippers; parkas; pelisses; ponchos; heelpieces for stockings; sandals; bath sandals; shoes; esparto shoes or sandals; bath shoes; gymnastic shoes; beach shoes; football shoes; sports shoes; ski boots; neck scarves [muff-lers]; trouser straps; half-boots; boots; fur stoles; soles for footwear; heels; gloves [clothing].

260) AM 2021 112530 A

(800) 1585043

(151) 2020 12 21

(891) 2020 12 21

(731) AmerisourceBergen Services Corporation  
1300 Morris Drive, Chesterbrook PA 19087,  
USA

(540)



(591) Black, white

(531) 27.05.22

(511)

35 – Wholesale distributorship services in the field of pharmaceuticals, medical and healthcare products; wholesale services connected with the sale of pharmaceutical, medical and healthcare products; wholesale distributorship services in the field of specialty pharmaceutical products, namely, disease specific pharmaceuticals; wholesale services connected with the sale of specialty pharmaceutical products, namely, disease specific pharmaceuticals; wholesale distributorship services featuring specialty healthcare products in the

nature of pharmaceuticals and chemotherapeutics supplied in accordance with specially developed protocols to health-care providers and their patients; wholesale services connected with the sale of specialty healthcare products in the nature of pharmaceuticals and chemotherapeutics supplied in accordance with specially developed protocols to health-care providers and their patients; mail order retail services featuring pharmaceutical and biotechnological products; wholesale distributorship services in the field of animal health and veterinary products; wholesale distributorship services in the field of veterinary supplies featuring animal care and grooming products, animal nutritional supplements and medication; wholesale services connected with the sale of animal health and veterinary products; wholesale services connected with the sale of veterinary supplies featuring animal care and grooming products, animal nutritional supplements and medication; business consulting in the field of development and commercialization of biotechnological products; business consulting in the field of veterinary practice management; business consulting in the field of livestock management; business consulting services in the field of pharmaceuticals and other healthcare technologies, including the application of analytical and statistical methodology to the study of healthcare products and their impact on the overall healthcare market; advertising and marketing services in the field of healthcare products and services; cost containment in the field of healthcare providers and pharmacies relating to containing drug acquisition costs and recovering allowable reimbursement; business management consulting services in the field of pharmaceutical and healthcare products and services; business management consulting services in the field of pharmaceutical and healthcare product manufacturing, distribution, and logistics, namely, analyzing data about product inventory and sales, managing formularies, and marketing such products; healthcare business administration services in the healthcare field for pharmaceutical, biotechnology and medical device suppliers, namely, business consulting services in the cost and payment management of health care cost containment services, namely, providing expedited review, processing and follow-up of prior authorization requests initiated by physicians' offices and pharmacies, providing group purchasing of pharmaceuticals and chemotherapeutics for community-based providers including oncologists and oncology practices, business consulting services in the field of reimbursement for medical services rendered; conducting market research surveys in the field of healthcare costs and delivery cooperative advertising and marketing in the field of biotechnological products; providing information from an online non-downloadable database featuring information about consumer product sales at retail locations, about wholesale product sales to outlets, and about inventories of health-care products for use by commercial entities; retail pharmacy services

featuring specialty pharmaceuticals and chemotherapeutics; temporary staffing for pharmacies, namely, providing, recruiting, retaining pharmacy personnel, and interim business managing of pharmacy operational and clinical functions; administration of a group purchasing and customer loyalty program for enabling participants to obtain unique benefits and perks in the nature of discounts on the costs of goods and services through use of a membership program to promote veterinary pharmaceuticals and services; providing business support staff services to manufacturers of pharmaceuticals; business management of customs brokers; administrative services, namely, tracking and monitoring import agency compliance for business purposes; administrative services relating to customs clearance.

36 – Financial management of reimbursement programs for healthcare providers and pharmacies relating to containing drug acquisition costs; providing counseling in the field of insurance coverage; customs brokerage; customs bonding, namely, issuance of importer bonds; processing of payment transactions relating to payment and return of customs duties.

39 – Courier services featuring storage, transport, and delivery of high-value, time-critical, ambient condition-sensitive, goods to professional and commercial users, namely, storage, transport, and delivery of investigational drugs, patient samples, and supplies used to conduct clinical trials, medicines and critical consumables for hospitals, clinics, research organizations, and physician practices, and critical parts and equipment for manufacturing, maintenance, and repair in the fields of aviation, automotive, oil and gas, and high tech; computerized tracking and tracing of documents, packages and freight in transit to ensure on-time delivery for business purposes.

(260) AM 2021 112532 A  
(800) 1585100  
(151) 2021 01 15  
(891) 2021 01 15  
(731) Apple Inc.  
One Apple Park Way, Cupertino CA 95014,  
USA  
(540)



(591) Red and white  
(531) 24.17.10; 26.04.04; 29.01.12  
(554) მოცულობითი

(511)  
38 – Broadcasting and transmission of voice, data, images, music, audio, video, multimedia, television, and radio by means of telecommunications networks; broadcasting and transmission of radio and television programs; presentation services, namely, broadcasting of radio programs, television programs and sound recordings; streaming of audio material, namely, music, via the internet; broadcasting and streaming subscription radio program featuring music.

41 – Entertainment services, namely, providing non-downloadable prerecorded audio and audiovisual content, information and commentary in the fields of music, concerts, videos, movies, television, and cultural events all online via a global computer network; providing radio, internet, and satellite music programming by means of telecommunications networks, computer networks, the Internet, satellite, radio, and wireless communication networks; arranging, organizing, conducting, and presenting concerts, live musical performances, entertainment special events in the nature of musical and cultural events; production and distribution of radio programs and sound recordings; entertainment services, namely, providing ongoing radio, audio programs, video programs, podcasts, and webcast programs in the field of entertainment; entertainment services, namely, providing streamed and non-downloadable audio and video content to users through a subscription service provided online via a communication network; providing non-downloadable audio and video programming featuring music.

(260) AM 2021 112534 A  
(800) 1585153  
(151) 2020 12 11  
(891) 2020 12 11  
(731) URSA Salgótarján Glass Wool Close Co., Ltd.  
Szépvölgyi út 41, 2/2, H-1037 Budapest,  
Hungary  
(540)



(591) Blue and red  
(531) 03.01.14; 03.01.24; 03.01.26; 26.11.02;  
26.11.08; 27.05.10; 29.01.12  
(511)  
17 – Insulating, soundproofing and stopping materials; fabrics, webs, plates, panels and sheets made from insulation material; materials for padding (stuffing) of cavities; mineral wool, glass wool, stone wool, rock wool, slag wool and fiber glass for thermal or

acoustic insulation; glass fibers for insulation; blow wool, glass wool blankets and panels for building insulation; plastic insulation materials, especially foamed plastic materials; insulation boards, made from polystyrene, especially made from extruded polystyrene; extruded polythene sheeting of high light transmission [other than for packaging]; plastic film, other than for packaging purposes; substances for insulating buildings against moisture; sealant compounds for joints; insulating paper, insulating tape and band, rubber, gutta-percha, gum, asbestos, mica; plastics in extruded form for use in manufacture; packing materials of rubber or plastics and flexible pipes, not of metal; membranes and other materials for air tightness and vapor barriers (membrane for moisture protection); insulating adhesives; insulating material for buildings and glass mineral wool for insulation purposes together with the respective fixing material for fastening the insulation material and mineral wool to the building; composite structures containing insulation material, waterproof claddings and mounting devices (bars and fillets, clips, glues and tapes) for attaching components of the composite structure to walls, for use in building and construction; panels and sheets of mineral fibers (especially fiber glass) for buildings.

19 – Building materials (non-metallic); ducts for air conditioning, not of metal; woven materials (non-metallic) for use in buildings; non-metallic rigid pipes for building; asphalt, pitch and bitumen; non-metallic transportable buildings; monuments, not of metal.

(260) AM 2021 112556 A

(800) 1585595

(151) 2020 01 21

(891) 2020 01 21

(731) "Trading house MEGA TOYS" Limited  
Liability Company  
Mikhailovsky sh., 31, Belgorod city,  
RU-308000 Belgorod region, Russian  
Federation

(540)



(591) White, dark gray, gray, light gray, black and red

(531) 03.01.15; 18.01.09; 27.03.03; 28.05; 29.01.14

(526) TOYS

(511)

28 – Amusement machines, automatic and coin-operated; apparatus for games; appliances for gymnastics;

arcade video game machines; archery implements; artificial fishing bait; artificial snow for Christmas trees; ascenders [mountaineering equipment]; baby gyms; backgammon games; bags especially designed for skis and surfboards; ball pitching machines; balls for games; bar-bells; baseball gloves; batting gloves [accessories for games]; bells for Christmas trees; billiard balls; billiard cue tips; billiard cues; billiard markers; billiard table cushions; billiard tables; bingo cards; bite indicators [fishing tackle]; bite sensors [fishing tackle]; bladders of balls for games; board games; bob-sleighs; bodyboards; body-building apparatus; boomerangs; bowling apparatus and machinery; bows for archery; boxing gloves; building blocks [toys]; building games; butterfly nets; camouflage screens [sports articles]; candle holders for Christmas trees; caps for pistols [toys]; carnival masks; chalk for billiard cues; checkerboards; checkers [games]; chess games; chessboards; chest expanders [exercisers]; Christmas crackers [party novelties]; Christmas tree stands; Christmas trees of synthetic material; clay pigeon traps; clay pigeons [targets]; climbers' harness; coin-operated billiard tables; confetti; conjuring apparatus; controllers for game consoles; controllers for toys; counters [discs] for games; creels [fishing traps]; cricket bags; cups for dice; darts; decoys for hunting or fishing; dice; discuses for sports; divot repair tools [golf accessories]; dolls; dolls' beds; dolls' clothes; dolls' feeding bottles; dolls' houses; dolls' rooms; dominoes; drones [toys]; dumb-bells; edges of skis; elbow guards [sports articles]; electronic targets; fairground ride apparatus; fencing gauntlets; fencing masks; fencing weapons; fish hooks; fishing lines; fishing tackle; flippers for diving; flippers for swimming; floats for fishing; flying discs [toys]; football tables; games; gloves for games; golf bag carts; golf bags, with or without wheels; golf clubs; golf gloves; gut for fishing; gut for rackets; gyroscopes and flight stabilizers for model aircraft; hand-held consoles for playing video games; hang gliders; harness for sailboards; harpoon guns [sports articles]; hockey sticks; horseshoe games; hunting game calls; ice skates; inflatable games for swimming pools; in-line roller skates; jigsaw puzzles; joysticks for video games; kaleidoscopes; kite reels; kites; knee guards [sports articles]; landing nets for anglers; machines for physical exercises; mah-jong; marbles for games; masks [playthings]; masts for sailboards; matryoshka dolls; men's athletic supporters [sports articles]; needles for pumps for inflating balls for games; nets for sports; novelty toys for parties; novelty toys for playing jokes; ornaments for Christmas trees, except lights, candles and confectionery; pachinkos; paddleboards; paintball guns [sports apparatus]; paintballs [ammunition for paintball guns] [sports apparatus]; paper party hats; paragliders; parlor games; party poppers [party novelties]; percussion caps [toys]; pinatas; play balloons; play tents; playing balls; playing cards; plush toys; plush toys with attached comfort blanket; poles for



pole vaulting; portable games with liquid crystal displays; protective films adapted for screens for portable games; protective paddings [parts of sports suits]; pumps specially adapted for use with balls for games; punching bags; puppets; quoits; rackets; rattles [playthings]; reels for fishing; remote-controlled toy vehicles; rhythmic gymnastics ribbons; ring games; rocking horses; rods for fishing; roller skates; roller skis; rollers for stationary exercise bicycles; rosin used by athletes; sailboards; scale model kits [toys]; scale model vehicles; scent lures for hunting or fishing; scooters [toys]; scratch cards for playing lottery games; seal skins [coverings for skis]; shin guards [sports articles]; shuttlecocks; skateboards; skating boots with skates attached; ski bindings; ski sticks; ski sticks for roller skis; skis; skittles; skittles [games]; sleds [sports articles]; slides [playthings]; sling shots [sports articles]; snow globes; snowboards; snowshoes; soap bubbles [toys]; sole coverings for skis; spinning tops [toys]; spring boards [sports articles]; starting blocks for sports; stationary exercise bicycles; strings for rackets; stuffed toys; surf skis; surfboard leashes; surfboards; swimming belts; swimming jackets; swimming kickboards; swimming pool air floats; swimming pools [play articles]; swimming webs; swings; tables for table tennis; targets; teddy bears; tennis ball throwing apparatus; tennis nets; theatrical masks; toy air pistols; toy dough; toy figures; toy imitation cosmetics; toy mobiles; toy models; toy pistols; toy putty; toy robots; toy vehicles; toys; toys for pets; trading cards for games; tricycles for infants [toys]; twirling batons; video game consoles; video game machines; waist trimmer exercise belts; water wings; waterskis; weight lifting belts [sports articles]; yoga swings.

(260) AM 2021 112642 A

(800) 1586479

(151) 2020 12 29

(891) 2020 12 29

(731) BETEK BOYA VE KİMYA SANAYİ

ANONİM ŞİRKETİ

Zümrütevler Mah. Ural Sok. No:38, Maltepe,

TR-34852 İSTANBUL, Turkey

(540)

# Aqusto

(591) Black, white

(531) 27.05.01; 27.05.17

(511)

2 – Paints, varnishes, lacquers, preservatives against rust, preservatives against deterioration of wood, thinners and binders for paints, pigments, preservatives for metals, shoe dyes, printing dyes and ink, toners (including filled toner cartridges), colorants for food, pharmaceuticals and beverages; raw natural resins;

metals in foil and powder form for painters, decorators, printers and artists.

(260) AM 2021 112650 A

(800) 1586652

(151) 2020 12 21

(891) 2020 12 21

(731) Hebei Wuyi Import and Export Corporation

No.98, Wenchang street, Ningwu Road,

Circular, Economy Park, Wuyi, Hengshui,

Hebei, China

(540)



(591) Black, white

(531) 03.01.04; 26.01.04; 26.01.15; 26.01.18; 28.03

(511)

6 – Safety cashboxes; safes [strong boxes]; chests of metal for food; safes, electronic.

20 – Metal cabinet; filing cabinets; display stands.

(260) AM 2021 112745 A

(800) 1587307

(151) 2020 08 10

(891) 2020 08 10

(731) Huzhou Guoneng New Material Co., Ltd.

4th Floor, Building 1, 1518 Mengxi Road,

Huzhou City, Zhejiang Province, China

(540)

# VISBELLA

(591) Black, white

(531) 26.03.23; 27.05.01; 27.05.07

(511)

3 – Stain removers; rust removing preparations; silicon detergent; grinding preparations; polishing preparations; polishing wax; degreasers other than for use in manufacturing processes; cleaning preparations; oils for cleaning purposes; leather detergent; bleaching preparations.

5 – Antibacterial handwashes; sterilizing preparations; disinfectants for hygiene purposes; disinfectants; medicinal alcohol; disinfectants for chemical toilets; deodoratives; disinfectant wipes; germicides.



(260) AM 2021 112784 A  
 (800) 1587953  
 (151) 2020 11 26  
 (891) 2020 11 26  
 (731) Egis Gyógyszergyár Zrt.  
 Keresztúri út 30-38., H-1106 Budapest,  
 Hungary  
 (540)

## MOLAMITUM

(591) Black, white  
 (511)  
 3 – Cosmetics and cosmetic preparations.  
 5 – Human pharmaceutical preparations; dietetic substances adapted for medical use; dietary supplements; medicinal ointments; medicated skin creams; plasters, materials for dressings.

(260) AM 2021 112804 A  
 (800) 1588380  
 (151) 2020 12 11  
 (891) 2020 12 11  
 (731) Open-Type Joint Stock Company  
 "ROT FRONT"  
 2-oy Novokuznetskiy pereulok, d. 13/15,  
 RU-115184 Moscow, Russian Federation  
 (540)



(591) White, green-blue, dark red and dark pink  
 (531) 19.03.24; 26.11.09; 27.05.02; 29.01.12  
 (526) Cranberry&Mint  
 (511)  
 30 – High-protein cereal bars; pancakes; buns; bread rolls; waffles; malt biscuits; cake frosting [icing]; artificial coffee; fruit jellies [confectionery]; confectionery for decorating Christmas trees; cakes; pastries; peanut confectionery; almond confectionery; frozen yogurt [confectionery ices]; caramels [sweets]; sweets; liquorice [confectionery]; peppermint sweets; crackers; ice cream; dessert mousses [confectionery]; muesli; mint for confectionery; coffee-based beverages; tea-based beverages; pastilles [confectionery]; cookies; petit-beurre biscuits; pies; fondants [confectionery]; gingerbread; puddings; chewing gum; cake dough; confectionery; tarts; halvah; chocolate.

(260) AM 2021 112805 A  
 (800) 1588390  
 (151) 2021 02 26  
 (891) 2021 02 26  
 (731) HUONS GLOBAL CO., LTD.  
 C-901, 253, Pangyo-ro, Bundang-gu,  
 Seongnam-si, Gyeonggi-do, Republic  
 of Korea  
 (540)

## HUONS

(591) Black, white  
 (511)  
 5 – Food for babies; milk sugar for medical purposes [lactose]; pharmaceutical agents affecting sensory organs; pharmaceutical products for the treatment of infectious diseases; pharmaceutical preparations for the treatment of Musculo-skeletal disorders; pharmaceutical agents affecting metabolism; anaesthetics; vaccines; pharmaceutical preparations for treating dandruff; vitamin preparations; sterilising preparations; pharmaceutical preparations for wounds; anti-inflammatory preparations; pharmaceutical agents affecting digestive organs; cardiovascular pharmaceutical preparations; ophthalmologic preparations; ferments for pharmaceutical purposes; nutritional supplements; disinfectants for hygiene purposes; chemical reagents for medical or veterinary purposes; dietetic beverages adapted for medical purposes; medical diagnostic reagents; hormones for medical purposes; enzymes for medical purposes; pharmaceutical preparations acting on the central nervous system; pharmaceutical preparations for the treatment of immune system related diseases and disorders; medical preparations for slimming purposes; medicines for dental purposes; pain relief medication; pharmaceutical preparations for use in dermatology; anti-diabetic pharmaceuticals; antibiotics; antiallergic medicines; tumor suppressing agents; febrifuges; pharmaceutical preparations for the treatment of hormonal disorders; pharmaceutical products for treating respiratory diseases; mineral food supplements; dietetic foods adapted for medical purposes; bacterial preparations for medical purposes; implants comprising living tissue; test strips for measuring blood glucose levels; antiseptic cotton; materials for dental fillings; adult diapers; biological tissue cultures for medical purposes.

10 – Heartbeat measuring apparatus; genetic testing apparatus for medical purposes; devices for measuring blood sugar; arterial blood pressure measuring apparatus; blood testing apparatus; anaesthetic apparatus; surgical apparatus and instruments; endoscopic equipment for medical purposes; lithotripters; medical apparatus for introducing pharmaceutical preparations into the human body; injection device for pharmaceuticals; needles for medical purposes; body rehabilitation apparatus for medical purposes; syringes for injections; ultrasonic therapy apparatus; endoprostheses; surgical apparatus and instruments for medical use;

massaging apparatus for personal use; surgical apparatus and instruments for dental use; filling instruments for dental purposes; contraceptive apparatus; kinesiology tapes; electric massage apparatus for household use; clothing especially for operating rooms; gloves for medical purposes; respiratory masks for medical purposes; medical apparatus and instruments; medical skin care apparatus; diagnostic apparatus for medical purposes.

35 – Advertising; advertising relating to pharmaceutical products and in-vivo imaging products; advice concerning chemical product marketing; management of health care clinics for others; marketing research in the fields of cosmetics, perfumery and beauty products; updating and maintenance of data in computer databases; import-export agency services; administrative processing of purchase orders; wholesale store services featuring cosmetics; wholesale store services featuring pharmaceutical preparations for use in dermatology; wholesale store services featuring injection device for pharmaceuticals; wholesale store services featuring make-up brushes; wholesale store services featuring cosmetic bottles sold empty; wholesale store services featuring vitamin preparations; wholesale store services featuring energy drinks; wholesale store services featuring medical apparatus and instruments; wholesale store services featuring high-protein cereal bars; wholesale store services featuring medicines for human purposes; wholesale store services featuring dietetic foods adapted for medical purposes; business administration services in the field of healthcare; wholesale store services featuring protein milk.

43 – Services for providing food and beverages; temporary accommodation.

(260) AM 2021 112806 A

(800) 1588396

(151) 2021 03 01

(891) 2021 03 01

(731) Heli-Guides AG

Kreuzlingerstrasse 5, CH-8574 Lengwil,  
Switzerland

(540)



(591) Black, white

(531) 06.01.02; 18.05.01; 27.05.10

(511)

35 – Advertising; commercial business management; commercial administration; office functions.

39 – Transport; packaging and storage of merchandise; travel organization.

41 – Education; training; entertainment; sporting and cultural activities.

---

**INTERNATIONAL TRADEMARKS PROTECTED IN GEORGIA**

(260) AM 2021 106618 A  
(800) 1508850  
(151) 2019 12 02  
(181) 2029 12 02  
(891) 2019 12 02  
(511) 09, 09, 35

---

(260) AM 2021 107246 A  
(800) 1515900  
(151) 2019 10 17  
(181) 2029 10 17  
(891) 2019 10 17  
(511) 09, 36

---

(260) AM 2021 107253 A  
(800) 1516155  
(151) 2019 10 17  
(181) 2029 10 17  
(891) 2019 10 17  
(511) 09, 36

---

(260) AM 2021 107793 A  
(800) 1010062  
(151) 2009 04 03  
(181) 2029 04 03  
(891) 2020 02 27  
(511) 03, 05, 08, 20, 21, 24, 25, 27, 35

---

(260) AM 2021 108982 A  
(800) 1539539  
(151) 2020 05 27  
(181) 2030 05 27  
(891) 2020 05 27  
(511) 29, 29, 30, 30

---

(260) AM 2021 109206 A  
(800) 1525882  
(151) 2019 12 23  
(181) 2029 12 23  
(891) 2020 06 01  
(511) 07, 09, 11, 37, 42

---

(260) AM 2021 109207 A  
(800) 1532975  
(151) 2019 12 23  
(181) 2029 12 23  
(891) 2020 06 01  
(511) 07, 09, 11, 37, 42

---

(260) AM 2021 109243 A  
(800) 1542650  
(151) 2020 06 22  
(181) 2030 06 22  
(891) 2020 06 22  
(511) 09

---

(260) AM 2021 109345 A  
(800) 1339288  
(151) 2017 01 13  
(181) 2027 01 13  
(891) 2020 07 09  
(511) 35

---

(260) AM 2021 109346 A  
(800) 1377383  
(151) 2017 10 24  
(181) 2027 10 24  
(891) 2020 07 09  
(511) 25

---

(260) AM 2021 110081 A  
(800) 1554317  
(151) 2020 06 15  
(181) 2030 06 15  
(891) 2020 06 15  
(511) 09, 14, 18

---

(260) AM 2021 110084 A  
(800) 1554425  
(151) 2020 06 19  
(181) 2030 06 19  
(891) 2020 06 19  
(511) 30

---

(260) AM 2021 110094 A  
(800) 1554638  
(151) 2020 06 23  
(181) 2030 06 23  
(891) 2020 06 23  
(511) 07, 09, 35, 37, 40, 42

---

(260) AM 2021 110172 A  
(800) 1555820  
(151) 2020 07 20  
(181) 2030 07 20  
(891) 2020 07 20  
(511) 33

---

(260) AM 2021 110173 A  
(800) 1555851  
(151) 2020 06 11  
(181) 2030 06 11  
(891) 2020 06 11  
(511) 12

---

(260) AM 2021 110255 A  
(800) 1556717  
(151) 2020 09 24  
(181) 2030 09 24  
(891) 2020 09 24  
(511) 12

---

(260) AM 2021 110242 A  
(800) 1556324  
(151) 2020 08 27  
(181) 2030 08 27  
(891) 2020 08 27  
(511) 02, 19

---

(260) AM 2021 110256 A  
(800) 1556781  
(151) 2020 08 09  
(181) 2030 08 09  
(891) 2020 08 09  
(511) 35

---

(260) AM 2021 110243 A  
(800) 1556326  
(151) 2020 07 29  
(181) 2030 07 29  
(891) 2020 07 29  
(511) 05

---

(260) AM 2021 110257 A  
(800) 1556834  
(151) 2020 09 23  
(181) 2030 09 23  
(891) 2020 09 23  
(511) 30

---

(260) AM 2021 110244 A  
(800) 1556498  
(151) 2020 08 17  
(181) 2030 08 17  
(891) 2020 08 17  
(511) 33

---

(260) AM 2021 110258 A  
(800) 1556866  
(151) 2020 06 02  
(181) 2030 06 02  
(891) 2020 06 02  
(511) 09, 28, 41

---

(260) AM 2021 110245 A  
(800) 1556521  
(151) 2020 09 02  
(181) 2030 09 02  
(891) 2020 09 02  
(511) 29, 30

---

(260) AM 2021 110259 A  
(800) 1556883  
(151) 2020 06 11  
(181) 2030 06 11  
(891) 2020 06 11  
(511) 45

---

(260) AM 2021 110248 A  
(800) 1556560  
(151) 2019 12 27  
(181) 2029 12 27  
(891) 2019 12 27  
(511) 29, 30, 31

---

(260) AM 2021 110260 A  
(800) 1557004  
(151) 2020 06 22  
(181) 2030 06 22  
(891) 2020 06 22  
(511) 09

---

(260) AM 2021 110254 A  
(800) 1556696  
(151) 2020 08 17  
(181) 2030 08 17  
(891) 2020 08 17  
(511) 41

---

(260) AM 2021 110261 A  
(800) 1557033  
(151) 2020 08 19  
(181) 2030 08 19  
(891) 2020 08 19  
(511) 12

---

(260) AM 2021 110316 A  
(800) 1557593  
(151) 2020 06 11  
(181) 2030 06 11  
(891) 2020 06 11  
(511) 25

---

(260) AM 2021 110318 A  
(800) 1557663  
(151) 2020 10 02  
(181) 2030 10 02  
(891) 2020 10 02  
(511) 33

---

(260) AM 2021 110319 A  
(800) 1557673  
(151) 2020 09 03  
(181) 2030 09 03  
(891) 2020 09 03  
(511) 05

---

(260) AM 2021 110320 A  
(800) 1557675  
(151) 2020 07 08  
(181) 2030 07 08  
(891) 2020 07 08  
(511) 09

---

(260) AM 2021 110321 A  
(800) 1557689  
(151) 2020 06 02  
(181) 2030 06 02  
(891) 2020 06 02  
(511) 33

---

(260) AM 2021 110322 A  
(800) 1557703  
(151) 2020 08 25  
(181) 2030 08 25  
(891) 2020 08 25  
(511) 12

---

(260) AM 2021 110323 A  
(800) 1557890  
(151) 2020 06 02  
(181) 2030 06 02  
(891) 2020 06 02  
(511) 09, 28, 41

---

(260) AM 2021 110324 A  
(800) 1557895  
(151) 2020 09 28  
(181) 2030 09 28  
(891) 2020 09 28  
(511) 17

---

(260) AM 2021 110325 A  
(800) 1557911  
(151) 2020 07 21  
(181) 2030 07 21  
(891) 2020 07 21  
(511) 01, 03, 29, 30, 31, 32, 35, 39, 40, 41, 42, 43

---

(260) AM 2021 110331 A  
(800) 1558114  
(151) 2020 07 02  
(181) 2030 07 02  
(891) 2020 07 02  
(511) 31

---

(260) AM 2021 110332 A  
(800) 1558143  
(151) 2020 05 15  
(181) 2030 05 15  
(891) 2020 05 15  
(511) 07, 12

---

(260) AM 2021 110333 A  
(800) 1558190  
(151) 2020 09 17  
(181) 2030 09 17  
(891) 2020 09 17  
(511) 05, 25

---

(260) AM 2021 110334 A  
(800) 1558196  
(151) 2020 09 10  
(181) 2030 09 10  
(891) 2020 09 10  
(511) 16, 18, 20, 27

---

(260) AM 2021 110335 A  
(800) 1558229  
(151) 2020 06 03  
(181) 2030 06 03  
(891) 2020 06 03  
(511) 09

---

---

(260) AM 2021 110336 A  
(800) 1558279  
(151) 2020 05 29  
(181) 2030 05 29  
(891) 2020 05 29  
(511) 43

---

---

(260) AM 2021 110389 A  
(800) 1558460  
(151) 2020 09 25  
(181) 2030 09 25  
(891) 2020 09 25  
(511) 17, 20, 24

---

---

(260) AM 2021 110337 A  
(800) 1558297  
(151) 2020 07 21  
(181) 2030 07 21  
(891) 2020 07 21  
(511) 30

---

---

(260) AM 2021 110390 A  
(800) 1558485  
(151) 2020 07 27  
(181) 2030 07 27  
(891) 2020 07 27  
(511) 41

---

---

(260) AM 2021 110338 A  
(800) 1558301  
(151) 2019 12 13  
(181) 2029 12 13  
(891) 2019 12 13  
(511) 08, 16, 20, 21, 24, 35

---

---

(260) AM 2021 110391 A  
(800) 1558499  
(151) 2020 10 02  
(181) 2030 10 02  
(891) 2020 10 02  
(511) 06, 42

---

---

(260) AM 2021 110339 A  
(800) 1558322  
(151) 2020 06 15  
(181) 2030 06 15  
(891) 2020 06 15  
(511) 03, 35

---

---

(260) AM 2021 110392 A  
(800) 1558545  
(151) 2020 07 29  
(181) 2030 07 29  
(891) 2020 07 29  
(511) 05

---

---

(260) AM 2021 110340 A  
(800) 1558349  
(151) 2020 08 24  
(181) 2030 08 24  
(891) 2020 08 24  
(511) 30

---

---

(260) AM 2021 110393 A  
(800) 1558552  
(151) 2020 09 25  
(181) 2030 09 25  
(891) 2020 09 25  
(511) 17, 20

---

---

(260) AM 2021 110350 A  
(800) 1371412  
(151) 2017 08 10  
(181) 2027 08 10  
(891) 2020 09 28  
(511) 25, 27, 28, 41

---

---

(260) AM 2021 110400 A  
(800) 1558744  
(151) 2020 07 31  
(181) 2030 07 31  
(891) 2020 07 31  
(511) 29, 30

---

---

(260) AM 2021 110353 A  
(800) 1420749  
(151) 2018 07 31  
(181) 2028 07 31  
(891) 2020 09 28  
(511) 11, 21

---

---

(260) AM 2021 110401 A  
(800) 1558779  
(151) 2020 09 20  
(181) 2030 09 20  
(891) 2020 09 20  
(511) 09

---

(260) AM 2021 110403 A  
(800) 1558816  
(151) 2020 06 09  
(181) 2030 06 09  
(891) 2020 06 09  
(511) 04, 06, 07, 09, 19, 35, 37, 39, 40, 42

---

(260) AM 2021 110414 A  
(800) 1559142  
(151) 2020 08 27  
(181) 2030 08 27  
(891) 2020 08 27  
(511) 03

---

(260) AM 2021 110404 A  
(800) 1558820  
(151) 2020 06 16  
(181) 2030 06 16  
(891) 2020 06 16  
(511) 28

---

(260) AM 2021 110415 A  
(800) 1559168  
(151) 2020 10 02  
(181) 2030 10 02  
(891) 2020 10 02  
(511) 14

---

(260) AM 2021 110405 A  
(800) 1558836  
(151) 2020 09 24  
(181) 2030 09 24  
(891) 2020 09 24  
(511) 34

---

(260) AM 2021 110416 A  
(800) 1559201  
(151) 2020 08 11  
(181) 2030 08 11  
(891) 2020 08 11  
(511) 33

---

(260) AM 2021 110406 A  
(800) 1558855  
(151) 2020 09 20  
(181) 2030 09 20  
(891) 2020 09 20  
(511) 09

---

(260) AM 2021 110417 A  
(800) 1559202  
(151) 2020 08 11  
(181) 2030 08 11  
(891) 2020 08 11  
(511) 33

---

(260) AM 2021 110407 A  
(800) 1558864  
(151) 2020 07 15  
(181) 2030 07 15  
(891) 2020 07 15  
(511) 05, 10

---

(260) AM 2021 110418 A  
(800) 1559203  
(151) 2020 08 11  
(181) 2030 08 11  
(891) 2020 08 11  
(511) 33

---

(260) AM 2021 110408 A  
(800) 1558957  
(151) 2020 04 06  
(181) 2030 04 06  
(891) 2020 04 06  
(511) 39, 41, 43

---

(260) AM 2021 110419 A  
(800) 1559216  
(151) 2020 07 17  
(181) 2030 07 17  
(891) 2020 07 17  
(511) 09, 38, 41, 42, 44, 45

---

(260) AM 2021 110409 A  
(800) 1558980  
(151) 2020 10 06  
(181) 2030 10 06  
(891) 2020 10 06  
(511) 12

---

(260) AM 2021 110421 A  
(800) 1559234  
(151) 2020 08 21  
(181) 2030 08 21  
(891) 2020 08 21  
(511) 03

---

---

(260) AM 2021 110422 A  
(800) 1559238  
(151) 2020 09 22  
(181) 2030 09 22  
(891) 2020 09 22  
(511) 33

---

---

(260) AM 2021 110553 A  
(800) 1560311  
(151) 2020 06 22  
(181) 2030 06 22  
(891) 2020 06 22  
(511) 05, 29, 30, 32

---

---

(260) AM 2021 110423 A  
(800) 1559275  
(151) 2020 07 02  
(181) 2030 07 02  
(891) 2020 07 02  
(511) 03

---

---

(260) AM 2021 110554 A  
(800) 1560322  
(151) 2020 06 08  
(181) 2030 06 08  
(891) 2020 06 08  
(511) 03, 05

---

---

(260) AM 2021 110424 A  
(800) 1559289  
(151) 2020 07 16  
(181) 2030 07 16  
(891) 2020 07 16  
(511) 03, 14, 18, 25, 35

---

---

(260) AM 2021 110555 A  
(800) 1560343  
(151) 2020 07 08  
(181) 2030 07 08  
(891) 2020 07 08  
(511) 03

---

---

(260) AM 2021 110490 A  
(800) 1559624  
(151) 2019 12 10  
(181) 2029 12 10  
(891) 2019 12 10  
(511) 36

---

---

(260) AM 2021 110556 A  
(800) 1560355  
(151) 2020 07 23  
(181) 2030 07 23  
(891) 2020 07 23  
(511) 19

---

---

(260) AM 2021 110491 A  
(800) 1559686  
(151) 2020 09 18  
(181) 2030 09 18  
(891) 2020 09 18  
(511) 01

---

---

(260) AM 2021 110557 A  
(800) 1560361  
(151) 2020 06 08  
(181) 2030 06 08  
(891) 2020 06 08  
(511) 33

---

---

(260) AM 2021 110492 A  
(800) 1559688  
(151) 2020 09 02  
(181) 2030 09 02  
(891) 2020 09 02  
(511) 25

---

---

(260) AM 2021 110559 A  
(800) 1560568  
(151) 2020 09 15  
(181) 2030 09 15  
(891) 2020 09 15  
(511) 05

---

---

(260) AM 2021 110493 A  
(800) 1560007  
(151) 2020 07 13  
(181) 2030 07 13  
(891) 2020 07 13  
(511) 03

---

---

(260) AM 2021 110560 A  
(800) 1560583  
(151) 2020 07 09  
(181) 2030 07 09  
(891) 2020 07 09  
(511) 32

---



(260) AM 2021 110561 A  
(800) 1560598  
(151) 2020 10 01  
(181) 2030 10 01  
(891) 2020 10 01  
(511) 20

---

(260) AM 2021 110574 A  
(800) 1560811  
(151) 2020 08 13  
(181) 2030 08 13  
(891) 2020 08 13  
(511) 03, 35

---

(260) AM 2021 110562 A  
(800) 1560607  
(151) 2020 07 21  
(181) 2030 07 21  
(891) 2020 07 21  
(511) 30

---

(260) AM 2021 110578 A  
(800) 1561128  
(151) 2020 10 19  
(181) 2030 10 19  
(891) 2020 10 19  
(511) 03, 35

---

(260) AM 2021 110563 A  
(800) 1560621  
(151) 2020 09 18  
(181) 2030 09 18  
(891) 2020 09 18  
(511) 05

---

(260) AM 2021 110586 A  
(800) 1561296  
(151) 2020 08 03  
(181) 2030 08 03  
(891) 2020 08 03  
(511) 35, 42

---

(260) AM 2021 110564 A  
(800) 1560640  
(151) 2020 06 17  
(181) 2030 06 17  
(891) 2020 06 17  
(511) 36

---

(260) AM 2021 110589 A  
(800) 1561332  
(151) 2020 07 20  
(181) 2030 07 20  
(891) 2020 07 20  
(511) 09, 28, 41

---

(260) AM 2021 110568 A  
(800) 1560706  
(151) 2020 07 20  
(181) 2030 07 20  
(891) 2020 07 20  
(511) 09, 28, 41

---

(260) AM 2021 110590 A  
(800) 1115568  
(151) 2012 03 13  
(181) 2022 03 13  
(891) 2020 10 16  
(511) 05

---

(260) AM 2021 110570 A  
(800) 1560730  
(151) 2020 08 17  
(181) 2030 08 17  
(891) 2020 08 17  
(511) 01, 04, 37

---

(260) AM 2021 110592 A  
(800) 1307688  
(151) 2016 05 24  
(181) 2026 05 24  
(891) 2020 10 19  
(511) 05, 35

---

(260) AM 2021 110571 A  
(800) 1560754  
(151) 2020 07 20  
(181) 2030 07 20  
(891) 2020 07 20  
(511) 09, 28, 41

---

(260) AM 2021 110593 A  
(800) 1307825  
(151) 2016 05 24  
(181) 2026 05 24  
(891) 2020 10 19  
(511) 05, 35

---

---

(260) AM 2021 110594 A  
(800) 1406286  
(151) 2018 01 18  
(181) 2028 01 18  
(891) 2020 10 12  
(511) 05, 09, 35

---

---

(260) AM 2021 110641 A  
(800) 1561936  
(151) 2020 10 19  
(181) 2030 10 19  
(891) 2020 10 19  
(511) 05, 42

---

---

(260) AM 2021 110595 A  
(800) 1411877  
(151) 2018 04 24  
(181) 2028 04 24  
(891) 2020 10 30  
(511) 43

---

---

(260) AM 2021 110655 A  
(800) 1562450  
(151) 2020 10 08  
(181) 2030 10 08  
(891) 2020 10 08  
(511) 05, 09

---

---

(260) AM 2021 110631 A  
(800) 1561579  
(151) 2020 06 19  
(181) 2030 06 19  
(891) 2020 06 19  
(511) 16, 35, 41, 42

---

---

(260) AM 2021 110658 A  
(800) 1562558  
(151) 2020 08 07  
(181) 2030 08 07  
(891) 2020 08 07  
(511) 03, 35, 41, 44

---

---

(260) AM 2021 110632 A  
(800) 1561597  
(151) 2020 09 14  
(181) 2030 09 14  
(891) 2020 09 14  
(511) 33

---

---

(260) AM 2021 110659 A  
(800) 1173893  
(151) 2013 02 25  
(181) 2023 02 25  
(891) 2020 10 28  
(511) 01, 02, 17, 19

---

---

(260) AM 2021 110633 A  
(800) 1561659  
(151) 2020 07 17  
(181) 2030 07 17  
(891) 2020 07 17  
(511) 29

---

---

(260) AM 2021 110660 A  
(800) 1177872  
(151) 2013 07 30  
(181) 2023 07 30  
(891) 2020 10 20  
(511) 04

---

---

(260) AM 2021 110634 A  
(800) 1561665  
(151) 2020 06 10  
(181) 2030 06 10  
(891) 2020 06 10  
(511) 01, 03, 05, 10

---

---

(260) AM 2021 110661 A  
(800) 1178663  
(151) 2013 07 29  
(181) 2023 07 29  
(891) 2020 10 16  
(511) 05

---

---

(260) AM 2021 110635 A  
(800) 1561681  
(151) 2020 09 04  
(181) 2030 09 04  
(891) 2020 09 04  
(511) 10, 25, 28, 36, 37, 41, 45

---

---

(260) AM 2021 110663 A  
(800) 1330365  
(151) 2016 11 09  
(181) 2026 11 09  
(891) 2020 10 07  
(511) 04

---

(260) AM 2021 110664 A  
(800) 1462006  
(151) 2018 12 28  
(181) 2028 12 28  
(891) 2020 10 06  
(511) 05

---

(260) AM 2021 110725 A  
(800) 1563584  
(151) 2020 10 20  
(181) 2030 10 20  
(891) 2020 10 20  
(511) 09

---

(260) AM 2021 110666 A  
(800) 1524712  
(151) 2020 02 27  
(181) 2030 02 27  
(891) 2020 09 29  
(511) 03

---

(260) AM 2021 110727 A  
(800) 1563638  
(151) 2020 10 20  
(181) 2030 10 20  
(891) 2020 10 20  
(511) 09

---

(260) AM 2021 110698 A  
(800) 1562632  
(151) 2020 07 23  
(181) 2030 07 23  
(891) 2020 07 23  
(511) 05

---

(260) AM 2021 110728 A  
(800) 1563661  
(151) 2020 07 24  
(181) 2030 07 24  
(891) 2020 07 24  
(511) 39

---

(260) AM 2021 110710 A  
(800) 1562960  
(151) 2020 07 31  
(181) 2030 07 31  
(891) 2020 07 31  
(511) 05

---

(260) AM 2021 110729 A  
(800) 1563672  
(151) 2020 09 24  
(181) 2030 09 24  
(891) 2020 09 24  
(511) 05, 42, 44

---

(260) AM 2021 110711 A  
(800) 1562967  
(151) 2020 10 27  
(181) 2030 10 27  
(891) 2020 10 27  
(511) 03

---

(260) AM 2021 110731 A  
(800) 1563753  
(151) 2020 02 24  
(181) 2030 02 24  
(891) 2020 02 24  
(511) 35, 42

---

(260) AM 2021 110712 A  
(800) 1563041  
(151) 2020 09 03  
(181) 2030 09 03  
(891) 2020 09 03  
(511) 41

---

(260) AM 2021 110825 A  
(800) 1564640  
(151) 2020 05 25  
(181) 2030 05 25  
(891) 2020 05 25  
(511) 07, 12, 35

---

(260) AM 2021 110723 A  
(800) 1563514  
(151) 2020 09 22  
(181) 2030 09 22  
(891) 2020 09 22  
(511) 33

---

(260) AM 2021 110826 A  
(800) 1564641  
(151) 2020 07 20  
(181) 2030 07 20  
(891) 2020 07 20  
(511) 09, 28, 41

---

(260) AM 2021 110827 A  
(800) 1564654  
(151) 2020 10 14  
(181) 2030 10 14  
(891) 2020 10 14  
(511) 12

---

(260) AM 2021 111009 A  
(800) 1566510  
(151) 2020 06 24  
(181) 2030 06 24  
(891) 2020 06 24  
(511) 07

---

(260) AM 2021 110900 A  
(800) 1565150  
(151) 2020 09 25  
(181) 2030 09 25  
(891) 2020 09 25  
(511) 03

---

(260) AM 2021 111011 A  
(800) 1566540  
(151) 2020 09 25  
(181) 2030 09 25  
(891) 2020 09 25  
(511) 03

---

(260) AM 2021 110902 A  
(800) 1565181  
(151) 2020 09 25  
(181) 2030 09 25  
(891) 2020 09 25  
(511) 03

---

(260) AM 2021 111012 A  
(800) 1566578  
(151) 2020 10 19  
(181) 2030 10 19  
(891) 2020 10 19  
(511) 34

---

(260) AM 2021 111005 A  
(800) 1566411  
(151) 2020 08 14  
(181) 2030 08 14  
(891) 2020 08 14  
(511) 04, 05, 06, 19, 31, 35, 39, 40, 41, 42

---

(260) AM 2021 111014 A  
(800) 1566678  
(151) 2020 07 01  
(181) 2030 07 01  
(891) 2020 07 01  
(511) 06, 09

---

(260) AM 2021 111006 A  
(800) 1566417  
(151) 2020 09 28  
(181) 2030 09 28  
(891) 2020 09 28  
(511) 30

---

(260) AM 2021 111007 A  
(800) 1566471  
(151) 2020 10 26  
(181) 2030 10 26  
(891) 2020 10 26  
(511) 03

---

(260) AM 2021 111008 A  
(800) 1566488  
(151) 2020 10 01  
(181) 2030 10 01  
(891) 2020 10 01  
(511) 03

---

---

# OFFICIAL NOTIFICATIONS INVENTIONS

## RESTORATION OF PATENTS

(21) AP 2016 14798  
(11) P 2021 7219 B  
(73) Feltrim Pastoral Company Pty LTD  
(54) APPARATUS FOR STORING ORGANIC MATERIAL  
DATE OF CANCELLATION OF PATENT: 2021 10 27  
THE TERM OF RESTORATION OF PATENT: 2021 12 10

---

## ABOLITION OF PATENTS WITH THE RIGHT TO RESTORE

(21) AP 2005 10125  
(11) P 2012 5565 B  
(73) Incyte Holdings Corporation  
(54) LACTAM COMPOUNDS AND THEIR PHARMACEUTICAL USE  
DATE OF CANCELLATION OF PATENT: 2021 11 09  
LIMITED DATE OF RESTORATION OF PATENT: 2022 11 09

---

(21) AP 2007 11309  
(11) P 2012 5459 B  
(73) Millennium Pharmaceuticals Inc.  
(54) COMPOUNDS FOR INHIBITING MITOTIC PROGRESSION  
DATE OF CANCELLATION OF PATENT: 2021 11 14  
LIMITED DATE OF RESTORATION OF PATENT: 2022 11 14

---

(21) AP 2010 12757  
(11) P 2014 6206 B  
(73) RV Lizenz AG  
(54) THERMAL-CHEMICAL UTILIZATION OF CARBON-CONTAINING MATERIALS, IN PARTICULAR  
FOR THE EMISSION-FREE GENERATION OF ENERGY  
DATE OF CANCELLATION OF PATENT: 2021 11 19  
LIMITED DATE OF RESTORATION OF PATENT: 2022 11 19

---

(21) AP 2011 13117  
(11) P 2015 6346 B  
(73) H. Lundbeck A/S  
(54) IMIDAZOLE DERIVATIVES AS PDE10A ENZYME INHIBITORS  
DATE OF CANCELLATION OF PATENT: 2021 11 18  
LIMITED DATE OF RESTORATION OF PATENT: 2022 11 18

---

(21) AP 2018 14926  
(11) P 2020 7207 B  
(73) Goga Chakhaia;  
Levani Tsulukidze;  
Zurab Lobzhanidze;  
Sophie Gogilava;  
LTD "Higher Education Education Academy"  
(54) CONSTRUCTION FOR SNOWSLIDE CONTROL

---

DATE OF CANCELLATION OF PATENT: 2021 11 16  
LIMITED DATE OF RESTORATION OF PATENT: 2022 11 16

---

(21) AP 2018 14929  
(11) P 2020 7116 B  
(73) Savle Chkhitunidze  
(54) SOIL TREATMENT TOOL  
DATE OF CANCELLATION OF PATENT: 2021 11 21  
LIMITED DATE OF RESTORATION OF PATENT: 2022 11 21

---

(21) AP 2005 9065  
(11) P 2007 4235 B  
(73) Mariam Mchedlishvili  
(54) METHOD FOR BIODESTRUCTION OF OIL AND/OR OIL PRODUCTS, INCUBATING NUTRIENT MEDIUM FOR MICROORGANISMS-OIL DESTRUCTORS AND METHOD FOR ITS INCUBATION  
DATE OF CANCELLATION OF PATENT: 2021 11 18  
LIMITED DATE OF RESTORATION OF PATENT: 2022 11 18

---

## EXPIRATION OF TERMS OF RESTORATION OF PATENTS

(21) AP 2005 10137  
(11) P 2010 4961 B  
(73) Arena Pharmaceuticals Inc.  
(54) 3-PHENYL-PYRAZOLE DERIVATIVES AS MODULATORS OF THE 5-HT<sub>2A</sub> SEROTONIN RECEPTOR USEFUL FOR THE TREATMENT OF DISORDERS RELATED THERETO  
DATE OF CANCELLATION OF PATENT: 2020 11 17  
THE TERM OF RESTORATION OF PATENT VALIDITY HAS EXPIRED: 2021 11 17

---

(21) AP 2009 12239  
(11) P 2014 6064 B  
(73) Pfizer Inc.  
(54) 3-MINOCYCLOPENTANECARBOXAMIDES AS CHEMOKINE RECEPTOR MODULATORS  
DATE OF CANCELLATION OF PATENT: 2020 11 20  
THE TERM OF RESTORATION OF PATENT VALIDITY HAS EXPIRED: 2021 11 20

---

(21) AP 2011 12930  
(11) P 2016 6551 B  
(73) Novamedica LLC  
(54) SELECTIVE, LIPOPHILIC, AND LONG-ACTING BETA AGONISTS MONOTHERAPEUTIC FORMULATIONS TIONS AND METHODS FOR COSMETIC TREATMENT OF ADIPOSITY AND CONTOUR BULGING  
DATE OF CANCELLATION OF PATENT: 2020 11 22  
THE TERM OF RESTORATION OF PATENT VALIDITY HAS EXPIRED: 2021 11 22

---

(21) AP 2013 13847  
(11) P 2017 6637 B  
(73) Laboratoire Hra-Pharma  
(54) CO-MICRONISATION PRODUCT COMPRISING ULIPRISTAL ACETATE  
DATE OF CANCELLATION OF PATENT: 2020 11 07  
THE TERM OF RESTORATION OF PATENT VALIDITY HAS EXPIRED: 2021 11 07

---

(21) AP 2013 13848  
(11) P 2017 6648 B  
(73) Laboratoire Hra-Pharma  
(54) CO-MICRONISATION PRODUCT COMPRISING SELECTIVE PROGESTERONE-RECEPTOR MODULATOR  
DATE OF CANCELLATION OF PATENT: 2020 11 07  
THE TERM OF RESTORATION OF PATENT VALIDITY HAS EXPIRED: 2021 11 07

---

(21) AP 2015 13994  
(11) P 2018 6832 B  
(73) LEPL "Agricultural Scientific-Research Center"  
(54) GRAIN COMBINE  
DATE OF CANCELLATION OF PATENT: 2020 11 16  
THE TERM OF RESTORATION OF PATENT VALIDITY HAS EXPIRED: 2021 11 16

---

(21) AP 2014 14151  
(11) P 2018 6878 B  
(73) Pfizer Inc.  
(54) 2,6-SUBSTITUTED PURINE DERIVATIVES AND THEIR USE IN THE TREATMENT OF PROLIFERATIVE DISORDERS  
DATE OF CANCELLATION OF PATENT: 2020 11 10  
THE TERM OF RESTORATION OF PATENT VALIDITY HAS EXPIRED: 2021 11 10

---

(21) AP 2014 14169  
(11) P 2019 6998 B  
(73) Ejzajibashi tuqetim urunleri sanaii ve tijaret anonim shirqeti  
(54) A DISPENSER COMPRISING A SYSTEM FACILITATING THE PLACEMENT OF THE PRODUCT MADE OF PAPER INTO THE DISPENSER  
DATE OF CANCELLATION OF PATENT: 2020 11 17  
THE TERM OF RESTORATION OF PATENT VALIDITY HAS EXPIRED: 2021 11 17

---

(21) AP 2015 14485  
(11) P 2019 6949 B  
(73) H.lundbek A/s  
(54) 2-AMINO-6-(DIFLUOROMETHYL)-5, 5-DIFLUORO-6-PHENYL-3, 4, 5, 6-TETRA-HYDROPYRIDINES AS BACE1 INHIBITORS  
DATE OF CANCELLATION OF PATENT: 2020 11 09  
THE TERM OF RESTORATION OF PATENT VALIDITY HAS EXPIRED: 2021 11 09

---

(21) AP 2017 14629  
(11) P 2019 7022 B  
(73) Tamaz Agladze;  
Marine Donadze;  
Lepi Shota Rustaveli National Science Foundation (GE)  
(54) METHOD FOR SILVER MONODISPERSE NANOPARTICLES PREPARATION  
DATE OF CANCELLATION OF PATENT: 2020 11 20  
THE TERM OF RESTORATION OF PATENT VALIDITY HAS EXPIRED: 2021 11 20

---

(21) AP 2016 14719  
(11) P 2020 7062 B  
(73) Dong-hyun SEO;  
Min-kiu Seo;  
HYUN ENGINEERING AND CONSTRUCTION CO., LTD.  
(54) TUNNEL CONSTRUCTION METHOD USING PRE-SUPPORT AND POST-SUPPORT  
DATE OF CANCELLATION OF PATENT: 2020 11 23  
THE TERM OF RESTORATION OF PATENT VALIDITY HAS EXPIRED: 2021 11 23

---

(21) AP 2002 8840  
(11) P 2007 4105 B  
(73) SABAF S.P.A.  
(54) GAS BURNER WITH SEPARATE FEEDING OF THE FLAME CROWNS  
DATE OF CANCELLATION OF PATENT: 2020 11 12  
THE TERM OF RESTORATION OF PATENT VALIDITY HAS EXPIRED: 2021 11 12

---

## EXPIRATION OF TERMS OF PATENTS

(21) AP 2001 6199  
(11) P 2003 2881 B  
(73) Gela Sulaberidze  
(54) Method for Preparing Paste for Bread of High Nutritive Value  
EXPIRATION DATE OF PATENT: 2021 11 19

---

(21) AP 2001 7009  
(11) P 2005 3497 B  
(73) Bayer Healthcare LLC  
(54) Compositions for Enhanced Acaricidal Activity  
EXPIRATION DATE OF PATENT: 2021 11 26

---

## CHANGES OF NAMES AND/OR ADDRESSES OF PATENT OWNER

(21) AP 2002 6666  
(11) P 2004 3355 B  
(54) PHARMACEUTICAL COMPOSITION POSSESSING ANTIMYCOTIC ACTIVITY AND METHOD OF ITS PRODUCTION

NEW NAME AND NEW ADDRESS:	Joint-Stock Company "Nizhegorodskiy Chemical-Pharmaceutical Plant" /JSC "NizhPharm" (RU) Salganskaja St.7, 603950, Nizhnij Novgorod, Russian Federation (RU)
FORMER NAME AND FORMER ADDRESS:	Joint-Stock Company "Nizhegorodskiy Chemical-Pharmaceutical Plant" Salganskaja St.7, ГСН-459, Nizhnij Novgorod, 603950, Russian Federation (RU)
DATE OF REGISTRATION:	2021 11 25

---



## UTILITY MODELS

### ABOLITION OF PATENTS WITH THE RIGHT TO RESTORE

(21) AU 2015 13993  
(11) U 2017 1920 Y  
(73) Khvicha Tvalabeishvili  
(54) THERAPEUTIC AGENT FOR LACTOSTASIS, MASTOPATHY, AND MASTITIS TREATMENT AND/OR PROPHYLAXIS  
DATE OF CANCELLATION OF PATENT: 2021 11 12  
LIMITED DATE OF RESTORATION OF PATENT: 2022 11 12

---

(21) AU 2016 14321  
(11) U 2018 1964 Y  
(73) Merab Diasamidze;  
Merab Topchiashvili;  
Zurab Suladze;  
Davit Suladze  
(54) METHOD FOR ARTICLE MANUFACTURE WITH WOOD- POLYMER COMPOSITE  
DATE OF CANCELLATION OF PATENT: 2021 11 14  
LIMITED DATE OF RESTORATION OF PATENT: 2022 11 14

---

(21) AU 2018 14927  
(11) U 2021 2083 Y  
(73) LLC Higher Education Institution "Education Academy"  
Гора Чаяя;  
Zurab Lobjanidze;  
Levani Tsulukidze;  
Sopio Gogilava  
(54) RADIAL CATCHMENT DRAINAGE  
DATE OF CANCELLATION OF PATENT: 2021 11 16  
LIMITED DATE OF RESTORATION OF PATENT: 2022 11 16

---

### EXPIRATION OF PATENTS RESTORATION

(21) AU 2014 13637  
(11) U 2015 1873 Y  
(73) Lali Latsabidze  
(54) DRYING ROOM FOR LINEN OR CLOTHS WITH PROTECTIVE OVERLAP  
DATE OF CANCELLATION OF PATENT: 2020 11 17  
THE TERM OF RESTORATION OF PATENT VALIDITY HAS EXPIRED: 2021 11 17

---

(21) AU 2015 13988  
(11) U 2018 1977 Y  
(73) Temur Chakhunashvili;  
Teimuraz Rokva;  
Zhiuli Keadze;  
Merab Dadunashvili;  
Zinaida Vatsadze  
(54) ANODE FOR RECEIVING ELECTROLYTIC MANGANESE DIOXIDE  
DATE OF CANCELLATION OF PATENT: 2020 11 09  
THE TERM OF RESTORATION OF PATENT VALIDITY HAS EXPIRED: 2021 11 09

---

(21) AU 2015 13989  
(11) U 2018 1978 Y  
(73) Temur Chakhunashvili;  
Teimuraz Rokva;  
Zhiuli Keadze;  
Zinaida Vatsadze;  
Merab Dadunashvili  
(54) CATHODE FOR RECEIVING ELECTROLYTIC MANGANESE DIOXIDE  
DATE OF CANCELLATION OF PATENT: 2020 11 09  
THE TERM OF RESTORATION OF PATENT VALIDITY HAS EXPIRED: 2021 11 09

---

(21) AU 2013 14096  
(11) U 2017 1952 Y  
(73) Irina MIROCHNIK  
(54) ENVELOPE FOR PACKING OF SMALL PIECE GOODS  
DATE OF CANCELLATION OF PATENT: 2020 11 15  
THE TERM OF RESTORATION OF PATENT VALIDITY HAS EXPIRED: 2021 11 15

---

(21) AU 2013 14097  
(11) U 2017 1953 Y  
(73) Irina MIROCHNIK  
(54) FLEXIBLE WRAPPING MATERIAL FOR MANUFACTURE FOR PACKING OF SMALL PIECE GOODS  
DATE OF CANCELLATION OF PATENT: 2020 11 15  
THE TERM OF RESTORATION OF PATENT VALIDITY HAS EXPIRED: 2021 11 15

---

(21) AU 2017 14621  
(11) U 2019 2007 Y  
(73) Merab Jgenti;  
Levan Gulua;  
Tamar Turmanidze;  
Lepl Shota Rustaveli National Science Foundation  
Nle Agricultural University of Georgia  
(54) METHOD FOR UNCOOKED BILBERRIES STORAGE  
DATE OF CANCELLATION OF PATENT: 2020 11 07  
THE TERM OF RESTORATION OF PATENT VALIDITY HAS EXPIRED: 2021 11 07

---

(21) AU 2014 14784  
(11) U 2019 2022 Y  
(73) Ejzajibashi Tuqetim Urunleri Sanaii Ve Tijaret Anoim Shirqeti  
(54) A DISPENSER COMPRISING A PRODUCT LOADING MECHANISM  
DATE OF CANCELLATION OF PATENT: 2020 11 17  
THE TERM OF RESTORATION OF PATENT VALIDITY HAS EXPIRED: 2021 11 17

---

(21) AU 2018 14921  
(11) U 2019 2026 Y  
(73) Anthony Frolov  
(54) GROUND ENTERTAINMENT ATTRACTION  
DATE OF CANCELLATION OF PATENT: 2020 11 09  
THE TERM OF RESTORATION OF PATENT VALIDITY HAS EXPIRED: 2021 11 09

---

## TRANSFER OF RIGHT

(21) AU 2018 14928

(11) U 2020 2030 Y

(54) THERAPEUTIC AGENT FOR TYPE II DIABETES

NEW NAME AND NEW ADDRESS:

Marine Nikolaishvili (GE)

Shevardenidze str. 9, app. 13, 0160, Tbilisi, Georgia (GE);

Tea Museliani

Kostava st.1, Lentekhi District, Georgia

Elene Giorgadze (GE)

D. Aghmashenebeli Ave. 181, app. 17, Tbilisi, Georgia (GE);

Elene Giorgadze (GE)

D. Aghmashenebeli Ave. 181, app. 17, Tbilisi, Georgia (GE);

Natia Chkheidze (GE)

Chikovani Str. 85b, Tbilisi, Georgia (GE);

FORMER NAME AND FORMER ADDRESS:

Marine Nikolaishvili (GE)

Shevardenidze str. 9, app. 13, 0160, Tbilisi, Georgia (GE);

Natia Chkheidze (GE)

Chikovani Str. 85b, Tbilisi, Georgia (GE);

Elene Giorgadze (GE)

D. Aghmashenebeli Ave. 181, app. 17, Tbilisi, Georgia (GE);

Tea Museliani

Kostava st.1, Lentekhi District, Georgia

DATE OF REGISTRATION: 2021 11 18

---

## DESIGNS

### EXTENSION OF TERMS OF INTERNATIONAL DESIGN REGISTRATION

(11) DM/77148

(73) TOMIL S.R.O.

Gen. Svatoně 149/IV, CZ-566 01 Vysoké Mýto (EM)

(15) 2011 11 02

(24) 2011 11 02

(18) 2026 11 02

(28) 4

(28') 4

(54) Sanitary dispensing devices

---

(11) DM/77221

(73) SWATCH AG (SWATCH SA) (SWATCH LTD.)

Jakob-Stämpfli-Strasse 94, CH-2502 BIEL/BIENNE (CH)

(15) 2011 11 28

(24) 2011 11 28

(18) 2026 11 28

(28) 4

(28') 4

(54) Display units

---

(11) DM/77231

(73) SWATCH AG (SWATCH SA) (SWATCH LTD.)

Jakob-Stämpfli-Strasse 94, CH-2502 BIEL/BIENNE (CH)

(15) 2011 11 30  
(24) 2011 11 30  
(18) 2026 11 30  
(28) 2  
(28') 2  
(54) Display units

---

(11) DM/77447  
(73) ALFRED KÄRCHER GMBH & CO. KG  
Alfred-Kärcher-Straße 28-40, 71364 Winnenden (DE)  
(15) 2012 01 12  
(24) 2012 01 12  
(18) 2027 01 12  
(28) 2  
(28') 2  
(54) High pressure cleaners

---

(11) DM/93095  
(73) PEUGEOT CITROËN AUTOMOBILES SA  
Route de Gisy, F-78140 VELIZY-VILLACOUBLAY (FR)  
(15) 2016 10 12  
(24) 2016 10 12  
(18) 2026 10 12

(28) 1  
(28') 1  
(54) Automobile

---

(11) DM/93291  
(73) MONTRES JAQUET DROZ SA (MONTRES JAQUET DROZ AG) (MONTRES JAQUET DROZ LTD.)  
Allée du Tourbillon 2, CH-2300 La Chaux-de-Fonds (CH)  
(15) 2016 11 02  
(24) 2016 11 02  
(18) 2026 11 02  
(28) 5  
(28') 3  
(54) Dials

---

(11) DM/93292  
(73) OMEGA SA (OMEGA AG) (OMEGA LTD.)  
Jakob-Stämpfli-Strasse 96, CH-2502 Biel/Bienne (CH)  
(15) 2016 11 02  
(24) 2016 11 02  
(18) 2026 11 02  
(28) 1  
(28') 1  
(54) Watch

---

(11) DM/93340  
(73) PEUGEOT CITROËN AUTOMOBILES SA  
Route de Gisy, F-78140 VELIZY-VILLACOUBLAY (FR)  
(15) 2016 10 12  
(24) 2016 10 12

(18) 2026 10 12  
(28) 1  
(28') 1  
(54) Automobile

---

(11) DM/93342  
(73) PEUGEOT CITROËN AUTOMOBILES SA  
Route de Gisy, F-78140 VELIZY-VILLACOUBLAY (FR)  
(15) 2016 10 12  
(24) 2016 10 12  
(18) 2026 10 12  
(28) 1  
(28') 1  
(54) Automobile

---

(11) DM/93501  
(73) HARRY WINSTON SA  
Chemin du Tourbillon 8, CH-1228 Plan-les-Ouates (CH)  
(15) 2016 11 16  
(24) 2016 11 16  
(18) 2026 11 16  
(28) 3  
(28') 3  
(54) Earring, Finger ring, Necklace

---

(11) DM/93557  
(73) HARRY WINSTON SA  
Chemin du Tourbillon 8, CH-1228 Plan-les-Ouates (CH)  
(15) 2016 11 21  
(24) 2016 11 21  
(18) 2026 11 21  
(28) 3  
(28') 3  
(54) Finger ring, Necklace, Pendant

---

(11) DM/93660  
(73) OMEGA SA (OMEGA AG) (OMEGA LTD.)  
Jakob-Stämpfli-Strasse 96, CH-2502 Biel/Bienne (CH)  
(15) 2016 11 29  
(24) 2016 11 29  
(18) 2026 11 29  
(28) 1  
(28') 1  
(54) Oscillating weight

---

(11) DM/94007  
(73) VALENTINO S.P.A.  
Via Turati, 16/18, I-20121 Milano (EM)  
(15) 2016 12 09  
(24) 2016 12 09  
(18) 2026 12 09  
(28) 1  
(28') 1  
(54) Bag

---

## CANCELLATION OF INTERNATIONAL DESIGNS REGISTRATION

(11) DM/74651  
(73) Microsoft Mobile OY  
Keilahdentie 2-4 Espoo FI-02150 (FI)  
CANCELLATION DATE OF REGISTRATION: 2020 10 20  
(58) 2021 11 25

---

(11) DM/74796  
(73) MICROSOFT MOBILE OY  
Keilahdentie 2-4, FI-02150 Espoo (FI)  
CANCELLATION DATE OF REGISTRATION: 2020 11 15  
(58) 2021 11 25

---

(11) DM/75142  
(73) Microsoft Mobile OY  
Keilahdentie 2-4 Espoo FI-02150 (FI)  
CANCELLATION DATE OF REGISTRATION: 2020 12 17  
(58) 2021 11 25

---

**TRADEMARKS****EXTENSION OF TERMS OF REGISTRATION**

(111) M 2001 14007 R2  
(156) 2001 09 12  
(186) 2031 09 12  
(732) Evyap Sabun Yag Gliserin Sanayi  
Ve Ticaret Anonim Sirketi  
İstanbul Deri Organize Sanayi Bölgesi Güderi  
Caddesi, No:1, X-1, Özel Parsel Tuzla  
İstanbul, Turkey

(111) M 2002 14261 R2  
(156) 2002 01 18  
(186) 2032 01 18  
(732) Ipr Pharmaceuticals, Inc.  
Road 188, Lot 17, San Isidro Industrial  
Park, Canovanas, PR 00729 Puerto Rico,  
USA

(111) M 2002 14446 R2  
(156) 2002 05 01  
(186) 2032 05 01  
(732) PT Sumatra Tobacco Trading Company  
Jln. Pattimura No.3, Pematang Siantar,  
Sumatera Utara, Indonesia

(111) M 2002 14504 R2  
(156) 2002 06 13  
(186) 2032 06 13  
(732) PT Sumatra Tobacco Trading Company  
Jln. Pattimura No3, Pematang Siantar,  
Sumatera Utara, Indonesia

(111) M 2002 14671 R2  
(156) 2002 09 13  
(186) 2032 09 13  
(732) Gallaher Limited  
Members Hill, Brooklands Road,  
Weybridge, Surrey KT13 0QU,  
United Kingdom

(111) M 2002 14831 R2  
(156) 2002 11 28  
(186) 2032 11 28  
(732) Gallaher Limited  
Members Hill, Brooklands Road,  
Weybridge, Surrey KT13 0QU,  
United Kingdom

(111) M 2002 14737 R2  
(156) 2002 10 15  
(186) 2032 10 15  
(732) Gallaher Limited  
Members Hill, Brooklands Road,  
Weybridge, Surrey KT13 0QU,  
United Kingdom

(111) M 2011 21998 R1  
(156) 2011 11 30  
(186) 2031 11 30  
(732) Yildiz Holding A.S.  
Kısıklı Mahallesi Çeşme Çıkmazi,  
Sokak No:6/1, Üsküdar İstanbul,  
Turkey

(111) M 2011 21515 R1  
(156) 2011 05 25  
(186) 2031 05 25  
(732) JSC "Insurance Company Alpha"  
Al. Kazbegi Ave. 16, 0160, Saburtalo District,  
Tbilisi, Georgia

(111) M 2011 21499 R1  
(156) 2011 05 25  
(186) 2031 05 25  
(732) I/M Davit Chikhradze  
Mukhiani 3 mcr. bld. 17, app. 70, 0172, Gldani  
District, Tbilisi, Georgia

(111) M 2011 21969 R1  
(156) 2011 11 17  
(186) 2031 11 17  
(732) Yildiz Holding Anonim Sirketi  
Kısıklı Mahallesi Çeşme Çıkmazi,  
No:6/1, Üsküdar İstanbul, Turkey

(111) M 2011 21788 R1  
(156) 2011 09 19  
(186) 2031 09 19  
(732) Astellas Deutschland GmbH  
Ridlerstrasse 57, D-80339, München,  
Germany

(111) M 2011 21789 R1  
(156) 2011 09 19  
(186) 2031 09 19  
(732) Astellas Deutschland GmbH

---

Ridlerstrasse 57, D-80339, München,  
Germany

---

(111) M 2011 21791 R1  
(156) 2011 09 19  
(186) 2031 09 19  
(732) Astellas Deutschland GmbH  
Ridlerstrasse 57, D-80339, München,  
Germany

---

(111) M 2011 22035 R1  
(156) 2011 12 07  
(186) 2031 12 07  
(732) Ltd "Georgian Wine Corporation"  
Simon Chiqovani st. 35, 0171, Tbilisi, Georgia

---

(111) M 2012 22323 R1  
(156) 2012 02 24  
(186) 2032 02 24  
(732) Vifor (International) AG, Vifor (International)  
Ltd, Vifor (International) Inc.  
Rechenstrasse 37, 9014 St. Gall,  
Switzerland

---

(111) M 2011 22180 R1  
(156) 2011 12 29  
(186) 2031 12 29  
(732) Ltd "Georgian Wine Corporation"  
Simon Chiqovani St. 35, 0171, Tbilisi, Georgia

---

(111) M 2011 22185 R1  
(156) 2011 12 29  
(186) 2031 12 29  
(732) Amgen Inc.  
One Amgen Center Drive, Thousand  
Oaks, California 91320-1799, USA

---

(111) M 2012 22789 R1  
(156) 2012 07 13  
(186) 2032 07 13  
(732) F21 IPCO, LLC  
1411 Broadway, New York,  
New York, 10018, USA

---

(111) M 2012 22388 R1  
(156) 2012 03 06  
(186) 2032 03 06  
(732) GALLAHER LIMITED  
Members Hill, Brooklands Road,  
Weybridge, Surrey, KT13 0QU,  
United Kingdom

---

(111) M 2012 22303 R1  
(156) 2012 02 14  
(186) 2032 02 14  
(732) Gallaher Limited  
Members Hill, Brooklands Road,  
Weybridge, Surrey KT13 0QU,  
United Kingdom

---



## COMPLETE TRANSFER OF RIGHTS

- 
- (111) M 2003 15287 R  
(732) Merz Consumer Care GmbH  
Eckenheimer Landstr. 100 60318  
Frankfurt am Main, Germany  
(770) Merz Pharma GmbH & CO. KgaA  
Eckenheimer Landstrasse 100, 60318  
Frankfurt am Main, Germany  
(580) 2021 09 22
- 
- (111) M 2004 15742 R  
(732) Merz Consumer Care GmbH  
Eckenheimer Landstr. 100 60318  
am Main, Germany  
(770) Merz Pharma GmbH & CO. KgaA  
Eckenheimer Landstrasse 100, 60318  
am Main, Germany  
(580) 2021 09 23
- 
- (111) M 1997 5630 R  
(732) Atnahs Pharma uk Limited  
One Apple Park Way Suite 1,  
3rd Floor 11-12 St. James's  
London SW1Y 4LB, United Kingdom  
(770) F. Hoffmann-la Roche AG  
124 Grenzacherstrasse, CH-4002 Basle,  
Switzerland  
(580) 2021 11 24
- 
- (111) M 2007 18086 R  
(732) GSK Consumer Healthcare SARL  
Route de l'Etraz 1197 Prangins,  
Switzerland  
(770) Novartis AG  
CH-4002 Basel, Switzerland  
(580) 2021 12 01
- 
- (111) M 1996 3171 R  
(732) Sanofi Mature IP  
54, ru La Boétie 75008 Paris,  
France  
(770) Aventis Pharma S.A.  
20, avenue Raymond Aron, 92160  
Antony, France  
(580) 2021 11 25
- 
- (111) M 1996 3171 R  
(732) Sanofi-Aventis Deutschland GmbH  
Brüningstrasse 50 65926 Frankfurt  
am Main, Germany
- 
- (770) Sanofi Mature IP  
54, ru La Boétie 75008 Paris, France  
(580) 2021 11 25
- 
- (111) M 1998 9346 R  
(732) Sanofi-Aventis Deutschland GmbH  
Brüningstrasse 50 65926 Frankfurt  
am Main, Germany  
(770) Sanofi Mature IP  
54, ru La Boétie 75008 Paris, France  
(580) 2021 11 25
- 
- (111) M 1998 9346 R  
(732) Sanofi Mature IP  
54, ru La Boétie 75008 Paris, France  
(770) Aventis Pharma S.A.  
20, avenue Raymond Aron, 92160  
Antony, France  
(580) 2021 11 25
- 
- (111) M 2019 30821 R  
(732) "Besini Company" LLC  
Gamrekeli st. 19, Vake-Saburtalo  
District, Tbilisi, Georgia  
(770) LTD "Vite Vera"  
Z. Faliashvili st. 33a, 0179, Tbilisi,  
Georgia  
(580) 2021 11 24
-

## CHANGES OF NAMES AND/OR ADDRESSES OF TRADEMARK OWNER

(111) M 2002 14446 R  
(732) PT Sumatra Tobacco Trading Company  
Jln. Pattimura No3, Pematang Siantar,  
Sumatera Utara, Indonesia  
(770) N.V. Sumatra Tobacco Trading  
Company  
Jln. Pattimura No.3, Pematang Siantar,  
Sumatera Utara, Indonesia  
(580) 2021 11 09

---

(111) M 2002 14504 R  
(732) PT Sumatra Tobacco Trading Company  
Jln. Pattimura No3, Pematang Siantar,  
Sumatera Utara, Indonesia  
(770) N.V. Sumatra Tobacco  
Company  
Jln. Pattimura No3, Pematang Siantar,  
Sumatera Utara, Indonesia  
(580) 2021 11 09

---

(111) M 2011 21998 R  
(732) Yildiz Holding A.S.  
Kısıklı Mahallesi Çeşme ÇıkmaZI,  
Sokak No:6/1, Üsküdar İstanbul,  
Turkey  
(770) Yildiz Holding A.S.  
Kisikli mah. Ferah cad. Cesme sok.  
N2/4 B. Camlica, Uskudar, Istanbul,  
Turkey  
(580) 2021 11 15

---

(111) M 2011 21515 R  
(732) JSC "Insurance Company Alpha"  
Al. Kazbegi Ave. 16, 0160, Saburtalo District,  
Tbilisi, Georgia  
(770) LTD "Insurance Company Alpha"  
Davit Agmashenebeli Ave. 148a, 0112, Tbilisi,  
Georgia  
(580) 2021 10 19

---

(111) M 2011 21969 R  
(732) Yildiz Holding Anonim Sirketi  
Kısıklı Mahallesi Çeşme ÇıkmaZI, Sokak  
No:6/1, Üsküdar İstanbul, Turkey  
(770) Yildiz Holding Anonim Sirketi  
Kisikli Mah. Ferah Cad. Kisikli Cesme  
Sk. No: 2/4 B. Camlica, Uskudar/Istanbul,  
Turkey  
(580) 2021 11 15

---

(111) M 2015 25754 R  
(732) Private Joint-Stock Company "MHP"  
vul. Elevatorna 1, 08800, Myronivka,  
Kyivska obl., Ukraine  
(770) Public Joint Stock Company  
"myronivsky Hliboproduct"  
vul. Elevatorna 1, 08800, Myronivka,  
Kyivska obl., Ukraine  
(580) 2021 11 22

---

(111) M 1997 6556 R  
(732) Groupe Canal +  
50 Rue Camille Desmoulins, 92863  
Issy-Les-Moulineaux Cedex 9, France  
(770) Groupe Canal +  
1 Place du Spectacle, 92130  
Issy Les Moulineaux, France  
(580) 2021 11 03

---

## CANCELLATION OF TRADEMARKS REGISTRATION

(111) M 2011 21456 R (151) 2011 05 16 (732) Lifescan ip Holdings, LLC 360 North Crescent Drive, Beverly Hills, CA 90210, USA (141) 2021 11 24	(141) 2021 11 24
(111) M 2011 21457 R (151) 2011 05 16 (732) JSC "Nobel Ilac Sanayii Ve Ticaret Anonim Sirketi" Representative in Georgia Liberty Square 4, 0105, Tbilisi, Georgia (141) 2021 11 24	(111) M 2011 21435 R (151) 2011 05 11 (732) LTD "Universal Card Corporation" Marjanishvili str. 6, 0102, Tbilisi, Georgia (141) 2021 11 24
(111) M 2011 21432 R (151) 2011 05 11 (732) Shantou S.E.Z. Hai Cheng Cosmetic Co., Ltd. 6 th Floor, building F1, Taihua Industrial District, Fenghuangshan road, Shantou, Guangdong Province, China (141) 2021 11 24	(111) M 2011 21460 R (151) 2011 05 16 (732) Mikheil Manasheridze Gldani 6 <sup>th</sup> mcr. bld. 18, app. 82, Tbilisi, Georgia (141) 2021 11 24
(111) M 2011 21458 R (151) 2011 05 16 (732) Harrington Development Inc. Elvira Mendez Street, Vallarino bldg., 3rd Floor, Panama, Republic of Panama (141) 2021 11 24	(111) M 2011 21437 R (151) 2011 05 11 (732) JSC "Telavi Wine Cellar" Vill. Kurdgelauri, 2200, Telavi, Georgia (141) 2021 11 24
(111) M 2011 21459 R (151) 2011 05 16 (732) Harrington Development Inc. Elvira Mendez Street, Vallarino bldg., 3rd Floor, Panama, Republic of Panama (141) 2021 11 24	(111) M 2011 21461 R (151) 2011 05 16 (732) Maka Metreveli Larsi Lane 3, app. 29, 0179, Tbilisi, Georgia (141) 2021 11 24
(111) M 2011 21433 R (151) 2011 05 11 (732) Harrington Development Inc. Elvira Mendez Street, Vallarino bldg., 3rd Floor, Panama, Republic of Panama (141) 2021 11 24	(111) M 2011 21464 R (151) 2011 05 16 (732) Maka Metreveli Larsi Lane 3, app. 29, 0179, Tbilisi, Georgia (141) 2021 11 24
(111) M 2011 21434 R (151) 2011 05 11 (732) Harrington Development Inc. Elvira Mendez Street, Vallarino bldg., 3rd Floor, Panama, Republic of Panama	(111) M 2011 21466 R (151) 2011 05 16 (732) Aliosha Bakuridze Iakob Nikoladze Lane 2/4, b. 41, 0179, Tbilisi, Georgia (141) 2021 11 24
	(111) M 2011 21469 R (151) 2011 05 16 (732) LTD "Geoplant" Vill. Rukhi, 2100, Sugdidi district, Georgia (141) 2021 11 24

(111) M 2011 21470 R  
(151) 2011 05 16  
(732) LTD "Geoplant"  
Vill. Rukhi, 2100, Sugdidi district, Georgia  
(141) 2021 11 24

---

(111) M 2011 21436 R  
(151) 2011 05 11  
(732) LTD "ji da ji qoofereishen"  
Oniashvili str. 54, 0160, TbilisiGeorgia  
(141) 2021 11 24

---

(111) M 2011 21438 R  
(151) 2011 05 11  
(732) LTD "ji da ji qoofereishen"  
Oniashvili str. 54, 0160, TbilisiGeorgia  
(141) 2021 11 24

---

(111) M 2011 21439 R  
(151) 2011 05 11  
(732) LTD "ji da ji qoofereishen"  
Oniashvili str. 54, 0160, TbilisiGeorgia  
(141) 2021 11 24

---

(111) M 2011 21440 R  
(151) 2011 05 11  
(732) LTD "ji da ji qoofereishen"  
Oniashvili str. 54, 0160, TbilisiGeorgia  
(141) 2021 11 24

---

(111) M 2011 21441 R  
(151) 2011 05 11  
(732) LTD "universal Card Corporation"  
Marjanishvili str. 6, 0102, Tbilisi, Georgia  
(141) 2021 11 24

---

(111) M 2011 21442 R  
(151) 2011 05 11  
(732) LTD "universal Card Corporation"  
Marjanishvili str. 6, 0102, Tbilisi, Georgia  
(141) 2021 11 24

---

(111) M 2011 21443 R  
(151) 2011 05 11  
(732) LTD "universal Card Corporation"  
Marjanishvili str. 6, 0102, Tbilisi, Georgia  
(141) 2021 11 24

---

(111) M 2011 21475 R  
(151) 2011 05 16  
(732) Maka Metreveli  
Larsi Lane 3, app. 29, 0179, Tbilisi, Georgia  
(141) 2021 11 24

---

(111) M 2011 21476 R  
(151) 2011 05 16  
(732) Maka Metreveli  
Larsi Lane 3, app. 29, 0179, Tbilisi, Georgia  
(141) 2021 11 24

---

(111) M 2011 21444 R  
(151) 2011 05 11  
(732) LTD "jimarti"  
Chavchavadze Ave.9, 0179, Tbilisi, Georgia  
(141) 2021 11 24

---

(111) M 2011 21445 R  
(151) 2011 05 11  
(732) LTD "jimarti"  
Chavchavadze Ave. 9, 0179, Tbilisi, Georgia  
(141) 2021 11 24

---

(111) M 2011 21479 R  
(151) 2011 05 16  
(732) Exelixis, Inc., a Delaware corporation  
210 East Grand Avenue, South San  
Francisco, California 94083-0511, USA  
(141) 2021 11 24

---

(111) M 2011 21446 R  
(151) 2011 05 11  
(732) LTD "Geosport"  
Ambrolauri st. 166, bld. 6, app. 24, 0160,  
Tbilisi Georgia  
(141) 2021 11 24

---

(111) M 2011 21447 R  
(151) 2011 05 11  
(732) LTD "teqno bumi"  
Vazha-fshavela Ave. 30a, 0160, Tbilisi,  
Georgia  
(141) 2021 11 24

---

(111) M 2011 21448 R  
(151) 2011 05 11  
(732) LTD "teqno bumi"  
Vazha-fshavela Ave. 30a, 0160, Tbilisi,  
Georgia  
(141) 2021 11 24

---

(111) M 2011 21449 R  
(151) 2011 05 11  
(732) LTD "teqno bumi"  
Vazha-fshavela Ave. 30a, 0160, Tbilisi,  
Georgia  
(141) 2021 11 24

---

(141) 2021 11 30

---

(111) M 2012 23121 R  
(151) 2012 11 29  
(732) LTD "TOBI"  
Rustaveli Ave. 40-40a, 0108, Tbilisi, Georgia  
(141) 2021 11 30 – Canceled by Court Decision

---

(111) M 2011 21450 R  
(151) 2011 05 11  
(732) LTD "teqno bumi"  
Vazha-fshavela Ave. 30a, 0160, Tbilisi,  
Georgia  
(141) 2021 11 24

---

(111) M 2011 21451 R  
(151) 2011 05 11  
(732) Konstantine Zhgenti  
I. Abashidze str. 62, app. 10, 0162, Tbilisi,  
Georgia  
(141) 2021 11 24

---

(111) M 2011 21483 R  
(151) 2011 05 16  
(732) Openrevolution LLC  
1130 Connecticut Avenue, NW, Suite 700,  
Washington, DC 20036, USA  
(141) 2021 11 24

---

(111) M 2011 21484 R  
(151) 2011 05 16  
(732) Openrevolution LLC  
1130 Connecticut Avenue, NW, Suite 700,  
Washington, DC 20036, USA  
(141) 2021 11 24

---

(111) M 2011 21455 R  
(151) 2011 05 16  
(732) Harrington Development Inc.  
Arango-Orillac Bldg., East 54th street,  
Republic of Panama  
(141) 2021 11 24

---

(111) M 2011 21485 R  
(151) 2011 05 20  
(732) Japan Tobacco Inc.  
2-2-1, Toranomom, Minato-ku, Tokyo, Japan  
(141) 2021 11 30

---

(111) M 2011 21486 R  
(151) 2011 05 20  
(732) Japan Tobacco Inc.  
2-2-1, Toranomom, Minato-ku, Tokyo, Japan

---

---

# CLASSIFICATION INDEXES

## INVENTIONS

### CONCORDANCE TABLE OF INTERNATIONAL CLASSIFICATION INDEX AND PUBLICATION NUMBERS

INTERNATIONAL CLASSIFICATION INDEXES (51)	NUMBER OF PUBLISHED APPLICATION (10)
A 61 K 31/415; A 61 P 29/00; C 07 D 241/12; C 07 D 233/64; C 07 D 333/38; C 07 D 333/28; C 07 D 231/56; C 07 D 231/12; C 07 D 333/58; C 07 D 277/56; C 07 D 213/56; C 07 D 495/04	AP 2021 15141 A
A 61 K 31/437; A 61 P 31/12; C 07 D 513/04; C 07 D 519/00	AP 2021 15351 A
A 61 K 31/437; A 61 P 31/12; C 07 D 471/04; C 07 D 471/18; C 07 D 487/04; C 07 D 519/00	AP 2021 15353 A
A 61 K 39/00; C 07 K 16/36	AP 2021 14983 A
A 62 C 2/06	AP 2021 15411 A
C 07 D 209/14; C 07 D 209/16; Z 61 K 31/4045; Z 61 P 25/28	AP 2021 14363 A
F 01 K 25/10; H 02 K 35/02; H 02 K 7/18	AP 2021 15458 A

### CONCORDANCE TABLE OF PUBLICATION NUMBERS AND INTERNATIONAL CLASSIFICATION INDEX

NUMBER OF PUBLISHED APPLICATION (10)	INTERNATIONAL CLASSIFICATION INDEXES (51)
AP 2021 14363 A	C 07 D 209/14; C 07 D 209/16; Z 61 K 31/4045; Z 61 P 25/28
AP 2021 14983 A	A 61 K 39/00; C 07 K 16/36
AP 2021 15141 A	A 61 K 31/415; A 61 P 29/00; C 07 D 241/12; C 07 D 233/64; C 07 D 333/38; C 07 D 333/28; C 07 D 231/56; C 07 D 231/12; C 07 D 333/58; C 07 D 277/56; C 07 D 213/56; C 07 D 495/04
AP 2021 15351 A	A 61 K 31/437; A 61 P 31/12; C 07 D 513/04; C 07 D 519/00
AP 2021 15353 A	A 61 K 31/437; A 61 P 31/12; C 07 D 471/04; C 07 D 471/18; C 07 D 487/04; C 07 D 519/00
AP 2021 15411 A	A 62 C 2/06
AP 2021 15458 A	F 01 K 25/10; H 02 K 35/02; H 02 K 7/18

**CONCORDANCE TABLE OF INTERNATIONAL CLASSIFICATION INDEX,  
PATENT NUMBERS AND PUBLICATION NUMBERS**

INTERNATIONAL CLASSIFICATION INDEX (51)	NUMBER OF PATENT (11)	NUMBER OF PUBLISHED APPLICATION (10)
A 23 C 21/06; A 23 C 1/00; C 13 K 5/00	P 2021 7333 B	AP 2021 15471 A
A 23 C 21/00	P 2021 7334 B	AP 2021 15514 A
A 61 K 31/4375; A 61 P 13/00; A 61 P 9/00; C 07 D 471/04; C 07 D 491/107	P 2021 7332 B	AP 2021 15045 A
A 61 K 31/4439; A 61 P 11/12; C 07 D 498/14; C 07 D 471/14; C 07 D 401/14	P 2021 7329 B	AP 2021 15057 A
A 61 K 31/27; A 61 K 31/438; A 61 K 31/435; C 07 D 403/04; C 07 D 295/205; C 07 D 471/10	P 2021 7327 B	AP 2021 15281 A
A 61 K 39/395; C 07 K 16/28; C 07 K 16/30; C 07 K 16/46	P 2021 7328 B	AP 2021 14828 A
C 07 B 59/00; C 07 D 295/145	P 2021 7330 B	AP 2021 14132 A
C 07 K 16/28; A 61 K 39/395; A 61 P 37/02; A 61 K 39/00	P 2021 7331 B	AP 2021 14450 A

**CONCORDANCE TABLE OF PATENT NUMBERS,  
PUBLICATION NUMBERS AND INTERNATIONAL CLASSIFICATION INDEX**

NUMBER OF PATENT (11)	NUMBER OF PUBLISHED APPLICATION (10)	INTERNATIONAL CLASSIFICATION INDEX (51)
P 2021 7327 B	AP 2021 15281 A	A 61 K 31/27; A 61 K 31/438; A 61 K 31/435; C 07 D 403/04; C 07 D 295/205; C 07 D 471/10
P 2021 7328 B	AP 2021 14828 A	A 61 K 39/395; C 07 K 16/28; C 07 K 16/30; C 07 K 16/46
P 2021 7329 B	AP 2021 15057 A	A 61 K 31/4439; A 61 P 11/12; C 07 D 498/14; C 07 D 471/14; C 07 D 401/14
P 2021 7330 B	AP 2021 14132 A	C 07 B 59/00; C 07 D 295/145
P 2021 7331 B	AP 2021 14450 A	C 07 K 16/28; A 61 K 39/395; A 61 P 37/02; A 61 K 39/00
P 2021 7332 B	AP 2021 15045 A	A 61 K 31/4375; A 61 P 13/00; A 61 P 9/00; C 07 D 471/04; C 07 D 491/107
P 2021 7333 B	AP 2021 15471 A	A 23 C 21/06; A 23 C 1/00; C 13 K 5/00
P 2021 7334 B	AP 2021 15514 A	A 23 C 21/00

**CONCORDANCE TABLE OF APPLICATION NUMBERS,  
PUBLICATION NUMBERS AND PATENTS**

NUMBER OF APPLICATION (21)	NUMBER OF PUBLISHED APPLICATION (10)	NUMBER OF PATENT (11)
AP 2014 14132	AP 2021 14132 A	P 2021 7330 B
AP 2015 14450	AP 2021 14450 A	P 2021 7331 B
AP 2016 14828	AP 2021 14828 A	P 2021 7328 B
AP 2017 15045	AP 2021 15045 A	P 2021 7332 B
AP 2017 15057	AP 2021 15057 A	P 2021 7329 B
AP 2018 15281	AP 2021 15281 A	P 2021 7327 B
AP 2020 15471	AP 2021 15471 A	P 2021 7333 B
AP 2020 15514	AP 2021 15514 A	P 2021 7334 B

**UTILITY MODELS**

INTERNATIONAL CLASSIFICATION INDEXES (51)	NUMBER OF PUBLISHED APPLICATION (10)
A 21 D 10/04; A 21 C 1/00	AU 2021 15552 U

**CONCORDANCE TABLE OF PUBLICATION NUMBERS  
AND INTERNATIONAL CLASSIFICATION INDEX**

NUMBER OF PUBLISHED APPLICATION (10)	INTERNATIONAL CLASSIFICATION INDEXES (51)
AU 2021 15552 U	A 21 D 10/04; A 21 C 1/00

**DESIGNS**

**CONCORDANCE TABLE OF INTERNATIONAL CLASSIFICATION INDEX  
AND PUBLICATION NUMBERS**

INTERNATIONAL CLASSIFICATION INDEXES (51)	NUMBER OF PUBLISHED APPLICATION (10)
06-10	AD 2021 1224 S
09-03	AD 2021 1226 S
11-02	AD 2021 1231 S
12-08	AD 2021 1217 S



CONCORDANCE TABLE OF PUBLICATION NUMBERS  
AND INTERNATIONAL CLASSIFICATION INDEX

NUMBER OF PUBLISHED APPLICATION (10)	INTERNATIONAL CLASSIFICATION INDEXES (51)
AD 2021 1217 S	12-08
AD 2021 1224 S	06-10
AD 2021 1226 S	09-03
AD 2021 1231 S	11-02

## TRADEMARKS

### CONCORDANCE TABLE OF REGISTRATION NUMBERS, APPLICATION NUMBERS, PUBLICATION NUMBERS AND BULLETIN NUMBERS

NUMBER OF REGISTRATION (111)	NUMBER OF APPLICATIONS (210)	NUMBER OF PUBLISHED APPLICATIONS (260)	NUMBER OF BULLETIN
1	2	3	4
M 2021 34764 R	AM 115401	–	22(578)2021
M 2021 34765 R	AM 113683	–	22(578)2021
M 2021 34766 R	AM 115320	–	22(578)2021
M 2021 34767 R	AM 115321	–	22(578)2021
M 2021 34768 R	AM 115509	–	22(578)2021
M 2021 34769 R	AM 115313	–	22(578)2021
M 2021 34770 R	AM 115314	–	22(578)2021
M 2021 34771 R	AM 115315	–	22(578)2021
M 2021 34772 R	AM 115601	–	22(578)2021
M 2021 34773 R	AM 115316	–	22(578)2021
M 2021 34774 R	AM 115317	–	22(578)2021
M 2021 34775 R	AM 115318	–	22(578)2021
M 2021 34776 R	AM 115438	–	22(578)2021
M 2021 34777 R	AM 115592	–	22(578)2021
M 2021 34778 R	AM 115595	–	22(578)2021
M 2021 34779 R	AM 115603	–	22(578)2021
M 2021 34780 R	AM 110029	AM 2021 110029 A	8(564)2021
M 2021 34781 R	AM 110044	AM 2021 110044 A	14(570)2021
M 2021 34782 R	AM 110289	AM 2021 110289 A	9(565)2021
M 2021 34783 R	AM 110290	AM 2021 110290 A	9(565)2021
M 2021 34784 R	AM 110305	AM 2021 110305 A	9(565)2021
M 2021 34785 R	AM 110358	AM 2021 110358 A	14(570)2021
M 2021 34786 R	AM 110443	AM 2021 110443 A	10(566)2021
M 2021 34787 R	AM 110451	AM 2021 110451 A	9(565)2021
M 2021 34788 R	AM 110465	AM 2021 110465 A	10(566)2021
M 2021 34789 R	AM 110466	AM 2021 110466 A	9(565)2021
M 2021 34790 R	AM 110467	AM 2021 110467 A	10(566)2021
M 2021 34791 R	AM 110468	AM 2021 110468 A	9(565)2021
M 2021 34792 R	AM 110469	AM 2021 110469 A	10(566)2021
M 2021 34793 R	AM 110545	AM 2021 110545 A	12(568)2021
M 2021 34794 R	AM 110615	AM 2021 110615 A	11(567)2021
M 2021 34795 R	AM 110880	AM 2021 110880 A	12(568)2021
M 2021 34796 R	AM 110971	AM 2021 110971 A	13(569)2021
M 2021 34797 R	AM 110977	AM 2021 110977 A	14(570)2021
M 2021 34798 R	AM 111158	AM 2021 111158 A	14(570)2021
M 2021 34799 R	AM 111426	AM 2021 111426 A	15(571)2021
M 2021 34800 R	AM 111501	AM 2021 111501 A	15(571)2021
M 2021 34801 R	AM 111502	AM 2021 111502 A	15(571)2021
M 2021 34802 R	AM 111523	AM 2021 111523 A	15(571)2021
M 2021 34803 R	AM 111532	AM 2021 111532 A	15(571)2021
M 2021 34804 R	AM 111533	AM 2021 111533 A	15(571)2021
M 2021 34805 R	AM 111535	AM 2021 111535 A	15(571)2021

**CONCORDANCE TABLE OF PUBLICATION NUMBERS  
AND APPLICATION NUMBERS**

NUMBER OF PUBLISHED APPLICATION (260)	NUMBER OF APPLICATION (210)	1	2
1	2		
AM 2021 110201 A*	AM 110201	AM 2021 112917 A	AM 112917
AM 2021 112185 A	AM 112185	AM 2021 112918 A	AM 112918
AM 2021 112585 A	AM 112585	AM 2021 112919 A	AM 112919
AM 2021 112666 A	AM 112666	AM 2021 112920 A	AM 112920
AM 2021 112667 A	AM 112667	AM 2021 113009 A	AM 113009
AM 2021 112670 A	AM 112670	AM 2021 113033 A	AM 113033
AM 2021 112671 A	AM 112671	AM 2021 113034 A	AM 113034
AM 2021 112677 A	AM 112677	AM 2021 113037 A	AM 113037
AM 2021 112678 A	AM 112678	AM 2021 113038 A	AM 113038
AM 2021 112707 A	AM 112707	AM 2021 113043 A	AM 113043
AM 2021 112708 A	AM 112708	AM 2021 113044 A	AM 113044
AM 2021 112709 A	AM 112709	AM 2021 113045 A	AM 113045
AM 2021 112710 A	AM 112710	AM 2021 113048 A	AM 113048
AM 2021 112711 A	AM 112711	AM 2021 113105 A	AM 113105
AM 2021 112712 A	AM 112712	AM 2021 113106 A	AM 113106
AM 2021 112722 A	AM 112722	AM 2021 113108 A	AM 113108
AM 2021 112723 A	AM 112723	AM 2021 113111 A	AM 113111
AM 2021 112724 A	AM 112724	AM 2021 113112 A	AM 113112
AM 2021 112732 A	AM 112732	AM 2021 113113 A	AM 113113
AM 2021 112835 A	AM 112835	AM 2021 113119 A	AM 113119
AM 2021 112836 A	AM 112836	AM 2021 113124 A	AM 113124
AM 2021 112909 A	AM 112909	AM 2021 113131 A	AM 113131
AM 2021 112910 A	AM 112910	AM 2021 113132 A	AM 113132
AM 2021 112911 A	AM 112911	AM 2021 113134 A	AM 113134
AM 2021 112912 A	AM 112912	AM 2021 113145 A	AM 113145
AM 2021 112913 A	AM 112913	AM 2021 113147 A	AM 113147
AM 2021 112914 A	AM 112914	AM 2021 113183 A	AM 113183
AM 2021 112915 A	AM 112915	AM 2021 113184 A	AM 113184
AM 2021 112916 A	AM 112916	AM 2021 113187 A	AM 113187
		AM 2021 113188 A	AM 113188
		AM 2021 113197 A	AM 113197
		AM 2021 113198 A	AM 113198
		AM 2021 113237 A	AM 113237

CONCORDANCE TABLE OF INDEX OF GOODS AND/OR SERVICES  
AND APPLICATION NUMBERS

INDEX OF GOODS AND/OR SERVICES (511)	NUMBER OF PUBLISHED APPLICATIONS (260)	1	2
1	2		
1	AM 2021 113134 A	16	AM 2021 113108 A
3	AM 2021 112732 A	21	AM 2021 112732 A
3	AM 2021 113105 A	21	AM 2021 113009 A
3	AM 2021 113106 A	21	AM 2021 113037 A
3	AM 2021 113147 A	22	AM 2021 112835 A
3	AM 2021 113237 A	25	AM 2021 112185 A
5	AM 2021 112677 A	25	AM 2021 112835 A
5	AM 2021 112678 A	25	AM 2021 113111 A
5	AM 2021 112732 A	25	AM 2021 113188 A
5	AM 2021 112836 A	25	AM 2021 113237 A
5	AM 2021 112909 A	28	AM 2021 112835 A
5	AM 2021 112910 A	28	AM 2021 113113 A
5	AM 2021 112911 A	29	AM 2021 112723 A
5	AM 2021 112912 A	29	AM 2021 112724 A
5	AM 2021 112913 A	30	AM 2021 112709 A
5	AM 2021 112914 A	30	AM 2021 112723 A
5	AM 2021 112915 A	30	AM 2021 112724 A
5	AM 2021 112916 A	30	AM 2021 113113 A
5	AM 2021 112917 A	30	AM 2021 113113 A
5	AM 2021 112918 A	32	AM 2021 110201 A*
5	AM 2021 112919 A	32	AM 2021 112707 A
5	AM 2021 112920 A	33	AM 2021 110201 A*
5	AM 2021 113105 A	33	AM 2021 112666 A
5	AM 2021 113106 A	33	AM 2021 112667 A
5	AM 2021 113134 A	33	AM 2021 112670 A
5	AM 2021 113183 A	33	AM 2021 112671 A
5	AM 2021 113184 A	33	AM 2021 112710 A
5	AM 2021 113187 A	33	AM 2021 112710 A
5	AM 2021 113197 A	33	AM 2021 113045 A
5	AM 2021 113198 A	34	AM 2021 113043 A
6	AM 2021 112835 A	34	AM 2021 113044 A
7	AM 2021 113009 A	35	AM 2021 112710 A
7	AM 2021 113037 A	35	AM 2021 112723 A
7	AM 2021 113124 A	35	AM 2021 112724 A
7	AM 2021 113131 A	35	AM 2021 113009 A
7	AM 2021 113132 A	35	AM 2021 113108 A
8	AM 2021 112835 A	35	AM 2021 113112 A
8	AM 2021 113009 A	35	AM 2021 113237 A
8	AM 2021 113037 A	37	AM 2021 112585 A
8	AM 2021 113124 A	37	AM 2021 112722 A
9	AM 2021 112185 A	38	AM 2021 112185 A
9	AM 2021 112708 A	38	AM 2021 113048 A
9	AM 2021 112711 A	41	AM 2021 113048 A
9	AM 2021 112712 A	41	AM 2021 113111 A
9	AM 2021 113145 A	41	AM 2021 113119 A
11	AM 2021 113009 A	42	AM 2021 112185 A
11	AM 2021 113037 A	42	AM 2021 112711 A
11	AM 2021 113038 A	42	AM 2021 112712 A
		42	AM 2021 113033 A
		43	AM 2021 112723 A
		43	AM 2021 112724 A
		43	AM 2021 113119 A
		44	AM 2021 113034 A

CONCORDANCE TABLE OF INDEX OF GOODS AND/OR SERVICES  
AND NUMBERS OF TRADEMARKS REGISTERED ACCORDING  
TO THE ACCELERATED PROCEDURE

INDEX OF GOODS AND/OR SERVICES (511)	NUMBERS OF REGISTERED ACCORDING TO THE ACCELERATED PROCEDURE (111)
5	M 2021 34778 R
5	M 2021 34779 R
9	M 2021 34766 R
9	M 2021 34767 R
16	M 2021 34766 R
16	M 2021 34767 R
19	M 2021 34769 R
19	M 2021 34770 R
19	M 2021 34771 R
19	M 2021 34773 R
19	M 2021 34774 R
19	M 2021 34775 R
25	M 2021 34766 R
28	M 2021 34766 R
29	M 2021 34776 R
32	M 2021 34764 R
33	M 2021 34765 R
33	M 2021 34776 R
35	M 2021 34766 R
35	M 2021 34767 R
35	M 2021 34778 R
35	M 2021 34779 R
36	M 2021 34768 R
36	M 2021 34777 R
38	M 2021 34766 R
38	M 2021 34767 R
41	M 2021 34766 R
41	M 2021 34767 R
42	M 2021 34766 R
42	M 2021 34767 R
43	M 2021 34772 R

# OFFICIAL BULLETIN OF THE INDUSTRIAL PROPERTY

**INVENTIONS  
UTILITY MODEL  
DESIGNS  
TRADEMARKS**

**22(578)**

EDITOR-IN-CHIEF: N. Bebrishvili

EDITOR-TRANSLATOR: E. Gabunia

PROOFREADER: A. Shikhashvili

COMPUTER LAYOUT: K. Svanidze

[info@sakpatenti.gov.ge](mailto:info@sakpatenti.gov.ge)  
[www.sakpatenti.gov.ge](http://www.sakpatenti.gov.ge)