

Official Bulletin of the Industrial Property

Inventions

Utility Models

Designs

Trademarks



საქართველოს ინტელექტუალური
საკუთრების ეროვნული ცენტრი

საქპატენტი

SAKPATENTI

NATIONAL INTELLECTUAL PROPERTY
CENTER OF GEORGIA

www.sakpatenti.gov.ge

Date of Publication – 2022 02 25

4(583)

INID CODES FOR IDENTIFICATION OF BIBLIOGRAPHIC DATA

INVENTIONS, UTILITY MODELS

- (10) Number of publication for application, which has been examined
- (11) Number of patent and kind of document
- (21) Serial number of application
- (22) Date of filing of the application
- (23) Date of exhibition or the date of the earlier filing and the number of application, if any
- (24) Date from which patent may have effect
- (31) Number of priority application
- (32) Date of filing of priority application
- (33) Code of the country or regional organization allotting priority application number
- (44) Date of publication of application not granted, but examined and number of bulletin
- (45) Date of publication of registered document
- (51) International Patent Classification Index

- (54) Title of the invention
- (57) Abstract
- (60) Number of examined patent document granted by foreign patent office, date from which patent has effect and country code
- (62) Number of the earlier application and in case of divided application, date of filing an application
- (71) Name, surname and address of applicant (country code)
- (72) Name, surname of inventor (country code)
- (73) Name, surname and address of patent owner (country code)
- (74) Name, surname of representative or patent attorney
- (85) Date of commencement of the national phase of International Application
- (86) Number and date of filing of international application
- (87) Number and date of publication of international application
- (94) Calculated date of expiry of the SPC or the duration of the SPC

DESIGNS

- (10) Number of publication for application
- (11) Number of patent and kind of document or number of registration
- (15) Date of registration/Date of patent renewal
- (18) Expected expiration date of patent or registration
- (21) Serial number of application
- (22) Date of filing of the application
- (23) Date of exhibition or the date of the earlier filing and the number of application, if any
- (24) Date from which patent may have effect
- (28) Number of designs included in the application
- (30) Data relating to priority (number of application, date of filing of application, two-letter code identifying the authority with whom the priority application was made)
- (31) Number of priority application
- (32) Date of filing of priority application
- (33) Code of the country or regional organization allotting priority application number
- (34) Two-letter code according to WIPO St.3 identifying the authority with which the priority application was made
- (44) Date of publication of design and number of bulletin (the first publication)
- (45) Date of publication of design registered by WIPO and number of bulletin

- (51) International Classification for designs (class and subclass of the Locarno Classification)
- (54) Title of the invention
- (55) Reproduction of the design
- (57) Description of characteristic features of the design including indication of colors
- (58) Date of recording of any kind of amendment in the Register
- (62) Number of the earlier application, registration and document number and if available the date of filing an application in case of divided application
- (71) Name, surname and address of applicant (country code)
- (72) Name, surname of creator (country code)
- (73) Name, surname and address of patent owner (country code)
- (74) Name, surname of representative or patent attorney
- (81) Contracting states concerned
 - II designated contracting states according to the 1960 Act
 - III designated contracting states according to the 1999 Act
- (85) Owner's permanent address
- (86) Owner's nationality
- (87) Owner's residence
- (88) State in which the owner has a real and effective industrial or commercial establishment

TRADEMARKS

- (111) - Number of registration
- (151) - Date of registration
- (156) - Date of the renewal
- (181) - Expected expiration date of registration
- (186) - Renewal expiration date of registration
- (141) - Date of cancel of duration of the mark
- (210) - Serial number of application
- (220) - Date of filing of the application
- (230) - Data concerning exhibition
- (260) - Number of application, for which favorable decision of examination about registration has been taken (publication number)
- (310) - Number of the first application
- (320) - Date of filing of the first application
- (330) - Code, identifying national or regional Office where the first application was made
- (511) - International Classification of Goods and Services for the purposes of registration of trade marks and/or list of goods and/or services classified according thereto
- (526) - Disclaimer
- (531) - Description of figurative elements of Trade Marks according to the International Classification of the Figurative Elements of Marks

- (540) - Reproduction of Trade Mark
- (550) - Nature and kind of Trade Mark
- (551) - Indication to the effect that the mark is a collective mark, a certification mark or a guarantee mark
- (554) - Three-dimensional mark
- (580) - Date of recording of any kind changes in respect of applications or registrations
- (591) - Information concerning colors claimed
- (731) - Name and address of the applicant
- (732) - Name and address of the holder of the registration
- (740) - Name and address of the representative
- (750) - Addreses for correspondence
- (770) - Name and address of the previous applicant or holder in case of change in ownership
- (771) - Previous name and address of the applicant or holder in case of change in ownership
- (791) - Name and address of the licensee
- (793) - Indication of conditions and/or restrictions under the license (Type of license, number of license agreement, data of license, data of validity of license)
- (800) - Certain data relating to the international registration of Trade Marks under the Protocol Relating to Madrid Agreement (International registration number
- (852) - Partial cancellation of the list of goods and services
- (891) - Date of subsequent designation

CODES FOR PUBLICATION IN BULLETIN

- (21) AP 0000 000000 - serial number of application for invention
- (10) AP 0000 0000 A - number of published application for invention (first publication)
- (11) P 0000 0000 B - number of patent for invention (second publication)
- (21) API 0000 000000 - number of application for imported patent
- (11) PI 0000 0000 A - number of imported patent (first publication)
- (21) AU 0000 000000 - serial number of application for utility model
- (10) AU 0000 000 U - number of published application for utility model (first publication)
- (11) U 0000 000 Y - number of patent for utility model (second publication)
- (21) AD 0000 000000 - serial number of application for design
- (10) AD 0000 000 S - number of published application for design (first publication)
- (11) D 0000 000 S - registered design

INTERNATIONAL PATENT CLASSIFICATION FOR INVENTIONS AND UTILITY MODELS

- SECTION A - HUMAN NECESSITIES
- SECTION B - PERFORMING OPERATIONS; TRANSPORTING
- SECTION C - CHEMISTRY; METALLURGY
- SECTION D - TEXTILES; PAPER
- SECTION E - FIXED CONSTRUCTIONS
- SECTION F - MECHANICAL ENGINEERING; LIGHTING; HEATING; WEAPONS; BLASTING
- SECTION G - PHYSICS
- SECTION H - ELECTRICITY

-
- M - Trade Mark
 - (210) AM 0000 000000 - Serial number of application;
 - (260) AAM 0000 00000 A - Publication number of application;
 - (111) M 0000 00000 R - Number of registration;
 - (111) MMM0000 00000 Rn - Number of renewals, in which n=1,2,3;
 - (111) M 0000 00000 R(P) - Number of registration under partial assignment of rights
-

Official Bulletin of the Industrial Property

Inventions

Utility Models

Designs

Trademarks

CONTENT

PUBLISHED TITLES OF PROTECTION	3
INVENTIONS	
▪ APPLICATIONS APPROVED FOR GRANTING PATENT	4
▪ PATENTED INVENTIONS	7
UTILITY MODELS	
▪ APPLICATIONS APPROVED FOR GRANTING PATENT	9
▪ PATENTED UTILITY MODELS	10
DESIGNS	
▪ APPLICATIONS APPROVED FOR REGISTRATION	11
▪ REGISTERED DESIGNS	13
▪ DESIGNS, WHICH HAVE BEEN REGISTERED WITH THE INTERNATIONAL BUREAU CLAIMING PRIORITY ON THE TERRITORY OF GEORGIA	14
TRADEMARKS	
▪ APPLICATIONS FILED UNDER THE NATIONAL PROCEDURE APPROVED FOR REGISTRATION	23
▪ REGISTERED TRADEMARKS	33
▪ TRADEMARKS REGISTERED ACCORDING TO THE ACCELERATED PROCEDURE	38
▪ INTERNATIONAL TRADEMARKS FOR WHICH A DECISION ON GRANTING PROTECTION IS TAKEN	43
▪ INTERNATIONAL TRADEMARKS PROTECTED IN GEORGIA	112
OFFICIAL NOTIFICATIONS	
INVENTIONS	
▪ RESTORATION OF PATENTS	121
▪ ABOLITION OF PATENTS WITH THE RIGHT TO RESTORE	121
▪ EXPIRATION OF TERMS OF RESTORATION OF PATENTS	124
▪ CHANGES OF NAMES AND/OR ADDRESSES OF PATENTOWNERS	125
UTILITY MODELS	
▪ RESTORATION OF PATENTS	125
▪ ABOLITION OF PATENTS WITH THE RIGHT TO RESTORE	126
▪ EXPIRATION OF TERM OF RESTORATION OF PATENT	126
DESIGNS	
▪ EXTENSION OF TERMS OF DESIGN REGISTRATION	127
▪ CANCELLATION OF DESIGN REGISTRATION	127
▪ EXTENSION OF TERMS OF INTERNATIONAL DESIGNS REGISTRATION	127
TRADEMARKS	
▪ EXTENSION OF TERMS OF TRADEMARKS REGISTRATION	130
▪ COMPLETE TRANSFER OF RIGHTS	132
▪ CHANGES OF NAMES AND/OR ADDRESSES OF TRADEMARK OWNER	133
▪ CANCELLATION OF TRADEMARKS REGISTRATION	135
▪ REGISTRATION OF LICENSE AGREEMENT	136
▪ INTERNATIONAL LICENSES AGREEMENTS	137
CLASSIFICATION INDEXES	
INVENTIONS	139
UTILITY MODELS	140
DESIGNS	142
TRADEMARKS	143

PUBLISHED TITLES OF PROTECTION

INVENTIONS

- **APPLICATIONS APPROVED FOR GRANTING PATENT:**
14391; 15228; 13376; 15592; 15368
- **PATENTED INVENTIONS:**
7352-7358

UTILITY MODELS

- **APPLICATIONS APPROVED FOR GRANTING PATENT:**
15602; 15807
- **PATENTED UTILITY MODELS:**
2109, 2110

DESIGNS

- **APPLICATIONS APPROVED FOR REGISTRATION:**
1240; 1235
- **REGISTERED DESIGN:**
923
- **DESIGNS, WHICH HAVE BEEN REGISTERED WITH THE INTERNATIONAL BUREAU CLAIMING PRIORITY ON THE TERRITORY OF GEORGIA:**
217760; 217890; 215129

TRADEMARKS

- **APPLICATIONS FILED UNDER THE NATIONAL PROCEDURE APPROVED FOR REGISTRATION:**
109851; 111082; 111712; 112507; 112698, 112699; 113139; 113427, 113428; 113694; 113703; 113765; 113771; 113778, 113779; 113783; 113787; 113790, 113791; 113793; 113846; 113848; 113854; 113866; 113868-113870; 113882, 113883; 113885, 113886; 113888, 113889; 113973; 113976; 113979; 114003; 114034, 114035; 114037, 114038; 114042; 114044; 114050; 114052; 114060; 114063; 114135, 114136; 114140, 114141; 114146; 114149; 114234-114236; 114238; 114309; 114311
- **REGISTERED TRADEMARKS:**
35040-35057; 35073-35106
- **TRADEMARKS REGISTERED ACCORDING TO THE ACCELERATED PROCEDURE:**
35035-35039; 35058-35972; 35107
- **INTERNATIONAL TRADEMARKS FOR WHICH A DECISION ON GRANTING PROTECTIONS IS TAKEN:**
105478*; 109313; 109714; 111777; 111780; 112438; 112463; 112516; 112533; 112535; 112563; 112573; 112629; 112758; 112798; 112801; 112826-112830; 112853; 112855-112858; 112872; 112874-112876; 112880-112883; 112885-112888; 112946-112949; 112951-112953; 112955, 112956; 112958; 112963, 112964; 112966, 112967; 112972, 112973; 112983; 112987, 112988; 112990-112992; 113005; 113052; 113061; 113063-113066; 113080-113085; 113089-113091; 113153-113157; 113159-113163; 113174; 113176; 113288-113290; 113294-113297; 113302, 113303; 113305-113313; 113438; 113440, 113441; 113443; 113454-113457; 113481; 113530, 113531; 113563; 113565; 113567; 113570-113575; 113673-113675; 113715; 113731; 113743
- **INTERNATIONAL TRADEMARKS PROTECTED IN GEORGIA:**
110739; 110993; 111115; 111128; 111134; 111223; 111298-111302; 111349-111355; 111384; 111386; 111456-111460; 111490; 111494; 111549; 111551; 111554; 111556; 111576; 111621; 111626; 111651; 111665, 111666; 111686, 111687; 111767, 111768; 111771, 111772; 111776; 111778; 111792-111800; 111807; 111809; 111811, 111812; 111814; 111822-111825; 111832; 111886; 111900; 111904; 111915-111917; 111919; 111980-111982; 111992-111994; 112000, 112001; 112004; 112011; 112014; 112016; 112018, 112019; 112022; 112030, 112031; 112111; 112121-112125; 112127, 112128; 112130-112132; 112197, 112198; 112202; 112219, 112220; 112226, 112227; 112229-112235; 112323; 112337, 112338; 112346-112352

INVENTIONS

APPLICATIONS APPROVED FOR GRANTING PATENT

The decision can be appealed at the Chamber of Appeal of Sakpatenti within 3 months from the publication or at the Mtskheta District Court Administrative Cases Board (Address: №17, Samkhedro St., Mtskheta), within 1 month following the publication.

PART A

A 01

- (10) AP 2022 14391 A (51) Int. Cl. (2006)
A 01 N 25/02
A 01 N 25/04
A 01 N 25/16
A 01 N 53/00
A 01 P 7/04
- (21) AP 2015 14391 (22) 2015 06 24
(31) 62/016,242
(32) 2014 06 24
(33) US
- (71) FMC Corporation (US)
2929 Walnut Street, Philadelphia,
PA 19104 (US)
- (72) BIRD, David (US);
MARTIN, Timothy, M. (US);
YAN, Laibin, B. (US)
- (74) Tamaz Shilakadze
(85) 2017 01 23
(86) PCT/US2015/037327, 2015 06 24
- (54) FOAM FORMULATIONS AND
EMULSIFIABLE CONCENTRATES
- (57) Present invention is directed to agricultural formulations containing agriculturally active ingredients in suitable solvent system for generating foam containing formulations for application in a furrow in the form of foam, wherein agriculturally active ingredient may be an insecticide, a pesticide, a fungicide, an herbicide, a fertilizer, or a combination thereof.
- Claims: 3 independents
41 dependents
- Table: 5
-

A 61

- (10) AP 2022 15228 A (51) Int. Cl. (2006)
A 61 F 13/00
A 61 F 13/49
- (21) AP 2017 15228 (22) 2017 12 26
(31) 2017/01975
(32) 2017 09 02
(33) TR
- (71) Evyap Sabun Yag Gliserin Sanayi Ve
Ticaret Anonim Sirketi (TR)
Istanbul Deri Organize Sanayi Bolgesi Guderli
Caddesi No: X-1 Ozel Parsel Tuzla, Istanbul,
Turkey (TR)
- (72) ERTAN, Asli (TR);
BEKTAS, Cagla (TR)
- (74) Tamaz Shilakadze
(85) 2019 11 27
(86) PCT/TR2017/050698, 2017 12 26
- (54) ACQUISITION AND DISTRIBUTION
LAYER FOR DIAPERS
- (57) Acquisition and distribution layer (1) comprises upper layer (2) comprising of semi-hydrophilicity and/or hydrophobicity cross-combed fibers, and lower layer (3) comprising of high hydrophilicity oriented fibers having longitudinally connected comb. The ratio of fiber concentration used in upper layer to obtain capillary concentration gradient to fiber concentration used in lower layer is 2-10, and fluid absorption time to obtain the hydrophilicity gradient between upper and lower layers is preferably 2-15 sec.
- Claims: 1 independent
9 dependents

Fig.: 1

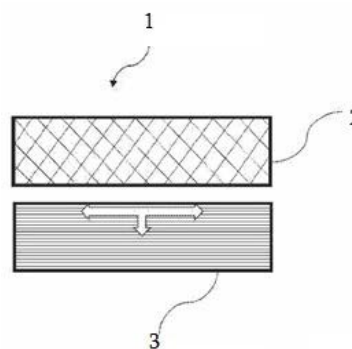
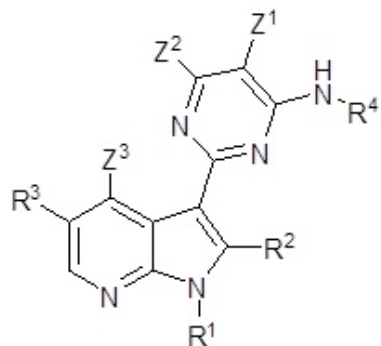

Fig. 1

- (10) AP 2022 13376 A (51) Int. Cl. (2006)
A 61 K 31/506
A 61 P 31/16
- (21) AP 2010 13376 (22) 2010 06 17
(62) AP201012538
(31) 61/287,781; 61/187,713
(32) 2009 12 18; 2009 06 17
(33) US; US
- (71) Vertex Pharmaceuticals Incorporated (US)
130 Waverly Street, Cambridge, MA 02139 (US)
- (72) CHARIFSON, Paul (US);
CLARK, Michael, P. (US);
BANDARAGE, Upul, K. (US);
BETHIEL, Randy, S. (US);
COURT, John, J. (US);
DENG, Hongbo (CN);
DRUTU, Ioana (RO);
DUFFY, John, P. (US);
FARMER, Luc (CA);
GAO, Huai (CN);
GU, Wenxin (CN);
JACOBS, Dylan, H. (US);
SALITURO, Francesco G. (US);
KWONG, Ann Dak-Yee (US)
- (74) Shalva Gvaramadze
(85) 2014 02 03
(86) PCT/US2010/038988, 2010 06 17
- (54) INHIBITORS OF INFLUENZA
VIRUSES REPLICATION
- (57) An invention relates to compounds of formula (1A),



pharmaceutically acceptable salts, and preparation methods thereof. The invention relates to compositions containing them, and their usage against influenza viruses, as well.

Claims: 4 independents
29 dependents
Fig.: 8

- (10) AP 2022 15592 A (51) Int. Cl. (2006)
A 61 K 31/4184
A 61 K 31/4365
A 61 K 9/00
A 61 P 1/04
A 61 P 7/02
- (21) AP 2019 15592 (22) 2019 08 27
(31) 10-2018-0101047

- (32) 2018 08 28
(33) KR
- (71) HK INNO.N Corporation (KR)
6F, 7F, 8F, 100, Eulji-ro, Jung-Gu Seoul 04551, Korea (KR)
- (72) CHO, Tae Keun (KR);
CHO, Young Dae (KR);
KWON, Eunji (KR);
SHIN, Myung Jin (KR)
- (74) Shalva Gvaramadze
(85) 2021 03 25
(86) PCT/KR2019/010891, 2019 08 27
- (54) PHARMACEUTICAL COMPOSITION
COMPRISING ANTIPLATELET AGENT
AND GASTRIC ACID SECRETION
INHIBITOR
- (57) Pharmaceutical composition comprises clopidogrel or pharmaceutically acceptable salts thereof; and compound of formula 1 or pharmaceutically acceptable salts thereof.

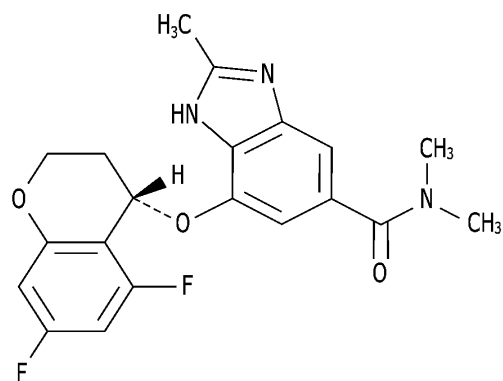

Claims: 4 independents
18 dependents
Fig.: 11

PART B

B 07

- (10) AP 2022 15368 A (51) Int. Cl. (2006)
B 07 B 1/28
B 07 B 1/42
B 07 B 1/46
- (21) AP 2020 15368 (22) 2020 06 16
- (71) Viktor Zviadauri (GE)
Vazha-Pshavela Ave., V qu., bld. 4, app. 79,
Tbilisi, Georgia (GE);
Tengiz Nadiradze (GE)
Bakhtrioni St. 7a, app. 33, Tbilisi, Georgia (GE);
Giorgi Tumanishvili (GE)
Didi Dighomi, III mcr., bld. 4, app. 65, 0131,
Tbilisi, Georgia (GE);
Tamaz Natriashvili (GE)

Panaskerteli St. 17, app. 4, 0194, Tbilisi,
 Georgia (GE);
 Davit Sakhvadze (GE)
 Saiatnova St. 1, Tbilisi, Georgia (GE)

(72) Viktor Zviadauri (GE);
 Tengiz Nadiradze (GE);
 Giorgi Tumanishvili (GE);
 Tamaz Natriashvili (GE);
 Davit Sakhvadze (GE)

(54) DEVICE FOR POWDERED BINDING
 MATERIAL DOSAGE SUPPLEMENT
 FROM HOPPER, TRANSPORTATION
 AND SCREENING THEREOF

(57) A device includes a hopper 1, on the neck wall thereof the perforated tube 4 is screwed radially, a vibrator 2 is fastened on to the wall, and changeable dosator or a plug 5 is axially screwed into the end of neck; at that, draugh cuts 6, whereon screening grid 7 is stretched and fixed, are made on vibroscreen 3 bottom; furthermore, the device includes flexible kronstein 9 fastened onto the vibroscreen case with a clamp 8, and power unit 11 with widened perforated 12 outlet thereof is placed into the clamp 10 disposed on another end; at that, a hose 14 passing out from water pump 13 is connected to power unit 11 placed into flexible kronstein clamp, and another hose 15 – to perforated tube 4 fastened into hopper neck wall.

Claims: 1 independent

Fig.: 2

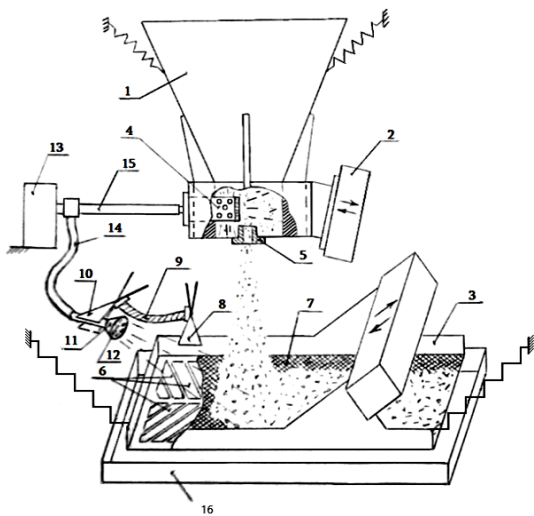

Fig. 1

PATENTED INVENTIONS

PART A

A 61

- (11) P 2022 7354 B (51) Int. Cl. (2006)
A 61 K 31/454
A 61 P 11/00
A 61 P 17/06
A 61 P 19/02
A 61 P 29/00
- (10) AP 2021 15467 A (44) 18(574)/2021
(21) AP 2018 15467
(22) 2018 03 06
(24) 2018 03 06
(62) AP 2018 15309 2018 03 06
(31) 2017131435
(32) 2017 09 07
(33) RU
(86) PCT/RU2018/000135, 2018 03 06
(73) Obschestvo s Ogranichennoy Otvetstvennostiyu "Pharmenterprises" (Ru)
Skolkovo Innovation Centre, Bolshoj Blvd., 42,
Bld. 1, Office 771, 772, 121205, Moscow,
Russian Federation (RU)
(72) RYDLOVSKAYA, Anastasia Vladimirovna (RU);
NEBOLSIN, Vladimir Evgenievich (RU)
(74) Shalva Gvaramadze
(54) USE OF A GLUTARIMIDE DERIVATIVE
TO TREAT DISEASES RELATED TO THE
ABERRANT ACTIVITY OF CYTOKINES

- (11) P 2022 7353 B (51) Int. Cl. (2006)
A 61 K 31/4985
A 61 K 31/5365
A 61 K 31/424
A 61 P 31/18
C 07 D 487/16
C 07 D 498/16
- (10) AP 2021 15121 A (44) 17(573)/2021
(21) AP 2017 15121
(22) 2017 11 30
(24) 2017 11 30
(31) 62/429,470
(32) 2016 12 02
(33) US
(86) PCT/US2017/063831, 2017 11 30
(73) Merck Sharp & Dohme Corp. (US)
126 East Lincoln Ave. Rahway,
NJ 07065-0907, USA (US)
(72) ZHANG, Yonglian (US);
MCCAULEY, John, A. (US);
YU, Tao (US);
GRAHAM, Thomas, H. (US)

- (74) Shalva Gvaramadze
(54) TETRACYCLIC HETEROCYCLE
COMPOUNDS USEFUL AS HIV
INTEGRASE INHIBITORS

- (11) P 2022 7357 B (51) Int. Cl. (2006)
A 61 K 31/519
A 61 K 31/5377
A 61 K 31/55
A 61 P 35/00
A 61 P 45/06
- (10) AP 2021 15242 A (44) 20(576)/2021
(21) AP 2018 15242
(22) 2018 06 21
(24) 2018 06 21
(31) 62/523,389; 17189550.1
(32) 2017 06 22; 2017 09 06
(33) US; EP
(86) PCT/EP2018/066551, 2018 06 21
(73) Novartis AG (CH)
Lichtstrasse 35, Basel, 4056, Switzerland (CH);
Les Laboratoires Servier (FR)
35, Rue de Verdun, Suresnes Cedex, 92284,
France (FR)
(72) WEI, Andrew (AU);
MOUJALLED, Donia (AU);
POMILIOO, Giovanna (AU);
GENESTE, Olivier (FR);
MARAGNO Ana-Leticia (FR)
(74) Tamaz Shilakadze
(54) COMBINATION OF MCL-1 INHIBITOR
AND STANDARD OF CARE TREATMENT
FOR HEMATOLOGIC CANCERS, USES
AND ASSOCIATED PHARMACEUTICAL
COMPOSITIONS

PART B

B 62

- (11) P 2022 7356 B (51) Int. Cl. (2006)
B 62 D 55/075
- (10) AP 2021 15450 A (44) 19(575)/2021
(21) AP 2020 15450
(22) 2020 09 18
(24) 2020 09 18
(73) LEPL "Technical University Of Georgia" (GE)
M. Kostava St. 77, 0109, Tbilisi, Georgia (GE)
(72) Zviadi Ghvianiashvil (GE);
Tamaz Dzaganian (GE);
Mikheil Janikashvili (GE);

Davit Tavkheldze (GE);
Niko Nebieridze (GE);
Vazha Kiria (GE)

(74) Tamazi Urtmelidze

(54) VEHICLE FOR DISABLE PERSONS'
WHEELCHAIRS MOTION UP-DOWN ONTO
STAIRS

PART C

C 07

(11) P 2022 7358 B (51) Int. Cl. (2006)
C 07 C 273/04
B 01 D 19/00
B 01 D 5/00
C 07 C 273/14
F 28 D 7/06
F 28 F 21/08
F 28 F 9/02

(10) AP 2021 15347 A (44) 16(572)/2021

(21) AP 2018 15347

(22) 2018 10 26

(24) 2018 10 26

(31) 17198990.8

(32) 2017 10 27

(33) EP

(86) PCT/NL2018/050711, 2018 10 26

(73) Stamicarbon B.V. (NL)

Mercator 3, Sittard NL-6135 KW,
Netherlands (NL)

(72) POPA, Dorin (NL)

(74) Liliana Darakhvelidze

(54) HIGH PRESSURE CARBAMATE
CONDENSER

(54) GAS DETECTOR

G 09

(11) P 2022 7352 B (51) Int. Cl. (2006)
G 09 B 1/00

(10) AP 2021 15438 A (44) 19(575)/2021

(21) AP 2019 15438

(22) 2019 02 24

(24) 2019 02 24

(31) 15/906,374

(32) 2018 02 27

(33) US

(86) PCT/US2019/019329 , 2019 02 24

(73) RANKINE, Anthony, John (US)

5072 16 Street, Dr. The Northern-East 28601
Hikory, North Carolina, USA (US)

(72) RANKINE, Anthony, John (US)

(74) Shalva Gvaramadze

(54) BEAD-ON-TILE APPARATUS AND
METHODS

PART G

G 01

(11) P 2022 7355 B (51) Int. Cl. (2006)
G 01 N 27/12

(10) AP 2021 15196 A (44) 16(572)/2021

(21) AP 2019 15196

(22) 2019 10 15

(24) 2019 10 15

(73) LEPL "Georgian Technical University" (GE)

M. Kostava St. 77, 0175, Tbilisi, Georgia (GE)

(72) Iuri Khutashvili (GE);

Archil Prangishvili (GE);

Nugzar Iashvili (GE)

(74) Givi Sibashvili

UTILITY MODELS

APPLICATIONS APPROVED FOR GRANTING PATENT

The decision can be appealed at the Chamber of Appeal of Sakpatenti within 3 months from the publication or at the Mtskheta District Court Administrative Cases Board (Address: №17, Samkhedro St., Mtskheta), within 1 month following the publication.

PART C

C 12

(10) AU 2022 15602 U (51) Int. Cl. (2006)
C 12 G 1/06

(21) AU 2021 15602 (22) 2021 04 13

(71) Teimuraz Lomsadze (GE)
Sairme St. 5, app. 27, 0194, Tbilisi,
Georgia (GE)

(72) Teimuraz Lomsadze (GE)

(74) Shalva Gvaramadze

(54) METHOD FOR SPAKLING WINE
PRODUCTION

(57) A method provides basic dry wine production with fermentation of juice received by white grape clusters pressing in the qvevri (wine jar), wine olding, lees removal, filtration, assemblage, blending with yeast-enriched circulation liqueur, circulation thereof, secondary fermentation therein horizontally disposed bottles, olding therein, and the bottles replacement at the time of wine olding, the bottles putting into wine stand, remuage (riddling), bottle neck freezing, disgorging, introducing therein expeditionary liquer, made with wine spirit delaed on white grape seeds, and bottles sealing.

Claims: 1 independent

rings 6 and 7 having different diameters. Leaning on a wall the decorative bowl 8 made with refractory clay is fastened with, at least, one ring forming the frame. Qvevri-shaped decorative component 9 is placed in capacity knot, whereon, at least, three extractions 10 are executed. Said stems of capacity knot are disposed along the edges formed by extractions. A cartridge with placed inside thereof the light source is executed in central part of qvevri-shaped decorative component.

Claims: 1 independent

4 dependents

Fig.: 2

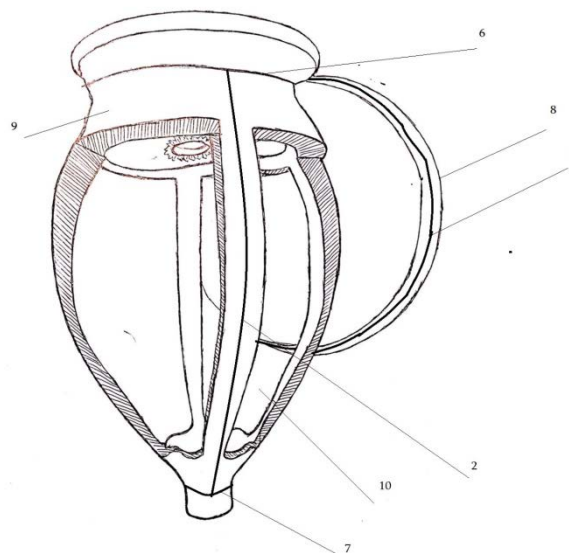

Fig. 1

PART F

F 21

(10) AU 2022 15807 U (51) Int. Cl. (2006)
F 21 S 8/00

(21) AU 2021 15807 (22) 2021 11 26

(71) Zurab Asashvili (GE)
Davit Aghmashenebeli St. 33, Vill.
Dighomi, Tbilisi, Georgia (GE)

(72) Zurab Asashvili (GE)

(54) DECORATIVE LAMP

(57) Decorative lamp includes metallic frame, and longitudinal component connected thereto, wherein the frame is formed as, at least, one ring 1, and longitudinal component is executed with, at least, four stems 2, 3, 4, 5 formed as capacity knot. At least, knot four stems connection is provided with

PATENTED UTILITY MODELS

PART C

C 04

- (11) U 2022 2110 Y (51) Int. Cl. (2006)
C 04 B 14/10
C 04 B 14/12
C 04 B 14/38
C 04 B 20/04
C 04 B 20/06
- (10) AU 2021 15434 U (44) 19(575)/2021
(21) AU 2020 15434
(22) 2020 09 03
(24) 2020 09 03
- (73) LEPL "Technical University Of Georgia" (GE)
M. Kostava St. 77, 0109, Tbilisi, Georgia (GE);
LEPL "Shota Rustaveli National Scientific
Foundation" (GE)
Merab Aleksidze St. II Lane 2, 0193, Tbilisi,
Georgia (GE)
- (72) Elene Shapakidze (GE);
Ioseb Gejadze (GE);
Merab Abazadze (GE);
Malkhaz Turdzeladze (GE);
Shalva Verulava (GE);
Razhden Skhvitaridze (GE);
Teimuraz Cheishvili (GE);
Akaki Skhvitaridze (GE)
- (54) METHOD FOR CEMENT-CONCRETE
FILLER PREPARATION WITH CLAY
MATERIAL THERMAL MODIFICA-
TION AND FILLING
-

PART E

E 04

- (11) U 2022 2109 Y (51) Int. Cl. (2006)
E 04 B 1/00
- (10) AU 2021 15425 U (44) 17(573)/2021
(21) AU 2020 15425
(22) 2020 08 26
(24) 2020 08 26
- (73) Roland Zhorzholiani (GE)
Vill. Kochara, 0121, Ochamchire Region,
Georgia (GE)
- (72) Roland Zhorzholiani (GE)
- (54) COASTLINE ANTI-LANDSLIDE FAST
CONSTRUCTING WALL
-

DESIGNS

APPLICATIONS APPROVED FOR REGISTRATION

The decision can be appealed at the Chamber of Appeal of Sakpatenti within 3 months from the publication or at the Mtskheta District Court Administrative Cases Board (Address: №17, Samkhedro str., Mtskheta), within 1 month following the publication.

- (10) AD 2022 1240 S (51) 02-02
(21) AD 2021 1240 (22) 2021 10 04
(28) 2
(71) Teimuraz Murvanidze (GE)
S. Virsaladze St. 2/4, 0108, Tbilisi, Georgia (GE)
(72) Teimuraz Murvanidze (GE)
(74) Shalva Gvaramadze (GE)
(54) 1.-2. COMBINED COSTUME
(55)



1.1



1.2



2.1



2.2

(10) AD 2022 1235 S (51) 27-05
(21) AD 2021 1235 (22) 2021 08 16
(28) 8
(71) Mikheil Khukhashvili (GE)
L. Asatiani St. 32, 0105, Tbilisi, Georgia (GE);
Vazha Dolaberidze (GE)
Didi Kheivani 21a, 0114, Tbilisi, Georgia (GE)
(72) Mikheil Khukhashvili (GE);
Vazha Dolaberidze (GE)
(74) Tamaz Shilakadze (GE)
(54) LIGHTER
(55)

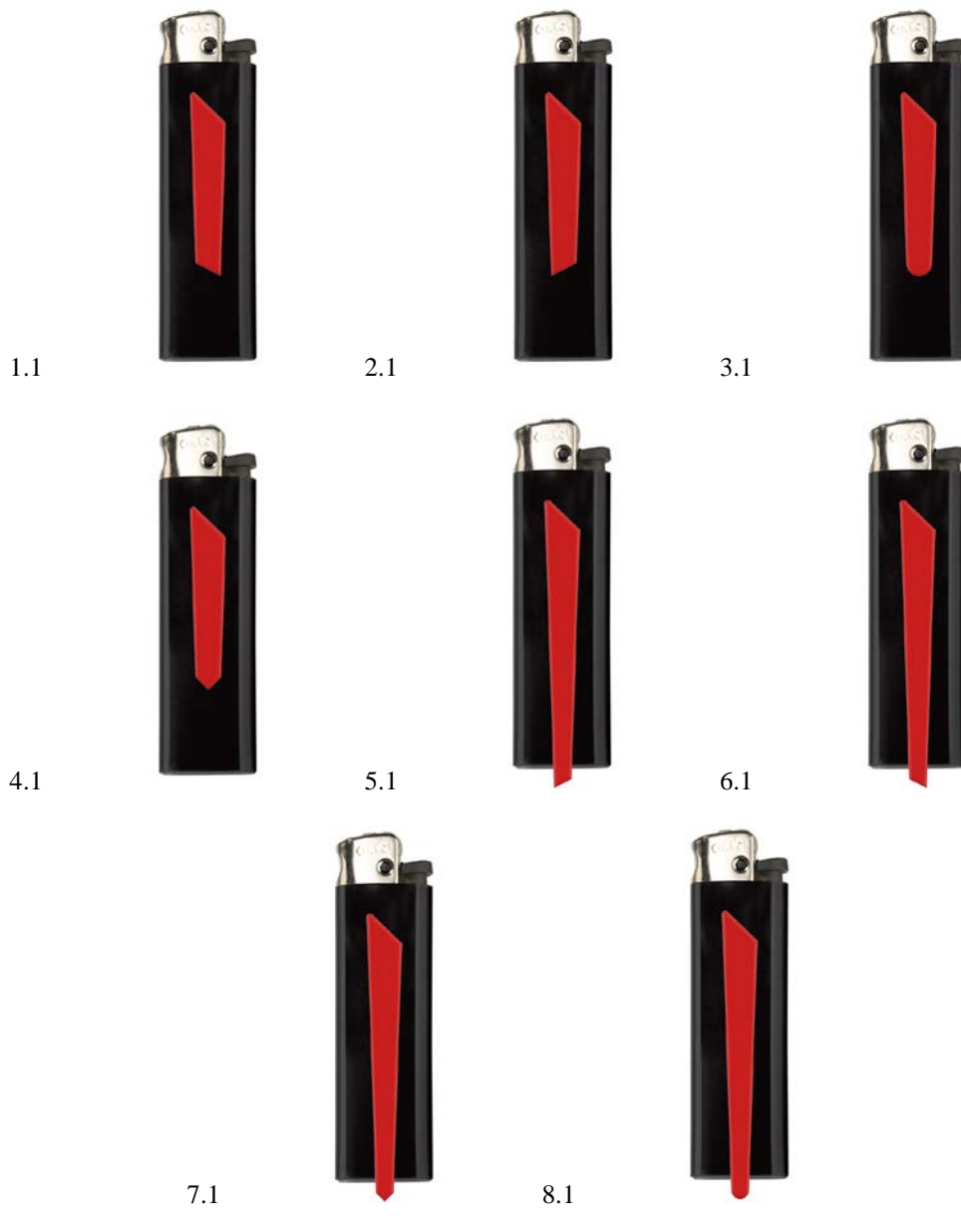

REGISTERED DESIGN

- (11) D 2022 923 S (51) 32-00
(10) AD 2021 1225 S (44) 2021 11 10 №20
(21) AD 2021 1225
(22) 2021 06 20
(24) 2021 06 20
(28) 4
(18) 2026 06 20
(73) LTD "Ninea" (GE)
 Nino Zhvania St. 28, 0148, Tbilisi,
 Georgia (GE)
(72) Sopio Chkhenkeli (GE)
(54) 1.-4. GRAPHICAL SYMBOL
-

DESIGNS, WHICH HAVE BEEN REGISTERED WITH THE INTERNATIONAL BUREAU CLAIMING PRIORITY ON THE TERRITORY OF GEORGIA

The decision can be appealed at the Chamber of Appeal of Sakpatenti within 3 months from the publication or at the Mtskheta District Court Administrative Cases Board (Address: №17, Samkhedro St., Mtskheta), within 1 month following the publication.

- (11) DM/217 760 (51) 09-01
(15) 2021 11 29 (44) 50/2021 (2021 12 17)
(22) 2021 11 29
(28) 1
(73) Vitalii Naumovych Shmulevych
Vul. Levanevskoho, 7, Kv. 63, 65062 Odesa (UA);
Igor Isaakovych Markushevskiy
Vul. Bolharska, 82, Kv. 8, 65005 Odesa (UA);
Volodymyr Mykolaiovych Maslenkov
Vul. M. Hovorova 1-2, Kv. 101, 65058 Odesa (UA)
(85) -; -; -
(86) UA; UA; UA
(87) -; -; -
(88) -; -; -
(89) UA; UA; UA
(81) III. AM, AZ, BY, CA, EM, GB, GE, IL, KG, MD, MN, NO, RU, US
(72) Volodymyr Mykolaiovych Maslenkov
Vul. M. Hovorova 1-2, Kv. 101, 65058 Odesa (UA);
Igor Isaakovych Markushevskiy
Vul. Bolharska, 82, Kv. 8, 65005 Odesa (UA);
Vitalii Naumovych Shmulevych
Vul. Levanevskoho, 7, Kv. 63, 65062 Odesa (UA)
(74) Denys Borukha
Gerzena Str. 17-25, Of. 168, 04050 Kyiv (UA)
(54) 1. Bottle
(55)



- (11) DM/217 890 (51) 02-04
 (15) 2021 12 06 (44) 51/2021 (2021 12 24)
 (22) 2021 12 06
 (28) 2
 (73) Valentino S.p.A.
 Via Turati 16/18, 20121 Milano (EM)
 (85) –
 (86) EM, IT
 (87) EM, IT
 (88) EM
 (89) EM, IT
 (81) III. AZ, EM, GB, GE, JP, KG, KR, RU, TJ, TR, UA
 (72) Pierpaolo PICCIOLI
 C/o VALENTINO S.p.A., Via Turati, 16/18, 20121, Milano (IT)
 (74) Jacobacci & Partners/ Salvatore Giovanni Pennacchio
 Via Senato, 8, 20121 Milano (IT)
 (54) 1. Shoe, 2. Shoe
 (55)



1.1



1.2



1.3



1.4



1.5



1.6

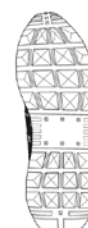

1.7

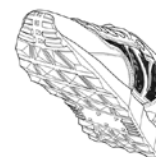

1.8



2.1



2.2



2.3



2.4



2.5



2.6



2.7



2.8

- (11) DM/215 129 (51) 11-01
 (15) 2021 06 25 (44) 52/2021 (2021 12 31)
 (22) 2021 06 25
 (28) 9
 (73) HARRY WINSTON SA
 Chemin Du Tourbillon 8, 1228 Plan-les-Ouates (CH)
 (85) CH
 (86) CH
 (87) CH
 (88) CH
 (89) CH
 (81) II. MA III. AL, AM, AZ, BA, BZ, CA, CH, EM, GB, GE, KG, LI, MC, MD, ME, MK, MN, NO, OM, SG, TN, TR, UA
 (72) 1,3 Rie YATSUGI-KANG
 C/o Harry Winston Inc. 718 Fifth Avenue, 10019, New York (US);
 2 Dominique RIVIERE
 C/o Harry Winston Inc. 718 Fifth Avenue, 10019, New York (US);
 4-9 Delphine ABDOURAHIM
 C/o Harry Winston Inc. 718 Fifth Avenue, 10019, New York (US)
 (74) The Swatch Group AG (The Swatch Group SA) (The Swatch Group Ltd.)
 Faubourg Du Lac 6, 2501 Biel/Bienne (CH)
 (54) 1. Necklace, 2.-3. Pair of earrings, 4. Necklace, 5.-7. Lapel pin, 8. Brooch, 9. Pair of earrings
 (55)

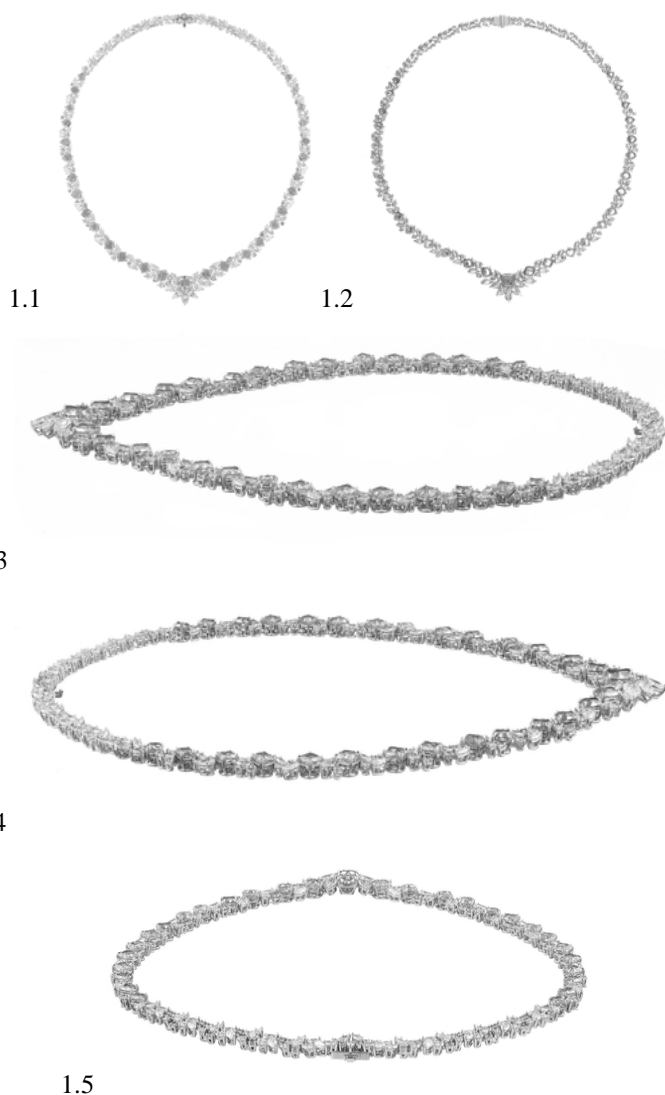



1.6



1.7



1.8



2.1



2.2



2.3



2.4



2.5



2.6



2.7



2.8

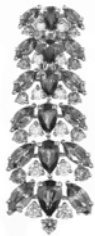

3.1

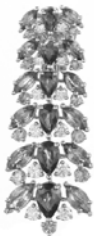

3.2



3.3



3.4



3.5



3.6



3.7



3.8



4.1



4.2



4.3



4.4



4.5



4.6



4.7



4.8

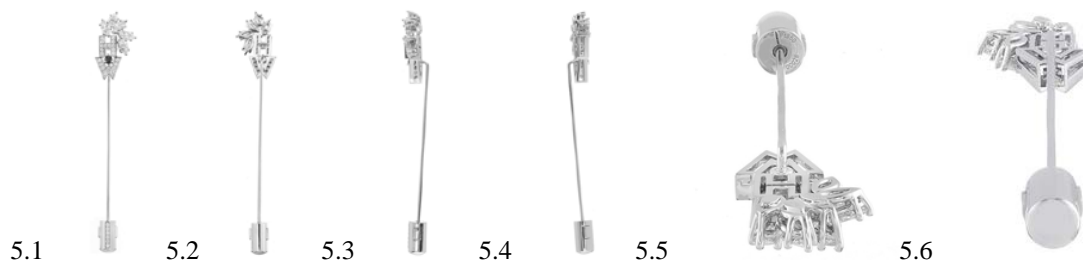





8.7



8.8



9.1

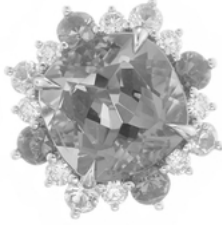

9.2



9.3



9.4



9.5



9.6



9.7



9.8



TRADEMARKS

APPLICATIONS FILED UNDER THE NATIONAL PROCEDURE APPROVED FOR REGISTRATION

The decision can be appealed at the Chamber of Appeal of Sakpatenti within 3 months from the publication or at the Mtskheta District Court Administrative Cases Board (Address: №17, Samkhedro St., Mtskheta), within 1 month following the publication.

(260) AM 2022 109851 A
(210) AM 109851
(220) 2021 08 04
(731) LTD "Coch Kablo"
Amaghleba St.15, fl. 2, app. 2, Mtatsminda
District, Tbilisi, Georgia
(540)



(591) Red, black
(531) 26.03.04; 26.03.05; 27.05.01; 29.01.12
(511) 9

(260) AM 2022 111082 A
(210) AM 111082
(220) 2020 12 29
(731) N(N)LE "Foundation Atinati"
Irakli Abashidze St. 28, app. 6, 0109, Tbilisi,
Vake District, Georgia
(740) Tamaz Urtmelidze;
Miranda Gurgenidze
(540)



(591) Black-white
(531) 27.05.01; 27.05.21; 28.19
(511) 35, 40, 41, 42

(260) AM 2022 111712 A
(210) AM 111712
(220) 2021 08 05
(731) Tamuna Elizarashvili
Bachana St., Lane 1/4, app. 7, Tbilisi, Georgia
(540)



(591) Black, yellow
(531) 03.04.11; 03.04.13; 03.04.15; 03.04.24;
27.05.01; 27.05.17; 29.01.12
(511) 31

(260) AM 2022 112507 A
(210) AM 112507
(220) 2021 04 08
(731) LTD "Kakhetian Traditional Winemaking"
Sulkhan Tsintsadze St. 12, non-residential
space 3-6, 0160, Tbilisi, Georgia
(540)

ვაზი ჯვარისა

(591) Black-white
(511) 33

(260) AM 2022 112698 A
(210) AM 112698
(220) 2021 04 21
(731) Posco International Corporation
134 Teheran-ro, Gangnam-gu, Seoul,
Republic of Korea
(740) Nugzar Ksovreli
(540)

DAEWOO

(591) Black-white
(531) 27.05.01; 27.05.17
(511) 7, 11

(260) AM 2022 112699 A
 (210) AM 112699
 (220) 2021 04 21
 (731) Posco International Corporation
 134 Teheran-ro, Gangnam-gu, Seoul,
 Republic of Korea
 (740) Nugzar Ksovreli
 (540)



(591) Black-white
 (531) 10.03.07; 26.01.02; 26.01.12; 26.01.24;
 26.11.12
 (511) 7, 11

(260) AM 2022 113428 A
 (210) AM 113428
 (220) 2021 06 10
 (731) Posco International Corporation
 134 Teheran-ro, Gangnam-gu, Seoul,
 Republic of Korea
 (740) Nugzar Ksovreli
 (540)



(591) Black-white
 (531) 03.07.17; 26.01.02; 26.01.12; 26.01.15;
 26.01.24; 26.11.12
 (511) 9, 11

(260) AM 2022 113139 A
 (210) AM 113139
 (220) 2021 05 27
 (731) JSC "TBILVINO"
 Sarajishvili Av. 2, 0153, Tbilisi, Georgia
 Posco International Corporation
 134 Teheran-ro, Gangnam-gu, Seoul,
 Republic of Korea
 (740) Giorgi Taktakishvili
 (540)

TBILVINO
 WINE OF GEORGIA

(591) Golden, white, black
 (531) 27.05.01; 27.05.10; 27.05.11; 29.01.12
 (526) GEORGIA
 (511) 33

(260) AM 2022 113694 A
 (210) AM 113694
 (220) 2021 06 28
 (731) LTD "Royal Houm Luxury"
 Rustavi Highway 19, bl. 3, farce, floor 1,
 Krtsanisi District, Tbilisi, Georgia
 (540)

ROYAL HOME.
Luxury

(591) 050404 black-white
 (531) 24.09.02; 24.09.11; 27.05.01; 27.05.09;
 27.05.11
 (511) 24, 35

(260) AM 2022 113427 A
 (210) AM 113427
 (220) 2021 06 10
 (731) Posco International Corporation
 134 Teheran-ro, Gangnam-gu, Seoul,
 Republic of Korea
 (740) Nugzar Ksovreli
 (540)

DAEWOO

(591) Black-white
 (531) 27.05.01; 27.05.17
 (511) 9, 11

(260) AM 2022 113703 A
 (210) AM 113703
 (220) 2021 06 30
 (731) LTD "Tifliski Vini Pogreb"
 Yumashev St. 27, 0198, Tbilisi, Georgia
 (740) Shalva Gvaramadze
 (540)

МАРГАЛИТИ
MARGALITI
მარგალიტი

(591) Black-white
 (511) 33

(260) AM 2022 113765 A
 (210) AM 113765
 (220) 2021 07 02
 (731) LTD "Online Moli"
 V. Barnov/Tarkhnishvili St. 49/29, app. 6,
 Tbilisi, Georgia
 (540)



(591) Black, red, yellow
 (531) 26.01.19; 26.11.12; 27.05.01; 27.05.04; 28.19;
 29.01.13
 (511) 20, 35

(260) AM 2022 113771 A
 (210) AM 113771
 (220) 2021 07 05
 (731) LTD "Bioplant"
 Ak. Tsereteli Av. 116, Tbilisi, Georgia
 (540)

აგრომომმი-100
Agromomm-100
Агромомм-100

(591) Black-white
 (511) 1, 35

(260) AM 2022 113778 A
 (210) AM 113778
 (220) 2021 07 07
 (731) David Arevazov
 Parnavaz Mepe Av. 18, entrance 2, app. 87,
 0131, Tbilisi, Georgia
 (540)



(591) White, black, green, light brown, dark
 brown, burgundy
 (531) 05.07.10; 19.09.02; 25.01.19; 29.01.15
 (511) 31, 33

(260) AM 2022 113779 A
 (210) AM 113779
 (220) 2021 07 07
 (731) LTD "Kakhetian Traditional Winemaking"
 Sulkhan Tsintsadze St. 12, 0192, Tbilisi,
 Georgia
 (540)

იმერელი
Imereli
Имерели

(591) FFFFFFF white, 0F0101 black
 (511) 35

(260) AM 2022 113783 A
 (210) AM 113783
 (220) 2021 07 07
 (731) LTD "Kakhetian Traditional Winemaking"
 Sulkhan Tsintsadze St. 12, 0192, Tbilisi,
 Georgia
 (540)

ვარციხელი მეღვინე

(591) Black-white
 (511) 35

(260) AM 2022 113787 A
 (210) AM 113787
 (220) 2021 07 07
 (731) Philip Morris Brands Sàrl
 Quai Jeanrenaud 3, 2000 Neuchâtel,
 Switzerland
 (740) Pavle Meipariani
 (540)

MANHATTAN

(591) Black-white
 (511) 34

(260) AM 2022 113790 A
 (210) AM 113790
 (220) 2021 07 08
 (731) Colgate-Palmolive Company
 Delaware Corporation
 300 Park Avenue, New York, New York
 10022, USA
 (740) Tamaz Shilakadze

(540)

ზიგზაგის

(591) Black-white
(511) 21

(260) AM 2022 113791 A
(210) AM 113791
(220) 2021 07 08
(731) British American Tobacco (Brands) Inc.
(a Delaware corporation)
251 Little Falls Drive, Suite 100,
Wilmington, Delaware,
19808-1674, USA

(740) Tamar Kochlamazashvili
(540)



(591) White, grey, blue, sky-blue
(531) 25.07.15; 26.04.04; 26.04.09; 26.04.19;
26.04.24; 26.11.09; 27.05.01; 27.05.24;
29.01.13
(511) 34

(260) AM 2022 113793 A
(210) AM 113793
(220) 2021 07 09
(731) Essity Hygiene and Health Aktiebolag
SE-405 03 Göteborg, Sweden
(740) Tamaz Shilakadze
(540)

COUR-V

(591) Black-white
(511) 5

(260) AM 2022 113846 A
(210) AM 113846
(220) 2021 07 09
(731) LTD "Nalan Chamashir"
mcr. XVI, LTD "Unity" negotiable
area/mcr. XVI, Surrounding Area
(Leonidze St. 15), 3700, Rustavi,
Georgia

(540)



(591) Black, red, neon grey, white
(531) 26.01.01; 26.01.24; 26.03.01; 26.03.05;
26.03.24; 26.04.22; 26.04.24; 26.07.03;
27.01.01; 27.01.05; 27.01.06; 27.05.01;
27.05.10; 27.05.17; 27.05.24; 29.01.13
(511) 25, 35

(260) AM 2022 113848 A
(210) AM 113848
(220) 2021 07 11
(731) LTD "Ninea"
Nino Zhvania St. 28, app. 1, Tbilisi, Georgia
(540)



(591) Black-white
(531) 28.19
(511) 25, 35

(260) AM 2022 113854 A
(210) AM 113854
(220) 2021 07 12
(731) Limited Liability Company "Supermash"
30 A Verhniy Val Str., Kyiv, 04071, Ukraine
(740) Shalva Gvaramadze
(540)



(591) Yellow, white, orange, various tones of green
(531) 01.15.05; 05.03.13; 05.03.15; 26.04.02;
26.04.13; 26.04.15; 26.04.22; 26.04.24;
29.01.13
(511) 3

(260) AM 2022 113866 A
 (210) AM 113866
 (220) 2021 07 14
 (731) Eldar Iukuridze
 Zhukovski St. 19, app. 9, Odessa, Ukraine
 (740) Giorgi Taktakishvili
 (540)



(591) Black-white
 (531) 02.01.13; 02.01.16; 02.01.23; 10.03.01
 (511) 29, 33, 41, 43

(260) AM 2022 113868 A
 (210) AM 113868
 (220) 2021 07 14
 (731) LTD "New Light"
 Al. Kazbegi St. 25a, Tbilisi, Georgia
 (540)



(591) Black-white
 (531) 26.03.01; 26.03.12; 26.03.24; 26.11.02;
 26.11.05; 26.11.13; 27.05.01; 27.05.10
 (511) 11

(260) AM 2022 113869 A
 (210) AM 113869
 (220) 2021 07 14
 (731) LTD "New Light"
 Al. Kazbegi St. 25a, Tbilisi, Georgia
 (540)



(591) Black, white, yellow
 (531) 26.04.01; 26.04.02; 26.04.05; 26.04.12;
 26.04.24; 26.11.03; 26.11.05; 26.11.09; 28.19;
 29.01.01; 29.01.13
 (511) 20

(260) AM 2022 113870 A
 (210) AM 113870
 (220) 2021 07 14
 (731) LTD "New Light"
 Al. Kazbegi St. 25a, Tbilisi, Georgia
 (540)



(591) White, black, yellow
 (531) 26.04.01; 26.04.02; 26.04.12; 26.04.24;
 26.11.03; 26.11.09; 27.05.01; 27.05.10;
 29.01.13
 (511) 20

(260) AM 2022 113882 A
 (210) AM 113882
 (220) 2021 07 15
 (731) LLC "FDI Georgia"
 Kindzmarauli St. 5, Tbilisi, Georgia
 (540)

FALCON DYNAMIC SYSTEMS

(591) Black-white
 (511) 13

(260) AM 2022 113883 A
 (210) AM 113883
 (220) 2021 07 15
 (731) LTD "FDI Georgia"
 Kindzmarauli St. 5, Tbilisi, Georgia
 (540)

FALCON EYE

(591) Black-white
 (511) 13

(260) AM 2022 113885 A
 (210) AM 113885
 (220) 2021 07 15
 (731) LTD "FDI Georgia"
 Kindzmarauli St. 5, Tbilisi, Georgia
 (540)

FALCON 127M

(591) Black-white
 (511) 13

(260) AM 2022 113886 A
 (210) AM 113886
 (220) 2021 07 15
 (731) LTD "FDI Georgia"
 Kindzmarauli St. 5, Tbilisi, Georgia

(540)

**FALCON GHOST
HUNTER H.B.R**

(591) Black-white

(511) 13

(260) AM 2022 113888 A

(210) AM 113888

(220) 2021 07 15

(731) LTD "Almir"

Uznadze St. 111, app. 11, bl. 2, Didube-
Chughureti District, Tbilisi, Georgia

(540)

Almir

(591) Black-white

(511) 34

(260) AM 2022 113889 A

(210) AM 113889

(220) 2021 07 15

(731) British American Tobacco (Brands) Inc.
(a Delaware corporation)

251 Little Falls Drive, Suite 100, Wilmington
Delaware, Delaware, 19808-1674, USA

(740) Tamar Kochlamazashvili

(540)

VOLT

(591) Black-white

(511) 34

(260) AM 2022 113973 A

(210) AM 113973

(220) 2021 07 16

(731) Guangdong Oppo Mobile

Telecommunications Corp., LTD
No.18 Haibin Road, Wusha, Chang'an,
Dongguan, Guangdong, China

(740) Shalva Gvaramadze

(540)

OPPO Reno

(591) Black-white

(511) 9

(260) AM 2022 113976 A

(210) AM 113976

(220) 2021 07 19

(731) LTD "Academy of Cleaning and Hygiene"

Ipolitov-Ivanov St. 9, app. 185, Gldani
District, Tbilisi, Georgia

(540)



(591) F2E3E3 white, 32B298 turquoise,
366488 blue

(531) 05.03.13; 05.03.15; 09.07.22; 26.01.05;
26.01.15; 26.01.16; 26.01.21; 29.01.13

(511) 37, 41

(260) AM 2022 113979 A

(210) AM 113979

(220) 2021 07 19

(731) LTD "Erti Kava Coffe Room"

Aleksandre Griboedov St. 6 / Mitropane
Laghidze St. 8, 0108, Mtatsminda District,
Tbilisi, Georgia

(540)

ERTI KAVA



Specialty coffee for life lovers

(591) Black, white, dark red, (carnelian)

(531) 02.09.01; 06.01.01; 06.01.04; 11.03.04;
27.05.01; 27.05.10; 27.05.11; 29.01.13

(511) 43

(260) AM 2022 114003 A

(210) AM 114003

(220) 2021 07 21

(731) Erekle Abashidze

Akaki Tsereteli Av. 78, 0119, Tbilisi, Georgia

(540)



(591) Black-white
(531) 27.05.01; 27.05.11; 27.05.19; 27.05.22
(511) 6, 16, 26

(260) AM 2022 114034 A
(210) AM 114034
(220) 2021 07 23
(731) Philip Morris Products S.A.
Quai Jeanrenaud 3, 2000 Neuchâtel,
Switzerland
(740) Pavle Meipariani
(540)

TEAK

(591) Black-white
(511) 34

(260) AM 2022 114035 A
(210) AM 114035
(220) 2021 07 23
(731) Philip Morris Products S.A.
Quai Jeanrenaud 3, 2000 Neuchâtel,
Switzerland
(740) Pavle Meipariani
(540)

TEREA YELLOW

(591) Black-white
(511) 34

(260) AM 2022 114037 A
(210) AM 114037
(220) 2021 07 26
(731) Stockup
Vill. Gogolesubani, Chokhatauri Region,
Georgia
(540)



(591) Green, red, black
(531) 24.15.01; 24.15.08; 27.05.01; 27.05.02;
27.05.10; 27.05.11; 27.05.24; 29.01.13
(511) 35

(260) AM 2022 114038 A
(210) AM 114038
(220) 2021 07 26
(731) Zakrytoe Aktionernoe Obshestvo
"Pharmfirm "Sotex"
Selskoe Poselenie Bereznyakovskoe,
Pos. Belikovo, dom 11, Sergeevo-Posadsky

Municipal region, 141345, Moskovskaya
oblast, Russian Federation
(740) Giorgi Taktakishvili
(540)

ПРОФЕМАК

(591) Black-white
(511) 5

(260) AM 2022 114042 A
(210) AM 114042
(220) 2021 07 26
(731) Philip Morris Products S.A.
Quai Jeanrenaud 3, 2000 Neuchâtel,
Switzerland
(740) Pavle Meipariani
(540)

TEREA BRONZE

(591) Black-white
(511) 34

(260) AM 2022 114044 A
(210) AM 114044
(220) 2021 07 27
(731) Yongkang Pengcheng Grinding Apparatus &
Abrasive Co., LTD
Building 2, No.398 Jinquan North Road,
Xiangzhu Village 4, Xiangzhu Town,
Yongkang City, Jinhua City, Zhejiang
Province, People's Republic of China
(740) Shalva Gvaramadze
(540)

KAKU

(591) Black-white
(531) 27.05.17
(511) 8

(260) AM 2022 114050 A
(210) AM 114050
(220) 2021 07 28
(731) LTD "Barbarestan"
Vazha-Pshavela Av., III quarter, bl. 10,
app. 60, Tbilisi, Georgia
(540)

ბარბარესგან
barbaresgan

(591) Black-white
(511) 29, 30, 31, 32, 33, 35, 43

(260) AM 2022 114052 A
 (210) AM 114052
 (220) 2021 07 28
 (731) Lego Juris A/S
 DK-7190 Billund, Denmark
 (740) Giorgi Ghvinjilia
 (540)

NINJAGG

(591) Black-white
 (531) 27.05.01
 (511) 28

(260) AM 2022 114060 A
 (210) AM 114060
 (220) 2021 07 28
 (731) Philip Morris Products S.A.
 Quai Jeanrenaud 3, 2000 Neuchâtel,
 Switzerland
 (740) Pavle Meipariani
 (540)

TURQUOISE

(591) Black-white
 (511) 34

(260) AM 2022 114063 A
 (210) AM 114063
 (220) 2021 07 29
 (731) LTD "Black Tomatoes"
 M. and A. Balanchivadze St. 40, app. 40a,
 Saburtalo District, Tbilisi, Georgia
 (540)



Black Tomato

(591) Yellow, red, blue
 (531) 05.09.17; 27.05.01; 29.01.14
 (511) 43

(260) AM 2022 114135 A
 (210) AM 114135
 (220) 2021 08 02
 (731) FMC Agro Singapore Pte Ltd
 77 Robinson Road #13-00, Robinson 77,
 Singapore 068896, Singapore;
 FMC Corporation
 2929 Walnut Street Philadelphia, Pennsylvania
 19104, USA

(740) Tamaz Shilakadze
 (540)

ЭКСИРЕЛЬ

(591) Black-white
 (511) 5

(260) AM 2022 114136 A
 (210) AM 114136
 (220) 2021 08 02
 (731) FMC Agro Singapore Pte Ltd
 77 Robinson Road #13-00, Robinson 77,
 Singapore 068896, Singapore;
 FMC Corporation
 2929 Walnut Street Philadelphia, Pennsylvania
 19104, USA
 (740) Tamaz Shilakadze
 (540)

EXIREL

(591) Black-white
 (511) 5

(260) AM 2022 114140 A
 (210) AM 114140
 (220) 2021 08 02
 (731) LTD "Impexpharm"
 Giorgi Saakadze's II exit 17, 0160, Saburtalo
 District, Tbilisi, Georgia
 (740) Nugzar Ksovreli
 (540)

Ascofreez

(591) Black-white
 (511) 5

(260) AM 2022 114141 A
 (210) AM 114141
 (220) 2021 08 02
 (731) LTD "Gurilla"
 Shalva Nutsubidze St. 56/Vazha-Pshavela Av.,
 I quarter., bl. 17, app. 82, Tbilisi, Georgia
 (740) Giorgi Meipariani
 (540)

Clip-Clap

(591) Black-white
 (511) 32, 33

(260) AM 2022 114146 A
 (210) AM 114146
 (220) 2021 08 03
 (731) LTD "Idea Development"
 Pekin Av. 2, app. 59, Saburtalo District,
 Tbilisi, Georgia
 (740) Tamar Kharazishvili

(540)

OXON
solutions

(591) Golden, white
(531) 27.05.01; 27.05.10; 29.01.03
(511) 35, 36, 37, 41

(260) AM 2022 114149 A
(210) AM 114149
(220) 2021 08 04
(731) Ela Magrakvelidze
Sopromadze St. 1, 2400, Terjola, Georgia
(540)



Kundalini Yoga
Marina Kvataia

(591) White, turquoise, sky-blue
(531) 05.05.16; 05.05.20; 27.05.01; 27.05.10;
29.01.04
(511) 41

(260) AM 2022 114234 A
(210) AM 114234
(220) 2021 08 12
(731) Levan Tsanava
O. Chkheidze St. 12, app. 6, 0186, Tbilisi,
Georgia
(740) Irakli Chichinadze
(540)

L•E•T•O

(591) Black-white
(531) 24.17.01; 24.17.02; 27.05.15
(511) 30, 43

(260) AM 2022 114235 A
(210) AM 114235
(220) 2021 08 12
(731) LTD "Tsinandali+"
Chirnakhuli St. 5-7, Samgori District, Tbilisi,
Georgia
(740) Vakhtang Torotadze

(540)

VASENIN

(591) F9EFA7 yellow, 000000 black
(531) 27.05.01; 27.05.02; 29.01.12
(511) 33

(260) AM 2022 114236 A
(210) AM 114236
(220) 2021 08 12
(731) LTD "Tsinandali+"
Chirnakhuli St. 5-7, Samgori District, Tbilisi,
Georgia
(740) Vakhtang Torotadze
(540)



**VASO
MARANI**

(591) FCD32F yellow, FFFFFFF white,
000000 black
(531) 06.01.01; 06.01.02; 27.05.10; 29.01.12
(511) 33

(260) AM 2022 114238 A
(210) AM 114238
(220) 2021 08 12
(731) LTD "Tsaghveri"
Borrow Tsaghveri, 1212, Borjomi, Georgia
(740) David Dzamukashvili
(540)

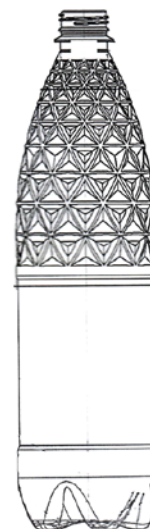
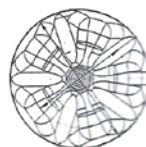

(554) Three dimensional
(591) Black-white
(531) 19.07.01; 19.07.23
(511) 5, 32

(260) AM 2022 114309 A
(210) AM 114309
(220) 2021 08 13
(731) LTD "Kartuli Tema"
Irakli Gamrekeli St. 35v, 0186, Tbilisi, Georgia
(540)



(554) Three dimensional
(591) Orange, blue, white, green, red, pink,
yellow, black
(531) 03.07.05; 03.07.24; 04.02.20; 08.01.19;
08.01.23; 08.07.11; 19.03.01; 19.03.15;
19.03.25; 29.01.15
(511) 28, 30

(260) AM 2022 114311 A
(210) AM 114311
(220) 2021 08 13
(731) MLS Co., LTD
No.1 MuLinSen Avenue, Xiaolan, Zhongshan
City, Guangdong Province, People's Republic
of China
(740) Merab Kvimsadze
(540)

Forest Lighting

(591) Black-white
(531) 27.05.01
(511) 11

REGISTERED TRADEMARKS

(111) M 2022 35040 R
 (151) 2022 02 08
 (181) 2032 02 08
 (260) AM 2020 110689 A
 (220) 2020 12 01
 (732) LLC "Georgian Lemonade"
 Aleksidze St., I qu., corp. 4, app. 25, 0112,
 Tbilisi, Georgia

(111) M 2022 35041 R
 (151) 2022 02 08
 (181) 2032 02 08
 (260) AM 2020 111060 A
 (220) 2020 12 25
 (732) British American Tobacco (Brands) Limited
 Globe House, 4 Temple Place, London,
 WC2R 2PG, United Kingdom

(111) M 2022 35042 R
 (151) 2022 02 08
 (181) 2032 02 08
 (260) AM 2020 111061 A
 (220) 2020 12 25
 (732) British American Tobacco (Brands) Inc.
 (a Delaware corporation)
 251 Little Falls Drive, Suite 100, Wilmington,
 19808-1674, Delaware, USA

(111) M 2022 35043 R
 (151) 2022 02 08
 (181) 2032 02 08
 (260) AM 2020 111063 A
 (220) 2020 12 25
 (732) British American Tobacco (Brands) Inc.
 (a Delaware corporation)
 251 Little Falls Drive, Suite 100, Wilmington,
 19808-1674, Delaware, USA

(111) M 2022 35044 R
 (151) 2022 02 08
 (181) 2032 02 08
 (260) AM 2021 111273 A
 (220) 2021 01 12
 (732) Peak Oyun Yazilim ve Pazarlama A.S.
 DBA Peak Games Inebolu
 Sokak No:39, 3rd Floor, Kabatas Beyoglu,
 Istanbul, 34427, Turkey

(111) M 2022 35045 R
 (151) 2022 02 08
 (181) 2032 02 08
 (260) AM 2021 111274 A
 (220) 2021 01 12
 (732) Peak Oyun Yazilim ve Pazarlama A.S.
 DBA Peak Games Inebolu
 Sokak No:39, 3rd Floor, Kabatas Beyoglu,
 Istanbul, 34427, Turkey

(111) M 2022 35046 R
 (151) 2022 02 08
 (181) 2032 02 08
 (260) AM 2021 111275 A
 (220) 2021 01 12
 (732) Peak Oyun Yazilim ve Pazarlama A.S.
 DBA Peak Games Inebolu
 Sokak No:39, 3rd Floor, Kabatas Beyoglu,
 Istanbul, 34427, Turkey

(111) M 2022 35047 R
 (151) 2022 02 08
 (181) 2032 02 08
 (260) AM 2021 111335 A
 (220) 2021 01 21
 (732) British American Tobacco (Brands) Inc.
 (a Delaware corporation)
 251 Little Falls Drive, Suite 100, Delaware,
 Wilmington, 19808-1674, USA

(111) M 2022 35048 R
 (151) 2022 02 08
 (181) 2032 02 08
 (260) AM 2021 111449 A
 (220) 2021 01 28
 (732) Ekaterine Tskhadadze
 Guramishvili Av. 1, app. 10, Tbilisi, Georgia
 Giorgi Khechuashvili
 Badri Shoshitishvili St., 6th Lane, app. 9,
 Tbilisi, Georgia

(111) M 2022 35049 R
 (151) 2022 02 08
 (181) 2032 02 08
 (260) AM 2021 111508 A
 (220) 2021 02 01
 (732) Aleksii Morchiladze
 Chkondideli St. 22, 0180, Tbilisi, Georgia

(111) M 2022 35050 R
(151) 2022 02 08
(181) 2032 02 08
(260) AM 2021 111528 A
(220) 2021 02 03
(732) JSC "Kazunion Holding"
Varketili – 3, II mcr., korp. 25a, app. 24,
0163, Tbilisi, Georgia

(111) M 2022 35051 R
(151) 2022 02 08
(181) 2032 02 08
(260) AM 2021 111706 A
(220) 2021 02 15
(732) Daio Paper Corporation
2-60, Mishima-Kamiya-cho, Shikokuchuo-Shi
Ehime-ken 799-0402, Japan

(111) M 2022 35052 R
(151) 2022 02 08
(181) 2032 02 08
(260) AM 2021 111707 A
(220) 2021 02 15
(732) Daio Paper Corporation
2-60, Mishima-Kamiya-cho, Shikokuchuo-Shi
Ehime-ken 799-0402, Japan

(111) M 2022 35053 R
(151) 2022 02 08
(181) 2032 02 08
(260) AM 2021 111838 A
(220) 2021 02 19
(732) Aleksii Morchiladze
Chkondideli St. 22, 0180, Tbilisi, Georgia

(111) M 2022 35054 R
(151) 2022 02 08
(181) 2032 02 08
(260) AM 2021 111967 A
(220) 2021 03 04
(732) Basmat Al Hayat Household Appliances
(L.L.C)
P. O. Box 5154 Dubai, United Arab Emirates

(111) M 2022 35055 R
(151) 2022 02 08
(181) 2032 02 08
(260) AM 2021 112067 A
(220) 2021 03 09
(732) National Association of Realtors
430 North Michigan Avenue, Chicago,
Illinois, USA

(111) M 2022 35056 R
(151) 2022 02 08
(181) 2032 02 08
(260) AM 2021 112258 A
(220) 2021 03 19
(732) JSC Corporation Kindzmarauli,
Ilia Chavchavadze St. 55, 4800, Kvareli,
Georgia

(111) M 2022 35057 R
(151) 2022 02 08
(181) 2032 02 08
(260) AM 2020 109592 A
(220) 2020 08 31
(732) Dow AgroSciences LLC
a Delaware Limited Liability Company
9330 Zionsville Road, Indianapolis, Indiana
46268, USA

(111) M 2022 35073 R
(151) 2022 02 18
(181) 2032 02 18
(260) AM 2020 110875 A
(220) 2020 12 15
(732) Faes Farma S.A.
Avenida Autonomía 10, 48940 Leioa
(Bizkaia), Spain

(111) M 2022 35074 R
(151) 2022 02 18
(181) 2032 02 18
(260) AM 2020 110949 A
(220) 2020 12 21
(732) LTD "Nalan Chamashir"
Rustavi Highway 19, corp. 3, fl. 1st,
0165, Tbilisi, Georgia

(111) M 2022 35075 R
(151) 2022 02 18
(181) 2032 02 18
(260) AM 2020 110973 A
(220) 2020 12 23
(732) Giorgi Chikhladze
N. Kipshidze St. 2, 0162, Tbilisi, Georgia

(111) M 2022 35076 R
(151) 2022 02 18
(181) 2032 02 18
(260) AM 2020 111090 A
(220) 2020 12 30
(732) LTD "Shevi"
Ilia Chavchavadze Av. 78, corp. 1, app. 4,
0179, Tbilisi, Georgia

(111) M 2022 35077 R
(151) 2022 02 18
(181) 2032 02 18
(260) AM 2020 111091 A
(220) 2020 12 30
(732) LTD "Shevi"
Ilia Chavchavadze Av. 78, corp. 1, app. 4,
0179, Tbilisi, Georgia

(111) M 2022 35078 R
(151) 2022 02 18
(181) 2032 02 18
(260) AM 2021 111267 A
(220) 2021 01 08
(732) EMVCo LLC
c/o Visa Holdings, Inc., 900 Metro Center
Boulevard, Foster City, California
94404, USA

(111) M 2022 35079 R
(151) 2022 02 18
(181) 2032 02 18
(260) AM 2021 111269 A
(220) 2021 01 12
(732) LLC "Kdema"
Besarion Zhgenti St., Lane 7, app. 10, 0183,
Tbilisi, Georgia

(111) M 2022 35080 R
(151) 2022 02 18
(181) 2032 02 18
(260) AM 2021 111344 A
(220) 2021 01 21
(732) WAWI-Schokolade AG
Landgrafenstraße 29, 66953, Pirmasens,
Germany

(111) M 2022 35081 R
(151) 2022 02 18
(181) 2032 02 18
(260) AM 2021 111404 A
(220) 2021 01 22
(732) LTD "Zedashe"
Pirosmani St. 18, 1600, Dedoplistskaro,
Georgia

(111) M 2022 35082 R
(151) 2022 02 18
(181) 2032 02 18
(260) AM 2021 111429 A
(220) 2021 01 26
(732) WAWI-Schokolade AG
Landgrafenstraße 29, Pirmasens, 66953,
Germany

(111) M 2022 35083 R
(151) 2022 02 18
(181) 2032 02 18
(260) AM 2021 111500 A
(220) 2021 01 29
(732) LTD "Marniskari"
Apakidze St. 11, Tbilisi, Georgia

(111) M 2022 35084 R
(151) 2022 02 18
(181) 2032 02 18
(260) AM 2021 111519 A
(220) 2021 02 02
(732) LLC "Alcoritale Group"
Giorgi Mdivani St. 3a, Tbilisi, Georgia

(111) M 2022 35085 R
(151) 2022 02 18
(181) 2032 02 18
(260) AM 2021 111520 A
(220) 2021 02 02
(732) LLC "Alcoretail Group"
Giorgi Mdivani St. 3a, Tbilisi, Georgia

(111) M 2022 35086 R
(151) 2022 02 18
(181) 2032 02 18
(260) AM 2021 111521 A
(220) 2021 02 03
(732) LTD "Tsinandali+"
Chirnakhuli St. 5-7, Samgori District, Tbilisi,
Georgia

(111) M 2022 35087 R
(151) 2022 02 18
(181) 2032 02 18
(260) AM 2021 111534 A
(220) 2021 02 04
(732) Off-White LLC
360 Hamilton Ave., N100 White Plains,
New York, 10601, USA

(111) M 2022 35088 R
(151) 2022 02 18
(181) 2032 02 18
(260) AM 2021 111951 A
(220) 2021 03 02
(732) Space Exploration Technologies Corp.
1 Rocket Road, Hawthorne, California
90250, USA

(111) M 2022 35089 R
(151) 2022 02 18
(181) 2032 02 18
(260) AM 2021 111969 A
(220) 2021 03 04
(732) Gaga Lomouri
M. Lermontov St. 67, Batumi, Georgia

(111) M 2022 35090 R
(151) 2022 02 18
(181) 2032 02 18
(260) AM 2021 111976 A
(220) 2021 03 04
(732) Gravity Co., Ltd.
(Sangam-dong) 15F. Nuritkum Square R&D
Tower, 396, World Cup Buk-Ro, Mapo-Gu,
Seoul, Republic of Korea

(111) M 2022 35091 R
(151) 2022 02 18
(181) 2032 02 18
(260) AM 2021 112174 A
(220) 2021 03 15
(732) LTD "Livin"
Ilia Chavchavadze Av. 47, Commercial
Space K-4, Tbilisi, Georgia

(111) M 2022 35092 R
(151) 2022 02 18
(181) 2032 02 18
(260) AM 2021 112286 A
(220) 2021 03 23
(732) LTD "Mega Star"
Gamsakhurdia Av. 25, corp. 12, app. 45,
Tbilisi, Georgia

(111) M 2022 35093 R
(151) 2022 02 18
(181) 2032 02 18
(260) AM 2021 112301 A
(220) 2021 03 24
(732) Qi Zhu
No.32, Hoichjou Stor, Jenan Neiborhud Komiti,
Danbei Taun, Danyang, Jiangsu, 212300,
China

(111) M 2022 35094 R
(151) 2022 02 18
(181) 2032 02 18
(260) AM 2021 112403 A
(220) 2021 03 30
(732) Glovoaap23 S.L.
Calle Pallars, 190, Barcelona, 08005, Spain

(111) M 2022 35095 R
(151) 2022 02 18
(181) 2032 02 18
(260) AM 2021 112404 A
(220) 2021 03 30
(732) LTD "Askaneli Dzmebi"
Kakheti Highway 110 a, 0198, Isani-Samgori
District, Tbilisi, Georgia

(111) M 2022 35096 R
(151) 2022 02 18
(181) 2032 02 18
(260) AM 2021 112410 A
(220) 2021 03 31
(732) LTD "Good Market"
Chabua Amirejibi Highway 6, app. 82, Vake
District, Tbilisi, Georgia

(111) M 2022 35097 R
(151) 2022 02 18
(181) 2032 02 18
(260) AM 2021 112488 A
(220) 2021 04 05
(732) Zurab Bezhashvili
Vazha-Pshavela Av., VII qu., corp. 15, app. 9,
0186, Tbilisi, Georgia

(111) M 2022 35098 R
(151) 2022 02 18
(181) 2032 02 18
(260) AM 2021 112491 A
(220) 2021 04 06
(732) JSC "Bank of Georgia"
Gagarin St. 29a, 0160, Tbilisi, Georgia

(111) M 2022 35099 R
(151) 2022 02 18
(181) 2032 02 18
(260) AM 2021 112492 A
(220) 2021 04 06
(732) JSC "Bank of Georgia"
Gagarin St. 29a, 0160, Tbilisi, Georgia

(111) M 2022 35100 R
(151) 2022 02 18
(181) 2032 02 18
(260) AM 2021 112504 A
(220) 2021 04 07
(732) JSC "Ardi Insurance"
Vazha-Psavela Av. 3, Tbilisi, Georgia

(111) M 2022 35101 R
(151) 2022 02 18
(181) 2032 02 18
(260) AM 2021 112582 A
(220) 2021 04 12

(732) Guangzhou Hualiang Xinxing Electronic
Manufacturing Co., Ltd
№5-1, Industrial Road, Quanxi Village,
Jianggao Town, Baiyun District, Guangzhou,
Guangdong, China

(732) LTD "Georgian Wine and Alcoholic Beverage
Company"
Vill. Achinebuli, 2200, Telavi, Georgia

(111) M 2022 35102 R
(151) 2022 02 18
(181) 2032 02 18
(260) AM 2021 112583 A
(220) 2021 04 12

(732) Guangzhou Hualiang Xinxing Electronic
Manufacturing Co., Ltd
№5-1, Industrial Road, Quanxi Village,
Jianggao Town, Baiyun District, Guangzhou,
Guangdong, China

(111) M 2022 35103 R
(151) 2022 02 18
(181) 2032 02 18
(260) AM 2021 112614 A
(220) 2021 04 14

(732) Bridgestone Corporation
1-1, Kyobashi 3-chome, Chuo-ku, Tokyo,
Japan

(111) M 2022 35104 R
(151) 2022 02 18
(181) 2032 02 18
(260) AM 2021 112615 A
(220) 2021 04 14

(732) Bridgestone Corporation
1-1, Kyobashi 3-chome, Chuo-ku, Tokyo,
Japan

(111) M 2022 35105 R
(151) 2022 02 18
(181) 2032 02 18
(260) AM 2021 112616 A
(220) 2021 04 14

(732) Bridgestone Corporation
1-1, Kyobashi 3-chome, Chuo-ku, Tokyo,
Japan

(111) M 2022 35106 R
(151) 2022 02 18
(181) 2032 02 18
(260) AM 2021 112738 A
(220) 2021 04 29

TRADEMARKS REGISTERED ACCORDING TO THE ACCELERATED PROCEDURE

The decision can be appealed at the Chamber of Appeal of Sakpatenti within 3 months from the publication.

(111) M 2022 35035 R

(151) 2022 02 07

(181) 2032 02 07

(210) AM 116434

(220) 2022 02 03

(732) LLC "FibSWAP DEX"

Bogdan Khmelnitkiy St. 8, app. 17, Tbilisi,
Georgia

(540)



(591) Lilac, sky-blue, pink, black

(531) 27.05.01; 28.05; 29.01.15

(511) 36

(591) White, grey, green, golden

(531) 01.05.01; 01.05.02; 27.05.01; 27.05.24;
29.01.14

(511) 37, 39, 42

(111) M 2022 35038 R

(151) 2022 02 08

(181) 2032 02 08

(210) AM 116516

(220) 2022 02 04

(732) JSC "Argo"

Lilo, Lochini Gorge (plot 05/001), 0151,
Tbilisi, Georgia

(540)

Bergbrau

ბერგბრაუ

(591) Black-white

(511) 32

(111) M 2022 35036 R

(151) 2022 02 07

(181) 2032 02 07

(210) AM 116427

(220) 2022 02 03

(732) Megainpharm GmbH

Wörthersee-Süduferstr. 163 c. 5, 9082 Maria
Wörth, Austria

(740) Giorgi Taktakishvili

(540)

მიკაფარმ

(591) Black-white

(531) 26.11.07; 28.19

(511) 3, 5

(111) M 2022 35039 R

(151) 2022 02 08

(181) 2032 02 08

(210) AM 116406

(220) 2022 01 31

(732) LLC "Grid Construction"

Gabashvili St. 3, 0162, Vake-Saburtalo
District, Tbilisi, Georgia

(540)

Grid Construction

გრიდ ქონსტრუქშენი

(591) 000000 Black, FFFFFFF white

(511) 37

(111) M 2022 35037 R

(151) 2022 02 08

(181) 2032 02 08

(210) AM 116235

(220) 2022 01 18

(732) Frontera Resources US LLC

3040 Post Oak Boulevard, Suite 1100,
Houston, Texas, 77056, USA

(740) Ana Rekhviashvili

(540)



(111) M 2022 35058 R

(151) 2022 02 08

(181) 2032 02 08

(210) AM 116163

(220) 2022 01 13

(732) LLC "Russian Diamond"

S. Chikovani St. 9/11, app. 33, 0171, Tbilisi,
Georgia

(540)



(591) White, black, grey, red

(531) 09.01.07; 17.02.01; 17.02.02; 25.01.05;
25.01.19; 26.05.02; 26.05.22; 26.11.08;
27.05.01; 27.05.10; 27.05.24; 29.01.14

(511) 33

(111) M 2022 35059 R

(151) 2022 02 08

(181) 2032 02 08

(210) AM 116395

(220) 2022 01 31

(732) Braun GmbH

Frankfurter Str. 145, Kronberg im Taunus,
61476, Germany

(540)

BRAUN

(591) Black-white

(531) 27.05.01; 27.05.10; 27.05.17

(511) 3, 7, 8, 9, 10, 11, 14, 21, 26, 28

(111) M 2022 35060 R

(151) 2022 02 08

(181) 2032 02 08

(210) AM 116396

(220) 2022 01 31

(732) Braun GmbH

Frankfurter Str. 145, Kronberg im Taunus,
61476, Germany

(540)

BRAUN

(591) Black-white

(531) 27.05.01

(511) 3, 7, 8, 9, 10, 11, 14, 21, 26, 28

(111) M 2022 35061 R

(151) 2022 02 08

(181) 2032 02 08

(210) AM 116410

(220) 2022 02 01

(732) Tukazban Patdakhova

Vill. Kirach-Mughanlo, Marneuli, Georgia

(540)

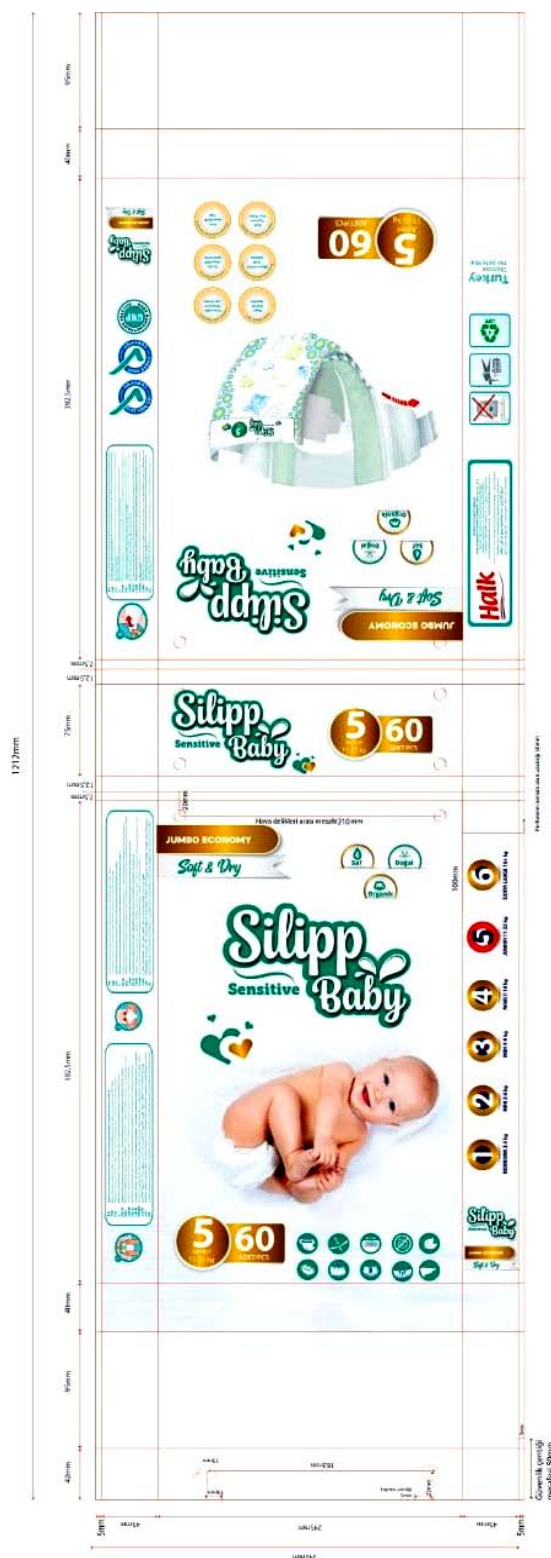

(591) White, light green, golden, red, black
 (531) 02.05.06; 02.05.17; 19.03.24; 19.13.15;
 29.01.15
 (511) 5

(111) M 2022 35062 R
 (151) 2022 02 08
 (181) 2032 02 08
 (210) AM 116436
 (220) 2022 02 03
 (732) RC Vinograph
 Vill. Shilda, 4816, Kvareli Region, Georgia
 (540)

თი'ვინო
 ti'vino
 ТИ'ВИНО

(591) Black-white
 (511) 33

(111) M 2022 35063 R
 (151) 2022 02 09
 (181) 2032 02 09
 (210) AM 116335
 (220) 2022 01 27
 (732) LLC "Royal Capital Management"
 Lekh and Maria Katchinskiy St. 3, fl. 16,
 Block "C", app. 1503, 6001, Batumi,
 Georgia

(540)



(591) Black, golden, yellow
 (531) 25.01.25; 27.05.01; 27.05.21; 27.05.24;
 29.01.12
 (526) BATUMI
 (511) 41

(111) M 2022 35064 R
 (151) 2022 02 09
 (181) 2032 02 09
 (210) AM 116409
 (220) 2022 02 01
 (732) JSC "Pediatri"
 Ushangi Chkheidze St. 10, 0102, Tbilisi,
 Georgia

(540)



(591) Green, orange
 (531) 02.07.10; 02.07.11; 02.07.23; 26.01.01;
 26.01.03; 26.01.24; 26.11.12; 29.01.12
 (511) 44

(111) M 2022 35065 R
 (151) 2022 02 09
 (181) 2032 02 09
 (210) AM 116518
 (220) 2022 02 04
 (732) LLC "Linkriver"
 Vazha-Pshavela Av. 71, fl. 2, Benchma-
 rking 3.90, Block II, Office Space 5, Tbilisi,
 Georgia

(740) Nana Kvinikadze
 (540)

Linkriver
 ლინკრივერი

(591) 000000 Black, white
 (511) 9, 38, 42

(111) M 2022 35066 R
 (151) 2022 02 10
 (181) 2032 02 10
 (210) AM 116428
 (220) 2022 02 03
 (732) Beka Gagunashvili
 Iashvili St. 13, 2200, Telavi, Georgia
 (540)



(591) Black, white, golden
 (531) 01.03.01; 01.15.09; 11.03.02; 19.07.01;
 27.05.01; 27.05.09; 27.05.10; 27.05.13;
 27.05.19; 29.01.13
 (511) 35

(111) M 2022 35067 R
 (151) 2022 02 14
 (181) 2032 02 14
 (210) AM 116334
 (220) 2022 01 27
 (732) JSC "Badagoni"
 Vill. Zemo Khodasheni, 105, Akhmeta,
 Georgia
 (740) Tamar Machavariani
 (540)



(591) Bronze, carnelian, ivory
 (531) 05.03.04; 05.07.10; 24.07.01; 24.13.01;
 24.13.09; 24.13.23; 25.01.19; 29.01.15
 (526) ГРУЗИИ, Image of the flag
 (511) 33, 35

(111) M 2022 35068 R
 (151) 2022 02 14
 (181) 2032 02 14
 (210) AM 116418
 (220) 2022 02 02
 (732) Enriko Beridze
 G. Tsitsishvili St. 18, Tbilisi, Georgia
 (740) Salome Jeladze

(540)

კალათა
Kalata

(591) Black-white
 (511) 35, 44

(111) M 2022 35069 R
 (151) 2022 02 17
 (181) 2032 02 17
 (210) AM 116536
 (220) 2022 02 08
 (732) LTD "Be Parent"
 Ana Antonovskaya St. 9b, app. 57, 0177,
 Tbilisi, Georgia
 (540)

Making Miracles Happen

(591) 000000 black, FFFFFFF white
 (511) 44

(111) M 2022 35070 R
 (151) 2022 02 18
 (181) 2032 02 18
 (210) AM 116403
 (220) 2022 01 31
 (732) JSC "Pasha Bank Georgia"
 I. Chavchavadze Av. 37m., 0162, Tbilisi,
 Georgia
 (540)

იყიდე ახლა
 გადაიხადე მერე

(591) Black-white
 (511) 36

(111) M 2022 35071 R
 (151) 2022 02 18
 (181) 2032 02 18
 (210) AM 116631
 (220) 2022 02 14
 (732) LLC "3D"
 Nutsbidze St. 10, app. 9, 0177, Tbilisi,
 Georgia
 (540)

დეგრიპო
 дегрипо
degripo

(591) Black-white
 (511) 5

(111) M 2022 35072 R

(151) 2022 02 18

(181) 2032 02 18

(210) AM 116635

(220) 2022 02 14

(732) LLC "3D"

Nutsubidze St. 10, app. 9, 0177, Tbilisi,

Georgia

(540)

აქტივამენტი

АКТИВАМЕНТ

Activamente

(591) Black-white

(511) 5

(111) M 2022 35107 R

(151) 2022 02 21

(181) 2032 02 21

(210) AM 116551

(220) 2022 02 10

(732) LLC "Tursa"

Angisi Settlement, 6010, Batumi, Georgia

(540)



(591) F4E1E1 white, EA222A red

(531) 26.02.07; 26.02.08; 26.02.09; 26.02.12;

26.02.18; 29.01.12

(511) 35

INTERNATIONAL TRADEMARKS FOR WHICH A DECISION ON GRANTING PROTECTIONS IS TAKEN

The decision can be appealed at the Chamber of Appeal of Sakpatenti within 3 months from the publication or at the Mtskheta District Court Administrative Cases Board (Address: №17, Samkhedro St., Mtskheta), within 1 month following the publication.

(260) AM 2022 105478 A*

(800) 1493775

(151) 2019 02 26

(891) 2019 02 26

(731) ŠKODA INVESTMENT a.s.

Emila Škody 2922/1, Jižní Předměstí,

CZ-301 00 Plzeň, Czech Republic

(540)

ŠKODA

(591) Black and white

(531) 27.05.17

(511)

37 – Mining for precious metals; mining extraction; quarrying services; mining for precious stones; wiring of buildings for telecommunication transmission.

(260) AM 2022 109313 A

(800) 1543920

(151) 2020 07 06

(891) 2020 07 06

(731) Tangshan Imex Industrial Co., Ltd.

In the Culture Creation Industrial Park, south of Yuegezhuang Road, west of Tangbai Road, Lunan District, Tangshan City, 100040 Hebei, China

(540)

Imēx

(591) Black, white

(511)

11 – Wash-hand bowls [parts of sanitary installations]; flushing apparatus; bath tubs; taps [faucets]; showers; toilet bowls; toilet seats; sinks; urinals being sanitary fixtures; bath installations.

(260) AM 2022 109714 A

(800) 1549661

(151) 2019 08 23

(891) 2019 08 23

(731) The Whistler Group, Inc.

PO Box 1397, Bentonville AR 72712-1397, USA

(540)

WHISTLER

(591) Black, white

(511)

9 – Laser object detectors for use on vehicles; laser speed detectors; radar object detectors for use on vehicles; radar detectors; inverters; power inverters; inspection cameras; borescopes; wireless communication devices for transmitting images taken by a camera; recorded and downloadable computer application software for mobile phones, namely, software for monitoring and activating a radar detector; automatic indicators of low pressure in tires; vehicle safety equipment, namely, electronic tire pressure monitors; electronic devices for locating and tracking golf balls using a global positioning system; devices used to detect red light and speed cameras and other photo radar devices using GPS and cellular communication technology; electronic GPS-based traffic and speed camera warning device; electronic communication apparatus for use in wireless radio transmission; battery charge devices; battery jump starters; monitoring devices for monitoring battery performance characteristics; scanners; devices for wireless radio transmission; vehicle safety equipment, namely, back-up sensors and cameras; vehicle safety equipment, namely, an on-board vehicular surveillance system comprised of cameras and monitors for exposing and eliminating the blind spots on both sides of the vehicle; motion-activated cameras; cameras; remote cameras; video cameras; digital video cameras; personal video recorders (PVRs); digital audio and video recorders and players for vehicles; digital video recorders; helmet safety lights; flashing and steady safety lights; camcorders for vehicles; camcorders for residential or commercial buildings; head-up displays for use in vehicles and residential buildings, namely, transparent electronic displays for providing users with navigational and operational information; remote video monitoring system consisting primarily of a camera and video monitor for recording and transmitting images to a remote location; downloadable and recorded digital video recording software for IP (Internet protocol) video surveillance; electric and electronic video surveillance installations; electronic video surveillance products, namely, electronic components of security systems; mounting devices for cameras and monitors; stands for handheld digital electronic devices, namely, mobile phones, MP3 players, and tablet computers; mounting devices specially adapted for computer monitors, radar detectors, GPS units, mobile phones,

MP3 players, and tablet computers; GPS tracking devices; vehicle detection equipment, namely, display monitors, computers, image sensors, video cameras, and recorded and downloadable operating system and application software used to detect vehicle location; global positioning system (GPS); GPS navigation device; electronic devices for locating and tracking personal vehicles and fleet vehicles using radio frequency identification tags; electronic devices used to locate lost articles employing the global positioning systems or cellular communication networks; vehicle locator and recovery device programmed to use global positioning systems and cellular telecommunications; sensors and detector units for use in controlling the actuation and operation of automotive safety apparatus and equipment; air bag vests being protective clothing for protection against motorcycle and bicycle accidents; emergency light bars for vehicles; near field communication (NFC) technology-enabled devices, namely, radar detectors.

(260) AM 2022 111777 A

(800) 1575778

(151) 2020 09 14

(891) 2020 09 14

(731) "Amalgame-Luxe", Community with limited Responsibility
Mala Morska Str, 108/1, Mykolayiv 54017,
Ukraine

(540)

SULS

(591) Black, white

(511)

3 – Abrasives; glass cloth [abrasive cloth]; abrasive paper; breath freshening sprays; diamantine [abrasive]; alum stones [astringents]; amber [perfume]; anti-static preparations for household purposes; balms, other than for medical purposes; hair dyes; cosmetic dyes; bergamot oil; lip glosses; nail glitter; badian essence; petroleum jelly for cosmetic purposes; cotton wool for cosmetic purposes; cotton swabs for cosmetic purposes; bleaching soda; laundry bleach; bleaching salts; bleaching preparations [decolorants] for cosmetic purposes; decorative transfers for cosmetic purposes; shoe wax; mustache wax; volcanic ash for cleaning; astringents for cosmetic purposes; cloths impregnated with a detergent for cleaning; gaultheria oil; dental bleaching gels; heliotropine; geraniol; make-up; lipsticks; deodorants for pets; deodorants for human beings or for animals; deodorant soap; depilatory wax; scented water; scented wood; ethereal essences; essential oils; essential oils of cedarwood; Javelle water; jasmine oil; greases for cosmetic purposes; flavorings for beverages [essential oils]; cake flavorings [essential oils]; preservatives for leather [polishes]; varnish-removing preparations; lacquer-removing preparations; degreasers, other than for use in manufacturing processes; color-removing preparations; desca-

ling preparations for household purposes; toothpaste; dentifrices; ionone [perfumery]; shaving stones [astringents]; carbides of metal [abrasives]; silicon carbide [abrasive]; extracts of flowers [perfumes]; adhesives for affixing false hair; adhesives for affixing false eyelashes; adhesives for cosmetic purposes; hair conditioners; quillaia bark for washing; corundum [abrasive]; cosmetics; eyebrow cosmetics; cosmetic preparations for eyelashes; cosmetics for animals; make-up powder; beauty masks; cosmetic kits; hair straightening preparations; cosmetic preparations for skin care; sun-tanning preparations [cosmetics]; cosmetic preparations for slimming purposes; cosmetic preparations for baths; tailors' wax; cleaning chalk; shoe cream; skin whitening creams; cosmetic creams; laundry starch; starch glaze for laundry purposes; cakes of toilet soap; lavender water; incense; hair spray; essential oils of lemon; polishing wax; polishing paper; polishing stones; polishing preparations; shoe polish; denture polishes; polish for furniture and flooring; hair lotions; lotions for cosmetic purposes; after-shave lotions; smoothing preparations [starching]; massage gels, other than for medical purposes; non-slipping wax for floors; almond oil; almond soap; almond milk for cosmetic purposes; washing soda, for cleaning; soap; shaving soap; soap for brightening textile; soap for foot perspiration; musk [perfumery]; fabric softeners for laundry use; mint for perfumery; mint essence [essential oil]; emery; emery cloth; emery paper; nail art stickers; neutralizers for permanent waving; fumigation preparations [perfumes]; eau de Cologne; eyebrow pencils; cosmetic pencils; oils for perfumes and scents; oils for toilet purposes; oils for cleaning purposes; oil of turpentine for degreasing; mouthwashes, not for medical purposes; bases for flower perfumes; drying agents for dishwashing machines; cleansing milk for toilet purposes; scouring solutions; perfumery; perfumery, essential oils; perfumery, essential oils, non-medicated cosmetics, non-medicated hair lotions; toiletry preparations; perfumes; pastes for razor strops; pumice stone; hydrogen peroxide for cosmetic purposes; polishing rouge; pomades for cosmetic purposes; laundry blueing; laundry preparations; air fragrancng preparations; shaving preparations; stain removers; rust removing preparations; paint stripping preparations; make-up preparations; nail care preparations; make-up removing preparations; hair waving preparations; preparations to make the leaves of plants shiny; preparations for unblocking drain pipes; dry-cleaning preparations; preparations for cleaning dentures; bath preparations, not for medical purposes; aloe vera preparations for cosmetic purposes; non-slipping liquids for floors; antiperspirant soap; windsheld cleaning liquids; floor wax removers [scouring preparations]; safrol; sachets for perfuming linen; tissues impregnated with cosmetic lotions; tissues impregnated with make-up removing preparations; turpentine for degreasing; breath freshening strips; soda lye; bath salts, not for medical purposes; sunscreen

preparations; douching preparations for personal sanitary or deodorant purposes [toiletries]; canned pressurized air for cleaning and dusting purposes; potpourris [fragrances]; dry shampoos; talcum powder, for toilet use; tripoli stone for polishing; rose oil; toilet water; mascara; lipstick cases; color-brightening chemicals for household purposes [laundry]; henna [cosmetic dye]; essential oils of citron; cleaning preparations; wallpaper cleaning preparations; chemical cleaning preparations for household purposes; shampoos; shampoos for pets [non-medicated grooming preparations]; shoemakers' wax; smoothing stones; false eyelashes; false nails; grinding preparations.

5 – Acaricides; aconitine; alkaloids for medical purposes; alginates for pharmaceutical purposes; alginate dietary supplements; algicides; aldehydes for pharmaceutical purposes; amino acids for veterinary purposes; amino acids for medical purposes; analgesics; anaesthetics; antibiotics; appetite suppressants for medical purposes; first-aid boxes, filled; aluminium acetate for pharmaceutical purposes; acetates for pharmaceutical purposes; germicides; bacterial poisons; bacterial preparations for medical and veterinary use; bacteriological preparations for medical and veterinary use; balms for medical purposes; balsamic preparations for medical purposes; aseptic cotton; tobacco-free cigarettes for medical purposes; bandages for dressings; protein dietary supplements; albuminous foodstuffs for medical purposes; albuminous preparations for medical purposes; biological preparations for veterinary purposes; biological preparations for medical purposes; biocides; bismuth subnitrate for pharmaceutical purposes; linseed meal for pharmaceutical purposes; flour for pharmaceutical purposes; bracelets impregnated with insect repellent; bromine for pharmaceutical purposes; bronchodilating preparations; vaginal washes for medical purposes; petroleum jelly for medical purposes; vaccines; wadding for medical purposes; cotton sticks for medical purposes; absorbent cotton; veterinary preparations; decoctions for pharmaceutical purposes; tartar for pharmaceutical purposes; vitamin preparations; mineral waters for medical purposes; hydrated chloral for pharmaceutical purposes; dietary fiber; charcoal for pharmaceutical purposes; gases for medical purposes; gallic acid for pharmaceutical purposes; guaiacol for pharmaceutical purposes; hematogen; hemoglobin; herbicides; panty liners [sanitary]; sanitary towels; sanitary panties; sanitary preparations for medical purposes; sanitary tampons; hydrastine; hydrastinine; mustard for pharmaceutical purposes; mustard oil for medical purposes; mustard plasters; glycerine for medical purposes; glycerophosphates; glucose for medical purposes; hormones for medical purposes; mud for baths; medicinal mud; gum for medical purposes; rubber for dental purposes; gamboge for medical purposes; gurjun balsam for medical purposes; disinfectants; disinfectants for hygiene purposes; disinfectants for chemical toilets; deodorants for clothing and textiles; deodorants,

other than for human beings or for animals; detergents for medical purposes; digitalin; diagnostic preparations for veterinary purposes; diagnostic preparations for medical purposes; diastase for medical purposes; dietary supplements for human beings and animals; glucose dietary supplements; dietary supplements for animals; linseed dietary supplements; royal jelly dietary supplements; pollen dietary supplements; propolis dietary supplements; wheat germ dietary supplements; dietetic beverages adapted for medical purposes; dietetic food and substances adapted for medical or veterinary use, food for babies; dietetic substances adapted for medical use; dietetic foods adapted for medical purposes; yeast for pharmaceutical purposes; yeast dietary supplements; eucalyptus for pharmaceutical purposes; eucalyptol for pharmaceutical purposes; extracts of hops for pharmaceutical purposes; elixirs [pharmaceutical preparations]; esters for pharmaceutical purposes; cellulose esters for pharmaceutical purposes; ethers for pharmaceutical purposes; cellulose ethers for pharmaceutical purposes; gelatine for medical purposes; milking grease; greases for veterinary purposes; greases for medical purposes; jujube, medicated; chewing gum for medical purposes; headache relief sticks; nervines; personal sexual lubricants; dental amalgams; dental amalgams of gold; dental mastics; dental cements; isotopes for medical purposes; immunostimulants; reagent paper for medical or veterinary purposes; reagent paper for veterinary purposes; reagent paper for medical purposes; insecticides; Irish moss for medical purposes; caustic pencils; caustics for pharmaceutical purposes; alkaline iodides for pharmaceutical purposes; iodides for pharmaceutical purposes; iodine for pharmaceutical purposes; iodoform; casein dietary supplements; calomel [fungicide]; camphor for medical purposes; camphor oil for medical purposes; capsules for medicines; carbolineum [parasiticide]; cachou for pharmaceutical purposes; quassia for medical purposes; quebracho for medical purposes; oxygen for medical purposes; acids for pharmaceutical purposes; oxygen baths; bone cement for surgical and orthopaedic purposes; adhesives for dentures; fly glue; cocaine; collodion for pharmaceutical purposes; compresses; condurango bark for medical purposes; angostura bark for medical purposes; mangrove bark for pharmaceutical purposes; barks for pharmaceutical purposes; quinquina for medical purposes; rhubarb roots for pharmaceutical purposes; lint for medical purposes; collyrium; cream of tartar for pharmaceutical purposes; creosote for pharmaceutical purposes; blood for medical purposes; depuratives; styptic preparations; dill oil for medical purposes; croton bark; starch for dietetic or pharmaceutical purposes; cultures of microorganisms for medical or veterinary use; curare; dental lacquer; lactose for pharmaceutical purposes; lecithin for medical purposes; lecithin dietary supplements; fly catching paper; adhesive tapes for medical purposes; medicine cases, portable, filled; medicines for alleviating cons-

tipation; medical preparations for slimming purposes; medicines for human purposes; medicines for veterinary purposes; drugs for medical purposes; remedies for perspiration; medicines for dental purposes; medicinal roots; medicated animal feed; medicinal tea; remedies for foot perspiration; medicinal infusions; medicinal oils; medicated hair lotions; medicinal hair growth preparations; medicated toiletry preparations; medicinal herbs; liniments; liquorice for pharmaceutical purposes; lotions for veterinary purposes; lotions for pharmaceutical purposes; lupulin for pharmaceutical purposes; linseed for pharmaceutical purposes; magnesia for pharmaceutical purposes; sunburn ointments; ointments for pharmaceutical purposes; frostbite salve for pharmaceutical purposes; gauze for dressings; teeth filling material; material for dental fillings and dental impressions; royal jelly for pharmaceutical purposes; melissa water for pharmaceutical purposes; menthol; almond milk for pharmaceutical purposes; dog washes [insecticides]; animal washes [insecticides]; cattle washes [insecticides]; insecticidal veterinary washes; mineral food supplements; bunion pads; moleskin for medical purposes; powdered milk for babies; lacteal flour for babies; sea water for medicinal bathing; mint for pharmaceutical purposes; scapulars for surgical purposes; vesicants; narcotics; tincture of iodine; tinctures for medical purposes; fumigation preparations for medical purposes; cachets for pharmaceutical purposes; wart pencils; oil of turpentine for pharmaceutical purposes; opiates; opium; opodeldoc; poisons; air purifying preparations; stick liquorice for pharmaceutical purposes; pants, absorbent, for incontinence; diapers for incontinence; paper for mustard plasters; mothproofing paper; parasiticides; pastilles for pharmaceutical purposes; insect repellent incense; pectin for pharmaceutical purposes; pepsins for pharmaceutical purposes; peptones for pharmaceutical purposes; dressings, medical; pearl powder for medical purposes; hydrogen peroxide for medical purposes; pesticides; tanning pills; appetite suppressant pills; slimming pills; antioxidant pills; babies' diapers; babies' diaper-pants; diapers for pets; pyrethrum powder; blood plasma; plasters, materials for dressings; nutritive substances for microorganisms; media for bacteriological cultures; nutritional supplements; pomades for medical purposes; powder of cantharides; porcelain for dental prostheses; hemorrhoid preparations; laxatives; corn remedies; preparations for callouses; chilblain preparations; air deodorizing preparations; mothproofing preparations; acne treatment preparations; preparations for destroying dry rot fungus; larvae exterminating preparations; preparations for destroying mice; fly destroying preparations; vermin destroying preparations; slug exterminating preparations; preparations for destroying noxious animals; preparations for the treatment of burns; opotherapy preparations; mouthwashes for medical purposes; soil-sterilising preparations; bath preparations for medical purposes; aloe vera preparations

for pharmaceutical purposes; lime-based pharmaceutical preparations; preparations of trace elements for human and animal use; bismuth preparations for pharmaceutical purposes; preparations to facilitate teething; medicated eye-washes; poultices; chemical conductors for electrocardiograph electrodes; food for babies; by-products of the processing of cereals for dietetic or medical purposes; purgatives; propolis for pharmaceutical purposes; protein supplements for animals; asthmatic tea; febrifuges; chemical contraceptives; antiseptic cotton; antiseptics; corn rings for the feet; antiparasitic collars for animals; antiparasitic preparations; anti-uric preparations; anticryptogamic preparations; leeches for medical purposes; radium for medical purposes; radioactive substances for medical purposes; diagnostic biomarker reagents for medical purposes; radiological contrast substances for medical purposes; insect repellents; repellents for dogs; digestives for pharmaceutical purposes; fish meal for pharmaceutical purposes; cod liver oil; ergot for pharmaceutical purposes; solutions for contact lenses; solvents for removing adhesive plasters; mercurial ointments; sarsaparilla for medical purposes; lead water; tissues impregnated with pharmaceutical lotions; serotherapeutic medicines; siccatives [drying agents] for medical purposes; serums; syrups for pharmaceutical purposes; sulfur sticks [disinfectants]; soporifics; bicarbonate of soda for pharmaceutical purposes; bath salts for medical purposes; smelling salts; mineral water salts; potassium salts for medical purposes; salts for medical purposes; sodium salts for medical purposes; malt for pharmaceutical purposes; malted milk beverages for medical purposes; semen for artificial insemination; alcohol for pharmaceutical purposes; alloys of precious metals for dental purposes; douching preparations for medical purposes; steroids; stem cells for veterinary purposes; stem cells for medical purposes; dental abrasives; strychnine; sulfonamides [medicines]; vulnerary sponges; therapeutic preparations for the bath; thermal water; turpentine for pharmaceutical purposes; thymol for pharmaceutical purposes; gentian for pharmaceutical purposes; smoking herbs for medical purposes; herbal teas for medicinal purposes; tobacco extracts [insecticides]; pharmaceutical preparations for treating dandruff; pharmaceutical preparations for skin care; pharmaceutical preparations; phenol for pharmaceutical purposes; fennel for medical purposes; ferments for pharmaceutical purposes; enzyme preparations for veterinary purposes; formic aldehyde for pharmaceutical purposes; molding wax for dentists; phosphates for pharmaceutical purposes; fungicides; fungicides, herbicides; chemical preparations for treating wheat blight; chemical preparations for treating phylloxera; chemico-pharmaceutical preparations; chemical preparations for the diagnosis of pregnancy; chemical preparations for treating diseases affecting vine plants; chemical preparations for veterinary purposes; chemical preparations for medical purposes; chemical preparations for phar-

maceutical purposes; chemical reagents for medical or veterinary purposes; quinine for medical purposes; chinoline for medical purposes; surgical implants comprised of living tissues; surgical glues; surgical dressings; diabetic bread adapted for medical use; chloroform; flowers of sulfur for pharmaceutical purposes; cement for animal hooves; medicated sweets; sugar for medical purposes; medicated shampoos for pets; insecticidal animal shampoos; medicated shampoos; pediculicidal shampoos; medicated dry shampoos; contact lens cleaning preparations; jalap; medicated soap; disinfectant soap; antibacterial soap.

(260) AM 2022 111780 A

(800) 1575887

(151) 2020 12 11

(891) 2020 12 11

(731) Maria Nilova

19 Lever Street, Suite 315, MANCHESTER,
Lancashire M1 1AN, United Kingdom

(540)

PATENTICA

(591) Black, white

(511)

41 – Correspondence courses; entertainment information; providing recreation facilities; club services [entertainment or education]; organization of competitions [education or entertainment]; recreation information; publication of texts, other than publicity texts; translation services, including patent translation services; arranging and conducting of congresses, conferences, seminars, symposiums; organization of exhibitions for cultural or educational purposes; educational services.

45 – Copyright management; trademark searches; intellectual property services including patenting inventions, designs and registration of trademarks; intellectual property maintenance services; legal consultation services; legal research; patent searches; licensing of intellectual property; domain name registration services; patent attorney services; patent research; domain name maintenance services; litigation services; intellectual property consultancy; intellectual property watching services; legal consultancy services.

(260) AM 2022 112438 A

(800) 1583871

(151) 2020 12 31

(891) 2020 12 31

(731) Obshchestvo s ogranichennoi otvetstvennostyu
"BIONET-plus"

Lermontova st., 343, RU-355029 g. Stavropol,
Stavropolskii krai, Russian Federation

(540)

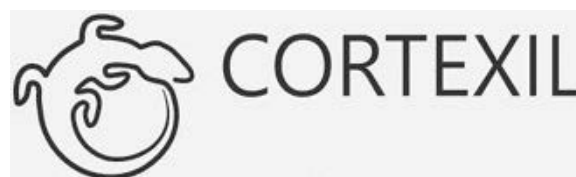

(591) Gray, black

(531) 03.11.10; 03.11.24

(511)

10 – Blood testing apparatus; anaesthetic apparatus; galvanic therapeutic appliances; apparatus for artificial respiration; apparatus for the treatment of deafness; physical exercise apparatus for medical purposes; body rehabilitation apparatus for medical purposes; surgical apparatus and instruments; resuscitation apparatus; physiotherapy apparatus; bed vibrators; hot air therapeutic apparatus; diagnostic apparatus for medical purposes; traction apparatus for medical purposes; radiotherapy apparatus; microdermabrasion apparatus; fumigation apparatus for medical purposes; apparatus for the regeneration of stem cells for medical purposes; apparatus for DNA and RNA testing for medical purposes; apparatus and installations for the production of X-rays, for medical purposes; magnetic resonance imaging [MRI] apparatus for medical purposes; radiological apparatus for medical purposes; X-ray apparatus for medical purposes; hearing aids; nasal aspirators; trusses; maternity belts; bandages, elastic; cupping glasses; bracelets for medical purposes; anti-nausea wristbands; anti-rheumatism bracelets; air cushions for medical purposes; vaporizers for medical purposes; hot air vibrators for medical purposes; vibromassage apparatus; gastroscopes; hemocytometers; lice combs; surgical sponges; defibrillators; dialyzers; containers especially made for medical waste; clips, surgical; mirrors for surgeons; probes for medical purposes; urethral probes; acupuncture needles; suture needles; needles for medical purposes; orthopaedic articles; surgical implants comprised of artificial materials; inhalers; hydrogen inhalers; injectors for medical purposes; incubators for medical purposes; incubators for babies; obstetric apparatus; obstetric apparatus for cattle; electric acupuncture instruments; surgical cutlery; insufflators; endoscopy cameras for medical purposes; cannulae; droppers for medical purposes; dropper bottles for medical purposes; heart pacemakers; heart rate monitoring apparatus; catheters; catgut; draw-sheets for sick beds; enema apparatus for medical purposes; artificial skin for surgical purposes; menstrual cups; teething rings; anti-rheumatism rings; compressors [surgical]; thermo-electric compresses [surgery]; abdominal corsets; corsets for medical purposes; crutches; dentists' armchairs; armchairs for medical or dental purposes; beds specially made for medical purposes; feeding bottle valves; love dolls [sex dolls]; lasers for medical purposes; lamps for medical purposes; quartz lamps for medical purposes; ultraviolet ray lamps for medical purposes; lancets; lenses [in-

traocular prostheses] for surgical implantation; spoons for administering medicine; respiratory masks for artificial respiration; anaesthetic masks; suture materials; childbirth mattresses; air mattresses for medical purposes; furniture especially made for medical purposes; water bags for medical purposes; douche bags; breast pumps; body fat monitors; body composition monitors; portable hand-held urinals; temperature indicator labels for medical purposes; knee bandages, orthopaedic; tips for crutches; finger guards for medical purposes; medical guidewires; pumps for medical purposes; thread, surgical; knives for surgical purposes; scissors for surgery; ambulance stretchers; stretchers, wheeled; boots for medical purposes; orthopaedic footwear; clothing especially for operating rooms; compression garments; blankets, electric, for medical purposes; supports for flat feet; ophthalmometers; ophthalmoscopes; cooling pads for first aid purposes; slings [supporting bandages]; gloves for massage; gloves for medical purposes; pessaries; saws for surgical purposes; ear picks; cooling patches for medical purposes; spittoons for medical purposes; plaster bandages for orthopaedic purposes; orthopaedic bandages for joints; suspensory bandages; abdominal pads; cushions for medical purposes; pads for preventing pressure sores on patient bodies; air pillows for medical purposes; soporific pillows for insomnia; heating cushions, electric, for medical purposes; abdominal belts; galvanic belts for medical purposes; hypogastric belts; belts for medical purposes; orthopaedic belts; umbilical belts; belts, electric, for medical purposes; condoms; aerosol dispensers for medical purposes; sphygmomanometers; pulse meters; esthetic massage apparatus; massage apparatus; veterinary apparatus and instruments; medical apparatus and instruments; urological apparatus and instruments; orthodontic appliances; brushes for cleaning body cavities; appliances for washing body cavities; corn knives; incontinence sheets; sterile sheets, surgical; surgical drapes; hair prostheses; artificial eyes; artificial breasts; dentures; artificial limbs; artificial jaws; ice bags for medical purposes; toe separators for orthopaedic purposes; orthodontic rubber bands; X-ray photographs for medical purposes; respirators for artificial respiration; surgical robots; ear trumpets; strait jackets; sex toys; scalpels; tongue scrapers; dummies for babies; feeding bottle teats; baby feeding dummies; receptacles for applying medicines; spirometers [medical apparatus]; vaginal syringes; implantable subcutaneous drug delivery devices; hearing protectors; contraceptives, non-chemical; orthopaedic soles; stents; stethoscopes; operating tables; commode chairs; basins for medical purposes; bed pans; instrument cases for use by doctors; arch supports for footwear; ear plugs [ear protection devices]; thermometers for medical purposes; tomographs for medical purposes; trocars; walking sticks for medical purposes; drainage tubes for medical purposes; X-ray tubes for medical purposes; radium tubes for medical purposes; balling guns; protection devices

against X-rays, for medical purposes; apparatus for acne treatment; filters for ultraviolet rays, for medical purposes; quad canes for medical purposes; wheeled walkers to aid mobility; walking frames for disabled persons; cases fitted for medical instruments; elastic stockings for surgical purposes; stockings for varices; splints, surgical; tongue depressors for medical purposes; syringes for injections; syringes for medical purposes; hypodermic syringes; uterine syringes; urethral syringes; forceps; castrating pincers; radiology screens for medical purposes; electrodes for medical use; electrocardiographs; brain pacemakers; analysers for bacterial identification for medical purposes; testing apparatus for medical purposes; biodegradable bone fixation implants; urinals being vessels; thermal packs for first aid purposes; surgical bougies; patient hoists.

(260) AM 2022 112463 A

(800) 1331788

(151) 2016 07 27

(891) 2021 02 26

(731) İMAN ÇOLAKOĞLU

Kandilli Göksu Cad. No:9, Üsküdar, İstanbul,
Turkey

(540)

İMANNOOR

(591) Black, white

(531) 27.05.01; 27.05.17

(511)

3 – Perfumery; cosmetic products, fragrances for personal use (including deodorants for human beings and animals); soaps.

4 – Candles, wicks, semi-finished wax, beeswax (waxes), paraffin, all for lighting purposes.

14 – Jewelry goods (including their imitation); gold, jewels, precious stones and jewelry made thereof, cuff-links, tie pins and ornaments [jewellery] and figurines of precious metal; clocks, watches and horological and chronometric instruments (including chronometers and their parts, watch straps).

24 – Woven and non-woven fabrics; textile goods for household purposes; curtains, bed covers, quilt covers, bed sheets, pillow cases, blankets, quilts, towels; textile flags, pennants, labels; crib sheets.

25 – Inner and outer clothing made from all kinds of material, except clothing for protective purposes, socks, foulards, shawls, bandanas, scarves, belts; footwear; shoes, slippers, sandals; headgear; hats, flat caps, berets, skull caps, caps.

27 – Carpets, rugs, mats, prayer rugs; artificial turf, cork for use as a floor or wall covering; gymnasium mats; wall coverings, not of textile, wallpaper; linoleum for covering existing floors.

30 – Coffee, cocoa; coffee or cocoa-based beverages, chocolate based beverages; pasta, stuffed dumplings, noodles; pastry and bakery products, chocolate deserts, desserts made of flour; bread, simit (bagels covered with sesame seed), pogaça (buns with or without filling), piadina [flat bread], sandwich wraps [bread], katmer (flat layers of thin pastry with filling), pastry (börek), cakes, baklava (sweet pastry with nuts), kadayif (angel's hair dessert), desserts made of flour with syrup, pudding, muhallebi (milk pudding), kazandibi (milk pudding slightly burnt on the bottom), sutlaç (a rice pudding), keskül (Turkish-style pudding); honey, bee glue for human consumption, propolis; spices and condiments for foodstuff, vanilla, spices, sauces including tomato sauces; yeasts, baking powder; all kinds of flour, semolina, starch for food; granulated sugar, cubed sugar, powdered sugar; teas, iced teas; confectioneries, chocolates, biscuits, crackers, wafers; chewing gums; ice cream, edible ice; salt; snack food made from grains (cereal), popcorn, oatmeal, corn chips, breakfast cereals, processed wheat, barley, oat, rye, rice; molasses for food.

(260) AM 2022 112516 A

(800) 1584680

(151) 2020 08 31

(891) 2020 08 31

(731) CytoSport, Inc.

1340 Treat Boulevard, Suite 350, Walnut Creek
CA 94597, USA

(540)

MUSCLE MILK

(591) Black, white

(531) 27.05.01

(511)

5 – Meal replacement drinks, containing proteins, vitamins and minerals; mixtures of meal replacement drinks containing proteins, vitamins and minerals; pre-mixed, nutritionally fortified beverages, containing proteins, vitamins and minerals; dietary, food, nutritional supplements containing proteins, vitamins and minerals.

29 – Protein-based snacks, nutritionally fortified, in the form of bars, sticks being meal replacements, puddings (terms too vague in the opinion of the International Bureau – Rule 13 (2) (b) of the Regulations).

32 – Albumin-based energy drinks; protein-based energy drinks.

(260) AM 2022 112533 A

(800) 1585151

(151) 2020 02 21

(891) 2020 02 21

(731) Tovarichtchestvo s ogranitchennoy

otvetstvennostyu "Torgoviy Dom Amanat"

ul. 40 let Oktyabrya, raion Promzona, stroenie
1/7, g. Rudniy, 111500 Kostanaiskaya oblast,
Kazakhstan

(540)



(591) Blue-green, yellow, black, white, green, light brown, beige, blue and red

(531) 03.01.15; 05.03.11; 08.07.01; 08.07.03;
11.03.07; 28.05; 29.01.15

(511)

29 – Flax seed for human consumption.

30 – Aromatic preparations for food; flavorings, other than essential oils, for cakes; flavorings, other than essential oils, for beverages; coffee flavorings; flavorings, other than essential oils; star aniseed; cereal bars; high-protein cereal bars; pancakes; noodle-based prepared meals; buns; bread rolls; vanillin [vanilla substitute]; vanilla [flavoring]; waffles; vermicelli, including instant vermicelli; natural sweeteners; sausage binding materials; substances for binding ice cream [edible ices]; sea water for cooking; seaweed [condiment]; malt biscuits; cloves [spice]; cake frosting [icing]; glucose for culinary purposes; mustard; gluten additives for culinary purposes; yeast; thickening agents for cooking foodstuffs; leaven; rice-based snack food; cereal-based snack food; artificial coffee; vegetal preparations for use as coffee substitutes; dressings for salad; fruit jellies [confectionery]; confectionery for decorating christmas trees; cakes; pastries; peanut confectionery; almond confectionery; pasta, including macaroni products of fast preparation; pie products; ginger [spice]; frozen yogurt [confectionery ices]; cocoa; capers; caramels [sweets]; curry [spice]; cereal milk for human consumption; ketchup [sauce]; quiches; gluten prepared as foodstuff; sweets; liquorice [confectionery]; peppermint sweets; cinnamon [spice]; coffee; unroasted coffee; starch for food; crackers; custard; hominy grits; semolina; oatmeal; crushed barley; groats for human food; corn, milled; corn, roasted; meat pies; turmeric for food; couscous [grits]; flour for food; noodles, including instant noodles; ice for refreshment; ice, natural or artificial; edible ices; candies; rice cakes; mayonnaise; macaroni [almond cookies]; macaroni; maltose; hominy; marinades; marzipan; honey; royal jelly; ice cream; bean meal; tapioca flour, food grade; potato flour, food grade; corn flour; flour; wheat flour, soya flour; barley meal; dessert mousses [confectionery]; chocolate mousses; muesli; mint for confectionery; cocoa beverages with

milk; coffee beverages with milk; coffee-based beverages; tea-based beverages; chocolate beverages with milk; chocolate-based beverages; cocoa-based beverages; infusions, not medicinal; crushed oats; husked oats; nutmegs; stick liquorice [confectionery]; soy paste [seasoning]; pastilles [confectionery]; molasses for food; pepper; allspice; peppers [seasonings]; pesto [sauce]; cookies; petit-beurre biscuits; pies; pizzas; meat gravies; fondants [confectionery]; popcorn; powders for making ice cream; baking powder; mustard meal; pralines; condiments; meat tenderizers for household purposes; cereal preparations; oat-based food; propolis; gingerbread; spices; petits fours [cakes]; puddings; cake powder; fruit coulis [sauces]; ravioli; chewing gum; relish [condiment]; rice; wheat germ for human consumption; spring rolls; sago; sugar; palm sugar; aniseed; golden syrup; cake dough; confectionery; baking soda [bicarbonate of soda for cooking purposes]; malt for human consumption; salt for preserving foodstuffs; cooking salt; celery salt; sorbets [ices]; ham glaze; soya sauce; tomato sauce; pasta sauce; sauces [condiments]; spaghetti, including quick cooking spaghetti; seasonings; preparations for stiffening whipped cream; rusks; breadcrumbs; sushi; sandwiches; tabbouleh; tacos; tapioca; cream of tartar for culinary purposes; tarts; dough; almond paste; tortillas; garden herbs, preserved [seasonings]; vinegar; beer vinegar; ferments for pastes; halvah; bread; unleavened bread; chips [cereal products]; corn flakes; oat flakes; chicory [coffee substitute]; tea; iced tea; chutneys [condiments]; cheeseburgers [sandwiches]; chow-chow [condiment]; saffron [seasoning]; chocolate; malt extract for food; essences for foodstuffs, except etheric essences and essential oils; husked barley.

35 – Arranging subscriptions to telecommunication services for others; import-export agency services; commercial information agency services; advertising agency services; cost price analysis; rental of advertising space; business auditing; employment agency services; computerized file management; book-keeping; invoicing; demonstration of goods; transcription of communications; opinion polling; market studies; business information; information and advice for commercial consumers [consumer product information]; business investigations; business research; marketing research; personnel recruitment; business management and organization consultancy; business organization consultancy; business management consultancy; personnel management consultancy; professional business consultancy; layout services for advertising purposes; marketing; business management of performing artists; business management of sports people; news clipping services; updating of advertising material; word processing; organization of exhibitions for commercial or advertising purposes; arranging newspaper subscriptions for others; organization of fashion shows for promotional purposes; organization of exhibitions and trade fairs for commercial or adver-

tising purposes; shop window dressing; business appraisals; payroll preparation; data search in computer files for others; sponsorship search; business management assistance; commercial or industrial management assistance; presentation of goods on communication media, for retail purposes; economic forecasting; auctioneering; retail or wholesale sale of medicines, veterinary and hygienic preparations and medical supplies; promoting the goods of others on the internet; production of advertising films; office machines and equipment rental; rental of advertising time on communication media; publicity material rental; rental of vending machines; rental of photocopying machines; publication of publicity texts; radio advertising; bill-posting; distribution of samples; dissemination of advertising matter; direct mail advertising; writing of publicity texts; advertising; online advertising on a computer network; advertising by mail order; television advertising; reproduction of documents; compilation of statistics; compilation of information into computer databases; business inquiries; systemization of information into computer databases; business management consulting services; tax preparation; drawing up of statements of accounts; preparation of advertising columns in the newspaper; telemarketing services; psychological testing for the selection of personnel; business management of hotels; commercial administration of the licensing of the goods and services of others; administrative processing of purchase orders; public relations; modelling for advertising or sales promotion; typing; services for the relocation of businesses; price comparison services; secretarial services; procurement services for others [purchasing goods and services for other businesses]; shorthand; outsourcing services [business assistance]; telephone answering for unavailable subscribers; photocopying services; business efficiency expert services.

(260) AM 2022 112535 A

(800) 1585176

(151) 2020 08 31

(891) 2020 08 31

(731) EVYAP SABUN MALAYSIA SDN.BHD

Plo 70 Jalan, Nibong 4, Tanjung Langsat
Industrial Complex, 91700 Pasir Gudang,
Johor Darul Takzim, Malaysia

(540)

Evyap-Oleo

(591) Blue, white

(531) 27.05.01; 29.01.04

(511)

1 – Chemicals used in industry, science, photography, agriculture, horticulture and forestry; unprocessed artificial resins and unprocessed plastics; fatty acids and fatty acids used for industrial purpose; fatty acids for

use in manufacture, fatty acid esters, glycerin for industrial purpose, glycerine for use in manufacture.

5 – Dietary supplements for pharmaceutical and veterinary purposes; dietary supplements; nutritional supplements; medical preparations for slimming purposes; food for babies; herbs and herbal beverages adapted for medicinal purposes; glycerine for medical purposes, hygienic products, namely, glycerine, for medical purposes.

(260) AM 2022 112563 A

(800) 695587

(151) 1998 03 23

(891) 2020 11 30

(731) Dr. Maertens Marketing GmbH

An der Ach 3; 82402 Seeshaupt, Germany;

Dr. Martens, International Trading GmbH

Ahornstraße 8a; 82166 Gräfelfing, Germany

(540)

DR. MARTENS

(591) Black, white

(511)

3 – Shoe cleaning and shoe polishing preparations.

26 – Ribbons and braid, shoe laces, buttons, hooks and eyes.

(260) AM 2022 112573 A

(800) 1581032

(151) 2021 01 27

(891) 2021 03 22

(731) Opel Automobile GmbH

Bahnhofplatz, 65423 Rüsselsheim, Germany

(540)

GSe

(591) Black, white

(511)

12 – Motor vehicles [excluding motorbikes and motorcycles], parts and spare parts therefor, included in this class.

27 – Rugs for cars.

28 – Games; toys (other than toy motorcycles); sporting articles (other than articles for motorcycle sport); toy cars; scale model vehicles; plush toys; teddy bears; electronic games (including video games); playing cards; plastic washers for a toss game; soccer balls; basketballs; softballs; all the aforesaid goods included in this class.

(260) AM 2022 112629 A

(800) 1585868

(151) 2020 08 31

(891) 2020 08 31

(731) EVYAP SABUN MALAYSIA SDN.BHD

Plo 70 Jalan, Nibong 4, Tanjung Langsat Industrial Complex, 91700 Pasir Gudang, Johor Darul Takzim, Malaysia

(540)

PalmCrystal

(591) Black, white

(531) 27.05.01

(511)

1 – Chemicals used in industry, science, photography, agriculture, horticulture and forestry; unprocessed artificial resins and unprocessed plastics; soap noodles as raw products, soap noodles being bases for soap products, soap noodles, for use in industry; soap noodles as semi-manufactured product.

3 – Bleaching and cleaning preparations, detergents other than for use in manufacturing operations and for medical purposes, laundry bleach, fabric softeners for laundry use, stain removers, dishwasher detergents; soaps; soap primarily consisting of soap noodles.

(260) AM 2022 112758 A

(800) 1587662

(151) 2020 01 30

(891) 2020 01 30

(731) ZILAN GLOBAL GROUP SL

C/ Zurbaran, 8 1º, E-28010 Madrid, Spain

(540)



(591) Yellow, orange and black

(531) 26.04.24; 27.05.24; 28.01; 29.01.13

(511)

18 – Leather and imitation leather; animal skins; luggage and carrier bags; umbrellas and parasols; walking sticks; collars, leashes and clothing for animals; bags (purses); purses and wallets.

(260) AM 2022 112798 A

(800) 1588221

(151) 2020 12 08

(891) 2020 12 08

(731) iFIT Inc.

1500 South 1000 West, Logan UT 84321, USA

(540)

PRO-FORM

(591) Black, white

(511)

27 – Yoga mats.

28 – Elliptical exercise machines; exercise balls; exercise doorway gym bars; exercise machines; exercise weights; manually-operated exercise equipment; physical fitness equipment, namely, treadmills, ellipticals, stationary exercise bicycles, stepping machines; vibrating apparatus used in fitness and exercise programs to stimulate muscles and increase strength and physical performance; wrist and ankle weights for exercise.

(260) AM 2022 112801 A
 (800) 1588272
 (151) 2020 12 09
 (891) 2020 12 09
 (731) iFIT Inc.
 1500 South 1000 West, Logan UT 84321,
 USA
 (540)

NORDICTRACK

(591) Black, white
 (511)
 28 – Exercise machines; exercise weights; manually-operated exercise equipment; elliptical exercise machines; exercise balls; physical fitness equipment, namely, treadmills, ellipticals, stationary exercise bicycles, stepping machines, rowers.

(260) AM 2022 112826 A
 (800) 1292222
 (151) 2016 02 15
 (891) 2021 04 13
 (731) Akzo Nobel Coatings International B.V.
 Velperweg 76, NL-6824 BM Arnhem,
 Netherlands
 (540)



(591) Black, white
 (531) 27.01.02; 27.05.07; 27.05.17; 27.05.23
 (511)
 2 – Paints; varnishes; lacquers; thinners and coloring matters, all being additives for paints, varnishes or lacquers; preservatives against rust and against deterioration of wood; priming preparations (in the nature of paints); wood stains.

(260) AM 2022 112827 A
 (800) 1382773
 (151) 2017 10 31
 (891) 2021 03 09
 (731) Technivorm B.V.
 Industrierweg 20, NL-3958 VR Amerongen,
 Netherlands
 (540)

MOCCAMASTER

(591) Black, white
 (511)
 11 – Household appliances, instruments and apparatus (not included in other classes), including electric coffee percolators, coffee machines, coffee grinding machines, coffee dispensers, coffee filters and coffee roasters.

(260) AM 2022 112828 A
 (800) 1383484
 (151) 2017 11 21
 (891) 2021 04 12
 (731) Bitpanda GmbH
 Campus 2, Jakov-Lind-Straße 2, A-1020 Wien,
 Austria
 (540)

BITPANDA

(591) Black, white
 (511)
 9 – Downloadable computer software for use in electronically trading, storing, sending, receiving, accepting, and transmitting digital currency, and managing digital currency payment and exchange transactions.
 36 – Currency exchange services; online real-time currency trading; cash management, namely, facilitating transfers of electronic cash equivalents; digital currency exchange transaction services for transferrable electronic cash equivalent units having a specified cash value.
 42 – Providing temporary use of online non-downloadable software for use in electronically trading, storing, sending, receiving, accepting and transmitting digital currency, and managing digital currency payment and exchange transactions.

(260) AM 2022 112829 A
 (800) 1402882
 (151) 2017 09 13
 (891) 2021 03 29
 (731) Dirk Rossmann GmbH
 Isernhägener Str. 16, 30938 Burgwedel,
 Germany

(540)



(591) Black, white

(531) 01.15.11; 04.02.01; 26.01.03

(511)

3 – Toiletry preparations; essential oils and aromatic extracts; cleaning and fragancing preparations; body cleaning and beauty care preparations; oral hygiene preparations; balms, other than for medical purposes; massage gels, other than for medical purposes; cotton sticks for cosmetic purposes; massage oils; tissues impregnated with cosmetic lotions; tissues impregnated with cosmetics; dentifrices; toothpaste; bath preparations; skin care preparations; soaps and gels; shower and bath gel; shower and bath foam; disposable wipes impregnated with cleansing compounds for use on the face; pre-moistened cosmetic wipes; soaps; cream soaps; shower creams; liquid bath soaps; liquid soaps for hands and face; soaps in liquid form; facial soaps; hand soaps; cosmetic soaps; soaps for body care; bath salts, not for medical purposes; bath preparations, not for medical purposes; baths (cosmetic preparations for); bath flakes; bath milk; bath gel; bath foam; bath soap; bath preparations, not for medical purposes; bubble bath; cosmetic creams; skincare cosmetics; lotions for cosmetic purposes; oils for cosmetic purposes; cleansing milk for toilet purposes; sunscreen preparations; baby powder; skin fresheners; moisturising creams, lotions and gels; skin moisturisers; face creams for cosmetic use; cosmetic facial lotions; facial washes [cosmetic]; skin lotion; skin cleansing lotion; body cream; wipes impregnated with a skin cleanser; suntan oils for cosmetic purposes; topical skin sprays for cosmetic purposes; waterproof sunscreen; essential oils; lavender oil; almond oil; color-removing preparations; stain removing preparations; refurbishing preparations; laundry preparations; dishwashing detergents; detergents for household use; laundry preparations; soap powder; liquid soap for laundry; laundry soap; baby oils; baby shampoo; baby bath mousse; baby lotions; baby body milks; baby bubble bath; baby shampoo mousse; baby wipes; baby hair conditioner; baby oils; baby lotions; baby sun creams; babies' creams [non-medicated]; baby care products (non-medicated); talcum powder (non-medicated) for babies; cotton wool for cosmetic purposes; cotton sticks for cosmetic purposes; cotton balls for cosmetic purposes; cotton balls for cosmetic purposes.

5 – Infant formula; babies' diapers; babies' diaper-pants; baby food; medicated baby oils; milk powders [foodstuff for babies]; medicated baby powders; ba-

bies' creams [medicated]; nappies for babies and incontinence; beverages for infants; paper diapers; powdered milk for babies; disposable swim diapers for babies; babies' swim diapers; infant formula; menthol vapor bath preparations for babies; disposable liners for babies' diapers; dietetic substances for babies; talcum powder (medicated) for babies; lacteal flour for babies; dietetic beverages for babies adapted for medical purposes; disposable pants of paper for holding a babies' napkin in place; disposable pants of cellulose for holding a babies' napkin in place; dietary supplements and dietetic preparations; hygienic preparations and articles; colostrum supplements; lactose free infant's formula; dietetic foods adapted for infants; powdered milk for babies; powdered milk foods for infants; substitutes for mothers milk; lacteal flour for babies; fibre (dietary); medicinal tea; nutritional supplements; glucose dietary supplements; vitamin preparations; pregnancy (chemical preparations for the diagnosis of); ovulation tests for use at home; pharmaceutical preparations for hydrating the skin during pregnancy; pharmaceutical preparations for preventing skin blemishes during pregnancy; pharmaceutical products and preparations against dry skin caused by pregnancy; pharmaceutical preparations for treating dry skin caused by pregnancy; pharmaceutical products and preparations for hydrating the skin during pregnancy; pharmaceutical products and preparations for pregnancy blemishes; pharmaceutical preparations for treating chloasma; pharmaceutical products and preparations for preventing skin blemishes during pregnancy; disinfectants and antiseptics; first-aid boxes, filled; breast-nursing pads; feminine hygiene products; sanitary towels; sanitary pads; sanitary pants; panty liners; tampons; sterilising preparations; disinfectants; antiseptics; medical and veterinary preparations; medical dressings, coverings and applicators; pharmaceuticals and natural remedies; adhesive plasters; bandages for making casts; anti-bacterial soap; disinfectant soap.

29 – Fish, seafood and molluscs; meat; dairy products and dairy substitutes; oils and fats; processed fruits, fungi and vegetables (including nuts and pulses); meat extracts; canned meat; preserved meat; meat; foods made from fish; canned fish; cheese products; yoghurt; curd; dried milk; milk products; milk; milk beverages, milk predominating; fat-containing mixtures for bread slices; coconut oil and fat [for food]; flaxseed oil for culinary purposes; oils for food; colza oil for food; fruit chips; fruit jellies; fruit pulp; fruit-based snack food; vegetables, cooked; cooked fruits; canned vegetables; potato flakes; berries, preserved; preserved vegetables; preserved fruits; fruit salads; raisins; apple puree; jellies; compotes; stock; potato fritters; soups; soup (preparations for making); soya milk [milk substitute]; rice milk; milk based beverages containing fruit juice; milk-based beverages flavored with chocolate; potato chips; potato snacks; vegetable chips; vegetable-based snack foods.

32 – Non-alcoholic beverages; preparations for making beverages; non-alcoholic beverages; flavoured carbonated beverages; non-dairy milk; juices; waters; juices; isotonic drinks; whey beverages; vegetable juices [beverages]; fruit juice beverages (non-alcoholic); non-alcoholic fruit extracts; fruit nectars, non-alcoholic; waters [beverages]; syrups for beverages; essences for making beverages; smoothies.

35 – Business assistance, management and administrative services; business analysis, research and information services; advertising, marketing and promotional services; provision of advertising space, time and media; product demonstrations and product display services, namely demonstration of goods and presentation of goods on communication media, for retail purposes; distribution of advertising, marketing and promotional material; public relations services; trade show and commercial exhibition services; loyalty, incentive and bonus program services; advertising, marketing and promotional consultancy, advisory and assistance services; marketing services; public relations services; administrative order processing; negotiation and conclusion of commercial transactions for third parties; telemarketing services; commercial administration of the licensing of the goods and services of others; consumers (commercial information and advice for) [consumer advice shop]; auctioneering services; import and export services; procurement services for others [purchasing goods and services for other businesses]; provision of an on-line marketplace for buyers and sellers of goods and services; marketing studies; retailing in relation to articles for babies, infants and small children, pregnancy articles, household and kitchen goods, pharmacy goods, body care preparations, essential oils, dietary supplements, food for babies, sanitary preparations and articles, medical preparations and articles, feminine hygiene articles, nappies for babies and incontinents, feeding aids and pacifiers, articles for the diagnosis of pregnancy, clothing, foodstuffs and beverages.

(260) AM 2022 112830 A
(800) 1472367
(151) 2019 02 20
(891) 2021 03 08
(731) GTV ASSET MANAGEMENT Spółka z ograniczoną odpowiedzialnością
ul. Przejazdowa 21, PL-05-800 Pruszków,
Poland
(540)

GTV VERSALITE

(591) Blue
(531) 27.01.05; 27.05.10; 29.01.04

(511)
6 – Fittings and ferrules of metal for drawers; runners and angle irons of metal for drawers; pulleys of metal for drawers; slats of metal for drawers; profiles of aluminium for drawers; profiles of metal for drawers; drawer fittings of metal; metal hardware for drawers.

(260) AM 2022 112853 A
(800) 1589143
(151) 2021 03 15
(891) 2021 03 15
(731) AS-Motor GmbH
Ellwanger Strasse 15, 74424 Bühlertann,
Germany
(540)

Ovis

(591) Black, white
(511)
7 – Motor-operated apparatus for mowing and mulching grass, undergrowth and young woodland and for removing weeds for use in agriculture, forestry and horticulture and for landscape conservation and garden maintenance; the aforementioned apparatus as walk-behind or ride-on apparatus; the aforementioned apparatus operated with internal combustion engine or electric motor; the aforementioned apparatus with or without traction drive; the aforementioned apparatus with or without remote control; the aforementioned apparatus with autonomous or without autonomous control; lawnmowers; rotary mowers; mulch mowers; flail mowers; meadow mowers; undergrowth mowers; two-stroke motors for motorized gardening equipment and landscape maintenance equipment; parts of the aforementioned goods insofar as included in this class.

(260) AM 2022 112855 A
(800) 1589203
(151) 2021 03 01
(891) 2021 03 01
(731) Bahlsen GmbH & Co. KG
Podbielskistraße 11, 30163 Hannover,
Germany
(540)



(591) Blue and brown
(531) 08.01.11; 08.01.20; 26.04.05; 26.04.18;
27.05.01; 29.01.13
(511)
29 – Meat; fish, not live; poultry, not live; game, not live; meat extracts; frozen fruits; fruit, preserved; dried fruit; fruit, stewed; frozen vegetables; vegetables,

preserved; vegetables, dried; vegetables, cooked; jellies for food; jams; compotes; eggs; milk; milk products; oils for food; edible fats; potato snacks; raisins; dried nuts; roasted nuts; salted nuts; spiced nuts; dried fruit products; fat-containing mixtures for bread slices; yoghurt; dairy products and dairy substitutes.

30 – Cocoa; sugar; rice; tapioca; sago; flour; cereal preparations; bread; pastries; chocolate confectionery containing pralines; snack foods consisting principally of confectionery; chocolate for confectionery and bread; non-medicated confectionery in jelly form; chocolate candies; flour confectionery; prepared desserts [confectionery]; confectionery items coated with chocolate; candy coated confections; truffles [confectionery]; edible ices; honey; golden syrup; yeast; baking powder; salt; mustard; vinegar; sauces [condiments]; spices; ice for refreshment; biscuits; aperitif biscuits; rolled wafers [biscuits]; cakes; chocolate; chocolate based products; candy bars; chocolates; bonbons made of sugar; sweetmeats [candy]; marzipan; extruded food products made of wheat; extruded food products made of rice; extruded food products made of maize; popcorn; waffles; coffee; tea; artificial coffee.

41 – Entertainment services; sporting activities; cultural activities.

(260) AM 2022 112856 A

(800) 1589210

(151) 2021 02 19

(891) 2021 02 19

(731) BIOFARMA

50 rue Carnot, F-92284 Suresnes CEDEX,
France

(540)

Детракальм

(591) Black, white

(531) 28.05

(511)

5 – Pharmaceutical products; medical preparations; veterinary preparations; hygienic products for medical purposes; dietetic substances and foodstuffs for medical or veterinary use, food for babies; food supplements for humans and animals; plasters, materials for dressings; material for dental fillings and dental impressions; disinfectants; products for destroying vermin; fungicides, herbicides.

(260) AM 2022 112857 A

(800) 1589212

(151) 2021 02 19

(891) 2021 02 19

(731) BIOFARMA

50 rue Carnot, F-92284 Suresnes CEDEX,
France

(540)

DETRACALM

(591) Black, white

(511)

5 – Pharmaceutical products; medical preparations; veterinary preparations; hygienic products for medical purposes; dietetic substances and foodstuffs for medical or veterinary use, food for babies; food supplements for humans and animals; plasters, materials for dressings; material for dental fillings and dental impressions; disinfectants; products for destroying vermin; fungicides, herbicides.

(260) AM 2022 112858 A

(800) 1589218

(151) 2021 03 17

(891) 2021 03 17

(731) Becton, Dickinson and Company

1 Becton Drive, Franklin Lakes NJ 07417, USA

(540)

**BD HORIZON
REALYELLOW**

(591) Black, white

(511)

1 – Reagents for scientific use.

(260) AM 2022 112872 A

(800) 1589710

(151) 2021 01 05

(891) 2021 01 05

(731) DONGFENG MOTOR CORPORATION

Special No.1 Dongfeng Road, Wuhan
Economic & Technical, Development Zone,
Wuhan, 430056 Hubei Province, China

(540)



(591) Black, white

(531) 24.11.25; 26.07.04; 26.13.25

(511)

12 – Cars; lorries; automobile chassis; automobile tires; automobile bodies; engines for land vehicles; gear boxes for land vehicles; hubs for automobile wheels; windshield wipers; windscreens.

37 – Motor vehicle maintenance and repair; vehicle service stations [refuelling and maintenance]; repair of automobiles; rustproofing; painting services; re-reading of tires; vulcanization of tires [repair]; repair

of rubber tires; burglar alarm installation and repair; rebuilding engines that have been worn or partially destroyed.

(260) AM 2022 112874 A
(800) 1589743
(151) 2021 02 18
(891) 2021 02 18
(731) Bahlsen GmbH & Co. KG
Podbielskistraße 11, 30163 Hannover,
Germany

(540)



(591) Blue and brown
(531) 08.01.09; 08.01.11; 26.04.05; 26.04.16;
27.05.01; 27.05.08; 29.01.14

(511)

29 – Meat; fish, not live; poultry, not live; game, not live; meat extracts; frozen fruits; fruit, preserved; dried fruit; fruit, stewed; frozen vegetables; vegetables, preserved; vegetables, dried; vegetables, cooked; jellies for food; jams; compotes; eggs; milk; milk products; oils for food; edible fats; potato snacks; raisins; dried nuts; roasted nuts; salted nuts; spiced nuts; dried fruit products; fat-containing mixtures for bread slices; yoghurt; dairy products and dairy substitutes.

30 – Cocoa; sugar; rice; tapioca; sago; flour; cereal preparations; bread; pastries; chocolate confectionery containing pralines; snack foods consisting principally of confectionery; chocolate for confectionery and bread; non-medicated confectionery in jelly form; chocolate candies; flour confectionery; prepared desserts [confectionery]; confectionery items coated with chocolate; candy coated confections; truffles [confectionery]; edible ices; honey; golden syrup; yeast; baking powder; salt; mustard; vinegar; sauces [condiments]; spices; ice for refreshment; biscuits; aperitif biscuits; rolled wafers [biscuits]; cakes; chocolate; chocolate based products; candy bars; chocolates; bonbons made of sugar; sweetmeats [candy]; marzipan; extruded food products made of wheat; extruded food products made of rice; extruded food products made of maize; popcorn; waffles; coffee; tea; artificial coffee.

41 – Entertainment services; sporting activities; cultural activities.

(260) AM 2022 112875 A
(800) 1589775
(151) 2020 11 05
(891) 2020 11 05
(731) EGE SERAMİK, SANAYİ VE TİCARET
ANONİM ŞİRKETİ

Kemalpaşa OSB Mahallesi, Ansızca Sanayi Sitesi Sokak, No: 297/1, Kemalpaşa, İzmir, Turkey

(540)



(591) Black and red are the feature of the mark
(531) 26.04.03; 26.04.04; 27.01.01; 27.01.03;
29.01.12

(526) seramik

(511)

19 – Sand, gravel, crushed stone, asphalt, bitumen, cement, gypsum, plaster, concrete, marble blocks for construction, included in this class; building materials (as finished products) made of concrete, gypsum, clay, potters' clay, stone, marble, wood, plastics and synthetic materials for building, construction, road construction purposes, included in this class; non-metallic buildings, non-metallic building materials, poles not of metal for power lines, barriers not of metal; natural and synthetic coatings in the form of panels and sheets, being building materials; bitumen cardboard coatings for roofing; bitumen coating for roofing; doors and windows of wood and synthetic materials; monuments and statuettes of stone, concrete and marble; building glass; tiles, not of metal, for building; ceramic tiles for walls, floors and ceilings; ceramic tiles; bricks; glass mosaics for use in building.

(260) AM 2022 112876 A

(800) 1589809

(151) 2020 11 20

(891) 2020 11 20

(731) Euro Games Technology Ltd.

4, "Maritsa" Str., "Vranya-Lozen-Triugulnika",
BG-1151 Sofia, Bulgaria

(540)



(591) Green, red, gold, blue, pink, yellow, purple,
black, gray, white and orange

(531) 05.03.06; 05.07.24; 22.03.05; 26.04.04;
26.04.05; 26.04.16; 26.04.18; 26.04.24;
27.05.01; 27.05.02; 27.05.03; 29.01.15

(511)

9 – Software; computer gaming software; computer software packages; computer operating system soft-

ware; computer software, recorded; software drivers; virtual reality software; games software; entertainment software for computer games; computer programs for network management; operating computer software for main frame computers; monitors (computer hardware); computer hardware; apparatus for recording images; monitors (computer programs); computer game programs; computer programs for recorded games; apparatus for recording, transmission or reproduction of sound or images; communications servers [computer hardware]; electronic components for gambling machines; computer application software featuring games and gaming; computer software for the administration of on-line games and gaming; computer hardware for games and gaming; computer hardware and software for gambling, gambling machines and gambling games provided via the Internet and via telecommunication network.

28 – Gaming machines for gambling; chips for gambling; mah-jong; arcade games; gambling machines operating with coins, notes and cards; games; electronic games; parlor games; gaming chips; gaming tables; slot machines [gaming machines]; LCD game machines; slot machines and gaming devices; coin-operated amusement machines; roulette chips; poker chips; chips and dice [gaming equipment]; gaming equipment for casinos; roulette tables; gaming roulette wheels; apparatus for casino games; automats and gambling machines; coin-operated amusement machines and / or electronic coin-operated amusement machines with or without the possibility of gain; boxes for coin-operated games machines and slot machines; electronic or electrotechnical gaming devices, namely, automats and machines, coin-operated machines; housings for coin-operated machines; gaming machines, electropneumatic and electrical gambling machines (slot machines).

41 – Gambling; services related to gambling; gaming services for entertainment purposes; casino, gaming and gambling services; training in the development of software systems; provision of equipment for gambling halls; providing casino equipment [gambling]; on-line gaming services; providing casino facilities [gambling]; providing entertainment services in the halls with gaming machines; amusement arcade services; games equipment rental; rental of gaming machines; providing amusement arcade services; rental of gaming machines with images of fruits; editing or recording of sounds and images; sound recording and video entertainment services; hire of sound reproducing apparatus; provision of gaming equipment for casinos; providing casino facilities; online gambling services; casino services; casino, gaming and gambling services.

(260) AM 2022 112880 A
(800) 1589939
(151) 2021 03 16
(891) 2021 03 16
(731) PEPSCO Poland Sp. z o.o.
Strzeszyńska 73A, PL-60-479 Poznań, Poland
(540)



(591) Black, white
(531) 24.17.02; 26.01.03; 26.01.24; 27.05.12
(511)
16 – Pencil cases.
18 – Rucksacks; school knapsacks; drawstring bags.

(260) AM 2022 112881 A
(800) 1589957
(151) 2020 12 07
(891) 2020 12 07
(731) GROUPE MECALAC
PAE Les Glaisins, 2 Avenue du Pré de Challes,
Annecy-Le-Vieux, F-74940 ANNECY, France
(540)

MyMecalac

(591) Black, white
(511)
7 – Machines and motors and engines and parts thereof, for use in agriculture, compacting, construction, demolition, soil conditioning, ground layout, earth moving, forestry, landscaping, lawn care, lifting, marine propulsion, material handling, mining, mulching, oil and gas distribution, oil and gas exploration, oil and gas production, paving, pipe laying, production of electricity, road construction and repair, site preparation and restoration, drilling of tunnels, rail transportation, railway servicing and vegetation management, namely, asphalt paving machines, cold planers, waste compactors, compact all-terrain crawler-tracked front-end loaders, dragline excavators, drills, electric rope shovels, feller-bunchers, forestry machines in the nature of wood harvesting machines, forwarders (forestry machines and excavators used for forestry applications), reapers and threshers, hydraulic mining shovels, graders, pipe layers, road reclaimers, open-cast mining conveyors being machines, telescopic handlers; machine tools for cleaning ditches, cutting trees and road verges, crushing rock; motors and engines (other than for land vehicles); machine couplings and transmission components (other than for land vehicles); attachments for earth moving machines, namely, excavation bucket teeth for earth moving machines; earth-moving, soil-improving and material-handling machines, namely, backhoe loaders, off-road

loaders, wheeled loaders, tracked excavators, wheeled excavators; earth moving, soil conditioning and material handling machines, namely, face shovels, telescopic material handling apparatus, crawler apparatus for material handling, wheel-mounted material handling apparatus, crawler tractors, tube layers, crawler loaders, compactors, compaction piles, wheel-mounted bulldozers, motor graders; earth moving, soil conditioning and material handling machines, namely, forestry machines in the nature of bulldozers, crawler skidders, wheel-mounted skidders, forwarders, crawler mowers, articulated boom loaders; loaders (machines), namely, all-terrain wheel loaders, log loaders, coal loaders for underground mines, shovel loaders, off-road wheel loaders, wheel loaders; attachments for earth moving, soil conditioning and handling machines, namely, asphalt spades, augers, backhoes, blades for moving earth and bulk objects, block handling tools in the nature of hammer teeth for loader buckets, loader forks, clearing rake, rock bucket, block bucket, loading buckets, cold sled levelers, compactors, vibrating compactors, crushing machines, cutting jaws, branch-loppers, pallet lifters, grippers, hammers; attachments for earth moving, soil conditioning and handling machines, namely, lifting hooks, material handling arms, multiprocessors in the nature of attachments for earth moving, conditioning and handling machines, in the nature of gripper buckets and blades for moving earth and objects: attachments for earth moving, soil conditioning and handling machines, namely, stump grinders, motor hoes, excavators; marine motors and engines (except motors and engines for land vehicles); industrial motors and engines other than for land vehicles; diesel engines for machines; gas engines other than for land vehicles; natural gas engines for machines; valves (parts of machines); spark plugs; machine or motor and engine parts, namely, air filters; machine or motor and engine parts, namely, water regulators; oil filters; couplings other than for land vehicles, namely, couplings for machines; assembly presses, namely, industrial machine presses; starters for motors and engines; pumps for machines; excavators; hydraulic excavating machines; hydraulic shovels; bulldozers; compact loaders; agricultural machines, namely, reapers and threshers; pickers, namely, corn pickers, cotton pickers; parts for earth moving machines, namely, scrapers and pavers; agricultural machines, namely, seed drills; motors and engines, other than for land vehicles, for industrial, marine and other applications, and parts thereof; motors and engines for electric, industrial, diesel, gas and natural gas generators, and parts therefor; cutting machines; parts of machines, motors and engines or motors and engines, namely, filters; parts for motors and engines and motors and engines, namely, belts; machine parts, namely, blades; earthmoving machines; crawler loaders; crawler-tracked power shovels; road marking machines; road construction machines; lifting apparatus, namely, mechanical and hydraulic

lifts, cranes; mobile cranes; crawler cranes; pipe laying machines; buckets for earth moving machines; hydraulic jacks; digging machines; conveyor belts; belts for machines; belts for motors and engines and motors and engines; compressed air machines; compressed air pumps; compressors as parts of machines; drilling machines; gearboxes other than for land vehicles; gears other than for land vehicles; grinding machines; machine parts, namely, hoods; machine parts, namely, hammers; pneumatic hammers; handling apparatus for loading and unloading, namely, goods handling machines; pulleys; machine parts, namely, unloading hoppers; machines, namely, winches; machines, namely, lawnmowers; loading ramps, namely, slides in the nature of motorized ramps; pneumatic transporters; presses, namely, blanking presses; pulleys; grinding and shredding machines; mechanical shovels; mechanical loading shovels; none of the aforesaid goods in the specific field of logistics in the storage sector.

9 – Telematic apparatus and instruments; telematic terminals; apparatus for recording, transmission or reproduction of sound or images; telephones, tablet computers and wireless communication devices for voice, data or image transmission, media players; apparatus for storing, transmitting and archiving messages as well as data relating to vehicle fleet, machine fleet and equipment management; apparatus for storing, transmitting and archiving messages as well as data relating to vehicle positioning, vehicle availability, vehicle and driver control, vehicle consumption and mileage, driving time and vehicle speed measurement, vehicle wear; satellite navigation apparatus; navigation apparatus for vehicles (on-board computers); global positioning systems; vehicle radios; optical data media; magnetic data media; sensors, transponders, detectors, transmitters of electronic signals; software; software for communication between machines; software for the Internet of Things (IoT) and data connectivity, management, configuration, supply, management, and control of devices; software enabling collection and transmission of data from devices for communication between machines and for devices connected to the Internet of Things (IoT) and integration of data to enterprise application software, online and mobile; software for collecting, editing, organizing, modifying, transmitting, storing and sharing data and information; application software for mobile phones, namely, software for data processing; application software for mobile phones, namely, software for facilitating communications; accessories for telephones, mobile phones, tablet computers and wireless communications devices, namely, headsets and headphones, phone chargers, battery chargers, struts for cars, mobile phone holders; none of the aforesaid goods in the specific field of logistics in the storage sector.

12 – Vehicles for use in agriculture, compacting, construction, demolition, soil conditioning, ground lay-

out, earth moving, forestry, landscaping, lifting, marine propulsion, material handling, extraction, mulching, oil and gas distribution, oil and gas exploration, oil and gas production, paving, pipe laying, production of electricity, road construction and repair, site preparation and restoration, drilling of tunnels and management of vegetation, rail transportation, railway servicing, namely, trucks, all-terrain trucks, articulated trucks, underground mining trucks, internal combustion forklift trucks, electric lift trucks; military vehicles, namely, armored vehicles; apparatus for locomotion by land, air or water, namely, trucks, off-road trucks, articulated trucks, underground mining trucks, internal combustion forklift trucks, electric lift trucks; tractors and tractor motors; road transport trucks and trailers; vehicles for use in mining, paving, agriculture, forestry, soil management and handling, namely, articulated trucks, all-terrain trucks, construction site tilting-carts, off-road tractors; internal combustion lift trucks; electric lifting cars; vehicle wheels; treads for vehicles, namely, treads for continuous track vehicles; trucks; dump trucks; dump trucks, namely, tilting-carts being land vehicles; all-terrain vehicles.

38 – Telematic services; communication services; telematic communication services; telematic transmission of information; electronic transmission of data; communications between machines for vehicle fleet, machine fleet and equipment management; transmission of data and information via telemetry; telematic sending of information relating to vehicle diagnostics and management; virtual private network services and private line services, namely, providing private and secure real time electronic communication over a computer network; telecommunications services for the Internet of Things (IoT); electronic and telematic transmission of data relating to the monitoring, location, recovery and tracking of assets and connected devices in various industries.

42 – Software as a Service (SaaS); computer programming and computer networking services; providing online non-downloadable telecommunications software for connecting individuals and entities to communications or IP networks; cloud computing; providing temporary use of online non-downloadable software for communication between machines and devices connected to a network and to the Internet; providing temporary use of online non-downloadable software for the Internet of Things (IoT); hosting of platforms [software] for managing communications between machines, IoT services, and connected and remote devices; electronic storage of data and documents for others; none of the aforesaid goods in the specific field of logistics in the storage sector.

(260) AM 2022 112882 A
(800) 1590019
(151) 2021 01 08
(891) 2021 01 08
(731) TÜRK HAVA YOLLARI ANONİM
ORTAKLIĞI
GENEL YÖNETİM BİNASI, YEŞİLKÖY
NO: 3, BAKIRKÖY, İSTANBUL, Turkey
(540)



(591) red, pink, orange
(531) 26.11.03; 26.11.12; 29.01.01
(511)
12 – Vehicles; apparatus for locomotion by land, air or water.

35 – Advertising; business management, organization and administration; office functions.

36 – Financial, monetary and banking services; insurance services; real estate affairs.

37 – Construction services; installation and repair services; mining extraction, oil and gas drilling.

39 – Transport; packaging and storage of goods; travel arrangement.

41 – Education; providing of training; entertainment; sporting and cultural activities.

(260) AM 2022 112883 A
(800) 1590068
(151) 2021 02 09
(891) 2021 02 09
(731) MABA KOZMETİK A.Ş.
ESEANTEPE MAH., YÜZBAŞI KAYA
ALDOĞAN SOK., NO:12/5, TR-34394 ŞİŞLİ
İSTANBUL, Turkey
(540)



(591) SILVER (pantone 877)
(531) 26.04.05; 26.04.24; 27.05.01; 27.05.09;
27.05.10; 27.05.24

(511)
3 – Bleaching and cleaning preparations, detergents other than for use in manufacturing operations and for

medical purposes, laundry bleach, fabric softeners for laundry use, stain removers, dishwasher detergents; perfumery; non-medicated cosmetics; fragrances; deodorants for personal use and animals; soaps; dental care preparations; dentifrices, denture polishes, tooth whitening preparations, mouth washes, not for medical purposes; abrasive preparations; emery cloth; sandpaper; pumice stone; abrasive pastes; polishing preparations for leather, vinyl, metal and wood, polishes and creams for leather, vinyl, metal and wood, wax for polishing.

5 – Pharmaceutical and veterinary preparations for medical purposes; chemical preparations for medical and veterinary purposes, chemical radioactive substances for pharmaceutical and veterinary purposes; medicated cosmetics; dietary supplements for pharmaceutical and veterinary purposes; dietary supplements; nutritional supplements; medical preparations for slimming purposes; food for babies; herbs and herbal beverages adapted for medicinal purposes; dental preparations and articles; teeth filling material, dental impression material, dental adhesives and material for repairing teeth; sanitary preparations for medical use; hygienic pads; hygienic tampons; plasters; materials for dressings; diapers made of paper and textiles for babies, adults and pets; preparations for destroying vermin; herbicides, fungicides, preparations for destroying rodents; deodorants, other than for human beings or for animals; air purifying preparations; air deodorising preparations; disinfectants; antiseptics; detergents for medical purposes; medicated soaps; disinfectant soaps; antibacterial hand lotions.

(260) AM 2022 112885 A
 (800) 1590081
 (151) 2021 03 25
 (891) 2021 03 25
 (731) Individual entrepreneur Dudukin Maksim Anatolievich
 Ladozhskaya street, 150-354, RU-440064
 Penza, Russian Federation
 (540)



(591) Green, white and black
 (531) 05.03.13; 05.03.15; 29.01.13
 (511)

3 – Balms, other than for medical purposes; toilet water; massage gels, other than for medical purposes; deodorants for human beings or for animals; perfumery; oils for perfumes and scents; oils for cosmetic

purposes; cosmetics; phytocosmetic preparations; shampoos.

29 – Mushrooms, preserved; jellies for food; edible fats; caviar; yogurt; meat, tinned; canned fruits and vegetables; oils for food; milk; meat; coconut milk-based beverages; almond milk-based beverages; vegetables, dried; nuts, prepared; milk products; fish-based foodstuffs; poultry, not live; fruit and vegetable salads; vegetable juices for cooking; sausages; preparations for making bouillon; preparations for making soup; tripe; soups; meat extracts.

30 – Flavourings, other than essential oils, for cakes; pancakes; bread rolls; vareniki [stuffed dumplings]; seawater for cooking; mustard; yeast; fruit jellies [confectionery]; pastries; peanut confectionery; almond confectionery; pasta; cocoa; sweets; coffee; groats for human food; edible ices; mayonnaise; marinades; honey; ice cream; wheat flour; tea-based beverages; infusions, not medicinal; chocolate-coated nuts; pelmeni; meat gravies; aromatic preparations for food; condiments; cereal preparations; ravioli; sugar; confectionery; seasonings; rusks; sushi; sandwiches; dough; halvah; bread; chocolate; essences for foodstuffs, except etheric essences and essential oils.

32 – Waters [beverages]; non-alcoholic beverages; protein-enriched sports beverages; energy drinks; beer; syrups for beverages; vegetable juices [beverages]; non-alcoholic preparations for making beverages; must; non-alcoholic fruit extracts; non-alcoholic essences for making beverages.

35 – Retail and wholesale services.

(260) AM 2022 112886 A
 (800) 1590091
 (151) 2021 01 27
 (891) 2021 01 27
 (731) LLC TorgCity
 Tatarskaya str., 1, lit. L, of. 303, Vladivostok,
 RU-690039 Primorskiy kray, Russian
 Federation
 (540)



(591) Red, dark red and white
 (531) 01.03.02; 05.05.20; 05.05.21; 25.07.25;
 27.05.08; 28.05; 29.01.12
 (511)

29 – Jams; ham; sheets of toasted laver; cheese substitutes; fish sausages; frozen french fried potatoes; gherkins; vegetable oils for food; linseed oil for food; mussels, not live, including mussels preserves; mus-

sels dried; mussels smoked; meat, frozen; frozen vegetables; nuts, prepared; walnuts, prepared; pine nuts, processed; cashews, processed; fern processed; fish paste; marmalade; tomatoes in tomato juice; preserves with mussels; fish, tinned; smoked fish products; frozen fish; dried fish, including dried fish sticks; smoked fish; pickled fish; sea Kale salads; fern salads; salads canned; artificial cream [dairy product substitutes]; snack mixes consisting of wasabi peas, processed nuts, dehydrated fruit or raisins; frozen vegetable mixes; frozen fruit or berry mixes; snack mixes consisting of processed nuts; snack mixes consisting of processed fruits, processed nuts or raisins; vegetable-cream spreads; fish steak; cottage cheese; strained soft white cheeses; pistachios, prepared; canned fruits, including canned pineapples; fruit, stewed, including dried fruit mixes; nutmeats.

31 – Algarovilla for animal consumption; anchovy, live; oranges, fresh; peanuts, fresh; artichokes, fresh; draff; beans, fresh; locust beans, raw; wreaths of natural flowers; grapes, fresh; algae, unprocessed, for human or animal consumption; fruit residue [marc]; dog biscuits; sea cucumbers, live; peas, fresh; mushroom spawn for propagation; mushrooms, fresh; trees; palm trees; turf, natural; unsawn timber; undressed timber; yeast for animal consumption; Christmas trees; edible chews for animals; live animals; menagerie animals; peanut cake for animals; oil cake; maize cake for cattle; rape cake for cattle; bagasses of cane [raw material]; cereal seeds, unprocessed; grains [cereals]; grains for animal consumption; lime for animal forage; fish spawn; vegetable marrows, fresh; cocoa beans, raw; potatoes, fresh; chestnuts, fresh; arrangements of fresh fruit; copra; raw barks; rough cork; animal foodstuffs; pet food; stall food for animals; bird food; strengthening animal forage; chicory roots; roots for animal consumption; nettles; groats for poultry; maize; edible sesame, unprocessed; shrubs; rose bushes; spiny lobsters, live; lemons, fresh; vine plants; salmon, live; onions, fresh; flower bulbs; leeks, fresh; olives, fresh; bran mash for animal consumption; shellfish, live; almonds [fruits]; mussels, live; peanut meal for animals; linseed meal for animal consumption; meal for animals; flax meal [fodder]; rice meal for forage; fish meal for animal consumption; straw mulch; beverages for pets; edible insects, live; oats; vegetables, fresh; cucumbers, fresh; lobsters, live; nuts, unprocessed; coconuts; kola nuts; bran; distillery waste for animal consumption; residue in a still after distillation; palms [leaves of the palm tree]; cuttle bone for birds; peppers [plants]; aromatic sand [litter] for pets; citrus fruit, fresh; litter for animals; mash for fattening livestock; unprocessed sweet corn ears [husked or unhusked]; animal fattening preparations; preparations for egg laying poultry; fishing bait, live; by-products of the processing of cereals, for animal consumption; seed germ for botanical purposes; poultry, live; wheat; pollen [raw material]; crayfish, live; crustaceans, live; seedlings; plants; aloe

vera plants; plants, dried, for decoration; rhubarb, fresh; rice, unprocessed; rye; wheat germ for animal consumption; fish, live; lettuce, fresh; sardines, live; beet, fresh; herrings, live; seeds for planting; linseed for animal consumption; edible linseed, unprocessed; hay; coconut shell; bred stock; sanded paper [litter] for pets; malt for brewing and distilling; straw [forage]; straw litter; salt for cattle; trunks of trees; wood chips for the manufacture of wood pulp; litter peat; garden herbs, fresh; sea-cucumbers, live; sugarcane; truffles, fresh; tuna, live; squashes, fresh; oysters, live; fruit, fresh; hazelnuts, fresh; fodder; hops; flowers, natural; flowers, dried, for decoration; chicory, fresh; silkworms; garlic, fresh; lentils, fresh; pine cones; hop cones; spinach, fresh; juniper berries; berries, fresh; eggs for hatching, fertilized; silkworm eggs; barley.

32 – Aperitifs, non-alcoholic; lithia water; seltzer water; soda water; waters [beverages]; aerated water; mineral water [beverages]; table waters; kvass; cocktails, non-alcoholic; beer-based cocktails; lemonades; non-alcoholic beverages; isotonic beverages; non-alcoholic honey-based beverages; rice-based beverages, other than milk substitutes; soya-based beverages, other than milk substitutes; aloe vera drinks, non-alcoholic; whey beverages; protein-enriched sports beverages; soft drinks; non-alcoholic beverages flavored with coffee; non-alcoholic beverages flavored with tea; non-alcoholic fruit juice beverages; fruit nectars, non-alcoholic; orgeat; beer; ginger beer; malt beer; powders for effervescing beverages; sarsaparilla [non-alcoholic beverage]; syrups for lemonade; syrups for beverages; smoothies; tomato juice [beverage]; cider, non-alcoholic; vegetable juices [beverages]; fruit juices; preparations for making aerated water; malt extracts for making liquors; non-alcoholic preparations for making beverages; must; grape must, unfermented; beer wort; malt wort; pastilles for effervescing beverages; sherbets [beverages]; non-alcoholic fruit extracts; extracts of hops for making beer; non-alcoholic essences for making beverages.

(260) AM 2022 112887 A

(800) 368772

(151) 1970 07 01

(891) 2021 02 22

(731) Jowat SE

Ernst-Hilker-Straße 10-14, 32758 Detmold,
Germany

(540)

Jowat

(591) Black, white

(531) 27.05.17

(511)

1 – Resins; adhesives; sizing and tanning substances.

16 – Adhesives.

(260) AM 2022 112888 A
 (800) 415593
 (151) 1975 05 26
 (891) 2021 03 11
 (731) Janssen Pharmaceutica N.V.
 Turnhoutseweg 30, B-2340 Beerse, Belgium
 (540)

JANSSEN

(591) Black, white
 (531) 27.05.01; 27.05.17
 (511)
 5 – Pharmaceutical preparations including vaccines.

(260) AM 2022 112946 A
 (800) 1590314
 (151) 2021 01 12
 (891) 2021 01 12
 (731) Kapman AB
 Fiskaregatan 1, SE-531 30 LIDKÖPING,
 Sweden
 (540)



BAHCO

(591) Black, white, light brown
 (531) 03.09.01; 03.09.24; 14.03.11; 27.05.17;
 29.01.12
 (511)
 11 – Lighting installations; lighting apparatus/units;
 vehicle lighting and lighting reflectors; lamps; lamp
 stands; lamp reflectors; inspection lamps; testing
 lamps for cars; casings for lamps; hanging lamps; in-
 door lamps and outdoor lamps; under bonnet light;
 cordless hand lamps; corded lamps; torches for ligh-
 ting; safety lamps; infrared lamps; helmet lights.

18 – Tool bags, empty; empty tool pouches; belt po-
 uchets; shoulder bags; back packs; carrying cases; bo-
 xes of leather or leatherboard.

(260) AM 2022 112947 A
 (800) 1590327
 (151) 2021 03 05
 (891) 2021 03 05
 (731) Landos Biopharma, Inc.
 Suite 216, 1800 Kraft Drive, Blacksburg
 WI 24060, USA
 (540)

PACIFY

(591) Black, white

(511)
 42 – Conducting clinical trials in the field of ulcerati-
 ve colitis.

(260) AM 2022 112948 A
 (800) 1590331
 (151) 2021 02 25
 (891) 2021 02 25
 (731) GIORGIO ARMANI S.P.A.
 Via Borgonuovo, 11, I-20121 MILANO
 (Milano), Italy
 (540)

CRUSHER
 DISTANCE

(591) Black, white
 (531) 26.11.21; 27.05.08; 27.05.10; 27.05.17
 (511)
 18 – Handbags; traveling bags; briefcases; leather
 briefcases; leather credit card holders; wallets; leather
 document briefcases; key-cases of leather and skins;
 purses; suit cases; cosmetic bags sold empty; gym
 bags; evening and shoulder bags for ladies; leather
 shopping bags; school bags; garment bags for travel;
 suit carriers for travel; shoe bags for travel; beach
 bags; diaper bags; backpacks; Boston bags; traveling
 trunks; duffel bags; overnight bags; carry-on bags;
 satchels; opera bags; vanity cases (not fitted); hides;
 cases and boxes made of leather; bags made of leather
 for packaging; leather straps; umbrellas; leather leas-
 hes; saddlery.

(260) AM 2022 112949 A
 (800) 1590352
 (151) 2021 02 09
 (891) 2021 02 09
 (731) FM World Sp. z o.o.
 ul. Żmigrodzka 247, PL-51-129 Wrocław,
 Poland
 (540)



H A I R L A B

(591) Black, white
 (531) 02.09.12; 26.01.01; 26.01.03; 26.01.12;
 26.01.14; 26.11.13; 27.05.01
 (511)
 3 – Lotions for cosmetic purposes; cosmetic dyes; hair
 dyes; hair colour removers; hair spray; beauty masks;
 neutralizers for permanent waving; hair nourishers;
 hair conditioners; hair moisturising conditioners; hair
 conditioner bars; hair conditioners for babies; hair lo-
 tions; hair waving preparations; permanent waving

and curling preparations; hair straightening preparations; dry shampoos; shampoos; tints for the hair; non-medicated shampoos; dandruff shampoo; emollient shampoos; shampoos for pets [non-medicated grooming preparations]; baby shampoo; shampoo-conditioners; hair mousse; mousses being hair styling aids; hair protection mousse; hair gel; styling gels; gel sprays being styling aids; hair protection gels.

(260) AM 2022 112951 A

(800) 1590375

(151) 2021 03 03

(891) 2021 03 03

(731) Obshchestvo s ogranichennoy otvetstvennostyu

"Nauchno-proizvodstvennaya kompaniya
"SKiFF"

Nauchny proezd, d.20, str. 3, floor 2, pom.204,
RU-117246 Moscow, Russian Federation

(540)

СЕКСБАРЬЕР

(591) Black, white

(531) 28.05

(511)

5 – Pharmaceutical, veterinary and hygienic preparations; dietetic substances for medical purposes; food for babies; plasters, materials for dressings; teeth filling material and dental impression materials; disinfectants; preparations for destroying noxious animals; fungicides, herbicides.

(260) AM 2022 112952 A

(800) 1590395

(151) 2021 03 03

(891) 2021 03 03

(731) TCL Technology Group Corporation

TCL Technology Building, No. 17, Huifeng 3rd
Road, Zhongkai High Technology,
Development District, Huizhou City, 516006
Guangdong Province, China

(540)

TCL Micro LED

(591) Black, white

(511)

9 – Fluorescent screens; video screens; remote control apparatus; transistors [electronic]; light-emitting diodes [LED]; television apparatus; audio- and video-receivers; portable media players; wearable video display monitors; semi-conductors; optical fibers [light conducting filaments]; mobile telephones; tablet computers; interactive touch screen terminals; electronic interactive whiteboards.

(260) AM 2022 112953 A

(800) 1590399

(151) 2020 11 19

(891) 2020 11 19

(731) Zakrytoe aktsionernoe obshchestvo "Myasnaya galereya"

ul. Poliny Osipenko, d. 65, of. 10, RU-600009
g. Vladimir, Russian Federation

(540)

Хотстеры

(591) Black, white

(531) 28.05

(511)

29 – Meat, fish, poultry and game; meat extracts; preserved, frozen, dried and cooked fruits and vegetables; jellies, jams, compotes; eggs; milk and milk products; edible oils and fats; ajvar [preserved peppers]; aloe vera prepared for human consumption; alginates for culinary purposes; anchovy, not live; peanuts, prepared; albumen for culinary purposes; white of eggs; beans, preserved; prepared meals consisting primarily of meat, fish, poultry or vegetables; frozen meals consisting primarily of meat, fish, poultry or vegetables; packaged meals consisting primarily of meat, fish, poultry or vegetables; beef stock; veal stock; chicken stock; prepared stock; soya beans, preserved, for food; broth; ginger jam; ham; fatty substances for the manufacture of edible fats; toasted laver; edible birds' nests; peas, preserved; mushrooms, preserved; beef; dried beef; beef slices; prepared beef; beef stew; beef jerky; gelatine; meat jellies; jellies for food; fruit jellies; yolk of eggs; coconut fat; bone oil for food; lard; suet for food; fruit-based snack food; frozen appetizers consisting primarily of chicken; potato-based snack foods; vegetable-based snack foods; brawn; charcuterie; raisins; caviar; fish roe, prepared; yogurt; sauerkraut; kefir; isinglass for food; clams, not live; milk shakes; blood sausage; bologna sausage; beef patties; veggie burger patties; soya burger patties; uncooked hamburger patties; turkey burger patties; meat, canned; vegetables, canned; fish, canned; fruits, canned; broth concentrates; gherkins; shrimps, not live; prawns, not live; buttercream; croquettes; silk-worm chrysalis for human consumption; kumys; potato-based dumplings; spiny lobsters, not live; lecithin for culinary purposes; salmon, not live; onions, preserved; margarine; marmalade; peanut butter; cocoa butter for food; coconut oil for food; coconut butter; corn oil for food; sesame oil for food; flaxseed oil for food; olive oil for food; palm oil for food; palm kernel oil for food; sunflower oil for food; rape oil for food; butter; mussels, not live; almonds, ground; animal marrow for food; mollusks, not live; condensed milk; protein milk; soya milk; fish meal for human consumption; vegetable mousses; fish mousses; fruit pulp; fried meat; meat-based snack foods; frozen meat; processed meat; sliced meat; prepared meat; minced meat; meat, preserved; milk beverages, milk predomina-

ting; pre-packaged dinners consisting primarily of meat; pre-packaged dinners consisting primarily of poultry; potato fritters; olives, preserved; lobsters, not live; coconut, desiccated; nuts, prepared; tomato paste; liver pâté; meat pastes; pectin for culinary purposes; liver; pickles; powdered eggs; kimchi; fish-based foodstuffs; processed meat products; curd; prostokvasha [soured milk]; poultry, not live; pollen prepared as foodstuff; cranberry compote; apple purée; crayfish, not live; crustaceans, not live; fish, preserved; fish, not live; salted fish; ryazhenka [fermented baked milk]; vegetable salads; fruit salads; bacon; sardines, not live; pork; pork, canned; canned pork and beans; herrings, not live; seeds, prepared; sunflower seeds, prepared; cream [dairy products]; whipped cream; fat-containing mixtures for bread slices; smetana [sour cream]; tomato juice for cooking; vegetable juices for cooking; salted meats; corned beef; sausages; vegetarian sausages; sausages in batter; hot dog sausages; preserved sausages; uncooked sausages; preparations for making bouillon; preparations for making soup; tripe; soups; vegetable soup preparations; whey; cheese; tahini; tofu; veal; sea-cucumbers, not live; truffles, preserved; tuna, not live; oysters, not live; milk ferments for culinary purposes; rennet; fish fillets; chicken breast fillets; dates; meatballs; frosted fruits; fruit preserved in alcohol; potato flakes; hummus; fruit peel; preserved garlic; lentils, preserved; potato chips; low-fat potato chips; fruit chips; bacon rinds; pork rinds; non-alcoholic eggnog; seaweed extracts for food; snail eggs for consumption.

30 – Coffee; tea; cocoa; artificial coffee; rice; tapioca; sago; flour and preparations made from cereals; bread, pastry and confectionery; ice cream; sugar, honey, treacle; yeast, baking-powder; salt; mustard; vinegar, condiments; spices; ice for refreshment; aromatic preparations for food; flavorings, other than essential oils, for cakes; flavorings, other than essential oils, for beverages; coffee flavorings; food flavorings, other than essential oils; star aniseed; cereal bars; high-protein cereal bars; pancakes; packaged meals consisting primarily of pasta or rice; pasta-based prepared meals; prepared meals consisting primarily of pasta or rice; noodle-based prepared meals; rice-based prepared meals; entrées consisting primarily of pasta or rice; boxed lunches consisting of rice, with added meat, fish or vegetables; biscuits; cheese-flavored biscuits; buns; bagels; bread rolls; jam buns; cream buns; vanillin [vanilla substitute]; vanilla flavorings for culinary purposes; waffles; vermicelli; natural sweeteners; sausage binding materials; binding agents for ice cream; sea water for cooking; seaweed [condiment]; biscuits for cheese; malt biscuits; hamburgers [sandwiches]; cloves [spice]; cake frosting [icing]; glucose for culinary purposes; croutons; gluten additives for culinary purposes; thickening agents for cooking foodstuffs; leaven; rice-based snack food; cereal-based snack food; vegetal preparations for use as coffee substitutes; dressings for salad; fruit jellies [confectione-

ry]; confectionery for decorating Christmas trees; frozen confectionery; pastries; cakes; peanut confectionery; almond confectionery; pasta; pasties; ginger [spice]; frozen yogurt [confectionery ices]; capers; caramels [sweets]; curry [spice]; gruel, with a milk base, for food; ketchup [sauce]; quiches; gluten prepared as foodstuff; sweets; liquorice [confectionery]; peppermint sweets; cinnamon [spice]; unroasted coffee; starch for food; crackers; custard; hominy grits; semolina; oatmeal; flour-based dumplings; rice dumplings; crushed barley; groats for human food; corn, milled; corn, roasted; meat pies; turmeric; couscous; farinaceous foods; noodles; ice, natural or artificial; edible ices; lollipops [confectionery]; fried dough cookies; rice cakes; mayonnaise; macarons; macaroni; maltose; hominy; marinades; marzipan; royal jelly; bean meal; tapioca flour; potato flour; corn flour; meal; wheat flour; soya flour; barley meal; dessert mousses [confectionery]; chocolate mousses; muesli; mint for confectionery; cocoa beverages with milk; coffee beverages with milk; coffee-based beverages; tea-based beverages; chocolate beverages with milk; chocolate-based beverages; cocoa-based beverages; infusions, not medicinal; crushed oats; husked oats; nutmegs; stick liquorice [confectionery]; soya bean paste [seasoning]; bread sticks; pastilles [confectionery]; molasses for food; pepper; allspice; peppers [seasonings]; pesto; cookies; petit-beurre biscuits; pies; poultry and game meat pies; pizzas; fresh pizzas; meat gravies; fondants [confectionery]; donuts; popcorn; powders for making ice cream; mustard meal; pralines; meat tenderizers for household purposes; oat-based food; bee glue; gingerbread; petits fours; puddings; cake powder; fruit coulis [sauces]; ravioli; pelmeni; chewing gum; relish [condiment]; wheat germ for human consumption; spring rolls; palm sugar; aniseed; flaxseed for culinary purposes [seasoning]; golden syrup; cake dough; sugar confectionery; baking soda [bicarbonate of soda for cooking purposes]; malt for human consumption; salt for preserving foodstuffs; cooking salt; celery salt; sherbets [ices]; ham glaze; soya sauce; tomato sauce; pasta sauce; hot dogs [sandwiches]; sauces [condiments]; wheat-based snack foods; cheese-flavored puffed corn snacks; extruded corn snacks; muesli snacks; spaghetti; spaghetti with meatballs; seasonings; preparations for stiffening whipped cream; rusks; breadcrumbs; sushi; sandwiches; tabbouleh; tacos; cream of tartar for culinary purposes; tarts; dough; almond paste; tortillas; garden herbs, preserved [seasonings]; beer vinegar; ferments for pastes; halvah; unleavened bread; baked goods; chips [cereal products]; corn flakes; oat flakes; chicory [coffee substitute]; iced tea; chutneys [condiments]; cheeseburgers [sandwiches]; chow-chow [condiment]; saffron [seasoning]; chocolate; malt extract for food; essences for foodstuffs, except etheric essences and essential oils; husked barley; piccalilli.

43 – Services for providing food and drink; temporary accommodation; accommodation bureau services [ho-

tels, boarding houses]; rental of temporary accommodation; rental of meeting rooms; tourist home services; hotel reservations; boarding house bookings; temporary accommodation reservations; hotel services; retirement home services; snack-bar services; café services; cafeteria services; motel services; boarding house services; boarding for animals; rental of cooking apparatus; rental of chairs, tables, table linen, glassware; rental of lighting apparatus other than for theatrical sets or television studios; rental of tents; rental of transportable buildings; rental of drinking water dispensers; restaurant services; self-service restaurant services; canteen services; holiday camp services [lodging]; bar services; providing campground facilities; food and drink catering; day-nursery [crèche] services.

(260) AM 2022 112955 A
(800) 1590541
(151) 2020 11 10
(891) 2020 11 10
(731) C. Bechstein Pianoforte AG
Kantstr. 17, 10623 Berlin, Germany
(540)

C. BECHSTEIN

(591) Black, white
(511)
9 – Devices and instruments for recording, transmitting, reproducing and processing of sounds, images or data, in particular mute systems and devices for recording, transmitting, reproducing and processing of musical content via sounds, images or data; recorded and downloadable media, in particular CDs, DVDs, downloads and streamings with musical content; computer software, in particular software and apps for recording, transmitting, reproducing and processing of sounds, images or data, in particular of musical content for entertainment and education purposes.

15 – Musical instruments, in particular pianos, grand pianos and accessories therefor; strings; electrical and electronical musical instruments and accessories therefor.

16 – Printed matter, in particular instrument catalogues, music journals, sheet music and book publications.

36 – Real estate services.

37 – Construction of event and concert houses.

38 – Providing third party users with access to a network infrastructure for the networked operation of musical instruments.

41 – Education, in particular music lessons, music study courses, master courses and workshops; entertainment, in particular sound and film recordings in the field of music, music broadcasts; cultural activities, in particular development and presentation of concerts

and music contests; arranging and conducting of event and concert houses.

(260) AM 2022 112956 A
(800) 1590553
(151) 2021 01 15
(891) 2021 01 15
(731) ORLEN OIL Sp. z o. o.
ul. Opolska 114, PL-31-323 Kraków, Poland
(540)



(591) Red and silver
(531) 27.05.01; 27.05.09; 29.01.12
(511)
4 – Motor oils; lubricants being gear oils; hydraulic-gear oils; non-chemical additives for oils; lubricants; lubricating oils being hydraulic oils.

(260) AM 2022 112958 A
(800) 1590587
(151) 2020 11 13
(891) 2020 11 13
(731) Limited Liability Company "Elfa
laboratory"
vul. Simi Sosninykh, 9, Kyiv 03148, Ukraine
(540)



(591) Black, white
(531) 24.03.07; 24.03.18; 24.03.19; 24.13.01;
26.01.01; 26.01.04; 26.01.21; 27.05.01
(511)
3 – Abrasive paper; abrasives; adhesives for affixing false eyelashes; adhesives for affixing false hair; adhesives for cosmetic purposes; after-shave lotions; air fragrance reed diffusers; air fragrancing preparations; almond milk for cosmetic purposes; almond oil; almond soap; aloe vera preparations for cosmetic purposes; alum stones [astringents]; amber [perfume]; ammonia [volatile alkali] [detergent]; antiperspirant soap; antiperspirants [toiletries]; antistatic dryer sheets; antistatic preparations for household purposes; aromatics [essential oils]; astringents for cosmetic purposes; baby wipes impregnated with cleaning pre-

parations; badian essence; balms, other than for medical purposes; bases for flower perfumes; basma [cosmetic dye]; bath preparations, not for medical purposes; bath salts, not for medical purposes; beard dyes; beauty masks; bergamot oil; bleaching preparations [decolorants] for cosmetic purposes; bleaching preparations [decolorants] for household purposes; bleaching salts, bleaching soda, body paint for cosmetic purposes; breath freshening preparations for personal hygiene; breath freshening sprays; breath freshening strips; cake flavourings [essential oils]; cakes of toilet soap; canned pressurized air for cleaning and dusting purposes; carbides of metal [abrasives]; chemical cleaning preparations for household purposes; cleaning chalk; cleaning preparations; preparations for cleaning dentures; cleansers for intimate personal hygiene purposes, non medicated; cleansing milk for toilet purposes; cloths impregnated with a detergent for cleaning; cobblers' wax; collagen preparations for cosmetic purposes; colorants for toilet purposes; colour run prevention laundry sheets; colour-brightening chemicals for household purposes [laundry]; colour-removing preparations; corundum [abrasive]; cosmetic creams; cosmetic dyes; cosmetic kits; cosmetic pencils; cosmetic preparations for baths; cosmetic preparations for eyelashes; cosmetic preparations for skin care; cosmetic preparations for slimming purposes; cosmetics; cosmetics for animals; cosmetics for children; cotton swabs for cosmetic purposes; cotton wool for cosmetic purposes; cotton wool impregnated with make-up removing preparations; creams for leather; decorative transfers for cosmetic purposes; degreasers, other than for use in manufacturing processes; dental bleaching gels; dentifrices, denture polishes; deodorant soap; deodorants for human beings or for animals; deodorants for pets; depilatory preparations; depilatory wax; descaling preparations for household purposes; detergents, other than for use in manufacturing operations and for medical purposes; diamantine [abrasive]; douching preparations for personal sanitary or deodorant purposes [toiletries]; dry shampoos; dry-cleaning preparations; drying agents for dishwashing machines; eau de Cologne; emery; emery cloth; emery paper; essential oils; essential oils of cedarwood; essential oils of citron; essential oils of lemon; ethereal essences; extracts of flowers [perfumes]; eye-washes, not for medical purposes; eyebrow cosmetics; eyebrow pencils; fabric softeners for laundry use; false eyelashes; false nails; flavourings for beverages [essential oils]; floor wax; floor wax removers [scouring preparations]; food flavourings [essential oils]; fumigation preparations [perfumes]; gaultheria oil; gel eye patches for cosmetic purposes; geraniol; glass cloth [abrasive cloth]; greases for cosmetic purposes; grinding preparations; hair conditioners; hair dyes; hair lotions*; hair spray; hair straightening preparations; hair waving preparations; heliotropine; henna [cosmetic dye]; herbal extracts for cosmetic purposes; hydrogen peroxide for cosmetic purposes; incense;

ionone [perfumery]; jasmine oil; Javelle water; joss sticks; lacquer-removing preparations; laundry bleach; laundry blueing; laundry glaze, laundry preparations; laundry soaking preparations; lavender oil; lavender water; leather bleaching preparations; leather preservatives [polishes]; preparations to make the leaves of plants shiny; lip glosses; lipstick cases; lipsticks, liquid latex body paint for cosmetic purposes; lotions for cosmetic purposes; make-up; make-up powder; make-up preparations; make-up removing preparations; mascara; massage candles for cosmetic purposes; massage gels, other than for medical purposes; micellar water, mint essence [essential oil]; mint for perfumery; moustache wax; mouthwashes, not for medical purposes; musk [perfumery]; nail art stickers; nail care preparations, nail glitter; nail varnish; nail varnish removers; neutralizers for permanent waving; non-slipping liquids for floors; non-slipping wax for floors; oil of turpentine for degreasing; oils for cleaning purposes; oils for cosmetic purposes; oils for perfumes and scents; oils for toilet purposes; paint stripping preparations; pastes for razor strops; perfumery; perfumes; petroleum jelly for cosmetic purposes; phytocosmetic preparations; polish for furniture and flooring; polishing creams; polishing paper; polishing preparations; polishing rouge; polishing stones; polishing wax; pomades for cosmetic purposes; potpourris [fragrances]; pumice stone; quillaia bark for washing; rose oil; rust removing preparations; sachets for perfuming linen; safrol; sandcloth; sandpaper; scented water; scented wood; scouring solutions; shampoos for animals [non-medicated grooming preparations]; shampoos for pets [non-medicated grooming preparations]; shampoos; shaving preparations; shaving soap; shaving stones [astringents]; shining preparations [polish]; shoe cream; shoe polish; shoe wax; shoemakers' wax; silicon carbide [abrasive]; skin whitening creams; smoothing preparations [starching]; smoothing stones; soap for brightening textile; soap for foot perspiration; soap; soda lye; stain removers; starch for laundry purposes; starch glaze for laundry purposes; sun-tanning preparations [cosmetics]; sunscreen preparations; tailors' wax; talcum powder, for toilet use; teeth whitening strips; terpenes [essential oils]; tissues impregnated with cosmetic lotions; tissues impregnated with make-up removing preparations; toilet water; toiletry preparations; toothpaste; tripoli stone for polishing; turpentine for degreasing; preparations for unblocking drain pipes; vaginal washes for personal sanitary or deodorant purposes; varnish-removing preparations, volcanic ash for cleaning; wallpaper cleaning preparations; washing soda, for cleaning; wax for parquet floors; whitening; windscreen cleaning liquids.

(260) AM 2022 112963 A

(800) 1590680

(151) 2020 11 19

(891) 2020 11 19

(731) Zakrytoe aktsionernoe obshchestvo "Myasnaya galereya"

ul. Poliny Osipenko, d. 65, of. 10, RU-600009

g. Vladimir, Russian Federation

(540)



(591) Red, black, white, pink and burgundy

(531) 03.07.17; 08.05.01; 28.05; 29.01.15

(526) Element ®

(511)

29 – Meat, fish, poultry and game; meat extracts; preserved, frozen, dried and cooked fruits and vegetables; jellies, jams, compotes; eggs; milk and milk products; edible oils and fats; albumen for culinary purposes; seaweed extracts for food; gelatine; anchovy, not live; peanut butter; butter; cocoa butter for food; coconut butter; buttercream; white of eggs; blood sausage; broth; preparations for making bouillon; caviar; fruit, preserved; charcuterie; potato chips; sauerkraut; coconut, desiccated; rape oil for food; broth concentrates; soups; raisins; gherkins; cream [dairy products]; cheese; frosted fruits; croquettes; crustaceans, not live; dates; crayfish, not live; fish fillets; rennet; fruit jellies; fruit pulp; fish, not live; jellies for food; meat jellies; ginger jam; soya beans, preserved, for food; fatty substances for the manufacture of edible fats; fat-containing mixtures for bread slices; herrings, not live; lobsters, not live; corn oil for food; palm kernel oil for food; sesame oil for food; oysters, not live; isinglass for food; ham; yolk of eggs; yogurt; vegetable soup preparations; vegetable juices for cooking; kefir; kumys; milk beverages, milk predominating; whey; spiny lobsters, not live; bacon; lentils, preserved; margarine; marmalade; animal marrow for food; mussels, not live; mollusks, not live; palm oil for food; nuts, prepared; powdered eggs; liver pâté; onions, preserved; olives, preserved; olive oil for food; bone oil for food; pectin for culinary purposes; pickles; peas, preserved; sausages; sardelki [sausages]; salted meats; preparations for making soup; tomato purée; vegetable salads; lard; fruit salads; sardines, not live; salmon, not live; suet for food; tuna, not live; tomato juice for cooking; sunflower oil for food;

tripe; truffles, preserved; poultry, not live; breaded pieces of chicken; fruit peel; alginates for culinary purposes; almonds, ground; peanuts, prepared; mushrooms, preserved; coconut fat; coconut oil for food; beans, preserved; liver; fish-based foodstuffs; fruit chips; clams, not live; fruit preserved in alcohol; pollen prepared as foodstuff; prawns, not live; fish, preserved; meat, preserved; shrimps, not live; snail eggs for consumption; tofu; whipped cream; pork; edible birds' nests; fish, canned; fish meal for human consumption; fruits, canned; meat, canned; potato fritters; salted fish; sea-cucumbers, not live; silkworm chrysalis for human consumption; vegetables, canned; sausages in batter; potato flakes; apple purée; cranberry compote; tahini; hummus; toasted laver; fruit-based snack food; curd; kimchi; soya milk; milk shakes; ajvar [preserved peppers]; sunflower seeds, prepared; fish mousses; non-alcoholic eggnog; vegetable mousses; fish roe, prepared; seeds, prepared; aloe vera prepared for human consumption; preserved garlic; protein milk; flaxseed oil for food; low-fat potato chips; lecithin for culinary purposes; milk ferments for culinary purposes; condensed milk; smetana; ryazhenka [fermented baked milk]; prostokvasha [soured milk]; tomato paste; vegetable marrow paste; eggplant paste; peanut milk for culinary purposes; almond milk for culinary purposes; rice milk; artichokes, preserved; arrangements of processed fruit; powdered milk; yakitori; bulgogi; candied nuts; flavored nuts; hazelnuts, prepared; berries, preserved.

30 – Coffee; tea; cocoa; artificial coffee; rice; tapioca; sago; flour and preparations made from cereals; bread, pastry and confectionery; ice cream; sugar, honey, treacle; yeast, baking-powder; salt; mustard; vinegar, condiments; spices; seaweed [condiment]; pasta; almond paste; aniseed; star aniseed; confectionery for decorating Christmas trees; infusions, not medicinal; coffee flavorings; aromatic preparations for food; seasonings; unleavened bread; salt for preserving foodstuffs; rusks; cookies; malt biscuits; peppermint sweets; sweets; waffles; buns; unroasted coffee; vegetal preparations for use as coffee substitutes; cakes; cinnamon [spice]; capers; caramels [sweets]; curry [spice]; chewing gum; chicory [coffee substitute]; chocolate; marzipan; cloves [spice]; sugar confectionery; corn flakes; popcorn; preparations for stiffening whipped cream; pancakes; essences for foodstuffs, except etheric essences and essential oils; cooking salt; thickening agents for cooking foodstuffs; turmeric; natural sweeteners; gingerbread; allspice; meal; bean meal; corn flour; mustard meal; barley meal; soya flour; wheat flour; starch for food; ferments for pastes; fondants [confectionery]; petits fours; flavorings, other than essential oils, for cakes; cake powder; cake dough; ginger [spice]; binding agents for ice cream; ice, natural or artificial; glucose for culinary purposes; gluten prepared as foodstuff; groats for human food; ketchup [sauce]; cocoa beverages with milk; coffee beverages with milk; chocolate beverages with milk;

leaven; sausage binding materials; macarons; macaroni; corn, milled; corn, roasted; maltose; molasses for food; golden syrup; mint for confectionery; husked barley; nutmegs; noodles; pies; crushed barley; sandwiches; pastilles [confectionery]; pastries; petit-beurre biscuits; bread rolls; peppers [seasonings]; pizzas; pepper; potato flour; puddings; pralines; ravioli; liquorice [confectionery]; saffron [seasoning]; sauces [condiments]; celery salt; semolina; sherbets [ices]; spaghetti; tapioca flour; tarts; vanilla flavorings for culinary purposes; vanillin [vanilla substitute]; vermicelli; meat pies; pâtés en croûte; meat tenderizers for household purposes; edible ices; powders for making ice cream; almond confectionery; peanut confectionery; food flavorings, other than essential oils; flavorings, other than essential oils, for beverages; crushed oats; husked oats; oat-based food; oat flakes; oatmeal; stick liquorice [confectionery]; beer vinegar; coffee-based beverages; cocoa-based beverages; chocolate-based beverages; lollipops [confectionery]; chips [cereal products]; chow-chow [condiment]; couscous; malt extract for food; malt for human consumption; bee glue; relish [condiment]; royal jelly; sea water for cooking; sushi; tomato sauce; mayonnaise; crackers; custard; fruit jellies [confectionery]; muesli; rice cakes; soya sauce; frozen yogurt [confectionery ices]; chutneys [condiments]; spring rolls; tacos; tortillas; iced tea; tea-based beverages; dressings for salad; breadcrumbs; tabbouleh; halvah; quiches; meat gravies; miso; cereal-based snack food; rice-based snack food; hominy; hominy grits; baking soda [bicarbonate of soda for cooking purposes]; garden herbs, preserved [seasonings]; noodle-based prepared meals; cake frosting [icing]; chocolate mousses; dessert mousses [confectionery]; fruit coulis [sauces]; marinades; cheeseburgers [sandwiches]; pesto; ham glaze; flaxseed for culinary purposes [seasoning]; wheat germ for human consumption; high-protein cereal bars; cream of tartar for culinary purposes; gluten additives for culinary purposes; pasta sauce; cereal bars; palm sugar; dough; flowers or leaves for use as tea substitutes; pastry dough; vareniki [stuffed dumplings]; pelmeni [dumplings stuffed with meat] including khinkali, manti; chocolate decorations for cakes; candy decorations for cakes; chocolate-coated nuts; rice pudding; nut flours; minced garlic [condiment]; baozi; rice pulp for culinary purposes; jiaozi; ramen; okonomiyaki [Japanese savory pancakes]; batter mixes for okonomiyaki [Japanese savory pancakes]; burritos; prepared rice rolled in seaweed; edible paper; edible rice paper; piccalilli.

43 – Services for providing food and drink; temporary accommodation; accommodation bureau services [hotels, boarding houses]; food and drink catering; retirement home services; café services; cafeteria services; providing campground facilities; canteen services; rental of temporary accommodation; boarding house services; tourist home services; hotel services; day-nursery [crèche] services; restaurant services; board-

ing house bookings; hotel reservations; self-service restaurant services; snack-bar services; boarding for animals; bar services; holiday camp services [lodging]; rental of transportable buildings; temporary accommodation reservations; motel services; rental of chairs, tables, table linen, glassware; rental of meeting rooms; rental of tents; rental of cooking apparatus; rental of drinking water dispensers; rental of lighting apparatus; food sculpting.

(260) AM 2022 112964 A

(800) 1590708

(151) 2020 12 16

(891) 2020 12 16

(731) Düker GmbH

Würzburger Strasse 10, 97753 Karlstadt,
Germany

(540)



(591) Black, white

(531) 26.11.01; 26.11.06; 26.11.08; 27.05.02;
27.05.11

(511)

6 – Pressure valves of cast metal for steam and hot water circulation; pipes; pipework; bends for pipes; pipe sockets, pipe collars or brackets; pipe connectors and parts thereof; fittings; valves of metal, for controlling the flow of fluids in pipes; valves of metal for shut-off the flow of fluids in pipes; valves of metal for preventing back flow in pipes; valves; coverings of metal for roads; fire resistant couplings for structural engineering and/or civil engineering, in particular for pipelines for gas, water and waste water; valves of metal for outlets of pipes; fitting and dismantling joints; exhaust chimneys; all the aforesaid goods of metal, preferably of cast iron or steel, with or without protective covers and linings in the form of enamelling or a synthetic or resin material coating and or lining.

11 – Hydrants.

40 – Custom manufacture of customised castings, contract enamelling, in particular of cast parts or steel parts.

(260) AM 2022 112966 A

(800) 1590745

(151) 2021 02 07

(891) 2021 02 07

(731) JIANGSU XINGDA STEEL TYRE CORD
CO., LTD.

No.88, Renmin West Road, Dainan Township,
Xinghua City, 225700 Jiangsu Province, China

(540)



(591) Black, white

(531) 05.05.20; 27.05.01; 29.01.13

(511)

6 – Steel wire; wire gauze; wire of common metal alloys, except fuse wire; steel fiber; wire rope; ironmongery; soldering wire of metal; steel, unwrought or semi-wrought; steel tubes; buildings of metal.

(260) AM 2022 112967 A

(800) 1590748

(151) 2021 04 14

(891) 2021 04 14

(731) XiaQuan

Room 2107, Block A, Jiaqiao International Plaza, Wanghu Street, Baohe District, Hefei City, Anhui Province, China

(540)

(591) Black, white

(531) 28.03

(511)

21 – Thermally insulated containers for food; drinking vessels; insect traps; kitchen utensils; dusting cloths [rags].

(260) AM 2022 112972 A

(800) 1590854

(151) 2021 01 26

(891) 2021 01 26

(731) Egis Gyógyszergyár Zrt.

Keresztúri út 30-38., H-1106 Budapest, Hungary

(540)

(591) Black, white

(531) 28.05

(511)

3 – Cosmetics and cosmetic preparations.

5 – Human pharmaceutical preparations; dietetic substances adapted for medical use; dietary supplements; medicinal ointments; medicated skin creams; plasters, materials for dressings.

(260) AM 2022 112973 A

(800) 1590856

(151) 2021 04 09

(891) 2021 04 09

(731) GUANGDONG MARUBI

BIOTECHNOLOGY CO., LTD

Building 2, No.92, Banhe Road, Science City, High-Tech Industrial Development Zone, Guangzhou, Guangdong, China

(540)

(591) Black, white

(531) 27.05.01; 28.03

(511)

3 – Cleansing milk for toilet purposes; cleaning preparations; polishing preparations; essential oils; grinding preparations; cosmetics; toothpaste; potpourris [fragrances]; cosmetics for animals; air fragrancing preparations.

(260) AM 2022 112983 A

(800) 1591088

(151) 2021 03 29

(891) 2021 03 29

(731) MINISTERO DELLE POLITICHE

AGRICOLE ALIMENTARI E FORESTALI (MIPAAF)

Via XX Settembre 20, I-00187 ROMA (RM), Italy

(540)



(591) Black, white

(531) 05.03.13; 05.03.14; 27.05.08; 27.05.09

(511)

31 – Garlic, fresh; citrus fruit, fresh; saplings; fruit trees; live Christmas trees; potted bonsai; trees; apricots, fresh; pineapples, fresh; watermelon, fresh; peanuts, fresh; oranges, fresh; shrubs; asparagus, fresh; oats; avocados, fresh; berries, fresh; bananas, fresh; beet, fresh; plant bulbs; bulbs (plant -) for agricultural use; sugarcane; artichokes, fresh; locust beans, raw; chestnuts, fresh; cabbage, fresh; chickpeas, fresh; vine plants; cereal seeds, unprocessed; unprocessed cereals; chervil, fresh; cucumbers, fresh; chicory, fresh; flower bulbs; onions, fresh; corms; flower corms; bran; chives, fresh; garden herbs, fresh; beans, fresh;

hay; flowers, natural; flowers; palm fronds; fresh fruits and vegetables; mushrooms, fresh; seed germ for botanical purposes; bean sprouts, fresh; grains [cereals]; wheat; maize; yams, fresh; kiwi fruit, fresh; lettuce, fresh; undressed timber; vegetables, fresh; lentils, fresh; limes, fresh; lemons, fresh; lychees, fresh; hops; malt; almonds [fruits]; mangos, fresh; quinces, fresh; apples, fresh; blueberries, fresh; hazelnuts, fresh; coconuts; nuts [fruits]; olives, fresh; nettles; barley; straw mulch; straw litter; palm trees; palms [leaves of the palm tree]; papayas, fresh; potatoes, fresh; chilies, fresh; peppers [plants]; peppers, fresh; pears, fresh; peaches, fresh; plants; flowering plants, natural; fruit plants; aloe vera plants; seedlings; pine cones; peas, fresh; pollen [raw material]; grape tomatoes, fresh; cherry tomatoes, fresh; tomatoes, fresh; pomelos, fresh; leeks, fresh; plums, fresh; nursery plants; unprocessed horticultural products; rhubarb, fresh; roots for animal consumption; rose bushes; roses; shallots, fresh; rye; crop seeds; agricultural seeds; seeds for horticultural purposes; seeds for growing flowers; seeds for growing fruits and vegetables; seeds for growing plants; seeds for sowing; seeds for planting; spinach, fresh; rough cork; turf, natural; truffles, fresh; trunks of trees; grapes, fresh; ginger, fresh; squashes, fresh; zucchini, fresh.

(260) AM 2022 112987 A

(800) 1591241

(151) 2021 03 08

(891) 2021 03 08

(731) Step One Clothing Pty Ltd

Fl2, 710 Collins St, DOCKLANDS VIC 3008,
Australia

(540)

STEP ONE

(591) Black, white

(531) 27.03.15; 27.05.01

(511)

25 – Apparel (clothing, footwear, headgear); athletic clothing; clothing; drawers (clothing); ladies clothing; men's clothing; woven articles of clothing; footwear; headgear for wear; jockstraps (underwear); briefs [underwear]; underwear; underclothes; underpants; bras; brassieres; boxer shorts; socks; sleepwear.

(260) AM 2022 112988 A

(800) 1591255

(151) 2021 02 11

(891) 2021 02 11

(731) Obshchestvo s ogranichennoy otvetstvennost'yu
"LAKRA SINTEZ"

ul. Dorozhnaya, d. 5, Noginskiy r-n, g. Staraya
Kupavna, RU-142450 Moskovskaya obl.,
Russian Federation

(540)



Lakra Sintez

(591) Black, white

(531) 01.13.15; 01.15.15; 27.05.01

(511)

1 – Adhesives for industrial purposes; adhesives for billposting; cement for footwear; cement-waterproofing chemicals, except paints; cement preservatives, except paints and oils; adhesives for wallpaper; leather glues; fireproofing preparations; synthetic resins, unprocessed; acrylic resins, unprocessed; preservatives for tiles, except paints and oils; adhesives for wall tiles; glue for industrial purposes; damp-proofing chemicals, except paints, for masonry; glaziers' putty; oil cement [putty]; chemicals for the manufacture of pigments.

2 – Paints; anti-corrosive preparations; bactericidal paints; badigeon; bitumen varnish; wood coatings [paints]; wood mordants; wood stains; wood preservatives for fencing; ink for leather; ceramic paints; shoe dyes; colorants; wood preservatives; dyes; pigments; distempers; enamels [varnishes]; enamels for painting; printing ink; coatings [paints]; fireproof paints; oils for the preservation of wood; anti-rust oils; protective preparations for metals; anti-rust preparations; whitewash; dyewood; lacquers; anti-fouling paints; anti-graffiti coatings [paints]; wood floor finishes.

16 – Adhesives [glues] for stationery or household purposes; glue for stationery or household purposes.

17 – Acrylic resins, semi-processed; weatherstripping compositions; non-conducting materials for retaining heat; insulating varnish; substances for insulating buildings against moisture; insulating paints; latex [rubber]; sealant compounds for joints; synthetic resins, semi-processed; insulating plaster; insulating refractory materials.

(260) AM 2022 112990 A

(800) 1591290

(151) 2020 10 10

(891) 2020 10 10

(731) Jey pakhsh shokoofa co

No,1199, Pirooz junction, Jomhour str,
Tehran, Islamic Republic of Iran

(540)



(591) Black, white and light brown

(531) 05.03.13; 05.03.15; 26.11.02; 26.11.08;

27.05.09; 27.05.10; 27.05.11; 28.01; 29.01.13

(511)

3 – Hair straightening preparation; hair frosting preparation; hair mousses; hair color sprays; hair oils; bath gels; shower gels; sanitary wet wipe for women; perfumed cream for cosmetic use; baby oils; cream for cracked foot; washing liquids; hair sprays; anti-perspirant sprays; shaving foams; eye masks for cosmetic purposes; liquid soaps; hair styling gels; anti-perspirant powders; bath oils; sun screen for children; massage creams other than for medical purposes; shaving creams; shaving gels; foot creams; facial masks for cosmetic use; baby oils; exfoliating creams; baby skin conditioners; baby creams; after sun lotions; sun screen gels; sun screen sprays; sun screen creams; anti-perspirant; gels; foot sprays; body sprays; deodorant roll on; vitamin creams for cosmetic use; cosmetic creams for firming the skins; baby lotions; face and hand creams; moisturizing hair sprays; face firming creams; anti-stretch mark creams for cosmetic use; hair masks; tooth whitening powders; lipsticks; hair removing sprays; hair removing creams; baby eau de cologne; baby lotions; baby soaps; anti-wrinkle creams for cosmetic use; face lotions; tissue impregnated with make-up removing preparations; bleaching powders; wax sprays; scented wet wipes; hair removing gels; impregnated with cleaning preparation; tissues impregnated with make-up removing preparations; stain removing liquids; soap powders; herbal cologne; herbal lotions; herbal massage oil other than for medical purposes; herbal make-up powders; herbal gels; herbal creams; herbal face masks; herbal strengthen hair lotions; herbal tooth pastes; herbal hand washing liquids; floor cleaning preparations; dish washing powders; fabric softener for laundry use; deodorant soaps; hair waving lotions; anti aging creams; non-medicated creams; cleaning preparations for clothing in the form of gels; bleaching liquids for laundry use; deodorant sprays; liquid eye liners, after shaving lotions; after shaving gels; mouth freshener sprays; cosmetic oils; tooth whitening gels; glass cleaning preparations; scented soaps; anti-perspirant body soaps; cream for whitening the skin; shaving soaps; shampoos; shaving preparations; cleaning preparation tooth pastes; eau de Cologne; make-up creams; hair sprays; hair lotion; hair color; lotions for cosmetic purposes; tissue impregnated with cosmetic lotions; creams for le-

ather; petroleum jelly for cosmetic purposes; perfumes; oil for perfumes and scents; make up creams; hair sprays; hair lotion; hair colors; lotions for cosmetic purposes; tissue impregnated with cosmetic lotions; creams for leather; perfumes.

5 – Medicated soaps; sanitary napkins; menstruation tampons; anesthetic sprays; insecticides; genital cleaning gels for medical purposes.

16 – Tissue of papers; towels of papers; cellulose wipes; pocket tissue of papers; disposable tissue papers; toilet seat covers of papers; tissue roll papers; toilet papers; kitchen towels.

35 – Export agency services; whole sale services and business management of the goods including hair straightening preparation, hair frosting preparation, hair mousses, hair color sprays, hair oils, bath gels, shower gels, sanitary wet wipe for women perfumed cream for cosmetic use, baby oils, cream for cracked foot, washing liquids, hair sprays, anti-perspirant sprays, shaving foams, eye masks for cosmetic purposes, liquid soaps, hair styling gels, anti-perspirant powders, bath oils, sun screen for children, massage creams other than for medical purposes, shaving creams, shaving gels, foot creams, facial masks for cosmetic use, baby oils, exfoliating creams, baby skin conditioners, baby creams, after sun lotions, sun screen gels, sun screen sprays, sun screen creams, anti-perspirant, gels, foot sprays, body sprays, deodorant roll on, vitamin creams for cosmetic use, cosmetic creams for firming the skins, baby lotions, face and hand creams, moisturizing hair sprays, face firming creams, anti-stretch mark creams for cosmetic use, hair masks, tooth whitening powders, lipsticks, hair removing sprays, hair removing creams, baby eau de cologne, baby lotions, baby soaps, anti-wrinkle creams for cosmetic use, face lotions, tissue impregnated with make-up removing preparations papers for removing make-up, bleaching powders, wax sprays, scented wet wipes, hair removing gels, impregnated with cleaning preparation, tissues impregnated with make-up removing preparations, stain removing liquids, soap powders, herbal cologne, herbal lotions, herbal massage oil other than for medical purposes, herbal make-up powders, herbal gels, herbal creams, herbal face masks, herbal strengthen hair lotions, herbal tooth pastes, herbal hand washing liquids, floor cleaning preparations, dish washing powders, fabric softener for laundry use, deodorant soaps, hair waving lotions, anti aging creams, non-medicated creams, cleaning preparations for clothing in the form of gels, bleaching liquids for laundry use, deodorant sprays, liquid eye liners, after shaving lotions, after shaving, gels, mouth freshener sprays, cosmetic oils, tooth whitening gels, glass cleaning preparations, scented soaps, anti-perspirant body soaps, cream for whitening the skin, shaving soaps, shampoos, shaving preparations, cleaning preparation tooth pastes, eau de cologne, make-up creams, shaving preparations, cleaning prepara-

ration tooth pastes, eau de cologne, make-up creams, hair sprays, hair lotion, hair color, lotions for cosmetic purposes, tissue impregnated with cosmetic lotions, creams for leather, petroleum jelly for cosmetic purposes, perfumes, oil for perfumes and scents, make up creams, hair sprays, hair lotion, hair colors, lotions for cosmetic purposes, tissue impregnated with cosmetic lotions, creams for leather, perfumes, hair sprays, hair lotion, hair color, lotions for cosmetic purposes, tissue impregnated with cosmetic lotions, creams for leather, petroleum jelly for cosmetic purposes, perfumes, oil for perfumes and scents, make up creams, hair sprays, hair lotion, hair colors, lotions for cosmetic purposes, tissue impregnated with cosmetic lotions, creams for leather, perfumes, tissue of papers, towels of papers, cellulose wipes, pocket tissue of papers, disposable tissue papers, toilet seat covers of papers, tissue roll papers, toilet papers, kitchen towels.

39 – Packaging of the goods including, hair straightening preparation, hair frosting preparation, hair mousses, hair color sprays, hair oils, bath gels, shower gels, sanitary wet wipe for women, perfumed cream for cosmetic use, baby oils, cream for cracked foot, washing liquids, hair sprays, anti perspirant sprays, shaving foams, eye masks for cosmetic purposes, liquid soaps, hair styling gels, anti perspirant powders, bath oils, sun screen for children, massage creams other than for medical purposes, shaving creams, shaving gels, foot creams, facial masks for cosmetic use, baby oils, exfoliating creams, baby skin conditioners, baby creams, after sun lotions, sun screen gels, sun screen sprays, sun screen creams, anti perspirant, gels, foot sprays, body sprays, deodorant roll on, vitamin creams for cosmetic use, cosmetic creams for firming the skins, baby lotions, face and hand creams, moisturizing hair sprays, face firming creams, anti-stretch mark creams for cosmetic use, hair masks, tooth whitening powders, lip sticks, hair removing sprays, hair removing creams, baby eau de cologn, baby lotions, baby soaps, anti-wrinkle creams for cosmetic use, face lotions, tissue impregnated with make-up removing preparations papers for removing make-up, bleaching powders, wax sprays, scented wet wipes, hair removing gels, impregnated with cleaning preparation, tissues impregnated with make-up removing preparations, stain removing liquids, soap powders, herbal cologne, herbal lotions, herbal massage oil other than for medical purposes, herbal make-up powders, herbal gels, herbal creams, herbal face masks, herbal strengthen hair lotions, herbal tooth pastes, herbal hand washing liquids, floor cleaning preparations, dish washing powders, fabric softener for laundry use, deodorant soaps, hair waving lotions, anti aging creams, non-medicated creams, cleaning preparations for clothing in the form of gels, bleaching liquids for laundry use, deodorant sprays, liquid eye liners, after shaving lotions, after shaving, gels, mouth freshener sprays, cosmetic oils, tooth whitening gels, glass cleaning preparations, scented soaps, anti perspirant body

soaps, cream for whitening the skin, shaving soaps, shampoos, shaving preparations, cleaning preparation tooth pastes, eau de cologne, make-up creams, shaving preparations, cleaning preparation tooth pastes, eau de cologne, make-up creams, hair sprays, hair lotion, hair color, lotions for cosmetic purposes, tissue impregnated with cosmetic lotions, creams for leather, petroleum jelly for cosmetic purposes, perfumes, oil for perfumes and scents, make up creams, hair sprays, hair lotion, hair colors, lotions for cosmetic purposes, tissue impregnated with cosmetic lotions, creams for leather, perfumes, hair sprays, hair lotion, hair color, lotions for cosmetic purposes, tissue impregnated with cosmetic lotions, creams for leather, petroleum jelly for cosmetic purposes, perfumes, oil for perfumes and scents, make up creams, hair sprays, hair lotion, hair colors, lotions for cosmetic purposes, tissue impregnated with cosmetic lotions, creams for leather, perfumes, tissue of papers, towels of papers, cellulose wipes, pocket tissue of papers, disposable tissue papers, toilet seat covers of papers, tissue roll papers, toilet papers, kitchen towels.

(260) AM 2022 112991 A

(800) 1591381

(151) 2021 03 15

(891) 2021 03 15

(731) DAW SE

Roßdörferstr. 50, 64372 Ober-Ramstadt,
Germany

(540)

CAPAFREE

(591) Black, white

(511)

1 – Industrial chemicals; preservative and damp-proofing preparations for masonry, roofing tiles, cement and concrete, except paints and oils; artificial resins, synthetic resins and plastics, unprocessed; solvents (chemicals); solvents for varnishes and lacquers; adhesives used in industry; adhesives for wallpaper; adhesives used in building; filler for the treatment of subsurfaces for paints (not included in other classes).

2 – Paints; varnishes; lacquers; glazes; coatings; preservatives against rust; primers; colorants; dyestuffs; dye pastes; mordants; paint thickeners; fixatives for paints; siccatives for paints; raw natural resins; thinning and binding preparations for paints and lacquers; solvents for thinning paints; preparations for preserving wood, wood mordants; wood preserving oils; paints, including structuring paints; bactericidal and/ or fungicidal paints; anti-corrosion preparations; protective preparations for metals; metals in foil and powder form for painters, decorators, printers, and artists.

19 – Building materials, not of metal or mainly not of metal, in particular profile rails and corner irons, finishing profiles; adjusting and levelling parts, spacers for building, sills, all not of metal or mainly not of metal;

natural and artificial stone; mortar (building materials); quartz; plaster [building materials]; coatings (building materials); wall and ceiling panels (not of metal or mainly not of metal, for building); fabric embedding compounds for building; fillers (building materials); fabrics for building, not of metal or mainly not of metal, in particular stabilising fabrics.

37 – Painting, in particular tinting of paints; constructions; construction consultancy; building insulating; scaffolding; wallpapering; consultancy with regard to the use of paints, plasters and other coating materials in the construction industry.

(260) AM 2022 112992 A

(800) 1591477

(151) 2021 02 10

(891) 2021 02 10

(731) Akcionerhoe obshchestvo "Konditerskaya fabrika "BELOGORE"

ul. Promyshlennaya, d. 19, g. Belgorod,
RU-308032 Belgorodskaya obl., Russian
Federation

(540)



(591) White, dark red, red, light red, gray and light gray

(531) 24.03.09; 24.03.18; 24.03.19; 26.05.01;

26.05.06; 26.05.22; 26.13.25; 28.05; 29.01.13

(511)

30 – Vanilla flavourings for culinary purposes; flavourings, other than essential oils, for cakes; flavourings, other than essential oils, for beverages; coffee flavourings; food flavourings, other than essential oils; star aniseed; baozi; cereal bars; high-protein cereal bars; pancakes; noodle-based prepared meals; freeze-dried dishes with the main ingredient being pasta; freeze-dried dishes with the main ingredient being rice; buns; bread rolls; edible rice paper; edible paper; burritos; vanillin [vanilla substitute]; vareniki [stuffed dumplings]; waffles; vermicelli; natural sweeteners; sausage binding materials; binding agents for ice cream; seawater for cooking; seaweed [condiment]; malt biscuits; cloves [spice]; mirror icing [mirror glaze]; cake frosting [icing]; glucose for culinary purposes; mustard; gluten additives for culinary purposes; yeast; thickening agents for cooking foodstuffs; leaven; rice-based snack food; cereal-based snack food; artificial coffee; vegetal preparations for use as coffee substitutes; dressings for salad; fruit jellies [confectionery]; candy decorations for cakes; confectio-

nery for decorating Christmas trees; cakes; pastries; peanut confectionery; almond confectionery; pasta; ginger [spice]; frozen yogurt [confectionery ices]; cocoa; cream of tartar for culinary purposes; capers; caramels [sweets]; curry [spice]; ketchup [sauce]; prepared rice rolled in seaweed; quiches; gluten prepared as foodstuff; flour-based dumplings; sweets; liquorice [confectionery]; peppermint sweets; dulce de leche; cinnamon [spice]; coffee; unroasted coffee; starch for food; crackers; custard; hominy grits; semolina; oatmeal; crushed barley; groats for human food; ice cubes; corn, milled; corn, roasted; meat pies; turmeric; couscous; noodles; ice for refreshment; ice, natural or artificial; edible ices; rice cakes; mayonnaise; macarons; macaroni; maltose; hominy; piccalilli; marinades; marzipan; honey; miso; royal jelly; ice cream; bean meal; tapioca flour; potato flour; corn flour; nut flours; flour; wheat flour; soya flour; barley meal; dessert mousses [confectionery]; chocolate mousses; muesli; mint for confectionery; cocoa beverages with milk; coffee beverages with milk; coffee-based beverages; cocoa-based beverages; chamomile-based beverages; tea-based beverages; chocolate beverages with milk; chocolate-based beverages; infusions, not medicinal; crushed oats; husked oats; okonomiyaki [Japanese savory pancakes]; onigiri [rice balls]; nutmegs; chocolate-coated nuts; stick liquorice [confectionery]; soy bean paste [seasoning]; lozenges [confectionery]; molasses for food; pâtés en croûte; pelmeni; pepper; allspice; peppers [seasonings]; pesto; biscuits; petit-beurre biscuits; bibimbap [rice mixed with vegetables and beef]; pies; pizzas; meat gravies; fondants [confectionery]; popcorn; powders for making ice cream; baking powder; mustard meal; pralines; aromatic preparations for food; condiments; meat tenderizers for household purposes; cereal preparations; oat-based food; propolis; gingerbread; spices; petits fours; rice pudding; puddings; cake powder; fruit coulis [sauces]; ravioli; ramen; chewing gum; relish [condiment]; rice; instant rice; wheat germ for human consumption; spring rolls; sago; palm sugar; sugar; sesame seeds [seasonings]; linseed for culinary purposes [seasoning]; processed seeds for use as a seasoning; aniseed; agave syrup [natural sweetener]; golden syrup; confectionery; savory pancake mixes; baking soda [bicarbonate of soda for cooking purposes]; malt for human consumption; salt for preserving foodstuffs; cooking salt; celery salt; sorbets [ices]; ham glaze; soya sauce; tomato sauce; sauces [condiments]; pasta sauce; spaghetti; seasonings; chocolate-based spreads; chocolate spreads containing nuts; preparations for stiffening whipped cream; rusks; bread-crumbs; sushi; sandwiches; tabbouleh; tacos; tapioca; tarts; dough; pastry dough; almond paste; rice pulp for culinary purposes; cake batter; tortillas; garden herbs, preserved [seasonings]; chocolate decorations for cakes; vinegar; beer vinegar; ferments for pastes; halvah; bread; unleavened bread; chips [cereal products]; corn flakes; oat flakes; hot dog sandwiches; flowers or

leaves for use as tea substitutes; jiaozi; chicory [coffee substitute]; tea; iced tea; chutneys [condiments]; minced garlic [condiment]; cheeseburgers [sandwiches]; chow-chow [condiment]; saffron [seasoning]; chocolate; malt extract for food; essences for foodstuffs, except etheric essences and essential oils; husked barley.

(260) AM 2022 113005 A

(800) 1544237

(151) 2020 06 24

(891) 2021 04 07

(731) F. Hoffmann-La Roche AG

Grenzacherstrasse 124, CH-4070 Basel,

Switzerland

(540)

VABYSMO

(591) Black, white

(511)

5 – Pharmaceutical preparations.

(260) AM 2022 113052 A

(800) 1591590

(151) 2020 12 30

(891) 2020 12 30

(731) Mooney S.p.A.

Via Privata Nino Bonnet 6/A, I-20154 Milano

MI, Italy

(540)

mooney

(591) Grey and yellow

(531) 27.05.01; 29.01.12

(511)

9 – Computer software applications, downloadable; credit card terminals; integrated circuit cards [smart cards]; computer software, recorded.

16 – Paper and cardboard; printed matter; instructional and teaching materials; albums; pictures; display binders; engravings; paintings [pictures], framed or unframed; pencils; newspapers; journals; tickets; drawing pads; pads [stationery]; leaflets; stamps [seals]; writing or drawing books; notebooks; folios; cardboard; catalogues; folders for papers; books; pencil holders; automatic pencils; envelopes [stationery]; nibs; erasing products; photographs [printed]; graphic reproductions; graphic representations; postcards; printed publications; manuals [handbooks], booklets; magazines [periodicals]; bookmarkers; greeting cards; calendars; trading cards, other than for games; flyers; banknotes.

35 – Advertising; business management; business administration; office functions; business management assistance; drawing up of statements of accounts; bu-

ness auditing; consultancy regarding business organisation and business economics; distribution of advertising material; commercial or industrial management assistance; business efficiency expert services; auctioneering services; market research; business appraisal; business investigations, business organization consultancy; public relations services; conducting of marketing studies; computerized file management; economic forecasting; organization of exhibitions for commercial or advertising purposes; opinion polling; on-line advertising on a computer network; commercial information and advice for consumers [consumer advice shop]; marketing; provision of commercial and business contact information; commercial intermediation services; business intermediary services relating to the matching of potential private investors with entrepreneurs needing funding.

36 – Financial customs brokerage services; accident insurance underwriting; numismatic appraisal; provident fund services; brokerage of carbon credits; stock brokerage services; business liquidation services, financial; bail-bonding; organization of monetary collections; processing of debit card payments; savings bank services; financing services; virtual currency trading and exchange services; financial management of reimbursement payments for others; trusteeship; financial evaluation [insurance, banking, real estate]; issuance of tokens of value; real estate brokerage; issuance of credit cards; insurance consultancy; loans [financing]; brokerage services for stocks and bonds; art appraisal; capital investment; real estate appraisal; safe deposit services; financial sponsorship; clearing, financial; financial valuation of intellectual property assets; medical insurance; electronic transfer of virtual currencies; financial research; leasing, namely, leasing of buildings, leasing of commercial property, leasing of real estate; fiscal valuation; marine insurance underwriting; real estate affairs; fire insurance underwriting, currency trading and exchange services; processing of credit card payments; credit bureau services; cheque verification, accommodation bureau services [apartments]; electronic funds transfer; actuarial services; repair costs evaluation [financial appraisal]; antique appraisal; financial evaluation of standing timber; providing insurance information; financial appraisals in responding to calls for tenders; financial advice; instalment loans; real estate agency services; jewellery appraisal; financial evaluation of development costs relating to the oil, gas and mining industries; preparation of quotes for cost estimation purposes; assurance underwriting; banking; arranging finance for construction projects; charitable fund raising; stock exchange quotations; lending against security; pawn brokerage; deposits of valuables, life insurance underwriting; debt advisory services; e-wallet payment services; debt collection agency services; online banking; arranging capital investments; stamp appraisal; surety services; financial analysis; financial evaluation of wool; fund investment services; retirement

payment services; providing financial information; mortgage banking; insurance brokerage.

37 – Installation, maintenance and repair of computer hardware.

41 – Education; providing of training; entertainment; sporting and cultural activities; academies [education]; entertainment services; organization of competitions [education or entertainment]; providing recreation facilities; publication of texts, other than publicity texts; teaching; publication of books; theater productions, production of shows; arranging and conducting of colloquiums; arranging and conducting of conferences; arranging and conducting of congresses; education information; entertainment information; organization of exhibitions for cultural or educational purposes; providing museum facilities [presentation, exhibitions]; arranging and conducting of seminars; arranging and conducting of workshops [training]; booking of seats for shows and booking of theatre tickets; on-line publication of electronic books and journals; electronic desktop publishing; vocational guidance [education or training advice]; ticket agency services [entertainment]; writing of texts.

42 – Computer software consultancy; server hosting; duplication of computer programs; off-site data backup; electronic monitoring of credit card activity to detect fraud via the internet; computer rental; providing search engines for the internet; computer technology consultancy; internet security consultancy; software development in the framework of software publishing; software as a service [SaaS]; installation of computer software.

(260) AM 2022 113061 A

(800) 1591973

(151) 2020 12 21

(891) 2020 12 21

(731) Fontaine Limited

c/o Tmf Group 8th Floor, 20 Farringdon Street,
London EC4A 4AB, United Kingdom

(540)

CREED

(591) Black, white

(511)

3 – Perfumes; fragrances; eau de parfum; toilet water; colognes; shaving preparations; shaving gels; shaving soaps; shaving foams; aftershave preparations; shaving balms; lotions for beards; toiletries; non-medicated toiletry preparations; soaps; soaps for personal use; cosmetic preparations for the bath and shower; non-medicated skin care preparations; nail care preparations; hair care preparations; essential oils; scented oils; deodorants for personal use; room fragrances.

4 – Candles; perfumed candles.

35 – Retail services connected with the sale of perfumes, fragrances, eau de parfum, toilet water, colognes, shaving preparations, shaving gels, shaving soaps, shaving foams, aftershave preparations, shaving balms, lotions for beards, toiletries, non-medicated toiletry preparations, soaps, soaps for personal use, cosmetic preparations for the bath and shower, non-medicated skin care preparations, nail care preparations, hair care preparations, essential oils, scented oils, deodorants for personal use, room fragrances, candles, candles scented with perfumes and fragrances, perfume atomisers.

(260) AM 2022 113063 A

(800) 1591990

(151) 2020 12 07

(891) 2020 12 07

(731) Jaguar Land Rover Limited

Abbey Road, Whitley, Coventry CV3 4LF,
United Kingdom

(540)

XE

(591) Black, white

(511)

12 – Automobiles; vehicles; motor vehicles; apparatus for locomotion by land, air and/or water; motor land vehicles; land vehicles; off-road vehicles; all terrain vehicles (atvs); driverless motor vehicles; autonomous motor vehicles; racing cars; reconditioned classic vehicles; vehicles sold in kit form; commercial vehicles; electric vehicles; hybrid vehicles; robotic cars; self-driving vehicles; military vehicles; vehicles for use by emergency services, search and rescue services; powerboats; powertrains for land vehicles; engines for land vehicles; motors for land vehicles; engines for motorcycles; motors for motorcycles; engines for bicycles; motors for bicycles; engines for racing cars; trailers; arm rests for vehicle seats; luggage bags specially adapted for fitting in the boot of vehicles; car interior organizer bags, nets and trays specially adapted for fitting in vehicles; head-rests for vehicle seats; steering wheels; voice activated steering wheels and steering devices; devices for steering vehicles; joysticks for steering vehicles; airbags; vehicle head rest covers; wing mirror protective and vanity covers; car seat covers; covers for vehicle steering wheels; fitted covers for vehicles; shaped or fitted mats and floor coverings for motor vehicles; wheels for vehicles; alloy wheels; wheel trims; wheel rims; spare wheels; hub caps for wheels; hub centre caps; wheel covers; wheel sprockets; tyres; automobile tyres, bicycle tyres; inner tubes for tyres; spoilers for vehicles; covers for vehicles; seats for vehicles; safety seats for vehicles; safety belts for vehicles; safety harnesses for vehicles; safety signals [audible] for vehicles; anti-theft, security and safety devices and equipment for vehicles; radiator grilles for vehicles; trim panels for vehicle bodies; doors for vehicles; vehicle windows;

vehicle windshields; window glass for vehicle windows and windshields; roof windows for vehicles; skylight windows for vehicles; vehicle bumpers; vehicle centre consoles sold as parts of vehicles and which incorporate electronic interfaces; bicycles; tri-cycles; parts, fittings and accessories for bicycles; self-balancing electric scooters; self-balancing boards; scooters; quadricycles; motorised unicycles; go-karts; strollers and prams, and their parts and accessories; baby, infant and child seats for vehicles; sun blinds, roof racks, luggage carriers and nets, cycle carriers, sail board carriers, ski carriers, and snow chains, all for vehicles; drones; unmanned aerial vehicles; personal air vehicles; hovercraft; underwater vehicles; jet vehicles for water sports; remote control vehicles, not toys; parts and fittings for all of the aforesaid goods.

(260) AM 2022 113064 A

(800) 1592010

(151) 2020 12 15

(891) 2020 12 15

(731) Apple Inc.

One Apple Park Way, Cupertino CA 95014,
USA

(540)



(591) Purple, blue, and green

(531) 04.05.03; 29.01.13

(511)

38 – Broadcasting and transmission of voice, data, images, music, audio, video, multimedia, television, video games, computer games, and radio by means of telecommunications networks, computer networks, the Internet, satellite, radio, wireless communications networks, television, and cable; broadcast and transmission of streamed music, audio, video, computer games, and multimedia content by means of telecommunications networks, computer networks, the Internet, satellite, radio, wireless communications networks, television, and cable; subscription and pay-per-view broadcasting and transmission services by means of telecommunications networks, computer networks, the Internet, satellite, radio, wireless communications networks, television, and cable.

41 – Recording, production, distribution, and presentation of radio programs, podcasts, television programs, motion pictures, multimedia entertainment content, video games, computer games, and sound recordings; providing ongoing television, radio, audio,

video, podcast, and webcast programs; providing entertainment, sports, music, informational, news, and current events programming by means of telecommunications networks, computer networks, the Internet, satellite, radio, wireless communications networks, television, and cable television; providing non-downloadable entertainment, sports, animation, music, informational, news, reality, and current events programming; arranging of entertainment, sports, music, art and cultural events, providing entertainment information and news reporting services via websites and computer applications; providing information in the field of entertainment, music, sports, news, and arts and culture via websites and computer applications; entertainment information; providing non-downloadable computer games, electronic games, interactive games, and video games.

42 – Cloud computing that features technology that enables users to share data; hosting a web site featuring technology that enables internet users to share documents, images, audio, videos, computer software applications, publications, video games, computer games, and electronic games; computer services, namely, interactive hosting services which allow the users to publish and share music, images, publications, videos, video games, computer games, electronic games, and computer software applications; hosting a web site featuring technology that enables internet users to share documents, images, audio, videos, computer software applications, publications, video games, computer games, and electronic games; providing an on-line network environment that features technology that enables users to share data.

(260) AM 2022 113065 A

(800) 1592019

(151) 2021 03 27

(891) 2021 03 27

(731) Společnost s ručením omezením IASIS

Vilova 266/26, CZ-100 00 Stranice, Praga 10,
Czech Republic

(540)



(591) Blue and red

(531) 27.05.17; 27.05.22; 29.01.12

(511)

39 – Air transport; motor coach rental; boat rental; garage rental; rental of vehicle roof racks; aircraft rental; parking place rental; rental of electric wine cellars; rental of warehouses; rental of tractors; booking of seats for travel; travel reservation; transport reserva-

tion; towing; vehicle breakdown towing services; bottling services; water distribution; water supplying; delivery of newspapers; message delivery; parcel delivery; delivery of goods; delivery of goods by mail order; flower delivery; replenishment of vending machines; launching of satellites for others; transportation logistics; rescue operations [transport]; arranging of cruises; arranging of passenger transportation services for others via an online application; arranging of transportation for travel tours; arranging for travel visas and travel documents for persons travelling abroad; armoured-car transport; hauling; carting; transport and storage of waste; transporting furniture; lighterage services; ferry-boat transport; removal services; transport of travellers; guarded transport of valuables; bus transport; car transport; barge transport; boat transport; railway transport; marine transport; passenger transport; river transport; ambulance transport; tram transport; porterage; piloting of civilian drones; refloating of ships; cash replenishment of automated teller machines; shipbrokerage; transport brokerage; freight brokerage [forwarding (Am.)]; providing driving directions for travel purposes; providing traffic information; providing information relating to storage services; providing transportation information; car rental; railway truck rental; rental of diving bells; rental of diving suits; rental of motor racing cars; rental of aircraft engines; railway coach rental; rental of storage containers; rental of wheelchairs; horse rental; rental of freezers; rental of navigational systems; refrigerator rental; vehicle rental; stevedoring; unloading cargo; electricity distribution; distribution of energy; packaging of goods; collection of recyclable goods [transport]; carpooling services; ice-breaking; piloting; escorting of travellers; transport by pipeline; wrapping of goods; operating canal locks; car parking; chauffeur services; pleasure boat transport; car sharing services; courier services [messages or merchandise]; salvaging; salvage of ships; gift wrapping; underwater salvage; taxi transport; transport; transport services for sightseeing tours; luggage storage; franking of mail; freight [shipping of goods]; freighting; physical storage of electronically stored data or documents; boat storage; storage of goods; storage; freight forwarding.

(260) AM 2022 113066 A
 (800) 1592031
 (151) 2021 03 05
 (891) 2021 03 05
 (731) Landos Biopharma, Inc.
 1800 Kraft Drive, Suite 216, Blacksburg
 WI 24060, USA
 (540)



The logo for PACIFY features the word "PACIFY" in a light blue, sans-serif font. Above the letters "A", "C", and "I" is a curved, light blue line that arches over them, resembling a stylized wave or a protective shield.

(591) The color(s) blue is/are claimed as a feature of the mark
 (531) 26.11.12; 27.05.01; 29.01.04
 (511)
 42 – Conducting clinical trials in the field of ulcerative colitis.

(260) AM 2022 113080 A
 (800) 1592521
 (151) 2021 03 10
 (891) 2021 03 10
 (731) Weichai Power Co., Ltd.
 197, Section A, Fushou East Street, High
 Technology Industrial, Development Zone,
 Weifang City, Shandong Province, China
 (540)



The logo for WEICHAI consists of the word "WEICHAI" in a bold, black, sans-serif font. The letters are closely spaced and have a slightly irregular, industrial feel.

(591) Black, white
 (531) 27.05.01; 27.05.17
 (511)
 9 – Battery packs; fuel cells; power packs [batteries]; power units [batteries]; charging devices for motor vehicles; solar cells; electric batteries for powering electric vehicles; car batteries; galvanic batteries; charging stations for electric vehicles.

(260) AM 2022 113081 A
 (800) 1592579
 (151) 2021 02 26
 (891) 2021 02 26
 (731) Kwikclick, LLC
 876 East Vine Street, Murray UT 84107, USA
 (540)



The logo for KWIKCLICK features the word "KWIKCLICK" in a bold, black, sans-serif font. The letters are closely spaced and have a slightly irregular, industrial feel.

(591) Black, white
 (511)
 35 – Providing information for connecting buyers and sellers of multi-level marketing goods and services via a website; providing information for connecting sellers with buyers via a website; business consultancy; business sales management and marketing consulting services; consultancy services regarding business strategies; information, advisory, and consultancy services relating to business establishment, administration, and management; multi-level marketing services; multi-level marketing consulting services; business advisor and consultant services in the fields of business management and multi-level marketing; multi-level marketing business development services provided to independent sales consultants; providing organizational development consultancy; providing information featuring business information on multi-level marketing business services via a website.

(260) AM 2022 113082 A
 (800) 1592613
 (151) 2021 03 24
 (891) 2021 03 24
 (731) Showa Chemical Industry Co., Ltd.
 2-14-32, Akasaka, Minato-ku, Tokyo 107-0052,
 Japan
 (540)

RADIOLITE

(591) Black, white
 (511)
 1 – Diatomaceous earth; plant growth regulating preparations; chemicals for the manufacture of paints; catalysts; biochemical catalysts; industrial chemicals; filtering materials of chemical substances; filtering preparations for the beverages industry.

(260) AM 2022 113083 A
 (800) 1592632
 (151) 2021 02 10
 (891) 2021 02 10
 (731) LEO Pharma A/S
 Industriparken 55, DK-2750 Ballerup, Denmark
 (540)



(591) Black, white
 (531) 01.15.24
 (511)
 5 – Pharmaceutical and medical preparations for treatment of skin diseases, atopic dermatitis, autoimmune and inflammatory diseases and for treatment of the skin.

38 – Providing online forums for information and communication about skin diseases, atopic dermatitis, autoimmune and inflammatory diseases and in relation treatment of the skin.

42 – Scientific and medical research in the field of skin diseases, atopic dermatitis, autoimmune and inflammatory diseases and in relation to treatment of the skin; research in the field of skin diseases, atopic dermatitis, autoimmune and inflammatory diseases and in relation to treatment of the skin; pharmaceutical research and development services in the field of skin diseases, atopic dermatitis, autoimmune and inflammatory diseases and in relation to treatment of the skin; scientific research for medical purposes in the field of skin diseases, atopic dermatitis, autoimmune and inflammatory diseases and in relation to treatment of the skin; providing information and consulting services in the field of research, development and science in relation to skin diseases and treatment of the skin; pharmaceutical tests of pharmaceutical preparations in the field of skin diseases, atopic dermatitis,

autoimmune and inflammatory diseases and in relation to treatment of the skin.

44 – Medical services in the field of skin diseases, atopic dermatitis, autoimmune and inflammatory diseases and in relation to treatment of the skin; medical, health and pharmaceutical consultation services in the field of skin diseases, atopic dermatitis, autoimmune and inflammatory diseases and in relation to treatment of the skin; medical tests in the field of skin diseases, atopic dermatitis, autoimmune and inflammatory diseases and in relation to treatment of the skin.

(260) AM 2022 113084 A
 (800) 1592648
 (151) 2021 03 17
 (891) 2021 03 17
 (731) MOLEAC PTE. LTD.
 11 BIOPOLIS WAY, #09-08 HELIOS,
 Singapore 138667, Singapore
 (540)

NuraID

(591) Dark blue (Pantone codes 25 Red 26 Green 138 Blue), clear blue (Pantone codes 147 Red 150 Green 197 Blue), medium blue (Pantone codes 57 Red 77 Green 150 Blue). The Nuraid letters, the "I" excepted, are filled in dark blue (Pantone codes 25 Red 26 Green 138 Blue), the upper part of the "I" of Nuraid is filled with clear blue (Pantone codes 147 Red 150 Green 197 Blue), the under part of the "I" of Nuraid is filled with a medium blue (Pantone codes 57 Red 77 Green 150 Blue)

(531) 19.13.21; 27.03.01; 27.05.01; 29.01.12
 (511)
 5 – Dietary food supplements.

(260) AM 2022 113085 A
 (800) 1592697
 (151) 2021 01 14
 (891) 2021 01 14
 (731) Herbonis AG
 Rheinstrasse 30, CH-4302 Augst, Switzerland
 (540)

(591) Black, white
 (531) 05.03.13; 05.03.15; 26.02.03; 27.05.07;
 27.05.09; 27.05.10
 (511)
 5 – Pharmaceutical and veterinary products; dietary foods and substances for medical or veterinary use; dietary food supplements for animals.

31 – Animal feed and animal drinks.

(260) AM 2022 113089 A
 (800) 1592747
 (151) 2021 03 23
 (891) 2021 03 23
 (731) SOOFT ITALIA S.p.A.
 Contrada Molino, 17, I-63833
 MONTEGIORGIO (FM), Italy
 (540)

TiORETIN

(591) Black, white
 (531) 27.05.01
 (511)
 5 – Dietetic foods adapted for medical purposes; dietetic substances adapted for medical use; chemical preparations for medicinal use; compresses; contact lens cleaning preparations; contact lens solutions; drugs for medical purposes; collyrium; medicinal herbs; mineral food-supplements; pastilles for pharmaceutical purposes; pharmaceutical preparations; vitamin preparations.

(260) AM 2022 113090 A
 (800) 1592809
 (151) 2021 03 16
 (891) 2021 03 16
 (731) FIDIA FARMACEUTICI S.p.A.
 Via Ponte della Fabbrica, 3/A, I-35031
 ABANO TERME (PD), Italy
 (540)

HYALOTEND

(591) Black, white
 (511)
 5 – Pharmaceutical and veterinary preparations; hygienic and sanitary products for medical purposes; dietetic food and substances adapted for medical or veterinary use; food supplements for humans and animals; plasters, materials for dressings; disinfectants; medicines; medical preparations for the prevention, control, therapy or attenuation of diseases or wounds; prefilled syringes containing pharmaceutical preparations for medical use.

(260) AM 2022 113091 A
 (800) 1059251
 (151) 2010 09 22
 (891) 2021 04 29
 (731) Ocean Pharma GmbH
 Dieselstr. 6, 21465 Reinbek, Germany
 (540)

Spirularin

(591) Black, white
 (511)
 3 – Cosmetics.

5 – Lotions for pharmaceutical purposes; lotions for veterinary purposes; medicinal drinks; medicinal hair growth preparations; mineral food supplements; dietetic beverages adapted for medical purposes; dietetic foods adapted for medical purposes; dietetic substances adapted for medical use.

29 – Weed extracts for food; alginates for food.

(260) AM 2022 113153 A
 (800) 1592960
 (151) 2021 03 25
 (891) 2021 03 25
 (731) LTD "VALENTA-INTELLEKT"
 ul. Ryabinovaya, d.26, str.10, k.6-26,
 RU-121471 Moscow, Russian Federation
 (540)

РАНКВИЛОН

(591) Black, white
 (531) 28.05
 (511)
 5 – Alkaloids for medical purposes; alginates for pharmaceutical purposes; aldehydes for pharmaceutical purposes; dental amalgams of gold; dental amalgams; amino acids for veterinary purposes; amino acids for medical purposes; analgesics; anaesthetics; antibiotics; antiseptics; medicine cases, portable, filled; first-aid boxes, filled; aluminium acetate for pharmaceutical purposes; acetates for pharmaceutical purposes; germicides; balms for medical purposes; bromine for pharmaceutical purposes; petroleum jelly for medical purposes; vaccines; oxygen baths; dietetic substances adapted for medical use; radiological contrast substances for medical purposes; nutritive substances for microorganisms; radioactive substances for medical purposes; bismuth subnitrate for pharmaceutical purposes; melissa water for pharmaceutical purposes; seawater for medicinal bathing; mineral waters for medical purposes; thermal water; dietary fibre; moulding wax for dentists; gases for medical purposes; guaiacol for pharmaceutical purposes; haematogen; haemoglobin; hydrastine; hydrastinine; glycerine for medical purposes; glycerophosphates; glucose for medical purposes; gentian for pharmaceutical purposes; hormones for medical purposes; mustard for pharmaceutical purposes; mud for baths; medicinal mud; gamboge for medical purposes; gurgun balsam for medical purposes; diastase for medical purposes; digitalin; mineral food supplements; nutritional supplements; albumin dietary supplements; dietary supplements for animals; alginate dietary supplements; glucose dietary supplements; casein dietary supplements; lecithin dietary supplements; linseed oil dietary supplements; propolis dietary supplements; protein

dietary supplements; protein supplements for animals; royal jelly dietary supplements; pollen dietary supplements; wheat germ dietary supplements; linseed dietary supplements; enzyme dietary supplements; yeast for pharmaceutical purposes; gelatine for medical purposes; cod liver oil; isotopes for medical purposes; insecticides; iodine for pharmaceutical purposes; iodides for pharmaceutical purposes; alkaline iodides for pharmaceutical purposes; iodoform; calomel; cream of tartar for pharmaceutical purposes; tartar for pharmaceutical purposes; camphor for medical purposes; capsules for medicines; cachets for pharmaceutical purposes; haemostatic pencils; wart pencils; caustic pencils; headache relief sticks; carbolineum [parasiticide]; caustics for pharmaceutical purposes; cachou for pharmaceutical purposes; quassia for medical purposes; quebracho for medical purposes; oxygen for medical purposes; gallic acid for pharmaceutical purposes; acids for pharmaceutical purposes; adhesives for dentures; stem cells for veterinary purposes; stem cells for medical purposes; cocaine; collodion for pharmaceutical purposes; corn rings for the feet; medicated sweets; angostura bark for medical purposes; barks for pharmaceutical purposes; cedar wood for use as an insect repellent; condurango bark for medical purposes; croton bark; mangrove bark for pharmaceutical purposes; myrobalan bark for pharmaceutical purposes; quinquina for medical purposes; medicinal roots; rhubarb roots for pharmaceutical purposes; lint for medical purposes; starch for dietetic or pharmaceutical purposes; creosote for pharmaceutical purposes; blood for medical purposes; cultures of microorganisms for medical or veterinary use; curare; dental lacquer; liquorice for pharmaceutical purposes; milk sugar for pharmaceutical purposes; medicated candies; adhesive plasters; medicines for alleviating constipation; adhesive tapes for medical purposes; lecithin for medical purposes; lotions for veterinary purposes; dog lotions; lotions for pharmaceutical purposes; personal sexual lubricants; lupulin for pharmaceutical purposes; magnesia for pharmaceutical purposes; liniments; ointments for pharmaceutical purposes; sunburn ointments; mercurial ointments; frostbite salve for pharmaceutical purposes; gauze for dressings; medicinal oils; mustard oil for medical purposes; camphor oil for medical purposes; castor oil for medical purposes; oil of turpentine for pharmaceutical purposes; dill oil for medical purposes; dental mastics; dental abrasives; dental impression materials; teeth filling material; dressings, medical; surgical dressings; drugs for medical purposes; medicines for veterinary purposes; serotherapeutic medicines; medicines for human purposes; medicines for dental purposes; menthol; medicinal drinks; moleskin for medical purposes; almond milk for pharmaceutical purposes; royal jelly for pharmaceutical purposes; milk ferments for pharmaceutical purposes; Irish moss for medical purposes; flour for pharmaceutical purposes; linseed meal for pharmaceutical purposes; fish meal for pharmaceuti-

cal purposes; mint for pharmaceutical purposes; dietetic beverages adapted for medical purposes; malted milk beverages for medical purposes; narcotics; medicinal infusions; tincture of iodine; eucalyptol for pharmaceutical purposes; tinctures for medical purposes; opium; opodeldoc; decoctions for pharmaceutical purposes; antiparasitic collars for animals; stick liquorice for pharmaceutical purposes; pastilles for pharmaceutical purposes; pectin for pharmaceutical purposes; pepsins for pharmaceutical purposes; peptones for pharmaceutical purposes; hydrogen peroxide for medical purposes; pesticides; leeches for medical purposes; blood plasma; pomades for medical purposes; anti-uric preparations; bacterial preparations for medical use; bacteriological preparations for medical use; balsamic preparations for medical purposes; albuminous preparations for medical purposes; biological preparations for medical purposes; bismuth preparations for pharmaceutical purposes; vitamin preparations; diagnostic preparations for medical purposes; therapeutic preparations for the bath; haemorrhoid preparations; preparations for callouses; preparations to facilitate teething; preparations for the treatment of burns; fumigation preparations for medical purposes; opotherapy preparations; eye-washes; bronchodilating preparations; preparations for reducing sexual activity; sterilizing preparations; corn remedies; pharmaceutical preparations for treating dandruff; pharmaceutical preparations for skin care; lime-based pharmaceutical preparations; medicinal hair growth preparations; opiates; aloe vera preparations for pharmaceutical purposes; preparations of trace elements for human and animal use; sulfonamides [medicines]; pharmaceutical preparations; drugs to reduce and prevent withdrawal syndrome, including for persons with alcohol, nicotine and drug addiction; pharmaceutical preparations for treating sunburn; enzyme preparations for medical purposes; chemico-pharmaceutical preparations; chemical preparations for the diagnosis of pregnancy; chemical preparations for medical purposes; chemical preparations for pharmaceutical purposes; chilblain preparations; collyrium; albuminous foodstuffs for medical purposes; dietetic foods adapted for medical purposes; by-products of the processing of cereals for dietetic or medical purposes; propolis for pharmaceutical purposes; pearl powder for medical purposes; radium for medical purposes; hydrated chloral for pharmaceutical purposes; vaginal washes; solutions for contact lenses; chemical reagents for medical or veterinary purposes; gum for medical purposes; chewing gum for medical purposes; sarsaparilla for medical purposes; sugar for medical purposes; asthmatic tea; linseed for pharmaceutical purposes; tobacco-free cigarettes for medical purposes; siccatives [drying agents] for medical purposes; syrups for pharmaceutical purposes; turpentine for pharmaceutical purposes; greases for medical purposes; soporifics; bicarbonate of soda for pharmaceutical purposes; salts for medical purposes; potassium salts

for medical purposes; sodium salts for medical purposes; smelling salts; malt for pharmaceutical purposes; alcohol for pharmaceutical purposes; medicinal alcohol; ergot for pharmaceutical purposes; cooling sprays for medical purposes; adjuvants for medical purposes; styptic preparations; vermifuges; douching preparations for medical purposes; appetite suppressants for medical purposes; medical preparations for slimming purposes; mouthwashes for medical purposes; febrifuges; depuratives; vesicants; purgatives; chemical contraceptives; antiparasitic preparations; sedatives; laxatives; tonics [medicines]; nervines; digestives for pharmaceutical purposes; bouillons for bacteriological cultures; strychnine; suppositories; serums; tanning pills; appetite suppressant pills; slimming pills; antioxidant pills; thymol for pharmaceutical purposes; biological tissue cultures for medical purposes; smoking herbs for medical purposes; medicinal herbs; charcoal for pharmaceutical purposes; fennel for medical purposes; phenol for pharmaceutical purposes; enzymes for medical purposes; ferments for pharmaceutical purposes; formic aldehyde for pharmaceutical purposes; phosphates for pharmaceutical purposes; quinine for medical purposes; chinoline for medical purposes; chloroform; flowers of sulfur for pharmaceutical purposes; medicinal tea; herbal teas for medicinal purposes; eucalyptus for pharmaceutical purposes; extracts of hops for pharmaceutical purposes; elixirs [pharmaceutical preparations]; ethers for pharmaceutical purposes; esters for pharmaceutical purposes; cellulose esters for pharmaceutical purposes; cellulose ethers for pharmaceutical purposes; jujube, medicated; jalap.

(260) AM 2022 113154 A
 (800) 1593075
 (151) 2021 03 19
 (891) 2021 03 19
 (731) Blaser Group GmbH
 Ziegelstadel 1, 88316 Isny, Germany
 (540)

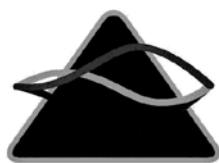

PTR-SYSTEM
 BY BLASER

(591) Black, white
 (531) 26.03.07; 26.03.12; 26.03.24; 27.05.10
 (511)
 25 – Apparel, footwear, headgear.

(260) AM 2022 113155 A
 (800) 1593107
 (151) 2021 03 19
 (891) 2021 03 19
 (731) Blaser Group GmbH
 Ziegelstadel 1, 88316 Isny, Germany
 (540)



3L-SHELTER
 BY BLASER

(591) Black, white
 (531) 26.03.04; 26.03.06; 26.03.07; 26.03.24;
 27.05.10
 (511)
 25 – Apparel, footwear, headgear.

(260) AM 2022 113156 A
 (800) 1593119
 (151) 2020 07 01
 (891) 2020 07 01
 (731) Egis Gyógyszergyár Zrt.
 Keresztúri út 30-38., H-1106 Budapest,
 Hungary
 (540)

PSORIBYE

(591) Black, white
 (511)
 5 – Pharmaceutical preparations; health care products; sanitary preparations for medical purposes; dietetic food and substances adapted for medical or veterinary use; dietary supplements for humans and animals; mineral food supplements; vitamins and vitamin-based preparations.

9 – Apparatus for recording, transmission or reproduction of sound or images; equipment for processing and transmission of data and information; software; computer software for analysing, storing and monitoring physiological data; personal digital assistant; connected bracelets [measuring instruments]; smart scales; smartwatches; computer software for medical purposes; downloadable applications for use with mobile devices; artificial intelligence software; wearable activity trackers; educational mobile applications; tracking devices for medical devices.

10 – Surgical, medical, veterinary and dental apparatus and instruments; medical measuring instruments and apparatus; diagnostic tools for medical purposes; diagnostic, measuring, examination and monitoring systems (terms considered too vague by the International Bureau – rule 13 (2) (b) of the Regulations); analyzers for medical purposes.

41 – Education; providing information in the field of health care (terms considered too vague by the International Bureau – rule 13 (2) (b) of the Regulations).

44 – Medical services; diagnostic services (terms considered too vague by the International Bureau – rule 13 (2) (b) of the Regulations); medical diagnostic services via electronic means; hygienic and beauty care; advisory services relating to health; pharmacy advice; telemedicine services; therapy services; providing of nursing services in the home; online medical prescriptions; providing medical support in the monitoring of patients receiving medical treatments; consultancy in the field of pharmacy, health care and therapy; medical information for patients; information and awareness programs in the field of health; remote medical examinations; counselling in relation to well-being and health; remote medical monitoring of patients.

(260) AM 2022 113157 A

(800) 1593164

(151) 2020 11 19

(891) 2020 11 19

(731) Lenzing Aktiengesellschaft

Werkstr. 2, A-4860 Lenzing, Austria

(540)

TENCEL

(591) Black, white

(511)

18 – All-purpose athletic bags; all-purpose carrying bags; ankle-mounted wallets; art portfolios [cases]; artificial fur bags; attaché cases; attache cases made of imitation leather; attache cases made of leather; baby carriers worn on the body; back frames for carrying children; backpacks for carrying infants; backpacks with rolling wheels; bags; bags for campers; bags for climbers; bags for sports; bags for sports clothing; bags made of imitation leather; bags made of leather; banknote holders; beach bags; belt bags and hip bags; book bags; boston bags; briefcases; briefcases [leather goods]; briefcases and attache cases; bucket bags; bumbags; business card cases; business card holders in the nature of wallets; business cases; canvas bags; canvas shopping bags; card cases [notecases]; card wallets [leatherware]; carriers for suits, shirts and dresses; carrying cases; carrying cases for documents; carry-on bags; carry-on suitcases; cases of imitation leather; children's shoulder bags; clutch bags; clutches [purses]; coin holders; coin purses, not of precious metal; commutation-ticket holders; compression cubes adapted for luggage; conference folders; cosmetic bags sold empty; cosmetic cases sold empty; cosmetic purses; courier bags; credit card cases [wallets]; credit card holders made of imitation leather; credit card holders made of leather; credit-card holders; cross-body bags; daypacks; diplomatic bags; document cases of leather; drawstring bags; drawstring pouches; driving licence cases; duffel bags; empty instrument

cases for use by doctors; evening handbags; fashion handbags; felt pouches; flexible bags for garments; flight bags; folding briefcases; folio cases; game bags [hunting accessories]; garment bags for travel; garment bags for travel made of leather; garment carriers; general purpose sport trolley bags; gentlemen's handbags; gladstone bags; grips [bags]; grocery tote bags; gym bags; handbag frames; handbags; handbags made of imitation leather; handbags made of leather; handbags, purses and wallets; hat boxes for travel; hat boxes of leather; haversacks; hiking bags; hiking rucksacks; hipsacks; holdalls for sports clothing; holders in the nature of cases for keys; imitation leather hat boxes; japanese utility pouches (shingen-bukuro); key bags; key cases; key cases made of leather; key cases of imitation leather; key-cases of leather and skins; kit bags; knitting bags; kori wicker trunks; ladies' handbags; leather bags and wallets; leather cases; leather coin purses; leather credit card wallets; leather pouches; leather purses; leather suitcases; leather wallets; luggage; luggage covers; luggage tags; luggage tags [leatherware]; make-up bags sold empty; make-up boxes; motorized suitcases; multi-purpose purses; music bags; music cases; nappy bags; nappy wallets; net bags for shopping; overnight bags; overnight cases; pocket wallets; portfolio cases [briefcases]; portmanteaus; pouch baby carriers; pouches; pouches for holding make-up, keys and other personal items; purses; purses made of precious metal; purses, not of precious metal; randsels [japanese school satchels]; reusable shopping bags; roll bags; roller bags; roller suitcases; rucksacks; rucksacks on castors; saddlebags; school bags; school book bags; school knapsacks; shaving bags sold empty; shoe bags; shoe bags for travel; shopping bags; shopping bags made of skin; shopping bags with wheels attached; shoulder bags; sling bags for carrying infants; sling bags; slings for carrying infants; slouch handbags; small bags for men; small clutch purses; small purses; small rucksacks; small suitcases; souvenir bags; specialty holsters adapted for carrying folding walking sticks; sporrans; sports packs; suitcases; suitcases with built-in shelves; suitcases with wheels; textile shopping bags; tie cases; tie cases for travel; toiletry bags; tool bags [empty] for motorcycles; tool bags of leather, empty; tool bags, empty; tool pouches, sold empty; towelling bags; travel baggage; travel bags made of plastic materials; travel cases; travel garment covers; travel luggage; travelling bags; travelling bags made of imitation leather; travelling sets; travelling sets [leatherware]; travelling trunks; trolley duffels; trunks [luggage]; trunks and suitcases; two-wheeled shopping bags; valises; vanity cases sold empty; vanity cases, not fitted; wallets for attachment to belts; wallets including card holders; wallets, not of precious metal; wash bags (not fitted); wash bags for carrying toiletries; waterproof bags; weekend bags; wheeled bags; wheeled luggage; wheeled shopping bags; work bags; wrist mounted

carryall bags; wrist mounted purses; wrist-mounted wallets.

(260) AM 2022 113159 A

(800) 1593369

(151) 2020 07 01

(891) 2020 07 01

(731) Egis Gyógyszergyár Zrt.

Keresztúri út 30-38., H-1106 Budapest,

Hungary

(540)

VIPSORY

(591) Black, white

(511)

5 – Pharmaceutical preparations; health care products; sanitary preparations for medical purposes; dietetic food and substances adapted for medical or veterinary use; dietary supplements for humans and animals; mineral food supplements; vitamins and vitamin-based preparations.

9 – Apparatus for recording, transmission or reproduction of sound or images; equipment for processing and transmission of data and information; software; computer software for analysing, storing and monitoring physiological data; personal digital assistant; connected bracelets [measuring instruments]; smart scales; smartwatches; computer software for medical purposes; downloadable applications for use with mobile devices; artificial intelligence software; wearable activity trackers; educational mobile applications; tracking devices for medical devices.

10 – Surgical, medical, veterinary and dental apparatus and instruments; medical measuring instruments and apparatus; diagnostic tools for medical purposes; diagnostic, measuring, examination and monitoring systems (terms considered too vague by the International Bureau – rule 13 (2) (b) of the Regulations); analyzers for medical purposes.

41 – Education; providing information in the field of health care (terms considered too vague by the International Bureau – rule 13 (2) (b) of the Regulations).

44 – Medical services; diagnostic services (terms considered too vague by the International Bureau – rule 13 (2) (b) of the Regulations); medical diagnostic services via electronic means; hygienic and beauty care; advisory services relating to health; pharmacy advice; telemedicine services; therapy services; providing of nursing services in the home; online medical prescriptions; providing medical support in the monitoring of patients receiving medical treatments; consultancy in the field of pharmacy, health care and therapy; medical information for patients; information and awareness programs in the field of health; remote medical examinations; counselling in relation to well-being and health; remote medical monitoring of patients.

(260) AM 2022 113160 A

(800) 1593373

(151) 2020 07 01

(891) 2020 07 01

(731) Egis Gyógyszergyár Zrt.

Keresztúri út 30-38., H-1106 Budapest,

Hungary

(540)

PSORISMART

(591) Black, white

(511)

5 – Pharmaceutical preparations; health care products; sanitary preparations for medical purposes; dietetic food and substances adapted for medical or veterinary use; dietary supplements for humans and animals; mineral food supplements; vitamins and vitamin-based preparations.

9 – Apparatus for recording, transmission or reproduction of sound or images; equipment for processing and transmission of data and information; software; computer software for analysing, storing and monitoring physiological data; personal digital assistant; connected bracelets [measuring instruments]; smart scales; smartwatches; computer software for medical purposes; downloadable applications for use with mobile devices; artificial intelligence software; wearable activity trackers; educational mobile applications; tracking devices for medical devices.

10 – Surgical, medical, veterinary and dental apparatus and instruments; medical measuring instruments and apparatus; diagnostic tools for medical purposes; diagnostic, measuring, examination and monitoring systems (terms considered too vague by the International Bureau – rule 13 (2) (b) of the Regulations); analyzers for medical purposes.

41 – Education; providing information in the field of health care (terms considered too vague by the International Bureau – rule 13 (2) (b) of the Regulations).

44 – Medical services; diagnostic services (terms considered too vague by the International Bureau – rule 13 (2) (b) of the Regulations); medical diagnostic services via electronic means; hygienic and beauty care; advisory services relating to health; pharmacy advice; telemedicine services; therapy services; providing of nursing services in the home; online medical prescriptions; providing medical support in the monitoring of patients receiving medical treatments; consultancy in the field of pharmacy, health care and therapy; medical information for patients; information and awareness programs in the field of health; remote medical examinations; counselling in relation to well-being and health; remote medical monitoring of patients.

(260) AM 2022 113161 A
 (800) 1593415
 (151) 2020 07 01
 (891) 2020 07 01
 (731) Egis Gyógyszergyár Zrt.
 Keresztúri út 30-38., H-1106 Budapest,
 Hungary
 (540)

PSORICOACH

(591) Black, white
 (511)
 5 – Pharmaceutical preparations; health care products; sanitary preparations for medical purposes; dietetic food and substances adapted for medical or veterinary use; dietary supplements for humans and animals; mineral food supplements; vitamins and vitamin-based preparations.

9 – Apparatus for recording, transmission or reproduction of sound or images; equipment for processing and transmission of data and information; software; computer software for analysing, storing and monitoring physiological data; personal digital assistant; connected bracelets [measuring instruments]; smart scales; smartwatches; computer software for medical purposes; downloadable applications for use with mobile devices; artificial intelligence software; wearable activity trackers; educational mobile applications; tracking devices for medical devices.

10 – Surgical, medical, veterinary and dental apparatus and instruments; medical measuring instruments and apparatus; diagnostic tools for medical purposes; diagnostic, measuring, examination and monitoring systems (terms considered too vague by the International Bureau – rule 13 (2) (b) of the Regulations); analyzers for medical purposes.

41 – Education; providing information in the field of health care (terms considered too vague by the International Bureau – rule 13 (2) (b) of the Regulations).

44 – Medical services; diagnostic services (terms considered too vague by the International Bureau – rule 13 (2) (b) of the Regulations); medical diagnostic services via electronic means; hygienic and beauty care; advisory services relating to health; pharmacy advice; telemedicine services; therapy services; providing of nursing services in the home; online medical prescriptions; providing medical support in the monitoring of patients receiving medical treatments; consultancy in the field of pharmacy, health care and therapy; medical information for patients; information and awareness programs in the field of health; remote medical examinations; counselling in relation to well-being and health; remote medical monitoring of patients.

(260) AM 2022 113162 A
 (800) 1593518
 (151) 2021 03 05
 (891) 2021 03 05
 (731) Brick Technology AB
 Södermannagatan 4, SE-116 40 Stockholm,
 Sweden
 (540)

BRICK

(591) Black, white
 (511)
 9 – Power banks; software applications [apps] for Internet of Things [IoT] enabled devices; application software for mobile phones, for use in connection with rental of powerbanks.

(260) AM 2022 113163 A
 (800) 1593534
 (151) 2021 04 05
 (891) 2021 04 05
 (731) Motion Picture Licensing Corporation
 5455 S. Centinela Ave., Los Angeles
 CA 90066, USA
 (540)



(591) Black, white
 (531) 26.11.01; 26.11.12; 27.05.01
 (511)
 45 – Copyright licensing of performance rights to motion pictures and other audiovisual programs.

(260) AM 2022 113174 A
 (800) 1286641
 (151) 2016 01 04
 (891) 2020 11 11
 (731) Tovaristvo z obmegeuou vidpovidalnistu
 "INTELKOM"
 vul. Mykytynetska, 7A, m. Ivano-Frankivsk
 7601, Ukraine
 (540)



(591) Red, blue and white
 (531) 03.01.16; 15.07.01; 15.07.03; 27.01.01;
 29.01.13

(511)

28 – Arcade video game machines; video game machines; climbers' harness; tennis ball throwing apparatus; swimming pools [play articles]; trampolines; billiard cues; billiard balls; billiard markers; billiard tables; coin-operated billiard tables; bodyboards; boxing gloves; rattles [playthings]; building blocks [toys]; twirling batons; teddy bears; stationary exercise bicycles; creels [fishing traps]; bite sensors [fishing tackle]; golf bag carts; lines for fishing; rods for fishing; dumb-bells; harpoon guns [sports articles]; golf clubs; bar-bells; swings; jigsaw puzzles; parlor games; hang gliders; bells for Christmas trees; spinning tops [toys]; discs for sports; dominoes; swimming kick boards; surfboards; sailboards; spring boards [sports articles]; chessboards; checkerboards; darts; electronic targets; chest expanders [exercisers]; poles for pole vaulting; gut for fishing; ascenders [mountaineering equipment]; novelties for parties, dances [party favors, favours]; ski bindings; scent lures for hunting or fishing; protective paddings [parts of sports suits]; kites; divot repair tools [golf accessories]; toys for domestic pets; practical jokes [novelties]; stuffed toys; toys; toy vehicles; toy models; toy pistols; toy figures; ring games; games; gaming machines for gambling; amusement machines, automatic and coin-operated; playing cards; playing balls; play balloons; kaleidoscopes; bladders of balls for games; rosin used by athletes; paper party hats; carnival masks; bingo cards; skittles; ninepins; mah-jong; quoits; ice skates; rocking horses; building games; controllers for game consoles; confetti; dice; chalk for billiard cues; counters [discs] for games; marbles for games; swimming jackets; flippers for swimming; flying discs [toys]; skis; waterskis; surf skis; wax for skis; edges of skis; bows for archery; dolls; dolls' clothes; dolls' rooms; dolls' beds; dolls' houses; marionettes; masks [playthings]; camouflage screens [sports articles]; matryoshka dolls [wooden nested Russian dolls]; ball pitching machines; soap bubbles [toys]; hunting game calls; targets; clay pigeons [targets]; scale model vehicles; scale model kits [toys]; plush toys; balls for games; reels for fishing; kite reels; water wings; billiard table cushions; knee guards [sports articles]; billiard cue tips; elbow guards [sports articles]; board games; in-line roller skates; golf gloves; paragliders; swimming belts; pachinkos; punching bags; horseshoe games; sole coverings for skis; landing nets for anglers; Christmas tree stands; piñatas; detonating caps [toys]; caps for pistols [toys]; dolls' feeding bottles; air pistols [toys]; surfboard leashes; bite indicators [fishing tackle]; floats for fishing; portable games with liquid crystal displays; weight lifting belts [sports articles]; harness for sailboards; ornaments for Christmas trees, except illumination articles and confectionery; archery implements; decoys for hunting or fishing; artificial fishing bait; apparatus for games; controllers for toys; radio-controlled toy vehicles; bats for games; fishing tackle; fish hooks; sling shots [sports articles]; rollers for stationa-

ry exercise bicycles; skateboards; roller skates; gloves for games; baseball gloves; roulette wheels; mobiles [toys]; scooters [toys]; sleds [sports articles]; bobsleighs; candle holders for Christmas trees; butterfly nets; nets for sports; scrapers for skis; scratch cards for playing lottery games; slot machines [gaming machines]; artificial snow for Christmas trees; snow globes; snowshoes; snowboards; starting blocks for sports; clay pigeon traps; tables for table tennis; foosball tables; strings for rackets; gut for rackets; men's athletic supporters [sports articles]; theatrical masks; tennis nets; slides [playthings]; golf bags, with or without wheels; cricket bags; machines for physical exercises; body rehabilitation apparatus; backgammon games; batting gloves [accessories for games]; appliances for gymnastics; bowling apparatus and machinery; conjuring apparatus; fairground ride apparatus; paintball guns [sports apparatus]; paintballs [ammunition for paintball guns] [sports apparatus]; fencing weapons; fencing masks; fencing gauntlets; chips for gambling; cosques [toy fireworks]; hockey sticks; cups for dice; skating boots with skates attached; bags especially designed for skis and surfboards; chess games; checkers [games]; seal skins [coverings for skis]; shin guards [sports articles]; masts for sailboards; Christmas trees of synthetic material.

(260) AM 2022 113176 A

(800) 1320188

(151) 2016 09 12

(891) 2021 05 11

(731) Districon GmbH

Am Joseph 15, 61273 Wehrheim, Germany

(540)

Zirkulin

(591) Black, white

(511)

3 – Laundry preparations; bleaching preparations; fur-bishing preparations; polishing preparations; grease-removing preparations; grinding preparations; soaps; perfumery; essential oils; cosmetics; hair lotion; dentifrices.

5 – Pharmaceuticals; propolis for pharmaceutical purposes; medical preparations; veterinary preparations; sanitary preparations for medical purposes; dietetic foodstuffs and substances for medical or veterinary purposes; infant formula; dietary supplements for humans; dietary supplements for animals; propolis dietary supplements; plasters, materials for dressings; dressings, medical; teeth filling material; dental impression materials; disinfectants; preparations for destroying vermin; fungicides; herbicides.

30 – Coffee; tea; cocoa; artificial coffee; rice; tapioca; sago; flour; cereals; bread; pastries; confectionery; edible ices; sugar; honey; syrups and treacles; yeast; baking powder; salt; mustard; vinegar; sauces [condi-

ments]; spices; ice; bee glue; propolis for food purposes.

(260) AM 2022 113288 A

(800) 1593993

(151) 2020 09 29

(891) 2020 09 29

(731) Vogt Medical Vertrieb GmbH

Rüppurrer Strasse 1a Haus B, 76137 Karlsruhe,
Germany

(540)



(591) Blue

(531) 04.05.03; 26.01.03; 26.03.23; 29.01.04

(511)

5 – Miticides; analgesics; anaesthetics; alkaloids for medical purposes; aconitine; antibiotics; anticryptogamic preparations; antiseptics; antiseptic cotton; aseptic cotton; asthmatic tea; medicines for dental purposes; balms for medical purposes; hygienic bandages; bandages for dressings; bath salts for medical purposes; bath preparations, medicated; cotton for medical purposes; tranquillizers; biological preparations for medical purposes; depuratives; haemostatic pencils; lead water; confectionery for pharmaceutical purposes; chemico-pharmaceutical preparations; quinine for medical purposes; chloroform; chemical contraceptives; chemical preparations for medical purposes; diagnostic preparations for medical purposes; germicides for hygiene purposes; diastase for medical purposes; dietetic beverages adapted for medical purposes; dietetic substances adapted for medical use; dietetic food for medical purposes; febrifuges; glucose for medical purposes; gum for medical purposes; gamboge for medical purposes; haemoglobin; haemorrhoid preparations; sticking plasters; herb teas; vaccines; iodine for pharmaceutical purposes; iodides for pharmaceutical purposes; iodoform; tinctures of iodine; capsules for medicines; chewing gum for medical purposes; medical adhesive tapes; adhesive tapes for medical purposes; compresses; solutions for use with contact lenses; mineral food supplements; migraine treatment preparations; mouthwashes for medical purposes; menstruation bandages; sanitary pants; food supplements for medical purposes; nervines; bicarbonate of soda for pharmaceutical purposes; sodium salts for medical purposes; medicinal oils; patches for medical purposes; preparations for bronchial dilation; castor oil for medical purposes; cleaning preparations for contact lenses; radiological contrast substances for medical purposes; salts for medical purposes; soporifics; mustard poultices; siccatives (drying agents) for medical purposes; sunburn ointments; sunburn prepa-

rations for pharmaceutical purposes; scapulars for surgical purposes; styptic preparations; tinctures for medical purposes; gauze for dressings; material for dressings; materials for dressings; absorbent cotton; vaginal douches; vitamin preparations; vulnerary sponges; medicinal roots.

9 – Transducers.

10 – Aerosol dispensers for medical purposes; apparatus for use in medical analysis; apparatus and installations for the production of x-rays, for medical purposes; urine bags, catheter Foley; respirators for artificial respiration; elastic bandages; blood testing apparatus; sphygmomanometers; trusses; breast prostheses; incubators for medical purposes; incubators for babies; surgical apparatus and instruments; surgical thread; cutlery (surgical); suture needles; suture materials; surgical sponges; mirrors for surgeons; diagnostic apparatus for medical purposes; dialysis apparatus; defibrillators; drainage tubes for medical purposes; ice bags for medical purposes; electric acupuncture apparatus; electrodes for medical use; electrocardiographs; epidural needles; thread (surgical); feeding bottle teats; dental burs; hearing protectors; gastroscopes; uterine syringes; obstetric apparatus; forceps; physiotherapy apparatus; plaster bandages for orthopaedic purposes; gynaecological instruments; gynaecological kits; urine bottles (urinals); urethral probes; urethral syringes; gloves for medical purposes; heart pacemakers; hearing aids; ear trumpets; insulin glucometers; insulin lancets; insulin pens; syringes for injections; inhalers; injectors for medical purposes; enemas for medical purposes; cannulae; catgut; catheters; catheters with safety protection; non-chemical contraceptives; elastic stockings (surgery); ambulance stretchers; draw-sheets for sick beds; lancets; ultraviolet ray lamps for medical purposes; lamps for medical purposes; masks for use by medical personnel; anaesthetic face masks; massage apparatus; knives for surgical purposes; medical apparatus and instruments; medical guidewires; spoons for administering medicine; breast pumps; anaesthetic apparatus; umbilical belts; needles for medical purposes; anaesthetic face masks; operating tables; surgical cloths; ophthalmometers; ophthalmoscope; clothing for use in operating theatres; ear picks; pessaries; balling guns; pumps for medical purposes; radiological apparatus for medical purposes; quartz lamps for medical purposes; x-ray apparatus for medical use; x-ray photographs for medical purposes; x-ray tubes for medical purposes; radiology screens for medical purposes; radium tubes for medical purposes; saws for surgical purposes; feeding bottles; feeding bottle valves; surgical splints; scissors for surgery; protection devices against roentgen rays, for medical purposes; surgical sponges; maternity belts; probes for medical purposes; scalpels; spirometers (medical apparatus); mirrors for surgeons; mirrors for dentists; syringes for medical purposes; syringes with safety protection for medical purposes;

injectors for medical purposes; sterile sheets (surgical); stethoscopes; boots for medical purposes; radiotherapy apparatus; elastic stockings (surgery); hypodermic syringes; galvanic therapeutic appliances; thermoelectric radiation therapy equipment; compresses (surgery); thermometers for medical use; droppers for medical purposes; dropper bottles for medical purposes; urological apparatus and instruments; filters for ultra-violet rays for medical purposes; ultraviolet ray lamps for medical purposes; vaginal syringes; bed vibrators; vibromassage apparatus; surgical clips; vaporisers for medical purposes.

(260) AM 2022 113289 A

(800) 1594014

(151) 2020 12 18

(891) 2020 12 18

(731) Dražen Poznanović

Ulica Petra i Tome Erdoedyja 5, HR-10000
Zagreb, Croatia

(540)



(591) Light red, dark red and white

(531) 07.15.08; 25.07.22; 25.12.25; 27.05.01;
27.05.09; 27.05.24; 29.01.12

(511)

19 – Building materials, not of metal; rigid pipes, not of metal, for building; pitch, tar, bitumen and asphalt; non-metallic transportable structures; monuments, not of metal.

20 – Decorative mirrors; furniture, mirrors, picture frames; furniture; furniture made from substitutes for wood; works of art of wood, wax, plaster or plastic; cane furniture; furniture of plastic materials; glass furniture; animal bone (unworked or partly worked material); mother-of-pearl; whalebone, unworked or semi-worked; tortoiseshells (unworked or partly worked material); meerschaum (raw or partly worked material).

21 – Utensils for household purposes; household containers; combs; sponges; brushes; material for brush-making; household utensils for cleaning, brushes and brush-making materials; brushes for parquet floors; apparatus for wax-polishing, non electric; glass, unworked or semi-worked, except building glass; porcelain articles for decorative purposes; ceramics for household purposes.

(260) AM 2022 113290 A

(800) 1594086

(151) 2021 03 04

(891) 2021 03 04

(731) Reality MagiQ, Inc.

H-Square S 711-1, 231, Pangyoyeok-ro,
Bundang-gu, Seongnam-si, Gyeonggi-do
13494, Republic of Korea

(540)

DYSTERRA

(591) Black, white

(511)

9 – Computer game programmes; downloadable mobile game software; computer game software, recorded; electronic game software; interactive multimedia software for playing games.

41 – Gaming services; electronic games services provided by means of the internet; mobile game services; online game services provided via mobile applications; providing on-line computer games; games equipment rental; arranging and conducting of game events; providing of game contents via online; games services provided via computer networks and global communication networks.

(260) AM 2022 113294 A

(800) 1594253

(151) 2021 04 08

(891) 2021 04 08

(731) Smithers-Oasis Company

295 South Water Street, Suite 201, Kent OH
44240, USA

(540)

OASIS

(591) Black, white

(511)

1 – Growing media for plants; substances for preserving cut flowers.

17 – Foam substitutes for use as supports for floral arrangements in the nature of natural fiber-based composite materials.

(260) AM 2022 113295 A

(800) 1594455

(151) 2020 12 03

(891) 2020 12 03

(731) PPF a.s.

Evropská 17, CZ-160 41 Praha 6, Dejvice,
Czech Republic

(540)

Yettel.

(591) Green

(531) 24.17.02; 27.05.01; 29.01.03

(511)

9 – Scientific, nautical, surveying, photographic, cinematographic apparatus and instruments, optical apparatus and instruments for weighing, measuring, signalling, checking (supervision), life-saving included in this class and teaching apparatus and instruments, apparatus and instruments for conducting, switching, transforming, accumulating, regulating or controlling of electric current, apparatus for recording, conversion, transmission or reproduction of sound or images, magnetic data media, optical data media, recording discs, SD cards, micro SD cards, USB flash drives, memory cards, hard disc drives, mechanisms for coin-operated apparatus, calculating machines, data-processing apparatus and computers, apparatus for transmission of sound and image, telecommunication apparatus, mobile telecommunication apparatus, mobile telecommunication kits, computer hardware, computer software, downloadable computer software from the internet, multimedia applications, PDA (personal digital assistant), pocket PCs, mobile telephones, laptops, telecommunication network apparatus, operating software for telecommunication networks and for telecommunication apparatus, video cameras, cameras, MP3 and MP4 players, electronic publications (downloadable), periodicals in electronic form, electronic databases and databases products, information and data in electronic form, downloadable data, information and databases recorded on data carriers, electronic data carriers, computer and communication networks of all kinds, covers for mobile phones and computers, protective films and cases adapted for mobile phones and computers, parts and accessories for all the aforesaid goods.

16 – Printed matter, paper labels, printed forms, brochures, printed catalogues, printed manuals, printed reference, user and other manuals, printed instructions and printed manuals for users; document files relating to user guides for computing, telecommunication and technical equipment and apparatus.

35 – Advertising, advertisement and promotional activities, marketing, rental of advertising time to advertisers, providing commercial or advertising information and data, commercial services provided by means of the Internet or other media, data search in computer files for others, online advertising, intermediation in the field of business relations, advertising, publicity and promotional activities, business management assistance, business administration, office functions, retail and wholesale services in connection with scientific, nautical, surveying, photographic, cinematographic apparatus and instruments, optical apparatus and instruments for weighing, measuring, signaling, checking (supervision), life-saving included in this class and teaching apparatus and instruments, apparatus and instruments for conducting, switching, transforming,

accumulating, regulating or controlling of electric current, apparatus for recording, conversion, transmission or reproduction of sound or images, magnetic data media, optical data media, recording discs, SD cards, micro SD cards, USB flash drives, memory cards, hard disc drives, mechanisms for coin-operated apparatus, calculating machines, data-processing apparatus and computers, apparatus for transmission of sound and image, telecommunication apparatus, mobile telecommunication apparatus, mobile telecommunication kits, computer hardware, computer software, downloadable computer software from the internet, multimedia applications, PDA (personal digital assistant), pocket PCs, mobile telephones, laptops, telecommunication network apparatus, operating software for telecommunication networks and for telecommunication apparatus, video cameras, cameras, MP3 and MP4 players, electronic publications (downloadable), periodicals in electronic form, electronic databases and databases products, information and data in electronic form, downloadable data, information and databases recorded on data carriers, electronic data carriers, computer and communication networks of all kinds, covers for mobile phones and computers, protective films and cases adapted for mobile phones and computers, parts and accessories for all the aforesaid goods, online retail and wholesale services in connection with scientific, nautical, surveying, photographic, cinematographic apparatus and instruments, optical apparatus and instruments for weighing, measuring, signaling, checking (supervision), life saving included in this class and teaching apparatus and instruments, apparatus and instruments for conducting, switching, transforming, accumulating, regulating or controlling of electric current, apparatus for recording, conversion, transmission or reproduction of sound or images, magnetic data media, optical data media, recording discs, SD cards, micro SD cards, USB flash drives, memory cards, hard disc drives, mechanisms for coin operated apparatus, calculating machines, data-processing apparatus and computers, apparatus for transmission of sound and image, telecommunication apparatus, mobile telecommunication apparatus, mobile telecommunication kits, computer hardware, computer software, downloadable computer software from the internet, multimedia applications, PDA (personal digital assistant), pocket PCs, mobile telephones, laptops, telecommunication network apparatus, operating software for telecommunication networks and for telecommunication apparatus, video cameras, cameras, MP3 and MP4 players, electronic publications (downloadable), periodicals in electronic form, electronic databases and databases products, information and data in electronic form, downloadable data, information and databases recorded on data carriers, electronic data carriers, computer and communication networks of all kinds, covers for mobile phones and computers, protective films and cases adapted for mobile phones and computers, parts and accessories for all the afore-

said goods, business mediation in the trade of scientific, nautical, surveying, photographic, cinematographic apparatus and instruments, optical apparatus and instruments for weighing, measuring, signaling, checking (supervision), life-saving included in this class and teaching apparatus and instruments, apparatus and instruments for conducting, switching, transforming, accumulating, regulating or controlling of electric current, apparatus for recording, conversion, transmission or reproduction of sound or images, magnetic data media, optical data media, recording discs, SD cards, micro SD cards, USB flash drives, memory cards, hard disc drives, mechanisms for coin-operated apparatus, calculating machines, data-processing apparatus and computers, apparatus for transmission of sound and image, telecommunication apparatus, mobile telecommunication apparatus, mobile telecommunication kits, computer hardware, computer software, downloadable computer software from the internet, multimedia applications, PDA (personal digital assistant), pocket PCs, mobile telephones, laptops, telecommunication network apparatus, operating software for telecommunication networks and for telecommunication apparatus, video cameras, cameras, MP3 and MP4 players, electronic publications (downloadable), periodicals in electronic form, electronic databases and databases products, information and data in electronic form, downloadable data, information and databases recorded on data carriers, electronic data carriers, computer and communication networks of all kinds, covers for mobile phones and computers, protective films and cases adapted for mobile phones and computers, parts and accessories for all the aforesaid goods; computerized data processing, systematization of information into computer databases, market research and market analysis, promotion by electronic means, including by means of Internet search engines, consultancy in the field of Internet marketing, rental of advertising spaces, dissemination of advertising matter, opinion polling, collecting, classifying, sorting and updating of data, administration and management of databases with marketing information, providing business information, including by means of Internet, via the cable network or other forms of data transmission, information, consultancy and advisory services in relation to the aforesaid services in this class, providing market research and consumer product information for others by brokers and other professional information providers.

36 – Banking, factoring, financing services, hire-purchase financing, financial analysis, financial evaluation (insurance, banking, real estate), financial information, financial consultancy, financial management, financial sponsorship, financial clearing houses, financial clearing, mortgage banking, investment of funds, capital investment, brokerage services, stocks and bonds brokerage, securities brokerage, online banking, insurance consultancy, providing financial information via a website, providing of rebates at partici-

pating establishments of others through use of a membership card, loans (financing), instalment loans, lending against security, financial research, insurance underwriting, fire insurance underwriting, accident insurance underwriting, health insurance underwriting, life insurance underwriting, insurance and reinsurance brokerage.

37 – Building construction supervision services relating to industrial complexes and residential buildings; construction, assembly relating to the installation, maintenance and repair of telecommunication equipment, radio communication equipment and data processing machines and equipment; installation, assembly relating to the installation, maintenance and repair of domestic and foreign telecommunication equipment and other equipment; installation, assembly relating to the installation, maintenance and repair of electrical machinery, apparatus and equipment; installation, assembly services relating to the installation, maintenance and repair of measuring and control equipment.

38 – Wireless broadcasting, electronic bulletin board services (telecommunication services), information about telecommunications, communication by fiber optic networks, communication by cellular phones, communication by computer terminals, online transmission of greeting cards online, paging (radio, telephone or other means of electronic communication), providing internet chatrooms, providing online forums, providing access to databases, providing telecommunications connections to a global computer network, providing telecommunications channels for teleshopping services, providing user access to global computer networks, rental of access time to global computer networks, rental of fax machines, rental of modems, rental of apparatus for transmitting messages, rental of telephones, rental of telecommunication equipment, transmission of digital files, electronic mail transmission, facsimile transmission, telegram transmission, video-on-demand transmission, computer-aided transmission of messages and images, radio communication, radio broadcasting, satellite transmission, voice mail services, news agency services, telecommunications routing and junction services, streaming of data, communication by telephone, telephone services, communication by telegraph, telegraph services, teleconferencing services, television broadcasting, telex services, videoconferencing services, cable television broadcasting, messaging services, communications (telecommunications), network telecommunication services, mobile telecommunication services, telecommunication services provided via Internet portals, providing access to mobile telecommunication networks, activity in the field of telecommunication, mobile telecommunication and data communication services, fixed line telecommunication services, provision of broadband telecommunications access, wireless broadband communication services, broadcasting services, television broadcasting services, broadcast-

ting services relating to IP/TV or based on IP/TV, IP/TV access services, television broadcasting services provided via the Internet Protocol technology, including IP/TV, television and IP/TV, Internet access services, services of e-mail, text and multimedia messages, services relating to the provision of access to computer networks, in particular assurance, provision and rental of access time to data networks and databases, in particular to the Internet, provision of access to computer databases and communication services relating thereto, advice services relating to rental of telecommunication equipment, providing access to information via data networks, expert advisory and consultancy services in the field of telecommunication and data communication services, information, consultancy and advisory services in relation to the aforesaid services in this class, rental of telecommunications apparatus, rental of data transmission apparatus, rental of telecommunication apparatus and installations.

41 – Publishing and writing of texts, other than publicity texts, education and training, training services, entertainment, sports and cultural activities, interactive entertainment services, electronic games services provided via computer networks or communication networks, entertainment and information services relating to the aforesaid services provided via telecommunication networks, news reporters services, television entertainment services, providing entertainment via television and IP/TV, information, consultancy and advisory services relating to the aforesaid services in this class.

42 – Development of databases, updating of computer software, computer system analysis, cloud computing, digitization of documents (scanning), electronic monitoring of personally identifying information to detect identity theft via the internet, electronic monitoring of credit card activity to detect fraud via the internet, off-side data backup, graphic design of promotional materials, websites hosting services, installation of computer software, conversion of computer programs and data other than physical conversion, duplication of computer programs, recovery of computer data, unlocking of mobile phones, platform as a service (PaaS), computer programming, information technology (IT) consultancy, Internet security consultancy, consultancy in the design and development of computer hardware, web site design consultancy, computer software consultancy, computer technology consultancy, data encryption services, telecommunications technology consultancy, data security consultancy, computer security consultancy, providing information on computer technology and programming via a website, information technology services provided on an outsourcing basis, rental of computer software, rental of computers and data processing equipment, rental of web servers, surveying, providing search engine for the internet, server hosting, monitoring of

computer systems for detecting unauthorized access or data breach, monitoring of computer systems to detect breakdowns, software as a service (SaaS), computer software design, computer system design, maintenance of computer software, development of computer platforms, software development in the framework of software publishing, research in the field of telecommunications technology, monitoring of computer systems by remote access, scientific and technological services and research and development relating thereto, industrial analysis and research, research in the field of telecommunications, data services and telecommunication technology, designing, development and analysis of computer, telecommunication and data systems, rental of computers and data processing apparatus and installations, monitoring of telecommunication and data systems, technical consulting services in the field of information technology, computer technology and data technology, engineering services in the field of information, telecommunications and data technology, design and development of computer hardware and software, information technology, computer programming services, programming services, recovery of computer data, consultancy in the field of computer software, consultancy in the design and development of computer hardware, backup and copying of computer programs, rental of computers, creation, design and development of computer software, installation and maintenance of computer software, updating of computer software, rental of computer software and hardware, conversion of data or documents from physical to electronic media, conversion of data and computer programs (not physical conversion), creating and maintaining websites for others, webhosting, planning and designing services in the field of telecommunication equipment, information, consultancy and advisory services relating to the aforesaid services in this class.

(260) AM 2022 113296 A

(800) 1594466

(151) 2021 03 12

(891) 2021 03 12

(731) DESIGN HOLDING S.P.A.

Via A. Manzoni 38, I-20121 Milano, Italy

(540)

Design Holding

(591) Black, white

(531) 27.05.01

(511)

35 – Advertising; business management; business administration; office functions; dissemination of advertisements; dissemination of advertising matter; rental of advertising space; assistance and consultancy in the management of commercial and industrial enterprises, professional business consultation, franchising, name-

ly services rendered by a franchisor consisting in the help, management and development of a commercial enterprise (services for third parties); grouping on behalf of others of various products which enables the consumer to view and buy such products in retail stores; professional business consultancy; shop window dressing; commercial administration of the licensing of the goods and services of others; administrative processing of purchase orders; organization of exhibitions for commercial or advertising purposes; presentation of goods on communication media, for retail purposes; sales promotion for others; auctioneering services; retail services in relation to furniture; wholesaling in relation to furniture; business management consultancy; personnel management consultancy; consultancy regarding public relations communication strategies; consultancy regarding advertising communication strategies; consultancy relating to sponsorship search; advertising and business management consultancy; business consultancy services relating to the creation and operation of franchising; consultancy services relating to commercial management and commercial operations; consultancy and information services relating to accounting.

36 – Financial management of holding companies; financial administration of shares; financial advice; stock trading; public equity investment management; investment consultancy; fund investment consultation; company planning; administration of group insurance; finance services.

(260) AM 2022 113297 A

(800) 1594479

(151) 2021 01 28

(891) 2021 01 28

(731) Herbonis AG

Rheinstrasse 30, CH-4302 Augst BL,
Switzerland

(540)

PANBONIS

(591) Black, white

(511)

5 – Pharmaceutical and veterinary products; dietary foods and substances for medical or veterinary use; dietary food supplements for animals.

31 – Animal feed and animal drinks.

(260) AM 2022 113302 A

(800) 1594568

(151) 2021 04 07

(891) 2021 04 07

(731) SIMVALIN HOLDINGS LIMITED

Kritis, 32 Papachristoforou Build., 4th floor,
CY-3087 Limassol, Cyprus

(540)

PROCOMFORT

(591) Black, white

(511)

5 – Food for babies; lacteal flour for babies; dietetic foods, including dietetic products, dietetic beverages.

(260) AM 2022 113303 A

(800) 1594577

(151) 2021 04 05

(891) 2021 04 05

(731) VISTA PHYTOLAB Inc.

111 Cherrytree Drive, Brampton ON L6Y 3N5,
Canada

(540)

**V-ГИНОТОН
ТЕЕНЗ**

(591) Black, white

(531) 28.05

(511)

5 – Acaricides; aconitine; alkaloids for medical purposes; alginates for pharmaceutical purposes; algicides; aldehydes for pharmaceutical purposes; dental amalgams of gold; dental amalgams; amino acids for veterinary purposes; amino acids for medical purposes; analgesics; anaesthetics; antibiotics; antiseptics; medicine cases, portable, filled; first-aid boxes, filled; aluminium acetate for pharmaceutical purposes; acetates for pharmaceutical purposes; germicides; balms for medical purposes; bandages for dressings; diagnostic biomarker reagents for medical purposes; biocides; bromine for pharmaceutical purposes; paper for mustard plasters; fly catching paper; reagent paper for veterinary purposes; reagent paper for medical purposes; mothproofing paper; petroleum jelly for medical purposes; vaccines; oxygen baths; antiseptic cotton; aseptic cotton; absorbent cotton; wadding for medical purposes; cotton for medical purposes; dietetic substances adapted for medical use; radiological contrast substances for medical purposes; nutritive substances for microorganisms; radioactive substances for medical purposes; melissa water for pharmaceutical purposes; seawater for medicinal bathing; mineral waters for medical purposes; thermal water; dietary fibre; moulding wax for dentists; gases for medical purposes; guaiacol for pharmaceutical purposes; sexual stimulant gels; haematogen; haemoglobin; hydrastine; hydrastinine; glycerine for medical purposes; glycerophosphates; glucose for medical purposes; gentian for pharmaceutical purposes; hormones for medical purposes; mustard for pharmaceutical purposes; mustard plasters; mud for baths; medicinal mud; gamboge for medical purposes; gurgun balsam for medical purposes; air deodorizing preparations; deodorants, other than for human beings or for animals; deodorants for clothing and textiles; diastase for medical purposes; digitalin; vitamin supplement patches; mineral food supplements; nutritional supplements;

albumin dietary supplements; dietary supplements for animals; yeast dietary supplements; alginate dietary supplements; glucose dietary supplements; casein dietary supplements; lecithin dietary supplements; linseed oil dietary supplements; propolis dietary supplements; protein dietary supplements; protein supplements for animals; royal jelly dietary supplements; pollen dietary supplements; wheat germ dietary supplements; linseed dietary supplements; acai powder dietary supplements; dietary supplements with a cosmetic effect; enzyme dietary supplements; yeast for pharmaceutical purposes; gelatine for medical purposes; cod liver oil; isotopes for medical purposes; immunostimulants; insecticides; iodine for pharmaceutical purposes; iodides for pharmaceutical purposes; alkaline iodides for pharmaceutical purposes; iodoform; calomel [fungicide]; tartar for pharmaceutical purposes; camphor for medical purposes; capsules for medicines; cachets for pharmaceutical purposes; haemostatic pencils; wart pencils; caustic pencils; carbolineum [parasiticide]; caustics for pharmaceutical purposes; cachou for pharmaceutical purposes; quassia for medical purposes; quebracho for medical purposes; oxygen for medical purposes; gallic acid for pharmaceutical purposes; acids for pharmaceutical purposes; adhesives for dentures; surgical glues; stem cells for veterinary purposes; stem cells for medical purposes; cocaine; collagen for medical purposes; colloidion for pharmaceutical purposes; corn rings for the feet; medicated sweets; barks for pharmaceutical purposes; cedar wood for use as an insect repellent; croton bark; mangrove bark for pharmaceutical purposes; myrobalan bark for pharmaceutical purposes; quinquina for medical purposes; medicated animal feed; medicinal roots; rhubarb roots for pharmaceutical purposes; lint for medical purposes; starch for dietetic or pharmaceutical purposes; creosote for pharmaceutical purposes; blood for medical purposes; cultures of microorganisms for medical or veterinary use; curare; dental lacquer; liquorice for pharmaceutical purposes; milk sugar for pharmaceutical purposes; medicinal drops; adhesive plasters; medicines for alleviating constipation; adhesive tapes for medical purposes; lecithin for medical purposes; lotions for veterinary purposes; medicated hair lotions; lotions for pharmaceutical purposes; medicated after-shave lotions; personal sexual lubricants; lupulin for pharmaceutical purposes; magnesia for pharmaceutical purposes; liniments; ointments for pharmaceutical purposes; sunburn ointments; mercurial ointments; frostbite salve for pharmaceutical purposes; gauze for dressings; medicinal oils; mustard oil for medical purposes; camphor oil for medical purposes; castor oil for medical purposes; oil of turpentine for pharmaceutical purposes; dill oil for medical purposes; dental mastics; dental abrasives; dental impression materials; teeth filling material; dressings, medical; surgical dressings; drugs for medical purposes; medicines for veterinary purposes; serotherapeutic medicines; medicines for

human purposes; medicines for dental purposes; menthol; medicinal drinks; moleskin for medical purposes; almond milk for pharmaceutical purposes; powdered milk for babies; royal jelly for pharmaceutical purposes; milk ferments for pharmaceutical purposes; Irish moss for medical purposes; flour for pharmaceutical purposes; linseed meal for pharmaceutical purposes; fish meal for pharmaceutical purposes; fly glue; antibacterial soap; disinfectant soap; medicated soap; freeze-dried meat adapted for medical purposes; mint for pharmaceutical purposes; dietetic beverages adapted for medical purposes; malted milk beverages for medical purposes; narcotics; medicinal infusions; tincture of iodine; eucalyptol for pharmaceutical purposes; tinctures for medical purposes; opium; opodeldoc; decoctions for pharmaceutical purposes; antiparasitic collars for animals; stick liquorice for pharmaceutical purposes; sulfur sticks [disinfectants]; pastilles for pharmaceutical purposes; medicated toothpaste; pectin for pharmaceutical purposes; pepsins for pharmaceutical purposes; peptones for pharmaceutical purposes; hydrogen peroxide for medical purposes; pesticides; food for babies; leeches for medical purposes; blood plasma; nicotine patches for use as aids to stop smoking; eyepatches for medical purposes; poultices; compresses; scapulars for surgical purposes; babies' diapers; diapers for pets; diapers for incontinence; bunion pads; breast-nursing pads; pomades for medical purposes; powder of cantharides; pyrethrum powder; anti-uric preparations; bacterial preparations for medical and veterinary use; bacteriological preparations for medical and veterinary use; balsamic preparations for medical purposes; albuminous preparations for medical purposes; biological preparations for veterinary purposes; biological preparations for medical purposes; veterinary preparations; bismuth preparations for pharmaceutical purposes; vitamin preparations; diagnostic preparations for veterinary purposes; diagnostic preparations for medical purposes; bath preparations for medical purposes; therapeutic preparations for the bath; haemorrhoid preparations; preparations for callouses; lice treatment preparations [pediculicides]; acne treatment preparations; preparations to facilitate teething; preparations for the treatment of burns; fumigation preparations for medical purposes; opotherapy preparations; air purifying preparations; bronchodilating preparations; preparations for reducing sexual activity; sterilizing preparations; soil-sterilizing preparations; corn remedies; pharmaceutical preparations for treating dandruff; preparations for destroying noxious animals; herbicides; preparations for destroying dry rot fungus; larvae exterminating preparations; fly destroying preparations; preparations for destroying mice; slug exterminating preparations; vermin destroying preparations; pharmaceutical preparations for skin care; contact lens cleaning preparations; preparations of microorganisms for medical or veterinary use; lime-based pharmaceutical preparations; hemostatic preparations; medicated eye-

washes; medicinal hair growth preparations; nutraceutical preparations for therapeutic or medical purposes; opiates; anticryptogamic preparations; aloe vera preparations for pharmaceutical purposes; bismuth subnitrate for pharmaceutical purposes; disinfectants; cream of tartar for pharmaceutical purposes; angostura bark for medical purposes; condurango bark for medical purposes; cotton swabs for medical purposes; styptic pencils; preparations of trace elements for human and animal use; sulfonamides [medicines]; pharmaceutical preparations; pharmaceutical preparations for treating sunburn; enzyme preparations for veterinary purposes; enzyme preparations for medical purposes; phytotherapy preparations for medical purposes; chemico-pharmaceutical preparations; chemical preparations for veterinary purposes; chemical preparations for the diagnosis of pregnancy; chemical preparations for medical purposes; chemical preparations for treating wheat blight; chemical preparations for treating diseases affecting vine plants; chemical preparations for treating mildew; chemical preparations for treating phyloxera; chemical preparations for pharmaceutical purposes; chilblain preparations; mothproofing preparations; collyrium; lead water; chemical conductors for electrocardiograph electrodes; albuminous foodstuffs for medical purposes; dietetic foods adapted for medical purposes; by-products of the processing of cereals for dietetic or medical purposes; homogenized food adapted for medical purposes; freeze-dried food adapted for medical purposes; pharmaceuticals; sanitary towels; panty liners [sanitary]; propolis for pharmaceutical purposes; pearl powder for medical purposes; radium for medical purposes; hydrated chloral for pharmaceutical purposes; solvents for removing adhesive plasters; vaginal washes for medical purposes; solutions for contact lenses; chemical reagents for medical or veterinary purposes; gum for medical purposes; rubber for dental purposes; chewing gum for medical purposes; nicotine gum for use as an aid to stop smoking; insect repellents; insect repellent incense; repellents for dogs; tissues impregnated with pharmaceutical lotions; sarsaparilla for medical purposes; sugar for medical purposes; asthmatic tea; fumigating sticks; massage candles for therapeutic purposes; linseed for pharmaceutical purposes; tobacco-free cigarettes for medical purposes; siccatives [drying agents] for medical purposes; syrups for pharmaceutical purposes; turpentine for pharmaceutical purposes; greases for veterinary purposes; greases for medical purposes; lacteal flour for babies; infant formula; soporifics; bicarbonate of soda for pharmaceutical purposes; bath salts for medical purposes; salts for mineral water baths; salts for medical purposes; potassium salts for medical purposes; sodium salts for medical purposes; smelling salts; mineral water salts; malt for pharmaceutical purposes; semen for artificial insemination; alcohol for pharmaceutical purposes; medicinal alcohol; alloys of precious metals for dental purposes; ergot for pharmaceutical purposes; cooling

sprays for medical purposes; antibacterial handwashes; adjuvants for medical purposes; astringents for medical purposes; vermifuges; disinfectants for hygiene purposes; disinfectants for chemical toilets; appetite suppressants for medical purposes; medical preparations for slimming purposes; parasiticides; mouthwashes for medical purposes; febrifuges; depuratives; animal washes [insecticides]; detergents for medical purposes; cattle washes [insecticides]; dog washes [insecticides]; insecticidal veterinary washes; vesicants; purgatives; remedies for perspiration; remedies for foot perspiration; chemical contraceptives; antiparasitic preparations; laxatives; tonics [medicines]; medicated toiletry preparations; digestives for pharmaceutical purposes; nervines; bouillons for bacteriological cultures; steroids; strychnine; serums; tanning pills; appetite suppressant pills; slimming pills; antioxidant pills; sanitary tampons; vulnerary sponges; thymol for pharmaceutical purposes; biological tissue cultures for veterinary purposes; biological tissue cultures for medical purposes; smoking herbs for medical purposes; medicinal herbs; the implants [living tissues]; surgical implants comprised of living tissues; pants, absorbent, for incontinence; sanitary panties; babies' diaper-pants; charcoal for pharmaceutical purposes; porcelain for dental prostheses; phenol for pharmaceutical purposes; enzymes for veterinary purposes; enzymes for medical purposes; ferments for pharmaceutical purposes; formic aldehyde for pharmaceutical purposes; phosphates for pharmaceutical purposes; fungicides; quinine for medical purposes; chinoline for medical purposes; diabetic bread adapted for medical use; chloroform; flowers of sulfur for pharmaceutical purposes; cement for animal hooves; bone cement for surgical and orthopaedic purposes; dental cements; medicinal tea; herbal teas for medicinal purposes; insecticidal animal shampoos; medicated shampoos; medicated shampoos for pets; pediculicidal shampoos; medicated dry shampoos; pre-filled syringes for medical purposes; eucalyptus for pharmaceutical purposes; herbal extracts for medical purposes; plant extracts for pharmaceutical purposes; tobacco extracts [insecticides]; extracts of hops for pharmaceutical purposes; elixirs [pharmaceutical preparations]; ethers for pharmaceutical purposes; esters for pharmaceutical purposes; cellulose esters for pharmaceutical purposes; rat poison; poisons; bacterial poisons; jalap; capsules made of dendrimer-based polymers, for pharmaceuticals; chemical preparations for treating diseases affecting cereal plants; injectable dermal fillers; bracelets impregnated with insect repellent; suppositories; milking grease; douching preparations for medical purposes; sedatives; jujube, medicated; fennel for medical purposes; cellulose ethers for pharmaceutical purposes.

(260) AM 2022 113305 A
 (800) 1594613
 (151) 2021 04 07
 (891) 2021 04 07
 (731) VESYNC (SINGAPORE) PTE. LTD.
 112 ROBINSON ROAD, #03-01, ROBINSON
 112, SINGAPORE 068902, Singapore

(540)



(591) Black, white
 (531) 04.05.21; 24.15.13; 27.05.01
 (511)

7 – Disintegrators; juice extractors, electric; food preparation machines, electromechanical; coffee extracting machines; beverage preparation machines, electromechanical; electrical apparatus for sealing plastics (packaging); mixing machines; coffee grinders, other than hand-operated; mills for household purposes, other than hand-operated; hand-held tools, other than hand-operated; pumps [machines]; door openers, electric; machines and apparatus for cleaning, electric; cleaning appliances utilizing steam; vacuum cleaners; filtering machines; rechargeable sweepers; central vacuum cleaning installations; electric cordless sweepers; dust removing installations for cleaning purposes; machines and apparatus for carpet shampooing, electric; industrial robots; vacuum cleaner attachments for disseminating perfumes and disinfectants.

9 – Computer software applications, downloadable; downloadable software applications for use with mobile phones; smartwatches; time recording apparatus; time clocks [time recording devices]; scales; measures; signal lanterns; network routers; wearable activity trackers; monitoring apparatus, other than for medical purposes; screens [photography]; infrared detectors; inductors [electricity]; measuring devices, electric; air analysis apparatus; hygrometers; thermometers, not for medical purposes; diagnostic apparatus for testing food; photometers; materials for electricity mains [wires, cables]; electric sockets; heat regulating apparatus; ionization apparatus not for the treatment of air or water; protection devices for personal use against accidents; smoke detectors; electronic access control systems for interlocking doors; electrified fences.

10 – Arterial blood pressure measuring apparatus; massage apparatus; medical apparatus and instruments; thermometers for medical purposes; dental apparatus and instruments; galvanic belts for medical purposes; galvanic therapeutic appliances; acupuncture bands; gum massagers for babies; babies' bottles.

11 – Lighting apparatus and installations; fruit roasters; roasting apparatus; coffee machines, electric; kettles, electric; electric roasters for household purposes; microwave ovens [cooking apparatus]; air fryers; cooking

apparatus and installations; heating and cooling apparatus for dispensing hot and cold beverages; electric refrigerators for household purposes; refrigerating apparatus and machines; gas lighters; air conditioners; ionization apparatus for the treatment of air or water; air purifying apparatus and machines; humidifiers for household use; dehumidifiers for household use; air filtering installations; hair driers; fabric steamers; heating apparatus, electric; hot water heating installations; flushing apparatus; water purifying apparatus and machines; usb-powered hand warmers.

21 – Blenders, non-electric, for household purposes; fruit presses, non-electric, for household purposes; containers for household or kitchen use; tableware, other than knives, forks and spoons; kettles, non-electric; jugs; kitchen utensils; coffee pots, non-electric; combs; water apparatus for cleaning teeth and gums; toothbrushes, electric; thermally insulated containers for food; lint removers, electric or non-electric; animal activated animal feeders.

(260) AM 2022 113306 A
 (800) 1594614
 (151) 2021 04 05
 (891) 2021 04 05
 (731) VISTA PHYTO LAB Inc.
 111 Cherrytree Drive, Brampton ON L6Y 3N5,
 Canada

(540)

ИММУНОМЕЛЬ

(591) Black, white
 (531) 28.05
 (511)

5 – Acaricides; aconitine; alkaloids for medical purposes; alginates for pharmaceutical purposes; algicides; aldehydes for pharmaceutical purposes; dental amalgams of gold; dental amalgams; amino acids for veterinary purposes; amino acids for medical purposes; analgesics; anaesthetics; antibiotics; antiseptics; medicine cases, portable, filled; first-aid boxes, filled; aluminium acetate for pharmaceutical purposes; acetates for pharmaceutical purposes; germicides; balms for medical purposes; bandages for dressings; diagnostic biomarker reagents for medical purposes; biocides; bromine for pharmaceutical purposes; paper for mustard plasters; fly catching paper; reagent paper for veterinary purposes; reagent paper for medical purposes; mothproofing paper; petroleum jelly for medical purposes; vaccines; oxygen baths; antiseptic cotton; aseptic cotton; absorbent cotton; wadding for medical purposes; cotton for medical purposes; dietetic substances adapted for medical use; radiological contrast substances for medical purposes; nutritive substances for microorganisms; radioactive substances for medical purposes; melissa water for pharmaceutical purposes; seawater for medicinal bathing;

mineral waters for medical purposes; thermal water; dietary fibre; moulding wax for dentists; gases for medical purposes; guaiacol for pharmaceutical purposes; sexual stimulant gels; haematogen; haemoglobin; hydrastine; hydrastinine; glycerine for medical purposes; glycerophosphates; glucose for medical purposes; gentian for pharmaceutical purposes; hormones for medical purposes; mustard for pharmaceutical purposes; mustard plasters; mud for baths; medicinal mud; gamboge for medical purposes; gurjun balsam for medical purposes; air deodorizing preparations; deodorants, other than for human beings or for animals; deodorants for clothing and textiles; diastase for medical purposes; digitalin; vitamin supplement patches; mineral food supplements; nutritional supplements; albumin dietary supplements; dietary supplements for animals; yeast dietary supplements; alginate dietary supplements; glucose dietary supplements; casein dietary supplements; lecithin dietary supplements; linseed oil dietary supplements; propolis dietary supplements; protein dietary supplements; protein supplements for animals; royal jelly dietary supplements; pollen dietary supplements; wheat germ dietary supplements; linseed dietary supplements; acai powder dietary supplements; dietary supplements with a cosmetic effect; enzyme dietary supplements; yeast for pharmaceutical purposes; gelatine for medical purposes; cod liver oil; isotopes for medical purposes; immunostimulants; insecticides; iodine for pharmaceutical purposes; iodides for pharmaceutical purposes; alkaline iodides for pharmaceutical purposes; iodoform; calomel [fungicide]; tartar for pharmaceutical purposes; camphor for medical purposes; capsules for medicines; cachets for pharmaceutical purposes; haemostatic pencils; wart pencils; caustic pencils; carbolineum [parasiticide]; caustics for pharmaceutical purposes; cachou for pharmaceutical purposes; quassia for medical purposes; quebracho for medical purposes; oxygen for medical purposes; gallic acid for pharmaceutical purposes; acids for pharmaceutical purposes; adhesives for dentures; surgical glues; stem cells for veterinary purposes; stem cells for medical purposes; cocaine; collagen for medical purposes; colloidion for pharmaceutical purposes; corn rings for the feet; medicated sweets; barks for pharmaceutical purposes; cedar wood for use as an insect repellent; croton bark; mangrove bark for pharmaceutical purposes; myrobalan bark for pharmaceutical purposes; quinquina for medical purposes; medicated animal feed; medicinal roots; rhubarb roots for pharmaceutical purposes; lint for medical purposes; starch for dietetic or pharmaceutical purposes; creosote for pharmaceutical purposes; blood for medical purposes; cultures of microorganisms for medical or veterinary use; curare; dental lacquer; liquorice for pharmaceutical purposes; milk sugar for pharmaceutical purposes; medicinal drops; adhesive plasters; medicines for alleviating constipation; adhesive tapes for medical purposes; lecithin for medical purposes; lotions for veterinary pur-

poses; medicated hair lotions; lotions for pharmaceutical purposes; medicated after-shave lotions; personal sexual lubricants; lupulin for pharmaceutical purposes; magnesia for pharmaceutical purposes; liniments; ointments for pharmaceutical purposes; sunburn ointments; mercurial ointments; frostbite salve for pharmaceutical purposes; gauze for dressings; medicinal oils; mustard oil for medical purposes; camphor oil for medical purposes; castor oil for medical purposes; oil of turpentine for pharmaceutical purposes; dill oil for medical purposes; dental mastics; dental abrasives; dental impression materials; teeth filling material; dressings, medical; surgical dressings; drugs for medical purposes; medicines for veterinary purposes; serotherapeutic medicines; medicines for human purposes; medicines for dental purposes; menthol; medicinal drinks; moleskin for medical purposes; almond milk for pharmaceutical purposes; powdered milk for babies; royal jelly for pharmaceutical purposes; milk ferments for pharmaceutical purposes; Irish moss for medical purposes; flour for pharmaceutical purposes; linseed meal for pharmaceutical purposes; fish meal for pharmaceutical purposes; fly glue; antibacterial soap; disinfectant soap; medicated soap; freeze-dried meat adapted for medical purposes; mint for pharmaceutical purposes; dietetic beverages adapted for medical purposes; malted milk beverages for medical purposes; narcotics; medicinal infusions; tincture of iodine; eucalyptol for pharmaceutical purposes; tinctures for medical purposes; opium; opodeldoc; decoctions for pharmaceutical purposes; antiparasitic collars for animals; stick liquorice for pharmaceutical purposes; sulfur sticks [disinfectants]; pastilles for pharmaceutical purposes; medicated toothpaste; pectin for pharmaceutical purposes; pepsins for pharmaceutical purposes; peptones for pharmaceutical purposes; hydrogen peroxide for medical purposes; pesticides; food for babies; leeches for medical purposes; blood plasma; nicotine patches for use as aids to stop smoking; eyepatches for medical purposes; poultices; compresses; scapulars for surgical purposes; babies' diapers; diapers for pets; diapers for incontinence; bunion pads; breast-nursing pads; pomades for medical purposes; powder of cantharides; pyrethrum powder; anti-uric preparations; bacterial preparations for medical and veterinary use; bacteriological preparations for medical and veterinary use; balsamic preparations for medical purposes; albuminous preparations for medical purposes; biological preparations for veterinary purposes; biological preparations for medical purposes; veterinary preparations; bismuth preparations for pharmaceutical purposes; vitamin preparations; diagnostic preparations for veterinary purposes; diagnostic preparations for medical purposes; bath preparations for the bath; haemorrhoid preparations; preparations for callouses; lice treatment preparations [pediculicides]; acne treatment preparations; preparations to facilitate teething; preparations for the treatment of burns; fu-

migation preparations for medical purposes; opotherapy preparations; air purifying preparations; bronchodilating preparations; preparations for reducing sexual activity; sterilizing preparations; soil-sterilizing preparations; corn remedies; pharmaceutical preparations for treating dandruff; preparations for destroying noxious animals; herbicides; preparations for destroying dry rot fungus; larvae exterminating preparations; fly destroying preparations; preparations for destroying mice; slug exterminating preparations; vermin destroying preparations; pharmaceutical preparations for skin care; contact lens cleaning preparations; preparations of microorganisms for medical or veterinary use; lime-based pharmaceutical preparations; hemostatic preparations; medicated eye-washes; medicinal hair growth preparations; nutraceutical preparations for therapeutic or medical purposes; opiates; anticryptogamic preparations; aloe vera preparations for pharmaceutical purposes; bismuth subnitrate for pharmaceutical purposes; disinfectants; cream of tartar for pharmaceutical purposes; angostura bark for medical purposes; condurango bark for medical purposes; cotton swabs for medical purposes; styptic pencils; preparations of trace elements for human and animal use; sulfonamides [medicines]; pharmaceutical preparations; pharmaceutical preparations for treating sunburn; enzyme preparations for veterinary purposes; enzyme preparations for medical purposes; phytotherapy preparations for medical purposes; chemico-pharmaceutical preparations; chemical preparations for veterinary purposes; chemical preparations for the diagnosis of pregnancy; chemical preparations for medical purposes; chemical preparations for treating wheat blight; chemical preparations for treating diseases affecting vine plants; chemical preparations for treating mildew; chemical preparations for treating phylloxera; chemical preparations for pharmaceutical purposes; chilblain preparations; mothproofing preparations; collyrium; lead water; chemical conductors for electrocardiograph electrodes; albuminous foodstuffs for medical purposes; dietetic foods adapted for medical purposes; by-products of the processing of cereals for dietetic or medical purposes; homogenized food adapted for medical purposes; freeze-dried food adapted for medical purposes; pharmaceuticals; sanitary towels; panty liners [sanitary]; propolis for pharmaceutical purposes; pearl powder for medical purposes; radium for medical purposes; hydrated chloral for pharmaceutical purposes; solvents for removing adhesive plasters; vaginal washes for medical purposes; solutions for contact lenses; chemical reagents for medical or veterinary purposes; gum for medical purposes; rubber for dental purposes; chewing gum for medical purposes; nicotine gum for use as an aid to stop smoking; insect repellents; insect repellent incense; repellents for dogs; tissues impregnated with pharmaceutical lotions; sarsaparilla for medical purposes; sugar for medical purposes; asthmatic tea; fumigating sticks; massage candles for therapeutic purposes; lin-

seed for pharmaceutical purposes; tobacco-free cigarettes for medical purposes; siccatives [drying agents] for medical purposes; syrups for pharmaceutical purposes; turpentine for pharmaceutical purposes; greases for veterinary purposes; greases for medical purposes; lacteal flour for babies; infant formula; soporifics; bicarbonate of soda for pharmaceutical purposes; bath salts for medical purposes; salts for mineral water baths; salts for medical purposes; potassium salts for medical purposes; sodium salts for medical purposes; smelling salts; mineral water salts; malt for pharmaceutical purposes; semen for artificial insemination; alcohol for pharmaceutical purposes; medicinal alcohol; alloys of precious metals for dental purposes; ergot for pharmaceutical purposes; cooling sprays for medical purposes; antibacterial handwashes; adjuvants for medical purposes; astringents for medical purposes; vermifuges; disinfectants for hygiene purposes; disinfectants for chemical toilets; appetite suppressants for medical purposes; medical preparations for slimming purposes; parasiticides; mouthwashes for medical purposes; febrifuges; depuratives; animal washes [insecticides]; detergents for medical purposes; cattle washes [insecticides]; dog washes [insecticides]; insecticidal veterinary washes; vesicants; purgatives; remedies for perspiration; remedies for foot perspiration; chemical contraceptives; antiparasitic preparations; laxatives; tonics [medicines]; medicated toiletry preparations; digestives for pharmaceutical purposes; nervines; bouillons for bacteriological cultures; steroids; strychnine; serums; tanning pills; appetite suppressant pills; slimming pills; antioxidant pills; sanitary tampons; vulnery sponges; thymol for pharmaceutical purposes; biological tissue cultures for veterinary purposes; biological tissue cultures for medical purposes; smoking herbs for medical purposes; medicinal herbs; the implants [living tissues]; surgical implants comprised of living tissues; pants, absorbent, for incontinence; sanitary panties; babies' diaper-pants; charcoal for pharmaceutical purposes; porcelain for dental prostheses; phenol for pharmaceutical purposes; enzymes for veterinary purposes; enzymes for medical purposes; ferments for pharmaceutical purposes; formic aldehyde for pharmaceutical purposes; phosphates for pharmaceutical purposes; fungicides; quinine for medical purposes; chinoline for medical purposes; diabetic bread adapted for medical use; chloroform; flowers of sulfur for pharmaceutical purposes; cement for animal hooves; bone cement for surgical and orthopaedic purposes; dental cements; medicinal tea; herbal teas for medicinal purposes; insecticidal animal shampoos; medicated shampoos; medicated shampoos for pets; pediculicidal shampoos; medicated dry shampoos; pre-filled syringes for medical purposes; eucalyptus for pharmaceutical purposes; herbal extracts for medical purposes; plant extracts for pharmaceutical purposes; tobacco extracts [insecticides]; extracts of hops for pharmaceutical purposes; elixirs [pharmaceutical preparations]; ethers

for pharmaceutical purposes; esters for pharmaceutical purposes; cellulose esters for pharmaceutical purposes; rat poison; poisons; bacterial poisons; jalap; capsules made of dendrimer-based polymers, for pharmaceuticals; chemical preparations for treating diseases affecting cereal plants; injectable dermal fillers; bracelets impregnated with insect repellent; suppositories; milking grease; douching preparations for medical purposes; sedatives; jujube, medicated; fennel for medical purposes; cellulose ethers for pharmaceutical purposes.

(260) AM 2022 113307 A

(800) 1594639

(151) 2020 07 15

(891) 2020 07 15

(731) F. Hoffmann-La Roche AG

Grenzacherstrasse 124, CH-4070 Basel,
Switzerland

(540)

SUSVIMO

(591) Black, white

(511)

5 – Pharmaceutical preparations.

(260) AM 2022 113308 A

(800) 1594669

(151) 2021 02 19

(891) 2021 02 19

(731) Open-Type Joint Stock Company

"ROT FRONT"

2-oy Novokuznetskiy pereulok, d. 13/15,
RU-115184 Moscow, Russian Federation

(540)

ЧИКИ БАМБОНИ

(591) Black, white

(531) 28.05

(511)

30 – Coffee flavorings; seasonings; candies; cocoa; coffee; capers; caramels [candies]; chocolate; marzipan; condiments; confectionery; corn flakes; popcorn; ice cream; fondants [confectionery]; cocoa beverages with milk; coffee beverages with milk; molasses for food; honey; pastries; puddings; pralines; liquorice [confectionery]; sago; sherbets [ices]; edible ices; oat flakes; chocolate mousses; dessert mousses [confectionery]; pesto.

(260) AM 2022 113309 A

(800) 1594683

(151) 2021 04 08

(891) 2021 04 08

(731) RVL Pharmaceuticals, Inc.

400 Crossing Boulevard, Bridgewater
NJ 08807, USA

(540)



(591) Black, white

(531) 01.15.15; 27.05.01; 27.05.03; 27.05.21

(511)

5 – Ophthalmic pharmaceutical preparations.

(260) AM 2022 113310 A

(800) 1594688

(151) 2021 02 04

(891) 2021 02 04

(731) "Dmitrievsky chemical plant – Production"

LLC

Proizvodstvennaya str., 1, Kineshma,

RU-155808 Ivanovo region, Russian Federation

(540)



(591) Yellow, black and pale turquoise

(531) 26.03.05; 26.11.13; 27.05.01; 29.01.13

(511)

2 – Annatto [dyestuff]; auramine; Canada balsam; white lead; paper for dyeing easter eggs; dyes; binding preparations for paints; glazes [paints, lacquers]; litharge; primers; gamboge for painting; titanium dioxide [pigment]; repositionable paint patches; indigo [colorant]; gum resins; colophony; caramel [food colorant]; carbonyl [wood preservative]; cochineal carmine; toner cartridges, filled, for printers and photocopiers; ink cartridges, filled, for printers and photocopiers; edible ink cartridges, filled, for printers; copal; alizarine dyes; aniline dyes; colorants for the restoration of furniture in the form of markers; ink for leather; colorants for liqueurs; colorants for beverages; shoe dyes; colorants for beer; colorants for butter; dyewood; malt colorants; food dyes; colorants; watercolor paints for use in art; aluminium paints; asbestos paints; bactericidal paints; ceramic paints; marking ink for animals; distempers; oil paints for use in art; anti-urine paints; fireproof paints; printing ink; engraving ink; enamels for painting; paints; creosote for wood preservation; turmeric [colorant]; black japan; bitumen varnish; bronzing lacquers; wood floor finishes; copal varnish; lacquers; anti-corrosive bands; an-

ti-rust oils; oils for the preservation of wood; mastic [natural resin]; lime wash; wood stains; cobalt oxide [colorant]; zinc oxide [pigment]; silver paste; printers' pastes [ink]; pigments; coatings [paints]; coatings for roofing felt [paints]; wood coatings [paints]; anti-graffiti coatings [paints]; undercoating for vehicle chassis; anti-fouling paints; varnishes; aluminium powder for painting; bronze powder for painting; silvering powders; metals in powder form for use in painting, decorating, printing and art; anti-corrosive preparations; protective preparations for metals; wood mordants; mordants for leather; mordants; thinners for paints; thinners for lacquers; whitewash; soot [colorant]; carbon black [pigment]; lamp black [pigment]; sandarac; thickeners for paints; sienna earth; siccatives [drying agents] for paints; anti-rust greases; natural resins, raw; malt caramel [food colorant]; badi-geon; anti-tarnishing preparations for metals; anti-rust preparations; wood preservatives; sumac for varnishes; minium; turpentine [thinner for paints]; toner for printers and photocopiers; fixatives [varnishes]; fixatives for watercolors; metal foil for use in painting, decorating, printing and art; yellowwood [colorant]; ink for printers and photocopiers; edible inks; saffron [colorant]; dyewood extracts; enamels [varnishes]; silver emulsions [pigments]; gum-lac.

(260) AM 2022 113311 A

(800) 1594702

(151) 2021 02 05

(891) 2021 02 05

(731) Euro Games Technology Ltd.

4, "Maritsa" Str., "Vranya-Lozen-Triugulnika",
BG-1151 Sofia, Bulgaria

(540)



(591) Brown, blue, light blue, yellow

(531) 24.03.09; 24.03.18; 26.03.04; 26.03.19;

26.03.24; 26.04.03; 26.04.11; 26.04.19;

27.05.03; 27.05.17; 29.01.13

(511)

9 – Software; computer gaming software; computer software packages; computer operating system software; computer software, recorded; software drivers; virtual reality software; games software; entertainment software for computer games; computer programs for network management; operating computer software for main frame computers; monitors (computer hardware); computer hardware; apparatus for recording images; monitors (computer programs); computer game programs; computer programs for recor-

ded games; apparatus for recording, transmission or reproduction of sound or images; communications servers [computer hardware]; electronic components for gambling machines; computer application software featuring games and gaming; computer software for the administration of on-line games and gaming; computer hardware for games and gaming; electronic components and computer software for gambling, gambling machines, gambling games on the Internet and via telecommunication network.

28 – Gaming machines for gambling; chips for gambling; mah-jong; arcade games; gambling machines operating with coins, banknotes and cards; games; electronic games; parlor games; gaming chips; gaming tables; slot machines [gaming machines]; LCD game machines; slot machines and gaming devices; coin-operated amusement machines; roulette chips; poker chips; chips and dice [gaming equipment]; gaming equipment for casinos; roulette tables; gaming roulette wheels; casino games; gambling machines and amusement machines, automatic and coin-operated; coin-operated amusement machines and/or electronic coin-operated amusement machines with or without the possibility of gain; boxes for coin-operated machines, slot machines and gaming machines; electronic or electrotechnical amusement machines and apparatus, gaming machines, coin-operated entertainment machines; housings for coin-operated machines, gaming equipment, gaming machines, machines for gambling; electropneumatic and electrical gambling machines (slot machines).

41 – Gambling; entertainment services related to gambling; gaming services for entertainment purposes; casino, gaming and gambling services; training in the development of software systems; provision of equipment for gambling halls; providing casino equipment [gambling]; gaming machine entertainment services; providing casino facilities [gambling]; gaming hall services; amusement arcade services; games equipment rental; rental of gaming machines; providing amusement arcade services; rental of gaming machines with images of fruits; editing or recording of sounds and images; sound recording and video entertainment services; hire of sound reproducing apparatus; provision of gaming equipment for casinos; providing of casino facilities; online gambling services; casino, gaming and gambling services; provision of gaming facilities, gaming hall facilities, Internet casinos and online gambling services.

(260) AM 2022 113312 A

(800) 1594744

(151) 2021 02 05

(891) 2021 02 05

(731) Euro Games Technology Ltd.

4, "Maritsa" Str., "Vranya-Lozen-Triugulnika",
BG-1151 Sofia, Bulgaria

(540)

Blazing Terra

(591) Black, white

(511)

9 – Software; computer gaming software; computer software packages; computer operating system software; computer software, recorded; software drivers; virtual reality software; games software; entertainment software for computer games; computer programs for network management; operating computer software for main frame computers; monitors (computer hardware); computer hardware; apparatus for recording images; monitors (computer programs); computer game programs; computer programs for recorded games; apparatus for recording, transmission or reproduction of sound or images; communications servers [computer hardware]; electronic components for gambling machines; computer application software featuring games and gaming; computer software for the administration of on-line games and gaming; computer hardware for games and gaming; electronic components and computer software for gambling, gambling machines, gambling games on the Internet and via telecommunication network.

28 – Gaming machines for gambling; chips for gambling; mah-jong; arcade games; gambling machines operating with coins, banknotes and cards; games; electronic games; parlor games; gaming chips; gaming tables; slot machines [gaming machines]; LCD game machines; slot machines and gaming devices; coin-operated amusement machines; roulette chips; poker chips; chips and dice [gaming equipment]; gaming equipment for casinos; roulette tables; gaming roulette wheels; casino games; gambling machines and amusement machines, automatic and coin-operated; coin-operated amusement machines and/or electronic coin-operated amusement machines with or without the possibility of gain; boxes for coin-operated machines, slot machines and gaming machines; electronic or electrotechnical amusement machines and apparatus, gaming machines, coin-operated entertainment machines; housings for coin-operated machines, gaming equipment, gaming machines, machines for gambling; electropneumatic and electrical gambling machines (slot machines).

41 – Gambling; entertainment services related to gambling; gaming services for entertainment purposes; casino, gaming and gambling services; training in the development of software systems; provision of equipment for gambling halls; providing casino equipment [gambling]; gaming machine entertainment services; providing casino facilities [gambling]; gaming hall services; amusement arcade services; games equipment rental; rental of gaming machines; providing amusement arcade services; rental of gaming machines with images of fruits; editing or recording of sounds and images; sound recording and video entertainment services; hire of sound reproducing apparatus;

provision of gaming equipment for casinos; providing of casino facilities; online gambling services; casino, gaming and gambling services; provision of gaming facilities, gaming hall facilities, Internet casinos and online gambling services.

(260) AM 2022 113313 A

(800) 1594750

(151) 2021 03 25

(891) 2021 03 25

(731) LTD "VALENTA-INTELLEKT"

ul. Ryabinovaya, d.26, str.10, k.6-26,

RU-121471 Moscow, Russian Federation

(540)

POLINEVRIN

(591) Black, white

(531) 27.05.01

(511)

5 – Acaricides; aconitine; alkaloids for medical purposes; alginates for pharmaceutical purposes; algicides; aldehydes for pharmaceutical purposes; dental amalgams of gold; dental amalgams; amino acids for veterinary purposes; amino acids for medical purposes; analgesics; anaesthetics; antibiotics; antiseptics; medicine cases, portable, filled; first-aid boxes, filled; aluminium acetate for pharmaceutical purposes; acetates for pharmaceutical purposes; germicides; balms for medical purposes; bandages for dressings; diagnostic biomarker reagents for medical purposes; biocides; bracelets impregnated with insect repellent; bromine for pharmaceutical purposes; paper for mustard plasters; fly catching paper; reagent paper for veterinary purposes; reagent paper for medical purposes; mothproofing paper; petroleum jelly for medical purposes; vaccines; oxygen baths; antiseptic cotton; aseptic cotton; absorbent cotton; wadding for medical purposes; cotton for medical purposes; dietetic substances adapted for medical use; radiological contrast substances for medical purposes; nutritive substances for microorganisms; radioactive substances for medical purposes; bismuth subnitrate for pharmaceutical purposes; melissa water for pharmaceutical purposes; seawater for medicinal bathing; mineral waters for medical purposes; thermal water; dietary fibre; moulding wax for dentists; gases for medical purposes; guaiacol for pharmaceutical purposes; sexual stimulant gels; haematogen; haemoglobin; hydrastine; hydrastinine; glycerine for medical purposes; glycerophosphates; glucose for medical purposes; gentian for pharmaceutical purposes; hormones for medical purposes; mustard for pharmaceutical purposes; mustard plasters; mud for baths; medicinal mud; gamboge for medical purposes; gurjun balsam for medical purposes; disinfectants; air deodorizing preparations; deodorants, other than for human beings or for animals; deodorants for clothing and textiles; diastase for medical purposes; digitalin; vitamin supplement patches; mineral food supplements; nutritional supplements;

albumin dietary supplements; dietary supplements for animals; yeast dietary supplements; alginate dietary supplements; glucose dietary supplements; casein dietary supplements; lecithin dietary supplements; linseed oil dietary supplements; propolis dietary supplements; protein dietary supplements; protein supplements for animals; royal jelly dietary supplements; pollen dietary supplements; wheat germ dietary supplements; linseed dietary supplements; acai powder dietary supplements; dietary supplements with a cosmetic effect; enzyme dietary supplements; yeast for pharmaceutical purposes; gelatine for medical purposes; cod liver oil; isotopes for medical purposes; immunostimulants; insecticides; iodine for pharmaceutical purposes; iodides for pharmaceutical purposes; alkaline iodides for pharmaceutical purposes; iodoform; calomel [fungicide]; cream of tartar for pharmaceutical purposes; tartar for pharmaceutical purposes; camphor for medical purposes; capsules for medicines; cachets for pharmaceutical purposes; capsules made of dendrimer-based polymers, for pharmaceuticals; haemostatic pencils; wart pencils; caustic pencils; carbolineum [parasiticide]; caustics for pharmaceutical purposes; cachou for pharmaceutical purposes; quassia for medical purposes; quebracho for medical purposes; oxygen for medical purposes; gallic acid for pharmaceutical purposes; acids for pharmaceutical purposes; adhesives for dentures; surgical glues; stem cells for veterinary purposes; stem cells for medical purposes; cocaine; collagen for medical purposes; collodion for pharmaceutical purposes; corn rings for the feet; medicated sweets; angostura bark for medical purposes; barks for pharmaceutical purposes; cedar wood for use as an insect repellent; condurango bark for medical purposes; croton bark; mangrove bark for pharmaceutical purposes; myrobalan bark for pharmaceutical purposes; quinquina for medical purposes; medicated animal feed; medicinal roots; rhubarb roots for pharmaceutical purposes; lint for medical purposes; starch for dietetic or pharmaceutical purposes; creosote for pharmaceutical purposes; blood for medical purposes; cultures of microorganisms for medical or veterinary use; curare; dental lacquer; liquorice for pharmaceutical purposes; milk sugar for pharmaceutical purposes; medicated candies; adhesive plasters; medicines for alleviating constipation; adhesive tapes for medical purposes; lecithin for medical purposes; lotions for veterinary purposes; medicated hair lotions; lotions for pharmaceutical purposes; medicated after-shave lotions; personal sexual lubricants; lupulin for pharmaceutical purposes; magnesia for pharmaceutical purposes; liniments; ointments for pharmaceutical purposes; sunburn ointments; mercurial ointments; frostbite salve for pharmaceutical purposes; gauze for dressings; medicinal oils; mustard oil for medical purposes; camphor oil for medical purposes; castor oil for medical purposes; oil of turpentine for pharmaceutical purposes; dill oil for medical purposes; dental mastics; dental abrasives;

dental impression materials; teeth filling material; dressings, medical; surgical dressings; drugs for medical purposes; medicines for veterinary purposes; serotherapeutic medicines; medicines for human purposes; medicines for dental purposes; menthol; medicinal drinks; moleskin for medical purposes; almond milk for pharmaceutical purposes; powdered milk for babies; royal jelly for pharmaceutical purposes; milk ferments for pharmaceutical purposes; Irish moss for medical purposes; flour for pharmaceutical purposes; linseed meal for pharmaceutical purposes; fish meal for pharmaceutical purposes; fly glue; antibacterial soap; disinfectant soap; medicated soap; freeze-dried meat adapted for medical purposes; mint for pharmaceutical purposes; dietetic beverages adapted for medical purposes; malted milk beverages for medical purposes; injectable dermal fillers; narcotics; medicinal infusions; tincture of iodine; eucalyptol for pharmaceutical purposes; tinctures for medical purposes; opium; opodeldoc; decoctions for pharmaceutical purposes; antiparasitic collars for animals; cotton swabs for medical purposes; stick liquorice for pharmaceutical purposes; sulfur sticks [disinfectants]; pastilles for pharmaceutical purposes; medicated toothpaste; pectin for pharmaceutical purposes; pepsins for pharmaceutical purposes; peptones for pharmaceutical purposes; hydrogen peroxide for medical purposes; pesticides; food for babies; leeches for medical purposes; blood plasma; nicotine patches for use as aids to stop smoking; eyepatches for medical purposes; poultices; compresses; scapulars for surgical purposes; babies' diapers; diapers for pets; diapers for incontinence; bunion pads; breast-nursing pads; pomades for medical purposes; powder of cantharides; pyrethrum powder; anti-uric preparations; bacterial preparations for medical and veterinary use; bacteriological preparations for medical and veterinary use; balsamic preparations for medical purposes; albuminous preparations for medical purposes; biological preparations for veterinary purposes; biological preparations for medical purposes; veterinary preparations; bismuth preparations for pharmaceutical purposes; vitamin preparations; diagnostic preparations for veterinary purposes; diagnostic preparations for medical purposes; douching preparations for medical purposes; bath preparations for medical purposes; therapeutic preparations for the bath; haemorrhoid preparations; preparations for callouses; lice treatment preparations [pediculicides]; acne treatment preparations; preparations to facilitate teething; preparations for the treatment of burns; fumigation preparations for medical purposes; opotherapy preparations; air purifying preparations; bronchodilating preparations; preparations for reducing sexual activity; sterilizing preparations; soil-sterilizing preparations; corn remedies; pharmaceutical preparations for treating dandruff; preparations for destroying noxious animals; herbicides; preparations for destroying dry rot fungus; larvae exterminating preparations; fly destroying preparations; preparations for des-

troying mice; slug exterminating preparations; vermin destroying preparations; pharmaceutical preparations for skin care; contact lens cleaning preparations; preparations of microorganisms for medical or veterinary use; lime-based pharmaceutical preparations; styptic preparations; medicated eye-washes; medicinal hair growth preparations; nutraceutical preparations for therapeutic or medical purposes; opiates; anticryptogamic preparations; aloe vera preparations for pharmaceutical purposes; preparations of trace elements for human and animal use; sulfonamides [medicines]; pharmaceutical preparations; pharmaceutical preparations for treating sunburn; enzyme preparations for veterinary purposes; enzyme preparations for medical purposes; phytotherapy preparations for medical purposes; chemico-pharmaceutical preparations; chemical preparations for veterinary purposes; chemical preparations for the diagnosis of pregnancy; chemical preparations for medical purposes; chemical preparations for treating diseases affecting cereal plants; chemical preparations for treating wheat blight; chemical preparations for treating diseases affecting vine plants; chemical preparations for treating mildew; chemical preparations for treating phylloxera; chemical preparations for pharmaceutical purposes; chilblain preparations; mothproofing preparations; collyrium; lead water; chemical conductors for electrocardiograph electrodes; albuminous foodstuffs for medical purposes; dietetic foods adapted for medical purposes; by-products of the processing of cereals for dietetic or medical purposes; homogenized food adapted for medical purposes; pharmaceuticals; sanitary towels; panty liners [sanitary]; propolis for pharmaceutical purposes; pearl powder for medical purposes; radium for medical purposes; hydrated chloral for pharmaceutical purposes; solvents for removing adhesive plasters; vaginal washes for medical purposes; solutions for contact lenses; chemical reagents for medical or veterinary purposes; gum for medical purposes; rubber for dental purposes; chewing gum for medical purposes; nicotine gum for use as an aid to stop smoking; insect repellents; insect repellent incense; repellents for dogs; tissues impregnated with pharmaceutical lotions; sarsaparilla for medical purposes; sugar for medical purposes; asthmatic tea; fumigating sticks; massage candles for therapeutic purposes; linseed for pharmaceutical purposes; tobacco-free cigarettes for medical purposes; siccatives [drying agents] for medical purposes; syrups for pharmaceutical purposes; turpentine for pharmaceutical purposes; greases for veterinary purposes; greases for medical purposes; lacteal flour for babies; infant formula; soporifics; bicarbonate of soda for pharmaceutical purposes; bath salts for medical purposes; salts for mineral water baths; salts for medical purposes; potassium salts for medical purposes; sodium salts for medical purposes; smelling salts; mineral water salts; malt for pharmaceutical purposes; semen for artificial insemination;

alcohol for pharmaceutical purposes; medicinal alcohol; alloys of precious metals for dental purposes; ergot for pharmaceutical purposes; cooling sprays for medical purposes; antibacterial handwashes; adjuvants for medical purposes; astringents for medical purposes; vermifuges; disinfectants for hygiene purposes; disinfectants for chemical toilets; appetite suppressants for medical purposes; medical preparations for slimming purposes; parasiticides; mouthwashes for medical purposes; febrifuges; depuratives; animal washes [insecticides]; detergents for medical purposes; cattle washes [insecticides]; dog washes [insecticides]; insecticidal veterinary washes; vesicants; purgatives; remedies for perspiration; remedies for foot perspiration; chemical contraceptives; antiparasitic preparations; laxatives; tonics [medicines]; medicated toiletry preparations; digestives for pharmaceutical purposes; nervines; bouillons for bacteriological cultures; steroids; strychnine; serums; tanning pills; appetite suppressant pills; slimming pills; antioxidant pills; sanitary tampons; vulnerary sponges; thymol for pharmaceutical purposes; biological tissue cultures for veterinary purposes; biological tissue cultures for medical purposes; smoking herbs for medical purposes; medicinal herbs; surgical implants comprised of living tissues; pants, absorbent, for incontinence; sanitary panties; babies' diaper-pants; charcoal for pharmaceutical purposes; porcelain for dental prostheses; phenol for pharmaceutical purposes; enzymes for veterinary purposes; enzymes for medical purposes; ferments for pharmaceutical purposes; formic aldehyde for pharmaceutical purposes; phosphates for pharmaceutical purposes; fungicides; quinine for medical purposes; chinoline for medical purposes; diabetic bread adapted for medical use; chloroform; flowers of sulfur for pharmaceutical purposes; cement for animal hooves; bone cement for surgical and orthopaedic purposes; dental cements; medicinal tea; herbal teas for medicinal purposes; insecticidal animal shampoos; medicated shampoos; medicated shampoos for pets; pediculicidal shampoos; medicated dry shampoos; pre-filled syringes for medical purposes; eucalyptus for pharmaceutical purposes; herbal extracts for medical purposes; plant extracts for pharmaceutical purposes; tobacco extracts [insecticides]; extracts of hops for pharmaceutical purposes; elixirs [pharmaceutical preparations]; ethers for pharmaceutical purposes; esters for pharmaceutical purposes; cellulose esters for pharmaceutical purposes; rat poison; poisons; bacterial poisons; jalap; suppositories; milking grease; sedatives; jujube, medicated; fennel for medical purposes; cellulose ethers for pharmaceutical purposes; vitamins; pharmaceuticals for the treatment of diseases of the nervous system; pharmaceuticals for the treatment of neurological diseases, including pharmaceuticals for the treatment of polyneuropathy; pharmaceuticals for treating neuralgia; pharmaceuticals for the treatment of lumboschialgia; pharmaceuticals for the treatment of radiculopathy; pharmaceuticals for the treatment of

cervicobrachial syndrome; pharmaceuticals for the treatment of radicular syndrome; pharmaceuticals for the treatment of neuritis.

(260) AM 2022 113438 A

(800) 1595303

(151) 2021 04 21

(891) 2021 04 21

(731) Suntory Holdings Limited

1-40, Dojimahama 2-chome, Kita-ku,
Osaka-shi, Osaka 530-8203, Japan

(540)



(591) Black, white

(531) 27.05.10; 28.03

(511)

33 – Whisky.

(260) AM 2022 113440 A

(800) 1595371

(151) 2021 04 05

(891) 2021 04 05

(731) VISTA PHYTO LAB Inc.

111 Cherrytree Drive, Brampton ON L6Y 3N5,
Canada

(540)

КРИНОРМ10000

(591) Black, white

(531) 27.07.01; 28.05

(511)

5 – Acaricides; aconitine; alkaloids for medical purposes; alginates for pharmaceutical purposes; algicides; aldehydes for pharmaceutical purposes; dental amalgams of gold; dental amalgams; amino acids for veterinary purposes; amino acids for medical purposes; analgesics; anaesthetics; antibiotics; antiseptics; medicine cases, portable, filled; first-aid boxes, filled; aluminium acetate for pharmaceutical purposes; acetates for pharmaceutical purposes; germicides; balms for medical purposes; bandages for dressings; diagnostic biomarker reagents for medical purposes; biocides; bromine for pharmaceutical purposes; paper for mustard plasters; fly catching paper; reagent paper for veterinary purposes; reagent paper for medical purposes; mothproofing paper; petroleum jelly for medical purposes; vaccines; oxygen baths; antiseptic cotton; aseptic cotton; absorbent cotton; wadding for medical

purposes; cotton for medical purposes; dietetic substances adapted for medical use; radiological contrast substances for medical purposes; nutritive substances for microorganisms; radioactive substances for medical purposes; melissa water for pharmaceutical purposes; seawater for medicinal bathing; mineral waters for medical purposes; thermal water; dietary fibre; moulding wax for dentists; gases for medical purposes; guaiacol for pharmaceutical purposes; sexual stimulant gels; haematogen; haemoglobin; hydrastine; hydrastinine; glycerine for medical purposes; glycerophosphates; glucose for medical purposes; gentian for pharmaceutical purposes; hormones for medical purposes; mustard for pharmaceutical purposes; mustard plasters; mud for baths; medicinal mud; gamboge for medical purposes; gurgun balsam for medical purposes; air deodorizing preparations; deodorants, other than for human beings or for animals; deodorants for clothing and textiles; diastase for medical purposes; digitalin; vitamin supplement patches; mineral food supplements; nutritional supplements; albumin dietary supplements; dietary supplements for animals; yeast dietary supplements; alginate dietary supplements; glucose dietary supplements; casein dietary supplements; lecithin dietary supplements; linseed oil dietary supplements; propolis dietary supplements; protein dietary supplements; protein supplements for animals; royal jelly dietary supplements; pollen dietary supplements; wheat germ dietary supplements; linseed dietary supplements; acai powder dietary supplements; dietary supplements with a cosmetic effect; enzyme dietary supplements; yeast for pharmaceutical purposes; gelatine for medical purposes; cod liver oil; isotopes for medical purposes; immunostimulants; insecticides; iodine for pharmaceutical purposes; iodides for pharmaceutical purposes; alkaline iodides for pharmaceutical purposes; iodoform; calomel [fungicide]; tartar for pharmaceutical purposes; camphor for medical purposes; capsules for medicines; cachets for pharmaceutical purposes; haemostatic pencils; wart pencils; caustic pencils; carbolineum [parasiticide]; caustics for pharmaceutical purposes; cachou for pharmaceutical purposes; quassia for medical purposes; quebracho for medical purposes; oxygen for medical purposes; gallic acid for pharmaceutical purposes; acids for pharmaceutical purposes; adhesives for dentures; surgical glues; stem cells for veterinary purposes; stem cells for medical purposes; cocaine; collagen for medical purposes; collodion for pharmaceutical purposes; corn rings for the feet; medicated sweets; barks for pharmaceutical purposes; cedar wood for use as an insect repellent; croton bark; mangrove bark for pharmaceutical purposes; myrobalan bark for pharmaceutical purposes; quinquina for medical purposes; medicated animal feed; medicinal roots; rhubarb roots for pharmaceutical purposes; lint for medical purposes; starch for dietetic or pharmaceutical purposes; creosote for pharmaceutical purposes; blood for medical purposes; cultures of microorganisms for medical

or veterinary use; curare; dental lacquer; liquorice for pharmaceutical purposes; milk sugar for pharmaceutical purposes; medicinal drops; adhesive plasters; medicines for alleviating constipation; adhesive tapes for medical purposes; lecithin for medical purposes; lotions for veterinary purposes; medicated hair lotions; lotions for pharmaceutical purposes; medicated after-shave lotions; personal sexual lubricants; lupulin for pharmaceutical purposes; magnesia for pharmaceutical purposes; liniments; ointments for pharmaceutical purposes; sunburn ointments; mercurial ointments; frostbite salve for pharmaceutical purposes; gauze for dressings; medicinal oils; mustard oil for medical purposes; camphor oil for medical purposes; castor oil for medical purposes; oil of turpentine for pharmaceutical purposes; dill oil for medical purposes; dental mastics; dental abrasives; dental impression materials; teeth filling material; dressings, medical; surgical dressings; drugs for medical purposes; medicines for veterinary purposes; serotherapeutic medicines; medicines for human purposes; medicines for dental purposes; menthol; medicinal drinks; moleskin for medical purposes; almond milk for pharmaceutical purposes; powdered milk for babies; royal jelly for pharmaceutical purposes; milk ferments for pharmaceutical purposes; Irish moss for medical purposes; flour for pharmaceutical purposes; linseed meal for pharmaceutical purposes; fish meal for pharmaceutical purposes; fly glue; antibacterial soap; disinfectant soap; medicated soap; freeze-dried meat adapted for medical purposes; mint for pharmaceutical purposes; dietetic beverages adapted for medical purposes; malted milk beverages for medical purposes; narcotics; medicinal infusions; tincture of iodine; eucalyptol for pharmaceutical purposes; tinctures for medical purposes; opium; opodeldoc; decoctions for pharmaceutical purposes; antiparasitic collars for animals; stick liquorice for pharmaceutical purposes; sulfur sticks [disinfectants]; pastilles for pharmaceutical purposes; medicated toothpaste; pectin for pharmaceutical purposes; pepsins for pharmaceutical purposes; peptones for pharmaceutical purposes; hydrogen peroxide for medical purposes; pesticides; food for babies; leeches for medical purposes; blood plasma; nicotine patches for use as aids to stop smoking; eyepatches for medical purposes; poultices; compresses; scapulars for surgical purposes; babies' diapers; diapers for pets; diapers for incontinence; bunion pads; breast-nursing pads; pomades for medical purposes; powder of cantharides; pyrethrum powder; anti-uric preparations; bacterial preparations for medical and veterinary use; bacteriological preparations for medical and veterinary use; balsamic preparations for medical purposes; albuminous preparations for veterinary purposes; biological preparations for medical purposes; veterinary preparations; bismuth preparations for pharmaceutical purposes; vitamin preparations; diagnostic preparations for veterinary purposes; diagnostic preparations for medical purposes; bath

preparations for medical purposes; therapeutic preparations for the bath; haemorrhoid preparations; preparations for callouses; lice treatment preparations [pediculicides]; acne treatment preparations; preparations to facilitate teething; preparations for the treatment of burns; fumigation preparations for medical purposes; ootherapy preparations; air purifying preparations; bronchodilating preparations; preparations for reducing sexual activity; sterilizing preparations; soil-sterilizing preparations; corn remedies; pharmaceutical preparations for treating dandruff; preparations for destroying noxious animals; herbicides; preparations for destroying dry rot fungus; larvae exterminating preparations; fly destroying preparations; preparations for destroying mice; slug exterminating preparations; vermin destroying preparations; pharmaceutical preparations for skin care; contact lens cleaning preparations; preparations of microorganisms for medical or veterinary use; lime-based pharmaceutical preparations; hemostatic preparations; medicated eye-washes; medicinal hair growth preparations; nutraceutical preparations for therapeutic or medical purposes; opiates; anticryptogamic preparations; aloe vera preparations for pharmaceutical purposes; bismuth subnitrate for pharmaceutical purposes; disinfectants; cream of tartar for pharmaceutical purposes; angostura bark for medical purposes; condurango bark for medical purposes; cotton swabs for medical purposes; styptic pencils; preparations of trace elements for human and animal use; sulfonamides [medicines]; pharmaceutical preparations; pharmaceutical preparations for treating sunburn; enzyme preparations for veterinary purposes; enzyme preparations for medical purposes; phytotherapy preparations for medical purposes; chemico-pharmaceutical preparations; chemical preparations for veterinary purposes; chemical preparations for the diagnosis of pregnancy; chemical preparations for medical purposes; chemical preparations for treating wheat blight; chemical preparations for treating diseases affecting vine plants; chemical preparations for treating mildew; chemical preparations for treating phyloxera; chemical preparations for pharmaceutical purposes; chilblain preparations; mothproofing preparations; collyrium; lead water; chemical conductors for electrocardiograph electrodes; albuminous foodstuffs for medical purposes; dietetic foods adapted for medical purposes; by-products of the processing of cereals for dietetic or medical purposes; homogenized food adapted for medical purposes; freeze-dried food adapted for medical purposes; pharmaceuticals; sanitary towels; panty liners [sanitary]; propolis for pharmaceutical purposes; pearl powder for medical purposes; radium for medical purposes; hydrated chloral for pharmaceutical purposes; solvents for removing adhesive plasters; vaginal washes for medical purposes; solutions for contact lenses; chemical reagents for medical or veterinary purposes; gum for medical purposes; rubber for dental purposes; chewing gum for medical purposes; nicotine gum for use as an aid to

stop smoking; insect repellents; insect repellent incense; repellents for dogs; tissues impregnated with pharmaceutical lotions; sarsaparilla for medical purposes; sugar for medical purposes; asthmatic tea; fumigating sticks; massage candles for therapeutic purposes; linseed for pharmaceutical purposes; tobacco-free cigarettes for medical purposes; siccatives [drying agents] for medical purposes; syrups for pharmaceutical purposes; turpentine for pharmaceutical purposes; greases for veterinary purposes; greases for medical purposes; lacteal flour for babies; infant formula; soporifics; bicarbonate of soda for pharmaceutical purposes; bath salts for medical purposes; salts for mineral water baths; salts for medical purposes; potassium salts for medical purposes; sodium salts for medical purposes; smelling salts; mineral water salts; malt for pharmaceutical purposes; semen for artificial insemination; alcohol for pharmaceutical purposes; medicinal alcohol; alloys of precious metals for dental purposes; ergot for pharmaceutical purposes; cooling sprays for medical purposes; antibacterial handwashes; adjuvants for medical purposes; astringents for medical purposes; vermifuges; disinfectants for hygiene purposes; disinfectants for chemical toilets; appetite suppressants for medical purposes; medical preparations for slimming purposes; parasiticides; mouthwashes for medical purposes; febrifuges; depuratives; animal washes [insecticides]; detergents for medical purposes; cattle washes [insecticides]; dog washes [insecticides]; insecticidal veterinary washes; vesicants; purgatives; remedies for perspiration; remedies for foot perspiration; chemical contraceptives; antiparasitic preparations; laxatives; tonics [medicines]; medicated toiletry preparations; digestives for pharmaceutical purposes; nervines; bouillons for bacteriological cultures; steroids; strychnine; serums; tanning pills; appetite suppressant pills; slimming pills; antioxidant pills; sanitary tampons; vulnervary sponges; thymol for pharmaceutical purposes; biological tissue cultures for veterinary purposes; biological tissue cultures for medical purposes; smoking herbs for medical purposes; medicinal herbs; the implants [living tissues]; surgical implants comprised of living tissues; pants, absorbent, for incontinence; sanitary panties; babies' diaper-pants; charcoal for pharmaceutical purposes; porcelain for dental prostheses; phenol for pharmaceutical purposes; enzymes for veterinary purposes; enzymes for medical purposes; ferments for pharmaceutical purposes; formic aldehyde for pharmaceutical purposes; phosphates for pharmaceutical purposes; fungicides; quinine for medical purposes; chinoline for medical purposes; diabetic bread adapted for medical use; chloroform; flowers of sulfur for pharmaceutical purposes; cement for animal hooves; bone cement for surgical and orthopaedic purposes; dental cements; medicinal tea; herbal teas for medicinal purposes; insecticidal animal shampoos; medicated shampoos; medicated shampoos for pets; pediculicidal shampoos; medicated dry shampoos; pre-filled syringes for

medical purposes; eucalyptus for pharmaceutical purposes; herbal extracts for medical purposes; plant extracts for pharmaceutical purposes; tobacco extracts [insecticides]; extracts of hops for pharmaceutical purposes; elixirs [pharmaceutical preparations]; ethers for pharmaceutical purposes; esters for pharmaceutical purposes; cellulose esters for pharmaceutical purposes; rat poison; poisons; bacterial poisons; jalap; capsules made of dendrimer-based polymers, for pharmaceuticals; chemical preparations for treating diseases affecting cereal plants; injectable dermal fillers; bracelets impregnated with insect repellent; suppositories; milking grease; douching preparations for medical purposes; sedatives; jujube, medicated; fennel for medical purposes; cellulose ethers for pharmaceutical purposes.

(260) AM 2022 113441 A

(800) 1595392

(151) 2021 01 26

(891) 2021 01 26

(731) Zablotskyy Yaroslav

12 Ivana Franka str., Birky vil., Yavorivskyy district, Lviv region 81092, Ukraine

(540)

INTERNATIONAL GROUP
CLINIC
Zablotskyy

(591) Black, white

(531) 27.05.10

(511)

35 – Business management services; office functions; business auditing; outsourced administrative management for companies; negotiation of business contracts for others; demonstration of goods; business administration in the field of medical clinics and health centers; advisory services for business management; business research; providing user reviews for commercial or advertising purposes; providing business information; compilation and systemization of information into computer databases; computerized file management; business management and organization consultancy; marketing consulting services relating to long-term and short-term business strategy development for medical clinics and health centers; provision of an online marketplace for buyers and sellers of goods and services; organization of exhibitions and trade fairs for commercial or advertising purposes; shop window dressing; business intermediary services relating to the matching of potential private investors with entrepreneurs needing funding; outsourcing services [business assistance]; business project management services for construction projects; corporate communications services; website traffic optimization; procurement services for others [purchasing goods and ser-

vices for other businesses]; media and public relations services; wholesale services for pharmaceutical and sanitary preparations and medical supplies; retail services for pharmaceutical and sanitary preparations and medical supplies; professional counseling and advice on the management of dental clinics and dental care centers; sales promotion for others; negotiation and conclusion of commercial transactions for third parties; professional business consulting; business advisory services relating to the establishment and operation of franchises; human resources consultancy; updating and maintenance of data in computer databases; providing assistance in the field of business management within the framework of a franchise contract; advertising.

41 – Providing of training; arranging and conducting of congresses; arranging and conducting of colloquiums; arranging and conducting of conferences; arranging and conducting of in-person educational forums; arranging and conducting of workshops [training]; arranging and conducting of seminars; arranging and conducting of symposiums; electronic desktop publishing; providing user reviews for entertainment or cultural purposes; providing information in the field of education; providing online electronic publications, not downloadable; tutoring; writing and publishing of texts, other than publicity texts; organization of exhibitions for cultural or educational purposes; organization of educational events; coaching [training]; health and fitness club services; practical training [demonstration]; vocational retraining; online publication of electronic books and journals; publication of books; publication of texts, other than publicity texts; personal trainer services; education and training services; educational services.

44 – Health counselling; medical assistance; health care; medical advice for individuals with disabilities; medical screening; health care services; plastic surgery; hospital services; orthodontic services; medical clinic services; health center services; medical equipment rental; rental of hair styling apparatus; rental of sanitary installations; dentistry services.

(260) AM 2022 113443 A

(800) 1595420

(151) 2021 04 09

(891) 2021 04 09

(731) Shanghai Aowei Technology Development Co., Ltd.

No.188 Guoshoujing Road, China(Shanghai)

Pilot Free Trade Zone, 200120 Shanghai, China

(540)



The logo for OrstCap features a stylized lightning bolt symbol to the left of the word "OrstCap" in a bold, sans-serif font.

(591) Black, white

(531) 01.15.03; 26.01.13; 27.05.01; 27.05.08

(511)

9 – Condensers, namely, capacitors; batteries, electric; charging stations for electric vehicles; battery chargers; telepresence robots; transistors, electronic; security surveillance robots; humanoid robots with artificial intelligence; electronic numeric displays.

(260) AM 2022 113454 A

(800) 1595761

(151) 2020 11 27

(891) 2020 11 27

(731) BEST MODE TEKSTİL SANAYİ VE DIŞ TİCARET LİMİTED ŞİRKETİ

Yarımburgaz Mahallesi, Cumhuriyet Caddesi,

Şahin Sokak, No:21/A, Halkalı, Küçükçekmece –

İstanbul, Turkey

(540)



(591) Black, white

(531) 26.04.02; 26.04.05; 26.04.18; 27.05.01

(511)

18 – Unworked or semi-worked leather and animal skins, imitations of leather, stout leather, leather used for linings; goods made of leather, imitations of leather or other materials, designed for carrying items, included in this class; bags, wallets, boxes and trunks made of leather or stout leather; keycases, trunks [luggage], suitcases; umbrellas; parasols; sun umbrellas; walking sticks; whips; harness; saddlery; stirrups; straps of leather (saddlery).

25 – Clothing, including underwear and outerclothing, other than special purpose protective clothing; socks, mufflers [clothing], shawls, bandanas, scarves, belts [clothing]; footwear, shoes, slippers, sandals; headgear, hats, caps with visors, berets, caps [headwear], skull caps.

35 – Advertising, marketing and public relations; organization of exhibitions and trade fairs for commercial or advertising purposes; the bringing together, for the benefit of others, of a variety of goods, namely, unworked or semi-worked leather and animal skins, imitations of leather, stout leather, leather used for linings, goods made of leather, imitations of leather or other materials, designed for carrying items, bags, wallets, boxes and trunks made of leather or stout leather, keycases, trunks [luggage], suitcases, umbrellas, parasols, sun umbrellas, walking sticks, whips, harness, saddlery, stirrups, straps of leather (saddlery), clothing, including underwear and outerclothing, ot-

her than special purpose protective clothing, socks, mufflers [clothing], shawls, bandanas, scarves, belts [clothing], footwear, shoes, slippers, sandals, headgear, hats, caps with visors, berets, caps [headwear], skull caps, enabling customers to conveniently view and purchase those goods, such services may be provided by retail stores, wholesale outlets, by means of electronic media or through mail order catalogues.

(260) AM 2022 113455 A

(800) 1595766

(151) 2021 04 02

(891) 2021 04 02

(731) BIOFARMA

50 rue Carnot, F-92284 SURESNES CEDEX,
France

(540)

QUADRIXO

(591) Black, white

(511)

5 – Pharmaceutical products; medical preparations; veterinary preparations; hygienic products for medicine; dietetic substances and foodstuffs for medical or veterinary use, food for babies; food supplements for humans and animals; plasters, materials for dressings; material for dental fillings and dental impressions; disinfectants; products for destroying vermin; fungicides, herbicides.

(260) AM 2022 113456 A

(800) 1595790

(151) 2021 01 26

(891) 2021 01 26

(731) Egis Gyógyszergyár Zrt.

Keresztúri út 30-38., H-1106 Budapest,
Hungary

(540)

AZELEAL

(591) Black, white

(511)

3 – Cosmetics and cosmetic preparations.

5 – Human pharmaceutical preparations; dietetic substances adapted for medical use; dietary supplements; medicinal ointments; medicated skin creams; plasters, materials for dressings.

(260) AM 2022 113457 A

(800) 1595869

(151) 2021 04 07

(891) 2021 04 07

(731) Shandong Chunwang Food Technology, Co.,
Ltd.

No.1, Chunwang Rd., Bancheng Industrial park,
Lanshan Dist., Linyi City, Shandong, China

(540)



(591) Red

(531) 02.09.01; 27.03.02; 27.05.01; 28.03; 29.01.01

(511)

29 – Nuts, prepared; peanuts, prepared; seeds, prepared; candied nuts; flavored nuts; fishskin peanut; honeyed peanuts; odd taste bean; processed edible seeds; baked nuts.

(260) AM 2022 113481 A

(800) 1578267

(151) 2021 01 29

(891) 2021 04 26

(731) SHOKZ HOLDING LIMITED

RM 2603A 26/F TOWER 1 LIPPO CTR,
89 QUEENSWAY ADMIRALTY, Hong Kong,
China

(540)

openrun

(591) Black, white

(531) 27.05.01

(511)

9 – Electronic memory devices; smartglasses (data processing apparatus); memory expansion modules; earphones; megaphones; microphones; horns for loudspeakers; headphones; virtual reality headsets; MP3 players; wireless speakers; batteries; battery charge devices; lithium ion batteries; eyeglasses.

(260) AM 2022 113530 A

(800) 1596502

(151) 2020 12 10

(891) 2020 12 10

(731) Jin Jiangming

No. 61, Yidong Road, Choucheng Street, Yiwu
City, Jinhua City, 322099 Zhejiang Province,
China

(540)

Kaisa Villa

(591) Black, white

(511)

21 – Kitchen utensils; thermally insulated containers for food; heat-insulated containers; liqueur sets; daily glassware (including cups, plates, pots, jars); daily porcelain, including basins, bowls, plates, pots, tableware, crocks, demijohns and pots; porcelain ware;

iron pan; cooking pots; utensils for household purposes.

(260) AM 2022 113531 A

(800) 1596534

(151) 2021 03 18

(891) 2021 03 18

(731) CELLTRION, INC.

23, Academy-ro, Yeonsu-gu, Incheon 22014,
Republic of Korea

(540)

Юфлайма

(591) Black, white

(531) 28.05

(511)

5 – Pharmaceutical preparations for the treatment of autoimmune diseases.

(260) AM 2022 113563 A

(800) 1597361

(151) 2020 12 30

(891) 2020 12 30

(731) Cynosure, LLC

5 Carlisle Road, Westford MA 01886, USA

(540)

CYNOSURE

(591) Black, white

(511)

3 – Soaps, polishes, cosmetics; skin and body topical lotions, moisturizers, gels, creams, ointments, and oils for cosmetic use; skin care preparations; sun screen preparations; sun block lotions; skin and body topical lotions, moisturizers, gels, creams, ointments, and oils for cosmetic use made in whole or in part of natural ingredients; skin care preparations made in whole or in part of natural ingredients; body care masks; beauty masks; gel eye patches for cosmetic purposes; facial masks for cosmetic purposes; plasters and dressings for cosmetic purposes; materials for dressings for cosmetic purposes; cosmetic creams in the nature of exfoliators, namely, skin and facial exfoliators.

5 – Medicated skin care preparations; medicated skin and body topical lotions, moisturizers, gels, creams, ointments and oils; medicated cosmetics; acne treatment preparations; acne medications; medicated sunscreen; pharmaceutical preparations for skin care; pharmaceutical preparations for treating sunburn and sun damage; pharmaceutical preparations and substances for the treatment of damaged skin and tissue; pharmaceutical preparations for use in dermatology; pharmaceutical preparations for treating skin disorders, hyperhidrosis and wrinkles; pharmaceutical skin lotions; dermal implants; dermal implants for filling

wrinkles; dermal fillers; tissue augmenting gel; gel injected under the skin to smooth out wrinkles; gel injected into one or more of the epidermal skin layer, dermal skin layer, and below the dermal skin layer to smooth out wrinkles; pharmaceutical preparations for the treatment of lines, wrinkles, asymmetries and defects and conditions of the human skin; pharmaceutical preparations for use in augmentation of soft tissue, smoothing out wrinkles and fine lines, and contouring the face; kits consisting of syringes prefilled with pharmaceutical preparations for soft tissue augmentation, smoothing out wrinkles and fine lines, and contouring the face; vitamins; dietary and nutritional supplements; medicated skin care preparations made in whole or in part of natural ingredients; medicated skin and body topical lotions, moisturizers, gels, creams, ointments and oils made in whole or in part of natural ingredients; medicated cosmetics made in whole or in part of natural ingredients; medicated plasters; plasters and dressings for medical purposes; materials for dressings.

10 – Medical instruments; surgical instruments; energy-based medical apparatus for the medical treatment of the face, body, tissue and skin; energy-based medical apparatus for dermatological uses; energy-based apparatus for the cosmetic treatment of the face, body, tissue and skin; energy-based apparatus for the cosmetic treatment of one or more of the epidermal skin layer, dermal skin layer, and below the dermal skin layer; energy-based apparatus for the cosmetic treatment of the epidermal skin layer; energy-based apparatus for the cosmetic treatment of the dermal skin layer; energy-based apparatus for the cosmetic treatment below the dermal skin layer; energy delivery instruments for one or more of medical use, dermatological use, and cosmetic treatment; light-based medical apparatus for the medical treatment of the face, body, tissue and skin; light-based medical apparatus for dermatological uses; light-based apparatus for the cosmetic treatment of the face, body, tissue and skin; light-based apparatus for the cosmetic treatment of one or more of the epidermal skin layer, dermal skin layer, and below the dermal skin layer; light-based apparatus for the cosmetic treatment of the epidermal skin layer; light-based apparatus for the cosmetic treatment of the dermal skin layer; light-based apparatus for the cosmetic treatment below the dermal skin layer; radio frequency apparatus for medical uses; radio frequency apparatus for the cosmetic treatment of the face, body, tissue and skin; lasers for medical uses; lasers for the cosmetic treatment of the face, body, tissue and skin; lasers for medical purposes; laser beam delivery instruments for medical use; injection needles and syringes for surgical, medical, dermatological and cosmetic injections; injection needles and syringes for injections into the lips and perioral areas, the periorbital areas, glabellar lines, and wrinkles; injection needles and syringes for injections into one or more of the epidermal skin layer, dermal skin layer,

and below the dermal skin layer; surgical implants comprised of artificial materials for therapeutic, cosmetic and aesthetic treatment.

44 – Medical consulting services in the field of dermatology and cosmetic treatments; providing medical information in the field of dermatology and cosmetic treatments; medical services, namely, energy-based procedures for treatment of the face, body, tissue and skin; medical services; hygienic and beauty care for human beings; beauty care; hair implantation; medical equipment rental; plastic surgery; tattooing; beauty salon services; medical advisory services in the field of skin and beauty therapy; medical assistance; pharmacy advice; nursing, medical; chiropractic; health counseling; medical service; medical clinic services; therapy services; dermatology services; physical therapy.

(260) AM 2022 113565 A

(800) 1597380

(151) 2021 02 18

(891) 2021 02 18

(731) FERVIAN TECHNOLOGIES LIMITED

Trust Company Complex, Ajeltake Road,
Ajeltake Island, MH96960 Majuro, Marshall
Islands

(540)



(591) Black, white

(531) 26.11.12; 27.05.01

(511)

7 – Robotic vacuum cleaners; robotic window cleaners.

9 – Breathalysers, alcohol detection devices, not for medical purposes; electrical adapters and WI-FI adapters; universal power supply units for computers; connected bracelets [measuring instruments], including fitness bracelets; brackets for TVs and monitors; selfie sticks [hand-held monopods]; stands adapted for laptops, smartphones and monitors; laboratory robots; teaching robots; security surveillance robots; wireless routers; surge protectors; smartwatches; sound recording and reproducing devices, namely radio cassette player.

10 – Breathalysers, alcohol detection devices, for medical purposes.

12 – Push scooters [vehicles], namely, electric push scooters.

20 – Armchairs, namely office and computer armchairs; tables, namely office and computer tables.

28 – Portable games and toys incorporating telecommunication functions, including radio-controlled toys and robot toys.

(260) AM 2022 113567 A

(800) 695736

(151) 1998 06 17

(891) 2021 01 14

(731) VAGHEGGI S.P.A.

Via F. Pigafetta, 6, I-36024 NANTO
(VICENZA), Italy

(540)

VAGHEGGI

(591) Black, white

(511)

3 – Facial, body and foot scrubs in the form of gel, cream, fluid and salt; eye make-up remover; skin cleansing creams; skin cleansing lotions; skin cleansing gel; skin cleansing milk; skin cleansing emulsions; whitening cleansing milk; face and body lotions, serums and fluids; face and body tonic lotions; whitening tonic, creams and fluid; face creams and emulsions; body creams and emulsions; cosmetic lifting effect creams; non-medicated foot and leg creams, gels and fluids; cosmetic hand creams, lotions, fluids and emulsions; eye and lip contour creams, gels and fluids; beauty masks; cosmetic lifting effect masks; whitening cream face masks; non-medicated deodorising foot lotions and creams; essential oils for personal use; essential oils, emulsions, creams, lotions, for massage; non-medicated body wraps and strips for skin; perfumes; toilet water; deodorants for personal use; shower gel; bubble bath; non-medicated bath and shower oils and salts; bath pearls; bath and shower cleansing milk; non-medicated skin and toilet soaps; non-medicated footbath creams, gels and lotions; shaving balms; shaving cream; aftershave lotions, creams, emulsions and gels; cosmetic concealer for make-up; cosmetic pencils; foundation make-up; face powders; eye shadow; talcum powder; rouges; lipsticks; mascaras; eye liner; sun screen preparations; cosmetic sun-tanning preparations; nail polish; nail polish removers; hair shampoos; hair sprays; hair lotions; cosmetic hair balms and creams; hair care serums; hair styling serums; non-medicated protective hair oils; hair gels; hair masks; hair conditioners; hair lacquers; hair mousse; depilatory creams; depilatory wax; depilatory preparations; depilatory strips; depilatory roll-strips and sticks; moustache wax; dentifrices; non-medicated compress-substances for skin care.

(260) AM 2022 113570 A

(800) 1227975

(151) 2014 07 25

(891) 2021 04 14

(731) Rinah – Società per azioni

Via Ciro Menotti 1, I-00195 Roma, Italy

(540)

DAN JOHN

(591) Black, white

(511)

25 – Clothing, namely dresses, trousers, skirts, t-shirts, jackets (clothing), raincoats, shirts, blouses, scarves, cardigans, jumpsuits, sweaters, jerseys, pullovers; hosiery; clothing of leather, fur coats; fur stoles; babies' pants; underwear, lingerie, pants, bras, vests, slips, boxer shorts; stockings, tights, socks, leg warmers, suspenders; pajamas, night shirts, dressing gowns; bathing suits and bathing trunks, wrap-around skirt, bath robes; dance cloth; masquerade costumes; wedding cloth; foulards, scarfs; ties, turbans, boas; gloves (clothing), belts (clothing); headgear for wear, namely hats and caps; footwear, namely leather shoes, rubber shoes, court shoes or half boots, winter boots, beach shoes, sandals, running shoes, rain boots, long boots, boots.

(260) AM 2022 113571 A

(800) 1247362

(151) 2015 03 31

(891) 2021 05 19

(731) Edge Systems LLC

2277 Redondo Avenue, Signal Hill CA 90755,
USA

(540)

HYDRAFACIAL

(591) Black, white

(511)

3 – Cleaning preparations for microdermabrasion machines; non-medicated skin care preparations, namely, lotions and serums.

(260) AM 2022 113572 A

(800) 1365502

(151) 2017 06 02

(891) 2021 05 18

(731) Edge Systems LLC

2165 E. Spring Street, Long Beach CA 90806,
USA

(540)

HYDRAFACIAL

(591) Black, white

(511)

44 – Medical and cosmetic treatment services provided by a health spa, namely minimally and non-invasive cosmetic facial and body treatment services.

(260) AM 2022 113573 A

(800) 1503204

(151) 2019 11 07

(891) 2021 06 01

(731) Chrome Hearts LLC

915 N. Mansfield; Hollywood CA 90038,
USA

(540)

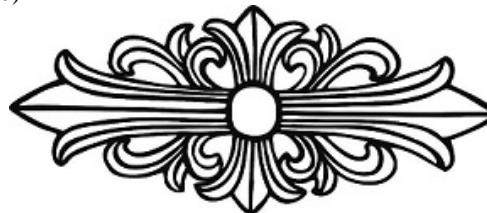

(591) Black, white

(531) 24.13.25; 25.01.25

(511)

9 – Eyewear, namely, eyeglasses, sunglasses, eyeglass cases and sunglass cases.

(260) AM 2022 113574 A

(800) 1543882

(151) 2020 07 01

(891) 2021 05 28

(731) Bayer Consumer Care AG

Peter Merian Strasse 84, CH-4052 Basel,
Switzerland

(540)

ТЕРАЛІВ

(591) Black, white

(531) 28.05

(511)

5 – Pharmaceutical products; nutritional supplements; food supplements, dietetic food supplements for humans; dietetic substances and foods for medical use; dietary fibers; biologically active additives for medical use; hygienic products for medical use; food for babies; plasters, materials for dressings; teeth filling materials, dental impression materials; disinfectants.

(260) AM 2022 113575 A

(800) 1546175

(151) 2020 07 01

(891) 2021 05 28

(731) Bayer Consumer Care AG

Peter Merian Strasse 84, CH-4052 Basel,
Switzerland

(540)

THERALEVE

(591) Black, white

(511)

5 – Pharmaceutical products; nutritional supplements; food supplements, dietetic food supplements for humans; dietetic substances and foods for medical use;

dietary fibers; biologically active additives for medical use; hygienic products for medical use; food for babies; plasters, materials for dressings; teeth filling material, dental impression materials; disinfectants.

(260) AM 2022 113673 A
 (800) 1006010
 (151) 2009 02 24
 (891) 2021 04 22
 (731) LABORATORIOS FARMACEUTICOS ROVI,
 S.A.
 C/ Julián Camarillo, 35, E-28037 MADRID,
 Spain

(540)

ROVI

(591) Black, white

(511)

5 – Pharmaceutical products excluding advertising and veterinary pharmaceutical specialties; hygienic products for medicine; dietetic substances for medical use, food for babies; plasters, material for dressings; material for dental fillings and for dental impressions; disinfectants; products for destroying vermin; fungicides, herbicides.

(260) AM 2022 113674 A
 (800) 1023697
 (151) 2009 10 05
 (891) 2021 06 03
 (731) Crostalia Limited
 Unit 1102, 11/F, 29 Austin Road, Tsim Sha
 Tsui, Kowloon, Hong Kong, China

(540)

БИЗНЕС ЛАНЧ

(591) Black, white

(531) 28.05

(511)

29 – Potato puree; fast-preparation potato puree, including potato puree with supplements of other foodstuffs.

30 – Noodles; fast-preparation noodles, including noodles with supplements of other foodstuffs.

(260) AM 2022 113675 A
 (800) 1226748
 (151) 2014 10 06
 (891) 2021 06 07
 (731) FIDIA FARMACEUTICI S.p.A.
 Via Ponte della Fabbrica, 3/A, I-35031
 Abano Terme (PD), Italy

(540)

HYALFID

(591) Black, white

(511)

5 – Pharmaceutical and veterinary preparations; medical-surgical supplies; sanitary preparations for medical purposes; dietetic products for medical use, food for babies; plasters, materials for dressings; material for stopping teeth, dental wax; disinfectants; preparations for destroying vermin; fungicides; herbicides; biomaterials for healthcare purposes.

10 – Surgical, medical, dental and veterinary apparatus and instruments, artificial limbs, eyes and teeth; orthopedic articles; suture materials.

(260) AM 2022 113715 A
 (800) 1599180
 (151) 2021 04 21
 (891) 2021 04 21
 (731) SHOKZ HOLDING LIMITED
 RM 2603A 26/F TOWER 1 LIPPO CTR 89,
 QUEENSWAY ADMIRALTY, Hong Kong,
 China

(540)

openrace

(591) Black, white

(531) 27.05.01

(511)

9 – Photocopiers; weighing apparatus and instruments; measures; earphones; ear pads for headphones; virtual reality headsets; portable media players; microphones; horns for loudspeakers; headsets for virtual reality games; megaphones; headphones; MP3 players; music headphones; cameras [photography]; connected bracelets [measuring instruments]; telescopes; materials for electricity mains [wires, cables]; ear plugs for divers; goggles for sports; swimming goggles; eyeglasses; sunglasses; sports glasses; batteries, electric; USB chargers.

(260) AM 2022 113731 A
 (800) 1599723
 (151) 2021 03 15
 (891) 2021 03 15
 (731) Winner Star Holdings Limited
 Room 306, Yip Fung Building, 2-12 D'Aguiar
 Street Central, Hong Kong, China

(540)

J&T

(591) Black, white

(531) 24.17.01; 27.05.01; 27.05.17

(511)

35 – Promotion of goods and services through sponsorship of sports events; writing of publicity texts;

layout services for advertising purposes; rental of advertising time on communication media; presentation of goods on communication media, for retail purposes; business management consultancy; sales promotion for others; import-export agency services; provision of an online marketplace for buyers and sellers of goods and services; compilation of information into computer databases; advertising; television advertising; advertising agency services; online advertising on a computer network.

36 – Providing insurance information; electronic funds transfer; processing of debit card payments; art appraisal; real estate agency services; rental of real estate; financial customs brokerage services; surety services; charitable fund raising; fiduciary; lending against security; insurance brokerage; real estate brokerage; securities brokerage.

39 – Freighting; transport; freight brokerage; wrapping of goods; marine transport; car transport; air transport; car rental; storage of goods; warehousing; parcel delivery; courier services [messages or merchandise]; transport services for sightseeing tours.

(260) AM 2022 113743 A

(800) 1600161

(151) 2021 04 21

(891) 2021 04 21

(731) OLIMP LABORATORIES Sp. z o.o.

Pustynia 84 F, PL-39-200 Dębica, Poland

(540)

Gold-Vit

(591) Black, white

(511)

5 – Pharmaceuticals; veterinary preparations; medicines for human purposes; food supplements; health food supplements for persons with special dietary requirements; herbal supplements; vitamins and vitamin preparations; vitamin and mineral preparations; herbal compounds for medical use; dietary supplement drink mixes; dietetic foods adapted for medical purposes; meal replacement powders; dietetic beverages adapted for medical purposes; nutritional supplement meal replacement bars for boosting energy.

INTERNATIONAL TRADEMARKS PROTECTED IN GEORGIA

(260) AM 2022 110739 A
(800) 1537539
(151) 2020 02 25
(181) 2030 02 25
(891) 2020 10 12
(511) 09

(260) AM 2022 110993 A
(800) 1566169
(151) 2020 08 04
(181) 2030 08 04
(891) 2020 08 04
(511) 01, 05, 09, 10

(260) AM 2022 111115 A
(800) 1568035
(151) 2020 01 14
(181) 2030 01 14
(891) 2020 01 14
(511) 09, 11, 12, 18, 20, 21, 24, 27, 28, 35, 37, 39, 40,
41, 42

(260) AM 2022 111128 A
(800) 1568354
(151) 2020 07 09
(181) 2030 07 09
(891) 2020 07 09
(511) 09, 29, 40, 42

(260) AM 2022 111134 A
(800) 1246496
(151) 2014 10 10
(181) 2024 10 10
(891) 2020 12 09
(511) 03

(260) AM 2022 111223 A
(800) 1569410
(151) 2020 08 06
(181) 2030 08 06
(891) 2020 08 06
(511) 16, 40

(260) AM 2022 111298 A
(800) 1570779
(151) 2020 11 19
(181) 2030 11 19
(891) 2020 11 19
(511) 05, 42, 44

(260) AM 2022 111299 A
(800) 1570810
(151) 2020 07 09
(181) 2030 07 09
(891) 2020 07 09
(511) 03, 35

(260) AM 2022 111300 A
(800) 1570817
(151) 2020 05 20
(181) 2030 05 20
(891) 2020 05 20
(511) 09, 35, 38, 41, 42

(260) AM 2022 111301 A
(800) 1570818
(151) 2020 09 20
(181) 2030 09 20
(891) 2020 09 20
(511) 16

(260) AM 2022 111302 A
(800) 1570821
(151) 2020 07 09
(181) 2030 07 09
(891) 2020 07 09
(511) 03, 05, 35

(260) AM 2022 111349 A
(800) 1571067
(151) 2020 10 28
(181) 2030 10 28
(891) 2020 10 28
(511) 10

(260) AM 2022 111350 A
(800) 1571071
(151) 2020 10 28
(181) 2030 10 28
(891) 2020 10 28
(511) 10

(260) AM 2022 111351 A
(800) 1571100
(151) 2020 10 28
(181) 2030 10 28
(891) 2020 10 28
(511) 10

(260) AM 2022 111352 A
(800) 1571114
(151) 2020 10 26
(181) 2030 10 26
(891) 2020 10 26
(511) 09

(260) AM 2022 111457 A
(800) 1572260
(151) 2020 11 20
(181) 2030 11 20
(891) 2020 11 20
(511) 30

(260) AM 2022 111353 A
(800) 1571129
(151) 2020 09 10
(181) 2030 09 10
(891) 2020 09 10
(511) 01, 02

(260) AM 2022 111458 A
(800) 1572261
(151) 2020 12 08
(181) 2030 12 08
(891) 2020 12 08
(511) 09

(260) AM 2022 111354 A
(800) 1571162
(151) 2020 10 29
(181) 2030 10 29
(891) 2020 10 29
(511) 07, 09, 11

(260) AM 2022 111459 A
(800) 1572278
(151) 2020 07 31
(181) 2030 07 31
(891) 2020 07 31
(511) 36

(260) AM 2022 111355 A
(800) 1571167
(151) 2020 08 20
(181) 2030 08 20
(891) 2020 08 20
(511) 14, 16, 18, 18, 25, 28

(260) AM 2022 111460 A
(800) 1572296
(151) 2020 12 08
(181) 2030 12 08
(891) 2020 12 08
(511) 09

(260) AM 2022 111384 A
(800) 1571933
(151) 2020 11 26
(181) 2030 11 26
(891) 2020 11 26
(511) 07, 11

(260) AM 2022 111490 A
(800) 1572868
(151) 2020 12 18
(181) 2030 12 18
(891) 2020 12 18
(511) 41

(260) AM 2022 111386 A
(800) 1064109
(151) 2010 11 03
(181) 2030 11 03
(891) 2020 12 31
(511) 03, 05, 38, 44

(260) AM 2022 111494 A
(800) 1484943
(151) 2019 07 12
(181) 2029 07 12
(891) 2021 01 08
(511) 34

(260) AM 2022 111456 A
(800) 1572247
(151) 2020 08 20
(181) 2030 08 20
(891) 2020 08 20
(511) 09, 35, 36, 38, 41, 42, 45

(260) AM 2022 111549 A
(800) 1573144
(151) 2020 10 06
(181) 2030 10 06
(891) 2020 10 06
(511) 12

(260) AM 2022 111551 A
(800) 1573262
(151) 2020 12 03
(181) 2030 12 03
(891) 2020 12 03
(511) 01

(260) AM 2022 111665 A
(800) 1575247
(151) 2020 12 15
(181) 2030 12 15
(891) 2020 12 15
(511) 09

(260) AM 2022 111554 A
(800) 1573381
(151) 2020 12 11
(181) 2030 12 11
(891) 2020 12 11
(511) 30, 31, 32, 43

(260) AM 2022 111666 A
(800) 1575250
(151) 2020 12 01
(181) 2030 12 01
(891) 2020 12 01
(511) 05, 30

(260) AM 2022 111556 A
(800) 1573399
(151) 2020 09 20
(181) 2030 09 20
(891) 2020 09 20
(511) 38, 41, 42

(260) AM 2022 111686 A
(800) 1462089
(151) 2019 03 04
(181) 2029 03 04
(891) 2021 01 20
(511) 34

(260) AM 2022 111576 A
(800) 1513739
(151) 2019 07 09
(181) 2029 07 09
(891) 2020 09 17
(511) 03, 05

(260) AM 2022 111687 A
(800) 1514854
(151) 2020 01 09
(181) 2030 01 09
(891) 2021 01 13
(511) 03

(260) AM 2022 111621 A
(800) 1574217
(151) 2020 12 07
(181) 2030 12 07
(891) 2020 12 07
(511) 35

(260) AM 2022 111767 A
(800) 1575556
(151) 2020 12 15
(181) 2030 12 15
(891) 2020 12 15
(511) 05

(260) AM 2022 111626 A
(800) 1574332
(151) 2020 07 20
(181) 2030 07 20
(891) 2020 07 20

(260) AM 2022 111768 A
(800) 1575560
(151) 2020 12 15
(181) 2030 12 15
(891) 2020 12 15
(511) 05

(260) AM 2022 111651 A
(800) 1575029
(151) 2020 12 24
(181) 2030 12 24
(891) 2020 12 24
(511) 09

(260) AM 2022 111771 A
(800) 1575611
(151) 2020 11 04
(181) 2030 11 04
(891) 2020 11 04
(511) 30

(260) AM 2022 111772 A
(800) 1575633
(151) 2020 07 27
(181) 2030 07 27
(891) 2020 07 27
(511) 03

(260) AM 2022 111796 A
(800) 1576374
(151) 2021 01 15
(181) 2031 01 15
(891) 2021 01 15
(511) 09

(260) AM 2022 111776 A
(800) 1575761
(151) 2020 10 02
(181) 2030 10 02
(891) 2020 10 02
(511) 05, 10

(260) AM 2022 111797 A
(800) 1576397
(151) 2021 01 18
(181) 2031 01 18
(891) 2021 01 18
(511) 09

(260) AM 2022 111778 A
(800) 1575850
(151) 2021 01 12
(181) 2031 01 12
(891) 2021 01 12
(511) 09, 43

(260) AM 2022 111798 A
(800) 1576419
(151) 2021 01 07
(181) 2031 01 07
(891) 2021 01 07
(511) 05

(260) AM 2022 111792 A
(800) 1576311
(151) 2020 12 17
(181) 2030 12 17
(891) 2020 12 17
(511) 07

(260) AM 2022 111799 A
(800) 1576431
(151) 2020 12 15
(181) 2030 12 15
(891) 2020 12 15
(511) 05

(260) AM 2022 111793 A
(800) 1576320
(151) 2020 11 16
(181) 2030 11 16
(891) 2020 11 16
(511) 09

(260) AM 2022 111800 A
(800) 1576440
(151) 2021 01 07
(181) 2031 01 07
(891) 2021 01 07
(511) 05

(260) AM 2022 111794 A
(800) 1576328
(151) 2021 01 15
(181) 2031 01 15
(891) 2021 01 15
(511) 09

(260) AM 2022 111807 A
(800) 1576620
(151) 2020 12 30
(181) 2030 12 30
(891) 2020 12 30
(511) 36

(260) AM 2022 111795 A
(800) 1576342
(151) 2021 01 19
(181) 2031 01 19
(891) 2021 01 19
(511) 09

(260) AM 2022 111809 A
(800) 1576697
(151) 2020 11 05
(181) 2030 11 05
(891) 2020 11 05
(511) 34

(260) AM 2022 111811 A
(800) 1576773
(151) 2020 07 01
(181) 2030 07 01
(891) 2020 07 01
(511) 25

(260) AM 2022 111832 A
(800) 1542049
(151) 2020 06 05
(181) 2030 06 05
(891) 2021 01 21
(511) 05

(260) AM 2022 111812 A
(800) 1576775
(151) 2020 11 10
(181) 2030 11 10
(891) 2020 11 10
(511) 09

(260) AM 2022 111886 A
(800) 1576834
(151) 2020 10 12
(181) 2030 10 12
(891) 2020 10 12
(511) 41

(260) AM 2022 111814 A
(800) 1576825
(151) 2020 11 18
(181) 2030 11 18
(891) 2020 11 18
(511) 07, 09

(260) AM 2022 111900 A
(800) 1577360
(151) 2020 12 31
(181) 2030 12 31
(891) 2020 12 31
(511) 09

(260) AM 2022 111822 A
(800) 1357492
(151) 2016 12 01
(181) 2026 12 01
(891) 2021 02 01
(511) 09, 38

(260) AM 2022 111904 A
(800) 1577426
(151) 2020 03 20
(181) 2030 03 20
(891) 2020 03 20
(511) 29, 35

(260) AM 2022 111823 A
(800) 1372394
(151) 2015 09 25
(181) 2025 09 25
(891) 2021 01 26
(511) 19, 35

(260) AM 2022 111915 A
(800) 1577787
(151) 2020 11 06
(181) 2030 11 06
(891) 2020 11 06
(511) 30

(260) AM 2022 111824 A
(800) 1381552
(151) 2017 11 21
(181) 2027 11 21
(891) 2021 01 28
(511) 05

(260) AM 2022 111916 A
(800) 1577788
(151) 2020 07 24
(181) 2030 07 24
(891) 2020 07 24
(511) 35, 38, 42

(260) AM 2022 111825 A
(800) 1391463
(151) 2017 11 27
(181) 2027 11 27
(891) 2021 01 20
(511) 14, 35

(260) AM 2022 111917 A
(800) 1577789
(151) 2021 01 13
(181) 2031 01 13
(891) 2021 01 13
(511) 32, 33

(260) AM 2022 111919 A
(800) 1577800
(151) 2021 01 18
(181) 2031 01 18
(891) 2021 01 18
(511) 42

(260) AM 2022 112000 A
(800) 1578582
(151) 2021 01 16
(181) 2031 01 16
(891) 2021 01 16
(511) 37

(260) AM 2022 111980 A
(800) 1578034
(151) 2020 11 24
(181) 2030 11 24
(891) 2020 11 24
(511) 28

(260) AM 2022 112001 A
(800) 1578583
(151) 2021 01 16
(181) 2031 01 16
(891) 2021 01 16
(511) 12

(260) AM 2022 111981 A
(800) 1578097
(151) 2021 01 25
(181) 2031 01 25
(891) 2021 01 25
(511) 30

(260) AM 2022 112004 A
(800) 1578604
(151) 2021 01 16
(181) 2031 01 16
(891) 2021 01 16
(511) 35

(260) AM 2022 111982 A
(800) 1578125
(151) 2020 12 19
(181) 2030 12 19
(891) 2020 12 19
(511) 09

(260) AM 2022 112011 A
(800) 1578804
(151) 2020 09 08
(181) 2030 09 08
(891) 2020 09 08
(511) 09

(260) AM 2022 111992 A
(800) 1578382
(151) 2020 11 24
(181) 2030 11 24
(891) 2020 11 24
(511) 35, 36

(260) AM 2022 112014 A
(800) 1578929
(151) 2020 12 18
(181) 2030 12 18
(891) 2020 12 18
(511) 09

(260) AM 2022 111993 A
(800) 1578405
(151) 2020 11 20
(181) 2030 11 20
(891) 2020 11 20
(511) 09, 28, 41

(260) AM 2022 112016 A
(800) 1578980
(151) 2020 09 29
(181) 2030 09 29
(891) 2020 09 29
(511) 07, 09, 35, 37

(260) AM 2022 111994 A
(800) 1578407
(151) 2020 11 25
(181) 2030 11 25
(891) 2020 11 25
(511) 33

(260) AM 2022 112018 A
(800) 1578988
(151) 2021 01 18
(181) 2031 01 18
(891) 2021 01 18
(511) 09, 42

(260) AM 2022 112019 A
(800) 1579017
(151) 2020 12 29
(181) 2030 12 29
(891) 2020 12 29
(511) 31

(260) AM 2022 112123 A
(800) 1580389
(151) 2021 01 27
(181) 2031 01 27
(891) 2021 01 27
(511) 01

(260) AM 2022 112022 A
(800) 1579053
(151) 2021 01 13
(181) 2031 01 13
(891) 2021 01 13
(511) 12, 18

(260) AM 2022 112124 A
(800) 1580418
(151) 2020 10 07
(181) 2030 10 07
(891) 2020 10 07
(511) 13

(260) AM 2022 112030 A
(800) 1579249
(151) 2021 01 20
(181) 2031 01 20
(891) 2021 01 20
(511) 32

(260) AM 2022 112125 A
(800) 1580429
(151) 2020 12 28
(181) 2030 12 28
(891) 2020 12 28
(511) 11

(260) AM 2022 112031 A
(800) 1579286
(151) 2020 08 31
(181) 2030 08 31
(891) 2020 08 31
(511) 04

(260) AM 2022 112127 A
(800) 1580497
(151) 2020 12 18
(181) 2030 12 18
(891) 2020 12 18
(511) 07, 09, 10, 20

(260) AM 2022 112111 A
(800) 1579734
(151) 2021 01 08
(181) 2031 01 08
(891) 2021 01 08
(511) 28

(260) AM 2022 112128 A
(800) 1580542
(151) 2020 07 16
(181) 2030 07 16
(891) 2020 07 16
(511) 35, 41, 42

(260) AM 2022 112121 A
(800) 1580295
(151) 2020 10 09
(181) 2030 10 09
(891) 2020 10 09
(511) 19, 37

(260) AM 2022 112130 A
(800) 1580549
(151) 2021 01 21
(181) 2031 01 21
(891) 2021 01 21
(511) 35, 38

(260) AM 2022 112122 A
(800) 1580375
(151) 2020 12 30
(181) 2030 12 30
(891) 2020 12 30
(511) 18

(260) AM 2022 112131 A
(800) 1580573
(151) 2020 09 10
(181) 2030 09 10
(891) 2020 09 10
(511) 06, 09, 37

(260) AM 2022 112132 A
(800) 1580582
(151) 2020 12 17
(181) 2030 12 17
(891) 2020 12 17
(511) 36

(260) AM 2022 112227 A
(800) 1581649
(151) 2021 02 08
(181) 2031 02 08
(891) 2021 02 08
(511) 30

(260) AM 2022 112197 A
(800) 1580971
(151) 2020 12 25
(181) 2030 12 25
(891) 2020 12 25
(511) 33

(260) AM 2022 112229 A
(800) 1581664
(151) 2021 02 02
(181) 2031 02 02
(891) 2021 02 02
(511) 30

(260) AM 2022 112198 A
(800) 1581001
(151) 2020 12 07
(181) 2030 12 07
(891) 2020 12 07
(511) 41

(260) AM 2022 112230 A
(800) 1581667
(151) 2020 09 30
(181) 2030 09 30
(891) 2020 09 30
(511) 03, 05, 10, 32

(260) AM 2022 112202 A
(800) 1581036
(151) 2021 01 28
(181) 2031 01 28
(891) 2021 01 28
(511) 05

(260) AM 2022 112231 A
(800) 1581669
(151) 2020 09 28
(181) 2030 09 28
(891) 2020 09 28
(511) 19

(260) AM 2022 112219 A
(800) 1581453
(151) 2020 12 16
(181) 2030 12 16
(891) 2020 12 16
(511) 12

(260) AM 2022 112232 A
(800) 1581698
(151) 2020 01 27
(181) 2030 01 27
(891) 2020 01 27
(511) 09, 28

(260) AM 2022 112220 A
(800) 1581529
(151) 2020 11 24
(181) 2030 11 24
(891) 2020 11 24
(511) 05

(260) AM 2022 112233 A
(800) 1581707
(151) 2021 01 21
(181) 2031 01 21
(891) 2021 01 21
(511) 31

(260) AM 2022 112226 A
(800) 1581618
(151) 2021 01 07
(181) 2031 01 07
(891) 2021 01 07
(511) 03

(260) AM 2022 112234 A
(800) 1581726
(151) 2020 11 23
(181) 2030 11 23
(891) 2020 11 23
(511) 09, 16, 18, 25, 35, 38, 41, 42, 45

(260) AM 2022 112235 A
 (800) 1581762
 (151) 2020 11 23
 (181) 2030 11 23
 (891) 2020 11 23
 (511) 09, 16, 18, 25, 35, 38, 41, 42, 45

(260) AM 2022 112349 A
 (800) 1583247
 (151) 2020 03 18
 (181) 2030 03 18
 (891) 2020 03 18
 (511) 10, 25

(260) AM 2022 112323 A
 (800) 1582418
 (151) 2021 02 02
 (181) 2031 02 02
 (891) 2021 02 02
 (511) 10

(260) AM 2022 112350 A
 (800) 1583271
 (151) 2020 08 27
 (181) 2030 08 27
 (891) 2020 08 27
 (511) 12, 37

(260) AM 2022 112337 A
 (800) 1583044
 (151) 2021 02 05
 (181) 2031 02 05
 (891) 2021 02 05
 (511) 12

(260) AM 2022 112351 A
 (800) 1583281
 (151) 2021 01 27
 (181) 2031 01 27
 (891) 2021 01 27
 (511) 01

(260) AM 2022 112338 A
 (800) 1583053
 (151) 2020 12 07
 (181) 2030 12 07
 (891) 2020 12 07
 (511) 30, 32, 43

(260) AM 2022 112352 A
 (800) 1583292
 (151) 2020 11 19
 (181) 2030 11 19
 (891) 2020 11 19
 (511) 03, 09, 14, 18, 25, 35

(260) AM 2022 112346 A
 (800) 1583128
 (151) 2021 01 27
 (181) 2031 01 27
 (891) 2021 01 27
 (511) 30, 31, 32

(260) AM 2022 112347 A
 (800) 1583196
 (151) 2021 02 11
 (181) 2031 02 11
 (891) 2021 02 11
 (511) 09

(260) AM 2022 112348 A
 (800) 1583201
 (151) 2021 02 12
 (181) 2031 02 12
 (891) 2021 02 12
 (511) 25

OFFICIAL NOTIFICATIONS

INVENTIONS

RESTORATION OF PATENTS

(21) AP 2012 13326
(11) P 2017 6614 B
(73) Joint Stock Company "Pharmasyntez"
(54) COMPOUNDS, PHARMACEUTICAL COMPOSITIONS AND A METHOD FOR THE
PROPHYLAXIS AND TREATMENT OF THE ADHESION PROCESS
DATE OF CANCELLATION OF PATENT: 2021 05 17
THE TERM OF RESTORATION OF PATENT: 2022 02 25

(21) AP 2016 14120
(11) P 2017 6714 B
(73) LTD "Intelcom Group"
(54) INSTRUMENT PROTECTING COVER REMOVAL FROM OPTIC CABLE
DATE OF CANCELLATION OF PATENT: 2021 05 04
THE TERM OF RESTORATION OF PATENT: 2022 02 25

ABOLITION OF PATENTS WITH THE RIGHT TO RESTORE

(21) AP 2011 12842
(11) P 2017 6587 B
(73) Corteva Agriscience LLC
(54) ENGINEERED LANDING PADS FOR GENE TARGETING IN PLANTS
DATE OF CANCELLATION OF PATENT: 2022 01 21
LIMITED DATE OF RESTORATION OF PATENT: 2023 01 21

(21) AP 2011 12848
(11) P 2015 6229 B
(73) Boehringer Ingelheim International Gmbh
(54) 5-ALKYNYL-PYRIMIDINES
DATE OF CANCELLATION OF PATENT: 2022 01 26
LIMITED DATE OF RESTORATION OF PATENT: 2023 01 26

(21) AP 2013 12974
(11) P 2016 6446 B
(73) Zurab Aslamazashvili;
Giorgi Oniashvili;
Garegin Zakharov;
Giorgi Tavadze;
Avtandil Khvadagiani;
Otar Okrostsvardize;
Aleksandre Berner
(54) HARD ALLOY
DATE OF CANCELLATION OF PATENT: 2022 01 22
LIMITED DATE OF RESTORATION OF PATENT: 2023 01 22

(21) AP 2013 12976

(11) P 2016 6519 B

(73) Zurab Aslamazashvili;

Giorgi Oniashvili;

Garegin Zakharov;

Giorgi Tavadze;

Avtandil Khvadagiani;

Otar Okrostsvaridze

(54) METHOD FOR PRODUCING SYNTHETIC COMPOSITE CERAMIC MATERIALS-HARD ALLOY HAVING ULTRAFINE STRUCTURE IN SYSTEMS TI-B-N-ME AND TI-B-N-C-ME

DATE OF CANCELLATION OF PATENT: 2022 01 22

LIMITED DATE OF RESTORATION OF PATENT: 2023 01 22

(21) AP 2014 13369

(11) P 2015 6323 B

(73) Avtandil Tevdoradze

(54) SPRINKLER KNAPSACK

DATE OF CANCELLATION OF PATENT: 2022 01 31

LIMITED DATE OF RESTORATION OF PATENT: 2023 01 31

(21) AP 2014 13374

(11) P 2014 6174 B

(73) Ioseb Maisuradze

(54) METHOD TO REPAIR RAILWAY AND/OR UNDERGROUND CARRIAGE FRAME CROSS BEAM CRACK

DATE OF CANCELLATION OF PATENT: 2022 02 03

LIMITED DATE OF RESTORATION OF PATENT: 2023 02 03

(21) AP 2013 13532

(11) P 2017 6767 B

(73) Chiesi Farmaceutici S.P.A.

(54) DRY POWDER FORMULATION COMPRISING A CORTICOSTEROID AND A BETA-ADRENERGIC FOR ADMINISTRATION BY INHALATION

DATE OF CANCELLATION OF PATENT: 2022 01 23

LIMITED DATE OF RESTORATION OF PATENT: 2023 01 23

(21) AP 2013 13555

(11) P 2016 6540 B

(73) Les Laboratoires Servier;

Vernalis (R & D) LTD

(54) NEW INDOLIZINE DERIVATIVES, METHOD FOR THEIR PREPARATION AND PHARMACEUTICAL COMPOSITIONS CONTAINING THEREOF

DATE OF CANCELLATION OF PATENT: 2022 01 23

LIMITED DATE OF RESTORATION OF PATENT: 2023 01 23

(21) AP 2015 13702

(11) P 2016 6425 B

(73) LEPL "Sokhumi Institute of Physics and Equipment of Ilia Vekua"

(54) METHOD AND EQUIPMENT FOR RECEIVING GIANT LASER IMPULSES

DATE OF CANCELLATION OF PATENT: 2022 01 22

LIMITED DATE OF RESTORATION OF PATENT: 2023 01 22

(21) AP 2015 13727
(11) P 2017 6652 B
(73) Bichiko Surguladze;
Nugzar Svianadze;
Levan Pirkulashvili
(54) PRELIMINARILY TENSED FRAME CONSTRUCTION
DATE OF CANCELLATION OF PATENT: 2022 02 06
LIMITED DATE OF RESTORATION OF PATENT: 2023 02 06

(21) AP 2015 13728
(11) P 2016 6478 B
(73) Tamaz Shioshvili
(54) DEVICE FOR GETTING HAIR ROOT AND TRANSPLANTATION THEREOF
DATE OF CANCELLATION OF PATENT: 2022 02 06
LIMITED DATE OF RESTORATION OF PATENT: 2023 02 06

(21) AP 2014 13925
(11) P 2019 7049 B
(73) Boris Gorinshtein
(54) COMPOSITIONS AND METHODS FOR TREATING SURFACE WOUNDS
DATE OF CANCELLATION OF PATENT: 2022 01 29
LIMITED DATE OF RESTORATION OF PATENT: 2023 01 29

(21) AP 2017 14402
(11) P 2018 6897 B
(73) LEPL "Georgian Technical University";
LEPL "National Science Foundation of Shota Rustaveli"
(54) METHOD FOR CEMENT PRODUCTION
DATE OF CANCELLATION OF PATENT: 2022 02 02
LIMITED DATE OF RESTORATION OF PATENT: 2023 02 02

(21) AP 2016 14833
(11) P 2020 7176 B
(73) Natco Pharma LTD
(54) PHARMACEUTICAL COMPOSITIONS COMPRISING PHENYLAMINOPYRIMIDINE DERIVATIVE
DATE OF CANCELLATION OF PATENT: 2022 01 30
LIMITED DATE OF RESTORATION OF PATENT: 2023 01 30

(21) AP 2017 14845
(11) P 2021 7312 B
(73) Tolmar International Limited
(54) VENTED COVER PLATE FOR AN ARRAY OF SYRINGES
DATE OF CANCELLATION OF PATENT: 2022 02 03
LIMITED DATE OF RESTORATION OF PATENT: 2023 02 03

(21) AP 2017 14871
(11) P 2020 7163 B
(73) Lindsay MOLONEY;
Guy SCOTT
(54) A SYSTEM AND METHOD FOR DOCUMENT INFORMATION AUTHENTICITY VERIFICATION
DATE OF CANCELLATION OF PATENT: 2022 02 07
LIMITED DATE OF RESTORATION OF PATENT: 2023 02 07

(21) AP 2019 14995
(11) P 2020 7153 B
(73) LEPL "Rafael Dvali Institute of Machine Mechanics"
(54) AIR-HYDRAULIC FORGING MACHINE
DATE OF CANCELLATION OF PATENT: 2022 02 08
LIMITED DATE OF RESTORATION OF PATENT: 2023 02 08

(21) AP 2018 15169
(11) P 2020 7202 B
(73) Chiesi Farmaceutici S.P.A.
(54) TYROSINE AMIDE DERIVATIVES AS RHO-KINASE INHIBITORS
DATE OF CANCELLATION OF PATENT: 2022 01 26
LIMITED DATE OF RESTORATION OF PATENT: 2023 01 26

EXPIRATION OF TERMS OF RESTORATION OF PATENTS

(21) AP 2011 12849
(11) P 2014 6177 B
(73) GB007 Inc.
(54) PYRAZOLE COMPOUNDS AS CRTH2 ANTAGONISTS
DATE OF CANCELLATION OF PATENT: 2021 01 24
THE TERM OF RESTORATION OF PATENT VALIDITY HAS EXPIRED:2022 01 24

(21) AP 2015 13698
(11) P 2016 6549 B
(73) Jondo Togonidze
(54) METHOD FOR GUILDING LARGESPAN BRIDGES
DATE OF CANCELLATION OF PATENT: 2021 01 21
THE TERM OF RESTORATION OF PATENT VALIDITY HAS EXPIRED:2022 01 21

(21) AP 2015 13724
(11) P 2016 6563 B
(73) Vladimer Loladze;
Vakhtang Loladze;
Giorgi Loladze;
Nino Loladze
(54) DEVICE FOR FIRE EXTINGUISHING AND ENERGY CARRIER REJECTED FROM DAMAGED HEEL
OR PIPE DUCT WITHDRAWAL
DATE OF CANCELLATION OF PATENT: 2021 02 05
THE TERM OF RESTORATION OF PATENT VALIDITY HAS EXPIRED:2022 02 05

CHANGES OF NAMES AND/OR ADDRESSES OF PATENTOWNERS

(21) AP 2015 14379

(11) P 2019 7011 B

(54) HETEROARYL COMPOUNDS FOR KINASE INHIBITION

NEW NAME AND NEW ADDRESS: Ariad Pharmaceuticals Inc.
40 Landsdowne Street Cambridge, MA 02139, USA (US)

FORMER NAME AND FORMER ADDRESS: Ariad Pharmaceuticals Inc.
26 Landsdowne Street Cambridge, MA 02139, USA (US)

DATE OF REGISTRATION: 2022 02 11

(21) AP 2015 14706

(11) P 2020 7111 B

(54) HETEROARYL COMPOUNDS FOR KINASE INHIBITION

NEW NAME AND NEW ADDRESS: Ariad Pharmaceuticals Inc.
40 Landsdowne Street Cambridge, MA 02139, USA (US)

FORMER NAME AND FORMER ADDRESS: Ariad Pharmaceuticals Inc.
26 Landsdowne Street Cambridge, MA 02139, USA (US)

DATE OF REGISTRATION: 2022 02 11

UTILITY MODELS

RESTORATION OF PATENTS

(21) AU 2015 14021

(11) U 2016 1914 Y

(73) Shakespo Yusupov;

Daniel Iosebashvili;

Mukhran Bedianidze

(54) METHOD FOR BAKING BREAD

DATE OF CANCELLATION OF PATENT: 2021 12 21

THE TERM OF RESTORATION OF PATENT: 2022 02 25

(21) AU 2017 14407

(11) U 2018 1982 Y

(73) Giorgi Khmiadashvili

(54) FRUIT AND VEGETABLE DRYING PLANT

DATE OF CANCELLATION OF PATENT: 2022 02 03

THE TERM OF RESTORATION OF PATENT: 2022 02 25

(21) AU 2019 14990

(11) U 2020 2045 Y

(73) Paata Gogoladze

(54) METHOD FOR RETICULAR TISSUE PRODUCTION FOR ARMORING ASPHALT CONCRETE

DATE OF CANCELLATION OF PATENT: 2022 01 25

THE TERM OF RESTORATION OF PATENT: 2022 02 25

ABOLITION OF PATENTS WITH THE RIGHT TO RESTORE

(21) AU 2017 14407
(11) U 2018 1982 Y
(73) Giorgi Khmiadashvili
(54) FRUIT AND VEGETABLE DRYING PLANT
DATE OF CANCELLATION OF PATENT: 2022 02 03
LIMITED DATE OF RESTORATION OF PATENT: 2024 02 03

(21) AU 2020 15267
(11) U 2021 2078 Y
(73) Avtandil Bitsadze
(54) HELIODRYER FOR AGRICULTURAL PRODUCTION
DATE OF CANCELLATION OF PATENT: 2022 01 30
LIMITED DATE OF RESTORATION OF PATENT: 2023 01 30

(21) AU 2020 15270
(11) U 2021 2080 Y
(73) Nino Mchedlishvili
(54) MULTIPLE USAGE PAD FOR LADY
DATE OF CANCELLATION OF PATENT: 2022 02 04
LIMITED DATE OF RESTORATION OF PATENT: 2023 02 04

(21) AU 2020 15275
(11) U 2021 2066 Y
(73) Davit Chichua
(54) MOBILE SYSTEM FOR EDUCATIONAL, EXAMINATION OR CONFERENCE PURPOSES
DATE OF CANCELLATION OF PATENT: 2022 02 13
LIMITED DATE OF RESTORATION OF PATENT: 2023 02 13

EXPIRATION OF TERMS OF RESTORATION OF PATENT

(21) AU 2019 14993
(11) U 2020 2034 Y
(73) Revaz Sikharulidze
(54) SIKHARULIDZE'S WALL
DATE OF CANCELLATION OF PATENT: 2021 02 06
THE TERM OF RESTORATION OF PATENT VALIDITY HAS EXPIRED:2022 02 06

DESIGNS

EXTENSION OF TERMS OF DESIGN REGISTRATION

- (11) D 2013 526 S
 - (73) Giorgi Chukhukidze (GE)
Dighomi Array III quarter, building 6v, app. 57, 0159, Tbilisi, Georgia (GE)
 - (54) LINGERIE WITH ROAD SIGN APPLICATIONS
 - (28) 2
 - (24) 2012 06 06
 - (18) 2027 06 06
 - (58) 2022 02 07
-

CANCELLATION OF DESIGN REGISTRATION

- (11) D 2017 704 S
 - (73) Malkhaz Molodini (GE)
Vill. Ksovrisi, 3313, Mtskheta, Georgia (GE)
 - (54) QVEVRI (WINE JAR) WITH CONTAINER
 - (18) 2021 08 05
 - (58) 2022 02 16
-

EXTENSION OF TERMS OF INTERNATIONAL DESIGNS REGISTRATION

- (11) DM/68378
 - (73) SARA LEE HOUSEHOLD AND BODY CARE NEDERLAND B.V.
Vleutensevaart 35, NL-3532 AD Utrecht (NL)
 - (15) 2006 12 14
 - (24) 2006 12 14
 - (18) 2026 12 14
 - (28) 2
 - (28') 2
 - (54) Air deodorising apparatus, Refill for air deodorizing apparatus
-

- (11) DM/93727
 - (73) SEXY BACK BRA, LLC
100 Whitefish Hills Dr, Whitefish MT 59937 (US)
 - (15) 2016 08 08
 - (24) 2016 08 08
 - (18) 2026 08 08
 - (28) 1
 - (28') 1
 - (54) Brassiere
-

(11) DM/93755
(73) OMEGA SA (OMEGA AG) (OMEGA LTD.)
Jakob-Stämpfli-Strasse 96, CH-2502 Biel/Bienne (CH)
(15) 2016 12 05
(24) 2016 12 05
(18) 2026 12 05
(28) 4
(28') 4
(54) Dials, Watch cases

(11) DM/94088
(73) MONTRES JAQUET DROZ SA (MONTRES JAQUET DROZ AG) (MONTRES JAQUET DROZ LTD.)
Allée du Tourbillon 2, CH-2300 La Chaux-de-Fonds (CH)
(15) 2016 12 28
(24) 2016 12 28
(18) 2026 12 28
(28) 4
(28') 4
(54) Dial, Dials, Watch

(11) DM/94093
(73) ETA SA MANUFACTURE HORLOGÈRE SUISSE
Schild-Rust-Strasse 17, CH-2540 Grenchen (CH)
(15) 2016 12 28
(24) 2016 12 28
(18) 2026 12 28
(28) 4
(28') 2
(54) Display unit without storage elements, Display unit with storage elements, Storage elements for display unit

(11) DM/94457
(73) LARPLAST PLASTİK AMBALAJ SANAYİ VE TİCARET LİMİTED ŞİRKETİ
Selahaddin Eyyubi Mah. Piri Reis Cad. No:10 Çamsan Fabrika Binası Bodrum 1. Kat Kiraç Esenyurt, (TR)
(15) 2016 12 13
(24) 2016 12 13
(18) 2026 12 13
(28) 1
(28') 1
(54) Disposable containers for storing food

(11) DM/94484
(73) BLANCPAIN SA
Le Rocher 12, CH-1348 LE BRASSUS (CH)
(15) 2017 01 26
(24) 2017 01 26
(18) 2027 01 26
(28) 3
(28') 2
(54) Dials

- (11) DM/94780
 - (73) PEUGEOT CITROËN AUTOMOBILES SA
Route de Gisy, F-78140 VELIZY-VILLACOUBLAY (FR)
 - (15) 2017 02 17
 - (24) 2017 02 17
 - (18) 2027 02 17
 - (28) 2
 - (28') 2
 - (54) Radiator grilles for motor vehicles
-

TRADEMARKS

EXTENSION OF TERMS OF REGISTRATION

(111) M 2002 14783 R2

(156) 2002 10 29

(186) 2032 10 29

(732) Efes Holland Technical

Management Consultancy B.V.
Strawinskylaan 1229, 1077XX Amsterdam,
Netherlands

Salganskaya St. 7, Nizhniy Novgorod,
RU-603950, Russian Federation

(111) M 2002 14778 R2

(156) 2002 10 29

(186) 2032 10 29

(732) Efes Holland Technical

Management Consultancy B.V.
Strawinskylaan 1229, 1077XX Amsterdam,
Netherlands

(111) M 2011 22003 R1

(156) 2011 11 30

(186) 2031 11 30

(732) Akcionernoe Obchestvo "Nizegorodskiy
Khimiko-Pharmaceuticheskiy Zavod"
Salganskaya St. 7, Nizhniy Novgorod,
RU-603950, Russian Federation

(111) M 2010 20880 R1

(156) 2010 11 03

(186) 2030 11 03

(732) LLC "Vartsikhe Group"

Paliashvili St. 64, Vake-Saburtalo District,
Tbilisi, Georgia

(111) M 2011 21933 R1

(156) 2011 10 28

(186) 2031 10 28

(732) Eurobank S.A.
8 Othonos Street, 10557 Athen, Greece

(111) M 2012 22656 R1

(156) 2012 06 07

(186) 2032 06 07

(732) LLC "Pharmaceutical House +"

Lvovi St. 92, Tbilisi, Georgia

(111) M 2012 22193 R1

(156) 2012 01 18

(186) 2032 01 18

(732) SmileGate Entertainment, Inc.
5th, Solidspace Bldg., 673, Sampyeong-dong,
Bundang-gu, Seongnam-si, Gyeonggi-do,
463-400, Republic of Korea

(111) M 2011 21674 R1

(156) 2011 08 04

(186) 2031 08 04

(732) Paroc Group Oy

Energiakuja 3, FI-00180 Helsinki, Finland

(111) M 2012 22245 R1

(156) 2012 02 03

(186) 2032 02 03

(732) Efes Holland Technical
Management Consultancy B.V.
Strawinskylaan 1229, 1077XX Amsterdam,
Netherlands

(111) M 2012 22235 R1

(156) 2012 02 03

(186) 2032 02 03

(732) YILDIZ HOLDING A.S.

Kısıklı Mahallesi Çeşme Çıkmazı, Sokak
No:6/1, Üsküdar İstanbul, Turkey

(111) M 2012 22256 R1

(156) 2012 02 03

(186) 2032 02 03

(732) Shiseido Company Limited
7-5-5 Ginza, Chuo-ku, Tokyo 104-8010,
Japan

(111) M 2011 22001 R1

(156) 2011 11 30

(186) 2031 11 30

(732) Akcionernoe Obchestvo "Nizegorodsky
Khimiko-Pharmaceuticheskiy Zavod"

(111) M 2012 22271 R1

(156) 2012 02 03

(186) 2032 02 03

(732) Obshestvo s Ogranichennoy Otvestvennostiu
"New Product"
Ul. Sportivnaya 3, 01033, Kiev, Ukraine

(111) M 2012 22272 R1
(156) 2012 02 03
(186) 2032 02 03
(732) JSC "Galichpharm"
Ul. Oprishkovskaya, 6/8, 79024, Lvov,
Ukraine

(111) M 2012 23093 R1
(156) 2012 11 28
(186) 2032 11 28
(732) Royal Armenia JV LLC
Apt. 38, Bld 26, Davitashen 2nd district,
0054, Yerevan, Armenia

(111) M 2012 22273 R1
(156) 2012 02 03
(186) 2032 02 03
(732) JSC "Galichpharm"
Ul. Oprishkovskaya, 6/8, 79024, Lvov,
Ukraine

(111) M 2012 23122 R1
(156) 2012 11 29
(186) 2032 11 29
(732) Zeltiq Aesthetics Inc.
1 N. Waukegan Road, North Chicago,
IL 60064, USA

(111) M 2012 23143 R1
(156) 2012 11 29
(186) 2032 11 29
(732) Zeltiq Aesthetics Inc.
1 N. Waukegan Road, North Chicago,
IL 60064, USA

(111) M 2012 23144 R1
(156) 2012 11 29
(186) 2032 11 29
(732) Zeltiq Aesthetics Inc.
1 N. Waukegan Road, North Chicago,
IL 60064, USA

(111) M 2012 23091 R1
(156) 2012 11 28
(186) 2032 11 28
(732) Royal Armenia JV LLC
Apt.38, Bld 26, Davitashen 2nd district,
0054, Yerevan, Armenia

(111) M 2012 23092 R1
(156) 2012 11 28
(186) 2032 11 28
(732) Royal Armenia JV LLC
Apt.38, Bld 26, Davitashen 2nd district,
0054, Yerevan, Armenia

COMPLETE TRANSFER OF RIGHTS

(111) M 2020 33117 R
(732) LLC "Albatros"
Zahesi Settlement, Mikheil Tsinamdzgvrishvili Str. 19, Gldani district, Tbilisi, Georgia
(770) Luka Akhvlediani
Sulkhan-Saba St. 48, app. 21, Kutaisi, Georgia;
Ina Nemsadze
Rustaveli St. 162, app. 38, Kobuleti, Georgia
(580) 2022 02 04

(111) M 2020 33118 R
(732) LLC "Albatros"
Zahesi Settlement, Mikheil Tsinamdzgvrishvili Str. 19, Gldani district, Tbilisi, Georgia
(770) Luka Akhvlediani
Sulkhan-Saba St. 48, app. 21, Kutaisi, Georgia;
Ina Nemsadze
Rustaveli St. 162, app. 38, Kobuleti, Georgia
(580) 2022 02 04

(111) M 2021 34327 R
(732) Sun Pharmaceuticals Industries Limited
Sparc, Tandalja, Vadodara - 390 012, Gujarat, India
(770) Sun Pharma Global FZE
Executive Suite Y-43, P.O. Box 122304, Saif Zone, Sharjah, United Arab Emirates
(580) 2022 01 25

(111) M 2021 34786 R
(732) Shenzhen Baseus Technology Co., LTD
2/F, Building B, Baseus Intelligence Park, No.2008, Xuegang Road, Gangtou Community, Bantian Street, Longgang District, Shenzhen, China
(770) Shenzhen Times Innovation Technology Co., LTD
5th Floor, Building B, Baseus Intelligence Park, No.2008, Xuegang Rd, Gangtou Community, Bantian Street, Longgang District, Shenzhen City, Guangdong Province, China
(580) 2022 02 03

(111) M 2011 21674 R
(732) Paroc Group Oy
Energiakuja 3, FI-00180 Helsinki, Finland
(770) Paroc Oy AB
Energiakuja 3, 00180 Helsinki, Finland
(580) 2022 02 02

(111) M 2011 21933 R
(732) Eurobank S.A.
8 Othonos Street, 10557 Athen, Greece
(770) Eurobank Ergasias SA
8 Othonos St., 10557 Athens, Greece
(580) 2022 01 28

(111) M 1996 3238 R
(732) Abg Izod LLC
1411 Broadway, New York, NY 10018, USA
(770) Cluett Peabody & Co., Inc.
200 Madison Avenue New York, NY 10016, USA
(580) 2022 02 10

(111) M 1996 3210 R
(732) Abg Izod LLC
1411 Broadway, New York, NY 10018, USA
(770) Cluett Peabody & Co., Inc.
200 Madison Avenue New York, NY 10016,
(580) 2022 02 10

(111) M 1999 12016 R
(732) Abg Izod LLC
1411 Broadway, New York, NY 10018, USA
(770) PVH Corp.
200 Madison Avenue, New York, New York 10016, USA
(580) 2022 02 10

(111) M 2019 30935 R
(732) Shenjen Baseus Teqnoloji Ko., Ltd
2/F, Building B, Baseus Intelligence Park, No.2008, Xuegang Road, Gangtou Community, Bantian Street, District, Shenzhen, China
(770) Shenzhen Times Innovation Technology Co., LTD
Room 03, 6/F, Building 3, Winlead, Fada Road, Bantian Street, Longgang District, Shenzhen City, Guangdong Province, China
(580) 2022 02 03

CHANGES OF NAMES AND/OR ADDRESSES OF TRADEMARKS OWNER

(111) M 2020 33481 R
(732) Subway IP LLC
325 Sub Way, Milford, CT 06461, USA
(770) Subway IP LLC
8400 Chrd-das, 36-e St., Sti 530, Doral,
Florida 33166, USA
(580) 2022 01 18

(111) M 1998 8580 R
(732) The Quaker Oats Company
433 West Van Buren Street, Suite 350N,
Chicago, Illinois 60607, USA
(770) The Quaker Oats Company
555, West Monroe Street, Chicago,
Illinois 60661, USA
(580) 2022 02 10

(111) M 1999 12459 R
(732) TotalEnergies Holdings
2, place Jean Millier, La Defense 6,
F-92400 Courbevoie, France
(770) Total Holdings SAS
2, place Jean Millier, La Defense 6,
F-92400 Courbevoie, France
(580) 2022 01 28

(111) M 2000 13177 R
(732) Subway IP LLC
325 Sub Way, Milford, CT 06461, USA
(770) Subway IP LLC
8400 NW 36th St., Ste 530, Doral, Florida,
33166, USA
(580) 2022 01 18

(111) M 1998 10178 R
(732) The Quaker Oats Company
433 West Van Buren Street, Suite 350N,
Chicago, Illinois 60607, USA
(770) The Quaker Oats Company
555, West Monroe Street, Chicago,
Illinois 60661, USA
(580) 2022 02 10

(111) M 2011 21674 R
(732) Paroc Oy AB
Energiakuja 3, 00180 Helsinki, Finland
(770) Paroc Oy AB
Lakkisepantie 23, 00620, Helsinki, Finland
(580) 2022 02 02

(111) M 2012 22235 R
(732) Yildiz Holding A.S.
Kısıklı Mahallesi Çeşme Çıkmazı, Sokak
No:6/1, Üsküdar İstanbul, Turkey
(770) Yildiz Holding A.S.
Kısıklı mah. Ferah Cad. Kısıklı Cesme Sk.
No:2/4 B. Camlica, Uskudar/Istanbul, Turkey
(580) 2022 01 28

(111) M 2012 22193 R
(732) SmileGate Entertainment, Inc.
5th, Solidspace Bldg., 673, Sampyeong-dong,
Bundang-gu, Seongnam-si, Gyeonggi-do,
463-400, Republic of Korea
(770) SmileGate, Inc.
5th, Solidspace Bldg., 673, Sampyeong-dong,
Bundang-gu, Seongnam-si, Gyeonggi-do,
463-400, Republic of Korea
(580) 2022 01 17

(111) M 2012 22272 R
(732) JSC "Galichpharm"
Ul. Oprishkovskaya 6/8, 79024, Lvov,
Ukraine
(770) Aktsionernoe Obchestvo Otkritogo Tipa
"Galichpharm"
Ul. Oprishkovskaya 6/8, 79024 Lvovi, Ukraine
(580) 2022 02 04

(111) M 2012 22273 R
(732) JSC "Galichpharm"
Ul. Oprishkovskaya 6/8, 79024, Lvov,
Ukraine
(770) Aktsionernoe Obchestvo Otkritogo Tipa
"Galichpharm"
Ul. Oprishkovskaya 6/8, 79024 Lvovi, Ukraine
(580) 2022 02 04

(111) M 2012 23122 R
(732) Zeltiq Aesthetics Inc.
1 N. Waukegan Road, North Chicago,
IL 60064, USA
(770) Zeltiq Aesthetics Inc.
4698 Willow Road, Suite 100, Pleasanton,
California 94588, USA
(580) 2022 02 10

(111) M 2012 23143 R
(732) Zeltiq Aesthetics Inc.
1 N. Waukegan Road, North Chicago,
IL 60064, USA

(770) Zeltiq Aesthetics Inc.
4698 Willow Road, Suite 100, Pleasanton,
California 94588, USA
(580) 2022 02 10

(111) M 2012 23144 R
(732) Zeltiq Aesthetics Inc.
1 N. Waukegan Road, North Chicago,
IL 60064, USA
(770) Zeltiq Aesthetics Inc.
4698 Willow Road, Suite 100, Pleasanton,
California 94588, USA
(580) 2022 02 10

(111) M 2012 23091 R
(732) Royal Armenia JV LLC
Apt. 38, Bld 26, Davitashen 2nd district,
0054, Yerevan, Armenia
(770) JV Royal Armenia LTD
38 app/26, davidashen 2, Erevani, Armenia
(580) 2022 02 08

(111) M 2012 23092 R
(732) Royal Armenia JV LLC
Apt. 38, Bld 26, Davitashen 2nd district,
0054, Yerevan, Armenia
(770) JV Royal Armenia LTD
38 app/26, davidashen 2, Erevani, Armenia
(580) 2022 02 08

(111) M 2012 23093 R
(732) Royal Armenia JV LLC
Apt. 38, Bld 26, Davitashen 2nd district,
0054, Yerevan, Armenia
(770) JV Royal Armenia LTD
38 app/26, davidashen 2, Erevani, Armenia
(580) 2022 02 08

(111) M 1999 11966 R
(732) Posco International Corporation
134 Teheranro, Gangnam-gu, Seoul,
Republic of Korea
(770) Posco International Corporation
10, Tongil-ro, Jung-gu, Seoul,
Republic of Korea
(580) 2022 02 07

(111) M 1999 11967 R
(732) Posco International Corporation
134 Teheran-ro, Gangnam-gu, Seoul,
Republic of Korea

(770) Posco International Corporation
10, Tongil-ro, Jung-gu, Seoul,
Republic of Korea
(580) 2022 02 07

(111) M 2015 26438 R
(732) LX Hausys LTD
98, Huam-ro, Jung-gu, Seoul, Republic of
Korea
(770) LG Hausys LTD
One IFC Building, 10 Gukjegeumyung-ro,
Yeongdeungpo-gu, Seoul 150-876, Republic
Korea
(580) 2022 01 05

(111) M 1998 8514 R
(732) The Quaker Oats Company
433 West Van Buren Street, Suite 350N,
Chicago, Illinois 60607, USA
(770) The Quaker Oats Company
555, West Monroe Street, Chicago,
Illinois 60661, USA
(580) 2022 02 10

(111) M 1998 8515 R
(732) The Quaker Oats Company
433 West Van Buren Street, Suite 350N,
Chicago, Illinois 60607, USA
(770) The Quaker Oats Company
555, West Monroe Street, Chicago,
Illinois 60661, USA
(580) 2022 02 10

(111) M 1998 8516 R
(732) The Quaker Oats Company
433 West Van Buren Street, Suite 350N,
Chicago, Illinois 60607, USA
(770) The Quaker Oats Company
555, West Monroe Street, Chicago,
Illinois 60661, USA
(580) 2022 02 10

(111) M 2019 30729 R
(732) Subway IP LLC
325 Sub Way, Milford, CT 06461, USA
(770) Subway IP LLC
8400 NW 36th St., Ste 530, Dorali, Florida,
33166, USA
(580) 2022 01 18

(111) M 2019 30730 R
(732) Subway IP LLC
325 Sub Way, Milford, CT 06461, USA
(770) Subway IP LLC
8400 NW 36th St., Ste 530, Dorali,
Florida, 33166, USA
(580) 2022 01 18

CANCELLATION OF TRADEMARKS REGISTRATION

(111) M 2011 21673 R
(151) 2011 08 04
(732) Sopio Japaridze
Petriashvili St. 6, 0179, Tbilisi, Georgia
(141) 2022 02 14

(111) M 2011 21676 R
(151) 2011 08 04
(732) Astellas Pharma Inc.
5-1, Nihonbashi-Honcho 2-Chome, Chuo-ku,
Tokyo 103-8411, Japan
(141) 2022 02 14

(111) M 2011 21677 R
(151) 2011 08 04
(732) Astellas Pharma Inc.
3-11, Nihonbashi-Honcho, 2-Chome, Chuo-ku,
Tokyo, Japan
(141) 2022 02 14

(111) M 2011 21678 R
(151) 2011 08 04
(732) Astellas Pharma Inc.
3-11, Nihonbashi-Honcho, 2-Chome, Chuo-ku,
Tokyo, Japan
(141) 2022 02 14

(111) M 2011 21679 R
(151) 2011 08 04
(732) Astellas Pharma Inc.
3-11, Nihonbashi-Honcho, 2-Chome, Chuo-ku,
Tokyo, Japan
(141) 2022 02 14

(111) M 2011 21680 R
(151) 2011 08 04
(732) LTD "Premier 777"
Tsabadze St. 8, 0112, Tbilisi, Georgia
(141) 2022 02 14

(111) M 2011 21663 R
(151) 2011 08 01
(732) Global Tobacco International LLC
520 S. 7th Street, Suite C, Las Vegas, Nevada,
NV 89101, USA
(141) 2022 02 09

(111) M 2011 21661 R
(151) 2011 07 28
(732) LTD "Geo-Motors"
Javakheti St. 64, 0182, Tbilisi, Georgia
(141) 2022 02 08

(111) M 2011 21664 R
(151) 2011 08 04
(732) LTD "Geo-Motors"
Javakheti St. 64, 0182, Tbilisi, Georgia
(141) 2022 02 14

(111) M 2011 21665 R
(151) 2011 08 04
(732) LLC "Standard Tobacco Incorporated"
Abuseridze-Tbeli St. 13, 0120, Tbilisi, Georgia
(141) 2022 02 14

(111) M 2011 21666 R
(151) 2011 08 04
(732) LLC "Standard Tobacco Incorporated"
Abuseridze-Tbeli St. 13, 0120, Tbilisi, Georgia
(141) 2022 02 14

(111) M 2011 21667 R
(151) 2011 08 04
(732) LLC "Standard Tobacco Incorporated"
Abuseridze-Tbeli St. 13, 0120, Tbilisi, Georgia
(141) 2022 02 14

(111) M 2011 21668 R
(151) 2011 08 04
(732) LLC "Standard Tobacco Incorporated"
Abuseridze-Tbeli St. 13, 0120, Tbilisi, Georgia
(141) 2022 02 14

(111) M 2011 21669 R
(151) 2011 08 04
(732) LLC "Standard Tobacco Incorporated"
Abuseridze-Tbeli St. 13, 0120, Tbilisi, Georgia
(141) 2022 02 14

(111) M 2011 21685 R
(151) 2011 08 04
(732) Harrington Development Inc.
Elvira Mendez Street, Vallarino bldg.,
3rd Floor, Panama, Republic of Panama
(141) 2022 02 14

REGISTRATION OF LICENSE AGREEMENT

(111) M 2013 24134 R
(732) LLC "Glavspirtprom"
Lilo Settlement 51, 0198, Samgori District, Tbilisi, Georgia
(791) Obvcesto's Ogranchnoy Otvarson "Alvi"
U. Kievskaya, dom 7, stage 7, Pom Litt B, Comnata 40, 41, 121059, Moscow, Russian Federation
(793) №1691
from 16 02 2022 to 17 102023
Exclusive
Klass: 33

INTERNATIONAL LICENSES AGREEMENTS

(800) 1529685
 (732) Yandex LLC
 Lev Tolstoy St. 16, RU-119021 Moscow,
 Russian Federation
 (791) Yandex. Taxi LLC
 1st Krasnogvardeyskiy Passage 21, building 1,
 room 36.9e, floor 36, 123112 Moscow,
 Russian Federation
 (793) №1685
 Simple
 From 03 09 2020 to a matter of action
 Klass: 9, 12, 18, 25, 35, 36, 37, 39, 41, 42

(800) 1529836
 (732) Yandex LLC
 Lev Tolstoy St. 16, RU-119021 Moscow,
 Russian Federation
 (791) Yandex. Taxi LLC
 1st Krasnogvardeyskiy Passage 21, building 1,
 room 36.9e, floor 36, 123112 Moscow,
 Russian Federation
 (793) №1684
 Simple
 From 03 09 2020 to a matter of action
 Klass: 9, 12, 18, 25, 35, 36, 37, 39, 41, 42

(800) 820785
 (732) Yandex LLC
 Lev Tolstoy St. 16, RU-119021 Moscow,
 Russian Federation
 (791) Yandex. Taxi LLC
 1st Krasnogvardeyskiy Passage 21, building 1,
 room 36.9e, floor 36, 123112 Moscow,
 Russian Federation
 (793) №1683
 Simple
 From 03 09 2020 to a matter of action
 Klass: 9, 16, 18, 35, 36, 38, 39, 41, 42

(800) 893063
 (732) Obshchestvo s ogranichennoi otvetstvennostyu
 "Sovmestnoe Predpriyatie Karo"
 Pushkinskaya pl. 2, RU-127006 Moscow,
 Russian Federation
 (791) LLC "Georgian Capital Group"
 Right bank of the river Mtkvari, the present
 area of the restaurant "Berikoni", Tbilisi,
 Georgia
 (793) №1686
 Simple
 from 07 12 2021 to 07 12 2025
 Klass: 41

(800) 1033942
 (732) Obshchestvo s ogranichennoi otvetstvennostyu
 "Sovmestnoe Predpriyatie Karo"
 Pushkinskaya pl. 2, RU-127006 Moscow,
 Russian Federation
 (791) LLC "Georgian Capital Group"
 Right bank of the river Mtkvari, the present
 area of the restaurant "Berikoni", Tbilisi,
 Georgia
 (793) №1687
 Simple
 from 07 12 2021 to 07 12 2025
 Klass: 28, 41

(800) 1334648
 (732) Yandex LLC
 Lev Tolstoy St. 16, RU-119021 Moscow,
 Russian Federation
 (791) Yandex. Taxi LLC
 1st Krasnogvardiyskiy Passage 21, building 1,
 room 36.9e, floor 36, 123112 Moscow,
 Russian Federation
 (793) №1682
 Simple
 From 03 09 2020 to a matter of action
 Klass: 9, 16, 35, 38, 39, 41, 42

(800) 1146129
 (732) Adama Agan LTD
 Northern Industrial Zone, 7710201 Ashdod,
 Israel
 (791) LLC "Agrokartli"
 Tskhinvali Highway 4, 1400, Gori, Georgia
 (793) №1688
 Exclusive
 from 16 02 2022 to 16 02 2024
 Klass: 1, 5, 44

(800) 1191718
 (732) Adama Agan LTD
 Northern Industrial Zone 77102 Ashdod,
 Israel
 (791) LLC "Agrokartli"
 Tskhinvali Highway 4, 1400, Gori, Georgia
 (793) №1689
 Exclusive
 from 16 02 2022 to 16 02 2024
 Klass: 1, 5, 44

(800) 1052978

(732) ADAMA Registrations B.V.

Arnhemseweg 87, P.O. Box 205, NL-3830

AE Leusden, NL

(791) LLC "Agrokartli"

Tskhinvali Highway 4, 1400, Gori, Georgia

(793) №1690

Exclusive

from 16 02 2022 to 16 02 2024

Klass: 5

CLASSIFICATION INDEXES

INVENTIONS

CONCORDANCE TABLE OF INTERNATIONAL CLASSIFICATION INDEX AND PUBLICATION NUMBERS

INTERNATIONAL CLASSIFICATION INDEXES (51)	NUMBER OF PUBLISHED APPLICATION (10)
A 01 N 25/02; A 01 N 25/04; A 01 N 25/16; A 01 N 53/00; A 01 P 7/04	AP 2022 14391 A
A 61 F 13/00; A 61 F 13/49	AP 2022 15228 A
A 61 K 31/506; A 61 P 31/16	AP 2022 13376 A
A 61 K 31/4184; A 61 K 31/4365; A 61 K 9/00; A 61 P 1/04; A 61 P 7/02	AP 2022 15592 A
B 07 B 1/28; B 07 B 1/42; B 07 B 1/46	AP 2022 15368 A

CONCORDANCE TABLE OF PUBLICATION NUMBERS AND INTERNATIONAL CLASSIFICATION INDEX

NUMBER OF PUBLISHED APPLICATION (10)	INTERNATIONAL CLASSIFICATION INDEXES (51)
AP 2022 13376 A	A 61 K 31/506; A 61 P 31/16
AP 2022 14391 A	A 01 N 25/02; A 01 N 25/04; A 01 N 25/16; A 01 N 53/00; A 01 P 7/04
AP 2022 15228 A	A 61 F 13/00; A 61 F 13/49
AP 2022 15368 A	B 07 B 1/28; B 07 B 1/42; B 07 B 1/46
AP 2022 15592 A	A 61 K 31/4184; A 61 K 31/4365; A 61 K 9/00; A 61 P 1/04; A 61 P 7/02

CONCORDANCE TABLE OF INTERNATIONAL CLASSIFICATION INDEX, PATENT NUMBERS AND PUBLICATION NUMBERS

INTERNATIONAL CLASSIFICATION INDEX (51)	NUMBER OF PATENT (11)	NUMBER OF PUBLISHED APPLICATION (10)
A 61 K 31/454; A 61 P 11/00; A 61 P 17/06; A 61 P 19/02; A 61 P 29/00	P 2022 7354 B	AP 2021 15467 A
A 61 K 31/4985; A 61 K 31/5365; A 61 K 31/424; A 61 P 31/18; C 07 D 487/16; C 07 D 498/16	P 2022 7353 B	AP 2021 15121 A
A 61 K 31/519; A 61 K 31/5377; A 61 K 31/55; A 61 P 35/00; A 61 P 45/06	P 2022 7357 B	AP 2021 15242 A
B 62 D 55/075	P 2022 7356 B	AP 2021 15450 A
C 07 C 273/04; B 01 D 19/00; B 01 D 5/00; C 07 C 273/14; F 28 D 7/06; F 28 F 21/08; F 28 F 9/02	P 2022 7358 B	AP 2021 15347 A
G 01 N 27/12	P 2022 7355 B	AP 2021 15196 A
G 09 B 1/00	P 2022 7352 B	AP 2021 15438 A

**CONCORDANCE TABLE OF PATENT NUMBERS,
PUBLICATION NUMBERS AND INTERNATIONAL CLASSIFICATION INDEX**

NUMBER OF PATENT (11)	NUMBER OF PUBLISHED APPLICATION (10)	INTERNATIONAL CLASSIFICATION INDEX (51)
P 2022 7352 B	AP 2021 15438 A	G 09 B 1/00
P 2022 7353 B	AP 2021 15121 A	A 61 K 31/4985; A 61 K 31/5365; A 61 K 31/424; A 61 P 31/18; C 07 D 487/16; C 07 D 498/16
P 2022 7354 B	AP 2021 15467 A	A 61 K 31/454; A 61 P 11/00; A 61 P 17/06; A 61 P 19/02; A 61 P 29/00
P 2022 7355 B	AP 2021 15196 A	G 01 N 27/12
P 2022 7356 B	AP 2021 15450 A	B 62 D 55/075
P 2022 7357 B	AP 2021 15242 A	A 61 K 31/519; A 61 K 31/5377; A 61 K 31/55; A 61 P 35/00; A 61 P 45/06
P 2022 7358 B	AP 2021 15347 A	C 07 C 273/04; B 01 D 19/00; B 01 D 5/00; C 07 C 273/14; F 28 D 7/06; F 28 F 21/08; F 28 F 9/02

**CONCORDANCE TABLE OF APPLICATION NUMBERS,
PUBLICATION NUMBERS AND PATENTS**

NUMBER OF APPLICATION (21)	NUMBER OF PUBLISHED APPLICATION (10)	NUMBER OF PATENT (11)
AP 2017 15121	AP 2021 15121 A	P 2022 7353 B
AP 2019 15196	AP 2021 15196 A	P 2022 7355 B
AP 2018 15242	AP 2021 15242 A	P 2022 7357 B
AP 2018 15347	AP 2021 15347 A	P 2022 7358 B
AP 2019 15438	AP 2021 15438 A	P 2022 7352 B
AP 2020 15450	AP 2021 15450 A	P 2022 7356 B
AP 2018 15467	AP 2021 15467 A	P 2022 7354 B

UTILITY MODELS

**CONCORDANCE TABLE OF INTERNATIONAL CLASSIFICATION INDEX
AND PUBLICATION NUMBERS**

INTERNATIONAL CLASSIFICATION INDEXES (51)	NUMBER OF PUBLISHED APPLICATION (10)
C 12 G 1/06	AU 2022 15602 U
F 21 S 8/00	AU 2022 15807 U

**CONCORDANCE TABLE OF PUBLICATION NUMBERS
AND INTERNATIONAL CLASSIFICATION INDEX**

NUMBER OF PUBLISHED APPLICATION (10)	INTERNATIONAL CLASSIFICATION INDEXES (51)
AU 2022 15602 U	C 12 G 1/06
AU 2022 15807 U	F 21 S 8/00

**CONCORDANCE TABLE OF INTERNATIONAL CLASSIFICATION INDEX,
PATENT NUMBERS AND PUBLICATION NUMBERS**

INTERNATIONAL CLASSIFICATION INDEX (51)	NUMBER OF PATENT (11)	NUMBER OF PUBLISHED APPLICATION (10)
C 04 B 14/10; C 04 B 14/12; C 04 B 14/38; C 04 B 20/04; C 04 B 20/06	U 2022 2110 Y	AU 2021 15434 U
E 04 B 1/00	U 2022 2109 Y	AU 2021 15425 U

**CONCORDANCE TABLE OF PATENT NUMBERS,
PUBLICATION NUMBERS AND INTERNATIONAL CLASSIFICATION INDEX**

NUMBER OF PATENT (11)	NUMBER OF PUBLISHED APPLICATION (10)	INTERNATIONAL CLASSIFICATION INDEX (51)
U 2022 2109 Y	AU 2021 15425 U	E 04 B 1/00
U 2022 2110 Y	AU 2021 15434 U	C 04 B 14/10; C 04 B 14/12; C 04 B 14/38; C 04 B 20/04; C 04 B 20/06

**CONCORDANCE TABLE OF APPLICATION NUMBERS,
PUBLICATION NUMBERS AND PATENTS**

NUMBER OF APPLICATION (21)	NUMBER OF PUBLISHED APPLICATION (10)	NUMBER OF PATENT (11)
AU 2020 15425	AU 2021 15425 U	U 2022 2109 Y
AU 2020 15434	AU 2021 15434 U	U 2022 2110 Y

DESIGNS**CONCORDANCE TABLE OF INTERNATIONAL CLASSIFICATION INDEX
AND PUBLICATION NUMBERS**

INTERNATIONAL CLASSIFICATION INDEXES (51)	NUMBER OF PUBLISHED APPLICATION (10)
02-02	AD 2022 1240 S
27-05	AD 2022 1235 S

**CONCORDANCE TABLE OF PUBLICATION NUMBERS
AND INTERNATIONAL CLASSIFICATION INDEX**

NUMBER OF PUBLISHED APPLICATION (10)	INTERNATIONAL CLASSIFICATION INDEXES (51)
AD 2022 1235 S	27-05
AD 2022 1240 S	02-02

**CONCORDANCE TABLE OF INTERNATIONAL CLASSIFICATION INDEX,
NUMBERS OF REGISTRATION AND PUBLICATION NUMBERS**

INTERNATIONAL CLASSIFICATION INDEX (51)	NUMBER OF REGISTRATION (11)	NUMBER OF PUBLISHED APPLICATION (10)
32-00	D 2022 923 S	AD 2021 1225 S

**CONCORDANCE TABLE OF NUMBERS OF REGISTRATION,
PUBLICATION NUMBERS AND INTERNATIONAL CLASSIFICATION INDEX**

NUMBER OF REGISTRATION (11)	NUMBER OF PUBLISHED APPLICATION (10)	INTERNATIONAL CLASSIFICATION INDEX (51)
D 2022 923 S	AD 2021 1225 S	32-00

**CONCORDANCE TABLE OF APPLICATION NUMBERS,
PUBLICATION NUMBERS AND NUMBERS OF REGISTRATION**

NUMBER OF APPLICATION (21)	NUMBER OF PUBLISHED APPLICATION (10)	NUMBER OF REGISTRATION (11)
AD 2021 1225	AD 2021 1225 S	D 2022 923 S

TRADEMARKS

CONCORDANCE TABLE OF REGISTRATION NUMBERS, APPLICATION NUMBERS, PUBLICATION NUMBERS AND BULLETIN NUMBERS

NUMBER OF REGISTRATION (111)	NUMBER OF APPLICATIONS (210)	NUMBER OF PUBLISHED APPLICATIONS (260)	NUMBER OF BULLETIN
1	2	3	4
M 2022 35035 R	AM 116434	–	4(583)2022
M 2022 35036 R	AM 116427	–	4(583)2022
M 2022 35037 R	AM 116235	–	4(583)2022
M 2022 35038 R	AM 116516	–	4(583)2022
M 2022 35039 R	AM 116406	–	4(583)2022
M 2022 35040 R	AM 110689	AM 2021 110689 A	13(569)2021
M 2022 35041 R	AM 111060	AM 2021 111060 A	14(570)2021
M 2022 35042 R	AM 111061	AM 2021 111061 A	14(570)2021
M 2022 35043 R	AM 111063	AM 2021 111063 A	14(570)2021
M 2022 35044 R	AM 111273	AM 2021 111273 A	14(570)2021
M 2022 35045 R	AM 111274	AM 2021 111274 A	14(570)2021
M 2022 35046 R	AM 111275	AM 2021 111275 A	14(570)2021
M 2022 35047 R	AM 111335	AM 2021 111335 A	14(570)2021
M 2022 35048 R	AM 111449	AM 2021 111449 A	14(570)2021
M 2022 35049 R	AM 111508	AM 2021 111508 A	15(571)2021
M 2022 35050 R	AM 111528	AM 2021 111528 A	17(573)2021
M 2022 35051 R	AM 111706	AM 2021 111706 A	15(571)2021
M 2022 35052 R	AM 111707	AM 2021 111707 A	15(571)2021
M 2022 35053 R	AM 111838	AM 2021 111838 A	17(573)2021
M 2022 35054 R	AM 111967	AM 2021 111967 A	18(574)2021
M 2022 35055 R	AM 112067	AM 2021 112067 A	18(574)2021
M 2022 35056 R	AM 112258	AM 2021 112258 A	19(575)2021
M 2022 35057 R	AM 109592	AM 2021 109592 A	6(562)2021
M 2022 35058 R	AM 116163	–	4(583)2022
M 2022 35059 R	AM 116395	–	4(583)2022
M 2022 35060 R	AM 116396	–	4(583)2022
M 2022 35061 R	AM 116410	–	4(583)2022
M 2022 35062 R	AM 116436	–	4(583)2022
M 2022 35063 R	AM 116335	–	4(583)2022
M 2022 35064 R	AM 116409	–	4(583)2022
M 2022 35065 R	AM 116518	–	4(583)2022
M 2022 35066 R	AM 116428	–	4(583)2022
M 2022 35067 R	AM 116334	–	4(583)2022
M 2022 35068 R	AM 116418	–	4(583)2022
M 2022 35069 R	AM 116536	–	4(583)2022
M 2022 35070 R	AM 116403	–	4(583)2022
M 2022 35071 R	AM 116631	–	4(583)2022
M 2022 35072 R	AM 116635	–	4(583)2022
M 2022 35073 R	AM 110875	AM 2021 110875 A	14(570)2021
M 2022 35074 R	AM 110949	AM 2021 110949 A	14(570)2021
M 2022 35075 R	AM 110973	AM 2021 110973 A	19(575)2021
M 2022 35076 R	AM 111090	AM 2021 111090 A	14(570)2021
M 2022 35077 R	AM 111091	AM 2021 111091 A	14(570)2021
M 2022 35078 R	AM 111267	AM 2021 111267 A	14(570)2021
M 2022 35079 R	AM 111269	AM 2021 111269 A	14(570)2021

1	2	3	4
M 2022 35080 R	AM 111344	AM 2021 111344 A	15(571)2021
M 2022 35081 R	AM 111404	AM 2021 111404 A	15(571)2021
M 2022 35082 R	AM 111429	AM 2021 111429 A	15(571)2021
M 2022 35083 R	AM 111500	AM 2021 111500 A	20(576)2021
M 2022 35084 R	AM 111519	AM 2021 111519 A	16(572)2021
M 2022 35085 R	AM 111520	AM 2021 111520 A	17(573)2021
M 2022 35086 R	AM 111521	AM 2021 111521 A	15(571)2021
M 2022 35087 R	AM 111534	AM 2021 111534 A	15(571)2021
M 2022 35088 R	AM 111951	AM 2021 111951 A	18(574)2021
M 2022 35089 R	AM 111969	AM 2021 111969 A	19(575)2021
M 2022 35090 R	AM 111976	AM 2021 111976 A	19(575)2021
M 2022 35091 R	AM 112174	AM 2021 112174 A	20(576)2021
M 2022 35092 R	AM 112286	AM 2021 112286 A	20(576)2021
M 2022 35093 R	AM 112301	AM 2021 112301 A	20(576)2021
M 2022 35094 R	AM 112403	AM 2021 112403 A	19(575)2021
M 2022 35095 R	AM 112404	AM 2021 112404 A	20(576)2021
M 2022 35096 R	AM 112410	AM 2021 112410 A	20(576)2021
M 2022 35097 R	AM 112488	AM 2021 112488 A	20(576)2021
M 2022 35098 R	AM 112491	AM 2021 112491 A	19(575)2021
M 2022 35099 R	AM 112492	AM 2021 112492 A	19(575)2021
M 2022 35100 R	AM 112504	AM 2021 112504 A	20(576)2021
M 2022 35101 R	AM 112582	AM 2021 112582 A	20(576)2021
M 2022 35102 R	AM 112583	AM 2021 112583 A	20(576)2021
M 2022 35103 R	AM 112614	AM 2021 112614 A	20(576)2021
M 2022 35104 R	AM 112615	AM 2021 112615 A	20(576)2021
M 2022 35105 R	AM 112616	AM 2021 112616 A	20(576)2021
M 2022 35106 R	AM 112738	AM 2021 112738 A	20(576)2021
M 2022 35107 R	AM 116551	–	4(583)2022

CONCORDANCE TABLE OF PUBLICATION NUMBERS
AND APPLICATION NUMBERS

NUMBER OF PUBLISHED APPLICATION (260)	NUMBER OF APPLICATION (210)	1	2
1	2		
AM 2022 109851 A	AM 109851	AM 2022 113883 A	AM 113883
AM 2022 111082 A	AM 111082	AM 2022 113885 A	AM 113885
AM 2022 111712 A	AM 111712	AM 2022 113886 A	AM 113886
AM 2022 112507 A	AM 112507	AM 2022 113888 A	AM 113888
AM 2022 112698 A	AM 112698	AM 2022 113889 A	AM 113889
AM 2022 112699 A	AM 112699	AM 2022 113973 A	AM 113973
AM 2022 113139 A	AM 113139	AM 2022 113976 A	AM 113976
AM 2022 113427 A	AM 113427	AM 2022 113979 A	AM 113979
AM 2022 113428 A	AM 113428	AM 2022 114003 A	AM 114003
AM 2022 113694 A	AM 113694	AM 2022 114034 A	AM 114034
AM 2022 113703 A	AM 113703	AM 2022 114035 A	AM 114035
AM 2022 113765 A	AM 113765	AM 2022 114037 A	AM 114037
AM 2022 113771 A	AM 113771	AM 2022 114038 A	AM 114038
AM 2022 113778 A	AM 113778	AM 2022 114042 A	AM 114042
AM 2022 113779 A	AM 113779	AM 2022 114044 A	AM 114044
AM 2022 113783 A	AM 113783	AM 2022 114050 A	AM 114050
AM 2022 113787 A	AM 113787	AM 2022 114052 A	AM 114052
AM 2022 113790 A	AM 113790	AM 2022 114060 A	AM 114060
AM 2022 113791 A	AM 113791	AM 2022 114063 A	AM 114063
AM 2022 113793 A	AM 113793	AM 2022 114135 A	AM 114135
AM 2022 113846 A	AM 113846	AM 2022 114136 A	AM 114136
AM 2022 113848 A	AM 113848	AM 2022 114140 A	AM 114140
AM 2022 113854 A	AM 113854	AM 2022 114141 A	AM 114141
AM 2022 113866 A	AM 113866	AM 2022 114146 A	AM 114146
AM 2022 113868 A	AM 113868	AM 2022 114149 A	AM 114149
AM 2022 113869 A	AM 113869	AM 2022 114234 A	AM 114234
AM 2022 113870 A	AM 113870	AM 2022 114235 A	AM 114235
AM 2022 113882 A	AM 113882	AM 2022 114236 A	AM 114236
		AM 2022 114238 A	AM 114238
		AM 2022 114309 A	AM 114309
		AM 2022 114311 A	AM 114311

CONCORDANCE TABLE OF INDEX OF GOODS AND/OR SERVICES
AND APPLICATION NUMBERS

INDEX OF GOODS AND/OR SERVICES (511)	NUMBER OF PUBLISHED APPLICATIONS (260)	1	2
1	2	31	AM 2022 114050 A
1	AM 2022 113771 A	32	AM 2022 114050 A
3	AM 2022 113854 A	32	AM 2022 114141 A
5	AM 2022 113793 A	32	AM 2022 114238 A
5	AM 2022 114038 A	33	AM 2022 112507 A
5	AM 2022 114135 A	33	AM 2022 113139 A
5	AM 2022 114136 A	33	AM 2022 113703 A
5	AM 2022 114140 A	33	AM 2022 113778 A
5	AM 2022 114238 A	33	AM 2022 113866 A
6	AM 2022 114003 A	33	AM 2022 114050 A
7	AM 2022 112698 A	33	AM 2022 114141 A
7	AM 2022 112699 A	33	AM 2022 114235 A
8	AM 2022 114044 A	33	AM 2022 114236 A
9	AM 2022 109851 A	34	AM 2022 113787 A
9	AM 2022 113427 A	34	AM 2022 113791 A
9	AM 2022 113428 A	34	AM 2022 113888 A
9	AM 2022 113973 A	34	AM 2022 113889 A
11	AM 2022 112698 A	34	AM 2022 114034 A
11	AM 2022 112699 A	34	AM 2022 114035 A
11	AM 2022 113427 A	34	AM 2022 114042 A
11	AM 2022 113428 A	34	AM 2022 114060 A
11	AM 2022 113868 A	35	AM 2022 111082 A
11	AM 2022 114311 A	35	AM 2022 113694 A
13	AM 2022 113882 A	35	AM 2022 113765 A
13	AM 2022 113883 A	35	AM 2022 113771 A
13	AM 2022 113885 A	35	AM 2022 113779 A
13	AM 2022 113886 A	35	AM 2022 113783 A
16	AM 2022 114003 A	35	AM 2022 113846 A
20	AM 2022 113765 A	35	AM 2022 113848 A
20	AM 2022 113869 A	35	AM 2022 114037 A
20	AM 2022 113870 A	35	AM 2022 114050 A
21	AM 2022 113790 A	35	AM 2022 114146 A
24	AM 2022 113694 A	36	AM 2022 114146 A
25	AM 2022 113846 A	37	AM 2022 113976 A
25	AM 2022 113848 A	37	AM 2022 114146 A
26	AM 2022 114003 A	40	AM 2022 111082 A
28	AM 2022 114052 A	41	AM 2022 111082 A
28	AM 2022 114309 A	41	AM 2022 113866 A
29	AM 2022 113866 A	41	AM 2022 113976 A
29	AM 2022 114050 A	41	AM 2022 114146 A
30	AM 2022 114050 A	41	AM 2022 114149 A
30	AM 2022 114234 A	42	AM 2022 111082 A
30	AM 2022 114309 A	43	AM 2022 113866 A
31	AM 2022 111712 A	43	AM 2022 113979 A
31	AM 2022 113778 A	43	AM 2022 114050 A
		43	AM 2022 114063 A
		43	AM 2022 114234 A

CONCORDANCE TABLE OF INDEX OF GOODS AND/OR SERVICES
AND NUMBERS OF TRADEMARKS REGISTERED ACCORDING
TO THE ACCELERATED PROCEDURE

INDEX OF GOODS AND/OR SERVICES (511)	NUMBERS OF REGISTERED ACCORDING TO THE ACCELERATED PROCEDURE (111)
3	M 2022 35036 R
3	M 2022 35059 R
3	M 2022 35060 R
5	M 2022 35036 R
5	M 2022 35061 R
5	M 2022 35071 R
5	M 2022 35072 R
7	M 2022 35059 R
7	M 2022 35060 R
8	M 2022 35059 R
8	M 2022 35060 R
9	M 2022 35059 R
9	M 2022 35060 R
9	M 2022 35065 R
10	M 2022 35059 R
10	M 2022 35060 R
11	M 2022 35059 R
11	M 2022 35060 R
14	M 2022 35059 R
14	M 2022 35060 R
21	M 2022 35059 R
21	M 2022 35060 R
26	M 2022 35059 R
26	M 2022 35060 R
28	M 2022 35059 R
28	M 2022 35060 R
32	M 2022 35038 R
33	M 2022 35058 R
33	M 2022 35062 R
33	M 2022 35067 R
35	M 2022 35066 R
35	M 2022 35067 R
35	M 2022 35068 R
35	M 2022 35107 R
36	M 2022 35035 R
36	M 2022 35070 R
37	M 2022 35037 R
37	M 2022 35039 R
38	M 2022 35065 R
39	M 2022 35037 R
41	M 2022 35063 R
42	M 2022 35037 R
42	M 2022 35065 R
44	M 2022 35064 R
44	M 2022 35068 R
44	M 2022 35069 R

OFFICIAL BULLETIN OF THE INDUSTRIAL PROPERTY

**INVENTIONS
UTILITY MODELS
DESIGNS
TRADEMARKS**

4(583)

EDITOR-IN-CHIEF: N. Bebrishvili

EDITOR-TRANSLATOR: E. Gabunia

PROOFREADER: A. Shikhiashvili

COMPUTER LAYOUT: M. Ordenidze
K. Svanidze

info@sakpatenti.gov.ge
www.sakpatenti.gov.ge