

Official Bulletin of the Industrial Property

Inventions

Utility Models

Designs

Trademarks



საქართველოს ინტელექტუალური
საკუთრების ეროვნული ცენტრი

საკპატი

SAKPATENTI

NATIONAL INTELLECTUAL PROPERTY
CENTER OF GEORGIA

www.sakpatenti.gov.ge

Date of Publication – 2022 03 25

6(585)

INID CODES FOR IDENTIFICATION OF BIBLIOGRAPHIC DATA

INVENTIONS, UTILITY MODELS

- (10) Number of publication for application, which has been examined
- (11) Number of patent and kind of document
- (21) Serial number of application
- (22) Date of filing of the application
- (23) Date of exhibition or the date of the earlier filing and the number of application, if any
- (24) Date from which patent may have effect
- (31) Number of priority application
- (32) Date of filing of priority application
- (33) Code of the country or regional organization allotting priority application number
- (44) Date of publication of application not granted, but examined and number of bulletin
- (45) Date of publication of registered document
- (51) International Patent Classification Index

- (54) Title of the invention
- (57) Abstract
- (60) Number of examined patent document granted by foreign patent office, date from which patent has effect and country code
- (62) Number of the earlier application and in case of divided application, date of filing an application
- (71) Name, surname and address of applicant (country code)
- (72) Name, surname of inventor (country code)
- (73) Name, surname and address of patent owner (country code)
- (74) Name, surname of representative or patent attorney
- (85) Date of commencement of the national phase of International Application
- (86) Number and date of filing of international application
- (87) Number and date of publication of international application
- (94) Calculated date of expiry of the SPC or the duration of the SPC

DESIGNS

- (10) Number of publication for application
- (11) Number of patent and kind of document or number of registration
- (15) Date of registration/Date of patent renewal
- (18) Expected expiration date of patent or registration
- (21) Serial number of application
- (22) Date of filing of the application
- (23) Date of exhibition or the date of the earlier filing and the number of application, if any
- (24) Date from which patent may have effect
- (28) Number of designs included in the application
- (30) Data relating to priority (number of application, date of filing of application, two-letter code identifying the authority with whom the priority application was made)
- (31) Number of priority application
- (32) Date of filing of priority application
- (33) Code of the country or regional organization allotting priority application number
- (34) Two-letter code according to WIPO St.3 identifying the authority with which the priority application was made
- (44) Date of publication of design and number of bulletin (the first publication)
- (45) Date of publication of design registered by WIPO and number of bulletin

- (51) International Classification for designs (class and subclass of the Locarno Classification)
- (54) Title of the invention
- (55) Reproduction of the design
- (57) Description of characteristic features of the design including indication of colors
- (58) Date of recording of any kind of amendment in the Register
- (62) Number of the earlier application, registration and document number and if available the date of filing an application in case of divided application
- (71) Name, surname and address of applicant (country code)
- (72) Name, surname of creator (country code)
- (73) Name, surname and address of patent owner (country code)
- (74) Name, surname of representative or patent attorney
- (81) Contracting states concerned
 - II designated contracting states according to the 1960 Act
 - III designated contracting states according to the 1999 Act
- (85) Owner's permanent address
- (86) Owner's nationality
- (87) Owner's residence
- (88) State in which the owner has a real and effective industrial or commercial establishment

TRADEMARKS

- (111) - Number of registration
- (151) - Date of registration
- (156) - Date of the renewal
- (181) - Expected expiration date of registration
- (186) - Renewal expiration date of registration
- (141) - Date of cancel of duration of the mark
- (210) - Serial number of application
- (220) - Date of filing of the application
- (230) - Data concerning exhibition
- (260) - Number of application, for which favorable decision of examination about registration has been taken (publication number)
- (310) - Number of the first application
- (320) - Date of filing of the first application
- (330) - Code, identifying national or regional Office where the first application was made
- (511) - International Classification of Goods and Services for the purposes of registration of trade marks and/or list of goods and/or services classified according thereto
- (526) - Disclaimer
- (531) - Description of figurative elements of Trade Marks according to the International Classification of the Figurative Elements of Marks

- (540) - Reproduction of Trade Mark
- (550) - Nature and kind of Trade Mark
- (551) - Indication to the effect that the mark is a collective mark, a certification mark or a guarantee mark
- (554) - Three-dimensional mark
- (580) - Date of recording of any kind changes in respect of applications or registrations
- (591) - Information concerning colors claimed
- (731) - Name and address of the applicant
- (732) - Name and address of the holder of the registration
- (740) - Name and address of the representative
- (750) - Addreses for correspondence
- (770) - Name and address of the previous applicant or holder in case of change in ownership
- (771) - Previous name and address of the applicant or holder in case of change in ownership
- (791) - Name and address of the licensee
- (793) - Indication of conditions and/or restrictions under the license (Type of license, number of license agreement, data of license, data of validity of license)
- (800) - Certain data relating to the international registration of Trade Marks under the Protocol Relating to Madrid Agreement (International registration number
- (852) - Partial cancellation of the list of goods and services
- (891) - Date of subsequent designation

CODES FOR PUBLICATION IN BULLETIN

- (21) AP 0000 000000 - serial number of application for invention
- (10) AP 0000 0000 A - number of published application for invention (first publication)
- (11) P 0000 0000 B - number of patent for invention (second publication)
- (21) API 0000 000000 - number of application for imported patent
- (11) PI 0000 0000 A - number of imported patent (first publication)
- (21) AU 0000 000000 - serial number of application for utility model
- (10) AU 0000 000 U - number of published application for utility model (first publication)
- (11) U 0000 000 Y - number of patent for utility model (second publication)
- (21) AD 0000 000000 - serial number of application for design
- (10) AD 0000 000 S - number of published application for design (first publication)
- (11) D 0000 000 S - registered design

INTERNATIONAL PATENT CLASSIFICATION FOR INVENTIONS AND UTILITY MODELS

- SECTION A - HUMAN NECESSITIES
- SECTION B - PERFORMING OPERATIONS; TRANSPORTING
- SECTION C - CHEMISTRY; METALLURGY
- SECTION D - TEXTILES; PAPER
- SECTION E - FIXED CONSTRUCTIONS
- SECTION F - MECHANICAL ENGINEERING; LIGHTING; HEATING; WEAPONS; BLASTING
- SECTION G - PHYSICS
- SECTION H - ELECTRICITY

-
- M - Trade Mark
 - (210) AM 0000 000000 - Serial number of application;
 - (260) AAM 0000 00000 A - Publication number of application;
 - (111) M 0000 00000 R - Number of registration;
 - (111) MMM0000 00000 Rn - Number of renewals, in which n=1,2,3;
 - (111) M 0000 00000 R(P) - Number of registration under partial assignment of rights
-

Official Bulletin of the Industrial Property

Inventions

Utility Models

Designs

Trademarks

CONTENT

PUBLISHED TITLES OF PROTECTION	3
INVENTIONS	
▪ APPLICATIONS APPROVED FOR GRANTING PATENT	4
▪ PATENTED INVENTIONS	5
UTILITY MODELS	
PATENTED UTILITY MODEL	7
DESIGNS	
▪ REGISTERED DESIGNS	8
▪ DESIGNS REGISTERED ACCORDING TO THE ACCELERATED PROCEDURE	9
▪ DESIGNS, WHICH HAVE BEEN REGISTERED WITH THE INTERNATIONAL BUREAU CLAIMING PRIORITY ON THE TERRITORY OF GEORGIA	11
TRADEMARKS	
▪ APPLICATIONS FILED UNDER THE NATIONAL PROCEDURE APPROVED FOR REGISTRATION	18
▪ REGISTERED TRADEMARKS	22
▪ TRADEMARKS REGISTERED ACCORDING TO THE ACCELERATED PROCEDURE	28
▪ INTERNATIONAL TRADEMARKS FOR WHICH A DECISION ON GRANTING PROTECTION IS TAKEN	31
▪ INTERNATIONAL TRADEMARKS PROTECTED IN GEORGIA	95
OFFICIAL NOTIFICATIONS	
INVENTIONS	
▪ RESTORATION OF PATENTS	104
▪ ABOLITION OF PATENTS WITH THE RIGHT TO RESTORE	104
▪ EXPIRATION OF TERMS OF RESTORATION OF PATENTS	106
▪ CORRECTION OF THE PUBLISHED INFORMATION	107
UTILITY MODELS	
▪ RESTORATION OF PATENTS	108
▪ EXPIRATION OF TERMS OF RESTORATION OF PATENTS	108
▪ TRANSFER OF RIGHT	109
DESIGNS	
▪ CANCELLATION OF DESIGNS REGISTRATION	109
▪ EXTENSION OF TERMS OF INTERNATIONAL DESIGNS REGISTRATION	110
TRADEMARKS	
▪ EXTENSION OF TERMS OF TRADEMARKS REGISTRATION	113
▪ COMPLETE TRANSFER OF RIGHTS	115
▪ CHANGES OF NAMES AND/OR ADDRESSES OF TRADEMARKS OWNER	118
▪ CANCELLATION OF TRADEMARKS REGISTRATION	120
▪ CHANGE OF THE LIST OF GOODS AND/OR SERVICE OF TRADEMARK	120
CLASSIFICATION INDEXES	
INVENTIONS	121
UTILITY MODELS	122
DESIGNS	123
TRADEMARKS	125

PUBLISHED TITLES OF PROTECTION

INVENTIONS

- **APPLICATIONS APPROVED FOR GRANTING PATENT:**
15476; 15472; 15497
- **PATENTED INVENTIONS:**
7364-7368

UTILITY MODELS

- **PATENTED UTILITY MODEL:**
2112

DESIGNS

- **REGISTERED DESIGNS:**
927-930
- **DESIGNS REGISTERED ACCORDING TO THE ACCELERATED PROCEDURE:**
926; 931
- **DESIGNS, WHICH HAVE BEEN REGISTERED WITH THE INTERNATIONAL BUREAU CLAIMING PRIORITY ON THE TERRITORY OF GEORGIA:**
218133; 218134; 216054, 216055

TRADEMARKS

- **APPLICATIONS FILED UNDER THE NATIONAL PROCEDURE APPROVED FOR REGISTRATION:**
111416; 111717; 113881; 114133; 114144; 114151; 114216-114218; 114237; 114245, 114246; 114322; 114324; 114342; 114344; 114393; 114396-114398; 114408
- **REGISTERED TRADEMARKS:**
35126-35193; 35197, 35198
- **TRADEMARKS REGISTERED ACCORDING TO THE ACCELERATED PROCEDURE:**
35119-35125; 35194-35196; 35199
- **INTERNATIONAL TRADEMARKS FOR WHICH A DECISION ON GRANTING PROTECTIONS IS TAKEN:**
109171*; 109995; 110103*; 110246*; 110306*; 111055*; 113168; 113175; 113178, 113179; 113181; 113291-113293; 113298; 113304; 113314-113329; 113331-113334; 113434-113437; 113444; 113458- 113464; 113466; 113468; 113472-113478; 113537; 113539, 113540; 113543-113548; 113634, 113635; 113637, 113638; 113640-113643; 113645; 113647-113651; 113653, 113654; 113669-113671; 113729, 113730; 113732; 113734-113742; 113760; 113796-113799; 113825; 113840; 113938; 113942; 114017; 114020; 114022-114025; 114118
- **INTERNATIONAL TRADEMARKS PROTECTED IN GEORGIA:**
108201; 110234; 111559; 111631; 111633; 111635; 111654; 111671; 111678; 111688; 111758, 111759; 111762-111766; 111782-111786; 111813; 111817-111821; 111887; 111890-111895; 111899; 111907; 111912-111914; 111985; 111987, 111988; 111991; 111995-111999; 112002, 112003; 112006; 112008; 112020; 112040, 112041; 112106, 112107; 112110; 112112-112115; 112117, 112118; 112120; 112133; 112141-112143; 112145-112150; 112152-112155; 112201; 112203; 112212-112214; 112221-112225; 112238; 112240; 112246, 112247; 112249, 112250; 112317; 112325; 112341-112345; 112356; 112423; 112428-112434; 112527, 112528; 112530; 112532; 112534; 112556; 112642; 112650; 112745; 112784; 112804-112806

INVENTIONS

APPLICATIONS APPROVED FOR GRANTING PATENT

The decision can be appealed at the Chamber of Appeal of Sakpatenti within 3 months from the publication or at the Mtskheta District Court Administrative Cases Board (Address: №17, Samkhedro St., Mtskheta), within 1 month following the publication.

PART A

A 61

(10) AP 2022 15476 A (51) Int. Cl. (2006)
A 61 K 31/585
A 61 K 31/57
A 61 K 31/55
A 61 K 31/565
A 61 P 5/30
(21) AP 2019 15476 (22) 2019 04 19
(31) 18168234.5; 18174985.4; 19150421.6
(32) 2018 04 19; 2018 05 30; 2019 01 04
(33) EP; EP; EP
(7) Estetra SPRL (BE)
Rue Saint-George, 5, 4000, Liege, Belgium (BE)

(72) TAZIAUX, Melanie (BE);
RAUSIN, Glwadys (BE);
MAWET, Marie (BE);
JOST, Maud (BE)

(74) Larisa Amirkhanyan
(85) 2020 10 22

(86) PCT/EP2019/060221, 2019 04 19

(54) COMPOUNDS AND THEIR USES FOR
ALLEVIATING MENOPAUSE-ASSO-
CIATED SYMPTOMS

(57) A composition comprising estetrol component is used for alleviating menopause-associated symptoms. At that, the composition is introduced in daily amount equivalent to 15 mg of estetrol.

Claims: 2 independents
13 dependents

(10) AP 2022 15472 A (51) Int. Cl. (2006)
A 61 K 31/858
A 61 K 31/57
A 61 K 31/55
A 61 K 31/565
A 61 P 5/30

(21) AP 2019 15472 (22) 2019 04 19

(31) 18168336.8; 18174982.1; 19150423.2

(32) 2018 04 19; 2018 05 30; 2019 01 04

(33) EP; EP; EP

(71) Estetra SPRL (BE)

Rue Saint-George, 5, 4000, Liege, Belgium (BE)

(72) TAZIAUX, Melanie (BE);
RAUSIN, Glwadys (BE);

JOST, Maud (BE);

MAWET, Marie (BE)

(74) Larisa Amirkhanyan

(85) 2020 10 20

(86) PCT/EP2019/060220, 2019 04 19

(54) COMPOUNDS AND THEIR USES FOR
ALLEVIATING MENOPAUSE-ASSO-
CIATED SYMPTOMS

(57) A composition comprising estetrol component is used for alleviating menopause-associated symptoms. At that, the composition is introduced in daily amount equivalent to 15-25 mg of estetrol.

Claims: 1 independent

13 dependents

(10) AP 2022 15497 A (51) Int. Cl. (2006)
A 61 M 16/00

(21) AP 2020 15497 (22) 2020 11 25

(71) Temur Maisuradze (GE)

Mukhiani I m/r, bld. 10, app. 139, 0172, Tbilisi,
Georgia (GE)

(72) Temur Maisuradze (GE)

(54) PORTABLE ARTIFICIAL RESPIRATION
APPARATUS

(57) Portable artificial respiration apparatus is disclosed. The apparatus includes control- and power supply blocks, air supply, and pressure regulating systems, and is connected to patient trident by means of valves with air inlet and outlet channels. The apparatus is equipped with the pumps having pumps working with twocircuit syplhonic principle, where from one is connected to air absorbing and supply channels, and another – to air pumping and outlet channels.

Claims: 1 independent

Fig.: 1

PATENTED INVENTIONS

PART A

A 61

- (11) P 2022 7365 B (51) Int. Cl. (2006)
 A 61 K 31/437
 A 61 K 31/4375
 A 61 K 31/444
 A 61 K 31/4709
 A 61 K 31/497
 A 61 K 31/506
 A 61 K 45/06
 A 61 P 11/00
 A 61 P 9/10
 C 07 D 519/00
 C 07 D 471/04
- (10) AP 2021 14952 A (44) 18(574)/2021
 (21) AP 2017 14952
 (22) 2017 05 08
 (24) 2017 05 08
 (31) EP16168809.8
 (32) 2016 05 09
 (33) EP
 (86) PCT/EP2017/060900, 2017 05 08
 (73) Bayer Pharma Aktiengesellschaft (DE)
 Müllerstraße 178, Berlin, 13353,
 Germany (DE);
 Bayer Aktiengesellschaft (DE)
 Kaiser-Wilhelm-Allee 1, Leverkusen,
 51373, Germany (DE)
- (72) TIMMERMANN, Andreas (DE);
 ZUBOV, Dmitry (DE);
 KÖLLING, Florian (DE);
 BADOCK, Volker (DE);
 MOOSMAYER, Dieter (DE);
 SCHULZ, Alexander (DE);
 BROCKSCHNIEDER, Damian (DE);
 NEUBAUER, Thomas (DE);
 SCHÄFER, Martina (DE);
 TERJUNG, Carsten (DE);
 LINDNER, Niels (DE);
 MIYATAKE ONDOZABAL, Hideki (DE);
 BIBER, Nicole (DE);
 MOORE, Stephen (GB);
 GERICKE, Kersten Matthias (DE);
 MEDING, Jörg (DE);
 MEIER, Heinrich (DE);
 LUSTIG, Klemens (DE)
- (74) Giorgi Kartvelishvili
 (54) SUBSTITUTED 5,6,7,8-TETRAHYDRO
 [1,2,4]TRIAZOLO[4,3-A]PYRIDINE-3
 (2H)-ONES AND 2,5,6,7-TETRAHYDRO-
 3H-PYRROLO[2,1-C][1,2,4]TRIAZOL-3-
 ONES, AND USE THEREOF
- (11) P 2022 7366 B (51) Int. Cl. (2006)
 A 61 K 31/4995
 A 61 K 31/5386
 A 61 P 11/00
 A 61 P 25/00
 C 07 D 471/08
 C 07 D 498/08
- (10) AP 2021 15256 A (44) 18(574)/2021
 (21) AP 2018 15256
 (22) 2018 06 07
 (24) 2018 06 07
 (31) 17176046.5; 17193252.8
 (32) 2017 06 14; 2017 09 26
 (33) EP; EP
 (86) PCT/EP2018/064977, 2018 06 07
 (73) Bayer Pharma Aktiengesellschaft (DE)
 Müllerstraße 178, Berlin, 13353,
 Germany (DE);
 Bayer Aktiengesellschaft (DE)
 Kaiser-Wilhelm-Allee 1, Leverkusen,
 51373, Germany (DE)
- (72) DELBECK, Martina (DE);
 MÜLLER, Thomas (DE);
 BECK-BROICHSITTER, Moritz (DE);
 ALBUS, Udo (DE);
 GEHRING, Doris (DE);
 ROSENSTEIN, Björn (DE);
 LINDNER, Niels (DE);
 NICOLAI, Janine (DE);
 HAHN, Michael (DE);
 LUSTIG, Klemens (DE);
 COLLINS, Karl (DE)
- (74) Giorgi Kartvelishvili
 (54) DIAZABICYCLIC SUBSTITUTED IMIDA-
 ZOPYRIMIDINES AND THEIR USE FOR
 THE TREATMENT OF BREATHING
 DISORDERS
-
- (11) P 2022 7364 B (51) Int. Cl. (2006)
 A 61 K 36/00
- (10) AP 2021 15561 A (44) 21(577)/2021
 (21) AP 2021 15561
 (22) 2021 02 16
 (24) 2021 02 16
 (73) Babry, Oren (US)
 15050 Sherman Way, №201, Van Nuys,
 CA, 91356, USA (US)
- (72) BABRY, Oren (US)
 (74) Davit Dzamukashvili
 (54) PHARMACEUTICAL COMPOSITION BASED
 ON PLANT RAW MATERIALS
-

PART C**C 07**

- (11) P 2022 7368 B (51) Int. Cl. (2006)
C 07 D 209/14
C 07 D 209/16
Z 61 K 31/4045
Z 61 P 25/28
- (10) AP 2021 14363 A (44) 22(578)/2021
(21) AP 2015 14363
(22) 2015 07 03
(24) 2015 07 03
(31) PA2014 00369
(32) 2014 07 04
(33) DK
(86) PCT/EP2015/065176, 2015 07 03
(73) H. Lundbeck A/S (DK)
Ottoliavej 9, DK-2500 Valby, Denmark (DK)
- (72) ANDERSEN, Kristine, Birklund (DK);
ROCK, Michael, Harold (DK);
DE DIEGO, Heidi, Lopez (DK);
THERKELSEN, Frans, Dennis (DK)
- (74) Tamaz Shilakadze
- (54) NOVEL POLYMORPHIC FORM OF N-[2-(6-FLUORO-LH-INDOL-3-YL)ETHYL]-3-(2,2,3,3-TETRAFLUOROPROPOXY) BENZYLAMINE HYDROCHLORIDE FOR THE TREATMENT OF ALZHEIMER'S
-

PART F**F 02**

- (11) P 2022 7367 B (51) Int. Cl. (2006)
F 02 B 75/04
F 02 D 15/00
- (10) AP 2021 15405 A (44) 19(575)/2021
(21) AP 2020 15405
(22) 2020 08 06
(24) 2020 08 06
(73) Ramzan Goytemirov (RU)
Razdelnaya St. 13, Grozno, Republic of Chechnya, Russian Federation (RU)
- (72) Ramzan Goytemirov (RU)
- (74) Besiki Kobakhidze
- (54) ENGINE HAVING COMPRESSION RATIO CONTROL MECHANISM
-

UTILITY MODELS

PATENTED UTILITY MODEL

PART C

C 04

- (11) U 2022 2112 Y (51) Int. Cl. (2006)
C 04 B 35/32
H 01 L 39/00
- (10) AU 2021 15487 U (44) 21(577)/2021
(21) AU 2020 15487
(22) 2020 11 09
(24) 2020 11 09
- (71) Nikoloz Margiani (GE)
Vazha-Pshavela Av., IV qu., corp. 4, app. 27,
0186, Tbilisi, Georgia (GE);
Giorgi Mumladze (GE)
Politkovskaya St. 47, app. 91, 0186, Tbilisi,
Georgia (GE);
Vakhtangi Zhghamadze (GE)
Varketili 3, I mcr., corp. 3, app. 108, 0163,
Tbilisi, Georgia (GE);
Iamze Kvartskhava (GE)
Demetre Tavdadebuli St. 7, app. 27, 4400, Poti,
Georgia (GE);
Natia Margiani (GE)
Vazha-Pshavela Av., IV qu., corp. 4, app. 27,
0186, Tbilisi, Georgia (GE);
Nino Mumladze (GE)
Politkovskaya St. 47, app. 91, 0186, Tbilisi,
Georgia (GE)
- (72) Nikoloz Margiani (GE);
Giorgi Mumladze (GE);
Vakhtangi Zhghamadze (GE);
Iamze Kvartskhava (GE);
Natia Margiani (GE);
Nino Mumladze (GE)
- (54) COBALT BASED THERMOELECTRIC
POTTERY
-

DESIGNS

REGISTERED DESIGNS

(11) D 2022 929 S	(51) 06-10	(11) D 2022 928 S	(51) 12-08
(10) AD 2021 1224 S	(44) 2021 12 10 №22	(10) AD 2021 1217 S	(44) 2021 12 10 №22
(21) AD 2021 1224		(21) AD 2021 1217	
(22) 2021 06 15		(22) 2021 05 31	
(24) 2021 06 15		(24) 2021 05 31	
(28) 1		(28) 1	
(18) 2026 06 15		(18) 2026 05 31	
(31) 202030779890.7		(73) Zake Tkemaladze (GE)	
(32) 2020 12 17		Zurab Chavchavadze St. 8/108, 4600, Kutaisi,	
(33) CN		Georgia (GE)	
(73) Shaoxing Keqiao Diwan Textile Co. LTD (CN)		(72) Zake Tkemaladze (GE)	
Qingfeng Vill. Qianqing Town, Keqiao District,		(54) AUTOMOBILE DESIGN	
Shaoxing, Zhejiang 312030, China (CN)			
(72) GUO, Zhen (CN)			
(74) Larisa Amirkhanyan (GE)			
(54) CURTAIN WITH TIEBACKS			

(11) D 2022 930 S	(51) 09-03
(10) AD 2021 1226 S	(44) 2021 12 10 №22
(21) AD 2021 1226	
(22) 2021 06 20	
(24) 2021 06 20	
(28) 3	
(18) 2026 06 20	
(73) Zurab Mamulashvili (GE)	
Al. Kazbegi Ave. 35b, 0177, Tbilisi,	
Georgia (GE)	
(72) Zurab Mamulashvili (GE)	
(74) Zurab Mamulashvili (GE)	
(54) 1. BOX FOR WOODY KNIFE;	
2. BOX FOR WOODY FORK;	
3. BOX FOR WOODY SPOON	

(11) D 2022 927 S	(51) 11-02
(10) AD 2021 1231 S	(44) 2021 12 10 №22
(21) AD 2021 1231	
(22) 2021 07 27	
(24) 2021 07 27	
(28) 2	
(18) 2026 07 27	
(73) LLC "Zarapkhana" (GE)	
Lublina St. 15, 0159, Tbilisi, Georgia (GE)	
(72) Tea Tetradze (GE)	
(54) 1.-2.COLLECTION KNIFE	

DESIGNS REGISTERED ACCORDING TO THE ACCELERATED PROCEDURE

The decision can be appealed at the Chamber of Appeal of Sakpatenti within 3 months from the publication.

- (11) D 2022 926 S (51) 09-03
(21) AD 2021 1253 (22) 2021 12 18
(24) 2021 12 18
(28) 1
(18) 2026 12 18
(73) Beka Tskhovrebadze (GE)
Zghvisubani IV mkr., bld. 11, app. 48, 0197, Tbilisi, Georgia (GE)
(72) Beka Tskhovrebadze (GE)
(54) BOX
(55)

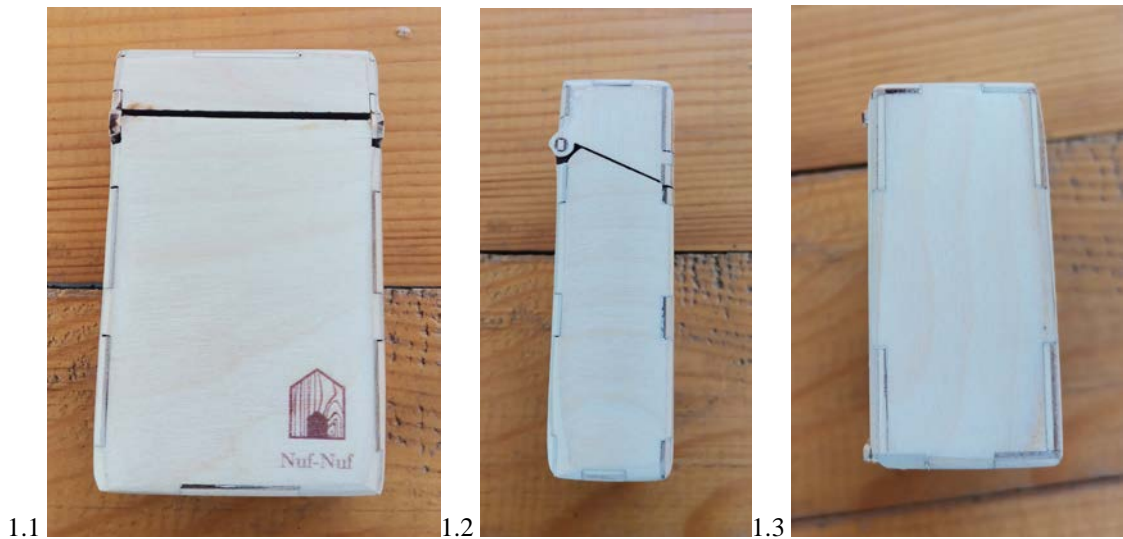

(11) D 2022 931 S (51) 11-01
(21) AD 2022 1259 (22) 2022 03 02
(24) 2022 03 02
(28) 5
(18) 2027 03 02
(73) LTD "ESHVI" (GE)
Gergeti St. 3, 0105, Mtatsminda District, Tbilisi, Georgia (GE)
(72) Natia Chkhartishvili (GE)
(54) 1.EARING; 2.-5. RING
(55)



1.1



2.1



3.1



4.1



5.1

DESIGNS, WHICH HAVE BEEN REGISTERED WITH THE INTERNATIONAL BUREAU CLAIMING PRIORITY ON THE TERRITORY OF GEORGIA

The decision can be appealed at the Chamber of Appeal of Sakpatenti within 3 months from the publication or at the Mtskheta District Court Administrative Cases Board (Address: №17, Samkhedro St., Mtskheta), within 1 month following the publication.

- (11) DM/218 133 (51) 02-04
 (15) 2021 12 24 (44) 02/2022 (2022 01 07)
 (22) 2021 12 24
 (28) 2
 (73) Valentino S.p.A
 Via Turati 16/18, I-20121 Milano (EM)
 (85) –
 (86) EM, IT
 (87) EM, IT
 (88) EM, IT
 (89) EM
 (81) III. AZ, EM, GB, GE, JP, KG, KR, RU, TJ, TR, UA
 (72) Pierpaolo Piccioli
 C/o Valentino S.p.A. Via Turati, 16/18, I-20121, Milano (IT)
 (74) Jacobacci & Partners / Matteo Mozzi
 Via Senato, 8, I-20121 Milano (IT)
 (54) 1.-2. SHOES
 (55)

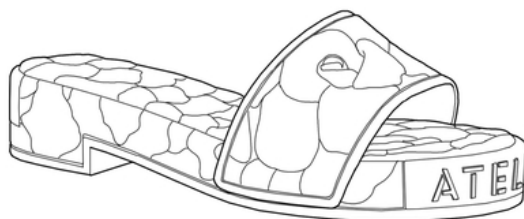

1.1



1.2



1.3

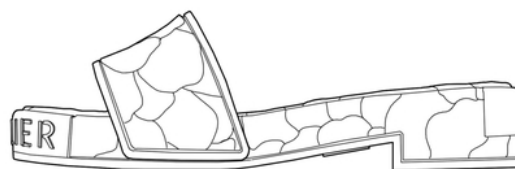

1.4

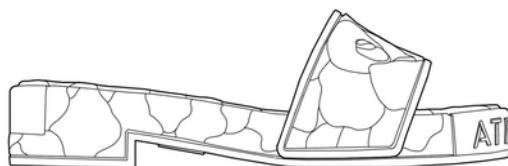

1.5

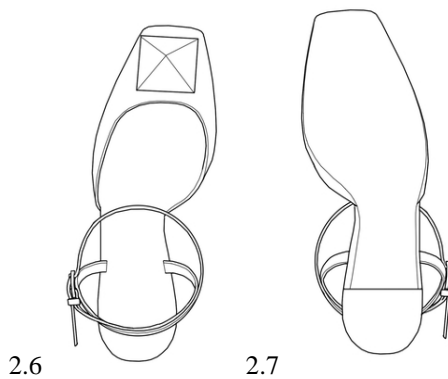
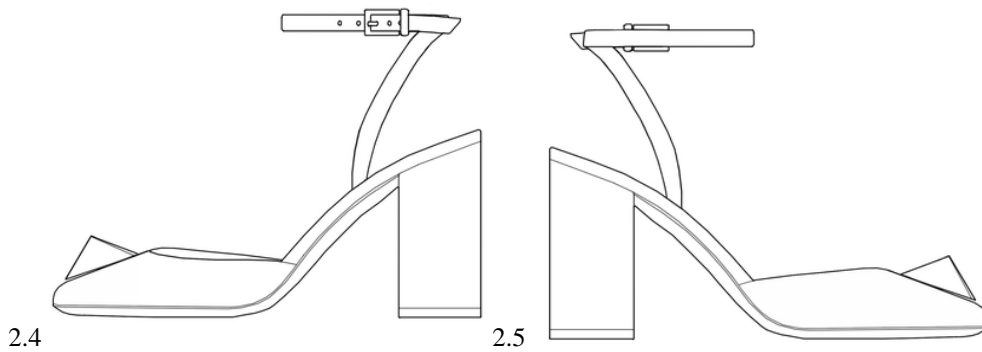
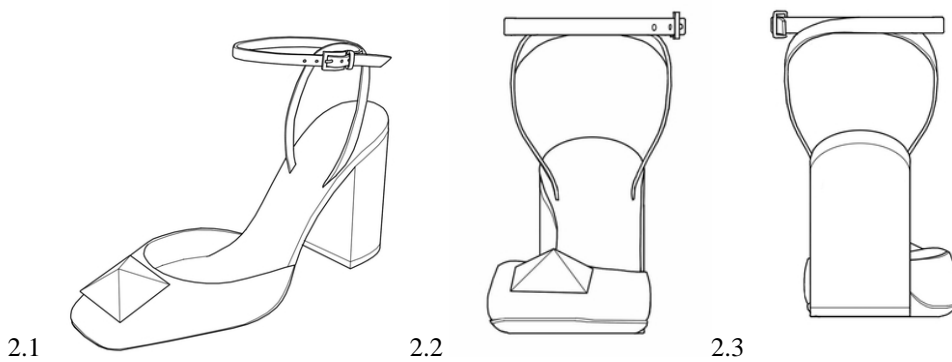
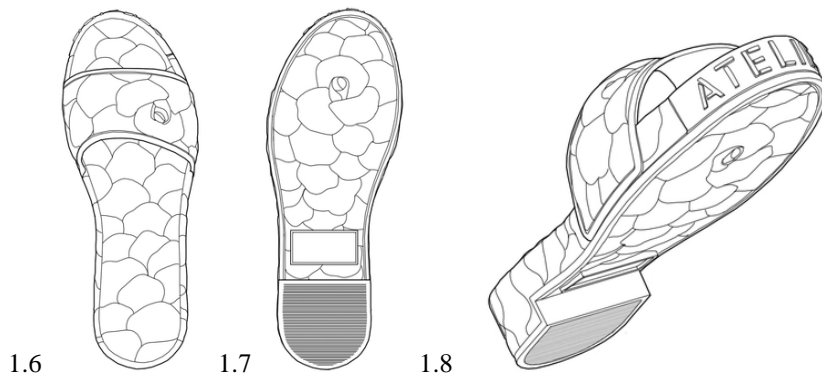

(11) DM/218 134 (51) 03-01
 (15) 2021 12 24 (44) 02/2022 (2022 01 14)

(22) 2021 12 24
 (28) 2

(73) Valentino S.p.A
 Via Turati 16/18, I-20121 Milano (EM)

(85) –
 (86) EM, IT
 (87) EM, IT
 (88) EM, IT

(89) EM
 (81) III. AZ, EM, GB, GE, JP, KG, KR, RU, TJ, TR, UA

(72) Pierpaolo Piccioli
 C/o Valentino S.p.A. Via Turati, 16/18, I-20121, Milano (IT)

(74) Jacobacci & Partners / Matteo Mozzi
 Via Senato, 8, I-20121 Milano (IT)

(54) 1.-2. BAG
 (55)

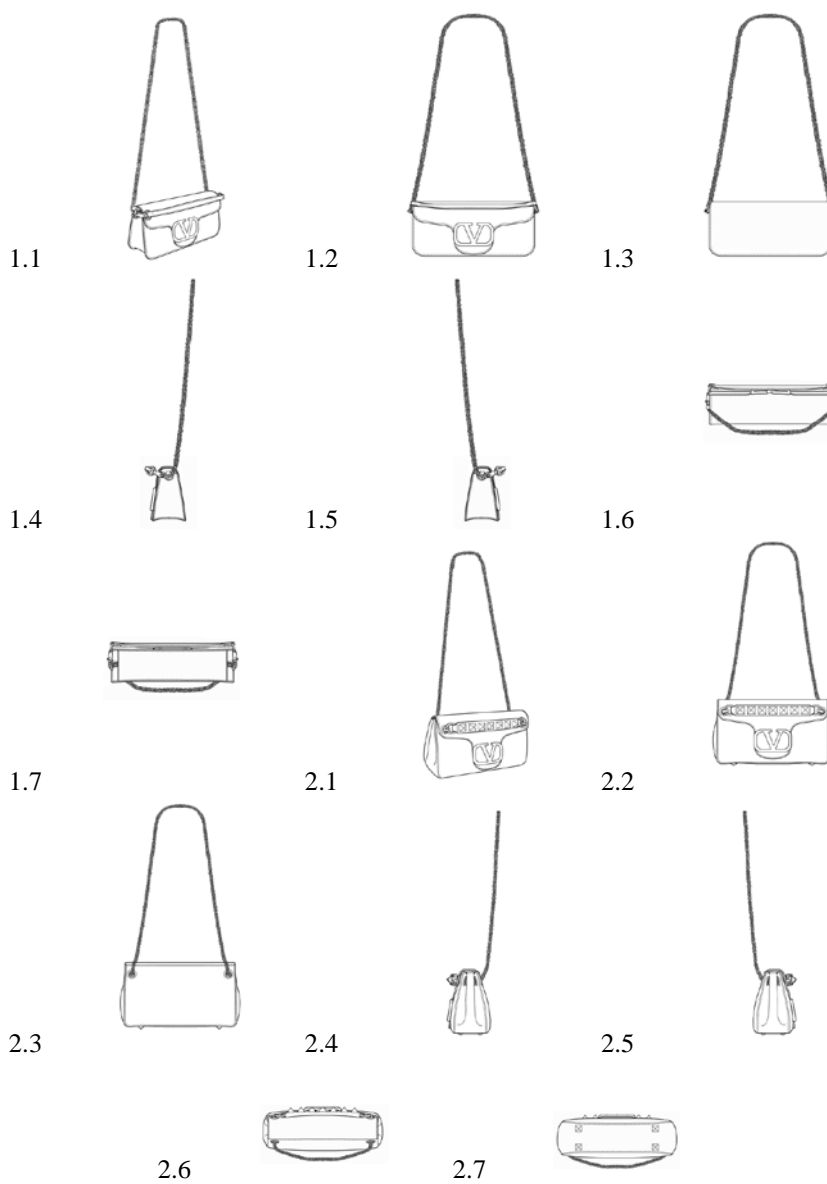

(11) DM/216 054

(51) 09-05

(15) 2021 08 05

(44) 06/2022 (2022 02 11)

(22) 2021 08 05

(28) 1

(73) Daio Paper Corporation

2-60, Mishimakamiya-cho, Shikokuchuo-shi, 799-0492 Ehime (JP)

(85) -

(86) JP

(87) -

(88) -

(89) JP

(81) III. AZ, BY, GE, RU, TR, UA

(72) Masayoshi Matsuo

C/o Elleair International Turkey, Balçık Mahallesi Pelitli Yolu Caddesi No:138/1/1 Gebze, Kocaeli (TR)

(74) Hiroshi Arafune

17F, Tokyo Takarazuka Building, 1-1-3, Yurakucho, Chiyoda-ku, 100-0006 Tokyo (JP)

(54) I. PACKAGING SACHET FOR WIPES

(55)



1.1



1.2

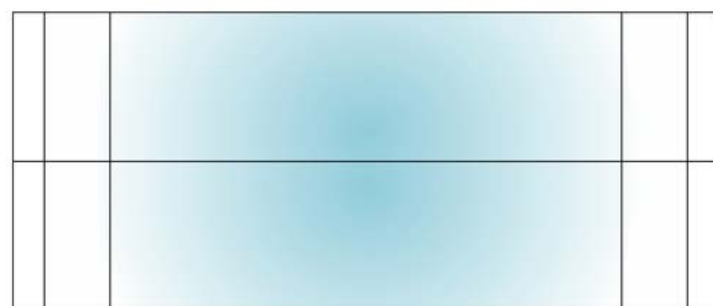

1.3

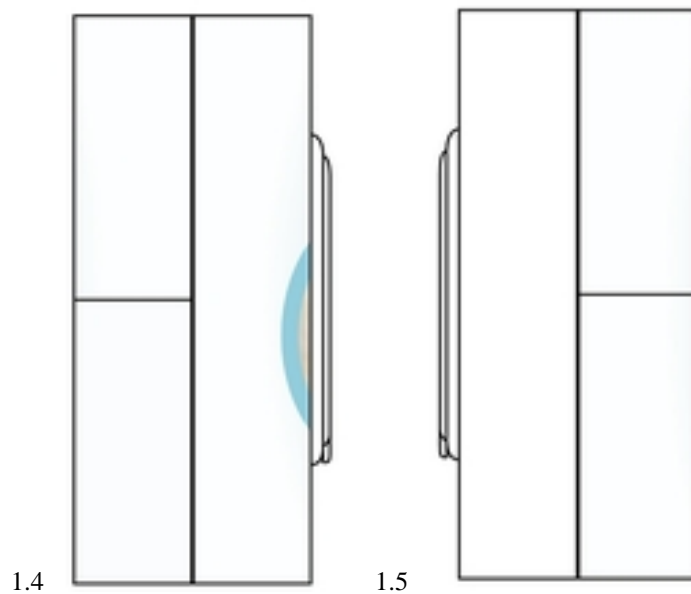

- (11) DM/216 055 (51) 09-05
(15) 2021 08 05 (44) 06/2022 (2022 02 11)
(22) 2021 08 05
(28) 1
(73) Daio Paper Corporation
2-60, Mishimakamiya-cho, Shikokuchuo-shi, 799-0492 Ehime (JP)
(85) –
(86) JP
(87) –
(88) –
(89) JP
(81) III. AZ, BY, GE, RU, TR, UA
(72) Masayoshi Matsuo
C/o Elleair International Turkey, Balçık Mahallesi Pelitli Yolu Caddesi No:138/1/1 Gebze, Kocaeli (TR)
(74) Hiroshi Arafune
17F, Tokyo Takarazuka Building, 1-1-3, Yurakucho, Chiyoda-ku, 100-0006 Tokyo (JP)
(54) I. PACKAGING SACHET FOR WIPES
(55)



1.1



1.2



1.3

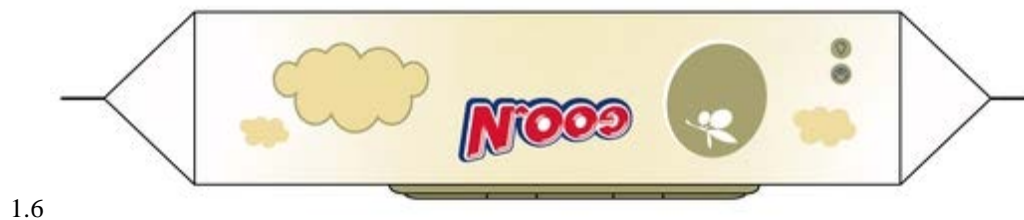
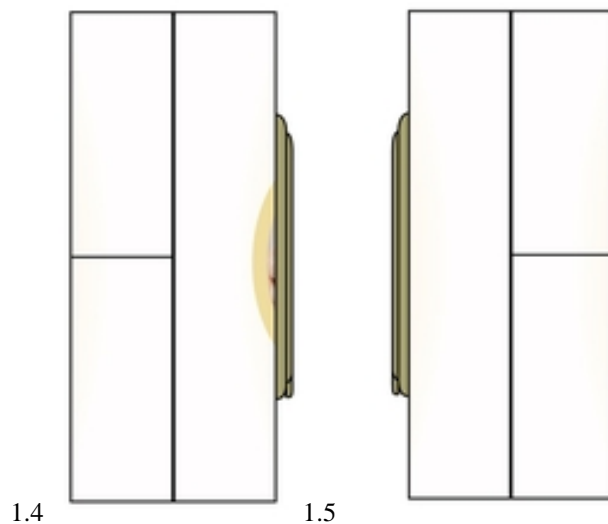

TRADEMARKS

APPLICATIONS FILED UNDER THE NATIONAL PROCEDURE APPROVED FOR REGISTRATION

The decision can be appealed at the Chamber of Appeal of Sakpatenti within 3 months from the publication or at the Mtskheta District Court Administrative Cases Board (Address: №17, Samkhedro St., Mtskheta), within 1 month following the publication.

(260) AM 2022 111416 A
(210) AM 111416
(220) 2021 01 25
(731) LLC "Artpharma"
Gamrekeli Str. 19 (512), 0160, Tbilisi,
Georgia
(740) Giorgi Taktakishvili
(540)

ფეროლიპოლი
Ferrolipole
Ферролипол

(591) Black-white
(511) 5

(260) AM 2022 111717 A
(210) AM 111717
(220) 2021 09 07
(731) LTD "Geotrade Group"
Kote Marjanishvili Str., bld. 7, app. 2,
Rustavi, Georgia
(540)

**allstone**

(591) Dark blue, light blue, swampy green
(531) 26.13.25; 27.05.01; 29.01.13
(511) 19, 35

(260) AM 2022 113881 A
(210) AM 113881
(220) 2021 07 15
(731) LTD "F D I Georgia"
Kindzmarauli Str. 5, Tbilisi, Georgia
(540)

**FDI
GEORGIA**

(591) Yellow, blue, black, white
(531) 03.07.01; 03.07.02; 24.15.03; 27.05.02;
27.05.10; 29.01.13

(526) GEORGIA
(511) 13

(260) AM 2022 114133 A
(210) AM 114133
(220) 2021 08 02
(731) Tingyi (Cayman Islands) Holding Corp.
P.O. Box 309 Ugland House, Grand Cayman
KY1-1104, Cayman Islands
(740) Giorgi Taktakishvili
(540)

**KANG SHI FU**

(591) Black-white
(531) 02.01.11; 27.05.01; 28.03
(511) 30, 32

(260) AM 2022 114144 A
(210) AM 114144
(220) 2021 08 03
(731) LLC "Agropharm"
Davit Jokhadze Str. 27, 1983, Vill. Tsavkisi,
Mtatsminda District, Tbilisi, Georgia
(740) Elene Tskrialashvili
(540)

კაზფოსფატი
Kazphosphate
Казфосфат

(591) Black-white
(511) 1, 5

(260) AM 2022 114151 A
(210) AM 114151
(220) 2021 08 04
(731) Toyota Jidosha Kabushiki Kaisha
(also trading as Toyota Motor Corporation)
1, Toyota-cho, Toyota-shi, Aichi-ken, Japan

(740) Tamar Kochlamazashvili
(540)

BZ

(591) Black-white
(531) 27.05.01; 27.05.23
(511) 12

(260) AM 2022 114216 A
(210) AM 114216
(220) 2021 08 06
(731) Cerba Healthcare
11-13 rue René Jacques, Issy Les Moulineaux,
92130, France
(740) Shalva Gvaramadze
(540)

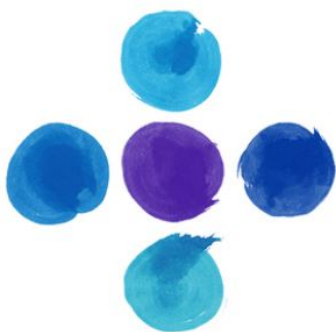

(591) Lilac, sky-blue, various tones of blue
(531) 26.01.01; 26.01.06; 26.01.24; 29.01.12
(511) 1, 5, 9, 10, 35, 39, 41, 42, 44

(260) AM 2022 114217 A
(210) AM 114217
(220) 2021 08 06
(731) LTD "Georgian Agro House"
Demetre Tavdadebuli Str. 29, Tbilisi,
Georgia
(540)



(591) F6AD71 peach pink, 5AAF39 green
(531) 05.03.06; 05.03.13; 05.03.15
(511) 31

(260) AM 2022 114218 A
(210) AM 114218
(220) 2021 08 06
(731) Cerba

Zone industrielle des Bethunes, Rue de
l'Equerre, Saint Ouen L'aumône, 95310,
France

(740) Shalva Gvaramadze
(540)

CERBA

(591) Black-white
(511) 5, 9, 35, 39, 41, 42, 44

(260) AM 2022 114237 A
(210) AM 114237
(220) 2021 08 12
(731) N(N)LE "Association Tea Road"
Gabriel Episkoposi Str. 25, b. 23, 3500,
Ozurgeti, Georgia
(540)



(591) Black, green, white
(531) 05.03.13; 05.03.15; 26.01.15; 27.05.01; 28.19;
29.01.12
(511) 30, 39

(260) AM 2022 114245 A
(210) AM 114245
(220) 2021 08 13
(731) LTD "Airline Geo Sky"
Arboshiki Str. 2, 0144, Isani District,
Tbilisi Georgia
(540)



(591) 16428D blue, E31013 red
(531) 01.05.02; 18.05.01; 18.05.03; 27.05.06;
27.05.08; 29.01.13
(511) 12, 16, 35, 38, 39, 41, 43

(260) AM 2022 114246 A
(210) AM 114246
(220) 2021 08 13
(731) LTD "Airline Geo Sky"

Arboshiki Str. 2, 0144, Isani District,
Tbilisi Georgia

(540)



(591) C7C9C7 grey, 004C97 blue, EE2737 red
(531) 18.05.01; 18.05.03; 29.01.13
(511) 12, 39

(260) AM 2022 114322 A

(210) AM 114322

(220) 2021 08 16

(731) JSC "Savane-Wine №1 Factory"

Petriashvili Str. 1, 0179, Old Tbilisi, Tbilisi,
Georgia

(540)



(591) 03989E Persian green
(531) 07.01.01; 07.01.08; 07.01.12; 28.19; 29.01.03
(511) 32, 33, 41, 43

(260) AM 2022 114324 A

(210) AM 114324

(220) 2021 08 17

(731) Reckitt & Colman (Overseas) Health Limited

103-105 Bath Road, Slough, Berkshire,
SL1 3UH, United Kingdom

(740) Liliana Darakhvelidze

(540)



(591) Blue, white, light brown
(531) 25.03.03; 26.01.02; 26.01.20; 26.01.24;
27.05.01; 27.05.21; 27.07.11; 29.01.13
(511) 3, 5

(260) AM 2022 114342 A

(210) AM 114342

(220) 2021 08 19

(731) LTD "Bioplus"

I. Noneshvili Str. 65, 6000, Batumi,
Georgia

(740) Monika Kvaratskhelia

(540)

ვიტაფლექს დუალი
VITAFLEX DUAL
ВИТАФЛЕКС ДУАЛ

(591) Black-white

(511) 5

(260) AM 2022 114344 A

(210) AM 114344

(220) 2021 08 19

(310) 35736

(320) 2021 03 03

(330) AD

(731) Philip Morris Brands Sàrl

Quai Jeanrenaud 3, 2000 Neuchâtel,
Switzerland

(740) Pavle Meipariani

(540)

CODE EDITION

(591) Black-white

(511) 34

(260) AM 2022 114393 A

(210) AM 114393

(220) 2021 08 20

(731) Nikai Gulf FZCO

P.O. Box 9200, Dubai, United
Arab Emirates

(740) Tamaz Shilakadze

(540)

NIKAI

(591) Black-white

(511) 8

(260) AM 2022 114396 A

(210) AM 114396

(220) 2021 08 20

(731) CEDC International Sp. zo.o

Ul. Kowanowska 48, Obornik, 64-600,
Poland

(740) Nugzar Ksovreli

(540)



(591) Grey, black, golden, white

(531) 01.15.21; 03.09.01; 03.09.06; 27.05.01;
27.05.09; 27.05.10; 27.05.24; 29.01.13

(511) 33

(260) AM 2022 114397 A

(210) AM 114397

(220) 2021 08 20

(731) CEDC International Sp. zo.o
Ul. Kowanowska 48, Obornik, 64-600,
Poland

(740) Nugzar Ksovreli

(540)



(591) Golden, white, black

(531) 01.15.21; 03.09.01; 03.09.06; 27.05.01;
27.05.09; 27.05.10; 27.05.17; 27.05.24;
29.01.13

(511) 33

(260) AM 2022 114398 A

(210) AM 114398

(220) 2021 08 20

(731) CEDC International Sp. zo.o
Ul. Kowanowska 48, Obornik, 64-600,
Poland

(740) Nugzar Ksovreli

(540)



(554) Three dimensional

(591) White, golden, grey, black

(531) 01.15.21; 03.09.01; 03.09.06; 19.07.01;
19.07.23; 27.05.01; 27.05.09; 27.05.10;
29.01.13

(511) 33

(260) AM 2022 114408 A

(210) AM 114408

(220) 2021 08 24

(731) LTD "Georgian Agro House"
Demetre Tavidadbuli Str. 29, Tbilisi,
Georgia

(540)



PLANTA

(591) F6AD71 peach pink, 5AAF39 green

(531) 05.03.15; 27.05.01; 29.01.12

(511) 31

REGISTERED TRADEMARKS

(111) M 2022 35126 R
(151) 2022 03 15
(181) 2032 03 15
(260) AM 2021 109506 A
(220) 2021 04 12

(732) Demasi
Nearby March 9 Garden,
Old Tbilisi District, 0105, Tbilisi, Georgia

(111) M 2022 35127 R
(151) 2022 03 15
(181) 2032 03 15
(260) AM 2020 110201 A
(220) 2020 10 19

(732) LLC "Ori Nabiji"
Navtlughi St. 39-41, 0113, Isani District,
Tbilisi, Georgia

(111) M 2022 35128 R
(151) 2022 03 15
(181) 2032 03 15
(260) AM 2020 110383 A
(220) 2020 11 05

(732) LTD "Georgian Cellar"
Gldani, IIIa mcr., bld. 17, app. 52, 0167,
Tbilisi, Georgia

(111) M 2022 35129 R
(151) 2022 03 15
(181) 2032 03 15
(260) AM 2020 110602 A
(220) 2020 11 20

(732) Platinum Wines Sp. z o.o.
Ul. Wolodyjowskiego 70/1, Warszawa, 02-724,
Poland

(111) M 2022 35130 R
(151) 2022 03 15
(181) 2032 03 15
(260) AM 2020 110858 A
(220) 2020 12 11

(732) LTD "Simba 2015"
Varketili 3, I mcr., bld. 13, app. 94, Tbilisi,
Georgia

(111) M 2022 35131 R
(151) 2022 03 15
(181) 2032 03 15
(260) AM 2020 110981 A
(220) 2020 12 24

(732) LTD "Targmani"
Merab Aleksidze St. 1, bld. 3, entrance 1,
app. 31, 0171, Tbilisi, Georgia

(111) M 2022 35132 R
(151) 2022 03 15
(181) 2032 03 15
(260) AM 2020 111062 A
(220) 2020 12 25

(732) American-Cigarette Company (Overseas)
Limited
Route de France 17, Boncourt, CH-2926,
Switzerland

(111) M 2022 35133 R
(151) 2022 03 15
(181) 2032 03 15
(260) AM 2021 111278 A
(220) 2021 01 13

(732) LTD "JapanGeorgia"
Dighomi, II qu., bld. 19, app. 35, 0159, Tbilisi,
Georgia

(111) M 2022 35134 R
(151) 2022 03 15
(181) 2032 03 15
(260) AM 2021 111422 A
(220) 2021 01 25

(732) Magda Zibzibadze
Araleti St. 16, 0178, Tbilisi, Georgia

(111) M 2022 35135 R
(151) 2022 03 15
(181) 2032 03 15
(260) AM 2021 111435 A
(220) 2021 01 27

(732) LLC "Bolero & Company"
Kuchishvili St. 12-14-16, 0179, Tbilisi, Georgia

(111) M 2022 35136 R
(151) 2022 03 15
(181) 2032 03 15
(260) AM 2021 111511 A
(220) 2021 02 01

(732) Ekaterine Podiashvili
Mukhiani, I mcr., bld. 17, entrance 6,
app. 137, 0172, Tbilisi, Georgia

(111) M 2022 35137 R
 (151) 2022 03 15
 (181) 2032 03 15
 (260) AM 2021 111513 A
 (220) 2021 02 02
 (732) LTD "Berika"
 Il. Chavchacadze Av., Lane I, bld. 6, app. 80,
 Tbilisi, Georgia

(111) M 2022 35143 R
 (151) 2022 03 15
 (181) 2032 03 15
 (260) AM 2021 111971 A
 (220) 2021 03 04
 (732) LTD "Aversi-Pharma"
 David Aghmashenebeli Av. 148, 0112, Tbilisi,
 Georgia

(111) M 2022 35138 R
 (151) 2022 03 15
 (181) 2032 03 15
 (260) AM 2021 111607 A
 (220) 2021 02 10
 (732) House of Prince A/S
 Vester Farimagsgade 19, Copenhagen V,
 DK-1606, Denmark

(111) M 2022 35144 R
 (151) 2022 03 15
 (181) 2032 03 15
 (260) AM 2021 111972 A
 (220) 2021 03 04
 (732) LTD "Aversi-Pharma"
 David Aghmashenebeli Av. 148, 0112, Tbilisi,
 Georgia

(111) M 2022 35139 R
 (151) 2022 03 15
 (181) 2032 03 15
 (260) AM 2021 111698 A
 (220) 2021 02 12
 (732) British American Tobacco (Brands) Inc.
 (a Delaware corporation)
 251 Little Falls Drive, Suite 100, Wilmington,
 Delaware, 19808-1674, USA

(111) M 2022 35145 R
 (151) 2022 03 15
 (181) 2032 03 15
 (260) AM 2021 112171 A
 (220) 2021 03 15
 (732) LLC "Biopolus"
 I. Noneshvili St. 65, Batumi, Georgia

(111) M 2022 35140 R
 (151) 2022 03 15
 (181) 2032 03 15
 (260) AM 2021 111703 A
 (220) 2021 02 14
 (732) Rusudan Ghudushauri
 Saakadze St. 167, 0186, Tbilisi, Georgia;
 LTD "Granatapfel Road"
 Saakadze St. 167, 0186, Tbilisi, Georgia

(111) M 2022 35146 R
 (151) 2022 03 15
 (181) 2032 03 15
 (260) AM 2021 112182 A
 (220) 2021 03 16
 (732) LTD "Vinery"
 O. Khizanishvili St. 8, app. 66, 0167,
 Tbilisi Georgia

(111) M 2022 35141 R
 (151) 2022 03 16
 (181) 2032 03 16
 (260) AM 2021 111939 A
 (220) 2021 02 27
 (732) Pegas Touristik UK Limited
 16 Upper Woburn Place, London, England,
 WC1H 0BS, United Kingdom

(111) M 2022 35147 R
 (151) 2022 03 15
 (181) 2032 03 15
 (260) AM 2021 112191 A
 (220) 2021 03 18
 (732) LTD "Anticredit"
 Petre Iberi St. Lane 3, app. 50, 0179,
 Tbilisi Georgia

(111) M 2022 35142 R
 (151) 2022 03 15
 (181) 2032 03 15
 (260) AM 2021 111942 A
 (220) 2021 03 01
 (732) LLC "Barambo"
 Vill. Natakhtari, 3308, Mtskheta, Georgia

(111) M 2022 35148 R
 (151) 2022 03 15
 (181) 2032 03 15
 (260) AM 2021 112253 A
 (220) 2021 03 19
 (732) Molson Canada 2005
 33 Carlingview Drive, Toronto, M9W 5E4,
 Canada

(111) M 2022 35149 R
(151) 2022 03 15
(181) 2032 03 15
(260) AM 2021 112279 A
(220) 2021 03 23
(732) LTD "G-M-P"

Vill. Ponitchala 65, 0165, Tbilisi, Georgia

(111) M 2022 35155 R
(151) 2022 03 15
(181) 2032 03 15
(260) AM 2021 112390 A
(220) 2021 03 29
(732) LTD "Biopolas"

Noneshvili St. 65, 6000, Batumi, Georgia

(111) M 2022 35150 R
(151) 2022 03 15
(181) 2032 03 15
(260) AM 2021 112283 A
(220) 2021 03 23
(732) LLC "Elite Group"

Vekua St. 14, Gldani-Nadzaladevi District,
Tbilisi, Georgia

(111) M 2022 35156 R
(151) 2022 03 15
(181) 2032 03 15
(260) AM 2021 112401 A
(220) 2021 03 30
(732) LTD "Monolit Group"

Chiatura St. 4/6, bld. 3, fl. 11, app. 66,
0171, Saburtalo District, Tbilisi, Georgia

(111) M 2022 35151 R
(151) 2022 03 15
(181) 2032 03 15
(260) AM 2021 112300 A
(220) 2021 03 24
(732) LLC "Parvus Group"

Gldani, IIIa mcr., bld. 22, app. 107, 0107,
Gldani District, Tbilisi, Georgia

(111) M 2022 35157 R
(151) 2022 03 15
(181) 2032 03 15
(260) AM 2021 112406 A
(220) 2021 03 30
(732) JSC "Corporation Kindzmarauli"

Ilia Chavchavadze St. 55, 4800, Kvareli,
Georgia

(111) M 2022 35152 R
(151) 2022 03 15
(181) 2032 03 15
(260) AM 2021 112312 A
(220) 2021 03 25
(732) Toyota Jidosha Kabushiki Kaisha
(also trading as Toyota Motor Corporation)
1, Toyota-cho, Toyota-shi, Aichi-ken, Japan

(111) M 2022 35158 R
(151) 2022 03 15
(181) 2032 03 15
(260) AM 2021 112408 A
(220) 2021 03 31
(732) LTD "Aisi"
Varketili 3, I mcr., bld. 28, app. 26, 0163,
Tbilisi, Georgia

(111) M 2022 35153 R
(151) 2022 03 15
(181) 2032 03 15
(260) AM 2021 112365 A
(220) 2021 03 26
(732) JSC "Georgian Beer Company"
Vill. Saguramo, 3311, Mtskheta, Georgia

(111) M 2022 35159 R
(151) 2022 03 15
(181) 2032 03 15
(260) AM 2021 112419 A
(220) 2021 04 01
(732) Yiwu Finder Import & Export Co., LTD
Shop 19846, 19847, 19848, 19849, Section 2,
International Trade City, Futian District, Yiwu
City, Zhejiang Province, China

(111) M 2022 35154 R
(151) 2022 03 15
(181) 2032 03 15
(260) AM 2021 112387 A
(220) 2021 03 29
(732) LTD "Monolit Group"
Chiatura St. 4/6, bld. 3, fl. 11, app. 66,
0171, Saburtalo District, Tbilisi, Georgia

(111) M 2022 35160 R
(151) 2022 03 15
(181) 2032 03 15
(260) AM 2021 112485 A
(220) 2021 04 05
(732) Tamaz Bekauri
Otar Oniashvili St. 89, app. 2, 0160, Tbilisi,
Georgia

(111) M 2022 35161 R
(151) 2022 03 15
(181) 2032 03 15
(260) AM 2021 112489 A
(220) 2021 04 06
(732) JSC "Bank of Georgia"
Gagarin St. 29a, 0160, Tbilisi, Georgia

(111) M 2022 35162 R
(151) 2022 03 15
(181) 2032 03 15
(260) AM 2021 112490 A
(220) 2021 04 06
(732) JSC "Bank of Georgia"
Gagarin St. 29a, 0160, Tbilisi, Georgia

(111) M 2022 35163 R
(151) 2022 03 15
(181) 2032 03 15
(260) AM 2021 112493 A
(220) 2021 04 06
(732) JSC "Bank of Georgia"
Gagarin St. 29a, 0160, Tbilisi, Georgia

(111) M 2022 35164 R
(151) 2022 03 15
(181) 2032 03 15
(260) AM 2021 112499 A
(220) 2021 04 07
(732) LTD "Lynus & Co"
Madneuli St. 10, Vill. Kazreti, Bolnisi,
Georgia

(111) M 2022 35165 R
(151) 2022 03 15
(181) 2032 03 15
(260) AM 2021 112510 A
(220) 2021 04 08
(732) LTD "Lynus & Co"
Madneuli St. 10, Vill. Kazreti, Bolnisi,
Georgia

(111) M 2022 35166 R
(151) 2022 03 15
(181) 2032 03 15
(260) AM 2021 112577 A
(220) 2021 04 12
(732) Johnson & Johnson
One Johnson & Johnson Plaza,
New Brunswick, New Jersey 08933, USA

(111) M 2022 35167 R
(151) 2022 03 15
(181) 2032 03 15
(260) AM 2021 112578 A
(220) 2021 04 12
(732) Johnson & Johnson
One Johnson & Johnson Plaza,
New Brunswick, New Jersey 08933, USA

(111) M 2022 35168 R
(151) 2022 03 15
(181) 2032 03 15
(260) AM 2021 112587 A
(220) 2021 04 12
(732) Ketevan Giorgobiani
Paliashvili St. 80a, Tbilisi, Georgia

(111) M 2022 35169 R
(151) 2022 03 15
(181) 2032 03 15
(260) AM 2021 112595 A
(220) 2021 04 13
(732) Nuqul Brothers Company Limited
P.O. Box 154, Amman, 11118, Jordan

(111) M 2022 35170 R
(151) 2022 03 15
(181) 2032 03 15
(260) AM 2021 112596 A
(220) 2021 04 13
(732) JSC "Georgian Beer Company"
Vill. Saguramo, 3311, Mtskheta, Georgia

(111) M 2022 35171 R
(151) 2022 03 15
(181) 2032 03 15
(260) AM 2021 112597 A
(220) 2021 04 13
(732) Nuqul Brothers Company Limited
P.O. Box 154, Amman, 11118, Jordan

(111) M 2022 35172 R
(151) 2022 03 15
(181) 2032 03 15
(260) AM 2021 112598 A
(220) 2021 04 13
(732) Anhui Jianghuai Automobile Group Corp., Ltd
No.176 Dongliu Road, Hefei City, Anhui
Province, China

(111) M 2022 35173 R
(151) 2022 03 15
(181) 2032 03 15
(260) AM 2021 112607 A
(220) 2021 04 14
(732) LTD "Macro"
Kakhaveri St. 48, 6400, Batumi, Georgia

(111) M 2022 35174 R
(151) 2022 03 15
(181) 2032 03 15
(260) AM 2021 112609 A
(220) 2021 04 14
(732) Nippon Soda Co., LTD
2-1, Ohtemachi 2-chome, Chiyoda-ku, Tokyo,
Japan

(111) M 2022 35175 R
(151) 2022 03 15
(181) 2032 03 15
(260) AM 2021 112626 A
(220) 2021 04 15
(732) Levan Kobaladze
Brothers Zubalashvili St. 2, app. 1, 0108,
Tbilisi, Georgia

(111) M 2022 35176 R
(151) 2022 03 15
(181) 2032 03 15
(260) AM 2021 112628 A
(220) 2021 04 16
(732) H Group Construction
Rustaveli St. 22, app. 30, Batumi, Georgia

(111) M 2022 35177 R
(151) 2022 03 15
(181) 2032 03 15
(260) AM 2021 112674 A
(220) 2021 04 16
(732) Grindeks As
Krustpils Iela 53, Riga, 1057, Latvia

(111) M 2022 35178 R
(151) 2022 03 15
(181) 2032 03 15
(260) AM 2021 112701 A
(220) 2021 04 21
(732) JSC "Georgian Beer Company"
Vill. Saguramo, 3311, Mtskheta, Georgia

(111) M 2022 35179 R
(151) 2022 03 15
(181) 2032 03 15
(260) AM 2021 112714 A
(220) 2021 04 26
(732) BMJ Industries FZ-LLC
Al-Jazeera Al-Hamra, Ras Al Khaimah, UAE,
United Arab Emirates

(111) M 2022 35180 R
(151) 2022 03 15
(181) 2032 03 15
(260) AM 2021 112716 A
(220) 2021 04 26
(732) BMJ Industries FZ-LLC
Al-Jazeera Al-Hamra, Ras-Al-Khaimah, UAE,
United Arab Emirates

(111) M 2022 35181 R
(151) 2022 03 15
(181) 2032 03 15
(260) AM 2021 112719 A
(220) 2021 04 27
(732) Ty Inc.
280 Chestnut Avenue, Westmont, Illinois
60559, USA

(111) M 2022 35182 R
(151) 2022 03 15
(181) 2032 03 15
(260) AM 2021 112721 A
(220) 2021 04 27
(732) LTD "Agronom"
Bidzina Kvernadze St. 35, app. 56, 0171,
Tbilisi, Georgia

(111) M 2022 35183 R
(151) 2022 03 15
(181) 2032 03 15
(260) AM 2021 112929 A
(220) 2021 05 13
(732) JSC "Smart Retail"
Ilia Chavchavadze Av. 74b, Vake District,
Tbilisi, Georgia

(111) M 2022 35184 R
(151) 2022 03 15
(181) 2032 03 15
(260) AM 2020 108503 A
(220) 2020 06 02
(732) Advanced New Technologies Co., Ltd.
Cayman Corporate Centre, 27 Hospital Road,
George Town, Grand Cayman KY1-9008,
Cayman Islands

(111) M 2022 35185 R
(151) 2022 03 15
(181) 2032 03 15
(260) AM 2020 104205 A
(220) 2020 02 17
(732) LLC "Demasi"

Right Coast, Surrounding Area of
the 9 March Garden, Tbilisi, Georgia

(111) M 2022 35186 R
(151) 2022 03 15
(181) 2032 03 15
(260) AM 2020 110482 A
(220) 2020 11 13
(732) LTD "Bio Georgia"

Sopiko Chiaureli St. 16, Tbilisi, Georgia

(111) M 2022 35187 R
(151) 2022 03 15
(181) 2032 03 15
(260) AM 2021 111586 A
(220) 2021 02 06
(732) LLC "Georgian Wine House"

Vill. Zegaani, 1500, Gurjaani, Georgia

(111) M 2022 35188 R
(151) 2022 03 15
(181) 2032 03 15
(260) AM 2021 111604 A
(220) 2021 02 09
(732) Besik Paichadze

Bakhtrioni St. 14b, app. 8, Tbilisi, Georgia

(111) M 2022 35189 R
(151) 2022 03 15
(181) 2032 03 15
(260) AM 2021 112164 A
(220) 2021 03 15
(732) Veronika Gamieva

Metrologichna St. 113, app. 42 Kyiv, Ukraine

(111) M 2022 35190 R
(151) 2022 03 15
(181) 2032 03 15
(260) AM 2021 112710 A
(220) 2021 04 23
(732) LLC "Rtvelisi"

R. Shmerling St. 19, 0131, Tbilisi, Georgia

(111) M 2022 35191 R
(151) 2022 03 15
(181) 2032 03 15
(260) AM 2021 112722 A

(220) 2021 04 28

(732) LTD "Cyclone"

Sulkhan Tsintsadze St. 58, Commercial Space
10, bld. B, entr. 3, fl. 1, 0160, Saburtalo
District, Tbilisi, Georgia

(111) M 2022 35192 R

(151) 2022 03 15

(181) 2032 03 15

(260) AM 2021 113009 A

(220) 2021 05 14

(732) LTD "MS Group"

Chirnakhuli St. 4, 0151, Tbilisi, Georgia

(111) M 2022 35193 R

(151) 2022 03 15

(181) 2032 03 15

(260) AM 2021 113113 A

(220) 2021 05 24

(732) LTD "Georgian Theme"

Irakli Gamrekeli St. 35v, 0186, Tbilisi, Georgia

(111) M 2022 35197 R

(151) 2022 03 17

(181) 2032 03 17

(260) AM 2016 87174 A

(220) 2016 05 05

(732) LTD "Zhorzholiani Trading"

Nutsubidze Plateau IV mcr., bld. 17, 0183,
Tbilisi, Georgia

(111) M 2022 35198 R

(151) 2022 03 17

(181) 2032 03 17

(260) AM 2016 88279 A

(220) 2016 08 15

(732) LTD "Zhorzholiani Trading"

Nutsubidze Plateau IV mcr., bld. 17, 0183,
Tbilisi, Georgia

TRADEMARKS REGISTERED ACCORDING TO THE ACCELERATED PROCEDURE

The decision can be appealed at the Chamber of Appeal of Sakpatenti within 3 months from the publication.

(111) M 2022 35119 R
 (151) 2022 03 11
 (181) 2032 03 11
 (210) AM 116667
 (220) 2022 02 17
 (732) Georgian Football Federation
 Iliа Chavchavadze Ave. 76a, 0179, Tbilisi,
 Georgia

(540)

მე ვარ საქართველო

(591) Black-white
 (526) საქართველო
 (511) 25, 28

Tsotne Dadiani Str., II mcr, bld. 2, app. 1,
 Gldani-Nadzaladevi District, Tbilisi, Georgia

(740) Shalva Gvaramadze

(540)



(591) Black, white, red
 (531) 14.03.01; 14.03.03; 15.07.01; 15.07.03;
 27.05.21; 28.05; 29.01.13
 (511) 7

(111) M 2022 35120 R
 (151) 2022 03 11
 (181) 2032 03 11
 (210) AM 116759
 (220) 2022 02 23
 (732) LTD "Europebet Saqomago"
 Merab Kostava Str. 47/57, Mtatsminda
 District, Tbilisi, Georgia

(540)



(591) Orange, white, black, green, brown
 (531) 02.09.15; 02.09.19; 09.01.07; 19.07.01;
 19.08.07; 21.03.01; 25.01.05; 26.01.01;
 26.01.18; 26.01.19; 26.01.22; 26.04.01; 28.19;
 29.01.15

(511) 32

(111) M 2022 35122 R
 (151) 2022 03 11
 (181) 2032 03 11
 (210) AM 116760
 (220) 2022 02 23
 (732) LTD "Europebet Saqomago"
 Merab Kostava Str. 47/57, Mtatsminda
 District, Tbilisi, Georgia

(540)



(111) M 2022 35121 R
 (151) 2022 03 11
 (181) 2032 03 11
 (210) AM 116662
 (220) 2022 02 17
 (732) Malakhat Mamedova

(554) Three Dimensional
 (591) Orange, white
 (531) 19.08.05; 26.01.01; 26.01.18; 27.05.01;
 27.05.21; 29.01.12
 (511) 32

(111) M 2022 35123 R
 (151) 2022 03 11
 (181) 2032 03 11
 (210) AM 116656
 (220) 2022 02 16
 (732) LTD "Coastal-Investment Group"
 Didube District, between Khosharauli and
 Eliava Streets, and Left Bank of the
 River Mtkvari and Vakhushti Bridge,
 Tbilisi Georgia

(540)



(591) Red, yellow, blue, green, white
 (531) 26.11.25; 27.05.01; 27.05.10; 29.01.15
 (511) 35, 36, 37

(111) M 2022 35124 R
 (151) 2022 03 11
 (181) 2032 03 11
 (210) AM 116539
 (220) 2022 02 09
 (732) LTD "Martipia"
 Akaki Belashvili Str. 104, 0159, Tbilisi,
 Georgia

(540)



(591) FFFFFFF white, 018E43 green
 (531) 03.01.06; 03.01.16; 03.01.24; 29.01.12
 (511) 36

(111) M 2022 35125 R
 (151) 2022 03 14
 (181) 2032 03 14
 (210) AM 116963
 (220) 2022 03 07
 (732) LTD "Out Flat"
 Petre Kavtaradze Str. 74, app. 10, 0186,
 Tbilisi, Georgia

(540)

აუთფლეთი
OutFlat

(591) Black-white
 (511) 36

(111) M 2022 35194 R
 (151) 2022 03 15
 (181) 2032 03 15
 (210) AM 116984
 (220) 2022 03 09
 (732) JSC "Microfinance Organization Swiss
 Capital"
 Akaki Tsereteli Ave. 118, I Pavilion, Tbilisi,
 Georgia

(540)

scapp ✓
სკაპი ✓

(591) Red, black, white
 (531) 24.17.20; 27.05.01; 28.19; 29.01.12
 (511) 36

(111) M 2022 35195 R
 (151) 2022 03 16
 (181) 2032 03 16
 (210) AM 116847
 (220) 2022 03 01
 (732) Ivane Kuzanov
 Kote Marjanishvili Str. 42, Tbilisi, Georgia;
 Iagor Kuzanov
 Kote Marjanishvili Str. 42, Tbilisi, Georgia;
 Aleksandre Kuzanov
 Kote Marjanishvili Str. 42, Tbilisi, Georgia

(540)



(591) Black-white
 (531) 26.04.02; 26.04.12; 26.04.24; 27.05.01; 28.05;
 28.19
 (511) 5, 33, 41, 43, 44

(111) M 2022 35196 R
 (151) 2022 03 17
 (181) 2032 03 17
 (210) AM 116956
 (220) 2022 03 04
 (732) Nobel Ilac Sanayii ve Ticaret Anonim
 Sirketi Representative in Georgia
 Liberty Square 4, 0105, Tbilisi, Georgia

(740) Tinatin Tskhvediani

(540)

Moludes
მოლუდესი

(591) Black-white

(511) 5, 35

(111) M 2022 35199 R

(151) 2022 03 18

(181) 2032 03 18

(210) AM 117072

(220) 2022 03 15

(732) LTD "Fanshin Trade Limited Company"
Pridon Khalvashi Str. 18, 6000, Batumi,
Georgia

(540)



(591) FFFF00 yellow, 009D4E green

(531) 01.01.01; 01.01.02; 01.01.10; 26.04.02;
26.04.22; 26.04.24; 27.05.01; 27.05.24;
29.01.12

(511) 43

INTERNATIONAL TRADEMARKS FOR WHICH A DECISION ON GRANTING PROTECTIONS IS TAKEN

The decision can be appealed at the Chamber of Appeal of Sakpatenti within 3 months from the publication or at the Mtskheta District Court Administrative Cases Board (Address: №17, Samkhedro St., Mtskheta), within 1 month following the publication.

(260) AM 2022 109171 A*

(800) 1541878

(151) 2019 12 16

(891) 2019 12 16

(731) UPL LTD.

upl house, 610 b/2, bandra village, off western express highway, bandra (east), mumbai, maharashtra 400051, India

(540)



(591) Black, white

(531) 26.01.06; 26.13.25

(511)

1 – Fertilizer and chemical products for use in agriculture, plant nutrient, additive chemical to fungicides, additive chemical to insecticides, flower preservatives, chemicals for forestry, phosphorus, plant growth regulating preparations, carbolineum for the protection of plant.

5 – Pesticides, insecticides, fungicides, herbicides, vermicides, rodenticides, weedicides, preparations for killing weeds and destroying vermin.

31 – Seeds, seedlings, agricultural, horticultural and forestry products and grains not included in other classes, fresh fruits and vegetable seeds, natural plants and flowers.

35 – Advertising, business management, business administration, office functions, retail and online wholesale services, all pertaining to the field of manufacturing and marketing agrochemicals, seeds and other agricultural related products, industrial chemicals, chemical intermediates, and specialty chemicals and providing crop protection solutions.

41 – Education; providing of training; entertainment; sporting and cultural activities; vocational guidance.

44 – Medical services; veterinary services; hygienic and beauty care for human beings or animals; agriculture, horticulture and forestry services.

(260) AM 2022 109995 A

(800) 1553179

(151) 2020 06 30

(891) 2020 06 30

(731) A.B.S. All Brake Systems B.V.

Tinbergenlaan 7, NL-3401 MT IJSSELSTEIN, Netherlands

(540)



DRIVEN BY EXPERTISE



(591) Black, grey and red

(531) 15.07.07; 15.07.09; 15.07.19; 18.01.21;

24.01.03; 26.01.04; 26.01.05; 26.04.18;

29.01.12

(511)

1 – Oils for brakes; brake fluid; power steering fluid; sealants for leaks in power steering systems of cars.

4 – Lubricating oils for wheels.

9 – Brake testing apparatus; brake pad wear sensors; brake fluid testers; wheel alignment measuring apparatus; anti-blocking system sensors.

12 – Brakes for motor vehicles; braking systems for vehicles; brake sets for vehicles; disc brakes; brake drums; brake facings; main brake cylinders; brake plates for land vehicles; brake rotors for vehicles; brake cables for vehicles; brake calipers for vehicles; brake levers for vehicles; brake pads for vehicles; brake pedals for vehicles; brake shoes for vehicles; brake lines for vehicles; brake pressure regulators for vehicles; brake hardware for vehicles; reservoirs for maintaining the level of fluids in vehicle braking systems; steering wheels; steering brakes; handlebars; covers for vehicle steering wheels; steering units for vehicles; handlebar dampers [parts of vehicles]; steering columns for vehicles; handlebar grips [parts of motorcycles]; vehicle wheels; tyres; wheel hubs; hub caps; wheel brakes; spoke clips for wheels; wheel arch extensions for vehicles; wheel suspensions; wheel trims; range spacers for wheels of vehicles; tyres for vehicle wheels; wheel bearings for vehicles; wheel covers for vehicles; repair outfits for tyres; loader swivel axles

for vehicles; fender flares for vehicles; wheel axles for vehicles; tire chains [vehicle parts]; chains for vehicle wheels; steering wheel locks; handlebar stems.

(260) AM 2022 110103 A*

(800) 967714

(151) 2008 05 09

(891) 2020 09 22

(731) OLIMP LABORATORIES SPOLKA Z
OGRANICZONA ODPOWIEDZIALNOSCIA
Pustynia 84F, PL-39-200 Dębica, Poland

(540)



(591) Yellow, gray and black

(531) 03.13.05; 26.05.04; 27.05.01; 29.01.14

(511)

5 – Strengthening nutrients containing parapharmaceutical preparations for prophylactic use and for convalescents (these goods are only for human and not for animals).

29 – Concentrates and high protein nutrients enriched with vitamins, mineral salts and amino acids (these goods are only for human and not for animals).

30 – Glucidic concentrates and foodstuffs with high energy content enriched with vitamins and mineral salts (these goods are only for human and not for animals).

32 – Non-alcoholic beverages enriched with vitamins and mineral salts (these goods are only for human and not for animals).

(260) AM 2022 110246 A*

(800) 1556524

(151) 2020 06 02

(891) 2020 06 02

(731) Euro Games Technology Ltd.
4, "Maritsa" Str., "Vranya-Lozen-Triugulnika",
BG-1151 Sofia, Bulgaria

(540)



(591) Brown, gold, yellow, pink, orange and black

(531) 05.05.16; 27.05.03; 28.03; 29.01.15

(511)

9 – Software drivers; computer programs for network management; operating computer software for main frame computers; monitors (computer hardware); computer hardware; apparatus for recording images; monitors (computer programs); apparatus for recording, transmission or reproduction of sound or images; communications servers [computer hardware]; electronic components for gambling machines.

28 – Boxes for coin-operated amusement machines, slot machines and gaming machines; housings for coin-operated amusement machines, gaming equipment, gaming machines, machines for gambling.

41 – Training in the development of software systems; rental of gambling machines for gambling halls; providing casino equipment [gambling]; gaming hall services; games equipment rental; rental of gaming machines; rental of gaming machines with images of fruits; editing or recording of sounds and images; sound recording and video entertainment services; hire of sound reproducing apparatus; provision of gaming equipment for casinos.

(260) AM 2022 110306 A*

(800) 1557333

(151) 2020 06 02

(891) 2020 06 02

(731) Euro Games Technology Ltd.
4, "Maritsa" Str., "Vranya-Lozen-Triugulnika";
BG-1151 Sofia, Bulgaria

(540)



(591) Brown, gold, yellow, pink, orange and black

(531) 05.05.16; 27.05.03; 28.03; 29.01.13

(511)

9 – Software drivers; computer programs for network management; operating computer software for main frame computers; monitors (computer hardware); computer hardware; apparatus for recording images; monitors (computer programs); apparatus for recording, transmission or reproduction of sound or images; communications servers [computer hardware]; electronic components for gambling machines.

28 – Boxes for coin-operated amusement machines, slot machines and gaming machines; housings for coin-operated amusement machines, gaming equipment, gaming machines, machines for gambling.

41 – Training in the development of software systems; rental of gambling machines for gambling halls; providing casino equipment [gambling]; gaming hall services; games equipment rental; rental of gaming ma-

chines; rental of gaming machines with images of fruits; editing or recording of sounds and images; sound recording and video entertainment services; hire of sound reproducing apparatus; provision of gaming equipment for casinos.

(260) AM 2022 111055 A*

(800) 1433146

(151) 2018 06 18

(891) 2020 10 23

(731) Farmak International Holding GmbH

Mariahilferstrasse 136, A-1150 Wien, Austria

(540)

ОГРАНИЯ

(591) Black, white

(531) 28.05

(511)

5 – Antiepileptic pharmaceutical preparations.

(260) AM 2022 113168 A

(800) 722689

(151) 1999 11 11

(891) 2020 04 29

(731) DSM IP Assets B.V.

Het Overloon 1, NL-6411 TE Heerlen,

Netherlands

(540)

ALPAFLOR

(591) Black, white

(511)

1 – Chemicals, plant extracts and vegetable agents for industrial purposes.

3 – Plant extracts for cosmetic purposes, cosmetics.

(260) AM 2022 113175 A

(800) 1312034

(151) 2015 12 21

(891) 2021 05 11

(731) WindStar Medical GmbH

Am Joseph 15, 61273 Wehrheim, Germany

(540)



(591) Black, white

(531) 24.13.01; 24.13.14; 24.17.05; 26.04.24;
27.05.24

(511)

3 – Preparations for body and beauty care; cosmetics; nail care products; perfumery; hair shampoos; toothpaste; hair lotions; sunscreens.

5 – Pharmaceutical products and preparations for health care; mineral food supplements; food supplements based on amino acids; nutritional supplements on the basis of minerals; nutritional supplements on the basis of trace elements; food supplements for medical purposes; vitamins, all included in this class, in the form of effervescent tablets; candy for medical purposes; dietetic substances adapted for medical purposes; dressings; bandages for dressing purposes; plasters for medical purposes; plasters for medical purposes; solvents for removing adhesive plasters; medicines for human purposes; test strips for medical purposes; diagnostic preparations for medical purposes; cloths impregnated with pharmaceutical lotions; disinfectants; chemical preparations for medical purposes; cold spray for medical purposes; ointments for pharmaceutical purposes; dietetic foods or food supplements for non-medical purposes on the basis of proteins, fats, fatty acids, with added vitamins, minerals, trace elements, either singly or in combination; dietetic foods or food supplements for non-medical purposes on the basis of carbohydrates, roughage, with added vitamins, minerals, trace elements, either singly or in combination.

10 – Medical equipment and instruments; orthopedic articles; syringes for medical purposes; elastic bandages; orthopedic joint bandages; gloves for medical purposes; heating or cooling orthopaedic bandages; heating pads for medical purposes.

29 – Dietary food for non-medical purposes on the basis of milk proteins, fats with added vitamins, fatty acids, minerals, trace elements, either singly or in combination, included in this class.

(260) AM 2022 113178 A

(800) 1504220

(151) 2019 10 17

(891) 2021 05 11

(731) WindStar Medical GmbH

Am Joseph 15, 61273 Wehrheim, Germany

(540)

BodyMedica

(591) Black, white

(511)

3 – Non-medicated cosmetics and toiletry preparations; body cleaning and beauty care preparations; bath preparations; cosmetic preparations for slimming purposes; slimming aids [cosmetic], other than for medical use; oils for cosmetic purposes; massage oils; essential oils and aromatic extracts.

5 – Dietary supplements and dietetic preparations; milk sugar; medicinal tea; nutritional supplements; soy protein dietary supplements; food supplements; nutraceuticals for use as a dietary supplement; dietetic beverages adapted for medical purposes; dietetic foods adapted for medical purposes; protein supplement

shakes; dietary fiber to aid digestion; probiotic supplements; meal replacement powders; slimming pills; dietetic sugar substitutes for medical use; appetite suppressants; vitamins and vitamin preparations; pharmaceuticals and natural remedies; herbal teas for medicinal purposes; digestives for pharmaceutical purposes; medical preparations for slimming purposes; appetite suppressants for medical purposes; pharmaceuticals; bath preparations for medical purposes; medicinal oils; dietetic sweeteners for medical purposes.

29 – Dairy products and dairy substitutes; powdered soya milk; powdered milk; drinks made from dairy products; processed fruits, fungi and vegetables (including nuts and pulses); fruit-based meal replacement bars; nut-based meal replacement bars.

30 – Coffee, teas and cocoa and substitutes therefor; infusions, not medicinal; chips [cereal products]; cereal bars and energy bars; chocolate-based meal replacement bars; cereal-based meal replacement bars; snacks manufactured from muesli; non-medicated confectionery for use as part of a calorie controlled diet; processed grains, starches, and goods made thereof, baking preparations and yeasts; yeast and leavening agents; cereal preparations; cereals; oat flakes; breakfast cereals, porridge and grits; natural low calorie sweeteners; sugar; natural sweeteners; bakery goods; dairy confectionery; muesli desserts; puddings; chocolate; flour confectionery; candy coated confections; non-medicated flour confectionery; chocolate confectionery containing pralines; snack foods consisting principally of confectionery; chocolate candies; cereal-based snack food; prepared meals containing [principally] pasta.

32 – Soft drinks; whey beverages; juices; waters; functional water-based beverages; pastilles for effervescent beverages; aloe vera juices; energy drinks; non-alcoholic preparations for making beverages; syrups and other non-alcoholic preparations for making beverages; powders for the preparation of beverages.

(260) AM 2022 113179 A

(800) 1509004

(151) 2019 11 22

(891) 2021 05 11

(731) WindStar Medical GmbH

Am Joseph 15, 61273 Wehrheim, Germany

(540)

EyeMedica

(591) Black, white

(511)

3 – Cleaning sprays; foam detergents; cleansing masks; eyeglass lens cleaning solutions; eye cream; eye lotions; skin, eye and nail care preparations; gel eye patches for cosmetic purposes; eye compresses for cosmetic purposes; eye-washes, not for medical

purposes; cleaning preparations impregnated into pads; eye gels.

5 – Eyepatches for medical purposes; eye pads for medical use; pharmaceutical products and health-care products; mineral food supplements; food supplements with a base of amino acids; food supplements with a base of minerals; dietary supplements on the basis of trace elements; nutritional supplements; vitamin preparations, including in the form of effervescent pastilles; dietetic preparations adapted for medical use; solutions for contact lenses; contact lens cleaning preparations; dietary supplements, not for medical purposes, based on proteins, fats, with added fatty acids, vitamins, minerals, trace elements, either singly or in combination; food supplements not adapted for medical use, with a base of carbohydrates, roughage, with added vitamins, minerals, trace elements, either singly or in combination.

29 – Dietetic food adapted for medical use, based on proteins, fats, with added fatty acids, vitamins, minerals, trace elements, either singly or in combination, made predominantly from meat, fish, poultry, game, milk and/or vegetables, included in this class.

30 – Dietetic food, not adapted for medical use, based on carbohydrates, dietary fibre, with added vitamins, minerals, trace elements, either singly or in combination, predominantly made from cereals, rice, sugar and/or salt, included in this class.

(260) AM 2022 113181 A

(800) 1545823

(151) 2020 07 03

(891) 2021 04 26

(731) Aquis Hairsiences Inc.

621 Sansome St., San Francisco CA 94111,
USA

(540)

K18

(591) Black, white

(511)

3 – Cosmetic preparations; essential oils for hair care; hair care preparations; hair oils; oil baths for hair care; oils for hair conditioning.

(260) AM 2022 113291 A

(800) 1594117

(151) 2021 04 19

(891) 2021 04 19

(731) WINE-TRADEMARKS S.R.L.

str. Andrei Lupan, 4, ap, 2, MD-2059
mun. Chiqinlu, Republic of Moldova

(540)

BASTA БАСТА

(591) Black, white

(531) 28.05

(511)

32 – Beer; non-alcoholic beverages; mineral and aerated waters; fruit beverages and fruit juices; syrups and other non-alcoholic preparations for making beverages; aperitifs, non-alcoholic; barley wine [beer]; carbonated water; lithia water; seltzer water; soda water; waters [beverages]; mineral water [beverages]; table waters; kvass; cocktails, non-alcoholic; beer-based cocktails; lemonades; isotonic beverages; non-alcoholic honey-based beverages; rice-based beverages, other than milk substitutes; soya-based beverages, other than milk substitutes; aloe vera drinks, non-alcoholic; whey beverages; protein-enriched sports beverages; soft drinks; non-alcoholic beverages flavoured with coffee; non-alcoholic beverages flavoured with tea; non-alcoholic fruit juice beverages; energy drinks; fruit nectars, non-alcoholic; orgeat; ginger beer; malt beer; powders for effervescing beverages; sarsaparilla [non-alcoholic beverage]; syrups for lemonade; syrups for beverages; smoothies; tomato juice [beverage]; cider, non-alcoholic; vegetable juices [beverages]; fruit juices; non-alcoholic preparations for making beverages; preparations for making carbonated water; must; grape must, unfermented; beer wort; malt wort; pastilles for effervescing beverages; sherbets [beverages]; non-alcoholic fruit extracts; extracts of hops for making beer; non-alcoholic essences for making beverages.

33 – Alcoholic beverages, except beer; aperitifs; arack [arak]; baijiu [Chinese distilled alcoholic beverage]; brandy; wine; piquette; whisky; vodka; anisette [liqueur]; kirsch; gin; digesters [liqueurs and spirits]; cocktails; curacao; anise [liqueur]; liqueurs; pre-mixed alcoholic beverages, other than beer-based; alcoholic beverages containing fruit; spirits [beverages]; distilled beverages; mead [hydromel]; peppermint liqueurs; bitters; nira [sugarcane-based alcoholic beverage]; rum; sake; perry; cider; rice alcohol; alcoholic extracts; fruit extracts, alcoholic; alcoholic essences.

(260) AM 2022 113292 A

(800) 1594207

(151) 2020 07 29

(891) 2020 07 29

(731) Qatar Airways Group (Q.C.S.C.)

Qatar Airways Tower, Airport Road,
P.O. Box 22550, Doha, Qatar

(540)

QATAR

AIRWAYS القطرية



(591) Black, white

(531) 03.04.07; 03.04.13; 03.04.24; 25.07.15;
27.05.10; 28.01

(511)

9 – Recorded media; downloadable media; downloadable electronic publications; downloadable electronic publications, namely guides on travel and accommodation; downloadable electronic publications in the field of travel and accommodation; computer software for use in the provision of travel and accommodation services; downloadable electronic games; video game software; video game discs; application software; application software relating to travel and accommodation; mobile application software; mobile application software relating to travel and accommodation; interactive computer software that provides navigational and travel information; video films and cinematographic films; video films and cinematographic films relating to travel and accommodation services; downloadable electronic maps; computer digital maps; encoded loyalty cards; sunglasses; cases for sunglasses; magnets; decorative magnets; fridge magnets; laptop cases; phone cases; mobile phone cases; parts, fittings and accessories for the aforesaid goods.

16 – Paper; cardboard; printed matter; printed publications; newsletters; magazines; travel magazines; magazines relating to air transport; brochures; travel brochures; brochures relating to air transport; stationery; drawing materials; colouring books; colouring crayons; pens; pencils; stickers; postcards; business cards; tickets; airline tickets; timetables; maps; menus; vouchers; notebooks; diaries; calendars; paper labels; paper tags; parts, fittings and accessories for the aforesaid goods.

18 – Leather and imitations of leather; luggage and carrying bags; umbrellas and parasols; walking sticks; trunks and travelling bags; suitcases; luggage tags; leather luggage tags; bags; leather bags; handbags; leather handbags; briefcases; leather briefcases; travelling trunks; sports bags; beach bags; tote bags; duffel bags; rucksacks; garment bags; suit bags; fitted protective covers for luggage; toiletry bags; cosmetic bags; card holders; credit card cases; credit card holders; purses; wallets; shopping bags; textile shopping bags; canvas bags; parts, fittings and accessories for the aforesaid goods.

25 – Clothing; footwear; headgear; t-shirts; shirts; tunics; shorts; sweatshirts; sweaters; blouses; skirts; dresses; robes; trousers; ties; jackets; hats; sun hats; caps; baseball caps; pyjamas; eye masks; fabric face masks (clothing); socks; slippers; sports footwear;

football boots; studs for football boots; football shirts; gloves; scarves; silk scarves; head scarves; uniforms; belts; parts, fittings and accessories for the aforesaid goods.

35 – Advertising; business management; business administration; office functions; marketing and promotional services; organisation, operation and supervision of loyalty and incentive schemes; management of loyalty and incentive schemes; organisation, operation and supervision of frequent flyer programmes; management of frequent flyer programmes; organisation of events for commercial and advertising purposes; promotion of special events; arranging and conducting of promotional events; arranging and conducting of promotional events in the field of travel; promotion of sports competitions and events; promotion of goods and services through sponsorship; promotion of goods and services through sponsorship of sports events; providing marketing information via a website; providing advertising information via a website; organising of prize draws for promotional purposes; organisation of prize draws for advertising purposes; retail and on-line retail services relating to the sale of cosmetics, toiletries, perfumes, fragrances, aftershave, makeup, reed diffusers, computer software, application software, sunglasses, cases for sunglasses, magnets, decorative magnets, fridge magnets, laptop cases, phone cases, mobile phone cases, mobile phones, smart phones, digital cameras, wireless speakers, ear phones, wireless ear phones, ear plugs, flight socks, keyrings, jewellery, watches, tie-pins, cufflinks, badges of metal, books, booklets, travel guides, journals, magazines, maps, periodicals, stationery, drawing materials, colouring books, colouring crayons, pens, pencils, stickers, postcards, posters, timetables, vouchers, notebooks, notepads, diaries, calendars, luggage, suitcases, handbags, bags, toiletry bags, card holders, purses, wallets, shopping bags, tote bags, mugs, travel mugs, coffee mugs, insulated mugs, combs, hair brushes, toothbrushes, towels, blankets, pillows, pillow cases, lanyards for wear, clothing, t-shirts, sweat-shirts, hats, caps, pyjamas, eye masks, fabric face masks, socks, slippers, games, toys, soft toys, stuffed toys, dolls, puzzles, toy airplanes, model aircraft, video game machines, video game apparatus, video game software, video game discs, playing cards, balls for sports, food, chocolates, confectionery, tea, coffee, marmalade, fruit preserves; information, advisory and consultancy services in relation to the aforesaid.

39 – Transport; packaging and storage of goods; travel arrangement; reservation and booking services for transportation; travel services; travel reservation and booking services; travel information services; airline services; scheduled passenger airline services; air transport; reservation services for airline travel; airline booking services; air transportation services for passengers; airline services for the transportation of goods; reservation and booking of seats for travel; cargo

storage services; cargo handling services; air charter services; aircraft chartering services; package holiday services for arranging travel; arranging and booking of travel for package holidays; arranging of excursions as part of package holidays; arranging car hire as part of package holidays; arranging of sightseeing tours as part of package holidays; arranging of tours; arranging of excursions; arranging of cruises; arranging of flights; arranging of car hire; vehicle rental services; vehicle parking services; booking agency services for travel; travel courier services; courier services; transportation of freight; air transportation of freight; provision of information relating to airline departures; provision of information relating to airline arrivals; information, advisory and consultancy services relating to the aforesaid.

(260) AM 2022 113293 A

(800) 1594213

(151) 2021 03 30

(891) 2021 03 30

(731) Qingzhou Tanboer Garment Co., Ltd.
No. 3588 Zhaode Road, Qingzhou City,
Weifang City, Shandong Province, China

(540)

坦博尔
TANBOER

(591) Black, white

(531) 28.03

(511)

25 – Clothing; layettes [clothing]; clothing for gymnastics; theatrical costumes; shoes; hats; hosiery; neckties; girdles; gloves [clothing].

(260) AM 2022 113298 A

(800) 1594528

(151) 2021 01 11

(891) 2021 01 11

(731) SUZHOU DAKE MACHINERY CO., LTD.
No. 45 Songbei Road, Suzhou Industrial Park,
Suzhou City, 215128 Jiangsu Province, China

(540)

WADFOW

(591) Black, white

(511)

6 – Junctions of metal for pipes; sleeves [metal hardware]; fittings of metal for building; staircases of metal; railway material of metal; steel wire; screws of metal; wall plugs of metal; door bells of metal, non-electric; safes; identification bracelets of metal; traps for wild animals; iron ores; monuments of metal; el-

bows of metal for pipes; collars of metal for fastening pipes; building materials of metal; scaffolding of metal; ropes of metal; clips of metal for cables and pipes; fittings of metal for furniture; hinges of metal; ironmongery; keys of metal; tool chests of metal, empty; bells for animals; weather vanes of metal; tree protectors of metal; works of art of common metal; props of metal; common metals, unwrought or semi-wrought; reinforcing materials of metal for pipes; valves of metal, other than parts of machines; fences of metal; bands of metal for tying-up purposes; nails; locks of metal, other than electric; vice claws of metal; pulleys of metal, other than for machines; rods of metal for welding; angle irons of metal; pipes of metal; buildings, transportable, of metal; buckles of common metal [hardware]; padlocks of metal, other than electronic; hooks [metal hardware]; labels of metal; anchors.

7 – Milking machines; centrifugal mills; tobacco processing machines; brick making machines; enamel making machinery; fertilizer manufacturing machines; mine borers; metalworking machines; steam engines; electric wire and cable manufacturing machines; hand-held tools, other than hand-operated; gas separating installations; valves [parts of machines]; door openers, electric; welding machines, electric; machines and apparatus for cleaning, electric; disintegrators; shoe polishers, electric; agricultural machines; fodder cutting machines [feed cutters]; cardboard box making machines; looms; sizing machines; leatherworking machines; machines for battery industry; cord making machines; mixing machines; washing machines [laundry]; oil-well pumps for petroleum industry; needle making machines; stands for machines; trimming machines; angle polishers; machines for the electronic industry; dynamos; pumps [machines]; compressed air machines; propulsion mechanisms, other than for land vehicles; electric gate scrolling machines; electroplating machines; electric shearing machines; aerating pumps for aquaria; printing machines; food preparation machines, electromechanical; stitching machines; bicycle assembling machines; packing machines; briquet making machines; glass-working machines; foundry machines; zipper making machines; tools [parts of machines]; drilling heads [parts of machines]; optical cold working machines; paint-spraying machines; motors, other than for land vehicles; belts for machines; vacuum cleaners; lawnmowers [machines]; saws [machines]; woodworking machines; diaper manufacturing machines; tea manufacturing machines; brewing machines; engraving machines; light bulb making machines; kitchen machines, electric; rubber cementing machines; electromechanical machines for chemical industry; cutters [machines]; hoist cranes; pneumatic hammers; igniting devices for internal combustion engines; wind-powered installations for generating electricity [wind power plants]; machines and apparatus for polishing [electric]; cutting machines; pneumatic cylinders [parts of

machines]; bearings [parts of machines]; high pressure washers; filter presses.

8 – Hand tools, hand-operated; manicure sets; riveters [hand tools]; pruning scissors; sabres; abrading instruments [hand instruments]; bits [parts of hand tools]; lifting jacks, hand-operated; graving tools [hand tools]; garden tools, hand-operated; harpoons; perforating tools [hand tools]; table cutlery [knives, forks and spoons]; handles for hand-operated hand tools; agricultural implements, hand-operated; instruments and tools for skinning animals; guns, hand-operated, for the extrusion of mastics; masons' trowels.

9 – Printers for use with computers; mobile power supply [rechargeable battery]; event data recorders; bathroom scales; computer network switches; computer network bridges; network routers; radio receivers and transmitters; weighing apparatus and instruments; computer program (downloadable software); counters; apparatus to check franking; counterfeit coin detectors; ticket dispensers; voting machines; face recognition apparatus; photocopiers [photographic, electrostatic, thermic]; slide calipers; measures; rulers [measuring instruments]; micrometers; square rulers for measuring; measuring tapes; electronic sliding calipers; electronic notice boards; navigational instruments; electric and electronic video surveillance installations; cameras [photography]; measuring apparatus; surveying apparatus and instruments; levels [instruments for determining the horizontal]; speed checking apparatus for vehicles; pressure measuring apparatus; chemistry apparatus and instruments; measuring devices, electric; lasers, not for medical purposes; optical apparatus and instruments; materials for electricity mains [wires, cables]; semi-conductors; electronic chips; capacitors; switches, electric; connections, electric; electric plugs; control panels [electricity]; covers for electric outlets; video screens; remote control apparatus; optical fibers [light conducting filaments]; heat regulating apparatus; lightning arresters; electrolyzers; fire extinguishing apparatus; radiological apparatus for industrial purposes; protection devices for personal use against accidents; clothing for protection against accidents, irradiation and fire; protective masks; gloves for protection against accidents; kneepads for workers; theft prevention installations, electric; locks, electric; spectacles; batteries, electric; battery chargers; animated cartoons; protective industrial boots; electrical sockets; electric contacts; ear plugs for divers; biometric fingerprint door locks; endoscopy cameras for industrial purposes; rearview cameras for vehicles; sensors; alarms; cabinets for loudspeakers; radio signal tuners; electric door bells; intercoms; videophones; video monitors; air analysis apparatus; wireless routers.

11 – Curling lamps; cooling appliances and installations; extractor hoods for kitchens; air-conditioning installations; air purifying apparatus and machines;

sanitary apparatus and installations; electric water purifiers for household purposes; water purifying apparatus and machines; water purification installations; electrically heated clothing; lighters; electric lamps; lights for vehicles; kettles, electric; gas ranges; humidifiers for household purposes; air purifiers [for household purposes]; hair dryers; heating apparatus, electric; heat guns; pipes [parts of sanitary installations]; taps; light bulbs; searchlights; oil lamps; cooking apparatus and installations; fans [air-conditioning]; spigots for pipes and pipelines; disinfectant apparatus; radiators, electric; polymerisation installations; germicidal lamps for purifying air; fluorescent tubes; electric flashlights; lighting apparatus and installations; lava rocks for use in barbecues; refrigerating appliances and installations; fog machines for theater; watering installations, automatic; bath installations; pocket warmers.

21 – Containers for household or kitchen use; glass bowls; ceramics for household purposes; toilet utensils; brushes; toothbrushes; drinking troughs; works of art of porcelain, ceramic, earthenware, terra-cotta or glass; indoor aquaria; insect traps; drinking vessels; cosmetic utensils; thermally insulated containers for food; mop wringer buckets; watering cans; garbage cans; steel wool for cleaning; cleaning instruments, hand-operated; gardening gloves; unworked or semi-worked glass [except glass used in building]; mops.

35 – Advertising; online advertising on a computer network; business management assistance; organization of exhibitions for commercial or advertising purposes; commercial administration of the licensing of the goods and services of others; import-export agency services; sales promotion for others; procurement services for others [purchasing goods and services for other businesses]; personnel management consultancy; administrative services for the relocation of businesses; systemization of information into computer databases; office machines and equipment rental; accounting; rental of vending machines; sponsorship search; rental of sales stands; retail services for pharmaceutical, veterinary and sanitary preparations and medical supplies; wholesale services for pharmaceutical, veterinary and sanitary preparations and medical supplies; employment agencies; commercial information agency services; marketing; provision of an online marketplace for buyers and sellers of goods and services.

(260) AM 2022 113304 A
 (800) 1594583
 (151) 2020 10 15
 (891) 2020 10 15
 (731) ROYAL ARMENIA JV LTD
 Davtashen 2nd Block 268, 0054 Yerevan,
 Armenia

(540)



(591) Dark red, red, light red, white and black
 (531) 02.07.23; 05.07.27; 06.01.02; 07.05.05;
 22.05.10; 25.01.15; 25.07.01; 29.01.14
 (526) ARMENIA GROUND COFFEE ARABICA &
 ROBUSTA
 (511)
 30 – Ground coffee.

(260) AM 2022 113314 A
 (800) 1594755
 (151) 2021 02 09
 (891) 2021 02 09
 (731) Bundesanstalt für Finanzdienstleistungsaufsicht,
 Anstalt des öffentlichen Rechts
 Graurheindorfer Str. 108, 53117 Bonn,
 Germany

(540)



BaFin

Bundesanstalt für
 Finanzdienstleistungsaufsicht

(591) Black, red, yellow
 (531) 26.11.13; 27.05.10; 29.01.13
 (511)
 16 – Brochures, publications.
 36 – Financial affairs.

(260) AM 2022 113315 A
 (800) 1594793
 (151) 2021 04 29
 (891) 2021 04 29
 (731) GKG Precision Machine Co., Ltd.
 No. 2 Shalang Road, DongCheng Street,
 DongGuan, GuangDong, China
 (540)

GKG

(591) Black, white
 (531) 27.05.01; 27.05.23
 (511)

7 – Electrostatic industrial equipment, namely, automatic electrostatic paint sprayers, automatic sprayers for electrostatic painting; electrical industrial equipment, namely, machines for manufacturing and assembling printed circuit boards, namely, electronic-component placers, screen printers for chip placing, component inserters, glue dispensers, printed circuit board conveyors, solder reflowing units, adhesive curing units, and parts for all of the foregoing; electrical industrial equipment, namely, surface mounting machines for mounting electronic components on to printed circuit boards and parts therefor; electrical industrial equipment, namely, power-operated dispensers for applying adhesive to printed circuit boards and parts therefor; electrical industrial equipment, namely, automatic solder-paste printers for printing solder paste on circuit boards and parts therefor; electrical industrial equipment, namely, machines for placing electronic components on printed circuit boards; electrical industrial equipment, namely, machines for mounting electronic components on printed circuit boards; electrical industrial equipment, namely, machines for inserting electronic components on printed circuit boards; electrical industrial equipment, namely, machines for dispensing semi-conductors and component parts thereof used for manufacturing and assembling printed circuit boards; industrial printing machines, namely, screen printers for manufacturing and assembling printed circuit boards; machines for processing printed circuit boards; electrostatic generators.

(260) AM 2022 113316 A
 (800) 1594794
 (151) 2020 10 15
 (891) 2020 10 15
 (731) ROYAL ARMENIA JV LTD
 Davtashen 2nd Block 268, 0054 Yerevan,
 Armenia
 (540)



(591) Black, white, green, red

(531) 02.07; 02.07.23; 05.07; 05.07.27; 06.01;
 06.01.02; 07.05; 07.05.05; 22.05; 22.05.10;
 25.01; 25.01.15; 25.07; 25.07.01; 27.05;
 27.05.10; 29.01.14

(526) "ARMENIA", "®", "CLASSIC", "GROUND COFFEE", "ARABICA & ROBUSTA"

(511)
 30 – Ground coffee.

(260) AM 2022 113317 A
 (800) 1594872
 (151) 2021 03 25
 (891) 2021 03 25
 (731) DAVLI
 221 RUE PAUL VAILLANT COUTURIER,
 F-94140 ALFORTVILLE, France
 (540)

MENZZO

(591) Black, white
 (511)
 20 – Furniture; mirrors (looking glasses); picture frames; works of art made of wood, wax, plaster or plastic materials; chests of drawers; cushions; shelves; armchairs; seats; bedding except linen; mattresses; plate racks; boxes of wood or plastic.

(260) AM 2022 113318 A
 (800) 1594896
 (151) 2021 04 20
 (891) 2021 04 20
 (731) OÜ Good Design
 Harju maakond, Tallinn, Mustamäe linnaosa,
 EE-12618 Leiva tn 3, Estonia
 (540)



(591) Black, white
 (531) 26.13.25
 (511)
 3 – Amber [perfume]; aromatics [essential oils]; air fragrancing preparations; breath freshening sprays; balms, other than for medical purposes; basma [cosmetic dye]; lip glosses; nail glitter; petroleum jelly for cosmetic purposes; cotton wool for cosmetic purposes; adhesives for cosmetic purposes; scented water;

Javelle water; lavender water; toilet water; depilatory wax; moustache wax; massage gels, other than for medical purposes; dental bleaching gels; geraniol; make-up; deodorants for pets; deodorants for human beings or for animals; depilatory preparations; air fragrance reed diffusers; scented wood; perfumes; greases for cosmetic purposes; perfumery; decorative transfers for cosmetic purposes; ionone [perfumery]; shaving stones [astringents]; eyebrow pencils; cosmetic pencils; adhesives for affixing false eyelashes; adhesives for affixing false hair; hair conditioners; beard dyes; cosmetic dyes; cosmetic creams; skin whitening creams; incense; hair spray; nail varnish; hair lotions; lotions for cosmetic purposes; after-shave lotions; beauty masks; oils for perfumes and scents; oils for cosmetic purposes; oils for toilet purposes; essential oils; essential oils of cedarwood; essential oils of lemon; essential oils of citron; bergamot oil; gaultheria oil; jasmine oil; lavender oil; almond oil; rose oil; almond milk for cosmetic purposes; cleansing milk for toilet purposes; musk [perfumery]; deodorant soap; shaving soap; cakes of toilet soap; antiperspirant soap; soap for foot perspiration; soap; almond soap; mint for perfumery; cosmetic kits; gel eye patches for cosmetic purposes; nail art stickers; false nails; eau de Cologne; bases for flower perfumes; joss sticks; dentifrices; pumice stone; lipstick cases; hydrogen peroxide for cosmetic purposes; breath freshening strips; teeth whitening strips; lipsticks; pomades for cosmetic purposes; shaving preparations; cosmetic preparations for baths; bath preparations, not for medical purposes; hair straightening preparations; hair waving preparations; colour-removing preparations; leather bleaching preparations; mouthwashes, not for medical purposes; cosmetic preparations for slimming purposes; eye-washes, not for medical purposes; make-up removing preparations; nail care preparations; collagen preparations for cosmetic purposes; aloe vera preparations for cosmetic purposes; sunscreen preparations; breath freshening preparations for personal hygiene; make-up powder; nail varnish removers; vaginal washes for personal sanitary or deodorant purposes; false eyelashes; baby wipes impregnated with cleaning preparations; tissues impregnated with cosmetic lotions; tissues impregnated with make-up removing preparations; massage candles for cosmetic purposes; potpourris [fragrances]; bath salts, not for medical purposes; fumigation preparations [perfumes]; astringents for cosmetic purposes; eyebrow cosmetics; make-up preparations; sun-tanning preparations [cosmetics]; hair dyes; neutralizers for permanent waving; cosmetic preparations for eyelashes; cosmetic preparations for skin care; cosmetics; cosmetics for children; cosmetics for animals; mascara; cleansers for intimate personal hygiene purposes, non medicated; douching preparations for personal sanitary or deodorant purposes [toiletries]; bleaching preparations [decolorants] for cosmetic purposes; antiperspirants [toiletries]; toiletry preparations; phytocos-

metic preparations; talcum powder, for toilet use; cotton swabs for cosmetic purposes; terpenes [essential oils]; henna [cosmetic dye]; shampoos for animals [non-medicated grooming preparations]; shampoos for pets [non-medicated grooming preparations]; dry shampoos; shampoos; herbal extracts for cosmetic purposes; extracts of flowers [perfumes]; ethereal essences; badian essence; mint essence [essential oil].

(260) AM 2022 113319 A

(800) 1594977

(151) 2020 09 09

(891) 2020 09 09

(731) ÇELİK MOTOR TİCARET A.Ş.

Fatih Sultan Mehmet Mahallesi, Balkan
Caddesi No: 58 Buyaka E Blok, Tepeüstü
Ümraniye, İstanbul, Turkey

(540)



(591) Black, white, Turquoise

(531) 09.07.01; 18.01.21; 20.05.15; 27.05.10;
29.01.12

(511)

35 – Services relating to advertising, marketing and public relations, organization of exhibitions and trade fairs for commercial or advertising purposes, advertising material design services (terms too vague in the opinion of the International Bureau – Rule 13 (2) (b) of the Regulations); providing an online marketplace for buyers and sellers, all related to motor land vehicles; office functions; secretarial services, services for arranging newspaper subscriptions, compilation of statistics, rental of office machines, systemization of information into computer databases, telephone answering services, all related to motor land vehicles; business management, administration and consultancy, accounting and commercial consultancy services thereof, personnel recruitment, placement, personnel selection, personnel procurement services, import-export agency services, temporary personnel placement services; business follow up such as paving bills, paying taxes, handling traffic procedures for others, all related to motor land vehicles; services of organizing and performing auctions, all related to motor land vehicles; the bringing together, for the benefit of

others, of a variety of goods, namely, motor land vehicles enabling customers to conveniently view and purchase those goods, such services may be provided by retail stores, wholesale outlets, by means of electronic media or through mail order catalogues.

36 – Insurance services, all related to motor land vehicles; financial and monetary affairs, all related to motor land vehicles; real estate brokerage, consultancy and administration services; all related to motor land vehicles; customs brokerage services; all related to motor land vehicles.

38 – Radio and television broadcasting services; communication services, providing access to the Internet; news agency services.

42 – Scientific and industrial examination, research services; engineering services, engineering and architectural design services, testing goods/services for the certification of quality and standard; computer design and development; computer programming, computer virus protection, computer system designing, creating, maintaining and updating of web sites for others, software designing, rental and updating, providing Internet search engines, hosting, consulting in the area of computer hardware, rental of computer hardware; design of computer software and systems; graphic art design services, excluding commercial design and landscape design; authenticating services for the originality of works of art.

(260) AM 2022 113320 A

(800) 1595023

(151) 2021 04 12

(891) 2021 04 12

(731) BOARD OF SUPERVISORS OF LOUISIANA STATE UNIVERSITY AND AGRICULTURAL AND MECHANICAL COLLEGE
LSU Trademark Licensing, 330 Thomas Boyd Hall, Baton Rouge LA 70803, USA

(540)

LSU

(591) Black, white

(511)

25 – Clothing, namely, T-shirts, sweatshirts, and jerseys.

(260) AM 2022 113321 A

(800) 1595033

(151) 2021 03 18

(891) 2021 03 18

(731) Incyte Holdings Corporation
1801 Augustine Cut-Off, Wilmington
DE 19803, USA

(540)

ZYNYZ²

(591) Black, white

(531) 27.05.09; 27.05.10; 27.05.17; 27.05.19

(511)

5 – Pharmaceutical preparations for the prevention and treatment of cancer.

44 – Providing information to patients and healthcare providers containing healthcare information regarding diseases, diagnoses and treatment of diseases via a website.

(260) AM 2022 113322 A

(800) 1595113

(151) 2021 03 26

(891) 2021 03 26

(731) Jose Bay e.U.

DC Tower, Donau-City-Straße 7/20.Stock,
A-1220 Wien, Austria

(540)

Jobchain

(591) Black, white

(511)

38 – Telecommunications; telecommunication services by means of networks; telecommunication services; online messaging services; online communication services; transmission of information on-line; online services, namely the sending of messages; consultancy relating to data communications; advice in the telecommunications sector; automatic transfer of digital data using telecommunications channels; information about telecommunications; audio text services; remote data transmission; remote data transmission by means of telecommunications; data transfer through telecommunications; data transfer by means of telecommunications; data transmission by laser beam; data transmission via satellite; data transmission services via telecommunication networks; sending of data and transmission of documents by telematic services; data transmission services; digital transmission of data; digital transmission of data via the Internet; digital communication services; digital transmission services; wireless communication services; electronic information communication; electronic communication services for data transmission; electronic communication services for the remote transmission of data; electronic communications services; electronic communication services within the framework of credit card verification; electronic communication services; electronic communication services for financial institutions; electronic communication services for the presentation of financial information; electronic voice transmissi-

on; electronic telecommunications services; electronic transmission of information; electronic transmission of messages and data; electronic transmission of documents; electronic transmission of images; electronic transmission and retransmission of sounds, images, documents, messages and data; electronic telecommunications services for the transmission of data; electronic transmission of instant messages and data; electronic transmission of written communications; electronic and telecommunications transmission services; transmission of information via national and international networks; radio telecommunication services; communication services for the exchange of data in electronic form; communication services for the electronic transmission of images; communication services for the electronic transmission of voice; communication services for the transmission of information; communication services by means of telex messages; communication services via multinational telecommunication networks; communication services for electronic remote data transmission; telecommunications services between financial institutions; telecommunication services via cellular networks; telecommunication services via digital networks; telecommunication services for the dissemination of data; telecommunication services between computer networks; telematic sending of information; transmission of data, messages and information; message sending; transmission of data, sound and images by satellite; transmission of information for business purposes; transmission of information by satellite; transmission of information via digital networks; transmission of messages by electronic media; transmission of sound, video and information.

41 – Providing on-line training; providing on-line tutorials; organization of online teaching courses; business education; providing of training; training advice; legal education; coaching [training]; instruction and training; computer-based training; training in computer programming; training in corporate matters; training for managers; computer training; educational services from universities; education, upbringing, entertainment and sports; publishing and reporting; translation and interpreting; preparation of language translations; translation services.

(260) AM 2022 113323 A

(800) 1595117

(151) 2020 12 30

(891) 2020 12 30

(731) Limited Liability Company "Association

"Soyuzpichsheprom"

pos. Melkombinat-2, uchastok 1, d. 37,

RU-454080 Chelyabinsk, Russian Federation

(540)



(591) Green and white

(531) 26.13.25; 28.05; 29.01.12

(511)

29 – Oils for food; mustard oil for food; corn oil for food; linseed oil for food; sunflower oil for food; rape oil for food; milk substitutes; peanut milk; coconut milk; almond milk; oat milk; rice milk; wheat milk; buckwheat milk; soya milk; peanut milk-based beverages; coconut milk-based beverages; almond milk-based beverages; rice milk-based beverages; oat milk-based beverages; wheat milk-based beverages; vegetable-based cream; milk shakes; yogurt, including oatmeal yogurt; kefir, including oatmeal kefir; kissel, including oatmeal kissel.

30 – Buckwheat flour; corn flour; flour; wheat flour; soya flour; groats for human food; buckwheat, processed; husked oats; rice; husked barley; hominy grits; semolina; oatmeal; crushed barley; couscous; bulgur; corn, milled; crushed oats; cereal preparations; oat-based food; chips [cereal products]; corn flakes; oat flakes; vermicelli; pasta; noodles; macaroni; spaghetti; rice-based snack food; cereal-based snack food; muesli.

32 – Cocktails, non-alcoholic; non-alcoholic beverages; non-alcoholic beverages based on cereals, oats, rice, soya; rice-based beverages, other than milk substitutes; soya-based beverages, other than milk substitutes; whey beverages; protein-enriched sports beverages.

(260) AM 2022 113324 A

(800) 1595158

(151) 2021 02 19

(891) 2021 02 19

(731) Public Joint Stock Company "Krasnyj Ocyabr"

ul. Malaya Krasnoselskaya, d. 7, str. 24,

RU-107140 Moscow, Russian Federation

(540)



(591) White, red and dark blue

(531) 01.01.10; 18.05.10; 25.01.15; 25.07.25;
26.13.01; 28.05; 29.01.12

(511)

30 – Confectionery for decorating Christmas trees; coffee flavorings; seasonings; cookies; candies; waffles; cocoa; coffee; cakes; capers; caramels [candies]; cereal preparations; chocolate; marzipan; condiments; confectionery; corn flakes; popcorn; ice cream; pancakes; fondants [confectionery]; cake dough; cocoa beverages with milk; coffee beverages with milk; molasses for food; honey; pies; pastries; petit-beurre biscuits; puddings; pralines; liquorice [confectionery]; sago; sherbets [ices]; tarts; edible ices; almond confectionery; peanut confectionery; oat flakes; chocolate mousses; dessert mousses [confectionery]; pesto; cereal bars.

(260) AM 2022 113325 A

(800) 1595172

(151) 2021 01 29

(891) 2021 01 29

(731) Amazon Technologies, Inc.

410 Terry Ave N, Seattle WA 98109, USA

(540)

AWS

(591) Black, white

(511)

9 – Computer hardware; data processing computer software; computer software for cloud computing; computer software for virtualization; computer software for managing and deploying virtual machines to a cloud computing platform; computer software for use in cloud infrastructure management and automation; computer software for running cloud computing based applications; computer software platforms for cloud computing networks and applications; computer software that provides access to cloud-based scalable computing resources and data storage; computer software for monitoring cloud and application performance; computer software for data backup, recovery and archiving; computer software for data transfer; database management software; computer software for

creating, configuring, provisioning and scaling databases; computer software for video streaming; game software; game engine software; computer software to manage, connect, and operate internet of things (IOT) electronic devices; computer software for enabling electronic devices to operate and communicate locally while retaining the benefits of analytics and high-level services in the cloud; computer software development tools; software development kits (SDK); computer software for application development, testing, deployment and management.

35 – Business consulting; business consulting services in the field of information technology (IT) and cloud computing; business consulting services in the field of enterprise architecture; business risk management consultation; compilation and systemization of information into computer databases; database management services; business records management; business data analysis; data processing services; trade show management services; conducting and arranging trade show exhibitions in the fields of technology, cloud computing, web services, software, software as a service (SaaS), artificial intelligence, software development, game development, databases, data processing and analytics, data storage, data warehousing, data archiving, data and information security, networking, mobile computing, and the Internet of Things (IoT); computerized on-line ordering featuring developer tools and cloud computing software and services; providing an on-line marketplace for buyers and sellers of goods and services; domain name directory services; message and conference call transcription services.

38 – Electronic data transmission; streaming of data; streaming of software applications; providing data streaming capacity to others; streaming of audio and video material on the Internet; video-on-demand transmission; providing access to telecommunication networks; providing multiple user access to global computer information networks for the transfer and dissemination of a wide range of information; providing user access to computer software in data networks; providing access to remotely hosted operating systems and computer applications through the internet; providing access to cloud based computing resources and storage; providing access to databases; providing virtual private network (VPN) services; telephone communications; voice over Internet protocol (VOIP) services; web conferencing services; call routing services; providing voice chat services; providing internet chat rooms; transmission of messages; providing on-line forums for transmission of messages among computer users; call recording services.

41 – Education services, namely, conducting seminars, classes, workshops and conferences in the fields of technology, cloud computing, web services, software, software as a service (SaaS), artificial intelligence, software development, game development, da-

tabases, data processing and analytics, data storage, data warehousing, data archiving, data and information security, networking, mobile computing, and the Internet of Things (IoT); publication of online diaries (blogs) featuring information in the field of technology, cloud computing, web services, software, software as a service (SaaS), artificial intelligence, software development, game development, databases, data processing and analytics, data storage, data warehousing, data archiving, data and information security, networking, mobile computing, and the Internet of Things (IoT).

42 – Information technology (IT) consulting services; computer services, namely, cloud hosting provider services; hosting of digital content on the Internet; cloud hosting of electronic databases and virtual computing environments; server hosting; computer time-sharing services; providing virtual computer systems and virtual computer environments through cloud computing; computer services, namely, providing virtual application, web, file, database and storage servers of variable capacity to others; scaling services, namely, providing variable computing and electronic data storage capacity to others; administering and maintaining databases and virtual computing environments for others; electronic data storage; application service provider (ASP), namely, hosting computer software applications and databases of others; computer services, namely, hosting, managing, provisioning, scaling, administering, maintaining, monitoring, securing, encrypting, decrypting, replicating and backing up databases and cloud computing environments for others; computer software rental; consulting and providing information in the fields of information technology, cloud computing, web services, software, software as a service (SaaS), artificial intelligence, software development, game development, databases, data processing and analytics, data storage, data warehousing, data archiving, data and information security, computer networking, mobile computing, and the Internet of Things (IoT); planning, design and implementation of computer technologies for others; software configuration management services; data and application migration services; data mining services; data backup and data restoration services; remote online backup of computer data; data encryption and decryption services; data warehousing; technical support services, namely, troubleshooting of computer software problems; computer services, namely, monitoring the web sites of others to improve their scalability and performance; computer services, namely, enforcing, restricting and controlling access privileges of users of computing and network resources based on assigned credentials; providing search engines for obtaining data via communications networks; creating indexes of computer network-based information, sites, and other resources available on global computer networks for others; computer services, namely, unauthorized user and unauthorized software intrusion

detection and protection; computer services, namely, web traffic filtering; computer services, namely, providing virtual data storage and caching to others; cross-platform conversion of digital content into other forms of digital content; digital compression of computer data; hosting an online community website featuring shared communications between community members interested in technology, cloud computing, web services, software, software as a service (SaaS), artificial intelligence, software development, game development, databases, data processing and analytics, data storage, data warehousing, data archiving, data and information security, networking, mobile computing, and the Internet of Things (IoT); software as a service (SaaS) featuring software for data processing; software as a service (SaaS) featuring software for virtualization; software as a service (SaaS) featuring software for managing and deploying virtual machines to a cloud computing platform; software as a service (SaaS) featuring software for use in cloud infrastructure management and automation; software as a service (SaaS) featuring software for running cloud computing based applications; software as a service (SaaS) featuring software that provides access to cloud-based scalable computing resources and data storage; software as a service (SaaS) featuring software for monitoring cloud and application performance; software as a service (SaaS) featuring software for event logging, reporting, analysis and alert generation; software as a service (SaaS) featuring software for collecting, editing, modifying, organizing, synchronizing, integrating, monitoring, transmitting, storage and sharing of data and information; software as a service (SaaS) featuring software for data, desktop and application streaming; software as a service (SaaS) featuring software for data backup, recovery and archiving; software as a service (SaaS) featuring software for data transfer and migration; software as a service (SaaS) featuring software for data protection and data security; software as a service (SaaS) featuring software for data warehousing; software as a service (SaaS) featuring database management software; software as a service (SaaS) featuring software for creating, configuring, provisioning and scaling databases; software as a service (SaaS) featuring software for storing, retrieving, caching, extracting, formatting, structuring, systematizing, organizing, indexing, processing, querying, analyzing, replicating and controlling access to data; software as a service (SaaS) featuring software for logging changes within a database; software as a service (SaaS) featuring software for improving database performance; software as a service (SaaS) featuring software for configuring, provisioning and scaling data cache storage for databases; software as a service (SaaS) featuring software for computer network management and automation; software as a service (SaaS) featuring software for monitoring computer network access and activity; software as a service (SaaS) featuring user authenti-

cation software; software as a service (SaaS) featuring cryptography software; software as a service (SaaS) featuring software for monitoring, tracking, logging, analyzing, auditing and reporting in the field of regulatory and information security compliance; software as a service (SaaS) featuring software for monitoring, tracking, logging and analyzing computer network events, user activity, changes to resource activity and security statistics; software as a service (SaaS) featuring network security software; software as a service (SaaS) featuring network threat detection software; software as a service (SaaS) featuring network access management and monitoring software; software as a service (SaaS) featuring search engine software; software as a service (SaaS) featuring software for searching databases; software as a service (SaaS) featuring software for creating searchable databases of information and data; software as a service (SaaS) featuring software that provides real-time, integrated business management intelligence by combining information from various databases; software as a service (SaaS) featuring business analytics software for collecting and analyzing data to facilitate business decision making; software as a service (SaaS) featuring software for use in big data analysis; software as a service (SaaS) featuring software that automates the processing of un-structured, semi-structured and structured information and data stored on computer networks and the Internet; software as a service (SaaS) featuring e-commerce software to allow users to perform electronic business transactions via a global computer network; software as a service (SaaS) featuring software for operating and managing call centers and contact centers; software as a service (SaaS) featuring software platforms for providing customer service and customer support; software as a service (SaaS) featuring software for speech, facial and optical character recognition; software as a service (SaaS) featuring software for converting text to speech; software as a service (SaaS) featuring software for image analysis, identification, processing, conversion, cropping, resizing and enhancement; software as a service (SaaS) featuring software for video streaming and for high-speed formatting and processing of audio and video streams; software as a service (SaaS) featuring software for deploying live and on-demand video content; software as a service (SaaS) featuring software for provisioning and dynamically scaling video processing, delivery, and storage services; software as a service (SaaS) featuring software used to process, convert, transcode, encode, decode, encrypt, decrypt, distribute and manipulate digital video, image and audio files; software as a service (SaaS) featuring software for inserting and removing advertising and other content into video streams; software as a service (SaaS) featuring software for digital rights management; software as a service (SaaS) featuring software for time-shifted television viewing; software as a service (SaaS) featuring game software;

software as a service (SaaS) featuring game engine software; software as a service (SaaS) featuring software to manage, connect, and operate internet of things (IOT) electronic devices; software as a service (SaaS) featuring software for enabling electronic devices to operate and communicate locally while retaining the benefits of analytics and high-level services in the cloud; software as a service (SaaS) featuring software development tools; software as a service (SaaS) featuring software for application development, testing, deployment and management; software as a service (SaaS) featuring software for managing software development projects and teams; monitoring of computer systems and databases for security purposes in the nature of protecting data and information from unauthorized access; computerized security services, namely, electronically monitoring, detecting and reporting on suspicious and abnormal patterns of computer network access or activity in the nature of protecting data and information from unauthorized access; providing user authentication services using single sign-on and multi-factor technology for accessing a secure virtual computing environment; providing authentication services via online non-downloadable software for establishing and transmitting security credentials for domain name services; monitoring of computer systems and databases for security purposes in the nature of protecting data and information from unauthorized access; computerized security services, namely, electronically monitoring, detecting and reporting on suspicious and abnormal patterns of computer network access or activity in the nature of protecting data and information from unauthorized access; providing user authentication services for accessing a secure virtual computing environment; providing authentication services via online non-downloadable software for establishing and transmitting security credentials for domain name services; application service provider, namely, providing, hosting, managing, developing and maintaining applications, software, websites and databases in the fields of e-commerce, online payments, order queuing, website design, data storage and shared computing capacity scaling services.

45 – Domain name registry services, namely, coordinating the registration of domain names for identification of users and internet protocol addresses on the internet; providing domain name registration information via an online computer database.

(260) AM 2022 113326 A

(800) 1595202

(151) 2021 02 03

(891) 2021 02 03

(731) WTM Establishment

Städtle 28, FL-9490 Vaduz, Liechtenstein

(540)



(591) White, blue, light blue, red, silver, gray and beige

(531) 19.07.01; 24.07.01; 24.07.23; 27.05.01; 29.01.15

(554) მოცულობითი

(526) Wording "VODKA", shape of the bottle

(511)

33 – Vodka.

(260) AM 2022 113327 A

(800) 689476

(151) 1998 03 13

(891) 2020 12 01

(731) GIULIO COCCHI SPUMANTI S.R.L.

Via Orfanotrofia, 10, I-14100 ASTI, Italy

(540)

COCCHI

(591) Black, white

(511)

33 – Alcoholic beverages (except beer).

(260) AM 2022 113328 A

(800) 1035645

(151) 2010 03 08

(891) 2020 07 27

(731) Fapa Vital AG

Eschnerstrasse 64, FL-9487 Gamprin-Bendern,

Liechtenstein

(540)

PROFERTIL

(591) Black, white

(511)

5 – Food supplements for medical use; vitamin preparations; nutritional supplements containing minerals, amino acids, trace minerals; dietetic foods adapted for medical purposes; medicinal herbs; nutritional additives for medical purposes for use in foods and dietary supplements for human consumption.

(260) AM 2022 113329 A

(800) 1134533

(151) 2012 01 05

(891) 2021 04 26

(731) OLIMP LABORATORIES Sp. z o.o.

Pustynia 84F, PL-39-200 Dębica, Poland

(540)

BORN IN THE GYM

(591) Black, white

(511)

5 – Dietary supplements and other dietetic foods for medicinal purposes, energising supplements for medicinal purposes, pharmaceutical preparations used prophylactically and administered to convalescents for medicinal purposes, drugs for humans, auxiliary drugs, drugs in liquid form, ointments for pharmaceutical purposes, analgesics, balms for medicinal purposes; food supplements, namely, high-protein concentrates and supplements enriched with vitamins, mineral salts and amino acids; food supplements, namely, carbohydrate concentrates as well as carbohydrate and high-energy supplements enriched with vitamins and mineral salts.

25 – T-shirts, polo shirts, shirts, socks, hooded sweat-shirts, sweatshirts without hood, trousers, jeans, bonnets, tank tops, tracksuit bottoms, shorts, caps, belts with buckles, underwear, ladies' tunics, jackets, skirts, jeans skirts, leather jackets, sports shoes, sweaters, bathing suits, dresses, footwear, shawls, scarves, gloves; hats, leather headbands, leather belts, leather arm bands.

28 – Sports articles, baseball gloves, boxing gloves, leashes for surfing boards, devices for gymnastics, mechanical devices for gymnastics, bags for cricket equipment, devices used in bodybuilding, knee-pads, elbow guards (sports articles), weightlifting belts as sports articles, devices for physical exercise, bags for skis and surfing boards, springboards as sports articles, punchbags.

32 – Alcohol-free drinks enriched with vitamins and minerals, whey drinks, isotonic drinks, fruit juice drinks, fruit nectars; non-alcoholic beverages containing proteins and carbohydrates; energetic drinks.

35 – Retail and wholesale trade of goods including, dietary supplements and other dietetic foods for medicinal purposes, energising supplements for medicinal purposes, pharmaceutical preparations used prophylactically and administered to convalescents for medicinal purposes, drugs for humans, auxiliary drugs, drugs in liquid form, ointments for pharmaceutical purposes, analgesics, balms for medicinal purposes, spectacles, pince-nez, spectacle chains, protective goggles for practising sports, anti-dazzling glasses, sunglasses, spectacle frames, amulets, jewellery, cellular jewellery, strass glass jewellery, bracelets, wristwatch bracelets, charms, decoration key rings, brooches, pocket watch holders, cases used in watchma-

king, semi-precious stones, precious stones, earrings, watch cases, chains, pocket watch chains, medallions, necklaces, silver threads, gold threads, threads of noble metals, rings, ornaments, silver ornaments, watches, wristwatches, docks, gold unprocessed or wrought, portfolios, briefcases, key holders, leather imitations, hats, leather travelling sets, vanity cases, luggage trunks, travelling trunks, leather armlets, leather packagings, leather headbands, umbrellas and sun umbrellas, parasols, leather belts, rucksacks, tourist backpacks, wallets, business card holders, purses, wire mesh purses, boxes of leather or secondary leather, fibre paper boxes, saddlebags and moneybags of leather, leather packing panniers, string bags, leather arm belts, leather leashes, leather ropes, leather boxes for hats, leather packing bags, bags on wheels, travelling bags for clothing, shopping bags, beach bags, travelling bags, leather tool bags, without contents, sports bags, tourist bags, handbags, small suitcases, suitcases, suitcases of leather or secondary leather, big suitcases, T-shirts, polo shirts, shirts, socks, hooded sweatshirts, sweatshirts without hood, trousers, jeans, bonnets, tank tops, tracksuit bottoms, shorts, caps, belts with buckles, underwear, ladies' tunics, jackets, skirts, jeans skirts, leather jackets, sports shoes, sweaters, bathing suits, dresses, footwear, shawls, scarves, gloves, sports articles, baseball gloves, boxing gloves, leashes for surfing boards, devices for gymnastics, mechanical devices for gymnastics, bags for cricket equipment, devices used in bodybuilding, knee-pads, patches constituting parts of sportswear, elbow patches as sports articles, weightlifting belts as sports articles, devices for physical exercise, bags for skis and surfing boards, springboards as sports articles, punch-bags, high-protein concentrates and supplements enriched with vitamins, mineral salts and amino acids, dairy products such as: milk, yoghurts, kefir, cheeses, milk proteins, wheys, milk drinks or drinks with a predominant content of milk, carbohydrate concentrates as well as carbohydrate and high-energy supplements enriched with vitamins and mineral salts, alcohol-free drinks enriched with vitamins and minerals, whey drinks, isotonic drinks, fruit juice drinks, fruit nectars, protein, carbohydrate and energetic drinks, including trade of the above listed goods by means of the Internet (on-line sale) and mail-order sale, marketing, advertising, radio advertising, television advertising, press advertising, website advertising, distribution of advertising materials, promotion of the above-listed goods and rendered services, presentation of the commercial offers in the Internet; arranging and conducting of fairs and exhibitions for business and advertising purposes connected with promotion of the above goods.

(260) AM 2022 113331 A
 (800) 1427336
 (151) 2018 06 01
 (891) 2021 04 22
 (731) STOCK COMPANY "CLOSED NON-DIVERSIFIED VENTURE, CORPORATE INVESTMENT FUND "ARISTON"
 59 Zhilyanska street, office 102, Kyiv 01033, Ukraine

(540)



(591) Black, white
 (531) 27.05.01; 27.05.03; 27.05.17
 (511)

30 – Peanut confectionery; baozi [stuffed buns]; cereal bars; high-protein cereal bars; muesli bars; chocolate bars; chocolate bars with stuffing; pastries; bread rolls; buns; waffles; flour-based dumplings; biscuits; chewing gum for breath freshening; chewing gum; cereal-based snack food; rice-based snack food; cereal preparations; zephyr [confectionery]; caramels [candy]; confectionery; confectionery for decorating Christmas trees; sugar confectionery; croutons; liquorice [confectionery]; macarons [pastry]; marzipan; almond confectionery; dessert mousses [confectionery]; chocolate mousses; mints for breath freshening; peppermint sweets; stick liquorice [confectionery]; pastila [confectionery]; lozenges [confectionery]; biscuits; fondants [confectionery]; pralines; candy decorations for cakes; chocolate decorations for cakes; gingerbread; sweetmeats [candy]; petit-beurre biscuits; fruit jellies [confectionery]; candy; chocolate.

(260) AM 2022 113332 A
 (800) 1475704
 (151) 2019 05 31
 (891) 2021 05 10
 (731) TREK BICYCLE CORPORATION
 801 West Madison Street, WATERLOO
 WI 53594, USA

(540)

MARLIN

(591) Black, white
 (511)
 12 – Bicycles, bicycle frames and structural parts.

(260) AM 2022 113333 A
 (800) 1552284
 (151) 2020 07 10
 (891) 2021 05 12
 (731) ISteam Group AG
 Unter Altstadt 28, CH-6300 Zug, Switzerland

(540)

freigeist

(591) Black, white

(511)

5 – Dietetic foods for use in clinical nutrition; vitamin and mineral supplements for pets; dietetic food preparations adapted for medical use; nutraceuticals for use as a dietary supplement; dietetic foods adapted for medical purposes; dietetic foods adapted for medical purposes; dietetic foods adapted for medical purposes; dietetic foods adapted for medical purposes; dietetic foods adapted for medical purposes; dietetic food adapted for veterinary use; food for diabetics; food supplements; dietary supplements for human beings and animals; dietary supplements consisting of vitamins; food supplements for non-medical purposes; herbal supplements; anti-oxidant food supplements; nutritional supplements; food supplements in liquid form; dietary supplements with a cosmetic effect; medicinal oils; pharmaceutical preparations for use in discouraging the smoking habit; tobacco-free cigarettes for medical purposes; multi-vitamin preparations; multi-vitamin preparations; liquid vitamin supplements; vitamin D preparations; vitamin preparations; vitamin supplements for animals; vitamin A preparations; vitamin B preparations; vitamin and mineral supplements; vitamins for pets; health food supplements made principally of vitamins; vitamin C preparations; multi-vitamin preparations; vitamin preparations in the nature of food supplements; preparations for supplementing the body with essential vitamins and microelements; vitamin and mineral preparations; vitamins and vitamin preparations; vitamins for animals.

10 – Evaporators for liquid anaesthetics; vaporizers for the treatment of upper respiratory conditions; electric vaporisers for administering steam inhalants; inhalers for medical use; inhalers for medical purposes [sold empty].

34 – Flavourings, other than essential oils, for tobacco; flavorings, other than essential oils, for tobacco substitutes; flavourings, other than essential oils, for use in electronic cigarettes; electronic cigarette liquid [e-liquid] comprised of propylene glycol; electronic cigarette liquid [e-liquid] comprised of vegetable glycerin; electronic cigarette liquid [e-liquid] comprised of flavorings in liquid form used to refill electronic cigarette cartridges; cartridges for electronic cigarettes; electronic cigarette boxes; electronic cigarette cartomizers; electronic cigarettes; smoking sets for electronic cigarettes; refill cartridges for electronic cigarettes; cartridges sold filled with chemical flavorings in liquid form for electronic cigarettes; liquid solutions for use in electronic cigarettes; electronic cigarette atomizers; holders for electronic cigarettes; cartridges for electronic cigarettes; electronic cigarette cleaners; liquid solutions for use in electronic cigarettes; electronic cigarette cases; personal vaporisers and electronic cigarettes, and flavourings and solutions therefor; chemical flavorings in liquid form used

to refill electronic cigarette cartridges; oral vaporizers for smokers; inhalers for use as an alternative to tobacco cigarettes.

(260) AM 2022 113334 A

(800) 1570352

(151) 2020 11 10

(891) 2021 03 18

(731) Anhui Anguo Fishing Tackle Co., Ltd.
Bazhen Industrial Zone, Chaohu City,
Anhui Province, China

(540)

DARMELI

(591) Black, white

(531) 27.05.17

(511)

28 – Rods for fishing; landing nets for anglers; floats for fishing; fish hooks; decoys for hunting or fishing; creels [fishing traps]; fishing tackle; fishing lines; artificial fishing bait; reels for fishing.

(260) AM 2022 113434 A

(800) 1595220

(151) 2021 04 23

(891) 2021 04 23

(731) BHARAT BIOTECH INTERNATIONAL
LIMITED
Genome valley, Turkapally, Shameerpet,
Hyderabad, Telangana – 500078, India

(540)

INCOVACC

(591) Black, white

(531) 27.05.01

(511)

5 – Vaccine for human use.

(260) AM 2022 113435 A

(800) 1595246

(151) 2021 02 19

(891) 2021 02 19

(731) Otkrytoe aktsionernoe obshchestvo "MINSK
KRISTALL" – upravlyayushchaya, kompaniya
kholdinga, "MINSK KRISTALL GRUPP"
ul. Oktyabrskaya 15, g. Minsk, 220030, Belarus

(540)

СТОЛЬГРАДНАЯ

(591) Black, white

(531) 28.05

(511)

33 – Alcoholic beverages, except beer.

(260) AM 2022 113436 A
 (800) 1595255
 (151) 2021 02 05
 (891) 2021 02 05
 (731) Euro Games Technology Ltd.
 4, "Maritsa" Str., "Vranya-Lozen-Triugulnika",
 BG-1151 Sofia, Bulgaria

(540)

Burning Spins

(591) Black, white

(511)

9 – Software; computer gaming software; computer software packages; computer operating system software; computer software, recorded; software drivers; virtual reality software; games software; entertainment software for computer games; computer programs for network management; operating computer software for main frame computers; monitors (computer hardware); computer hardware; apparatus for recording images; monitors (computer programs); computer game programs; computer programs for recorded games; apparatus for recording, transmission or reproduction of sound or images; communications servers [computer hardware]; electronic components for gambling machines; computer application software featuring games and gaming; computer software for the administration of on-line games and gaming; computer hardware for games and gaming; electronic components and computer software for gambling, gambling machines, gambling games on the Internet and via telecommunication network.

28 – Gaming machines for gambling; chips for gambling; mah-jong; arcade games; gambling machines operating with coins, banknotes and cards; games; electronic games; parlor games; gaming chips; gaming tables; slot machines [gaming machines]; LCD game machines; slot machines and gaming devices; coin-operated amusement machines; roulette chips; poker chips; chips and dice [gaming equipment]; gaming equipment for casinos; roulette tables; gaming roulette wheels; casino games; gambling machines and amusement machines, automatic and coin-operated; coin-operated amusement machines and/or electronic coin-operated amusement machines with or without the possibility of gain; boxes for coin-operated machines, slot machines and gaming machines; electronic or electrotechnical amusement machines and apparatus, gaming machines, coin-operated entertainment machines; housings for coin-operated machines, gaming equipment, gaming machines, machines for gambling; electropneumatic and electrical gambling machines (slot machines).

41 – Gambling; entertainment services related to gambling; gaming services for entertainment purposes; casino, gaming and gambling services; training in the development of software systems; provision of equipment for gambling halls; providing casino equipment [gambling]; gaming machine entertainment services;

providing casino facilities [gambling]; gaming hall services; amusement arcade services; games equipment rental; rental of gaming machines; providing amusement arcade services; rental of gaming machines with images of fruits; editing or recording of sounds and images; sound recording and video entertainment services; hire of sound reproducing apparatus; provision of gaming equipment for casinos; providing of casino facilities; online gambling services; casino, gaming and gambling services; provision of gaming facilities, gaming hall facilities, Internet casinos and online gambling services.

(260) AM 2022 113437 A

(800) 1595285

(151) 2021 01 20

(891) 2021 01 20

(731) Obshchestvo s ogranichennoy, otvetstvennostiu "Essen"

Zvenigorodskoye sh., 18/20, korp. 1, podv.
 pom. I, komn. 11, RU-123022 Moskva,
 Russian Federation

(540)

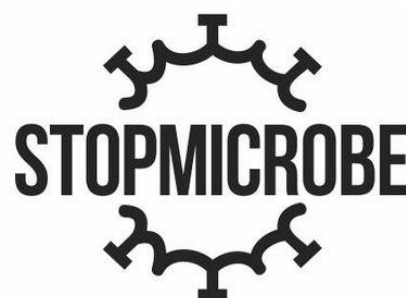

(591) Black, white

(531) 01.13.01; 01.13.15; 26.13.25

(511)

1 – Additives, chemical, to drilling muds; additives, chemical, to fungicides; chemical additives to fungicides; additives, chemical, to insecticides; additives, chemical, to motor fuel; adhesive preparations for surgical bandages; adhesives for billposting; adhesives for industrial purposes; adhesives for paperhanging; adhesives for wallpaper; adhesives for wall tiles; adjuvants, other than for medical or veterinary purposes; agar-agar for industrial purposes; agglutinants for concrete; agricultural chemicals, except fungicides, herbicides, insecticides and parasiticides; albumenized paper; albumin [animal or vegetable, raw material]; alcohol; aldehydes; alginates for industrial purposes; alginates for the food industry; alkalies; alkaline iodides for industrial purposes; alkaline metals; alkaline-earth metals; alkaloids; alum; alumina; aluminium acetate; aluminium alum; aluminium chloride; aluminium hydrate; aluminium iodide; aluminium silicate; americium; ammonia [volatile alkali] for industrial purposes; ammonia alum; ammonia; ammoniacal salts; ammonium aldehyde; ammonium nitrate; ammonium salts; amyl acetate; amyl alcohol; anhydrides; anhydrous ammonia; animal albumen [raw ma-

terial]; animal carbon; animal carbon preparations; animal charcoal; animal manure; metal annealing preparations; anthranilic acid; anti-boil preparations for engine coolants; anti-frothing solutions for batteries; anti-incrustants; anti-knock substances for internal combustion engines; anti-sprouting preparations for vegetables; anti-tarnishing chemicals for windows; antifreeze; antimony; antimony oxide; antimony sulfide; antioxidants for use in manufacture; antioxidants for use in the manufacture of cosmetics; antioxidants for use in the manufacture of food supplements; antioxidants for use in the manufacture of pharmaceuticals; antistatic preparations, other than for household purposes; argon; arsenic; arsenious acid; artificial sweeteners [chemical preparations]; astatine; auxiliary fluids for use with abrasives; bacterial preparations, other than for medical and veterinary use; bacteriological preparations for acetification; bacteriological preparations, other than for medical and veterinary use; barium; barium compounds; barium sulfate; baryta; baryta paper; barytes; bases [chemical preparations]; basic gallate of bismuth; bate for dressing skins; bauxite; beer preserving agents; beer-clarifying and preserving agents; bentonite; benzene; benzene derivatives; benzene-based acids; benzoic acid; benzoic sulfimide; benzol; berkelium; bicarbonate of soda for chemical purposes; bichloride of tin; bichromate of potassium; bichromate of soda; biochemical catalysts; biological preparations, other than for medical or veterinary purposes; biological tissue cultures, other than for medical or veterinary purposes; birdlime; bismuth; bismuth subnitrate for chemical purposes; blood charcoal; blue vitriol; blueprint cloth; blueprint paper; bone charcoal; borax; boric acid for industrial purposes; brake fluid; brazing fluxes; brazing preparations; brickwork preservatives, except paints and oils; bromine for chemical purposes; by-products of the processing of cereals for industrial purposes; caesium; calcined soda; calcium carbide; calcium cyanamide [fertilizer]; calcium salts; californium; calomel [mercurous chloride]; camphor, for industrial purposes; carbide; carbolineum for the protection of plants; carbon; carbon black for industrial purposes; carbon disulfide; carbon for filters; carbon tetrachloride; carbonates; carbonic acid; carbonic hydrates; casein for industrial purposes; casein for the food industry; cassiopium [lutetium]; catalysts; catechu; caustic alkali; caustic soda for industrial purposes; caustics for industrial purposes; cellulose; cellulose derivatives [chemicals]; cellulose esters for industrial purposes; cellulose ethers for industrial purposes; cement [metallurgy]; cement for footwear; cement for mending broken articles; cement preservatives, except paints and oils; cement waterproofing chemicals, except paints; ceramic compositions for sintering [granules and powders]; ceramic glazings; ceramic materials in particulate form, for use as filtering media; cerium; chemical additives for oils; chemical coatings for ophthalmic lenses; chemical condensation preparations;

chemical intensifiers for paper; chemical intensifiers for rubber; chemical preparations for facilitating the alloying of metals; chemical preparations for scientific purposes, other than for medical or veterinary use; chemical preparations for smoking meat; chemical preparations for use in photography; chemical preparations to prevent diseases affecting cereal plants; chemical preparations to prevent diseases affecting vine plants; chemical preparations to prevent mildew; chemical preparations to prevent wheat blight; chemical reagents, other than for medical or veterinary purposes; chemical substances for analyses in laboratories, other than for medical or veterinary purposes; chemical substances for preserving foodstuffs; chemicals for the manufacture of paints; chemicals for the manufacture of pigments; chemicals for use in forestry, except fungicides, herbicides, insecticides and parasiticides; chemicals, except pigments, for the manufacture of enamel; chimney cleaners, chemical; chlorates; chlorides; chlorine; cholic acid; chromates; chrome alum; chrome salts; chromic acid; chromic salts; chromium oxide; cinematographic film, sensitized but not exposed; citric acid for industrial purposes; clarification preparations; coal saving preparations; cobalt oxide for industrial purposes; collagen for industrial purposes; collodion; colour-brightening chemicals for industrial purposes; combusting preparations [chemical additives to motor fuel]; compost; concrete preservatives, except paints and oils; concrete-aeration chemicals; condensation-preventing chemicals; coolants for vehicle engines; corrosive preparations; cream of tartar for chemical purposes; cream of tartar for industrial purposes; cream of tartar for the food industry; creosote for chemical purposes; crotonic aldehyde; cryogenic preparations; cultures of microorganisms, other than for medical and veterinary use; curium; currying preparations for leather; currying preparations for skins; cyanides [prussiates]; solutions for cyanotyping; cymene; damp-proofing chemicals, except paints, for masonry; decolorants for industrial purposes; bleaching preparations [decolorants] for industrial purposes; defoliants; degreasing preparations for use in manufacturing processes; dehydrating preparations for industrial purposes; dendrimer-based polymers for use in the manufacture of capsules for pharmaceuticals; descaling preparations, other than for household purposes; detergent additives to petrol; detergents for use in manufacturing processes; dextrin [size]; diagnostic preparations, other than for medical or veterinary purposes; diastase for industrial purposes; diatomaceous earth; diazo paper; disin crustants; dispersions of plastics; preparations of the distillation of wood alcohol; distilled water; dolomite for industrial purposes; drilling muds; dry ice [carbon dioxide]; dysprosium; electrophoresis gels; emollients for industrial purposes; emulsifiers; enamel-staining chemicals; engine-decarbonising chemicals; enzyme preparations for industrial purposes; enzyme preparations for the food industry; enzymes for

industrial purposes; enzymes for the food industry; epoxy resins, unprocessed; erbium; esters; ethane; ethers; ethyl alcohol; ethyl ether; europium; expanded clay for hydroponic plant growing [substrate]; fat-bleaching chemicals; fatty acids; ferments for chemical purposes; fermium; ferrocyanides; ferrotype plates [photography]; fertilizers; fertilizing preparations; filtering materials of chemical substances; filtering materials of mineral substances; filtering materials of unprocessed plastics; filtering materials of vegetable substances; filtering preparations for the beverages industry; finishing preparations for use in the manufacture of steel; fire extinguishing compositions; fireproofing preparations; fish meal fertilizers; fissionable chemical elements; fissionable material for nuclear energy; fixing baths [photography]; fixing solutions [photography]; flashlight preparations; flavonoids [phenolic compounds] for industrial purposes; flocculants; flour for industrial purposes; flower preservatives; flowers of sulfur for chemical purposes; fluids for hydraulic circuits; fluorine; fluorspar compounds; formic acid; formic aldehyde for chemical purposes; foundry binding substances; foundry moulding preparations; foundry sand; francium; fuel for nuclear reactors; fuel-saving preparations; fuller's earth for use in the textile industry; fulling preparations; fulling preparations for use in the textile industry; gadolinium; gallic acid for the manufacture of ink; gallium; gallnuts; gallotannic acid; galvanizing baths; baths for galvanizing; galvanizing preparations; gambier; gas purifying preparations; gelatine for industrial purposes; gelatine for photographic purposes; genes of seeds for agricultural production; getters [chemically active substances]; glass-frosting chemicals; glass-staining chemicals; glaziers' putty; glucose for industrial purposes; glucose for the food industry; glucosides; glue for industrial purposes; glutamic acid for industrial purposes; gluten [glue], other than for stationery or household purposes; gluten for industrial purposes; gluten for the food industry; glutinous tree-grafting preparations; glycerides; glycerine for industrial purposes; glycol; glycol ether; gold salts; grafting mastic for trees; grafting wax for trees; graphene; graphite for industrial purposes; guano; gum arabic for industrial purposes; gum solvents; gum tragacanth for industrial purposes; gums [adhesives] for industrial purposes; gurjun balsam for use in the manufacture of varnish; gypsum for use as a fertilizer; metal hardening preparations; heavy water; helium; holmium; hormones for hastening the ripening of fruit; horticultural chemicals, except fungicides, herbicides, insecticides and parasiticides; humus; humus top dressing; hydrates; hydrazine; hydrochlorates; hydrochloric acid; hydrofluoric acid; hydrogen; hydrogen peroxide for industrial purposes; hypochlorite of soda; hyposulfites; industrial chemicals; iodic acid; iodine for chemical purposes; iodine for industrial purposes; iodised albumen; iodised salts; ion exchangers [chemicals]; iron salts; isinglass, other than for stationery, house-

hold or alimentary purposes; isotopes for industrial purposes; kainite; kaolin; ketones; kieselgur; krypton; lactic acid; lactose [raw material]; lactose for industrial purposes; lactose for the food industry; lamp black for industrial purposes; lanthanum; lead acetate; lead arsenate; lead oxide; leather glues; leather-dressing chemicals; leather-impregnating chemicals; leather-renovating chemicals; leather-waterproofing chemicals; lecithin [raw material]; lecithin for industrial purposes; lecithin for the food industry; lime acetate; lime carbonate; lime chloride; limestone hardening substances; liquids for removing sulfates from batteries; lithia [lithium oxide]; lithium; litmus paper; loam; magnesite; magnesium carbonate; magnesium chloride; magnetic fluid for industrial purposes; malt albumen; manganate; manganese dioxide; mangrove bark for industrial purposes; masonry preservatives, except paints and oils; mastic for leather; mastic for tyres; meat tenderizers for industrial purposes; mercuric oxide; mercury; mercury salts; metalloids; methane; methyl benzene; methyl benzol; methyl ether; preparations of microorganisms, other than for medical and veterinary use; milk ferments for chemical purposes; milk ferments for industrial purposes; milk ferments for the food industry; mineral acids; moderating materials for nuclear reactors; moistening [wetting] preparations for use in bleaching; moistening [wetting] preparations for use in dyeing; mordants for metals; mould-release preparations; must-finishing preparations; nanopowders for industrial purposes; naphthalene; neodymium; neon; neptunium; nitrate paper; nitrates; nitric acid; nitrogen; nitrogenous fertilizers; nitrous oxide; oenological bactericides [chemical preparations for use in wine making]; oil cement [putty]; oil dispersants; oil-bleaching chemicals; oil-purifying chemicals; oil-separating chemicals; oils for currying leather; oils for preparing leather in the course of manufacture; oils for tanning leather; oils for the preservation of food; oleic acid; olivine [silicate mineral]; opacifiers for enamel; opacifiers for glass; organic digestate [fertilizer]; oxalates; oxalic acid; oxygen for industrial purposes; palladium chloride; paper pulp; paste fillers for automobile body repair; peat [fertilizer]; peat pots for horticulture; pectin [photography]; pectin for industrial purposes; pectin for the food industry; perborate of soda; percarbonates; perchlorates; persulfates; persulfuric acid; petroleum dispersants; phenol for industrial purposes; compositions for the manufacture of phonograph records; phosphates [fertilizers]; phosphatides; phosphoric acid; phosphorus; photographic developers; photographic emulsions; photographic paper; photographic sensitizers; photometric paper; photosensitive plates; picric acid; plant growth regulating preparations; plasticizers; plastics, unprocessed; plastisols; plutonium; polish removing substances; polonium; polymer resins, unprocessed; potash; potash water; potassium; potassium dioxalate; potato flour for industrial purposes; potting soil; power steering fluid; praseodymium; preparations for

stimulating cooking for industrial purposes; preservatives for tiles, except paints and oils; preservatives for use in the pharmaceutical industry; preparations for preventing the tarnishing of glass; preparations for preventing the tarnishing of lenses; substances for preventing runs in stockings; promethium; propellant gases for aerosols; protactinium; protective gases for welding; protein [raw material]; proteins for the food industry; proteins for use in manufacture; proteins for use in the manufacture of food supplements; pyrogalllic acid; quebracho for industrial purposes; radiator flushing chemicals; radioactive elements for scientific purposes; radium for scientific purposes; radon; rare earths; reagent paper, other than for medical or veterinary purposes; reducing agents for use in photography; refrigerants; renovating preparations for phonograph records; compositions for repairing inner tubes of tyres; compositions for repairing tyres; rhenium; rock salt; rubber preservatives; rubidium; saccharin; sal ammoniac; sal ammoniac spirits; salicylic acid; salt for preserving, other than for foodstuffs; salt, raw; saltpeter; salts [chemical preparations]; salts [fertilizers]; salts for colouring metal; salts for galvanic cells; salts for industrial purposes; salts from rare earth metals; salts of alkaline metals; salts of precious metals for industrial purposes; samarium; sauce for preparing tobacco; scandium; seawater for industrial purposes; seaweeds [fertilizers]; sebacic acid; seed preserving substances; selenium; self-toning paper [photography]; sensitized cloth for photography; sensitized films, unexposed; sensitized paper; sensitized photographic plates; sensitized plates for offset printing; separating and unsticking [ungluing] preparations; silicates; silicon; silicon carbide [raw material]; silicones; silver nitrate; silver salt solutions for silvering; size for finishing and priming; size for use in the textile industry; sizing preparations; slag [fertilizers]; soap [metallic] for industrial purposes; soda ash; sodium; sodium salts [chemical compounds]; soil conditioning preparations; soil for growing; soldering chemicals; soldering fluxes; solidified gases for industrial purposes; solvents for varnishes; soot for industrial or agricultural purposes; sorrel salt; spinel [oxide mineral]; spirits of salt; spirits of vinegar [dilute acetic acid]; stain-preventing chemicals for use on fabrics; starch for industrial purposes; starch paste [adhesive], other than for stationery or household purposes; starch-liquifying chemicals [ungluing agents]; stearic acid; stem cells, other than for medical or veterinary purposes; strontium; substrates for soil-free growing [agriculture]; sulfates; sulfides; sulfonic acids; sulfur; sulfuric acid; sulfuric ether; sulfurous acid; sumac for use in tanning; superphosphates [fertilizers]; synthetic materials for absorbing oil; synthetic resins, unprocessed; talc [magnesium silicate]; tan; tan-wood; tannic acid; tannin; tanning substances; tapioca flour for industrial purposes; tartar, other than for pharmaceutical purposes; tartaric acid; tea extracts for the food industry; tea extracts for use in the manufacture of

cosmetics; tea extracts for use in the manufacture of pharmaceuticals; technetium; compositions for the manufacture of technical ceramics; tellurium; metal tempering preparations; tensio-active agents; terbium; test paper, chemical; tetrachlorides; textile-brightening chemicals; textile-impregnating chemicals; textile-waterproofing chemicals; thallium; thiocarbamide; thorium; compositions for threading; thulium; thymol for industrial purposes; titanite; titanium dioxide for industrial purposes; toluol; toning baths [photography]; toning salts [photography]; topsoil; toxic gas neutralizers; preparations of trace elements for plants; transmission fluid; transmission oil; tree cavity fillers [forestry]; tungstic acid; uranium; uranium nitrate; uranium oxide; vinic alcohol; viscose; vitamins for the food industry; vitamins for use in the manufacture of cosmetics; vitamins for use in the manufacture of food supplements; vitamins for use in the manufacture of pharmaceuticals; vulcanization accelerators; vulcanizing preparations; wallpaper removing preparations; water glass [soluble glass]; water-purifying chemicals; water-softening preparations; wax-bleaching chemicals; wine finings; witherite; wood alcohol; wood pulp; wood vinegar [pyroligneous acid]; X-ray films, sensitized but not exposed; xenon; xylene; xylol; ytterbium; yttrium; zirconia.

3 – Abrasive paper; abrasives; adhesives for affixing false eyelashes; adhesives for affixing false hair; adhesives for cosmetic purposes; after-shave lotions; air fragrance reed diffusers; air fragrancing preparations; almond milk for cosmetic purposes; almond oil; almond soap; aloe vera preparations for cosmetic purposes; alum stones [astringents]; amber [perfume]; ammonia [volatile alkali] [detergent]; antiperspirant soap; antiperspirants [toiletries]; antistatic dryer sheets; antistatic preparations for household purposes; aromatics [essential oils]; astringents for cosmetic purposes; baby wipes impregnated with cleaning preparations; badian essence; balms, other than for medical purposes; bases for flower perfumes; basma [cosmetic dye]; bath preparations, not for medical purposes; bath salts, not for medical purposes; beard dyes; beauty masks; bergamot oil; bleaching preparations [decolorants] for cosmetic purposes; bleaching preparations [decolorants] for household purposes; bleaching salts; bleaching soda; body paint for cosmetic purposes; breath freshening preparations for personal hygiene; breath freshening sprays; breath freshening strips; cake flavourings [essential oils]; cakes of toilet soap; canned pressurized air for cleaning and dusting purposes; carbides of metal [abrasives]; chemical cleaning preparations for household purposes; cleaning chalk; cleaning preparations; preparations for cleaning dentures; cleansers for intimate personal hygiene purposes, non medicated; cleansing milk for toilet purposes; cloths impregnated with a detergent for cleaning; cobblers' wax; collagen preparations for cosmetic purposes; colorants for toilet purposes; colour run prevention laundry sheets; colour-brightening chemicals

for household purposes [laundry]; colour-removing preparations; corundum [abrasive]; cosmetic creams; cosmetic dyes; cosmetic kits; cosmetic pencils; cosmetic preparations for baths; cosmetic preparations for eyelashes; cosmetic preparations for skin care; cosmetic preparations for slimming purposes; cosmetics; cosmetics for animals; cosmetics for children; cotton swabs for cosmetic purposes; cotton wool for cosmetic purposes; cotton wool impregnated with make-up removing preparations; creams for leather; decorative transfers for cosmetic purposes; degreasers, other than for use in manufacturing processes; dental bleaching gels; dentifrices; denture polishes; deodorant soap; deodorants for human beings or for animals; deodorants for pets; depilatory preparations; depilatory wax; descaling preparations for household purposes; detergents, other than for use in manufacturing operations and for medical purposes; diamantine [abrasive]; douching preparations for personal sanitary or deodorant purposes [toiletries]; dry shampoos; dry-cleaning preparations; drying agents for dishwashing machines; eau de Cologne; emery; emery cloth; emery paper; essential oils; essential oils of cedarwood; essential oils of citron; essential oils of lemon; ethereal essences; extracts of flowers [perfumes]; eye-washes, not for medical purposes; eyebrow cosmetics; eyebrow pencils; fabric softeners for laundry use; false eyelashes; false nails; flavourings for beverages [essential oils]; floor wax; floor wax removers [scouring preparations]; food flavourings [essential oils]; fumigation preparations [perfumes]; gaultheria oil; gel eye patches for cosmetic purposes; geraniol; glass cloth [abrasive cloth]; greases for cosmetic purposes; grinding preparations; hair conditioners; hair dyes; hair lotions; hair spray; hair straightening preparations; hair waving preparations; heliotropine; henna [cosmetic dye]; herbal extracts for cosmetic purposes; hydrogen peroxide for cosmetic purposes; incense; ionone [perfumery]; jasmine oil; Javelle water; joss sticks; lacquer removing preparations; laundry bleach; laundry blueing; laundry glaze; laundry preparations; laundry soaking preparations; lavender oil; lavender water; leather bleaching preparations; leather preservatives [polishes]; preparations to make the leaves of plants shiny; lip glosses; lipstick cases; lipsticks; liquid latex body paint for cosmetic purposes; lotions for cosmetic purposes; make-up; make-up powder; make-up preparations; make-up removing preparations; mascara; massage candles for cosmetic purposes; massage gels, other than for medical purposes; micellar water; mint essence [essential oil]; mint for perfumery; moustache wax; mouthwashes, not for medical purposes; musk [perfumery]; nail art stickers; nail care preparations; nail glitter; nail varnish; nail varnish removers; neutralizers for permanent waving; non-slipping liquids for floors; non-slipping wax for floors; oil of turpentine for degreasing; oils for cleaning purposes; oils for cosmetic purposes; oils for perfumes and scents; oils for toilet purposes; paint strip-

ping preparations; pastes for razor strops; perfumery; perfumes; petroleum jelly for cosmetic purposes; phytocosmetic preparations; polish for furniture and flooring; polishing creams; polishing paper; polishing preparations; polishing rouge; polishing stones; polishing wax; pomades for cosmetic purposes; potpourris [fragrances]; pumice stone; quillaia bark for washing; rose oil; rust removing preparations; sachets for perfuming linen; safrol; sandcloth; sandpaper; scented water; scented wood; scouring solutions; shampoos for animals [non-medicated grooming preparations]; shampoos for pets [non-medicated grooming preparations]; shampoos; shaving preparations; shaving soap; shaving stones [astringents]; shining preparations [polish]; shoe cream; shoe polish; shoe wax; shoemakers' wax; silicon carbide [abrasive]; skin whitening creams; smoothing preparations [starching]; smoothing stones; soap for brightening textile; soap for foot perspiration; soap; soda lye; stain removers; starch for laundry purposes; starch glaze for laundry purposes; sun-tanning preparations [cosmetics]; sunscreen preparations; tailors' wax; talcum powder, for toilet use; teeth whitening strips; terpenes [essential oils]; tissues impregnated with cosmetic lotions; tissues impregnated with make-up removing preparations; toilet water; toiletry preparations; toothpaste; tripoli stone for polishing; turpentine for degreasing; preparations for unblocking drain pipes; vaginal washes for personal sanitary or deodorant purposes; varnish-removing preparations; volcanic ash for cleaning; wallpaper cleaning preparations; washing soda for cleaning; wax for parquet floors; whitening; windscreen cleaning liquids.

5 – Albumin dietary supplements; albuminous foodstuffs for medical purposes; albuminous preparations for medical purposes; alcohol for pharmaceutical purposes; aldehydes for pharmaceutical purposes; algicides; alginate dietary supplements; alginates for pharmaceutical purposes; alkaline iodides for pharmaceutical purposes; alkaloids for medical purposes; alloys of precious metals for dental purposes; almond milk for pharmaceutical purposes; aloe vera preparations for pharmaceutical purposes; aluminium acetate for medical purposes; amino acids for veterinary purposes; anaesthetics; analgesics; angostura bark for medical purposes; animal washes [insecticides]; anti-uric preparations; antibacterial handwashes; antibacterial soap; antibiotics; anticryptogamic preparations; antioxidant pills; antiparasitic collars for animals; antiparasitic preparations; antiseptic cotton; antiseptics; appetite suppressant pills; appetite suppressants for medical purposes; aseptic cotton; asthmatic tea; astringents for medical purposes; babies' diaper-pants; babies' diapers; bacterial poisons; bacterial preparations for medical and veterinary use; bacteriological preparations for medical and veterinary use; balms for medical purposes; balsamic preparations for medical purposes; bandages for dressings; barks for pharmaceutical purposes; bath preparations for medical purposes; bath

salts for medical purposes; bicarbonate of soda for pharmaceutical purposes; biocides; biological preparations for medical purposes; biological preparations for veterinary purposes; biological tissue cultures for medical purposes; biological tissue cultures for veterinary purposes; bismuth preparations for pharmaceutical purposes; bismuth subnitrate for pharmaceutical purposes; blood for medical purposes; blood plasma; bone cement for surgical and orthopaedic purposes; bone void fillers comprised of living tissues; bouillons for bacteriological cultures; bracelets impregnated with insect repellent; breast-nursing pads; bromine for pharmaceutical purposes; bronchodilating preparations; bunion pads; by-products of the processing of cereals for dietetic or medical purposes; cachets for pharmaceutical purposes; calomel [fungicide]; camphor for medical purposes; camphor oil for medical purposes; cannabis for medical purposes; capsules for medicines; capsules made of dendrimer-based polymers, for pharmaceuticals; carbolineum [parasiticide]; casein dietary supplements; castor oil for medical purposes; cattle washes [insecticides]; caustic pencils; caustics for pharmaceutical purposes; cedar wood for use as an insect repellent; cellulose esters for pharmaceutical purposes; cellulose ethers for pharmaceutical purposes; cement for animal hooves; charcoal for pharmaceutical purposes; chemical conductors for electrocardiograph electrodes; chemical contraceptives; chemical preparations for medical purposes; chemical preparations for pharmaceutical purposes; chemical preparations for the diagnosis of pregnancy; chemical preparations for treating diseases affecting cereal plants; chemical preparations for treating diseases affecting vine plants; chemical preparations for treating mildew; chemical preparations for treating phyloxera; chemical preparations for treating wheat blight; chemical preparations for veterinary purposes; chemical reagents for medical or veterinary purposes; chemico-pharmaceutical preparations; chewing gum for medical purposes; chilblain preparations; chinoline for medical purposes; chloroform; cocaine; cod liver oil; collagen for medical purposes; collodion for pharmaceutical purposes; collyrium; compresses; condurango bark for medical purposes; contact lens cleaning preparations; contraceptive sponges; cooling sprays for medical purposes; corn remedies; corn rings for the feet; cotton for medical purposes; cotton swabs for medical purposes; cream of tartar for pharmaceutical purposes; creosote for pharmaceutical purposes; croton bark; crystallized rock sugar for medical purposes; cultures of microorganisms for medical or veterinary use; curare; decoctions for pharmaceutical purposes; dental abrasives; dental amalgams; dental amalgams of gold; dental cements; dental impression materials; dental lacquer; dental mastics; deodorants for clothing and textiles; deodorants, other than for human beings or for animals; depuratives; preparations for destroying dry rot fungus; preparations for destroying mice; preparations for destroying noxious

animals; detergents for medical purposes; diabetic bread adapted for medical use; diagnostic biomarker reagents for medical purposes; diagnostic preparations for medical purposes; diagnostic preparations for veterinary purposes; diaper changing mats, disposable, for babies; diapers for incontinence; diapers for pets; diastase for medical purposes; dietary fibre; dietary supplements for animals; dietary supplements with a cosmetic effect; dietetic beverages adapted for medical purposes; dietetic foods adapted for medical purposes; dietetic substances adapted for medical use; digestives for pharmaceutical purposes; digitalin; dill oil for medical purposes; disinfectant soap; disinfectants; disinfectants for chemical toilets; disinfectants for hygiene purposes; dog washes [insecticides]; douching preparations for medical purposes; dressings, medical; drugs for medical purposes; elixirs [pharmaceutical preparations]; enzyme dietary supplements; enzyme preparations for medical purposes; enzyme preparations for veterinary purposes; enzymes for medical purposes; enzymes for veterinary purposes; ergot for pharmaceutical purposes; esters for pharmaceutical purposes; ethers for pharmaceutical purposes; eucalyptol for pharmaceutical purposes; eucalyptus for pharmaceutical purposes; extracts of hops for pharmaceutical purposes; eyepatches for medical purposes; preparations to facilitate teething; febrifuges; fennel for medical purposes; ferments for pharmaceutical purposes; first-aid boxes, filled; fish meal for pharmaceutical purposes; flour for pharmaceutical purposes; flowers of sulfur for pharmaceutical purposes; fly catching paper; fly destroying preparations; fly glue; food for babies; formic aldehyde for pharmaceutical purposes; freeze-dried food adapted for medical purposes; freeze-dried meat adapted for medical purposes; frostbite salve for pharmaceutical purposes; fumigating sticks; fumigation preparations for medical purposes; fungicides; gallic acid for pharmaceutical purposes; gamboge for medical purposes; gases for medical purposes; gauze for dressings; gelatine for medical purposes; gentian for pharmaceutical purposes; germicides; glucose dietary supplements; glucose for medical purposes; glycerine for medical purposes; glycerophosphates; greases for medical purposes; greases for veterinary purposes; guaiacol for pharmaceutical purposes; gum for medical purposes; gurjun balsam for medical purposes; haematogen; haemoglobin; haemorrhoid preparations; haemostatic pencils; headache relief sticks; herbal extracts for medical purposes; herbal teas for medicinal purposes; herbicides; homogenized food adapted for medical purposes; hormones for medical purposes; hydrastine; hydrastinine; hydrated chloral for pharmaceutical purposes; hydrogen peroxide for medical purposes; immunostimulants; infant formula; injectable dermal fillers; insect repellent incense; insect repellents; insecticidal animal shampoos; insecticidal veterinary washes; insecticides; iodides for pharmaceutical purposes; iodine for pharmaceutical purposes; iodoform;

Irish moss for medical purposes; isotopes for medical purposes; jalap; jujube, medicated; lacteal flour for babies; larvae exterminating preparations; laxatives; lead water; lecithin dietary supplements; lecithin for medical purposes; leeches for medical purposes; lice treatment preparations [pediculicides]; lime-based pharmaceutical preparations; liniments; linseed dietary supplements; linseed for pharmaceutical purposes; linseed meal for pharmaceutical purposes; linseed oil dietary supplements; lint for medical purposes; liquorice for pharmaceutical purposes; lotions for pharmaceutical purposes; lotions for veterinary purposes; lupulin for pharmaceutical purposes; magnesia for pharmaceutical purposes; malt for pharmaceutical purposes; malted milk beverages for medical purposes; mangrove bark for pharmaceutical purposes; massage candles for therapeutic purposes; massage gels for medical purposes; medical preparations for slimming purposes; medicated after-shave lotions; medicated animal feed; medicated dentifrices; medicated dry shampoos; medicated eye-washes; medicated hair lotions; medicated shampoos; medicated shampoos for pets; medicated soap; medicated sweets; medicated toiletry preparations; medicated toothpaste; medicinal alcohol; medicinal drinks; medicinal hair growth preparations; medicinal herbs; medicinal infusions; medicinal mud; medicinal oils; medicinal roots; medicinal tea; medicine cases, portable, filled; medicines for alleviating constipation; medicines for dental purposes; medicines for human purposes; medicines for veterinary purposes; melissa water for pharmaceutical purposes; menthol; mercurial ointments; preparations of microorganisms for medical or veterinary use; milk ferments for pharmaceutical purposes; milk sugar for pharmaceutical purposes; milking grease; mineral food supplements; mineral water salts; mineral waters for medical purposes; mint for pharmaceutical purposes; moleskin for medical purposes; mothproofing paper; mothproofing preparations; moulding wax for dentists; mouthwashes for medical purposes; mud for baths; mustard for pharmaceutical purposes; mustard oil for medical purposes; mustard plasters; myrobalan bark for pharmaceutical purposes; narcotics; nervines; nicotine gum for use as an aid to stop smoking; nicotine patches for use as aids to stop smoking; nutraceutical preparations for therapeutic or medical purposes; nutritional supplements; nutritive substances for microorganisms; oil of turpentine for pharmaceutical purposes; ointments for pharmaceutical purposes; opiates; opium; opodeldoc; opotherapy preparations; oxygen baths; oxygen cylinders, filled, for medical purposes; oxygen for medical purposes; pants, absorbent, for incontinence; panty liners [sanitary]; paper for mustard plasters; parasiticides; pastilles for pharmaceutical purposes; pearl powder for medical purposes; pectin for pharmaceutical purposes; pediculicidal shampoos; pepsins for pharmaceutical purposes; peptones for pharmaceutical purposes; pesticides; petroleum jelly for medical purposes; pharmaceutical prepara-

tions; pharmaceutical preparations for skin care; pharmaceutical preparations for treating dandruff; pharmaceutical preparations for treating sunburn; pharmaceuticals; phenol for pharmaceutical purposes; phosphates for pharmaceutical purposes; phytotherapy preparations for medical purposes; plant extracts for pharmaceutical purposes; poisons; pollen dietary supplements; pomades for medical purposes; porcelain for dental prostheses; potassium salts for medical purposes; poultices; powder of cantharides; powdered milk for babies; pre-filled syringes for medical purposes; propolis dietary supplements; propolis for pharmaceutical purposes; protein dietary supplements; protein supplements for animals; purgatives; pyrethrum powder; quassia for medical purposes; quebracho for medical purposes; quinine for medical purposes; quinquina for medical purposes; radioactive substances for medical purposes; radiological contrast substances for medical purposes; radium for medical purposes; rat poison; reagent paper for medical purposes; reagent paper for veterinary purposes; preparations for reducing sexual activity; remedies for foot perspiration; remedies for perspiration; repellents for dogs; rhubarb roots for pharmaceutical purposes; royal jelly dietary supplements; royal jelly for pharmaceutical purposes; rubber for dental purposes; salts for medical purposes; salts for mineral water baths; sanitary panties; sanitary tampons; sanitary towels; sarsaparilla for medical purposes; scapulars for surgical purposes; sea water for medicinal bathing; sedatives; semen for artificial insemination; serotherapeutic medicines; serums; personal sexual lubricants; sexual stimulant gels; siccatives [drying agents] for medical purposes; slimming pills; slug exterminating preparations; smelling salts; smoking herbs for medical purposes; sodium salts for medical purposes; soil-sterilizing preparations; solvents for removing adhesive plasters; soporifics; starch for dietetic or pharmaceutical purposes; stem cells for medical purposes; stem cells for veterinary purposes; sterilizing preparations; steroids; stick liquorice for pharmaceutical purposes; strychnine; styptic preparations; sugar for medical purposes; sulfonamides [medicines]; sulfur sticks [disinfectants]; sunburn ointments; suppositories; surgical dressings; surgical glues; surgical implants comprised of living tissues; swim diapers, disposable, for babies; swim diapers, reusable, for babies; syrups for pharmaceutical purposes; tanning pills; tartar for pharmaceutical purposes; teeth filling material; therapeutic preparations for the bath; thermal water; thymol for pharmaceutical purposes; tincture of iodine; tinctures for medical purposes; tissues impregnated with pharmaceutical lotions; tobacco extracts [insecticides]; tobacco-free cigarettes for medical purposes; tonics [medicines]; preparations of trace elements for human and animal use; transplants [living tissues]; preparations for the treatment of burns; turpentine for pharmaceutical purposes; vaccines; vaginal washes for medical purposes; vermifuges; vermin destroying preparati-

ons; vesicants; veterinary preparations; vitamin preparations; vitamin supplement patches; vulnerary sponges; wadding for medical purposes; wart pencils; wheat germ dietary supplements; yeast dietary supplements; yeast for pharmaceutical purposes.

(260) AM 2022 113444 A

(800) 1595548

(151) 2020 10 14

(891) 2020 10 14

(731) ESKA VALVE ANONİM ŞİRKETİ
SAKARYA 1. ORGANİZE SANAYİ
BÖLGESİ 11., CADDE NO:8, ARİFİYE –
SAKARYA, Turkey

(540)



(591) Blue

(531) 27.05.17; 29.01.04

(511)

6 – Containers for compressed gas, valves of metal, other than parts of machines, namely, water-pipe valves of metal, piston valves, ball valves, gate valves, gas discharge valves, gas shut-off valves, flap valves, mechanical earthquake valves.

7 – Pressure regulators [parts of machines] for controlling the pressure and flow of gas, pressure reducers, pressure valves, pressure switches as parts of machines, hydraulic and pneumatic actuators.

9 – Gas alarms, flow regulators, solenoid valves, steam solenoid valves, gas solenoid valves, compressor solenoid valves, stainless steel solenoid valves, explosion solenoid valves, gasoline and fuel solenoid valves, flanged solenoid valves, solar panels; electric and electronic components for use in industrial, hydraulic, pneumatic machines; measuring and checking indicators, test equipment namely flow, level, pressure and temperature measurement and control instruments, level switches, flowmeters, level measuring instruments, level gauges, flow switches, flow indicators, pressure sensors, pressure gauges, temperature sensors, thermometers, manometers, thermostats, thermocouples, humidity meters, electronic control systems, position sensors, hydrometers, digital torque gauges, ampere-hour meters, circuit breakers, circuit distribution boards, water level gauges, gas meters, gas testing equipment and apparatuses.

(260) AM 2022 113458 A

(800) 1595924

(151) 2021 03 03

(891) 2021 03 03

(731) "Nauchno-vnedrencheskoe predpriyatie
"Astrafarm"

Nauchnyj proezd, d.20, stroenie 3, et/pom/kom.
3/15, RU-117246 Moscow, Russian Federation

(540)



(591) Black, white

(531) 28.05

(511)

5 – Acaricides; insecticides; lotions for veterinary purposes; dog lotions; anti-horse-fly oils; antiparasitic collars for animals; bacterial preparations for medical and veterinary use; biological preparations for veterinary purposes; veterinary preparations; preparations for destroying noxious animals; larvae exterminating preparations; fly destroying preparations; vermin destroying preparations; enzyme preparations for veterinary purposes; chemical preparations for veterinary purposes; repellents; repellents for dogs; tissues impregnated with pharmaceutical lotions; greases for veterinary purposes; parasiticides; animal washes; cattle washes; dog washes; antiparasitic preparations; enzymes for veterinary purposes.

(260) AM 2022 113459 A

(800) 1595969

(151) 2021 02 25

(891) 2021 02 25

(731) Scientific Technological Pharmaceutical Firm
"POLYSAN" Ltd.

Salova Street, 72, Bldg. 2, Liter A, RU-192102
Saint Petersburg, Russian Federation

(540)



(591) Black, white

(531) 28.05

(511)

5 – Drugs for medical purposes; medicines for veterinary purposes; medicines for human purposes; veterinary preparations; vitamin preparations; opotherapy preparations; pharmaceutical preparations; chemico-pharmaceutical preparations; chemical preparations for veterinary purposes; chemical preparations for medical purposes; tonics [medicines].

(260) AM 2022 113460 A

(800) 1595975

(151) 2020 12 14

(891) 2020 12 14

(731) NOVRUZOVA Fidan

Str. București nr. 91/1, MD-2012 Chișinău,
Republic of Moldova

(540)

FIDAN NOVRUZOVA

(591) Black, white

(511)

25 – Clothing, footwear, headgear.

26 – Lace, braid and embroidery, and haberdashery ribbons and bows; buttons, hooks and eyes, pins and needles; artificial flowers; hair decorations; false hair.

(260) AM 2022 113461 A

(800) 1595988

(151) 2021 02 24

(891) 2021 02 24

(731) UralAktiv LTD

Yumasheva str., d. 11, ofc. 45, Ekaterinburg,
RU-620014 Sverdlovsk region, Russian
Federation

(540)

XИМБЕHT

(591) Black, white

(531) 28.05

(511)

7 – Vending machines; 3D printers; welding machines, electric; welding apparatus, gas-operated; vulcanization apparatus; acetylene cleaning apparatus; high pressure washers; apparatus for drawing up beer under pressure; apparatus for aerating water; apparatus for aerating beverages; electrical apparatus for sealing plastics [packaging]; electric arc cutting apparatus; electric arc welding apparatus; electric welding apparatus; inking apparatus for printing machines; soldering apparatus, electric; fittings for engine boilers; expansion tanks [parts of machines]; drums [parts of machines]; reels, mechanical, for flexible hoses; brake shoes, other than for vehicles; concrete mixers [machines]; reels [parts of machines]; bobbins for weaving looms; harrows; journal boxes [parts of machines]; bulldozers; hoppers [mechanical discharging]; mine borers; railway wagon lifts; rolling mill cylinders; crank shafts; printing rollers for machines; camshafts for vehicle engines; transmission shafts, other than for land vehicles; valves [parts of machines]; fans for motors and engines; saw benches [parts of machines]; winnowers; vibrators [machines] for industrial use; bearings [parts of machines]; water heaters [parts of machines]; bellows [parts of machines]; agitators; exhausts for motors and engines; drilling rigs, floating or non-floating; lawnmowers [machines];

card clothing [parts of carding machines]; nail pullers, electric; emergency power generators; alternators; dynamos; bicycle dynamos; current generators; generators of electricity; hydraulic controls for machines, motors and engines; mufflers for motors and engines; drilling heads [parts of machines]; drilling bits [parts of machines]; cylinder heads for engines; soldering blow pipes, gas-operated; gas-operated blow torches; raking machines; stalk separators [machines]; sieves [machines or parts of machines]; mud catchers and collectors [machines]; tarring machines; rubber tracks being parts of crawlers on mining machines; rubber tracks being parts of crawlers on snow ploughs; rubber tracks being parts of crawlers on loading-unloading machines and apparatus; rubber tracks being parts of crawlers on agricultural machines; rubber tracks being parts of crawlers on construction machines; hydraulic engines and motors; aeronautical engines; aeroplane engines; engines for air cushion vehicles; compressed air engines; jet engines, other than for land vehicles; engines for boats; driving motors, other than for land vehicles; motors, other than for land vehicles; propulsion mechanisms, other than for land vehicles; de-aerators for feedwater; disintegrators; tympan [parts of printing presses]; holding devices for machine tools; turf removing ploughs; pump diaphragms; hydraulic door closers; pneumatic door closers; electric door closers; chisels for machines; jacks [machines]; rack and pinion jacks; moving walkways; electric hand drills; crushers for kitchen use, electric; flues for engine boilers; reapers; reapers and binders; millstones; rakes for raking machines; shredders [machines] for industrial use; kitchen grinders, electric; injectors for engines; incubators for eggs; ski edge sharpening tools, electric; tools [parts of machines]; hand-held tools, other than hand-operated; agricultural implements, other than hand-operated; air condensers; control cables for machines, engines or motors; capstans; calenders; rotary steam presses, portable, for fabrics; ditchers [ploughs]; carburettors; carriages for knitting machines; crankcases for machines, motors and engines; steamrollers; pressure valves [parts of machines]; clack valves [parts of machines]; pressure reducers [parts of machines]; cowlings [parts of machines]; machine wheels; freewheels, other than for land vehicles; scale collectors for machine boilers; lasts for shoes [parts of machines]; brake pads, other than for vehicles; piston segments; grease rings [parts of machines]; reapers and threshers; coal-cutting machines; compressors [machines]; air pumps [garage installations]; compressors for refrigerators; conveyors [machines]; belt conveyors; converters for steelworks; steam condensers [parts of machines]; aerocondensers; diggers [machines]; rams [machines]; thermic lances [machines]; mechanized feeders for animals; boxes for matrices [printing]; gear boxes, other than for land vehicles; grease boxes [parts of machines]; housings [parts of machines]; harvesting machines; steam engine boilers; coffee

grinders, other than hand-operated; taps [parts of machines, engines or motors]; cranes [lifting and hoisting apparatus]; roller bridges; mobile cranes; water separators; spray guns for paint; cranks [parts of machines]; potters' wheels; grindstones [parts of machines]; cultivators [machines]; soldering lamps; winches; ploughshares; belts for conveyors; lubricators [parts of machines]; igniting magnetos; handling machines, automatic [manipulators]; churns; matrices for use in printing; machine fly-wheels; hair clipping machines for animals; papermaking machines; blowing machines; knitting machines; galvanizing machines; bending machines; ironing machines; mineworking machines; blowing machines for the compression, exhaustion and transport of gases; blowing machines or fans for the compression, sucking and carrying of grain; net hauling machines [fishing]; electroplating machines; bottle sealing machines; sealing machines for industrial purposes; embossing machines; engraving machines; finishing machines; crushing machines; waste disposal units; blade sharpening [stropping] machines; earth moving machines; cord making machines; lace making machines; butter machines; cigarette machines for industrial purposes; sausage making machines; stereotype machines; hosiery looms; grinding machines; dyeing machines; bottle washing machines; dishwashers; bottle filling machines; racket stringing machines; leather-working machines; dairy machines; glass-working machines; tobacco processing machines; grain husking machines; painting machines; oil refining machines; peeling machines; machines for processing plastics; ore treating machines; printing machines for use on sheet metal; brewing machines; whitewashing machines; road sweeping machines, self-propelled; leather paring machines; bitumen making machines; pasta making machines, electric; machines for the production of sugar; weeding machines; sifting machines; cinder sifters [machines]; puddling machines; notchers [machine tools]; bread cutting machines; road making machines; railroad constructing machines; machines for the textile industry; rammers [machines]; rail-laying machines; bottle capping machines; bottle stoppering machines; packing machines; waste compacting machines; die-stamping machines; stamping machines; darning machines; milking machines; drainage machines; wrapping machines; grain separators; bookbinding apparatus and machines for industrial purposes; machines and apparatus for cleaning, electric; machines and apparatus for carpet shampooing, electric; machines and apparatus for polishing [electric]; sizing machines; punching machines; riveting machines; kitchen machines, electric; foundry machines; smoothing presses; fleshing machines; rinsing machines; flour mill machines; type-setting machines [printing]; hemming machines; grating machines for vegetables; braiding machines; wringing machines for laundry; cutting machines; steam engines; printing machines; rotary printing presses; industrial inkjet printing machines; com-

pressed air machines; tilling machines for agricultural purposes; trimming machines; spinning machines; filling machines; friezing machines; cutters [machines]; satinizing machines; agricultural machines; mixing machines; sorting machines for industry; stitching machines; washing machines [laundry]; coin-operated washing machines; clippers [machines]; spinning frames; spin driers [not heated]; looms; kneading machines; typographic machines; type-setting machines [photocomposition]; beating machines; beaters, electric; filtering machines; moulding machines; carding machines; sewing machines; typecasting machines; electromechanical machines for chemical industry; labellers [machines]; mills [machines]; mills for household purposes, other than hand-operated; pepper mills, other than hand-operated; centrifugal mills; machine wheelwork; feeders [parts of machines]; forge blowers; mixers [machines]; blenders, electric, for household purposes; vacuum cleaner bags; threshing machines; pneumatic hammers; hammers [parts of machines]; tilt hammers; power hammers; reeling apparatus, mechanical; motorized cultivators; motors for boats; clutches, other than for land vehicles; meat choppers [machines]; superchargers; brake linings, other than for vehicles; guides for machines; suction nozzles for vacuum cleaners; vacuum cleaner attachments for disseminating perfumes and disinfectants; pumps [machines]; pumps [parts of machines, engines or motors]; aerating pumps for aquaria; vacuum pumps [machines]; compressed air pumps; pumps for heating installations; beer pumps; pumps for counter-current swimming; lubricating pumps; self-regulating fuel pumps; fuel dispensing pumps for service stations; centrifugal pumps; hydrogen dispensing pumps for service stations; blades [parts of machines]; can openers, electric; knives for mowing machines; chaff cutter blades; knives, electric; shears, electric; scissors, electric; vegetable spiralizers, electric; engine mounts, other than for land vehicles; bearing brackets for machines; pulverisers [machines]; axles for machines; steam traps; chucks [parts of machines]; drill chucks [parts of machines]; exhaust manifold for engines; soldering irons, gas-operated; soldering irons, electric; superheaters; gears, other than for land vehicles; reduction gears, other than for land vehicles; drilling machines; saws [machines]; chain saws; guns [tools using explosives]; glue guns, electric; compressed air guns for the extrusion of mastics; carburetter feeders; feeding apparatus for engine boilers; loading ramps; ploughs; pneumatic transporters; pneumatic controls for machines, motors and engines; hangers [parts of machines]; anti-friction bearings for machines; roller bearings; self-oiling bearings; bearings for transmission shafts; ball-bearings; elevators [lifts]; hoists; lifts, other than ski-lifts; pulleys; saw blades [parts of machines]; pistons [parts of machines or engines]; shock absorber plungers [parts of machines]; pistons for engines; pistons for cylinders; catalytic converters; torque converters, other than for land ve-

hicles; fuel conversion apparatus for internal combustion engines; presses [machines for industrial purposes]; wine presses; basket presses; electric fruit squeezers; fodder presses; printing presses; typographic presses; swaging machines; pedal drives for sewing machines; cleaning appliances utilizing steam; food processors, electric; springs [parts of machines]; spinning wheels; punches for punching machines; vacuum cleaners; tambours for embroidery machines; radiators [cooling] for motors and engines; sewage pulverizers; air brushes for applying colour; regulators [parts of machines]; pressure regulators [parts of machines]; speed governors for machines, engines and motors; knives [parts of machines]; cutting blow pipes, gas-operated; blade holders [parts of machines]; loom shafts; gears for weaving looms; belts for machines; elevator belts; fan belts for motors and engines; dynamo belts; belts for motors and engines; adhesive bands for pulleys; industrial robots; 3D printing pens; kick starters for motorcycles; joysticks being parts of machines, other than for game machines; stuffing boxes [parts of machines]; paper feeders [printing]; whisks, electric, for household purposes; sparking plugs for internal combustion engines; glow plugs for Diesel engines; brake segments, other than for vehicles; tedding machines; steam/oil separators; cream/milk separators; ball rings for bearings; sowers [machines]; pigs for cleaning pipes; snow ploughs; sheaf-binding machines; shaft couplings [machines]; juice extractors, electric; chaff cutters; suction cups for milking machines; stands for machines; machine tools; die-cutting and tapping machines; woodworking machines; sharpening machines; bicycle assembling machines; mortising machines; stone-working machines; metalworking machines; threading machines; planing machines; lathes [machine tools]; milling machines; trueing machines; metal drawing machines; rolling mills; starters for motors and engines; stators [parts of machines]; glaziers' diamonds [parts of machines]; tables for machines; derricks; slide rests [parts of machines]; couplings, other than for land vehicles; heat exchangers [parts of machines]; transmissions for machines; transmissions, other than for land vehicles; boiler tubes [parts of machines]; wind turbines; hydraulic turbines; turbines, other than for land vehicles; turbocompressors; connecting rods for machines, motors and engines; joints [parts of engines]; central vacuum cleaning installations; suction machines for industrial purposes; machines for the mineralization of drinking water; washing installations for vehicles; degreasers [machines]; dust exhausting installations for cleaning purposes; sifting installations; pneumatic tube conveyors; dust removing installations for cleaning purposes; condensing installations; pneumatic waste oil drainers; lifting apparatus; air suction machines; dividing machines; igniting devices for internal combustion engines; window closers, hydraulic; window closers, electric; window closers, pneumatic; washing apparatus; binding apparatus

for hay; extractors for mines; door openers, hydraulic; door openers, pneumatic; door openers, electric; window openers, hydraulic; window openers, pneumatic; window openers, electric; curtain drawing devices, electrically operated; adhesive tape dispensers [machines]; anti-pollution devices for motors and engines; beverage preparation machines, electromechanical; food preparation machines, electromechanical; elevator operating apparatus; control mechanisms for machines, engines or motors; shoe polishers, electric; machines and apparatus for wax-polishing, electric; air cushion devices for moving loads; handling apparatus for loading and unloading; elevating apparatus; aprons [parts of machines]; filter presses; filters for cleaning cooling air, for engines; filters being parts of machines or engines; molds [parts of machines]; printing plates; journals [parts of machines]; centrifugal machines; elevator chains [parts of machines]; driving chains, other than for land vehicles; transmission chains, other than for land vehicles; cylinders for motors and engines; cylinders for machines; printing cylinders; pneumatic jacks; shuttles [parts of machines]; universal joints [Cardan joints]; steam mops; pulleys [parts of machines]; vacuum cleaner hoses; screwdrivers, electric; brushes [parts of machines]; dynamo brushes; vacuum cleaner brushes; brushes, electrically operated [parts of machines]; carbon brushes [electricity]; ejectors; robotic exoskeleton suits, other than for medical purposes; fuel economisers for motors and engines; excavators; shovels, mechanical; agricultural elevators; motors, electric, other than for land vehicles; electrodes for welding machines; electric hammers; parquet wax-polishers, electric; cartridges for filtering machines; moving staircases [escalators]; automatic grapnels for marine purposes.

11 – Lamp shades; steam accumulators; heat accumulators; defrosters for vehicles; disinfectant apparatus for medical purposes; distillation apparatus; desiccating apparatus; hydromassage bath apparatus; disinfectant apparatus; air deodorizing apparatus; tanning apparatus [sun beds]; ionization apparatus for the treatment of air or water; coffee roasters; beverage cooling apparatus; hand drying apparatus for washrooms; fruit roasters; water purifying apparatus and machines; refrigerating apparatus and machines; drying apparatus and installations; freezers; heating and cooling apparatus for dispensing hot and cold beverages; drying apparatus; coolers for furnaces; expansion tanks for central heating installations; flushing tanks; refining towers for distillation; bidets; boilers, other than parts of machines; bath tubs; spa baths [vessels]; bath tubs for sitz baths; waffle irons, electric; fans [air-conditioning]; fans [parts of air-conditioning installations]; electric fans for personal use; roasting spits; refrigerating display cabinets; heated display cabinets; water heaters; water heaters [apparatus]; water flushing installations; air reheaters; extractor hoods for kitchens; gas condensers, other than parts of machines; acetylene generators; microbubble

generators for baths; hydrants; fairy lights for festive decoration; burners; acetylene burners; gas burners; burners for lamps; germicidal burners; incandescent burners; oxyhydrogen burners; laboratory burners; oil burners; alcohol burners; hot water bottles; footwarmers, electric or non-electric; bed warmers; USB-powered hand warmers; pocket warmers; warming pans; grills [cooking appliances]; food dehydrators, electric; lampshade holders; stills; showers; refrigerating containers; lighters; gas lighters; friction lighters for igniting gas; chimney blowers; coils [parts of distilling, heating or cooling installations]; furnace ash boxes; evaporators; electric yogurt makers; shower enclosures; Turkish bath cabinets, portable; heating apparatus; cool boxes, electric; refrigerating chambers; fireplaces, domestic; chimney flues; structural framework for ovens; air valves for steam heating installations; level controlling valves in tanks; thermostatic valves [parts of heating installations]; electrically heated carpets; light bulbs; light bulbs, electric; solar thermal collectors [heating]; distillation columns; furnace grates; ventilation hoods; ventilation hoods for laboratories; lamp globes; air-conditioning apparatus; air conditioners for vehicles; gas boilers; laundry room boilers; heating boilers; coffee machines, electric; taps; faucets for pipes and pipelines; mixer faucets for water pipes; forges, portable; lava rocks for use in barbecue grills; couscous cookers, electric; electric lights for Christmas trees; acetylene flares; safety lamps; gas lamps; curling lamps; nail lamps; curing lamps, not for medical purposes; germicidal lamps for purifying air; light bulbs for directional signals for vehicles; arc lamps; laboratory lamps; oil lamps; ultraviolet ray lamps, not for medical purposes; miners' lamps; electric lamps; chandeliers; barbecues; bread baking machines; watering machines for agricultural purposes; ice-cream making machines; pounded rice cake making machines, electric, for household purposes; multicookers; footmuffs, electrically heated; heaters for baths; heaters for heating irons; immersion heaters; brackets for gas burners; anti-splash tap nozzles; heat pumps; filaments for electric lamps; magnesium filaments for lighting; heating filaments, electric; luminous house numbers; socks, electrically heated; heating apparatus for defrosting vehicle windows; hot air bath fittings; bath fittings; loading apparatus for furnaces; kiln furniture [supports]; sauna bath installations; refrigerating appliances and installations; directional lights for bicycles; electrically heated clothing; blankets, electric, not for medical purposes; fabric steamers; lamp reflectors; vehicle reflectors; hearths; electric cooktops; food steamers, electric; steam boilers, other than parts of machines; pasteurisers; lamp mantles; sockets for electric lights; coffee percolators, electric; stoves [heating apparatus]; bakers' ovens; hot air ovens; kitchen ranges [ovens]; microwave ovens [cooking apparatus]; microwave ovens for industrial purposes; incinerators; kilns; solar furnaces; dental ovens; furnaces, other than for laboratory use; urinals

being sanitary fixtures; feeding apparatus for heating boilers; heating plates; cookers; hot plates; wine cellars, electric; heaters, electric, for feeding bottles; aquarium heaters; USB-powered cup heaters; aquarium lights; heating cushions, electric, not for medical purposes; clean chambers [sanitary installations]; tortilla presses, electric; water intake apparatus; deodorizing apparatus, not for personal use; apparatus for dehydrating food waste; fumigation apparatus, not for medical purposes; gas scrubbing apparatus; oil-scrubbing apparatus; glue-heating appliances; electric appliances for making yoghurt; forage drying apparatus; water filtering apparatus; air purifying apparatus and machines; ice machines and apparatus; cooling appliances and installations; cooking apparatus and installations; lighting apparatus and installations; sanitary apparatus and installations; cooking rings; lighting apparatus for vehicles; light-emitting diodes [LED] lighting apparatus; heating apparatus for solid, liquid or gaseous fuels; heating apparatus, electric; hot air apparatus; steam facial apparatus [saunas]; safety accessories for water or gas apparatus and pipes; regulating and safety accessories for gas apparatus; regulating accessories for water or gas apparatus and pipes; regulating and safety accessories for water apparatus; regulating and safety accessories for gas pipes; roasting jacks; plate warmers; anti-glare devices for vehicles [lamp fittings]; rotisseries; radiator caps; searchlights; diving lights; washers for water faucets; heat guns; radiators [heating]; central heating radiators; radiators, electric; sinks; disinfectant dispensers for toilets; drip irrigation emitters [irrigation fittings]; light diffusers; nuclear reactors; heat regenerators; pressure water tanks; roasters; lamps; floor lamps; ceiling lights; toilet seats; hydroponic growing systems; lighting installations for air vehicles; sous-vide cookers, electric; pressure cookers, electric; gas scrubbers [parts of gas installations]; lamp glasses; sterilizers; water sterilizers; air sterilizers; air dryers; laundry dryers, electric; hair dryers; malt roasters; tobacco roasters; tajines, electric; heat exchangers, other than parts of machines; thermo-pots, electric; standard lamps; bread toasters; discharge tubes, electric, for lighting; lamp chimneys; luminous tubes for lighting; pipes [parts of sanitary installations]; flues for heating boilers; boiler pipes [tubes] for heating installations; toilets [water-closets]; toilets, portable; humidifiers for central heating radiators; wash-hand basins [parts of sanitary installations]; toilet bowls; water conduits installations; bath installations; air-conditioning installations; desalination plants; installations for processing nuclear fuel and nuclear moderating material; watering installations, automatic; cooling installations for water; cooling installations for liquids; milk cooling installations; cooling installations for tobacco; water purification installations; purification installations for sewage; steam generating installations; water distribution installations; air filtering installations; swimming pool chlorinating apparatus; ventilation

[air-conditioning] installations and apparatus; ventilation [air-conditioning] installations for vehicles; water softening apparatus and installations; cooling installations and machines; heating installations; heaters for vehicles; hot water heating installations; polymerisation installations; water supply installations; flare stacks for use in the oil industry; ash conveyor installations, automatic; whirlpool-jet apparatus; air cooling apparatus; aquarium filtration apparatus; cooking utensils, electric; flaming torches; headlights for automobiles; vehicle headlights; filters for air conditioning; filters for drinking water; wicks adapted for oil stoves; lights for automobiles; bicycle lights; motorcycle lights; lights for vehicles; electric torches; head torches; lanterns for lighting; candle lanterns; street lamps; Chinese lanterns; fountains; ornamental fountains; chocolate fountains, electric; air fryers; deep fryers, electric; fittings, shaped, for ovens; oven fittings made of fireclay; bread-making machines; refrigerators; refrigerators, cooling apparatus and freezers for medical storage purposes; chromatography apparatus for industrial purposes; kettles, electric; dampers [heating]; book sterilization apparatus; refrigerating cabinets; carbon for arc lamps; heating elements.

20 – Picture frame brackets; bumper guards for cots, other than bed linen; reels, not of metal, non-mechanical, for flexible hoses; pulleys of plastics for blinds; bolts, not of metal; casks of wood for decanting wine; mooring buoys, not of metal; casks, not of metal; barrels, not of metal; identification bracelets, not of metal; sideboards; busts of wood, wax, plaster or plastic; costume stands; bolsters; fans for personal use, non-electric; work benches; vice benches [furniture]; valet stands; coatstands; coat hangers; shoulder poles [yokes]; screws, not of metal; display stands; showcases [furniture]; newspaper display stands; jewelry organizer displays; collars, not of metal, for fastening pipes; comb foundations for beehives; signboards of wood or plastics; loading gauge rods, not of metal, for railway wagons; nuts, not of metal; covers for clothing [wardrobe]; shoe pegs, not of metal; nesting boxes; coffins; doors for furniture; curtain holders, not of textile material; pegs [pins], not of metal; divans; door closers, not of metal, non-electric; kennels for household pets; birdhouses; keyboards for hanging keys; display boards; plugs [dowels], not of metal; containers, not of metal, for liquid fuel; troughs, not of metal, for mixing mortar; oil drainage containers, not of metal; packaging containers of plastic; indoor window blinds [furniture]; indoor window blinds of paper; indoor window blinds of woven wood; indoor window blinds of textile; flower-stands [furniture]; curtain tie-backs; clips, not of metal, for cables and pipes; binding screws, not of metal, for cables; clips of plastic for sealing bags; rivets, not of metal; imitation tortoiseshell; locks, not of metal, for vehicles; locks, other than electric, not of metal; bead curtains for decoration; door bolts, not of metal; bottle closures, not of metal; closures, not of metal, for containers; lat-

hes, not of metal; mirrors [looking glasses]; hand-held mirrors [toilet mirrors]; bamboo; scratching posts for cats; animal claws; animal hooves; coral; meerschaum; whalebone, unworked or semi-worked; stag antlers; tortoiseshell; shells; horn, unworked or semi-worked; animal horns; rattan; corozo; plaited straw, except matting; wickerwork; hampers [baskets] for the transport of items; works of art of wood, wax, plaster or plastic; cabinet work; reeds [plaiting materials]; settees; jerrycans, not of metal; curtain rods; index cabinets [furniture]; reels of wood for yarn, silk, cord; drain traps [valves] of plastic; water-pipe valves of plastic; valves, not of metal, other than parts of machines; staves of wood; plastic keys; plastic key cards, not encoded and not magnetic; mats for infant playpens; sleeping mats; saw horses; bed casters, not of metal; furniture casters, not of metal; brush mountings; chopping blocks [tables]; wind chimes [decoration]; door bells, not of metal, non-electric; bottle caps, not of metal; cradles; tent pegs, not of metal; curtain rings; split rings, not of metal, for keys; chests of drawers; console tables; containers, not of metal [storage, transport]; floating containers, not of metal; lecterns; dog kennels; bakers' bread baskets; baskets, not of metal; Moses baskets; bottle casings of wood; tool boxes, not of metal, empty; faucets, not of metal, for casks; armchairs; hairdressers' chairs; deck chairs; beds; hospital beds; waterbeds, not for medical purposes; bedsteads of wood; air beds, not for medical purposes; cots for babies; edgings of plastic for furniture; brackets, not of metal, for furniture; screw tops, not of metal, for bottles; table tops; sash fasteners, not of metal, for windows; hooks, not of metal, for clothes rails; curtain hooks; clothes hooks, not of metal; bag hangers, not of metal; beds for household pets; nesting boxes for household pets; ladders of wood or plastics; playpens for babies; mannequins; mattresses; air mattresses, not for medical purposes; camping mattresses; furniture; furniture of metal; inflatable furniture; office furniture; school furniture; mobiles [decoration]; door knockers, not of metal; shoe dowels, not of metal; curtain rails; runners, not of metal, for sliding doors; legs for furniture; feet for furniture; house numbers, not of metal, non-luminous; barrel hoops, not of metal; door stops, not of metal or rubber; window stops, not of metal or rubber; moldings for picture frames; bed bases; furniture partitions of wood; freestanding partitions [furniture]; mother-of-pearl, unworked or semi-worked; ambroid plates; registration plates, not of metal; identity plates, not of metal; loading pallets, not of metal; handling pallets, not of metal; transport pallets, not of metal; mirror tiles; headrests [furniture]; trays, not of metal; stakes, not of metal, for plants or trees; trestles [furniture]; magazine racks; book rests [furniture]; stands for calculating machines; flower-pot pedestals; plastic ramps for use with vehicles; baby changing mats; pet cushions; pillows; cushions; head support cushions for babies; anti-roll cushions for babies; air cushions,

not for medical purposes; air pillows, not for medical purposes; head positioning pillows for babies; removable mats or covers for sinks; racks [furniture]; library shelves; shelves for file cabinets; furniture shelves; shelves for storage; wood ribbon; straw edgings; towel stands [furniture]; hat stands; bathtub grab bars, not of metal; cask stands, not of metal; inflatable publicity objects; counters [tables]; bedding, except linen; corks for bottles; corks; stoppers, not of glass, metal or rubber; sealing caps, not of metal; stair rods; standing desks; embroidery frames; dispensers for dog waste bags, fixed, not of metal; towel dispensers, fixed, not of metal; picture frames; sections of wood for beehives; crucifixes of wood, wax, plaster or plastic, other than jewelry; tanks, not of metal nor of masonry; fodder racks; curtain rollers; door handles, not of metal; knobs, not of metal; fishing baskets; writing desks; bath seats for babies; seats of metal; benches [furniture]; vats, not of metal; honeycombs; sofas; bungs, not of metal; statues of wood, wax, plaster or plastic; figurines of wood, wax, plaster or plastic; oyster shells; silvered glass [mirrors]; shelving units; ambroid bars; umbrella stands; gun racks; carts for computers [furniture]; lap desks; dressing tables; washstands [furniture]; tables; typing desks; drafting tables; massage tables; tables of metal; wall-mounted baby changing platforms; saw benches [furniture]; desks; portable desks; tea carts; dinner wagons [furniture]; steps [ladders], not of metal; step stools, not of metal; chairs [seats]; high chairs for babies; shower chairs; chests, not of metal; placards of wood or plastics; stools; footstools; crates; trolleys [furniture]; straw plaits; mobile boarding stairs, not of metal, for passengers; straw mattresses; decorations of plastic for foodstuffs; beehives; door fasteners, not of metal; window fasteners, not of metal; funerary urns; winding spools, not of metal, non-mechanical, for flexible hoses; hand-held flagpoles, not of metal; door fittings, not of metal; coffin fittings, not of metal; bed fittings, not of metal; furniture fittings, not of metal; window fittings, not of metal; infant walkers; garment covers [storage]; stuffed animals; stuffed birds; hinges, not of metal; chaise longues; poles, not of metal; screens [furniture]; filing cabinets; medicine cabinets; plate racks; meat safes; bookcases; wardrobes; cupboards; bamboo curtains; slatted indoor blinds; screens for fireplaces [furniture]; labels of plastic; yellow amber; lockers; chests for toys; tool chests, not of metal, empty; boxes of wood or plastic; letter boxes, not of metal or masonry; bottle racks.

(260) AM 2022 113462 A

(800) 1596037

(151) 2021 01 11

(891) 2021 01 11

(731) J.C. Bamford Excavators Limited

Rocester, Uttoxeter, Staffordshire ST14 5JP,
United Kingdom

(540)



(591) Black, white and yellow

(531) 26.04.07; 26.04.18; 27.05.10; 27.05.24;
29.01.13

(511)

1 – Hydraulic fluid; automatic transmission fluid; brake fluid; antifreeze; distilled water and battery acid for batteries; resins and hardening preparations and substances; tyre repair compositions; degreasing and degumming preparations; hydraulic oil.

4 – Lubricants, oils and greases; engine oil; gear oil.

7 – Power operated machines and apparatus all for the digging, excavating, mechanical handling, lifting, loading and transporting of earth, minerals, soil crops and of like materials; parts and fittings for all the aforesaid goods including engines; compacting and vibrating machines and equipment, vibratory plate compactors, rollers, asphalt and concrete cutting machines; parts and fittings for all the aforementioned goods; hydraulic cylinders and pistons; hydraulic engines and motors; hydraulic connectors and fittings being parts and fittings of machines and engines; hydraulic and pneumatic lifting jacks; lifting chains being parts for machines; alternators; oil and water pumps; fuel, transmission, oil and air filters for engines; radiators and their parts (for engines); connecting rods for engines; rigid fuel pipes and tubes (fitted parts for machines); exhaust and silencing systems for engines; belts for machines; ignition devices; power operated tools including drills, screwdrivers, saws, planers, sanders; gardening and woodworking tools and parts and fittings for these goods; parts and fittings for engines (for land vehicles).

12 – Parts and fittings for vehicles; agricultural vehicles and tractors; vehicle alarm systems; mirrors for vehicles; tyres for vehicles; baby carriages; bicycles; parts and fittings for all the aforesaid goods.

37 – Repair and maintenance services for machines and apparatus all for the lifting, loading and transporting of earth, minerals, soil crops and of like materials, and for vehicles and agricultural vehicles including tractors; rental of power operated machines and of construction equipment including pumps and cranes; provision of information concerning the repair and maintenance of power operated machines and vehicles, including such services provided using the Internet.

(260) AM 2022 113463 A

(800) 1596053

(151) 2020 11 26

(891) 2020 11 26

(731) Viaservice B.V.

Radarweg 29, NL-1043 NX Amsterdam,
Netherlands

(540)

TRANSFOLLOW

(591) Black, white

(511)

9 – Computer network hardware; network management computer software; computer software; computer software in the field of transport, packaging, distribution, delivery and storage of goods; application software; application software in the field of transport, packaging, distribution, delivery and storage of goods; data communications apparatus; mobile data communications apparatus; telecommunication devices and apparatus; electronic apparatus and instruments for processing, recording, storing, transmitting, receiving and printing of data; global positioning systems; electronic navigational and positioning apparatus and instruments; computer terminals for use with navigation systems, route planners and/or digital maps; electronic publications (downloadable).

35 – Business administration; office functions; provision of commercial information; searching, compilation and analysis of data and information into computer databases; database management services; compilation of data files, including the creation and management of data files for websites; consultancy on the aforesaid services, including the aforesaid services provided via the Internet.

36 – Insurance services; financial affairs; financial management; financial services; financial risk management; warranty insurance services; provision of financial guarantees; transport insurance brokerage; insurance services relating to goods in transit; commodity trading [financial services]; trading of financial instruments and commodities; providing information relating to the trading of commodity futures.

38 – Digital transmission of data; digital network telecommunications services; transmission of digital files; wireless transfer of data via digital mobile telephony; information transmission services via digital networks; automatic transfer of digital data using telecommunications channels; online document delivery via a global computer network; telecommunications.

39 – Transport, packaging and storage of merchandise; organization of transport services; road transport services; transportation logistics; advisory services relating to the distribution and delivery of goods; inspection of goods prior to transport; transportation information; planning and booking of travel and transport via electronic means; supply chain logistics and reverse logistics services comprising storage,

transport and delivery of goods for third parties by plane, railway, ship or truck; advisory services relating to the storage and transportation of goods, freight or cargo; freight forwarding services; providing online information in the field of transport, packaging and storage of goods; collection, transport and delivery of goods; information and advice regarding or in connection with all the aforesaid services.

42 – Consultancy services relating to selection, implementation and use of the computer hardware and software in the field of transport, packaging, distribution, delivery and storage of goods; computer programming; design and development of telecommunications networks; technical design and planning of mobile data communication networks; design, development and implementation of software, and consultancy relating thereto; consultancy services relating to selection, implementation and use of the computer hardware and software relating to mobile and satellite technology; management of computer projects and computer networks, not including maintenance and repair of computer hardware; providing software on a global computer network, in particular software for remotely locating ships, lorries and other vehicles; consultancy services relating to selection, implementation and use of the computer hardware and software relating to the use of the Internet and online services in the field of transport, packaging, distribution, delivery and storage of goods; planning, design, development and maintenance of online websites for third parties; hosting websites; electronic data storage; inspection of motor vehicles before transport [for roadworthiness].

(260) AM 2022 113464 A

(800) 1596071

(151) 2020 12 02

(891) 2020 12 02

(731) Alfred Kärcher SE & Co. KG

Alfred-Kärcher-Str. 28-40, 71364 Winnenden,
Germany

(540)

KÄRCHER

(591) Black, white

(511)

3 – Cleaning agents; cleaning agents and care products for carpets and wall-to-wall carpets; chemical products for the cleaning and care of motor vehicles; blasting abrasives for mechanical surface treatment, in particular mineral blasting abrasives and sandblasting abrasives; shining preparations [polish]; laundry detergents; soaps.

7 – Mechanical spraying, rinsing and cleaning apparatus, and installations consisting thereof, in particular high-pressure cleaning apparatus, steam cleaning and steam jet apparatus, particle jet apparatus, spray extraction apparatus, brushing machines, vacuum cleaners, floor cleaning machines; vacuuming and wiping

robots; floor polishing apparatus; carpet brushing vacuum cleaners; cleaning machines for hard surfaces; cleaning machines for hard floors; cleaning machines for textile covers; motorized sweepers; apparatus for cleaning the inside of containers; cleaning machines for glass surfaces; mechanical window cleaning apparatus; automatic window cleaning apparatus (electric); mechanically operated apparatus for cleaning motor vehicles; motor-powered tools for scraping off ice; cleaning machines for parts made of metal, plastic and/or glass; degreasing machines; cleaning robots; electric suction apparatus for industrial purposes; vehicle washing installations; mechanical apparatus for removing preservatives from vehicles; washing machines; dishwashers; hydraulic controls for machines; mechanical apparatus for producing dry-ice granulate; parts of the aforesaid goods, in particular brushes, hoses, hand-held spray guns, suction heads, spray nozzles, jet tubes, vacuum cleaner hoses, vacuum cleaner bags, vacuum cleaner filters; mechanical hose reels; motor-powered gardening implements; motor-powered forestry implements and machines; motor-powered agricultural implements and machines; weeding machines; motor-powered mowing implements and mowing machines; harvesting machines; power saws; chains for power saws; brush cutters (machines); scythes (machines); hedge trimmers (machines); lawn mowers (machines); automatic lawn mowers (electric); mowing robots; scarifiers (machines); horticultural machines; machines for cleaning streets; earth moving machines; shovels for earth moving machines; motor-powered spreading implements and spreading machines; accessories for motor-powered spreading implements and spreading machines (included in this class); snow blowers; snow ploughs; snow clearing machines; snow plough shovels; front loaders; shovels for front loaders; clearing machines; clearing blades; motor-powered soil cultivation implements and soil cultivation machines; working equipment mountable on vehicles for horticulture, agriculture, forestry and municipal purposes; working equipment drawn by vehicles for horticulture, agriculture, forestry and municipal purposes; pumps (included in this class), in particular water pumps, pumps for ponds, submersible pumps, garden pumps, house water pumps, high-pressure pumps, metering pumps; leaf suction pumps; leaf blowers; mechanical high-pressure water jet apparatus for cleaning, removing and treating surfaces and for cutting, drilling and deburring; high-pressure water tools, in particular high-pressure lances and high-pressure spray guns; water jet nozzles (parts of machines); nozzle supports (parts of machines); valves (parts of machines); injectors (parts of machines); filter apparatus (machines); pneumatic, hydraulic, electric or manually driven handling machines, positioning devices, feed mechanisms and robots for guiding high-pressure water tools; generators for power generation.

9 – Apparatus and instruments for conducting, switching, transforming, accumulating, regulating and controlling electricity; wireless transmitters and receivers; data storage media; mobile data communications apparatus; electric controls, including coin-operated; electric controllers; radio remote controls; time switches; electric connection cables; extension cords; batteries (electric); rechargeable electric batteries; chargers for electric batteries; electric irrigation control apparatus; readers for the contactless reading of markings, in particular bar code readers and RFID (Radio Frequency Identification) readers; measuring apparatus; dosimeters; data processing equipment and computers; computer software (stored); computer software (downloadable); application software; protective clothing for protecting from fire, radioactive radiation, biological contamination and chemical contamination; protective and safety equipment; protective helmets; protective glasses; protective masks; protective boots; respiratory masks; filters for respiratory masks; protective work clothing.

11 – Drying apparatus, in particular for motor vehicles; apparatus for cleaning the body, namely body showers; garden showers; cooling apparatus; heating apparatus; heating installations; steam generating apparatus; hot air generating apparatus; water heaters (apparatus); sprinkler systems for irrigation; water dispensing apparatus; dispensers for dispensing mineral waters, carbonated waters, table waters, fruit beverages, fruit juices and/or lemonades (other than vending machines); water distribution installations; drop nozzles for irrigation installations; irrigation apparatus for agricultural and horticultural use; water filters; filters for drinking water; air filters; blowers for ventilation purposes; air purifiers; air dryers; air humidifiers; thermal oil heaters; electric cooking appliances and cooking installations; mobile field kitchens, namely transportable electric, fuel-powered or gas-powered cooking appliances; field laundries, namely transportable electric, fuel-powered or gas-powered laundry dryers; drinking water and waste water treatment apparatus and installations consisting thereof.

35 – Wholesale and retail services, including wholesale and retail services via the internet and/or mail order catalogues for cleaning agents, detergents, soaps, household goods, electric goods, electronic goods, data carriers, domestic technology, communications technology, cleaning technology, washing installations, material treatment and surface treatment technology, horticultural, agricultural, forestry and municipal apparatus, mechanical and hand-operated gardening implements, water treatment technology, cooling, heating and cooking technology; organizational and business management consultancy for companies, in particular with regard to optimizing processes; compiling data in computer databases; statistical evaluation of data; systematization of data in compu-

ter databases; recording and updating of data in computer databases for business purposes and for organization and optimization of the use of cleaning machines and cleaning apparatus for building, path and street cleaning; business management evaluation of data.

37 – Building construction; domestic maintenance, repair and cleaning services (caretaker services); assembling of machine plant (installation work); maintenance, upkeep and servicing of buildings; street cleaning; car park cleaning; cleaning of articles made of metal, plastic and glass; interior and exterior cleaning of buildings; window cleaning; carpet and upholstery cleaning; facade cleaning; maintenance and repair of cleaning, water treatment, cooling, heating and cooking apparatus and installations and of mechanical high-pressure water jet apparatus, high-pressure water tools, handling machines, positioning devices, feed mechanisms and robots for guiding high-pressure water tools; maintenance and repair of horticultural, agricultural, forestry and municipal apparatus; cleaning, servicing and maintenance of motor vehicles; servicing and cleaning of motor vehicles by provision of motor vehicle cleaning installations and motor vehicle servicing installations; servicing and cleaning of motor vehicles by making available self-service vehicle washing installations in return for payment; rental of machines and mechanical apparatus for cleaning, in particular high-pressure cleaning apparatus, steam cleaning and steam jet apparatus, particle jet apparatus, spray extraction apparatus, brushing machines, vacuum cleaners, floor cleaning machines, vacuuming and wiping robots, floor polishing apparatus, carpet brushing vacuum cleaners, cleaning machines for hard surfaces, cleaning machines for hard floors, cleaning machines for textile covers, motorized sweepers, apparatus for cleaning the inside of containers, cleaning machines for glass surfaces, mechanical window cleaning apparatus, automatic window cleaning apparatus (electric), mechanically operated apparatus for cleaning motor vehicles, motor-powered tools for scraping off ice, cleaning machines for parts made of metal, plastic and/or glass, degreasing machines, cleaning robots; rental of electric suction apparatus for industrial purposes; rental of vehicle washing installations; rental of laundry dryers; rental of steam generating apparatus and hot air generating apparatus for cleaning and washing purposes; rental of washing machines, dishwashers and laundry dryers; rental of earth moving machines, motor-powered spreading implements and spreading machines, snow blowers and snow ploughs, snow clearing machines; rental of clearing machines and clearing blades; rental of pumps for drainage purposes and for irrigation purposes and for supplying service water and drinking water, in particular water pumps, submersible pumps, house water pumps, high-pressure pumps; rental of mechanical high-pressure water jet apparatus for cleaning surfaces; rental of high-pressure water tools, in

particular high-pressure lances and high-pressure spray guns; rental of pneumatic, hydraulic, electric or manually driven handling machines, positioning devices, feed mechanisms and robots for guiding high-pressure water tools; consultancy services relating to cleaning, in particular building, path and street cleaning, and relating to organization and optimization of the use of cleaning machines and cleaning apparatus for building, path and street cleaning; leasing of machines and mechanical apparatus for cleaning, in particular high-pressure cleaning apparatus, steam cleaning and steam jet apparatus, particle jet apparatus, spray extraction apparatus, brushing machines, vacuum cleaners, floor cleaning machines, vacuuming and wiping robots, floor polishing apparatus, carpet brushing vacuum cleaners, cleaning machines for hard surfaces, cleaning machines for hard floors, cleaning machines for textile covers, motorized sweepers, apparatus for cleaning the inside of containers, cleaning machines for glass surfaces, mechanical window cleaning apparatus, automatic window cleaning apparatus (electric), mechanically operated apparatus for cleaning motor vehicles, motor-powered tools for scraping off ice, cleaning machines for parts made of metal, plastic and/or glass, degreasing machines, cleaning robots; leasing of electric suction apparatus for industrial purposes; leasing of vehicle washing installations; leasing of washing machines, dishwashers and laundry dryers; leasing of earth moving machines, motor-powered spreading implements and spreading machines, snow blowers and snow ploughs, snow clearing machines; leasing of clearing machines and clearing blades; leasing of pumps, in particular water pumps, pumps for ponds, submersible pumps, garden pumps, house water pumps, high-pressure pumps, metering pumps; leasing of leaf suction pumps and leaf blowers; leasing of mechanical high-pressure water jet apparatus for cleaning, removing and treating surfaces and for cutting, drilling and deburring; leasing of high-pressure water tools, in particular high-pressure lances and high-pressure spray guns; leasing of pneumatic, hydraulic, electric or manually driven handling machines, positioning devices, feed mechanisms and robots for guiding high-pressure water tools; rental of electric pumps for ponds; rental of leaf suction pumps and leaf blowers.

(260) AM 2022 113466 A

(800) 1596110

(151) 2021 02 05

(891) 2021 02 05

(731) Euro Games Technology Ltd.

4, "Maritsa" Str., "Vranya-Lozen-Triugulnika",
BG-1151 Sofia, Bulgaria

(540)



(591) Brown, orange, red, yellow, gold and black

(531) 07.15.05; 07.15.08; 27.05.02; 27.05.03;

27.05.09; 27.05.10; 29.01.15

(511)

9 – Software; computer gaming software; computer software packages; computer operating system software; computer software, recorded; software drivers; virtual reality software; games software; entertainment software for computer games; computer programs for network management; operating computer software for main frame computers; monitors (computer hardware); computer hardware; apparatus for recording images; monitors (computer programs); computer game programs; computer programs for recorded games; apparatus for recording, transmission or reproduction of sound or images; communications servers [computer hardware]; electronic components for gambling machines; computer application software featuring games and gaming; computer software for the administration of on-line games and gaming; computer hardware for games and gaming; electronic components and computer software for gambling, gambling machines, gambling games on the Internet and via telecommunication network.

28 – Gaming machines for gambling; chips for gambling; mah-jong; arcade games; gambling machines operating with coins, banknotes and cards; games; electronic games; parlor games; gaming chips; gaming tables; slot machines [gaming machines]; LCD game machines; slot machines and gaming devices; coin-operated amusement machines; roulette chips; poker chips; chips and dice [gaming equipment]; gaming equipment for casinos; roulette tables; gaming roulette wheels; casino games; gambling machines and amusement machines, automatic and coin-operated; coin-operated amusement machines and/or electronic coin-operated amusement machines with or without the possibility of gain; boxes for coin-operated machines, slot machines and gaming machines; electronic or electrotechnical amusement machines and apparatus, gaming machines, coin-operated entertainment machines; housings for coin-operated machines, gaming equipment, gaming machines, machines for gambling; electropneumatic and electrical gambling machines (slot machines).

41 – Gambling; entertainment services related to gambling; gaming services for entertainment purposes; casino, gaming and gambling services; training in the development of software systems; provision of equipment for gambling halls; providing casino equipment [gambling]; gaming machine entertainment services; providing casino facilities [gambling]; gaming hall services; amusement arcade services; games equipment rental; rental of gaming machines; providing amusement arcade services; rental of gaming machines with images of fruits; editing or recording of sounds and images; sound recording and video entertainment services; hire of sound reproducing apparatus;

provision of gaming equipment for casinos; providing of casino facilities; online gambling services; casino, gaming and gambling services; provision of gaming facilities, gaming hall facilities, Internet casinos and online gambling services.

(260) AM 2022 113468 A

(800) 1596177

(151) 2021 04 12

(891) 2021 04 12

(731) HOLIDAY DEPILATORI S.R.L.

Viale Etruria, 65, I-53047 SARTEANO (SI),
Italy

(540)



(591) Black, white

(531) 26.04.05; 26.04.18; 26.04.24; 27.05.01;

27.05.11

(511)

3 – Depilatory preparations; depilatory wax; depilatory preparations and substances; depilatory lotions; depilatory creams; wax strips for removing body hair; wax stripping preparations; cosmetic hair regrowth inhibiting preparations; cosmetic creams; moisturising skin creams [cosmetic]; exfoliant creams; cleansing creams [cosmetic]; face creams for cosmetic purposes; serums for cosmetic purposes; cosmetic scrubs for the face and body; cosmetic facial toners; cosmetic hand creams; cosmetics; body powder; body mask lotion; beauty masks; cosmetic facial masks; moisturizing milk; cosmetic skin care lotions; creams for cellulite reduction; moisturizing gels [cosmetic]; cosmetics for children; perfumes; perfume oils; essential oils; essential oils for cosmetic purposes; massage oils; bath oil; make-up removing preparations; shaving preparations; shaving lotion; shaving gel; shaving foam; shaving balms; pre-shave creams; shaving cream; after-shave lotions; shaving foam; nail varnish; nail varnish removers; moist wipes for sanitary and cosmetic purposes; make-up pads of cotton wool; cosmetics and make-up; perfumery; perfumes; eyelashes; false eyelashes; cosmetic preparations for eyelashes; eyelash dye; adhesives for affixing false eyelashes; adhesives for false eyelashes, hair and nails; deodorants for human beings; soap; cakes of toilet soap; hand cleansers and gel; cleaning agents for the hands; bath foam; hair lotions; shampoos; hair conditioners; tints for the hair; hair gel; hair spray; sachets for perfuming linen; household fragrances; dentifrices; bleaching preparations and other substances for laundry use; cleaning, polishing, scouring and abrasive preparations.

(260) AM 2022 113472 A
 (800) 836997
 (151) 2004 05 27
 (891) 2021 05 25
 (731) Orkla ASA
 Nedre Skøyen vei 26, N-0276 Oslo, Norway
 (540)

MÖLLER'S

(591) Black, white
 (511)
 5 – Pharmaceutical preparations, food supplements containing fish oils, mineral food supplements, food supplements, containing fatty acids and vitamins, cod-liver oil, liquid fish oil and fish oil vials, primrose oil, natural remedies and preparations, health food.

(260) AM 2022 113473 A
 (800) 891860
 (151) 2006 04 05
 (891) 2021 02 26
 (731) OZANTEKS TEKSTİL SANAYİ VE
 TİCARET ANONİM ŞİRKETİ
 BOZBURUN MAH. 7042, SOKAK NO:6,
 TR-20085 MERKEZEFENDİ DENİZLİ,
 Turkey
 (540)



(591) Orange, white
 (531) 26.01.02; 26.01.04; 26.01.20; 29.01.12
 (511)
 24 – Woven or non-woven fabric, fiberglass fabrics for textile use, fabrics impervious to gases, waterproof fabrics, fabric of imitation animal skins, all kinds of linings (textile), buckrams, filter materials of textile, curtains, tablecloths including oilcloth, bed sheets, bed linens, pillow covers, furniture coverings, coffee table covers, napkins, prayer rugs (lap robes), bed sheets of paper, washing mitts and soaping cloths, hand and face towels, bath towels, tapestry (wall hangings) of textile, handkerchiefs of textile, flags (not of paper), streamers of textile, labels (not of paper).

(260) AM 2022 113474 A
 (800) 908820
 (151) 2006 11 06
 (891) 2021 05 21
 (731) Depeche S.r.l.
 Via dell'Agricoltura, 47/49, I-41012 Carpi,
 Modena, Italy
 (540)

ANIYE BY

(591) Black, white
 (511)
 14 – Precious metals and their alloys and goods in precious metals or coated therewith, not included in other classes; jewellery, precious stones; horological and chronometric instruments.

18 – Leather and imitations of leather, and goods made of these materials and not included in other classes; animal skins, hides; trunks and travelling bags; umbrellas, parasols and walking sticks; whips, harness and saddlery.

25 – Clothing, footwear, headgear.

(260) AM 2022 113475 A
 (800) 983769
 (151) 2008 10 06
 (891) 2021 04 23
 (731) Schöffhofer Weizenbier GmbH
 Darmstädter Landstraße 185, 60598 Frankfurt
 am Main, Germany
 (540)

Schöffhofer

(591) Black, white
 (511)
 32 – Beer.

(260) AM 2022 113476 A
 (800) 1213746
 (151) 2014 05 20
 (891) 2021 05 20
 (731) Andersen Tax LLC
 1177 Avenue of the Americas, 18th Floor,
 New York NY 10036, USA
 (540)

ANDERSEN CONSULTING

(591) Black, white
 (511)
 35 – Tax preparation and services provided by consultants relating thereto; business management consultancy; services provided by consultants in the field of commercial strategy and in the field of business planning; services provided by consultants in connection with business processes; services provided by consultants in the field of mergers, acquisitions and sale of companies; market and competition analysis services; accounting; commercial activity appraisal services; business appraisals; services provided by consultants relating to accounting, tax preparation, trading and commercial business management; services provided by consultants relating to business risk management; business risk assessment services.

36 – Provision of financial advice relating to fiscal planning; financial consulting and advisory services; actuarial consultancy services; financial evaluation services; financial analysis; financial investment services; capital investment; financial risk management; consultants relating to financial instruments and derivatives; provision of information relating to finance and securities.

(260) AM 2022 113477 A

(800) 1369285

(151) 2017 03 06

(891) 2021 05 21

(731) True Westfjords ehf

Hafnargötu 76, IS-415 Bolungarvík, Iceland

(540)



dropi

(591) Black, white

(531) 01.15.15

(511)

5 – Pharmaceutical and veterinary preparations; sanitary preparations for medical purposes; dietetic substances adapted for medical use, food for babies; plasters, materials for dressing, material for stopping teeth, dental wax; disinfectants; preparations for destroying vermin; fungicides, herbicides.

29 – Meat, fish, poultry and game; meat extracts; preserved, frozen, dried and cooked fruits and vegetables; jellies, jams, compotes; eggs, milk and milk products; edible oils and fats.

(260) AM 2022 113478 A

(800) 1500373

(151) 2019 08 26

(891) 2021 05 05

(731) SULHAN MODA GİYİM SANAYİ VE
TİCARET ANONİM ŞİRKETİ

Merkez Mahallesi, Silahşör Caddesi, No:38

Kat:5, Bomonti Şişli, İstanbul, Turkey

(540)

E  QUISE

(591) Black and pink are the features of the mark

(531) 27.03.01; 27.03.11; 27.05.01; 29.01.12

(511)

25 – Clothing, including underwear and outer clothing, other than special purpose protective clothing; socks, mufflers [clothing], shawls, bandanas, scarves, belts [clothing]; footwear, shoes, slippers, sandals; headgear, hats, caps with visors, berets, caps [headwear], skull caps, blouses, bustiers, jackets [clothing], dresses, skirts, shirts, coats, pants.

35 – Advertising, marketing and public relations; organization of exhibitions and trade fairs for commercial or advertising purposes; design of advertising materials; provision of an online marketplace for buyers and sellers of goods and services; office functions; secretarial services; arranging newspaper subscriptions for others; compilation of statistics; rental of office machines; systemization of information into computer databases; telephone answering for unavailable subscribers; business management, business administration and business consultancy; accounting; commercial consultancy services; personnel recruitment, personnel placement, employment agencies, import-export agencies; temporary personnel placement services; auctioneering; the bringing together, for the benefit of others, of a variety of goods, namely, clothing, including underwear and outer clothing, other than special purpose protective clothing, socks, mufflers [clothing], shawls, bandanas, scarves, belts [clothing], footwear, shoes, slippers, sandals, headgear, hats, caps with visors, berets, caps [headwear], skull caps, blouses, bustiers, jackets [clothing], dresses, skirts, shirts, coats, pants, enabling customers to conveniently view and purchase those goods, such services may be provided by retail stores, wholesale outlets, by means of electronic media or through mail order catalogues.

(260) AM 2022 113537 A

(800) 1596714

(151) 2021 04 12

(891) 2021 04 12

(731) SOREMARTEC S A.

16, route de Trèves, L-2633 Senningerberg

(540)



(591) The color(s) White, Gray, Blue, Red, Brown, Beige/Khaki is/are claimed as a feature of the mark

(531) 05.07.06; 08.01.19; 08.01.21; 26.04.09;

26.04.16; 26.04.18; 26.04.24; 27.05.03;

27.05.11; 29.01.15

(511)
30 – Chocolate-coated bars.

(260) AM 2022 113539 A

(800) 1596875

(151) 2021 05 06

(891) 2021 05 06

(731) Obschestvo s ogranichennoy otvetstvennostiu
"WDS"

Kulakova street, 20, bldg. 1G, RU-123592
Moscow, Russian Federation

(540)

Argacol

(591) Black, white

(531) 27.05.01

(511)

5 – Pharmaceuticals, medical and veterinary preparations; sanitary preparations for medical purposes; dietetic food and substances adapted for medical or veterinary use, food for babies; dietary supplements for human beings and animals; plasters, materials for dressings; material for dental fillings and dental impressions; disinfectants; preparations for destroying noxious animals; fungicides, herbicides; acaricides; aconitine; alkaloids for medical purposes; alginates for pharmaceutical purposes; algicides; aldehydes for pharmaceutical purposes; dental amalgams of gold; dental amalgams; amino acids for veterinary purposes; amino acids for medical purposes; analgesics; anaesthetics; antibiotics; antiseptics; medicine cases, portable, filled; first-aid boxes, filled; aluminium acetate for pharmaceutical purposes; acetates for pharmaceutical purposes; germicides; oxygen cylinders, filled, for medical purposes; balms for medical purposes; bandages for dressings; diagnostic biomarker reagents for medical purposes; biocides; bracelets impregnated with insect repellent; bromine for pharmaceutical purposes; paper for mustard plasters; fly catching paper; reagent paper for veterinary purposes; reagent paper for medical purposes; mothproofing paper; petroleum jelly for medical purposes; vaccines; oxygen baths; antiseptic cotton; aseptic cotton; absorbent cotton; wadding for medical purposes; cotton for medical purposes; dietetic substances adapted for medical use; radiological contrast substances for medical purposes; nutritive substances for microorganisms; radioactive substances for medical purposes; bismuth subnitrate for pharmaceutical purposes; melissa water for pharmaceutical purposes; seawater for medicinal bathing; mineral waters for medical purposes; thermal water; dietary fibre; moulding wax for dentists; gases for medical purposes; guaiacol for pharmaceutical purposes; massage gels for medical purposes; sexual stimulant gels; haematogen; haemoglobin; hydrastine; hydrastinine; glycerine for medical purposes; glyce-

rophosphates; glucose for medical purposes; gentian for pharmaceutical purposes; hormones for medical purposes; mustard for pharmaceutical purposes; mustard plasters; mud for baths; medicinal mud; contraceptive sponges; gamboge for medical purposes; gurgun balsam for medical purposes; air deodorizing preparations; deodorants, other than for human beings or for animals; deodorants for clothing and textiles; diastase for medical purposes; digitalin; vitamin supplement patches; mineral food supplements; nutritional supplements; albumin dietary supplements; dietary supplements for animals; yeast dietary supplements; alginate dietary supplements; glucose dietary supplements; casein dietary supplements; lecithin dietary supplements; linseed oil dietary supplements; propolis dietary supplements; protein dietary supplements; protein supplements for animals; royal jelly dietary supplements; pollen dietary supplements; wheat germ dietary supplements; linseed dietary supplements; acai powder dietary supplements; dietary supplements with a cosmetic effect; enzyme dietary supplements; yeast for pharmaceutical purposes; gelatine for medical purposes; cod liver oil; isotopes for medical purposes; immunostimulants; insecticides; iodine for pharmaceutical purposes; iodides for pharmaceutical purposes; alkaline iodides for pharmaceutical purposes; iodoform; calomel [fungicide]; cream of tartar for pharmaceutical purposes; tartar for pharmaceutical purposes; camphor for medical purposes; capsules for medicines; cachets for pharmaceutical purposes; capsules made of dendrimer-based polymers, for pharmaceuticals; haemostatic pencils; wart pencils; caustic pencils; carbolineum [parasiticide]; caustics for pharmaceutical purposes; cachou for pharmaceutical purposes; quassia for medical purposes; quebracho for medical purposes; oxygen for medical purposes; gallic acid for pharmaceutical purposes; acids for pharmaceutical purposes; adhesives for dentures; surgical glues; stem cells for veterinary purposes; stem cells for medical purposes; cocaine; collagen for medical purposes; collodion for pharmaceutical purposes; corn rings for the feet; cannabis for medical purposes; medicated sweets; angostura bark for medical purposes; barks for pharmaceutical purposes; cedar wood for use as an insect repellent; condurango bark for medical purposes; croton bark; mangrove bark for pharmaceutical purposes; myrobalan bark for pharmaceutical purposes; quinquina for medical purposes; medicated animal feed; medicinal roots; rhubarb roots for pharmaceutical purposes; lint for medical purposes; starch for dietetic or pharmaceutical purposes; creosote for pharmaceutical purposes; blood for medical purposes; cultures of microorganisms for medical or veterinary use; curare; dental lacquer; liquorice for pharmaceutical purposes; milk sugar for pharmaceutical purposes; adhesive plasters; medicines for alleviating constipation; adhesive tapes for medical purposes; lecithin for medical purposes; lotions for veterinary purposes; medicated hair lotions; lotions for

pharmaceutical purposes; medicated after-shave lotions; personal sexual lubricants; lupulin for pharmaceutical purposes; magnesia for pharmaceutical purposes; liniments; ointments for pharmaceutical purposes; sunburn ointments; mercurial ointments; frost-bite salve for pharmaceutical purposes; gauze for dressings; medicinal oils; mustard oil for medical purposes; camphor oil for medical purposes; castor oil for medical purposes; oil of turpentine for pharmaceutical purposes; dill oil for medical purposes; dental mastics; dental abrasives; dental impression materials; teeth filling material; dressings, medical; surgical dressings; drugs for medical purposes; medicines for veterinary purposes; serotherapeutic medicines; medicines for human purposes; medicines for dental purposes; menthol; medicinal drinks; moleskin for medical purposes; almond milk for pharmaceutical purposes; powdered milk for babies; royal jelly for pharmaceutical purposes; milk ferments for pharmaceutical purposes; Irish moss for medical purposes; flour for pharmaceutical purposes; linseed meal for pharmaceutical purposes; fish meal for pharmaceutical purposes; fly glue; antibacterial soap; disinfectant soap; medicated soap; freeze-dried meat adapted for medical purposes; mint for pharmaceutical purposes; dietetic beverages adapted for medical purposes; malted milk beverages for medical purposes; injectable dermal fillers; bone void fillers comprised of living tissues; narcotics; medicinal infusions; tincture of iodine; eucalyptol for pharmaceutical purposes; tinctures for medical purposes; opium; opodeldoc; decoctions for pharmaceutical purposes; antiparasitic collars for animals; cotton sticks for medical purposes; stick liquorice for pharmaceutical purposes; sulfur sticks [disinfectants]; pastilles for pharmaceutical purposes; medicated toothpaste; pectin for pharmaceutical purposes; pepsins for pharmaceutical purposes; peptones for pharmaceutical purposes; hydrogen peroxide for medical purposes; pesticides; food for babies; leeches for medical purposes; blood plasma; nicotine patches for use as aids to stop smoking; eyepatches for medical purposes; poultices; compresses; scapulars for surgical purposes; babies' diapers; diapers for pets; swim diapers, reusable, for babies; swim diapers, disposable, for babies; diapers for incontinence; diaper changing mats, disposable, for babies; bunion pads; breast-nursing pads; pomades for medical purposes; powder of cantharides; pyrethrum powder; anti-uric preparations; bacterial preparations for medical and veterinary use; bacteriological preparations for medical and veterinary use; balsamic preparations for medical purposes; albuminous preparations for medical purposes; biological preparations for veterinary purposes; biological preparations for medical purposes; veterinary preparations; bismuth preparations for pharmaceutical purposes; vitamin preparations; diagnostic preparations for veterinary purposes; diagnostic preparations for medical purposes; douching preparations for medical purposes; bath preparations for medical purposes;

therapeutic preparations for the bath; haemorrhoid preparations; preparations for callouses; lice treatment preparations [pediculicides]; acne treatment preparations; preparations to facilitate teething; preparations for the treatment of burns; fumigation preparations for medical purposes; opotherapy preparations; air purifying preparations; bronchodilating preparations; preparations for reducing sexual activity; sterilizing preparations; soil-sterilizing preparations; corn remedies; pharmaceutical preparations for treating dandruff; herbicides; preparations for destroying dry rot fungus; larvae exterminating preparations; fly destroying preparations; preparations for destroying mice; slug exterminating preparations; vermin destroying preparations; pharmaceutical preparations for skin care; contact lens cleaning preparations; preparations of microorganisms for medical or veterinary use; lime-based pharmaceutical preparations; styptic preparations; medicated eye-washes; medicinal hair growth preparations; nutraceutical preparations for therapeutic or medical purposes; opiates; anticryptogamic preparations; aloe vera preparations for pharmaceutical purposes; preparations of trace elements for human and animal use; sulfonamides [medicines]; pharmaceutical preparations; pharmaceutical preparations for treating sunburn; enzyme preparations for veterinary purposes; enzyme preparations for medical purposes; phytotherapy preparations for medical purposes; chemico-pharmaceutical preparations; chemical preparations for veterinary purposes; chemical preparations for the diagnosis of pregnancy; chemical preparations for medical purposes; chemical preparations for treating diseases affecting cereal plants; chemical preparations for treating wheat blight; chemical preparations for treating diseases affecting vine plants; chemical preparations for treating mildew; chemical preparations for treating phylloxera; chemical preparations for pharmaceutical purposes; chilblain preparations; mothproofing preparations; collyrium; lead water; chemical conductors for electrocardiograph electrodes; albuminous foodstuffs for medical purposes; dietetic foods adapted for medical purposes; by-products of the processing of cereals for dietetic or medical purposes; homogenized food adapted for medical purposes; freeze-dried food adapted for medical purposes; pharmaceuticals; sanitary towels; panty liners [sanitary]; propolis for pharmaceutical purposes; pearl powder for medical purposes; radium for medical purposes; hydrated chloral for pharmaceutical purposes; solvents for removing adhesive plasters; vaginal washes for medical purposes; solutions for contact lenses; chemical reagents for medical or veterinary purposes; gum for medical purposes; rubber for dental purposes; chewing gum for medical purposes; nicotine gum for use as an aid to stop smoking; insect repellents; insect repellent incense; repellents for dogs; tissues impregnated with pharmaceutical lotions; sarsaparilla for medical purposes; sugar for medical purposes; crystallized rock sugar for medical

purposes; asthmatic tea; fumigating sticks; massage candles for therapeutic purposes; suppositories; linseed for pharmaceutical purposes; tobacco-free cigarettes for medical purposes; siccatives [drying agents] for medical purposes; syrups for pharmaceutical purposes; turpentine for pharmaceutical purposes; milking grease; greases for veterinary purposes; greases for medical purposes; lacteal flour for babies; infant formula; soporifics; bicarbonate of soda for pharmaceutical purposes; bath salts for medical purposes; salts for mineral water baths; salts for medical purposes; potassium salts for medical purposes; sodium salts for medical purposes; smelling salts; mineral water salts; malt for pharmaceutical purposes; semen for artificial insemination; alcohol for pharmaceutical purposes; medicinal alcohol; alloys of precious metals for dental purposes; ergot for pharmaceutical purposes; cooling sprays for medical purposes; antibacterial handwashes; adjuvants for medical purposes; astringents for medical purposes; vermifuges; disinfectants for hygiene purposes; disinfectants for chemical toilets; appetite suppressants for medical purposes; medical preparations for slimming purposes; parasiticides; mouthwashes for medical purposes; medicated dentifrices; febrifuges; depuratives; animal washes (insecticides); detergents for medical purposes; cattle washes [insecticides]; dog washes [insecticides]; insecticidal veterinary washes; vesicants; purgatives; remedies for perspiration; remedies for foot perspiration; chemical contraceptives; antiparasitic preparations; sedatives; laxatives; tonics [medicines]; medicated toiletry preparations; digestives for pharmaceutical purposes; nervines; bouillons for bacteriological cultures; steroids; headache relief sticks; strychnine; serums; tanning pills; appetite suppressant pills; slimming pills; jujube, medicated; antioxidant pills; cotton swabs for medical purposes; sanitary tampons; vulnerary sponges; thymol for pharmaceutical purposes; biological tissue cultures for veterinary purposes; biological tissue cultures for medical purposes; smoking herbs for medical purposes; medicinal herbs; transplants [living tissues]; surgical implants comprised of living tissues; pants, absorbent, for incontinence; sanitary panties; babies' diaper-pants; charcoal for pharmaceutical purposes; fennel for medical purposes; porcelain for dental prostheses; phenol for pharmaceutical purposes; enzymes for veterinary purposes; enzymes for medical purposes; ferments for pharmaceutical purposes; formic aldehyde for pharmaceutical purposes; phosphates for pharmaceutical purposes; fungicides; quinine for medical purposes; chinoline for medical purposes; diabetic bread adapted for medical use; chloroform; flowers of sulfur for pharmaceutical purposes; cement for animal hooves; bone cement for surgical and orthopaedic purposes; dental cements; medicinal tea; herbal teas for medicinal purposes; insecticidal animal shampoos; medicated shampoos; medicated shampoos for pets; pediculicidal shampoos; medicated dry shampoos; pre-filled

syringes for medical purposes; eucalyptus for pharmaceutical purposes; herbal extracts for medical purposes; plant extracts for pharmaceutical purposes; tobacco extracts [insecticides]; extracts of hops for pharmaceutical purposes; elixirs [pharmaceutical preparations]; ethers for pharmaceutical purposes; esters for pharmaceutical purposes; cellulose esters for pharmaceutical purposes; cellulose ethers for pharmaceutical purposes; rat poison; poisons; bacterial poisons; jalap.

(260) AM 2022 113540 A

(800) 1596876

(151) 2021 02 19

(891) 2021 02 19

(731) Open-Type Joint Stock Company "ROT FRONT"

2-oy Novokuznetskiy pereulok, d. 13/15,
RU-115184 Moscow, Russian Federation

(540)



(591) Green, dark green, white, red, black, yellow

(531) 05.03.13; 05.03.20; 05.07.09; 19.03.24;

25.03.07; 25.07.25; 26.11.06; 26.11.07; 28.05

(526) ®

(511)

30 – Confectionery.

(260) AM 2022 113543 A

(800) 1596915

(151) 2021 02 05

(891) 2021 02 05

(731) Euro Games Technology Ltd.

4, "Maritsa" Str., "Vranya-Lozen-Triugulnika",
BG-1151 Sofia, Bulgaria

(540)



(591) Yellow, gold, purple, black, pink, light blue and dark blue

(531) 05.01.12; 27.05.03; 27.05.10; 29.01.15

(511)

9 – Software; computer gaming software; computer software packages; computer operating system software; computer software, recorded; software drivers; virtual reality software; games software; entertain-

ment software for computer games; computer programs for network management; operating computer software for main frame computers; monitors (computer hardware); computer hardware; apparatus for recording images; monitors (computer programs); computer game programs; computer programs for recorded games; apparatus for recording, transmission or reproduction of sound or images; communications servers [computer hardware]; electronic components for gambling machines; computer application software featuring games and gaming; computer software for the administration of on-line games and gaming; computer hardware for games and gaming; electronic components and computer software for gambling, gambling machines, gambling games on the Internet and via telecommunication network.

28 – Gaming machines for gambling; chips for gambling; mah-jong; arcade games; gambling machines operating with coins, banknotes and cards; games; electronic games; parlor games; gaming chips; gaming tables; slot machines [gaming machines]; LCD game machines; slot machines and gaming devices; coin-operated amusement machines; roulette chips; poker chips; chips and dice [gaming equipment]; gaming equipment for casinos; roulette tables; gaming roulette wheels; casino games; gambling machines and amusement machines, automatic and coin-operated; coin-operated amusement machines and/or electronic coin-operated amusement machines with or without the possibility of gain; boxes for coin-operated machines, slot machines and gaming machines; electronic or electrotechnical amusement machines and apparatus, gaming machines, coin-operated entertainment machines; housings for coin-operated machines, gaming equipment, gaming machines, machines for gambling; electropneumatic and electrical gambling machines (slot machines).

41 – Gambling; entertainment services related to gambling; gaming services for entertainment purposes; casino, gaming and gambling services; training in the development of software systems; provision of equipment for gambling halls; providing casino equipment [gambling]; gaming machine entertainment services; providing casino facilities [gambling]; gaming hall services; amusement arcade services; games equipment rental; rental of gaming machines; providing amusement arcade services; rental of gaming machines with images of fruits; editing or recording of sounds and images; sound recording and video entertainment services; hire of sound reproducing apparatus; provision of gaming equipment for casinos; providing of casino facilities; online gambling services; casino, gaming and gambling services; provision of gaming facilities, gaming hall facilities, Internet casinos and online gambling services.

(260) AM 2022 113544 A
(800) 1596923
(151) 2021 02 19
(891) 2021 02 19
(731) Open-Type Joint Stock Company "ROT FRONT"
2-oy Novokuznetskiy pereulok, d. 13/15,
RU-115184 Moscow, Russian Federation
(540)



(591) Purple, green, white, yellow, blue, red
(531) 05.03.13; 05.05.20; 05.07.14; 19.03.24;
25.01.19; 25.03.07; 25.07.25; 26.11.06;
26.11.07; 28.05; 29.01.15
(526) ®
(511)
30 – Confectionery.

(260) AM 2022 113545 A
(800) 1596967
(151) 2020 12 04
(891) 2020 12 04
(731) PENOPLEX SPb LTD
Saperniy lane 1, lit. A, RU-191014
St. Petersburg, Russian Federation
(540)

ПЕНОПЛЭКС ФУНДАМЕНТ

(591) Black, white
(531) 28.05
(511)
17 – Asbestos; balata; insulating paper; asbestos felt; plastic fibers, other than for textile use; asbestos fibers; vulcanized fiber; gutta-percha; lute; asbestos millboards; liquid rubber; synthetic rubber; rubber, raw or semi-worked; insulating paints; insulating varnish; latex [rubber]; insulating tapes; adhesive bands, other than stationery and not for medical or household purposes; asbestos sheets; viscose sheets, other than for wrapping; sheets of regenerated cellulose, other than for wrapping; reinforcing materials, not of metal, for pipes; caulking materials; soundproofing materials; insulating materials; insulating refractory materials; non-conducting materials for retaining heat; asbestos packing; plastic substances, semi-processed; insulating plaster; plastic film, other than for wrapping; asbestos coverings; rubber solutions; synthetic

resins, semi-processed; substances for insulating buildings against moisture; chemical compositions for repairing leaks; glass wool for insulation; fiberglass for insulation; asbestos fabrics; insulating fabrics; waterproof packings; foils of metal for insulating; asbestos slate; slag wool [insulator]; ebonite.

19 – Asphalt; bitumen; building paper; binding agents for making briquettes; binding material for road repair; geotextiles, including geotextiles for use in connection with road construction, railroad construction, tunnel construction, waterway construction and public works construction; bitumen paper for building; wood pulp board for building; paperboard for building; roofing, not of metal; xylolith; reinforcing materials, not of metal, for building; bituminous products for building; tar; pitch; duckboards, not of metal; wall tiles, not of metal; floor tiles, not of metal; tiles, not of metal, for building; paving blocks, not of metal; bituminous coatings for roofing; roof coverings, not of metal; linings, not of metal, for building; mortar for building; roofing tiles, not of metal; slate; slag [building material]; flashing, not of metal, for building.

(260) AM 2022 113546 A

(800) 1596968

(151) 2021 01 19

(891) 2021 01 19

(731) Zakrytoe aktsionernoe obshchestvo "Myasnaya galereya"
ul. Poliny Osipenko, 65, of. 10, RU-600009
Vladimir, Russian Federation

(540)

ГОТОВУШКИ

(591) Black, white

(531) 28.05

(511)

29 – Agar-agar for culinary purposes; aloe vera prepared for human consumption; alginates for culinary purposes; andouillettes; anchovy, not live; peanuts, prepared; artichokes, preserved; albumen for culinary purposes; white of eggs; beans, preserved; soya beans, preserved, for food; broth; ginger jam; ham; fatty substances for the manufacture of edible fats; liver, preserved; edible birds' nests; sea-cucumbers, not live; cabbage rolls stuffed with meat; peas, preserved; mushrooms, preserved; guacamole; game, not live; gelatine; meat jellies; jellies for food; fruit jellies; yolk of eggs; coconut fat; bone oil for food; lard; suet for food; edible fats; curd; fruit-based snack food; milk substitutes; soya patties; tofu patties; charcuterie; raisins; caviar; eggplant paste; vegetable marrow paste; fish roe, prepared; ginger, preserved; crystallized ginger; pickled ginger; yogurt; sauerkraut; cassoulet; quark; kefir; kimchi; isinglass for food; clams, not live; potato-based dumplings; klipfish [salted and dried cod]; milk shakes; black pudding; onion rings; arrange-

ments of processed fruit; compotes; meat, canned; vegetables, canned; fish, canned; fruits, canned; duck confits; broth concentrates; vegetable-based concentrate for cooking; fruit-based concentrate for cooking; corn dogs; gherkins; shrimps, not live; prawns, not live; buttercream; croquettes; silkworm chrysalis for human consumption; sweet corn, processed; kumys; spiny lobsters, not live; lecithin for culinary purposes; edible ant larvae, prepared; salmon, not live; onions, preserved; margarine; marmalade; oils for food; peanut butter; cocoa butter for food; coconut oil for food; coconut butter; corn oil for food; sesame oil for food; linseed oil for food; extra virgin olive oil for food; olive oil for food; palm oil for food; palm kernel oil for food; sunflower oil for food; rape oil for food; butter; soya bean oil for food; mussels, not live; almonds, ground; animal marrow for food; mollusks, not live; milk; peanut milk; peanut milk for culinary purposes; coconut milk; coconut milk for culinary purposes; almond milk; almond milk for culinary purposes; oat milk; rice milk; rice milk for culinary purposes; protein milk; condensed milk; soured milk; soya milk; powdered milk; fermented baked milk; fish meal for human consumption; vegetable mousses; fish mousses; fruit pulp; meat; meat, preserved; freeze-dried meat; lactic acid drinks; milk beverages, milk predominating; peanut milk-based beverages; coconut milk-based beverages; almond milk-based beverages; edible insects, not live; sausage casings, natural or artificial; vegetables, preserved; freeze-dried vegetables; vegetables, processed; vegetables, dried; vegetables, cooked; hash browns; potato fritters; olives, preserved; lobsters, not live; omelets; flavored nuts; candied nuts; coconut, desiccated; nuts, prepared; tomato paste; pressed fruit paste; liver pâté; pectin for culinary purposes; preserved peppers; liver; pickles; jams; powdered eggs; milk products; fish-based foodstuffs; poultry, not live; white pudding; bulgogi; pollen prepared as foodstuff; cranberry compote; tomato purée; apple purée; crayfish, not live; crustaceans, not live; shellfish, not live; ratatouille; fish, preserved; fish, not live; salted fish; vegetable salads; fruit salads; bacon; sardines, not live; satay; pork; herrings, not live; seeds, prepared; sunflower seeds, prepared; cream [dairy products]; whipped cream; vegetable-based cream; fat-containing mixtures for bread slices; smetana; lemon juice for culinary purposes; tomato juice for cooking; vegetable juices for cooking; salted meats; sausages; sausages in batter; hot dog sausages; preparations for making bouillon; preparations for making soup; tofu skin; vegetable-based spreads; nut-based spreads; tripe; soups; vegetable soup preparations; whey; cottage cheese fritters; cheese; tagine [prepared meat, fish or vegetable dish]; tahini; cottage cheese; tofu; tempeh; truffles, preserved; tuna, not live; oysters, not live; falafel; milk ferments for culinary purposes; rennet; fish fillets; dates; frosted fruits; frozen fruits; fruit, preserved; fruit, processed; fruit preserved in alcohol; fruit, stewed; hazelnuts, prepared; potato

flakes; hummus; edible flowers, dried; fruit peel; preserved garlic; lentils, preserved; potato chips; low-fat potato chips; fruit chips; choucroute garnie; non-alcoholic eggnog; seaweed extracts for food; meat extracts; berries, preserved; eggs; snail eggs for consumption; yakitori.

30 – Vanilla flavorings for culinary purposes; flavorings, other than essential oils, for cakes; flavorings, other than essential oils, for beverages; coffee flavorings; food flavorings, other than essential oils; star aniseed; baozi; cereal bars; high-protein cereal bars; pancakes; savory pancakes; noodle-based prepared meals; freeze-dried dishes with the main ingredient being pasta; freeze-dried dishes with the main ingredient being rice; buns; bulgur; bread rolls; chocolatinés; edible paper wafers; edible rice paper; edible paper; burritos; vanillin [vanilla substitute]; waffles; vermicelli; natural sweeteners; sausage binding materials; binding agents for ice cream; orange blossom water for culinary purposes; sea water for cooking; seaweed [condiment]; malt biscuits; cloves [spice]; mirror icing [mirror glaze]; cake frosting [icing]; glucose for culinary purposes; mustard; croutons; buckwheat, processed; gluten additives for culinary purposes; yeast; thickening agents for cooking foodstuffs; leaven; rice-based snack food; cereal-based snack food; artificial coffee; vegetal preparations for use as coffee substitutes; dressings for salad; fruit jellies [confectionery]; candy decorations for cakes; confectionery for decorating Christmas trees; cakes; pastries; peanut confectionery; almond confectionery; fruit confectionery; pasta; ground ginger; frozen yogurt [confectionery ices]; cocoa; cream of tartar for culinary purposes; capers; coffee capsules, filled; caramels [sweets]; curry [spice]; ketchup [sauce]; quinoa, processed; quiches; gluten prepared as foodstuff; flour-based dumplings; sweets; liquorice [confectionery]; peppermint sweets; dulce de leche; cinnamon [spice]; coffee; unroasted coffee; starch for food; crackers; rice crackers; custard; crème brûlée; croissants; hominy grits; semolina; oatmeal; crushed barley; groats for human food; ice cubes; corn, milled; corn, roasted; meat pies; turmeric; couscous; laksa; noodles; soba noodles; udon noodles; ice for refreshment; ice, natural or artificial; edible ices; ice pops; potato-based flatbreads; rice cakes; mayonnaise; macarons; macaroni; maltose; hominy; piccalilli; marinades; marzipan; honey; miso; royal jelly; ice cream; bean meal; buckwheat flour; tapioca flour; potato flour; corn flour; nut flours; flour; wheat flour; soya flour; barley meal; dessert mousses [confectionery]; chocolate mousses; muesli; mint for confectionery; cocoa beverages with milk; coffee beverages with milk; coffee-based beverages; cocoa-based beverages; chamomile-based beverages; tea-based beverages; chocolate beverages with milk; chocolate-based beverages; infusions, not medicinal; nougat; crushed oats; husked oats; kimchi pancakes; onigiri; nutmegs; chocolate-coated nuts; stick liquorice [confectionery]; ginger paste (seasoning); pastilles [con-

fectionery]; molasses for food; pâtés en croûte; pelmeni; pepper; allspice; peppers [seasonings]; pesto; cookies; coconut macarons; petit-beurre biscuits; bibimbap [rice mixed with vegetables and beef]; pies; pizzas; meat gravies; fondants [confectionery]; popcorn; powders for making ice cream; baking powder; mustard meal; pralines; aromatic preparations for food; condiments; meat tenderizers for household purposes; cereal preparations; oat-based food; bee glue; profiteroles; gingerbread; spices; petits fours [cakes]; rice pudding; puddings; cake powder; fruit coulis [sauces]; ravioli; ramen; chewing gum; chewing gum for breath freshening; relish [condiment]; rice; prepared rice rolled in seaweed; instant rice; wheat germ for human consumption; spring rolls; sago; sugar; crystallized rock sugar; palm sugar; sesame seeds [seasonings]; linseed for culinary purposes [seasoning]; processed seeds for use as a seasoning; aniseed; agave syrup [natural sweetener]; golden syrup; confectionery; savory pancake mixes; batter mixes; baking soda [bicarbonate of soda for cooking purposes]; malt for human consumption; salt for preserving foodstuffs; cooking salt; celery salt; sherbets [ices]; ham glaze; cranberry sauce [condiment]; soya sauce; tomato sauce; apple sauce [condiment]; sauces [condiments]; pasta sauce; spaghetti; seasonings; chocolate-based spreads; chocolate spreads containing nuts; preparations for stiffening whipped cream; shaved ice with sweetened red beans; rusks; breadcrumbs; sushi; sandwiches; tabbouleh; tacos; tamarind [condiment]; tapioca; tarts; dough; pastry dough; almond paste; rice pulp for culinary purposes; cake dough; tortillas; garden herbs, preserved [seasonings]; chocolate decorations for cakes; vinegar; beer vinegar; ferments for pastes; halvah; harissa [condiment]; bread; gluten-free bread; unleavened bread; chips [cereal products]; corn flakes; oat flakes; hot dog sandwiches; flowers or leaves for use as tea substitutes; jiaozi; chicory [coffee substitute]; tea; kelp tea; iced tea; chutneys [condiments]; minced garlic [condiment]; cheeseburgers [sandwiches]; chow-chow [condiment]; saffron [seasoning]; chocolate; malt extract for food; essences for foodstuffs, except etheric essences and essential oils; husked barley.

35 – Arranging subscriptions to telecommunication services for others; import-export agency services; commercial information agency services; publicity agency services; cost price analysis; rental of office equipment in co-working facilities; rental of advertising space; business auditing; financial auditing; business intermediary services relating to the matching of potential private investors with entrepreneurs needing funding; employment agency services; computerized file management; accounting; invoicing; demonstration of goods; transcription of communications [office functions]; opinion polling; market studies; business investigations; business research; marketing research; personnel recruitment; business management and organization consultancy; business organization consul-

tancy; business management consultancy; personnel management consultancy; professional business consultancy; consultancy regarding advertising communication strategies; consultancy regarding public relations communication strategies; layout services for advertising purposes; marketing; marketing in the framework of software publishing; targeted marketing; business management of performing artists; business management of sports people; writing of résumés for others; scriptwriting for advertising purposes; news clipping services; updating and maintenance of information in registries; updating and maintenance of data in computer databases; updating of advertising material; word processing; online retail services for downloadable and pre-recorded music and movies; online retail services for downloadable ring tones; online retail services for downloadable digital music; organization of exhibitions for commercial or advertising purposes; arranging newspaper subscriptions for others; organization of fashion shows for promotional purposes; organization of trade fairs; shop window dressing; business appraisals; payroll preparation; data search in computer files for others; sponsorship search; administrative assistance in responding to calls for tenders; business management assistance; commercial or industrial management assistance; commercial intermediation services; providing business information; providing business information via a web site; providing commercial and business contact information; providing commercial information and advice for consumers in the choice of products and services; providing user reviews for commercial or advertising purposes; web indexing for commercial or advertising purposes; providing user rankings for commercial or advertising purposes; provision of an online marketplace for buyers and sellers of goods and services; presentation of goods on communication media, for retail purposes; media relations services; economic forecasting; auctioneering; wholesale services for pharmaceutical, veterinary and sanitary preparations and medical supplies; retail services for works of art provided by art galleries; retail services for pharmaceutical, veterinary and sanitary preparations and medical supplies; sales promotion for others; promotion of goods and services through sponsorship of sports events; production of teleshopping programs; production of advertising films; office machines and equipment rental; rental of advertising time on communication media; publicity material rental; rental of billboards [advertising boards]; rental of vending machines; rental of sales stands; rental of photocopying machines; consumer profiling for commercial or marketing purposes; publication of publicity texts; radio advertising; development of advertising concepts; bill-posting; distribution of samples; dissemination of advertising matter; direct mail advertising; registration of written communications and data; writing of publicity texts; advertising; online advertising on a computer network; outdoor advertising; adverti-

sing by mail order; television advertising; compilation of statistics; compilation of information into computer databases; business inquiries; systemization of information into computer databases; administrative services for medical referrals; advisory services for business management; corporate communications services; negotiation of business contracts for others; negotiation and conclusion of commercial transactions for third parties; compiling indexes of information for commercial or advertising purposes; tax preparation; drawing up of statements of accounts; telemarketing services; psychological testing for the selection of personnel; interim business management; outsourced administrative management for companies; business management of hotels; business management for freelance service providers; business project management services for construction projects; commercial administration of the licensing of the goods and services of others; business management of reimbursement programs for others; administration of consumer loyalty programs; administration of frequent flyer programs; administrative processing of purchase orders; administrative services for the relocation of businesses; public relations; commercial lobbying services; competitive intelligence services; modelling for advertising or sales promotion; typing; market intelligence services; appointment reminder services [office functions]; web site traffic optimization; tax filing services; search engine optimization for sales promotion; appointment scheduling services [office functions]; retail services relating to bakery products; gift registry services; price comparison services; pay per click advertising; secretarial services; procurement services for others [purchasing goods and services for other businesses]; shorthand; outsourcing services [business assistance]; telephone answering for unavailable subscribers; telephone switchboard services; photocopying services; business efficiency expert services.

43 – Accommodation bureau services [hotels, boarding houses]; rental of temporary accommodation; rental of meeting rooms; tourist home services; hotel reservations; boarding house bookings; temporary accommodation reservations; hotel services; retirement home services; snack-bar services; information and advice in relation to the preparation of meals; café services; cafeteria services; motel services; boarding house services; boarding for animals; rental of cooking apparatus; rental of chairs, tables, table linen, glassware; rental of lighting apparatus; rental of tents; rental of transportable buildings; rental of drinking water dispensers; restaurant services; self-service restaurant services; reception services for temporary accommodation [management of arrivals and departures]; food sculpting; canteen services; decorating of food; cake decorating; holiday camp services [lodging]; bar services; hookah lounge services; providing campground facilities; personal chef services; food and drink catering; washoku restaurant services; udon

and soba restaurant services; day-nursery [crèche] services.

(260) AM 2022 113547 A
 (800) 1596982
 (151) 2021 02 05
 (891) 2021 02 05
 (731) Blaser Group GmbH
 Ziegelstadel 1, 88316 Isny, Germany
 (540)

HunTec

(591) Black, white
 (511)
 25 – Apparel, footwear, headgear.

(260) AM 2022 113548 A
 (800) 1597006
 (151) 2021 04 21
 (891) 2021 04 21
 (731) Celotech chemical Co., Ltd
 Room 101, Complex Building North, Second
 Floor, No. 48 Zoumatang Road, Mudu,
 Wuzhongqu, Suzhou, 215000 Jiangsu, China
 (540)

CELOFIBER

(591) Black, white
 (511)
 1 – Cellulose ethers for industrial purposes; starch for industrial purposes; cellulose; polyvinyl acetate emulsions; cellulose esters for industrial purposes; cellulose derivatives [chemicals]; glucosides; bonding agents for concrete; chemical additives to drilling muds; celluloid.

(260) AM 2022 113634 A
 (800) 1597881
 (151) 2020 12 17
 (891) 2020 12 17
 (731) Kia Corporation
 12, Heolleung-ro, Seocho-gu, Seoul 06797,
 Republic of Korea
 (540)



(591) Black, white
 (531) 27.05.01; 27.05.01; 27.05.19; 27.05.22
 (511)
 9 – Downloadable computer software for providing remote vehicle diagnosis, vehicle maintenance information, entertainment in the form of audio and visual displays in vehicles, third-party communication in vehicles, navigation function, and audio and visual dis-

play in vehicles; downloadable smart phone application (software); downloadable computer application software for vehicles; downloadable computer application software for mobile phones for use in the operation and management of vehicles; computer software; downloadable computer application software for use on smart phones for the provision of information relating to vehicle trip information history, parking location management, trip information, vehicle health management, driving information, and third-party promotional data in the form of advertising for drivers; computer application software for use on smart phones for a vehicle lease; computer application software for smart phones for use in rental car leasing and rental car maintenance; computer application software for use on smart phones for use in the management of vehicle rental and vehicle maintenance; smart phone application (software) for simple payments; computer software for simple payments; apparatus for processing electronic payments; smart phone application (software) allowing use of and simple payment for fueling, parking, tollgates, food and drink, and various other stores; computer e-commerce software; software for secure data storage and retrieval and transmission of customer information used by individuals, banking and financial institutions for electronic payment; computer software for facilitating payment transactions by electronic means over wireless networks, global computer networks and/or mobile telecommunications devices; computer hardware for facilitating payment transactions by electronic means over wireless networks, global computer networks and/or mobile telecommunications devices; application software for providing electronic payment agency service; encoded plastic cards; encoded cards for use in relation to the electronic transfer of financial transactions; electronic payment terminal operated by encoded cards, stored value cards, prepaid cards and smart cards; navigation apparatus for vehicles in the nature of on-board computers; computer application software for computers and mobile devices, namely, software for locating and sharing information regarding electric vehicle charging stations; computer software for use with route planners, electronic maps and digital dictionaries for navigation purposes; computer hardware for use with satellite and/or GPS navigation systems for navigation purposes; lidar sensor for detecting objects and motions for autonomous cars; lidar sensor for precision measuring devices for vehicles; fuel cells; rechargeable batteries; voice processing systems; remote controlling devices for in-vehicle simple payment; Audio Video Navigation for vehicles mounted with in-vehicle simple payment system; terminals for electronic transaction with built in cars; in-vehicle Audio Video Navigation software for simple payment; smartphone application (software) for in-vehicle simple payment; smartphone application (software) accessible to in-vehicle systems; computer program for simple payment

through in-vehicle Audio Video Navigation; smart phone application (software) that enables the drivers to make in-vehicle simple payment regarding refueling, parking, using toll gate and purchasing products at various stores as well as ordering purchase of foods and beverages in vehicle; computer software that enables the drivers to make in-vehicle simple payment regarding refueling, parking, using toll gate and purchasing products at various stores as well as ordering purchase of foods and beverages in vehicle; computer firmware for platform of in-vehicle simple payment; computer software for platform of in-vehicle simple payment; speech recognition apparatus; security terminal for in-vehicle electronic transactions; devices for in-vehicle e-payment process; DNA chips; optical glass; electric locks for vehicles; encoded key; apparatus and instruments for physics; optical apparatus and instruments except for glasses and photographic apparatus; car recognizing cameras; night vision infrared cameras with built-in airlines; video conferencing apparatus; mounting devices for cameras and monitors; home theater systems; audiovisual teaching apparatus; range sensor; sensors for determining position; apparatus for driving vehicles automatically; thermostats for vehicles; parking sensors for vehicles; sensors for engines; mileage recorders for vehicles; diagnostic apparatus for vehicles; automatic indicators of low pressure in vehicle tires; sensors for measuring speed; apparatus for testing vehicle brakes; apparatus for testing vehicle transmissions; On-Board Diagnosis apparatus for automobiles; electronic taximeters; protective eyeglasses; sunglasses; frames for spectacles and sunglasses; time recording equipment; calculating machines and data-processing equipment; coin-operated gates for car parks or parking lots; life saving apparatus and equipment; life jackets; collision alarms; warning apparatus for engine virtual sound of automobiles; alarms for tire pressure monitoring system; warning lamps for vehicles; lifeboats; satellites; fire engines; electrical controlling devices for engines; uninterruptible electrical power supplies; rectifiers for starting; electricity energy supply controller; apparatus and instruments for conveying, distributing, transforming, storing, regulating or controlling electric current; electric controller module for airline cockpit; electric control board for airline cockpit; apparatus for adjusting headlights; electric hybrid cables; voltage regulators for vehicles; solar modules; batteries for vehicles; electricity measuring apparatus and instruments; starter cables for motors; electric door bells; black boxes [data recorders]; video recording apparatus for vehicles; car cassette players; radio transceivers; smartwatches; ear phones; apparatus for recording, transmission or reproduction of sound, images and data; navigation apparatus for vehicles [on-board computers]; GPS navigation devices for cars; radar object detectors for vehicles; electric igniting apparatus for igniting at a distance for vehicles; headset; laboratory robots; computer software platforms; re-

corded computer software for safe car driving; computer components and parts; steering apparatus, automatic, for vehicles; automobile motor controlling circuit; magnets; video game cartridges and cassettes; signalling whistles; gloves for protection against accidents; protective helmets; safety goggles; protective clothing for the prevention of injury; downloadable music files; computer digital maps; downloadable coupon; downloadable ticket; downloadable electronic maps.

(260) AM 2022 113635 A

(800) 1597899

(151) 2021 02 24

(891) 2021 02 24

(731) Euro Games Technology Ltd.

4, "Maritsa" Str., "Vranya-Lozen-Triugulnika",
BG-1151 Sofia, Bulgaria

(540)



(591) Yellow, gold, purple, black, pink, light blue,
brown and orange

(531) 17.02.02; 27.05.02; 27.05.03; 29.01.15

(511)

9 – Software; computer gaming software; computer software packages; computer operating system software; computer software, recorded; software drivers; virtual reality software; games software; entertainment software for computer games; computer programs for network management; operating computer software for main frame computers; monitors (computer hardware); computer hardware; apparatus for recording images; monitors (computer programs); computer game programs; computer programs for recorded games; apparatus for recording, transmission or reproduction of sound or images; communications servers [computer hardware]; electronic components for gambling machines; computer application software featuring games and gaming; computer software for the administration of on-line games and gaming; computer hardware for games and gaming; electronic components and computer software for gambling, gambling machines, gambling games on the Internet and via telecommunication network.

28 – Gaming machines for gambling; chips for gambling; mah-jong; arcade games; gambling machines operating with coins, notes and cards; games; electronic games; parlor games; gaming chips; gaming tables; slot machines [gaming machines]; LCD game machines; slot machines and gaming devices; coin-operated amusement machines; roulette chips; poker chips; chips and dice [gaming equipment]; gaming equipment for casinos; roulette tables; gaming roulette wheels; casino games; gambling machines and amu-

sement machines, automatic and coin-operated; coin-operated amusement machines and/or electronic coin-operated amusement machines with or without the possibility of gain; boxes for coin-operated machines, slot machines and gaming machines; electronic or electrotechnical amusement machines and apparatus, gaming machines, coin-operated entertainment machines; housings for coin-operated machines, gaming equipment, gaming machines, machines for gambling; electropneumatic and electrical gambling machines (slot machines).

41 – Gambling; entertainment services related to gambling; gaming services for entertainment purposes; casino, gaming and gambling services; training in the development of software systems; provision of equipment for gambling halls; providing casino equipment [gambling]; gaming machine entertainment services; providing casino facilities [gambling]; gaming hall services; amusement arcade services; games equipment rental; rental of gaming machines; providing amusement arcade services; rental of gaming machines with images of fruits; editing or recording of sounds and images; sound recording and video entertainment services; hire of sound reproducing apparatus; provision of gaming equipment for casinos; providing of casino facilities; online gambling services; casino, gaming and gambling services; provision of gaming facilities, gaming hall facilities, Internet casinos and online gambling services.

(260) AM 2022 113637 A

(800) 1597945

(151) 2020 10 22

(891) 2020 10 22

(731) DSM GRUP DANISMANLIK ILETISIM VE SATIS TICARET A.S.

Maslak Mahalesi, Büyükdere Caddesi, (Spine Plaza) No. 243, İç Kapı No. 19 Sarıyer, ISTANBUL, Turkey

(540)

Trendyol Collection

(591) Black, white

(531) 27.05.01

(511)

25 – Clothing, footwear and headwear for human beings namely clothing; outer clothing; waterproof clothing; overalls; overcoats; parkas; pelerines; petticoats; ponchos; rash guards; coats; ready-made clothing; shirt fronts; shirts; shirt yokes; short-sleeve shirts; collars [clothing]; combinations [clothing]; suits; dresses; dressing gowns; dress shields; sweaters; aprons [clothing]; jackets [clothing]; clothing of imitations of leather; clothing of leather; liveries; maniples; mantillas; masquerade costumes; leggings [leg warmers]; leggings [trousers]; leotards; tee-shirts; tights; trousers; trouser straps; uniforms; vests; babies'

pants [underwear]; bibs, not of paper; bibs, layettes [clothing]; bathing caps; bathing suits; bathing trunks; bath robes; bath sandals; bath slippers; beach clothes; beach shoes; wet suits for water-skiing; cyclists' clothing; jackets [clothing]; jerseys [clothing]; judo uniforms; jumper dresses; karate uniforms; kimonos; knitwear [clothing]; fishing vests; furs [clothing]; fur stoles; clothing containing slimming substances; clothing for gymnastics; motorists' clothing; belts [clothing]; money belts [clothing]; headwear; berets; caps being headwear; hats; headbands [clothing]; headscarves; hoods [clothing]; visors being headwear; ear muffs [clothing]; cuffs; detachable collars; gloves [clothing]; mittens; muffs [clothing]; neck gaiters; neckties; paper hats [clothing]; shower caps; ready-made linings [parts of clothing]; saris; sarongs; sashes for wear; scarfs; shawls; veils [clothing]; togas; turbans; bandanas [neckerchiefs]; ascots; bodices [lingerie]; camisoles; corselets; corsets [underclothing]; garters; girdles; boxer shorts; braces for clothing [suspenders]; gaiters; pyjamas; panties; slippers [underclothing]; brassieres; underpants; underwear; sweat-absorbent underwear; hosiery; stockings; stocking suspenders; footwear; shoes; footwear uppers; boots; boots for sports; boot uppers; sandals; football boots; foot muffs, not electrically heated; gymnastic shoes; half-boots; heelpieces for footwear; heelpieces for stockings; heel protectors for shoes; slippers; heels; inner soles; galoshes; breeches for wear; non-slipping devices for footwear; ski boots; ski gloves; skirts; shorts; skull caps; sleep masks; socks; sock suspenders; soles for footwear; sports jerseys; sports shoes; sports singlets.

35 – Administration of consumer loyalty programs; administrative processing of purchase orders; advertising; advertising agency services; advertising by mail order; business appraisals; business auditing; business efficiency expert services; business inquiries; business management and organization consultancy; business management assistance; business management consultancy; business research; commercial administration of the licensing of the goods and services of others; commercial information agency services; commercial intermediation services; commercial lobbying services; commercial or industrial management assistance; compilation of information into computer databases; consumer profiling for commercial or marketing purposes; cost price analysis; data search in computer files for others; demonstration of goods; development of advertising concepts; direct mail advertising; dissemination of advertising matter; gift registry services; marketing; marketing research; market intelligence services; market studies; modelling for advertising or sales promotion; online advertising on a computer network; organization of exhibitions for commercial or advertising purposes; organization of fashion shows for promotional purposes; organization of trade fairs; procurement services for others [purchasing goods and services for other businesses];

rental of advertising space; rental of sales stands; sales promotion for others; search engine optimization for sales promotion; telemarketing services; provision of an online marketplace for buyers and sellers of goods and services; presentation of goods on communication media, for retail purposes; the bringing together, for the benefit of others, of a variety of goods namely dyes, paints, varnishes, cosmetics and toiletry preparations, dentifrices, perfumery, essential oils, bleaching preparations and other substances for laundry use, cleaning, polishing, scouring and abrasive preparations, candles, sanitary preparations for personal hygiene, diapers for babies and incontinence, deodorants other than for human beings, medicated shampoos, lotions and dentifrices, dietary supplements, dietetic food and beverages, hand tools and implements, hand-operated, cutlery, side arms, except firearms, razors, smart watches, wearable activity trackers, eye glasses, sun glasses, protective masks, medical masks, surgical masks, face masks, clothing for medical purposes, supportive bandages for medical purpose, precious metals and their alloys, jewellery, precious and semi-precious stones, horological and chronometric instruments, goods made of leather and imitation of leather, bags, suitcases, briefcases, beach bags, pet clothing, credit card holders and cases, garment bags for travelling, hand bags, parasols, sling bags for carrying infants, straps of leather, suitcases, tool bags, travelling bags, umbrellas, valises, walking sticks, vanity bags, clothing, footwear, headgear, textiles and substitutes for textiles, household linen, curtains of textile or plastic, household or kitchen utensils and containers, cookware and tableware, except forks, knives and spoons, combs and sponges, brushes, except paintbrushes, brush-making materials, articles for cleaning purposes, unworked or semi-worked glass, except building glass, glassware, porcelain and earthenware, lace, braid and embroidery, and haberdashery ribbons and bows, buttons, hooks and eyes, pins and needles, artificial flowers, hair decorations, false hair, (excluding the transport thereof), enabling customers to conveniently view and purchase those goods; such services may be provided by retail stores, wholesale outlets, through vending machines, mail order catalogues or by means of electronic media, for example, through web sites or television shopping programmes.

(260) AM 2022 113638 A
 (800) 1597984
 (151) 2021 04 09
 (891) 2021 04 09
 (731) BAXTER INTERNATIONAL INC.
 One Baxter Parkway, DEERFIELD,
 IL 60015, USA
 (540)

MYCLARIA

(591) Black, white

(511)
 9 – Downloadable software in the form of a mobile application for facilitating communication, namely, enabling patients and healthcare professionals to consult, share and collect information on the treatment of kidney diseases; downloadable software in the form of a mobile application for users to receive training on medical devices and therapy concerning the treatment of kidney diseases.

41 – Educational services, namely, provision of non-downloadable videos and interactive training services online in the field of healthcare and medical procedures for the treatment of kidney diseases via a website; educational services, namely, provision of interactive training services online on medical devices via a website; educational services, namely, provision of non-downloadable educational videos in the field of medical procedures and medical devices for the treatment of renal failure via a website.

(260) AM 2022 113640 A
 (800) 1598169
 (151) 2021 04 07
 (891) 2021 04 07
 (731) IQ Martrade Holding und
 Managementgesellschaft mbH Jägerhofstraße
 19-20, 40479 Düsseldorf, Germany
 (540)

Martrade

(591) Black, white
 (511)
 35 – Administrative services relating to customs clearance; commercial intermediary services for the operation of bulk ships and general cargo ships.

39 – Transportation of freight of all kinds in particular by sea, road, rail, inland water and air; heavy and special transports; freight-forwarding services of all kinds including arrangement of transportation and related services; port services for ships and boats; loading of ships; storage of goods and cargo of all kinds; consultancy for freight forwarding, logistic, storage and freight services by land air and water.

42 – Provision of technological consultancy and technological services for operating bulk ships and general cargo ships.

(260) AM 2022 113641 A
 (800) 1598178
 (151) 2021 02 18
 (891) 2021 02 18
 (731) VivaChek Biotech (Hangzhou) Co., Ltd.
 Level 2, Block 2, 146 East Chaofeng Road,
 Yuhang Economy Development Zone,
 Hangzhou, 310000 Zhejiang, China

(540)

 The logo for VivaGuard features the brand name in a bold, sans-serif font. A thick, black, curved line arches over the letters 'V' and 'a', starting from the left and ending above the 'd'.

(591) Black, white

(531) 26.11.01; 26.11.12; 27.05.01; 27.05.12

(511)

5 – Adhesive tapes for medical purposes; chemical preparations for medical purposes; biological preparations for medical purposes; chemical preparations for veterinary purposes; diagnostic preparations for medical purposes; chemical preparations for the diagnosis of pregnancy.

10 – Glucose meters; diagnostic apparatus for medical purposes; blood testing apparatus; testing apparatus for medical purposes.

44 – Nursing, medical; rest home services; dietary and nutritional guidance; rental of sanitary installations; medical clinic services; medical assistance; telemedicine services; nutritional therapy services; health care services, namely, providing health care treatment and information all for treatment and diagnostic purposes; services of a psychologist.

(260) AM 2022 113642 A

(800) 1598179

(151) 2021 02 10

(891) 2021 02 10

(731) GROUPE GO SPORT

17 Avenue de la Falaise, F-38360

SASSENAGE, France

(540)

 The logo for Endurance Shop features a stylized green and black circular emblem at the top containing three upward-pointing arrows. Below this emblem, the words "ENDURANCE" and "SHOP" are written in a bold, blocky, sans-serif font, with "ENDURANCE" on the top line and "SHOP" on the bottom line.

(591) Green-pantone 375 EC

(531) 17.05.17; 24.15.03; 26.01.07; 26.01.16;

26.01.19; 26.01.24; 27.05.02; 27.05.24;

29.01.13

(511)

35 – Retail services and presentation on all means of communication chronometers, pedometers, heart-rate measuring units, energy drinks and foods for sport, watches, photographic cameras, video cameras, global positioning system browsers, directional compasses, altimeters, binoculars, meteorological terminals, books, geographical maps, tents for camping, sleeping bags, sun block preparations, sports bags, rucksacks, bags for campers, clothing, sports clothing, footwear, headgear, underclothing and underwear, gymnastic and sporting articles, orthopedic articles, soles for fo-

otwear, spectacles, sleeves, walking sticks, wellness products for the care and beauty of the body and feet, braces, electric pocket torches, safety lamps, public lighting, headlamps, solar lamps, ear phones, computerized apparatuses for the stimulation of muscles and appliances for gymnastics, body rehabilitation apparatuses; the bringing together, for the benefit of others (excluding the transport thereof), of a variety of goods namely: chronometers, pedometers, heart-rate measuring units, energy drinks and foods for sport, watches, photographic cameras, video cameras, global positioning system browsers, directional compasses, altimeters, binoculars, meteorological terminals, books, geographical maps, tents for camping, sleeping bags, sun block preparations, sports bags, rucksacks, bags for campers, clothing, sports clothing, footwear, headgear, underclothing and underwear, gymnastic and sporting articles, orthopedic articles, soles for footwear, spectacles, sleeves, walking sticks, wellness products for the care and beauty of the body and feet, braces, electric pocket torches, safety lamps, public lighting, headlamps, solar lamps, headphones, computerized apparatus for the stimulation of muscles and appliances for gymnastics, body rehabilitation apparatuses; online retail and online ordering services for chronometers, pedometers, heart-rate measuring units, energy drinks and foods for sport, watches, photographic cameras, cameras, global positioning system browsers, directional compasses, altimeters, binoculars, meteorological terminals, books, geographical maps, tents for camping, sleeping bags, sun block preparations, sports bags, rucksacks, bags for campers, clothing, sports clothing, footwear, headgear, underclothing and underwear, gymnastic and sporting articles, orthopedic articles, soles for footwear, spectacles, sleeves, walking sticks, wellness products for the care and beauty of the body and feet, braces, electric pocket torches, safety lamps, public lighting, headlamps, solar lamps, headphones, computerized apparatus for the stimulation of muscles and appliances for gymnastics, body rehabilitation apparatus; sales promotion for third parties; administration of consumer loyalty programs; management of loyalty and incentive programs; management of customer loyalty, bonuses and promotions; organization and management of commercial incentive and loyalty programs; customer loyalty services for commercial, promotional or advertising purposes; promotion of goods and services by means of sponsorship of sports events.

41 – Providing information (other than publicity) featuring sports and equipment relating thereto provided by a retail store of sporting goods via telecommunications or computer networks; entertainment; organization of games and competitions; game services provided online from a computer network; sporting and cultural activities; organization of colloquiums, conferences, congresses, seminars, symposiums; organization of sports competitions; organizing and conducting of sports events; sports training services; sports enter-

tainment services; sports camp services; organization and conducting of non-virtual educational forums; club services (entertainment or education); coaching (training); health club services (health and fitness training); organization of exhibitions for cultural or educational purposes; organization and conducting of training workshops; planning of receptions (entertainment); organization of fashion shows for entertainment purposes; information relating to education and entertainment; online publication of specialized electronic books and journals; provision of non-downloadable online electronic publications; provision of non-downloadable music online; provision of non-downloadable videos online; electronic desktop publishing; photographic reporting; publication of newspapers, periodicals, catalogs and brochures; publication of printed matter, also in electronic form, other than for advertising purposes; rental of photographic cameras, video cameras, books, maps, gymnastic and sporting articles, walking sticks.

(260) AM 2022 113643 A

(800) 1598199

(151) 2021 05 25

(891) 2021 05 25

(731) Weichai Power Co., Ltd.

197, Section A, Fushou East Street, High Technology Industrial, Development Zone, Weifang City, Shandong Province, China

(540)



(591) Black, white

(531) 26.01.01; 26.01.04; 26.01.12

(511)

9 – Battery packs; fuel cells; power packs [batteries]; power units [batteries]; charging appliances for rechargeable equipment; solar cells; electric batteries for powering electric vehicles; car batteries; galvanic batteries; charging stations for electric vehicles.

(260) AM 2022 113645 A

(800) 1598258

(151) 2021 02 23

(891) 2021 02 23

(731) MA-PA MAKİNA PARÇALARI
ENDÜSTRİSİ ANONİM ŞİRKETİ

TOSB – TAYSAD, Organize Sanayi Bölgesi,
1. Cadde 22 Çayırova, Kocaeli, Turkey

(540)



(591) Black, white, yellow

(531) 26.04.22; 26.04.24; 27.05.10; 29.01.13

(511)

7 – Machine tools; motors and engines (except for land vehicles); machine coupling and transmission components (except for land vehicles); agricultural implements other than hand operated; incubators for eggs.

12 – Vehicles; apparatus for locomotion by land, air or water.

(260) AM 2022 113647 A

(800) 1598287

(151) 2021 04 08

(891) 2021 04 08

(731) "Unilactis" Limited Liability Partnership

Zhansugurov Street, 482, 050000 Almaty city,
Kazakhstan

(540)

MonCafe

(591) Black, white

(531) 27.05.01

(511)

30 – Coffee, tea, cocoa and artificial coffee; rice; tapioca and sago; flour and preparations made from cereals; bread, pastries and confectionery; ice cream; sugar, honey, treacle; yeast, baking-powder; salt; mustard; vinegar, sauces [condiments]; spices; ice for refreshment.

35 – Advertising; business management services; business administration services; office functions.

43 – Services for providing food and drink; providing temporary housing accommodation.

(260) AM 2022 113648 A

(800) 1598314

(151) 2021 04 23

(891) 2021 04 23

(731) Yangtze Memory Technologies Co., Ltd.

No.88 Weilai 3rd Road, East Lake High-tech
Development Zone, Wuhan, Hubei, China

(540)



(591) Black, white

(531) 25.07.23; 26.03.23; 26.04.02; 26.04.07;
26.04.11; 26.04.18; 26.04.24; 27.05.01

(511)

9 – Microchip cards; memory cards; electronic memories; semi-conductor memory units; microprocessors; integrated circuit cards; smart cards [integrated circuit cards]; USB flash drives; electronic semi-conductors; computer chips; transistors; electronic integrated circuits; multiprocessor chips; microchips [computer hardware]; high definition graphic chipsets; electronic chips for the manufacture of integrated circuits; integrated circuits; semi-conductors; chips [integrated circuits]; wafers for integrated circuits; computer memory devices; solid state drives; memory expansion cards; computer peripheral devices.

(260) AM 2022 113649 A

(800) 1598356

(151) 2021 04 26

(891) 2021 04 26

(731) JINAN MEIDE CASTING CO., LTD.

Jinan Meide Technopark, Industrial Park,
Pingyin, Jinan, Shandong, China

(540)

MECH

(591) Black, white

(531) 27.05.17

(511)

9 – Pressure measuring apparatus; pressure indicator plugs for valves; tool measuring instruments; flowmeters; water meters; water temperature gauges; temperature indicators; manometers; pressure indicators.

(260) AM 2022 113650 A

(800) 1598374

(151) 2021 03 12

(891) 2021 03 12

(731) HALCON CERAMICAS, S.L.

Partida Foyes Ferraes s/n, E-12110 Alcora
(Castellón), Spain

(540)

emotion ceramics

(591) Black, white

(531) 27.05.09; 27.05.10

(526) Ceramics

(511)

19 – Non-metallic building materials, particularly ceramic tiles for wall cladding, ceramic tiles for floor and wall coverings, non-metallic and non-woven valances, ceramic tiles for walls, floors and ceilings, sandstone, natural stone, marble, granite.

(260) AM 2022 113651 A

(800) 1598392

(151) 2021 03 05

(891) 2021 03 05

(731) Biofarm Sp. z o.o.

ul. Wałbrzyska 13, PL-60-198 Poznań, Poland

(540)

ВИГАЛЕКС

(591) Black, white

(531) 28.05

(511)

5 – Pharmaceuticals; medicines; dietetic food and substances for medical purposes; mineral food supplements; dietary supplements and dietetic preparations; vitamins; disinfectants and antiseptics; all above-mentioned goods excluding ophthalmic and otorhinolaryngological pharmaceutical preparations.

(260) AM 2022 113653 A

(800) 1598429

(151) 2021 04 02

(891) 2021 04 02

(731) China Tobacco Jiangsu Industrial Co., Ltd.

No. 406-3 Zhongshan North Road, Nanjing,
210011 Jiangsu, China

(540)



(591) Black, white

(531) 04.03.03; 05.03.13; 05.05.20; 26.11.03;
26.11.12; 27.05.01

(511)

34 – Lighters for smokers; cigarettes containing tobacco substitutes, not for medical purposes; matches; cigarette paper; cigarettes; cigarette filters; cigarette cases; cigars; tobacco; ashtrays for smokers.

(260) AM 2022 113654 A
 (800) 1598445
 (151) 2021 04 16
 (891) 2021 04 16
 (731) Siemens Healthcare GmbH
 Henkestraße 127, 91052 Erlangen, Germany
 (540)

High-V

(591) Black, white
 (511)
 9 – Software, in particular software for use in connection with medical imaging apparatus; software as a component of magnetic resonance imaging apparatus for medical use; computer software integrated into a medical imaging device and sold as a part of the medical imaging device.
 10 – Magnetic resonance imaging instruments for medical purposes.
 42 – Software as a service (SaaS) for use in connection with apparatus for medical imaging; software as a service (SaaS) for magnetic resonance imaging apparatus for medical use.

(260) AM 2022 113669 A
 (800) 1598957
 (151) 2021 02 19
 (891) 2021 02 19
 (731) Open-Type Joint Stock Company "ROT FRONT"
 2-oy Novokuznetskiy pereulok, d. 13/15,
 RU-115184 Moscow, Russian Federation
 (540)

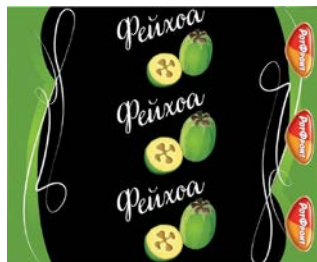

(591) Black, green, white, yellow, brown, dark brown, red
 (531) 05.07.21; 05.07.22; 19.03.24; 25.01.19;
 25.01.25; 25.03.07; 25.07.25; 28.05; 29.01.15
 (511)
 30 – Confectionery.

(260) AM 2022 113670 A
 (800) 1598977
 (151) 2020 08 21
 (891) 2020 08 21
 (731) SARPER DAMITIMCILIK ANONİM
 ŞİRKETİ
 2. Cadde, No:7, Organize Sanayi Bölgesi,
 Akhisar – Manisa, Turkey

(540)
**BEYLERBEYİ Göbeğin
 Göbeği**

(591) Black, white
 (511)
 33 – Wines, liqueurs, alcoholic preparations for making beverages, alcoholic cocktails containing milk, cocktails, aperitifs, brandy, raki [traditional Turkish alcoholic drink], whiskey, anisette, sake.

(260) AM 2022 113671 A
 (800) 1599009
 (151) 2021 04 21
 (891) 2021 04 21
 (731) Obshchestvo s ogranichennoy otvetstvennostyu
 "Promservis"
 Aviamotornaya ul., 10-2, office 8,
 RU-111024 Moscow, Russian Federation
 (540)

PROFKA

(591) Black, white
 (531) 27.05.01
 (511)
 3 – Lip glosses; depilatory wax; depilatory preparations; depilatories; perfumery; eyebrow pencils; cosmetic pencils; hair conditioners; cosmetic creams; hair lotions; lotions for cosmetic purposes; beauty masks; oils for cosmetic purposes; essential oils; cosmetic kits; gel eye patches for cosmetic purposes; lipsticks; pomades for cosmetic purposes; sunscreen preparations; eyebrow cosmetics; sun-tanning preparations [cosmetics]; hair dyes; hair colorants; neutralizers for permanent waving; cosmetic preparations for eyelashes; cosmetic preparations for skin care; cosmetics; mascara; bleaching preparations [decolorants] for cosmetic purposes; shampoos; dry shampoos.

(260) AM 2022 113729 A
 (800) 1599654
 (151) 2021 04 28
 (891) 2021 04 28
 (731) Clubhouse Candle Company LLC
 700 South Santa Fe Avenue, Second Floor,
 Los Angeles CA 90021, USA
 (540)

CLUBHOUSE CANDLE CO.

(591) Black, white
 (526) CANDLE
 (511)
 4 – Candles.

(260) AM 2022 113730 A

(800) 1599698

(151) 2020 12 24

(891) 2020 12 24

(731) Midea Group Co., Ltd.

B26-28F, Midea Headquarter Building, No.6

Midea Avenue, Beijiao, Shunde, Foshan,

Guangdong, China

(540)

(591) Black, white

(531) 27.05.01

(511)

7 – Pressure regulators [parts of machines]; dynamos; dynamo belts; generators of electricity; industrial robots; mechanical arm for industrial use; pumps [machines]; automatic handling machines [manipulators]; starters for motors and engines; electric motors for refrigerators; air filters [engine parts]; regulating valves; taps [parts of machines, engines or motors]; engines, other than for land vehicles; motors, other than for land vehicles; compressors for refrigerators; compressors [machines]; turbo compressors; compressed air machines; charging sweepers; electromechanical food preparation machines; wrapping machines; electric kitchen machines; electric blenders for household purposes; electric fruit presses for household purposes; dry cleaning machines; mixing machines; dishwashers; washing machines [laundry]; wringing machines for laundry; dust removing installations for cleaning purposes; electromechanical beverage preparation machines; electric juicer; electric machines and apparatus for cleaning; electric beaters; vacuum cleaners; mills [machines]; steam mops; cleaning appliances utilizing steam; coffee grinders, other than hand-operated; electric food processors; juice grinders for food industries; 3D printers; AC servo motors; condensing installations; refrigerated vending machine; noodle making machines; power operated meat grinders; shearing machines for animals; electric feeder for animals; beer pumps; garbage disposal units; stators [parts of machines]; vegetable slicers; electric whisks for household purposes; sealing machines for industrial purposes; apparatus for drawing up beer under pressure; spin driers [not heated]; thermostatic control valves for machines; aerating pumps for aquaria; soda-pop making machines; apparatus for aerating water; electric machines for making aerated drinks; drums [parts of machines]; ironing machines; bottle sealing machines; electric scissors; electric shearing machines; electric screw vegetable slicers; electronic industry equipment; electrically operated curtain drawing devices; meat mincers [machines]; aerocondensers; compressors for air conditioners; meat choppers [machines]; vending machines; automatic vacuum cleaners; filtering machines; brewing machines; hand-

held tools, other than hand-operated; automatic food packing machines; beverage processing machines; apparatus for aerating beverages; agricultural machines; incubators for eggs; electric salt mills; woodworking machines; papermaking machines; diaper producing equipment; printing presses; dyeing machines; tea processing machines; tobacco processing machines; leather-working machines; bicycle assembling machines; potters' wheels; industrial marking machines; battery making machines; cord making machines; machines for processing local agricultural products; spindriers for silkworm eggs; machines for making chopsticks; peeling machines; machines for making pens; machines for making wax; machines for knitting straw mats; machines for manufacturing enamel; machines for manufacturing bulbs; coalball machines; machines for pharmaceutical processing industry; embossing machines; glass-working machines; machines for manufacturing fertilizer; electromechanical machines for chemical industry; drilling machines; cutters [machines]; oil refining machines; mechanical shovels; elevators [lifts]; punch presses; moulding machines; steam condensers [parts of machines]; carburetors; turbines, other than for land vehicles; pushpin making machines; machines for making buttons; machines for manufacturing electrical wires; optic cold processing equipment; gas separating equipment; painting machines; air cylinders [parts of machines]; bearings [parts of machines]; belts for machines; electric welding machines; labellers [machines]; electric shoe polishers; racket stringing machines; robotic exoskeleton suits, other than for medical purposes; joints for aviation refuellers; liquid tanks [parts of machines].

9 – Semi-conductors; electric installations for the remote control of industrial operations; heat regulating apparatus; air analysis apparatus; electronic chips; integrated circuits; temperature indicators; vacuum tubes for radios; food analysis apparatus; transducers; thermostats; control panels [electricity]; electric switches; voltage regulators; electronic numeric displays; remote controllers for household purposes; remote controllers for projectors; electronic key [remote-controlled devices]; remote control apparatus; transponders; optical lenses; humanoid robots with artificial intelligence; downloadable cellular phone applications; downloadable computer software applications; virtual reality headsets; security surveillance robots; recorded computer programs; alarms; pocket computers; detectors; digital door locks; data processing apparatus; smartphones; surveying apparatus and instruments; smoke detectors; electronic weight scales; electric theft prevention installations; electric batteries; battery chargers; materials for electricity mains [wires, cables]; electric locks; monitors [computer programs]; scales; portable electric sources [rechargeable batteries]; electronic access control devices for interlocking door; weighing apparatus and instruments; video monitors; downloadable computer

programs; modems; couplers [data processing equipment]; electro-dynamic apparatus for the remote control of signals; monitoring apparatus, other than for medical purposes; printers for use with computers; protection devices for personal use against accidents; face recognition equipment; bathroom scales; portable digital electronic scales; remotely deployable spike strips used to stop cars by puncturing tyres; portable scales; light conducting filaments [optical fibers]; holograms; animated cartoons; chemistry apparatus and instruments; electronic scales for kitchen use; dictating machines; photocopiers [photographic, electrostatic, thermic]; laboratory robots; petri dishes for laboratory use; incubators with constant temperature for laboratory use; incubators with constant humidity for laboratory use; gasification devices for laboratory use; bioreactors for laboratory use; glassware for use in scientific experiments; body fat scales for household purposes; radiological apparatus for industrial purposes; scales with body mass analysers; invoicing machines; inductors [electricity]; mechanisms for co-in-operated apparatus; voting machines; Electronic Random Number Indicator Equipment [ERNIE]; carpenters' rules; car audio equipment; fire extinguishers; lamp boxes in the nature of illuminated advertising devices; photo printers; cameras [photography]; egg-candlers; material testing instruments for chemical or physical experiments and composition analysis; electronic navigation equipment; electrified fences; electrolyzers; eyeglasses; ticket printers; infrared detectors; acid proof gloves for protection against accidents or injury; hemline markers; decorative magnets; audiovisual teaching apparatus; chronographs [time recording apparatus]; computers; electronic collars for animal training; test tubes; audio scales; sports whistles; thermostats for vehicles; simulators for the steering and control of vehicles; microphones for remote communication devices; microphones for communication devices; lightning arresters; apparatus to check stamping mail; droppers for measuring, other than for medical or household purposes; testing apparatus not for medical purposes; skin moisture testing apparatus not for medical purposes.

11 – Bread-making machines; heated display cabinets; extractor hoods for kitchen use; electric multicookers; electric ovens for household purposes; drying apparatus and installations; microwave ovens [cooking apparatus]; roasters; cooking apparatus and installations; cooking stoves; electric autoclaves for cooking; gas cookers; electric coffee machines; electric pressure cookers; electric laundry dryers; electric lamps; electric cookers; electric cooking utensils; electric kettles; electric frying pans; induction cookers; electric food steamers; electric rice cookers; air purifying apparatus and machines; air conditioning installations; air-conditioners; fabric steamers; fans [air-conditioning]; electric hair driers; pocket warmers; gas lighters; stoves [heating apparatus]; electric radiators; heating installations; heating and cooling apparatus for dispensing

hot and cold beverages; domestic fireplaces; water purifying apparatus and machines; water filtering apparatus; disinfectant apparatus; dampers [heating]; heat pumps; gas burners; burners; electric stoves; pipes [parts of sanitary installations]; ventilation [air-conditioning] installations and apparatus; water dispensers; freezers; refrigerators; flushing apparatus; cooling appliances and installations; refrigerating display cabinets; ice machines and apparatus; sanitary apparatus and installations; solar water heaters; water closets; water heaters for the use of washing (gas or electric heating); bath fittings; heaters for baths; electric wine cellars; toilet seats; USB-powered hand warmers; portable electric foot baths; heat-storage warmers; refrigerating appliances and installations; cooling installations and machines; refrigerating chambers; refrigerating containers; ice makers; ice-lolly machines; machines for manufacturing ice creams; heating apparatus; coffee roasters; laboratory lamps; laboratory burners; charcoal ovens for household purposes; household water purifiers for household purposes; tap filters for household purposes; electric water purifiers for household purposes; electric radiant heaters for household purposes; electric cookers for household purposes; ultrasonic sterilizers for household purposes; lighters; LED driers for nail polish; walk-in refrigerators; water purifying machines; water purification installations; hydromassage bath apparatus; water softening apparatus and installations; automobile lights; air conditioning equipment for automobiles; bath installations; bath microbubble generators; sterilizers; sterilizers for household purposes; hot water bottles; lighting apparatus and installations; gas ovens for household purposes; milk sterilizers; hair dryers for barber shops; electric coffee makers; electric foot baths; electric coffee pots; electric coffee percolators; electronic candles; electric slow cookers; electric stew pots; electrically heated clothing; electric heating casseroles; electric heating braisers; germicidal lamps for purifying air; air sterilization equipment; nail lamps; polymerisation installations; water purifying installations; smoke generating machines for creating special theatrical effects; steam facial apparatus; steam facial apparatus [saunas]; ornamental fountains; smoked ovens for outdoor barbecue; lava rocks for use in barbecue grills; electric heating cushions and pads, not for medical purposes; electric food warmers; filters for drinking water; drinking water filtration equipment; hair driers; soybean milk machines for household purposes.

21 – Flat-iron stands; ironing boards; insulating flasks; kitchen containers; kitchen utensils; non-electric heaters for feeding bottles; scoops [tableware] for household purposes; containers for household or kitchen use; non-electric blenders for household purposes; carpet sweepers; jugs; stir-frying spoons made of iron; stew-pans; griddles [cooking utensils]; cookery moulds; non-electric autoclaves for cooking; cooking pots; frying pans; electric toothbrushes; iron

pans; pot lids; earthenware saucepans; heat-insulated containers; non-electric pressure cookers; non-electric coffeepots; disposable chopsticks; stainless steel cutting boards; vacuum bottles; vacuum flasks [insulating flasks]; isothermic bags; chopsticks for children training; knife rests; cutting boards; materials for brush-making; roller tubes for peeling garlic; combs for animals; toothbrushes for animals; water troughs for animals; animal-activated animal feeders; animal-activated livestock waterers; spoon shovels [tableware]; mess-tins; make-up removing appliances; cosmetic facial cleansing devices; garlic presses; cutting boards for kitchen use; graters for kitchen use; chopping blocks for kitchen use; non-mechanical portable waterers for pets; straw cups; coffee services [tableware]; coffee cups; plastic lunch boxes; finger toothbrushes for infants; pet feeding bowls; litter boxes for pets; litter trays for pets; brushes for pets; pet feeding utensils; toothbrushes for pets; automatic litter boxes for pets; hair removing brushes for pets; hair removing combs for pets; automatic feeders for pets; automatic pet feeding bowls; pet drinking bowls; indoor aquaria; chocolate making moulds for household purposes; containers for household purposes; non-electric whisks for household purposes; pudding moulds; wide-mouth glass bottles with sealed screw lids; flat-bottomed glasses; pans; corkscrews; electric or non-electric corkscrews; bottle openers; electric or non-electric bottle openers; services [dishes]; cooking pot sets; hand-operated machines for making noodles; hand-operated coffee grinders; Japanese teapots; travelling mugs; mugs; cups; cupcake moulds; cupcake baking cups; combs; moulds [kitchen utensils]; crystal [glassware]; fruit cups; fruit bowls; cruet sets for oil and vinegar; stir fry pan; baking cups; non-electric cooking pans; pans for frying eggs; non-electric frying pans; gas hot pots; toothbrushes; water apparatus for cleaning teeth and gums; litter trays for cats; glasses [receptacles]; glass flasks [containers]; glass jars; bottles; china ornaments; electric brushes, except parts of machines; electric hair brushes; heads for electric toothbrushes; electric and non-electric aromatic oil diffusers, other than reed diffusers; electric combs; floss picks driven by batteries; salt cellars; table plates; insulating vacuum bottles; stone pots; bowls [basins]; chopsticks; chopsticks containers; confectioners' decorating bags [pastry bags]; slender glasses; urns; pots; pepper pots; tea services [tableware]; teapots; teacups; wine openers; garlic presses [kitchen utensils]; steamer baskets; cake moulds; cake decorating tips and tubes; electric devices for attracting and killing insects; spice sets; cruet; metal lunch boxes; scoops [household or kitchen utensils]; not electrically heated hot pots; non-electric eggbeaters; non-electric coffee grinders; non-electric coffee percolators; non-electric coffee filters; non-electric stir fry pans; non-electric cooking steamers; non-electric meat grinders; non-electric teapots; non-electric food steamers; hand-operated noodle machines; glass jars for food preser-

vation; thermally insulated containers for food; thermally insulated containers for food or beverages; draining racks for tableware; lunch boxes; rice scoops for household purposes; drinking glasses; cookie and biscuit cutters; electric and non-electric candle warmers.

(260) AM 2022 113732 A
 (800) 1599729
 (151) 2021 02 16
 (891) 2021 02 16
 (731) MONEGAL PERFUMES, S.L.
 BUIGAS, 27-29 4^o-1^a, E-08017 BARCELONA,
 Spain
 (540)



(591) Black, white
 (531) 27.05.01
 (511)
 3 – Perfumery and cosmetics.

(260) AM 2022 113734 A
 (800) 1599752
 (151) 2021 05 11
 (891) 2021 05 11
 (731) Apple Inc.
 One Apple Park Way, Cupertino CA 95014,
 USA
 (540)

NUMBERS

(591) Black, white
 (511)
 42 – Software as a service (SAAS) services featuring computer software for creating spreadsheets, tables, graphs, and charts, and for organizing and analyzing data; providing temporary use of on-line non-downloadable software for creating spreadsheets, tables, graphs, and charts, and for organizing and analyzing data.

(260) AM 2022 113735 A
 (800) 1599809
 (151) 2021 02 25
 (891) 2021 02 25
 (731) Limited liability company "Altayvita"
 proezd Rybozavodskoy 42, RU-656016 city
 of Barnaul, Russian Federation

(540)



(591) Brown, light brown, light gray, gray, dark gray, blue, pink, dark pink, black, yellow, burgundy, green, light green, dark green and white

(531) 03.07.05; 03.07.24; 05.11.11; 09.01.10; 26.04.05; 26.04.18; 26.04.24; 27.05.01; 27.05.24; 29.01.15

(511)

5 – Nutritional supplements; pollen dietary supplements; dietary supplements with a cosmetic effect; medicinal roots; dietetic beverages adapted for medical purposes; medicinal infusions; tinctures for medical purposes; decoctions for pharmaceutical purposes; dietetic foods adapted for medical purposes; asthmatic tea; medicinal herbs; medicinal tea; herbal teas for medicinal purposes; herbal extracts for medical purposes; plant extracts for pharmaceutical purposes.

30 – Chamomile-based beverages; tea-based beverages; infusions, not medicinal; aromatic preparations for food; garden herbs, preserved [seasonings]; processed seeds for use as a seasoning; flowers or leaves for use as tea substitutes; tea; iced tea.

(260) AM 2022 113736 A

(800) 1600014

(151) 2021 05 14

(891) 2021 05 14

(731) Youdao Tyre Co., LTD.

Tangshan Town, Huantai County, Zibo City,
Shandong Province, China

(540)



(591) Black, white

(531) 24.15.03; 26.03.23; 27.05.08; 27.05.17;
27.05.21

(511)

12 – Repair outfits for inner tubes; inner tubes [for automobile tires]; truck tires; solid tires for vehicle wheels; inner tubes for pneumatic tires; tires for commercial vehicles; automobile tires; inner tubes for vehicle tires; bus tires; tires for vehicle wheels.

(260) AM 2022 113737 A

(800) 1600059

(151) 2021 03 23

(891) 2021 03 23

(731) NOVARTIS AG

CH-4002 Basel, Switzerland

(540)



(591) Black, white, gray

(531) 01.15.15; 26.13.25

(511)

5 – Pharmaceutical preparations.

(260) AM 2022 113738 A

(800) 1600074

(151) 2021 05 10

(891) 2021 05 10

(731) Apple Inc.

One Apple Park Way, Cupertino CA 95014,
USA

(540)

KEYNOTE

(591) Black, white

(511)

42 – Software as a service (SAAS) services featuring computer software for presentation graphics, namely, software for generating, storing, retrieving, manipulating and altering texts and graphics for use in presentations; providing temporary use of on-line non-downloadable software for presentation graphics, namely, software for generating, storing, retrieving, manipulating and altering texts and graphics for use in presentations.

(260) AM 2022 113739 A

(800) 1600108

(151) 2020 12 03

(891) 2020 12 03

(731) Apple Inc.

One Apple Park Way, Cupertino CA 95014,
USA

(540)



(591) Black, white and gray

(531) 16.01.11; 26.01.05; 26.01.16; 26.01.24;
26.11.12

(511)

9 – Downloadable and recorded computer software; downloadable and recorded computer software for processing, facilitating, verifying, and authenticating mobile payments and contactless transactions with retailers, merchants, and vendors via wearable and mobile devices; downloadable and recorded computer software for use in searching, transmitting, receiving, storing, accessing, finding, organizing and viewing geographic location information and providing content based on location; downloadable and recorded computer software for application development; downloadable and recorded computer software development tools; downloadable and recorded computer software used in developing other software applications; downloadable and recorded application programming interface (API) software; downloadable and recorded software development kits (SDK); downloadable and recorded computer software to maintain and operate a computer system; downloadable and recorded computer operating software.

(260) AM 2022 113740 A

(800) 1600109

(151) 2020 12 03

(891) 2020 12 03

(731) Apple Inc.

One Apple Park Way, Cupertino CA 95014,
USA

(540)

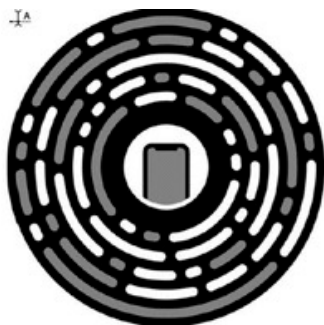

(591) Black, white and gray

(531) 16.01.11; 26.01.05; 26.01.12; 26.01.15;
26.01.24; 26.11.12

(511)

42 – Providing online non-downloadable application development software; providing online non-downloadable computer software development tools; providing online non-downloadable computer software used in developing other software applications; user authentication services using a software application; user authentication services using technology for e-commerce transactions; providing online information relating to computer technology, computer programming, and computer software.

(260) AM 2022 113741 A

(800) 1600149

(151) 2020 11 26

(891) 2020 11 26

(731) TECHNIKA METERING LIMITED

C/P Cox Costello & Horne, 26 Main Avenue,
Moor Park, Northwood HA6 2HJ, United
Kingdom

(540)

KRIZIK

(591) Black, white

(511)

9 – Meters; water meters; apparatus and instruments for weighing, measuring, signalling, checking (supervision) water; apparatus and instruments for conducting, switching, transforming, accumulating, regulating or controlling water namely water meters, water level indicators, water level gauges, indicators (water level -), water temperature gauges, oil-water thermistors, water leakage detection alarms, water distress luminous beacons, rods for water diviners, oil-water level sensors, water level detection apparatus, water level indicators for vehicles, water sprinkling devices for fire control, scientific apparatus for determining the water content in petroleum products; electric meters; electricity meters; electric flow meters; electric current meters; electronic meters; thermal meters; heating meters; temperature meters for household use; temperature meters for industrial use; temperature meters for scientific use; pressure meters; gas meters; gas flow meters; rotary gas meters; flowmeters; fluid flow meters; mass flow meters; soil moisture meters; liquid level meters; PH meters; level meters; acidity meters; gravity meters; moisture meters; humidity meters; millivolt meters; current-meters; power meters; speed meters; distance meters; turbine meters; fuel gauges; capacitance meters; panel meters; conductivity meters; voltmeters; torque meters; concentration meters; acoustic meters; exposure meters; light meters; vibration meters; luminoflux meters; parking meters; frequency meters; electronic distance meters; cryogenic turbine meters; fuel consumption meters; positive displacement meters; wheel alignment meters; phase angle meters; insulation resistance meters; digital panel meters; electrotechnical vibration meters; sound level

meters; radio-frequency power meters; exposure meters for photographic devices.

(260) AM 2022 113742 A

(800) 1600157

(151) 2021 06 07

(891) 2021 06 07

(731) Hebei Zaimei Technology Development Co., Ltd
1-3-801, Lehuicheng, No. 11, East Zhongshan Road, Chang 'an District, Shijiazhuang, Hebei, China

(540)

REMEI

(591) Black, white

(531) 27.05.01

(511)

1 – Wood pulp; plastisols; sizing preparations; fire-proofing preparations; fertilizers; plastics, unprocessed; chemical intensifiers for rubber; fulling preparations; alkalies; industry silicon.

(260) AM 2022 113760 A

(800) 1471926

(151) 2019 04 09

(891) 2021 06 02

(731) YIWU SUJUE CYCLE CO., LTD
No. 3, Building 19, Lingyun 5 Zone, Qingxi Village, Beiyuan Street, Yiwu City, Zhejiang Province, China

(540)

soldier

(591) Black, white

(531) 02.01.08; 18.01.05; 27.03.01; 27.03.02; 27.03.15

(511)

12 – Repair outfits for inner tubes; vehicle roof racks; direction indicators for land vehicles; seats for bicycle, tricycle or motorcycle; bicycle handlebars; pumps for bicycle tires; bicycle mudguards; rims for bicycle wheels; bicycle frames.

(260) AM 2022 113796 A

(800) 1600416

(151) 2021 04 30

(891) 2021 04 30

(731) Perenio IoT spol. s r.o.
Na Dlouhém 79, CZ-251 01 Říčany – Jazlovice, Czech Republic

(540)

perenio
SMART HEALTH

(591) Black, white

(531) 24.17.25; 26.11.02; 26.11.22; 27.03.15; 27.05.01; 27.05.09; 27.05.10

(511)

7 – Vacuum cleaners; robotic vacuum cleaners.

9 – Ozonisers [ozonators]; covers for smartphones; cases for telephones; anti-glare glasses.

10 – Ultraviolet ray lamps for medical purposes.

11 – Ultraviolet ray lamps, not for medical purposes; humidifiers; air purifiers, electric; sterilizers.

(260) AM 2022 113797 A

(800) 1600432

(151) 2021 04 25

(891) 2021 04 25

(731) Xi'an Jiabs Business Management Co., Ltd.
Room B1707, New Silk Road E-commerce Industrial Park, No. 9 Gangwu Avenue, Xi'an International Trade & Logistics Park, Xi'an City, Shaanxi Province, China

(540)

Joybos

(591) Black, white

(531) 27.05.01

(511)

20 – Furniture; furniture fittings, not of metal; kennels for household pets; pillows; works of art made of bamboo and wood; mirrors [looking glasses]; door fittings, not of metal; casks, not of metal; works of art of wood, wax, plaster or plastic; brush mountings.

21 – Drinking bottles for sports; heat-insulated containers; material for brush-making; brushes; garbage cans; containers for household or kitchen use; mops; glassware for daily use, including cups, plates, kettles and jars; porcelain for daily use, including basins, bowls, plates, kettles, tableware, jars, jugs and pots; combs; toothbrushes.

35 – Advertising; business management assistance; sales promotion for others; provision of an online marketplace for buyers and sellers of goods and services; personnel management consultancy; photocopying services; accounting; sponsorship search; rental of vending machines; rental of sales stands; retail services for pharmaceutical, veterinary and sanitary pre-

parations and medical supplies; marketing; procurement services for others [purchasing goods and services for other businesses]; administrative services for the relocation of businesses.

(260) AM 2022 113798 A

(800) 1600453

(151) 2021 04 20

(891) 2021 04 20

(731) Eskaro Group AB

Box 11918, SE-404 39 Göteborg, Sweden

(540)

ОПТИМИСТ

(591) Black, white

(531) 28.05

(511)

2 – Paints, varnishes, lacquers; preservatives against rust and against deterioration of wood; colorants, dyes; mordants; natural resins, raw; metals in foil and powder form for use in painting, decorating, printing and art.

17 – Unprocessed and semi-processed rubber, gutta-percha, gum, asbestos, mica and substitutes for all these materials; plastics in extruded form for use in manufacture; packing, stopping and insulating materials; flexible pipes, tubes and hoses, not of metal.

(260) AM 2022 113799 A

(800) 1600456

(151) 2021 04 26

(891) 2021 04 26

(731) JINAN MEIDE CASTING CO., LTD.

Jinan Meide Technopark, Industrial Park,

Pingyin, Jinan, Shandong, China

(540)



(591) Black, white

(531) 01.15.24; 25.01.19; 26.04.03; 26.04.05;

26.04.16; 26.11.01; 26.11.13

(511)

9 – Temperature indicators; pressure indicators; pressure measuring apparatus; tool measuring instruments; water meters; pressure indicator plugs for valves; flowmeters; water temperature gauges; manometers.

(260) AM 2022 113825 A

(800) 1601310

(151) 2021 03 10

(891) 2021 03 10

(731) BALENCIAGA

40 rue de Sèvres, F-75007 Paris, France

(540)

BALENCIAGA

(591) Black, white

(511)

9 – Protective masks; respiratory masks other than for artificial respiration; anti-pollution masks for respiratory protection; dust masks; face masks specially adapted for protective sports helmets; filters for respiratory masks; inserts for respiratory masks; spectacle frames; spectacles; sunglasses; spectacle cases; goggles for sports; contact lenses; eyewear; optical apparatus and instruments; binoculars; cords and chains for eyeglasses and sunglasses; 3D spectacles; connected watches; smart watches; connected spectacles; smart glasses; smart rings; digital electronic devices to be worn on your person in the nature of watchbands, bracelets or cuffs; wearable activity trackers; apparatus for the recording, transmission, reproduction of data, sound or images; telephones, portable telephones, smartphones, tablets, PDAs (personal digital assistants) and MP3 players; accessories for telephones, portable telephones, smartphones, tablets, PDAs (personal digital assistants) and MP3 players, namely, hands-free kits for telephones, batteries, covers, cases, casings, facings, chargers, straps for portable telephone, wrist straps or neck straps; virtual and augmented reality headsets; accessories for electronic devices for wireless transmission of data and/or voice signals, namely, batteries, car kits, charging docks and chargers, cases to be attached to belts, helmets, adapters, adapter cases, holders adapted for laptops, tablets, mobile telephones, docking stations, cases and covers for laptops, sheaths for electric cables, covers for batteries; magnetic recording media, USB flash drives and other digital recording media; digital audio players; earphones for music; corded or cordless loudspeakers for music; pedometers (step counters); software for activation, configuration, operation and control of portable devices, mobile telephones, smart watches, smart glasses, earphones, headsets; peripheral devices for mobile telephones, portable electronic devices, smart watches, smart glasses, earphones, headsets; remote controls for controlling mobile telephones, portable electronic devices, smart watches, smart glasses, earphones, headsets; interfaces for mobile telephones, portable electronic devices, smart watches, smart glasses; covers, bags, cases, sleeves, straps and lanyards for portable electronic devices, smart watches, smart glasses, earphones, headsets; connected jewelry articles, namely, bracelets (measuring instruments) and/or watches; smart jewelry articles, namely, bracelets (measuring instruments) and/or watches; data gloves with haptic sensors; com-

puters; laptop computers; computer peripherals; computer programs (downloadable software).

10 – Protective face masks for hygienic and medical use; surgical masks; sanitary masks for medical use; masks for protection against pollen, fungi, germs, viruses and toxic substances for hygienic, medical and surgical use; antibacterial protection masks for hygienic, medical and surgical use; protective respiratory masks for medical and surgical use; pediatric respiratory masks for medical use.

21 – Utensils for household use; kitchen utensils; containers for household use; kitchen containers; combs; sponges; brushes (except paintbrushes); brush-making materials; hand-operated cleaning instruments; steel wool; glass, unworked or semi-worked, except building glass; porcelain ware; earthenware; bottles; art objects of porcelain, ceramic, earthenware or glass; statuettes of porcelain, ceramic, earthenware or glass; figurines (statuettes) of porcelain, ceramic, earthenware or glass; toilet utensils; toilet cases; trash cans; glasses (receptacles); tableware; mugs; drinking bottles; vases; services (dishes); serving utensils (tableware); fitted picnic baskets (including dishes); baskets for picnics sold with crockery; lunch boxes; non-electric portable coldboxes; perfume burners; incense burners; perfume sprayers; perfume vaporizers; scented oil burners; perfume diffusers (receptacles); essential oil diffuser; aromatic oil diffusers other than stick diffusers; apparatus for perfuming the air; bottles for perfumery.

(260) AM 2022 113840 A

(800) 1527421

(151) 2020 02 21

(891) 2021 06 10

(731) ÇELİK KAÇUK VE PLASTİK HORTUM
SANAYİ VE TİCARET LİMİTED ŞİRKETİ
2. Organize Sanayi Bölgesi, Reisköy Caddesi,
No:6, Selçuklu, Konya, Turkey

(540)

powerdrip

(591) Black, white

(531) 27.05.01

(511)

17 – Rubber, gutta-percha, gum, asbestos, mica and semi-finished synthetic goods made from these materials in the form of powder, bars, panels and foils included in this class; insulation, stopping and sealing materials: insulation paints, insulation fabrics, insulating tape and band, insulation covers for industrial machinery, joint sealant compounds for joints, gaskets, O-rings for sealing purposes (other than gaskets for motors, cylinders and washer for water taps); flexible pipes made from rubber and plastic; hoses made of plastic and rubber, including those used for

vehicles; junctions for pipes of plastic and rubber; pipe jackets of plastic and rubber; hoses of textile material; junctions for pipes, not of metal; pipe jackets, not of metal; connecting hose for vehicle radiators.

(260) AM 2022 113938 A

(800) 1602622

(151) 2021 06 14

(891) 2021 06 14

(731) Kia Corporation

12, Heolleung-ro, Seocho-gu, Seoul,
Republic of Korea

(540)



(591) Black, white

(531) 27.05.19; 27.07.01

(511)

12 – Vans [vehicles]; motor buses; sports cars; automobiles; electric cars; trucks.

(260) AM 2022 113942 A

(800) 1602806

(151) 2021 04 26

(891) 2021 04 26

(731) HARMONT & BLAINE S.p.A.

Strada Statale 87 Km. 16, 460 Zona A.S.I.,
I-80023 CAIVANO (NA), Italy

(540)



harmont&blaine

(591) Black, white

(531) 03.01.08; 03.01.24; 24.17.25; 27.05.01

(511)

18 – Bags; travel baggage; handbags; clutches [purses]; valises; pocket wallets; leather purses; purses; school bags; document cases of leather; travelling trunks; key-cases of leather and skins; vanity cases, not fitted; garment carriers; rucksacks; umbrellas; walking sticks; saddlery.

25 – Clothing; coats; mantles; raincoats; dust coats; pelisses; dresses; suits; skirts; jackets [clothing]; knitwear [clothing]; trousers; short sets [clothing]; bermuda shorts; denim jeans; waistcoats; shirts; tee-shirts; tops [clothing]; chemisettes; jerseys [clothing]; sweaters; blazers; cardigans; stockings; socks; underwear; corsets [underclothing]; brassieres; underpants; nighties; shift dresses; pyjamas; bath robes, bathing suits; coverups; sunsuits; blousons; waterproof clothing, parkas; cagoules; gym suits; neckties; scarves; shawls;

mufflers [clothing]; foulards [clothing articles]; caps being headwear; hats; hoods [clothing]; gloves [clothing]; puttees; footwear; beach shoes; sports shoes; boots; shoes; slippers.

35 – Retail services, provided also on-line, in relation to cosmetics, perfumes, solid perfumes, antiperspirants [toiletries], soap, soaps in liquid form, cakes of toilet soap, bath foam, dentifrices, shampoos, ethereal oils, hair care lotions, permanent waving and curling preparations, cosmetics in the form of gels, tints for the hair, face creams for cosmetic use, mascara, eyeliner, eyelid shadow, make-up pencils, facial packs for toilet purposes, lipsticks, make-up foundations, body cream, nail varnish, preparations for reinforcing the nails, nail varnish removers, oils for cosmetic purposes, suntan creams, prescription eyeglasses, sunglasses, spectacle frames, lenses for eyeglasses, contact lenses, spectacle cases, spectacle chains, optical apparatus and instruments, flip covers for smart phones, cases adapted for computers, cases adapted for mobile phones, leather cases for mobile phones, mobile telephone cases made of leather or imitations of leather, leather cases for smartphones, leather cases for tablet computers, bags adapted for laptops, carrying cases for cellular phones, electronic book reader covers, cases for spectacles and sunglasses, cases for smartphones, cases for tablet computers, cases for telephones, camcorder covers, flip covers for tablet computers, covers for tablet computers, mobile telephone covers made of cloth or textile materials, tablet computers, mobile telephones, cell phone straps, hands-free headsets for cell phones, headsets for mobile telephones, wireless headsets for use with mobile telephones, cell phone covers, flip covers for mobile phones, usb flash drives, usb chargers, e-books, smartwatches, waterproof cases for smart phones, smartglasses, smartphones in the shape of a watch, wearable smart phones, smartbands, smartphones, wristwatches, pocket watches, alarm clocks, digital clocks, clock cases, watch chains, watch glasses, watch bands, chronographs for use as timepieces, jewellery, paste jewellery, bags, travel baggage, handbags, clutches [purses], valises, pocket wallets, leather purses, purses, school bags, document cases of leather, travelling trunks, key-cases of leather and skins, vanity cases, not fitted, garment carriers, rucksacks, umbrellas, walking sticks, saddlery, apparel fabrics, textiles for furnishings, towels of textile, bath linen, except clothing, linens, bed linen, table linen not of paper, bed blankets, bed throws, covers for cushions, textile tissues, pillowcases, sheets [textile], furniture coverings of textile, cloth, curtains of textile or plastic, table napkins of textile, fabrics for textile use, clothing, coats, mantles, raincoats, dust coats, pelisses, dresses, suits, skirts, jackets [clothing], knitwear [clothing], trousers, short sets [clothing], bermuda shorts, denim jeans, waistcoats, shirts, tee-shirts, tops [clothing], chemisettes, jerseys [clothing], sweaters, blazers, cardigans, stockings, socks, underwear, corsets [underclothing], bra-

ssieres, underpants, nighties, shift dresses, pyjamas, bath robes, bathing suits, coverups, sunsuits, blousons, waterproof clothing, parkas, cagoules, gym suits, neckties, scarves, shawls, mufflers [clothing], foulards [clothing articles], caps being headwear, hats, hoods [clothing], gloves [clothing], puttees, footwear, beach shoes, sports shoes, boots, shoes, slippers.

(260) AM 2022 114017 A

(800) 1603454

(151) 2021 03 19

(891) 2021 03 19

(731) CHONGQING AMITY MACHINERY CO., LTD.

28-5#, No. 200 Zhongshan 2 Road, Yuzhong District, Chongqing, China

(540)

DECAKILA

(591) Black, white

(511)

14 – Unwrought or semi-wrought precious metals; jewellery boxes; earrings; jewellery; wristwatches; precious stones; works of art of precious metal; chronometric instruments; clocks; watches; key chains made of precious metal comprised of split rings with decorative fobs or trinkets; clocks and watches.

(260) AM 2022 114020 A

(800) 1603700

(151) 2021 06 28

(891) 2021 06 28

(731) SHANGHAI TOBACCO GROUP CO., LTD.

717 Chang Yang Road, Yangpu District, Shanghai, China

(540)



(591) Black, white

(531) 28.03

(511)

34 – Lighters for smokers; cigarettes; cigars; tobacco.

(260) AM 2022 114022 A

(800) 1280880

(151) 2015 09 15

(891) 2021 07 05

(731) FARMEC SA

Str. Henri Barbusse no. 16, Cluj-Napoca, Romania

(540)



(591) Black, white

(531) 26.13.25; 27.05.13

(511)

3 – Cosmetics; cosmetic creams; cosmetic preparations for skin care; cosmetic dyes; cosmetic preparations for slimming purposes; lotions for cosmetic purposes; almond milk for cosmetic purposes; adhesives for cosmetic purposes; cosmetic preparations for baths; cosmetic preparations for eyelashes; cosmetic kits; cosmetic pencils; cleansing milk for toilet purposes; douching preparations for personal sanitary or deodorant purposes (toilettries); tissues impregnated, with cosmetic lotions; tissues impregnated with make-up removing preparations; balms other than for medical purposes; oils for cosmetic purposes; greases for cosmetic purposes; pomades for cosmetic purposes; astringents for cosmetic purposes; petroleum jelly for cosmetic purposes; smoothing preparations (starching) for cosmetic purposes; soaps; medicated soap; shaving soap; disinfectant soap; cakes of toilet soap; antiperspirant soap; deodorant soaps; bath salts, not for medical purposes; bath preparations, not for medical purposes; almond soap; sun-tanning preparations; sunscreen preparations; shaving preparations; shaving stones (astringents); after-shave lotions; deodorants for human beings; antiperspirants (toilettries); perfumery; perfumes; eau de cologne; toilet water; scented water; toilettries; talcum powder, for toilet use; oils for toilet purposes; shampoos; hair lotions; hair dyes; hair colorants; hair waving preparations; hair sprays; hair conditioners; hair straightening preparations; neutralizers for permanent waving; hydrogen peroxide for cosmetic purposes; cotton swabs for cosmetic purposes; cotton sticks for cosmetic purposes; cotton wool for cosmetic purposes; pumice stone; alum stones (astringents); make-up preparations; make-up; mascara; make-up powder; make-up removing preparations; lip glosses; lipsticks; eyebrow cosmetics; eyebrow pencils; adhesives for affixing false eyelashes; beauty masks; skin whitening creams; essential oils; nail care preparations; nail varnish; nail polish; depilatory preparations; depilatories; depilatory wax; moustache wax; massage gels other than for medical purposes; dentifrices; dental bleaching gels; denture polishes; mouthwashes, not for medical purposes; preparations for cleaning dentures; breath freshening sprays; breath freshening strips.

(260) AM 2022 114023 A

(800) 1312284

(151) 2016 05 06

(891) 2021 06 11

(731) AGROQUÍMICA CODIAGRO, S.L.

Pol. Ind. Caseta Blanca, C/ Albocácer nº 6,

E-12194 VALL D'ALBA (CASTELLÓN),

Spain

(540)



(591) White, light blue and dark blue

(531) 05.03.13; 05.03.14; 26.04.02; 26.04.22;

26.04.24; 29.01.12; 29.01.12

(511)

1 – Chemical products for use in industry, science and photography, as well as in agriculture, horticulture and forestry; unprocessed artificial resins, unprocessed plastics; soil fertilizers; fire extinguishing compositions; metal tempering and soldering preparations; chemical products for preserving foodstuffs; tanning substances; adhesives for use in industry.

5 – Pharmaceutical and veterinary products; hygienic and sanitary products for medical use; dietetic substances for medical use, food for babies; plasters, material for dressings; teeth filling and dental impression materials; disinfectants; products for destroying vermin; fungicides, herbicides.

(260) AM 2022 114024 A

(800) 1577900

(151) 2021 01 04

(891) 2021 07 02

(731) Fall Creek Farm and Nursery, Inc.

39318 Jasper-Lowell Road, Lowell OR 97452,

USA

(540)

ARABELLABLUE

(591) Black, white

(511)

31 – Fresh fruit; living plants.

(260) AM 2022 114025 A

(800) 1584233

(151) 2021 02 11

(891) 2021 07 05

(731) F. Hoffmann-La Roche AG

Grenzacherstrasse 124, CH-4070 Basel,

Switzerland

(540)

CONTIVUE

(591) Black, white

(511)

10 – Ophthalmic equipment and instruments.

(260) AM 2022 114118 A

(800) 1473701

(151) 2019 04 23

(891) 2021 07 14

(731) KRKA, tovarna zdravil, d.d., Novo mesto
Šmarješka cesta 6, SI-8000 Novo mesto,
Slovenia

(540)

SORVITIMB

(591) Black, white

(511)

5 – Pharmaceutical preparations.

INTERNATIONAL TRADEMARKS PROTECTED IN GEORGIA

(260) AM 2022 108201 A
(800) 1463570
(151) 2019 01 02
(181) 2029 01 02
(891) 2020 04 20
(511) 09, 42

(260) AM 2022 111671 A
(800) 1575309
(151) 2020 12 10
(181) 2030 12 10
(891) 2020 12 10
(511) 09, 16, 25, 28, 41

(260) AM 2022 110234 A
(800) 1556088
(151) 2020 09 02
(181) 2030 09 02
(891) 2020 09 02
(511) 17, 19

(260) AM 2022 111678 A
(800) 1575395
(151) 2020 11 24
(181) 2030 11 24
(891) 2020 11 24
(511) 08, 20, 21

(260) AM 2022 111559 A
(800) 1573626
(151) 2020 10 01
(181) 2030 10 01
(891) 2020 10 01
(511) 03, 05

(260) AM 2022 111688 A
(800) 1517194
(151) 2019 12 19
(181) 2029 12 19
(891) 2021 01 22
(511) 05

(260) AM 2022 111631 A
(800) 1574536
(151) 2020 09 22
(181) 2030 09 22
(891) 2020 09 22
(511) 44

(260) AM 2022 111758 A
(800) 1575521
(151) 2020 12 15
(181) 2030 12 15
(891) 2020 12 15
(511) 05

(260) AM 2022 111633 A
(800) 1574631
(151) 2020 11 10
(181) 2030 11 10
(891) 2020 11 10
(511) 18, 25

(260) AM 2022 111759 A
(800) 1575524
(151) 2020 12 15
(181) 2030 12 15
(891) 2020 12 15
(511) 05

(260) AM 2022 111635 A
(800) 1574708
(151) 2020 08 21
(181) 2030 08 21
(891) 2020 08 21
(511) 09, 37, 42

(260) AM 2022 111762 A
(800) 1575545
(151) 2020 12 15
(181) 2030 12 15
(891) 2020 12 15
(511) 05

(260) AM 2022 111654 A
(800) 1575109
(151) 2021 01 05
(181) 2031 01 05
(891) 2021 01 05
(511) 12, 37

(260) AM 2022 111763 A
(800) 1575546
(151) 2020 12 15
(181) 2030 12 15
(891) 2020 12 15
(511) 05

(260) AM 2022 111764 A
(800) 1575548
(151) 2020 12 15
(181) 2030 12 15
(891) 2020 12 15
(511) 05

(260) AM 2022 111786 A
(800) 1576181
(151) 2020 09 28
(181) 2030 09 28
(891) 2020 09 28
(511) 21

(260) AM 2022 111765 A
(800) 1575549
(151) 2020 12 15
(181) 2030 12 15
(891) 2020 12 15
(511) 05

(260) AM 2022 111813 A
(800) 1576802
(151) 2020 12 11
(181) 2030 12 11
(891) 2020 12 11
(511) 30

(260) AM 2022 111766 A
(800) 1575554
(151) 2020 12 15
(181) 2030 12 15
(891) 2020 12 15
(511) 05

(260) AM 2022 111817 A
(800) 1155759
(151) 2012 10 17
(181) 2022 10 17
(891) 2021 01 04
(511) 05, 29, 30, 32

(260) AM 2022 111782 A
(800) 1576122
(151) 2020 12 28
(181) 2030 12 28
(891) 2020 12 28
(511) 03, 04, 05

(260) AM 2022 111818 A
(800) 1258845
(151) 2015 04 23
(181) 2025 04 23
(891) 2020 12 30
(511) 05, 29, 30, 32

(260) AM 2022 111783 A
(800) 1576150
(151) 2020 10 27
(181) 2030 10 27
(891) 2020 10 27
(511) 03, 05

(260) AM 2022 111819 A
(800) 1304812
(151) 2016 05 04
(181) 2026 05 04
(891) 2021 01 20
(511) 29, 30

(260) AM 2022 111784 A
(800) 1576164
(151) 2020 12 15
(181) 2030 12 15
(891) 2020 12 15
(511) 36

(260) AM 2022 111820 A
(800) 1328602
(151) 2015 12 23
(181) 2025 12 23
(891) 2021 02 03
(511) 09, 12, 25

(260) AM 2022 111785 A
(800) 1576171
(151) 2020 10 27
(181) 2030 10 27
(891) 2020 10 27
(511) 03, 05

(260) AM 2022 111821 A
(800) 1350701
(151) 2017 03 30
(181) 2027 03 30
(891) 2021 02 03
(511) 09, 11, 12, 25

(260) AM 2022 111887 A
(800) 1576894
(151) 2020 10 22
(181) 2030 10 22
(891) 2020 10 22
(511) 07

(260) AM 2022 111890 A
(800) 1576925
(151) 2020 10 22
(181) 2030 10 22
(891) 2020 10 22
(511) 30

(260) AM 2022 111891 A
(800) 1576948
(151) 2020 11 26
(181) 2030 11 26
(891) 2020 11 26
(511) 05, 44

(260) AM 2022 111892 A
(800) 1576959
(151) 2020 12 14
(181) 2030 12 14
(891) 2020 12 14
(511) 16, 34

(260) AM 2022 111893 A
(800) 1576981
(151) 2020 11 18
(181) 2030 11 18
(891) 2020 11 18
(511) 09

(260) AM 2022 111894 A
(800) 1577005
(151) 2021 01 14
(181) 2031 01 14
(891) 2021 01 14
(511) 01, 07, 16

(260) AM 2022 111895 A
(800) 1577121
(151) 2020 10 13
(181) 2030 10 13
(891) 2020 10 13
(511) 03, 14, 25, 35, 43

(260) AM 2022 111899 A
(800) 1577357
(151) 2020 07 20
(181) 2030 07 20
(891) 2020 07 20
(511) 02, 17, 37

(260) AM 2022 111907 A
(800) 1577528
(151) 2020 08 21
(181) 2030 08 21
(891) 2020 08 21
(511) 30

(260) AM 2022 111912 A
(800) 1577662
(151) 2021 01 15
(181) 2031 01 15
(891) 2021 01 15
(511) 09

(260) AM 2022 111913 A
(800) 1577683
(151) 2020 11 30
(181) 2030 11 30
(891) 2020 11 30
(511) 19

(260) AM 2022 111914 A
(800) 1577686
(151) 2020 12 10
(181) 2030 12 10
(891) 2020 12 10
(511) 03, 05, 10

(260) AM 2022 111985 A
(800) 1578202
(151) 2019 06 11
(181) 2029 06 11
(891) 2019 06 11
(511) 07, 09, 11, 35, 37, 41, 42

(260) AM 2022 111987 A
(800) 1578252
(151) 2020 11 25
(181) 2030 11 25
(891) 2020 11 25
(511) 05

(260) AM 2022 111988 A
(800) 1578274
(151) 2020 09 03
(181) 2030 09 03
(891) 2020 09 03
(511) 03, 05

(260) AM 2022 112002 A
(800) 1578590
(151) 2021 01 27
(181) 2031 01 27
(891) 2021 01 27
(511) 07

(260) AM 2022 111991 A
(800) 1578343
(151) 2020 12 15
(181) 2030 12 15
(891) 2020 12 15
(511) 09

(260) AM 2022 112003 A
(800) 1578596
(151) 2020 12 10
(181) 2030 12 10
(891) 2020 12 10
(511) 07

(260) AM 2022 111995 A
(800) 1578410
(151) 2020 12 17
(181) 2030 12 17
(891) 2020 12 17
(511) 11

(260) AM 2022 112006 A
(800) 1578737
(151) 2021 01 25
(181) 2031 01 25
(891) 2021 01 25
(511) 03

(260) AM 2022 111996 A
(800) 1578429
(151) 2021 01 08
(181) 2031 01 08
(891) 2021 01 08
(511) 09

(260) AM 2022 112008 A
(800) 1578760
(151) 2021 01 12
(181) 2031 01 12
(891) 2021 01 12
(511) 11

(260) AM 2022 111997 A
(800) 1578492
(151) 2021 01 06
(181) 2031 01 06
(891) 2021 01 06
(511) 29

(260) AM 2022 112020 A
(800) 1579025
(151) 2021 01 13
(181) 2031 01 13
(891) 2021 01 13
(511) 01, 03, 05, 35

(260) AM 2022 111998 A
(800) 1578508
(151) 2020 12 18
(181) 2030 12 18
(891) 2020 12 18
(511) 09

(260) AM 2022 112040 A
(800) 1573416
(151) 2020 12 02
(181) 2030 12 02
(891) 2021 02 18
(511) 05

(260) AM 2022 111999 A
(800) 1578522
(151) 2020 12 19
(181) 2030 12 19
(891) 2020 12 19
(511) 09

(260) AM 2022 112041 A
(800) 1573504
(151) 2020 12 02
(181) 2030 12 02
(891) 2021 02 17
(511) 05

(260) AM 2022 112106 A
(800) 1579689
(151) 2020 11 20
(181) 2030 11 20
(891) 2020 11 20
(511) 09, 28, 41

(260) AM 2022 112117 A
(800) 1579978
(151) 2020 12 14
(181) 2030 12 14
(891) 2020 12 14
(511) 12

(260) AM 2022 112107 A
(800) 1579697
(151) 2021 01 19
(181) 2031 01 19
(891) 2021 01 19
(511) 01

(260) AM 2022 112118 A
(800) 1579985
(151) 2020 12 14
(181) 2030 12 14
(891) 2020 12 14
(511) 22, 23, 24, 25, 27

(260) AM 2022 112110 A
(800) 1579723
(151) 2021 01 11
(181) 2031 01 11
(891) 2021 01 11
(511) 09

(260) AM 2022 112120 A
(800) 1580220
(151) 2020 10 16
(181) 2030 10 16
(891) 2020 10 16
(511) 29, 30

(260) AM 2022 112112 A
(800) 1579793
(151) 2020 09 02
(181) 2030 09 02
(891) 2020 09 02
(511) 33

(260) AM 2022 112133 A
(800) 1580597
(151) 2021 01 21
(181) 2031 01 21
(891) 2021 01 21
(511) 35, 38

(260) AM 2022 112113 A
(800) 1579816
(151) 2020 12 09
(181) 2030 12 09
(891) 2020 12 09
(511) 03

(260) AM 2022 112141 A
(800) 1580811
(151) 2020 10 07
(181) 2030 10 07
(891) 2020 10 07
(511) 05

(260) AM 2022 112114 A
(800) 1579818
(151) 2021 02 09
(181) 2031 02 09
(891) 2021 02 09
(511) 12

(260) AM 2022 112142 A
(800) 1580846
(151) 2021 01 19
(181) 2031 01 19
(891) 2021 01 19
(511) 01

(260) AM 2022 112115 A
(800) 1579868
(151) 2020 12 28
(181) 2030 12 28
(891) 2020 12 28
(511) 35

(260) AM 2022 112143 A
(800) 1580847
(151) 2021 01 13
(181) 2031 01 13
(891) 2021 01 13
(511) 11

(260) AM 2022 112145 A
(800) 1580866
(151) 2020 12 29
(181) 2030 12 29
(891) 2020 12 29
(511) 09

(260) AM 2022 112153 A
(800) 1525213
(151) 2020 03 12
(181) 2030 03 12
(891) 2021 02 23
(511) 03, 05

(260) AM 2022 112146 A
(800) 1580893
(151) 2021 01 19
(181) 2031 01 19
(891) 2021 01 19
(511) 01, 05, 31

(260) AM 2022 112154 A
(800) 1525233
(151) 2020 03 12
(181) 2030 03 12
(891) 2021 02 23
(511) 03, 05

(260) AM 2022 112147 A
(800) 1580925
(151) 2020 12 02
(181) 2030 12 02
(891) 2020 12 02
(511) 34

(260) AM 2022 112155 A
(800) 1545844
(151) 2020 05 15
(181) 2030 05 15
(891) 2020 12 02
(511) 03

(260) AM 2022 112148 A
(800) 1114346
(151) 2012 03 14
(181) 2022 03 14
(891) 2021 01 27
(511) 19

(260) AM 2022 112201 A
(800) 1581011
(151) 2021 01 15
(181) 2031 01 15
(891) 2021 01 15
(511) 18, 25

(260) AM 2022 112149 A
(800) 1305115
(151) 2016 05 02
(181) 2026 05 02
(891) 2021 02 03
(511) 25, 28

(260) AM 2022 112203 A
(800) 1581089
(151) 2020 04 30
(181) 2030 04 30
(891) 2020 04 30
(511) 30

(260) AM 2022 112150 A
(800) 1332354
(151) 2016 08 19
(181) 2026 08 19
(891) 2021 02 22
(511) 31

(260) AM 2022 112212 A
(800) 1581242
(151) 2020 12 17
(181) 2030 12 17
(891) 2020 12 17
(511) 07, 09

(260) AM 2022 112152 A
(800) 1427638
(151) 2018 02 09
(181) 2028 02 09
(891) 2021 02 02
(511) 03

(260) AM 2022 112213 A
(800) 1581248
(151) 2020 08 31
(181) 2030 08 31
(891) 2020 08 31
(511) 04

(260) AM 2022 112214 A
(800) 1581257
(151) 2020 09 18
(181) 2030 09 18
(891) 2020 09 18
(511) 38, 41, 42, 45

(260) AM 2022 112240 A
(800) 1582090
(151) 2021 02 05
(181) 2031 02 05
(891) 2021 02 05
(511) 25

(260) AM 2022 112221 A
(800) 1581534
(151) 2020 12 29
(181) 2030 12 29
(891) 2020 12 29
(511) 43

(260) AM 2022 112246 A
(800) 1066624
(151) 2010 08 23
(181) 2030 08 23
(891) 2021 02 20
(511) 03, 05, 09, 14, 16, 21, 25, 28, 30, 32, 35, 41

(260) AM 2022 112222 A
(800) 1581549
(151) 2021 01 15
(181) 2031 01 15
(891) 2021 01 15
(511) 16

(260) AM 2022 112247 A
(800) 1135892
(151) 2012 10 08
(181) 2022 10 08
(891) 2021 02 20
(511) 29

(260) AM 2022 112223 A
(800) 1581562
(151) 2020 12 18
(181) 2030 12 18
(891) 2020 12 18
(511) 07, 08

(260) AM 2022 112249 A
(800) 1457606
(151) 2018 12 03
(181) 2028 12 03
(891) 2020 12 23
(511) 44

(260) AM 2022 112224 A
(800) 1581590
(151) 2021 01 11
(181) 2031 01 11
(891) 2021 01 11
(511) 34

(260) AM 2022 112250 A
(800) 1495323
(151) 2019 05 24
(181) 2029 05 24
(891) 2020 07 30
(511) 03

(260) AM 2022 112225 A
(800) 1581596
(151) 2020 10 05
(181) 2030 10 05
(891) 2020 10 05
(511) 08, 10, 11, 18, 20, 21, 24, 27, 28, 35

(260) AM 2022 112317 A
(800) 1582357
(151) 2020 12 25
(181) 2030 12 25
(891) 2020 12 25
(511) 05, 21

(260) AM 2022 112238 A
(800) 1581858
(151) 2021 01 22
(181) 2031 01 22
(891) 2021 01 22
(511) 30

(260) AM 2022 112325 A
(800) 1582640
(151) 2020 10 09
(181) 2030 10 09
(891) 2020 10 09
(511) 09, 35, 41

(260) AM 2022 112341 A
 (800) 1583076
 (151) 2020 11 20
 (181) 2030 11 20
 (891) 2020 11 20
 (511) 05

(260) AM 2022 112428 A
 (800) 1583552
 (151) 2021 01 22
 (181) 2031 01 22
 (891) 2021 01 22
 (511) 09, 12, 37

(260) AM 2022 112342 A
 (800) 1583082
 (151) 2020 11 20
 (181) 2030 11 20
 (891) 2020 11 20
 (511) 05

(260) AM 2022 112429 A
 (800) 1583566
 (151) 2021 02 04
 (181) 2031 02 04
 (891) 2021 02 04
 (511) 05

(260) AM 2022 112343 A
 (800) 1583099
 (151) 2020 11 20
 (181) 2030 11 20
 (891) 2020 11 20
 (511) 05

(260) AM 2022 112430 A
 (800) 1583576
 (151) 2021 02 03
 (181) 2031 02 03
 (891) 2021 02 03
 (511) 10

(260) AM 2022 112344 A
 (800) 1583104
 (151) 2021 01 30
 (181) 2031 01 30
 (891) 2021 01 30
 (511) 05

(260) AM 2022 112431 A
 (800) 1583594
 (151) 2021 01 25
 (181) 2031 01 25
 (891) 2021 01 25
 (511) 33

(260) AM 2022 112345 A
 (800) 1583122
 (151) 2021 01 21
 (181) 2031 01 21
 (891) 2021 01 21
 (511) 31

(260) AM 2022 112432 A
 (800) 1583615
 (151) 2020 11 23
 (181) 2030 11 23
 (891) 2020 11 23
 (511) 25

(260) AM 2022 112356 A
 (800) 1318835
 (151) 2016 06 22
 (181) 2026 06 22
 (891) 2021 01 12
 (511) 05, 35

(260) AM 2022 112433 A
 (800) 1583671
 (151) 2020 10 22
 (181) 2030 10 22
 (891) 2020 10 22
 (511) 35, 42

(260) AM 2022 112423 A
 (800) 1583403
 (151) 2020 12 07
 (181) 2030 12 07
 (891) 2020 12 07
 (511) 08, 21, 25

(260) AM 2022 112434 A
 (800) 1583737
 (151) 2021 02 12
 (181) 2031 02 12
 (891) 2021 02 12
 (511) 05

(260) AM 2022 112527 A
(800) 1584996
(151) 2020 12 17
(181) 2030 12 17
(891) 2020 12 17
(511) 35

(260) AM 2022 112650 A
(800) 1586652
(151) 2020 12 21
(181) 2030 12 21
(891) 2020 12 21
(511) 06, 20

(260) AM 2022 112528 A
(800) 1584998
(151) 2021 01 13
(181) 2031 01 13
(891) 2021 01 13
(511) 25

(260) AM 2022 112745 A
(800) 1587307
(151) 2020 08 10
(181) 2030 08 10
(891) 2020 08 10
(511) 03, 05

(260) AM 2022 112530 A
(800) 1585043
(151) 2020 12 21
(181) 2030 12 21
(891) 2020 12 21
(511) 35, 36, 39

(260) AM 2022 112784 A
(800) 1587953
(151) 2020 11 26
(181) 2030 11 26
(891) 2020 11 26
(511) 03, 05

(260) AM 2022 112532 A
(800) 1585100
(151) 2021 01 15
(181) 2031 01 15
(891) 2021 01 15
(511) 38, 41

(260) AM 2022 112804 A
(800) 1588380
(151) 2020 12 11
(181) 2030 12 11
(891) 2020 12 11
(511) 30

(260) AM 2022 112534 A
(800) 1585153
(151) 2020 12 11
(181) 2030 12 11
(891) 2020 12 11
(511) 17, 19

(260) AM 2022 112805 A
(800) 1588390
(151) 2021 02 26
(181) 2031 02 26
(891) 2021 02 26
(511) 05, 10, 35

(260) AM 2022 112556 A
(800) 1585595
(151) 2020 01 21
(181) 2030 01 21
(891) 2020 01 21
(511) 28

(260) AM 2022 112806 A
(800) 1588396
(151) 2021 03 01
(181) 2031 03 01
(891) 2021 03 01
(511) 35, 39, 41, 43

(260) AM 2022 112642 A
(800) 1586479
(151) 2020 12 29
(181) 2030 12 29
(891) 2020 12 29
(511) 02

OFFICIAL NOTIFICATIONS INVENTIONS

RESTORATION OF PATENTS

(21) AP 2015 13702
(11) P 2016 6425 B
(73) LEPL "Institute of Physics and Equipment of Ilia Vekua
(54) METHOD AND EQUIPMENT FOR RECEIVING GIANT LASER IMPULSES
DATE OF CANCELLATION OF PATENT: 2022 01 22
THE TERM OF RESTORATION OF PATENT: 2022 03 25

(21) AP 2015 13728
(11) P 2016 6478 B
(73) Tamaz Shioshvili
(54) DEVICE FOR GETTING HAIR ROOT AND TRANSPLANTATION THEREOF
DATE OF CANCELLATION OF PATENT: 2022 02 06
THE TERM OF RESTORATION OF PATENT: 2022 03 25

(21) AP 2016 14065
(11) P 2017 6701 B
(73) Tamaz Shioshvili
(54) WIND RECEIVING DEVICE
DATE OF CANCELLATION OF PATENT: 2022 02 22
THE TERM OF RESTORATION OF PATENT: 2022 03 25

(21) AP 2017 14871
(11) P 2020 7163 B
(73) Lindsay MOLONEY;
Guy SCOTT
(54) A SYSTEM AND METHOD FOR DOCUMENT INFORMATION AUTHENTICITY VERIFICATION
DATE OF CANCELLATION OF PATENT: 2022 02 07
THE TERM OF RESTORATION OF PATENT: 2022 03 25

ABOLITION OF PATENTS WITH THE RIGHT TO RESTORE

(21) AP 2010 11695
(11) P 2011 5360 B
(73) Vazha Khositashvili
(54) VEGETATIVE GATHERING – ANTIOXIDANT, ANTIRADIATION AND FOR TREATMENT OF
CARDIOVASCULAR DISEASES AND MEDICAL MEANS ON ITS BASIS
DATE OF CANCELLATION OF PATENT: 2022 02 23
THE TERM OF RESTORATION OF PATENT: 2023 02 23

(21) AP 2010 11696
(11) P 2011 5361 B
(73) Vazha Khositashvili;
Levan Khositashvili;
Babri Oreni
(54) PREPARATION - ANTIOXIDANT, ANTIRADIATION, REGULATING LIPIDIC EXCHANGE AND
PREPARATION FOR TREATMENT OF CARDIOVASCULAR DISEASES
DATE OF CANCELLATION OF PATENT: 2022 02 23
THE TERM OF RESTORATION OF PATENT: 2023 02 23

(21) AP 2012 12603
(11) P 2013 5971 B
(73) Eter Kemertelidze;
Mariam Benidze;
Aleksandre Skhirtladze;
Petre Naskidashvili;
Ivane Zedgenidze
(54) METHOD OF OBTAINING PLANT GROW STIMULATOR "ALEXIN"
DATE OF CANCELLATION OF PATENT: 2022 02 28
THE TERM OF RESTORATION OF PATENT: 2023 02 28

(21) AP 2014 13945
(11) P 2018 6886 B
(73) Paion UK Limited
(54) OXIDATION REACTION WITH EXCELLENT CONVERSION RATE
DATE OF CANCELLATION OF PATENT: 2022 03 03
THE TERM OF RESTORATION OF PATENT: 2023 03 03

(21) AP 2016 14074
(11) P 2017 6732 B
(73) Andro Maisuradze;
Lasha Maisuradze
(54) THREE-FLOW TURBOJET ENGINE
DATE OF CANCELLATION OF PATENT: 2022 02 28
THE TERM OF RESTORATION OF PATENT: 2023 02 28

(21) AP 2015 14278
(11) P 2018 6829 B
(73) Sintetica S.A.
(54) PROCESS FOR PRODUCING A STABLE LOW CONCENTRATION, INJECTABLE SOLUTION OF
NORADRENALINE
DATE OF CANCELLATION OF PATENT: 2022 02 26
THE TERM OF RESTORATION OF PATENT: 2023 02 26

(21) AP 2017 14434
(11) P 2019 7014 B
(73) Tengiz Chkhaidze;
Revaz Varsimashvili;
Nino Chkhaidze
(54) DEVICE FOR BREAKING PRODUCTS
DATE OF CANCELLATION OF PATENT: 2022 02 27
THE TERM OF RESTORATION OF PATENT: 2023 02 27

(21) AP 2020 15295
(11) P 2021 7233 B
(73) Zurab Vashalomidze
(54) BOTTLES SET CLAMP
DATE OF CANCELLATION OF PATENT: 2022 03 02
THE TERM OF RESTORATION OF PATENT: 2023 03 02

EXPIRATION OF TERMS OF RESTORATION OF PATENT

(21) AP 2007 10928
(11) P 2013 5796 B
(73) Geeta Shroff
(54) COMPOSITIONS COMPRISING HUMAN EMBRYONIC STEM CELLS AND DERIVATIVES THEREOF, METHODS OF THEIR PREPARATION, AND USAGE THEREOF
DATE OF CANCELLATION OF PATENT: 2021 03 06
THE TERM OF RESTORATION OF PATENT VALIDITY HAS EXPIRED: 2022 03 06

(21) AP 2010 12388
(11) P 2015 6221 B
(73) Les Laboratoires Servier
(54) AGOMELATINE HYDROHALIDE COMPLEX AND PREPARATION METHOD THEREOF
DATE OF CANCELLATION OF PATENT: 2021 02 26
THE TERM OF RESTORATION OF PATENT VALIDITY HAS EXPIRED: 2022 02 26

(21) AP 2010 12398
(11) P 2013 5832 B
(73) Pierre Fabre Medicament
(54) BENZOTHIAZINES DERIVATIVES, PREPARATION THEREOF, AND THEIR APPLICATION AS DRUGS
DATE OF CANCELLATION OF PATENT: 2021 03 02
THE TERM OF RESTORATION OF PATENT VALIDITY HAS EXPIRED: 2022 03 02

(21) AP 2012 12608
(11) P 2013 5865 B
(73) Giorgi Topadze;
Irakli Topadze;
Zurab Kostava;
Giorgi Topadze;
Giorgi Tedoradze
(54) METHOD OF NATURAL AROMATIZER PREPARATION
DATE OF CANCELLATION OF PATENT: 2021 03 01
THE TERM OF RESTORATION OF PATENT VALIDITY HAS EXPIRED: 2022 03 01

(21) AP 2012 12613
(11) P 2014 6017 B
(73) Les Laboratoires Servier;
Egis Gyogyszergyar Nyrt
(54) NOVEL DIHYDRO-OXAZOLOBENZO-DIAZEPINONE COMPOUNDS, METHOD OF THEIR PREPARATION, AND PHARMACEUTICAL COMPOSITIONS CONTAINING THEREOF
DATE OF CANCELLATION OF PATENT: 2021 03 05
THE TERM OF RESTORATION OF PATENT VALIDITY HAS EXPIRED: 2022 03 05

(21) AP 2013 13583
 (11) P 2017 6773 B
 (73) Boehringer Ingelheim International GMBH
 (54) CX3CR1 – BINDING POLYPEPTIDES
 DATE OF CANCELLATION OF PATENT: 2021 02 25
 THE TERM OF RESTORATION OF PATENT VALIDITY HAS EXPIRED: 2022 02 25

(21) AP 2013 13589
 (11) P 2016 6581 B
 (73) Aziende Chimiche Riunite Angelini Francesco A.C.R.A.F. S.p.A.
 (54) GLYCOGEN-BASED CATIONIC POLYMERS
 DATE OF CANCELLATION OF PATENT: 2021 02 21
 THE TERM OF RESTORATION OF PATENT VALIDITY HAS EXPIRED: 2022 02 21

CORRECTION OF THE PUBLISHED INFORMATION

Bulletin №4(583) 2022 02 25

APPLICATION № (10)	PAGE	COLOMN	COMPLETE LIST OF AUTHORS
AP 2022 13376 A	5	I	(72) CHARIFSON, Paul (US); CLARK, Michael, P. (US); BANDARAGE, Upul, K. (US); BETHIEL, Randy, S. (US); COURT, John, J. (US); DENG, Hongbo (CN); DRUTU, Ioana (RO); DUFFY, John, P. (US); FARMER, Luc (CA); GAO, Huai (CN); GU, Wenxin (CN); JACOBS, Dylan, H. (US); KENNEDY, Joseph, M. (US); LEDEBOER, Mark, W. (US); LEDFORD, Brian (US); MALTAIS, Francois (US); PEROLA, Emanuele (IT); WANG, Tiansheng (US); WANNAMAKER, M., Woods (US); BYRN, Randal (US); ZHOU, Yi (US); LIN, Chao (US); JIANG, Min (US); JONES, Steven (US); GERMANN, Ursula, A. (CH); SALITURO, Francesco G. (US); KWONG, Ann Dak-Yee (US)

UTILITY MODELS RESTORATION OF PATENTS

(21) AU 2016 14064
(11) U 2016 1915 Y
(73) LTD "Maltisoft"
(54) PAYMENT SYSTEM FOR SERVICE BY ABONENT USING TELENET
DATE OF CANCELLATION OF PATENT: 2022 02 22
THE TERM OF RESTORATION OF PATENT: 2022 03 25

(21) AU 2020 15267
(11) U 2021 2078 Y
(73) Avtandil Bitsadze
(54) HELIODRYER FOR AGRICULTURAL PRODUCTION
DATE OF CANCELLATION OF PATENT: 2022 01 30
THE TERM OF RESTORATION OF PATENT: 2022 03 25

EXPIRATION OF TERMS OF RESTORATION OF PATENTS

(21) AU 2012 12582
(11) U 2015 1846 Y
(73) Eter Kemertelidze;
Durmishkhan Turabelidze
(54) METHOD OF OINTMENT OF KERATOID ACTIVITY TREATING PSORIASIS
DATE OF CANCELLATION OF PATENT: 2021 02 20
THE TERM OF RESTORATION OF PATENT VALIDITY HAS EXPIRED: 2022 02 20

(21) AU 2012 12605
(11) U 2013 1782 Y
(73) Eter Kemertelidze;
Mariam Benidze;
Aleksandre Skhirtladze
(54) METHOD OF HERBAL DRUG PREPARATION FOR ATHEROSCLEROSIS TREATMENT
DATE OF CANCELLATION OF PATENT: 2021 02 28
THE TERM OF RESTORATION OF PATENT VALIDITY HAS EXPIRED: 2022 02 28

TRANSFER OF RIGHT

(21) AU 2020 15285

(11) U 2021 2091 Y

(54) TEAPOT LID

NEW PATENTOWNER AND NEW ADDRESS:

Astrata AG (CH)

Gewerbestrasse 5, Cham, Canton Zug 6330,

Switzerland, (CH)

FORMER PATENTOWNER AND FORMER ADDRESS:

Limited Liability Company "Polaris International
Limited" (RU)

Elektrodnaya St., Dom 8, Stroenie 2, Moscow, 111524,
Russian Federation (RU)

DATE OF REGISTRATION: 2022 03 14

DESIGNS

CANCELLATION OF DESIGNS REGISTRATION

(11) D 2012 493 S

(73) Chongqing Sokon Industry Group Stock Co., LTD (CN)

No. 61-1 Jinciao Road, Shapingba District, Chongqing, People's Republic of China (CN)

(54) AUTOMOBILE

(18) 2021 08 16

(58) 2022 03 09

(11) D 2016 687 S

(73) LTD "Goodwine" (GE)

S. Janashia Str. 11a, 0179, Tbilisi, Georgia (GE)

(54) WINE TRANSPORTING AND STORING CONTAINER FOR BOTTLING AUTOMATIC
MACHINE FOR TRADE

(18) 2021 07 07

(58) 2022 03 09

(11) D 2017 705 S

(73) Donari Surmanidze (GE)

Bakos Str. 74, app. 51, 6000, Batumi, Georgia

(54) PARCELED GEORGIAN BLACK TEA PACKAGE

(18) 2021 09 01

(58) 2022 03 16

EXTENSION OF TERMS OF INTERNATIONAL DESIGN REGISTRATION

(11) DM/68573
(73) BREITLING SA
Schlachthausstrasse, 2 Case postale 1132, CH-2540 Grenchen (CH)
(15) 2007 02 14
(24) 2007 02 14
(18) 2027 02 14
(28) 3
(28') 3
(54) Watch case, watch case with dial, watch dial

(11) DM/77676
(73) ALFRED KÄRCHER GMBH & CO. KG
Alfred-Kärcher-Straße 28-40, 71364 Winnenden (DE)
(15) 2012 02 10
(24) 2012 02 10
(18) 2027 02 10
(28) 2
(28') 2
(54) High pressure cleaners

(11) DM/77711
(73) INTERCONTINENTAL GREAT BRANDS LLC
100 Deforest Avenue, East Hanover, New Jersey 07936 (US)
(15) 2012 02 13
(24) 2012 02 13
(18) 2027 02 13
(28) 1
(28') 1
(54) Biscuit [pastry]

(11) DM/77777
(73) COMPAGNIE DES MONTRES LONGINES, FRANCILLON S.A.
(LONGINES WATCH CO., FRANCILLON LTD.)
CH-2610 St-Imier (CH)
(15) 2012 02 24
(24) 2012 02 24
(18) 2027 02 24
(28) 3
(28') 3
(54) Watches

(11) DM/77812
(73) MONTRES BREGUET S.A.
CH-1344 L'ABBAYE (CH)
(15) 2012 02 28
(24) 2012 02 28
(18) 2027 02 28
(28) 3
(28') 3
(54) 1. Ring, 2. Earrings, 3. Pendant

(11) DM/78126
(73) COMPTOIR NOUVEAU DE LA PARFUMERIE
23, rue Boissy d'Anglas, F-75008 PARIS (FR)
(15) 2012 04 11
(24) 2012 04 11
(18) 2027 04 11
(28) 1
(28') 1
(54) Small bottle

(11) DM/78170
(73) KISTLER HOLDING AG
Eulachstrasse 22, CH-8408 Winterthur (CH)
(15) 2012 04 11
(24) 2012 04 11
(18) 2027 04 11
(28) 1
(28') 1
(54) Force sensor

(11) DM/94672
(73) OMEGA SA (OMEGA AG) (OMEGA LTD.)
Jakob-Stämpfli-Strasse 96, CH-2502 Biel/Bienne (CH)
(15) 2017 02 09
(24) 2017 02 09
(18) 2027 02 09
(28) 3
(28') 3
(54) 1.-2. Finger rings, 3. Pendant

(11) DM/94783
(73) MONTRES JAQUET DROZ SA (MONTRES JAQUET DROZ AG) (MONTRES JAQUET DROZ LTD)
Allée du Tourbillon 2, CH-2300 La Chaux-de-Fonds (CH)
(15) 2017 02 15
(24) 2017 02 15
(18) 2027 02 15
(28) 3
(28') 3
(54) 1. Watch case, 2. Dial, 3. Oscillating weight

(11) DM/94817
(73) BALEV EOOD, blvd. Vladislav Varnenchik No.256, BG-9009 Varna (BG);
BALEV CORPORATION EOOD, Blvd. Vladislav Varnenchik No.260, BG-9009 Varna (BG)
DIMITAR HRISTOV BALEV, Blvd. Vitosha No.137, apt. 17, BG-1408 Sofia (BG)
(15) 2017 02 07
(24) 2017 02 07
(18) 2027 02 07
(28) 2
(28') 2
(54) Labels

(11) DM/95140
(73) THE SWATCH GROUP MANAGEMENT SERVICES AG (THE SWATCH GROUP MANAGEMENT SERVICES SA)
(THE SWATCH GROUP MANAGEMENT SERVICES LTD.)
Seevorstadt 6, CH-2502 BIEL/BIENNE (CH)
(15) 2017 02 27
(24) 2017 02 27
(18) 2027 02 27
(28) 2
(28') 2
(54) Wristwatches

(11) DM/95584
(73) MANN & SCHRÖDER GMBH
Bahnhofstrasse 14, 74936 Siegelbach (DE)
(15) 2017 03 30
(24) 2017 03 30
(18) 2027 03 30
(28) 3
(28') 3
(54) Bottles for cosmetics

(11) DM/95792
(73) VALENTINO S.P.A.
Via Turati, 16/18, I-20121 Milano (EM)
(15) 2017 03 30
(24) 2017 03 30
(18) 2027 03 30
(28) 2
(28') 2
(54) Shoes

TRADEMARKS

EXTENSION OF TERMS OF TRADEMARKS REGISTRATION

(111) M 2002 14840 R2

(156) 2002 11 28

(186) 2032 11 28

(732) Apple Inc.

One Apple Park Way, Cupertino, California
95014, USA

(111) M 2011 22089 R1

(156) 2011 12 14

(186) 2031 12 14

(732) Bausch Health Ireland Limited

3013 Lake Drive, Citywest Business Campus,
Dublin 24, Ireland

(111) M 2002 14348 R2

(156) 2002 02 18

(186) 2032 02 18

(732) Qingdao Haishang Zhicai Management

Consulting Co., Ltd.
Haier Industrial Park, No.1 Haier Road,
Laoshan District, Qingdao City, Shandong
Province, China

(111) M 2011 22090 R1

(156) 2011 12 14

(186) 2031 12 14

(732) Bausch Health Ireland Limited

3013 Lake Drive, Citywest Business Campus,
Dublin 24, Ireland

(111) M 2011 21532 R1

(156) 2011 06 14

(186) 2031 06 14

(732) LTD "Knauf Marketing Tbilisi"

Gamrekeli Str. 19, Tbilisi, Georgia;

LTD "Knauf GIPS Tbilisi"

Kiziki Str. 17, Tbilisi, Georgia

(111) M 2012 22545 R1

(156) 2012 04 30

(186) 2032 04 30

(732) Ajanta Pharma Ltd.

Ajanta House, Charkop, Kandivli (W),
Mumbai - 67, India

(111) M 2011 22064 R1

(156) 2011 12 14

(186) 2031 12 14

(732) Amber IP Brands Sàrl

Avenue Reverdil 14, 1260 Nyon, Switzerland

(111) M 2012 22547 R1

(156) 2012 04 30

(186) 2032 04 30

(732) Ajanta Pharma Ltd.

Ajanta House, Charkop, Kandivli (W),
Mumbai - 67, India

(111) M 2011 22065 R1

(156) 2011 12 14

(186) 2031 12 14

(732) Amber IP Brands Sàrl

Avenue Reverdil 14, 1260 Nyon, Switzerland

(111) M 2012 22358 R1

(156) 2012 02 24

(186) 2032 02 24

(732) AO "DANON POSSIA"

Ul. Viatskaia, d.27, str.13-14, 127015
Moskovi, Russian Federation

(111) M 2011 22088 R1

(156) 2011 12 14

(186) 2031 12 14

(732) Bausch Health Ireland Limited

3013 Lake Drive, Citywest Business Campus,
Dublin 24, Ireland

(111) M 2012 22423 R1

(156) 2012 03 16

(186) 2032 03 16

(732) General Motors LLC

300 Renaissance Center, City of Detroit,
State of Michigan 48265-3000, USA

(111) M 2012 22694 R1

(156) 2012 07 02

(186) 2032 07 02

(732) Elguja Bubuteishvili

Paliashvili St. 62, 0179, Tbilisi, Georgia

(111) M 2012 22483 R1
(156) 2012 04 05
(186) 2032 04 05
(732) The Procter & Gamble Company
One Procter & Gamble Plaza, Cincinnati,
Ohio 45202, USA

(111) M 2012 22611 R1
(156) 2012 05 16
(186) 2032 05 16
(732) Ascensia Diabetes Care Holdings AG
Peter Merian-Strasse 90, 4052 Basel,
Switzerland

(111) M 2012 22623 R1
(156) 2012 05 16
(186) 2032 05 16
(732) Apple Inc.
One Apple Park Way, Cupertino, California
95014, USA

(111) M 2012 22566 R1
(156) 2012 04 30
(186) 2032 04 30
(732) GlaxoSmithKline Consumer Healthcare (UK)
IP Limited
980 Great West Road, Brentford, Middlesex
TW8 9GS, United Kingdom

(111) M 2013 23361 R1
(156) 2013 02 20
(186) 2033 02 20
(732) LLC "Sairme Mineral Water"
Resort Sairme, 1000, Baghdati district,
Georgia

COMPLETE TRANSFER OF RIGHTS

(111) M 1998 10246 R
 (732) N.V. Organon
 Kloosterstraat 6, 5349 AB Oss, Netherlands
 (770) Merck Sharp & Dohme Corp.
 One Merck Drive, Whitehouse Station,
 New Jersey 08889, USA
 (580) 2022 02 24

(111) M 2021 33602 R
 (732) Nana Shengelia
 Archil Cagareli St. 13, Tbilisi, Georgia
 (770) LTD "Ideal"
 Mikheil Javakhishvili Str., I Lane 7, 0108,
 Tskneti, Tbilisi, Georgia
 (580) 2022 03 01

(111) M 1998 10457 R
 (732) Baxter Healthcare SA (a Switzerland
 Corporation)
 Thurgauerstrasse 130, 8152 Glattpark
 (Opfikon), Switzerland
 (770) Alza Corporation (a Delaware Corporation)
 700 Eubanks Drive, Vacaville CA 95688, USA
 (580) 2022 01 18

(111) M 1998 10457 R
 (732) Baxter International Inc.
 One Baxter Parkway, Deerfield,
 IL 60015, USA
 (770) Baxter Healthcare SA (a Switzerland
 Corporation)
 Thurgauerstrasse 130, 8152 Glattpark
 (Opfikon), Switzerland
 (580) 2022 01 18

(111) M 2000 13145 R
 (732) Netco United Pte. Ltd
 120 Lower Delta Road, #15-10, Cendex
 Centre, 169208, Singapore
 (770) N.E.T. CO. United S.A., Offshore
 Incorporations United
 Vistra Corporate Services Centre, Wickhams
 Cay II, Road Town, Tortola, Virgin Islands
 (British)
 (580) 2022 03 04

(111) M 2001 13918 R
 (732) Netco United Pte. Ltd
 120 Lower Delta Road, #15-10, Cendex
 Centre, 169208, Singapore

(770) N.E.T. Co. United S.A.
 Vistra Corporate Services Centre, Wickhams
 Cay II, Road Town, Tortola VG1110, Virgin
 Islands (British)
 (580) 2022 03 04

(111) M 2001 13919 R
 (732) Netco United Pte. Ltd
 120 Lower Delta Road, #15-10, Cendex
 Centre, 169208, Singapore
 (770) N.E.T. Co. United S.A.
 Vistra Corporate Services Centre, Wickhams
 Cay II, Road Town, Tortola VG1110, Virgin
 Islands (British)
 (580) 2022 03 04

(111) M 2001 13920 R
 (732) Netco United Pte. Ltd
 120 Lower Delta Road, #15-10, Cendex
 Centre, 169208, Singapore
 (770) N.E.T. Co. United S.A.
 Vistra Corporate Services Centre, Wickhams
 Cay II, Road Town, Tortola VG1110, Virgin
 Islands (British)
 (580) 2022 03 04

(111) M 2002 14295 R
 (732) N.V. Organon
 Kloosterstraat 6, 5349 AB Oss, Netherlands
 (770) MSD International Holdings GmbH
 Veystrasse 20, CH-6000, Lucerne 6,
 Switzerland
 (580) 2022 02 24

(111) M 2002 14300 R
 (732) N.V. Organon
 Kloosterstraat 6, 5349 AB Oss, Netherlands
 (770) MSD International Holdings GmbH
 Veystrasse 20, CH-6000, Lucerne 6,
 Switzerland
 (580) 2022 02 24

(111) M 2002 14383 R
 (732) N.V. Organon
 Kloosterstraat 6, 5349 AB Oss, Netherlands
 (770) Merck Sharp & Dohme Corp.
 One Merck Drive, Whitehouse Station,
 New Jersey 08889, USA
 (580) 2022 02 24

(111) M 2003 15057 R
 (732) N.V. Organon
 Kloosterstraat 6, 5349 AB Oss, Netherlands
 (770) MSD International Holdings GmbH
 Veystrasse 20, CH-6000, Lucerne 6,
 Switzerland
 (580) 2022 02 24

(111) M 2003 15058 R
 (732) N.V. Organon
 Kloosterstraat 6, 5349 AB Oss, Netherlands
 (770) MSD International Holdings GmbH
 Veystrasse 20, CH-6000, Lucerne 6,
 Switzerland
 (580) 2022 02 24

(111) M 1994 59 R
 (732) Ebaut, Ink.
 28 Liberty Street, New York, New York
 10005, USA
 (770) Advance Magazine Publishers Inc.
 Four Times Square, New York, N. Y.
 10036, USA
 (580) 2022 02 24

(111) M 1995 1143 R
 (732) N.V. Organon
 Kloosterstraat 6, 5349 AB Oss, Netherlands
 (770) Merck Sharp & Dohme Corp.
 One Merck Drive, Whitehouse Station,
 New Jersey 08889, USA
 (580) 2022 02 24

(111) M 1996 2687 R
 (732) N.V. Organon
 Kloosterstraat 6, 5349 AB Oss, Netherlands
 (770) Merck Sharp & Dohme Corp.
 One Merck Drive, Whitehouse Station,
 New Jersey 08889, USA
 (580) 2022 02 24

(111) M 1996 2493 R
 (732) N.V. Organon
 Kloosterstraat 6, 5349 AB Oss, Netherlands
 (770) Merck Sharp & Dohme Corp.
 One Merck Drive, Whitehouse Station,
 New Jersey 08889, USA
 (580) 2022 02 24

(111) M 1995 786 R
 (732) N.V. Organon
 Kloosterstraat 6, 5349 AB Oss, Netherlands
 (770) Merck Sharp & Dohme Corp.

One Merck Drive, Whitehouse Station,
 New Jersey 08889, USA
 (580) 2022 02 24

(111) M 1995 785 R
 (732) N.V. Organon
 Kloosterstraat 6, 5349 AB Oss, Netherlands
 (770) Merck Sharp & Dohme Corp.
 One Merck Drive, Whitehouse Station,
 New Jersey 08889, USA
 (580) 2022 02 24

(111) M 1995 768 R
 (732) N.V. Organon
 Kloosterstraat 6, 5349 AB Oss, Netherlands
 (770) Merck Sharp & Dohme Corp.
 One Merck Drive, Whitehouse Station,
 New Jersey 08889, USA
 (580) 2022 02 24

(111) M 1996 2932 R
 (732) N.V. Organon
 Kloosterstraat 6, 5349 AB Oss, Netherlands
 (770) Merck Sharp & Dohme Corp.
 One Merck Drive, Whitehouse Station,
 New Jersey 08889, USA
 (580) 2022 02 24

(111) M 1995 1170 R
 (732) N.V. Organon
 Kloosterstraat 6, 5349 AB Oss, Netherlands
 (770) Merck Sharp & Dohme Corp.
 One Merck Drive, Whitehouse Station,
 New Jersey 08889, USA
 (580) 2022 02 24

(111) M 1995 1169 R
 (732) N.V. Organon
 Kloosterstraat 6, 5349 AB Oss, Netherlands
 (770) Merck Sharp & Dohme Corp.
 One Merck Drive, Whitehouse Station,
 New Jersey 08889, USA
 (580) 2022 02 24

(111) M 1995 1177 R
 (732) N.V. Organon
 Kloosterstraat 6, 5349 AB Oss, Netherlands
 (770) Merck Sharp & Dohme Corp.
 One Merck Drive, Whitehouse Station,
 New Jersey 08889, USA
 (580) 2022 02 24

(111) M 2013 23668 R
(732) Thai Energy Storage Technology Public
Company Limited
387 Moo 4, Sukhumvit Road, Phraek Sa
Sub-district, Mueang Samut Prakan District,
Samut Prakan Province, Thailand
(770) Hitachi Chemical Storage Battery (Thailand)
Public Company Limited
387 Moo 4, Soi Pattana 3, Sukhumvit Road,
Bangpoo Industrial Estate, Praekasa
Samutprakarn 10280, Thailand
(580) 2022 03 01

(111) M 2013 23669 R
(732) Thai Energy Storage Technology Public
Company Limited
387 Moo 4, Sukhumvit Road, Phraek Sa
Sub-district, Mueang Samut Prakan District,
Samut Prakan Province, Thailand
(770) Hitachi Chemical Storage Battery (Thailand)
Public Company Limited
387 Moo 4, Soi Pattana 3, Sukhumvit Road,
Bangpoo Industrial Estate, Praekasa
Samutprakarn 10280, Thailand
(580) 2022 03 01

(111) M 2013 23613 R
(732) Thai Energy Storage Technology Public
Company Limited
387 Moo 4, Sukhumvit Road, Phraek Sa
Sub-district, Mueang Samut Prakan District,
Samut Prakan Province, Thailand
(770) Hitachi Chemical Storage Battery (Thailand)
Public Company Limited
387 Moo 4, Soi Pattana 3, Sukhumvit Road,
Bangpoo Industrial Estate, Praekasa
Samutprakarn 10280, Thailand
(580) 2022 03 01

(111) M 2013 23670 R
(732) Thai Energy Storage Technology Public
Company Limited
387 Moo 4, Sukhumvit Road, Phraek Sa
Sub-district, Mueang Samut Prakan District,
Samut Prakan Province, Thailand
(770) Hitachi Chemical Storage Battery (Thailand)
Public Company Limited
387 Moo 4, Soi Pattana 3, Sukhumvit Road,
Bangpoo Industrial Estate, Praekasa
Samutprakarn 10280, Thailand
(580) 2022 03 01

(111) M 1999 12101 R
(732) N.V. Organon
Kloosterstraat 6, 5349 AB Oss, Netherlands
(770) Merck Sharp & Dohme B.V
Waarderweg 39, 2013 BN Haarlem,
Netherlands
(580) 2022 02 24

(111) M 2014 24921 R
(732) N.V. Organon
Kloosterstraat 6, 5349 AB Oss, Netherlands
(770) Merck Sharp & Dohme B.V
Waarderweg 39, Haarlem 2013 BN,
Netherlands
(580) 2022 02 24

(111) M 2014 24922 R
(732) N.V. Organon
Kloosterstraat 6, 5349 AB Oss, Netherlands
(770) Merck Sharp & Dohme B.V
Waarderweg 39, Haarlem 2013 BN,
Netherlands
(580) 2022 02 24

(111) M 2014 25274 R
(732) N.V. Organon
Kloosterstraat 6, 5349 AB Oss, Netherlands
(770) Merck Sharp & Dohme B.V
Waarderweg 39, Haarlem 2013 BN,
Netherlands
(580) 2022 02 24

(111) M 2015 25684 R
(732) N.V. Organon
Kloosterstraat 6, 5349 AB Oss, Netherlands
(770) Merck Sharp & Dohme Corp.
One Merck Drive, Whitehouse Station,
New Jersey 08889, USA
(580) 2022 02 24

(111) M 2015 25584 R
(732) N.V. Organon
Kloosterstraat 6, 5349 AB Oss, Netherlands
(770) Merck Sharp & Dohme B.V
Waarderweg 39, Haarlem 2013 BN,
Netherlands
(580) 2022 02 24

- (111) M 2016 26917 R
(732) Caisse Federale de Credit Mutuel
4 rue Frédéric-Guillaume Raiffeisen 67000
Strasbourg, France
(770) Groupe Monetico International Inc.
1, Kompleqs Desjardini, 36 Etaji, Tur Siudi,
Monreali, Kvebeki H5B 1B2, Canada
(580) 2022 02 04
-

- (111) M 1997 5558 R
(732) Onkyo Technology Kabushiki Kaisha
1-1-41 Kawamata, Higashiosaka-shi, Osaka,
577-0063, Japan
(770) Onkyo Home Entertainment
Corporation
1-1-41 Kawamata, Higashiosaka-shi, Osaka,
Japan
(580) 2022 03 01
-

CHANGES OF NAMES AND/OR ADDRESSES OF TRADEMARKS OWNER

- (111) M 2021 34577 R
(732) Ontex Tüketim Ürünleri Sanayi
Ve Ticaret Anonim Sirketi
Selimpşa Mah. 6093 Soc. N78, Istanbul,
Turkey
(770) Ontex Tüketim Ürünleri Sanayi
Ve Ticaret Anonim Sirketi
Oruç Reis Mah. Teqstilqent Jad. Qoza Plaza
A Bloq, Qar.: 2 Esenleri, İstanbul, Turkey
(580) 2022 02 08
-

- (111) M 2004 15554 R
(732) N.E.T. CO. United S.A.
Vistra Corporate Services Centre, Wickhams
Cay II, Road Town, Tortola, VG 1110,
Virgin Islands (British)
(770) N.E.T. CO. United S.A.
Offshore Incorporations Limited of P.O.
Box 957, Offshore Incorporations Centre,
Road Town, Tortola, Virgin Islands (British)
(580) 2022 03 04
-

- (111) M 2010 20335 R
(732) Ontex Tüketim Urunleri Sanayi ve Ticaret
Anonim Şirketi
Selimpşa Mah. 6093 Soc. N78, Istanbul,
Turkey
(770) Ontex Tüketim Urunleri Sanayi ve Ticaret
Anonim Şirketi

- Oruç Reis Mah., Tekstil Kent Cad. Koza Plaza
A Blk, No:12B İç K.N:021-022-024 Esenler-
İstanbul, Turkey
(580) 2022 01 26
-

- (111) M 2012 22876 R
(732) Playboy Enterprises International, Inc.
10960 Wilshire Blvd., Suite 2200, Los
Angeles, California 90024, USA
(770) Playboy Enterprises International, Inc.
680 North Lake Shore Drive Chicago,
Illinois 60611, USA
(580) 2022 03 04
-

- (111) M 2012 22877 R
(732) Playboy Enterprises International, Inc.
10960 Wilshire Blvd., Suite 2200,
Los Angeles, California 90024, USA
(770) Playboy Enterprises International, Inc.
680 North Lake Shore Drive Chicago,
Illinois 60611, USA
(580) 2022 03 04
-

- (111) M 2013 23668 R
(732) Hitachi Chemical Storage Battery (Thailand)
Public Company Limited
387 Moo 4, Soi Pattana 3, Sukhumvit Road,

Bangpoo Industrial Estate, Praekasa
Samutprakarn 10280, Thailand
(770) Thai Storage Battery Public Company Limited
387 Moo 4, Soi Pattana 3, Sukhumvit Road,
Bangpoo Industrial Estate, Praekasa
Samutprakarn 10280, Thailand
(580) 2022 03 01

(111) M 2013 23669 R
(732) Hitachi Chemical Storage Battery (Thailand)
Public Company Limited
387 Moo 4, Soi Pattana 3, Sukhumvit Road,
Bangpoo Industrial Estate, Praekasa
Samutprakarn 10280, Thailand
(770) Thai Storage Battery Public Company Limited
387 Moo 4, Soi Pattana 3, Sukhumvit Road,
Bangpoo Industrial Estate, Praekasa
Samutprakarn 10280, Thailand
(580) 2022 03 01

(111) M 2013 23613 R
(732) Hitachi Chemical Storage Battery (Thailand)
Public Company Limited
387 Moo 4, Soi Pattana 3, Sukhumvit Road,
Bangpoo Industrial Estate, Praekasa
Samutprakarn 10280, Thailand
(770) Thai Storage Battery Public Company Limited
387 Moo 4, Soi Pattana 3, Sukhumvit Road,
Bangpoo Industrial Estate, Praekasa
Samutprakarn 10280, Thailand
(580) 2022 03 01

(111) M 2013 23670 R
(732) Hitachi Chemical Storage Battery (Thailand)
Public Company Limited
387 Moo 4, Soi Pattana 3, Sukhumvit Road,
Bangpoo Industrial Estate, Praekasa
Samutprakarn 10280, Thailand
(770) Thai Storage Battery Public Company Limited
387 Moo 4, Soi Pattana 3, Sukhumvit Road,
Bangpoo Industrial Estate, Praekasa
Samutprakarn 10280, Thailand
(580) 2022 03 01

(111) M 2018 29432 R
(732) AO "Dominanta-Service"
142100, Moskovskaia Oblast, Gorod Podolsk,
Ul. Komsomolskaia, d. 1, Stroenie 49,
Pomeschenie 1, Komnata 223, Russian
Federation
(770) ZAO "Dominanta-Service"
142100, Moskovskaia Oblast, Gorod Podolsk,
Ul. Komsomolskaia, d. 1, Russian Federation
(580) 2022 03 01

(111) M 2017 28602 R
(732) LTD "Odrex Software"
Tashenti Str., Lane 4, app. 16, 0160,
Tbilisi, Georgia
(770) LTD "Odrex Software"
Ghrmaghele Str. 3, 0192, Tbilisi, Georgia
(580) 2022 03 10

(111) M 1997 5558 R
(732) Onkyo Home Entertainment Corporation
1-1-41 Kawamata, Higashiosaka-shi, Osaka,
Japan
(770) Onkyo Kabushiki Kaisha (Onkyo Corporation)
1-go, 2-ban, Nisshin-cho, Neyagawa-shi,
Osaca-fu, Japan
(580) 2022 03 01

CANCELLATION OF TRADEMARKS REGISTRATION

(111) M 2011 21730 R
(151) 2011 08 29
(732) Harrington Development Inc.
Elvira Mendez Street, Vallarino bldg.,
3rd Floor, Panama, Republic of Panama
(141) 2022 03 09

(111) M 2011 21731 R
(151) 2011 08 29
(732) RCF S.p.A.
Via Raffaello, 13, 42124, Rejio Emilia, Italy
(141) 2022 03 14

(111) M 2011 21732 R
(151) 2011 09 09
(732) Levan Alapishvili
Temka settlement, IV mcr., bld. 2, app. 37,
0197, Tbilisi, Georgia
(141) 2022 03 17

(111) M 2014 24565 R
(151) 2014 03 12
(732) OOO "Best Clean"
Proektiruemyy proezd 251, vl. 2, 142700,
Vidnoe, Nord Promzona Territory,
Moscow Region, Lenin District, Russian
Federation
(141) 2022 03 17 – The request of the owner

CHANGE OF THE LIST OF GOODS AND/OR SERVICE OF TRADEMARK

(111) M 2021 34698 R
(732) Kraft Foods Schweiz Holding GmbH
Chollerstrasse 4, Zug 6300, Switzerland
(511) 30
(580) 2022 02 21

CLASSIFICATION INDEXES

INVENTIONS

CONCORDANCE TABLE OF INTERNATIONAL CLASSIFICATION INDEX AND PUBLICATION NUMBERS

INTERNATIONAL CLASSIFICATION INDEXES (51)	NUMBER OF PUBLISHED APPLICATION (10)
A 61 K 31/585; A 61 K 31/57; A 61 K 31/55; A 61 K 31/565; A 61 P 5/30	AP 2022 15476 A
A 61 K 31/858; A 61 K 31/57; A 61 K 31/55; A 61 K 31/565; A 61 P 5/30	AP 2022 15472 A
A 61 M 16/00	AP 2022 15497 A

CONCORDANCE TABLE OF PUBLICATION NUMBERS AND INTERNATIONAL CLASSIFICATION INDEX

NUMBER OF PUBLISHED APPLICATION (10)	INTERNATIONAL CLASSIFICATION INDEXES (51)
AP 2022 15472 A	A 61 K 31/858; A 61 K 31/57; A 61 K 31/55; A 61 K 31/565; A 61 P 5/30
AP 2022 15476 A	A 61 K 31/585; A 61 K 31/57; A 61 K 31/55; A 61 K 31/565; A 61 P 5/30
AP 2022 15497 A	A 61 M 16/00

CONCORDANCE TABLE OF INTERNATIONAL CLASSIFICATION INDEX, PATENT NUMBERS AND PUBLICATION NUMBERS

INTERNATIONAL CLASSIFICATION INDEX (51)	NUMBER OF PATENT (11)	NUMBER OF PUBLISHED APPLICATION (10)
A 61 K 31/437; A 61 K 31/4375; A 61 K 31/444; A 61 K 31/4709; A 61 K 31/497; A 61 K 31/506; A 61 K 45/06; A 61 P 11/00; A 61 P 9/10; C 07 D 519/00; C 07 D 471/04	P 2022 7365 B	AP 2021 14952 A
A 61 K 31/4995; A 61 K 31/5386; A 61 P 11/00; A 61 P 25/00; C 07 D 471/08; C 07 D 498/08	P 2022 7366 B	AP 2021 15256 A
A 61 K 36/00	P 2022 7364 B	AP 2021 15561 A
C 07 D 209/14; C 07 D 209/16; Z 61 K 31/4045; Z 61 P 25/28	P 2022 7368 B	AP 2022 14363 A
F 02 B 75/04; F 02 D 15/00	P 2021 7367 B	AP 2021 15405 A

**CONCORDANCE TABLE OF PATENT NUMBERS,
PUBLICATION NUMBERS AND INTERNATIONAL CLASSIFICATION INDEX**

NUMBER OF PATENT (11)	NUMBER OF PUBLISHED APPLICATION (10)	INTERNATIONAL CLASSIFICATION INDEX (51)
P 2022 7364 B	AP 2021 15561 A	A 61 K 36/00
P 2022 7365 B	AP 2021 14952 A	A 61 K 31/437; A 61 K 31/4375; A 61 K 31/444; A 61 K 31/4709; A 61 K 31/497; A 61 K 31/506; A 61 K 45/06; A 61 P 11/00; A 61 P 9/10; C 07 D 519/00; C 07 D 471/04
P 2022 7366 B	AP 2021 15256 A	A 61 K 31/4995; A 61 K 31/5386; A 61 P 11/00; A 61 P 25/00; C 07 D 471/08; C 07 D 498/08
P 2022 7367 B	AP 2021 15405 A	F 02 B 75/04; F 02 D 15/00
P 2022 7368 B	AP 2021 14363 A	C 07 D 209/14; C 07 D 209/16; Z 61 K 31/4045; Z 61 P 25/28

**CONCORDANCE TABLE OF APPLICATION NUMBERS,
PUBLICATION NUMBERS AND PATENTS**

NUMBER OF APPLICATION (21)	NUMBER OF PUBLISHED APPLICATION (10)	NUMBER OF PATENT (11)
AP 2015 14363	AP 2021 14363 A	P 2022 7368 B
AP 2017 14952	AP 2021 14952 A	P 2022 7365 B
AP 2018 15256	AP 2021 15256 A	P 2022 7366 B
AP 2020 15405	AP 2021 15405 A	P 2022 7367 B
AP 2021 15561	AP 2021 15561 A	P 2022 7364 B

UTILITY MODELS

**CONCORDANCE TABLE OF INTERNATIONAL CLASSIFICATION INDEX,
PATENT NUMBERS AND PUBLICATION NUMBERS**

INTERNATIONAL CLASSIFICATION INDEX (51)	NUMBER OF PATENT (11)	NUMBER OF PUBLISHED APPLICATION (10)
C 04 B 35/32; H 01 L 39/00	U 2022 2112 Y	AU 2021 15487 U

**CONCORDANCE TABLE OF PATENT NUMBERS,
PUBLICATION NUMBERS AND INTERNATIONAL CLASSIFICATION INDEX**

NUMBER OF PATENT (11)	NUMBER OF PUBLISHED APPLICATION (10)	INTERNATIONAL CLASSIFICATION INDEX (51)
U 2022 2112 Y	AU 2021 15487 U	C 04 B 35/32; H 01 L 39/00

**CONCORDANCE TABLE OF APPLICATION NUMBERS,
PUBLICATION NUMBERS AND PATENTS**

NUMBER OF APPLICATION (21)	NUMBER OF PUBLISHED APPLICATION (10)	NUMBER OF PATENT (11)
AU 2020 15487	AU 2021 15487 U	U 2022 2112 Y

DESIGNS

**CONCORDANCE TABLE OF INTERNATIONAL CLASSIFICATION INDEX,
NUMBERS OF REGISTRATION AND PUBLICATION NUMBERS**

INTERNATIONAL CLASSIFICATION INDEX (51)	NUMBER OF REGISTRATION (11)	NUMBER OF PUBLISHED APPLICATION (10)
06-10	D 2022 929 S	AD 2021 1224 S
09-03	D 2022 930 S	AD 2021 1226 S
11-02	D 2022 927 S	AD 2021 1231 S
12-08	D 2022 928 S	AD 2021 1217 S

**CONCORDANCE TABLE OF NUMBERS OF REGISTRATION,
PUBLICATION NUMBERS AND INTERNATIONAL CLASSIFICATION INDEX**

NUMBER OF REGISTRATION (11)	NUMBER OF PUBLISHED APPLICATION (10)	INTERNATIONAL CLASSIFICATION INDEX (51)
D 2022 927 S	AD 2021 1231 S	11-02
D 2022 928 S	AD 2021 1217 S	12-08
D 2022 929 S	AD 2021 1224 S	06-10
D 2022 930 S	AD 2021 1226 S	09-03

**CONCORDANCE TABLE OF APPLICATION NUMBERS,
PUBLICATION NUMBERS AND NUMBERS OF REGISTRATION**

NUMBER OF APPLICATION (21)	NUMBER OF PUBLISHED APPLICATION (10)	NUMBER OF REGISTRATION (11)
AD 2021 1217	AD 2021 1217 S	D 2022 928 S
AD 2021 1224	AD 2021 1224 S	D 2022 929 S
AD 2021 1226	AD 2021 1226 S	D 2022 930 S
AD 2021 1231	AD 2021 1231 S	D 2022 927 S

DESIGNS REGISTERED ACCORDING TO THE ACCELERATED PROCEDURE

CONCORDANCE TABLE OF INTERNATIONAL CLASSIFICATION INDEX AND PUBLICATION NUMBERS

INTERNATIONAL CLASSIFICATION INDEXES (51)	NUMBER OF REGISTRATION (11)
09-03	D 2022 926 S
11-01	D 2022 931 S

CONCORDANCE TABLE OF PUBLICATION NUMBERS AND INTERNATIONAL CLASSIFICATION INDEX

NUMBER OF REGISTRATION (11)	INTERNATIONAL CLASSIFICATION INDEXES (51)
D 2022 926 S	09-03
D 2022 931 S	11-01

CONCORDANCE TABLE OF APPLICATION NUMBERS, PUBLICATION NUMBERS AND PATENTS

NUMBER OF APPLICATION (21)	NUMBER OF REGISTRATION (11)
AD 2021 1253	D 2022 926 S
AD 2022 1259	D 2022 931 S

TRADEMARKS

CONCORDANCE TABLE OF REGISTRATION NUMBERS, APPLICATION NUMBERS, PUBLICATION NUMBERS AND BULLETIN NUMBERS

NUMBER OF REGISTRATION (111)	NUMBER OF APPLICATIONS (210)	NUMBER OF PUBLISHED APPLICATIONS (260)	NUMBER OF BULLETIN
1	2	3	4
M 2022 35119 R	AM 116667	–	6(585)2022
M 2022 35120 R	AM 116759	–	6(585)2022
M 2022 35121 R	AM 116662	–	6(585)2022
M 2022 35122 R	AM 116760	–	6(585)2022
M 2022 35123 R	AM 116656	–	6(585)2022
M 2022 35124 R	AM 116539	–	6(585)2022
M 2022 35125 R	AM 116963	–	6(585)2022
M 2022 35126 R	AM 109506	AM 2021 109506 A	21(577)2021
M 2022 35127 R	AM 110201	AM 2021 110201 A	22(578)2021
M 2022 35128 R	AM 110383	AM 2021 110383 A	10(566)2021
M 2022 35129 R	AM 110602	AM 2021 110602 A	16(572)2021
M 2022 35130 R	AM 110858	AM 2021 110858 A	13(569)2021
M 2022 35131 R	AM 110981	AM 2021 110981 A	14(570)2021
M 2022 35132 R	AM 111062	AM 2021 111062 A	16(572)2021
M 2022 35133 R	AM 111278	AM 2021 111278 A	15(571)2021
M 2022 35134 R	AM 111422	AM 2021 111422 A	15(571)2021
M 2022 35135 R	AM 111435	AM 2021 111435 A	16(572)2021
M 2022 35136 R	AM 111511	AM 2021 111511 A	15(571)2021
M 2022 35137 R	AM 111513	AM 2021 111513 A	15(571)2021
M 2022 35138 R	AM 111607	AM 2021 111607 A	16(572)2021
M 2022 35139 R	AM 111698	AM 2021 111698 A	16(572)2021
M 2022 35140 R	AM 111703	AM 2021 111703 A	16(572)2021
M 2022 35141 R	AM 111939	AM 2021 111939 A	19(575)2021
M 2022 35142 R	AM 111942	AM 2021 111942 A	18(574)2021
M 2022 35143 R	AM 111971	AM 2021 111971 A	19(575)2021
M 2022 35144 R	AM 111972	AM 2021 111972 A	19(575)2021
M 2022 35145 R	AM 112171	AM 2021 112171 A	19(575)2021
M 2022 35146 R	AM 112182	AM 2021 112182 A	20(576)2021
M 2022 35147 R	AM 112191	AM 2021 112191 A	20(576)2021
M 2022 35148 R	AM 112253	AM 2021 112253 A	20(576)2021
M 2022 35149 R	AM 112279	AM 2021 112279 A	20(576)2021
M 2022 35150 R	AM 112283	AM 2021 112283 A	20(576)2021
M 2022 35151 R	AM 112300	AM 2021 112300 A	19(575)2021
M 2022 35152 R	AM 112312	AM 2021 112312 A	20(576)2021
M 2022 35153 R	AM 112365	AM 2021 112365 A	21(577)2021
M 2022 35154 R	AM 112387	AM 2021 112387 A	20(576)2021
M 2022 35155 R	AM 112390	AM 2021 112390 A	20(576)2021
M 2022 35156 R	AM 112401	AM 2021 112401 A	20(576)2021
M 2022 35157 R	AM 112406	AM 2021 112406 A	21(577)2021
M 2022 35158 R	AM 112408	AM 2021 112408 A	21(577)2021
M 2022 35159 R	AM 112419	AM 2021 112419 A	21(577)2021
M 2022 35160 R	AM 112485	AM 2021 112485 A	20(576)2021
M 2022 35161 R	AM 112489	AM 2021 112489 A	21(577)2021
M 2022 35162 R	AM 112490	AM 2021 112490 A	21(577)2021
M 2022 35163 R	AM 112493	AM 2021 112493 A	21(577)2021

1	2	3	4
M 2022 35164 R	AM 112499	AM 2021 112499 A	20(576)2021
M 2022 35165 R	AM 112510	AM 2021 112510 A	20(576)2021
M 2022 35166 R	AM 112577	AM 2021 112577 A	21(577)2021
M 2022 35167 R	AM 112578	AM 2021 112578 A	21(577)2021
M 2022 35168 R	AM 112587	AM 2021 112587 A	20(576)2021
M 2022 35169 R	AM 112595	AM 2021 112595 A	20(576)2021
M 2022 35170 R	AM 112596	AM 2021 112596 A	21(577)2021
M 2022 35171 R	AM 112597	AM 2021 112597 A	20(576)2021
M 2022 35172 R	AM 112598	AM 2021 112598 A	21(577)2021
M 2022 35173 R	AM 112607	AM 2021 112607 A	20(576)2021
M 2022 35174 R	AM 112609	AM 2021 112609 A	20(576)2021
M 2022 35175 R	AM 112626	AM 2021 112626 A	21(577)2021
M 2022 35176 R	AM 112628	AM 2021 112628 A	20(576)2021
M 2022 35177 R	AM 112674	AM 2021 112674 A	21(577)2021
M 2022 35178 R	AM 112701	AM 2021 112701 A	21(577)2021
M 2022 35179 R	AM 112714	AM 2021 112714 A	20(576)2021
M 2022 35180 R	AM 112716	AM 2021 112716 A	20(576)2021
M 2022 35181 R	AM 112719	AM 2021 112719 A	20(576)2021
M 2022 35182 R	AM 112721	AM 2021 112721 A	20(576)2021
M 2022 35183 R	AM 112929	AM 2021 112929 A	21(577)2021
M 2022 35184 R	AM 108503	AM 2021 108503 A	15(571)2021
M 2022 35185 R	AM 104205	AM 2021 104205 A	17(573)2021
M 2022 35186 R	AM 110482	AM 2021 110482 A	16(572)2021
M 2022 35187 R	AM 111586	AM 2021 111586 A	16(572)2021
M 2022 35188 R	AM 111604	AM 2021 111604 A	16(572)2021
M 2022 35189 R	AM 112164	AM 2021 112164 A	19(575)2021
M 2022 35190 R	AM 112710	AM 2021 112710 A	22(578)2021
M 2022 35191 R	AM 112722	AM 2021 112722 A	22(578)2021
M 2022 35192 R	AM 113009	AM 2021 113009 A	22(578)2021
M 2022 35193 R	AM 113113	AM 2021 113113 A	22(578)2021
M 2022 35194 R	AM 116984	–	6(585)2022
M 2022 35195 R	AM 116847	–	6(585)2022
M 2022 35196 R	AM 116956	–	6(585)2022
M 2022 35197 R	AM 87174	AM 2019 87174 A	4(512)2019
M 2022 35198 R	AM 88279	AM 2019 88279 A	4(512)2019
M 2022 35199 R	AM 117072	–	6(585)2022

**CONCORDANCE TABLE OF PUBLICATION NUMBERS
AND APPLICATION NUMBERS**

NUMBER OF PUBLISHED APPLICATION (260)	NUMBER OF APPLICATION (210)	1	2
		1	2
AM 2022 111416 A	AM 111416	AM 2022 114218 A	AM 114218
AM 2022 111717 A	AM 111717	AM 2022 114237 A	AM 114237
AM 2022 113881 A	AM 113881	AM 2022 114245 A	AM 114245
AM 2022 114133 A	AM 114133	AM 2022 114246 A	AM 114246
AM 2022 114144 A	AM 114144	AM 2022 114322 A	AM 114322
AM 2022 114151 A	AM 114151	AM 2022 114324 A	AM 114324
AM 2022 114216 A	AM 114216	AM 2022 114342 A	AM 114342
AM 2022 114217 A	AM 114217	AM 2022 114344 A	AM 114344
		AM 2022 114393 A	AM 114393
		AM 2022 114396 A	AM 114396
		AM 2022 114397 A	AM 114397
		AM 2022 114398 A	AM 114398
		AM 2022 114408 A	AM 114408

CONCORDANCE TABLE OF INDEX OF GOODS AND/OR SERVICES
AND APPLICATION NUMBERS

INDEX OF GOODS AND/OR SERVICES (511)	NUMBER OF PUBLISHED APPLICATIONS (260)	1	2
1	2	32	AM 2022 114133 A
1	AM 2022 114144 A	32	AM 2022 114322 A
1	AM 2022 114216 A	33	AM 2022 114322 A
3	AM 2022 114324 A	33	AM 2022 114396 A
5	AM 2022 111416 A	33	AM 2022 114397 A
5	AM 2022 114144 A	33	AM 2022 114398 A
5	AM 2022 114216 A	34	AM 2022 114344 A
5	AM 2022 114218 A	35	AM 2022 111717 A
5	AM 2022 114218 A	35	AM 2022 114216 A
5	AM 2022 114324 A	35	AM 2022 114218 A
5	AM 2022 114342 A	35	AM 2022 114245 A
8	AM 2022 114393 A	38	AM 2022 114245 A
9	AM 2022 114216 A	39	AM 2022 114216 A
9	AM 2022 114218 A	39	AM 2022 114218 A
9	AM 2022 114218 A	39	AM 2022 114237 A
10	AM 2022 114216 A	39	AM 2022 114245 A
12	AM 2022 114151 A	39	AM 2022 114246 A
12	AM 2022 114245 A	41	AM 2022 114216 A
12	AM 2022 114246 A	41	AM 2022 114218 A
13	AM 2022 113881 A	41	AM 2022 114245 A
16	AM 2022 114245 A	41	AM 2022 114322 A
19	AM 2022 111717 A	42	AM 2022 114216 A
30	AM 2022 114133 A	42	AM 2022 114218 A
30	AM 2022 114237 A	43	AM 2022 114245 A
31	AM 2022 114217 A	43	AM 2022 114322 A
31	AM 2022 114408 A	44	AM 2022 114216 A
		44	AM 2022 114218 A

CONCORDANCE TABLE OF INDEX OF GOODS AND/OR SERVICES
AND NUMBERS OF TRADEMARKS REGISTERED ACCORDING
TO THE ACCELERATED PROCEDURE

INDEX OF GOODS AND/OR SERVICES (511)	NUMBERS OF REGISTERED ACCORDING TO THE ACCELERATED PROCEDURE (111)
5	M 2022 35195 R
5	M 2022 35196 R
7	M 2022 35121 R
25	M 2022 35119 R
28	M 2022 35119 R
32	M 2022 35120 R
32	M 2022 35122 R
33	M 2022 35195 R
35	M 2022 35123 R
35	M 2022 35196 R
36	M 2022 35123 R
36	M 2022 35124 R
36	M 2022 35125 R
36	M 2022 35194 R
37	M 2022 35123 R
41	M 2022 35195 R
43	M 2022 35195 R
43	M 2022 35199 R
44	M 2022 35195 R

OFFICIAL BULLETIN OF THE INDUSTRIAL PROPERTY

INVENTIONS
UTILITY MODELS
DESIGNS
TRADEMARKS

6(585)

EDITOR-IN-CHIEF: N. Bebrishvili

EDITOR-TRANSLATOR: E. Gabunia

PROOFREADER: A. Shikhashvili

COMPUTER LAYOUT: M. Ordenidze
K. Svanidze

info@sakpatenti.gov.ge
www.sakpatenti.gov.ge