

Official Bulletin of the Industrial Property

Inventions

Utility Models

Designs

Trademarks



საქართველოს ინტელექტუალური
საკუთრების ეროვნული ცენტრი

საქპატენტი

SAKPATENTI
NATIONAL INTELLECTUAL PROPERTY
CENTER OF GEORGIA

www.sakpatenti.gov.ge

Date of Publication – 2022 04 11

7(586)

INID CODES FOR IDENTIFICATION OF BIBLIOGRAPHIC DATA

INVENTIONS, UTILITY MODELS

- (10) Number of publication for application, which has been examined
- (11) Number of patent and kind of document
- (21) Serial number of application
- (22) Date of filing of the application
- (23) Date of exhibition or the date of the earlier filing and the number of application, if any
- (24) Date from which patent may have effect
- (31) Number of priority application
- (32) Date of filing of priority application
- (33) Code of the country or regional organization allotting priority application number
- (44) Date of publication of application not granted, but examined and number of bulletin
- (45) Date of publication of registered document
- (51) International Patent Classification Index

- (54) Title of the invention
- (57) Abstract
- (60) Number of examined patent document granted by foreign patent office, date from which patent has effect and country code
- (62) Number of the earlier application and in case of divided application, date of filing an application
- (71) Name, surname and address of applicant (country code)
- (72) Name, surname of inventor (country code)
- (73) Name, surname and address of patent owner (country code)
- (74) Name, surname of representative or patent attorney
- (85) Date of commencement of the national phase of International Application
- (86) Number and date of filing of international application
- (87) Number and date of publication of international application
- (94) Calculated date of expiry of the SPC or the duration of the SPC

DESIGNS

- (10) Number of publication for application
- (11) Number of patent and kind of document or number of registration
- (15) Date of registration/Date of patent renewal
- (18) Expected expiration date of patent or registration
- (21) Serial number of application
- (22) Date of filing of the application
- (23) Date of exhibition or the date of the earlier filing and the number of application, if any
- (24) Date from which patent may have effect
- (28) Number of designs included in the application
- (30) Data relating to priority (number of application, date of filing of application, two-letter code identifying the authority with whom the priority application was made)
- (31) Number of priority application
- (32) Date of filing of priority application
- (33) Code of the country or regional organization allotting priority application number
- (34) Two-letter code according to WIPO St.3 identifying the authority with which the priority application was made
- (44) Date of publication of design and number of bulletin (the first publication)
- (45) Date of publication of design registered by WIPO and number of bulletin

- (51) International Classification for designs (class and subclass of the Locarno Classification)
- (54) Title of the invention
- (55) Reproduction of the design
- (57) Description of characteristic features of the design including indication of colors
- (58) Date of recording of any kind of amendment in the Register
- (62) Number of the earlier application, registration and document number and if available the date of filing an application in case of divided application
- (71) Name, surname and address of applicant (country code)
- (72) Name, surname of creator (country code)
- (73) Name, surname and address of patent owner (country code)
- (74) Name, surname of representative or patent attorney
- (81) Contracting states concerned
 - II designated contracting states according to the 1960 Act
 - III designated contracting states according to the 1999 Act
- (85) Owner's permanent address
- (86) Owner's nationality
- (87) Owner's residence
- (88) State in which the owner has a real and effective industrial or commercial establishment

TRADEMARKS

- (111) - Number of registration
- (151) - Date of registration
- (156) - Date of the renewal
- (181) - Expected expiration date of registration
- (186) - Renewal expiration date of registration
- (141) - Date of cancel of duration of the mark
- (210) - Serial number of application
- (220) - Date of filing of the application
- (230) - Data concerning exhibition
- (260) - Number of application, for which favorable decision of examination about registration has been taken (publication number)
- (310) - Number of the first application
- (320) - Date of filing of the first application
- (330) - Code, identifying national or regional Office where the first application was made
- (511) - International Classification of Goods and Services for the purposes of registration of trade marks and/or list of goods and/or services classified according thereto
- (526) - Disclaimer
- (531) - Description of figurative elements of Trade Marks according to the International Classification of the Figurative Elements of Marks

- (540) - Reproduction of Trade Mark
- (550) - Nature and kind of Trade Mark
- (551) - Indication to the effect that the mark is a collective mark, a certification mark or a guarantee mark
- (554) - Three-dimensional mark
- (580) - Date of recording of any kind changes in respect of applications or registrations
- (591) - Information concerning colors claimed
- (731) - Name and address of the applicant
- (732) - Name and address of the holder of the registration
- (740) - Name and address of the representative
- (750) - Addreses for correspondence
- (770) - Name and address of the previous applicant or holder in case of change in ownership
- (771) - Previous name and address of the applicant or holder in case of change in ownership
- (791) - Name and address of the licensee
- (793) - Indication of conditions and/or restrictions under the license (Type of license, number of license agreement, data of license, data of validity of license)
- (800) - Certain data relating to the international registration of Trade Marks under the Protocol Relating to Madrid Agreement (International registration number
- (852) - Partial cancellation of the list of goods and services
- (891) - Date of subsequent designation

CODES FOR PUBLICATION IN BULLETIN

- (21) AP 0000 000000 - serial number of application for invention
- (10) AP 0000 0000 A - number of published application for invention (first publication)
- (11) P 0000 0000 B - number of patent for invention (second publication)
- (21) API 0000 000000 - number of application for imported patent
- (11) PI 0000 0000 A - number of imported patent (first publication)
- (21) AU 0000 000000 - serial number of application for utility model
- (10) AU 0000 000 U - number of published application for utility model (first publication)
- (11) U 0000 000 Y - number of patent for utility model (second publication)
- (21) AD 0000 000000 - serial number of application for design
- (10) AD 0000 000 S - number of published application for design (first publication)
- (11) D 0000 000 S - registered design

INTERNATIONAL PATENT CLASSIFICATION FOR INVENTIONS AND UTILITY MODELS

- SECTION A - HUMAN NECESSITIES
- SECTION B - PERFORMING OPERATIONS; TRANSPORTING
- SECTION C - CHEMISTRY; METALLURGY
- SECTION D - TEXTILES; PAPER
- SECTION E - FIXED CONSTRUCTIONS
- SECTION F - MECHANICAL ENGINEERING; LIGHTING; HEATING; WEAPONS; BLASTING
- SECTION G - PHYSICS
- SECTION H - ELECTRICITY

-
- M - Trade Mark
 - (210) AM 0000 000000 - Serial number of application;
 - (260) AAM 0000 00000 A - Publication number of application;
 - (111) M 0000 00000 R - Number of registration;
 - (111) MMM0000 00000 Rn - Number of renewals, in which n=1,2,3;
 - (111) M 0000 00000 R(P) - Number of registration under partial assignment of rights
-

Official Bulletin of the Industrial Property

Inventions

Utility Models

Designs

Trademarks

CONTENT

PUBLISHED TITLES OF PROTECTION	3
INVENTIONS	
▪ APPLICATIONS APPROVED FOR GRANTING PATENT	4
▪ PATENTED INVENTIONS	9
UTILITY MODELS	
▪ APPLICATIONS APPROVED FOR GRANTING PATENT	10
▪ PATENTED UTILITY MODELS	12
DESIGNS	
▪ APPLICATIONS APPROVED FOR REGISTRATION	13
▪ REGISTERED DESIGNS	14
▪ DESIGNS, WHICH HAVE BEEN REGISTERED WITH THE INTERNATIONAL BUREAU CLAIMING PRIORITY ON THE TERRITORY OF GEORGIA	15
TRADEMARKS	
▪ APPLICATIONS FILED UNDER THE NATIONAL PROCEDURE APPROVED FOR REGISTRATION	27
▪ REGISTERED TRADEMARKS	34
▪ TRADEMARKS REGISTERED ACCORDING TO THE ACCELERATED PROCEDURE	37
▪ INTERNATIONAL TRADEMARKS FOR WHICH A DECISION ON GRANTING PROTECTION IS TAKEN	38
▪ INTERNATIONAL TRADEMARKS PROTECTED IN GEORGIA	70
OFFICIAL NOTIFICATIONS	
INVENTIONS	
▪ ABOLITION OF PATENTS WITH THE RIGHT TO RESTORE	79
▪ EXPIRATION OF TERMS OF RESTORATION OF PATENT	80
▪ CHANGE OF NAME AND/OR ADDRESS OF PATENTOWNER	81
UTILITY MODELS	
▪ RESTORATION OF PATENT	82
▪ ABOLITION OF PATENTS WITH THE RIGHT TO RESTORE	82
▪ EXPIRATION OF TERMS OF RESTORATION OF PATENT	82
▪ TRANSFER OF RIGHTS	83
DESIGNS	
▪ CANCELLATION OF DESIGNS REGISTRATION	84
▪ TRANSFER OF RIGHT	84
▪ EXTENSION OF TERMS OF INTERNATIONAL DESIGNS REGISTRATION	84
TRADEMARKS	
▪ EXTENSION OF TERMS OF TRADEMARKS REGISTRATION	89
▪ COMPLETE TRANSFER OF RIGHTS	90
▪ CHANGES OF NAMES AND/OR ADDRESSES OF TRADEMARKS OWNER	91
▪ CANCELLATION OF TRADEMARKS REGISTRATION	94
▪ REGISTRATION OF LICENSES AGREEMENTS	97
▪ INTERNATIONAL LICENSE AGREEMENT	97
CLASSIFICATION INDEXES	
INVENTIONS	98
UTILITY MODELS	99
DESIGNS	100
TRADEMARKS	102

PUBLISHED TITLES OF PROTECTION

INVENTIONS

- **APPLICATIONS APPROVED FOR GRANTING PATENT:**
15023; 15535; 15303; 15309; 15584; 15454; 15503; 15427; 15675; 15510
- **PATENTED INVENTION:**
7369

UTILITY MODELS

- **APPLICATIONS APPROVED FOR GRANTING PATENT:**
15629; 15569; 15539
- **PATENTED UTILITY MODELS:**
2113-2115

DESIGNS

- **APPLICATION APPROVED FOR REGISTRATION:**
1247
- **REGISTERED DESIGN:**
932
- **DESIGNS, WHICH HAVE BEEN REGISTERED WITH THE INTERNATIONAL BUREAU CLAIMING PRIORITY ON THE TERRITORY OF GEORGIA:**
218218; 215729; 215533; 218643; 216784; 216785

TRADEMARKS

- **APPLICATIONS FILED UNDER THE NATIONAL PROCEDURE APPROVED FOR REGISTRATION:**
111430; 111757; 112413*; 112613*; 112694*; 113586; 114226; 114337; 114347; 114394; 114400; 114404; 114414-14417; 114420; 114462; 114464; 114466; 114467; 114470; 114471; 114529-114531; 114537-114539; 114544; 114546; 114592-114595; 114609; 114614; 114617; 114618; 114736; 114756
- **REGISTERED TRADEMARKS:**
35200-35232
- **TRADEMARKS REGISTERED ACCORDING TO THE ACCELERATED PROCEDURE:**
25233-25237
- **INTERNATIONAL TRADEMARKS FOR WHICH A DECISION ON GRANTING PROTECTIONS IS TAKEN:**
113528, 113529; 113536; 113538; 113541, 113542; 113549, 113550; 113556; 113558; 113560, 113561; 113577; 113623, 113624; 113626; 113629; 113631; 113636; 113646; 113655-113663; 113665; 113667, 113668; 113676-113680; 113682; 113714; 113716-113718; 113724, 113725; 113727, 113728; 113733; 113748; 113801, 113802; 113814; 113816; 113818; 113824; 113826-113828; 113894, 113895; 113897; 113909-113913; 113919-113922; 113954; 113964; 113966-113968; 114153-114156; 114162, 114163
- **INTERNATIONAL TRADEMARKS PROTECTED IN GEORGIA:**
109856; 110588; 110919; 111801; 111925-111929; 112023; 112025-112029; 112099-112105; 112108, 112109; 112136-112140; 112215, 112216; 112248; 112322; 112331-112334; 112336; 112340; 112358, 112359; 112424-112426; 112436; 112439; 112444; 112446; 112455-112458; 112460-112462; 112464; 112466; 112514, 112515; 112517; 112522-112525; 112529; 112531; 112536; 112552-112554; 112562; 112564-112566; 112572; 112643-112647; 112655, 112656; 112742, 112743; 112752-112756; 112777-112779; 112781; 112783; 112787-112791; 112802, 112803; 112812-112814; 112816; 112859-112863; 112974, 112975; 112979; 113092; 113150

INVENTIONS

APPLICATIONS APPROVED FOR GRANTING PATENT

The decision can be appealed at the Chamber of Appeal of Sakpatenti within 3 months from the publication or at the Mtskheta District Court Administrative Cases Board (Address: №17, Samkhedro St., Mtskheta), within 1 month following the publication.

PART A

A 61

- (10) AP 2022 15023 A (51) Int. Cl. (2006)
A 61 K 31/167
A 61 K 31/573
A 61 K 31/40
A 61 K 9/00
A 61 K 47/10
A 61 K 47/02
A 61 P 11/00
- (21) AP 2017 15023 (22) 2017 08 17
(31) 16184608.4
(32) 2016 08 17
(33) EP
- (71) Chiesi Farmaceutici SpA (IT)
Via Palermo 26/A, 43122, Parma, Italy (IT)
- (72) SCURI, Mario (IT);
COLI, Pierfrancesco (IT);
DELMONTE, Giuseppe (IT)
- (74) Tamaz Shilakadze
(85) 2019 03 12
(86) PCT/EP2017/070850, 2017 08 17
(54) COMBINATION THERAPY FOR COPD
(57) Aerosol formulations comprising combination of glycopyrronium bromide, formoterol, and beclomethasone dipropionate are useful to reduce the frequency of COPD exacerbations. In addition, the drug contains inorganic acid in the form of stabilizer, and the combination is dissolved in hydrofluoroalkane (HFA) propellant and co-solvent.
Claims: 1 independent
3 dependents
Fig.: 4

- (10) AP 2022 15535 A (51) Int. Cl. (2006)
A 61 K 31/423
A 61 P 35/00
C 07 D 413/04
C 07 D 413/12
C 07 D 417/12
C 07 D 261/20
- (21) AP 2019 15535 (22) 2019 06 20
(31) 1810092.5
(32) 2018 06 20
(33) GB

- (71) STXT PTY LTD (AU)
305 Grattan Street Parkville Melbourne,
Victoria 300, Australia (AU)
- (72) STUPPLE, Paul Anthony (AU);
LAGIAKOS, Helen Rachel (AU);
MORROW, Benjamin Joseph (AU);
FOITZIK, Richard Charles (AU);
HEMLEY, Katrin Fae (AU);
CAMERINO, Michael Ang (AU);
BERGMAN BOZIKIS, Ylva Elisabet (AU);
WALKER, Scott Raymond (AU)
- (74) Shalva Gvaramadze
(85) 2021 01 15
(86) PCT/EP2019/066337, 2019 06 20
(54) COMPOUNDS
(57) Compound of formula (I),

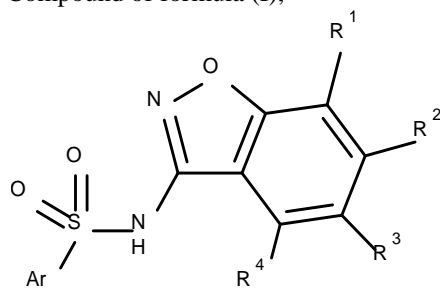

- or pharmaceutically acceptable salts thereof, wherein values of Ar R¹, R², R³ and R⁴ substituents are provided in the claims, and usage therefor cancer treatment.
Claims: 2 independents
15 dependents
Table: 19

- (10) AP 2022 15303 A (51) Int. Cl. (2006)
A 61 K 31/4439
A 61 K 31/433
A 61 K 31/427
- (21) AP 2018 15303 (22) 2018 09 27
(31) 62/566,779
(32) 2017 10 02
(33) US
- (71) Merck Sharp & Dohme Corp. (US)
126 East Lincoln Avenue, Rahway,
NJ 07065-0907, USA (US)
- (72) BIFTU, Tesfaye (US);
HUANG, Xianhai (US);
LIU, Weiguo (US);
PAN, Weidong (US);
PARK, Min (US);

PASTERNAK, Alexander (US);
 SUN, Wanying (US);
 TANG, Haifeng (US);
 ZANG, Yi (US)

(74) Tamaz Shilakadze

(85) 2020 03 26

(86) PCT/US2018/053039, 2018 09 27

(54) CHROMANE MONOBACTAM
 COMPOUNDS FOR THE TREATMENT
 OF BACTERIAL INFECTIONS

(57) Monobactam compounds of formula (I),

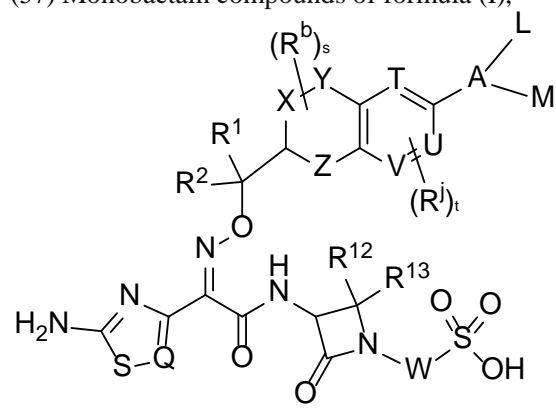

(I)

pharmaceutical compositions on the basis thereof,
 and usage thereof bacterial infections treatment.

Claims: 8 independents

29 dependents

(10) AP 2022 15309 A (51) Int. Cl. (2006)

A 61 K 31/454

A 61 P 11/00

A 61 P 17/06

A 61 P 19/02

A 61 P 29/00

(21) AP 2018 15309 (22) 2018 03 06

(31) 2017131435

(32) 2017 09 07

(33) RU

(71) LLC "Valenta-Intellect" (RU)

Riabinov St. 26, bld. 10, Office 6-26,

Moscow, 121471, Russian Federation (RU);

NEBOLSIN, Vladimir Evgenievich (RU)

Golitsyn St., bld. 457, Vill. Borzye, Istrinsky

District, Moscow Oblast, 143581, Russian

Federation (RU)

(72) NEBOLSIN, Vladimir Evgenievich (RU);

RYDLOVSKAYA, Anastasia Vladimirovna (RU)

(74) Shalva Gvaramadze

(85) 2020 04 06

(86) PCT/RU2018/000135, 2018 03 06

(54) USE OF GLUTARIMIDE DERIVATIVE
 TO TREAT DISEASES RELATED TO
 ABERRANT ACTIVITY OF CYTOKINES

(57) 1-(2-(1H-imidazol-4-yl)ethyl)piperidine-2,6-
 dione is used for the treatment of alveolitis,

autoimmune disease, pain, fever, and high tempe-
 rature; at that, autoimmune disease is not psoriasis.

Claims: 1 independent

3 dependents

PART B

B 01

(10) AP 2022 15584 A (51) Int. Cl. (2006)

B 01 D 1/00

B 01 D 5/00

B 01 D 1/30

B 01 D 1/28

C 02 F 1/14

C 02 F 1/04

(21) AP 2019 15584

(22) 2019 08 14

(31) A60125/2018

(32) 2018 08 17

(33) AT

(71) Watertransformer GMBH (AT)

Schrutkagasse 48/10, Vienna, 1130, Austria (AT)

(72) BUDIL, Matthias (AT)

(74) Tamar Kochlamazashvili

(85) 2021 03 15

(86) PCT/AT2019/060258, 2019 08 14

(54) SOLAR-POWERED CONTINUOUS
 DISTILLATION ASSEMBLY HAVING
 EFFICIENT HEAT RECOVERY

(57) The invention relates to distillation assembly
 which, with the aid of solar energy, continuously
 evaporates a feed liquor. Said distillation assembly
 comprises: a container containing the feed liquor, a
 container wherein the distillate is collected; at that,
 these containers being in thermal contact. The
 compressor compresses the vapour produced by
 boiling the feed liquor using the concentration of
 solar energy and/or using negative pressure, into
 the distillate container such that the vapour
 condenses there, and the evaporation enthalpy and
 thermal energy are returned to the feed liquor by
 the thermal contact.

Claims: 1 independent

14 dependents

Fig.: 18

B 22

- (10) AP 2022 15454 A (51) Int. Cl. (2006)
B 22 B 3/08
B 22 B 47/00
- (21) AP 2020 15454 (22) 2020 09 21
- (71) Gocha Kurdadze (GE)
Kekelidze St. 5, app. 16, 2000, Zestaponi,
Georgia (GE)
- (72) Gocha Kurdadze (GE)
- (74) Nikoloz Gogilidze
- (54) METHOD FOR RECOVERY OF
MANGANESE AND OBTAINING
SIMN METAL PHASE
- (57) The invention proposes a method for the recovery of manganese from manganese ore concentrate providing manganese-containing raw material containing fractions of various categories; providing coke 0-6 mm fraction screening; melting of manganese-containing raw material in an oven at 1400-1450°C; separation of coming out from the oven, and treated material the slag and metal in multistage ladles; at that, in the transition from first to second step, the introduction of mixture of at least one fraction of manganese-containing raw material and 0-6 mm fraction screen of coke; delay the material on second step for at least 2 days.
- Claims: 1 independent

B 61

- (10) AP 2022 15503 A (51) Int. Cl. (2006)
B 61 K 9/00
G 01 M 11/08
- (21) AP 2020 15503 (22) 2020 11 30
- (71) Nikoloz Mghebrishvili (GE)
Pankisi St. 7/9, 0160, Tbilisi, Georgia (GE);
Grigoriy Moiseev (GE)
Turgenev Dead End 18, 3700, Rustavi,
Georgia (GE);
Tengiz Tabidze (GE)
Tamar Mepe Ave. 15, 0112, Tbilisi,
Georgia (GE);
Maxim Yavich (GE)
Machabeli St. 16, Tbilisi, Georgia (GE);
Lasha Pkhakadze (GE)
Dolidze St. 8, Tbilisi, Georgia (GE);
Amiran Nodia (GE)
Benashvili St. 24, Tbilisi, Georgia (GE);
Shota Rustaveli National Science Foundation of
Georgia (GE)
Merab Aleksidze St. II Lane 2, 0193, Tbilisi,
Georgia (GE);
Georgian Technical University (GE)
M. Kostava St. 77, 0160, Tbilisi, Georgia (GE)

- (72) Nikoloz Mghebrishvili (GE);
Grigoriy Moiseev (GE);
Tengiz Tabidze (GE);
Maxim Yavich (GE);
Lasha Pkhakadze (GE);
Amiran Nodia (GE)
- (54) COUPLING ROD AND RAILS MONITORING SYSTEM USING FIBER-OPTIC CABLE
- (57) Proposed system includes single-mode fiber-optic cable tightly attached along the rail, the branches whereof are "fragments having mechanical amplifier", they are creating fiber optic transmitters, at the same time. The OTDR reflectometer is disposed at the top of rail, the output whereof, through corresponding registers in the microprocessor computing unit, is connected to the inputs of computing unit, the output whereof is connected to the analysis unit input, output whereof is connected to indication block.
- Claims: 1 independent
- Fig.: 4

PART F**F 02**

- (10) AP 2022 15427 A (51) Int. Cl. (2006)
F 02 D 17/00
F 02 P 5/152
- (21) AP 2020 15427 (22) 2020 08 31
- (71) GOYTEMIROV, Ramzan (RU)
Razdelnaya St. 13, Grozno, Russian
Federation (RU)
- (72) GOYTEMIROV, Ramzan (RU)
- (74) Besiki Kobakhidze
- (54) ROTOR-PISTON DRIVE
- (57) A drive includes a case 4, at least, one cylinder 5 having suction 6, exhaust 7, and cleaning 8 windows, a rotor mounted in the case 4 onto the joints 2 with sealing partitions 3 on periphery of perimeter, and installed on the side the rotor 1 having working chambers on the outer shoulder circumference, executed as extractions 10 wherein reciprocally movable pistons 11 having cut heads are inserted into the cylinder; at that, the surfaces of extractions and pistons cut heads are executed so that at the moment of maximum compression of fuel mixture they are capable to be disposed in parallel to each other.
- Claims: 1 independent
3 dependents

Fig.: 2

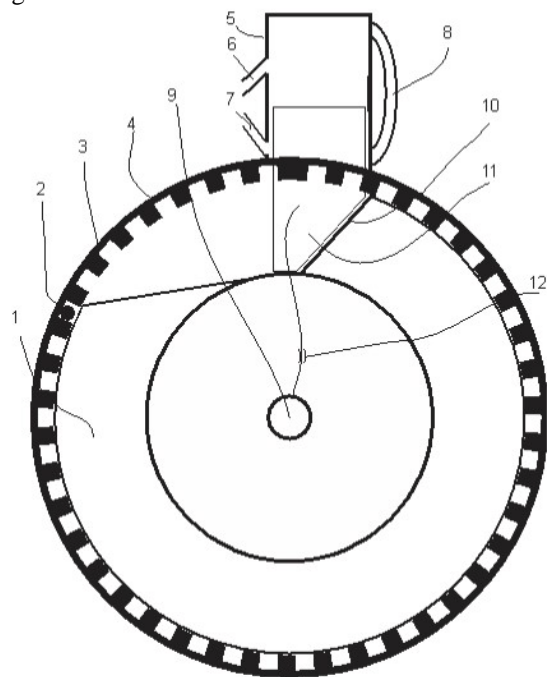

Fig. 1

F 03

(10) AP 2022 15675 A (51) Int. Cl. (2006)

F 03 D 5/02

F 03 D 7/00

(21) AP 2021 15675 (22) 2021 06 29

(71) JSC "ZAGO TECHNOLOGY" (GE)

Besiki St. 4, Business Center in Besiki,
Office 203, 0108, Tbilisi, Georgia (GE);
Levan Nikoladze (GE)Besiki St. 4, Business Center in Besiki,
Office 203, 0108, Tbilisi, Georgia (GE)

(72) ZAGORUYCHENKO, Vyacheslav (GE);

Levan Nikoladze (GE)

(54) WIND POWER PLANT

(57) A plant includes actuating continues belt 1, plurality of blades 4 disposed in distance, fastened rotatable onto said actuating belt outer surface, and intended to accept wind power, wherein each blade is fixed onto the shaft 9 rotatable around the axis thereof, and electric generator functionally connected to actuating belt; at that, the plant includes plurality of regulators regulating each blade rotation, wherein each regulator includes a couple of supporting componentry 6 having upper and lower ends, wherein lower end is fixed onto the belt outer surface, the pushers 7 are attached to supporting componentry, cam fason discs 8 are mounted and fastened onto blade shaft ends, and have pre-defined profile; spring component 10, the ends whereof are fastened nearby said supporting componentry upper ends so that said pushers are in friction contact with said fason discs by said spring component tension force.

Claims: 1 independent

3 dependents

Fig.: 6

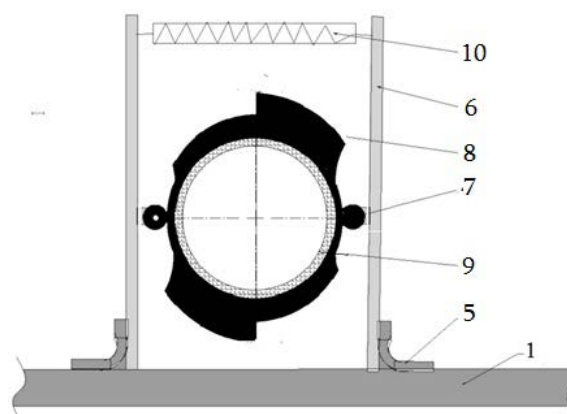

Fig. 2

F 28

(10) AP 2022 15510 A (51) Int. Cl. (2006)

F 28 D 1/03

F 28 D 1/053

F 28 F 3/04

F 28 F 1/16

(21) AP 2019 15510 (22) 2019 05 17

(31) 102018000005477

(32) 2018 05 17

(33) IT

(71) Fondital S.p.A. Socio Unico (IT)

Via Cerreto, 40, Vobarno, BS 25079,
Italy (IT)

(72) NIBOLI, Orlando (IT)

(74) Tamar Kochlamazashvili

(85) 2020 12 07

(86) PCT/IB2019/054103, 2019 05 17

(54) HEATING RADIATOR ELEMENT

(57) Heating radiator component 1 comprises passing on substantially longitudinal axis A the outlet case 2, and at least adjacent rib triplet 11 located nearby each other, and having at least one main straight longitudinal sections 21 essentially parallel to the axis A, and vertically in use, the ratio of sum R between triplet first rib 11.1 longitudinal section 21 axial length L1 and disposed vis a vis thereto the triplet second and third ribs 11.2 and 11.3 longitudinal sections axial length L2, L3 is equal or less than 0.40.

Claims: 1 independent

8 dependents

Fig.: 8

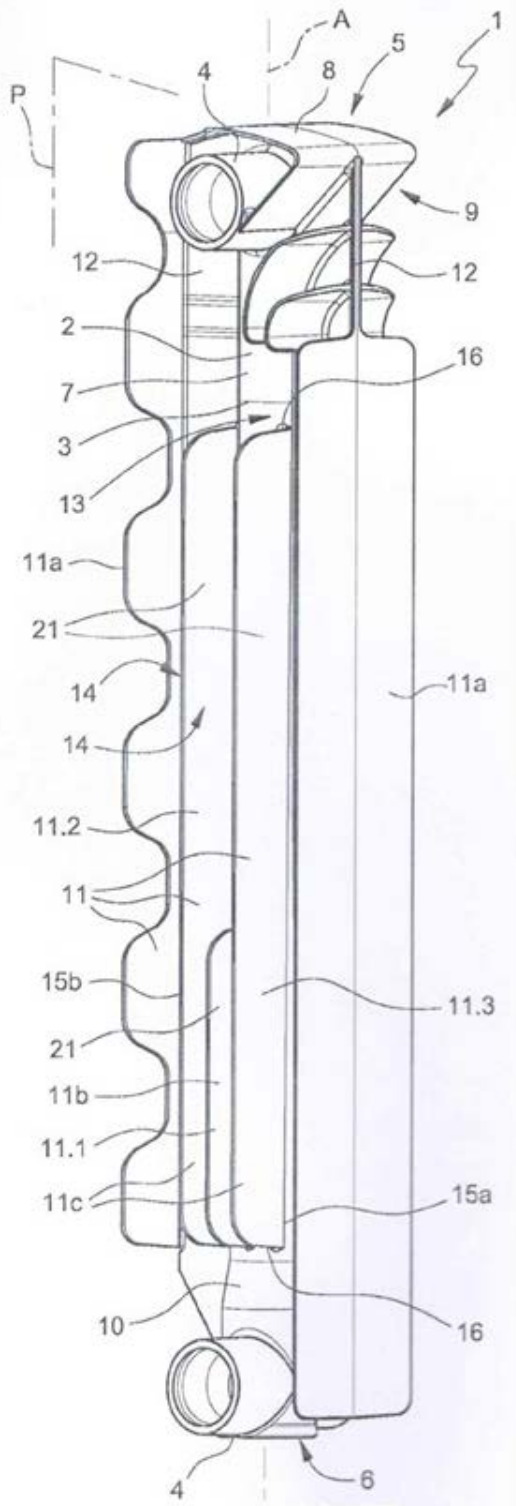

Fig. 1

UTILITY MODELS

APPLICATIONS APPROVED FOR GRANTING PATENT

The decision can be appealed at the Chamber of Appeal of Sakpatenti within 3 months from the publication or at the Mtskheta District Court Administrative Cases Board (Address: №17, Samkhedro St., Mtskheta), within 1 month following the publication.

PART A

A 47

- (10) AU 2022 15629 U (51) Int. Cl. (2006)
A 47 G 21/00
- (21) AU 2021 15629 (22) 2021 05 13
- (71) Nikoloz Kozanashvili (GE)
Kalistrate Kutrateladze St. 17, app. 41, 0179,
Tbilisi, Georgia (GE)
- (72) Nikoloz Kozanashvili (GE)
- (74) Khatuna Imnadze
- (54) FOOD FIXTURE
- (57) Food fixture consists of circle sector shaped plates 1 connected together with tops thereof; the plates have a wall 3 on their back wide part 2 disposed with 90° relative thereto. The plates have different length and are foldable in each other.

Claims: 1 independent

Fig.: 1

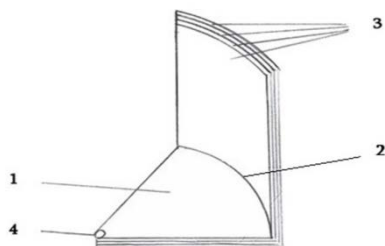

Fig.. 1

- Vakhtangi Zhghamadze (GE)
Varketili 3, I mcd., bld. 3, app. 108, 0163,
Tbilisi, Georgia (GE);
Iamze Kvartskhava (GE)
Demetre Tavdadebuli St. 7, app. 27, 4400,
Poti, Georgia (GE);
Zurab Adamia (GE)
G. Kartoziya St. 1, app. 5, 0177, Tbilisi,
Georgia (GE);
Mzia Tsirekidze (GE)
Vazisubani III mcd., II qu., bld. 14,
app. 2, 0152, Tbilisi, Georgia (GE)
- (72) Nikoloz Margiani (GE);
Giorgi Mumladze (GE);
Vakhtangi Zhghamadze (GE);
Iamze Kvartskhava (GE);
Zurab Adamia (GE);
Mzia Tsirekidze (GE)

(54) OXIDE THERMOELECTRIC CERAMICS

(57) Oxide thermoelectric ceramics comprises oxides: Bi_2O_3 , SrO , Co_3O_4 ; at that, additionally comprises lead borate – $\text{Pb}(\text{BO}_2)_2$ with their following ratio of componentry (mass %):

Bi_2O_3 52,1 ÷ 54,5

SrO 25,1 ÷ 25,2

Co_3O_4 17,5 ÷ 17,6

$\text{Pb}(\text{BO}_2)_2$ 2,7 ÷ 5,3

Claims: 1 independent

PART C

C 01

- (10) AU 2022 15569 U (51) Int. Cl. (2006)
C 01 G 29/00
C 01 G 51/04
C 04 B 35/32
H 01 L 35/00
- (21) AU 2021 15569 (22) 2021 02 24
- (71) Nikoloz Margiani (GE)
Vazha–Pshavela Ave., IV qu., bld. 4,
app. 27, 0186, Tbilisi, Georgia (GE);
Giorgi Mumladze (GE)
Politkovskaya St. 47, app. 91, 0186,
Tbilisi, Georgia (GE);

PART G

G 09

- (10) AU 2022 15539 U (51) Int. Cl. (2006)
G 09 B 5/00
- (21) AU 2021 15539 (22) 2021 01 18
- (71) Archil Prangishvili (GE)
Paster St. 1a, b. 1, 0102, Tbilisi, Georgia (GE);
Levani Imnaishvili (GE)
Nutsubidze Plateau, IV mcd., bld. 11,
app. 46, 0183, Tbilisi, Georgia (GE);
Maguli Bedineishvili (GE)
Nutsubidze Plateau, IV mcd., bld. 11,
app. 46, 0183, Tbilisi, Georgia (GE);
Gocha Zedginidze (GE)
Sh. Rustaveli St. 173, Akhaltsikhe,
Georgia (GE)

(72) Archil Prangishvili (GE);
Levani Imnaishvili (GE);
Maguli Bedineishvili (GE);
Gocha Zedginidze (GE)

(54) REMOTE LABORATORY SYSTEM

(57) Remote lab (laboratory) system is disclosed. The system includes computerized lab stand integrated into at least one computer-based lab cluster, connected thereto the computer connected to the internet, and equipped with a webcam and audio set; surveillance webcam optically focused on lab stand, and interactive software platform. Lab cluster includes instructor computer connected to the internet, and equipped with the webcam and audio set, as well.

Claims: 1 independent

Fig.: 1

PATENTED UTILITY MODELS

PART A

A 21

- (11) U 2022 2114 Y (51) Int. Cl. (2006)
A 21 D 10/04
A 21 C 1/00
- (10) AU 2021 15552 U (44) 22(578)/2021
(21) AU 2021 15552
(22) 2021 02 06
(24) 2021 02 06
- (73) Ramini Ghvaladze (GE)
Varketili 3, IV mcr., bld. 414, app. 165,
0163, Tbilisi, Georgia (GE)
- (72) Ramini Ghvaladze (GE)
- (54) METHOD FOR DOUGH PRODUCTION
FOR BAKING BREAD WITHOUT
YEAST
-

A 61

- (11) U 2022 2113 Y (51) Int. Cl. (2006)
A 61 K 36/00
A 61 K 35/76
A 61 K 9/20
- (10) AU 2021 15659 U (44) 21(577)/2021
(21) AU 2021 15659
(22) 2021 06 10
(24) 2021 06 10
- (73) G. Eliava Institute of Bacteriophages,
Microbiology and Virusology (GE)
Gotua St. 3, 0160, Tbilisi, Georgia (GE);
Lasha Bakuridze (GE)
Davit Ghmashenebeli Alley 12th km-s, 0159,
Tbilisi, Georgia (GE);
Marine Goderdzishvili (GE)
Kalistrate Kutateladze St. 22, 0160,
Tbilisi, Georgia (GE);
Irine Chkonia (GE)
Gotua St. 22, 0160, Tbilisi, Georgia (GE);
Ia Kusradze (GE)
Gotua St. 3, 0160, Tbilisi, Georgia (GE)
- (72) Lasha Bakuridze (GE);
Nora Kirtadze (GE);
Salome Barbakadze (GE);
Nino Tatrishvili (GE);
Teona Dvalidze (GE);
Natia Karumidze (GE);
Marine Goderdzishvili (GE);
Irine Chkonia (GE);
Ia Kusradze (GE)

- (54) SUCKING HEALING FORM AGAINST
INFECTIONS OF UPPER RESPIRATORY
TRACT AND MOUTH CAVITY
-

PART C

C 01

- (11) U 2022 2115 Y (51) Int. Cl. (2006)
C 01 G 51/00
C 04 B 35/32
H 01 L 35/00
- (10) AU 2021 15507 U (44) 23(579)/2021
(21) AU 2020 15507
(22) 2020 12 05
(24) 2020 12 05
- (73) Nikoloz Margiani (GE)
Vazha-Pshavela Ave. 4th qu., bld. 4, app. 27,
0186, Tbilisi, Georgia (GE);
Giorgi Mumladze (GE)
Politkovskaya St. 47, app. 91, 0186, Tbilisi,
Georgia (GE);
Vakhtang Zhghamadze (GE)
Varketili 3, 1 mcr.bld. 3, app. 108, 0163,
Tbilisi, Georgia (GE);
Iamze Kvartskhava (GE)
Demetre Tavdadebuli St. 7, app. 27, 4400,
Poti, Georgia (GE)
Zurab Adamia (GE)
G. Kartoza St. 1, app. 5, 0177, Tbilisi,
Georgia (GE);
Natia Margiani (GE)
Vazha-Pshavela Ave. 4th qu., bld. 4, app. 27,
0186, Tbilisi, Georgia (GE);
Nino Mumladze (GE)
Politkovskaya St.47, app. 91, 0186, Tbilisi,
Georgia (GE)
- (72) Nikoloz Margiani (GE);
Giorgi Mumladze (GE);
Vakhtang Zhghamadze (GE);
Iamze Kvartskhava (GE);
Zurab Adamia (GE);
Natia Margiani (GE);
Nino Mumladze (GE)
- (54) COBALT BASED OXIDE THERMO-
ELECTRIC CERAMICS
-

DESIGNS

APPLICATION APPROVED FOR REGISTRATION

The decision can be appealed at the Chamber of Appeal of Sakpatenti within 3 months from the publication or at the Mtskheta District Court Administrative Cases Board (Address: №17, Samkhedro str., Mtskheta), within 1 month following the publication.

(10) AD 2022 1247 S (51) 32-00

(21) AD 2021 1247 (22) 2021 10 26

(28) 1

(71) LTD "Seven Hills" (GE)

Grigol Lortkipanidze St. 154, 0145, Samgori District, Tbilisi, Georgia (GE)

(72) Numan Koray Demirrenk (TR)

(54) NAPKIN ORNAMENT

(55)

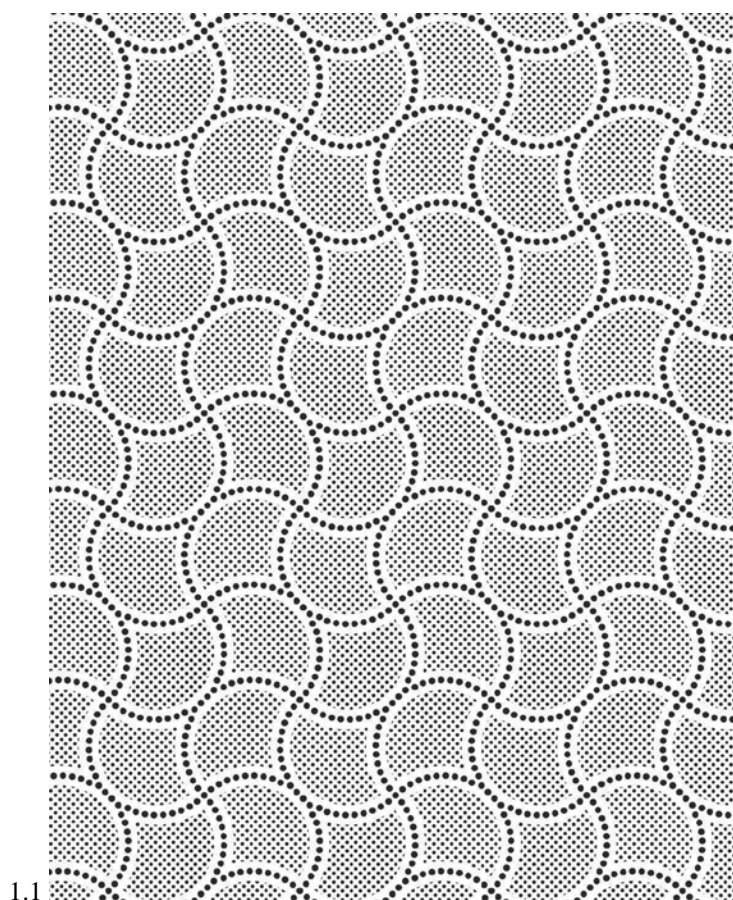

REGISTERED DESIGN

- (11) D 2022 932 S (51) 02-04
(10) AD 2021 1232 S (44) 2021 12 27 №23
(21) AD 2021 1232
(22) 2021 07 27
(24) 2021 07 27
(28) 1
(18) 2026 07 27
(73) Tornike Matiashvili (GE)
 Balanchivadze St., corp. 8th, I Ent., app. 34,
 0171, Tbilisi, Georgia (GE)
(72) Tornike Matiashvili (GE)
(54) SHOES
-

DESIGNS, WHICH HAVE BEEN REGISTERED WITH THE INTERNATIONAL BUREAU CLAIMING PRIORITY ON THE TERRITORY OF GEORGIA

The decision can be appealed at the Chamber of Appeal of Sakpatenti within 3 months from the publication or at the Mtskheta District Court Administrative Cases Board (Address: №17, Samkhedro St., Mtskheta), within 1 month following the publication.

- (11) DM/218 218 (51) 09-01
 (15) 2022 01 06 (44) 03/2022 (2022 01 21)
 (22) 2022 01 06
 (28) 4
 (30) No1: 07.07.2021; 008602155; EM; No2: 07.07.2021; 008602155; EM;
 No3: 07.07.2021; 008602155; EM; No4: 07.07.2021; 008602155; EM
 (73) VERALLIA PACKAGING
 Tour CARPE DIEM - Esplanade Nord, 31 Place des Corolles, 92400 COURBEVOIE (FR)
 (85) –
 (86) –
 (87) –
 (88) FR
 (89) FR
 (81) III. GB, GE, RU, US
 (72) 1,4: Camille PAUPHILET
 31 Place des Corolles, 92400, COURBEVOIE (FR);
 2: Maria-Grazia MALATESTA
 Loc. Colletto 4, 17058, DEGO (IT);
 3: Dmytro HARMATIUK
 Velyka Zhytomyrska 25/2, 01001, Kyiv (UA)
 (74) TMARK Conseils
 9 Avenue Percier, 75008 PARIS (FR)
 (54) 1.-4. Bottle
 (55)







3.3



3.4



3.5



3.6



3.7



4.1



4.2



4.3



4.4



4.5



4.6

- (11) DM/215 729
- (15) 2021 07 16
- (22) 2021 07 16
- (28) 2
- (73) HARRY WINSTON SA
Chemin Du Tourbillon 8, 1228 Plan-les-Ouates (CH)
- (85) CH
- (86) CH
- (87) CH
- (88) CH
- (89) CH
- (81) II. MA III. AL, AM, AZ, BA, BZ, CH, EM, GB, GE, KG, LI, MC, MD, ME, MK, MN,
NO, OM, SG, TN, TR, UA
- (72) Emmanuelle Dominguez
C/o Harry Winston SA Chemin Du Tourbillon 8, 1228, Plan-les-Ouates (CH)
- (74) The Swatch Group AG (The Swatch Group SA) (The Swatch Group Ltd.)
Faubourg Du Lac 6, 2501 Biel/Bienne (CH)
- (54) 1. Watch case with bracelet, 2. Watch dial
- (55)



1.1



1.2

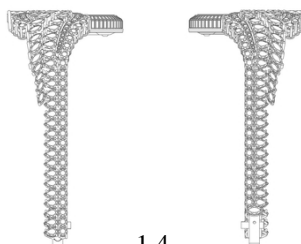

1.3

1.4



1.5

1.6



1.7



1.8

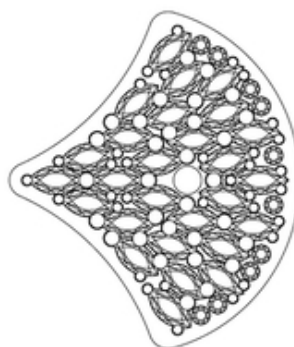

2.1

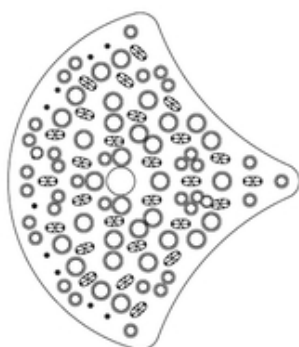

2.2

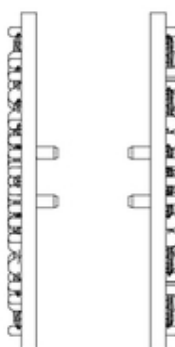

2.3

2.4



2.5

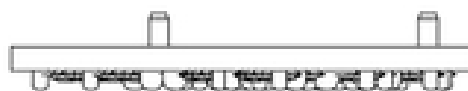

2.6

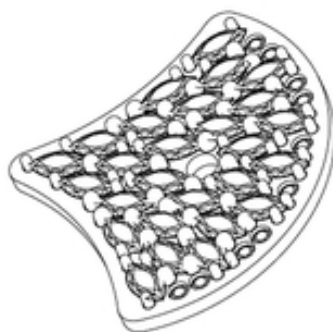

2.7

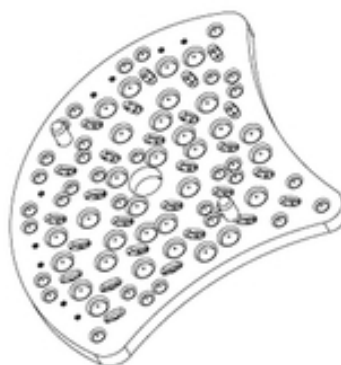

2.8

- (11) DM/215 533
- (15) 2021 07 23
- (22) 2021 07 23
- (28) 2
- (73) HARRY WINSTON SA
Chemin Du Tourbillon 8, 1228 Plan-les-Ouates (CH)
- (85) CH
- (86) CH
- (87) CH
- (88) CH
- (89) CH
- (81) II. MA III. AL, AM, AZ, BA, BZ, CA, CH, EM, GB, GE, KG, LI, MC, MD, ME, MK,
MN, NO, OM, SG, TN, TR, UA
- (72) 1 Delphine ABDOURAHIM
C/o Harry Winston Inc. 718 Fifth Avenue, 10019, New York (US);
2 Rie YATSUGI-KANG
C/o Harry Winston Inc. 718 Fifth Avenue, 10019, New York (US)
- (74) The Swatch Group AG (The Swatch Group SA) (The Swatch Group Ltd.)
Faubourg Du Lac 6, 2501 Biel/Bienne (CH)
- (54) 1.-2. Necklace
- (55)



1.1



1.2



1.3



1.4



1.5

1.6



1.7



1.8



2.1



2.2



2.3



2.4



2.5



2.6



2.7



2.8



- (11) DM/218 643
- (15) 2022 01 20
- (22) 2022 01 20
- (28) 4
- (30) No1: 08.12.2021; 6180125; GB; No2: 08.12.2021; 6180126; GB;
 No3: 08.12.2021; 6180127; GB;
 No4: 08.12.2021; 6180128; GB
- (73) United Biscuits (UK) Limited
 Building 3 Chiswick Park 566 Chiswick High Rd Chiswick, W4 5YA London (GB)
- (85) –
- (86) GB
- (87) GB
- (88) –
- (89) GB
- (81) III. AL, AZ, BY, CA, EG, EM, GE, GH, IL, JP, KR, MD, ME, MK, RS, RU, SY, TM, TN, TR, US, VN
- (72) Timothy James REYNOLDS
 1 Winchester Park, BR2 0PY, Bromley (GB)
- (74) Abel & Imray
 Westpoint Building James Street West, BA1 2DA Bath (GB)
- (46) 2022-02-11
- (54) 1.-4. Biscuit
- (55)



1.1



1.2

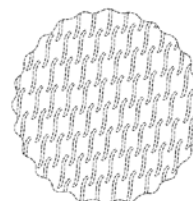

1.3



1.4

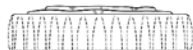

1.5

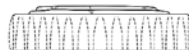

1.6

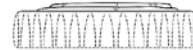

1.7



2.1



2.2

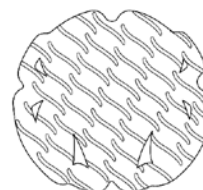

2.3



2.4



2.5



2.6



2.7



3.1



3.2

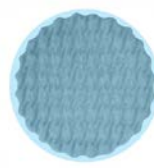

3.3



3.4



3.5



3.6



3.7



4.1



4.2

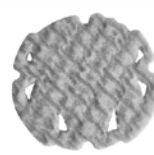

4.3



4.4



4.5



4.6



4.7

- (11) DM/216 784 (51) 10-07
(15) 2021 08 05 (44) 06/2022 (2022 02 11)
(22) 2021 08 05
(28) 1
(30) No1: 26.03.2021; 145880; CH
(73) ROLEX SA
Rue François-Dussaud 3-5-7, 1211 Genève 26 (CH)
(85) CH
(86) CH
(87) CH
(88) CH
(89) CH
(81) II. MA III. AL, AM, AZ, BA, BN, BW, BY, BZ, CA, EG, EM, GB, GE, GH, IL, IS, JP, KG, KH, KP, KR, LI, MC, MD, ME, MK, MN, MX, NA, NO, OA, OM, RS, RU, RW, SG, SM, SR, ST, SY, TJ, TM, TN, TR, UA
(72) Vincent De Peyer
1, Place De Saint-Gervais, 1201, GENEVE (CH)
(74) BUGNION S.A.
10, Route De Florissant Case Postale 375, 1211 Genève 12 (CH)
(54) 1. Watch dial
(55)



1.1



1.2

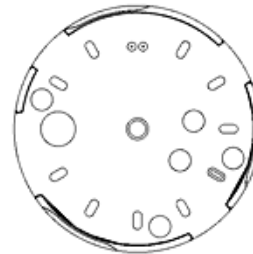

1.3



1.4



1.5



1.6



1.7

- (11) DM/216 785 (51) 10-07
 (15) 2021 08 05 (44) 06/2022 (2022 02 11)
 (22) 2021 08 05
 (28) 2
 (30) No1: 26.03.2021; 145881; CH; No2: 26.03.2021; 145881; CH
 (73) ROLEX SA
 Rue François-Dussaud 3-5-7, 1211 Genève 26 (CH)
 (85) CH
 (86) CH
 (87) CH
 (88) CH
 (89) CH
 (81) II. MA III. AL, AM, AZ, BA, BN, BW, BY, BZ, CA, EG, EM, GB, GE, GH, IL, IS, JP, KG, KH, KP, KR, LI, MC, MD, ME, MK, MN, MX, NA, NO, OA, OM, RS, RU, RW, SG, SM, SR, ST, SY, TJ, TM, TN, TR, UA
 (72) Davide AIROLDI
 16 Rue Du Grand-Bureau, 1227, Genève (CH)
 (74) BUGNION S.A.
 10, Route De Florissant Case Postale 375, 1211 Genève 12 (CH)
 (54) 1.-2. Watch dial
 (55)



1.1



1.2

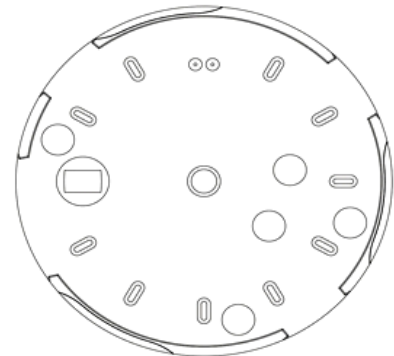

1.3



1.4



1.5



1.6

1.7

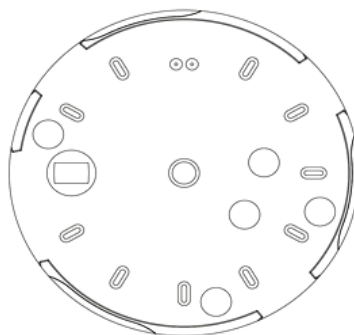
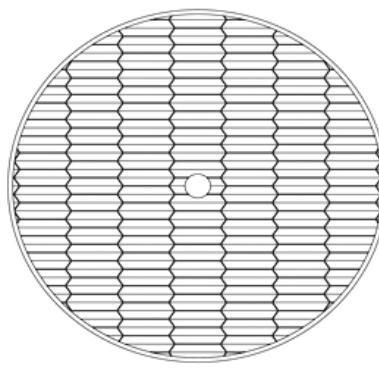
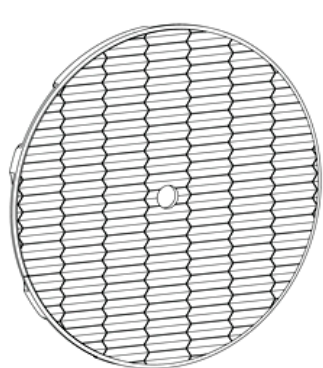

TRADEMARKS

APPLICATIONS FILED UNDER THE NATIONAL PROCEDURE APPROVED FOR REGISTRATION

The decision can be appealed at the Chamber of Appeal of Sakpatenti within 3 months from the publication or at the Mtskheta District Court Administrative Cases Board (Address: №17, Samkhedro St., Mtskheta), within 1 month following the publication.

(260) AM 2022 111430 A
(210) AM 111430
(220) 2021 07 23
(731) LTD "Akhali Tbilisi"
Nearby Vazha-Pshavela Ave. 64, Tbilisi,
Georgia
(540)



(591) Yellow, black
(531) 26.04.02; 26.04.03; 26.04.04; 26.04.09; 28.19;
29.01.12
(526) თბილისი
(511) 35, 37

(260) AM 2022 111757 A
(210) AM 111757
(220) 2021 09 14
(731) LTD "Gurmania"
Vazha-Pshavela Ave., V qu., bld. 4,
app. 150, Tbilisi, Georgia
(540)

მერდინი

Mer dini

Мердини

(591) Black-white
(531) 27.05.01; 28.05; 28.19
(511) 29, 30, 31, 32, 33, 35, 43

(260) AM 2022 112413 A*
(210) AM 112413
(220) 2021 03 31
(731) Mitsubishi Jidosha Kogyo Kabushiki Kaisha
1-21, Shibaura 3-chome, Minato-ku, Tokio
108-8410, Japan
(740) Tamar Kochlamazashvili
(540)

L355

(591) Black-white
(511) 12

(260) AM 2022 112613 A*
(210) AM 112613
(220) 2021 04 14
(731) Mitsubishi Jidosha Kogyo Kabushiki Kaisha
1-21, Shibaura 3-chome, Minato-ku, Tokio
108-8410, Japan
(740) Tamar Kochlamazashvili
(540)

L317

(591) Black-white
(511) 12

(260) AM 2022 112694 A*
(210) AM 112694
(220) 2021 04 20
(731) Marshall Boya ve Vernik Sanayii A.S.
(Kocaeli)
Dilovasi Organize Bölgesi, 1, Kisim, Tuna cad
No:1, Dilovasi Gebze Kocaeli, 41455, Turkey
(740) Tamar Kochlamazashvili
(540)



(591) Blue, red, orange, yellow, green, sky-blue, white
 (531) 01.15.05; 02.01.23; 26.04.16; 26.04.22;
 27.05.10; 27.05.17; 29.01.15
 (511) 2

(260) AM 2022 113586 A
 (210) AM 113586
 (220) 2021 06 19
 (731) McDonald's International Property Company Ltd
 A corporation organized and existing under the laws of the State of Delaware 110 N. Carpenter Street, Chicago, State of Illinois 60607, USA

(740) Shalva Gvaramadze
 (540)

SHAREBOX

(591) Black-white
 (511) 29, 30, 43

(260) AM 2022 114226 A
 (210) AM 114226
 (220) 2021 08 10
 (731) IDS Borjomi Beverages Co.N.V.
 Pareraweg 45, Curaçao

(740) Giorgi Jokharidze
 (540)

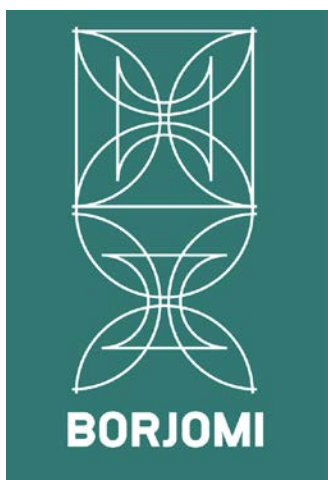

(591) White, green
 (531) 26.02.01; 26.02.03; 26.02.05; 26.02.07;
 26.07.01; 26.07.03; 26.13.25; 29.01.03;
 29.01.12
 (526) BORJOMI
 (511) 32, 35

(260) AM 2022 114337 A
 (210) AM 114337
 (220) 2021 08 18
 (731) The Procter & Gamble Company
 One Procter & Gamble Plaza, Cincinnati, Ohio 45202, USA

(740) Merab Kvimsadze
 (540)



(591) Black-white
 (531) 01.15.17; 27.05.01; 27.05.15; 27.05.17
 (511) 1, 3

(260) AM 2022 114347 A
 (210) AM 114347
 (220) 2021 08 20
 (310) 83629; 83631
 (320) 2021 06 25
 (330) JM
 (731) Six Continents Limited
 Broadwater Park, Denham, Buckinghamshire, UB9 5HR, United Kingdom
 (740) Tamar Kochlamazashvili
 (540)

VIGNETTE

(591) Black-white
 (511) 35, 43

(260) AM 2022 114394 A
 (210) AM 114394
 (220) 2021 08 20
 (731) IDS Borjomi Beverages Co.N.V.
 Pareraweg 45, Curaçao
 (740) Giorgi Jokharidze
 (540)

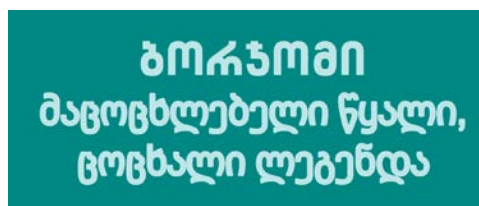

(591) Blue, green
 (531) 28.19; 29.01.12
 (526) ბორჯომი
 (511) 32, 35

(260) AM 2022 114400 A
 (210) AM 114400
 (220) 2021 08 23
 (731) Limited Liability Company "Tsaghveri"
 Borough Tsaghveri, 1212, Borjomi, Georgia

(740) Davit Dzamukashvili
(540)



(591) White, blue
(531) 05.03.07; 28.05; 29.01.04
(526) ЦАГВЕРИ
(511) 5, 32

(260) AM 2022 114404 A
(210) AM 114404
(220) 2021 08 23
(731) Jysk A/S
Sødalsparken 18, Brabrand, 8220, Denmark
(740) Tamar Kochlamazashvili
(540)



(591) Blue, white
(531) 03.07.24; 26.04.15; 26.04.22; 26.04.24;
27.05.01; 27.05.24; 29.01.12
(511) 20, 24, 35

(260) AM 2022 114414 A
(210) AM 114414
(220) 2021 08 26
(731) Zarbi'z Inc.
50 Old Field Road, Greenwich CT, 06830, USA
(740) Giorgi Taktakishvili
(540)

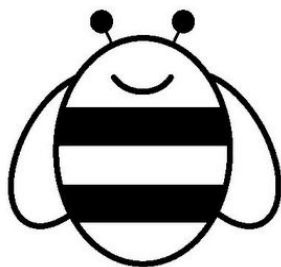

(591) Black-white
(531) 03.13.04; 03.13.24
(511) 3, 5

(260) AM 2022 114415 A
(210) AM 114415
(220) 2021 08 26
(731) Zarbi'z Inc.
50 Old Field Road, Greenwich CT, 06830, USA

(740) Giorgi Taktakishvili
(540)

ZARBEE'S NATURALS

(591) Black-white
(511) 3, 5

(260) AM 2022 114416 A
(210) AM 114416
(220) 2021 08 26
(731) Zarbi'z Inc.
50 Old Field Road, Greenwich CT, 06830, USA
(740) Giorgi Taktakishvili
(540)

ZARBEE'S

(591) Black-white
(511) 3, 5

(260) AM 2022 114417 A
(210) AM 114417
(220) 2021 08 26
(731) Zarbi'z Inc.
50 Old Field Road, Greenwich CT, 06830, USA
(740) Giorgi Taktakishvili
(540)

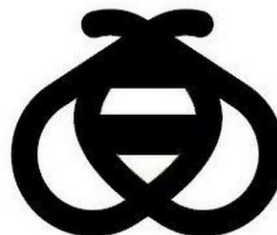

(591) Black-white
(531) 03.13.04; 03.13.24
(511) 3, 5

(260) AM 2022 114420 A
(210) AM 114420
(220) 2021 08 26
(731) LTD "Merkado"
Gldani, VI mkr, bld. 28, app. 53, Gldani
District, Tbilisi, Georgia
(540)

BLAMANJE
DESSERTS • COFFEE • MORE

(591) Green, pink
(531) 24.17.01; 24.17.02; 27.05.01; 27.05.09;
27.05.10; 29.01.12
(511) 43

(260) AM 2022 114462 A
 (210) AM 114462
 (220) 2021 08 27
 (731) LTD "Space Georgia"
 Vill. Sakhalvasho, Kobuleti, Georgia
 (540)



(591) Black, white, red, grey
 (531) 02.03.01; 02.03.02; 05.09.15; 28.19; 29.01.13
 (511) 29, 30

(260) AM 2022 114464 A
 (210) AM 114464
 (220) 2021 08 27
 (731) LTD "UAS Pharmaceuticals PTY"
 15 Cansdale Place, Castle Hill NSW, 2154,
 Australia
 (740) Valeri Bendianishvili;
 Lia Tsintsabadze;
 Gvantsa Shvangiradze
 (540)

DERMQURE

(591) Black-white
 (511) 3, 5, 44

(260) AM 2022 114466 A
 (210) AM 114466
 (220) 2021 08 27
 (731) Montres Tudor SA
 Rue François-Dussaud 3, Geneva, Switzerland
 (740) Shalva Gvaramadze
 (540)

TUDOR

(591) Black-white
 (511) 14, 35, 37

(260) AM 2022 114467 A
 (210) AM 114467
 (220) 2021 08 27
 (731) Montres Tudor SA
 Rue François-Dussaud 3, Geneva, Switzerland
 (740) Shalva Gvaramadze

(540)



(591) Black-white
 (531) 24.01.03
 (511) 14, 35, 37

(260) AM 2022 114470 A
 (210) AM 114470
 (220) 2021 08 30
 (731) LTD "Biopolus"
 Noneshvili Str. 65, 6000, Batumi, Georgia
 (740) Monika Kvaratskhelia
 (540)

უნივიტა
Univita
УНИВИТА

(591) Black-white
 (511) 5

(260) AM 2022 114471 A
 (210) AM 114471
 (220) 2021 08 30
 (731) PepsiCo Inc.
 700 Anderson Hill Road, Purchase, 10577-
 1444, New York, USA
 (740) Tamar Kochlamazashvili
 (540)

პატარა მომენტების დიდი
ემოციები

(591) Black-white
 (511) 29, 30

(260) AM 2022 114529 A
 (210) AM 114529
 (220) 2021 09 03
 (731) Quramax Limited U.K.
 Quramax Limited, Artisans House, 7
 Queensbridge Northampton NN4 7BF, United
 Kingdom
 (740) Giorgi Taktakishvili
 (540)

Quramax

(591) Black-white
 (511) 35

(260) AM 2022 114530 A
 (210) AM 114530
 (220) 2021 09 03
 (731) Quramax Limited U.K.
 Quramax Limited, Artisans House, 7
 Queensbridge Northampton NN4 7BF, United
 Kingdom
 (740) Giorgi Taktakishvili
 (540)

Marion Biotech

(591) Black-white
 (511) 35

(260) AM 2022 114531 A
 (210) AM 114531
 (220) 2021 09 03
 (731) LTD "Lerto"
 Aleksandre Kazbegi Ave. 11a, app. 21, 0160,
 Saburtalo District, Tbilisi, Georgia
 (540)



(591) 57675B green
 (531) 07.03.01; 07.03.03; 07.03.25; 07.05.10;
 27.07.01; 28.19
 (511) 43

(260) AM 2022 114537 A
 (210) AM 114537
 (220) 2021 09 07
 (731) Hoco Technology Development (Shenzhen)
 Co. LTD
 Rm 408, 4th Floor, Block A, Weidonglong
 Business Building, No.2125, Meilong Road,
 Tsinghua Community, Longhua Street,
 Longhua District, Shenzhen, P.R. China,
 Chineti, 518000, China
 (740) Nino Gazdeliani
 (540)

BOROFONE

(591) Black-white
 (531) 27.05.01
 (511) 9

(260) AM 2022 114538 A
 (210) AM 114538
 (220) 2021 09 07
 (731) Hoco Technology Development (Shenzhen)
 Co. LTD
 Shenzhen, Longhua District, Longhua Street,
 Tsinghua Community, Meilong Road,
 No.22125, Business Building Weidonglong,
 Block A, 4th Floor, Rm 408, 518000, China,
 People's Republic of China
 (740) Nino Gazdeliani
 (540)

hoco.

(591) Black-white
 (531) 24.17.02; 27.05.17
 (511) 9, 35,

(260) AM 2022 114539 A
 (210) AM 114539
 (220) 2021 09 07
 (731) Toyota Jidosha Kabushiki Kaisha
 (also trading as Toyota Motor Corporation)
 1, Toyota-cho, Toyota-shi, Aichi-ken, Japan
 (740) Tamar Kochlamazashvili
 (540)

LM350h

(591) Black-white
 (531) 27.07.01; 27.07.11
 (511) 12

(260) AM 2022 114544 A
 (210) AM 114544
 (220) 2021 09 09
 (731) Inpha LLP's Representative Office in Georgia
 Nearby of Besiki Str. 4, plot 46/10, 0108,
 Tbilisi, Georgia
 (540)

Teapel ტეარელი Tearel

(591) Black-white
 (511) 5

(260) AM 2022 114546 A
 (210) AM 114546
 (220) 2021 09 09
 (731) LTD "Khairat Al Minafie Co for Transport and
 General Trading"
 27 Boulevard Saborni, Varna, 9000, Bulgaria
 (740) Irakli Gvilia

(540)

ATLAS

(591) Black-white
(511) 34

(260) AM 2022 114592 A
(210) AM 114592
(220) 2021 09 10
(731) Nicholas Jonathan Michael Momprou
116 Rezidencia Les Sabletes-28800
Mohamedia-maroko, France
(740) Konstantine Chokoraia
(540)

(591) White, blue
(531) 21.01.02; 27.05.01; 29.01.12
(511) 36, 41

(260) AM 2022 114593 A
(210) AM 114593
(220) 2021 09 10
(731) Nicholas Jonathan Michael Momprou
116 Rezidencia Les Sabletes-28800
Mohamedia-maroko, France
(740) Konstantine Chokoraia
(540)

(591) Blue, yellow, white
(531) 18.05.03; 18.05.05; 18.05.10; 27.05.01;
29.01.12
(511) 36, 41

(260) AM 2022 114594 A
(210) AM 114594
(220) 2021 09 13
(731) LTD "Master-Nova"
Zubalashvili Str. 34-36, Batumi, Georgia
(540)



(591) FFFFFFF white, AA36D1 lilac
(531) 01.15.21; 26.01.02; 26.01.20; 26.01.24;
27.05.01; 27.05.24; 29.01.12
(511) 35, 36, 38, 41, 42, 45

(260) AM 2022 114595 A
(210) AM 114595
(220) 2021 09 13
(731) Trippe Manufacturing Company
1111 West 35th Street, Chicago Illinois
60609, USA
(740) Giorgi Meipariani
(540)

Tripp-Lite

(591) Black-white
(511) 9

(260) AM 2022 114609 A
(210) AM 114609
(220) 2021 09 14
(731) Tp-Link Corporation Limited
Room 901, 9/F., New East Ocean Centre,
9 Science Museum Road, Tsim Sha Tsui,
Kowloon, Hong Kong
(740) Liliana Darakhvelidze
(540)

VASATA

(591) Black-white
(511) 9

(260) AM 2022 114614 A
(210) AM 114614
(220) 2021 09 15
(731) LTD "Gurila"
Shalva Nutsbidze Str. 56 / Vazha-Pshavela
Ave., I qu., bld. 17, app. 82, Tbilisi, Georgia
(740) Giorgi Meipariani
(540)

PSOROSTOP

**ფსოროსტოპი
ПСОРОСТОП**

(591) Black-white
(511) 5

(260) AM 2022 114617 A
(210) AM 114617
(220) 2021 09 16
(731) Novartis AG
4002 Basel, Switzerland
(740) Shalva Gvaramadze

(540)

Эмсэлби

(591) Black-white

(511) 5

(260) AM 2022 114618 A

(210) AM 114618

(220) 2021 09 16

(731) Novartis AG

4002 Basel, Switzerland

(740) Shalva Gvaramadze

(540)

Имселби

(591) Black-white

(511) 5

(260) AM 2022 114736 A

(210) AM 114736

(220) 2021 09 24

(731) Shalva Abramishvili

Tsageri Str. 6, app. 4, 0160, Tbilisi, Georgia

(740) Shalva Abramishvili

(540)



(591) Blue, sky-blue, orange, pink

(531) 01.03.01; 01.03.02; 01.03.06; 01.03.13;
01.15.17; 06.01.01; 06.01.04; 26.03.01;
26.03.07; 26.03.13; 26.03.16; 26.03.19;
26.03.22; 29.01.13

(511) 41

(260) AM 2022 114756 A

(210) AM 114756

(220) 2021 09 30

(731) LTD "Zetline"

Akaki Beliashvili Str. 43, Tbilisi, Georgia

(540)



(591) Yellow, red, black, white

(531) 26.01.02; 26.01.03; 26.01.16; 26.01.22;
26.13.25; 27.05.01; 29.01.14

(511) 4

REGISTERED TRADEMARKS

(111) M 2022 35200 R
(151) 2022 03 21
(181) 2032 03 21
(260) AM 2021 111736 A
(220) 2021 02 17

(732) Philip Morris Brands Sàrl
Quai Jeanrenaud 3, 2000 Neuchâtel,
Switzerland

(111) M 2022 35201 R
(151) 2022 03 21
(181) 2032 03 21
(260) AM 2021 111850 A
(220) 2021 02 23

(732) Monge & C. S.P.A
Via Savigliano 31, 12030 Monasterolo
di Savigliano, Cuneo, Italy

(111) M 2022 35202 R
(151) 2022 03 21
(181) 2032 03 21
(260) AM 2021 111851 A
(220) 2021 02 23

(732) Monge & C. S.P.A
Via Savigliano 31, 12030 Monasterolo
di Savigliano, Cuneo, Italy

(111) M 2022 35203 R
(151) 2022 03 21
(181) 2032 03 21
(260) AM 2021 111852 A
(220) 2021 02 23

(732) Monge & C. S.P.A
Via Savigliano 31, 12030 Monasterolo
di Savigliano, Cuneo, Italy

(111) M 2022 35204 R
(151) 2022 03 21
(181) 2032 03 21
(260) AM 2021 112065 A
(220) 2021 03 09

(732) LTD "Big Trade"
Sherif Khimshiashvili St. 41, app. 26, 6010,
Batumi, Georgia

(111) M 2022 35205 R
(151) 2022 03 21
(181) 2032 03 21
(260) AM 2021 112254 A
(220) 2021 03 19

(732) LTD "4 Bros"
Ist St. 27, Vill. Velistsikhe, 1560, Gurjaani,
Georgia

(111) M 2022 35206 R
(151) 2022 03 21
(181) 2032 03 21
(260) AM 2021 112255 A
(220) 2021 03 19

(732) LTD "4 Bros"
Ist St. 27, Vill. Velistsikhe, 1560, Gurjaani,
Georgia

(111) M 2022 35207 R
(151) 2022 03 21
(181) 2032 03 21
(260) AM 2021 112267 A
(220) 2021 03 22

(732) LTD "Restobro"
Mikheil Tamarashvili Ave. 130, app. 163,
Tbilisi Georgia

(111) M 2022 35208 R
(151) 2022 03 21
(181) 2032 03 21
(260) AM 2021 112909 A
(220) 2021 05 11

(732) Alkaloid AD Skopje
Blvd. Aleksandar Makedonski 12, Skopje,
1000, The Republic of North Macedonia

(111) M 2022 35209 R
(151) 2022 03 21
(181) 2032 03 21
(260) AM 2021 112910 A
(220) 2021 05 11

(732) Alkaloid AD Skopje
Blvd. Aleksandar Makedonski 12, Skopje,
1000, The Republic of North Macedonia

(111) M 2022 35210 R
(151) 2022 03 21
(181) 2032 03 21
(260) AM 2021 112911 A
(220) 2021 05 11

(732) Alkaloid AD Skopje
Blvd. Aleksandar Makedonski 12, Skopje,
1000, The Republic of North Macedonia

(111) M 2022 35211 R
(151) 2022 03 21
(181) 2032 03 21
(260) AM 2021 112912 A
(220) 2021 05 11
(732) Alkaloid AD Skopje
Blvd. Aleksandar Makedonski 12, Skopje,
1000, The Republic of North Macedonia

(111) M 2022 35217 R
(151) 2022 03 21
(181) 2032 03 21
(260) AM 2021 112918 A
(220) 2021 05 11
(732) Alkaloid AD Skopje
Blvd. Aleksandar Makedonski 12, Skopje,
1000, The Republic of North Macedonia

(111) M 2022 35212 R
(151) 2022 03 21
(181) 2032 03 21
(260) AM 2021 112913 A
(220) 2021 05 11
(732) Alkaloid AD Skopje
Blvd. Aleksandar Makedonski 12, Skopje,
1000, The Republic of North Macedonia

(111) M 2022 35218 R
(151) 2022 03 21
(181) 2032 03 21
(260) AM 2021 112919 A
(220) 2021 05 11
(732) Alkaloid AD Skopje
Blvd. Aleksandar Makedonski 12, Skopje,
1000, The Republic of North Macedonia

(111) M 2022 35213 R
(151) 2022 03 21
(181) 2032 03 21
(260) AM 2021 112914 A
(220) 2021 05 11
(732) Alkaloid AD Skopje
Blvd. Aleksandar Makedonski 12, Skopje,
1000, The Republic of North Macedonia

(111) M 2022 35219 R
(151) 2022 03 21
(181) 2032 03 21
(260) AM 2021 112920 A
(220) 2021 05 11
(732) Alkaloid AD Skopje
Blvd. Aleksandar Makedonski 12, Skopje,
1000, The Republic of North Macedonia

(111) M 2022 35214 R
(151) 2022 03 21
(181) 2032 03 21
(260) AM 2021 112915 A
(220) 2021 05 11
(732) Alkaloid AD Skopje
Blvd. Aleksandar Makedonski 12, Skopje,
1000, The Republic of North Macedonia

(111) M 2022 35220 R
(151) 2022 03 21
(181) 2032 03 21
(260) AM 2021 113033 A
(220) 2021 05 18
(732) LTD "Tradezone"
Telavi St. 45a, app. 28, 0105, Tbilisi,
Georgia

(111) M 2022 35215 R
(151) 2022 03 21
(181) 2032 03 21
(260) AM 2021 112916 A
(220) 2021 05 11
(732) Alkaloid AD Skopje
Blvd. Aleksandar Makedonski 12, Skopje,
1000, The Republic of North Macedonia

(111) M 2022 35221 R
(151) 2022 03 21
(181) 2032 03 21
(260) AM 2021 113034 A
(220) 2021 05 18
(732) LLC "Ni Estetic Georgia"
Vazha-Pshavela Ave. 70a, 0186, Tbilisi, Georgia

(111) M 2022 35216 R
(151) 2022 03 21
(181) 2032 03 21
(260) AM 2021 112917 A
(220) 2021 05 11
(732) Alkaloid AD Skopje
Blvd. Aleksandar Makedonski 12, Skopje,
1000, The Republic of North Macedonia

(111) M 2022 35222 R
(151) 2022 03 21
(181) 2032 03 21
(260) AM 2021 113038 A
(220) 2021 05 19
(732) LTD "Enso"
Varketili III, I qu., bld. A, Commercial Space,
Samgori District, Tbilisi, Georgia

(111) M 2022 35223 R
(151) 2022 03 21
(181) 2032 03 21
(260) AM 2021 113124 A
(220) 2021 05 25
(732) Ningbo Genin Industrial Co., LTD.
Room 536, Bld. 5, N22 Henghe Road, Beilun
District, Ningbo, Zhejiang Province, China

(111) M 2022 35229 R
(151) 2022 03 21
(181) 2032 03 21
(260) AM 2021 113198 A
(220) 2021 05 28
(732) LTD "Helios Pharma"
Ilia Chavchavadze Ave. 17g, 0179, Tbilisi,
Georgia

(111) M 2022 35224 R
(151) 2022 03 21
(181) 2032 03 21
(260) AM 2021 113145 A
(220) 2021 05 27
(732) ADP Inc.
One ADP Boulevard, Roseland, New Jersey,
07068, USA

(111) M 2022 35230 R
(151) 2022 03 21
(181) 2032 03 21
(260) AM 2021 112185 A
(220) 2021 05 17
(732) JSC "Faber"
Davit Aghmashenebeli Ave. 55/1, Tbilisi,
Georgia

(111) M 2022 35225 R
(151) 2022 03 21
(181) 2032 03 21
(260) AM 2021 113183 A
(220) 2021 05 28
(732) LLC "Novator Pharma"
Vill. Irganchai, 1707, Dmanisi, Georgia

(111) M 2022 35231 R
(151) 2022 03 21
(181) 2032 03 21
(260) AM 2021 112584 A
(220) 2021 04 12
(732) LLC "Berketi-Design"
Vazha-Pshavela Av., VII qu., bld. a,
app. 90, 0186, Saburtalo District, Tbilisi, Georgia

(111) M 2022 35226 R
(151) 2022 03 21
(181) 2032 03 21
(260) AM 2021 113184 A
(220) 2021 05 28
(732) LLC "Novator Pharma"
Vill. Irganchai, 1707, Dmanisi, Georgia

(111) M 2022 35232 R
(151) 2022 03 21
(181) 2032 03 21
(260) AM 2021 112585 A
(220) 2021 04 12
(732) LLC "Berketi-Design"
Vazha-Pshavela Av., VII qu., bld. 1a,
app. 90, 0186, Saburtalo District, Tbilisi, Georgia

(111) M 2022 35227 R
(151) 2022 03 21
(181) 2032 03 21
(260) AM 2021 113187 A
(220) 2021 05 28
(732) LLC "Novator Pharma"
Vill. Irganchai, 1707, Dmanisi, Georgia

(111) M 2022 35228 R
(151) 2022 03 21
(181) 2032 03 21
(260) AM 2021 113197 A
(220) 2021 05 28
(732) LTD "Helios Pharma"
Ilia Chavchavadze Ave. 17g, 0179, Tbilisi,
Georgia

TRADEMARKS REGISTERED ACCORDING TO THE ACCELERATED PROCEDURE

The decision can be appealed at the Chamber of Appeal of Sakpatenti within 3 months from the publication.

(111) M 2022 35233 R

(151) 2022 03 22

(181) 2032 03 22

(210) AM 117095

(220) 2022 03 16

(732) LTD "Made To Make"

Akaki Tsereteli Ave. 41, 0154, Tbilisi, Georgia

(540)



(591) White, red, blue

(531) 27.05.12; 27.07.11; 29.01.13

(511) 35

(111) M 2022 35234 R

(151) 2022 03 22

(181) 2032 03 22

(210) AM 117063

(220) 2022 03 11

(732) LTD "Nextra Group "

Irodion Evdoshvili Str. 18, Floor 2, Office
Space 3, 0154, Tbilisi, Georgia

(540)

დექსიდროლი
Dexydrop
Дексидроп

(591) Black-white

(511) 5

(111) M 2022 35235 R

(151) 2022 03 25

(181) 2032 03 25

(210) AM 117107

(220) 2022 03 17

(732) Deedsgood LTD

2100 Weston Rd, 1607, Toronto, Ontario,
Canada, M9N 3W6, Canada

(740) Nino Bakhtadze

(540)

DEEDSGOOD

(591) Black-white

(511) 35, 36, 38, 42

(111) M 2022 35236 R

(151) 2022 03 29

(181) 2032 03 29

(210) AM 117180

(220) 2022 03 21

(732) LTD "Pointpay"

Vill. Untsa, Adigen Region, Georgia

(540)



(591) White, sky-blue

(531) 26.04.01; 26.04.04; 26.04.18; 27.05.01;
27.05.05; 27.05.21; 29.01.12

(511) 36

(111) M 2022 35237 R

(151) 2022 03 29

(181) 2032 03 29

(210) AM 117181

(220) 2022 03 21

(732) LTD "Pointpay"

Vill. Untsa, Adigen Region, Georgia

(540)



(591) White, dak purple, light purple

(531) 15.09.16; 26.04.02; 26.04.09; 26.04.16;
26.04.22; 26.04.24; 27.05.01; 27.05.01;
27.05.05; 27.05.23; 27.05.24; 29.01.12

(511) 36

INTERNATIONAL TRADEMARKS FOR WHICH A DECISION ON GRANTING PROTECTIONS IS TAKEN

The decision can be appealed at the Chamber of Appeal of Sakpatenti within 3 months from the publication or at the Mtskheta District Court Administrative Cases Board (Address: №17, Samkhedro St., Mtskheta), within 1 month following the publication.

(260) AM 2022 113528 A

(800) 1596455

(151) 2021 02 23

(891) 2021 02 23

(731) Big City Beats GmbH

Cassellastraße 30-32, 60386 Frankfurt am Main, Germany

(540)



(591) Black, white

(531) 26.11.03; 26.11.06; 26.11.12; 26.13.25

(511)

9 – Computer hardware and computer software; computer peripheral devices; apparatus for recording, transmission or reproduction of sound, images or data; machine-readable data recording media; sound recording carriers; telephone apparatus; mobile telephones; accessories for mobile phones as far as included in this class; electronic publications, downloadable.

25 – Clothing; trousers; headgear; outerclothing; macintoshes; neck scarves [mufflers]; footwear; lingerie [clothing]; sweaters; t-shirts.

35 – Presentation of companies on the internet and other media for advertising purposes; presentation of goods and services for retail; advertising agency services; rental of advertising space, also on the internet; updating and maintaining data in computer databases; updating of advertising material; public relations services; online advertising in a computer network; multimedia advertising; organisation and conduct of advertising events; organization of exhibitions and fairs for economic and advertising purposes; organizational project management in the IT area; job placement; presentation of goods and services in retail communication media; publications of printed matter [also in electronic form] for advertising purposes; radio advertising; consumer advice shop; writing of publicity texts; compilation, systematisation, updating and ma-

intenance of data, in particular customer data and user profiles in computer databases; statistical evaluation of data using computer programs; mediation, rental of addresses and data for business and advertising purposes; mediation of trade business for third parties, including e-commerce, mobile commerce and e-business; mediation of trade contacts; arranging of contracts for others for the buying and selling of goods and the providing of services.

38 – Telecommunication services provided via Internet platforms and portals, especially for file creation, file maintenance and for the exchange of documents, files and information; provision of portals, electronic discussion forums, newsgroups and internet chatrooms on the internet; communication services provided over the internet, in open networks and other electronic media; transmission of electronic mail; short message services; electronic exchange of messages via e-mail, sms, chatlines, chatrooms and internet forums; broadcasting, dissemination, distribution and retransmission of television, radio, telecommunications and information signals over any network; collecting and delivery of messages [news agencies]; internet services, namely providing access to information via the medium of the internet, providing internet access to software in data networks for internet access, mobile telephone services; electronic bulletin board services; providing telecommunication channels for teleshopping services; electronic transmission of broadcasts and downloadable media files in particular audio and video files via electronic and communication networks]; broadcasting of audio and video content via a worldwide computer network [ip-tv]; digital video broadcasting [dwb]; transmission of addresses and data for business and advertising purposes; provision of access to databases in computer networks on the internet in the fields of music, video, radio, television, news, sports, games, cultural events, entertainment, as well as art and leisure via communication networks; provision of access to information, audio, video, graphics, text and other multimedia content on the above areas on the Internet; providing access to platforms on the internet, in particular for initiating and arranging private and business contacts and for exchanging information; provision of access to databases in computer networks on the internet, in particular for music, audio and video data; provision of platforms on the internet for evaluating and getting to know media content, in particular audio and video data; arranging and leasing of access times to databases.

41 – Radio entertainment; production and compilation of radio and television programs of educational, instructional and entertainment nature; recording studio services, also on the internet; organisation and conducting of concerts, dance events, live events and balls; organisation of competitions in the fields of education, teaching, entertainment and sports; organisation of gambling, tombolas; providing entertainment programs on the Internet; publication of audio and video sound recordings; publication of texts and images, including in electronic form, except for advertising purposes; [online] gaming services on the internet; box office services; correspondence courses; party planning; recreation information; editorial support for internet presences, namely editing of texts for publication on the internet; music publishing services [excluding printing services].

42 – Web design, in particular design, programming and creation of websites; rental and maintenance of storage space for use as websites for third parties [webhosting]; provision, allocation or rental of electronic storage space [webspace] on the internet; updating of Internet pages; providing search engines for the Internet; services of an electronic data processing programmer; electronic data collection, backup and data storage; creating programs for data processing, in particular creating software for arranging business and private contacts and for exchanging messages and data; rental of web servers, data processing equipment, computer software and electronic and optical data carriers; electronic storage of media content for provision for download on the internet.

(260) AM 2022 113529 A
 (800) 1596480
 (151) 2020 09 07
 (891) 2020 09 07
 (731) Arian Tejarat Shargh Co.
 10th floor, no. 1, 1st Saei Alley, Vali-e-Asr Ave., Tehran, Islamic Republic of Iran
 (540)

Eurocell

(591) Black, white
 (526) Cell and Euro to be used alone
 (511)
 9 – Battery boxes; electrical cells and batteries; chargers for electric batteries; cell phone batteries, battery charger monitor and indicator; battery dischargers; electronic devices for transmitting battery information; medium battery, sealed acid battery charger; sealed acid battery; lithium polymer battery charger; lithium polymer batteries; lithium ion battery charger; lithium ion batteries; equipment for communication network; nickel metal hydride batteries; nickel-cadmium storage batteries; replaceable batteries; rechargeable batteries; large batteries; AA batteries; electric batteries for vehicles; batteries, electric; solar batteries;

batteries for pocket lamps; battery plate (positive pole); battery chargers; electric batteries; batteries for lighting; anode batteries; battery container (glass); chargers for batteries; vehicle batteries; electric batteries for vehicles; anode batteries; acidometers for batteries; batteries.

(260) AM 2022 113536 A
 (800) 1596683
 (151) 2020 10 15
 (891) 2020 10 15
 (731) ROYAL ARMENIA JV LTD
 Davtashen 2nd Block 268, 0054 Yerevan, Armenia
 (540)



(591) Black, blue, light blue, red, white
 (531) 02.07.23; 05.07.27; 06.01.02; 07.05.05;
 22.05.10; 25.01.15; 25.07.01; 27.05.10;
 29.01.15
 (526) "ARMENIA", "@", "ULTRA", "GROUND
 COFFEE", "ARABICA & ROBUSTA"
 (511)
 30 – Ground coffee.

(260) AM 2022 113538 A
 (800) 1596868
 (151) 2021 03 22
 (891) 2021 03 22
 (731) PRYSMIAN S.P.A.
 Via Chiese, 6, I-20126 MILANO (MI), Italy
 (540)



(591) Green and white
 (531) 05.03.14; 14.01.01; 25.03.01; 26.01.05;
 27.05.01; 27.05.24; 29.01.12

(511)
 9 – Electric cables; optical cables; fiber optic cables;
 data cables.

(260) AM 2022 113541 A

(800) 1596901

(151) 2021 03 24

(891) 2021 03 24

(731) KyungDong One Co., Ltd.
 (Yeouido-dong) 22, 76-gil, Gukhoi-daero,
 Yeongdeungpo-gu, Seoul, Republic of Korea

(540)



(591) Orange, navy
 (531) 26.05.04; 26.05.18; 26.05.24; 27.05.01;
 27.05.19; 27.05.22; 27.05.24; 29.01.13

(511)
 11 – Gas grills; gas ranges; gas lighters; gas regulators; heaters for heating irons; sterilizers for household purposes; air conditioners for household purposes; drainage treatment apparatus for household purposes; domestic boilers; heater for drying furnace; air purifying apparatus; agricultural drying equipment; cooling installations for tobacco; luminous house numbers; toilet bowls; non-electric lighting apparatus and devices; beds for sauna; cooling apparatus for ships; washers for water faucets; aquarium filtration apparatus; heating apparatus and devices for laboratory use; sink units; bath tubs; beverage cooling apparatus; apparatus for dehydrating food waste; medical sterilizer; toilets, portable; heating and cooling systems for motor cars, not being parts of engines or motors; bicycle lights; electric space cooling apparatus; cool boxes, electric; electric lighting apparatus; heating and cooling systems for railway vehicles; dental ovens; pocket warmers; heating and cooling systems for aircrafts; ventilating installations; hand-held electric hair dryers; heat guns; water treatment apparatus; micro filter for water treatment; sewage treatment device; non-electric water purifiers for household purposes; water purifiers for household purposes; water purifier for commercial purpose; non-electric water purifier filters for household purposes; water purifier filter for industrial purpose; electric water purifiers for household purposes; electric water purification filters for household purposes.

35 – Price comparison services; retail store services featuring gas leak alarms; retail store services featuring electric heating water mats for household purposes; retail store services featuring household air cleaners; retail store services featuring domestic boilers; retail store services featuring water heaters for household purposes; retail store services featuring air circulation equipment; retail store services featuring air purifiers; retail store services featuring filters for air purifiers; retail store services featuring air conditioning units; retail store services featuring filters for air conditioning unit; retail store services featuring household air cleaners; retail store services featuring filters for household air cleaners; advertising and business management consultancy; advertising and commercial information services; retail store services featuring apparatus for heating/ventilating and air conditioning; retail store services featuring closed circuit television cameras for doors; retail store services featuring automatic controlling devices for the temperature of boilers; retail store services featuring video telephones; providing business and marketing information; providing commercial information and advice for consumers in the choice of products and services; providing information for other sales of goods; accountancy advice relating to taxation; import and export agencies; retail store services featuring smart remote controllers; retail store services featuring application software for smartphones; retail store services featuring temperature control apparatus [electric switches]; auctioneering provided on the internet; retail store services featuring remote multi switches; promoting the goods and services of others by means of operating an on-line comprehensive shopping mall; retail store services featuring interphones; retail store services featuring electrical heating apparatus; retail store services featuring electric entrance access control systems; business intermediary services relating to mail order by telecommunications; telephone answering services; compilation of information into computer databases; personnel recruitment services and employment agencies; computerized on-line ordering services; retail store services featuring home network devices; retail store services featuring fire alarms.

37 – Repair and maintenance of gas ranges; cleaning of household air cleaners; repair and maintenance of electric ovens for household purposes; installation of household air cleaners; repair of household air cleaners; repair and maintenance of drainage treatment apparatus for household purposes; installation of household heating boilers; repair of household heating boilers; cleaning of household heating boilers; repair and maintenance of non-electric water purifiers for household purposes; repair and maintenance of electric bidets for household purposes; repair and maintenance of ventilating fans for household use; installation of air circulation equipment; repair of air circulation equipment; cleaning of air circulation equipment; repair and installation of air purifiers; repair of air

purifiers; cleaning of air purifiers; repair of filters for air purifiers; installation of filters for air purifiers; cleaning of filters for air purifiers; repair and maintenance of air purifying apparatus; repair of air conditioning apparatus; installation of air conditioning apparatus; air conditioning apparatus cleaning services; installation of filters for air conditioning unit; repair of filters for air conditioning unit; cleaning of filters for air conditioning unit; installation of household air cleaners; repair of household air cleaners; cleaning of household air cleaners; repair of filter for household air cleaners; installation of filters for household air cleaners; cleaning of filters for household air cleaners; repair and maintenance of filters for air extractor hoods; construction services relating to the installation of heating, ventilating and air conditioning systems; repair of apparatus for heating/ventilating and air conditioning; installation of apparatus for heating/ventilating and air conditioning; repair and maintenance of apparatus for heating/ventilating and air conditioning; cleaning of apparatus for heating/ventilating and air conditioning; repair and maintenance of refrigerating appliances and installations; repair and maintenance of cooking apparatus and installations; repair and maintenance of beverage-cooling apparatus; repair and maintenance of apparatus for dehydrating food waste; repair and maintenance of disposable pocket warmers; repair and maintenance of electric air purifiers; repair and maintenance of ventilating installations; repair and maintenance of installations for ventilation.

(260) AM 2022 113542 A

(800) 1596906

(151) 2021 02 05

(891) 2021 02 05

(731) Euro Games Technology Ltd.

4, "Maritsa" Str., "Vranya-Lozen-Triugulnika",
BG-1151 Sofia, Bulgaria

(540)

WEALTH PALACE

(591) Red, orange, green and gold

(531) 27.05.01; 27.05.02; 27.05.03; 27.05.09;
29.01.13

(511)

28 – Gaming machines for gambling; chips for gambling; mah-jong; arcade games; gambling machines operating with coins, banknotes and cards; games; electronic games; parlor games; gaming chips; gaming tables; slot machines [gaming machines]; LCD game machines; slot machines and gaming devices; coin-operated amusement machines; roulette chips; poker chips; chips and dice [gaming equipment]; gaming equipment for casinos; roulette tables; gaming roulette wheels; casino games; gambling machines and amusement machines, automatic and coin-operated; coin-operated amusement machines and/or electronic coin-

operated amusement machines with or without the possibility of gain; boxes for coin-operated machines, slot machines and gaming machines; electronic or electrotechnical amusement machines and apparatus, gaming machines, coin-operated entertainment machines; housings for coin-operated machines, gaming equipment, gaming machines, machines for gambling; electropneumatic and electrical gambling machines (slot machines).

41 – Gambling; entertainment services related to gambling; gaming services for entertainment purposes; casino, gaming and gambling services; training in the development of software systems; provision of equipment for gambling halls; providing casino equipment [gambling]; gaming machine entertainment services; providing casino facilities [gambling]; gaming hall services; amusement arcade services; games equipment rental; rental of gaming machines; providing amusement arcade services; rental of gaming machines with images of fruits; editing or recording of sounds and images; sound recording and video entertainment services; hire of sound reproducing apparatus; provision of gaming equipment for casinos; providing of casino facilities; online gambling services; casino, gaming and gambling services; provision of gaming facilities, gaming hall facilities, Internet casinos and online gambling services.

(260) AM 2022 113549 A

(800) 1597039

(151) 2021 05 17

(891) 2021 05 17

(731) Yangtze Memory Technologies Co., Ltd.

No.88 Weilai 3rd Road, East Lake High-tech
Development Zone, Wuhan, Hubei, China

(540)



(591) Black, white

(531) 26.03.23; 26.07.18; 26.11.09

(511)

9 – Counters; apparatus to check franking; ticket dispensers; electronic tags for goods; telephone apparatus; electronic surveillance apparatus; cameras [photography]; screens for photoengraving; detectors; microscopes; regulating apparatus, electric; lightning rods; alarms; locks, electric; batteries, electric; solar batteries; holders for electric coils; computers; data processing apparatus; computer memory devices; computer programs, recorded; identity cards, magnetic; microprocessors; monitors [computer hardware]; pro-

cessors [central processing units]; integrated circuit cards [smart cards]; usb flash drives; semi-conductors; wafers for integrated circuits; integrated circuits; chips [integrated circuits]; electronic chips; semi-conductor devices; transistors [electronic]; electromagnetic coils; potentiometers; condensers [capacitors]; resistances, electric; sensors; video screens; remote control apparatus.

35 – Advertising; sponsorship search; sales promotion for others; marketing; import-export agency services; commercial administration of the licensing of the goods and services of others; employment agencies; office machines and equipment rental; retail or wholesale services for pharmaceutical, veterinary and sanitary preparations and medical supplies; online advertising on a computer network.

42 – Scientific laboratory services; chemical research; technological research; research and development of new products for others; material testing; industrial design; authenticating works of art; scientific research; information technology [IT] consultancy; conducting technical project studies.

(260) AM 2022 113550 A

(800) 1597045

(151) 2021 02 19

(891) 2021 02 19

(731) Open-Type Joint Stock Company

"ROT FRONT"

2-oy Novokuznetskiy pereulok, d. 13/15,

RU-115184 Moscow, Russian Federation

(540)



(591) Green, dark green, yellow, dark yellow, white, red

(531) 05.03.13; 05.07.12; 19.03.24; 25.01.19; 25.03.07; 25.07.25; 25.12.03; 26.11.07; 28.05; 29.01.15

(526) ®

(511)

30 – Confectionery.

(260) AM 2022 113556 A

(800) 1597142

(151) 2021 02 09

(891) 2021 02 09

(731) Industria de Diseño Textil, S.A (Inditex, S.A) x

Avenida de la Diputación,, Edificio Inditex,

E-15142 Arteixo, A Coruña, Spain

(540)



(591) Black, white

(531) 26.04.12; 26.04.16; 26.04.18; 26.04.24

(511)

25 – Clothing; footwear; headwear; motorists' clothing; clothing for cyclists; bibs not of paper; headbands [clothing]; bath robes; bathing suits; caps [headwear]; bath sandals; boas [clothing]; scarves; footwear for sports; footwear for the beach; hoods [clothing]; shawls; belts [clothing]; money belts [clothing]; wet suits for water-skiing; neckties; girdles [corsets]; foulards; caps; gloves [clothing]; raincoats; girdles [underwear]; body linen [garments]; mantillas; stockings; socks; neckerchiefs; furs [clothing]; fur stoles; pajamas; soles for footwear; heels; veils [clothing]; suspenders; layettes [clothing]; capes; sports jerseys; mittens; ear muffs [clothing]; inner soles; cuffs; dress shields; beach wear; dressing gowns; pockets for clothing; sock suspenders; stocking suspenders; petticoats; tights; aprons; masquerade costumes; uniforms; sun visors; wooden shoes; caps; coats; esparto shoes or sandals; non-slip devices for footwear; bath slippers; caps (headwear); blouses; bodies [clothing]; berets; footmuffs, not electrically heated; lace boots; boots; boot uppers; studs for football boots; half-boots; fittings of metal for footwear; tips for footwear; heelpieces for footwear; shirts; shirt yokes; shirt fronts; T-shirts; bodices [lingerie]; vests; jackets; fishing vests; stuff jackets; slips [undergarments]; ready-made clothing; detachable collars; collars [clothing]; clothing of leather; clothing of imitation leather; shower caps; slippers; skirts; trousers; ready-made linings [parts of clothing]; top coats; coats; gabardines [clothing]; gymnastic shoes; jerseys [clothing]; pullovers; sweaters; liveries; muffs [clothing]; footwear uppers; pocket squares; parkas; pelerines; pelisses; spats; leggings; knitwear [clothing]; clothing for gymnastics; underwear; sandals; saris; underpants; hats; wimples; togas; trouser straps; suits; turbans; sneakers; clothing; slippers; shoes; footwear for sports.

(260) AM 2022 113558 A

(800) 1597188

(151) 2021 03 05

(891) 2021 03 05

(731) KPO MARKETING COMPANY LIMITED

Egypt Street, 12, CY-1097 Nicosia, Cyprus

(540)

Siberian express

(591) Red, black, white.

(531) 07.11.10; 07.11.15; 24.17.24; 29.01.13

(511)

33 – Aperitifs; arrack [arak]; brandy; wine; piquette; whisky; vodka; anisette [liqueur]; kirsch; gin; digestifs [liqueurs and spirits]; cocktails; curacao; anise [liqueur]; liqueurs; grain-based distilled alcoholic beverages; sugarcane-based alcoholic beverages; pre-mixed alcoholic beverages, other than beer-based; alcoholic beverages, except beer; alcoholic beverages containing fruit; spirits [beverages]; distilled beverages; mead [hydromel]; peppermint liqueurs; bitters; rum; sake; perry; cider; rice alcohol; alcoholic extracts; fruit extracts, alcoholic; alcoholic essences.

(260) AM 2022 113560 A

(800) 1597232

(151) 2021 05 19

(891) 2021 05 19

(731) UAB "Narbutas International"

Odminių g. 3-23, LT-01122 Vilnius, Lithuania

(540)

MOVE&LEAD

(591) Black, white

(511)

20 – Furniture.

(260) AM 2022 113561 A

(800) 1597252

(151) 2021 04 02

(891) 2021 04 02

(731) TAIZHOU FIT GARMENT EQUIPMENT CO., LTD.

Square B, Room 802, No.6, Building, Zhonghuan Century Centre, Taizhou, 318000 Zhejiang, China

(540)

Imachine

(591) Black, white

(531) 27.05.01

(511)

7 – Sewing machines; ironing machines; leather paring machines; pedal drives for sewing machines; leather ironing machine; overlock sewing machines; button attach machines; cloth cutting machines; feeding

machines for sewing machines; stand table for industrial sewing machines.

(260) AM 2022 113577 A

(800) 1560116

(151) 2020 08 21

(891) 2021 04 22

(731) DAIO PAPER CORPORATION

2-60, Mishima-Kamiya-cho, Shikokuchuo-Shi, Ehime-ken 799-0402, Japan

(540)



(591) Black, white

(531) 02.03.16; 02.03.23; 27.03.02; 28.03

(511)

5 – Pharmaceutical preparations; preparations for destroying vermin, fungicides, herbicides; oiled paper for medical purposes; drug delivery agents in the form of edible wafers for wrapping powdered pharmaceuticals; gauze for dressings; empty capsules for pharmaceuticals; eyepatches for medical purposes; ear bandages; menstruation bandages; menstruation tampons; sanitary napkins; sanitary panty liners; sanitary panties; absorbent cotton; adhesive plasters; bandages for dressings; liquid bandages; breast-nursing pads; incontinence pads; disposable diaper liners; disposable liners for incontinence diapers; baby diapers; adult diapers; diapers for incontinence; diaper covers.

(260) AM 2022 113623 A

(800) 1597488

(151) 2021 03 03

(891) 2021 03 03

(731) Limited Liability Company "NEARMEDIC PHARMA"

ul. Koroleva, 4, office 402, RU-249030 Obninsk, Kaluzhskaya oblast, Russian Federation

(540)

INLARESTIN

(591) Black, white

(531) 27.05.17

(511)

5 – Pharmaceuticals; medical preparations; medicines for human purposes; analgesics; anti-inflammatory pharmaceutical preparations; pharmaceutical preparations and medicines for the treatment of respiratory system; pharmaceutical preparations and medicines

for the treatment of sore throat; medical solutions for the treatment of sore throat; medical lozenges for the treatment of sore throat; medical drops for the treatment of sore throat; medical tablets for the treatment of sore throat; pharmaceuticals in the form of anti-inflammatory sprays; pharmaceuticals in the form of antibacterial sprays; medicines in the form of oral sprays; cooling sprays for medical purposes; chemical preparations for medical purposes; chemical preparations for pharmaceutical purposes; antiseptics; antifungal pharmaceutical preparations; antifungal medicines; antimicrobial pharmaceuticals; pharmaceutical preparations and substances with anaesthetic properties, including for topical application; mouthwashes for medical purposes; medicated toothpaste.

42 – Research and development of new products for others; scientific research, including in the field of medicine and pharmacology; clinical trials.

44 – Medical services; pharmacy advice; medical assistance; therapy services.

(260) AM 2022 113624 A

(800) 1597525

(151) 2021 03 19

(891) 2021 03 19

(731) Société des Produits Nestlé S.A.

CH-1800 Vevey, Switzerland

(540)

NESCAFÉ GOLD ROASTERY

(591) Black, white

(511)

30 – Coffee, coffee extracts, coffee-based beverages; iced coffee; tea, tea extracts, tea-based beverages; iced tea; malt-based preparations for human consumption; cocoa and cocoa-based beverages; chocolate, chocolate-based beverages; confectionery, sugar confectionery, candy; sugar; chewing gum not for medical use; natural sweeteners; bakery products, bread, yeast, pastries; biscuits, cookies, cakes, wafers, caramels, puddings; edible ices, water ices, sherbets, frozen confectionery, ice-cream cakes, ice cream, frozen yogurts; breakfast cereals, muesli, corn flakes, cereal bars, ready-to-eat cereals; cereal preparations.

(260) AM 2022 113626 A

(800) 1597544

(151) 2021 04 26

(891) 2021 04 26

(731) Otkrytoe aktsionernoe obshchestvo

"Belgorodskie molochnye produkty"

Mikhaylovskoye sh., 14, RU-308013 Belgorod,

Russian Federation

(540)



(591) White and dark blue

(531) 26.04.04; 26.04.05; 26.04.06; 26.04.22; 28.05; 29.01.12

(511)

29 – Agar-agar for culinary purposes; aloe vera prepared for human consumption; alginates for culinary purposes; andouillettes; anchovy, not live; peanuts, prepared; artichokes, preserved; albumen for culinary purposes; white of eggs; beans, preserved; soya beans, preserved, for food; broth; ginger jam; ham; fatty substances for the manufacture of edible fats; laver, preserved; edible birds' nests; cabbage rolls stuffed with meat; peas, preserved; mushrooms, preserved; guacamole; game, not live; gelatine; meat jellies; jellies for food; fruit jellies; yolk of eggs; coconut fat; bone oil for food; lard; suet for food; edible fats; fruit-based snack food; milk substitutes; tofu patties; charcuterie; raisins; caviar; aubergine paste; vegetable marrow paste; fish roe, processed; ginger, preserved; crystallized ginger; pickled ginger; yogurt; sauerkraut; cassoulet; quark; kephir; kimchi; isinglass for food; clams, not live; potato-based dumplings; klipfish [salted and dried cod]; milk shakes; black pudding; onion rings; arrangements of processed fruit; compotes; meat, tinned; vegetables, tinned; fish, tinned; fruits, tinned; duck confits; broth concentrates; vegetable-based concentrate for cooking; fruit-based concentrate for cooking; gherkins; shrimps, not live; prawns, not live; buttercream; croquettes; silkworm chrysalis for human consumption; sweet corn, processed; koumiss; spiny lobsters, not live; lecithin for culinary purposes; edible ant larvae, prepared; salmon, not live; onions, preserved; margarine; marmalade; oils for food; peanut butter; cocoa butter for food; coconut oil for food; coconut butter; maize oil for food; sesame oil for food; linseed oil for food; extra virgin olive oil for food; olive oil for food; palm oil for food; palm kernel oil for food; sunflower oil for food; rape oil for food; butter; soya bean oil for food; shellfish, not live; almonds, ground; animal marrow for food; mussels, not live; milk; peanut milk; peanut milk for culinary purposes; coconut milk; coconut milk for culinary purposes; almond milk; almond milk for culinary purposes; oat milk; rice milk; rice milk for culinary purposes; condensed milk; soured milk; soya milk; albumin milk; powdered milk; fermented baked milk; fish meal for human consumption; vegetable mousses; fish mousses; fruit pulp; meat; meat, preserved; freeze-dried meat; lactic acid drinks; milk beverages, milk predominating; peanut milk-based beverages; coconut milk-based beverages; almond milk-based beverages; edible insects, not live; sausage casings, natural or artificial; vegetab-

les, cooked; vegetables, preserved; freeze-dried vegetables; vegetables, processed; vegetables, dried; hash browns; potato fritters; olives, preserved; lobsters, not live; omelettes; flavoured nuts; candied nuts; coconut, desiccated; nuts, prepared; tomato purée; pressed fruit paste; liver pâté; pectin for culinary purposes; preserved peppers; liver; pickles; jams; powdered eggs; milk products; fish-based foodstuffs; poultry, not live; white pudding; bulgogi; pollen prepared as foodstuff; cranberry compote; apple purée; crayfish, not live; crustaceans, not live; ratatouille; fish, preserved; fish, not live; salted fish; vegetable salads; fruit salads; bacon; sardines, not live; satay; pork; herrings, not live; seeds, prepared; sunflower seeds, prepared; cream [dairy products]; whipped cream; vegetable-based cream; fat-containing mixtures for bread slices; smetana; vegetable juices for cooking; lemon juice for culinary purposes; tomato juice for cooking; salted meats; sausages; sausages in batter; hot dog sausages; preparations for making bouillon; preparations for making soup; tofu skin; vegetable-based spreads; nut-based spreads; tripe; soups; vegetable soup preparations; whey; cottage cheese fritters; cheese; tajine [prepared meat, fish or vegetable dish]; tahini; cottage cheese; tempeh; truffles, preserved; tuna, not live; oysters, not live; falafel; milk ferments for culinary purposes; rennet; dates; fruit preserved in alcohol; fruit, stewed; crystallized fruits; frozen fruits; fruit, preserved; fruit, processed; hazelnuts, prepared; potato flakes; hummus; edible flowers, dried; fruit peel; preserved garlic; lentils, preserved; potato crisps; low-fat potato crisps; fruit chips; choucroute garnie; non-alcoholic eggnog; seaweed extracts for food; meat extracts; berries, preserved; eggs; snail eggs for consumption; yakitori; sea-cucumbers, not live; fish fillets; tofu; corn dogs; soya patties.

30 – Vanilla flavourings for culinary purposes; flavourings, other than essential oils, for cakes; flavourings, other than essential oils, for beverages; coffee flavourings; food flavourings, other than essential oils; star aniseed; baozi; cereal bars; high-protein cereal bars; pancakes; savoury pancakes; freeze-dried dishes with the main ingredient being pasta; freeze-dried dishes with the main ingredient being rice; noodle-based prepared meals; buns; bulgur; bread rolls; edible paper wafers; edible rice paper; edible paper; vanillin [vanilla substitute]; waffles; vermicelli; natural sweeteners; sausage binding materials; binding agents for ice cream; orange blossom water for culinary purposes; seawater for cooking; seaweed [condiment]; malt biscuits; cloves [spice]; mirror icing [mirror glaze]; cake frosting [icing]; glucose for culinary purposes; mustard; croûtons; buckwheat, processed; gluten additives for culinary purposes; yeast; thickening agents for cooking foodstuffs; leaven; rice-based snack food; cereal-based snack food; artificial coffee; vegetal preparations for use as coffee substitutes; dressings for salad; fruit jellies [confectionery]; candy decorations for cakes; confectionery for decorating

Christmas trees; cakes; pastries; peanut confectionery; almond confectionery; fruit confectionery; pasta; ground ginger; frozen yogurt [confectionery ices]; cocoa; capers; coffee capsules, filled; caramels [sweets]; curry [spice]; ketchup [sauce]; quinoa, processed; quiches; gluten prepared as foodstuff; flour-based dumplings; sweets; liquorice [confectionery]; peppermint sweets; mints for breath freshening; dulce de leche; cinnamon [spice]; coffee; unroasted coffee; starch for food; crackers; rice crackers; crème brûlée; custard; croissants; hominy grits; semolina; oatmeal; crushed barley; groats for human food; ice cubes; corn, milled; corn, roasted; meat pies; turmeric; couscous; laksa; noodles; soba noodles; udon noodles; ice for refreshment; ice, natural or artificial; edible ices; ice pops; potato-based flatbreads; rice cakes; mayonnaise; macarons; macaroni; maltose; hominy; piccalilli; marinades; marzipan; honey; miso; royal jelly; ice cream; bean meal; buckwheat flour; tapioca flour; potato flour; corn flour; nut flours; flour; wheat flour; soya flour; barley meal; dessert mousses [confectionery]; chocolate mousses; muesli; mint for confectionery; cocoa beverages with milk; coffee beverages with milk; coffee-based beverages; cocoa-based beverages; chamomile-based beverages; tea-based beverages; chocolate beverages with milk; chocolate-based beverages; infusions, not medicinal; nougat; crushed oats; husked oats; kimchi pancakes; onigiri; chocolate-coated nuts; nutmegs; stick liquorice [confectionery]; ginger paste [seasoning]; lozenges [confectionery]; molasses for food; pâtés en croûte; pelmeni; pepper; allspice; peppers [seasonings]; pesto; biscuits; coconut macarons; petit-beurre biscuits; bibimbap [rice mixed with vegetables and beef]; pies; pizzas; meat gravies; fondants [confectionery]; popcorn; powders for making ice cream; baking powder; mustard meal; pralines; condiments; meat tenderizers for household purposes; cereal preparations; oat-based food; propolis; profiteroles; gingerbread; spices; petits fours; puddings; rice pudding; cake powder; fruit coulis [sauces]; ravioli; ramen; chewing gum; chewing gum for breath freshening; relish [condiment]; rice; prepared rice rolled in seaweed; instant rice; wheat germ for human consumption; spring rolls; sago; sugar; crystallized rock sugar; palm sugar; sesame seeds [seasonings]; linseed for culinary purposes [seasoning]; processed seeds for use as a seasoning; aniseed; agave syrup [natural sweetener]; confectionery; savoury pancake mixes; batter mixes; baking soda [bicarbonate of soda for cooking purposes]; malt for human consumption; salt for preserving foodstuffs; cooking salt; celery salt; sorbets [ices]; ham glaze; cranberry sauce [condiment]; soya sauce; tomato sauce; sauces [condiments]; pasta sauce; apple sauce [condiment]; spaghetti; seasonings; chocolate-based spreads; chocolate spreads containing nuts; preparations for stiffening whipped cream; shaved ice with sweetened red beans; rusks; bread-crumbs; sushi; sandwiches; tabbouleh; tacos; tamarind [condiment]; tapioca; tarts; dough; pastry dough; al-

mond paste; rice pulp for culinary purposes; cake batter; garden herbs, preserved [seasonings]; chocolate decorations for cakes; vinegar; beer vinegar; ferments for pastes; halvah; harissa [condiment]; bread; gluten-free bread; unleavened bread; chips [cereal products]; corn flakes; oat flakes; hot dog sandwiches; jiaozi; chicory [coffee substitute]; tea; kelp tea; iced tea; chutneys [condiments]; minced garlic [condiment]; cheeseburgers [sandwiches]; chow-chow [condiment]; saffron [seasoning]; chocolate; malt extract for food; essences for foodstuffs, except etheric essences and essential oils; husked barley; pains au chocolat; flowers or leaves for use as tea substitutes; tortillas; golden syrup; cream of tartar for culinary purposes; burritos.

(260) AM 2022 113629 A
(800) 1597636
(151) 2021 04 07
(891) 2021 04 07
(731) QUIPMENT
269 rue Julie Daubié, F-54000 NANCY, France
(540)

Quipsite

(591) Black, white
(511)
9 – Inventory management and traceability software for medical apparatus and instruments and laboratory equipment; downloadable software applications relating to medical equipment management and medical studies.
38 – Provision of access to data via the Internet, namely provision of access to an Internet platform related to medical equipment management and medical studies.

(260) AM 2022 113631 A
(800) 1597780
(151) 2021 05 31
(891) 2021 05 31
(731) Shenzhen SOFARSOLAR Co., Ltd.
401, Building 4, AnTongDa Industrial Park,
District 68, XingDong Community, XinAn
Street, BaoAn District, Shenzhen, 518000
Guangdong, China

(540)
AMASSTORE

(591) Black, white
(531) 27.05.01
(511)
9 – Naval signalling apparatus; batteries, electric; battery charging devices for motor vehicles.

(260) AM 2022 113636 A
(800) 1597906
(151) 2021 04 06
(891) 2021 04 06
(731) GUANGZHOU HUIHUANG ELECTRONICS
CO., LTD.
No.28 Yongxing Middle Street, Taihe Town,
Baiyun District, Guangzhou City, Guangdong
Province, China
(540)

KAKUSIGA

(591) Black, white
(511)
9 – Materials for electricity mains [wires, cables]; USB cables; battery chargers; batteries, electric; headphones; cabinets for loudspeakers; protective cases for tablet computers; protective films adapted for computer screens; stands adapted for laptops; microphones.

(260) AM 2022 113646 A
(800) 1598275
(151) 2021 04 26
(891) 2021 04 26
(731) Fall Creek Farm and Nursery, Inc.
39318 Jasper-Lowell Road, Lowell OR 97452,
USA
(540)

LORETOBLUE

(591) Black, white
(511)
31 – Living plants.

(260) AM 2022 113655 A
(800) 1598447
(151) 2021 02 24
(891) 2021 02 24
(731) Euro Games Technology Ltd.
4, "Maritsa" Str., "Vranya-Lozen-Triugulnika",
BG-1151 Sofia, Bulgaria
(540)



(591) Yellow, gold, purple, black, red, light blue, brown and orange
(531) 27.05.02; 27.05.03; 29.01.15
(511)
9 – Software; computer gaming software; computer software packages; computer operating system software; computer software, recorded; software drivers; virtual reality software; games software; entertainment software for computer games; computer programs for network management; operating computer software for main frame computers; monitors (computer hardware); computer hardware; apparatus for re-

cording images; monitors (computer programs); computer game programs; computer programs for recorded games; apparatus for recording, transmission or reproduction of sound or images; communications servers [computer hardware]; electronic components for gambling machines; computer application software featuring games and gaming; computer software for the administration of on-line games and gaming; computer hardware for games and gaming; electronic components and computer software for gambling, gambling machines, gambling games on the Internet and via telecommunication network.

28 – Gaming machines for gambling; chips for gambling; mah-jong; arcade games; gambling machines operating with coins, notes and cards; games; electronic games; parlor games; gaming chips; gaming tables; slot machines [gaming machines]; LCD game machines; slot machines and gaming devices; coin-operated amusement machines; roulette chips; poker chips; chips and dice [gaming equipment]; gaming equipment for casinos; roulette tables; gaming roulette wheels; casino games; gambling machines and amusement machines, automatic and coin-operated; coin-operated amusement machines and/or electronic coin-operated amusement machines with or without the possibility of gain; boxes for coin-operated machines, slot machines and gaming machines; electronic or electrotechnical amusement machines and apparatus, gaming machines, coin-operated entertainment machines; housings for coin-operated machines, gaming equipment, gaming machines, machines for gambling; electropneumatic and electrical gambling machines (slot machines).

41 – Gambling; entertainment services related to gambling; gaming services for entertainment purposes; casino, gaming and gambling services; training in the development of software systems; provision of equipment for gambling halls; providing casino equipment [gambling]; gaming machine entertainment services; providing casino facilities [gambling]; gaming hall services; amusement arcade services; games equipment rental; rental of gaming machines; providing amusement arcade services; rental of gaming machines with images of fruits; editing or recording of sounds and images; sound recording and video entertainment services; hire of sound reproducing apparatus; provision of gaming equipment for casinos; providing of casino facilities; online gambling services; casino, gaming and gambling services; provision of gaming facilities, gaming hall facilities, Internet casinos and online gambling services.

(260) AM 2022 113656 A
(800) 1598510
(151) 2021 05 05
(891) 2021 05 05
(731) F. Hoffmann-La Roche AG
Grenzacherstrasse 124, CH-4070 Basel,
Switzerland

(540)

RONAPREVE

(591) Black, white

(511)

5 – Pharmaceutical preparations for the treatment or prevention of COVID-19, coronavirus diseases and respiratory diseases and disorders; antivirals for the treatment or prevention of COVID-19, coronavirus diseases and respiratory diseases and disorders.

(260) AM 2022 113657 A
(800) 1598512
(151) 2021 03 31
(891) 2021 03 31
(731) Kuzyakova Natalya Andreevna
Merenyasheva street, d. 111, RU-440012 Penza,
Russian Federation

(540)



(591) Blue, light blue, gray, white, flesh, black,
red-brown, brick, yellow-brown

(531) 02.05.01; 28.05; 29.01.15

(511)

30 – Fruit jellies [confectionery]; pastries; peanut confectionery; sweets; marzipan; confectionery; halvah; chocolate.

(260) AM 2022 113658 A
(800) 1598609
(151) 2021 01 18
(891) 2021 01 18
(731) Closed Joint Stock Company, "Starodvorskie
kolbasy"
ul. Poliny Osipenko, 41, of. 210; RU-600009
g. Vladimir, Russian Federation

(540)

Дугушки

(591) Black, white

(531) 28.05

(511)

29 – Preserved peppers; aloe vera prepared for human consumption; alginates for culinary purposes; anchovy, not live; peanuts, prepared; artichokes, preserved; albumen for culinary purposes; white of eggs; beans,

preserved; soya beans, preserved, for food; broth; ginger jam; ham; fatty substances for the manufacture of edible fats; toasted laver; edible birds' nests; sea-cucumbers, not live; peas, preserved; mushrooms, preserved; guacamole; game, not live; gelatine; meat jellies; jellies for food; fruit jellies; yolk of eggs; coconut fat; bone oil for food; lard; suet for food; edible fats; curd; fruit-based snack food; milk substitutes; charcuterie; raisins; caviar; eggplant paste; vegetable marrow paste; fish roe, prepared; yogurt; galbi [grilled meat dish]; sauerkraut; kefir; kimchi; isinglass for food; clams, not live; potato-based dumplings; milk shakes; black pudding; onion rings; arrangements of processed fruit; compotes; meat, canned; vegetables, canned; fish, canned; fruits, canned; broth concentrates; corn dogs; gherkins; shrimps, not live; prawns, not live; buttercream; croquettes; silkworm chrysalis for human consumption; sweet corn, processed; kumys; spiny lobsters, not live; lecithin for culinary purposes; salmon, not live; onions, preserved; margarine; marmalade; oils for food; peanut butter; cocoa butter for food; coconut oil for food; coconut butter; corn oil for food; sesame oil for food; linseed oil for food; extra virgin olive oil for food; olive oil for food; palm oil for food; palm kernel oil for food; sunflower oil for food; rape oil for food; butter; soya bean oil for food; mussels, not live; almonds, ground; animal marrow for food; mollusks, not live; milk; peanut milk; peanut milk for culinary purposes; coconut milk; coconut milk for culinary purposes; almond milk; almond milk for culinary purposes; oat milk; rice milk; rice milk for culinary purposes; protein milk; condensed milk; soya milk; powdered milk; fish meal for human consumption; vegetable mousses; fish mousses; fruit pulp; meat; meat, preserved; freeze-dried meat; chicken nuggets; milk beverages, milk predominating; peanut milk-based beverages; coconut milk-based beverages; almond milk-based beverages; edible insects, not live; pieces of chicken fried in batter; sausage casings, natural or artificial; vegetables, preserved; freeze-dried vegetables; vegetables, dried; vegetables, cooked; potato fritters; olives, preserved; lobsters, not live; flavored nuts; candied nuts; coconut, desiccated; nuts, prepared; tomato paste; liver pâté; pectin for culinary purposes; liver; pickles; jams; powdered eggs; milk products; fish-based foodstuffs; soured milk; poultry, not live; bulgogi; pollen prepared as foodstuff; cranberry compote; tomato purée; apple purée; crayfish, not live; crustaceans, not live; fish, preserved; fish, not live; salted fish; fermented baked milk; vegetable salads; fruit salads; bacon; sardelki [sausages]; sardines, not live; pork; herrings, not live; seeds, prepared; sunflower seeds, prepared; cream [dairy products]; whipped cream; vegetable-based cream; fat-containing mixtures for bread slices; smetana; lemon juice for culinary purposes; tomato juice for cooking; vegetable juices for cooking; salted meats; sausages; sausages in batter; hot dog sausages; preparations for making bouillon; preparations for making soup; nut-

based spreads; tripe; soups; vegetable soup preparations; whey; cheese; tahini; tofu; truffles, preserved; tuna, not live; oysters, not live; falafel; milk ferments for culinary purposes; rennet; fish fillets; dates; frosted fruits; frozen fruits; fruit, preserved; fruit preserved in alcohol; fruit, stewed; hazelnuts, prepared; potato flakes; hummus; fruit peel; preserved garlic; lentils, preserved; potato chips; low-fat potato chips; fruit chips; shpikachki [sausages]; non-alcoholic eggnog; seaweed extracts for food; meat extracts; edible ant larvae, prepared; berries, preserved; snail eggs for consumption; eggs; yakitori.

30 – Vanilla flavorings for culinary purposes; flavorings, other than essential oils, for cakes; flavorings, other than essential oils, for beverages; coffee flavorings; food flavorings, other than essential oils; star aniseed; baozi; cereal bars; high-protein cereal bars; pancakes; noodle-based prepared meals; freeze-dried dishes with the main ingredient being pasta; freeze-dried dishes with the main ingredient being rice; buns; bread rolls; edible rice paper; edible paper; burritos; vanillin [vanilla substitute]; vareniki [stuffed dumplings]; waffles; vermicelli; natural sweeteners; sausage binding materials; binding agents for ice cream; sea water for cooking; seaweed [condiment]; malt biscuits; cloves [spice]; mirror icing [mirror glaze]; cake frosting [icing]; glucose for culinary purposes; mustard; gluten additives for culinary purposes; yeast; thickening agents for cooking foodstuffs; leaven; rice-based snack food; cereal-based snack food; artificial coffee; vegetal preparations for use as coffee substitutes; dressings for salad; fruit jellies [confectionery]; candy decorations for cakes; confectionery for decorating Christmas trees; cakes; pastries; peanut confectionery; almond confectionery; pasta; ginger [spice]; frozen yogurt [confectionery ices]; cocoa; cream of tartar for culinary purposes; capers; caramels [sweets]; curry [spice]; ketchup [sauce]; prepared rice rolled in seaweed; quiches; gluten prepared as foodstuff; flour-based dumplings; sweets; liquorice [confectionery]; peppermint sweets; dulce de leche; cinnamon [spice]; coffee; unroasted coffee; starch for food; crackers; custard; hominy grits; semolina; oatmeal; crushed barley; groats for human food; ice cubes; corn, milled; corn, roasted; meat pies; turmeric; couscous; noodles; ice for refreshment; ice, natural or artificial; edible ices; candies; rice cakes; mayonnaise; macarons; macaroni; maltose; hominy; piccalilli; marinades; marzipan; honey; miso [seasoning]; royal jelly; ice cream; bean meal; tapioca flour; potato flour; corn flour; nut flours; flour; wheat flour; soya flour; barley meal; dessert mousses [confectionery]; chocolate mousses; muesli; mint for confectionery; cocoa beverages with milk; coffee beverages with milk; coffee-based beverages; cocoa-based beverages; chamomile-based beverages; tea-based beverages; chocolate beverages with milk; chocolate-based beverages; infusions, not medicinal; crushed oats; husked oats; savory pancakes; onigiri; nutmegs; chocolate-coated nuts;

stick liquorice [confectionery]; pastilles [confectionery]; molasses for food; pâtés en croûte; pelmeni; pepper; allspice; peppers [seasonings]; pesto; cookies; petit-beurre biscuits; bibimbap [rice mixed with vegetables and beef]; pies; pizzas; meat gravies; fondants [confectionery]; popcorn; powders for making ice cream; baking powder; mustard meal; pralines; aromatic preparations for food; condiments; meat tenderizers for household purposes; cereal preparations; oat-based food; bee glue; gingerbread; spices; petits fours [cakes]; rice pudding; puddings; cake powder; fruit coulis [sauces]; ravioli; ramen; chewing gum; relish [condiment]; rice; instant rice; wheat germ for human consumption; spring rolls; sago; palm sugar; sugar; sesame seeds [seasonings]; linseed for culinary purposes [seasoning]; processed seeds for use as a seasoning; aniseed; agave syrup [natural sweetener]; golden syrup; confectionery; savory pancake mixes; baking soda [bicarbonate of soda for cooking purposes]; malt for human consumption; salt for preserving foodstuffs; cooking salt; celery salt; sherbets [ices]; ham glaze; soya sauce; tomato sauce; sauces [condiments]; pasta sauce; spaghetti; seasonings; chocolate-based spreads; chocolate spreads containing nuts; preparations for stiffening whipped cream; rusks; breadcrumbs; sushi; senbei [rice crackers]; sandwiches; tabbouleh; tacos; tapioca; tarts; dough; pastry dough; almond paste; rice pulp for culinary purposes; cake dough; tortillas; garden herbs, preserved [seasonings]; chocolate decorations for cakes; vinegar; beer vinegar; ferments for pastes; halvah; bread; unleavened bread; chips [cereal products]; corn flakes; oat flakes; hot dog sandwiches; flowers or leaves for use as tea substitutes; jiaozi; chicory [coffee substitute]; tea; iced tea; chutneys [condiments]; chebureki [deep-fried pies]; minced garlic [condiment]; cheeseburgers [sandwiches]; chow-chow [condiment]; saffron [seasoning]; chocolate; malt extract for food; essences for foodstuffs, except etheric essences and essential oils; husked barley.

35 – Arranging subscriptions to telecommunication services for others; import-export agency services; commercial information agency services; publicity agency services; cost price analysis; rental of advertising space; business auditing; business intermediary services relating to the matching of potential private investors with entrepreneurs needing funding; employment agency services; computerized file management; accounting; invoicing; demonstration of goods; transcription of communications [office functions]; opinion polling; market studies; business information; commercial information and advice for consumers in the choice of products and services; business investigations; business research; marketing research; personnel recruitment; business management and organization consultancy; business organization consultancy; consultancy regarding public relations communication strategies; business management consultancy; personnel management consultancy; professional bu-

siness consultancy; consultancy regarding advertising communication strategies; layout services for advertising purposes; marketing; business management of performing artists; business management of sports people; writing of résumés for others; scriptwriting for advertising purposes; news clipping services; updating and maintenance of information in registries; updating and maintenance of data in computer databases; updating of advertising material; word processing; organization of exhibitions for commercial or advertising purposes; arranging newspaper subscriptions for others; organization of fashion shows for promotional purposes; organization of trade fairs for commercial or advertising purposes; shop window dressing; preparation of advertising materials; business appraisals; payroll preparation; data search in computer files for others; sponsorship search; business management assistance; commercial or industrial management assistance; commercial intermediation services; providing business information via a web site; providing commercial and business contact information; provision of an online marketplace for buyers and sellers of goods and services; web indexing for commercial or advertising purposes; presentation of goods on communication media, for retail purposes; economic forecasting; auctioneering; wholesale services for pharmaceutical, veterinary and sanitary preparations and medical supplies; retail services for pharmaceutical, veterinary and sanitary preparations and medical supplies; sales promotion for others; production of teleshopping programs; production of advertising films; office machines and equipment rental; rental of advertising time on communication media; publicity material rental; rental of billboards [advertising boards]; rental of vending machines; rental of sales stands; rental of photocopying machines; publication of publicity texts; radio advertising; bill-posting; outdoor advertising; distribution of samples; dissemination of advertising matter; direct mail advertising; registration of written communications and data; writing of publicity texts; advertising; online advertising on a computer network; advertising by mail order; television advertising; document reproduction; compilation of statistics; compilation of information into computer databases; business inquiries; systemization of information into computer databases; advisory services for business management; negotiation of business contracts for others; negotiation and conclusion of commercial transactions for third parties; compiling indexes of information for commercial or advertising purposes; tax preparation; drawing up of statements of accounts; telemarketing services; psychological testing for the selection of personnel; outsourced administrative management for companies; business management of hotels; business management for freelance service providers; business project management services for construction projects; commercial administration of the licensing of the goods and services of others; business management of reimburse-

sement programs for others; administration of consumer loyalty programs; administration of frequent flyer programs; administrative processing of purchase orders; public relations; modelling for advertising or sales promotion; typing; appointment reminder services [office functions]; web site traffic optimization; administrative services for the relocation of businesses; tax filing services; search engine optimization for sales promotion; appointment scheduling services [office functions]; price comparison services; pay per click advertising; secretarial services; procurement services for others [purchasing goods and services for other businesses]; shorthand; outsourcing services [business assistance]; telephone answering for unavailable subscribers; photocopying services; business efficiency expert services.

43 – Accommodation bureau services [hotels, boarding houses]; rental of temporary accommodation; rental of meeting rooms; tourist home services; hotel reservations; boarding house bookings; temporary accommodation reservations; hotel services; retirement home services; snack-bar services; information and advice in relation to the preparation of meals; café services; cafeteria services; motel services; boarding house services; boarding for animals; rental of cooking apparatus; rental of chairs, tables, table linen, glassware; rental of lighting apparatus; rental of tents; rental of transportable buildings; rental of drinking water dispensers; restaurant services; self-service restaurant services; reception services for temporary accommodation [management of arrivals and departures]; food sculpting; canteen services; decorating of food; cake decorating; holiday camp services [lodging]; bar services; providing campground facilities; food and drink catering; washoku restaurant services; udon and soba restaurant services; day-nursery [crèche] services.

(260) AM 2022 113659 A

(800) 1598626

(151) 2020 05 23

(891) 2020 05 23

(731) Monsieur Philippe Tourrasse

72 A rue Jean Mermoz, F-13008 Marseille,
France

(540)

CAMOIN

(591) Black, white

(511)

28 – Playing cards; Tarot cards; card decks; games; toys; card decks; board games.

(260) AM 2022 113660 A

(800) 1598672

(151) 2021 04 14

(891) 2021 04 14

(731) AIMA TECHNOLOGY GROUP CO., LTD

No.5 Aima Road, South Zone of, Jinghai

Economic Development Zone, Tianjin, China

(540)

AIMA

(591) Black, white

(531) 27.05.01

(511)

12 – Electric vehicles; motorcycles; cars; bicycles; electric bicycles; electric tricycles; tires for vehicle wheels; anti-theft devices for vehicles; horns for vehicles; bicycle frames; trolleys; electric motorcycles; battery pallet trucks; bicycle saddles; self-balancing one-wheeled electric scooters; self-balancing two-wheeled electric scooters; self-balancing unicycles; self-balancing electric scooters; self-balancing scooters; frames for two-wheeled motor vehicles; bodies for vehicles; folding electric bicycles; safety seats for children, for vehicles; push scooters [vehicles]; pumps for bicycle tires.

(260) AM 2022 113661 A

(800) 1598678

(151) 2021 04 27

(891) 2021 04 27

(731) SUN PHARMACEUTICAL INDUSTRIES
LIMITED

Sun House, Plot No.201 b/1, Western Express
Highway, Goregaon (East), Mumbai-400063,
India

(540)

COLDACT SINUS

(591) Black, white

(531) 27.05.01

(511)

5 – Pharmaceutical and medicinal preparations.

(260) AM 2022 113662 A

(800) 1598709

(151) 2021 02 18

(891) 2021 02 18

(731) Perrine Bourguignon

Rue du Château Massart 43, B-4000 Liège,
Belgium

(540)

YSEULT

(591) Black, white
 (531) 27.05.01; 27.05.17
 (511)

25 – Bermuda shorts; blazers; overalls; blousons; blue jeans; reefer jackets; cardigans; sweaters; shirts; collared shirts; long-sleeved shirts; button-down shirts; sports shirts; shirts and suits; blouses; one-piece playsuits; slippers; jump suits [clothing]; tank tops; denim clothing; halter tops; long scarves; scarves; vests; knit tops; raincoats; jeans; skirts; divided skirts; kimonos; coats; half-coats; winter coats; raincoats; women's coats; miniskirts; trousers; dress pants; slacks; trousers and shorts; pullovers; sweaters; crew neck sweaters; v-neck jerseys; dresses; summer dresses; dresses for women; safari jackets; dungarees; shorts; sweatshirts; tee-shirts; tailleurs; suits and pant suits; tee-shirts; short-sleeved t-shirts; trench coats; knitwear [clothing]; jackets; zipper jackets; jackets with sleeves; sports coats; long jackets; outdoor wear for women; ready-made clothing; outerwear for women; ready-made clothing; clothing for women.

(260) AM 2022 113663 A
 (800) 1598719
 (151) 2021 03 22
 (891) 2021 03 22
 (731) "KONTI-RUS" JOINT STOCK COMPANY
 ul. Zolotaia, 13, RU-305000 Kursk, Kursk
 oblast, Russian Federation

(540)

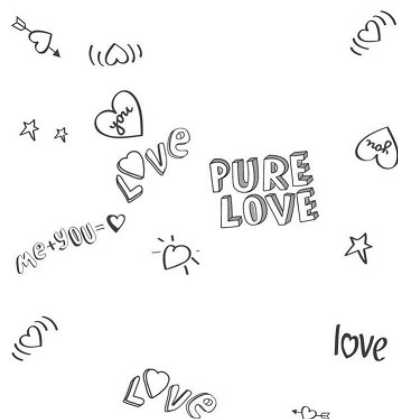

(591) Black, white
 (531) 01.01.10; 01.01.12; 02.09.01; 24.15.02;
 24.15.05; 24.15.11; 27.03.02; 27.05.01;
 27.05.03; 27.05.08; 27.05.09

(511)

30 – Pastries and confectionery.

(260) AM 2022 113665 A
 (800) 1598867
 (151) 2021 03 03
 (891) 2021 03 03
 (731) RAINBOW S.P.A.
 Via Brece Snc, I-60025 LORETO (AN),
 Italy

(540)



(591) Black, white
 (531) 03.05.01; 03.05.03; 03.05.05; 03.05.20;
 03.05.25; 18.01.19; 19.01.07; 24.17.25;
 27.05.02

(511)

16 – Printed matter; stationery; stationery cases; diaries and agendas; pocket diaries; note pads; drawing pads; writing tablets; albums; notebook; printed tickets; gift cards; envelopes [stationery]; wrapping paper; folders for papers; folders of paper; ring binders; calendars; drawing paper; writing paper; adhesives [glues] for stationery or household purposes; stickers [decalcomanias]; collector trading cards; trivia cards; towels of paper; handkerchiefs of paper; party decorations of paper; party ornaments of paper; drawing pads for party invitations; banners of paper; flags of paper; gift bags; babies' bibs of paper; table napkins of paper; tablecloths of paper; place mats of paper; paper bags and sacks; paper gift bags; stamps [seals]; inking pads; stamp mounts; stamp cases; artists' materials; paintbrushes; drawing instruments; pens [office requisites]; pencils; decorations for pencils; rubber erasers; crayons; felt-tip pens; children's paint-boxes; aquarelles; chalks for colouring; bookmarkers; paperweights; photographs [printed]; photograph stands; printed publications; educational publications; newspapers; periodicals; strategy guide magazines for card games; computer game instruction manuals; pamphlets; recipe books; books; children's books; sticker activity books; children's books incorporating an audio component; typewriters, electric or non-electric; office requisites, except furniture; instructional and teaching material (except apparatus); plastic materials for packaging; printing fonts; bookbinding material; printing blocks; modelling paste; paper decorations for cakes; glitter glue for stationery purposes.

25 – Clothing; hosiery; sweaters; cardigans; waistcoats; dresses; trousers; shorts; jerseys; leather clothing; waterproof clothing; stockings; stocking suspenders; sock suspenders; wind-resistant jackets; raincoats; ski pants; fur coats; evening coats; overcoats; skirts; suits; jackets; undershirts; T-shirts; clothing for gymnastics; collars; shirts; head scarves; neckerchiefs; swimming

costumes; bikinis; sundresses; tracksuits; sweat suits; wedding dresses; bath robes; beach robes; underwear; brassieres; corsets; slippers; underpants; briefs; nightshirts; housecoats; pyjamas; gloves (clothing); mittens; shawls; scarves; ties; bow ties; cassocks; layettes [clothing]; cloth bibs; babies' bibs of plastic; sleepwear for babies; aprons [clothing]; masquerade costumes; Halloween costumes; party hats [clothing]; belts made from imitation leather; textile belts [clothing]; belts made from leather or skin; braces; headgear for wear; caps; ear muffs [clothing]; wrist warmers; headbands; shoes; boots; ankle boots; leather shoes; galoshes; rain boots; sports footwear; sandals; slippers; soles for footwear; heels; footwear uppers.

28 – Games and playthings; dolls; dolls' clothing; dolls' clothing accessories; dolls' houses; furniture for dolls' houses; toy houses; bean bag dolls; carnival masks; toy figures; playsets for action figures; plush toys; marionettes; imitation cosmetic preparations being toys; parlour games; toys adapted for educational purposes; electronic educational teaching games; toy clocks and watches; electronic toys; hand-held electronic video games; free-standing video games apparatus; electronic amusement apparatus incorporating a liquid crystal display; free-standing video games machines; protective carrying cases specially adapted for handheld video games; mechanical toys; building games; toy building blocks; jigsaw puzzles; action skill games; chess games; board games; clockwork toys; magic tricks; playing cards; toy figures; musical toys; toy musical boxes; toy record cassette players; bathtub toys; infants' swings; multiple activity toys for babies; snow globes; marbles for games; spinning tops [toys]; novelties for parties, dances [party favors, favours]; party favor hats; toy horns; Halloween masks; costume masks; carnival caps in the nature of paper party hats; toy money boxes; inflatable toys; bouncy castles; inflatable bath toys; stuffed toys; bubble making wand and solution sets; kites; toy buckets and spades; swimming rings; toy furniture; play tents; play mats incorporating infant toys [playthings]; toy bicycles; ride-on toy vehicles; scale model vehicles; toy scooters; toy cars; toy trucks; toy model hobby craft kits; water squirting toys; gymnastic and sporting articles; rubber balls; balloons; soccer balls; basketballs; baseballs; beach balls; bowling balls; tennis balls; tables for table tennis; golf balls; golf gloves; gloves for games; gloves made specifically for use in playing sports; baseball bats; hockey pucks; roller skates; scooters [toys]; skateboards; snowboards; wakeboards; bags especially designed for skis and surfboards; protectors for elbows for use when riding bicycles [sports articles]; skipping rope; targets; punching bags; shuttlecocks; flying discs [toys]; paper party favours; paper party hats; streamers [party novelties]; decorations for Christmas trees, except illumination articles and confectionery; Christmas stockings, accessories for games; fishing tackle; toy putty; toy jewellery; toy cookware; toy sewing sets.

35 – Business management services; on-line retail and wholesale store services, and the bringing together, for the benefit of others, of a variety of goods, enabling customers to conveniently view and purchase those goods in relation to soap, perfumery, essential oils, cosmetics, hair lotions, dentifrices, bleaching preparations and other substances for laundry use, cleaning, polishing, scouring and abrasive preparations, instructional and teaching apparatus and instruments, apparatus for recording, transmission or reproduction of sound or images, headphones, computer mice, mouse pads, USB flash drives, computer hardware, tablet computers, stands adapted for tablet computers, hand-held computers, software for tablet computers, DVDs, CD-ROMs, blank discs, digital recording media, computer game software, video games software, computer software, joy sticks, decorative magnets, audiovisual teaching apparatus, downloadable electronic publications, eyeglasses, eyeglass cases, eyeglass cords, eyeglass frames, spectacle lenses, optical apparatus and instruments, cellular phones, smartphones, portable telecommunications apparatus, telephone earpieces, battery chargers for cellular phones, downloadable ring tones for mobile phones, cases adapted for cellular phones, cell phone straps, bags adapted for laptops, DVD cases, cases adapted for cameras, cases adapted for optical articles, coin-operated mechanisms, protective helmets for sports, photographic apparatus and instruments, measuring apparatus, electrical weighing apparatus, vehicles, apparatus for locomotion by land, air or water, bicycles; on-line retail and wholesale store services, and the bringing together, for the benefit of others, of a variety of goods, enabling customers to conveniently view and purchase those goods in relation to precious metals and their alloys, gold jewelry, jewellery, precious stones, timepieces, chronometric instruments, musical instruments, paper, cardboard, printed matter, book-binding material, printed photographs, stationery, stationery cases, diaries, agendas, adhesives [glues] for stationery or household purposes, artists' materials, paintbrushes, typewriters and office requisites other than furniture, instructional and teaching material other than apparatus, plastic materials for packaging, printing fonts, printing blocks, trading cards, printed publications, leather and imitations of leather, bags, coin purses, wallets, credit card holders made of leather, keycases, key cases of leather and skins, rucksacks, haversacks, school satchels, suitcases, bum-bags, empty cosmetic bags, trunks and travelling bags, clothing for pets, umbrellas, parasols, walking sticks, furniture, mirrors, picture frames, photograph frames, storage boxes, magazine racks, bathroom fittings in the nature of furniture, baskets, trays not of metal, sculptures of bone, clothes stands, umbrella stands, screens [furniture], trolleys [furniture], chairs [seats], divans, beds, cots for babies, crib bumpers, babies' bouncing chairs, high chairs for babies, infant walkers, baby changing mats, mats for infant playpens,

chests for toys, baby changing platforms, mattresses, cushions, playpens for babies, household or kitchen utensils or containers, combs, sponges, brushes, articles for cleaning purposes, glassware for household purposes, porcelain ware, toilet utensils, household or kitchen utensils and containers, thermally insulated containers for food and drink, baskets for domestic use, vases, figurines [statuettes] of porcelain, ceramic, earthenware or glass, decorative articles of porcelain; on-line retail and wholesale store services, and the bringing together, for the benefit of others, of a variety of goods, enabling customers to conveniently view and purchase those goods in relation to textile goods and substitutes for textile goods, bed linen, quilts, bath linen except clothing, towels of textile, table linen of textile, table covers, furniture coverings of textile, curtains of textile or plastic, clothing, shoes, headgear for wear, belts, lace and embroidery, ribbons and braid, buttons, hooks and eyes, brooches, needles, artificial flowers, hair ornaments not of precious metal, brooches [clothing accessories], buckles [clothing accessories], games, toys, gymnastic and sporting articles, decorations for Christmas trees, meat, fish, poultry, game, meat extracts, preserved, frozen, dried and cooked fruits and vegetables, jellies, jams, compotes, eggs, milk and milk products, edible oils and fats, coffee, tea, cocoa, artificial coffee, rice, tapioca, sago, flour, cereal preparations, bread, pastries, confectionery, ice cream, sugar, honey, golden syrup, yeast, baking-powder, salt, mustard, vinegar, sauces in the nature of condiments, spices, ice, beer, mineral and aerated waters and other non-alcoholic beverages, fruit beverages and fruit juices, syrups and other preparations for making beverages; presentation of goods on communication media, for retail purposes; business merchandising display services; sales promotion for others; organization of events, exhibitions, fairs and shows for commercial, promotional and advertising purposes; advertising, including on-line advertising on a computer network; business administration; office functions; business management assistance; import-export agency services; personnel management consultancy; administrative services for the relocation of businesses; secretarial services; book-keeping; rental of vending machines; vending machine services; retail or wholesale services for pharmaceutical, veterinary and sanitary preparations and medical supplies.

41 – Entertainment services; entertainment in the form of films; producing, distribution and rental of motion pictures, television and radio programmes, sound recordings and videos; creating animated cartoons; production of cartoons; production of entertainment live performances; showing of cinematographic films; presentation of recital; television entertainment in the nature of live-action, comedy, drama, and/or animated television programmes; providing non-downloadable films and television programs via a video-on-demand service; providing films, not down-

loadable, via video-on-demand services; providing television programmes, not downloadable, via video-on-demand services; rental of videotapes; providing on-line electronic publications, not downloadable; television entertainment; entertainment services provided via a global computer network; providing of films available online on the internet, non-downloadable; provision of non-downloadable games on the internet; publication of books, magazines and electronic publications on cinema, music and video games; information on services related to games, music and cinema services available on-line, not downloadable; booking of rooms for entertainment; provision of entertainment facilities; entertainment services provided by clowns; holiday camp amusement centre services; amusement parks; amusement parks and arcades; theme park services; zoological garden services; amusement park services; providing waterpark services; entertainment services in the nature of an amusement park show; organisation of entertainment, sporting, recreational, cultural and artistic events; organisation of group recreational activities; ticket agency services; ticket reservation and booking services for entertainment events; booking of seats for shows and booking of theatre tickets; booking agency services for cinema tickets; entertainment information; providing information on entertainment through computer networks; providing entertainment events in the form of live music shows; rental of amusement machines and apparatus; arranging and conducting conferences, exhibitions and seminars; arranging of contests; organization of competitions; theater productions; sporting and cultural activities; providing recreation facilities; teaching; providing of training; organization of training courses; workshops for training purposes; production of training videos; conducting of instructional seminars; provision of information relating to training; recreation and training services; provision of training facilities; instruction in group exercise; provision of instruction relating to nutrition; publishing printed matter and publications; publication of books, magazines, almanacs and journals; providing on-line publications.

(260) AM 2022 113667 A

(800) 1598914

(151) 2021 04 19

(891) 2021 04 19

(731) HELIOS SRBIJA AD

Radovana Grkovića 24, 32300 Gornji
Milanovac, Serbia

(540)

ZVEZDAPOL

(591) Black, white

(511)

1 – Chemical products for use in the chemical industry for production of paints and lacquers; unprocessed artificial resins; adhesives for use in industry.

2 – Paints, varnishes, lacquers; preservatives against rust and against deterioration of wood; mordants; dyestuffs; Unprocessed natural resins; metals in foil and powder form for painters, decorators, printers and artists.

(260) AM 2022 113668 A

(800) 1598956

(151) 2021 02 05

(891) 2021 02 05

(731) BHARAT SERUMS AND VACCINES LTD.

17th Floor, Hoechst house, Nariman point,
Mumbai – 400 021, India

(540)



(591) Black, white

(531) 26.15.01; 26.15.25; 27.05.10

(511)

5 – Pharmaceutical, medicinal and ayurvedic preparations and substances, dietetic food and substances adapted for medical use, dietary supplements for humans, nutritional supplements, nutraceutical preparations for therapeutic or medical purposes, nutraceuticals for use as dietary supplements, hand and body soaps; medicated facial soaps; disinfecting handwash; medicated handwash; all purpose disinfecting preparations; antibacterial cleaners; antibacterial preparations; antibacterial sprays; sanitary preparations for medical purposes; disinfectants, alcohol-based antibacterial skin sanitizer gels.

16 – Publicity materials made of paper, publication paper, posters, postcards, banners, magazines, periodicals, catalogues, pamphlets, printed instructional materials, leaflets.

35 – Advertising, business administration, office functions, business management and organization consultancy, marketing research, publication of publicity texts, business research in relation to pharmaceutical business, distribution of samples, marketing, sales and distribution services for the benefit of the distributors / stockists / wholesalers / retailers of the drugs and pharmaceutical products providing business information via a website, promotion, advertising and marketing of on-line websites, promoting the goods and services of others through advertisements on internet websites.

(260) AM 2022 113676 A

(800) 1312575

(151) 2016 08 18

(891) 2021 05 31

(731) Bumbu Rum Company LLC

383 W. Broadway, 5th Floor, New York
NY 10012, USA

(540)

BUMBU

(591) Black, white

(511)

33 – Brandy; digesters [liqueurs and spirits]; distilled beverages; gin; rice alcohol; rum; sake; spirits [beverages]; vodka; whisky.

(260) AM 2022 113677 A

(800) 1436082

(151) 2018 10 10

(891) 2021 05 25

(731) EPAC HOLDINGS, LLC

4330 Gaines Ranch Loop, Suite 230,
Austin TX 78735, USA

(540)

EPAC FLEXIBLE PACKAGING

(591) Black, white

(526) FLEXIBLE PACKAGING

(511)

40 – Printing services and digital printing; and lamination of packaging, corrugated paper and cardboard.

42 – Computer aided graphic design, graphic design services and visual design services in the nature of designing visual elements for on-line, broadcast, print, outdoor and other communication media.

(260) AM 2022 113678 A

(800) 1436697

(151) 2018 10 25

(891) 2021 05 24

(731) BioCryst Pharmaceuticals, Inc.

4505 Emperor Blvd., Durham NC 27703, USA

(540)

ORLADEYO

(591) Black, white

(511)

5 – Pharmaceutical preparations for the treatment of hereditary angioedema.

(260) AM 2022 113679 A

(800) 1506989

(151) 2019 10 03

(891) 2021 06 10

(731) RADISSON HOSPITALITY BELGIUM

BV/SRL

Avenue du Bourget 44, B-1130 Brussels,
Belgium

(540)



(591) Black, white
 (531) 27.05.11; 27.05.13
 (511)
 43 – Renting of temporary accommodations on behalf of others-hotel reservations for others; hotel and resort services; restaurant, catering and banquet services; computer services, namely, providing on-line information in the field of hotel and restaurant services, rendered by means of a global computer network.

(260) AM 2022 113680 A
 (800) 1513332
 (151) 2019 09 11
 (891) 2021 05 05
 (731) VENCHI S.P.A.
 Via Venchi 1, I-12040 Castelletto Stura, Cuneo,
 Italy
 (540)

Venchi

(591) Black, white
 (531) 27.05.01
 (511)
 30 – Chocolate; cocoa; pralines; chocolate bars; chocolates; muffins; cupcakes; biscuits; petits fours [cakes]; confectionery; chocolate powder; cocoa powder; cocoa-based beverages; hot-cocoa mix; edible ices; sherbets [ices]; ice lollies; ice cream gateaux; ice cream sandwiches; ice cream stick bars; frosting mixes; topping syrup; chocolate topping; ice cream sundaes; coffee; coffee-flavoured chocolate; coffee-based beverages; caramels; chocolate bars with hazelnuts, almonds and other fillings; chocolate based spreads.

43 – Restaurants; restaurants preparing and serving ice cream; services for providing food and drink, restaurants and cafés.

(260) AM 2022 113682 A
 (800) 1565097
 (151) 2020 09 25
 (891) 2021 05 25
 (731) EPAC HOLDINGS, LLC
 4509 Freidrich Lane, #102, Austin TX 78744,
 USA;
 EPAC Holdings, LLC
 4330 Gaines Ranch Loop, Suite 230, Austin
 TX 78735, USA
 (540)

ePacConnect

(591) Black, white
 (511)
 40 – Printing of packaging with bar codes, QR codes, or other markers for tracking the packaging.

(260) AM 2022 113714 A
 (800) 1599142
 (151) 2021 04 08
 (891) 2021 04 08
 (731) Obschestvo s ogranichennoi otvetstvennostyu
 "NAUCHNO-PROIZVODSTVENNAYA
 FIRMA, "MATERIA MEDICA HOLDING"
 Trety Samotechnny pereulok, 9, RU-127473
 Moscow, Russian Federation
 (540)

РАФАМИН

(591) Black, white
 (531) 28.05
 (511)
 5 – Pharmaceutical and veterinary preparations; sanitary preparations for medical purposes; dietetic food and substances adapted for medical or veterinary use, food for babies; dietary supplements for human beings and animals; plasters, materials for dressings; material for dental fillings and dental impressions; disinfectants; preparations for destroying noxious animals; fungicides, herbicides; acaricides; aconitine; alkaloids for medical purposes; alginates for pharmaceutical purposes; algicides; aldehydes for pharmaceutical purposes; dental amalgams of gold; dental amalgams; amino acids for veterinary purposes; amino acids for medical purposes; analgesics; anaesthetics; antibiotics; antiseptics; medicine cases, portable, filled; first-aid boxes, filled; aluminium acetate for pharmaceutical purposes; acetates for pharmaceutical purposes; germicides; balms for medical purposes; bandages for dressings; biocides; bromine for pharmaceutical purposes; fly catching paper; reagent paper for medical or veterinary purposes; mothproofing paper; petroleum jelly for medical purposes; vaccines; oxygen baths; antiseptic cotton; aseptic cotton; absorbent cotton; wadding for medical purposes; cotton for medical purposes; dietetic substances adapted for medical use; radiological contrast substances for medical purposes; nutritive substances for microorganisms; radioactive substances for medical purposes; bismuth subnitrate for pharmaceutical purposes; melissa water for pharmaceutical purposes; seawater for medicinal bathing; mineral waters for medical purposes; thermal water; dietary fibre; moulding wax for dentists; gases for medical purposes; guaiacol for pharmaceutical purposes; haematogen; haemoglobin; hydrastine; hydrastinine; glycerine for medical purposes; glycerophosphates; glucose for medical purposes; gentian for pharmaceutical purposes; hormones for medical purposes; mustard for pharmaceutical purposes; mustard plasters; mud for baths; medicinal mud; gamboge for medical purposes; gurgun balsam for medical purposes; air deodorizing preparations; deodorants, other than for human beings or for animals; deodorants for clothing and textiles; diastase for medical purposes; mineral food supplements; nutritional supplements; albumin dietary supplements; dietary supplements for animals; alginate dietary supple-

ments; glucose dietary supplements; casein dietary supplements; lecithin dietary supplements; linseed oil dietary supplements; propolis dietary supplements; protein dietary supplements; protein supplements for animals; royal jelly dietary supplements; pollen dietary supplements; wheat germ dietary supplements; linseed dietary supplements; enzyme dietary supplements; yeast for pharmaceutical purposes; gelatine for medical purposes; cod liver oil; isotopes for medical purposes; insecticides; iodine for pharmaceutical purposes; iodides for pharmaceutical purposes; alkaline iodides for pharmaceutical purposes; iodoform; calomel [fungicide]; cream of tartar for pharmaceutical purposes; tartar for pharmaceutical purposes; camphor for medical purposes; capsules for medicines; cachets for pharmaceutical purposes; haemostatic pencils; wart pencils; caustic pencils; headache relief sticks; carbolineum [parasiticide]; cachou for pharmaceutical purposes; quassia for medical purposes; quebracho for medical purposes; oxygen for medical purposes; gallic acid for pharmaceutical purposes; acids for pharmaceutical purposes; adhesives for dentures; stem cells for veterinary purposes; stem cells for medical purposes; cocaine; collodion for pharmaceutical purposes; corn rings for the feet; medicated sweets; angostura bark for medical purposes; barks for pharmaceutical purposes; cedar wood for use as an insect repellent; condurango bark for medical purposes; croton bark; mangrove bark for pharmaceutical purposes; myrobalan bark for pharmaceutical purposes; quinquina for medical purposes; medicinal roots; rhubarb roots for pharmaceutical purposes; lint for medical purposes; starch for dietetic or pharmaceutical purposes; creosote for pharmaceutical purposes; blood for medical purposes; cultures of microorganisms for medical or veterinary use; dental lacquer; liquorice for pharmaceutical purposes; milk sugar for pharmaceutical purposes; adhesive plasters; medicines for alleviating constipation; adhesive tapes for medical purposes; lecithin for medical purposes; lotions for veterinary purposes; dog washes [insecticides]; lotions for pharmaceutical purposes; personal sexual lubricants; lupulin for pharmaceutical purposes; magnesia for pharmaceutical purposes; liniments; ointments for pharmaceutical purposes; sunburn ointments; mercurial ointments; frostbite salve for pharmaceutical purposes; gauze for dressings; medicinal oils; mustard oil for medical purposes; camphor oil for medical purposes; castor oil for medical purposes; oil of turpentine for pharmaceutical purposes; dill oil for medical purposes; dental mastics; dental abrasives; dental impression materials; dressings, medical; surgical dressings; drugs for medical purposes; medicines for veterinary purposes; serotherapeutic medicines; medicines for human purposes; medicines for dental purposes; menthol; medicinal drinks; moleskin for medical purposes; almond milk for pharmaceutical purposes; royal jelly for pharmaceutical purposes; milk ferments for pharmaceutical purposes; irish moss for medical

purposes; flour for pharmaceutical purposes; linseed meal for pharmaceutical purposes; fish meal for pharmaceutical purposes; fly glue; mint for pharmaceutical purposes; dietetic beverages adapted for medical purposes; malted milk beverages for medical purposes; medicinal infusions; tincture of iodine; eucalyptol for pharmaceutical purposes; tinctures for medical purposes; opodeldoc; decoctions for pharmaceutical purposes; antiparasitic collars for animals; stick liquorice for pharmaceutical purposes; sulfur sticks [disinfectants]; pastilles for pharmaceutical purposes; pectin for pharmaceutical purposes; pepsins for pharmaceutical purposes; peptones for pharmaceutical purposes; hydrogen peroxide for medical purposes; pesticides; leeches for medical purposes; blood plasma; eyepatches for medical purposes; poultices; compresses; scapulars for surgical purposes; babies' diapers; diapers for pets; bunion pads; breast-nursing pads; pomades for medical purposes; powder of cantharides; pyrethrum powder; anti-uric preparations; bacterial preparations for medical and veterinary use; bacteriological preparations for medical and veterinary use; balsamic preparations for medical purposes; albuminous preparations for medical purposes; biological preparations for veterinary purposes; biological preparations for medical purposes; bismuth preparations for pharmaceutical purposes; vitamin preparations; diagnostic preparations for medical purposes; therapeutic preparations for the bath; haemorrhoid preparations; preparations for callouses; preparations to facilitate teething; preparations for the treatment of burns; fumigation preparations for medical purposes; opotherapy preparations; air purifying preparations; medicated eye-washes; bronchodilating preparations; preparations for reducing sexual activity; sterilizing preparations; soil-sterilizing preparations; corn remedies; pharmaceutical preparations for treating dandruff; herbicides; preparations for destroying dry rot fungus; larvae exterminating preparations; fly destroying preparations; preparations for destroying mice; slug exterminating preparations; vermin destroying preparations; pharmaceutical preparations for skin care; contact lens cleaning preparations; lime-based pharmaceutical preparations; medicinal hair growth preparations; anti-cryptogamic preparations; aloe vera preparations for pharmaceutical purposes; preparations of trace elements for human and animal use; sulfonamides [medicines]; pharmaceutical preparations for treating sunburn; enzyme preparations for veterinary purposes; enzyme preparations for medical purposes; chemico-pharmaceutical preparations; chemical preparations for veterinary purposes; chemical preparations for the diagnosis of pregnancy; chemical preparations for medical purposes; chemical preparations for treating wheat blight; chemical preparations for treating diseases affecting vine plants; chemical preparations for treating mildew; chemical preparations for treating phylloxera; chemical preparations for pharmaceutical purposes; chilblain preparations; mothproofing prepa-

rations; collyrium; lead water; chemical conductors for electrocardiograph electrodes; albuminous foodstuffs for medical purposes; dietetic foods adapted for medical purposes; by-products of the processing of cereals for dietetic or medical purposes; sanitary towels; pants, absorbent, for incontinence; panty liners [sanitary]; incontinence pads; propolis for pharmaceutical purposes; pearl powder for medical purposes; radium for medical purposes; hydrated chloral for pharmaceutical purposes; solvents for removing adhesive plasters; vaginal washes for medical purposes; solutions for contact lenses; chemical reagents for medical or veterinary purposes; gum for medical purposes; rubber for dental purposes; chewing gum for medical purposes; insect repellents; insect repellent incense; repellents for dogs; tissues impregnated with pharmaceutical lotions; sarsaparilla for medical purposes; sugar for medical purposes; asthmatic tea; fumigating sticks; linseed for pharmaceutical purposes; tobacco-free cigarettes for medical purposes; siccatives [drying agents] for medical purposes; syrups for pharmaceutical purposes; turpentine for pharmaceutical purposes; milking grease; greases for veterinary purposes; greases for medical purposes; lacteal flour for babies; soporifics; bicarbonate of soda for pharmaceutical purposes; bath salts for medical purposes; salts for mineral water baths; salts for medical purposes; potassium salts for medical purposes; sodium salts for medical purposes; smelling salts; mineral water salts; malt for pharmaceutical purposes; semen for artificial insemination; alcohol for pharmaceutical purposes; medicinal alcohol; alloys of precious metals for dental purposes; ergot for pharmaceutical purposes; cooling sprays for medical purposes; adjuvants for medical purposes; styptic preparations; vermifuges; disinfectants for hygiene purposes; disinfectants for chemical toilets; douching preparations for medical purposes; appetite suppressants for medical purposes; medical preparations for slimming purposes; parasiticides; mouthwashes for medical purposes; febrifuges; depuratives; animal washes [insecticides]; detergents for medical purposes; cattle washes [insecticides]; vesicants; migraine treatment preparations; purgatives; remedies for perspiration; remedies for foot perspiration; chemical contraceptives; antiparasitic preparations; sedatives; laxatives; tonics [medicines]; nervines; digestives for pharmaceutical purposes; boillons for bacteriological cultures; steroids; strychnine; suppositories; serums; tanning pills; appetite suppressant pills; slimming pills; yeast dietary supplements; antioxidant pills; sanitary tampons; vulnery sponges; thymol for pharmaceutical purposes; biological tissue cultures for veterinary purposes; biological tissue cultures for medical purposes; surgical implants comprised of living tissues; smoking herbs for medical purposes; medicinal herbs; sanitary panties; disposable training pants of paper or cellulose; charcoal for pharmaceutical purposes; fennel for medical purposes; porcelain for dental prostheses; phenol for

pharmaceutical purposes; enzymes for veterinary purposes; enzymes for medical purposes; ferments for pharmaceutical purposes; formic aldehyde for pharmaceutical purposes; phosphates for pharmaceutical purposes; quinine for medical purposes; chinoline for medical purposes; diabetic bread adapted for medical use; chloroform; flowers of sulfur for pharmaceutical purposes; cement for animal hooves; bone cement for surgical and orthopaedic purposes; dental cements; medicinal tea; herbal teas for medicinal purposes; eucalyptus for pharmaceutical purposes; tobacco extracts [insecticides]; extracts of hops for pharmaceutical purposes; elixirs [pharmaceutical preparations]; ethers for pharmaceutical purposes; esters for pharmaceutical purposes; cellulose esters for pharmaceutical purposes; cellulose ethers for pharmaceutical purposes; jujube, medicated; jalap.

(260) AM 2022 113716 A

(800) 1599231

(151) 2021 04 14

(891) 2021 04 14

(731) ROYAL ARMENIA JV LTD

Davtashen 2nd Block 268, 0054 Yerevan, Armenia

(540)



(591) Brown, light brown, dark brown, red, yellow, light yellow, cream, black and gray

(531) 03.07.05; 05.01.04; 08.01.19; 27.05.10; 29.01.15

(526) "ARMENIA", "HOT CHOCO"

(511)

30 – Instant chocolate mixes; hot chocolate.

(260) AM 2022 113717 A

(800) 1599251

(151) 2020 11 20

(891) 2020 11 20

(731) S.C. DAI TECH S.R.L.

28 Popa Sapca Street, Timisoara, Timis,
Romania

(540)



(591) gray, yellow

(531) 24.17.01; 27.03.02; 29.01.12

(511)

9 – Electric current sensors; alarm sensors; apparatus for verifying data on magnetically encoded cards; encoded key cards; electronic key cards; access control systems (automatic -); electronic tags; battery adapters; rechargeable electric batteries; power banks; batteries for phones; chargers; USB chargers; cell phone battery chargers for use in vehicles; battery chargers for tablet computers; battery chargers for laptop computers; battery chargers for use with telephones; chargers for mobile phones; mains chargers; wireless chargers; chargers for smartphones; joystick chargers; portable chargers; wireless charging pads for smartphones; dc input power supplies; power supplies for smartphones; ac/dc power supplies; interface cables [electric]; power adapters; alternating current adapters; travel adaptors for electric plugs; electrical adapters; power regulating apparatus; electric power controllers; apparatus and instruments for transforming electricity; apparatus and instruments for regulating electricity; voltage stabilizers; push-on accumulators; accumulators for photovoltaic power; lithium secondary batteries; chargers for electric batteries; apparatus and instruments for accumulating electricity; electricity storage apparatus; galvanic batteries; rechargeable batteries; electrical cells and batteries; mains monitoring apparatus (electric -); apparatus and instruments for controlling electricity; rectifier modules; LED drivers; dc/ac inverters; inverters [electricity]; frequency invertors [electronic]; voltage surge suppressors; limiters [electricity]; voltage transformers; transformers [electricity]; electronic transformers; cables, electric; electric cable connectors; electric charging cables; electrical cables for use in connections; electronic cables; battery leads; electricity conduits; connectors for electronic circuits; male connectors for electrical cables; cable connectors; wire connectors [electricity]; connections for electric cables; threaded cable connectors of metal; cable splices for electric cables; power line conditioners; power wires; cables for optical signal transmission; electrical circuits and circuit boards; plug adaptors; coaxial adaptors; gender changers [cable adapters]; gender chan-

gers [cable adapters] for cell phones; cable adapters; optical disc players; line drivers; conductor bars; bus bars; connection blocks [electric cable]; contact blocks (electric -); adapter cables (electric -); adapter cables for headphones; mobile high-definition link (MHL) cables; dustproof plugs for jacks of mobile phones; skeleton switches [electronic]; current collectors; collectors, electric; electronic components; electrical and electronic components; apparatus and instruments for accumulating the use of electricity; apparatus and instruments for conducting electricity; apparatus and instruments for accumulating the distribution of electricity; apparatus and instruments for regulating the distribution of electricity; autotransformers; battery booster cables; wireless switches; time switches, automatic; piezoelectric switches; tap changers for electric transformers; dimmers; frequency transformers; high frequency convertors; converters, electric; electrical frequency converters; rotary converters; current convertors; direct current convertors; voltage convertors; voltage-to-current convertors; inverters for power supply; current limiters; miniature circuit breakers; electronic load modules; phase modifiers; electric circuit interrupters; current breakers; electric breakers [switches]; current rectifiers; mains transformers (electric -); capacitive voltage transformers; electric power supply units; voltage stabilizing power supply; uninterruptable power supply apparatus; audio adaptors; electricity mains apparatus; apparatus and instruments for conducting the distribution of electricity; uninterruptible power supply apparatus [battery]; SCART leads; ac/dc convertors; DC/AC convertors; galena crystal detectors for use in electronics; instruments for distributing electrical current; electrical filters in the nature of electronic circuits; regulated power supply apparatus; lasers, not for medical purposes; laser scalpels, other than for medical use; luminous pointers; laser pointers; light-emitting electronic pointers; electronic tags for goods; electronic warning bells; USB cables; audio cable; telecommunications cables; coaxial cables; computer cabling; printer cables; modem cables; data synchronization cables; data transmission cables; electrical telephone wires; calculators; computers and computer hardware; peripherals adapted for use with computers and other smart devices; computerised personal organisers; storage apparatus for computer programs; computer interface apparatus; audio processing apparatus; regulating apparatus, electric; electric control apparatus; electronic regulators; electronic controllers; electrical controllers; energy regulators; wireless remote controls for portable electronic devices and computers; test pins for testing printed circuit boards; test adaptors for testing printed circuit boards; test probe assemblies for integrated circuits; flatness testing apparatus; testing apparatus for testing printed circuit boards; testing apparatus for checking electronic devices; probes for testing integrated circuits; testing devices for electronic parts; voltage testers; circuit testing instru-

ments; current testers; optical disc testers; battery testers; voltage monitoring units; electric current meters; measuring devices, electric; sensors; magnetic pens; recorded content; information technology and audiovisual, multimedia and photographic devices.

35 – Business analysis, research and information services; business assistance, management and administrative services; retail services in relation to computer hardware; retail services in relation to computer software; wholesale services in relation to computer hardware; wholesale services in relation to computer software; rental of sales stands; commercial administration of the licensing of the goods and services of others; sales administration; price analysis services; mediation of trade business for third parties; foreign trade information and consultation; information about sales methods; procuring of contracts for the purchase and sale of goods; arranging commercial transactions, for others, via online shops; arranging of trading transactions and commercial contracts; electronic order processing; advertising of the services of other vendors, enabling customers to conveniently view and compare the services of those vendors; clerical services for the taking of sales orders; computerized online ordering services; online ordering services; wholesale ordering services; business intermediary and advisory services in the field of selling products and rendering services; telephone order-taking services for others; import-export agency services; sales management services; intermediary services relating to advertising; advertising, marketing and promotional services.

(260) AM 2022 113718 A

(800) 1599264

(151) 2021 03 11

(891) 2021 03 11

(731) Salikhov Irek Faritovich

Yuzhnaya street, 11a, Aktanysh village,
Aktanyshsky district, RU-423740 Republic of
Tatarstan, Russian Federation

(540)

ЯДРАН / YADRAN

(591) Black, white

(531) 28.05

(511)

4 – Anthracite; wood briquettes; combustible briquettes; petroleum jelly for industrial purposes; wax [raw material]; ozokerite; wax for lighting; industrial wax; belting wax; carnauba wax; beeswax; gas for lighting; oil-gas; fuel gas; gasoline; producer gas; solidified gases [fuel]; fuel; lubricating graphite; additives, non-chemical, to motor fuel; firewood; paper spills for lighting fires; cutting fluids; fish oil, not edible; wool grease; oils for lighting; grease for leather; grease for footwear; tallow; industrial grease; kerosene; coke; lignin; wood spills for lighting fires; mazut; combus-

tible oil; oils for paints; oils for releasing form work [building]; oils for the preservation of masonry; oils for the preservation of leather; textile oil; lubricating oil; industrial oil; moistening oil; coal tar oil; coal naphtha; castor oil for industrial purposes; bone oil for industrial purposes; motor oil; sunflower oil for industrial purposes; rape oil for industrial purposes; lubricants; naphtha; petroleum, raw or refined; nightlights [candles]; oleine; paraffin; dust removing preparations; soya bean oil preparations for non-stick treatment of cooking utensils; non-slipping preparations for belts; coal dust [fuel]; firelighters; perfumed candles; Christmas tree candles; candles; grease for arms [weapons]; lubricating grease; grease for belts; vaporized fuel mixtures; dust absorbing compositions; dust binding compositions for sweeping; dust laying compositions; alcohol [fuel]; methylated spirit; leather-preserving oils and greases; stearine; diesel oil; lighting fuel; mineral fuel; motor fuel; fuel with an alcohol base; fuel oil; peat [fuel]; peat briquettes [fuel]; tinder; lignite; charcoal [fuel]; coal; coal briquettes; lamp wicks; wicks for candles; ceresine; electrical energy; ethanol [fuel]; petroleum ether.

40 – Paper finishing; applying finishes to textiles; up-cycling [waste recycling]; vulcanization [material treatment]; skin dressing; fruit crushing; embroidering; galvanization; electroplating; engraving; decontamination of hazardous materials; air deodorising; stripping finishes; tanning; metal tempering; freezing of foods; gilding; gold plating; providing information relating to material treatment; cadmium plating; permanent-press treatment of fabrics; food and drink preservation; food smoking; leather staining; fur dyeing; shoe staining; textile dyeing; cloth dyeing; laminating; lithographic printing; metal casting; fur glossing; tin plating; boilermaking; taxidermy; magnetization; nickel plating; abrasion; paper treating; water treating; woodworking; processing of cinematographic films; leather working; cloth edging; metal treating; fur conditioning; fur mothproofing; waste treatment [transformation]; textile mothproofing; fabric waterproofing; crease-resistant treatment for clothing; cloth fireproofing; textile treating; wool treating; framing of works of art; window tinting treatment, being surface coating; air freshening; fabric bleaching; air purification; soldering; clothing alteration; recycling of waste and trash; processing of oil; pattern printing; photographic printing; offset printing; metal plating; printing; burnishing by abrasion; flour milling; dressmaking; rental of boilers; knitting machine rental; rental of generators; rental of air-conditioning apparatus; rental of space heating apparatus; photographic film development; firing pottery; welding services; blacksmithing; custom assembling of materials for others; bookbinding; glass-blowing; saddlery working; grinding; cloth cutting; sawing [saw mill]; refining services; timber felling and processing; fur satining; silver plating; incineration of waste and trash; laser scribing; warping [looms]; sorting of waste and recyclable ma-

terial [transformation]; photocomposing services; quilting; planing [saw mill]; fulling of cloth; slaughtering of animals; destruction of waste and trash; cloth pre-shrinking; services of a dental technician; cryopreservation services; key cutting; dyeing services; sandblasting services; production of energy; custom tailoring; custom fashioning of fur; photogravure; millworking; chromium plating; colour separation services; silkscreen printing; optical glass grinding.

(260) AM 2022 113724 A

(800) 1599377

(151) 2020 12 03

(891) 2020 12 03

(731) Apple Inc.

One Apple Park Way, Cupertino CA
95014, USA

(540)

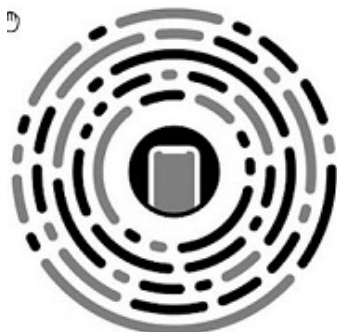

(591) Black, white and gray

(531) 16.01.11; 26.01.05; 26.01.16; 26.01.24;
26.11.12

(511)

42 – Providing online non-downloadable application development software; providing online non-downloadable computer software development tools; providing online non-downloadable computer software used in developing other software applications; user authentication services using a software application; user authentication services using technology for e-commerce transactions; providing online information relating to computer technology, computer programming, and computer software.

(260) AM 2022 113725 A

(800) 1599466

(151) 2021 04 28

(891) 2021 04 28

(731) Alpen Pharma AG

Finkenhubelweg 16, CH-3012 Bern,
Switzerland

(540)

ERHOLIV

(591) Black, white

(511)

5 – Pharmaceutical products, medical and veterinary preparations; hygienic products for medicine; dietetic

substances and foodstuffs for medical or veterinary use, food for babies; food supplements for humans and animals; plasters, materials for dressings; material for dental fillings and dental impressions; disinfectants; products for destroying vermin; fungicides, herbicides.

(260) AM 2022 113727 A

(800) 1599541

(151) 2021 04 13

(891) 2021 04 13

(731) Alcon Inc.

Rue Louis-d'Affry 6, CH-1701 Fribourg,
Switzerland

(540)

CLEARSPeAK

(591) Black, white

(511)

10 – Surgical apparatus and instruments for ophthalmic surgery.

(260) AM 2022 113728 A

(800) 1599555

(151) 2021 04 02

(891) 2021 04 02

(731) Borsehung GmbH

Steinfeldstr. 3, 39179 Barleben, Germany

(540)

Borsehung
GERMANY

(591) Black, white

(531) 27.05.10

(511)

1 – Combusting preparations [chemical additives to motor fuel]; viscose; detergent additives to petrol; oil dispersants; preparations for preventing the tarnishing of glass; antifreeze; power steering fluid; chemical petrol additives; brake fluid.

4 – Industrial grease; lubricating oil; lubricants; lubricating grease; motor oil; oils for the preservation of leather; diesel oil; dust removing preparations; petrol; moistening oil.

7 – Starters for motors and engines; dynamo belts; filters being parts of machines or engines; jacks [machines]; pistons [parts of machines or engines]; piston segments; condensing installations; radiators [cooling] for motors and engines; bearings [parts of machines]; filters for cleaning cooling air, for engines; hand-held tools, other than hand-operated; camshafts for vehicle engines; pumps [parts of machines, engines or motors]; belts for machines; valves [parts of machines]; lubricating pumps; valves [parts of machines]; alternators; shaft couplings [machines]; igniting magnetos; igniting devices for internal combustion engines.

9 – Transducers; thermostats for vehicles; converters, electric; current rectifiers; coils, electric; voltage regulators for vehicles; signal convertors; switches, electric; radar apparatus; navigation apparatus for vehicles [on-board computers]; collectors, electric; navigation apparatus for vehicles [on-board computers]; switches, electric; theft prevention installations, electric; steering apparatus, automatic, for vehicles; aerials; batteries, electric, for vehicles.

12 – Bumpers for automobiles; vehicle bumpers; clutches for land vehicles; rearview mirrors; axles for vehicles; connecting rods for land vehicles, other than parts of motors and engines; hubs for vehicle wheels; couplings for land vehicles; signal arms for vehicles; vehicle chassis; brake linings for vehicles; transmission shafts for land vehicles; driving motors for land vehicles.

17 – Waterproof sealants; flexible hoses, not of metal; junctions, not of metal, for pipes; pipe mufflers, not of metal; insulators; shock-absorbing buffers of rubber; draught excluder strips; water-tight rings; gaskets.

35 – Procurement services for others [purchasing goods and services for other businesses]; import and export agency services; commercial or industrial management assistance; commercial administration of the licensing of the goods and services of others; outsourcing services [business assistance]; price comparison services; sales promotion for others; demonstration of goods for advertising purposes; advertising.

(260) AM 2022 113733 A
(800) 1599742
(151) 2021 04 20
(891) 2021 04 20
(731) PACIFIC PHARMACEUTICALS PTE LTD
101 CECIL STREET, #17-07 TONG ENG
BUILDING, Singapore 069533, Singapore
(540)



(591) Red and black
(531) 20.05.07; 26.11.01; 26.11.13; 26.11.22;
27.03.15; 27.05.01; 27.05.09; 27.05.10;
29.01.12

(511)
5 – Mineral dietary supplements for humans; pharmaceutical drugs.

10 – Medical diagnostic instruments; surgical devices and instruments; dental apparatus and instruments; physiotherapy apparatus; heart rate monitoring appa-

ratus; blood pressure monitors; massage apparatus; apparatus for medical use; cushions for medical purposes; medical syringes; injection syringes; contraceptive devices; apparatus for physiotherapeutic treatment; artificial limbs; sutures; surgical splints; medical stents.

(260) AM 2022 113748 A
(800) 1600339
(151) 2021 06 07
(891) 2021 06 07
(731) Genki Forest(Beijing) Food Technology Group
Co., LTD
Room 501, 5th Floor, Building, No.6, East 3RD
Ring North Road, Chaoyang District, 100020
Beijing, China
(540)

元气森林

(591) Black, white
(531) 28.03
(511)

29 – Bouillon; fish-based foodstuffs; seaweed extracts for food; vegetable-based snack foods; fruit-based snack food; betel nuts, processed; vegetables, preserved; eggs; yogurt; milk beverages, milk predominating; milk tea, milk predominating; oils for food; fruit jellies; sausage casings, natural or artificial; sliced fruits, canned; tofu-based snacks; nuts, prepared.

30 – Sugar; sweets; oatmeal; cereal-based snack food; chamomile-based beverages; rice-based snack food; instant noodles; instant rice; chips [cereal products]; ice cream; condiments; coffee; coffee-based beverages; tea; tea-based beverages; shrimp chips.

32 – Beer; non-alcoholic fruit juice beverages; non-alcoholic beverages flavored with tea; soft drinks; mineral water [beverages]; non-alcoholic preparations for making beverages; protein-enriched sports beverages; soda water; sports drinks; energy drinks; sparkling water; non-alcoholic condensed smoked plum juice; grape juice; waters [beverages].

(260) AM 2022 113801 A
(800) 1600553
(151) 2021 04 14
(891) 2021 04 14
(731) Shenzhen Zime Technology Inc
Rm 704, Bldg B, Duocai Science and
Technology Innovation Park, No. 5, Guanle
Road, Luhua Community, Guanhu Street,
Longhua District, Shenzhen, Guangdong, China
(540)

zime

(591) Black, white
(531) 27.05.17
(511)

9 – Connectors [electricity]; battery charger; batteries, electric; earphones; mobile phone; downloadable mobile phone application software; computer software applications, downloadable; tablet computers; power connectors; USB cables; couplers [data processing equipment]; headsets; in-ear headphones; bluetooth headphones.

(260) AM 2022 113802 A

(800) 1600603

(151) 2021 03 30

(891) 2021 03 30

(731) Monsieur Ganael Bascoul

40 rue des 3 fontaines, F-30000 Nîmes, France

(540)

COTTAN

(591) Black, white
(511)

3 – Laundry preparations; polishing preparations; degreasing preparations; abrasive preparations; soaps; perfumes; essential oils; cosmetics; hair lotions; dentifrices; depilatories; make-up removing products; lipstick; beauty masks; shaving products; preservatives for leather (polishes); creams for leather.

(260) AM 2022 113814 A

(800) 1600944

(151) 2021 04 29

(891) 2021 04 29

(731) Opel Automobile GmbH

Bahnhofplatz, 65428 Rüsselsheim, Germany

(540)

FRONTERA

(591) Black, white
(511)

12 – Motor vehicles, their parts and spare parts, as far as included in this class.

27 – Foot mats for vehicles.

28 – Games; playthings; sporting articles, toy cars; model cars; soft toys; teddy bears; electronic games (including video games); playing cards; flying disks; footballs; basketballs; softballs; all the aforementioned goods included in this class.

(260) AM 2022 113816 A

(800) 1601002

(151) 2021 03 26

(891) 2021 03 26

(731) Blago Company LLC

Vorovskogo Str., Bld. 57, Armavir,

RU-352900 Krasnodar Krai, Russian Federation

(540)

ALMADOR

(591) Black, white
(511)

29 – Bouillon; fatty substances for the manufacture of edible fats; gelatin; jellies for food; fruit jellies; coconut fat; bone oil for food; lard; suet for food; edible fats; fruit-based snack food; compotes; vegetables, tinned; fruits, tinned; bouillon concentrates; margarine; edible oils; peanut oil; cocoa butter; coconut oil for food; coconut butter; corn oil for food; sesame oil for food; linseed oil for food; olive oil for food; palm oil for food; palm kernel oil for food; sunflower oil for food; olive oil for food; rape oil for food; butter; vegetable mousses; fruit pulp; vegetables, preserved; vegetables, dried; vegetables, cooked; tomato purée; jams; cranberry compote; apple purée; vegetable salads; fruit salads; seeds, prepared; sunflower seeds, prepared; fat-containing mixtures for bread slices; tomato juice for cooking; vegetable juices for cooking; preparations for making bouillon; preparations for making soup; spreads included in this class; creamy-vegetable spreads; vegetable-fat spreads; vegetable soup preparations; fruit, preserved; fruit preserved in alcohol; fruit, stewed.

(260) AM 2022 113818 A

(800) 1601086

(151) 2020 11 17

(891) 2020 11 17

(731) BEBETTO TEKSTİL ANONİM ŞİRKETİ

Duaçınarı Mahallesi, 4. Kırılmaç Sokak

No:2/1, Yıldırım-Bursa, Turkey

(540)



(591) Red and white

(531) 26.04.22; 27.05.01; 27.05.24; 29.01.12

(511)

18 – Unworked or semi-worked leather and animal skins, imitations of leather, stout leather, leather used for linings; goods made of leather, imitations of leather or other materials, designed for carrying items, included in this class; bags, wallets, boxes and trunks made of leather or stout leather; keycases, trunks [luggage], suitcases; umbrellas; parasols; sun umbrellas; walking sticks; whips; harness; saddlery; stirrups; straps of leather (saddlery).

24 – Woven or non-woven textile fabrics; textile goods for household use, not included in other classes; curtains, bed covers, sheets (textile), pillowcases, blankets, quilts, towels; flags, pennants, labels of textile.

25 – Clothing, including underwear and outer clothing, other than special purpose protective clothing; socks, mufflers [clothing], shawls, bandanas, scarves, belts [clothing]; footwear, shoes, slippers, sandals; headgear, hats, caps with visors, berets, caps [headwear], skull caps.

35 – Advertising, marketing and public relations; organization of exhibitions and trade fairs for commercial or advertising purposes; office functions; business management, business administration and business consultancy; accounting; commercial consultancy services; import-export agencies; auctioneering; the bringing together, for the benefit of others, of a variety of goods, enabling customers to conveniently view and purchase those goods, such services may be provided by retail stores, wholesale outlets, by means of electronic media or through mail order catalogues.

(260) AM 2022 113824 A
 (800) 1601276
 (151) 2021 03 26
 (891) 2021 03 26
 (731) SOLETANCHE FREYSSINET
 280 avenue Napoléon Bonaparte, F-92500
 RUEIL MALMAISON, France
 (540)

CMC

(591) Black, white
 (511)

19 – Structures, all completely or predominantly not made of metal, and particularly columns for ground stabilization and reinforcement; non-metallic materials for building; reinforcing materials not of metal for building; mechanical structures for earth stabilization; earth retaining structures; goods not of metal for civil engineering structures; reinforcement rods not of metal; mortar for building; non-metallic panels for forming the coating of structures, tunnels and culverts in mechanically stabilized earth; posts, not of metal.

37 – Land development, equipment and maintenance, particularly by setting up a network of semi-rigid vertical inclusions; construction of public works; construction and repair work; construction, repair and installation of columns for ground stabilization and reinforcement; construction of permanent buildings and buildings; masonry; plastering or plumbing; roofing services; sealing services (building); insulation services (building); demolition of buildings; construction information; supervision (management) of construction work (in particular delegated project management and assistance with project management); rental of construction equipment; scaffolding.

42 – Engineering services in the field of construction; civil and industrial engineering services in the field of soil improvement and reinforcement; research and ad-

vice relating to civil and industrial engineering in the field of soil improvement and reinforcement.

(260) AM 2022 113826 A
 (800) 1601345
 (151) 2021 03 25
 (891) 2021 03 25
 (731) Sopro Bauchemie GmbH
 Biebricher Straße 74, 65203 Wiesbaden,
 Germany
 (540)

S-Flow

(591) Black, white
 (511)

1 – Chemicals used in industry; impregnating preparations; adhesives used in industry, in particular made of synthetic resins; chemicals used in industry, being additives for building materials; chemicals used in industry, being additives for screed, concrete and mortar; liquid plastics, unprocessed, included in this class; preservatives for building materials (except for organic substances); refining agents for concrete, mortar and screed, included in this class, in particular for preventing the drying out of concrete and mortar, for screeds and finished concrete parts, for enhancing the resistance of cement screeds to impact, wear, frost and chemical stress, for increasing imperviousness against liquids and gases as well as for controlling the working consistency; unprocessed artificial resins; surface-active agents (tensides); damp proofing preparations for brickwork, except paints; horticulture chemicals; antifreeze; chemicals as aid for washing out (removing and cleaning) joint compounds; solvents for paints; solvents for varnishes; solvents for lacquers; silicones.

17 – Rubber, gutta-percha, gum, asbestos, mica; goods made of plastics as semi-finished products; artificial and synthetic resins (semi-finished products); resins (semi-finished products) for fabricating adhesives; cast resins (semi-finished products) including silica sand; sealing materials; packing materials; insulating materials; sealing tapes; sealing collars; rubber gloves for insulating purposes, not for household purposes; joint fillers (sealant compounds for joints); insulating coatings (paints) and insulating lacquers; insulating paints; self-adhesive tapes, other than stationery and not for medical or household purposes; insulating coatings; sound proofing materials; filling material as insulating, damping and sealing materials; bituminous sealing and insulating materials for roofs; fiberglass insulation materials for building purposes; fiberglass fabrics for building insulation.

19 – Building materials (non-metallic), in particular with damping and insulating properties; building materials (non-metallic), namely hydraulic binding agents such as cement, lime, gypsum and as additives for binding and hardening concrete, mortar and stony-

type building materials; building materials (non-metallic), namely hydraulic binding agents and mixtures composed thereof containing aggregates, pozzolanic materials (concrete admixtures) and/or chemical substances (concrete admixtures); mortar (building material); plaster (building material); screeds (building material); reinforcing fabrics (non-metallic) for building purposes; contact sludges (non-metallic) for building purposes; building materials, non-metallic, in the form of filling materials for building purposes for preparing surfaces made of concrete, mortar and other stony-type building materials; silica sand for building purposes; bitumen; bituminous products for building; pipes, not of metal, for building purposes; concrete; concrete building elements; roof coverings, not of metal; bituminous coatings for roofing (except for sealing and insulating purposes); windows, not of metal; felts for building; gravel; sand for building purposes; prefabricated swimming pools (not of metal); prefabricated chimneys, not of metal; floor tiles, not of metal; tile floorings, not of metal; binding material for road repair; road coating materials.

(260) AM 2022 113827 A

(800) 1601354

(151) 2021 06 14

(891) 2021 06 14

(731) UCB Biopharma SRL

Allée de la Recherche 60, B-1070 Bruxelles,
Belgium

(540)

MYROZIO

(591) Black, white

(511)

5 – Pharmaceutical preparations and substances.

(260) AM 2022 113828 A

(800) 1601355

(151) 2021 06 14

(891) 2021 06 14

(731) UCB Biopharma SRL

Allée de la Recherche 60, B-1070 Bruxelles,
Belgium

(540)

ALTIGGO

(591) Black, white

(511)

5 – Pharmaceutical preparations and substances.

(260) AM 2022 113894 A

(800) 1601625

(151) 2020 12 23

(891) 2020 12 23

(731) ABALIOĞLU LEZİTA GIDA SANAYİ
ANONİM ŞİRKETİ

Bağyurdu Yeni Mahallesi, İzmir Ankara
Caddesi, No:650/1, Kemalpaşa-İzmir, Turkey

(540)



(591) Red, orange, white and green are distinctive features of the mark

(531) 01.03.01; 01.03.02; 25.03.01; 26.11.13;
27.05.24; 29.01.14

(511)

29 – Meat, fish, poultry and game; processed meat products; dried pulses; soups, bouillon; processed olives, olive paste; milk and milk products, butter; dried, preserved, frozen, cooked, smoked or salted fruits and vegetables; tomato paste; prepared nuts and dried fruits as snacks; eggs and powdered eggs; potato chips.

30 – Pasta, stuffed dumplings, noodles; honey, bee glue for human consumption, propolis for food purposes; condiments for foodstuff, vanilla (flavoring), spices, sauces (condiments), tomato sauce; yeast, baking powder; flour, semolina, starch for food; sugar, cube sugar, powdered sugar; tea, iced tea; chewing gums; ice-cream, edible ices; salt; cereal-based snack food, popcorn, crushed oats, corn chips, breakfast cereals, processed wheat for human consumption, crushed barley for human consumption, processed oats for human consumption, processed rye for human consumption, rice; molasses for food.

(260) AM 2022 113895 A

(800) 1601733

(151) 2021 04 28

(891) 2021 04 28

(731) Aliev Alexander Alimovich

pr. Yuriya Gagarina, 73, kv.88, RU-196143
Saint-Petersburg, Russian Federation

(540)



(591) Black, white

(531) 26.04.05; 26.04.19; 27.05.01

(511)

5 – Sanitary preparations for medical purposes; disinfectants; anesthetics; bactericides; balms for medical purposes; biocides; reagent paper for medical or veterinary purposes; lotions for pharmaceutical purposes; bacterial preparations for medical purposes; diagnostic preparations for medical purposes; sterilizing pre-

parations; aloe vera preparations for pharmaceutical purposes; pharmaceutical preparations; tissues impregnated with pharmaceutical lotions; greases for medical purposes; medicinal alcohol; cooling sprays for medical purposes; adjuvants for medical purposes; disinfectants for hygiene purposes; disinfectants for chemical toilets; mouthwashes for medical purposes; detergents for medical purposes.

10 – Surgical, medical and dental apparatus and instruments; dental apparatus and instruments; surgical apparatus and instruments; resuscitation apparatus; dental apparatus, electric; diagnostic apparatus for medical purposes.

(260) AM 2022 113897 A

(800) 1601888

(151) 2021 03 05

(891) 2021 03 05

(731) WORLD MEDICINE İLAÇ SAN. VE TİC.
A.Ş.

15 Temmuz Mah. Cami Yolu Cad. No:50,
Bağcılar, İstanbul, Turkey

(540)

ASMADA-ACMAĐA

(591) Black, white

(531) 28.05

(511)

5 – Pharmaceutical and veterinary preparations for medical purposes, chemical preparations for medical purposes, dietary supplements, including those adapted for medical purposes, dietary supplements for slimming purposes, food for babies, herbs and herbal beverages adapted for medicinal purposes, dental preparations and articles, sanitary preparations for medical use, hygienic pads, hygienic tampons, plasters, materials for dressings, diapers, including those made of paper and textiles, preparations for destroying vermin, fungicides, herbicides, deodorants, other than for human beings or for animals, air deodorising preparations, disinfectants, antiseptics, detergents for medical purposes.

(260) AM 2022 113909 A

(800) 1602198

(151) 2021 05 19

(891) 2021 05 19

(731) AGRICULTURAL RESEARCH AND
DEVELOPMENT LIMITED, LIABILITY
COMPANY

11220 EDISON HIGHWAY, BAKERSFIELD
CA 93307, USA

(540)

ARRA HONEY POP

(591) Black, white

(511)

31 – Fresh table grapes.

(260) AM 2022 113910 A

(800) 1602199

(151) 2021 06 14

(891) 2021 06 14

(731) Kia Corporation

12, Heolleung-ro, Seocho-gu, Seoul,
Republic of Korea

(540)



(591) Black, white

(531) 27.05.19; 27.07.01

(511)

12 – Vans [vehicles]; motor buses; sports cars; automobiles; electric cars; trucks.

(260) AM 2022 113911 A

(800) 1602208

(151) 2021 06 14

(891) 2021 06 14

(731) Kia Corporation

12, Heolleung-ro, Seocho-gu, Seoul,
Republic of Korea

(540)



(531) 27.05.19; 27.05.22; 27.07.01

(511)

12 – Vans [vehicles]; motor buses; sports cars; automobiles; electric cars; trucks.

(260) AM 2022 113912 A

(800) 1602212

(151) 2021 02 18

(891) 2021 02 18

(731) Crystalex CZ, s.r.o.

Masarykovo nábřeží 2360, CZ-110 00 Praha 1,
Nové Město, Czech Republic

(540)



(591) Black, white

(531) 26.05.01; 26.05.16; 26.05.18; 26.13.25;
27.05.01

(511)
21 – Glass products of all kinds within this class, products of utility and smooth and refined art glass.

(260) AM 2022 113913 A

(800) 1602214

(151) 2021 06 14

(891) 2021 06 14

(731) Kia Corporation

12, Heolleung-ro, Seocho-gu, Seoul,
Republic of Korea

(540)



(591) Black, white

(531) 27.05.19; 27.07.01

(511)

12 – Vans [vehicles]; motor buses; sports cars; automobiles; electric cars; trucks.

(260) AM 2022 113919 A

(800) 1602249

(151) 2021 05 24

(891) 2021 05 24

(731) Obshchestvo s ogranichennoy otvetstvennostju
"KDV Voronezh"

Lesnaya str., Bld. 31, Derevnya Bogdanovo,
RU-396039 Voronezhskaya oblast, Russian
Federation

(540)

STRIKE

(591) Black, white

(511)

30 – Coffee; tea; cocoa; sugar; rice; tapioca; sago; artificial coffee; flour and preparations made from cereals; bread, pastries and confectionery; ice cream; honey; yeast; baking powder; cooking salt; mustard; vinegar; condiments; spices; edible ices; aromatic preparations for food; food flavourings, other than essential oils; star aniseed; pancakes; buns; bread rolls; vanillin [vanilla substitute]; waffles; vermicelli; coffee flavourings; natural sweeteners; sausage binding materials; binding agents for ice cream; seawater for cooking; glucose for culinary purposes; thickening agents for cooking foodstuffs; vegetal preparations for use as coffee substitutes; confectionery for decorating Christmas trees; cakes; pastries; peanut confectionery; almond confectionery; pasta; frozen yogurt [confectionery ices]; capers; caramels [sweets]; quiches; gluten prepared as foodstuff; sweets; liquorice [confectionery]; peppermint sweets; unroasted coffee; starch for food; crackers; groats for human food; corn, milled; corn, roasted; meat pies; turmeric; couscous; noodles; ice for refreshment; ice, natural or artificial; rice cakes; maltose; marzipan; custard; royal jelly; sorbets

[ices]; muesli; mint for confectionery; cocoa beverages with milk; coffee beverages with milk; coffee-based beverages; tea-based beverages; chocolate beverages with milk; chocolate-based beverages; cocoa-based beverages; infusions, not medicinal; crushed oats; husked oats; nutmegs; lozenges [confectionery]; molasses for food; pepper; petits fours; biscuits; pies; pizzas; fondants [confectionery]; popcorn; powders for making ice cream; pralines; meat tenderizers for household purposes; cereal preparations; oat-based food; propolis; gingerbread; puddings; cake powder; ravioli; chewing gum; spring rolls; aniseed; cake batter; confectionery; malt for human consumption; salt for preserving foodstuffs; celery salt; spaghetti; seasonings; preparations for stiffening whipped cream; rusks; breadcrumbs; sushi; sandwiches; tabbouleh; tacos; almond paste; tortillas; candy decorations for cakes; ferments for pastes; halvah; bread; unleavened bread; chips [cereal products]; chicory [coffee substitute]; iced tea; chocolate; malt extract for food; essences for foodstuffs, except etheric essences and essential oils.

(260) AM 2022 113920 A

(800) 1602251

(151) 2021 06 14

(891) 2021 06 14

(731) Kia Corporation

12, Heolleung-ro, Seocho-gu, Seoul,
Republic of Korea

(540)



(591) Black, white

(531) 27.05.01; 27.05.19; 27.05.22; 27.07.01;
27.07.11

(511)

12 – Vans [vehicles]; motor buses; sports cars; automobiles; electric cars; trucks.

(260) AM 2022 113921 A

(800) 1602266

(151) 2021 05 13

(891) 2021 05 13

(731) Semenov Rodion Aleksandrovich

ul. Novoslobodskaya, 46, kv. 36, RU-127055
Moscow, Russian Federation

(540)



(591) Black, white

(531) 27.05.01; 27.05.10

(511)

3 – Lip glosses; petroleum jelly for cosmetic purposes; adhesives for cosmetic purposes; cotton wool for

cosmetic purposes; make-up; cosmetic dyes; eyebrow pencils; cosmetic pencils; cosmetic creams; skin whitening creams; cream for whitening the skin; cosmetic kits; cotton sticks for cosmetic purposes; cotton swabs for cosmetic purposes; lipstick cases; lipsticks; pomades for cosmetic purposes; make-up removing preparations; make-up powder; false eyelashes; false eyelashes made from natural materials; cosmetic preparations for cleaning and disinfecting makeup brushes; tissues impregnated with cosmetic lotions; make-up preparations including decorative cosmetics for eyes, for eyebrows; cosmetic preparations for eyelashes; cosmetic preparations for skin care; cosmetic products, including decorative cosmetics for eyes, for eyebrows; mascara.

18 – Bags; handbags; vanity cases, not fitted, namely, cosmetic bags.

35 – Demonstration of goods; promoting the goods of others; procurement services for others [purchasing goods and services for other businesses]; presentation of goods on communication media, for retail purposes.

41 – Practical training [demonstration]; providing information in the field of education; arranging and conducting of seminars; arranging and conducting of conferences; arranging and conducting of workshops [training]; vocational retraining; educational examination; teaching; educational services; instruction services; educational services provided by schools.

44 – Beauty salon services; massage; manicuring; vi-sagists' services; hairdressing; hair implantation.

(260) AM 2022 113922 A
(800) 1602276
(151) 2021 05 11
(891) 2021 05 11
(731) IRONMATIK, LLC
10800 ALPHARETTA HWY, SUITE 208-457,
ROSWELL GA 30076, USA

(540)

ironMATIK

(591) Black, white
(531) 27.03.15; 27.05.01; 27.05.09; 27.05.17
(511)

21 – Ironing board covers; ironing boards.

(260) AM 2022 113954 A
(800) 639179
(151) 1995 06 08
(891) 2021 06 24
(731) LABORATOIRES SVR
ZAC de la Tremblaie, Rue de la Mare à Blot,
F-91220 Le Plessis Pate, France

(540)

TOPIALYSE

(591) Black, white

(531) 27.05.01

(511)

3 – Perfumery, cosmetics, soaps, hair preparations, dentifrices.

5 – Pharmaceutical preparations, veterinary, sanitary and dietetic products for medical use, containing excipient, lip-care products.

(260) AM 2022 113964 A

(800) 1269686

(151) 2015 09 16

(891) 2021 06 24

(731) LABORATOIRES SVR

ZAC de la Tremblaie, Rue de la Mare à Blot,
F-91220 Le Plessis Pate, France

(540)

HYDRALIANE

(591) Black, white

(511)

3 – Soaps; perfumery; essential oils; cosmetics.

(260) AM 2022 113966 A

(800) 1275440

(151) 2015 09 16

(891) 2021 06 24

(731) LABORATOIRES SVR

ZAC de la Tremblaie, Rue de la Mare à Blot,
F-91220 Le Plessis Pate, France

(540)

SEBIACLEAR

(591) Black, white

(511)

3 – Soaps, perfumery articles, essential oils, cosmetics, hair lotions; the aforesaid goods used for reducing sebum and purifying the skin in case of symptoms of acne and oily skin with seborrheic tendencies.

(260) AM 2022 113967 A

(800) 1342573

(151) 2017 02 03

(891) 2021 06 25

(731) Smithers-Oasis Company

295 South Water Street, Suite 201, Kent OH
44240, USA

(540)

DESIGN MASTER

(591) Black, white
(511)
2 – Aerosol spray paints, produced in a variety of colors.

(260) AM 2022 113968 A
(800) 1502097
(151) 2019 10 03
(891) 2021 06 10
(731) Tetsu Global Co., Ltd.
#1102 Asahi Plaza Tenjin, 9-3 Maizuru
1-chome, Chuo-ku, Fukuoka City, Fukuoka
Prefecture 810-0073, Japan
(540)



Uncle Tetsu

(591) White, pale orange, yellow and black
(531) 02.01.01; 02.01.11; 09.07.19; 16.03.13;
29.01.14

(511)
30 – Cakes; cheesecakes; crepes; puddings; cookies; apple pies; confectionery; pastries; bread; buns; sandwiches; hamburger sandwiches; pizzas; hot dog sandwiches; meat pies; tea; coffee; unroasted coffee; cocoa; ice cream; ice cream mixes; sherbet mixes; pancake mixes; condiments; seasonings; spices; chocolate-based spreads; sushi; noodles; pasta sauce.

(260) AM 2022 114153 A
(800) 1605199
(151) 2021 03 22
(891) 2021 03 22
(731) Egis Gyógyszergyár Zrt.
Keresztúri út 30-38., H-1106 Budapest,
Hungary
(540)

CESSOLUTE

(591) Black, white
(511)
3 – Cosmetics and cosmetic preparations.

5 – Human pharmaceutical preparations; dietetic substances adapted for medical use; dietary supplements;

medicinal ointments; medicated skin creams; plasters, materials for dressings.

(260) AM 2022 114154 A
(800) 1605200
(151) 2021 03 22
(891) 2021 03 22
(731) Egis Gyógyszergyár Zrt.
Keresztúri út 30-38., H-1106 Budapest,
Hungary
(540)

RAMIKOMB

(591) Black, white
(511)
5 – Human pharmaceutical preparations.

(260) AM 2022 114155 A
(800) 1605211
(151) 2021 05 31
(891) 2021 05 31
(731) Force Factor Brands LLC
280 Summer Street, Boston MA 02210,
USA
(540)

FORCE FACTOR

(591) Black, white
(511)
5 – Dietary and nutritional supplements; vitamin and mineral supplements; vitamin supplements.

(260) AM 2022 114156 A
(800) 1605245
(151) 2021 07 02
(891) 2021 07 02
(731) Guangzhou Temeisheng Electronics, Co., Ltd.
No.2 Nanxian Road, Jianggao county, Baiyun
District, Guangzhou City, Guangdong Province,
China
(540)

SOONTRAN

(591) Black, white
(531) 27.05.01
(511)
9 – Humanoid robots with artificial intelligence; smartwatches; dictating machines; electronic agendas; ticket dispensers; phototelegraphy apparatus; measuring devices, electric; measures; electronic notice boards; cabinets for loudspeakers; microphones; projection screens; audiovisual teaching apparatus; speed checking apparatus for vehicles; materials for electricity mains [wires, cables]; electric installations for the remote control of industrial operations; electrolyzers; fire extinguishing apparatus; radiological apparatus

for industrial purposes; protection devices for personal use against accidents; theft prevention installations, electric; eyeglasses; batteries, electric; animated cartoons; electro-dynamic apparatus for the remote control of signals.

(260) AM 2022 114162 A

(800) 1605304

(151) 2021 03 23

(891) 2021 03 23

(731) Egis Gyógyszergyár Zrt.

Kereszturi út 30-38, H-1106 Budapest, Hungary

(540)

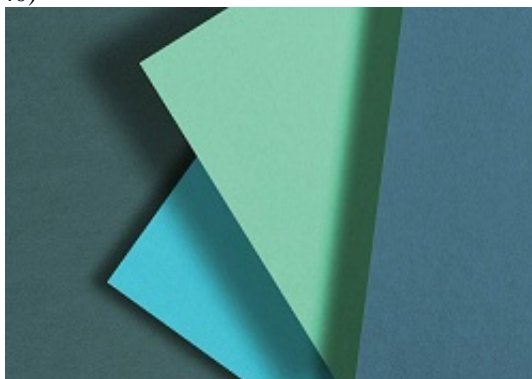

(591) Dark green, light blue, light green and dark blue

(531) 20.05.25; 26.04.16; 29.01.13

(511)

3 – Cosmetics and cosmetic preparations.

5 – Pharmaceutical preparations for human use; dietetic substances adapted for medical use; dietary supplements; medicinal ointments; medicated skin creams; plasters, materials for dressings.

(260) AM 2022 114163 A

(800) 1605309

(151) 2021 06 02

(891) 2021 06 02

(731) Ecolab USA Inc.

1 Ecolab Place, Saint Paul MN 55102 , USA

(540)

BIOQUELL QUBE

(591) Black, white

(511)

11 – Disinfectant apparatus; decontamination apparatus; sterilizers; sterilization apparatus and instruments, and related parts and equipment therefor.

INTERNATIONAL TRADEMARKS PROTECTED IN GEORGIA

(260) AM 2022 109856 A
(800) 1551245
(151) 2020 06 02
(181) 2030 06 02
(891) 2020 06 02
(511) 28, 41

(260) AM 2022 111928 A
(800) 1534095
(151) 2020 03 17
(181) 2030 03 17
(891) 2021 02 01
(511) 09, 36, 43

(260) AM 2022 110588 A
(800) 1561317
(151) 2020 07 21
(181) 2030 07 21
(891) 2020 07 21
(511) 28, 41

(260) AM 2022 111929 A
(800) 1559954
(151) 2020 09 15
(181) 2030 09 15
(891) 2021 02 04
(511) 12

(260) AM 2022 110919 A
(800) 584207
(151) 1992 02 28
(181) 2022 02 28
(891) 2020 11 30
(511) 18, 25

(260) AM 2022 112023 A
(800) 1579063
(151) 2021 01 19
(181) 2031 01 19
(891) 2021 01 19
(511) 28, 35

(260) AM 2022 111801 A
(800) 1576473
(151) 2020 12 07
(181) 2030 12 07
(891) 2020 12 07
(511) 09, 45

(260) AM 2022 112025 A
(800) 1579102
(151) 2020 08 27
(181) 2030 08 27
(891) 2020 08 27
(511) 04, 09, 12, 37

(260) AM 2022 111925 A
(800) 468014
(151) 1982 02 26
(181) 2022 02 26
(891) 2021 02 11
(511) 08, 21

(260) AM 2022 112026 A
(800) 1579103
(151) 2020 09 08
(181) 2030 09 08
(891) 2020 09 08
(511) 09, 12, 37

(260) AM 2022 111926 A
(800) 1115069
(151) 2012 03 26
(181) 2022 03 26
(891) 2021 01 20
(511) 14, 35

(260) AM 2022 112027 A
(800) 1579105
(151) 2020 09 09
(181) 2030 09 09
(891) 2020 09 09
(511) 12, 37

(260) AM 2022 111927 A
(800) 1482811
(151) 2019 07 08
(181) 2029 07 08
(891) 2021 01 27
(511) 03, 05, 29, 30, 32, 35

(260) AM 2022 112028 A
(800) 1579120
(151) 2020 10 09
(181) 2030 10 09
(891) 2020 10 09
(511) 29, 30

(260) AM 2022 112029 A
(800) 1579229
(151) 2021 01 15
(181) 2031 01 15
(891) 2021 01 15
(511) 42

(260) AM 2022 112105 A
(800) 1579622
(151) 2020 11 30
(181) 2030 11 30
(891) 2020 11 30
(511) 29

(260) AM 2022 112099 A
(800) 1579486
(151) 2020 10 06
(181) 2030 10 06
(891) 2020 10 06
(511) 35, 38, 41, 42

(260) AM 2022 112108 A
(800) 1579716
(151) 2021 01 14
(181) 2031 01 14
(891) 2021 01 14
(511) 36, 38

(260) AM 2022 112100 A
(800) 1579547
(151) 2020 11 16
(181) 2030 11 16
(891) 2020 11 16
(511) 09, 35, 39, 42

(260) AM 2022 112109 A
(800) 1579718
(151) 2021 02 09
(181) 2031 02 09
(891) 2021 02 09
(511) 12

(260) AM 2022 112101 A
(800) 1579553
(151) 2021 01 18
(181) 2031 01 18
(891) 2021 01 18
(511) 30

(260) AM 2022 112136 A
(800) 1580677
(151) 2020 11 25
(181) 2030 11 25
(891) 2020 11 25
(511) 05

(260) AM 2022 112102 A
(800) 1579561
(151) 2020 10 20
(181) 2030 10 20
(891) 2020 10 20
(511) 29, 30, 35, 43

(260) AM 2022 112137 A
(800) 1580682
(151) 2020 11 12
(181) 2030 11 12
(891) 2020 11 12
(511) 24, 35

(260) AM 2022 112103 A
(800) 1579601
(151) 2021 01 29
(181) 2031 01 29
(891) 2021 01 29
(511) 05

(260) AM 2022 112138 A
(800) 1580742
(151) 2020 11 20
(181) 2030 11 20
(891) 2020 11 20
(511) 19

(260) AM 2022 112104 A
(800) 1579613
(151) 2020 11 16
(181) 2030 11 16
(891) 2020 11 16
(511) 09, 35, 39, 42

(260) AM 2022 112139 A
(800) 1580764
(151) 2021 01 06
(181) 2031 01 06
(891) 2021 01 06
(511) 25

(260) AM 2022 112140 A
(800) 1580785
(151) 2021 01 27
(181) 2031 01 27
(891) 2021 01 27
(511) 01

(260) AM 2022 112333 A
(800) 1582898
(151) 2020 12 09
(181) 2030 12 09
(891) 2020 12 09
(511) 12, 37

(260) AM 2022 112215 A
(800) 1581328
(151) 2020 09 02
(181) 2030 09 02
(891) 2020 09 02
(511) 33

(260) AM 2022 112334 A
(800) 1582922
(151) 2021 02 08
(181) 2031 02 08
(891) 2021 02 08
(511) 01

(260) AM 2022 112216 A
(800) 1581346
(151) 2020 11 20
(181) 2030 11 20
(891) 2020 11 20
(511) 03, 05, 09, 10, 41, 44

(260) AM 2022 112336 A
(800) 1583035
(151) 2020 12 01
(181) 2030 12 01
(891) 2020 12 01
(511) 09, 12, 35, 37, 39

(260) AM 2022 112248 A
(800) 1189561
(151) 2013 09 16
(181) 2023 09 16
(891) 2021 02 24
(511) 25, 27, 28, 41

(260) AM 2022 112340 A
(800) 1583074
(151) 2021 01 13
(181) 2031 01 13
(891) 2021 01 13
(511) 05, 35

(260) AM 2022 112322 A
(800) 1582415
(151) 2020 12 06
(181) 2030 12 06
(891) 2020 12 06
(511) 36

(260) AM 2022 112358 A
(800) 1343270
(151) 2017 01 11
(181) 2027 01 11
(891) 2020 12 30
(511) 05

(260) AM 2022 112331 A
(800) 1582769
(151) 2020 12 23
(181) 2030 12 23
(891) 2020 12 23
(511) 06, 11, 21

(260) AM 2022 112359 A
(800) 1343278
(151) 2017 01 11
(181) 2027 01 11
(891) 2020 12 30
(511) 05

(260) AM 2022 112332 A
(800) 1582826
(151) 2021 02 17
(181) 2031 02 17
(891) 2021 02 17
(511) 16, 36, 41

(260) AM 2022 112424 A
(800) 1583436
(151) 2020 10 22
(181) 2030 10 22
(891) 2020 10 22
(511) 38, 41

(260) AM 2022 112425 A
(800) 1583450
(151) 2021 01 11
(181) 2031 01 11
(891) 2021 01 11
(511) 03, 06, 20, 21, 24

(260) AM 2022 112456 A
(800) 1071611
(151) 2011 02 09
(181) 2031 02 09
(891) 2021 03 15
(511) 18, 25

(260) AM 2022 112426 A
(800) 1583460
(151) 2021 01 15
(181) 2031 01 15
(891) 2021 01 15
(511) 01

(260) AM 2022 112457 A
(800) 1101674
(151) 2011 11 21
(181) 2021 11 21
(891) 2021 02 05
(511) 05, 32

(260) AM 2022 112436 A
(800) 1583842
(151) 2020 12 22
(181) 2030 12 22
(891) 2020 12 22
(511) 09, 28, 35, 38, 39, 41, 42, 45

(260) AM 2022 112458 A
(800) 1126659
(151) 2012 07 11
(181) 2022 07 11
(891) 2021 03 11
(511) 03, 05, 35, 44

(260) AM 2022 112439 A
(800) 1583947
(151) 2021 01 29
(181) 2031 01 29
(891) 2021 01 29
(511) 10

(260) AM 2022 112460 A
(800) 1236752
(151) 2014 12 05
(181) 2024 12 05
(891) 2021 03 11
(511) 03, 05, 35, 44

(260) AM 2022 112444 A
(800) 1584279
(151) 2021 01 12
(181) 2031 01 12
(891) 2021 01 12
(511) 11

(260) AM 2022 112461 A
(800) 1270265
(151) 2015 08 14
(181) 2025 08 14
(891) 2021 02 12
(511) 32

(260) AM 2022 112446 A
(800) 1584342
(151) 2021 02 12
(181) 2031 02 12
(891) 2021 02 12
(511) 09, 38, 42

(260) AM 2022 112462 A
(800) 1321267
(151) 2016 04 18
(181) 2026 04 18
(891) 2021 03 04
(511) 35, 36, 38, 41, 42

(260) AM 2022 112455 A
(800) 1071298
(151) 2011 03 03
(181) 2031 03 03
(891) 2021 03 16
(511) 16, 18, 35, 39, 40

(260) AM 2022 112464 A
(800) 1341840
(151) 2017 03 10
(181) 2027 03 10
(891) 2021 03 11
(511) 33

(260) AM 2022 112466 A
(800) 1500412
(151) 2019 10 08
(181) 2029 10 08
(891) 2021 02 25
(511) 05

(260) AM 2022 112514 A
(800) 1584633
(151) 2020 10 20
(181) 2030 10 20
(891) 2020 10 20
(511) 29, 30, 43

(260) AM 2022 112515 A
(800) 1584659
(151) 2020 12 14
(181) 2030 12 14
(891) 2020 12 14
(511) 28, 35, 38, 41

(260) AM 2022 112517 A
(800) 1584691
(151) 2020 10 20
(181) 2030 10 20
(891) 2020 10 20
(511) 29, 30, 43

(260) AM 2022 112522 A
(800) 1584935
(151) 2021 01 19
(181) 2031 01 19
(891) 2021 01 19
(511) 09, 42

(260) AM 2022 112523 A
(800) 1584964
(151) 2020 12 11
(181) 2030 12 11
(891) 2020 12 11
(511) 01, 03, 05, 09, 10, 16, 24, 25, 35, 39, 41, 42, 43,
44

(260) AM 2022 112524 A
(800) 1584975
(151) 2020 12 11
(181) 2030 12 11
(891) 2020 12 11
(511) 07, 08, 11, 21

(260) AM 2022 112525 A
(800) 1584977
(151) 2021 01 11
(181) 2031 01 11
(891) 2021 01 11
(511) 08, 10, 11, 18, 20, 21, 27, 28

(260) AM 2022 112529 A
(800) 1585026
(151) 2020 12 02
(181) 2030 12 02
(891) 2020 12 02
(511) 06, 37

(260) AM 2022 112531 A
(800) 1585049
(151) 2021 03 02
(181) 2031 03 02
(891) 2021 03 02
(511) 03, 05, 21, 28, 30

(260) AM 2022 112536 A
(800) 1585192
(151) 2021 01 05
(181) 2031 01 05
(891) 2021 01 05
(511) 07

(260) AM 2022 112552 A
(800) 1585484
(151) 2021 02 17
(181) 2031 02 17
(891) 2021 02 17
(511) 33

(260) AM 2022 112553 A
(800) 1585548
(151) 2021 01 28
(181) 2031 01 28
(891) 2021 01 28
(511) 16, 25

(260) AM 2022 112554 A
(800) 1585577
(151) 2020 12 16
(181) 2030 12 16
(891) 2020 12 16
(511) 01, 02, 06, 07, 08, 09, 16, 17, 19, 20, 24, 27, 35,
37, 39, 42

(260) AM 2022 112562 A
(800) 1585782
(151) 2021 02 15
(181) 2031 02 15
(891) 2021 02 15
(511) 03

(260) AM 2022 112645 A
(800) 1586542
(151) 2020 08 25
(181) 2030 08 25
(891) 2020 08 25
(511) 11, 37

(260) AM 2022 112564 A
(800) 974895
(151) 2008 06 05
(181) 2028 06 05
(891) 2021 03 22
(511) 05, 29, 30, 32

(260) AM 2022 112646 A
(800) 1586604
(151) 2021 02 10
(181) 2031 02 10
(891) 2021 02 10
(511) 09, 28, 41

(260) AM 2022 112565 A
(800) 1146723
(151) 2012 11 09
(181) 2022 11 09
(891) 2021 02 01
(511) 09, 38

(260) AM 2022 112647 A
(800) 1586611
(151) 2021 01 29
(181) 2031 01 29
(891) 2021 01 29
(511) 05

(260) AM 2022 112566 A
(800) 1234484
(151) 2014 10 02
(181) 2024 10 02
(891) 2021 03 15
(511) 19

(260) AM 2022 112655 A
(800) 1586871
(151) 2020 11 30
(181) 2030 11 30
(891) 2020 11 30
(511) 09, 16, 35, 41, 43, 44, 45

(260) AM 2022 112572 A
(800) 1557540
(151) 2020 08 18
(181) 2030 08 18
(891) 2021 02 26
(511) 05, 10, 44

(260) AM 2022 112656 A
(800) 1586939
(151) 2021 03 08
(181) 2031 03 08
(891) 2021 03 08
(511) 09

(260) AM 2022 112643 A
(800) 1586500
(151) 2021 03 08
(181) 2031 03 08
(891) 2021 03 08
(511) 09

(260) AM 2022 112742 A
(800) 1587059
(151) 2021 03 09
(181) 2031 03 09
(891) 2021 03 09
(511) 01

(260) AM 2022 112644 A
(800) 1586507
(151) 2021 01 18
(181) 2031 01 18
(891) 2021 01 18
(511) 07

(260) AM 2022 112743 A
(800) 1587074
(151) 2021 02 18
(181) 2031 02 18
(891) 2021 02 18
(511) 29, 30, 41

(260) AM 2022 112752 A
(800) 1587626
(151) 2021 01 15
(181) 2031 01 15
(891) 2021 01 15
(511) 20, 28

(260) AM 2022 112779 A
(800) 1308772
(151) 2016 04 11
(181) 2026 04 11
(891) 2021 04 07
(511) 01, 02

(260) AM 2022 112753 A
(800) 1587628
(151) 2021 02 12
(181) 2031 02 12
(891) 2021 02 12
(511) 41

(260) AM 2022 112781 A
(800) 1539474
(151) 2020 04 01
(181) 2030 04 01
(891) 2021 04 07
(511) 09, 35, 38, 41

(260) AM 2022 112754 A
(800) 1587632
(151) 2020 12 30
(181) 2030 12 30
(891) 2020 12 30
(511) 05

(260) AM 2022 112783 A
(800) 1566509
(151) 2020 10 19
(181) 2030 10 19
(891) 2021 04 07
(511) 05

(260) AM 2022 112755 A
(800) 1587641
(151) 2020 12 30
(181) 2030 12 30
(891) 2020 12 30
(511) 05, 10

(260) AM 2022 112787 A
(800) 1587998
(151) 2021 03 15
(181) 2031 03 15
(891) 2021 03 15
(511) 03

(260) AM 2022 112756 A
(800) 1587654
(151) 2020 08 14
(181) 2030 08 14
(891) 2020 08 14
(511) 03, 05, 16

(260) AM 2022 112788 A
(800) 1588008
(151) 2021 03 17
(181) 2031 03 17
(891) 2021 03 17
(511) 01

(260) AM 2022 112777 A
(800) 1207436
(151) 2014 01 29
(181) 2024 01 29
(891) 2021 03 15
(511) 05

(260) AM 2022 112789 A
(800) 1588030
(151) 2021 02 03
(181) 2031 02 03
(891) 2021 02 03
(511) 34

(260) AM 2022 112778 A
(800) 1277057
(151) 2015 07 17
(181) 2025 07 17
(891) 2021 02 26
(511) 35

(260) AM 2022 112790 A
(800) 1588041
(151) 2021 02 06
(181) 2031 02 06
(891) 2021 02 06
(511) 29

(260) AM 2022 112791 A
(800) 1588071
(151) 2021 02 17
(181) 2031 02 17
(891) 2021 02 17
(511) 16, 36, 41

(260) AM 2022 112859 A
(800) 1589226
(151) 2021 02 23
(181) 2031 02 23
(891) 2021 02 23
(511) 10

(260) AM 2022 112802 A
(800) 1588297
(151) 2021 01 29
(181) 2031 01 29
(891) 2021 01 29
(511) 29

(260) AM 2022 112860 A
(800) 1589289
(151) 2021 01 28
(181) 2031 01 28
(891) 2021 01 28
(511) 01, 17, 19

(260) AM 2022 112803 A
(800) 1588377
(151) 2021 02 02
(181) 2031 02 02
(891) 2021 02 02
(511) 02

(260) AM 2022 112861 A
(800) 1589301
(151) 2021 03 10
(181) 2031 03 10
(891) 2021 03 10
(511) 11, 12

(260) AM 2022 112812 A
(800) 1588556
(151) 2021 02 16
(181) 2031 02 16
(891) 2021 02 16
(511) 16

(260) AM 2022 112862 A
(800) 1589310
(151) 2020 11 19
(181) 2030 11 19
(891) 2020 11 19
(511) 29, 30, 43

(260) AM 2022 112813 A
(800) 1588557
(151) 2020 10 21
(181) 2030 10 21
(891) 2020 10 21
(511) 21

(260) AM 2022 112863 A
(800) 1589352
(151) 2020 11 11
(181) 2030 11 11
(891) 2020 11 11
(511) 03, 25, 35

(260) AM 2022 112814 A
(800) 1588665
(151) 2020 12 23
(181) 2030 12 23
(891) 2020 12 23
(511) 09, 10

(260) AM 2022 112974 A
(800) 1590873
(151) 2021 01 06
(181) 2031 01 06
(891) 2021 01 06
(511) 03, 05

(260) AM 2022 112816 A
(800) 1588781
(151) 2021 03 29
(181) 2031 03 29
(891) 2021 03 29
(511) 16, 18

(260) AM 2022 112975 A
(800) 1590877
(151) 2021 01 26
(181) 2031 01 26
(891) 2021 01 26
(511) 03, 05

(260) AM 2022 112979 A
(800) 1590995
(151) 2020 11 19
(181) 2030 11 19
(891) 2020 11 19
(511) 29, 30, 43

(260) AM 2022 113092 A
(800) 1306786
(151) 2016 06 15
(181) 2026 06 15
(891) 2021 05 05
(511) 39

(260) AM 2022 113150 A
(800) 1592844
(151) 2021 01 27
(181) 2031 01 27
(891) 2021 01 27
(511) 30

**OFFICIAL NOTIFICATIONS
INVENTIONS
ABOLITION OF PATENTS WITH THE RIGHT TO RESTORE**

(21) AP 2010 12443
(11) P 2015 6393 B
(73) Geox S.P.A.
(54) WATERPROOF AND VAPOR-PERMEABLE SHOE
DATE OF CANCELLATION OF PATENT: 2022 03 12
THE TERM OF RESTORATION OF PATENT: 2023 03 12

(21) AP 2010 12444
(11) P 2015 6394 B
(73) Geox S.P.A.
(54) METHOD FOR MANUFACTURING WATERPROOF AND VAPOR-PERMEABLE SHOE
DATE OF CANCELLATION OF PATENT: 2022 03 12
THE TERM OF RESTORATION OF PATENT: 2023 03 12

(21) AP 2013 13596
(11) P 2017 6774 B
(73) Lupin Limited
(54) HETEROCYCLYL COMPOUNDS
DATE OF CANCELLATION OF PATENT: 2022 03 11
THE TERM OF RESTORATION OF PATENT: 2023 03 11

(21) AP 2013 13599
(11) P 2018 6900 B
(73) Millennium Pharmaceuticals Inc.
(54) METHODS OF TREATING CANCER USING AURORA KINASE INHIBITORS
DATE OF CANCELLATION OF PATENT: 2022 03 19
THE TERM OF RESTORATION OF PATENT: 2023 03 19

(21) AP 2015 14297
(11) P 2020 7083 B
(73) Pfizer Inc.
(54) THERAPEUTIC NANOPARTICLES COMPRISING THERAPEUTIC AGENT AND METHODS OF MAKING AND USING SAME
DATE OF CANCELLATION OF PATENT: 2022 03 13
THE TERM OF RESTORATION OF PATENT: 2023 03 13

(21) AP 2016 14604
(11) P 2019 7007 B
(73) Kyowa Kirin Co. Ltd
(54) THERAPEUTIC AGENT FOR FRONTAL LOBE DYSFUNCTION
DATE OF CANCELLATION OF PATENT: 2022 03 18
THE TERM OF RESTORATION OF PATENT: 2023 03 18

(21) AP 2019 15024
(11) P 2021 7275 B
(73) Mikheil Ivanishvili;
 Mariam Kublashvili
(54) TOY CONSTRUCTOR
DATE OF CANCELLATION OF PATENT: 2022 03 19
THE TERM OF RESTORATION OF PATENT: 2023 03 19

EXPIRATION OF TERMS OF RESTORATION OF PATENT

(21) AP 2008 10623
(11) P 2009 4815 B
(73) Nino Kurdadze
(54) VEGETATIVE GATHER FOR TREATMENT OF DISEASES OF RESPIRATORY WAYS AND
 PHARMACEUTICAL FORMS ON ITS BASIS
DATE OF CANCELLATION OF PATENT: 2019 04 07
THE TERM OF RESTORATION OF PATENT VALIDITY HAS EXPIRED: 2020 04 07

(21) AP 1999 11232
(11) P 2009 4818 B
(73) Eli Lilly and Company
(54) 2-METHYL-THIENO-BENZODIAZE-PINE FORMULATION
DATE OF CANCELLATION OF PATENT: 2019 04 22
THE TERM OF RESTORATION OF PATENT VALIDITY HAS EXPIRED: 2020 04 22

(21) AP 2011 12133
(11) P 2012 5690 B
(73) Oleksand Litvin;
 Naum Simkhovich
(54) GLASS CAN SEALING CAP
DATE OF CANCELLATION OF PATENT: 2021 03 10
THE TERM OF RESTORATION OF PATENT VALIDITY HAS EXPIRED: 2022 03 10

(21) AP 2010 12406
(11) P 2014 6114 B
(73) Les Laboratoires Servier
(54) NEW CRYSTALLINE FORM VI OF AGOMELATINE, PREPARATION METHOD AND APPLICATION
 THEREOF
DATE OF CANCELLATION OF PATENT: 2021 03 09
THE TERM OF RESTORATION OF PATENT VALIDITY HAS EXPIRED: 2022 03 09

(21) AP 2011 12869
(11) P 2015 6231 B
(73) Les Laboratoires Servier
(54) AGOMELATINE HYDROCHLORIDE HYDRATE AND PREPARATION THEREOF
DATE OF CANCELLATION OF PATENT: 2021 03 17
THE TERM OF RESTORATION OF PATENT VALIDITY HAS EXPIRED: 2022 03 17

(21) AP 2011 12870
(11) P 2015 6232 B
(73) Les Laboratoires Servier
(54) AGOMELATINE HYDROCHLORIDE HYDRATE AND PREPARATION THEREOF
DATE OF CANCELLATION OF PATENT: 2021 03 17
THE TERM OF RESTORATION OF PATENT VALIDITY HAS EXPIRED: 2022 03 17

(21) AP 2015 13778
(11) P 2016 6564 B
(73) Tamaz Shioshvili;
Petre Badalov
(54) DEVICE FOR MAKING RECESS IN SKIN FOR FREE HAIR ROOTS TRANSPLANTATION
DATE OF CANCELLATION OF PATENT: 2019 03 31
THE TERM OF RESTORATION OF PATENT VALIDITY HAS EXPIRED: 2020 03 31

(21) AP 2016 14586
(11) P 2019 7040 B
(73) Gnosis S.p.A.
(54) SOLID FORMS OF MENAQUINOLS
DATE OF CANCELLATION OF PATENT: 2021 03 18
THE TERM OF RESTORATION OF PATENT VALIDITY HAS EXPIRED: 2022 03 18

CHANGES OF NAME AND/OR ADDRESS OF PATENTOWNER

(21) AP 2015 14546
(11) P 2019 7043 B
(54) 5-[(PIPERAZIN-1-YL)-3-OXO-PROPYL]-IMIDAZOLIDINE-2,4-DIONE DERIVATIVES AS ADAMTS
INHIBITORS FOR THE TREATMENT OF OSTEOARTHRITIS
NEW NAME AND NEW ADDRESS: Galapagos NV (BE)
Generaal de Wittelaan L 11/A3, 2800 Mechelen, Belgium (BE)
FORMER NAME AND FORMER ADDRESS: Galapagos NV (BE)
Generaal de Wittelaan L 11/A3, 2800 Mechelen, Belgium (BE);
Les Laboratoires Servier (FR)
35, Rue de Verdue, F-92284 Surrans Cedex, France (FR)
DATE OF REGISTRATION: 2022 03 29

UTILITY MODELS RESTORATION OF PATENT

(21) AU 2015 13963
(11) U 2017 1919 Y
(73) LEPL "TSMU Institute of Pharmacochimistry of Iovel Kutateladze";
LEPL "Tbilisi State Medical University"
(54) GEL FOR ELECTROTHERAPY
DATE OF CANCELLATION OF PATENT: 2021 10 16
THE TERM OF RESTORATION OF PATENT: 2022 04 11

ABOLITION OF PATENTS WITH THE RIGHT TO RESTORE

(21) AU 2016 14085
(11) U 2017 1926 Y
(73) Guram Makharadze;
Arkadi Rikrikadze
(54) DOUBLE-WINDING THREE-PHASE ELECTRIC MACHINE
DATE OF CANCELLATION OF PATENT: 2022 03 09
THE TERM OF RESTORATION OF PATENT: 2023 03 09

(21) AU 2018 14729
(11) U 2020 2051 Y
(73) Konstantine Maghradze;
Nugzar Jogleidze
(54) BAKERY PRODUCT FOR OSTEOPOROSIS PROLIFERATION
DATE OF CANCELLATION OF PATENT: 2022 03 16
THE TERM OF RESTORATION OF PATENT: 2023 03 16

(21) AU 2020 15300
(11) U 2020 2055 Y
(73) Nikoloz Osikmashvili
(54) TRANSPARENT BEEHIVE
DATE OF CANCELLATION OF PATENT: 2022 03 17
THE TERM OF RESTORATION OF PATENT: 2023 03 17

EXPIRATION OF TERMS OF RESTORATION OF PATENT

(21) AU 2015 13763
(11) U 2016 1889 Y
(73) Elena Shafakidze;
Guram Nadareishvili;
Ioseb Jogleidze;
Murad Tkemaladze;
Marine Nadirashvili;
Vera Maisuradze;

LEPL "Ivane Javakhishvili's Tbilisi State University";
LEPL "Shota Rustaveli National Science Foundation
(54) POZZOLAN PORTLAND CEMENT CONTENT
DATE OF CANCELLATION OF PATENT: 2021 03 13
THE TERM OF RESTORATION OF PATENT: 2022 03 13

TRANSFER OF RIGHTS

(21) AU 2020 15286
(11) U 2021 2090 Y
(54) TEAPOT LID

NEW PATENTOWNER AND NEW ADDRESS: Astrata AG (CH)
Gewerbstrasse 5, Cham, canton Zug 6330, Switzerland (CH)
FORMER PATENTOWNER AND FORMER ADDRESS: The limited liability company "Polaris International Limited"
Elektrodnaya St., dom 8, stroenie 2., 111524, Moscow, Russian Federation (RU)
DATE OF REGISTRATION: 2022 03 23

(21) AU 2020 15287
(11) U 2021 2089 Y
(54) TEAPOT LID

NEW PATENTOWNER AND NEW ADDRESS: Astrata AG (CH)
Gewerbstrasse 5, Cham, canton Zug 6330, Switzerland (CH)
FORMER PATENTOWNER AND FORMER ADDRESS: The limited liability company "Polaris International Limited"
Elektrodnaya St., dom 8, stroenie 2., 111524, Moscow, Russian Federation (RU)
DATE OF REGISTRATION: 2022 03 29

(21) AU 2020 15288
(11) U 2021 2088 Y
(54) TEAPOT LID

NEW PATENTOWNER AND NEW ADDRESS: Astrata AG (CH)
Gewerbstrasse 5, Cham, canton Zug 6330, Switzerland (CH)
FORMER PATENTOWNER AND FORMER ADDRESS: The limited liability company "Polaris International Limited"
Elektrodnaya St., dom 8, stroenie 2., 111524, Moscow, Russian Federation (RU)
DATE OF REGISTRATION: 2022 03 30

(21) AU 2020 15289
(11) U 2021 2087 Y
(54) TEAPOT LID

NEW PATENTOWNER AND NEW ADDRESS: Astrata AG (CH)
Gewerbstrasse 5, Cham, canton Zug 6330, Switzerland (CH)
FORMER PATENTOWNER AND FORMER ADDRESS: The limited liability company "Polaris International Limited"
Elektrodnaya St., dom 8, stroenie 2., 111524, Moscow, Russian Federation (RU)
DATE OF REGISTRATION: 2022 03 30

DESIGNS

CANCELLATION OF DESIGNS REGISTRATION

(11) D 2017 701 S
(73) Irakli Kirtskhalia (GE)
4th Str., app. 8, 3300, Vill. Chardakhi, Mtskheta, Georgia (GE)
(54) PICTURE FRAME
(18) 2021 08 23
(58) 2022 03 29

(11) D 2017 702 S
(73) Irakli Kirtskhalia (GE)
4th Str., app. 8, 3300, Vill. Chardakhi, Mtskheta, Georgia (GE)
(54) PICTURE FRAME
(18) 2021 08 23
(58) 2022 03 29

TRANSFER OF RIGHT

(11) D 2013 526 S
(54) LINGERIE WITH ROAD SIGN APPLICATIONS
NEW OWNER AND NEW ADDRESS: Lizi Abashvili (GE)
Dighomi 7, Pimen Kurashvili Str. 61, Tbilisi, Georgia (GE)
FORMER OWNER AND FORMER ADDRESS: Giorgi Chukhrukidze (GE)
Dighomi, III quart., bld. 6v, app. 57, 0159, Tbilisi, Georgia
(58) 2022 03 30

EXTENSION OF TERMS OF INTERNATIONAL DESIGN REGISTRATION

(11) DM/77859
(73) SAVERGLASS
3 rue de la Gare, F-60960 FEUQUIERES (FR)
(15) 2012 03 09
(24) 2012 03 09
(18) 2027 03 09
(28) 1
(28') 1
(54) Bottle

(11) DM/77933
(73) MONTRES BREGUET S.A.
CH-1344 L'ABBAYE (CH)
(15) 2012 03 06
(24) 2012 03 06
(18) 2027 03 06
(28) 2

(28') 2
(54) Wristwatches

(11) DM/77935
(73) SAVERGLASS
3 rue de la Gare, F-60960 FEUQUIERES (FR)
(15) 2012 03 06
(24) 2012 03 06
(18) 2027 03 06
(28) 1
(28') 1
(54) Bottle

(11) DM/77941
(73) SWATCH AG (SWATCH SA)(SWATCH LTD.)
Jakob-Stämpfli-Strasse 94, CH-2502 Biel/Bienne (CH)
(15) 2012 03 12
(24) 2012 03 12
(18) 2027 03 12
(28) 10
(28') 4
(54) Wristwatches

(11) DM/77976
(73) MONTRES JAQUET DROZ SA (MONTRES JAQUET DROZ AG) (MONTRES JAQUET DROZ LTD.)
Allée du Tourbillon 2, CH-2300 La Chaux-de-Fonds (CH)
(15) 2012 03 16
(24) 2012 03 16
(18) 2027 03 16
(28) 3
(28') 3
(54) Dials

(11) DM/78018
(73) THE SWATCH GROUP MANAGEMENT SERVICES AG (THE SWATCH GROUP MANAGEMENT SERVICES SA) (THE SWATCH GROUP MANAGEMENT SERVICES LTD)
Seevorstadt 6, CH-2502 Biel/Bienne (CH)
(15) 2012 03 22
(24) 2012 03 22
(18) 2027 03 22
(28) 8
(28') 4
(54) Watch cases, Watch case with bracelet, Wristwatch

(11) DM/92802
(73) KÖHLER ELEKTRİK SAYAÇLARI SANAYİ VE TİCARET ANONİM ŞİRKETİ
Tenha Sok. No:8 Uçarlar Han Karaköy, Beyoğlu, ISTANBUL (TR)
(15) 2016 08 22
(24) 2016 08 22
(18) 2026 08 22
(28) 10
(28') 10
(54) Electricity meters

(11) DM/94765
(73) SEXY BACK BRA, LLC
100 Whitefish Hills Dr, Whitefish MT 59937 (US)
(15) 2017 02 06
(24) 2017 02 06
(18) 2027 02 06
(28) 4
(28') 4
(54) 1.-4. Brassieres

(11) DM/95093
(73) MONTRES JAQUET DROZ SA (MONTRES JAQUET DROZ AG) (MONTRES JAQUET DROZ LTD.)
Allée du Tourbillon 2, CH-2300 La Chaux-de-Fonds (CH)
(15) 2017 03 01
(24) 2017 03 01
(18) 2027 03 01
(28) 2
(28') 1
(54) Dials

(11) DM/95097
(73) HARRY WINSTON SA
Chemin du Tourbillon 8, CH-1228 Plan-les-Ouates (CH)
(15) 2017 03 02
(24) 2017 03 02
(18) 2027 03 02
(28) 4
(28') 4
(54) 1. Dial, 2. Oscillating weight, 3.-4. Dials

(11) DM/95098
(73) HARRY WINSTON SA
Chemin du Tourbillon 8, CH-1228 Plan-les-Ouates (CH)
(15) 2017 03 02
(24) 2017 03 02
(18) 2027 03 02
(28) 4
(28') 4
(54) 1. Dial, 2.-3. Watch cases, 4. Dial

(11) DM/95099
(73) HARRY WINSTON SA
Chemin du Tourbillon 8, CH-1228 Plan-les-Ouates (CH)
(15) 2017 03 03
(24) 2017 03 03
(18) 2027 03 03
(28) 4
(28') 4
(54) 1. Watch case with bracelet, 2. Dial, 3. Watch case, 4. Dial

(11) DM/95184
(73) OMEGA SA (OMEGA AG) (OMEGA LTD.)
Jakob-Stämpfli-Strasse 96, CH-2502 Biel/Bienne (CH)
(15) 2017 03 07

(24) 2017 03 07
(18) 2027 03 07
(28) 2
(28') 2
(54) Dial, Watch case bottom

(11) DM/95266
(73) OMEGA SA (OMEGA AG) (OMEGA LTD.)
 Jakob-Stämpfli-Strasse 96, CH-2502 Biel/Bienne (CH)
(15) 2017 03 07
(24) 2017 03 07
(18) 2027 03 07
(28) 1
(28') 1
(54) Cuff links

(11) DM/95276
(73) HARRY WINSTON SA
 Chemin du Tourbillon 8, CH-1228 Plan-les-Ouates (CH)
(15) 2017 03 10
(24) 2017 03 10
(18) 2027 03 10
(28) 6
(28') 6
(54) Bracelet, Finger ring, Necklace, Pendant

(11) DM/95365
(73) OMEGA SA (OMEGA AG) (OMEGA LTD.)
 Jakob-Stämpfli-Strasse 96, CH-2502 Biel/Bienne (CH)
(15) 2017 03 15
(24) 2017 03 15
(18) 2027 03 15
(28) 4
(28') 4
(54) Dial, Watch, Watch bracelet, Watch case

(11) DM/95381
(73) HARRY WINSTON SA
 Chemin du Tourbillon 8, CH-1228 Plan-les-Ouates (CH)
(15) 2017 03 20
(24) 2017 03 20
(18) 2027 03 20
(28) 3
(28') 3
(54) Dials, Watch case with strap

(11) DM/95386
(73) THE SWATCH GROUP MANAGEMENT SERVICES AG (THE SWATCH GROUP MANAGEMENT SERVICES SA) (THE SWATCH GROUP MANAGEMENT SERVICES LTD)
 Seevorstadt 6, CH-2502 Biel/Bienne (CH)
(15) 2017 03 20
(24) 2017 03 20
(18) 2027 03 20
(28) 3

(28') 3

(54) 1. Dial with hands and movement, 2.-3. Wristwatches

(11) DM/95429

(73) HARRY WINSTON SA

Chemin du Tourbillon 8, CH-1228 Plan-les-Ouates (CH)

(15) 2017 03 21

(24) 2017 03 21

(18) 2027 03 21

(28) 1

(28') 1

(54) Necklace

(11) DM/95869

(73) DERNEK GRUP ELEKTRİK ELEKTRONİK DIŞ TİCARET VE SANAYİ LİMİTED ŞİRKETİ

İstanbul Trakya Serbest Bölgesi, Ferhatpaşa SB Mahallesi, Sümbül Sokak, No: 5/41, Çatalca - İstanbul (TR)

(15) 2016 11 04

(24) 2016 11 04

(18) 2026 11 04

(28) 5

(28') 4

(54) Sockets, Switches, Switch-socket

TRADEMARKS

EXTENSION OF TERMS OF TRADEMARKS REGISTRATION

(111) M 2012 22445 R1
(156) 2012 04 05
(186) 2032 04 05
(732) A. Grings S.A.
Rua Gal. Ernesto Dornelles, № 577,
Bairro Centro, Municipio de Igrejinha,
RS, CEP 95. 650-000, Brazil

(111) M 2012 22876 R1
(156) 2012 08 30
(186) 2032 08 30
(732) Playboy Enterprises International, Inc.
10960 Wilshire Blvd., Suite 2200,
Los Angeles, California 90024, USA

(111) M 2012 22877 R1
(156) 2012 08 30
(186) 2032 08 30
(732) Playboy Enterprises International, Inc.
10960 Wilshire Blvd., Suite 2200,
Los Angeles, California 90024, USA

(111) M 2012 22441 R1
(156) 2012 03 29
(186) 2032 03 29
(732) "Amber Beverage Group" SIA
Ranka dambis 30-120, Riga, LV-1048,
Latvia

COMPLETE TRANSFER OF RIGHTS

(111) M 2019 30974 R
(732) OOO JTI Russia
1 Krasnogvardeyskiy proezd, 15, floors 28-32
123112 Moscow, Russian Federation
(770) Joint Stock Company Donskoy Tabak
1-ya Lugovaia 17, 344002 Rostov-on-don,
Russian Federation
(580) 2022 03 09

(111) M 1995 494 R
(732) TotalEnergies SE
2, place Jean Millier, La Défense 6,
92400 Courbevoie, France
(770) Total Holdings SAS
2, place Jean Millier, La Defense 6,
92400 Courbevoie, France
(580) 2022 03 11

(111) M 1995 493 R
(732) TotalEnergies SE
2, place Jean Millier, La Défense 6,
92400 Courbevoie, France
(770) Total Holdings SAS
2, place Jean Millier, La Defense 6,
92400 Courbevoie, France
(580) 2022 03 11

(111) M 1995 456 R
(732) TotalEnergies SE
2, place Jean Millier, La Défense 6,
92400 Courbevoie, France
(770) Total Holdings SAS
2, place Jean Millier, La Defense 6,
92400 Courbevoie, France
(580) 2022 03 11

(111) M 1994 314 R
(732) TotalEnergies SE
2, place Jean Millier, La Défense 6,
92400 Courbevoie, France
(770) Total Holdings SAS
2, place Jean Millier, La Defense 6,
92400 Courbevoie, France
(580) 2022 03 11

(111) M 2004 15554 R
(732) Netco United Pte. Ltd
120 Lower Delta Road, #15-10, Cendex
Centre, 169208, Singapore

(770) N.E.T. CO. United S.A.
Vistra Corporate Services Centre, Wickhams
Cay II, Road Town, Tortola, VG 1110, Virgin
Islands (British)
(580) 2022 03 04

(111) M 1996 2500 R
(732) TotalEnergies SE
2, place Jean Millier, La Défense 6,
92400 Courbevoie, France
(770) Total Holdings SAS
2, place Jean Millier, La Defense 6,
92400 Courbevoie, France
(580) 2022 03 11

(111) M 1996 2433 R
(732) Unilever IP Holdings B.V.
Weena 455, 3013 AL Rotterdam, Netherlands
(770) Unilever N.V.
Weena 455, NL-3013 AL Rotterdam,
Netherlands
(580) 2022 03 18

(111) M 2012 22445 R
(732) A. Grings S.A.
Rua Gal. Ernesto Dornelles, Nº 577, Bairro
Centro, Municipio de Igrejinha, RS, CEP 95.
650-000, Brazil
(770) GKS Participacoes Ltda.
Benjamin Constant Street, number 273, room
04, Igrejinha/Center-Rio-Grande-do-Sul, 95,
650-000, Brazil
(580) 2022 03 16

(111) M 2017 28322 R
(732) LSC Communications LLC
4101 Winfeld Road, Warrenville, Illinois
60555, USA
(770) LSC Communications US, LLC
35 West Wacker Drive, Chicago, Illinois
60601, USA
(580) 2022 03 19

CHANGES OF NAMES AND/OR ADDRESSES OF TRADEMARKS OWNER

(111) M 2021 34283 R
 (732) Corteva Agriscience LLC
 9330 Zionsville Road, Indianapolis,
 Indiana 46268, USA
 (770) Dow AgroSciences LLC,
 a Delaware limited
 liability company
 9330 Zionsville Road, Indianapolis,
 Indiana 46268, USA
 (580) 2021 12 16

(111) M 2021 34323 R
 (732) Corteva Agriscience LLC
 9330 Zionsville Road, Indianapolis,
 Indiana 46268, USA
 (770) Dow AgroSciences LLC,
 a Delaware limited liability company
 9330 Zionsville Road, Indianapolis,
 Indiana 46268, USA
 (580) 2021 12 16

(111) M 2021 34324 R
 (732) Corteva Agriscience LLC
 9330 Zionsville Road, Indianapolis,
 Indiana 46268, USA
 (770) Dow AgroSciences LLC,
 a Delaware limited liability company
 9330 Zionsville Road, Indianapolis,
 Indiana 46268, USA
 (580) 2021 12 16

(111) M 2021 34325 R
 (732) Corteva Agriscience LLC
 9330 Zionsville Road, Indianapolis,
 Indiana 46268, USA
 (770) Dow AgroSciences LLC,
 a Delaware limited liability company
 9330 Zionsville Road, Indianapolis,
 Indiana 46268, USA
 (580) 2021 12 16

(111) M 2022 35057 R
 (732) Corteva Agriscience LLC
 9330 Zionsville Road, Indianapolis,
 Indiana 46268, USA
 (770) Dow AgroSciences LLC,
 a Delaware limited liability company
 9330 Zionsville Road, Indianapolis,
 Indiana 46268, USA
 (580) 2021 12 16

(111) M 2021 34524 R
 (732) Corteva Agriscience LLC
 9330 Zionsville Road, Indianapolis,
 Indiana 46268, USA
 (770) Dow AgroSciences LLC
 9330 Zionsville Road, Indianapolis,
 Indiana 46268, USA
 (580) 2021 12 16

(111) M 2021 34554 R
 (732) Corteva Agriscience LLC
 9330 Zionsville Road, Indianapolis,
 Indiana 46268, USA
 (770) Dow AgroSciences LLC
 9330 Zionsville Road, Indianapolis,
 Indiana 46268, USA
 (580) 2021 12 16

(111) M 2021 34555 R
 (732) Corteva Agriscience LLC
 9330 Zionsville Road, Indianapolis,
 Indiana 46268, USA
 (770) Dow AgroSciences LLC
 9330 Zionsville Road, Indianapolis,
 Indiana 46268, USA
 (580) 2021 12 16

(111) M 2021 34599 R
 (732) Corteva Agriscience LLC
 9330 Zionsville Road, Indianapolis,
 Indiana 46268, USA
 (770) Dow AgroSciences LLC
 9330 Zionsville Road, Indianapolis,
 Indiana 46268, USA
 (580) 2021 12 16

(111) M 2002 14800 R
 (732) Egis Gyógyszergyár Zrt.
 30-38, Keresztúri út. Budapest, H-1106,
 Budapest, Hungary
 (770) Egis Gyógyszergyár Nyilvánosan Működő
 Részvénytársaság
 30-38, Keresztúri út. Budapest, H-1106,
 Budapest, Hungary
 (580) 2022 03 08

(111) M 2004 15803 R
 (732) Max Rohr, Inc.
 103 Foulk Road, Suite 253, Wilmington,
 DE 19803, USA

(770) Max Rohr, Inc.
300 Delaware Avenue, Wilmington,
Delaware 19801, USA
(580) 2022 03 18

(111) M 1994 59 R
(732) Dotdash Media Inc.
28 Liberty Street, New York,
New York 10005, USA
(770) Ebaut, Ink.
28 Liberty Street, New York,
New York 10005, USA
(580) 2022 02 24

(111) M 2011 21320 R
(732) Corteva Agriscience LLC
9330 Zionsville Road, Indianapolis,
Indiana 46268, USA
(770) Dow AgroSciencesG LLC,
a Delaware limited liability company
9330 Zionsville Road, Indianapolis,
Indiana 46268, USA
(580) 2021 12 16

(111) M 1995 782 R
(732) L'oreal Travel Retail Americas Inc.
6100 Blue Lagoon Drive, Suite 200,
Miami, Florida 33126, USA
(770) Parbel of Florida, Inc.
Miami, Florida, USA
(580) 2022 03 21

(111) M 2011 21454 R
(732) Corteva Agriscience LLC
9330 Zionsville Road, Indianapolis,
Indiana 46268, USA
(770) Dow AgroSciences LLC,
a Delaware limited liability company
9330 Zionsville Road, Indianapolis,
Indiana 46268, USA
(580) 2021 12 16

(111) M 2012 22254 R
(732) Anest iwata Corporation
3176, Shinyoshida-cho, kohoku-ku,
Yokohama-shi, kanagawa-ken,
223-8501, Japan
(770) Anest iwata Corporation
3176, Shinyoshida-cho, kohoku-ku,
Yokohama 223-8501, Japan
(580) 2022 03 16

(111) M 2012 22441 R
(732) "Amber Beverage Group" SIA
Ranka dambis 30-120, Riga, LV-1048, Latvia
(770) "Amber Beverage Group" SIA
A. Čaka iela 160, Rīga, LV-1012, Latvia
(580) 2022 02 23

(111) M 1998 8741 R
(732) Fratelli Branca Distillerie S.p.A.
Via Broletto 35, Milano, Italy
(770) Fratelli Branca Distillerie S. r. L.
Via Broletto 35, Milano, Italy
(580) 2022 03 21

(111) M 2014 25490 R
(732) JSC "Insurance Company Unison"
Gamrekeli Str. 19, fl. 1, Saburtalo District,
Tbilisi, Georgia
(770) LLC "Insurance Company Unison"
Budapest Str. 15, 0160, Tbilisi, Georgia
(580) 2022 03 15

(111) M 1997 7852 R
(732) Fratelli Branca Distillerie S.p.A.
Via Broletto 35, I-20121 Milano, Italy
(770) Fratelli Branca Distillerie S. r. L.
Via Broletto 35, I-20121 Milano, Italy
(580) 2022 03 21

(111) M 1997 7853 R
(732) Fratelli Branca Distillerie S.p.A.
Via Broletto 35, I-20121 Milano, Italy
(770) Fratelli Branca Distillerie S. r. L.
Via Broletto 35, I-20121 Milano, Italy
(580) 2022 03 21

(111) M 1999 11959 R
(732) Fratelli Branca Distillerie S.p.A.
Via Broletto 35, I-20121 Milano, Italy
(770) Fratelli Branca Distillerie S. r. L.
Via Broletto 35, I-20121 Milano, Italy
(580) 2022 03 21

(111) M 1997 7873 R
(732) Fratelli Branca Distillerie S.p.A.
Via Broletto 35, I-20121 Milano, Italy
(770) Fratelli Branca Distillerie S. r. L.
Via Broletto 35, I-20121 Milano, Italy
(580) 2022 03 21

(111) M 1997 7704 R
(732) Corteva Agriscience LLC
9330 Zionsville Road, Indianapolis,
Indiana 46268, USA
(770) Dow Agrosiences Llc
9330 Zionsville Road, Indianapolis,
Indiana 46268, USA
(580) 2021 12 16

(111) M 1997 7748 R
(732) Corteva Agriscience LLC
9330 Zionsville Road, Indianapolis,
Indiana 46268, USA
(770) Dow Agrosiences Llc
9330 Zionsville Road, Indianapolis,
Indiana 46268, USA
(580) 2021 12 16

(111) M 1997 7752 R
(732) Corteva Agriscience LLC
9330 Zionsville Road, Indianapolis,
Indiana 46268, USA
(770) Dow Agrosiences Llc
9330 Zionsville Road, Indianapolis,
Indiana 46268, USA
(580) 2021 12 16

(111) M 2018 30133 R
(732) Reima Europe Oy
Karhumaentie 3, 01530 Vantaa, Finland
(770) Reima Oy
Karhumaentie 3, 01530 Vantaa, Finland
(580) 2022 03 11

CANCELLATION OF TRADEMARKS REGISTRATION

(111) M 2001 13982 R
(151) 2001 09 11
(732) Sanofi
54, rue La Boétie, 75008 Paris, France
(141) 2022 03 21

(111) M 2001 14011 R
(151) 2001 09 13
(732) LTD "Standard Tobacco Incorporated"
Abuseridze-Tbeli Str.13, 0120, Tbilisi,
Georgia
(141) 2022 03 21

(111) M 2001 13983 R
(151) 2001 09 11
(732) Sony Interactive Entertainment Inc.
1-7-1 Konan, Minato-ku, Tokyo, Japan
(141) 2022 03 21

(111) M 2001 13979 R
(151) 2001 09 11
(732) Betek Boya ve Kimya Sanayi Anonim Şirketi
Kaynarca, Kavakpınar Mah. Tandoğan Cad.
Kocamezarlık Karşısı, Pendik-Istanbul, Turkey
(141) 2022 03 21

(111) M 2001 13986 R
(151) 2001 09 11
(732) Colgate-Palmolive Company
300 Park Avenue, New York, NY 10022, USA
(141) 2022 03 21

(111) M 2001 13995 R
(151) 2001 09 11
(732) Unilever N.V.
Weena 455, NL-3013 AL Rotterdam,
Netherlands
(141) 2022 03 21

(111) M 2001 13996 R
(151) 2001 09 11
(732) Gallaher Limited
Members Hill, Brooklands Road, Weybridge,
Surrey KT13 0QU, United Kingdom
(141) 2022 03 21

(111) M 2011 21780 R
(151) 2011 09 19
(732) Mey Alkollu İçkiler Sanayii ve Ticaret
Anonim şirketi
Abide-i Hurriyet Cad. No:211 Bolkan Center
B Blok Sisli 34381 Istanbul, Turkey
(141) 2022 03 28

(111) M 2011 21803 R
(151) 2011 09 19
(732) LTD "Georgian Distribution Marketing
Company"
Davit Aghmashenebeli Ave. 78, 0102, Tbilisi,
Georgia
(141) 2022 03 28

(111) M 2011 21733 R
(151) 2011 09 12
(732) Patron Spirits International AG
Quaistrasse 11, 8200 Schaffhausen,
Switzerland
(141) 2022 03 21

(111) M 2011 21781 R
(151) 2011 09 19
(732) Reckitt & Colman (Overseas) Health Limited
103-105 Bath Road, Slough, Berkshire,
SL1 3UH, United Kingdom
(141) 2022 03 28

(111) M 2011 21735 R
(151) 2011 09 12
(732) Harrington Development Inc.
Arango-Orillac Bldg. East 54 th street,
Republic of Panama
(141) 2022 03 21

(111) M 2011 21738 R
(151) 2011 09 16
(732) JSC "G P S"
Marjanishvili Str. 26, 0164, Tbilisi, Georgia
(141) 2022 03 25

(111) M 2011 21739 R
(151) 2011 09 16
(732) LTD "Prima-Vita"
Crossing of Georgian Military Road and
Akhmeteli Street, 0159, Tbilisi, Georgia
(141) 2022 03 25

(111) M 2011 21741 R
 (151) 2011 09 16
 (732) LTD "Globalpharm"
 Tamar Mepe Ave. 7/13, 0112, Tbilisi, Georgia
 (141) 2022 03 25

(111) M 2011 21744 R
 (151) 2011 09 16
 (732) LTD "Globalpharm"
 Tamar Mepe Ave. 7/13, 0112, Tbilisi, Georgia
 (141) 2022 03 25

(111) M 2011 21783 R
 (151) 2011 09 19
 (732) Giorgi Baghaturia
 Mdinaris Gaghma Str. 38, app. 71, Sokhumi,
 Georgia
 (141) 2022 03 28

(111) M 2011 21784 R
 (151) 2011 09 19
 (732) შპს „ლაზათი“
 დიდმის მას. მე-2 კვარტ., კორპ., 13, ბ. 79,
 0159, თბილისი, საქართველო
 (141) 2022 03 28

(111) M 2011 21785 R
 (151) 2011 09 19
 (732) LTD "Lazati"
 Dighomi, II qu., bld. 13, app. 79, 0159, Tbilisi,
 Georgia
 (141) 2022 03 28

(111) M 2011 21749 R
 (151) 2011 09 16
 (732) LTD "Gold Niadi"
 Nino Ramishvili Str. 27a (Ilia Chavchavadze
 Ave., I Lane, bld. 27/27a, fl. 1) 0179, Tbilisi,
 Georgia
 (141) 2022 03 25

(111) M 2011 21806 R
 (151) 2011 09 19
 (732) Eter Shengelia
 Giorgi Brtskinvale Str. 31, 0131, Tbilisi,
 Georgia
 (141) 2022 03 28

(111) M 2011 21750 R
 (151) 2011 09 16
 (732) Akita Electronics Co. (L.L.C.)
 P.O. Box 9029, Dubai, United Arab Emirates

(141) 2022 03 25

(111) M 2011 21787 R
 (151) 2011 09 19
 (732) Bristol-Myers Squibb Company,
 a Delaware Corporation
 345 Park Avenue, New York, New York
 10154, USA
 (141) 2022 03 28

(111) M 2011 21793 R
 (151) 2011 09 19
 (732) Arcor S.A.I.C.
 Ave. Fulvio Pagani 487, Arroyito, Province
 of Cordoba, Argentina
 (141) 2022 03 28

(111) M 2011 21797 R
 (151) 2011 09 19
 (732) YoL Tekstil Sanayi İç Ve Dış Ticaret
 Limited Şirketi
 Yukari Öveçler Mah. 5, Cad. 127 Sok. No:10,
 Balgat- Ankara, Turkey
 (141) 2022 03 28

(111) M 2011 21798 R
 (151) 2011 09 19
 (732) Heinz Italia S.p.A.
 Via Migliara 45, 04100 Latina, Italy
 (141) 2022 03 28

(111) M 2011 21799 R
 (151) 2011 09 19
 (732) Mars, Incorporated
 6885 Elm Street Mclean, Virginia
 22101-3883, USA
 (141) 2022 03 28

(111) M 2011 21800 R
 (151) 2011 09 19
 (732) Global Conquistadors S.A.
 Cuba Avenue N36-36, PO Box 0816-06748,
 Panama 5, Republic of Panama
 (141) 2022 03 28

(111) M 2011 21754 R
 (151) 2011 09 16
 (732) JSC "Gepha"
 Akaki Beliashvili Str. 142, 0159, Tbilisi,
 Georgia
 (141) 2022 03 25

(111) M 2011 21755 R
(151) 2011 09 16
(732) LTD "ABC Pharmacy"
Sanapiro Str. 10a, 0108, Tbilisi, Georgia
(141) 2022 03 25

Jumber Kuchukhidze
Tamarashvili Str. 11, app. 159, 0162, Tbilisi,
Georgia;
Malkhaz Jokhadze
Nutsbidze plateau, III mcr., III qu., bld. 8,
app. 13, 0183, Tbilisi, Georgia
(141) 2022 04 04

(111) M 2011 21756 R
(151) 2011 09 16
(732) Philip Morris products S. A.
Quai Jeanrenaud 3, CH-2000 Neuchatel,
Switzerland
(141) 2022 03 25

(111) M 2001 14009 R
(151) 2001 09 12
(732) Giorgio BeverLY Hills Inc.
One Procter & Gamble Plaza, Cincinnati,
Ohio 45202, USA
(141) 2022 03 21

(111) M 2011 21762 R
(151) 2011 09 16
(732) Novartis AG
4002 Basel, Switzerland
(141) 2022 03 25

(111) M 2011 21802 R
(151) 2011 09 19
(732) Soso Nadareishvili
Paliashvili Str. 72, app. 50, 0162, Tbilisi,
Georgia
(141) 2022 03 28

(111) M 2011 21765 R
(151) 2011 09 16
(732) LTD "Pear Office Ge"
Mujirishvili Str. 7, 0103, Tbilisi, Georgia
(141) 2022 03 25

(111) M 2011 21769 R
(151) 2011 09 16
(732) Michal Negrin designs LTD.
an Israeli company of 5 Kaf Tet B'November
Street Bat Yam 59648, Israel
(141) 2022 03 25

(111) M 2011 21779 R
(151) 2011 09 16
(732) Embil İlac Sanayi Limited Şirketi
Eski Büyükdere Caddesi, Tahirağa Çeşme
Sokak, Ayazağa Ticaret Merkezi, No:11 Kat:1,
Maslak İstanbul 34398, Turkey
(141) 2022 03 25

(111) M 2011 21810 R
(151) 2011 09 23
(732) Tamaz Murtazashvili
Moscow Ave. 33, bld. 2, app. 3, 0137, Tbilisi,
Georgia;

REGISTRATION OF LICENSE AGREEMENTS

(111) M 2021 34868 R
(732) Intersun Holding Fzco
Ebal Ali Free Zone, 61051, Dubai,
United Arab Emirates
(791) LTD "Dapna"
Lilo Settlement (Plus 05/004), Isani-Samgori
District, Tbilisi, Georgia
(793) №1699
From 24 03 2022 to 22 12 2031
Special
Class – 30, 35

(111) M 2010 20335 R
(732) Ontex Tuketim Urunleri Sanayi ve Ticaret
Anonim Şirketi
elimpşa Mah. 6093 Soc. N78, Istanbul, Turkey
(791) LTD "Libo Group"
Davit Guramishvili Ave. 84, 0141,
Tbilisi, Georgia
(793) №1697
From 08 10 2021 to 01 09 2024
Exclusive
Class – 3, 5, 10, 16, 24, 25

(111) M 2021 34577 R
(732) Ontex Tüketim Ürünleri Sanayi
Ve Ticaret Anonim Sirketi
Selimpşa Mah. 6093 Soc. N78, Istanbul,
Turkey
(791) LTD "Libo Group"
Davit Guramishvili Ave. 84, 0141,
Tbilisi, Georgia
(793) №1698
from 08 10 2021 to 01 09 2024
Exclusive
Class – 5

INTERNATIONAL LICENSE AGREEMENT

(800) 1347165
(732) Ontex Tüketim Ürünleri
Sanayi ve Ticaret Anonim Sirketi
Selimpasa Mah. 6093 sok. No:78, Istanbul,
Turkey
(791) LTD "Libo Group"
Davit Guramishvili Ave. 84, 0141,
Tbilisi, Georgia
(793) №1696
Exclusive
From 08 10 2021 to 01 09 2024
Class – 5

CLASSIFICATION INDEXES

INVENTIONS

CONCORDANCE TABLE OF INTERNATIONAL CLASSIFICATION INDEX AND PUBLICATION NUMBERS

INTERNATIONAL CLASSIFICATION INDEXES (51)	NUMBER OF PUBLISHED APPLICATION (10)
A 61 K 31/167; A 61 K 31/573; A 61 K 31/40; A 61 K 9/00; A 61 K 47/10; A 61 K 47/02; A 61 P 11/00	AP 2022 15023 A
A 61 K 31/423; A 61 P 35/00; C 07 D 413/04; C 07 D 413/12; C 07 D 417/12; C 07 D 261/20	AP 2022 15535 A
A 61 K 31/4439; A 61 K 31/433; A 61 K 31/427	AP 2022 15303 A
A 61 K 31/454; A 61 P 11/00; A 61 P 17/06; A 61 P 19/02; A 61 P 29/00	AP 2022 15309 A
B 01 D 1/00; B 01 D 5/00; B 01 D 1/30; B 01 D 1/28; C 02 F 1/14; C 02 F 1/04	AP 2022 15584 A
B 22 B 3/08; B 22 B 47/00	AP 2022 15454 A
B 61 K 9/00; G 01 M 11/08	AP 2022 15503 A
F 02 D 17/00; F 02 P 5/152	AP 2022 15427 A
F 03 D 5/02; F 03 D 7/00	AP 2022 15675 A
F 28 D 1/03; F 28 D 1/053; F 28 F 3/04; F 28 F 1/16	AP 2022 15510 A

CONCORDANCE TABLE OF PUBLICATION NUMBERS AND INTERNATIONAL CLASSIFICATION INDEX

NUMBER OF PUBLISHED APPLICATION (10)	INTERNATIONAL CLASSIFICATION INDEXES (51)
AP 2022 15023 A	A 61 K 31/167; A 61 K 31/573; A 61 K 31/40; A 61 K 9/00; A 61 K 47/10; A 61 K 47/02; A 61 P 11/00
AP 2022 15303 A	A 61 K 31/4439; A 61 K 31/433; A 61 K 31/427
AP 2022 15309 A	A 61 K 31/454; A 61 P 11/00; A 61 P 17/06; A 61 P 19/02; A 61 P 29/00
AP 2022 15427 A	F 02 D 17/00; F 02 P 5/152
AP 2022 15454 A	B 22 B 3/08; B 22 B 47/00
AP 2022 15503 A	B 61 K 9/00; G 01 M 11/08
AP 2022 15510 A	F 28 D 1/03; F 28 D 1/053; F 28 F 3/04; F 28 F 1/16
AP 2022 15535 A	A 61 K 31/423; A 61 P 35/00; C 07 D 413/04; C 07 D 413/12; C 07 D 417/12; C 07 D 261/20
AP 2022 15584 A	B 01 D 1/00; B 01 D 5/00; B 01 D 1/30; B 01 D 1/28; C 02 F 1/14; C 02 F 1/04
AP 2022 15675 A	F 03 D 5/02; F 03 D 7/00

**CONCORDANCE TABLE OF INTERNATIONAL CLASSIFICATION INDEX,
PATENT NUMBERS AND PUBLICATION NUMBERS**

INTERNATIONAL CLASSIFICATION INDEX (51)	NUMBER OF PATENT (11)	NUMBER OF PUBLISHED APPLICATION (10)
A 61 K 39/39	P 2022 7369 B	AP 2021 14672 A

**CONCORDANCE TABLE OF PATENT NUMBERS,
PUBLICATION NUMBERS AND INTERNATIONAL CLASSIFICATION INDEX**

NUMBER OF PATENT (11)	NUMBER OF PUBLISHED APPLICATION (10)	INTERNATIONAL CLASSIFICATION INDEX (51)
P 2022 7369 B	AP 2021 14672 A	A 61 K 39/39

**CONCORDANCE TABLE OF APPLICATION NUMBERS,
PUBLICATION NUMBERS AND PATENTS**

NUMBER OF APPLICATION (21)	NUMBER OF PUBLISHED APPLICATION (10)	NUMBER OF PATENT (11)
AP 2016 14672	AP 2021 14672 A	P 2022 7369 B

UTILITY MODELS

**CONCORDANCE TABLE OF INTERNATIONAL CLASSIFICATION INDEX
AND PUBLICATION NUMBERS**

INTERNATIONAL CLASSIFICATION INDEXES (51)	NUMBER OF PUBLISHED APPLICATION (10)
A 47 G 21/00	AU 2022 15629 U
C 01 G 29/00; C 01 G 51/04; C 04 B 35/32; H 01 L 35/00	AU 2022 15569 U
G 09 B 5/00	AU 2022 15539 U

**CONCORDANCE TABLE OF PUBLICATION NUMBERS
AND INTERNATIONAL CLASSIFICATION INDEX**

NUMBER OF PUBLISHED APPLICATION (10)	INTERNATIONAL CLASSIFICATION INDEXES (51)
AU 2022 15539 U	G 09 B 5/00
AU 2022 15569 U	C 01 G 29/00; C 01 G 51/04; C 04 B 35/32; H 01 L 35/00
AU 2022 15629 U	A 47 G 21/00

**CONCORDANCE TABLE OF INTERNATIONAL CLASSIFICATION INDEX,
PATENT NUMBERS AND PUBLICATION NUMBERS**

INTERNATIONAL CLASSIFICATION INDEX (51)	NUMBER OF PATENT (11)	NUMBER OF PUBLISHED APPLICATION (10)
A 21 D 10/04; A 21 C 1/00	U 2022 2114 Y	AU 2021 15552 U
A 61 K 36/00; A 61 K 35/76; A 61 K 9/20	U 2022 2113 Y	AU 2021 15659 U
C 01 G 51/00; C 04 B 35/32; H 01 L 35/00	U 2022 2115 Y	AU 2021 15507 U

**CONCORDANCE TABLE OF PATENT NUMBERS,
PUBLICATION NUMBERS AND INTERNATIONAL CLASSIFICATION INDEX**

NUMBER OF PATENT (11)	NUMBER OF PUBLISHED APPLICATION (10)	INTERNATIONAL CLASSIFICATION INDEX (51)
U 2022 2113 Y	AU 2021 15659 U	A 61 K 36/00; A 61 K 35/76; A 61 K 9/20
U 2022 2114 Y	AU 2021 15552 U	A 21 D 10/04; A 21 C 1/00
U 2022 2115 Y	AU 2021 15507 U	C 01 G 51/00; C 04 B 35/32; H 01 L 35/00

**CONCORDANCE TABLE OF APPLICATION NUMBERS,
PUBLICATION NUMBERS AND PATENTS**

NUMBER OF APPLICATION (21)	NUMBER OF PUBLISHED APPLICATION (10)	NUMBER OF PATENT (11)
AU 2020 15507	AU 2021 15507 U	U 2022 2115 Y
AU 2021 15552	AU 2021 15552 U	U 2022 2114 Y
AU 2021 15659	AU 2021 15659 U	U 2022 2113 Y

DESIGNS

**CONCORDANCE TABLE OF INTERNATIONAL CLASSIFICATION INDEX
AND PUBLICATION NUMBERS**

INTERNATIONAL CLASSIFICATION INDEXES (51)	NUMBER OF PUBLISHED APPLICATION (10)
32-00	AD 2022 1247 S

**CONCORDANCE TABLE OF PUBLICATION NUMBERS
AND INTERNATIONAL CLASSIFICATION INDEX**

NUMBER OF PUBLISHED APPLICATION (10)	INTERNATIONAL CLASSIFICATION INDEXES (51)
AD 2022 1247 S	32-00

CONCORDANCE TABLE OF INTERNATIONAL CLASSIFICATION INDEX,
NUMBERS OF REGISTRATION AND PUBLICATION NUMBERS

INTERNATIONAL CLASSIFICATION INDEX (51)	NUMBER OF REGISTRATION (11)	NUMBER OF PUBLISHED APPLICATION (10)
02-04	D 2022 932 S	AD 2021 1232 S

CONCORDANCE TABLE OF NUMBERS OF REGISTRATION,
PUBLICATION NUMBERS AND INTERNATIONAL CLASSIFICATION INDEX

NUMBER OF REGISTRATION (11)	NUMBER OF PUBLISHED APPLICATION (10)	INTERNATIONAL CLASSIFICATION INDEX (51)
D 2022 932 S	AD 2021 1232 S	02-04

CONCORDANCE TABLE OF APPLICATION NUMBERS,
PUBLICATION NUMBERS AND NUMBERS OF REGISTRATION

NUMBER OF APPLICATION (21)	NUMBER OF PUBLISHED APPLICATION (10)	NUMBER OF REGISTRATION (11)
AD 2021 1232	AD 2021 1232 S	D 2022 932 S

TRADEMARKS

CONCORDANCE TABLE OF REGISTRATION NUMBERS, APPLICATION NUMBERS, PUBLICATION NUMBERS AND BULLETIN NUMBERS

NUMBER OF REGISTRATION (111)	NUMBER OF APPLICATIONS (210)	NUMBER OF PUBLISHED APPLICATIONS (260)	NUMBER OF BULLETIN
M 2022 35200 R	AM 111736	AM 2021 111736 A	17(573) 2021
M 2022 35201 R	AM 111850	AM 2021 111850 A	18(574)2021
M 2022 35202 R	AM 111851	AM 2021 111851 A	18(574)2021
M 2022 35203 R	AM 111852	AM 2021 111852 A	18(574)2021
M 2022 35204 R	AM 112065	AM 2021 112065 A	19(575)2021
M 2022 35205 R	AM 112254	AM 2021 112254 A	18(574)2021
M 2022 35206 R	AM 112255	AM 2021 112255 A	18(574)2021
M 2022 35207 R	AM 112267	AM 2021 112267 A	20(576)2021
M 2022 35208 R	AM 112909	AM 2021 112909 A	22(578)2021
M 2022 35209 R	AM 112910	AM 2021 112910 A	22(578)2021
M 2022 35210 R	AM 112911	AM 2021 112911 A	22(578)2021
M 2022 35211 R	AM 112912	AM 2021 112912 A	22(578)2021
M 2022 35212 R	AM 112913	AM 2021 112913 A	22(578)2021
M 2022 35213 R	AM 112914	AM 2021 112914 A	22(578)2021
M 2022 35214 R	AM 112915	AM 2021 112915 A	22(578)2021
M 2022 35215 R	AM 112916	AM 2021 112916 A	22(578)2021
M 2022 35216 R	AM 112917	AM 2021 112917 A	22(578)2021
M 2022 35217 R	AM 112918	AM 2021 112918 A	22(578)2021
M 2022 35218 R	AM 112919	AM 2021 112919 A	22(578)2021
M 2022 35219 R	AM 112920	AM 2021 112920 A	22(578)2021
M 2022 35220 R	AM 113033	AM 2021 113033 A	22(578)2021
M 2022 35221 R	AM 113034	AM 2021 113034 A	22(578)2021
M 2022 35222 R	AM 113038	AM 2021 113038 A	22(578)2021
M 2022 35223 R	AM 113124	AM 2021 113124 A	22(578)2021
M 2022 35224 R	AM 113145	AM 2021 113145 A	22(578)2021
M 2022 35225 R	AM 113183	AM 2021 113183 A	22(578)2021
M 2022 35226 R	AM 113184	AM 2021 113184 A	22(578)2021
M 2022 35227 R	AM 113187	AM 2021 113187 A	22(578)2021
M 2022 35228 R	AM 113197	AM 2021 113197 A	22(578)2021
M 2022 35229 R	AM 113198	AM 2021 113198 A	22(578)2021
M 2022 35230 R	AM 112185	AM 2021 112185 A	22(578)2021
M 2022 35231 R	AM 112584	AM 2021 112584 A	21(577)2021
M 2022 35232 R	AM 112585	AM 2021 112585 A	22(578)2021
M 2022 35233 R	AM 117095	-	7(586)2022
M 2022 35234 R	AM 117063	-	7(586)2022
M 2022 35235 R	AM 117107	-	7(586)2022
M 2022 35236 R	AM 117180	-	7(586)2022
M 2022 35237 R	AM 117181	-	7(586)2022

CONCORDANCE TABLE OF PUBLICATION NUMBERS
AND APPLICATION NUMBERS

NUMBER OF PUBLISHED APPLICATION (260)	NUMBER OF APPLICATION (210)	1	2
1	2		
AM 2022 111430 A	AM 111430	AM 2022 114464 A	AM 114464
AM 2022 111757 A	AM 111757	AM 2022 114466 A	AM 114466
AM 2022 112413 A*	AM 112413	AM 2022 114467 A	AM 114467
AM 2022 112613 A*	AM 112613	AM 2022 114470 A	AM 114470
AM 2022 112694 A*	AM 112694	AM 2022 114471 A	AM 114471
AM 2022 113586 A	AM 113586	AM 2022 114529 A	AM 114529
AM 2022 114226 A	AM 114226	AM 2022 114530 A	AM 114530
AM 2022 114337 A	AM 114337	AM 2022 114531 A	AM 114531
AM 2022 114347 A	AM 114347	AM 2022 114537 A	AM 114537
AM 2022 114394 A	AM 114394	AM 2022 114538 A	AM 114538
AM 2022 114400 A	AM 114400	AM 2022 114539 A	AM 114539
AM 2022 114404 A	AM 114404	AM 2022 114544 A	AM 114544
AM 2022 114414 A	AM 114414	AM 2022 114546 A	AM 114546
AM 2022 114415 A	AM 114415	AM 2022 114592 A	AM 114592
AM 2022 114416 A	AM 114416	AM 2022 114593 A	AM 114593
AM 2022 114417 A	AM 114417	AM 2022 114594 A	AM 114594
AM 2022 114420 A	AM 114420	AM 2022 114595 A	AM 114595
AM 2022 114462 A	AM 114462	AM 2022 114609 A	AM 114609
		AM 2022 114614 A	AM 114614
		AM 2022 114617 A	AM 114617
		AM 2022 114618 A	AM 114618
		AM 2022 114736 A	AM 114736
		AM 2022 114756 A	AM 114756

CONCORDANCE TABLE OF INDEX OF GOODS AND/OR SERVICES
AND APPLICATION NUMBERS

INDEX OF GOODS AND/OR SERVICES (511)	NUMBER OF PUBLISHED APPLICATIONS (260)	1	2
1	2	30	AM 2022 114462 A
1	AM 2022 114337 A	30	AM 2022 114471 A
2	AM 2022 112694 A*	31	AM 2022 111757 A
3	AM 2022 114337 A	32	AM 2022 111757 A
3	AM 2022 114414 A	32	AM 2022 114226 A
3	AM 2022 114415 A	32	AM 2022 114394 A
3	AM 2022 114416 A	32	AM 2022 114400 A
3	AM 2022 114417 A	33	AM 2022 111757 A
3	AM 2022 114464 A	34	AM 2022 114546 A
4	AM 2022 114756 A	35	AM 2022 111430 A
5	AM 2022 114400 A	35	AM 2022 111757 A
5	AM 2022 114414 A	35	AM 2022 114226 A
5	AM 2022 114415 A	35	AM 2022 114347 A
5	AM 2022 114416 A	35	AM 2022 114394 A
5	AM 2022 114417 A	35	AM 2022 114404 A
5	AM 2022 114464 A	35	AM 2022 114466 A
5	AM 2022 114470 A	35	AM 2022 114467 A
5	AM 2022 114544 A	35	AM 2022 114529 A
5	AM 2022 114614 A	35	AM 2022 114530 A
5	AM 2022 114617 A	35	AM 2022 114538 A
5	AM 2022 114618 A	35	AM 2022 114594 A
9	AM 2022 114537 A	36	AM 2022 114592 A
9	AM 2022 114538 A	36	AM 2022 114593 A
9	AM 2022 114595 A	36	AM 2022 114594 A
9	AM 2022 114609 A	37	AM 2022 111430 A
12	AM 2022 112413 A*	37	AM 2022 114466 A
12	AM 2022 112613 A*	37	AM 2022 114467 A
12	AM 2022 114539 A	38	AM 2022 114594 A
14	AM 2022 114466 A	41	AM 2022 114592 A
14	AM 2022 114467 A	41	AM 2022 114593 A
20	AM 2022 114404 A	41	AM 2022 114594 A
24	AM 2022 114404 A	41	AM 2022 114736 A
29	AM 2022 111757 A	42	AM 2022 114594 A
29	AM 2022 113586 A	43	AM 2022 111757 A
29	AM 2022 114462 A	43	AM 2022 113586 A
29	AM 2022 114471 A	43	AM 2022 114347 A
30	AM 2022 111757 A	43	AM 2022 114420 A
30	AM 2022 113586 A	43	AM 2022 114531 A
		44	AM 2022 114464 A
		45	AM 2022 114594 A

CONCORDANCE TABLE OF INDEX OF GOODS AND/OR SERVICES
AND NUMBERS OF TRADEMARKS REGISTERED ACCORDING
TO THE ACCELERATED PROCEDURE

INDEX OF GOODS AND/OR SERVICES (511)	NUMBERS OF REGISTERED ACCORDING TO THE ACCELERATED PROCEDURE (111)
5	M 2022 35234 R
35	M 2022 35233 R
35	M 2022 35235 R
36	M 2022 35235 R
36	M 2022 35236 R
36	M 2022 35237 R
38	M 2022 35235 R
42	M 2022 35235 R

OFFICIAL BULLETIN OF THE INDUSTRIAL PROPERTY

**INVENTIONS
UTILITY MODELS
DESIGNS
TRADEMARKS**

7(586)

EDITOR-IN-CHIEF: N. Bebrishvili

EDITOR-TRANSLATOR: E. Gabunia

PROOFREADER: A. Shikhashvili

COMPUTER LAYOUT: M. Ordenidze
K. Svanidze

info@sakpatenti.gov.ge
www.sakpatenti.gov.ge