



Official Bulletin of the Industrial Property

Inventions

Validation Of European Patents

Designs

Trademarks

Appellations of Origin of Goods



საქართველოს ინტელექტუალური
საკუთრების ეროვნული ცენტრი
საქპატენტი
SAKPATENTI
NATIONAL INTELLECTUAL PROPERTY
CENTER OF GEORGIA

7(682)

INID CODES FOR IDENTIFICATION OF BIBLIOGRAPHIC DATA

INVENTIONS, UTILITY MODELS

- (10) Number of publication of examined application/
Application publication number***
- (11) Patent number/ Patent number***
Registered utility model number***
- (21) Application number (domestic number)
- (22) Date of filing of the application
- (23) Date of exhibition priority
- (24) Date from which patent may have effect
- (30) Priority data
- (31) Number of priority application
- (32) Date of filing of priority application
- (33) Code of the country or regional organization allotting priority application number
- (43) Date of publication of application, number of bulletin***
- (44) Date of publication of examined application, on which no grant has taken place and number of bulletin
- (45) Date of publication of patent/ Date of publication of patent***
Date of publication of registered utility model***
- (51) IPC
- (54) Title of invention
- (57) Abstract
- (60) Number of examined patent document granted by foreign patent office, date from which patent has effect and country code
- (62) Number and filing date of the earlier application from which the present patent document has been divided up
- (71) Applicant
- (72) Inventor
- (73) Name and address of patent owner/patent owner***/ registered utility model owner***
(country code)
- (74) Representative
- (82) Date of publication of request of validation
- (85) Date of commencement of the national phase
- (86) PCT filing date, PCT application number
- (87) Number and date of publication of international application (PCT)
- (94) Calculated date of expiry of the SPC or the duration of the SPC
- (100) EP application publication number
- (210) EP application number
- (220) EP filing date
- (430) EP application publication date

DESIGNS

- (10) Number of publication for application
- (11) Number of patent and kind of document or number of registration
- (15) Date of registration/Date of patent renewal
- (18) Expected expiration date of patent or registration
- (21) Serial number of application
- (22) Date of filing of the application
- (23) Date of exhibition or the date of the earlier filing and the number of application, if any
- (24) Date from which patent may have effect
- (28) Number of designs included in the application
- (30) Data relating to priority (number of application, date of filing of application, two-letter code identifying the authority with whom the priority application was made)
- (31) Number of priority application
- (32) Date of filing of priority application
- (33) Code of the country or regional organization allotting priority application number
- (34) Two-letter code according to WIPO St.3 identifying the authority with which the priority application was made
- (44) Date of publication of design and number of bulletin (the first publication)
- (45) Date of publication of design registered by WIPO and number of bulletin
- (51) International Classification for designs (class and subclass of the Locarno Classification)
- (54) Title of the invention
- (55) Reproduction of the design
- (57) Description of characteristic features of the design including indication of colors
- (58) Date of recording of any kind of amendment in the Register
- (62) Number of the earlier application, registration and document number and if available the date of filing an application in case of divided application
- (71) Name, surname and address of applicant (country code)
- (72) Name, surname of creator (country code)
- (73) Name, surname and address of patent owner (country code)
- (74) Name, surname of representative or patent attorney
- (81) Contracting states concerned
II designated contracting states according to the 1960 Act
III designated contracting states according to the 1999 Act
- (85) Owner's permanent address
- (86) Owner's nationality
- (87) Owner's residence
- (88) State in which the owner has a real and effective industrial or commercial establishment

TRADEMARKS

- (111) – Number of registration
- (151) – Date of registration
- (156) – Date of the renewal
- (181) – Expected expiration date of registration
- (186) – Renewal expiration date of registration
- (141) – Date of cancel of duration of the mark
- (210) – Serial number of application
- (220) – Date of filing of the application
- (230) – Date concerning exhibition
- (260) – Number of application, for which favorable decision of examination about registration has been taken (publication number)
- (310) – Number of the first application
- (320) – Date of filing of the first application
- (330) – Code, identifying national or regional Office where the first application was made
- (511) – International Classification of Goods and Services for the purposes of registration of trade marks and/or list of goods and/or services classified according thereto
- (526) – Disclaimer
- (531) – Description of figurative elements of Trade Marks according to the International Classification of the Figurative Elements of Marks
- (540) – Reproduction of Trade Mark
- (550) – Nature and kind of Trade Mark
- (551) – Indication to the effect that the mark is a collective mark, a certification mark or a guarantee mark
- (554) – Three-dimensional mark
- (580) – Date of recording of any kind changes in respect of applications or registrations
- (591) – Information concerning colors claimed
- (731) – Name and address of the applicant
- (732) – Name and address of the holder of the registration
- (740) – Name and address of the representative
- (750) – Address for correspondence
- (770) – Name and address of the previous applicant or holder in case of change in ownership
- (771) – Previous name and address of the applicant or holder in case of change in ownership
- (791) – Name and address of the licensee
- (793) – Indication of conditions and/or restrictions under the license (Type of license, number of license agreement, data of license, data of validity of license)
- (800) – Certain data relating to the international registration of Trade Marks under the Protocol Relating to Madrid Agreement (International registration number)
- (852) – Partial cancellation of the list of goods and services
- (891) – Date of subsequent designation

CODES FOR PUBLICATION IN BULLETIN

- (21) AP 0000 000000 – number of application for invention
- (10) AP 0000 0000 A – number of publication of application for invention
- (11) P 0000 0000 B – number of patent for invention/ patent number***
- (21) API 0000 000000 – number of application for imported patent
- (11) PI 0000 0000 A – number of imported patent
- (21) AU 0000 000000 – number of application for utility model
- (10) AU 0000 000 U – number of publication of application for utility model
- (11) U 0000 000 Y – number of patent for utility model/ registered utility model number***
- (21) AD 0000 000000 – serial number of application for design
- (10) AD 0000 000 S – number of published application for design (first publication)
- (11) D 0000 000 S – registered design

INTERNATIONAL PATENT CLASSIFICATION FOR INVENTIONS AND UTILITY MODELS

- SECTION A – HUMAN NECESSITIES
- SECTION B – PERFORMING OPERATIONS; TRANSPORTING
- SECTION C – CHEMISTRY; METALLURGY
- SECTION D – TEXTILES; PAPER
- SECTION E – FIXED CONSTRUCTIONS
- SECTION F – MECHANICAL ENGINEERING; LIGHTING; HEATING; WEAPONS; BLASTING
- SECTION G – PHYSICS
- SECTION H – ELECTRICITY

* Number of application published after the decision of Appellation Chamber of SAKPATENTI

** Number of application published after Court decision

*** Materials published according to the amendments of May 16, 2023 (No. 2883-XI0b-X03) to the Patent Law of Georgia

- M – Trade Mark
- (210) AM 0000 000000 – Serial number of application;
- (260) AAM 0000 00000 A – Publication number of application;
- (111) M 0000 00000 R – Number of registration;
- (111) MMM0000 00000 Rn – Number of renewals, in which n=1,2,3;
- (111) M 0000 00000 R(P) – Number of registration under partial assignment of rights

Official Bulletin of the Industrial Property

Inventions

Validation Of European Patents

Designs

Trademarks

Appellations of Origin of Goods

CONTENT

PUBLISHED TITLES OF PROTECTION	2
INVENTIONS	
▪ APPLICATION APPROVED FOR GRANTING PATENT	4
▪ PATENTED INVENTION	5
▪ APPLICATIONS***	6
▪ PATENTS***	9
VALIDATION OF EUROPEAN PATENTS	
▪ EUROPEAN PATENT APPLICATIONS FOR WHICH THE VALIDATION IS REQUESTED IN GEORGIA	12
▪ VALIDATED EUROPEAN PATENT	27
DESIGNS	
▪ APPLICATIONS APPROVED FOR REGISTRATION	28
▪ DESIGN REGISTERED ACCORDING TO THE ACCELERATED PROCEDURE	30
▪ DESIGNS, WHICH HAVE BEEN REGISTERED WITH THE INTERNATIONAL BUREAU CLAIMING PRIORITY ON THE TERRITORY OF GEORGIA	32
TRADEMARKS	
▪ APPLICATIONS FILED UNDER THE NATIONAL PROCEDURE APPROVED FOR REGISTRATION	42
▪ REGISTERED TRADEMARKS	50
▪ TRADEMARKS REGISTERED ACCORDING TO THE ACCELERATED PROCEDURE	53
▪ INTERNATIONAL TRADEMARKS FOR WHICH A DECISION ON GRANTING PROTECTION IS TAKEN	57
▪ INTERNATIONAL TRADEMARKS PROTECTED IN GEORGIA	162
APPELLATIONS OF ORIGIN OF GOODS	
PROTECTED INTERNATIONAL APPELLATIONS OF ORIGIN OF GOODS	171
OFFICIAL NOTIFICATION	
INVENTIONS	
▪ LAPSE OF PATENT WITH THE RIGHT TO RESTORE	173
▪ EXPIRATION OF PATENT RESTORATION TERM	174
▪ EXPIRATION OF PATENT	174
▪ TRANSFER OF RIGHTS	174
▪ OPEN LICENSING REGIME	175
DESIGNS	
▪ EXTENSION OF TERM OF DESIGNS REGISTRATION	177
▪ CANCELLATION OF DESIGNS REGISTRATION	177
▪ EXTENSION OF TERM OF INTERNATIONAL DESIGNS REGISTRATION	178
TRADEMARKS	
▪ EXTENSION OF TERM OF TRADEMARKS REGISTRATION	191
▪ TRANSFER OF RIGHT	197
▪ CHANGES OF NAME AND/OR ADDRESS OF TRADEMARKS OWNERS	200
▪ CANCELLATION OF TRADEMARKS REGISTRATION	206
▪ REGISTRATION OF LICENSE AGREEMENTS	210
CLASSIFICATION INDEXES	
INVENTIONS	211
DESIGNS	214
TRADEMARKS	215

PUBLISHED TITLES OF PROTECTION

INVENTIONS

- **APPLICATION APPROVED FOR GRANTING PATENT**
15688
- **PATENTED INVENTION**
7880
- **APPLICATIONS:*****
16770; 16759; 16605; 16811; 16695; 16738
- **PATENTS:*****
7877-7879; 7881-7883

VALIDATION OF EUROPEAN PATENTS

- **EUROPEAN PATENT APPLICATIONS FOR WHICH THE VALIDATION IS REQUESTED IN GEORGIA:**
233-271
- **VALIDATED EUROPEAN PATENT**
3

DESIGNS

- **APPLICATIONS APPROVED FOR REGISTRATION:**
1454, 1455
- **DESIGN REGISTERED ACCORDING TO THE ACCELERATED PROCEDURE:**
1112
- **DESIGNS, WHICH HAVE BEEN REGISTERED WITH THE INTERNATIONAL BUREAU CLAIMING PRIORITY ON THE TERRITORY OF GEORGIA:**
243645; 248353; 253160; 253205

TRADEMARKS

- **APPLICATIONS FILED UNDER THE NATIONAL PROCEDURE APPROVED FOR REGISTRATION:**
128298; 132216*; 132664*; 134439; 134739; 134751; 134986; 135089; 135207-135209; 135211; 135215; 135216; 135220, 135221; 135280; 135284; 135307-135309; 135311; 135313, 135314; 135371, 135373; 135375; 135377; 135391; 135395; 135402-135408; 135463; 135465; 135484, 135485; 135490; 135492; 135494, 135495; 135497; 135505; 135554, 135555; 135619; 135624
- **REGISTERED TRADEMARKS:**
41009-41036
- **TRADEMARKS REGISTERED ACCORDING TO THE ACCELERATED PROCEDURE:**
41037-41058
- **INTERNATIONAL TRADEMARKS FOR WHICH A DECISION ON GRANTING PROTECTIONS IS TAKEN:**
129978; 130032, 130033; 130201-130203; 130274, 130275; 130278; 130360; 130362-130364; 130370; 130372; 130457-130461; 130585-130587; 130589-130591; 130676-130678; 130691-130694; 131128-131130; 131225; 131230; 131233; 131329-131333; 131335; 131458-131460; 131462-131464; 131472-131474; 131476-131478; 131537-131541; 131543; 131545-131549; 131611; 131613; 131655; 131657; 131659; 131687-131695; 131709, 131710; 131713; 131788, 131789; 131796; 132035; 132156; 132200; 132418-132422; 134161; 134218; 134221; 134240; 134302; 134313; 134315-134319; 134321; 134431-134434; 134495; 134501-134509; 134511-134513; 134627, 134628
- **INTERNATIONAL TRADEMARKS PROTECTED IN GEORGIA:**
128524-128526; 128528-128531; 128537-128539; 128541, 128542; 128549-128551; 128611-128613; 128681; 128881; 129002; 129017; 129080; 129105, 129106; 129356; 129526; 130707; 131905; 132023; 132058; 132060; 132120; 132184; 132186, 132187; 132205; 132278-132280; 132309; 132311, 132312; 132388; 132431, 132432; 132527-132530; 132539; 132555; 132637; 132711, 132712; 132716, 132717; 132816; 132818; 132891; 132942; 132945, 132946; 132948, 132949; 132982; 132998-133003; 133095, 133096; 133110-133113; 133120-133124; 133183-133188; 133213-133217; 133219; 133221-133224; 133289-133294; 133331-133337; 133437-133439; 133441

APPELLATIONS OF ORIGIN OF GOODS

PROTECTED INTERNATIONAL APPELLATIONS OF ORIGIN OF GOODS

1428-1430; 1438, 1439

INVENTIONS

APPLICATION APPROVED FOR GRANTING PATENT

The decision can be appealed at the Chamber of Appeal of Sakpatenti within 3 months from the publication or at the Mtskheta District Court Administrative Cases Board (Address: №17, Samkhedro St., Mtskheta), within 1 month following the publication.

PART A

A 61

(10) AP 2026 15688 A (51) Int. Cl. (2006)

A 61 K 39/00

C 07 K 16/26

(21) AP 2020 15688

(22) 2020 01 08

(31) 62/872,989; 62/842,162; 62/789,82

(32) 2019 07 11; 2019 05 02; 2019 01 08

(33) US; US; US

(71) H. Lundbeck A/S (DK)

Ottiliavej 9, DK-2500 Valby, Denmark (DK)

(72) CADY, Roger, K. (US);

SMITH, Jeffrey, T.L. (IE);

HIRMAN, Joseph (US);

SCHAEFFLER, Barbara (US);

MEHTA, Lahar (US)

(74) Tamaz Shilakadze

(85) 2021 07 08

(86) PCT/US2020/012781, 2020 01 08

(54) ACUTE TREATMENT AND RAPID
TREATMENT OF HEADACHE USING
ANTI-CGRP ANTIBODIES

(57) An invention relates to anti-CGRP antibodies for the treatment of acute migraine, when a patient already has migraine, and from beginning of migraine within 30 hours.

Claims: 1 independent

6 dependents

Fig.: 49

PATENTED INVENTION**PART A****A 61**

- (11) P 2026 7880 B (51) Int. Cl. (2006)
A 61 K 45/06
A 61 K 31/58
A 61 K 9/00
A 61 K 31/167
A 61 K 31/573
A 61 K 31/40
A 61 K 47/02
A 61 M 15/00
A 61 P 11/08
A 61 P 11/06
- (10) AP 2025 16227 A (44) 2025 12 10 №23
(21) AP 2021 16227
(22) 2021 10 08
(24) 2021 10 08
(31) 20201060.9
(32) 2020 10 09
(33) EP
(86) PCT/EP2021/077827, 2021 10 08
(73) Chiesi Farmaceutici S.P.A. (IT)
Via Palermo 26/A, 43122 Parma, Italy (IT)
(72) Enrico ZAMBELLI (IT);
Sauro BONELLI (IT);
Diego COPELLI (IT);
Massimiliano DAGLI ALBERI (IT);
Francesca USBERTI (IT)
(74) Shalva Gvaramadze
(54) A PHARMACEUTICAL FORMULATION
FOR PRESSURISED METERED DOSE
INHALER
-

APPLICATIONS***

PART A

A 01

(10) AP 2026 16770 A (51) Int. Cl. (2006)
A 01 D 45/00

(43) 2026 04 14 №7

(21) AP 2025 16770

(22) 2025 05 29

(71) Gia Maghlakelidze (GE)

Giorgi Brtskinvale St. 113, 4600, Kutaisi,
Georgia (GE);

Mikheil Kotishadze (GE)

Anna Politkovskaya St. 12a, ap. 8, 0186, Tbilisi,
Georgia (GE);

University of Georgia (GE)

Merab Kostava St. 77a, 0171, Tbilisi,
Georgia (GE)

(72) Gia Maghlakelidze (GE);

Mikheil Kotishadze (GE);

Miriani Maghlakelidze (GE)

(54) DEVICE FOR REMOVING LEAVES FROM
RAW LAUREL FOLIAGE

(57) A device includes a receiver 5 for cutting laurel branches 4, rotating around an axis the roller 9 equipped with a cutter 10, supplying means 3 executed as couple of rollers, a conveyor 2 for orienting the branches, adjustable support table 11 inclined at an angle α relative to horizontal axis of roller, arranged in such a way as to provide a gap δ between table edge and the cutter inserted into the roller, wherein $\delta=0.1-5$ mm, furthermore, offtake channel is equipped with a sieve 7 to remove leaves 12 from the branches. The device has aerodynamic device 8 for transporting the leaves.

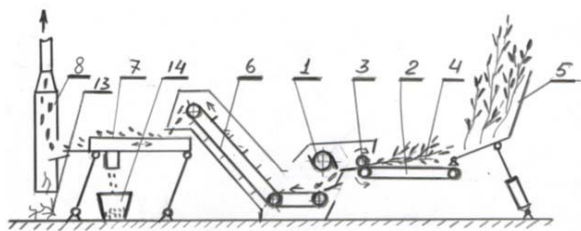

Fig. 1

(10) AP 2026 16759 A (51) Int. Cl. (2006)
A 01 G 9/10

(43) 2026 04 14 №7

(21) AP 2025 16759

(22) 2025 05 19

(71) Elene Jariashvili (GE)

Abastumani St., Bldg. 1st, ap. 16, 0102, Tbilisi,
Georgia (GE)

(72) Elene Jariashvili (GE)

(54) PLANT CONTAINER

(57) Air-permeable plant container is executed with thermoregulation, root formation and noise absorption effects, with acoustic panels executed with thermally pressing polyethylene terephthalate fibers by use of method of attaching the segments, walls (1-walls), bottom (2-bottom) and legs (3-legs) formed and cut on appropriate machine by means of contactable to each other the thermoreactive resins, hot melt glue or similar waterproof glue. An object of industrial design is characterized with combination of known and additional features from technical level providing the creation of favorable conditions for plant cultivation.

A 61

(10) AP 2026 16605 A (51) Int. Cl. (2006)
A 61 B 3/08
A 61 H 5/00

(43) 2026 04 14 №7

(21) AP 2024 16605

(22) 2024 09 25

(71) Llc "Ai2Ai" (GE)

Parnavaz Mepe Ave. 26a, Block B, Fl. 5, ap. 56,
0159, Tbilisi, Georgia (GE)

(72) Nia Toloraia (GE);

Vakhtang Nanava (GE)

(74) Nikoloz Gogilidze

(54) EYE TRAINING DEVICE

(57) An invention provides eye training device for the treatment of amblyopia, diplopia and strabismus, and it contains corpus callosum having disc-shaped frontal surface intended to be placed vertically in front of user, wherein the frontal surface has a plurality of areas, each area wherefrom is intended to emit light beams, wherein first three areas are arranged along vertical line on the distance from each other, and designed to emit blue or green or red light, white light and blue or green or red light, in sequence; and fourth area is located along horizontal line passing through the area intended to emit white light, and blue or green or red light on the distance therefrom; at least one light source located in the case is intended to emit light beams from specified areas.

PART B**B 21**

(10) AP 2026 16811 A (51) Int. Cl. (2006)
B 21 C 5/00

(43) 2026 04 14 №7

(21) AP 2025 16811

(22) 2025 07 29

(71) LEPL "Rafiel Dvali Institute of Machine
Mechanics" (GE)

Mindeli St. 10, Tbilisi, Georgia (GE)

(72) Tamaz Natriashvili (GE);

Slava Mebonia (GE);

Revaz Kavtaradze (GE);

Giorgi Shaorshadze (GE);

Tamaz Morchadze (GE)

(54) PIPE END FORGING DEVICE

(57) An invention relates to pressing of metals. Technical result of invention is in increasing the reliability and compactness of device for clamping the ends of pipes.

A device includes a case 1, wherein two-sided levers 3 are installed on the axes 2 (a machine has four levers – with heads), on one end whereof a hammer 4 is attached, and on another – a roller 5. A spring 6 is installed on same side of levers providing constant contact of roller with the surface of sole slider 7 having cylindrical outer axes 8 and 9, by means whereof it is inserted axially moveable into the slots executed in device case 1 and the cover 10. Rocker arm 11 is located into rectangular hole next to the slider 7, in cylindrical hole whereof the eccentric of eccentric shaft 12 is located, whereon a pulley-wheel 13 is inserted, and with belt drive 14 is connected to drive pulley 15 attached to a drive 16.

Present invention provides increased reliability and compactness of device for clamping the ends of pipes.

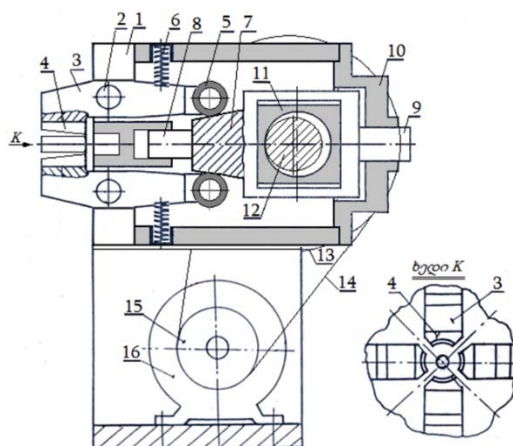

Fig. 1

PART F**F 27**

(10) AP 2026 16695 A (51) Int. Cl. (2006)
F 27 B 3/08
H 05 B 7/148

(43) 2026 04 14 №7

(21) AP 2025 16695

(22) 2025 02 28

(71) Gocha Kurdadze (GE)

Kekelidze St. 5/16, 2000, Zestaponi,

Georgia (GE)

(72) Gocha Kurdadze (GE)

(54) METHOD FOR CONTROLLING ELECTRIC
MODE ON COAL-FIRED FURNACES AND
SYSTEM FOR FURNACE AUTOMATIC
MANAGEMENT

(57) In the field of ferroalloy production equipping automatic management systems for coal-fired furnaces with modern technologies allows better controlling not only electric modes, but also temperature regimes and the process of switching electrodes. Automatic furnace regimes are acceptable under stable conditions of furnace and electrodes, operating the furnace in automatic mode makes capable for service personnel to devote more time to local furnace infrastructure, visually inspect condition of electrodes, providing the charge around the phases, managing the operation of cooling systems and executing all other necessary operations. Implementation of invention into the furnaces of ferroalloy factory causes significant economic benefits, in particular, production costs are significantly reduced with decreasing electric power consumption. Implementation of modern automated managing systems on furnaces is considered as innovative project in the field of ferroalloy production.

PART G**G 06**

(10) AP 2026 16738 A (51) Int. Cl. (2006)
G 06 F 18/24
G 06 F 21/55
G 06 F 21/60
G 06 F 21/62
H 04 L 9/32
H 04 L 9/40

(43) 2026 04 14 №7

(21) AP 2025 16738

(22) 2025 02 25

(31) 202510088049.5

(32) 2025 01 21

(33) CN

(71) Zongtong fu Public Information Industry Co.,
Ltd. (CN)
№191 Huang He Road, Urumqi, Xin Jiang
830000, People's Republic of China (CN)

(72) QIU, Lin (CN);
ASIMU, Abuliz (CN);
Ji Boqi (CN);
ZHANG, Jianxiong (CN);
WANG, Jun (CN);
WEI, Shengkun (CN);
FENG, Shan (CN);
LI, Wenjie (CN)

(74) Merab Kvimsadze

(85) 2025 04 15

(86) PCT/CN2025/079060, 2025 02 25

(54) DATA CLASSIFICATION HIERARCHY-
BASED DATA SECURITY SYSTEM

(57) The present invention relates to the technical field of data security, and provides a data classification-based data security system, comprising a system security component, a static data security component, a dynamic data security component, a data transmission security component, and a data security governance component; The system security component is used for checking and filtering a network request and defending against an external network attack. The static data security component is used for the configuration of an entity and a field security policy, and performs security processing on the data. The dynamic data security component is used for performing security processing on the data according to the classification classification configured by the data security governance component and a corresponding security policy. The data transmission security component is used for performing security processing on the data according to a transmission policy configured by the data security governance component. The beneficial effects of the present invention are as follows: the security of data during storage and transmission is improved, the system flexibility is high, and the efficiency is high.

PATENTS***

PART A

A 01

- (11) P 2026 7879 B (51) Int. Cl. (2006)
A 01 D 45/00
- (10) AP 2026 16770 A (43) 2026 04 14 №7
(45) 2026 04 14 №7
(21) AP 2025 16770
(22) 2025 05 29
- (73) Gia Maghlakelidze (GE)
Giorgi Brtskinvale St. 113, 4600, Kutaisi,
Georgia (GE);
Mikheil Kotishadze (GE)
Anna Politkovskaya St. 12a, ap. 8, 0186, Tbilisi,
Georgia (GE);
University of Georgia (GE)
Merab Kostava St. 77a, 0171, Tbilisi,
Georgia (GE)
- (72) Gia Maghlakelidze (GE);
Mikheil Kotishadze (GE);
Miriani Maghlakelidze (GE)
- (54) DEVICE FOR REMOVING LEAVES FROM
RAW LAUREL FOLIAGE
- (57) A device includes a receiver 5 for cutting laurel
branches 4, rotating around an axis the roller 9 equi-
pped with a cutter 10, supplying means 3 executed as
couple of rollers, a conveyor 2 for orienting the bran-
ches, adjustable support table 11 inclined at an angle
 α relative to horizontal axis of roller, arranged in
such a way as to provide a gap δ between table edge
and the cutter inserted into the roller, wherein $\delta=0.1-5$
mm, furthermore, offtake channel is equipped with
a sieve 7 to remove leaves 12 from the branches. The
device has aerodynamic device 8 for transporting the
leaves.

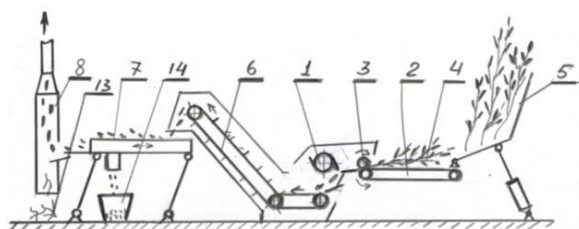

Fig. 1

- (11) P 2026 7881 B (51) Int. Cl. (2006)
A 01 G 9/10
- (10) AP 2026 16759 A (43) 2026 04 14 №7
(45) 2026 04 14 №7
(21) AP 2025 16759
(22) 2025 05 19
- (73) Elene Jariashvili (GE)

Abastumani St., bld. 1, ap. 16, 0102, Tbilisi,
Georgia (GE)

(72) Elene Jariashvili (GE)

(54) PLANT CONTAINER

(57) A container comprises a case 3 having intercon-
nected side walls 1 and a bottom 2 creting a cavity
for placing therein a substrate 4 and a plant. Case
side walls and bottom are executed with having 12-
24 mm thickness the PET (polyethylene tereph-
thalate) acoustic panels edge-joined with waterproof
glue. Furthermore, a container has support legs 5
executed with above-mentioned material placed on
the bottom of case from below and connected
therewith waterproof glue.

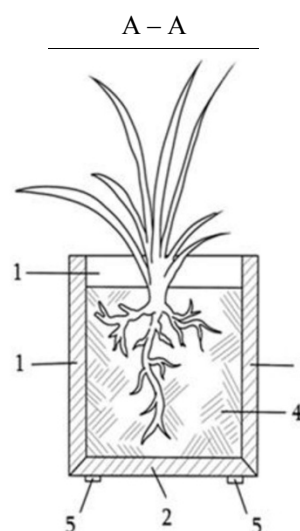

Fig. 3

PART B

B 21

- (11) P 2026 7883 B (51) Int. Cl. (2006)
B 21 C 5/00
- (10) AP 2026 16811 A (43) 2026 04 14 №7
(45) 2026 04 14 №7
(21) AP 2025 16811
(22) 2025 07 29
- (73) LEPL "Rafiel Dvali Institute of Machine
Mechanics" (GE)
Mindeli St. 10, Tbilisi, Georgia (GE)
- (72) Tamaz Natriashvili (GE);
Slava Mebonia (GE);
Revaz Kavtaradze (GE);
Giorgi Shaorshadze (GE);
Tamaz Morchadze (GE)

(54) PIPE END FORGING DEVICE

(57) A device includes a case 1, two-sided levers 3 with a hammer 4 on one end and a roller 5 on another end, and oscillation mechanism thereof executed as reciprocating-forward movable multi-face wedge slider 7 having an actuator 16, at that wedge slider has cylindrical outer axes 8 and 9 executed as wedges, by means whereof it is inserted axially moveable into the slots executed in device case 1 and the cover 10, and rocker arm 11 located in cylindrical hole is placed with eccentric shaft 12 located in rectangular hole next to the slider.

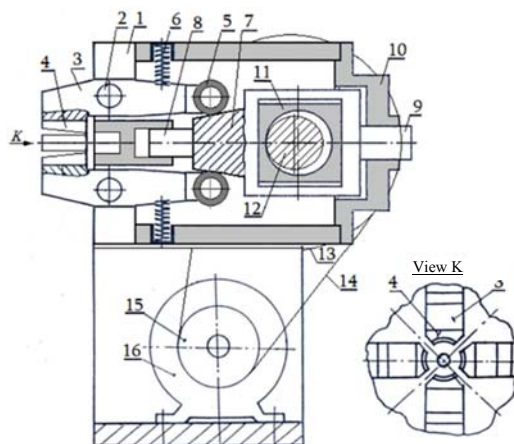

Fig. 1

PART F

F 27

- (11) P 2026 7878 B (51) Int. Cl. (2006)
F 27 B 3/08
H 05 B 7/148
- (10) AP 2026 16695 A (43) 2026 04 14 №7
- (45) 2026 04 14 №7
- (21) AP 2025 16695
- (22) 2025 02 28
- (73) Gocha Kurdadze (GE)
Kekelidze St. 5/16, 2000, Zestaponi,
Georgia (GE)
- (72) Gocha Kurdadze (GE)
- (54) METHOD FOR CONTROLLING ELECTRIC
MODE ON COAL-FIRED FURNACES AND
SYSTEM FOR FURNACE AUTOMATIC
MANAGEMENT

(57) A method for controlling mode provides measuring of electrical parameters, namely, phase active power, electrode active resistance, and electrode voltage from powered with three-phase transformer through voltage regulators the three electrodes mounted into charge by using a transmitter on each electrode of during melting process, determining position of electrodes, collecting the values of electrical

parameters, and automatically adjusting them. Before the process begins the furnace is equipped with radar-type sensors, programmable logic controller and energy meter, at that, measuring of electrical parameters and voltage on the electrodes is executed with the principle of continuous monitoring, furthermore, dynamical regulation of position of electrodes is provided automatically so that first electrode closest to the furnace outlet is less embedded in the charge and the most power is transmitted thereto, third electrode is the furthest away, and it is the one that is most deeply embedded in the charge, and second electrode in the middle is supplied with the lowest power than first and third electrodes, thus minimizing the asymmetry of short circuit and the distribution of power and thermal processes in the furnace is provided.

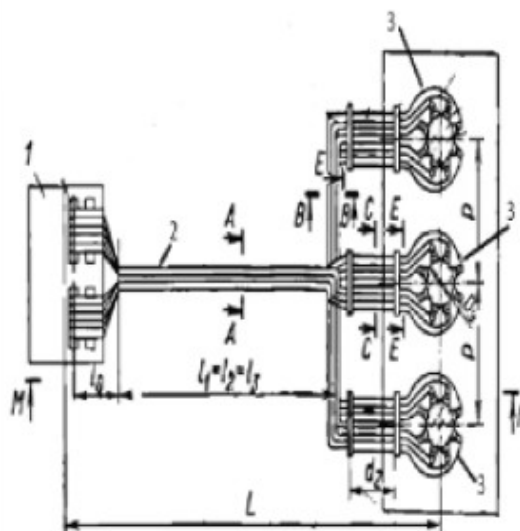

Fig. 1

PART G

G 06

- (11) P 2026 7882 B (51) Int. Cl. (2006)
G 06 F 18/24
G 06 F 21/55
G 06 F 21/60
G 06 F 21/62
H 04 L 9/32
H 04 L 9/40
- (10) AP 2026 16738 A (43) 2026 04 14 №7
- (45) 2026 04 14 №7
- (21) AP 2025 16738
- (22) 2025 02 25
- (31) 202510088049.5
- (32) 2025 01 21
- (33) CN
- (73) Zongtong fu Public Information Industry
Co., Ltd. (CN)

№191 Huang He Road, Urumqi, Xin Jiang
830000, People's Republic of China (CN)

- (72) QIU, Lin (CN);
ASIMU, Abuliz (CN);
JI Boqi (CN);
ZHANG, Jianxiong (CN);
WANG, Jun (CN);
WEI, Shengkun (CN);
FENG, Shan (CN);
LI, Wenjie (CN)

(74) Merab Kvimsadze

(85) 2025 04 15

(86) PCT/CN2025/079060, 2025 02 25

(54) DATA CLASSIFICATION HIERARCHY-
BASED DATA SECURITY SYSTEM

(57) According to present invention the data security system is provided.

Based on data sorting and classification, it belongs to the field of data security techniques and includes system security component, static data security component, dynamic data security component, data transmission security component, and data security governance component; The system security component is used for checking and filtering a network request and defending against an external network attack. The static data security component is used for the configuration of an entity and a field security policy, and performs security processing on the data. The dynamic data security component is used for performing security processing on the data according to the classification classification configured by the data security governance component and a corresponding security policy. The data transmission security component is used for performing security processing on the data according to a transmission policy configured by the data security governance component. The beneficial effects of the present invention are as follows: the security of data during storage and transmission is improved, the system flexibility is high, and the efficiency is high.

(85) 2024 07 23

(86) PCT/MY2022/050007, 2022 01 28

(73) HERMSEN, Franciscus Johannes (MY)
12-1 Suasana Bukit Ceylon, 2 Persiaran Raja
Chulan, Wilayah Persekutuan Kuala Lumpur,
50200, Malaysia (MY)

(72) HERMSEN, Franciscus Johannes (MY)

(74) Shalva Gvaramadze

(54) MAGNETIC TOROID AND A MAGNETICALLY ACTUATED ROTARY COUPLING DEVICE COMPRISING THEREOF

(57) Magnetic toroid core (100) is executed with Möbius-like toroid twisted by a degree, wherein the cross section of the Möbius-like toroid is a closed shape with at least four straight sides, wherein each side of the Möbius-like toroid is orthogonally magnetized to form the magnetic toroid (100), thereby creating a magnetic field having rotating polarity around the magnetic toroid (100) when the magnetic toroid (100) is spinning on its axis. The present invention also relates to a magnetically actuated rotary coupling device (200) comprising a first magnetic toroid (101) and a second magnetic toroid (102) being disposed adjacent to the first magnetic toroid (101), wherein the first magnetic toroid (101) is rotatable on its own axis relative to motion of the second magnetic toroid (102) when portions of their respective magnetic fields interact with each other.

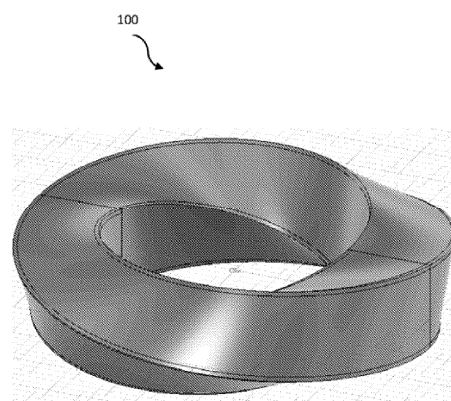

Fig. 1

PART H

H 01

- (11) P 2026 7877 B (51) Int. Cl. (2006)
H 01 F 17/06
H 01 F 7/14
H 02 K 7/09
- (10) AP 2024 16570 A (43) 2024 10 10 №19
(45) 2026 04 14 №7
(21) AP 2022 16570
(22) 2022 01 28
(31) PI2022000412
(32) 2022 01 20
(33) MY

VALIDATION OF EUROPEAN PATENTS

EUROPEAN PATENT APPLICATIONS FOR WHICH THE VALIDATION IS REQUESTED IN GEORGIA

(21) AE 2026 233
(82) 2026 04 10 (51) Int. Cl. (2006)
H 04 W 36/00
H 04 W 36/36
(30) IN 202341033649 05.12.2023
(86) EP2024060365, 2024 04 17
(71) Nokia Technologies Oy (FI)
Karakaari 7, 02610 Espoo, Finland (FI)
(72) RATOVELOMANANA, Frédéric (FR);
SELVAGANAPATHY, Srinivasan (IN);
PAPA, Arled (DE);
AWADA, Ahmad (DE);
KARABULUT, Umur (DE);
GÜRSU, Halit Murat (DE);
STANCZAK, Jędrzej (PL)
(54) USER EQUIPMENT CONFIGURED FOR CONDITIONAL HANDOVER WITH DUAL CONNECTIVITY
(210) 24720152.8
(220) 2024 04 17
(100) EP 4710620 A1
(430) 2026 03 18

(21) AE 2026 234
(82) 2026 04 10 (51) Int. Cl. (2006)
C 07 K 16/28
(30) US 202363465016 P 05.09.2023
(86) IB2024054490, 2024 05 08
(71) Janssen Biotech Inc. (US)
800/850 Ridgeview Drive, Horsham, PA 19044, USA (US)
(72) CHOUDHARI, Shyamal (US);
ZAKREWSKY, Michael (US)
(54) PHARMACEUTICAL COMPOSITIONS COMPRISING A BISPECIFIC BCMA/CD3 ANTIBODY
AT HIGH CONCENTRATION
(210) 24725962.5
(220) 2024 05 08
(100) EP 4709755 A1
(430) 2026 03 18

(21) AE 2026 235
(82) 2026 04 10 (51) Int. Cl. (2006)
A 61 K 39/00
A 61 P 35/00
C 07 K 16/28
(30) EP 23213531 11.30.2023; EP 23173143 05.12.2023
(86) EP2024062962, 2024 05 10
(71) Genmab A/S(DK)
Carl Jacobsens Vej 30, 2500 Valby, Denmark (DK);
BioNTech SE(DE)
An der Goldgrube 12, 55131 Mainz, Germany (DE)
(72) FELLERMEIER-KOPF, Sina (DE);

SAHIN, Ugur (DE);
 KÖHNE, Maren (DE);
 BREIJ, Esther, C, W, (NL);
 SATIJN, David (NL);
 GUELEN, Lars (NL);
 DE GOEJE, Pauline Linda (NL);
 VERZIJL, Dennis (NL);
 GORLANI, Andrea (NL);
 VAN DER KROEF, Maarten (NL);
 KEMPER, Kristel (NL)

(54) ANTIBODIES CAPABLE OF BINDING TO OX40, VARIANTS THEREOF AND USES THEREOF
 (210) 24726171.2
 (220) 2024 05 10
 (100) EP 4709411 A1
 (430) 2026 03 18

(21) AE 2026 236

(82) 2026 04 10 (51) Int. Cl. (2006)
 A 61 K 31/426
 A 61 K 31/573
 A 61 P 5/38

(30) US 202363464697 P 05.08.2023

(86) US2024028110, 2024 05 07

(71) NEUROCRINE BIOSCIENCES INC. (US)

6027 Edgewood Bend Court, San Diego, CA 92130, USA (US)

(72) FARBER, Robert H. (US);

CHAN, Jean L. (US)

(54) DOSAGE REGIME OF CRINECERFONT FOR TREATING CONGENITAL ADRENAL HYPERPLASIA
 IN A PEDIATRIC SUBJECT

(210) 24729617.1

(220) 2024 05 07

(100) EP 4709380 A1

(430) 2026 03 18

(21) AE 2026 237

(82) 2026 04 10 (51) Int. Cl. (2006)
 A 61 K 31/495
 A 61 K 31/513
 A 61 P 35/00
 C 07 D 405/12
 C 07 D 413/14
 C 07 D 403/12
 C 07 D 405/14
 C 07 D 239/22
 C 07 D 471/10
 C 07 D 401/12
 C 07 D 401/14

(30) US 202363530858 P 08.04.2023; US 202363465428 P 05.10.2023

(86) US2024028806, 2024 05 10

(71) Blueprint Medicines Corporation (US)

45 Sidney Street, Cambridge, MA 02139, USA (US)

(72) BURKE, Michael, J. (US);

BRUBAKER, Jason, D. (US);

WENGLOWSKY, Steven, Mark (US);

OZEN, Aysegul (US);

KIM, Joseph, L. (US);

GROSS, Stefan, David (US);

GROENDYKE, Brian, J. (US);
GE, Jie (US);
ENO, Meredith, Suzanne (US);
DINEEN, Thomas, A. (US)

(54) GSK3A INHIBITORS AND METHODS OF USE THEREOF

(210) 24736549.7
(220) 2024 05 10
(100) EP 4709712 A1
(430) 2026 03 18

(21) AE 2026 238

(82) 2026 04 10 (51) Int. Cl. (2006)
 C 07 C 1/12
 C 10 G 2/00
 C 25 B 1/04
 C 25 B 15/08

(30) US 202318445178 05.09.2023

(86) US2024000009, 2024 04 08

(71) Infinium Technology LLC (US)
2020 L Street, Suite 120, Sacramento, CA 95811-4260, USA (US)

(72) RODRIGUEZ, Ramer (US);
CALDWELL, Matthew (US);
HANBURY, Orion (US);
MCGINNIS, Glenn (US);
SCHUETZLE, Robert (US)

(54) ELECTRIFIED STEAM-METHANE-REFORMING REACTOR AND METHODS OF USE

(210) 24803852.3
(220) 2024 04 08
(100) EP 4709703 A1
(430) 2026 03 18

(21) AE 2026 239

(82) 2026 04 10 (51) Int. Cl. (2006)
 A 61 K 31/395
 A 61 K 31/166
 A 61 K 31/167
 A 61 K 31/47
 A 61 K 31/33

(30) US 202363469292 P 05.26.2023; US 202363502046 P 05.12.2023

(86) US2024028825, 2024 05 10

(71) Blossomhill Therapeutics Inc. (US)
10255 Science Center Drive, Suite 200, San Diego, CA 92121, USA (US)

(72) ROGERS, Evan W. (US);
RUI, Eugene Yuanjin (US);
CUI, Jingrong Jean (US)

(54) FUSED RING KRAS INHIBITORS FOR TREATING DISEASE

(210) 24807824.8
(220) 2024 05 10
(100) EP 4709376 A1
(430) 2026 03 18

(21) AE 2026 240
(82) 2026 04 10 (51) Int. Cl. (2006)
A 61 B 46/20
A 61 B 46/27
(30) US 202418439586 02.12.2024
(71) Medenvision (BE)
Boskant 16, 2260 Westerlo, Belgium (BE)
(72) GOYENS, Floris (BE);
CORTEN, Kristoff (BE);
FOULON, Wouter (BE);
VAN LIMBERGEN, Filip (BE);
DEBOECK, Pieter (BE)
(54) A SURGICAL DRAPE
(210) 25157521.3
(220) 2025 02 12
(100) EP 4599786 A1
(430) 2025 08 13

(21) AE 2026 241
(82) 2026 04 10 (51) Int. Cl. (2006)
C 25 D 7/06
C 25 D 15/00
F 28 F 13/18
F 28 F 21/02
(30) JP 2024160317 09.17.2024
(71) Hamada, Hareo (JP)
Rejions-Musashino P-III, 102 2-16, Sekimae 2-chome, Musashino-shi, Tokyo 180-0014, Japan (JP)
(72) Hamada, Hareo (JP)
(54) HEAT EXCHANGE MEMBER AND MANUFACTURING METHOD THEREOF
(210) 25202435.1
(220) 2025 09 16
(100) EP 4711507 A1
(430) 2026 03 18

(21) AE 2026 242
(82) 2026 04 10 (51) Int. Cl. (2006)
A 24 D 1/14
A 24 F 1/30
(30) US 202463678747 P 08.02.2024
(86) GB2025051016, 2025 05 12
(71) Shaheen Innovations Holding Limited (AE)
Unit 2, Level 7, Al Sila Tower Abu Dhabi Global Market Square Al Maryah Island, Abu Dhabi,
United Arab Emirates (AE)
(72) LOMAS, Peter (AE);
CHAUDHARY, Nveed (AE);
LAMOUREUX, Clement (AE);
DIVAKARAN, Dinil (AE);
ALSHAIBA SALEH GHANNAM ALMAZROUEI, Mohammed (AE)
(54) MIST INHALATION POD
(210) 25727203.9
(220) 2025 05 12
(100) EP 4709209 A1
(430) 2026 03 18

(21) AE 2026 243
 (82) 2026 04 10 (51) Int. Cl. (2006)
 A 24 D 1/14
 A 24 F 1/30
 A 24 F 40/05
 A 24 F 40/10
 A 24 F 40/485
 A 24 F 40/42
 (30) US 202463678747 P 08.02.2024
 (86) GB2025051017, 2025 05 12
 (71) Shaheen Innovations Holding Limited (AE)
 Unit 2, Level 7, Al Sila Tower Abu Dhabi Global Market Square Al Maryah Island, Abu Dhabi,
 United Arab Emirates (AE)
 (72) LOMAS, Peter (AE);
 CHAUDHARY, Nveed (AE);
 LAMOUREUX, Clement (AE);
 DIVAKARAN, Dinil (AE);
 ALSHAIBA SALEH GHANNAM AL-MAZROUEL, Mohammed (AE)
 (54) MIST INHALATION DEVICE
 (210) 25727204.7
 (220) 2025 05 12
 (100) EP 4709210 A1
 (430) 2026 03 18

(21) AE 2026 244
 (82) 2026 04 10 (51) Int. Cl. (2006)
 G 06 F 15/16
 G 06 Q 30/0601
 G 06 Q 30/0201
 (30) US 202318233781 08.14.2023
 (86) US2024042305, 2024 08 14
 (71) Sunhub LLC (US)
 1925 St. Clair Ave NE, no. 206, Cleveland, Ohio 44114, USA (US)
 (72) KAZMI, Azam (US);
 BIHUNIAK, Mitch (US);
 BEG, Kadeer (US)
 (54) MEDIATED ANONYMOUS NEGOTIATION SYSTEM
 (210) 24854872.9
 (220) 2024 08 14
 (100) EP 4710211 A2
 (430) 2026 03 18

(21) AE 2026 245
 (82) 2026 04 10 (51) Int. Cl. (2006)
 A 61 P 35/00
 C 07 K 1/18
 C 07 K 16/28
 (30) EP 23173500 05.15.2023
 (86) EP2024063361, 2024 05 15
 (71) Genmab A/S (DK)
 Carl Jacobsens Vej 30, 2500 Valby, Denmark (DK)
 (72) O'DONNELL, Rohan (DK);
 JENSEN, Søren S. (DK);
 BJERREGAARD, Bolette (DK);
 VAN KAMPEN, Muriel (NL);
 SANGERS, Sipke (NL);

OLIVEIRA DA COSTA, César F. (NL);
HIBBERT, Richard G. (NL)
(54) HIGHLY PURIFIED EPCORITAMAB COMPOSITIONS
(210) 24727240.4
(220) 2024 05 15
(100) EP 4713338 A1
(430) 2026 03 25

(21) AE 2026 246
(82) 2026 04 10 (51) Int. Cl. (2006)
A 61 K 39/395
A 61 K 39/00
A 61 P 35/02
C 07 K 16/28
(30) US 202463569470 P 03.25.2024; US 202363467370 P 05.18.2023; US 202363466596 P 05.15.2023
(86) EP2024063374, 2024 05 15
(71) Genmab A/S (DK)
Carl Jacobsens Vej 30, 2500 Valby, Denmark (DK)
(72) SACCHI, Mariana (US);
KILAVUZ, Nurgul (US)
(54) METHODS OF TREATING CD20 EXPRESSING B-CELL CANCERS
(210) 24727242.0
(220) 2024 05 15
(100) EP 4713011 A1
(430) 2026 03 25

(21) AE 2026 247
(82) 2026 04 10 (51) Int. Cl. (2006)
A 61 K 47/68
A 61 P 35/00
C 07 K 16/28
(30) EP 23315207 05.19.2023
(86) EP2024063676, 2024 05 17
(71) Les Laboratoires Servier (FR)
35, rue de Verdun, 92284 Suresnes Cedex, France (FR)
(72) GRANDAL, Michael Monrad (DK);
BRESSON, Laura (FR);
LE TOUMELIN-BRAIZAT, Gaëtane (FR);
HAUMONT, Sandra (FR);
PLANTIER, Sabine (FR);
KOSTOVA, Vesela (FR);
MARAGNO, Ana Leticia (FR)
(54) ANTI-MET ANTIBODIES, ANTIBODY-DRUG CONJUGATES, COMPOSITIONS AND USES THEREOF
(210) 24728922.6
(220) 2024 05 17
(100) EP 4713360 A1
(430) 2026 03 25

(21) AE 2026 248
(82) 2026 04 10 (51) Int. Cl. (2006)
A 61 K 31/444
A 61 K 31/519
A 61 K 31/506
A 61 K 31/437
A 61 K 31/427
A 61 P 35/00
C 07 D 471/04

C 07 D 487/04
 C 07 D 401/14
 (30) WO PCT/CN2023/095070 05.18.2023
 (86) IB2024054769, 2024 05 16
 (71) Insilico Medicine IP Limited (HK)
 26th Floor, Three Exchange Square 8 Connaught Place, Central, Hong Kong 999077, Hong Kong (HK)
 (72) QIN, Luoheng (CN);
 LIU, Jinxin (CN);
 WU, Jianping (CN)
 (54) SMALL MOLECULE INHIBITORS OF UBIQUITIN SPECIFIC PROTEASE 1 (USP1) AND USES THEREOF
 (210) 24729395.4
 (220) 2024 05 16
 (100) EP 4713319 A1
 (430) 2026 03 25

(21) AE 2026 249
 (82) 2026 04 10 (51) Int. Cl. (2006)
 A 61 K 39/395
 A 61 P 11/00
 A 61 P 37/02
 C 07 K 16/28
 (30) US 202363467169 P 05.17.2023
 (86) US2024029683, 2024 05 16
 (71) Syndax Pharmaceuticals Inc. (US)
 35 Gatehouse Drive Building D, Floor 3, Waltham, Massachusetts 02451, USA (US)
 (72) RADOJCIC, Vedran (US);
 ORDENTLICH, Peter (US)
 (54) METHODS OF TREATING CHRONIC GRAFT-VERSUS-HOST DISEASE-RELATED BRONCHIOLITIS OBLITERANS SYNDROME USING AN ANTI-COLONY STIMULATING FACTOR 1 RECEPTOR ANTIBODY
 (210) 24731792.8
 (220) 2024 05 16
 (100) EP 4713012 A1
 (430) 2026 03 25

(21) AE 2026 250
 (82) 2026 04 10 (51) Int. Cl. (2006)
 A 61 K 31/5025
 A 61 P 7/00
 A 61 P 7/06
 C 07 D 513/14
 (30) US 202363466552 P 05.15.2023
 (86) US2024029471, 2024 05 15
 (71) Agios Pharmaceuticals Inc. (US)
 88 Sidney Street, Cambridge, MA 02139, USA (US)
 (72) GRENIER, Louis (CA);
 ANGELILLO, Karlie E. (US);
 SIZEMORE, Jacob P. (US);
 SIMONE, Eric (US);
 LI, Hui (US);
 LEUNG, Cheuk-Yui (US);
 LEE, Jaemoon (US);
 LANE, Benjamin S. (US);
 FANDRICK, Daniel R. (US)

(54) CRYSTALLINE SALTS OR AMORPHOUS FORMS OF 2-((1H-PYRAZOL-3-YL)METHYL)-6-
 ((6-AMINOPYRIDIN-2-YL)METHYL)-4-METHYL-4,6-DIHYDRO -5H-THIAZOLO[5',4':4,5]
 PYRROLO [2,3-D]PYRIDAZIN-5-ONE
 (210) 24732122.7
 (220) 2024 05 15
 (100) EP 4713090 A1
 (430) 2026 03 25

(21) AE 2026 251

(82) 2026 04 10

(51) Int. Cl. (2006)
 A 61 K 31/4985
 A 61 P 3/00
 A 61 P 3/04
 A 61 P 3/10
 A 61 P 5/00
 A 61 P 5/38
 A 61 P 9/00
 A 61 P 9/10
 A 61 P 9/12
 A 61 P 15/00
 A 61 P 19/10
 A 61 P 25/00
 A 61 P 25/24
 A 61 P 27/02
 A 61 P 27/06
 A 61 P 27/12
 A 61 P 31/00
 A 61 P 43/00
 C 07 D 487/04

(30) JP 2023080580 05.16.2023

(86) JP2024017921, 2024 05 15

(71) Scohia Pharma Inc. (JP)

26-1 Muraoka-Higashi 2-chome, Fujisawa-shi, Kanagawa 251-8555, Japan (JP)

(72) HIROSE, Hideki (JP);

MAEKAWA, Tsuyoshi (JP);

KASAI, Shizuo (JP);

OGINO, Masaki (JP);

WATANABE, Koji (JP);

ASANO, Kohei (JP);

HARA, Ryoma (JP);

FUKUSHI, Hideto (JP);

IKOMA, Minoru (JP);

SASAKI, Satoshi (JP);

NOGUCHI, Naoyoshi (JP);

MATSUMOTO, Shigemitsu (JP)

(54) MELANOCORTIN 2-TYPE RECEPTOR ANTAGONIST

(210) 24807217.5

(220) 2024 05 15

(100) EP 4714953 A1

(430) 2026 03 25

(21) AE 2026 252

(82) 2026 04 10

(51) Int. Cl. (2006)
 A 24 F 40/05
 A 24 F 40/10
 A 24 F 40/44
 A 24 F 40/485
 A 61 M 11/00

A 61 M 15/00
A 61 M 15/06

(30) US 202463679371 P 08.05.2024
 (86) GB2025051435, 2025 06 30
 (71) Shaheen Innovations Holding Limited (AE)
 Unit 2, Level 7, Al Sila Tower Abu Dhabi Global Market Square Al Maryah Island, Abu Dhabi,
 United Arab Emirates (AE)
 (72) CHAUDHARY, Nveed (AE);
 LOMAS, Peter (AE);
 LAMOUREUX, Clement (AE);
 DIVAKARAN, Dinil (AE);
 ALSHAIBA SALEH GHANNAM ALMAZROUEI, Mohammed (AE)
 (54) MIST INHALATION POD
 (210) 25737776.2
 (220) 2025 06 30
 (100) EP 4712802 A1
 (430) 2026 03 25

(21) AE 2026 253
 (82) 2026 04 10 (51) Int. Cl. (2006)
 A 24 F 40/05
 A 24 F 40/10
 A 24 F 40/44

(30) US 202463679375 P 08.05.2024
 (86) GB2025051436, 2025 06 30
 (71) Shaheen Innovations Holding Limited (AE)
 Unit 2, Level 7, Al Sila Tower Abu Dhabi Global Market Square Al Maryah Island, Abu Dhabi,
 United Arab Emirates (AE)
 (72) CHAUDHARY, Nveed (AE);
 LOMAS, Peter (AE);
 LAMOUREUX, Clement (AE);
 DIVAKARAN, Dinil (AE);
 ALSHAIBA SALEH GHANNAM ALMAZROUEI, Mohammed (AE)
 (54) MIST INHALATION POD FOR DELIVERING A THERAPEUTIC
 (210) 25737777.0
 (220) 2025 06 30
 (100) EP 4712803 A1
 (430) 2026 03 25

(21) AE 2026 254
 (82) 2026 04 10 (51) Int. Cl. (2006)
 A 61 K 39/395
 C 07 K 16/28

(30) EP 23174324 05.19.2023
 (86) EP2024063788, 2024 05 17
 (71) Numab Therapeutics AG (CH)
 Bachtobelstrasse 5, 8810 Horgen, Switzerland (CH)
 (72) JOHANSSON, Maria (CH);
 WARMUTH, Stefan (CH)
 (54) ANTIBODY VARIABLE DOMAINS AND ANTIBODIES HAVING DECREASED IMMUNOGENICITY
 (210) 24725527.6
 (220) 2024 05 17
 (100) EP 4713010 A2
 (430) 2026 03 25

(21) AE 2026 255

(82) 2026 04 10

(51) Int. Cl. (2006)

A 01 B 5/00
 A 01 K 67/0275
 A 61 K 31/536
 A 61 K 31/4545
 A 61 K 31/517
 A 61 K 31/553
 A 61 K 31/4196
 A 61 K 31/44
 A 61 K 31/422
 A 61 K 31/437
 A 61 K 31/444
 A 61 K 31/506
 A 61 P 3/00
 C 07 D 413/14
 C 07 D 471/04
 C 07 D 401/14
 C 07 D 413/04
 C 07 D 403/04

(30) US 202363467125 P 05.17.2023

(86) US2024029738, 2024 05 16

(71) Agios Pharmaceuticals Inc. (US)

88 Sidney Street, Cambridge, MA 02139, USA (US)

(72) NAKHLA, Mina, C. (CA);

MCVAY, Michael (US);

LIU, Peng (US);

FINLAY, Heather, J. (US);

CHAN, Barden (US)

(54) BCAT2 INHIBITORS

(210) 24731222.6

(220) 2024 05 16

(100) EP 4713320 A2

(430) 2026 03 25

(21) AE 2026 256

(82) 2026 04 10

(51) Int. Cl. (2006)

A 61 K 38/22
 A 61 P 43/00
 C 07 K 14/47
 C 07 K 14/64
 C 07 K 16/40
 C 12 N 15/62
 C 12 N 15/63

(30) US 202463617398 P 01.03.2024; US 202363611732 P 12.18.2023; US 202363586868 P 09.29.2023;
 US 202363585849 P 09.27.2023; US 202363503101 P 05.18.2023

(86) US2024030016, 2024 05 17

(71) Tectonic Operating Company Inc. (US)

490 Arsenal Way, Suite 200, Watertown, MA 02472, USA (US)

(72) GRUSWITZ, Franz (US);

MUSLIN, Anthony J. (US);

ALVES, Washington (US);

KNIHTILA, Ryan (US);

DIENER, John (US)

(54) RELAXIN-2 FUSION PROTEIN ANALOGS AND METHODS OF USING SAME

(210) 24808204.2

(220) 2024 05 17

(100) EP 4713001 A2

(430) 2026 03 25

(100) EP 4716527 A1
 (430) 2026 04 01

(21) AE 2026 260
 (82) 2026 04 10 (51) Int. Cl. (2006)
 A 61 K 47/68
 C 07 K 16/18
 (30) US 202463555506 P 02.20.2024; US 202363503929 P 05.23.2023
 (86) US2024030863, 2024 05 23

(71) AbbVie Manufacturing Management Unlimited Company (IE)
 70 Sir John Rogerson's Quay, Dublin, D02 R296, Ireland (IE)

(72) ENGELHARDT, Benjamin (DE);
 BIESDORF DE ALMEIDA, Carla (US);
 ARISTIDE, Martha, Neagu (US);
 FREISE, Kevin (US);
 LI, Rui (US);
 MORRISON-THIELE, Gladys, Dufuah (US);
 PARIKH, Apurvasena, Shailesh (US);
 GUAN, Xiaowen (US)

(54) METHODS OF TREATMENT USING ANTI-C-MET ANTIBODY DRUG CONJUGATES

(210) 24733462.6
 (220) 2024 05 23
 (100) EP 4716553 A1
 (430) 2026 04 01

(21) AE 2026 261
 (82) 2026 04 10 (51) Int. Cl. (2006)
 A 61 K 31/506
 A 61 P 35/00
 C 07 K 16/32
 C 07 K 16/28

(30) US 202363540742 P 09.27.2023; US 202363468375 P 05.23.2023

(86) IB2024055039, 2024 05 23

(71) Janssen Biotech Inc. (US)
 800/850 Ridgeview Drive, Horsham, PA 19044, USA (US)

(72) KNOBLAUCH, Roland (US)

(54) METHODS FOR TREATMENT OF NON-SMALL CELL LUNG CANCER (NSCLC)

(210) 24733722.3
 (220) 2024 05 23
 (100) EP 4716538 A1
 (430) 2026 04 01

(21) AE 2026 262
 (82) 2026 04 10 (51) Int. Cl. (2006)
 A 61 K 9/51

(30) US 202363503771 P 05.23.2023

(86) US2024030775, 2024 05 23

(71) Cour Pharmaceuticals Development Company Inc. (US)
 8045 Lamon Avenue, 1202, Skokie, IL 60077, USA (US)

(72) BOYNE, Michael (US);
 MURTHY, Tushar (US);
 ELHOFY, Adam (US)

(54) PREPARATION OF TOLERIZING NANOPARTICLES FOR THE TREATMENT OF PRIMARY BILIARY CHOLANGITIS

(210) 24734630.7
 (220) 2024 05 23

(100) EP 4716528 A1
(430) 2026 04 01

(21) AE 2026 263
(82) 2026 04 10 (51) Int. Cl. (2006)
H 01 G 11/28
H 01 M 4/04
H 01 M 4/139

(30) IN 202321035308 05.20.2023
(86) IN2024050586, 2024 05 20
(71) Tekriwal, Krishnakant (IN)
30 Byramjittown, Nagpur 440013, India (IN)
(72) Tekriwal, Krishnakant (IN)
(54) TITLE OF THE INVENTION: A PLASMA PRINTING PROCESS TO MANUFACTURE AND PRODUCE
BATTERY ELECTRODES AND ENHANCE CUNENT COLLECTORS
(210) 24810619.7
(220) 2024 05 20
(100) EP 4716964 A1
(430) 2026 04 01

(21) AE 2026 264
(82) 2026 04 10 (51) Int. Cl. (2006)
A 61 K 31/138
A 61 K 31/353
A 61 K 31/404
A 61 K 31/4184
A 61 K 45/06
A 61 P 9/04
A 61 P 9/10
A 61 P 9/12

(30) IT 202400011176 05.16.2024
(71) Alba Research S.r.l. (IT)
Via M. Tondi, 89, 71016 San Severo (FG), Italy (IT)
(72) RICCIONI, Graziano (IT)
(54) COMPOSITIONS FOR TREATING ARTERIAL HYPERTENSION
(210) 25176840.4
(220) 2025 05 15
(100) EP 4649946 A1
(430) 2025 11 19

(21) AE 2026 265
(82) 2026 04 10 (51) Int. Cl. (2006)
B 60 B 33/00
B 60 B 33/06

(30) DE 202024103215 U 06.14.2024
(71) von der Mühlen, Roland (DE)
Behlinger Weg 17, 58256 Ennepetal, Germany (DE)
(72) von der Mühlen, Roland (DE)
(54) CASTOR
(210) 25179776.7
(220) 2025 05 30
(100) EP 4663428 A1
(430) 2025 12 17

(21) AE 2026 266
 (82) 2026 04 10 (51) Int. Cl. (2006)
 A 61 K 39/395
 A 61 P 35/00
 A 61 P 35/04
 C 07 K 16/28
 (30) US 202463691612 P 09.06.2024; US 202463621334 P 01.16.2024
 (86) IB2025050476, 2025 01 16
 (71) Janssen Biotech Inc. (US)
 800/850 Ridgeview Drive, Horsham, PA 19044, USA (US)
 (72) BAIG, Mahadi (US);
 PATEL, Kiran (US);
 KNOBLAUCH, Roland (US)
 (54) USE OF AMIVANTAMAB TO TREAT COLORECTAL CANCER
 (210) 25703221.9
 (220) 2025 01 16
 (100) EP 4716701 A1
 (430) 2026 04 01

(21) AE 2026 267
 (82) 2026 04 10 (51) Int. Cl. (2006)
 A 61 K 39/395
 A 61 K 39/00
 A 61 P 35/00
 C 07 K 16/28
 (30) US 202463720828 P 11.15.2024; US 202463623555 P 01.22.2024
 (86) IB2025050613, 2025 01 21
 (71) Janssen Biotech Inc. (US)
 800/850 Ridgeview Drive, Horsham, PA 19044, USA (US)
 (72) BAIG, Mahadi (US);
 KNOBLAUCH, Roland (US);
 BAUML, Joshua (US)
 (54) USE OF AMIVANTAMAB TO TREAT HEAD AND NECK CANCER
 (210) 25703666.5
 (220) 2025 01 21
 (100) EP 4716552 A1
 (430) 2026 04 01

(21) AE 2026 268
 (82) 2026 04 10 (51) Int. Cl. (2006)
 H 01 F 27/14
 (30) US 202418789031 07.30.2024; US 202463555652 P 02.20.2024
 (86) US2025016268, 2025 02 18
 (71) Philippe Magnier LLC (US)
 6024 Feagan Street, Houston, Texas 77007, USA (US)
 (72) MAGNIER, Philippe (US)
 (54) TECHNOLOGIES FOR PREVENTING THE EXPLOSION OF ELECTRICAL TRANSFORMERS
 (210) 25709908.5
 (220) 2025 02 18
 (100) EP 4716954 A1
 (430) 2026 04 01

(21) AE 2026 269
(82) 2026 04 10 (51) Int. Cl. (2006)
B 03 B 9/06
H 10 F 71/00
H 10 F 19/80

(30) IT 202400013945 06.18.2024
(86) IB2025056206, 2025 06 18
(71) EurekaHub S.r.l. (IT)
Via Luigia Stramesi, 1, 15045 Sale (AL), Italy (IT)
(72) MANFRON, Riccardo (IT)
(54) METHOD AND SYSTEM FOR THE TREATMENT OF PHOTOVOLTAIC PANELS
(210) 25740152.1
(220) 2025 06 18
(100) EP 4716596 A1
(430) 2026 04 01

(21) AE 2026 270
(82) 2026 04 10 (51) Int. Cl. (2006)
A 61 L 2/10
A 61 L 2/24
C 02 F 1/00
(30) US 202463701257 P 09.30.2024; US 202463701244 P 09.30.2024; US 202463679544 P 08.05.2024;
US 202463679538 P 08.05.2024
(86) GB2025051652, 2025 07 24
(71) Shaheen Innovations Holding Limited (AE)
Unit 2, Level 7, Al Sila Tower Abu Dhabi Global Market Square Al Maryah Island, Abu Dhabi,
United Arab Emirates (AE)
(72) ALSHAIBA SALEH GHANNAM ALMAZROUEI, Mohammed (AE)
(54) PORTABLE UV STERILISING DEVICE
(210) 25749939.2
(220) 2025 07 24
(100) EP 4716557 A1
(430) 2026 04 01

(21) AE 2026 271
(82) 2026 04 10 (51) Int. Cl. (2006)
A 61 L 2/10
A 61 L 2/24
C 02 F 1/00
(30) US 202463701257 P 09.30.2024; US 202463701244 P 09.30.2024; US 202463679544 P 08.05.2024;
US 202463679538 P 08.05.2024
(86) GB2025051653, 2025 07 24
(71) Shaheen Innovations Holding Limited (AE)
Unit 2, Level 7, Al Sila Tower Abu Dhabi Global Market Square Al Maryah Island, Abu Dhabi,
United Arab Emirates (AE)
(72) ALSHAIBA SALEH GHANNAM ALMAZROUEI, Mohammed (AE)
(54) PORTABLE UV STERILISING DEVICE WITH MACHINE LEARNING MODEL
(210) 25749940.0
(220) 2025 07 24
(100) EP 4716558 A1
(430) 2026 04 01

VALIDATED EUROPEAN PATENT

(11) E 2026 3 T2
(51) Int. Cl. (2006)
E 04 B 2/74
E 04 B 2/82

(21) AE 2025 21
(30) AT 505442023 07.07.2023
(45) 2026 04 14 №7
(82) 2025 07 10
(100) EP 4488465 A1
(110) EP 4488465 B1
(210) 24185653.3
(220) 2024 07 01
(430) 2025 01 08
(450) 2025 12 10
(71) Rhtb: Smart Living Systems Gmbh (AT)
Energishtrase 2, 2540, Bad Fioslau, Austria (AT)
(72) Rainer Haubenwaller (AT)
(73) Rhtb: Smart Living Systems Gmbh
(74) Nikolozzi Gogilidze
(54) PANEL FOR DRY INTERIOR EQUIPMENT

DESIGNS

APPLICATIONS APPROVED FOR REGISTRATION

The decision can be appealed at the Chamber of Appeal of Sakpatenti within 3 months from the publication or at the Mtskheta District Court Administrative Cases Board (Address: №17, Samkhedro str., Mtskheta), within 1 month following the publication.

- (10) AD 2026 1454 S (51) 03-01
(21) AD 2025 1454 (22) 2025 06 23
(28) 1
(71) Maia Tavadze (GE)
Amaghleba St. 9, fl. 2, ap. 6, 0105, Tbilisi, Georgia (GE)
(72) Maia Tavadze (GE)
(54) BAG
(55)



1.1

(10) AD 2026 1455 S (51) 03-01
(21) AD 2025 1455 (22) 2025 06 24
(28) 1
(71) Maia Tavadze (GE)
Amaghleba St. 9, fl. 2, ap. 6, 0105, Tbilisi, Georgia (GE)
(72) Maia Tavadze (GE)
(54) HANDBAG
(55)



1.1



1.2

DESIGNS REGISTERED ACCORDING TO THE ACCELERATED PROCEDURE

The decision can be appealed at the Chamber of Appeal of Sakpatenti within 3 months from the publication.

- (11) D 2026 1112 S (51) 02-02
 (21) AD 2026 1503
 (22) 2026 02 20
 (24) 2026 02 20
 (28) 1
 (18) 2031 02 20
 (73) Valeriani Jincharadze (GE)
 Nikoloz Agiashvili St., I Lane 15, 0180, Tbilisi, Georgia (GE)
 (72) Valeriani Jincharadze (GE)
 (54) GRAPHICAL COMPOSITION FOR CLOTHING
 (55)

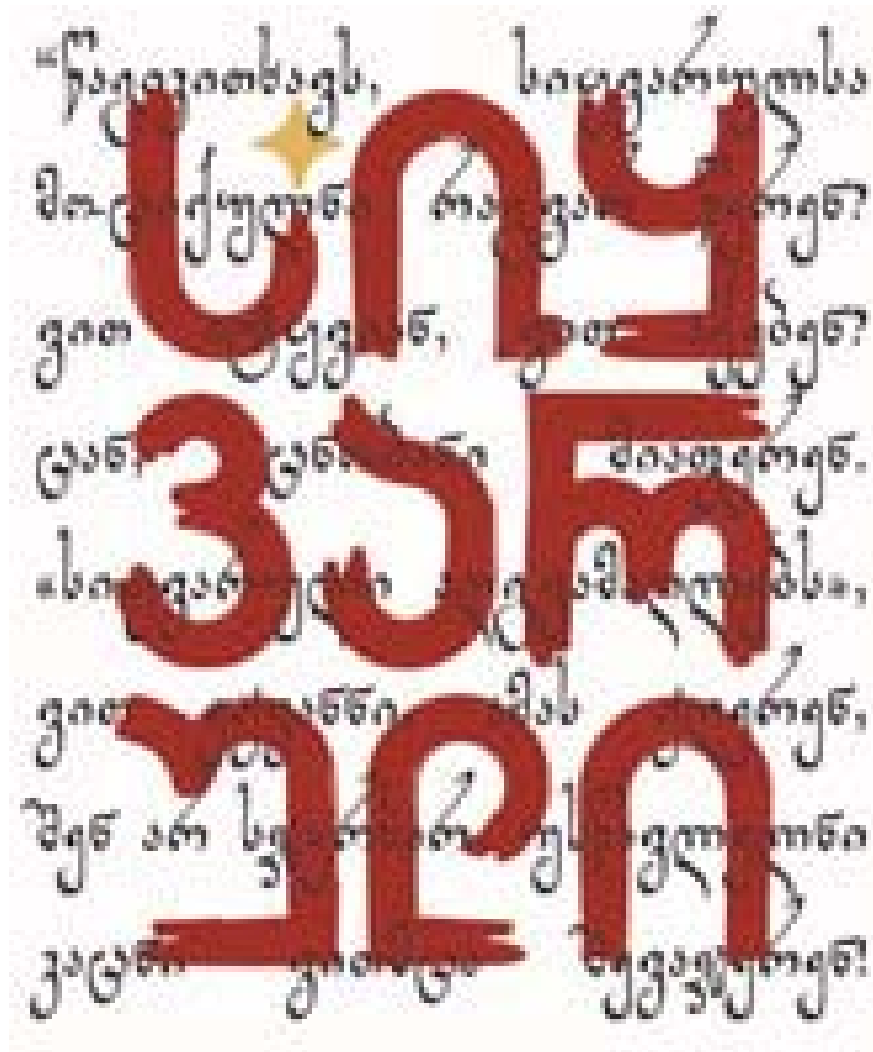



1.2

DESIGNS, WHICH HAVE BEEN REGISTERED WITH THE INTERNATIONAL BUREAU CLAIMING PRIORITY ON THE TERRITORY OF GEORGIA

The decision can be appealed at the Chamber of Appeal of Sakpatenti within 3 months from the publication or at the Mtskheta District Court Administrative Cases Board (Address: №17, Samkhedro St., Mtskheta), within 1 month following the publication.

- (11) DM/243 645
- (15) 2025 01 03
- (22) 2025 01 03
- (28) 2
- (30) №1: 16.07.2024; 015066620-0002; EM; №2: 16.07.2024; 015066673-0001; EM
- (73) Versuni Holding B.V.
Claude Debussylaan 88, NL-1082MD Amsterdam (EM)
- (85) EM
- (86) EM
- (87) EM
- (88) EM
- (89) EM
- (81) III. AL, AZ, BA, CH, GE, KR, MD, ME, NO, RS, TR
- (72) Lu Yan
Room 502, №59 Kangcheng Road, Lane 958, Xinsong Road, Minhang District, Shanghai (CN);
Jingy Sun
№308, No.11, Xinyi District, Lane 170, Xincun Road, Ganquan Road Street, Putuo District, Shanghai (CN);
QIURONG MA
№402, Shengshi Nianhua 2, Lane 100 Yushan Road, Pudong New Area, Shanghai (CN);
Chunjing Lai
№16 Street Nine, Jiazhou Garden, Huaqiaocheng Road, Huidong, Guangdong (CN)
- (74) Brandstock Legal GmbH
Möhlstraße 2, 81675 Munich (DE)
- (54) 1. AIR HUMIDIFIER, 2. AIR HUMIDIFIER
- (55)

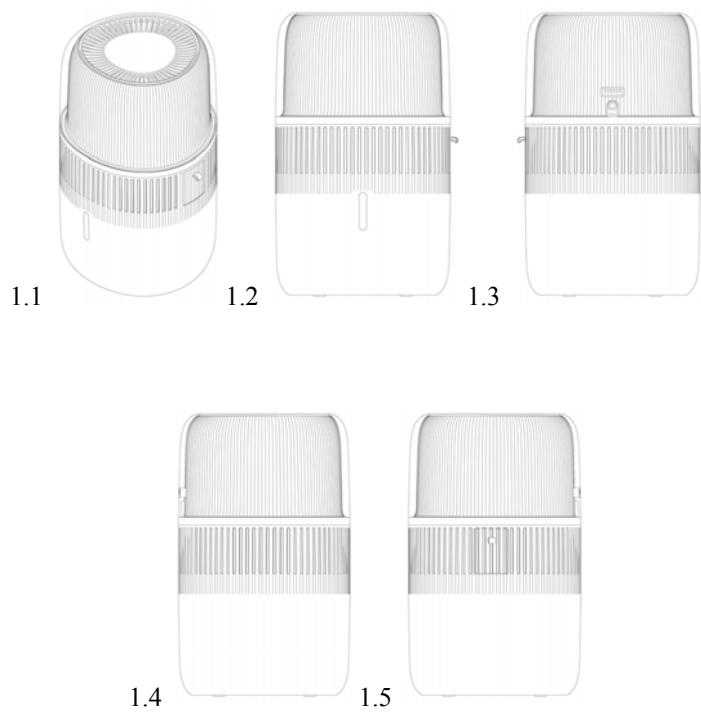

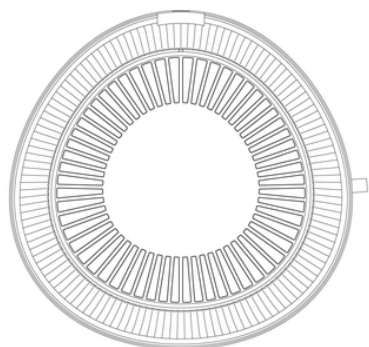

1.6

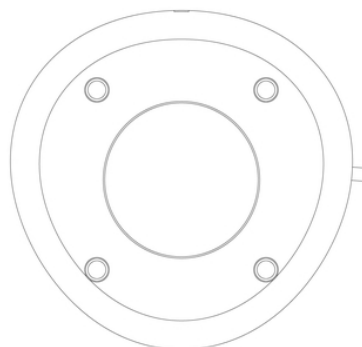

1.7



2.1

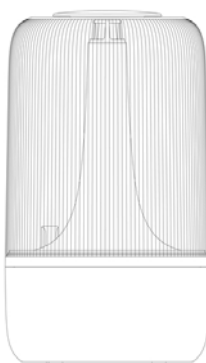

2.2

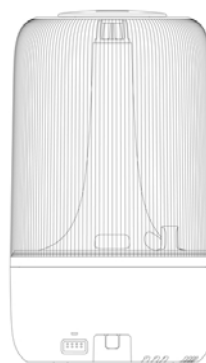

2.3

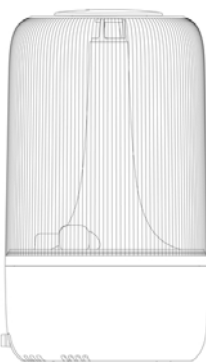

2.4

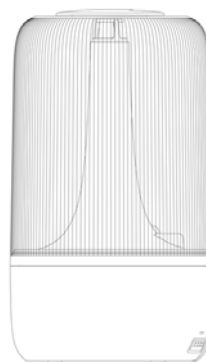

2.5

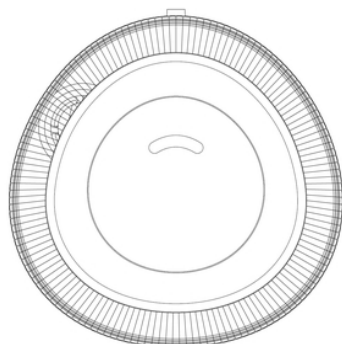

2.6

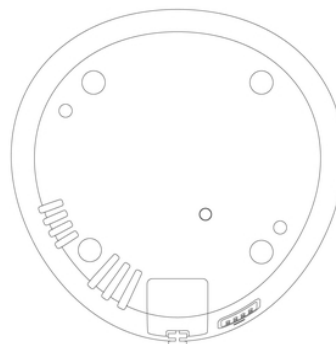

2.7

- (11) DM/248 353
- (15) 2025 07 11
- (22) 2025 07 11
- (28) 4
- (73) HARRY WINSTON SA
Chemin Du Tourbillon 8, 1228 Plan-les-Ouates (CH)
- (85) CH
- (86) CH
- (87) CH
- (88) CH
- (89) CH
- (81) III. AL, AM, AZ, BA, BZ, CA, CH, EM, GB, GE, IL, KG, KH, KR, LI, MA, MC, MD, ME, MK, MN, NO, OM, SG, TN, TR, UA
- (72) 1 Wei WANG
C/o Harry Winston Inc. 718 Fifth Avenue, 10019, New York (US);
2 Tobias WUEST
C/o Harry Winston Inc. 718 Fifth Avenue, 10019, New York (US);
3 Delphine ABDOURAHIM
C/o Harry Winston Inc. 718 Fifth Avenue, 10019, New York (US);
4 Rie YATSUGI-KANG
C/o Harry Winston Inc. 718 Fifth Avenue, 10019, New York (US)
- (74) The Swatch Group AG (The Swatch Group SA) (The Swatch Group Ltd.)
Faubourg Du Lac 6, 2501 Biel/Bienne (CH)
- (46) 2026 01 16
- (54) 1. FINGER RING, 2. PAIR OF EARRINGS, 3. NECKLACE, 4. NECKLACE
- (55)



1.1



1.2



1.3



1.4



1.5



1.6



1.7



1.8



2.1



2.2







- (11) DM/253 160 (51) 09-01
(15) 2025 12 12 (44) 03/2026 (2026 01 16)
(22) 2025 12 12
(28) 1
(73) AROKS
3 Rue Anatole France, 57360 AMNEVILLE (FR)
(85) –
(86) FR
(87) FR
(88) –
(89) FR
(81) III. AL, AM, AZ, BA, BG, BN, BR, BW, BX, BY, BZ, CA, CH, CN, DE, DK, EE, EG, EM, ES, FI, FR, GB, GE, GH, GR, HR, HU, IL, IS, IT, JM, JP, KG, KH, KN, KP, KR, LI, LT, LV, MA, MC, MD, ME, MK, MN, MU, MX, NA, NO, OA, OM, PL, RO, RS, RU, RW, SA, SG, SI, SM, SR, ST, SY, TJ, TM, TN, TR, UA, US, UZ, VN, WS
(72) Erick SKORA
3 Rue Anatole France , 57360, AMNEVILLE (FR)
(74) Aude Malherbe
50 Avenue De Maignon, 64600 ANGLET (FR)
(54) 1. BOTTLE FOR BEVERAGES
(55)



(11) DM/253 205

(15) 2025 12 29

(22) 2025 12 29

(28) 3

(73) CHANEL SARL

Quai Du Général-Guisan 24, 1204 Genève (CH)

(85) CH

(86) CH

(87) CH

(88) CH

(89) CH

(81) III. AZ, BG, DK, EE, EG, GE, GR, JP, LT, LV, MA, MD, NO, OM, PL, RU, SA, TN, TR, UA

(54) 1. NECKLACE [JEWELLERY], 2. FINGER RING, 3. FINGER RING

(55)

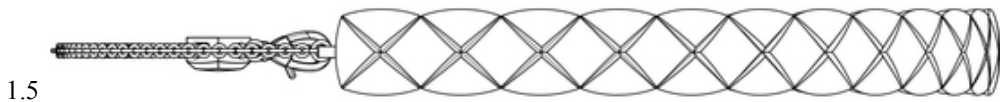
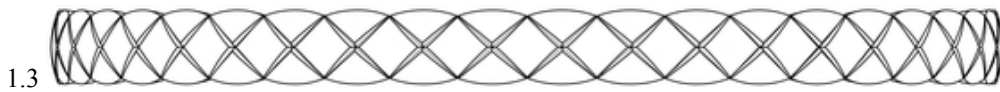

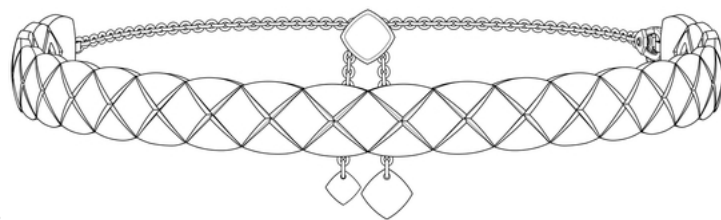

1.8

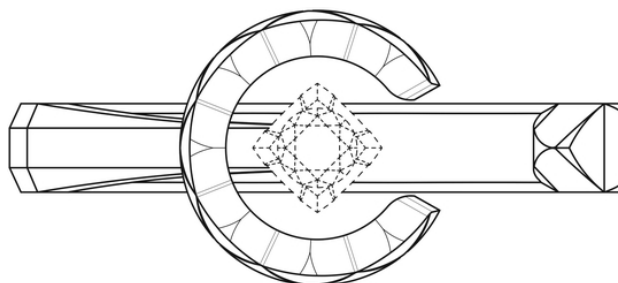

2.1

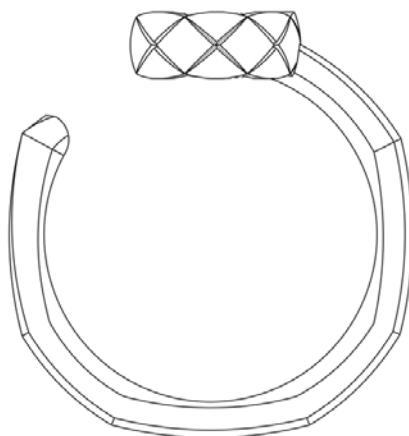

2.2

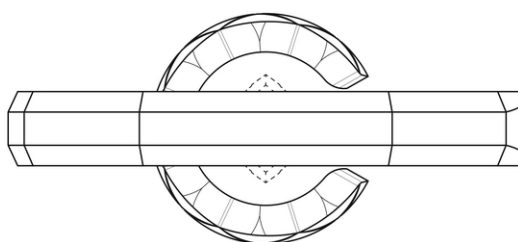

2.3

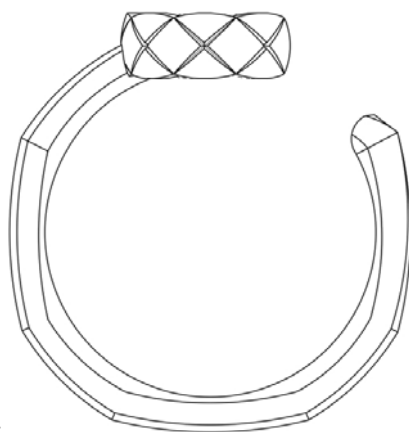

2.4

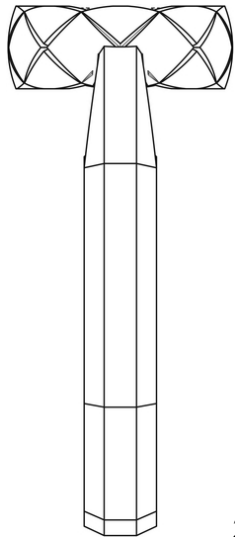

2.5

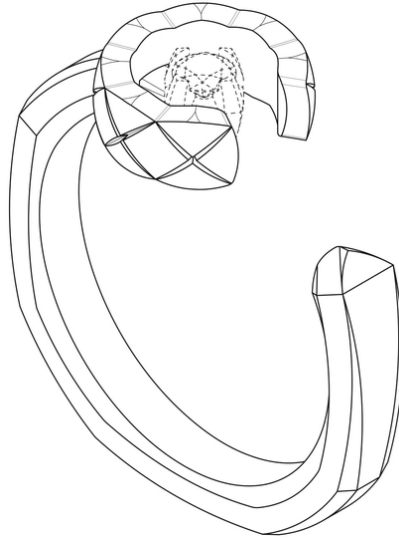

2.6

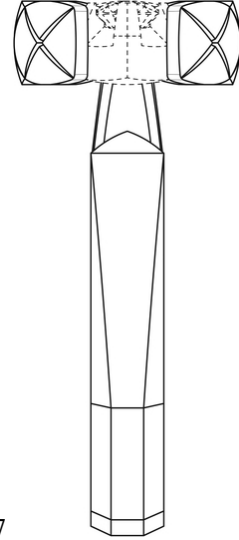

2.7

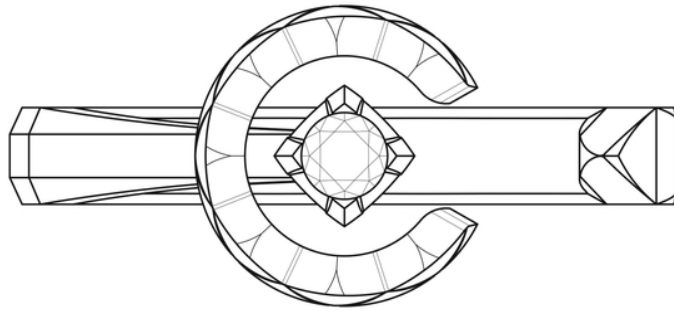

3.1

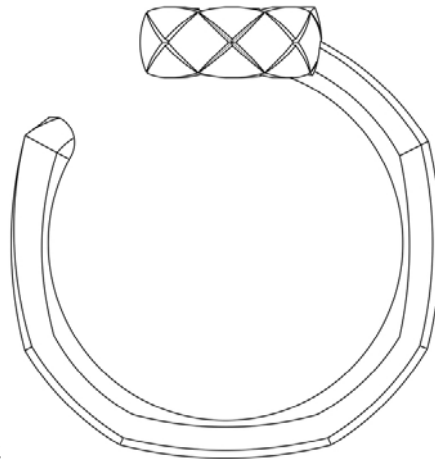

3.2

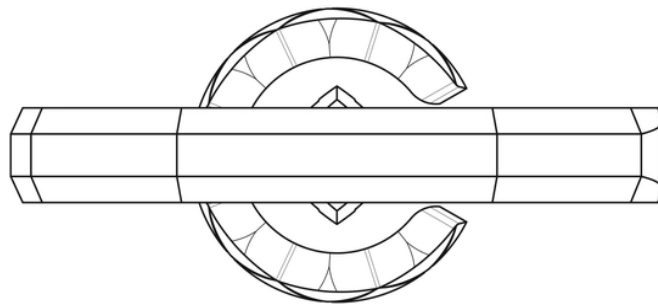

3.3

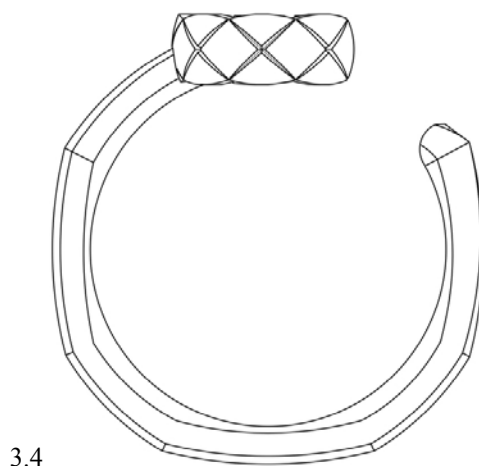

3.4

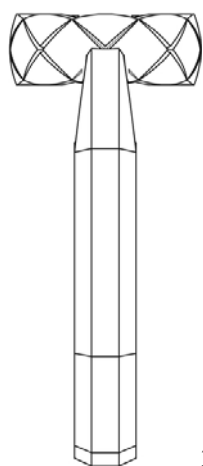

3.5

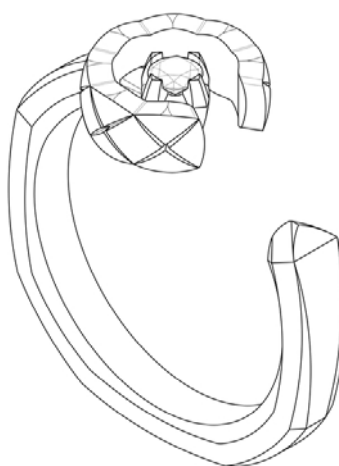

3.6

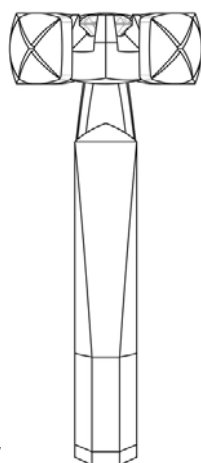

3.7

TRADEMARKS

APPLICATIONS FILED UNDER THE NATIONAL PROCEDURE APPROVED FOR REGISTRATION

The decision may be appealed to the Chamber of Appeals of Sakpatenti within 3 months of its publication or to the Administrative Cases Bench of Mtskheta District Court within 1 month, while the decisions of the Chamber of Appeals may be appealed only to the Administrative Cases Bench of Mtskheta District Court within 1 month (Address: 17 Samkhedro St., Mtskheta).

(260) AM 2026 128298 A
(210) AM 128298
(220) 2024 05 16
(731) Brunswick Corporation
26125 N. Riverwoods Blvd., Suite 500,
Mettawa, Illinois 60045, USA
(740) Shalva Gvaramadze
(540)

MERCURY

(591) Black-white
(511) 4, 7, 9, 12, 25, 28, 37

(260) AM 2026 132216 A*
(210) AM 132216
(220) 2025 02 10
(731) "International Masis Tabak" LLC
10 Hrant Vardanyan Str., 0802, Masis,
Ararat region, Armenia
(740) Giorgi Taktakishvili
(540)



(591) Yellow, blue, red, gray, white, black
(531) 24.01.05; 24.01.15; 24.01.17; 24.01.18;
24.01.19; 24.01.20; 24.09.01; 25.01.15;
25.01.25; 25.07.15; 25.07.20; 26.03.23;
26.04.18; 26.04.22; 27.05.10; 29.01.15
(511) 34

(260) AM 2026 132664 A*
(210) AM 132664
(220) 2025 03 03
(731) Altunis – Trading, Gestão E Serviços,
Sociedade Unipessoal LDA.
Avenida Arriaga, nº. 73, 1º andar, sala 113,
9000-060, Funchal, Madeira, Portugal
(740) Liliana Darakhvelidze

(540)



CIPRIANI

(591) Black-white
(531) 02.01.15; 27.05.01
(511) 32

(260) AM 2026 134439 A
(210) AM 134439
(220) 2025 06 27
(310) M 4317595
(320) 2025 05 06
(330) ES
(731) Ebro Motors Europe S.L.
CL Numero 3, 77-111 Pol.Ind.Zona Franca
Sector B, 08040, Barcelona, Spain
(740) Tamaz Shilakadze
(540)

EBRO

(591) Black-white
(531) 27.05.01
(511) 7, 12, 37

(260) AM 2026 134739 A
(210) AM 134739
(220) 2025 07 19
(731) Elene Danelia
Al. Kazbegi Av. 18, ap.12, 0160, Tbilisi,
Georgia
(540)



(591) Black-white
(531) 01.15.05; 02.09.01; 03.01.20; 03.01.22;
03.01.24; 03.01.26; 05.05.01; 24.01.03;

24.01.05; 24.01.13; 24.01.15; 24.01.19;
24.01.20; 24.15.02; 27.01.12
(511) 4, 9, 14, 16, 18, 20, 21, 24, 25, 26, 27, 28, 34

(260) AM 2026 134751 A
(210) AM 134751
(220) 2025 07 22
(731) LLC "Vartsikhe Cognac Factory"
Village of Vartsikhe, Baghdati
District, Georgia
(540)



(591) Black, golden
(531) 05.01.01; 07.01.01; 26.04.02; 26.04.16;
26.04.22; 26.04.24; 27.05.04; 27.05.24;
29.01.12
(511) 33

(260) AM 2026 134986 A
(210) AM 134986
(220) 2025 08 05
(731) LTD "Matanat"
Saburtalo St. 38, 0160, Tbilisi, Georgia
(740) Kakhaber Tsertsvadze
(540)



(591) 0A0909 black, orange
(511) 2, 17, 19, 35

(260) AM 2026 135089 A
(210) AM 135089
(220) 2025 08 09
(310) 86327271
(320) 2025 07 04
(330) PRC
(731) BYD Company Limited
№1, Yan'an Road, Kuichong Street, Dapeng
New District, Shenzhen, People's Republic
of China
(740) Giorgi Kartvelishvili

(540)
(591) Black-white
(531) 26.11.13
(511) 37

(260) AM 2026 135207 A
(210) AM 135207
(220) 2025 08 19
(731) LLC "Eplus Vape Georgia"
Zghvisubani Settlement, XI m/r, III qu,
bld. 54a, ap. 46, Nadzaladevi District,
Tbilisi, Georgia
(540)

SPACEX BAR

(591) Sky-blue, white
(531) 27.05.01
(511) 34

(260) AM 2026 135208 A
(210) AM 135208
(220) 2025 08 19
(731) LLC "Eplus Vape Georgia"
Zghvisubani Settlement, XI m/r, III qu,
bld. 54a, ap. 46, Nadzaladevi District,
Tbilisi, Georgia
(540)



(591) Black-white
(531) 01.01.01; 01.01.05; 24.03.01; 24.03.07;
24.09.01; 24.09.02; 24.09.05; 24.09.07;
25.07.08; 26.01.01; 26.13.25; 27.05.01
(511) 34

(260) AM 2026 135209 A
(210) AM 135209
(220) 2025 08 19
(731) LLC "Eplus Vape Georgia"
Zghvisubani Settlement, XI m/r, III qu,
bld. 54a, ap. 46, Nadzaladevi District,
Tbilisi, Georgia

(540)

Coxi bar

(591) Black-white
 (531) 27.05.01
 (511) 34

(260) AM 2026 135211 A

(210) AM 135211

(220) 2025 08 20

(731) LTD "Aisol"

III Mass., X qu., bld. "V", Samgori,
 District Tbilisi, Georgia

(540)

(591) Grey and red
 (531) 26.03.01; 26.03.05; 26.03.06; 26.03.18;
 27.05.01; 27.05.02; 27.05.17; 29.01.12
 (511) 2, 4, 7

(260) AM 2026 135215 A

(210) AM 135215

(220) 2025 08 20

(731) Wuhan Lotus Technology Co., Ltd.

A504, №3 Building, №28 Chuanjiangchi 2nd
 Rd., Wuhan Economic & Technological
 Development Zone, Wuhan City, Hubei
 Province, People's Republic of China

(740) Giorgi Taktakishvili

(540)

ELETRE

(591) Black-white
 (531) 27.05.01; 27.05.05
 (511) 12

(260) AM 2026 135216 A

(210) AM 135216

(220) 2025 08 20

(731) Wuhan Lotus Technology Co., Ltd.

A504, №3 Building, №28 Chuanjiangchi 2nd
 Rd., Wuhan Economic & Technological
 Development Zone, Wuhan City, Hubei
 Province, People's Republic of China

(740) Giorgi Taktakishvili

(540)

EMEYA

(591) Black-white
 (531) 26.04.18
 (511) 12

(260) AM 2026 135220 A

(210) AM 135220

(220) 2025 08 20

(731) LTD "Papris Mindvrebi"

Vill. Akhasheni, Gurjaani Region, Georgia

(740) Khatuna Imnadze

(540)

ЛАМПАРИ**ლამპარი****LAMPARI**

(591) Black-white

(511) 33

(260) AM 2026 135221 A

(210) AM 135221

(220) 2025 08 20

(731) LTD "Papris Mindvrebi"

Vill. Akhasheni, Gurjaani Region, Georgia

(740) Khatuna Imnadze

(540)

ЗАРЯ ВОСТОКА**ზარია ვასტოკა**

(591) Black-white

(511) 33

(260) AM 2026 135280 A

(210) AM 135280

(220) 2025 08 22

(731) LLC "Aversi-Pharma"

Davit Aghmashenebeli Av. 148, 0112,
 Tbilisi, Georgia

(540)

ნუროდუალი**Нуродуал****Nurodual**

(591) Black-white

(511) 5

(260) AM 2026 135284 A

(210) AM 135284

(220) 2025 08 22

(731) LLC "Aversi-Pharma"

Davit Aghmashenebeli Av. 148, 0112,
 Tbilisi, Georgia

(540)

სუსცისტეინი**Суцистеин****Suscystein**

(591) Black-white
(511) 5

(260) AM 2026 135307 A
(210) AM 135307
(220) 2025 08 26
(731) Weisheng Xu

2nd Floor, №4 Huannan Street, Liwan District,
Guangzhou City, Guangdong Province,
People's Republic of China

(740) Giorgi Kartvelishvili
(540)

ZEFUD

(591) Black-white
(531) 27.05.01; 27.05.17

(511) 18, 25

(260) AM 2026 135308 A
(210) AM 135308
(220) 2025 08 26
(731) Beauty Dialog LLC

8565 W 44th Ave Suite № 112, Haialia,
Florida, 33018, USA

(740) Khatuna Imnadze
(540)

Oli G

(591) Black-white
(511) 3, 21

(260) AM 2026 135309 A
(210) AM 135309
(220) 2025 08 27

(731) LLC "Simply Communication"
Tskalsadenis Q. №7, Bakhtrioni, Gldanis
Raioni, Tbilisi, Georgia

(740) Medea Chichinadze
(540)

SIMPLY

(591) Black, yellow
(531) 16.01.01; 26.04.18; 26.04.22; 27.05.01;
27.05.02; 27.05.22
(511) 35, 38

(260) AM 2026 135311 A
(210) AM 135311
(220) 2025 08 27

(731) LLC "Primehost"
Davit Aghmashenebeli Ave. 36, 0102, Tbilisi,
Didube District, Georgia

(540)

WEHOST

(591) White, 3CAD8D Light green
(531) 27.05.01; 27.05.17; 29.01.03; 29.01.11
(511) 36

(260) AM 2026 135313 A
(210) AM 135313
(220) 2025 08 27

(731) Basf SE
Carl-Bosch-Strasse 38, Ludwigshafen am
Rhein, Germany

(740) Giorgi Taktakishvili
(540)

G64

(591) Black-white
(511) 1

(260) AM 2026 135314 A
(210) AM 135314
(220) 2025 08 27

(731) Basf SE
Carl-Bosch-Strasse 38, Ludwigshafen am
Rhein, Germany

(740) Giorgi Taktakishvili
(540)

G65

(591) Black-white
(511) 1

(260) AM 2026 135371 A
(210) AM 135371
(220) 2025 09 01

(731) LLC "Caucasus University"
Paata Saakadze St. 1, 0102, Tbilisi, Georgia

(540)
კავკასიის უნივერსიტეტი
(591) 00080C Black-white
(511) 41

(260) AM 2026 135373 A
(210) AM 135373
(220) 2025 09 01

(731) LLC "Caucasus University"
Paata Saakadze St. 1, 0102, Tbilisi, Georgia

(540)
კავკასიის ბიზნესის სკოლა
(591) Black-white
(511) 41

(260) AM 2026 135375 A
 (210) AM 135375
 (220) 2025 09 01
 (731) Anthropic PBC
 548 Market St, PMB 90375, San Francisco,
 California 94104, USA
 (740) Tamaz Shilakadze
 (540)

ANTHROPIC

(591) Black-white
 (511) 9

(260) AM 2026 135377 A
 (210) AM 135377
 (220) 2025 09 01
 (731) LTD "Omnia Georgia"
 Mepe Miriani St. 49, ap. 177, Saburtalo
 District, Tbilisi, Georgia
 (740) Shalva Gvaramadze
 (540)



(591) Black-white
 (531) 27.05.01; 27.05.10; 27.05.17
 (511) 19, 37

(260) AM 2026 135391 A
 (210) AM 135391
 (220) 2025 09 02
 (731) JSC "Ai Texture"
 Near Gamsakhurdia Av. 34; Al. Kazbegi Av. 2,
 (plot 13/010), Aleksandre Kazbegi Ave. 2,
 (plot 13/011) Near Gamrekeli St. 19, Floor 2,
 Room 4, 0160, Saburtalo District, Tbilisi,
 Georgia
 (540)

TEXTURA

(591) Black-white
 (531) 27.05.01; 27.05.17
 (511) 9, 42

(260) AM 2026 135395 A
 (210) AM 135395
 (220) 2025 09 03
 (731) LTD "Lardi"
 Kalistrate Kutateladze St. 19, ap. 12, Tbilisi,
 Georgia
 (540)

ლარდი

(591) Black-white
 (511) 41

(260) AM 2026 135402 A
 (210) AM 135402
 (220) 2025 09 04
 (731) LLC "Holding. G"
 Marshal Gelovani Av. 2, 0159, Vake-
 Saburtalo District, Tbilisi, Georgia
 (540)



(591) White, grey
 (531) 28.19; 29.01.12
 (511) 35

(260) AM 2026 135403 A
 (210) AM 135403
 (220) 2025 09 04
 (731) LLC "Holding. G"
 Marshal Gelovani Av. 2, 0159, Vake-
 Saburtalo District, Tbilisi, Georgia
 (540)



(591) White, grey
 (531) 28.19; 29.01.12
 (511) 35

(260) AM 2026 135404 A
 (210) AM 135404
 (220) 2025 09 04
 (731) LLC "Holding. G"
 Marshal Gelovani Av. 2, 0159, Vake-
 Saburtalo District, Tbilisi, Georgia
 (540)



(591) Black-white
 (531) 28.19; 29.01.12
 (511) 35

(260) AM 2026 135405 A
 (210) AM 135405
 (220) 2025 09 04
 (731) LLC "Holding. G"
 Marshal Gelovani Av. 2, 0159, Vake-
 Saburtalo District, Tbilisi, Georgia
 (540)



(591) Black-white
 (531) 28.19; 29.01.12
 (511) 35

(260) AM 2026 135406 A
 (210) AM 135406
 (220) 2025 09 04
 (731) Philip Morris Brands Sàrl
 Quai Jeanrenaud 3, 2000 Neuchâtel,
 Switzerland
 (740) Pavle Meipariani
 (540)
მალბორო ქრავთილ არომა გოლდი
MARLBORO CRAFTED AROMA GOLD
 (591) Black-white
 (511) 34

(260) AM 2026 135407 A
 (210) AM 135407
 (220) 2025 09 04
 (731) Philip Morris Brands Sàrl
 Quai Jeanrenaud 3, 2000 Neuchâtel,
 Switzerland
 (740) Pavle Meipariani
 (540)
პარლამენტ სოჰო კომპაქტ ბლუ
PARLIAMENT SOHO COMPACT BLUE
 (591) Black-white
 (511) 34

(260) AM 2026 135408 A
 (210) AM 135408
 (220) 2025 09 04
 (731) Philip Morris Brands Sàrl
 Quai Jeanrenaud 3, 2000 Neuchâtel,
 Switzerland
 (740) Pavle Meipariani
 (540)
პარლამენტ სოჰო კომპაქტ სილვერი
PARLIAMENT SOHO COMPACT SILVER
 (591) Black-white
 (511) 34

(260) AM 2026 135463 A
 (210) AM 135463
 (220) 2025 09 05
 (731) LTD "Grape Man"
 Akaki Tsereteli Av. 87b, ap. 15, 0119,
 Didube District, Tbilisi, Georgia
 (540)

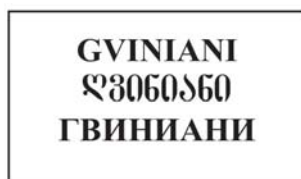

(591) Black-white

(531) 26.04.01; 27.05.01; 27.05.25
 (511) 33, 35

(260) AM 2026 135465 A
 (210) AM 135465
 (220) 2025 09 05
 (731) Qualcomm Incorporated
 5775 Morehouse Drive, San Diego,
 CA 92121, USA
 (740) Tamaz Shilakadze
 (540)



(591) Black-white
 (531) 01.15.05; 25.12.01; 26.01.16; 26.01.26;
 26.13.25; 29.01.12
 (511) 9

(260) AM 2026 135484 A
 (210) AM 135484
 (220) 2025 09 10
 (731) Khvicha Kvaratskhelia
 Nutsa Ghoghoberidze St. 9, Tbilisi,
 Georgia
 (540)

KVARATSKHELIA

(591) Black-white
 (511) 3, 9, 14, 16, 18, 25, 32, 33, 35, 43

(260) AM 2026 135485 A
 (210) AM 135485
 (220) 2025 09 10
 (731) Khvicha Kvaratskhelia
 Nutsa Ghoghoberidze St. 9, Tbilisi,
 Georgia
 (540)

კვარაცხელია

(591) Black-white
 (511) 3, 9, 14, 16, 18, 25, 32, 33, 35, 43

(260) AM 2026 135490 A
 (210) AM 135490
 (220) 2025 09 10
 (731) Khvicha Kvaratskhelia
 Nutsa Ghoghoberidze St. 9, Tbilisi,
 Georgia
 (540)

KK7

(591) Black-white
 (511) 3, 9, 14, 16, 18, 25, 32, 33, 35, 43

(260) AM 2026 135492 A
 (210) AM 135492
 (220) 2025 09 10
 (731) Jaba Bebua
 Nutsa Ghoghoberidze St. 9, 0179, Tbilisi,
 Georgia
 (540)

MODI

(591) Black-white
 (531) 27.01.25; 27.05.01; 27.05.08; 27.05.25;
 29.01.12
 (511) 29, 30, 43

(740) Tamaz Shilakadze
 (540)



(591) Black, grey, white
 (531) 25.05.02; 26.04.05; 26.04.16; 26.04.22;
 26.13.25; 27.05.01
 (511) 5

(260) AM 2026 135494 A
 (210) AM 135494
 (220) 2025 09 11
 (731) The Procter & Gamble Company
 One Procter & Gamble Plaza, Cincinnati,
 Ohio 45202, USA
 (740) Tamaz Shilakadze
 (540)



(591) Pink, white, golden
 (531) 01.01.02; 25.05.02; 26.04.05; 26.04.16;
 26.04.22; 26.13.25; 27.05.01
 (511) 5

(260) AM 2026 135505 A
 (210) AM 135505
 (220) 2025 09 11
 (731) Jaba Bebua
 Nutsa Ghoghoberidze St. 9, 0179, Tbilisi,
 Georgia
 (540)

Dediko

(591) Blue, white
 (531) 27.05.01; 27.05.10; 29.01.04; 29.01.11
 (511) 29, 30

(260) AM 2026 135495 A
 (210) AM 135495
 (220) 2025 09 11
 (731) Jaba Bebua
 Nutsa Ghoghoberidze St. 9, 0179, Tbilisi,
 Georgia
 (540)



(591) Golden, white, black
 (531) 24.17.02; 27.03.11; 27.05.01; 27.05.04;
 27.05.09; 27.05.17; 27.05.21; 28.05
 (511) 33, 35, 43

(260) AM 2026 135554 A
 (210) AM 135554
 (220) 2025 09 16
 (731) Alchem International (H.K.) Limited
 Rm/Flat 05-06 17/F The L Plaza 367-375
 Queen's Road, Central Hong Kong, Hong Kong
 (740) Liliana Darakhvelidze
 (540)

PHYTONODOL

(591) Black-white
 (511) 5

(260) AM 2026 135497 A
 (210) AM 135497
 (220) 2025 09 11
 (731) The Procter & Gamble Company
 One Procter & Gamble Plaza, Cincinnati,
 Ohio 45202, USA

(260) AM 2026 135555 A
 (210) AM 135555
 (220) 2025 09 16
 (731) AVATR Co., Ltd.
 №24, 1F, Building 1, №106, West Section of
 Jinkai Avenue, Yubei District, Chongqing,
 People's Republic of China
 (740) Pavle Meipariani
 (540)

AVATR

(591) Black-white
 (531) 27.01.05; 27.05.01; 27.05.09; 27.05.25
 (511) 12

(260) AM 2026 135619 A
 (210) AM 135619
 (220) 2025 09 19
 (731) Enriko Beridze
 G. Tsitsishvili St. 18, Tbilisi, Georgia
 (540)



(591) D5B785 sand color, 1C1C1C black
 (531) 02.03.01; 03.04.07; 25.01.25; 26.04.02;
 26.04.10; 26.04.14; 26.04.15; 26.04.16;
 26.04.22; 27.05.01; 29.01.12
 (511) 35, 43

(260) AM 2026 135624 A
 (210) AM 135624
 (220) 2025 09 21
 (731) LTD "Thermostar"
 Georgitsminda St. Vazha-Pshavela St. 12,
 0167, Tbilisi, Gldani District, Georgia
 (540)

თერმოსტარი  **ThermoStar™**

(591) EA5050 light red, CC3A37 dark green,
 287062 dark green, 408C7D light green,
 2499D5 dark blue, 117EC1 light blue,
 FF8C63 dark orange, FFFFFFFF light
 orange, FFFFFFFF dark yellow, FFFFFFFF
 light yellow
 (531) 01.01.02; 01.01.10; 01.01.25; 27.05.01;
 27.05.09; 27.05.17; 29.01.15
 (511) 11, 17

REGISTERED TRADEMARKS

(111) M 2026 41009 R
(151) 2026 03 20
(181) 2036 03 20
(260) AM 2025 132510 A
(220) 2025 02 26
(732) J.S.S. Tobacco LTD
Suite 404, Albany House, 324/326 Regent
Street, London W1B 3HH, United Kingdom
(511) 34

(111) M 2026 41010 R
(151) 2026 03 20
(181) 2036 03 20
(260) AM 2025 132110 A
(220) 2025 02 06
(732) LTD "Aversi-Pharma"
Davit Aghmashenebeli Av. 148, 0112, Tbilisi,
Georgia
(511) 5

(111) M 2026 41011 R
(151) 2026 03 20
(181) 2036 03 20
(260) AM 2025 133267 A
(220) 2025 04 07
(732) Santoni Societa' Per Azioni
Via Monte Napoleone 9, I-20121 Milano
(MI), Italy
(511) 35

(111) M 2026 41012 R
(151) 2026 03 20
(181) 2036 03 20
(260) AM 2025 132350 A
(220) 2025 02 18
(732) LTD "Aversi-Pharma"
Davit Aghmashenebeli Av. 148, 0112, Tbilisi,
Georgia
(511) 5

(111) M 2026 41013 R
(151) 2026 03 20
(181) 2036 03 20
(260) AM 2025 133399 A
(220) 2025 04 17
(732) Limited Liability Company "Arterium LTD"
139 Saksaganskogo St., Kyiv, 01032, Ukraine
(511) 5

(111) M 2026 41014 R
(151) 2026 03 20
(181) 2036 03 20
(260) AM 2025 132246 A
(220) 2025 02 12
(732) LTD "Kasa Latina"
Grigol Lortkipanidze St. 64, Samgori
District, Tbilisi, Georgia
(511) 33

(111) M 2026 41015 R
(151) 2026 03 20
(181) 2036 03 20
(260) AM 2025 133903 A
(220) 2025 05 22
(732) Anastasia Davidova
Tskaltubo St. 24, Blok "B" 0175,
Didube District, Tbilisi, Georgia
(511) 7

(111) M 2026 41016 R
(151) 2026 03 20
(181) 2036 03 20
(260) AM 2025 133571 A
(220) 2025 04 29
(732) LTD "Medical Laboratory Mylab"
Mikheil Chiaureli St. 9, 1st Floor, Office
Area 2, 0179, Tbilisi, Georgia;
Sopio Arjevanidze
Shalva Nutsubidze Plateau, II m/r, II qu.,
bld. 10, ap. 10, 0186, Tbilisi, Georgia
(511) 44

(111) M 2026 41017 R
(151) 2026 03 20
(181) 2036 03 20
(260) AM 2025 133653 A
(220) 2025 05 05
(732) LLC "Caucasus Import Company"
Grigol Robakidze Av. 7, 0167, Tbilisi, Georgia
(511) 16

(111) M 2026 41018 R
(151) 2026 03 20
(181) 2036 03 20
(260) AM 2025 133010 A
(220) 2025 03 21
(732) Pavel Maksakov
Pos. Barvikha 25, ap. 16, Odintsovskiy District,
Moscow Region, 143083, Russian Federation

(511) 29, 32, 35

(111) M 2026 41019 R
(151) 2026 03 20
(181) 2036 03 20
(260) AM 2025 133881 A
(220) 2025 05 19
(732) LLC "Georgian Mining Products"
Mikheil Burdzgla St. 18, bld. 14, 0102,
Saburtalo District, Tbilisi, Georgia
(511) 35

(111) M 2026 41020 R
(151) 2026 03 20
(181) 2036 03 20
(260) AM 2025 133559 A
(220) 2025 04 28
(732) LEPL "Trade With Georgia"
Gia Chanturia St. 12, 0102, Old Tbilisi
District, Tbilisi, Georgia
(511) 9, 16, 35, 36, 41, 42

(111) M 2026 41021 R
(151) 2026 03 20
(181) 2036 03 20
(260) AM 2025 133561 A
(220) 2025 04 28
(732) LEPL "Trade With Georgia"
Gia Chanturia St. 12, 0102, Old Tbilisi
District, Tbilisi, Georgia
(511) 9, 16, 35, 36, 41, 42

(111) M 2026 41022 R
(151) 2026 03 20
(181) 2036 03 20
(260) AM 2025 133558 A
(220) 2025 04 28
(732) LEPL "Trade With Georgia"
Gia Chanturia St. 12, 0102, Old Tbilisi
District, Tbilisi, Georgia
(511) 9, 16, 35, 36, 41, 42

(111) M 2026 41023 R
(151) 2026 03 20
(181) 2036 03 20
(260) AM 2025 133560 A
(220) 2025 04 28
(732) LEPL "Trade With Georgia"
Gia Chanturia St. 12, 0102, Old Tbilisi
District, Tbilisi, Georgia
(511) 9, 16, 35, 36, 41, 42

(111) M 2026 41024 R
(151) 2026 03 20
(181) 2036 03 20
(260) AM 2025 133556 A
(220) 2025 04 28
(732) LEPL "Trade With Georgia"
Gia. Chanturia St. 12, 0102, Old Tbilisi
District, Tbilisi, Georgia
(511) 9, 16, 35, 36, 41, 42

(111) M 2026 41025 R
(151) 2026 03 20
(181) 2036 03 20
(260) AM 2025 133562 A
(220) 2025 04 28
(732) LEPL "Trade With Georgia"
Gia Chanturia St. 12, 0102, Old Tbilisi
District, Tbilisi, Georgia
(511) 9, 16, 35, 36, 41, 42

(111) M 2026 41026 R
(151) 2026 03 20
(181) 2036 03 20
(260) AM 2025 133963 A
(220) 2025 05 26
(732) LTD "Kartuli Tema"
Irakli Gamrekeli St. 35v, Saburtalo District,
Tbilisi, Georgia
(511) 28, 30, 35

(111) M 2026 41027 R
(151) 2026 03 20
(181) 2036 03 20
(260) AM 2025 133962 A
(220) 2025 05 26
(732) LTD "Kartuli Tema"
Irakli Gamrekeli St. 35v, Saburtalo District,
Tbilisi, Georgia
(511) 30, 35

(111) M 2026 41028 R
(151) 2026 03 20
(181) 2036 03 20
(260) AM 2025 133645 A
(220) 2025 05 02
(732) LTD "Intrade"
Aleksandre Mrevlishvili St. 2, 0180, Tbilisi,
Georgia
(511) 29

(111) M 2026 41029 R
(151) 2026 03 20
(181) 2036 03 20
(260) AM 2025 133648 A

(220) 2025 05 05
 (732) LTD "Zumeri Georgia"
 Gogi Tsabadze St. 8, Tbilisi, Georgia
 (511) 35

(111) M 2026 41030 R
 (151) 2026 03 20
 (181) 2036 03 20
 (260) AM 2025 133582 A
 (220) 2025 04 30
 (732) LTD "PremiumGeorgiacom"
 Terenti Graneli St. 10-12, Commercial Space,
 Ent. 2, Floor 1, 0179, Chughureti District,
 Tbilisi, Georgia
 (511) 35, 41, 43, 45

(111) M 2026 41031 R
 (151) 2026 03 20
 (181) 2036 03 20
 (260) AM 2025 132938 A
 (220) 2025 03 20
 (732) CymaBay Therapeutics Inc.
 333 Lakeside Drive, Foster City,
 California, 94404, USA
 (511) 5

(111) M 2026 41032 R
 (151) 2026 03 20
 (181) 2036 03 20
 (260) AM 2025 132488 A
 (220) 2025 02 25
 (732) Gocha Pipia
 Budapesht St. 11, ap. 55, 0160, Tbilisi, Georgia
 (511) 33

(111) M 2026 41033 R
 (151) 2026 03 20
 (181) 2036 03 20
 (260) AM 2025 132358 A
 (220) 2025 02 19
 (732) Gocha Pipia
 Budapesht St. 11, ap. 55, 0160, Tbilisi, Georgia
 (511) 33

(111) M 2026 41034 R
 (151) 2026 03 20
 (181) 2036 03 20
 (260) AM 2025 133698 A
 (220) 2025 05 08
 (732) Zurab Chincharashvili
 Nutsubidze Slope, IV m/r, bld. 7, ap. 38,
 0186, Tbilisi, Georgia
 (511) 43

(111) M 2026 41035 R
 (151) 2026 03 20
 (181) 2036 03 20
 (260) AM 2025 133040 A
 (220) 2025 03 25
 (732) Maka Metreveli
 Larsi St., Lane 3, 0179, Tbilisi, Georgia
 (511) 25, 29, 30, 43

(111) M 2026 41036 R
 (151) 2026 03 20
 (181) 2036 03 20
 (260) AM 2025 133868 A
 (220) 2025 05 16
 (732) Majid Al Futtaim Retail LLC
 PO Box 91100, Majid Al Futtaim Tower, Port
 Saeed, Dubai, United Arab Emirates
 (511) 35

TRADEMARKS REGISTERED ACCORDING TO THE ACCELERATED PROCEDURE

The decision can be appealed at the Chamber of Appeal of Sakpatenti within 3 months from the publication.

(111) M 2026 41037 R

(151) 2026 03 23

(181) 2036 03 23

(210) AM 137854

(220) 2026 02 23

(732) LLC "Kvareli Cellar"

Village Chikaani, 4800, Kvareli, Georgia

(740) Khatuna Imnadze

(540)

გრანდ კოლხიდა
GRAND KOLKHIDA
ГРАНД КОЛХИДА

(591) Black-white

(526) კოლხიდა, KOLKHIDA, КОЛХИДА

(511) 33

(111) M 2026 41038 R

(151) 2026 03 23

(181) 2036 03 23

(210) AM 138018

(220) 2026 03 02

(732) LLC "Agent-C"

Tsminda Andria Pirveltsodebuli Highway 58,
Block III, ap. 605, Batumi, Georgia

(540)

Sakme

(591) Dark blue, white

(531) 27.05.01

(511) 9, 42

(111) M 2026 41039 R

(151) 2026 03 23

(181) 2036 03 23

(210) AM 138019

(220) 2026 03 02

(732) LLC "Agent-C"

Tsminda Andria Pirveltsodebuli Highway 58,
Block III, ap. 605, Batumi, Georgia

(540)



(591) Black-sky-blue

(531) 26.04.02; 26.04.05; 26.04.24; 27.05.01;
27.05.07; 27.05.17; 27.05.24; 29.01.12

(511) 9, 42

(111) M 2026 41040 R

(151) 2026 03 23

(181) 2036 03 23

(210) AM 138108

(220) 2026 03 09

(732) LLC "BG Wines"

Sulkhan Tsintsadze St. 18, B. 32, 0160,
Vake-Saburtalo District, Tbilisi,
Georgia

(540)



(591) Black, golden

(531) 03.07.17; 05.07.10; 24.01.15; 24.01.25;
24.09.01; 25.01.06; 25.01.13; 27.05.01;
27.05.04; 27.05.22; 27.05.23; 27.05.24;
29.01.12

(511) 33

(111) M 2026 41041 R

(151) 2026 03 23

(181) 2036 03 23

(210) AM 138031

(220) 2026 03 05

(732) LLC "Midpoint"

Lech and Maria Kaczynski St. 17, Office
301, Floor 3, Block "C", 6000, Batumi,
Georgia

(540)



(591) 173985 blue, white

(531) 26.01.01; 26.01.04; 26.01.11; 26.01.20;
27.05.01; 29.01.12

(511) 43

(111) M 2026 41042 R
 (151) 2026 03 23
 (181) 2036 03 23
 (210) AM 138114
 (220) 2026 03 10
 (732) LLC "Kvareli Cellar"
 Village Chikaani, 4800, Kvareli, Georgia
 (540)

თორელი
TORELI
ТОРЕЛИ

(591) Black-white
 (511) 33

(111) M 2026 41043 R
 (151) 2026 03 23
 (181) 2036 03 23
 (210) AM 138110
 (220) 2026 03 09
 (732) LLC "Nika Travel"
 Anton Chekhov St. 37, 0103, Isani District,
 Tbilisi, Georgia
 (540)



(591) Black-white
 (531) 26.11.02; 26.11.08; 27.05.01; 27.05.04;
 27.05.05; 27.05.10; 27.05.11
 (511) 43

(111) M 2026 41044 R
 (151) 2026 03 23
 (181) 2036 03 23
 (210) AM 138115
 (220) 2026 03 10
 (732) The Ritz-Carlton Hotel Company L.L.C.
 7750 Wisconsin Avenue, Bethesda, Maryland
 20814, USA
 (740) Tamaz Shilakadze
 (540)

RITZ-CARLTON

(591) Black-white
 (511) 36, 41, 44

(111) M 2026 41045 R
 (151) 2026 03 23
 (181) 2036 03 23
 (210) AM 138117

(220) 2026 03 10
 (732) The Ritz-Carlton Hotel Company L.L.C.
 7750 Wisconsin Avenue, Bethesda, Maryland
 20814, USA
 (740) Tamaz Shilakadze
 (540)



THE RITZ-CARLTON

(591) Black-white
 (531) 03.01.01; 03.01.02; 03.01.16; 03.01.24;
 27.05.17
 (511) 36, 41, 44

(111) M 2026 41046 R
 (151) 2026 03 23
 (181) 2036 03 23
 (210) AM 138133
 (220) 2026 03 12
 (732) Tamar Shaoshvili
 Zaza Panaskerteli St. 12, Tbilisi, Georgia
 (540)



(591) Golden, black
 (531) 03.04.11; 19.09.01; 19.09.02; 26.04.05;
 26.04.15; 27.05.01; 29.01.02; 29.01.08;
 29.01.12
 (511) 33, 41

(111) M 2026 41047 R
 (151) 2026 03 23
 (181) 2036 03 23
 (210) AM 138267
 (220) 2026 03 13
 (732) LTD "Kanti"
 Roman Chelidze St., II Lane 19,
 Gldani District, Tbilisi, Georgia
 (740) Shalva Gvaramadze
 (540)



(591) Black-white
 (531) 05.01.05; 05.01.13; 05.01.19; 05.03.14;
 19.09.02; 26.03.01; 26.03.16; 27.05.01
 (511) 33

(111) M 2026 41048 R
 (151) 2026 03 27
 (181) 2036 03 27
 (210) AM 138138
 (220) 2026 03 12
 (732) LLC "ExpatHub"
 Zakaria Paliashvili St. 41, ent. 1, Vake District,
 Tbilisi, Georgia
 (540)

ექსპატჰაბი

(591) Black-white
 (511) 35, 36, 45

(111) M 2026 41049 R
 (151) 2026 03 27
 (181) 2036 03 27
 (210) AM 138278
 (220) 2026 03 16
 (732) LLC "Barambo"
 Village Natakhtari, 3308, Mtskheta,
 Georgia
 (540)

Barambo magic

(591) Black-white
 (511) 30

(111) M 2026 41050 R
 (151) 2026 03 27
 (181) 2036 03 27
 (210) AM 138279
 (220) 2026 03 16
 (732) LLC "Barambo"
 Village Natakhtari, 3308, Mtskheta,
 Georgia
 (540)

Barambo roller

(591) Black-white
 (511) 30

(111) M 2026 41051 R
 (151) 2026 03 27
 (181) 2036 03 27
 (210) AM 138294
 (220) 2026 03 18
 (732) LLC "Kvareli Cellar"
 Village Chikaani, 4800, Kvareli,
 Georgia

(540)

მალავინა
MALAVINA
МАЛАВИНА

(591) Black-white
 (511) 33

(111) M 2026 41052 R
 (151) 2026 03 27
 (181) 2036 03 27
 (210) AM 138266
 (220) 2026 03 13
 (732) LLC "Berkana 7"
 Academician Yangeli St. 4, Vinnytsia, 21007,
 Ukraine
 (740) Irakli Gvilia
 (540)



(591) Red, yellow
 (531) 26.04.06; 26.04.07; 26.04.10; 29.01.01;
 29.01.02; 29.01.12
 (511) 3, 6, 16, 21

(111) M 2026 41053 R
 (151) 2026 03 30
 (181) 2036 03 30
 (210) AM 138022
 (220) 2026 03 03
 (732) Guri Khetsuriani
 Nutsubidze Plateau 1, bld. 6, ap. 19,
 Tbilisi, Georgia
 (740) Mariam Gogitidze
 (540)



საქართველოს ნიუს-ინსტიტუტი
 NLP INSTITUTE OF GEORGIA

(591) Sky-blue, blue, white, purple
 (531) 01.01.02; 01.01.09; 01.11.10; 03.13.01;
 05.05.16; 26.04.04; 26.04.05; 26.04.16;
 27.05.01; 29.01.14
 (526) „საქართველოს“ „Georgia“
 (511) 41, 44

(111) M 2026 41054 R
 (151) 2026 03 30
 (181) 2036 03 30
 (210) AM 138277
 (220) 2026 03 16
 (732) LTD "Gon LTD"
 Botchorishvili St. 37b, ap. 196, Tbilisi,
 Georgia

(540)



(591) Blue, sky-blue
 (531) 26.01.01; 26.01.03; 26.01.18; 26.11.01;
 26.11.13; 27.05.01; 27.05.17; 29.01.04;
 29.01.06; 29.01.13
 (511) 9

(111) M 2026 41057 R
 (151) 2026 04 02
 (181) 2036 04 02
 (210) AM 138423
 (220) 2026 03 24
 (732) LLC "GM Pharmaceuticals"
 Rustavi Highway 52, 0114, Tbilisi, Georgia

(740) Nugzar Ksovreli

(540)



(591) Blue, red, white
 (531) 01.13.15; 26.01.05; 26.11.02; 26.11.13;
 27.05.01; 27.05.10; 27.05.17; 29.01.12
 (511) 3, 5

(111) M 2026 41055 R
 (151) 2026 03 31
 (181) 2036 03 31
 (210) AM 138410
 (220) 2026 03 21
 (732) LTD "Alali Prime Trade"
 Kutaisi St. 40, Floor 1, ap. 1, Batumi,
 Georgia

(540)



(591) Black, E8212E red
 (531) 26.04.05; 26.11.06; 26.11.11; 26.13.25;
 27.05.01; 27.05.17; 29.01.12
 (511) 35, 37

(111) M 2026 41058 R
 (151) 2026 04 02
 (181) 2036 04 02
 (210) AM 138425
 (220) 2026 03 24
 (732) LLC "GM Pharmaceuticals"
 Rustavi Highway 52, 0114, Tbilisi, Georgia

(740) Nugzar Ksovreli

(540)



(591) 3244A8 blue, E53434 red, white
 (531) 01.13.15; 26.01.05; 26.11.02; 26.11.13;
 27.05.01; 27.05.10; 29.01.12
 (511) 3, 5

(111) M 2026 41056 R
 (151) 2026 04 01
 (181) 2036 04 01
 (210) AM 138302
 (220) 2026 03 19
 (732) LLC "Kvareli Cellar"
 Village Chikaani, 4800, Kvareli, Georgia

(740) Khatuna Imnadze

(540)

ბათუმის ბრისი
BATUMI BREEZE
БАТУМИ БРИЗ

(591) Black-white
 (526) ბათუმის, BATUMI, БАТУМИ
 (511) 33

INTERNATIONAL TRADEMARKS FOR WHICH A DECISION ON GRANTING PROTECTIONS IS TAKEN

The decision can be appealed at the Chamber of Appeal of Sakpatenti within 3 months from the publication or at the Mtskheta District Court Administrative Cases Board (Address: №17, Samkhedro St., Mtskheta), within 1 month following the publication.

(260) AM 2026 129978 A

(800) 1809166

(151) 2024 06 25

(891) 2024 06 25

(731) Obshchestvo s Ogranichennoy Otvetstvennostju

"KDV Yashkinskaya Melnica"

ul. Benivalenskogo, 10A, s. Polomoshnoe,

Yashkinskij rajon, RU-652020 Kemerovskaya

oblast, Russian Federation

(540)

Cardinale

(591) Black, white

(511)

30 – Vanilla flavourings for culinary purposes; flavourings, other than essential oils, for cakes; flavourings, other than essential oils, for beverages; coffee flavourings; food flavourings, other than essential oils; star aniseed; baozi; cereal bars; high-protein cereal bars; pancakes; noodle-based prepared meals; freeze-dried dishes with the main ingredient being pasta; freeze-dried dishes with the main ingredient being rice; buns; bulgur; bread rolls; edible rice paper; edible paper; burritos; vanillin [vanilla substitute]; pierogi [stuffed dumplings]; waffles; vermicelli; natural sweeteners; sausage binding materials; binding agents for ice cream; seawater for cooking; seaweed [condiment]; malt biscuits; cloves [spice]; mirror icing [mirror glaze]; cake frosting [icing]; glucose for culinary purposes; mustard; croûtons; buckwheat, processed; gluten additives for culinary purposes; yeast; thickening agents for cooking foodstuffs; leaven; rice-based snack food; cereal-based snack food; coffee substitutes; vegetal preparations for use as coffee substitutes; dressings for salad; zephyr being confectionery; fruit jellies [confectionery]; candy decorations for cakes; confectionery for decorating Christmas trees; cakes; pastries; peanut confectionery; almond confectionery; pasta; ginger [spice]; frozen yogurt [confectionery ices]; cocoa; cream of tartar for culinary purposes; capers; caramels [sweets]; curry [spice]; ketchup [sauce]; kimbap; quinoa, processed; quiches; gluten prepared as foodstuff; flour-based dumplings; sweets; liquorice [confectionery]; peppermint sweets; mints for breath freshening; dulce de leche; cinnamon [spice]; coffee; starch for food; crackers; custard; hominy grits; semolina; oatmeal; crushed barley; ice cubes; corn, milled; corn, roasted; meat pies; turmeric; couscous; noodles; soba noodles; udon noodles; ice for refreshment; ice, natural or artificial; edible ices; lollipops [confectionery]; rice cakes; mayonnaise; maca-

rooms [pastries]; macaroni; maltose; hominy; piccalilli; marinades; marzipan; honey; miso; royal jelly; ice cream; bean meal; buckwheat flour; tapioca flour; potato flour; corn flour; nut flours; flour; wheat flour; soya flour; barley meal; dessert mousses [confectionery]; chocolate mousses; muesli; mint for confectionery; cocoa beverages with milk; coffee beverages with milk; coffee-based beverages; cocoa-based beverages; chamomile-based beverages; tea-based beverages; chocolate beverages with milk; chocolate-based beverages; infusions, not medicinal; crushed oats; husked oats; okonomiyaki [Japanese savory pancakes]; onigiri; nutmegs [spice]; chocolate-coated nuts; stick liquorice [confectionery]; soya bean paste [condiment]; pastila [confectionery]; lozenges [confectionery]; treacle; pâtés en croûte; pelmeni; pepper; allspice; peppers [seasonings]; pesto; biscuits; petit-beurre biscuits; bibimbap [rice mixed with vegetables and beef]; pies; pizzas; meat gravies; fondants [confectionery]; popcorn; powders for making ice cream; baking powder; mustard meal; pralines; aromatic preparations for food; condiments; cereal preparations; oat-based food; propolis; gingerbread; spices; petits fours; rice pudding; puddings; cake powder; fruit-based sauces; ravioli; ramen; chewing gum; chewing gum for breath freshening; relish [condiment]; rice; instant rice; wheat germ for human consumption; spring rolls; sago; sugar; palm sugar; sesame seeds [seasonings]; linseed for culinary purposes [seasoning]; processed seeds for use as a seasoning; aniseed; agave syrup [natural sweetener]; golden syrup; candy bars; baking soda [bicarbonate of soda for cooking purposes]; malt for human consumption; salt for preserving foodstuffs; cooking salt; celery salt; sorbets [ices]; ham glaze; cranberry sauce [condiment]; soya sauce; tomato sauce; apple sauce [condiment]; sauces [condiments]; pasta sauce; spaghetti; seasonings; chocolate-based spreads; chocolate spreads containing nuts; preparations for stiffening whipped cream; shaved ice with sweetened red beans; rusks; breadcrumbs; sushi; sandwiches; tabbouleh; tacos; tapioca; tarts; dough; pastry dough; almond paste; rice pulp for culinary purposes; cake batter; garden herbs, preserved [seasonings]; chocolate decorations for cakes; vinegar; beer vinegar; ferments for dough; halvah; bread; unleavened bread; cereal flakes; corn flakes; oat flakes; hot dog sandwiches; flowers or leaves for use as tea substitutes; chicory [coffee substitute]; tea; iced tea; chutneys [condiments]; minced garlic [condiment]; cheeseburgers [sandwiches]; chow-chow [condiment]; saffron [seas-

oning]; chocolate; malt extract for food; essences for foodstuffs, except etheric essences and essential oils; husked barley.

(260) AM 2026 130032 A

(800) 1810020

(151) 2024 08 02

(891) 2024 08 02

(731) Egis Gyógyszergyár Zrt.

Keresztúri út 30-38; H-1106 Budapest,
Hungary

(540)

OBSUHART

(591) Black, white

(511)

5 – Pharmaceutical preparations for human use; vitamin preparations; food supplements; dietary supplements and dietetic preparations; medicinal ointments; medicated skin creams; antiseptic preparations; disinfectants.

(260) AM 2026 130033 A

(800) 1810021

(151) 2024 08 02

(891) 2024 08 02

(731) Egis Gyógyszergyár Zrt.

Keresztúri út 30-38; H-1106 Budapest,
Hungary

(540)

LIFTAQOLS

(591) Black, white

(511)

5 – Pharmaceutical preparations for human use; vitamin preparations; food supplements; dietary supplements and dietetic preparations; medicinal ointments; medicated skin creams; antiseptic preparations; disinfectants.

(260) AM 2026 130201 A

(800) 1812092

(151) 2024 02 02

(891) 2024 02 02

(731) Bernard Krone Holding SE & Co. KG

Heinrich-Krone-Str. 10, 48480 Spelle,
Germany

(540)

KRONE GROUP

(591) Black, white

(531) 27.05.09; 27.05.17

(511)

7 – Mechanical equipment for agriculture; machines and machine tools of all kinds for agriculture, including rotary rakes and rotary tedders; agricultural implements, in particular reapers and threshers, mower

conditioners, forage harvesters, baling machines, large square balers and pellet mills, mowing machines, raking machines, tedders and hay rakes, tilling machines and apparatus, sowers (machines), apparatus for the application of fertilisers and plant protection preparations, and parts and components therefor, including hydraulic control apparatus for machines, included in this class; motors and engines; parts and accessories for all the aforesaid goods, included in this class; self-propelled harvesters.

9 – Computer software, in particular downloadable software for engine control mechanisms for use and application in motor vehicles and agricultural machines, implements and vehicles; software for remote access to engine control mechanisms; electric, electro-mechanical, electronic installations and apparatus for the setting, modification, storage, processing, linking, monitoring, inspection, retrieval, capture, measuring, recording, evaluating, comparing, exchanging, including remote transmission, of operational data, operating conditions and other information, including travel destinations, travel routes, travel times, the location of motor vehicles, in particular goods transport vehicles and passenger vehicles, and agricultural machines, apparatus and vehicles; interoperable communications systems, telematics systems with apparatus for the recording, transmission and reproduction of speech, data and information, including computers, telephone apparatus and display apparatus for wireless communication between motor vehicles, in particular goods transport vehicles and passenger vehicles, and agricultural machines, apparatus and vehicles and/or stationary or mobile units, via terrestrial radio installations and extraterrestrial satellites; tracking systems for vehicles and moveable goods with integrated satellite-supported global positioning systems (GPS); software for analyzing transportation; software for organising, providing, enquiring about, managing and booking transports for businesses and agricultural services; computer software for receiving and responding to requests for transportation; software for the providing of means of land transport for businesses; software for access to services relating to vehicles for businesses and agricultural implements, machines and vehicles; software enabling access to carpooling services; computer software for detecting trip delays, vehicle location, and trip anomalies; computer software for safety and incident detection; software for accessing and viewing transit information, schedules, routes, and prices; software for comparing transportation costs; real-time mapping software for the tracking of motor vehicles and agricultural implements, machines and vehicles; software for the accounting, analysis and transmission of data relating to mobility and agricultural services; software for the planning and coordination of transport and agricultural services; software for the providing of means of transport and delivery, in particular lorries and trailers; downloadable computer software for the locating, booking and rental of

means of transportation and conveyance, in particular lorries and trailers, and agricultural implements, machines and vehicles; downloadable software for the collection and management of data during the use of land transport and agricultural machines, implements and vehicles; artificial intelligence software; artificial intelligence software for vehicles; artificial intelligence software for surveillance, evaluation and presentation; artificial intelligence software for image processing and analysis; artificial intelligence software for data collection and analysis; helmets for bicycles; measuring apparatus.

12 – Vehicles; apparatus for locomotion by land, and parts and components therefor, in particular trailers [vehicles]; cars; undercarriages for vehicles; vehicle chassis; refrigerated vehicles; tipping bodies for lorries [trucks]; box bodies being vehicle bodies; swap bodies being vehicle bodies; curtainsider; semi-trailers; container cars; push floor vehicles; electrically powered vehicles; electrically operated apparatus for locomotion by land, and parts and components therefor, in particular electrically operated trailers [vehicles]; electrically powered cars [vehicles]; electrically powered undercarriages for vehicles; electrically powered chassis for vehicles; electrically powered refrigerated vehicles; electrically powered lorry caps; electrically powered box bodies; electrically powered swap bodies; electrically powered curtainsiders; electrically powered semitrailers; electrically powered container vehicles; electrically powered push floor vehicles; height-adjustable floor segments being parts of vehicles; tipping bodies for vehicles; brake, suspension and traction control systems for vehicles; interchangeable containers [swap bodies] being parts of vehicles; tractors; loading vehicles; towing trucks; electric tractors; clutches, gear assemblies, hydraulic and mechanical apparatus for land vehicles, included in this class and other than cars; pedal karts for children; walking bikes for children; farm tractors, agricultural transport apparatus and trailers; loading, forage and discharge wagons.

25 – Clothing, in particular tee-shirts, pullovers, sweatshirts, polo shirts, shirts, trousers, underpants, jackets, vests, overalls, footwear, headwear, caps being headwear, gloves, scarves, socks.

28 – Games, playthings, toys, in particular model toys, toy replicas of machines and vehicles, plastic toys, namely children's vehicles; puzzles.

35 – Providing of an online marketplace for buyers of machines and vehicles (new and used), spare parts and services, in particular in the field of agricultural and forestry machines and motor vehicles; online ordering services in the field of software for the control of agricultural implements and motor vehicles; providing of an online marketplace for buyers of software goods, digital content and videos for download and streaming; provision of space on web-sites for adver-

tising goods and services; negotiation and conclusion of commercial transactions relating to used machines, in particular construction and agricultural machines and motor vehicles, for others, via telecommunication systems; administrative recording and handling of guarantees and warranties by means of a platform; providing of an online marketplace for buyers of custom-assembled machines and motor vehicles; consultancy and information relating to the aforesaid services, included in this class; company management; advertising; marketing and promotion services; commercial information and advice for consumers (consumer advice); retail and wholesale services relating to mechanical equipment for agriculture, machines and machine tools for agriculture, motor vehicles, motors and engines, parts and accessories for all the aforesaid goods; retailing and wholesaling in relation to information technology and audiovisual apparatus, optical apparatus and equipment, amplifiers and correctors, safety, security, protective and signalling apparatus and equipment, navigation, orientation, positioning, tracking and mapping apparatus, measuring, detecting and monitoring instruments, devices and regulators, parts and fittings for all of the aforesaid goods; vehicle fleet business management for rental to businesses; management of fleets for companies; professional business consultancy, research and analysis in the field of the leasing and rental of motor vehicles and agricultural machines, implements and vehicles; business management consultancy in the field of vehicle fleet management; business consultancy and administrative activities in the aforesaid fields.

36 – Insurance underwriting, finance services, monetary affairs, financing and lease-purchase financing of machines, vehicles and parts therefor.

37 – Repairs, namely the repair and maintenance of agricultural machines, commercial vehicles, lorries and trailers; installation, namely of electronic installations, computer hardware and telecommunications apparatus for the modification, storage, processing, linking, control, querying, measuring, recording, evaluation, comparison, exchange and remote transmission of operating data, operating states and other information such as destinations, routes, journey times, locations of motor vehicles, condition of the truck bed and freight, detection of persons on the truck bed, in particular goods transport vehicles; installation, namely of electronic installations, computer hardware and telecommunications apparatus for the modification, storage, processing, linking, control, querying, measuring, recording, evaluation, comparison, exchange and remote transmission of operating data, operating states and other information such as destinations, routes, journey times, locations of motor vehicles, condition of the truck bed and freight, detection of persons on the truck bed, in particular agricultural implements; vehicle maintenance; car cleaning; vehicle servicing (repair, maintenance, servicing, conversion); garage ser-

vices, namely the conducting of inspections, maintenance and repair of motor vehicles and agricultural implements, machines and vehicles, modification of motor vehicles and agricultural implements, machines and vehicles, installation, maintenance and overhaul of parts and accessories for motor vehicles and agricultural implements, machines and vehicles.

38 – Transfer of information and data via online services and the internet, in particular online services for the providing of digital content; electronic transmission of software for controlling engine control mechanisms by remote access; transmission of information on-line; providing access to online databases; telematic (data communication) services, in particular for the use of agricultural machines; telecommunication services, namely transmission of digital data in relation to navigation systems, apparatus enabling wireless access to vehicle and machine data, computerised databases; wireless data transmission; electronic transmission of data and documents via computer terminals and mobile applications; telematic communication services; telematic communication services; telematic communication services; data transmission services over telematic networks; data transmission via cellular radio networks; providing access to an online platform for the sale of machines and vehicles (new and used), spare parts and services, in particular in the field of agricultural and forestry machines and motor vehicles; providing access to an online platform for the sale of software products, digital content and videos for download and streaming; providing access to an online platform for the configuration of machines and motor vehicles.

39 – Rental of motor vehicles, in particular lorries and trailers for transport, and agricultural vehicles; rental of means of transportation and vehicle accessories; rental of bodies for vehicles, semi-trailers, vehicle systems, interchangeable containers for vehicles, container vehicles; rental of transport vehicles; consultancy services relating to transportation; professional consultancy relating to transport; fleet management services in the nature of tracking, monitoring of vehicle fleets and organising of transport services provided by vehicle fleets; transportation logistics; logistics services consisting of the transportation and warehousing of goods, tracking of vehicles, transportation logistics for planning and scheduling shipments for users of transportation services; consultancy in the field of transportation logistics, in particular in the arranging the transportation of goods for others, freight forwarding services; tracking, locating and monitoring of vehicles; cargo tracking services; locating and tracking of cargo for transportation purposes; tracking of passenger or freight vehicles by computer or via GPS; towing services.

41 – Organisation of conferences, exhibitions and competitions; services in the field of adult training, in particular digital e-learning services for the field of

agriculture, agricultural machines and motor vehicles; arranging and conducting of e-learning courses and webinars, in particular in the field of agricultural and construction machines and motor vehicles.

42 – IT services, in particular the design and development of software; hosting services and software as a service and rental of software; IT consultancy, advisory and information services; data duplication and conversion services, data coding services; scientific and technological services, in particular engineering; electronic storage of telemetry data for others (hosting), in particular for the deployment of agricultural machines and motor vehicles; online updating and maintenance of software, design and development of software for downloading via an online shop; online updating and maintenance of software.

44 – Rental of farming equipment and machines.

(260) AM 2026 130202 A
 (800) 1812106
 (151) 2024 03 21
 (891) 2024 03 21
 (731) SPACE EXPLORATION TECHNOLOGIES
 CORP.
 1 ROCKET ROAD, HAWTHORNE CA
 90250, USA

(540)

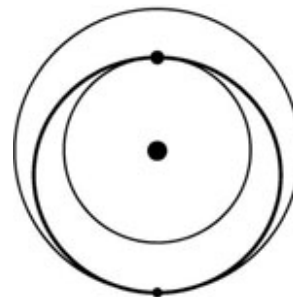

(591) Black, white
 (531) 26.01.05; 26.01.06
 (511)

9 – Global Positioning System using satellite constellations; Internet servers; telecommunication hardware, namely, devices in the nature of satellite-based and earth-based antenna systems that allow wireless connection to global communication networks and wireless connection of electronic devices to global communication networks, and accessories required for facilitating such wireless connection, namely, cables, travel cases, ethernet adaptors, and routers; downloadable and recorded computer software for enabling the transmission of information in the fields of meteorology, climatology, geography, topography, oceanography, and human and animal migration to telecommunications networks and navigation devices; downloadable computer software for enabling wireless connection to global communication networks and wireless connection of electronic devices to global communication networks; electronic global positioning

and geo-location systems devices, namely, global positioning satellite-based receivers; all of the foregoing excluding the US government's global positioning systems; equipment for receiving, processing, and transmitting voice, video, data and information via telecommunications and wireless signals, satellites, and computers, namely, satellite receivers, satellite receiver modules, transmitters of electronic signals, multiplexers, decoding boxes, data processors, integrated circuits, and accessories required for facilitating the transmission of such voice, video, data and information, namely, cables, travel cases, ethernet adaptors, and routers; computer operating hardware and downloadable and recorded computer operating software for use in the aforementioned goods, satellite terminals, and satellite earth stations.

38 – Internet service provider (ISP) services; satellite telecommunications services, namely, transmission of a wireless internet signal via satellites; providing third party users with access to satellite telecommunications infrastructure; telecommunication services, namely, transmission and delivery of digital data, light files, sound files, data, information and image signals, by means of computer and satellite networks; collecting and transmitting real-time data and images obtained via satellites and space vehicles; satellite communication and transmission services; wireless broadband communication services; transmission of data, voice and video via satellite; Interactive satellite communication services; delivery of messages by electronic transmission; providing telecommunications connections to the Internet; telecommunications gateway services; providing high-speed wireless internet access; providing multiple-user access to the internet, global computer networks, and electronic communications networks; providing access to global computer information networks; telecommunications services, namely, transmission of voice, data, graphics, images, audio and video by means of telecommunications networks, wireless communication networks, and the Internet; providing information in the field of satellite telecommunications services via a website; providing information via a website relating to providing Internet access via satellite.

39 – Providing transportation and navigation information for use in the fields of meteorology, climatology, geography, topography, oceanography, and human and animal migration via telecommunications networks and satellite aided navigation devices; providing transportation and navigation information via global positioning and geolocation wireless and satellite networks, excluding the US government's global positioning systems.

42 – Providing via a website geographic mapping data and images obtained via satellites and space vehicles; cloud storage services for electronic data and files; cloud computing services; cloud computing featuring software for collecting, tracking, monitoring and ana-

lyzing data obtained via satellites and space vehicles in the fields of meteorology, climatology, geography, topography, oceanography, human and animal migration; cloud computing featuring software for enabling and managing simultaneous, multiple modes of communication via satellites; cloud computing featuring software for use in connection with data processing, data storage, data capture, data collection, data warehousing, data management, data mining, database analytics, and secure data sharing; satellite telecommunications technology service to allow efficiencies of the carrier by creating efficient use of bandwidth on a satellite transponder; design, development, and maintenance of telecommunications networks, software and apparatus in the field of satellite communications; providing scientific research information in the fields of meteorology, climatology, geography, topography, oceanography, and human and animal migration via telecommunication networks and wireless navigation devices; providing online computer mapping services; research and development of technology in the field of satellite communications; engineering services in the field of satellite communications; scientific research; scientific and technological services, namely, scientific research and analysis of data in the fields of meteorology, climatology, geography, topography, and oceanography; electronic monitoring of environmental and atmospheric conditions using satellites and sensors; remote sensing services, namely, aerial surveying through the use of satellites; searching and retrieving information, sites, and other resources available on computer networks for others in relation to satellite data, recordings, and measurements; providing scientific research information concerning satellite internet services via a global information network.

(260) AM 2026 130203 A

(800) 1812134

(151) 2024 05 20

(891) 2024 05 20

(731) Suzhou Dake Investment Consultation Co., Ltd.
Room 618, Building Number 1, Lucky City
Commercial Center, Suzhou Industrial Park,
Suzhou City, 215000 Jiangsu Province, China

(540)

LAKIAUTO

(591) Black, white

(511)

6 – Tie plates being metal hardware; cast iron, unwrought or semi-wrought; sleeves of metal; metal cable clamps; clips of metal for cables and pipes; small hardware of metal; trays of metal; containers of metal for storage and transport purposes; tanks of metal for storage purposes; oil drainage containers of metal; containers of metal for liquid fuel; boxes of common metal; tool chests of metal, empty; tool boxes of metal, empty.

7 – Glass cutting machines; elevators; cranes; jacks, namely hydraulic jacks, pneumatic jacks and power jacks; derricks; stamping machines for metalworking purposes; apparatus for machining, namely car body repairing machines; power-operated saws; metalworking machine tools; electric polishing machines for use in grinding and polishing metal, wood, ceramics and plastics; bits for power drills, parts of machines; power drill bits; hand-held tools, other than hand-operated; electric hand-held drills; screwdrivers, electric; power drills; pneumatic nut runners; hydraulic torque wrenches; electric glue guns; power-driven spanners; power-operated angle grinders; paint spray guns; pneumatic waste oil drainers; pumps, as parts of machines, engines or motors; water pumps for automobiles; air pumps being garage installations; compressed air machines; welding machines, electric; soldering apparatus, gas-operated; dust removing installations for cleaning purposes; washing machines, namely, pressure washing machines and car washing machines; high pressure washers; dust exhausting installations for cleaning purposes; powered tire changer machines for land vehicles; power-operated tire mounting machines; machines for filling brake fluid.

8 – Shovels being hand tools; saw blades, parts of hand tools; files being hand tools; wood-working wrecking bars being hand tools; spanners; pliers; hand tools, hand-operated; screwdriver bits for hand-operated screwdrivers; bench vices being hand-operated implements; caulking guns, hand-operated; miter sanders being hand tools; glazing irons; tin snips.

9 – Measuring rules; micrometers; slide calipers; scanners for performing automotive diagnostics; refrigerant meters; surveying apparatus; surveying instruments; measuring instruments; precision measuring apparatus; infrared thermometers, not for medical purposes; vehicle wheel alignment machines; wheel alignment meters; voltage testers; digital multimeters; inspection mirrors; cable connectors with screw junctions; gloves for protection against accidents; clothing for protection against accidents, irradiation and fire; gas masks; protection devices for personal use against accidents; batteries, electric, for vehicles; batteries, electric; portable power chargers being rechargeable batteries; wheel balancing machines.

11 – Lamps; lighting apparatus and lighting installations; head torches; lights for vehicles; cooling installations for liquids; air conditioners for vehicles; heat guns; heating apparatus; disinfectant apparatus; electric pocket warmers for warming hands.

12 – Engine mounts for land vehicles; air pumps for automobiles; motors, electric, for land vehicles; air pumps for motorcycles; air pumps for bicycles; electric vehicles; electric bicycles; mechanics' creepers; carts; trolleys [mobile carts]; tyres for vehicle wheels; repair outfits for inner tubes; civilian drones; air pumps being vehicle accessories; luggage carriers for vehicles.

20 – Furniture; stools; furniture of metal, namely tool cabinets of metal; trolleys being furniture; containers, not of metal, for liquid fuel; trays, not of metal; tool boxes, not of metal, empty; tool chests, not of metal, empty; oil drainage containers, not of metal; clips, not of metal, for cables and pipes; vice benches being furniture; non-metal cable clamps; furniture fittings, not of metal; nuts, not of metal; ladders of wood or plastics; work benches; steps [ladders], not of metal; saw horses; step stools, not of metal; plastic ramps for use with vehicles.

(260) AM 2026 130274 A

(800) 1813088

(151) 2024 07 10

(891) 2024 07 10

(731) Apple Inc.

One Apple Park Way; MS 39-11PL; Cupertino
CA 95014, USA

(540)

APPLE MUSIC ATLAS

(591) Black, white

(511)

42 – Hosting a website featuring online non-downloadable computer software for accessing discographies; hosting a website featuring online non-downloadable computer software for accessing music database for music industry professionals.

(260) AM 2026 130275 A

(800) 1813130

(151) 2024 09 06

(891) 2024 09 06

(731) HEAVEN HILL DISTILLERIES, INC.

1064 LORETTO RD, BARDSTOWN KY
40004, USA

(540)

ELIJAH CRAIG

(591) Black, white

(511)

33 – Alcoholic beverages except beer.

(260) AM 2026 130278 A

(800) 1813268

(151) 2024 05 28

(891) 2024 05 28

(731) AŽD Praha s.r.o.

Žirovnická 3146/2, Záběhlice, CZ-106 00 Praha
10, Czech Republic

(540)

EPV 600

(591) Black, white

(511)

6 – Railway switches; railway switches; derailer (derailing point); parts of electromotive and motive point

machines; moving throwing and retaining mechanism for anchoring of electromotive point machines for using in the rail traffic; parts of switching and control mechanisms of electromotive actuators for railway transport [non-electric] – namely jaw locks, roller chairs, roller cams, sliding cams, switch rails, coupled switches, point boxes, clamping inserts; the mechanical point machines for using in railway traffic, [non-electric]; actuating, switching, holding, shifting and control mechanisms specifically for electromotive and electrohydraulic non-electric actuators.

9 – Electro-dynamic apparatus for the remote control of railway points; electromotive actuator with internal locking; electrohydraulic actuator; electromotive point machines [electric]; parts of electromotive actuators [electric] for railway transport – namely electric switch position detectors, electromagnetic locks, turnout actuators, turnout runs, cables, hydraulic mechanism; actuating, switching, holding, shifting, and control mechanisms specifically for electromotive and electrohydraulic electric actuators.

(260) AM 2026 130360 A

(800) 1814443

(151) 2024 07 30

(891) 2024 07 30

(731) SEID, S.A.

CTRA SABADELL A GRANOLLERS,
KM 15, E-08185 LLIÇA DE VALL
(Barcelona), Spain

(540)

Seidicalm

(591) Black, white

(511)

5 – Pharmaceutical and veterinary products; hygienic and sanitary products for medical use; dietetic food and substances for medical or veterinary use, food for babies; food supplements for humans or animals; plasters, material for dressings; teeth filling and dental impression materials; disinfectants; products for destroying vermin; fungicides, herbicides.

(260) AM 2026 130362 A

(800) 1814484

(151) 2024 06 06

(891) 2024 06 06

(731) FABIO FONTANA

Piazza Giorgione, 45, I-31033 Castelfranco
Veneto (TV), Italy

(540)

TAOPATCH

(591) Black, white

(511)

10 – Acupuncture needles; needles for medical purposes; biomagnetic rings for therapeutic or medical purposes; surgical apparatus and instruments; dental ap-

paratus and instruments; medical apparatus and instruments; veterinary apparatus and instruments; physical exercise apparatus for medical purposes; orthodontic appliances; physiotherapy apparatus; esthetic massage apparatus; body rehabilitation apparatus for medical purposes; orthopedic articles; bracelets for medical purposes; corsets for medical purposes; orthopaedic footwear; elastic stockings for surgical purposes; abdominal belts; orthopaedic belts; belts for medical purposes; abdominal corsets; crystals for therapeutic purposes; walking frames for persons with disabilities; dentures; support bandages; elastic bandages, not for dressings; filters for ultraviolet rays, for medical purposes; knee bandages, orthopaedic; gloves for massage; ultraviolet ray lamps for medical purposes; quartz lamps for medical purposes; lamps for medical purposes; kinesiology tapes; arch supports for footwear; electric acupuncture instruments; balling guns; dummies for babies; orthopaedic soles; supports for flat feet; vibromassage apparatus.

41 – Academies [education]; coaching [training]; practical training [demonstration]; providing online videos, not downloadable; providing online electronic publications, not downloadable; arranging and conducting of in-person educational forums; arranging and conducting of conferences; arranging and conducting of congresses; arranging and conducting of colloquiums; arranging and conducting of seminars; arranging and conducting of symposiums; arranging and conducting of workshops [training]; publication of books; publication of texts, other than publicity texts; online publication of electronic books and journals; electronic desktop publishing; writing of texts; physical education; personal trainer services [fitness training]; tutoring.

42 – Electronic data storage; material testing; clinical trials; research and development of new products for others; medical research.

44 – Acupuncture; health counselling; medical advice for individuals with disabilities; physiotherapy; massage; medical equipment rental; rental of hydrogen water generators for baths; medical screening; alternative medicine services; dentistry services; orthodontic services; health assessment services; medical assistance; health care; therapy services.

(260) AM 2026 130363 A

(800) 1814496

(151) 2024 06 20

(891) 2024 06 20

(731) SAMSUNG ELECTRONICS CO., LTD.

129, Samsung-ro, Yeongtong-gu, Suwon-si,
Gyeonggi-do, Republic of Korea

(540)

ArtfulColor

(591) Black, white

(531) 27.05.01

(511)

9 – Televisions; television sets; electronic display panels; monitors for commercial purposes; digital signage; digital signage display panels; digital signage monitors; electronic displays; computer software; software for smart television; software for interactive television.

(260) AM 2026 130364 A

(800) 1814546

(151) 2024 08 06

(891) 2024 08 06

(731) Verizon Trademark Services LLC

1300 I Street, NW, Suite 500 East, Washington
DC 20005, USA

(540)



(591) Red, orange and yellow is/are claimed as a feature of the mark.

(531) 27.05.03; 27.05.09; 27.05.17; 29.01.13

(511)

9 – Mobile telephones; telephone apparatus; cases for telephones; cases for mobile phones; headsets for telephones; network routers; internet servers; wireless routers; telephones; secure digital (SD) memory cards; modems; headphones; computer network servers; protective cases for smartphones; protective covers for smartphones; two-way radios; communication modems; wireless chargers; downloadable software development kits (SDK); USB cables for cellphones; computer network switches; ethernet switches; telecommunications multiplexers; tablet computers; protective films adapted for smartphones; DVD players; computer network adapters; smartphones in the shape of a watch.

37 – Installation of telephone lines; repair or maintenance of telecommunication machines and apparatus; telecommunication wiring; installation, repair and maintenance of computers and computer peripherals; repair of telecommunication machines and apparatus; installation, maintenance and repair of computer hardware; telephone installation and repair; installation of communications network apparatus; installation of communication equipment; installation of cables for internet access; advisory services relating to the installation of telephone equipment.

38 – Communication via television transmissions; electronic transmission of messages and data; voice over IP services; telecommunications gateway services; network transmission of sounds, images, signals and data; video broadcasting; telephone services; network conferencing services; broadcasting programs via a global computer network; providing multiple-user ac-

cess to a global computer information network; video-conference services; communications by fiber optic networks; providing multiple user wireless access to the internet; communication via radio; communication by cellular phones; broadcast of information by means of television; advisory services relating to telecommunications; video-on-demand transmission; wireless broadband communication services; long distance telephone communication services; subscription television broadcasting; international telephone services; video on demand transmissions; text messaging services; call forwarding services; leasing of telecommunication equipment; providing virtual private network (VPN) services; television broadcasting; teleconferencing services; call barring services; computer telephony services; providing third party users with access to telecommunication infrastructure; mobile telephony; mobile telephone communication; mobile radio telephone services; video conferencing services; telephone communications; provision of access to a global computer network; mobile telephone services; internet service provider services; provision of video conferencing services; transmission of sound, video and information; transmission of short messages; transmission of information on optical telecommunication networks; transmission of information by electronic communications networks; providing multiple use access to global computer information networks for the transfer and dissemination of a wide range of information; provision of access to the internet; providing user access to a global computer network; providing telecommunications connections to the internet or databases; teleconferencing and video conferencing services; voice mail services; providing telecommunications connections to a global computer network; pay-per-view television transmission services; streaming of data; providing access to telecommunication networks; communication by mobile telephone; cellular telephone communication; communications via fiber-optic networks; communications by mobile phones; internet broadcasting services; internet access provider services; broadcasting of radio programs; streaming of audio, visual and audiovisual material via a global computer network; transmission of audio content via the internet; audio streaming; telecommunications consultation; rental of computer communication apparatus and instruments; rental of smartphones; wireless PBX services; transmission of location-based messaging; web conferencing services; providing frame relay connectivity services for data transfer; telecommunications services, namely, ISDN services; computer aided transmission of messages and images; provision of access to electronic sites; information transmission by telematic codes; rental of telecommunications lines; rental of equipment for telecommunications; call screening services; internet telephony services; rental of telecommunication equipment; audio teleconferencing; rental of telecommunication routers.

42 – Testing of computer software; computer software design for others; computer network design for others; maintenance of computer software; recovery of computer data; design of computers for others; updating of computer programs for third parties; development of software for secure network operations; consultancy in the field of software design; writing and updating computer software; maintenance of computer software relating to computer security and prevention of computer risks; software design and development; design and writing of computer software; design and development of wireless computer networks; design and development of computer software; computer network configuration services; technical advice relating to operation of computers; technical advisory services relating to computer programs; telecommunications engineering consultancy; computer security threat analysis for protecting data; electronic data back-up services; consultancy in the design and development of computer hardware; computer hardware development; upgrading of computer software; computer software consulting; computer technology consultancy; installation, repair and maintenance of computer software; cloud storage services for electronic data; installation and maintenance of computer software; computer software consultancy; computer security consultancy; design and development of virtual reality software; computer hardware design; computer systems design; consultation services relating to computer software; electronic storage of documents and archived e-mails; online data storage; testing of computers; design of integrated circuits; computer programming; computer systems analysis; leasing of computers; data encryption services; installing computer programs; computer systems integration services; design and development of computer hardware; development of computer platforms; backup services for computer hard drive data; research in the field of edge computing; software engineering services; development, updating and maintenance of software and database systems; electronic storage of files and documents; providing virtual computer systems through cloud computing; testing of computing equipment; design and development of computer firmware; testing of computer hardware; troubleshooting of computer software problems; monitoring of computer systems to detect breakdowns; monitoring of computer systems for detecting unauthorized access or data breach; data security consultancy; computer system analysis; computer system design; electronic monitoring of personally identifying information to detect identity theft via the internet; internet security consultancy; design and development of virtual private network (VPN) operating software; providing user authentication services using single sign-on technology for online software applications; providing information relating to computer technology and programming via a website; consulting services in the field of cloud computing; testing of computer programs; recovery of smartphone data; re-

pair of computer software; providing temporary use of on-line non-downloadable software development tools; leasing of computer apparatus; computer performance testing.

(260) AM 2026 130370 A

(800) 1814751

(151) 2024 05 15

(891) 2024 05 15

(731) Volkova Militsa

vul. Sumska, 68, kv. 23, Kharkiv 61002,
Ukraine;

Valeulin Kostiantyn

prosp. Moskovskyyi, 38, kv. 57, Kharkiv 61001,
Ukraine

(540)

ЧЕРВОНА
КАЛЫНА

(591) Red and white

(531) 26.04.03; 27.05.01; 29.01.01

(511)

33 – Vodka.

(260) AM 2026 130372 A

(800) 1814772

(151) 2024 05 23

(891) 2024 05 23

(731) FAMBILI İLAÇ SANAYİ TİCARET
ANONİM ŞİRKETİ

15 TEMMUZ MAH. KOÇMAN CAD.,
DEMİRKOL PLAZA 54 71, Bağcılar,
İstanbul, Türkiye

(540)



(591) Navy blue

(531) 01.01.02; 01.01.09; 01.01.15; 26.04.03;

26.04.04; 26.04.05; 26.04.13; 26.04.24;

27.05.01; 27.05.10; 29.01.12

(526) PHARMACEUTICALS

(511)

5 – Pharmaceutical and veterinary preparations for medical purposes, chemical preparations for medical and veterinary purposes, chemical reagents for pharmaceutical and veterinary purposes, medicated cosmetics, dietary supplements for pharmaceutical and veterinary purposes, dietary supplements, nutritional supplements, medical preparations for slimming purposes, food for babies, herbs and herbal beverages adapted for medicinal purposes, dental preparations, teeth filling material, dental impression material, dental adhesives and material for repairing teeth, sanitary

preparations for medical use, hygienic pads, hygienic tampons, plasters, materials for dressings, diapers made of paper and textiles for babies, adults and pets, preparations for destroying vermin, herbicides, fungicides, preparations for destroying rodents, deodorants, other than for human beings or for animals, air purifying preparations, air deodorising preparations, disinfectants, antiseptics, detergents for medical purposes, medicated soaps, disinfectant soaps, antibacterial hand lotions.

10 – Surgical, medical, dental and veterinary apparatus and instruments, furniture especially made for medical purposes, artificial limbs and prostheses, medical orthopaedic articles, corsets for medical purposes, orthopaedic shoes, elastic bandages and supportive bandages, surgical gowns and surgical sterile sheets, adult sexual aids, condoms, babies' bottles, babies' pacifiers, teats, gum massagers for babies, bracelets and rings for medical purposes, anti-rheumatism bracelets, anti-rheumatism rings.

35 – Advertising, marketing and public relations, organization of exhibitions and trade fairs for commercial or advertising purposes, provision of an online marketplace for buyers and sellers of goods and services, office functions, secretarial services, arranging newspaper subscriptions for others, compilation of statistics, rental of office machines, systemization of information into computer databases, telephone answering for unavailable subscribers, business management, business administration and business consultancy, accounting, commercial consultancy services, personnel recruitment, personnel placement, employment agencies, import-export agencies, temporary personnel placement services, auctioneering, the bringing together, for the benefit of others, of a variety of goods, namely, chemicals used in industry, science, photography, agriculture, horticulture and forestry, manures and soils, unprocessed artificial resins and unprocessed plastics, fire extinguishing compositions, adhesives not for medical, household and stationery purposes, paints, varnishes, lacquers, preservatives against rust, preservatives against deterioration of wood, thinners and binders for paints, pigments, preservatives for metals, shoe dyes, printing dyes and ink, toners (including filled toner cartridges), colorants for food, pharmaceuticals and beverages, raw natural resins, metals in foil and powder form for painters, decorators, printers and artists, bleaching and cleaning preparations, detergents other than for use in manufacturing operations and for medical purposes, laundry bleach, fabric softeners for laundry use, stain removers, dishwasher detergents, perfumery, non-medicated cosmetics, fragrances, deodorants for personal use and animals, soaps, dental care preparations, dentifrices, denture polishes, tooth whitening preparations, mouth washes, not for medical purposes, abrasive preparations, emery cloth, sandpaper, pumice stone, abrasive pastes, polishing preparations for leather, vinyl, metal

and wood, polishes and creams for leather, vinyl, metal and wood, wax for polishing, industrial oils and greases, cutting fluids, dust absorbing, wetting and binding compositions, solid fuels, coal, firewood, liquid and gas fuels, petrol, diesel oil, liquified petroleum gas, natural gas, fuel oil and their non-chemical additives, candles, wicks, semi-finished wax, wax and paraffin for lighting purposes, electrical energy, pharmaceutical and veterinary preparations for medical purposes, chemical reagents for pharmaceutical and veterinary purposes, medicated cosmetics, dietary supplements for pharmaceutical and veterinary purposes, dietary supplements, nutritional supplements, medical preparations for slimming purposes, food for babies, herbs and herbal beverages adapted for medicinal purposes, dental preparations and articles, teeth filling material, dental impression material, dental adhesives and material for repairing teeth, sanitary preparations for medical use, hygienic pads, hygienic tampons, plasters, materials for dressings, diapers made of paper and textiles for babies, adults and pets, preparations for destroying vermin, herbicides, fungicides, preparations for destroying rodents, deodorants, other than for human beings or for animals, air purifying preparations, air deodorising preparations, disinfectants, antiseptics, detergents for medical purposes, medicated soaps, disinfectant soaps, antibacterial hand lotions, ores of non-precious metal, common metals and their alloys and semi-finished products made of these materials, irons for construction, mats and stirrups of common metals for buildings, common metals in the form of plate, billet, stick, profile, sheet and sheeting, goods and materials of common metal used for storage, wrapping, packaging and sheltering purposes, containers of metal (storage, transport), buildings of metal, frames of metal for building, poles of metal for building, metal boxes, packaging containers of metal, aluminium foil, fences made of metal, guard barriers of metal, metal tubes, storage containers of metal, metal containers for the transportation of goods, ladders of metal, goods of common metal for filtering and sifting purposes, doors, windows, shutters, jalousies and their cases and fittings of metal, non-electric cables and wires of metal, ironmongery, small hardware of metal, screws of metal, nails, bolts of metal, nuts of metal, pegs of metal, flakes of metal, pitons of metal, metal chains, furniture casters of metal, fittings of metal for furniture, industrial metal wheels, door handles of metal, window handles of metal, hinges of metal, metal latches, metal locks, metal keys for locks, metal rings for carrying keys, metal pulleys, ventilation ducts, vents, vent covers, pipes, chimney caps, manhole covers, grilles of metal for ventilation, heating, sewage, telephone, underground electricity and air conditioning installations, metal panels or boards (non-luminous and non-mechanical) used for signalling, route showing, publicity purposes, signboards of metal, advertisement columns of metal, signaling

panels of metal, non-luminous and non-mechanical traffic signs of metal, pipes of metal for transportation of liquids and gas, drilling pipes of metal and their metal fittings, valves of metal, couplings of metal for pipes, elbows of metal for pipes, clips of metal for pipes, connectors of metal for pipes, safes (strong boxes) of metal, metal railway materials, metal rails, metal railway ties, railway switches, bollards of metal, floating docks of metal, mooring buoys of metal, anchors, metal moulds for casting, other than machine parts, works of art made of common metals or their alloys, trophies of common metal, metal closures, bottle caps of metal, metal poles, metal pillars, scaffolding of metal, metal stakes, metal towers, metal pallets and metal ropes for lifting, loading and transportation purposes, metal hangers, ties, straps, tapes and bands used for load-lifting and load-carrying, wheel chocks made primarily of metal, metal profile laths for vehicles for the purposes of decoration, machines, machine tools and industrial robots for processing and shaping wood, metals, glass, plastics and minerals, 3d printers, construction machines and robotic mechanisms (machines) for use in construction, bulldozers, diggers (machines), excavators, road construction and road paving machines, drilling machines, rock drilling machines, road sweeping machines, lifting, loading and transmission machines and robotic mechanisms (machines) for lifting, loading and transmission purposes, elevators, escalators and cranes, machines and robotic mechanisms (machines) for use in agriculture and animal breeding, machines and robotic mechanisms (machines) for processing cereals, fruits, vegetables and food, machines for preparing and processing beverages, engines and motors, other than for land vehicles, parts and fittings therefor, hydraulic and pneumatic controls for engines and motors, brakes other than for vehicles, brake linings for engines, crankshafts, gearboxes, other than for land vehicles, cylinders for engines, pistons for engines, turbines, not for land vehicles, filters for engines and motors, oil, air and fuel filters for land vehicle engines, exhausts for land vehicle engines, exhaust manifolds for land vehicle engines, engine cylinders for land vehicles, engine cylinder heads for land vehicles, pistons for land vehicle engines, carburetors for land vehicles, fuel conversion apparatus for land vehicle engines, injectors for land vehicle engines, fuel economisers for land vehicle engines, pumps for land vehicle engines, valves for land vehicle engines, starter motors for land vehicles, dynamos for land vehicle engines, sparking plugs for land vehicle engines, bearings (parts of machines), roller or ball bearings, machines for mounting and detaching tires, alternators, current generators, electric generators, current generators operated with solar energy, painting machines, automatic spray guns for paint, electric, hydraulic and pneumatic punching machines and guns, electric adhesive tape dispensers [machines], electric guns for compressed gas or liquid spraying machines,

electric hand drills, electric hand saws, electric jigsaw machines, spiral machines, compressed air machines, compressors (machines), vehicle washing installations, industrial robots with the abovementioned functions, electric and gas-operated welding apparatus, electric arc welding apparatus, electric soldering apparatus, electric arc cutting apparatus, electrodes for welding machines, industrial robots (machines) with the abovementioned functions, printing machines, packaging machines, filling, plugging and sealing machines, labellers (machines), sorting machines, industrial robots (machines) with the abovementioned functions, electric packing machines for plugging and sealing of plastics, machines for textile processing, sewing machines, industrial robots (machines) with the abovementioned functions, pumps other than parts of machines or engines, fuel dispensing pumps for service stations, self-regulating fuel pumps, electric kitchen machines for chopping, grinding, crushing, mixing and mincing foodstuff, washing machines, laundry washing machines, dishwashers, spin driers (not heated), electric cleaning machines for cleaning floors, carpets or floorings, vacuum cleaners and parts thereof, automatic vending machines, galvanizing and electroplating machines, electric door openers and closers, gaskets for engines and motors, forks, spoons, knives and non-electric cutters, slicers, peelers for kitchen use, including those made of precious metals, side arms and blades (weapons), tools and apparatus for personal beauty care use, tools and apparatus for shaving, depilation, manicure and pedicure, electric hand implements for straightening and curling hair, scissors, hand-operated [non-electric] hand tools for the repair of machines, apparatus and vehicles and for use in construction, agriculture, horticulture and forestry, none of them being power tools, electric or non-electric irons, steam irons, handles for hand-operated hand tools, measurement apparatus and equipment including those for scientific, nautical, topographic, meteorologic, industrial and laboratory purposes, thermometers, not for medical purposes, barometers, ammeters, voltmeters, hygrometers, testing apparatus not for medical purposes, telescopes, periscopes, directional compasses, speed indicators, laboratory apparatus, microscopes, magnifying glasses, stills, binoculars, ovens and furnaces for laboratory experiments, apparatus for recording, transmission or reproduction of sound or images, cameras, photographic cameras, television apparatus, video recorders, cd and dvd players and recorders, mp3 players, computers, desktop computers, tablet computers, wearable technological devices (smart watches, wristbands, head-mounted devices) microphones, loudspeakers, earphones, telecommunications apparatus, apparatus for the reproduction of sound or images, computer peripheral devices, cell phones, covers for cell phones, telephone apparatus, computer printers, scanners [data processing equipment], photocopiers, magnetic and optical data carriers and computer software and programmes re-

corded thereto, downloadable and recordable electronic publications, encoded magnetic and optical cards, movies, tv series and video music clips recorded on magnetic, optical and electronic media, antennas, satellite antennas, amplifiers for antennas, parts of the aforementioned goods, ticket dispensers, automatic teller machines (atm), electronic components used in the electronic parts of machines and apparatus, semi-conductors, electronic circuits, integrated circuits, chips [integrated circuits], diodes, transistors [electronic], magnetic heads for electronic apparatus, electronic locks, photocells, remote control apparatus for opening and closing doors, optical sensors, counters and quantity indicators for measuring the quantity of consumption, automatic time switches, clothing for protection against accidents, irradiation and fire, safety vests and life-saving apparatus and equipment, eyeglasses, sunglasses, optical lenses and cases, containers, parts and components thereof, apparatus and instruments for conducting, transforming, accumulating or controlling electricity, electric plugs, junction boxes [electricity], electric switches, circuit breakers, fuses, lighting ballasts, battery starter cables, electrical circuit boards, electric resistances, electric sockets, transformers [electricity], electrical adapters, battery chargers, electric door bells, electric and electronic cables, batteries, electric accumulators, solar panels for production of electricity, alarms and anti-theft alarms, other than for vehicles, electric bells, signalling apparatus and instruments, luminous or mechanical signs for traffic use, fire extinguishing apparatus, fire engines, fire hose and fire hose nozzles, radar apparatus, sonars, night vision apparatus and instruments, decorative magnets, metronomes, surgical, medical, dental and veterinary apparatus and instruments, furniture especially made for medical purposes, artificial limbs and prostheses, medical orthopaedic articles, corsets for medical purposes, orthopaedic shoes, elastic bandages and supportive bandages, surgical gowns and surgical sterile sheets, adult sexual aids, condoms, babies' bottles, babies' pacifiers, teats, gum massagers for babies, bracelets and rings for medical purposes, anti-rheumatism bracelets, anti-rheumatism rings, lighting installations, lights for vehicles and interior-exterior spaces, heating installations using solid, liquid or gas fuels or electricity, central heating boilers, boilers for heating installations, radiators [heating], heat exchangers, not parts of machines, stoves, kitchen stoves, solar thermal collectors [heating], steam, gas and fog generators, steam boilers, other than parts of machines, acetylene generators, oxygen generators, nitrogen generators, installations for air-conditioning and ventilating, cooling installations and freezers, electric and gas-powered devices, installations and apparatus for cooking, drying and boiling, cookers, electric cooking pots, electric water heaters, barbecues, electric laundry driers, hair driers, hand drying apparatus, sanitary installations, taps [faucets], shower installations, toilets [water-closets], shower and bathing

cubicles, bath tubs, toilet seats, sinks, wash-hand basins [parts of sanitary installations], washers for water taps, stuffings (tap valves), water softening apparatus, water purification apparatus, water purification installations, waste water purification installations, electric bed warmers and electric blankets, not for medical use, electric pillow warmers, electric or non-electric footwarmers, hot water bottles, electrically heated socks, filters for aquariums and aquarium filtration apparatus, industrial type installations for cooking, drying and cooling purposes, pasteurizers and sterilizers, motor land vehicles, motorcycles, mopeds, engines and motors for land vehicles, clutches for land vehicles, transmissions, transmission belts and transmission chains for land vehicles, gearing for land vehicles, brakes, brake discs and brake linings for land vehicles, vehicle chassis, automobile bonnets, vehicle suspension springs, shock absorbers for automobiles, gearboxes for land vehicles, steering wheels for vehicles, rims for vehicle wheels, bicycles and their bodies, handlebars and mudguards for bicycles, vehicle bodies, tipping bodies for trucks, trailers for tractors, frigorific bodies for land vehicles, trailer hitches for vehicles, vehicle seats, head-rests for vehicle seats, safety seats for children, for vehicles, seat covers for vehicles, vehicle covers (shaped), sun-blinds adapted for vehicles, direction signals and arms for direction signals for vehicles, windscreen wipers and wiper arms for vehicles, inner tubes and tires for vehicle wheels, tubeless tires, tire-fixing sets comprised of tire patches and tire valves for vehicles, windows for vehicles, safety windows for vehicles, rearview mirrors and wing mirrors for vehicles, anti-skid chains for vehicles, luggage carriers for vehicles, bicycle and ski carriers for cars, saddles for bicycles or motorcycles, air pumps for vehicles, for inflating tires, anti-theft alarms for vehicles, horns for vehicles, safety belts for vehicle seats, air bags (safety devices for automobiles), baby carriages, wheelchairs, pushchairs, wheelbarrows, shopping carts, single or multi-wheeled wheelbarrows, shopping trolleys, grocery carts, handling carts, rail vehicles, locomotives, trains, trams, waggons, cable cars, chairlifts, vehicles for locomotion by water and their parts, other than their motors and engines, vehicles for locomotion by air and their parts, other than their motors and engines, firearms, air pistols (weapons), spring-loaded firearms, adapted cases and shoulder straps therefor, heavy weapons, mortars and rockets, fireworks, sprays for personal defence purposes, jewellery, imitation jewellery, gold, precious stones and jewellery made thereof, cufflinks, tie pins, statuettes and figurines of precious metal, clocks, watches and chronometrical instruments, chronometers and their parts, watch straps, trophies made of precious metal, rosaries, musical instruments and cases for musical instruments, paper and cardboard, paper and cardboard for packaging and wrapping purposes, cardboard boxes, paper towels, toilet paper, paper napkins, plastic materials for packaging and wrap-

ping purposes, printing blocks and types, bookbinding material, printed publications, printed matter, books, magazines, newspapers, bill books, printed dispatch notes, printed vouchers, calendars, posters, photographs [printed], paintings, stickers [stationery], postage stamps, stationery, office stationery, instructional and teaching material [except furniture and apparatus], writing and drawing implements, artists' materials, paper products for stationery purposes, adhesives for stationery purposes, pens, pencils, erasers, adhesive tapes for stationery purposes, cardboard cartons [artists' materials], writing paper, copying paper, paper rolls for cash registers, drawing materials, chalkboards, painting pencils, watercolors [paintings], office requisites, paint rollers and paintbrushes for painting, rubber, gutta-percha, gum, asbestos, mica and semi-finished synthetic goods made from these materials in the form of powder, bars, panels and foils, insulation, stopping and sealing materials, insulating paints, insulating fabrics, insulating tape and band, insulation covers for industrial machinery, joint sealant compounds for joints, gaskets, o-rings for sealing purposes (other than gaskets for motors, cylinders and washer for water taps), flexible pipes made from rubber and plastic, hoses made of plastic and rubber, including those used for vehicles, junctions for pipes of plastic and rubber, pipe jackets of plastic and rubber, hoses of textile material, junctions for pipes, not of metal, pipe jackets, not of metal, connecting hose for vehicle radiators, profile laths made of synthetic materials for vehicles for the purposes of decoration, unworked or semi-worked leather and animal skins, imitations of leather, stout leather, leather used for linings, goods made of leather, imitations of leather or other materials, designed for carrying items, bags, wallets, boxes and trunks made of leather or stout leather, keycases, trunks [luggage], suitcases, umbrellas, parasols, sun umbrellas, walking sticks, whips, harness, saddlery, stirrups, straps of leather (saddlery), sand, gravel, crushed stone, asphalt, bitumen, cement, gypsum, plaster, concrete, marble blocks for construction, building materials (as finished products) made of concrete, gypsum, clay, potters' clay, stone, marble, wood, plastics and synthetic materials for building, construction, road construction purposes, non-metallic buildings, non-metallic building materials, poles, not of metal for power lines, barriers not of metal, natural and synthetic coverings in the form of panels and sheets, being building materials, bitumen cardboard for roofing, bitumen covering for roofing, doors and windows of wood and synthetic materials, traffic signs not of metal, non-luminous and non-mechanical, for roads, monuments and statuettes of stone, concrete and marble, building glass, prefabricated swimming pools not of metal (structures), aquarium sand, furniture, made of any kind of material, mattresses, pillows, air mattresses and cushions, not for medical purposes, water beds, mirrors, beehives, artificial honeycombs and sections of wood for honeycombs, boun-

cing chairs for babies, playpens for babies, cradles, infant walkers, display boards, frames for pictures and paintings, identity plates, identification bracelets, name plates, identification tags, made of wood or synthetic materials packaging containers of wood or plastics, casks for use in transportation or storage, barrels, storage drums, tanks, boxes, storage containers, transportation containers, chests, loading pallets and closures for the aforementioned goods, of wood or plastics, small hardware goods of wood or synthetic materials, furniture fittings, of wood or synthetic materials, opening and closing mechanisms of wood or synthetic materials, ornaments and decorative goods of wood, cork, reed, cane, wicker, horn, bone, ivory, whalebone, shell, amber, mother-of-pearl, meerschaum, beeswax, plastic or plaster namely figurines, holiday ornaments for walls, sculptures, trophies, baskets, not of metal, fishing baskets, kennels, nesting boxes and beds for household pets, portable ladders and mobile boarding stairs of wood or synthetic materials, bamboo curtains, roller indoor blinds [for interiors], slatted indoor blinds, vertical indoor blinds, bead curtains for decoration, curtain hooks, curtain rings, curtain tie-backs, curtain rods, non-metal wheel chocks, hand-operated non-electric cleaning instruments and appliances, brushes, except paintbrushes, steel chips for cleaning, sponges for cleaning, steel wool for cleaning, cloths of textile for cleaning, gloves for dishwashing, non-electric polishing machines for household purposes, brooms for carpets, mops, toothbrushes, electric toothbrushes, dental floss, shaving brushes, hair brushes, combs, non-electric household or kitchen utensils, [other than forks, knives, spoons], services [dishes], pots and pans, bottle openers, flower pots, drinking straws, non-electric cooking utensils, ironing boards and shaped covers therefor, drying racks for washing, clothes drying hangers, cages for household pets, indoor aquariums, vivariums and indoor terrariums for animals and plant cultivation, ornaments and decorative goods of glass, porcelain, earthenware or clay namely statues, figurines, vases and trophies, mouse traps, insect traps, electric devices for attracting and killing flies and insects, fly catchers, fly swatters, perfume burners, perfume sprayers, perfume vaporizers, electric or non-electric make-up removing appliances, powder puffs, toilet cases, nozzles for sprinkler hose, nozzles for watering cans, watering devices, garden watering cans, unworked or semi-worked glass, except building glass, mosaics of glass and powdered glass for decoration, except for building, glass wool other than for insulation or textile use, ropes, strings, rope ladders, hammocks, fishing nets, tents, awnings, tarpaulins, sails, vehicle covers, not fitted, bags of textile, for packaging, padding and stuffing materials, except of rubber and plastics, including those of wool and cotton, synthetic fibers for textile use, raw spun fiber, glass fibers for textile use, yarns and threads for textile use, threads and yarns for sewing, embroidery and knitting, thread, elastic yarns

and threads for textile use, woven or non-woven textile fabrics, textile goods for household use, curtains, bed covers, sheets (textile), pillowcases, blankets, quilts, towels, flags, pennants, labels of textile, swaddling blankets, sleeping bags for camping, clothing, including underwear and outerclothing, other than special purpose protective clothing, socks, mufflers [clothing], shawls, bandanas, scarves, belts [clothing], footwear, shoes, slippers, sandals, headgear, hats, caps with visors, berets, caps [headwear], skull caps, laces and embroidery, guipure lace, festoons, ribbons (haberdashery), ribbons and braid, reinforcing tapes for clothing, cords for clothing, letters and numerals for marking linen, embroidered emblems, badges for wear, not of precious metal, shoulder pads for clothing, buttons for clothing, fastenings for clothing, eyelets for clothing, zippers, buckles for shoes and belts, rivet buttons, adhesive tapes [haberdashery], fasteners, pins, other than jewellery, needles, sewing needles, needles for sewing machines, lacing needles, needles for knitting and embroidery, boxes for needles, needle cushions, artificial flowers, artificial fruits, hair pins, hair buckles, hair bands, decorative articles for the hair, not made of precious metal, wigs, hair extensions, electric or non-electric hair curlers, other than hand implements, carpets, rugs, mats, prayer rugs, linoleum, artificial turf, linoleum for covering floors, gymnasium mats, wallpaper, wall hangings not of textile, games and toys, arcade video game machines, game apparatus and machines for use with an external display screen and monitor, including those coin-operated, toys for animals, toys for outdoor playgrounds, parks and game parks, gymnastic and sporting articles, fishing tackle, artificial fishing bait, decoys for hunting and fishing, artificial christmas trees, ornaments for christmas trees, artificial snow for christmas trees, rattles (playthings), novelties for parties, novelty toys for playing jokes and for parties, paper party hats, meat, fish, poultry and game, processed meat products, dried pulses, soups, bouillon, processed olives, olive paste, milks of animal origin, milks of herbal origin, milk products, butter, edible oils, dried, preserved, frozen, cooked, smoked or salted fruits and vegetables, tomato paste, prepared nuts and dried fruits as snacks, hazelnut spreads and peanut butter, tahini (sesame seed paste), eggs and powdered eggs, potato chips, coffee, cocoa, coffee or cocoa based beverages, chocolate based beverages, pasta, stuffed dumplings, noodles, pastries and bakery products based on flour, desserts based on flour and chocolate, bread, simit [turkish ring-shaped bagel covered with sesame seeds], poğaç [turkish bagel], pita, sandwiches, katmer [turkish pastry], pies, cakes, baklava [turkish desert based on dough coated with syrup], kadayıf [turkish dessert based on dough], desserts based on dough coated with syrup, puddings, custard, kazandibi [turkish pudding], rice pudding, keşkül [turkish pudding], honey, bee glue for human consumption, propolis for food purposes, condiments for foodstuff, vanilla (fla-

voring), spices, sauces (condiments), tomato sauce, yeast, baking powder, flour, semolina, starch for food, sugar, cube sugar, powdered sugar, tea, iced tea, confectionery, chocolate, biscuits, crackers, wafers, chewing gums, ice-cream, edible ices, salt, cereal-based snack food, popcorn, crushed oats, corn chips, breakfast cereals, processed wheat for human consumption, crushed barley for human consumption, processed oats for human consumption, processed rye for human consumption, rice, molasses for food, agricultural and horticultural products, seeds, forestry products, live animals, fertilized eggs for hatching, plants, dried plants for decoration, fresh garden herbs, dried garden herbs for decoration, animal foodstuffs, malt not for human consumption, underlays for pets, cat litters, beers, preparations for making beer, mineral water, spring water, table water, soda water, fruit juices and vegetable juices [beverages], fruit and vegetable concentrates for making beverages and non-alcoholic fruit extracts for making beverages, soft drinks, energy drinks, protein-enriched sports beverages alcoholic beverages (except beers), wines, raki [traditional turkish alcoholic drink], whisky, liqueurs, alcoholic cocktails, tobacco, chewing tobacco, cigarettes, cigars, smokers' articles including those made of precious metals, pipes, mouthpieces for cigars and cigarettes, ashtrays, tobacco boxes, pocket apparatus for rolling cigarettes, cigarette paper, tobacco pipes, firestones, lighters for smokers, electronic cigarettes and their cartridges, matches, enabling customers to conveniently view and purchase those goods, such services may be provided by retail stores, wholesale outlets, by means of electronic media or through mail order catalogues.

36 – Insurance services, financial and monetary affairs, real estate brokers, real estate agencies and real estate management, customs brokerage services.

39 – Land, water and air transport services, rental of land, water or air vehicles, arranging of tours, travel reservation, issuing of tickets for travel, courier services (messages or merchandise), car parking, garage rental, boat storage, transport by pipeline, electricity distribution, water supplying, rescue services for vehicles and goods, storage, wrapping and packaging of goods, transport and storage of trash, transport and storage of waste.

44 – Medical services, beauty care services, veterinary services, animal husbandry, animal breeding, shoeing horses [farrier services], agriculture, horticulture and forestry services, landscape design services, medical advisory services in the field of personnel health.

(260) AM 2026 130457 A
 (800) 1815337
 (151) 2024 07 23
 (891) 2024 07 23

(731) Shenzhen Bingbing Paper Ltd
Room 801, 802 and 812, 8th Floor, No.1
Office Block, Vanke Honor Mansion,
Luogang Community, Buji Street, Longgang
District, Shenzhen, Guangdong, China

(540)

MBEAUTY ATTITUDE

(591) Black, white

(511)

5 – Aseptic cotton; sanitary pads; disinfectant wipes; medical dressings; pants, absorbent, for incontinence; babies' diaper-pants; panty liners [sanitary]; sanitary panties; sanitary tampons; sanitary towels.

(260) AM 2026 130458 A

(800) 1815399

(151) 2024 09 09

(891) 2024 09 09

(731) RB HEALTH (US) LLC

399 INTERPACE PARKWAY, PARSIPPANY
NJ 07054, USA

(540)

MOVE FREE

(591) Black, white

(511)

5 – Dietary supplements.

(260) AM 2026 130459 A

(800) 1815413

(151) 2024 02 14

(891) 2024 02 14

(731) Zaychenko Ivan Pavlovich

9, Microraiyon 11, apartment 52, 720049
g. Bishkek, Kyrgyzstan

(540)

LIFEMART

(591) Black, white

(511)

29 – Ajvar being preserved peppers; aloe vera prepared for human consumption; alginates for culinary purposes; anchovy, not live; peanuts, prepared; artichokes, preserved; white of eggs; beans, preserved; soya beans, preserved, for food; bouillon; ginger jam; ham; fatty substances for the manufacture of edible fats; laver, preserved; edible birds' nests; peas, preserved; mushrooms, preserved; guacamole; game, not live; gelatine; meat jellies; jellies for food, other than confectionery; fruit jellies [jams]; yolk of eggs; coconut fat; bone oil for food; lard; suet for food; edible fats; fruit-based snack food; milk substitutes; soya patties; tofu patties; charcuterie; raisins; eggplant paste; vegetable marrow paste; fish roe, prepared; yogurt; sauerkraut; kephir; kimchi; isinglass for food; clams, not live; potato-based dumplings; klipfish [salted and dried cod]; milk shakes; black pudding; onion rings; arrangements of processed fruit; compotes; meat, tin-

ned; vegetables, tinned; fish, tinned; fruits, tinned; bouillon concentrates; corn dogs; gherkins; shrimps, not live; prawns, not live; buttercream; croquettes; silkworm chrysalis for human consumption; sweet corn, processed; kumys; spiny lobsters, not live; lecithin for culinary purposes; edible ant larvae, prepared; salmon, not live; onions, preserved; margarine; marmalade; oils for food; peanut butter; cocoa butter for food; coconut oil for food; coconut butter; corn oil for food; sesame oil for food; linseed oil for food; extra virgin olive oil for food; olive oil for food; palm oil for food; palm kernel oil for food; sunflower oil for food; colza oil for food; butter; soya bean oil for food; shellfish, not live; almonds, ground; animal marrow for food; mussels, not live; milk; peanut milk; peanut milk for culinary purposes; coconut milk; coconut milk for culinary purposes; almond milk; almond milk for culinary purposes; oat milk; rice milk; rice milk for culinary purposes; condensed milk; soured milk; soya milk; albumin milk; powdered milk; fermented baked milk; fish meal for human consumption; vegetable mousses; fish mousses; fruit pulp; meat; meat, preserved; freeze-dried meat; milk beverages, milk predominating; peanut milk-based beverages; coconut milk-based beverages; almond milk-based beverages; edible insects, not live; sausage casings, natural or artificial; vegetables, preserved; freeze-dried vegetables; vegetables, cooked; vegetables, dried; potato fritters; olives, preserved; lobsters, not live; flavored nuts; candied nuts; coconut, desiccated; nuts, prepared; tomato purée; pressed fruit paste; liver pâté; pectin for culinary purposes; liver; pickles; jams; powdered eggs; milk products; fish-based foodstuffs; poultry, not live; bulgogi; pollen prepared as foodstuff; cranberry compote; apple purée; crayfish, not live; crustaceans, not live; fish, preserved; fish, not live; salted fish; vegetable salads; fruit salads; bacon; sardines, not live; pork; herrings, not live; seeds, prepared; sunflower seeds, prepared; whipped cream; cream [dairy products]; vegetable-based cream; fat-containing mixtures for bread slices; smetana; vegetable juices for cooking; lemon juice for culinary purposes; tomato juice for cooking; salted meats; sausages; sausages in batter; hot dog sausages; preparations for making bouillon; preparations for making soup; tofu skin; nut-based spreads; tripe; soups; vegetable soup preparations; whey; cheese; tajine [prepared meat, fish or vegetable dish]; tahini; tofu; sea-cucumbers, not live; truffles, preserved; tuna, not live; oysters, not live; falafel; milk ferments for culinary purposes; rennet; fish fillets; dates; crystallized fruits; frozen fruits; fruit, preserved; fruit preserved in alcohol; fruit, stewed; hazelnuts, prepared; potato flakes; hummus; fruit peel; preserved garlic; lentils, preserved; potato chips; low-fat potato chips; fruit chips; non-alcoholic eggnog; seaweed extracts for food; meat extracts; berries, preserved; eggs; snail eggs for consumption; yakiori.

30 – Vanilla flavourings for culinary purposes; flavourings, other than essential oils, for cakes; flavourings, other than essential oils, for beverages; coffee flavorings; food flavourings, other than essential oils; star aniseed; baozi; cereal bars; high-protein cereal bars; pancakes; savory pancakes; freeze-dried dishes with the main ingredient being pasta; freeze-dried dishes with the main ingredient being rice; noodle-based prepared meals; buns; bulgur; bread rolls; chocolatinés; edible rice paper; edible paper; burritos; vanillin [vanilla substitute]; waffles; vermicelli; natural sweeteners; sausage binding materials; binding agents for ice cream; sea water for cooking; seaweed [condiment]; malt biscuits; cloves [spice]; mirror icing [mirror glaze]; cake frosting [icing]; glucose for culinary purposes; mustard; croûtons; buckwheat, processed; gluten additives for culinary purposes; yeast; thickening agents for cooking foodstuffs; leaven; rice-based snack food; cereal-based snack food; coffee flavourings; vegetal preparations for use as coffee substitutes; dressings for salad; fruit jellies [confectionery]; candy decorations for cakes; confectionery for decorating Christmas trees; cakes; pastries; peanut confectionery; almond confectionery; pasta; ground ginger; frozen yogurt [confectionery ices]; cocoa; cream of tartar for culinary purposes; capers; caramels [sweets]; curry [spice]; ketchup [sauce]; quinoa, processed; quiches; gluten prepared as foodstuff; flour-based dumplings; sweets; liquorice [confectionery]; peppermint sweets; mints for breath freshening; dulce de leche; cinnamon [spice]; coffee; unroasted coffee beans; starch for food; crackers; rice crackers; custard; hominy grits; semolina; oatmeal; crushed barley; groats for human food; ice cubes; corn, milled; corn, roasted; meat pies; turmeric; couscous; noodles; soba noodles; udon noodles; ice for refreshment; ice, natural or artificial; edible ices; potato-based flatbreads; rice cakes; mayonnaise; macarons; macaroni; maltose; hominy; piccalilli; marinades; marzipan; honey; miso; royal jelly; ice cream; bean meal; buckwheat flour; tapioca flour; potato flour; corn flour; nut flours; flour; wheat flour; soya flour; barley meal; dessert mousses [confectionery]; chocolate mousses; muesli; mint for confectionery; cocoa beverages with milk; coffee beverages with milk; coffee-based beverages; cocoa-based beverages; chamomile-based beverages; tea-based beverages; chocolate beverages with milk; chocolate-based beverages; infusions, not medicinal; crushed oats; husked oats; onigiri; chocolate-coated nuts; nutmegs [spice]; stick liquorice [confectionery]; pastilles [confectionery]; molasses for food; pâtés en croûte; pelmeni; pepper; allspice; peppers [seasonings]; pesto; biscuits; petit-beurre biscuits; bibimbap [rice mixed with vegetables and beef]; pies; pizzas; meat gravies; fondants [confectionery]; popcorn; powders for making ice cream; baking powder; mustard meal; pralines; aromatic preparations for food; condiments; meat tenderizers for culinary purposes; cereal preparations; oat-based food; propolis; gingerbread; spices; pe-

tits fours; puddings; rice pudding; cake powder; fruit coulis [sauces]; ravioli; ramen; chewing gum; chewing gum for breath freshening; relish [condiment]; rice; instant rice; wheat germ for human consumption; spring rolls; sago; sugar; palm sugar; sesame seeds [seasonings]; linseed for culinary purposes [seasoning]; processed seeds for use as a seasoning; aniseed; agave syrup [natural sweetener]; golden syrup; savory pancake mixes; baking soda [bicarbonate of soda for cooking purposes]; malt for human consumption; salt for preserving foodstuffs; cooking salt; celery salt; sorbets [ices]; ham glaze; cranberry sauce [condiment]; soya sauce; tomato sauce; pasta sauce; sauces [condiments]; spaghetti; seasonings; chocolate-based spreads; chocolate spreads containing nuts; preparations for stiffening whipped cream; shaved ice with sweetened red beans; rusks; breadcrumbs; sushi; sandwiches; tabbouleh; tacos; tapioca; tarts; dough; pastry dough; almond paste; rice pulp for culinary purposes; cake dough; tortillas; garden herbs, preserved [seasonings]; chocolate decorations for cakes; vinegar; beer vinegar; ferments for pastes; halvah; bread; unleavened bread; corn flakes; oat flakes; chips [cereal products]; hot dog sandwiches; flowers or leaves for use as tea substitutes; jiaozi; chicory [coffee substitute]; tea; iced tea; chutneys [condiments]; minced garlic [condiment]; cheeseburgers [sandwiches]; chow-chow [condiment]; saffron [seasoning]; chocolate; malt extract for food; essences for foodstuffs, except etheric essences and essential oils; husked barley.

31 – Algarovilla for animal consumption; anchovy, live; oranges, fresh; peanuts, fresh; artichokes, fresh; draff; beans, fresh; locust beans, raw; wreaths of natural flowers; grapes, fresh; algae, unprocessed, for human or animal consumption; fruit residue [marc]; dog biscuits; sea-cucumbers, live; peas, fresh; buckwheat, unprocessed; mushroom spawn for propagation; mushrooms, fresh; trees; palm trees; turf, natural; unsawn timber; undressed timber; yeast for animal consumption; Christmas trees; edible chews for animals; live animals; menagerie animals; peanut cake for animals; oil cake; maize cake for cattle; rape cake for cattle; bagasses of cane [raw material]; cereal seeds, unprocessed; grains [cereals]; grains for animal consumption; lime for animal forage; fish spawn; vegetable marrows, fresh; cocoa beans, raw; koi carp, live; potatoes, fresh; chestnuts, fresh; quinoa, unprocessed; arrangements of fresh fruit; copra; raw barks; rough cork; animal foodstuffs; pet food; stall food for animals; bird food; strengthening animal forage; chicory roots; roots for animal consumption; nettles; groats for poultry; maize; edible sesame, unprocessed; shrubs; rose bushes; spiny lobsters, live; lemons, fresh; vine plants; salmon, live; onions, fresh; flower bulbs; leeks, fresh; olives, fresh; bran mash for animal consumption; mussels, live; almonds [fruits]; molluscs, live; peanut meal for animals; linseed meal for animal consumption; meal for animals; flax meal [fodder]; rice meal for forage; fish meal for animal

consumption; straw mulch; beverages for animals; edible insects, live; oats; vegetables, fresh; cucumbers, fresh; lobsters, live; nuts, unprocessed; coconuts; kola nuts; bran; distillery waste for animal consumption; palms [leaves of the palm tree]; cuttle bone for birds; peppers [plants]; aromatic sand [litter] for pets; citrus fruit, fresh; litter for animals; mash for fattening livestock; unprocessed sweet corn ears [husked or unhusked]; animal feed preparations; preparations for egg laying poultry; fishing bait, live; by-products of the processing of cereals, for animal consumption; seeded germ for botanical purposes; poultry, live; wheat; pollen [raw material]; crayfish, live; crustaceans, live; seedlings; plants; aloe vera plants; plants, dried, for decoration; rhubarb, fresh; rice, unprocessed; rye; wheat germ for animal consumption; fish, live; lettuce, fresh; sardines, live; beet, fresh; herrings, live; seeds for planting; linseed for animal consumption; edible linseed, unprocessed; hay; coconut shell; bred stock; sanded paper [litter] for pets; malt for brewing and distilling; straw [forage]; straw litter; salt for cattle; trunks of trees; wood chips for the manufacture of wood pulp; litter peat; sugarcane; truffles, fresh; tuna, live; pumpkins, fresh; oysters, live; fruit, fresh; hazelnuts, fresh; fodder; hops; flowers, dried, for decoration; chicory, fresh; silkworms; garlic, fresh; lentils, fresh; pine cones; hop cones; spinach, fresh; juniper berries; berries, fresh; eggs for hatching, fertilized; silkworm eggs; barley; residue in a still after distillation; garden herbs, fresh; natural flowers.

32 – Aperitifs, non-alcoholic; aerated water; lithia water; seltzer water; soda water; mineral water [beverages]; waters [beverages]; table waters; kvass; cocktails, non-alcoholic; lemonades; non-alcoholic beverages; isotonic beverages; non-alcoholic honey-based beverages; rice-based beverages, other than milk substitutes; soya-based beverages, other than milk substitutes; aloe vera drinks, non-alcoholic; whey beverages; protein-enriched sports beverages; soft drinks; non-alcoholic beverages flavored with coffee; non-alcoholic beverages flavored with tea; non-alcoholic fruit juice beverages; energy drinks; fruit nectars, non-alcoholic; orgeat; powders for effervescing beverages; sarsaparilla [non-alcoholic beverage]; syrups for lemonade; syrups for beverages; smoothies; vegetable juices [beverages]; fruit juices; tomato juice [beverage]; cider, non-alcoholic; non-alcoholic preparations for making beverages; preparations for making aerated water; must; malt wort; pastilles for effervescing beverages; sherbets [beverages]; non-alcoholic fruit extracts; non-alcoholic essences for making beverages.

35 – Import-export agency services; demonstration of goods; providing commercial information and advice for consumers in the choice of products and services; marketing; targeted marketing; organization of exhibitions for commercial or advertising purposes; provision of an online marketplace for buyers and sellers of

goods and services; organization of trade fairs for commercial or advertising purposes; web indexing for commercial or advertising purposes; presentation of goods on communication media, for retail purposes; auctioneering; sales promotion for others; distribution of samples; price comparison services; procurement services for others [purchasing goods and services for other businesses].

43 – Snack-bar services; cafés; cafeteria services; restaurant services; self-service restaurants; food sculpting; canteen services; bar services; food and drink catering; washoku restaurant services; udon and soba restaurant services.

(260) AM 2026 130460 A

(800) 1815414

(151) 2024 03 25

(891) 2024 03 25

(731) Limited Liability Company "IFK Hotel Management"

ul. Gostinichnaya, d.1, et.4, of. 4/5,
munitsipal'nyy okrug Marfino vn.ter.g.,
RU-127106 Moscow, Russian Federation

(540)



**СМОРОДИНА
БЕЛАЯ**

(591) Black and beige

(531) 26.01.01; 26.01.04; 28.05; 29.01.13

(511)

43 – Accommodation bureau services [hotels, boarding houses]; rental of temporary accommodation; tourist home services; hotel reservations; boarding house bookings; temporary accommodation reservations; boarding house services; motel services; reception services for temporary accommodation [management of arrivals and departures]; holiday camp services [lodging]; hotel accommodation services; temporary accommodation provided by halfway houses.

(260) AM 2026 130461 A

(800) 1815417

(151) 2024 03 25

(891) 2024 03 25

(731) Limited Liability Company "IFK Hotel Management"

ul. Gostinichnaya, d. 1, et. 4, of. 4/5,
munitsipal'nyy okrug Marfino vn.ter.g.,
RU-127106 Moscow, Russian Federation

(540)



**СМОРОДИНА
КРАСНАЯ**

(591) Black and red.

(531) 01.07.06; 26.01.01; 26.01.04; 28.05; 29.01.13

(511)

43 – Accommodation bureau services [hotels, boarding houses]; rental of temporary accommodation; tourist home services; hotel reservations; boarding house bookings; temporary accommodation reservations; boarding house services; motel services; reception services for temporary accommodation [management of arrivals and departures]; holiday camp services [lodging]; hotel accommodation services; temporary accommodation provided by halfway houses.

(260) AM 2026 130585 A

(800) 1817284

(151) 2024 04 02

(891) 2024 04 02

(731) ETS ERSOY TURISTIK SERVISLERI

ANONIM SIRKETI

MERDİVENKÖY MAH. NUR SK. C BLOK

1 8, Kadıköy, İstanbul, Türkiye

(540)



(591) Black, yellow, white

(531) 27.05.09; 27.05.17; 27.05.24; 29.01.13

(511)

39 – Travel arrangement; trip, travel and transportation information, advice, search and reservation services; providing information on travel experiences, travel destinations, transportation and travel related services and topics via a searchable database; search and reservation services for travel and transport, flights, car rental, tours, taxi rides and airport transfers; providing travel information and trip routing; ticket reservation services (travel and transport); providing travel information, namely reviews, ratings, comments and recommendations of travel service providers, tours, local attractions (sightseeing services), the rental of vehicles, transportation, including flights, car rentals, transfer and taxi; providing user reviews, ratings, comments and recommendations in the field of travel, transportation; the aforementioned services being pro-

vided via an online platform, portal or other global computer network.

41 – Providing of training; entertainment; sporting and cultural activities; reservation, information and search services for cultural and sporting activities and events, local attractions, amusement and theme parks, entertainment, events, including concerts and shows; publication of newsletters in the fields of travel, travel destinations, trips, transportation, entertainment events, cultural and sporting events and activities; publishing of user reviews, ratings, comments and recommendations in the field of travel, travel destinations, hotels and other temporary accommodations, restaurants, bars, transportation, entertainment, cultural and sporting activities, attractions and events; the aforementioned services being provided via an online platform, portal or other global computer network.

43 – Services for providing food and drink; temporary accommodation; reservation, information and search services for hotels and other temporary accommodation, bars, restaurants and meals; providing information on hotels and other temporary accommodation, bars, restaurants and meals via searchable computer databases; providing information featuring temporary accommodations, bars and restaurants; providing user reviews, ratings, comments and recommendations of temporary accommodations, bars and restaurants; consultation services in the field of accommodation reservation services; providing user reviews, ratings, comments and recommendations in the field of hotels and other temporary accommodations, restaurants, bars; the aforementioned services being provided via an online platform, portal or other global computer network.

(260) AM 2026 130586 A

(800) 1817286

(151) 2024 05 31

(891) 2024 05 31

(731) TXT INTERNATIONAL DMCC

AG-03-E, AG Tower, Plot No: JLT-PH1-I1A,

Jumeirah Lakes Towers, Dubai, United Arab

Emirates

(540)

LIME

(591) Black, white

(531) 27.05.01

(511)

3 – Aromatics [essential oils]; air fragrancing preparations; balms, other than for medical purposes; lip glosses; nail glitter; body glitter; polishing stones; petroleum jelly for cosmetic purposes; cotton wool for cosmetic purposes; cotton wool impregnated with make-up removing preparations; scented water; Javelle water; lavender water; micellar water; toilet water; depilatory wax; moustache wax; massage gels, other

than for medical purposes; deodorants for animals; deodorants for human beings; depilatory preparations; air fragrance reed diffusers; scented wood; perfumes; perfumery; ionone [perfumery]; eyebrow pencils; teeth whitening pens; cosmetic pencils; adhesives for affixing false eyelashes; adhesives for affixing false hair; hair conditioners; colorants for toilet purposes; cosmetic dyes; body paint for cosmetic purposes; creams for leather; skin whitening creams; cosmetic creams; essential oil-based creams for aromatherapy use; incense; hair spray; nail varnish; liquid latex body paint for cosmetic purposes; hair lotions; lotions for cosmetic purposes; after-shave lotions; beauty masks; sheet masks for cosmetic purposes; disposable steam-heated masks, not for medical purposes; oils for perfumes and scents; oils for cosmetic purposes; oils for toilet purposes; essential oils; essential oils for aromatherapy use; essential oils of cedarwood; essential oils of lemon; essential oils of citron; oils for cleaning purposes; bergamot oil; gaultheria oil; jasmine oil; lavender oil; almond oil for cosmetic purposes; rose oil; oil of turpentine for degreasing; almond milk for cosmetic purposes; cleansing milk for toilet purposes; musk [perfumery]; deodorant soap; shaving soap; soap for brightening textile; cakes of toilet soap; anti-perspirant soap; soap for foot perspiration; soap; almond soap; mint for perfumery; gel eye patches for cosmetic purposes; nail art stickers; double eyelid tapes; false nails; eau de Cologne; make-up palettes containing cosmetics; joss sticks; toothpaste; pumice stone; lipstick cases; hydrogen peroxide for cosmetic purposes; dressings for nail reconstruction; breath freshening strips; teeth whitening strips; lipsticks; pomades for cosmetic purposes; shaving preparations; cosmetic preparations for baths; bath preparations, not for medical purposes; hair straightening preparations; hair waving preparations; mouthwashes, not for medical purposes; cosmetic preparations for slimming purposes; eye-washes, not for medical purposes; lacquer-removing preparations; make-up removing preparations; nail care preparations; collagen preparations for cosmetic purposes; aloe vera preparations for cosmetic purposes; sunscreen preparations; breath freshening preparations for personal hygiene; make-up powder; wax melts [fragrancing preparations]; nail varnish removers; false eyelashes; baby wipes impregnated with cleaning preparations; tissues impregnated with cosmetic lotions; tissues impregnated with make-up removing preparations; massage candles for cosmetic purposes; bath salts, not for medical purposes; breath freshening sprays; cooling sprays for cosmetic purposes; astringents for cosmetic purposes; eyebrow cosmetics; make-up preparations; sun-tanning preparations [cosmetics]; hair dyes; neutralizers for permanent waving; cosmetic preparations for eyelashes; cosmetic preparations for skin care; dentifrices; cosmetics; cosmetics for children; toiletry preparations; skin hydrators for cosmetic purposes; phytocosmetic preparations; serums for cosmetic purposes; all-purpose cotton

sticks for personal use; terpenes [essential oils]; mascara; henna [cosmetic dye]; dry shampoos; shampoos; herbal extracts for cosmetic purposes; extracts of flowers [perfumes]; ethereal essences; badian essence; mint essence [essential oil].

(260) AM 2026 130587 A

(800) 1817287

(151) 2024 05 03

(891) 2024 05 03

(731) TXT INTERNATIONAL DMCC

AG-03-E, AG Tower, Plot No: JLT-PH1-I1A,
Jumeirah Lakes Towers, Dubai, United Arab
Emirates

(540)

L I M É

(591) Black, white

(531) 27.05.01

(511)

3 – Perfumery.

9 – Sunglasses.

35 – Commercial information and advice for consumers; sales promotion for others; presentation of goods on communication media, for retail purposes; distribution of samples; procurement services for others [purchasing goods and services for other businesses].

(260) AM 2026 130589 A

(800) 1817326A

(151) 2024 09 03

(891) 2024 09 03

(731) DIDIANE LTD

11, Kynthou, KALLIKAS BLOCK, Flat/Office
A203, CY-2235 Nicosia, Latsia, Cyprus

(540)

1XBET

(591) Black, white

(511)

35 – Production of advertising films; compilation of statistics; web site traffic optimization; web site traffic optimisation.

41 – Provision of information relating to racehorses; provision of information relating to sports; provision of information relating to motor sports; provision of information relating to racing; provision of information relating to jockeys; provision of information relating to motor racing; racing information services; handicapping for sporting events; entertainment in the nature of basketball games; entertainment in the nature of hockey games; entertainment in the nature of football games; entertainment in the nature of soccer games; entertainment in the nature of automobile races; entertainment in the nature of gymnastic performan-

ces; entertainment in the nature of boxing contests; entertainment in the nature of baseball games; entertainment in the nature of yacht races; entertainment in the nature of golf tournaments; entertainment in the nature of wrestling contests; entertainment in the nature of tennis tournaments; entertainment services in the nature of skating events; entertainment in the nature of ice hockey games; entertainment in the nature of weight lifting competitions; entertainment in the nature of track and field competitions; providing wrestling news and information via a global computer network; sporting results services; betting services; horses (betting on -); casino, gaming and gambling services; providing of casino and gaming facilities; providing casino facilities [gambling]; dog races; football pools services; wagering services; on-line gaming services; gaming services for entertainment purposes; gambling; gambling services; game services provided on-line from a computer network; electronic game services and competitions provided by means of the internet; games equipment rental; providing on-line electronic publications, not downloadable; operating lotteries; recreation information.

42 – Computer programming; computer software design; rental of computer software; rental of computer software and programs; rental and maintenance of computer software; creating and maintaining websites; creating and maintaining web sites for others; providing information on computer technology and programming via a web site; maintenance of computer software; updating and maintenance of computer software.

(260) AM 2026 130590 A

(800) 1817353

(151) 2024 04 18

(891) 2024 04 18

(731) Euro Games Technology Ltd.

Panorama Sofia Str. 6, Richhill Business Center,
ground floor, BG-1766 Vitosha Region, Sofia,
Bulgaria

(540)

Lady's Secret

(591) Black, white

(511)

9 – Operating computer software for main frame computers; monitors (computer hardware); computer hardware; apparatus for recording images; monitors (computer programs); computer game programs; recorded computer game programs; apparatus for recording, transmission or reproduction of sound or images; communications servers (computer hardware); electronic components for gambling machines; computer application software featuring games and gaming; computer software for the administration of on-line games and gaming; computer hardware for games and gaming; hardware and software for gambling,

gambling machines, gambling games on the internet and via telecommunication network; computer systems; computer operating system software; computer terminals; interactive terminals; multimedia terminals; electronic terminals for generating lottery tickets; interactive touch screen terminals; computer touchscreens; electronic display panels; liquid crystal display screens; digital signage display panels; multimedia software; multimedia apparatus and instruments; interactive multimedia software for playing games; computer screens; lcd large-screen displays; liquid crystal displays [lcds] for home theatres; media streaming software; computer application software for streaming audio-visual media content via the internet; computer gaming software; software drivers; virtual reality software; games software; entertainment software for computer games; computer programs for network management; electronic lottery tickets; computer software platforms; operating systems; interactive computer systems; operating system programs; computer game software for use with on-line interactive games; interactive casino games provided through a computer or mobile platform; electronic ticket examination machines; software for slot machines, betting software, software for video slot games, for casino games, for gambling and bingo games, provided online or through computer networks and that can be played on any type of computer device, including arcade games, personal computers, portable devices and mobile phones.

28 – Gaming machines for gambling; chips for gambling; mah-jong; arcade games; gambling machines operating with coins, notes and cards; games; electronic games; parlor games; gaming chips; gaming tables; slot machines [gaming machines]; LCD game machines; slot machines and gaming devices; coin-operated amusement machines; roulette chips; poker chips; chips and dice [gaming equipment]; gaming equipment for casinos; roulette tables; gaming roulette wheels; casino games; gambling machines and amusement machines, automatic and coin-operated; coin-operated amusement machines and / or electronic coin-operated amusement machines with or without the possibility of gain; boxes for coin-operated amusement machines, slot machines and gaming machines; electronic or electrotechnical amusement machines and apparatus, gaming machines, coin-operated entertainment machines; housings for coin-operated amusement machines, gaming equipment, gaming machines, machines for gambling; electropneumatic and electrical gambling machines (slot machines); lottery games; electronic targets for games and sports; parlor game equipment and accessories not included in other classes, in particular tokens, chips, marbles; parlor games, apparatus, equipment and accessories therefor, not included in other classes, in particular electronic targets, backgammon, scratch cards, playing cards, lottery cards, dice; lottery tickets; printed lottery tickets; lottery scratch cards; scratch cards for playing lottery games.

41 – Gambling; services related to gambling; gaming services for entertainment purposes; casino, gaming and gambling services; training in the development of software systems; provision of gaming equipment for gambling halls; providing casino equipment [gambling]; gaming machine entertainment services; providing casino facilities [gambling]; amusement arcade services; games equipment rental; rental of gaming machines; providing amusement arcade services; rental of gaming machines with images of fruits; editing or recording of sounds and images; sound recording and video entertainment services; hire of sound reproducing apparatus; provision of gaming equipment for casinos; providing of casino facilities; online gambling services; services related to operation of amusement arcades, on-line casinos and on-line betting websites; online interactive entertainment; on-line casino services; online game services through mobile devices; providing online entertainment in the nature of game tournaments; providing on-line information in the field of computer gaming entertainment; sports betting services; online sports betting services; lottery services; organization of lotteries; conducting lotteries; prize draws [lotteries]; conducting lotteries for others; providing slot machine parlors; rental of slot machines [gaming machines]; providing online games and games of chance.

(260) AM 2026 130591 A
 (800) 1817381
 (151) 2024 08 28
 (891) 2024 08 28
 (731) Geotab, Inc.
 2440 Winston Park Drive, Oakville
 ON L6H 7V2, Canada

(540)



(591) Black, white
 (531) 01.01.03; 01.01.09; 27.05.10; 27.05.17
 (511)

42 – Software as service (SaaS) services featuring intelligent computer software used for vehicle fleet management; software as a service (SaaS) services featuring intelligent computer software used for querying and analyzing movable asset data, vehicle data and vehicle fleet data to generate analysis and insights for vehicle and asset management, vehicle fleet management; software as a service (SaaS) services featuring intelligent computer software used for querying and analyzing movable asset data, vehicle data and vehicle fleet data to generate analysis and insights for maintenance for movable assets, vehicles and vehicle fleets, optimization of routing and navigation, asset

tracking; software as a service (SaaS) services featuring intelligent computer software used for querying and analyzing movable asset data, vehicle data and vehicle fleet data to generate analysis and insights for driver behavior monitoring and coaching, vehicle and movable asset inventory management, fuel efficiency optimization, dispatching and compliance.

(260) AM 2026 130676 A
 (800) 1818729
 (151) 2024 08 13
 (891) 2024 08 13
 (731) MEVA NANO TEKNOLOJI KIMYA
 ITHALAT IHRACAT TICARET LIMITED
 SIRKETI
 SAHIBATA MAH. MIMAR MUZAFFER
 CAD. 30 A, Meram/Konya, Türkiye

(540)



(591) Blue, black
 (531) 24.17.08; 27.05.01; 29.01.12
 (511)
 14 – Jewellery; imitation jewellery; precious metals and their alloys; gemstones; artificial gemstones; clocks and watches; wristwatches; chronometrical instruments; cups [trophies] made of precious metal; trophies made of precious metal alloys; commemorative statuary cups of precious metal; jewellery boxes; presentation boxes for jewellery; boxes of precious metal; boxes for watches; presentation boxes for watches; rosaries.

(260) AM 2026 130677 A
 (800) 1818743
 (151) 2024 08 09
 (891) 2024 08 09
 (731) Shanghai Yiyi Fashion Co., Ltd.
 3rd and 4th floors, Building 2, No. 598,
 Guanghua Road, Minhang District, Shanghai
 City, China

(540)

Pure: Moment:

(591) Black, white
 (511)
 25 – Clothing; tops [clothing]; gloves [clothing]; wedding dresses; hats; skirts; hosiery; shoes; belts [clothing]; scarves.

(260) AM 2026 130678 A
 (800) 1818755
 (151) 2024 07 25
 (891) 2024 07 25
 (731) Schmitz Cargobull Aktiengesellschaft
 Siemensstr. 50, 48341 Altenberge, Germany

(540)

FERROSTRUKT

(591) Black, white

(511)

6 – Common metals and their alloys; building and construction materials and elements of metal; buildings, transportable, of metal; metal hardware; containers of metal for storage, transport and packaging; doors of metal; gates of metal.

12 – Insulated vehicle body panels; vehicles and conveyances; parts and fittings for vehicles; trailers [vehicles]; cars; undercarriages for vehicles; automobile chassis; refrigerated vehicles; tilt trucks; dump carts; container cars; fitted covers for vehicles; tarpaulins adapted [shaped] for use with vehicles; tarpaulins adapted [shaped] for use with vehicular trailers; blinds adapted for vehicles; side shields as structural parts of vehicles; brake segments for vehicles; brake segments for motor cars; drive transmissions for land vehicles; drive units for land vehicles; drive gears [land vehicle parts]; shock absorbers being parts of vehicle suspension; vehicle suspension springs; steering wheels [vehicle parts]; vehicle partitions; underbodies of vehicle; fitted vehicle covers; tail lifts for vehicles; sideguards for vehicles; monocoque structures for vehicles; body panels for vehicles; load bearing sections for chassis frames of vehicles; doors for vehicles; hardtops [roofs] for vehicles; hoods [folding roofs] for vehicles; aerodynamic attachments for vehicle bodies; clutch mechanisms for motor cars; couplings for land vehicles; gears for vehicles; reversing alarms for vehicles; hydraulic circuits for vehicles; anti-theft devices for vehicles; anti-theft alarms for vehicles; mudguards; axle journals; loader swivel axles for vehicles; shafts for land vehicles; brakes for motor cars; brake sets for vehicles; brakes for vehicles; loader swivel axle bogies for vehicles; vehicle chassis; bodies for vehicles; insulated vehicle bodies; bodywork parts for vehicles; tipping bodies for lorries; bodies for trailers; canopies for trailers; trailer chassis for vehicles; pickup truck caps; refrigerated trailers; airsprings for cushioning drivers seats; axles for air suspension systems in vehicles; air springs for vehicle suspension components for cushioning driver's seats and cabs; protecting strips for vehicle doors; hubs for vehicle wheels; axles for vehicles; shock absorbing springs for vehicles; reservoirs for maintaining the level of fluids in vehicle braking systems.

(260) AM 2026 130691 A

(800) 1819099

(151) 2024 06 14

(891) 2024 06 14

(731) Belgicast Internacional, S.L.

B° Zabalondo, 31, E-48100 Mungia (Bizkaia), Spain

(540)



(591) Blue

(531) 26.01.03; 26.01.19; 27.05.21; 29.01.04

(511)

6 – Common metals and their alloys; metal building materials; non-electric cables and wires of common metal; ironmongery, small items of metal hardware; pipes, tubes and hoses, and fittings therefor, including valves, of metal; ores; covers of metal; surface boxes of metal; metal flanges; metal castings; goods of common metal not included in other classes, namely couplings, joints, adaptors, clamps and pipe fittings.

(260) AM 2026 130692 A

(800) 1819114

(151) 2024 07 24

(891) 2024 07 24

(731) Acumatica, Inc.

3075 112th Avenue NE, Suite 200, Bellevue WA 98004, USA

(540)



(591) Blue and black

(531) 27.05.01; 27.05.02; 27.05.09; 27.05.21; 29.01.12

(511)

9 – Downloadable enterprise resource planning software.

42 – Software as a service (SAAS) services, namely, hosting software for use by others for use in enterprise resource planning; platform as a service (PAAS) featuring computer software platform for enterprise resource planning.

(260) AM 2026 130693 A

(800) 1819119

(151) 2024 08 08

(891) 2024 08 08

(731) Farmak AG

Lindenstrasse, 4, CH-6340 Baar, Switzerland

(540)

**DRIVING QUALITY
MEDICINES WORLDWIDE**

(591) Black, white

(511)

5 – Adjuvants for medical purposes; cooling sprays for medical purposes; acaricides; aconitine; alkaloids for medical purposes; albumin dietary supplements; alginates for pharmaceutical purposes; alginate dietary supplements; algicides; aldehydes for pharmaceutical purposes; amino acids for medical purposes; analgesics; anaesthetics; antibiotics; vermifuges / anthelmintics; anti-uric preparations; antiseptics; medicine cases, portable, filled; first-aid boxes, filled; aluminium acetate for pharmaceutical purposes; acetates for pharmaceutical purposes; germicides; bacterial preparations for medical use; bacteriological preparations for medical use; balms for medical purposes; balsamic preparations for medical purposes; royal jelly for pharmaceutical purposes; tobacco-free cigarettes for medical purposes; bandages for dressings; adhesive bandages for medical purposes; bicarbonate of soda for pharmaceutical purposes; albuminous preparations for medical purposes; albuminous foodstuffs for medical purposes; biological preparations for medical purposes; biocides; biocides; bismuth subnitrate for pharmaceutical purposes; linseed meal for pharmaceutical purposes / flaxseed meal for pharmaceutical purposes; flour for pharmaceutical purposes/meal for pharmaceutical purposes; fish meal for pharmaceutical purposes; bromine for pharmaceutical purposes; bronchodilating preparations; vaginal washes for medical purposes; petroleum jelly for medical purposes; vaccines; tartar for pharmaceutical purposes; decoctions for pharmaceutical purposes; vitamin preparations; seawater for medicinal bathing; mineral waters for medical purposes; hydrated chloral for pharmaceutical purposes; dietary fibre / dietary fiber; charcoal for pharmaceutical purposes; astringents for medical purposes; gases for medical purposes; guaiacol for pharmaceutical purposes; sexual stimulant gels; haematogen / hematogen; haemoglobin / hemoglobin; haemostatic pencils / hemostatic pencils; hydrastine; hydrastinine; mustard for pharmaceutical purposes; mustard oil for medical purposes; mustard plasters / mustard poultices; glycerine for medical purposes; glycerophosphates; glucose for medical purposes; homogenized food adapted for medical purposes / homogenised food adapted for medical purposes; hormones for medical purposes, mud for baths; medicinal mud / medicinal sediment [mud]; vulnerary sponges; contraceptive sponges; gamboge for medical purposes; gurjun balsam for medical purposes; disinfectants; detergents for medical purposes; digitalin; infant formula; diastase for medical purposes; royal jelly dietary supplements; glucose dietary supplements; pollen dietary supplements; linseed dietary supplements / flaxseed dietary supplements; linseed oil dietary supplements / flaxseed oil dietary supplements; acai powder dietary supplements; propolis dietary supplements; wheat germ dietary supplements; dietetic beverages adapted for medical purposes; dietetic substances adapted for medical use; dietetic foods adapted

for medical purposes; dietary supplements for human beings; whey protein dietary supplements; brewer's yeast dietary supplements; mineral dietary supplements; yeast for pharmaceutical purposes; yeast dietary supplements; eucalyptus for pharmaceutical purposes; eucalyptol for pharmaceutical purposes; plant extracts, other than essential oils, for pharmaceutical purposes; extracts of medicinal plants; herbal extracts, other than essential oils, for medical purposes; extracts of hops for pharmaceutical purposes; elixirs [pharmaceutical preparations]; enzymes for medical purposes; enzyme dietary supplements; enzyme preparations for medical purposes; esters for pharmaceutical purposes; cellulose esters for pharmaceutical purposes; ethers for pharmaceutical purposes; cellulose ethers for pharmaceutical purposes; febrifuges; gelatine for medical purposes; nicotine gum for use as an aid to stop smoking; chewing gum for medical purposes; nervines; isotopes for medical purposes; immunostimulants; Irish moss for medical purposes; iodine for pharmaceutical purposes; alkaline iodides for pharmaceutical purposes; iodides for pharmaceutical purposes; iodoform; casein dietary supplements; gum for medical purposes; camphor for medical purposes; camphor oil for medical purposes; cannabidiol for medical use; capsules for medicines; capsules made of dendrimer-based polymers, for pharmaceuticals; caustics for pharmaceutical purposes; caustic pencils; cachou for pharmaceutical purposes; quassia for medical purposes; quebracho for medical purposes; oxygen for medical purposes; gallic acid for pharmaceutical purposes; acids for pharmaceutical purposes; oxygen baths; cocaine for medical purposes; collagen for medical purposes; collodion for pharmaceutical purposes; compresses; chemical contraceptives; angostura bark for medical purposes; condurango bark for medical purposes; croton bark; mangrove bark for pharmaceutical purposes; myrobalan bark for pharmaceutical purposes; barks for pharmaceutical purposes; quina for medical purposes / cinchona for medical purposes; medicinal roots; rhubarb roots for pharmaceutical purposes; lint for medical purposes; collyrium; cream of tartar for pharmaceutical purposes; creosote for pharmaceutical purposes; blood for medical purposes; depuratives; pharmaceutical preparations for topical use; dill oil for medical purposes; starch for dietetic or pharmaceutical purposes; biological tissue cultures for medical purposes; cultures of microorganisms for medical use; curare; milk sugar for pharmaceutical purposes / lactose for pharmaceutical purposes; adhesive plasters / sticking plasters; lecithin for medical purposes; lecithin dietary supplements; medicines for alleviating constipation; medicines for human purposes; drugs for medical purposes; medicines for dental purposes; corn remedies; remedies for perspiration; remedies for foot perspiration; liniments; liquorice for pharmaceutical purposes; medicated hair lotions; lupulin for pharmaceutical purposes; magnesia for pharmaceutical purposes; sunburn ointments; honey-based

ointment for medical purposes; ointments for pharmaceutical purposes; frostbite salve for pharmaceutical purposes; massage gels for medical purposes; massage candles for therapeutic purposes; medical dressings; surgical dressings; medicinal alcohol; medical preparations for slimming purposes; melissa water for pharmaceutical purposes; menthol; almond milk for pharmaceutical purposes; antibacterial handwashes; moleskin for medical purposes; mint for pharmaceutical purposes; vitamin supplement patches; nicotine patches for use as aids to stop smoking; medicinal drinks; vesicants; narcotics; linseed for pharmaceutical purposes / flaxseed for pharmaceutical purposes; medicinal infusions; tincture of iodine; tinctures for medical purposes; nutraceutical preparations for therapeutic or medical purposes; cachets for pharmaceutical purposes; medicinal oils, other than essential oils; almond oil for medical purposes; oil of turpentine for pharmaceutical purposes; opiates; opium for medical purposes; opodeldoc; mouthwashes for medical purposes; medicated toothpaste; pastilles for pharmaceutical purposes; pectin for pharmaceutical purposes; pepsins for pharmaceutical purposes; peptones for pharmaceutical purposes; hydrogen peroxide for medical purposes; pearl powder for medical purposes; antioxidant pills; tanning pills; appetite suppressant pills; slimming pills; eyepatches for medical purposes; nutritional supplements; pomades for medical purposes; powder of cantharides; pyrethrum powder; laxatives; bismuth preparations for pharmaceutical purposes; pre-filled syringes for medical purposes; haemorrhoid preparations/hemorrhoid preparations; preparations for callouses; chilblain preparations; dermatological preparations; diagnostic preparations for medical purposes used by medical laboratories; diagnostic preparations for medical purposes; bath preparations for medical purposes; air deodorizing preparations / air deodorising preparations; preparations for reducing sexual activity; acne treatment preparations; preparations for the treatment of burns; lice treatment preparations [pediculicides]; fumigation preparations for medical purposes; ophotherapy preparations / organotherapy preparations; air purifying preparations; appetite suppressants for medical purposes; medicinal hair growth preparations; contact lens cleaning preparations; aloe vera preparations for pharmaceutical purposes; preparations of trace elements for human use; preparations of microorganisms for medical use; skin hydrators being injectable dermal fillers; medicated toiletry preparations; anti-inflammatories; chemical preparations for the diagnosis of pregnancy; preparations to facilitate teething; poultices; purgatives / evacuants; propolis for pharmaceutical purposes; protein dietary supplements; radioactive substances for medical purposes; diagnostic biomarker reagents for medical purposes; radiological contrast substances for medical purposes; digestives for pharmaceutical purposes; cod liver oil; castor oil for medical purposes; ergot for pharmaceutical purposes; solutions for con-

tact lenses; medicated eye-washes; solvents for removing adhesive plasters; cannabis for medical purposes / marijuana for medical purposes; mercurial ointments; sarsaparilla for medical purposes; lead water / Goulard water; sedatives / tranquilizers; wipes impregnated with disinfectants for hygiene purposes; tissues impregnated with pharmaceutical lotions; bouillons for bacteriological cultures for medical purposes / media for bacteriological cultures for medical purposes / bacteriological culture mediums for medical purposes; serotherapeutic medicines; syrups for pharmaceutical purposes; soporifics; salts for mineral water baths; bath salts for medical purposes; smelling salts; potassium salts for medical purposes; mineral water salts; salts for medical purposes; sodium salts for medical purposes; malt for pharmaceutical purposes; malted milk beverages for medical purposes; alcohol for pharmaceutical purposes; douching preparations for medical purposes; suppositories; fumigating pastilles; lozenges for pharmaceutical purposes; therapeutic preparations for the bath; thermal water; tetrahydrocannabinol [THC] for medical use; thymol for pharmaceutical purposes; gentian for pharmaceutical purposes; tonics [medicines]; medicinal herbs; sedatives / tranquilizers; pharmaceutical preparations; pharmaceutical preparations for treating dandruff; pharmaceutical preparations for skin care; pharmaceutical preparations for treating sunburn; lime-based pharmaceutical preparations; pharmaceuticals; phenol for pharmaceutical purposes; fennel for medical purposes; ferments for pharmaceutical purposes; injectable dermal fillers; phytotherapy preparations for medical purposes; formic aldehyde for pharmaceutical purposes; phosphates for pharmaceutical purposes; fungicides; chemical preparations for medical purposes; chemical preparations for pharmaceutical purposes; chemical reagents for medical purposes; chloroform; flowers of sulfur for pharmaceutical purposes; medicated sweets / medicated candies; crystallized rock sugar for medical purposes; sugar for medical purposes; herbal teas for medicinal purposes; bath tea for therapeutic purposes; medicinal tea; asthmatic tea; jujube, medicated; jalap.

35 – Administrative processing of purchase orders; administrative services for medical referrals; administration of consumer loyalty programs; cost price analysis; business auditing; financial auditing; auctioneering; outsourced administrative management for companies; accounting; negotiation of business contracts for others; market studies; opinion polling; invoicing; arranging and conducting of commercial events; payroll preparation; tax preparation; demonstration of goods; business inquiries; administrative assistance in responding to calls for tenders / administrative assistance in responding to requests for proposals [RFPs]; business management assistance; commercial or industrial management assistance; business research; economic forecasting; providing user reviews for commercial or advertising purposes; providing business

information via a website; providing business information; providing telephone directory information; providing commercial information and advice for consumers in the choice of products and services; providing user rankings for commercial or advertising purposes / providing user ratings for commercial or advertising purposes; compilation of information into computer databases; compilation of statistics; web indexing for commercial or advertising purposes; interim business management; commercial administration of the licensing of the goods and services of others; computerized management of medical records and files; computerized file management; personnel management consultancy; business management consultancy; consultancy regarding advertising communication strategies; consultancy regarding public relations communication strategies; business organization consultancy; marketing; influencer marketing; marketing in the framework of software publishing; targeted marketing; marketing through product placement for others in virtual environments; marketing research; provision of an online marketplace for buyers and sellers of goods and services; provision of an online marketplace for buyers and sellers of downloadable digital image files authenticated by non-fungible tokens [NFTs]; writing of curriculum vitae for others / writing of résumés for others; writing of publicity texts; scriptwriting for advertising purposes; book-keeping / accounting; word processing; updating of advertising material; updating and maintenance of data in computer databases; updating and maintenance of information in registries; search engine optimization for sales promotion / search engine optimisation for sales promotion; organization of exhibitions for commercial or advertising purposes; organization of trade fairs; rental of advertising space; shop window dressing; business appraisals; personnel recruitment; business management and organization consultancy; business intermediary services relating to the matching of potential private investors with entrepreneurs needing funding; commercial information agency services; employment agency services; advisory services for business management; business efficiency expert services; outsourcing services [business assistance]; competitive intelligence services; business consultancy services for digital transformation; corporate communications services; layout services for advertising purposes; appointment reminder services [office functions]; data processing services [office functions]; website traffic optimization / website traffic optimisation; price comparison services; sales prospecting for others; preparation of business profitability studies; market intelligence services; procurement services for others [purchasing goods and services for other businesses]; media relations services; appointment scheduling services [office functions]; gift registry services; tax filing services; import-export agency services; lead generation services; business intermediary services relating to the matching of various pro-

fessionals with clients; advertising agency services / publicity agency services; advertising services to create brand identity for others; business partnership search; public relations; commercial lobbying services; commercial intermediation services; wholesale services for pharmaceutical, veterinary and sanitary preparations and medical supplies; retail services for pharmaceutical, veterinary and sanitary preparations and medical supplies; data search in computer files for others; sponsorship search; presentation of goods on communication media, for retail purposes; publication of publicity texts; radio advertising; advertising / publicity; pay per click advertising; outdoor advertising; advertising by mail order; direct mail advertising; online advertising on a computer network; distribution of samples; dissemination of advertising matter; development of marketing concepts; development of advertising concepts; development of business organization strategies relating to corporate social responsibility; business investigations; systemization of information into computer databases; drawing up of statements of accounts; compiling indexes of information for commercial or advertising purposes; consumer profiling for commercial or marketing purposes; sales promotion for others; promotion of goods and services through sponsorship of sports events; promotion of goods through influencers; production of advertising films; production of teleshopping programmes / production of teleshopping programs; television advertising, telemarketing services, negotiation and conclusion of commercial transactions for third parties; professional business consultancy.

(260) AM 2026 130694 A

(800) 1819120

(151) 2024 08 14

(891) 2024 08 14

(731) Vİ-VET KOZMETİK SANAYİ VE TİCARET ANONİM ŞİRKETİ
İKİTELLİ OSB MAH. AYKOSAN 2 KISIM,
12A BLOK SK. AYKOSAN 12A BLOK 1,
Başakşehir, İstanbul, Türkiye

(540)



(591) White and purple

(531) 26.03.23; 26.13.25; 27.05.01; 29.01.12

(511)

3 – Bleaching and cleaning preparations, detergents other than for use in manufacturing operations and for

medical purposes, laundry bleach, fabric softeners for laundry use, stain removers, dishwasher detergents, perfumery, cosmetics, fragrances, deodorants for personal use and animals, soaps, dental care preparations: dentifrices, denture polishes, tooth whitening preparations, mouth washes, not for medical purposes, abrasive preparations, emery cloth, sandpaper, pumice stone, abrasive pastes, polishing preparations for leather, vinyl, metal and wood, polishes and creams for leather, vinyl, metal and wood, wax for polishing.

8 – Forks, spoons, knives and non-electric cutters, slicers, peelers for kitchen use, including those made of precious metals, side arms and blades (weapons), tools and apparatus included in this class for personal beauty care use: tools and apparatus included in this class for shaving, epilation, manicure and pedicure, electric hand implements for straightening and curling hair, scissors, hand-operated [non-electric] hand tools included in this class for the repair of machines, apparatus and vehicles and for use in construction, agriculture, horticulture and forestry, none of them being power tools, electric or non-electric irons, steam irons.

11 – Lighting installations, lights for vehicles and interior-exterior spaces, heating installations using solid, liquid or gas fuels or electricity, central heating boilers, boilers for heating installations, radiators [heating], heat exchangers, not parts of machines, stoves, kitchen stoves, solar thermal collectors [heating], steam, gas and fog generators, steam boilers, other than parts of machines, acetylene generators, oxygen generators, nitrogen generators, installations for air-conditioning and ventilating, cooling installations and freezers, electric and gas-powered devices, installations and apparatus for cooking, drying and boiling: cookers, electric cooking pots, electric water heaters, barbecues, electric laundry driers, hair driers, hand drying apparatus, sanitary installations, taps [faucets], shower installations, toilets [water-closets], shower and bathing cubicles, bath tubs, toilet seats, sinks, wash-hand basins [parts of sanitary installations], water softening apparatus, water purification apparatus, water purification installations, waste water purification installations, electric bed warmers and electric blankets, not for medical use, electric pillow warmers, electric or non-electric footwarmers, hot water bottles, filters for aquariums and aquarium filtration apparatus, industrial type installations for cooking, drying and cooling purposes, pasteurizers and sterilizers.

(260) AM 2026 131128 A

(800) 1824796

(151) 2024 08 08

(891) 2024 08 08

(731) Montres Tudor SA

Rue François-Dussaud 3, CH-1211 Genève 26,
Switzerland

(540)



(591) Black, white

(531) 24.01.03; 27.05.01

(511)

3 – Soaps, air fragrancing preparations, perfumes and toilet water, essential oils; shoe polish, polish for leather.

4 – Candles; industrial oils and greases; lubricants.

8 – Cutlery, forks and spoons; multi-function knives; manicure sets.

9 – Spectacles, spectacle cases, cords for spectacles, goggles for sports; binoculars; audio headsets, earpieces for remote communication, cameras [photography]; diving suits, diving gloves and masks, ear plugs for divers, nose clips for divers and swimmers; helmets for cyclists; smart watches.

11 – Table lamps, lamps for lighting.

14 – Horological instruments, namely, watches, wrist-watches, component parts of timepieces and accessories for timepieces not included in other classes, clocks and other chronometric instruments, chronometers, chronographs (horological instruments), watch bands, dials (horological instruments), watch movements and parts thereof, boxes and presentation cases for horological instruments and jewelry; jewelry, jewelry ("joaillerie"); precious stones and semi-precious stones; precious metals and alloys thereof; pins (jewelry); cuff links; key rings.

16 – Stationery, office requisites except furniture, writing instruments, calendars, gift wrap, terrestrial globes.

20 – Mirrors, hand-held mirrors (toilet mirrors), exhibition stands (display stands), display stands for watches, frames; mother-of-pearl, unworked or semi-worked; shells, meerschaum.

21 – Decanters; art objects made of porcelain, ceramic, earthenware, terracotta or glass; tableware; glassware, porcelain and earthenware, drinking bottles, mugs, coin banks; vases; combs; brushes.

22 – Pouches and bags made of textile for packaging and packing merchandise; tents and tarpaulins.

24 – Lap robes; sheets; bed blankets; beach towels; terry towels.

26 – Decorative ribbons (haberdashery); sewing boxes; sewing kits, buttons, pins and needles; hair ornaments; trouser clips for cyclists.

27 – Rugs, yoga mats, gymnastic mats, mats.

28 – Sporting articles; sports equipment, playing cards, games and toys, plush toys; sports bags (adapted to objects) for carrying sports articles; decorations for Christmas trees.

30 – Chocolates, confectionery, honey, coffee, tea, cocoa.

34 – Smokers' articles, lighters for smokers, matches, ashtrays for smokers.

35 – Advertising; promoting products and services via sponsorship of sports events; retail of perfumes, candles, cutlery, spectacles, lamps, stationery, articles made of leather and imitation leather, hand-held mirrors (toilet mirrors), display stands for watches, crockery, pouches and bags of textile for packaging and wrapping merchandise, lap robes, beach towels, sheets, clothing, sportswear, shoes, headgear, decorative ribbons (haberdashery), gymnastic mats, sports articles, sports equipment, playing cards, games and toys, chocolates, confectionery, smokers' articles.

(260) AM 2026 131129 A

(800) 1824840

(151) 2024 06 13

(891) 2024 06 13

(731) EASTMAN AUTO & POWER LTD

572, Udyog Vihar, Phase V, Gurugram,
Haryana 122016, India

(540)



(591) Black, white

(531) 27.05.01; 27.05.10; 27.05.11; 27.05.17

(511)

12 – Vehicles for locomotion by land, air, water or rail; vehicles (connecting rods for land -), other than parts of motors and engines; automobiles; cars; motor cars; vans [vehicles]; electric vehicles; vehicles (electric -); motor buses; motor coaches; motor homes; motorcycles; scooters [vehicles]; luggage trucks; bicycles; cycles; tricycles; carrier tricycles; tricycles (carrier -); golf carts; carts; casting cars; refrigerated vehicles; vehicles (refrigerated -); trailers [vehicles]; vehicles for transport (military -); vehicles (remote control -), other than toys; vehicles (space -); remote control vehicles, other than toys; trolleys; automobile bodies; bodies for vehicles; chains for bicycles, cycles; chains (cycle -); cycle chains; automobile chains; anti-skid chains; chains (anti-skid -); automobile chassis; chassis (automobile -); chassis (vehicle -); vehicle chassis; automobile hoods; hoods for vehicle engines; hoods for vehicles; automobile tires [tyres]; tires for

vehicle wheels; tires (non-skid devices for vehicle -); tires, solid, for vehicle wheels; vehicle wheel tires [tyres]; wheel tires [tyres] (vehicle -); tires for bicycles, cycles; tyres for bicycles, cycles; bicycle tires [tyres]; cycle tires [tyres]; wheels for bicycles, cycles; tires (flanges of railway wheel -); tyres for vehicle wheels; tyres (non-skid devices for vehicle -); tyres, solid, for vehicle wheels; spikes for tires [tyres]; valves for vehicle tires [tyres]; casings for pneumatic tires [tyres]; non-skid devices for vehicle tires [tyres]; anti-theft alarms for vehicles; anti-theft devices for vehicles; baskets adapted for cycles; bells for bicycles, cycles; bicycle bells; cycle bells; brakes for bicycles, cycles; bicycle brakes; cycle brakes; bicycle chains; bicycle frames; cycle frames; bicycle handle bars; cycle handle bars; bicycle pumps; cycle pumps; bicycle rims; cycle rims; bicycle saddles; cycle saddles; spokes for bicycles, cycles; bicycle spokes; cycle spokes; stands for bicycles, cycles [parts of bicycles, cycles]; bicycle stands; cycle stands; cranks for cycles; cycle cars; cycle hubs; cycle mudguards; mudguards; motors for cycles; pumps for bicycles, cycles; rims for wheels of bicycles, cycles; motors, electric, for land vehicles; driving motors for land vehicles; wheels (vehicle -); vehicle wheels; vehicle wheels (hubs for -); wheel hubs (vehicle -); vehicle wheel rims; vehicle wheel spokes; balance weights for vehicle wheels; bands for wheel hubs; hubs for vehicle wheels; rims for vehicle wheels; spoke clips for wheels; spokes (vehicle wheel -); steering wheels for vehicles; weights (balance -) for vehicle wheels; covers for vehicle steering wheels; covers (seat -) for vehicles; seat covers for vehicles; spare tire covers; spare tyre covers; spare wheel covers; steering wheels (covers for vehicle -); vehicle covers [shaped]; upholstery for vehicles; brakes for vehicles; brake linings for vehicles; brake segments for vehicles; brake shoes for vehicles; linings (brake -) for vehicles; segments (brake -) for vehicles; shoes (brake -) for vehicles; axle journals; axles for vehicles; vehicle seats; seats (vehicle -); safety belts for vehicle seats; safety seats for children, for vehicles; seats (safety -) for children, for vehicles; security harness for vehicle seats; shock absorbers for automobiles; shock absorbers (suspension -) for vehicles; shock absorbing springs for vehicles; suspension shock absorbers for vehicles; suspension springs (vehicle -); vehicle suspension springs; automobiles (sun-blinds adapted for -); bars (torsion -) for vehicles; bumpers for automobiles; caps for vehicle petrol [gas] tanks; casters for trolleys [vehicles] [carts (am.)]; clutches for land vehicles; concrete mixing vehicles; connecting rods for land vehicles, other than parts of motors and engines; converters (torque -) for land vehicles; couplings for land vehicles; crankcases for land vehicle components, other than for engines; driving chains for land vehicles; elevating tailgates (am.) [parts of land vehicles]; engines for land vehicles; gear boxes for land vehicles; gearing for land vehicles; head-rests for vehicle seats; horns for vehicles; hub

caps; hydraulic circuits for vehicles; lifts (tailboard -) [parts of land vehicles]; luggage carriers for vehicles; luggage nets for vehicles; mirrors (rearview -); propulsion mechanisms for land vehicles; pumps (air -) [vehicle accessories]; reduction gears for land vehicles; spoilers for vehicles; strollers; sun-blinds adapted for automobiles; torque converters for land vehicles; torsion bars for vehicles; trailer hitches for vehicles; transmission chains for land vehicles; transmission shafts for land vehicles; transmissions, for land vehicles; treads for vehicles [roller belts]; treads for vehicles [tractor type]; turbines for land vehicles; turn signals for vehicles; undercarriages for vehicles; vehicle bumpers; vehicle petrol [gas] tanks (caps for -); vehicle running boards; vehicles (air cushion -); vehicles (anti-glare devices for -); windows for vehicles; wind-screen wipers; windscreens; windshield wipers; windshields.

(260) AM 2026 131130 A

(800) 1824843

(151) 2024 07 02

(891) 2024 07 02

(731) Toruńskie Zakłady Materiałów Opatrunkowych
Spółka Akcyjna
Żółkiewskiego 20/26, PL-87-100 Toruń, Poland

(540)



(591) Navy blue, white and black

(531) 24.07.01; 24.07.23; 26.04.06; 26.04.07;
26.04.18; 27.05.10; 29.01.13

(511)

3 – Cleansers for intimate personal hygiene purposes, non-medicated; feminine hygiene cleansing towelettes.

5 – Sanitary towels; panty liners; menstruation tampons; pre-moistened medicated cleaning tissue for intimate hygiene personal use.

(260) AM 2026 131225 A

(800) 1233887

(151) 2014 09 03

(891) 2024 11 05

(731) Les Mills International Limited
Level 2, 200 Victoria Street West, Auckland
CBD, Auckland 1010, New Zealand

(540)

LES MILLS

(591) Black, white

(511)

41 – Recreation and training services; sporting activities; education services; producing and conducting exercise to music classes and programmes; producing and conducting exercise classes and programmes synchronised to or accompanied by audio visual content; production and presentation of entertainment including shows, performances and programmes with multimedia and interactive content; gymnasium services; health club services; sports club services; fitness club services; exercise instruction, advisory and training services; sports tuition, coaching and instruction; entertainment; information, advisory and consultancy services relating to any or all of the aforesaid; publication of printed matter and electronic media, including the publication of music and video and audio visual resources with respect to fitness and health club related programs and training materials in digital format; the provision of on-line electronic publications and digital music (not downloadable) from the Internet.

(260) AM 2026 131230 A

(800) 1750065

(151) 2023 08 04

(891) 2024 11 19

(731) Mkhitarian Gegam Garnikovich
apartment 60, 4/2, Kutuzovskiy Prospekt,
RU-121248 Moscow, Russian Federation

(540)

SHARMAX
ШАРМАКС

(591) Black, white

(531) 28.05

(511)

12 – Screw-propellers; screw-propellers for boats; engines for land vehicles; boats; quad bikes; mopeds; motorcycles; water vehicles; electric vehicles; motor scooters; launches.

35 – Demonstration of goods; presentation of goods on communication media, for retail purposes; promoting the goods of others; advertising; online advertising on a computer network.

(260) AM 2026 131233 A

(800) 1814519

(151) 2024 05 07

(891) 2024 11 19

(731) The American Society of Mechanical Engineers
Two Park Avenue, New York NY 10016, USA

(540)



(591) Black, white

(531) 01.05.02; 26.11.08; 27.05.01

(511)

9 – Downloadable electronic publications, namely, e-books, books, magazines, journals, manuals, academic papers, newspapers, newsletters, pamphlets, brochures not for advertising purposes, industry reports, white papers, articles, guides, case studies and codes and standards, namely, engineering specification manuals, all in the field of engineering, technology and science; downloadable software for providing online classes, accessing library materials for use in educational courses, workshops, seminars, conferences, symposia and training in the field of engineering technology and science; multi-media software recorded on digital media, for providing online classes, accessing library materials for use in educational courses, workshops, seminars, conferences, symposia and training in the field of engineering technology and science; downloadable mobile applications for providing event and conference information for use in the field of engineering, technology and science; downloadable mobile applications for reading publications for use in the field of engineering, technology and science; downloadable videos in the field of engineering, technology and science; downloadable podcasts in the field of engineering, technology and science; blank USB flash drives; battery chargers; batteries; USB hubs; computer stylus; USB wall chargers; laser pointers; sleeves for laptops; fitted plastic films known as skins for covering and protecting electronic apparatus, namely, mobile phones, tablets and laptops, cell phone holders in the nature of grips, stands adapted for mobile phones, hand grips for cell phones, mounts for cell phones; USB cables; cell phone battery chargers; wireless chargers; audio speakers; ear buds; wireless ear buds; calculators; mousepads; sunglasses; tire pressure gauges; USB chargers adapted for car cigarette lighter sockets; tape measures; emergency auto kits comprised of a battery charger.

16 – Print publications, namely, books, magazines, journals, codes and standards, namely engineering specification manuals, manuals, academic papers, newspapers, newsletters, pamphlets, brochures not for use in advertising, industry reports, white papers, articles, guides, case studies in the field of engineering, technology and science; writing instruments; pens; blank writing journals; decals; stickers; money clips; adhesive note paper; letter opener; retractable reels for name badge holders.

25 – Shirts, T-shirts, tops as clothing, dress shirts, blouses, hoodies, hooded sweatshirts, sweaters, shorts, tank tops, long-sleeve t-shirts, short sleeve t-shirts, pants, golf shirts, polo shirts, sweatshirts, vests, Henley shirts, sweatpants, jogging pants, jackets, coats, windbreakers, leggings, cardigans, baby bibs not of paper, bodysuits, baby bodysuits, stoles; caps; hats; beanies.

35 – Promoting the commercial and business interests of those involved with the engineering profession and promoting the use and services of engineers, technical professionals, and scientist; arranging, organizing and conducting engineering festivals for business purposes to promote the field of engineering; arranging, organizing and conducting business events in the nature of festivals for business purposes to promote educational opportunities and career opportunities in the fields of engineering, technology, science, medical, and biomedical; providing career information in the field of engineering, technology and science; organizing business networking events in the field of engineering, technology and science; arranging and conducting of exhibitions and trade shows for business purposes; arranging and conducting of trade exhibitions and trade shows for commercial or advertising purposes; providing employment information relating to career placement and career advancement information on engineering via a website; online retail store services featuring clothing, apparel, backpacks, wallets, passport cases, business card holders, pet apparel, umbrellas, tote bags, and bags; online retail store services featuring general consumer merchandise; online retail store services featuring cosmetics and sanitizer; online retail store services featuring electronics, electronics accessories, laptop sleeves, screen protectors, cell phone holders, grips and mounts, electronic cables, chargers, speakers, ear buds, calculators, mousepads, sunglasses, tire pressure gauges, tape measures, automotive emergency kits; online retail store services featuring carabiners, pocket knives, flashlights; online retail store services featuring jewelry and keychains; online retail store services featuring stationery, stickers, paper, journals, letter openers; online retail store services featuring household items, housewares, kitchenware, utensils, ornaments, décor; online retail store services featuring tents not for camping, stadium seats and folding chairs; online retail store services featuring, sporting goods, games, cards, golf accessories; online retail store services featuring confectionaries, candy and chocolate.

41 – Providing online non-downloadable publications, namely, e-books, books, magazines, journals, manuals, academic papers, newspapers, newsletters, pamphlets, non-advertising brochures, industry reports, white papers, articles, guides, case studies and codes and standards, namely, engineering specification manuals, all in the field of engineering, technology and science; entertainment services, namely, providing podcasts in the field of engineering, technology and science; educational services, namely, providing training programs in order to obtain certification in the fields of engineering, technology, and science; education services, namely, providing technical education training in the fields of engineering, technology, and science; educational services, namely, conducting seminars and conferences in the fields of engineering, technology, and science; education services, namely,

providing seminars and workshops in the field of engineering, technology and science; education services, namely, providing panel discussions in the fields of engineering, technology, and science; education services, namely, providing mentoring programs in the fields of engineering, technology, and science; education services, namely, providing panel discussions in the field of engineering, technology and science; interactive on-line training services for education and continuing education, namely, providing online classes in the field of engineering, technology, and science; live and online educational courses, classes, seminars, and workshops in the field of engineering, technology and science; providing online educational, non downloadable webinars for education and continuing education featuring lectures and discussions in the field of engineering, technology and science; arranging and conducting of conferences, exhibitions, and symposia, in the field of engineering, technology and science for educational purposes; providing online non-downloadable educational videos in the fields of engineering, technology, and science; on-line academic library services; corporate educational training, namely, providing classes, courses, workshops and symposia in the field of engineering for engineering professionals; career counseling, namely, providing advice concerning education options to pursue career opportunities; arranging and conducting educational competitions in the fields of engineering, technology, and science; arranging and conducting of contests in the fields of engineering, technology, and science; arranging and conducting of engineering competitions; arranging and conducting of engineering contests; providing online non-downloadable videos in the field of engineering, technology and science; providing online non-downloadable videos featuring engineering, technology and science; arranging and conducting business conferences in the field of engineering, technology, and science.

42 – Providing temporary use of non-downloadable computer software, namely, for personnel certification application and credentialing management; testing, analysis and evaluation of personnel performing testing and quality control inspections for the purpose of certification; consulting services in the field of mechanical engineering; research relating to mechanical engineering; technical consulting in the field of engineering; hosting websites featuring technical information on engineering; certification and accreditation services, namely, evaluation of manufacturers, fabricators, designers, inspection companies, and personnel in conforming to established accreditation standards in the fields of engineering, technology, and science; testing, analysis and evaluation of service providers to determine conformity with established quality accreditation standards for the purpose of certification.

(260) AM 2026 131329 A
(800) 1827976
(151) 2024 10 14
(891) 2024 10 14
(731) CERTUS ALCI VE DOKUM TEKNOLOJİ
SANAYİ ANONİM ŞİRKETİ
Muratpasa Mah.Siteler Cad. No.14 B,
Bayrampasa, İstanbul, Türkiye

(540)



(591) Black, green, white
(531) 26.04.22; 27.05.10; 29.01.13
(511)

19 – Sand, gravel, crushed stone, asphalt, bitumen, cement, gypsum for use in construction, road construction, repair and covering work; building materials (as finished products) made of concrete, gypsum, clay, potters' clay, natural or artificial stone, wood, plastics and synthetic materials for building, construction, road construction purposes, included in this class; non-metallic buildings, nonmetallic building materials, non-metallic transportable buildings, poles, not of metal for power lines, barriers not of metal, doors and windows of wood and synthetic materials; traffic signs not of metal, non-luminous and non-mechanical, for roads; monuments and statuettes of stone, concrete and marble; natural and synthetic surface coatings in the form of panels and sheets, being building materials; heat adhesive synthetic surface coating, being building materials; bitumen cardboard coatings for roofing; bitumen coating for roofing; building glass; prefabricated swimming pools not of metal (structures); aquarium sand.

(260) AM 2026 131330 A
(800) 1827977
(151) 2024 10 21
(891) 2024 10 21
(731) Merck Sharp & Dohme B.V.
Waarderweg 39, NL-2031 BN Haarlem,
Netherlands

(540)



(591) Red, purple and blue
(531) 26.01.01; 26.01.06; 26.01.24; 29.01.13

(511)
5 – Pharmaceutical preparations for use in oncology and to treat the abnormal growth of both benign and cancerous tumors and cysts.

(260) AM 2026 131331 A

(800) 1827986

(151) 2024 09 26

(891) 2024 09 26

(731) NINGBO UNITED TOOLS CO., LTD.

Room 501, No.1, Lishi Financial Plaza,
Shounan Street, Yinzhou District, Ningbo City,
Zhejiang Province, China

(540)



(591) Black, white

(531) 26.04.04; 26.04.05; 26.04.19; 26.04.24;
27.05.01; 27.05.09; 27.05.24

(511)

7 – Aerating pumps for aquaria; machines for processing plastics; jacks [machines]; winches; stamping machines; power hammers; metalworking machines; electric hammers; cutting machines; machines and apparatus for polishing [electric]; handling machines, automatic [manipulators]; cutting blow pipes, gas-operated; riveting machines; gas separating installations; gas liquefying installations; pressure regulating valves; thermic lances [machines]; welding machines, electric; welding apparatus, gas-operated; soldering blow pipes, gas-operated; soldering irons, gas-operated; gas-operated blow torches; electrodes for welding machines; electric welding apparatus; soldering irons, electric; electric arc welding apparatus; electric arc cutting apparatus; soldering lamps; meat mincers [machines]; juice extractors, electric; apparatus for drawing up beer under pressure; apparatus for aerating beverages; sewing machines; beaters, electric; washing machines [laundry]; electromechanical machines for chemical industry; machines for generating hydrogen and oxygen by electrolysis; mixing machines; beating machines; machines for the electronics industry; dynamos.

(260) AM 2026 131332 A

(800) 1827991

(151) 2024 09 30

(891) 2024 09 30

(731) Chongqing Zhouhai Intelligent Technology Co., Ltd.

4th Floor, Building 9, Linkong Intelligent
Industrial Park, No. 6 Langyue Road,
Shuangfengqiao Street, 401120 Yubei District,
Chongqing City, China

(540)

INFOWEAR

(591) Black, white

(511)

9 – Encoded identification bracelets, magnetic; smart-watches [data processing apparatus]; connected bracelets [measuring instruments]; memories for data processing equipment; smartphones in the shape of a watch; wrist-mounted smartphones; data processors; display screen for smartphones; downloadable smartphone software for heart rate monitoring; smartwatches.

14 – Alarm clocks; clocks and watches, electric; sports watches; watches for outdoor use; wristwatches; watch bands; automatic watches; watch cases [parts of watches]; chronographs [watches]; watch pouches.

(260) AM 2026 131333 A

(800) 1828017

(151) 2024 10 01

(891) 2024 10 01

(731) L.V. Vlaardingen Holding B.V.

Koggehaven 24, NL-3133 LA Vlaardingen,
Netherlands

(540)



(591) Black, white and various shades of red

(531) 24.09.01; 24.09.03; 24.09.05; 24.09.16;
24.09.24; 26.04.02; 26.04.18; 26.11.01;
26.11.11; 26.11.12; 26.11.13; 27.05.03;
27.05.11; 27.05.17; 27.05.22; 29.01.13

(511)

35 – Business assistance, management and administrative services; administrative services relating business assistance, management and administrative services; administrative services relating to customs clearance; import-export agency services; administrative data processing; administrative services relating to the operation of storage, delivery, handling and distribution centers; collection and systematization of business data; compilation and management of data files; consultancy and information regarding the aforesaid services; the aforesaid services also provided via electronic networks, such as the internet.

39 – Transport; collection and packaging of goods, including wrapping and repacking of goods for transportation; freight warehousing and transfer of goods; transportation logistics; transit services; ship chartering; ship brokerage and stevedoring; import and export cargo handling services; loading and unloading of vehicles; services of shipping companies (trans-

port); forwarding agency services; transport reservation; arranging of transportation; agency services, freight and transport brokerage services and services of intermediaries relating to transportation, storage and packaging of goods; rental of means of transportation; tracking and tracing of shipments [transport information]; consultancy and information regarding the aforesaid services; the aforesaid services also provided via electronic networks, such as the internet.

(260) AM 2026 131335 A

(800) 1828072

(151) 2024 06 04

(891) 2024 06 04

(731) Anheuser-Busch InBev S.A.

Grand-Place 1, B-1000 Brussels, Belgium

(540)



(591) Red, White, Black and Gold

(531) 01.01.02; 01.01.12; 22.01.05; 22.01.06;

22.01.07; 25.01.01; 25.01.05; 25.01.06;

25.01.09; 25.01.19; 25.01.25; 27.01.12;

27.05.24; 27.05.25; 29.01.13

(511)

32 – Beers; non-alcoholic beverages; mineral and aerated waters; fruit beverages and fruit juices; syrups and other non-alcoholic preparations for making beverages.

(260) AM 2026 131458 A

(800) 1829607

(151) 2024 11 19

(891) 2024 11 19

(731) Roche Diagnostics GmbH

Sandhofer Strasse 116, 68305 Mannheim,

Germany

(540)

COBAS DIRECT

(591) Black, white

(511)

5 – Chemical preparations for medical purposes; biological preparations for medical purposes; biochemical preparations for medical use; in vitro diagnostic preparations for medical use; diagnostic reagents for medical use; reagents for in-vitro laboratory use [for medical purposes]; diagnostic biomarker reagents for medical purposes.

9 – Scientific apparatus and instruments; laboratory instruments [other than for medical use]; instruments

for diagnosis [for scientific use]; quantitative polymerase chain reaction [PCR] instruments for scientific use; real-time polymerase chain reaction [PCR] instruments for scientific use; diagnostic apparatus for research laboratory use; research laboratory analyzers for measuring, testing and analyzing blood and other bodily fluids; laboratory instrument for the detection of pathogens and toxins in a biological sample for research use.

10 – Medical apparatus and instruments; testing apparatus for medical purposes; diagnostic apparatus for medical purposes; real-time polymerase chain reaction [PCR] instruments for medical use; diagnostic testing instruments for use in immunoassay procedure [medical]; immunochemical medical diagnostic testing apparatus for detecting and measuring antibody levels; apparatus for analysing substances [for medical use]; diagnostic apparatus for medical purposes used in medical laboratories.

(260) AM 2026 131459 A

(800) 1829666

(151) 2024 06 20

(891) 2024 06 20

(731) Roen Est S.p.A.

Via dell'Industria, 4, I-34077 Ronchi dei

Legionari, Italy

(540)

ENEX

(591) Black, white

(511)

11 – Heating, ventilating, air conditioning and purification equipment (ambient) and parts and fittings relating to the aforesaid; heat exchangers, other than parts of machines; refrigerating and freezing equipment; apparatus for the treatment of air or water; sanitary installations, water supply and sanitation equipment; evaporators; cooling appliances and installations; refrigerant condensers.

35 – Management of commercial affairs; business administration; office work; assistance to subsidiary companies in managing their business; business organization and management advice; accounting; reproduction of documents; computer file management; organization of exhibitions for commercial or advertising purposes; public relations; marketing; advertising.

37 – Electrical installation services; plant construction; repair of industrial machinery; construction of heating, ventilating, and air conditioning and purification equipment (ambient) and parts and fittings relating to the aforesaid, heat exchangers, other than parts of machines, refrigerating and freezing equipment, industrial treatment installations, sanitary installations, water supply and sanitation equipment, evaporators, cooling appliances and installations, refrigerant condensers; repair of heating, ventilating, air condition-

ning and purification equipment (ambient) and parts and fittings relating to the aforesaid, heat exchangers, other than parts of machines, refrigerating and freezing equipment, industrial treatment installations, sanitary installations, water supply and sanitation equipment, evaporators, cooling appliances and installations, refrigerant condensers; installation services of heating, ventilating, air conditioning and purification equipment (ambient) and parts and fittings relating to the aforesaid, heat exchangers, other than parts of machines, refrigerating and freezing equipment, industrial treatment installations, sanitary installations, water supply and sanitation equipment, evaporators, cooling appliances and installations, refrigerant condensers.

42 – Scientific and technological services; technological research; conducting technical project studies; scientific services and design relating thereto; technological services and design relating thereto; scientific research; industrial analysis and research services; design and development of computer software.

(260) AM 2026 131460 A

(800) 1829668

(151) 2024 08 16

(891) 2024 08 16

(731) Euro Games Technology Ltd.

Panorama Sofia Str. 6, Richhill Business
Center, ground floor, Vitosha Region, BG-1766
Sofia, Bulgaria

(540)

20 BEER CASH

(591) Orange, yellow, red, black, white and green

(531) 05.03.20; 27.05.02; 27.05.03; 27.05.08;
27.05.17; 27.07.02; 27.07.03; 27.07.17;
29.01.15

(511)

9 – Operating computer software for main frame computers; monitors (computer hardware); computer hardware; apparatus for recording images; monitors (computer programs); computer game programs; recorded computer game programs; apparatus for recording, transmission or reproduction of sound or images; communications servers (computer hardware); electronic components for gambling machines; computer application software featuring games and gaming; computer software for the administration of on-line games and gaming; computer hardware for games and gaming; computer hardware and software for gambling, gambling machines, gambling games on the internet and via telecommunication network; computer systems; computer operating system software; computer terminals; interactive terminals; multimedia terminals; electronic terminals for generating lottery tickets; interactive touch screen terminals; computer touchscreens; electronic display panels; liquid crystal display screens; digital signage display panels; multimedia software; multimedia apparatus and instru-

ments; interactive multimedia software for playing games; computer screens; LCD large-screen displays; liquid crystal displays [LCDs] for home theatres; media streaming software; computer application software for streaming audio-visual media content via the internet; computer gaming software; software drivers; virtual reality software; games software; entertainment software for computer games; computer programs for network management; electronic lottery tickets; computer software platforms; operating systems; interactive computer systems; operating system programs; computer game software for use with on-line interactive games; interactive casino games provided through a computer or mobile platform; electronic ticket examination machines; software for slot machines, betting software, software for video slot games, for casino games, for gambling and bingo games, provided online or through computer networks and that can be played on any type of computer device, including arcade games, personal computers, portable devices and mobile phones; software; computer software packages; computer software, recorded.

28 – Gaming machines for gambling; chips for gambling; mah-jong; arcade games; gambling machines operating with coins, notes and cards; games; electronic games; parlor games; gaming chips; gaming tables; slot machines [gaming machines]; LCD game machines; slot machines and gaming devices; coin-operated amusement machines; roulette chips; poker chips; chips and dice [gaming equipment]; gaming equipment for casinos; roulette tables; gaming roulette wheels; casino games; gambling machines and amusement machines, automatic and coin-operated; coin-operated amusement machines and/or electronic coin-operated amusement machines with or without the possibility of gain; boxes for coin-operated amusement machines, slot machines and gaming machines; electronic or electrotechnical amusement machines and apparatus, gaming machines, coin-operated entertainment machines; housings for coin-operated amusement machines, gaming equipment, gaming machines, machines for gambling; electropneumatic and electrical gambling machines (slot machines); lottery games; electronic targets for games and sports; parlor game equipment and accessories therefor, included in this class, in particular gaming tokens, chips and marbles; parlor games, game apparatus and equipment and accessories therefor, included in this class, in particular electronic targets, backgammon games, scratch cards, playing cards, lottery cards, dice; lottery tickets; printed lottery tickets; lottery scratch cards; scratch cards for playing lottery games.

41 – Gambling; gaming services for entertainment purposes; casino, gaming and gambling services; training in the development of software systems; provision of gaming equipment for gambling halls; providing casino equipment [gambling]; gaming machine entertainment services; providing casino facilities [gamb-

ling]; amusement arcade services; games equipment rental; rental of gaming machines; providing amusement arcade services; rental of gaming machines with images of fruits; editing or recording of sounds and images; sound recording and video entertainment services; hire of sound reproducing apparatus; provision of gaming equipment for casinos; providing of casino facilities; online gambling services; entertainment services related to operation of amusement arcades, on-line casinos and on-line betting services via websites; online interactive entertainment; on-line casino services; online game services through mobile devices; providing online entertainment in the nature of game tournaments; providing on-line information in the field of computer gaming entertainment; sports betting services; online sports betting services; lottery services; organization of lotteries; conducting lotteries; prize draws [lotteries]; conducting lotteries for others; providing slot machine parlors; rental of slot machines [gaming machines]; providing online games and games of chance.

(260) AM 2026 131462 A
(800) 702594
(151) 1998 11 06
(891) 2024 11 27
(731) Tikkurila Oyj
Heidehofintie 2, FI-01300 Vantaa,
Finland

(540)

MIRANOL

(591) Black, white
(511)
2 – Paints and lacquers.

(260) AM 2026 131463 A
(800) 872829
(151) 2005 11 14
(891) 2024 10 06
(731) ADIPHARM EAD
130, boul. "Simeonovsko chaussee", BG-1700
SOFIA, Bulgaria

(540)

FARINGOBLOC

(591) Black, white
(511)
5 – Pharmaceutical products.

(260) AM 2026 131464 A
(800) 919559
(151) 2007 03 09
(891) 2024 10 06
(731) ADIPHARM E A D
Boul. "Simeonovsko chaussee" 130, BG-1700
SOFIA, Bulgaria

(540)

METOCOR

(591) Black, white
(511)
5 – Medicines for arterial hypertonia (high blood pressure) treatment.

(260) AM 2026 131472 A
(800) 1690297
(151) 2022 09 12
(891) 2024 12 05
(731) JOE & THE JUICE A/S
Østergade 26, DK-1100 København K,
Denmark

(540)



(591) Pink, white and black
(531) 02.01.01; 02.01.16; 02.01.18; 02.01.23;
26.01.14; 29.01.13

(511)
30 – Coffee, tea, cocoa, sugar, rice, tapioca, sago, artificial coffee, flour and preparations made from cereals, namely ready-to-eat food bars made from cereals; bread, pastry and confectionery, namely cakes; ices, honey, treacle, yeast, baking powder, salt, mustard, vinegar, sauces (condiments), spices, ice.

32 – Beer, mineral and aerated waters and other non-alcoholic drinks in the form of sweet cider; fruit drinks and fruit juices, syrups and other preparations in powder form for making beverages.

35 – Advertising; business management; business administration; office functions; business assistance relating to franchising.

43 – Services for providing food and drink; temporary accommodation; cafés; restaurants; snack-bars.

(260) AM 2026 131473 A
(800) 1703297
(151) 2022 10 25
(891) 2024 12 04
(731) Citizen Tokei Kabushiki Kaisha also trading as
Citizen Watch Co., Ltd.
1-12, 6-chome, Tanashi-cho, Nishi-tokyo-shi,
Tokyo 188-8511, Japan

(540)



(591) Black, white

(531) 14.03.13; 26.01.01; 26.01.03; 26.01.12;
26.13.25; 27.05.01

(511)

14 – Watches, clocks, movements for clocks and watches, and parts and fittings thereof.

(260) AM 2026 131474 A

(800) 1760066

(151) 2023 07 07

(891) 2024 10 18

(731) SAMSUNG ELECTRONICS CO., LTD.

129, Samsung-ro, Yeongtong-gu, Suwon-si,
Gyeonggi-do, Republic of Korea

(540)

Knox Suite

(591) Black, white

(531) 27.05.01

(511)

9 – Security platform software programs; downloadable and preloaded computer security software; downloadable and preloaded smartphone security software; downloadable and preloaded tablet PC security software; computer hardware and software for providing secure remote access to computer and communication networks; smartphone hardware and software for providing secure remote access to smartphone and communication networks; tablet PC hardware and software for providing secure remote access to tablet PC and communication networks.

42 – Computer security consultancy; computer security threat analysis for protecting data; design and development of electronic data security systems; development of software for secure network operations; maintenance of computer software relating to computer security and prevention of computer risks; updating of computer software relating to computer security and prevention of computer risks; security consultancy for security platform software, computer security software, smartphone security software, tablet PC security software, and secure remote access to computer, smartphone, tablet PC and communication networks; computer security threat analysis for security platform software, computer security software, smartphone security software, tablet PC security software, and secure remote access to computer, smartphone, tablet PC and communication networks; design and development of security systems of secure remote access to computer, smartphone, tablet PC and communication networks; development of computer software for

security platform, computer security, smartphone security, tablet PC security and secure remote access to computer, smartphone, tablet PC and communication networks; maintenance of computer software relating to security platform, computer security, smartphone security, tablet PC security, and secure remote access to computer, smartphone, tablet PC and communication networks; updating of computer software relating to computer security, smartphone security, tablet PC security, and secure remote access to computer, smartphone, tablet PC and communication networks; prevention of risks relating to computer security, smartphone security, tablet PC security, and secure remote access to computer, smartphone, tablet PC and communication networks.

(260) AM 2026 131476 A

(800) 1776423

(151) 2023 09 18

(891) 2024 08 07

(731) INSPARK AKILLI İŞ ÇÖZÜMLERİ

LİMİTED ŞİRKETİ

ORTAKÖY MAHALLESİ, AMBARLIDERE

YOLU SOKAK, LOTUS VVORLD 6 16,

Beşiktaş, İstanbul, Türkiye

(540)

(591) Black, green and blue

(531) 26.11.12; 27.05.01; 27.05.08; 29.01.13

(511)

35 – Advertising, marketing and public relations; organization of exhibitions and trade fairs for commercial or advertising purposes; development of advertising concepts; provision of an online marketplace for buyers and sellers of goods and services; office functions; secretarial services; arranging newspaper subscriptions for others; compilation of statistics; rental of office machines; systemization of information into computer databases; telephone answering for unavailable subscribers; business management, business administration and business consultancy; accounting; commercial consultancy services; personnel recruitment, personnel placement, employment agencies, import-export agencies; temporary personnel placement services; auctioneering; the bringing together, for the benefit of others, of a variety of goods, namely, measurement apparatus and equipment including those for scientific, nautical, topographic, meteorologic, industrial and laboratory purposes, thermometers, not for medical purposes, barometers, ammeters, voltmeters, hygrometers, testing apparatus not for medical purposes, telescopes, periscopes, directional compasses, speed indicators, laboratory apparatus, microscopes, magnifying glasses, stills, binoculars, ovens and furnaces for laboratory experiments, apparatus for recording, transmission or reproduction of sound or images, cameras, photographic cameras, television appa-

ratus, video recorders, CD and DVD players and recorders, MP3 players, computers, desktop computers, tablet computers, wearable computers, wearable speakers, wearable activity trackers, wearable video display monitors, microphones, loudspeakers, earphones, telecommunications apparatus, apparatus for the reproduction of sound or images, computer peripheral devices, cell phones, covers for cell phones, telephone apparatus, computer printers, scanners [data processing equipment], photocopiers, magnetic and optical data carriers and computer software and programmes recorded thereto, downloadable and recordable electronic publications, encoded magnetic and optical cards, Movies, tv series and video music clips recorded on magnetic, optical and electronic media, antennas, satellite antennas, amplifiers for antennas, parts of the aforementioned goods, ticket dispensers, automatic teller machines (ATM), electronic components used in the electronic parts of machines and apparatus: semi-conductors, electronic circuits, integrated circuits, chips [integrated circuits], diodes, transistors [electronic], magnetic heads for electronic apparatus, electronic locks, photocells, remote control apparatus for opening and closing doors, optical sensors, counters and quantity indicators for measuring the quantity of consumption, automatic time switches, clothing for protection against accidents, irradiation and fire, safety vests and life-saving apparatus and equipment, eyeglasses, sunglasses, optical lenses and cases, containers, parts and components thereof, apparatus and instruments for conducting, transforming, accumulating or controlling electricity, electric plugs, junction boxes [electricity], electric switches, circuit breakers, fuses, lighting ballasts, battery starter cables, electrical circuit boards, electric resistances, electric sockets, transformers [electricity], electrical adapters, battery chargers, electric door bells, electric and electronic cables, batteries, electric accumulators, solar panels for production of electricity, alarms and anti-theft alarms, other than for vehicles, electric bells, signalling apparatus and instruments, luminous or mechanical signs for traffic use, fire extinguishing apparatus, fire engines, fire hose and fire hose nozzles, radar apparatus, sonars, night vision apparatus and instruments, decorative magnets, metronomes, enabling customers to conveniently view and purchase those goods, such services may be provided by retail stores, wholesale outlets, by means of electronic media or through mail order catalogues.

42 – Scientific and industrial analysis and research services; engineering; engineering and architectural design services; testing services for the certification of quality and standards; computer services, namely, computer programming, computer virus protection services, computer system design, creating, maintaining and updating websites for others, computer software design, updating and rental of computer software, providing search engines for the internet, hosting websites, consultancy in the design and development of co-

mputer hardware, rental of computer hardware; industrial design services, other than engineering, computer and architectural design; graphic arts designing; authenticating works of art.

(260) AM 2026 131477 A
 (800) 1784080
 (151) 2024 01 31
 (891) 2024 11 08
 (731) Limited Liability Company "Agroindustrial complex "DAMATE"
 prospect Stroiteley, bldg. 1 M, room 212,
 Penzenskaya region, city district of Penza,
 RU-440066 Penza, Russian Federation

(540)

ИНДИЛАЙТ

(591) Black, white

(531) 28.05

(511)

29 – Meat, poultry and game; meat extracts; ham; meat jellies; charcuterie; meat, tinned; broth concentrates; meat, preserved; liver pâté; poultry, not live; sausages; sausages in batter; preparations for making bouillon; tripe.

(260) AM 2026 131478 A
 (800) 1808208
 (151) 2024 07 01
 (891) 2024 11 05
 (731) "N-Tools" Limited Liability Partnership
 kv. 52, dom 94, Mikrorayon Aynabulak,
 Zhetysuskiy rayon, 050000 Almaty,
 Kazakhstan

(540)



(591) Black, white and red.

(531) 02.01.01; 02.01.23; 24.01.08; 27.05.01;
 27.05.17; 29.01.13

(511)

7 – 3D bioprinters; 3D printers; ticket vending machines; vending machines; welding machines, electric; soldering apparatus, gas-operated; apparatus for aerating water; vulcanization apparatus; acetylene cleaning apparatus; high pressure washers; apparatus for drawing up beer under pressure; apparatus for aerating beverages; electrical apparatus for sealing plastics [packaging]; electric arc cutting apparatus; electric arc welding apparatus; electric welding apparatus; inking apparatus for printing machines; soldering apparatus,

electric; fittings for engine boilers; expansion tanks [parts of machines]; drums [parts of machines]; brake shoes, other than for vehicles; concrete mixers [machines]; bioreactors for use in manufacturing biopharmaceuticals; bobbins for weaving looms; reels [parts of machines]; harrows; journal boxes [parts of machines]; bulldozers; mine borers; rolling mill cylinders; crank shafts; printing rollers for machines; camshafts for vehicle engines; transmission shafts, other than for land vehicles; fans for motors and engines; saw benches [parts of machines]; winnowers; vibrators [machines] for industrial use; water heaters being parts of machines; bellows [parts of machines]; agitators; drilling rigs, floating or non-floating; lawnmowers [machines]; card clothing [parts of carding machines]; nail extractors, electric; emergency power generators; alternators; dynamos; bicycle dynamos; current generators; electricity generators; hydraulic controls for machines, motors and engines; mufflers for motors and engines; drilling heads [parts of machines]; drilling bits [parts of machines]; cylinder heads for engines; soldering blow pipes, gas-operated; gas-operated blow torches; raking machines; stalk separators [machines]; sieves [machines or parts of machines]; mud catchers and collectors [machines]; tarring machines; rubber tracks being parts of crawlers on mining machines; rubber tracks being parts of crawlers on snow ploughs; rubber tracks being parts of crawlers on loading-unloading machines and apparatus; rubber tracks being parts of crawlers on agricultural machines; rubber tracks being parts of crawlers on construction machines; hydraulic engines and motors; aeronautical engines; aeroplane engines; engines for air cushion vehicles; compressed air engines; jet engines, other than for land vehicles; engines for boats; driving motors, other than for land vehicles; motors, other than for land vehicles; propulsion mechanisms, other than for land vehicles; de-aerators for feedwater; disintegrators; tympan [parts of printing presses]; holding devices for machine tools; turf removing ploughs; pump diaphragms; door closers, hydraulic; door closers, pneumatic; door closers, electric; chisels for machines; rack and pinion jacks; jacks [machines]; electric hand drills; crushers for kitchen use, electric; flues for engine boilers; reapers; reapers and binders; millstones; rakes for raking machines; needles for knitting machines; needles for wool combing machines; needles for sewing machines; kitchen grinders, electric; vegetable slicers, electric; shredders [machines] for industrial use; injectors for engines; incubators for eggs; ski edge sharpening tools, electric; hand-held tools, other than hand-operated; agricultural implements, other than hand-operated; tools [parts of machines]; air condensers; control cables for machines, engines or motors; capstans; calendars; rotary steam presses, portable, for fabrics; ditchers [ploughs]; carburettors; sliders for knitting machines; crankcases for machines, motors and engines; steamrollers; reels, mechanical, for flexible hoses; pressure valves [parts

of machines]; clack valves [parts of machines]; pressure reducers [parts of machines]; valves [parts of machines]; cowlings [parts of machines]; machine wheels; freewheels, other than for land vehicles; scale collectors for machine boilers; lasts for shoes [parts of machines]; brake pads, other than for vehicles; piston segments; grease rings [parts of machines]; reapers and threshers; coal-cutting machines; air pumps [garage installations]; compressors for refrigerators; compressors [machines]; belt conveyors; conveyors [machines]; converters for steelworks; aerocondensers; diggers [machines]; rams [machines]; thermic lances [machines]; mechanized livestock feeders; boxes for matrices [printing]; gear boxes, other than for land vehicles; stuffing boxes [parts of machines]; grease boxes [parts of machines]; housings [parts of machines]; harvesting machines; steam engine boilers; coffee grinders, other than hand-operated; roller bridges; mobile cranes; water separators; taps [parts of machines, engines or motors]; cranes [lifting and hoisting apparatus]; spray guns for paint; cranks [parts of machines]; potters' wheels; grindstones [parts of machines]; cultivators [machines]; soldering lamps; winches; blades [parts of machines]; ploughshares; belts for conveyors; lubricators [parts of machines]; igniting magnetos; churns; matrices for use in printing; machine fly-wheels; shearing machines for animals; blowing machines; knitting machines; galvanizing machines; bending machines; ironing machines; mineworking machines; blowing machines for the compression, exhaustion and transport of gases; blowing machines for the compression, sucking and carrying of grain; net hauling machines [fishing]; electroplating machines; bottle sealing machines; hoppers [mechanical discharging]; railway wagon lifts; moving walkways; steam condensers [parts of machines]; blade sharpening [stropping] machines / stropping machines; cutters [machines]; pump diaphragms; elevators [lifts]; lifts, other than ski-lifts; air brushes for applying colour; sealing machines for industrial purposes; embossing machines; engraving machines; finishing machines; crushing machines; waste disposal units; furnace loading machines; earth moving machines; sausage making machines; cord making machines; lace making machines; butter machines; miso making machines; cigarette machines for industrial purposes; soy sauce making machines; stereotype machines; dyeing machines; bottle washing machines; dishwashers; machines for the application of sizing; bottle filling machines; cheese slicers, electric; racket stringing machines; leather-working machines; dairy machines; glass-working machines; tobacco processing machines; grain husking machines; painting machines; oil refining machines; peeling machines; machines for processing plastics; ore treating machines; printing machines for use on sheet metal; brewing machines; whitewashing machines; road sweeping machines, self-propelled; leather paring machines; machines for generating gas by electrolysis; bitumen making machines; paperma-

king machines; pasta making machines, electric; semiconductor manufacturing machines; machines for the production of sugar; weeding machines; sifting machines; cinder sifters [machines]; puddling machines; fluid dispensing machines for industrial use; tape dispensing machines for industrial use; notchers [machine tools]; bread cutting machines; road making machines; railroad constructing machines; machines for the textile industry; rammers [machines]; rail-laying machines; bottle capping machines; bottle stoppering machines; waste compacting machines; vegetable peelers, electric; die-stamping machines; stamping machines; darning machines; milking machines; drainage machines; wrapping machines; grain separators; bookbinding apparatus and machines for industrial purposes; machines and apparatus for cleaning, electric; machines and apparatus for carpet shampooing, electric; machines and apparatus for polishing [electric]; punching machines; riveting machines; kitchen machines, electric; foundry machines; smoothing presses; fleshing machines; flour mill machines; typesetting machines [printing]; hemming machines; grating machines for vegetables; braiding machines; rinsing machines; wringing machines for laundry; cutting machines; steam engines; printing machines; rotary printing presses; industrial inkjet printing machines; compressed air machines; handling machines, automatic [manipulators]; tilling machines for agricultural purposes; trimming machines; spinning machines; filling machines; friezing machines; satinizing machines; agricultural machines; mixing machines; sorting machines for industry; stitching machines; laundry washing machines incorporating a drying tumbler; coin-operated washing machines; washing machines [laundry]; clippers [machines]; spinning frames; kneading machines; typographic machines; typesetting machines [photocomposition]; beating machines; beaters, electric; packing machines; packaging machines; filtering machines; moulding machines; carding machines; sewing machines; typecasting machines; electromechanical machines for chemical industry; labellers [machines]; mills for household purposes, other than hand-operated; pepper mills, other than hand-operated; centrifugal mills; mills [machines]; machine wheelwork; feeders [parts of machines]; transmission mechanisms, other than for land vehicles; forge blowers; blenders, electric, for household purposes; mixers [machines]; vacuum cleaner bags; threshing machines; pneumatic hammers; tilt hammers; power hammers; hammers [parts of machines]; reeling apparatus, mechanical; motorized cultivators; motors for boats; clutches, other than for land vehicles; meat cutters [machines]; superchargers; brake linings, other than for vehicles; guides for machines; suction nozzles for vacuum cleaners; vacuum cleaner attachments for disseminating perfumes and disinfectants; aerating pumps for aquaria; vacuum pumps [machines]; compressed air pumps; petrol pumps for service stations; pumps for heating installations; beer pumps; pumps

for counter-current swimming; lubricating pumps; self-regulating fuel pumps; fuel dispensing pumps for service stations; centrifugal pumps; pumps [machines]; pumps [parts of machines, engines or motors]; hydrogen dispensing pumps for service stations; tin openers, electric; knives for mowing machines; chaff cutter blades; knives, electric; knives being parts of machines; shears, electric; scissors, electric; vegetable spiralizers, electric; vegetable slicers, electric; bearing brackets for machines; pulverisers [machines]; axles for machines; steam traps; drill chucks [parts of machines]; chucks [parts of machines]; exhaust manifold for engines; soldering irons, gas-operated; soldering irons, electric; gears, other than for land vehicles; reduction gears, other than for land vehicles; drilling machines; chain saws; saws [machines]; glue guns, electric; compressed air guns for the extrusion of mastics; guns [tools using explosive cartridges]; carburetter feeders; feeding apparatus for engine boilers; loading ramps; ploughs; pneumatic transporters; pneumatic controls for machines, motors and engines; hangers [parts of machines]; anti-friction bearings for machines; roller bearings; self-oiling bearings; bearings for transmission shafts; ball-bearings; bearings [parts of machines]; hoists; pulleys; saw blades [parts of machines]; shock absorber plungers [parts of machines]; pistons for engines; pistons for cylinders; pistons [parts of machines or engines]; catalytic converters; torque converters, other than for land vehicles; fuel conversion apparatus for internal combustion engines; wine presses; fruit presses, electric, for household purposes; fodder presses; basket presses; printing presses; typographic presses; swaging machines; presses [machines for industrial purposes]; pneumatic or hydraulic linear actuators, other than for land vehicles; pedal drives for sewing machines; cleaning appliances utilizing steam; food processors, electric; springs [parts of machines]; spinning wheels; punches for punching machines; vacuum cleaners; touchless stationary vacuums; tambours for embroidery machines; radiators [cooling] for motors and engines; sewage pulverizers; pressure regulators [parts of machines]; speed governors for machines, engines and motors; regulators [parts of machines]; cutting blow pipes, gas-operated; blade holders [parts of machines]; loom shafts; gears for weaving looms; belts for machines; elevator belts; fan belts for motors and engines; dynamo belts; belts for motors and engines; adhesive bands for pulleys; industrial robots; household cleaning and laundry robots with artificial intelligence; robotic arms for preparing beverages; 3D printing pens; blade sharpening [stropping] machines; engine mounts, other than for land vehicles; kick starters for motorcycles; joysticks being parts of machines, other than for game machines; paper feeders [printing]; whisks, electric, for household purposes; sparking plugs for internal combustion engines; glow plugs for Diesel engines; brake segments, other than for vehicles; bedding machines; steam/oil separators; cre-

am/milk separators; ball rings for bearings; sowers [machines]; exhausts for motors and engines; pigs for cleaning pipes; snow ploughs; sheaf-binding machines; joints [parts of engines]; juice extractors, electric; straw [chaff] cutters; suction cups for milking machines; stands for machines; machine tools; die-cutting and tapping machines; woodworking machines; sharpening machines; portable laser engraving machines; bicycle assembling machines; machines for the textile industry; mortising machines; stone-working machines; metalworking machines; size adjustment cutting machines for industrial purposes; threading machines; trueing machines; planing machines; looms [machines]; lathes [machine tools]; milling machines; hosiery looms [machines]; grinding machines; metal drawing machines; rolling mills; starters for motors and engines; stators [parts of machines]; glaziers' diamonds [parts of machines]; tables for machines; derricks; slide rests [parts of machines]; spin dryers [not heated]; couplings, other than for land vehicles; heat exchangers [parts of machines]; transmissions for machines; boiler tubes [parts of machines]; wind turbines; hydraulic turbines; turbines, other than for land vehicles; turbocompressors; central vacuum cleaning installations; suction machines for industrial purposes; machines for the mineralization of drinking water; washing installations for vehicles; degreasers [machines]; dust exhausting installations for cleaning purposes; sifting installations; pneumatic tube conveyors; dust removing installations for cleaning purposes; milking machines; condensing installations; floating production, storage and offloading [FPSO] units; pneumatic waste oil drainers; lifting apparatus; air suction machines; dividing machines; igniting devices for internal combustion engines; washing apparatus; binding apparatus for hay; haulage apparatus [mining]; door openers, hydraulic; door openers, pneumatic; door openers, electric; curtain drawing devices, electrically operated; anti-pollution devices for motors and engines; beverage preparation machines, electromechanical; food preparation machines, electromechanical; portable ultrasonic washing devices for laundry; control mechanisms for machines, engines or motors; shoe polishers, electric; machines and apparatus for wax-polishing, electric; air cushion devices for moving loads; handling apparatus for loading and unloading; elevating apparatus; semiconductor exposure apparatus for use in manufacture; aprons [parts of machines]; filters for cleaning cooling air, for engines; filters being parts of machines or engines; filter presses; moulds [parts of machines]; printing plates; journals [parts of machines]; centrifugal machines; elevator chains [parts of machines]; drive chains, other than for land vehicles; transmission chains, other than for land vehicles; cylinders for motors and engines; cylinders for machines; printing cylinders; pneumatic jacks; shuttles [parts of machines]; universal joints [Cardan joints]; connecting rods for machines, motors and engines; steam mops; starter pinions; pulleys

[parts of machines]; vacuum cleaner hoses; screwdrivers, electric; dynamo brushes; brushes for vacuum cleaners; brushes, electrically operated [parts of machines]; carbon brushes [electricity]; brushes [parts of machines]; ejectors; robotic exoskeleton suits, other than for medical purposes; fuel economisers for motors and engines; excavators; shovels, mechanical; grain elevators; agricultural elevators; motors, electric, other than for land vehicles; electrodes for welding machines; electric hammers; parquet wax-polishers, electric; cartridges for filtering machines; moving staircases [escalators]; automatic grapnels for marine purposes; shaft couplings [machines]; window closers, hydraulic; window closers, pneumatic; window closers, electric; window openers, hydraulic; window openers, pneumatic; window openers, electric; passenger lift operating apparatus.

8 – Glaziers' diamonds [parts of hand tools]; apparatus for tattooing; laser hair removal apparatus, other than for medical purposes; razors, electric or non-electric; sharpening steels; scythe stones; gimlets [hand tools]; borers; carpenters' augers; augers [hand tools]; pickhammers; weeding forks [hand tools]; carving forks; table forks; agricultural forks [hand tools]; lawn clippers [hand instruments]; harpoons; nail extractors, hand-operated; sand trap rakes; rakes [hand tools]; cutter bars [hand tools]; whetstone holders; sculptors' chisels; priming irons [hand tools]; lifting jacks, hand-operated; hand drills, hand-operated; truncheons; clamps for carpenters or coopers; spades [hand tools]; rabbeting planes; chisels; engraving needles; tattoo needles; cutlery; edge tools [hand tools]; garden tools, hand-operated; abrading instruments [hand instruments]; numbering punches; goffering irons; implements for decanting liquids [hand tools]; depilation appliances, electric and non-electric; sharpening instruments; blade sharpening instruments; livestock marking tools; nail clippers, electric or non-electric; oyster openers; polishing irons [glazing tools]; ear-piercing apparatus; tube cutting instruments; wire strippers [hand tools]; riveters [hand tools]; expanders [hand tools]; cutting tools [hand tools]; ski edge sharpening tools, hand-operated; hand tools, hand-operated; sterile body piercing instruments; stamping-out tools [hand tools]; picks [hand tools]; sharpening stones; punch rings [knuckle dusters]; trowels; centre punches [hand tools]; daggers; pickaxes; mallets [hand instruments]; pliers; punch pliers [hand tools]; blades [weapons]; annular screw plates; tap wrenches; spanners [hand tools]; foundry ladles [hand tools]; ladles [hand tools]; meat claws; breast drills; lasts [shoemakers' hand tools]; scythe rings; instruments for punching tickets; diggers [hand tools]; rams [hand tools]; scythes; hainault scythes; fire irons; emery grinding wheels; grindstones [hand tools]; sledgehammers; thistle extractors [hand tools]; nail nippers; tree pruners; nail drawers [hand tools]; ice picks; razor blades; blades for planes; plane irons; blades [hand tools]; jig-saws; spoons; table knives, forks and spoons

for babies; table knives, forks and spoons of plastic; crow bars; trowels [gardening]; shovels [hand tools]; palette knives; machetes; beard clippers; hair clippers for personal use, electric and non-electric; hair clippers for animals [hand instruments]; taps [hand tools]; fireplace bellows [hand tools]; swords; emergency hammers; fullers [hand tools]; stone hammers; masons' hammers; riveting hammers [hand tools]; hammers [hand tools]; mattocks; ditchers [hand tools]; manicure sets; manicure sets, electric; pedicure sets; needle files; bits [hand tools]; emery files; files [tools]; air pumps, hand-operated; hand pumps; shaving cases; knives; cheese slicers, non-electric; fruit segmenters; egg slicers, non-electric; vegetable knives; pizza cutters, non-electric; scaling knives; hobby knives [scalpels]; fruit corers; moulding irons; ceramic knives; tin openers, non-electric; farriers' knives; multi-tool knives; budding knives; hunting knives; penknives; grafting tools [hand tools]; carving knives; braiders [hand tools]; bill-hooks; paring knives; box cutters; cleavers; mincing knives; scissors; wick trimmers [scissors]; shears; cattle shearers; border shears; shearers [hand instruments]; sword scabbards; kitchen mandolines; vegetable slicers, hand-operated; vegetable spiralizers, hand-operated; vegetable peelers, hand-operated; agricultural implements, hand-operated; side arms, other than firearms; stropping instruments; screwdrivers, non-electric; hand-operated corn cob strippers; stirring sticks for mixing paint; reamer sockets; drill holders [hand tools]; perforating tools [hand tools]; rammers [hand tools]; emery boards; nail files; nail files, electric; bow saws; saws [hand tools]; tweezers; hair-removing tweezers; hoes [hand tools]; non-electric caulking guns; guns, hand-operated, for the extrusion of mastics; guns [hand tools]; dies [hand tools]; fruit pickers [hand tools]; saw blades [parts of hand tools]; shear blades; tool belts [holders]; tube squeezers, hand-operated, other than for household purposes; hair braiders, electric; table cutlery [knives, forks and spoons]; crimping irons; hand implements for hair curling; vegetable choppers; money scoops; instruments and tools for skinning animals; fingernail polishers, electric or non-electric; hackles [hand tools]; pin punches; nail punches; fish tapes [hand tools]; food processors, hand-operated; punches [hand tools]; insecticide vaporizers [hand tools]; syringes for spraying insecticides; reamers; frames for handsaws; saw holders; rasps [hand tools]; paring irons [hand tools]; wine bottle foil cutters, hand-operated; graving tools [hand tools]; milling cutters [hand tools]; razor strops; leather strops; planes; scythe handles; knife handles; handles for hand-operated hand tools; levers; sabres; marline spikes; hollowing bits [parts of hand tools]; bits [parts of hand tools]; pruning scissors; mincing knives; silver plate [knives, forks and spoons]; pruning knives; sickles; drawing knives; scrapers for skis; scrapers [hand tools]; trowels [gardening]; mortise chisels; caulking irons; gouges [hand tools]; portable handlooms, hand-operated; mortars for pounding

[hand tools]; mitre boxes [hand tools]; long reach loppers; branding irons; hatchets; adzes [tools]; vices; bench vices [hand implements]; hoop cutters [hand tools]; axes; holing axes; earth rammers [hand tools]; fulling tools [hand tools]; tube cutters [hand tools]; hoes [hand tools]; squares [hand tools]; extension pieces for braces for screw taps; embossers [hand tools]; apparatus for destroying plant parasites, hand-operated; metal wire stretchers [hand tools]; metal band stretchers [hand tools]; irons [non-electric hand tools]; hand-operated fruit slicers; razor cases; ratchets [hand tools]; scraping tools [hand tools]; awls; chopping knives; spatulas for use by artists; spatulas [hand tools]; bayonets; pincers; curling tongs; nail nippers; cuticle tweezers; eyelash curlers.

11 – Lampshades; autoclaves, electric, for cooking; steam accumulators; heat accumulators; defrosters for vehicles; adsorption apparatus for generating gas; disinfectant apparatus for medical purposes; distillation apparatus; desiccating apparatus; hydromassage bath apparatus; disinfectant apparatus; air deodorizing apparatus; ionization apparatus for the treatment of air or water; coffee roasters; beverage cooling apparatus; apparatus for fertilizer irrigation; hand drying apparatus for washrooms; fruit roasters; water purifying apparatus and machines; refrigerating apparatus and machines; underfloor heating apparatus and installations; drying apparatus and installations; membrane apparatus for generating gas; freezers; heating and cooling apparatus for dispensing hot and cold beverages; drying apparatus; fermentation apparatus for industrial purposes; coolers for furnaces; expansion tanks for central heating installations; flushing tanks; refining towers for distillation; bidets; bioreactors for use in the treatment of wastewater; bioreactors for use in the treatment of waste; boilers, other than parts of machines; bath tubs; bath tubs for sitz baths; spa baths [vessels]; waffle irons, electric; electric fans for personal use; fans [air-conditioning]; fans [parts of air-conditioning installations]; roasting spits; refrigerating display cabinets; heated display cabinets; dehumidifiers; water heaters; water flushing installations; air reheaters; extractor hoods for kitchens; gas condensers, other than parts of machines; acetylene generators; microbubble generators for baths; hydrants; fairy lights for festive decoration; burners; acetylene burners; gas burners; burners for lamps; germicidal burners; incandescent burners; oxyhydrogen burners; laboratory burners; oil burners; alcohol burners; hot water bottles; footwarmers, electric or non-electric; bed warmers; USB-powered hand warmers; pocket warmers; warming pans; roasting apparatus; food dehydrators, electric; lampshade holders; stills; showers; refrigerating containers; gas lighters; friction lighters for igniting gas; chimney blowers; coils [parts of distilling, heating or cooling installations]; furnace ash boxes; evaporators; electric appliances for making yogurt; shower cubicles; Turkish bath cabinets, portable; heating apparatus; cool boxes, electric; refrige-

rating chambers; fireplaces, domestic; chimney flues; structural framework for ovens; cooking pots, electric; air valves for steam heating installations; level controlling valves in tanks; thermostatic valves [parts of heating installations]; electrically heated carpets; light bulbs; light bulbs, electric; solar thermal collectors [heating]; distillation columns; furnace grates; ventilation hoods; ventilation hoods for laboratories; lamp globes; air conditioners for vehicles; gas boilers; laundry room boilers; heating boilers; taps; taps for pipes and pipelines; mixer taps for water pipes; electrically heated mugs; forges, portable; lava rocks for use in barbecue grills; couscous cookers, electric; lights, electric, for Christmas trees; acetylene flares; safety lamps; gas lamps; curling lamps; nail lamps; smart light bulbs; curing lamps, not for medical purposes; germicidal lamps for purifying air; light bulbs for directional signals for vehicles; arc lamps; laboratory lamps; oil lamps; ultraviolet ray lamps, not for medical purposes; miners' lamps; electric lamps; chandeliers; barbecues; bread baking machines; watering machines for agricultural purposes; ice-cream making machines; beer brewing machines, electric, for household purposes; soya milk making machines, electric; snow-making machines; pounded rice cake making machines, electric, for household purposes; membranes for reverse osmosis units; membranes for water filtering apparatus; multicookers; footmuffs, electrically heated; heaters for baths; heaters for heating irons; immersion heaters; brackets for gas burners; anti-splash tap nozzles; heat pumps; magnesium filaments for lighting; heating filaments, electric; filaments for electric lamps; luminous house numbers; socks, electrically heated; heating apparatus for defrosting vehicle windows; hot air bath fittings; bath fittings; kiln furniture [supports]; sauna bath installations; refrigerating appliances and installations; directional lights for bicycles; running lights for vehicles; electrically heated clothing; blankets, electric, not for medical purposes; ozonizers for sanitizing purposes; air dryers; fabric steamers; lamp reflectors; vehicle reflectors; hearths; glow sticks for lighting; lightsticks, battery-operated; electric cooktops; fog machines; coffee capsules, empty, for electric coffee machines; coffee machines, electric; coffee machines incorporating water purifiers; air-conditioning apparatus; food steamers, electric; steam boilers, other than parts of machines; pasteurisers; lamp mantles; sockets for electric lights; coffee percolators, electric; bakers' ovens; hot air ovens; kitchen ranges [ovens]; microwave ovens for industrial purposes; microwave ovens [cooking apparatus]; incinerators; kilns; solar furnaces; dental ovens; stoves [heating apparatus]; furnaces, other than for laboratory use; urinals being sanitary fixtures; feeding apparatus for heating boilers; heating plates; cooking stoves; hot plates; wine cellars, electric; heaters, electric, for feeding bottles; aquarium heaters; USB-powered cup heaters; plate warmers; aquarium lights; heating cushions, electric, not for medical purposes;

clean chambers [sanitary installations]; tortilla presses, electric; water intake apparatus; apparatus for dehydrating food waste; fumigation apparatus, not for medical purposes; gas scrubbing apparatus; oil-scrubbing apparatus; glue-heating appliances; electric appliances for making yogurt; drying apparatus for fodder and forage; air purifying apparatus and machines; ice machines and apparatus; cooling appliances and installations; cooking apparatus and installations; lighting apparatus and installations; sanitary apparatus and installations; cooking rings; lighting apparatus for vehicles; light-emitting diodes [LED] lighting apparatus; heating apparatus for solid, liquid or gaseous fuels; heating apparatus, electric; hot air apparatus; steam facial apparatus [saunas]; safety accessories for water or gas apparatus and pipes; regulating and safety accessories for gas apparatus; regulating accessories for water or gas apparatus and pipes; regulating and safety accessories for water apparatus; regulating and safety accessories for gas pipes; roasting jacks; anti-glare devices for vehicles [lamp fittings]; rotisseries; radiator caps; searchlights; diving lights; light projectors; washers for water taps; snow-making machines; heat guns; central heating radiators; radiators, electric; radiators [heating]; sinks; kitchen sinks incorporating integrated worktops; drip irrigation emitters [irrigation fittings]; light diffusers; nuclear reactors; heat regenerators; pressure water tanks; roasters; beverage urns, electric; lamps; standard lamps; ceiling lights; toilet seats; hydroponic growing systems; lighting installations for air vehicles; autoclaves, electric, for cooking; venturi scrubbers; gas scrubbers [parts of gas installations]; tanning beds; lamp glasses; sterilizers; water sterilizers; air sterilizers; laundry dryers, electric; hair dryers; malt roasters; tobacco roasters; tajines, electric; heat exchangers, other than parts of machines; thermo-pots, electric; bread toasters; discharge tubes, electric, for lighting; lamp chimneys; luminous tubes for lighting; flues for heating boilers; boiler pipes [tubes] for heating installations; heat-stabilized polypropylene pipes for heating installations; pipes [parts of sanitary installations]; toilets, portable; toilets [water-closets]; humidifiers; humidifiers for central heating radiators; membrane filtration units for water treatment apparatus; wash-hand basins [parts of sanitary installations]; toilet bowls; water conduits installations; bath installations; air-conditioning installations; desalination plants; installations for processing nuclear fuel and nuclear moderating material; watering installations, automatic; cooling installations for water; cooling installations for liquids; milk cooling installations; cooling installations for tobacco; water purification installations; purification installations for sewage; steam generating installations; water distribution installations; air filtering installations; swimming pool chlorinating apparatus; ventilation [air-conditioning] installations and apparatus; ventilation [air-conditioning] installations for vehicles; water softening apparatus and installations; cooling ins-

tallations and machines; reverse osmosis units; heating installations; heaters for vehicles; heating installations [water]; polymerisation installations; water supply installations; flare stacks for use in the oil industry; ash conveyor installations, automatic; disinfectant apparatus for dispensing solutions into water-pipes for sanitary installations; whirlpool-jet apparatus; air cooling apparatus; apparatus for making ices and ice cream, electric; sous-vide cookers, electric; water filtering apparatus; full-body drying apparatus; aquarium filtration apparatus; cooking utensils, electric; flaming torches; headlights for automobiles; vehicle headlights; filters for drinking water; filters for water filtering apparatus; reverse osmosis membrane filters for water treatment; wicks adapted for oil stoves; lights for automobiles; bicycle lights; motorcycle lights; lights for vehicles; electric torches; head torches; lanterns for lighting; candle lanterns; street lamps; fountains; ornamental fountains; chocolate fountains, electric; air fryers; deep fryers, electric; fittings, shaped, for furnaces; oven fittings made of fireclay; bread-making machines; refrigerators; refrigerators, cooling apparatus and freezers for medical storage purposes; chromatography apparatus for industrial purposes; kettles, electric; dampers [heating]; book sterilization apparatus; refrigerating cabinets; carbon for arc lamps; heating elements; deodorizing apparatus, not for personal use; filters for air conditioning; Chinese lanterns.

(260) AM 2026 131537 A

(800) 1830318

(151) 2024 10 07

(891) 2024 10 07

(731) Philip Morris Products S.A.

Quai Jeanrenaud 3, CH-2000 Neuchâtel,
Switzerland

(540)



(591) Black, white

(531) 26.04.02; 26.04.04; 26.04.05; 26.04.18;
26.13.25; 27.05.01; 27.05.12; 27.05.17;
27.05.24

(511)

34 – Wired vaporizers for electronic cigarettes and electronic smoking devices; tobacco, raw or manufactured; tobacco products, including cigars, cigarettes, cigarillos, tobacco for roll-your-own cigarettes, pipe tobacco, chewing tobacco, snuff tobacco, kretek; snus; tobacco substitutes (not for medical purposes);

smokers' articles, namely cigarette paper and tubes, cigarette filters, tobacco tins, cigarette cases and ashtrays, pipes, pocket apparatus for rolling cigarettes, lighters; matches; tobacco sticks, tobacco products for the purpose of being heated, electronic devices and their parts for the purpose of heating cigarettes or tobacco in order to release nicotine-containing aerosol for inhalation; liquid nicotine solutions for use in electronic cigarettes; electronic smoking devices; electronic cigarettes; electronic cigarettes as substitutes for traditional cigarettes; electronic devices for the inhalation of nicotine-containing aerosols; oral vaporizing devices for smokers, tobacco products and tobacco substitutes; smokers' articles for electronic cigarettes; parts and fittings for the aforesaid products included in this class; devices for extinguishing heated cigarettes and cigars as well as heated tobacco sticks; electronic rechargeable cigarette cases.

(260) AM 2026 131538 A

(800) 1830328

(151) 2024 06 18

(891) 2024 06 18

(731) ROMANOVA NATALIIA VIKTOROVNA

ul. Ladozhskaia, 15, kv. 12, RU-105005

Moskva, Russian Federation

(540)



(591) Grey-blue, grey, light grey and black

(531) 26.04.18; 26.11.07; 27.05.01; 29.01.13

(511)

18 – Pocket wallets; card cases (notecases); briefcases; purses; leather straps; travelling bags; handbags; bags for campers; reusable shopping bags; school bags; suitcases; attache cases.

25 – Neckties; mufflers being neck scarves; gloves [clothing]; belts [clothing]; headwear; shawls; scarves.

35 – Sales promotion for others, including through wholesale and retail shops and online stores; procurement services for others (purchasing goods and services for other businesses).

(260) AM 2026 131539 A

(800) 1830344

(151) 2024 10 30

(891) 2024 10 30

(731) Ferdinand Richter GmbH & Co KG

Schärdinger Strasse 1, A-4061 Pasching,
Austria

(540)

Richter
KIDS SHOES SINCE 1893

(591) Blue

(531) 27.05.01; 27.05.10; 27.07.01; 29.01.04

(511)

18 – Leather and imitation leather; handbags and cases; bags and valises; school bags, shopping bags, briefcases, sports bags, cosmetic bags and baby changing bags; pocket wallets and purses; backpacks; umbrellas and parasols.

25 – Clothing, footwear, headgear, in particular for children and young people.

(260) AM 2026 131540 A

(800) 1830345

(151) 2024 10 10

(891) 2024 10 10

(731) Midea Group Co., Ltd.

B26-28F, Midea Headquarter Building, No. 6
Midea Avenue, Beijiao, Shunde, Foshan,
Guangdong, China

(540)

AI ECOMASTER

(591) Black, white

(531) 01.15.03; 27.03.12; 27.05.01; 27.05.09

(511)

7 – Centrifugal machines; washing machines [laundry]; laundry washing machines incorporating a drying tumbler; spin dryers [not heated]; wringing machines for laundry; dry-cleaning machines; coin-operated washing machines; dishwashers; dishwasher racks being parts of dishwashing machines; kitchen machines, electric; vacuum cleaners; rechargeable sweepers; electric cordless sweepers; household cleaning and laundry robots with artificial intelligence; steam engines; wrapping machines; electric fruit peelers; milk filtering machines; kneading machines; food preparation machines, electromechanical; bread cutting machines; condensed milk making machines; fish paste making machines; fruit washing machines; flour mill machines; dairy machines; butter machines; churns; cheese making machines; electric fruit squeezers; meat choppers, electric; electric food blenders; meat mincers, electric; centrifugal mills; electric food grinders; mixing machines; mills [machines]; beverage preparation machines, electromechanical; juice extractors, electric; food processors, electric; pepper mills, other than hand-operated; coffee grinders, other than hand-operated; vegetable spiralizers, electric; kitchen grinders, electric; whisks, electric, for household purposes; electric food blenders for household purposes; beaters, electric; can openers, electric; dust removing installations for cleaning purposes; snow plo-

ughs; car washing machines; waste disposal units; cleaning appliances utilizing steam; machines and apparatus for cleaning, electric; automated washers for surgical, medical and laboratory equipment; brushes for vacuum cleaners.

11 – Dehumidifiers; air sterilisers; heat pumps; air conditioning apparatus; air purifying apparatus and machines; ventilation [air-conditioning] installations and apparatus; disinfectant apparatus; heating installations; underfloor heating apparatus and installations; air-source heat pump water heaters; fireplaces, domestic; pressure water tanks; thermostatic valves [parts of heating installations]; water heaters; refrigerators; wine refrigerators; refrigerating cabinets; ice machines and apparatus; heating and cooling apparatus for dispensing hot and cold beverages; beverage cooling apparatus; freezers; refrigerators, cooling apparatus and freezers for medical storage purposes; drying apparatus and installations; wine cellars, electric; refrigerating chambers; walk-in refrigerators; refrigerating containers; coolers, electric; cooling installations and machines; cooling appliances and installations; refrigerating display cabinets; heated display cabinets; beer brewing machines, electric, for household purposes; cooling installations for liquids; refrigerating appliances and installations; laundry dryers, electric; water purifying apparatus and machines; chilled purified water dispensers; electric hot water dispensers; cooking ranges; extractor hoods for kitchens; ionization apparatus for the treatment of air or water; heaters for baths; water softening apparatus and installations; ventilation hoods; kitchen ranges [ovens]; water purification installations; cookers; gas burners; filters for drinking water; microwave ovens [cooking apparatus]; food steamers, electric; steam generating installations; roasting apparatus; roasters; bread baking machines; smokers [cooking apparatus]; cooking ovens; induction cookers; electric cooktops; electric rice cookers; pressure cookers, electric; fans [air-conditioning]; radiators, electric; coffee machines, electric; humidifiers; air conditioning installations; filters for air conditioning; fans [parts of air-conditioning installations]; air filtering installations; air cooling apparatus; ventilation [air-conditioning] installations for vehicles; air conditioners for vehicles; steam cabinets for the treatment of clothing; coffee machines incorporating water purifiers; coffee roasters; coffee percolators, electric; lamps; electric refrigerators for household purposes; cooking installations; cooking apparatus; electric water heating apparatus; hot water heating installations; bath installations; purification installations for sewage; kettles, electric; water supply installations.

(260) AM 2026 131541 A

(800) 1830465

(151) 2024 06 14

(891) 2024 06 14

(731) ALTINBAŞ PETROL VE TİCARET ANONİM
ŞİRKETİ
LEVENT MAH. LEVENT CAD. 19,
BEŞİKTAŞ, İSTANBUL, Türkiye

(540)



(591) Blue, green and white

(531) 26.01.18; 26.03.01; 27.05.01; 27.05.08;
29.01.13

(511)

1 – Chemicals used in industry, science, photography, agriculture, horticulture and forestry, manures and soils, unprocessed artificial resins and unprocessed plastics, fire extinguishing compositions, adhesives not for medical, household and stationery purposes.

4 – Industrial oils and greases, cutting fluids, dust absorbing, wetting and binding compositions, solid fuels, coal, firewood, liquid and gas fuels, petrol, diesel oil, liquified petroleum gas, natural gas, fuel oil and their non-chemical additives, candles, wicks, semi-finished wax, wax and paraffin for lighting purposes, electrical energy.

35 – The bringing together, for the benefit of others, of a variety of goods, namely, plastics and polymer as raw material, chemicals used in industry, science, photography, agriculture, horticulture and forestry, fire extinguishing compositions, adhesives not for medical, household and stationery purposes, industrial oils and greases, cutting fluids, dust absorbing, wetting and binding compositions, solid fuels, coal, firewood, liquid and gas fuels, petrol, diesel oil, liquefied petroleum gas, natural gas, fuel oil and their non-chemical additives, candles, wicks, semi-finished wax, wax and paraffin for lighting purposes, electrical energy, excluding the transport thereof, enabling customers to conveniently view and purchase those goods, such services may be provided by retail stores, wholesale outlets, by means of electronic media or through mail order catalogues.

37 – Vehicles service stations for land vehicles, maintenance, repair and refueling of land vehicles.

(260) AM 2026 131543 A

(800) 1830569

(151) 2024 09 19

(891) 2024 09 19

(731) GREENME SA

route de Champ-Colin 12, CH-1260 Nyon,
Switzerland

(540)



(591) Green, light green, yellow, white and red

(531) 05.03.13; 05.03.15; 05.07.11; 05.07.12;
05.07.22; 25.01.15; 29.01.14

(526) FRESH, LIME, LEMON, MINT, 100%
NATURAL INGREDIENTS

(511)

32 – Aperitifs, non-alcoholic; carbonated water; waters [beverages]; non-alcoholic cocktails; lemonades; non-alcoholic drinks; carbonated drinks; carbonated drinks with juice; soft drinks, non-alcoholic; energy drinks.

(260) AM 2026 131545 A

(800) 1830657

(151) 2024 09 12

(891) 2024 09 12

(731) Limited Liability Company "Consortium-PIQ"
Oruzheyniy pereulok, d. 25, str. 1, pomesch.
I/etazh1/komnata 21, RU-125047 Moscow,
Russian Federation

(540)

LACOLEXID

(591) Black, white

(511)

5 – Pharmaceutical products; pharmaceutical preparations; medical preparations; veterinary preparations; sanitary preparations for medical purposes; dietetic food and substances adapted for medical or veterinary use; food for babies; dietary supplements for human beings; dietary supplements for animals; plasters, materials for dressings; material for stopping teeth, dental wax; disinfectants; preparations for destroying vermin; fungicides, herbicides.

(260) AM 2026 131546 A

(800) 1830664

(151) 2024 10 24

(891) 2024 10 24

(731) XENON PHARMACEUTICALS INC.
200-3650 Gilmore Way, Burnaby, B.C.
V5G4W8, Canada

(540)

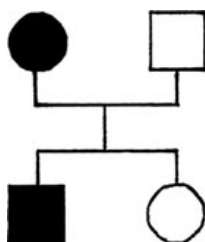

(591) Black, white
(531) 15.09.18; 26.07.25
(511)

5 – Pharmaceutical preparations for the treatment of neurological disorders.

44 – Providing healthcare providers and patients information regarding neurological disease states and treatment.

(260) AM 2026 131547 A

(800) 1830678

(151) 2024 09 12

(891) 2024 09 12

(731) Limited Liability Company "Consortium-PIQ"

Oruzheyniy pereulok, d. 25, str. 1, pomesch.
I/etazh1/komnata21, RU-125047 Moscow,
Russian Federation

(540)



Элькар®

(591) Light purple, violet, blue, green, yellow, orange and pink

(531) 01.15.23; 26.03.04; 28.05; 29.01.15

(526) ®

(511)

5 – Pharmaceutical products; veterinary products; pharmaceutical preparations; medical preparations; veterinary preparations; sanitary preparations for medical purposes; dietetic food and substances adapted for medical or veterinary use; food for babies; dietary supplements for human beings; dietary supplements for animals; plasters, materials for dressings; material for stopping teeth, dental wax; disinfectants; preparations for destroying vermin; fungicides, herbicides.

(260) AM 2026 131548 A

(800) 1830746

(151) 2024 11 29

(891) 2024 11 29

(731) BRAMO IMPORT S.R.O.

M. Curie Sklodowskej 1512/13, Petržalka,
SK-851 04 Bratislava-mestskacast, Slovakia

(540)

Walex

(591) Black, white

(511)

4 – Belting wax; fuel; lubricating graphite; additives, non-chemical, to motor fuel; cutting fluids; mazut; fuel oil; lubricating oil; industrial oil; motor oil; lubricants; naphtha; non-slipping preparations for belts; grease for belts; vaporized fuel mixtures; benzene fuel; diesel oil; carburants; mineral fuel.

(260) AM 2026 131549 A

(800) 1830749

(151) 2024 11 08

(891) 2024 11 08

(731) Suzhou Banghan Tools Co., Ltd.

No.20 Dagang Road, Fuqiao Town, Taicang
City, Suzhou City, Jiangsu Province, China

(540)

E25X

(591) Black, white

(511)

7 – Agricultural machines; kitchen machines, electric; machines and apparatus for polishing [electric]; hand-held tools, other than hand-operated; dynamos; compressed air machines; machines and apparatus for cleaning, electric; lawnmowers [machines]; vacuum cleaners; thermic lances [machines].

9 – Batteries, electric; battery chargers; mobile power supply [rechargeable batteries]; lithium secondary batteries; portable power chargers; accumulators, electric.

(260) AM 2026 131611 A

(800) 1831124

(151) 2024 10 11

(891) 2024 10 11

(731) GUANGZHOU KDT MACHINERY GROUP
CO., LTD.

No.3 Yunkai Road, Yunpu Industrial Park,
Huangpu District, Guangzhou, 510700
Guangdong, China

(540)



(591) Black, white

(531) 24.15.01; 24.15.07; 27.05.01; 27.05.08;
27.05.17

(511)

7 – Woodworking machines; mortising machines; paring machines; saws [machines]; log conveyors; sawdust making machines; put plank together machine; saw blades [parts of machines]; planing machines.

(260) AM 2026 131613 A

(800) 1831185

(151) 2024 07 31

(891) 2024 07 31

(731) DAS Solar Co., Ltd.

No.43 Bailing South Road, Quzhou City,
Zhejiang Province, China

(540)

DASOLAR

(591) Black, white

(531) 26.03.01; 26.03.24; 27.05.01; 27.05.19

(511)

9 – Solar batteries; photovoltaic cells; photovoltaic devices and equipment for solar power generation; solar panels for the production of electricity; batteries, electric; electric power converters; junction boxes [electricity]; semiconductors; integrated circuits; circuit breakers; connectors [electricity]; holders for electric coils; voltage regulators; conductors, electric; automatic control equipment for power station.

(260) AM 2026 131655 A

(800) 1832582

(151) 2024 12 05

(891) 2024 12 05

(731) Industria de Diseño Textil, S.A. (Inditex, S.A.)

Avenida de la Diputación, Edificio Inditex,
Arteixo, E-15143 A Coruña, Spain

(540)

BIG OLITA

(591) Black, white

(511)

25 – Clothing; footwear; headgear; bibs, not of paper; headbands [clothing]; bath robes; bathing suits; bath sandals; boas [necklets]; scarves; hoods [clothing]; shawls; belts [clothing]; money belts [clothing]; neckties; girdles; fur stoles; caps being headwear; gloves [clothing]; rain slickers; underwear; mantillas; stockings; socks; bandanas [neckerchiefs]; furs [clothing]; pajamas; soles for footwear; heels; veils [clothing]; braces [suspenders] for clothing; collars [clothing]; sports jerseys; fingerless gloves; ear muffs [clothing]; inner soles; cuffs; dress shields; beach clothes; dressing gowns; pockets for clothing; sock suspenders; stocking suspenders; petticoats; tights; aprons [clothing]; masquerade costumes; uniforms; sun visors [headwear]; wooden shoes; bonnets; coats; espadrilles; non-slipping devices for footwear; bath slippers; blouses; bodices [clothing]; berets; footmuffs, not electrically heated; boots; boot uppers; studs for football boots; ankle boots; fittings of metal for footwear; tips for footwear; heelpieces for footwear; shirts; shirt yokes; shirt fronts; tee-shirts; bodices [lingerie]; waistcoats; jackets [clothing]; fishing vests; stuff jackets [clothing]; slippers [underclothing]; ready-made clothing; detachable collars; clothing of leather; clothing of imitations of leather; shower caps; slippers; skirts; trousers;

users; ready-made linings [parts of clothing]; overcoats; gabardines [clothing]; gymnastic shoes; jerseys [clothing]; sweaters; liveries; muffs [clothing]; footwear uppers; pocket squares; parkas; pelerines; pelisses; gaiters; leggings [trousers]; knitwear [clothing]; clothing for gymnastics; sandals; saris; underpants; hats; wimples; togas; suits; turbans; dresses; sports shoes; shoes; motorists' clothing; cyclists' clothing; beach shoes.

(260) AM 2026 131657 A

(800) 624809

(151) 1994 10 13

(891) 2024 12 10

(731) Hofmeister Vermögensverwaltungs GmbH & Co. KG

Kemptener Str. 17-24, 87493 Lauben, Germany

(540)

Dorblu

(591) Black, white

(531) 27.05.17

(511)

29 – Milk and dairy products, namely butter, cheese, including soft cheese and melted cheese, cream, yoghurt, quark, powdered milk for consumption; margarine, edible oils and fats.

(260) AM 2026 131659 A

(800) 983668

(151) 2008 08 25

(891) 2024 12 16

(731) bioMérieux, Inc.

515 Colorow Drive, Salt Lake City UT 84108,
USA

(540)

BACT/ALERT

(591) Black, white

(511)

1 – Chemicals for use in industry and science; reagents and media to control and detect contaminating substances in industrial, agricultural, cosmetic, and pharmaceutical products.

5 – Reagents and media for medical and veterinary diagnosis.

9 – Scientific apparatus and instruments for controlling and detecting contaminating substances in industrial, agro-foodstuff, cosmetic, and pharmaceutical products; diagnosis apparatus and instruments, not for medical use.

10 – Apparatus and instruments for medical and veterinary diagnosis.

(260) AM 2026 131687 A

(800) 1832747

(151) 2024 11 07

(891) 2024 11 07

(731) Limited Liability Company "BEREZOVYY
MIR"

UL. BOLSHAYA POLYANKA, 7/10,
BUILDING 3, FLOOR 1, ROOM II, ROOMS
3,4,5, RU-119180 MOSCOW, Russian
Federation

(540)

TUBELON ТУБЕЛОН

(591) Black, white

(531) 28.05

(511)

5 – Balms for medical purposes; dietetic substances adapted for medical use; nutritional supplements for medical purposes; lotions for pharmaceutical purposes; medicinal oils, other than essential oils; medicines for human purposes; dietetic beverages adapted for medical purposes; pomades for medical purposes; vitamin preparations; therapeutic preparations for the bath; pharmaceutical preparations for skin care; pharmaceutical preparations; adjuvants for medical purposes; tonics [medicines]; herbal teas for medicinal purposes; slimming tea for medical purpose; mineral supplements for foodstuffs; medical preparations for slimming purposes.

35 – Demonstration of goods; market studies; distribution of samples; advertising; online advertising on a computer network; procurement services for others [purchasing goods and services for other businesses]; marketing research; sales promotions, for others; auctioneering.

(260) AM 2026 131688 A

(800) 1832750

(151) 2024 11 19

(891) 2024 11 19

(731) ABRAHAM INDUSTRIES S.r.l.

Via Fosse Incrociate 284, I-47822
Santarcangelo
di Romagna (Rimini), Italy

(540)

L.V..N.

(591) Black, white

(511)

3 – Perfumes; cosmetics.

4 – Candles; candles for lighting; floating candles; candles for absorbing smoke; perfumed candles.

9 – Spectacles; mobile telephones; bags adapted for laptops; cell phone covers; flip covers for mobile phones; cases adapted for mobile phones.

14 – Clocks; paste jewellery; jewellery.

18 – Leather purses; briefcases [leather goods]; travelling sets [leatherware]; shoulder belts [straps] of leather; briefcases; bags; overnight bags; holdalls for sports clothing; handbags; rucksacks; trunks [luggage]; suitcases; key cases; key-cases of leather and skins; document cases of leather; leather wallets; pocket wallets; banknote holders; card wallets [leatherware]; portfolio cases [briefcases]; attaché cases; toiletry bags sold empty; wheeled luggage; toiletry bags; cases of imitation leather; cosmetic cases sold empty; tool pouches, sold empty; luggage; travel luggage; carry-on bags; travelling trunks; bucket bags; shoulder bags; umbrellas; parasols; golf umbrellas.

24 – Towels of textile; bed clothes and blankets; sheets [textile]; textiles; printed textile piece goods; waterproof textile fabrics; textile piece goods for furnishing purposes; bed covers; table covers; fabric table toppers; table covers of damask; pillow shams; table linen; textile tablecloths; table covers of plastic.

25 – Menswear; skirts; trousers; denim jeans; shirts; blouses; jerseys [clothing]; sweaters; undershirts; vest tops; snow suits; flying suits; jumper suits; cloaks; stuff jackets [clothing]; casual jackets; blousons; jackets [clothing]; cagoules; raincoats; stockings; socks; hats; headgear; bonnets [headwear]; shrugs; gloves [clothing]; cravats; bathing suits; waist belts; shoes; beach shoes; slippers; boots; gymnastic shoes; tennis shoes; dressing gowns; tights; underwear; sportswear; ladies' clothing; children's wear; boys' clothing; girls' clothing.

(260) AM 2026 131689 A

(800) 1832797

(151) 2024 10 23

(891) 2024 10 23

(731) Fuzhou Honghui Information Technology Co.,
Ltd.

Room 02,22/F, Bangbang Fortune Center,
Building 1, 2 Chuangye Road, Shangjie Town,
Minhou County, Fuzhou City, Fujian Province,
China

(540)

FRANKBERG

(591) Black, white

(531) 26.04.22; 26.04.24; 26.04.24; 27.05.24

(511)

7 – Camshafts for vehicle engines; car washing machines; automatic tyre removing and installing devices; catalytic converters; motorcar jack; ignition coils for automotive engines; pneumatic nut runners; air brushes for applying colour; automobile oil pans; gasoline pumps for automobile engines.

12 – Snow-going vehicles; inflatable boats; vehicle suspension springs; air vehicles; automobile tires [tyres]; motorized cars [land vehicles]; roof racks for au-

tomobiles; mudguards; remote control vehicles, other than toys; slide plate for vehicle repair.

(260) AM 2026 131690 A

(800) 1832800

(151) 2024 10 23

(891) 2024 10 23

(731) Fuzhou Honghui Information Technology Co., Ltd.

Room 02,22/F, Bangbang Fortune Center,
Building1, 2 Chuangye Road, Shangjie Town,
Minhou County, Fuzhou City, Fujian Province,
China

(540)



(591) Black, white

(531) 27.05.22

(511)

7 – Camshafts for vehicle engines; car washing machines; automatic tyre removing and installing devices; catalytic converters; motorcar jack; ignition coils for automotive engines; pneumatic nut runners; air brushes for applying colour; automobile oil pans; gasoline pumps for automobile engines.

12 – Snow-going vehicles; inflatable boats; vehicle suspension springs; air vehicles; automobile tires [tyres]; motorized cars [land vehicles]; roof racks for automobiles; mudguards; remote control vehicles, other than toys; slide plate for vehicle repair.

(260) AM 2026 131691 A

(800) 1832899

(151) 2024 08 19

(891) 2024 08 19

(731) Limited Liability Company "Russian Standard Vodka"

Pulkovskoe shosse, 46, korp. 2, RU-196140
Saint Petersburg, Russian Federation

(540)

ЗОЛОТАЯ
РОССИЯ

(591) Beige, brown and white

(531) 28.05; 29.01.12

(511)

32 – Aperitifs, non-alcoholic; barley wine [beer]; carbonated water; lithia water; seltzer water; soda water; waters [beverages]; mineral water [beverages]; table waters; hop pellets for brewing beer; kvass; cocktails, non-alcoholic; beer-based cocktails; non-alcoholic be-

er-based cocktails; lemonades; non-alcoholic beverages; non-alcoholic dried fruit beverages; isotonic beverages; non-alcoholic honey-based beverages; rice-based beverages, other than milk substitutes; soya-based beverages, other than milk substitutes; aloe vera drinks, non-alcoholic; whey beverages; protein-enriched sports beverages; soft drinks; non-alcoholic beverages flavoured with coffee; non-alcoholic beverages flavoured with tea; non-alcoholic fruit juice beverages; energy drinks; fruit nectars, non-alcoholic; orgeat; beer; non-alcoholic beer; ginger beer; malt beer; powders for effervescing beverages; powders for making soft drinks; sarsaparilla [non-alcoholic beverage]; cider, non-alcoholic; syrups for lemonade; syrups for beverages; starch-based dry mixes for beverage preparation; smoothies; tomato juice [beverage]; vegetable juices [beverages]; fruit juices; preparations for making non-alcoholic beverages; preparations for making carbonated water; must; grape must, unfermented; beer wort; malt wort; pastilles for effervescing beverages; frozen hops for brewing beer; dried hops for brewing beer; shandy; sherbets [beverages]; non-alcoholic fruit extracts; extracts of hops for making beer; non-alcoholic essences for making beverages.

33 – Aperitifs; arrack [arak]; bitters; brandy; wine; piquette; whisky; vodka; anisette [liqueur]; kirsch; hydromel [mead]; gin; digestifs [liqueurs and spirits]; alcoholic seltzers; cocktails; curacao; anise [liqueur]; liqueurs; peppermint liqueurs; makkoli; grain-based distilled alcoholic beverages; sugarcane-based alcoholic beverages; pre-mixed alcoholic beverages, other than beer-based; flavoured brewed alcoholic malt beverages, except beers; alcoholic beverages, except beer; alcoholic beverages containing fruit; wine-based beverages; spirits [beverages]; distilled beverages; rum; sake; perry; cider; soju; rice alcohol; alcoholic extracts; fruit extracts, alcoholic; alcoholic essences.

(260) AM 2026 131692 A

(800) 1832904

(151) 2024 09 18

(891) 2024 09 18

(731) Akciju sabiedriba OLPHA

Rupnicu street 5, LV-2114 Olaine, Latvia

(540)

Alpha

(591) Dark green

(531) 26.01.03; 26.01.12; 26.01.16; 26.01.24;

26.11.01; 26.11.12; 27.05.01; 29.01.12

(511)

1 – Chemicals for use in industry and science; unprocessed artificial and synthetic resins; chemical preparations for soldering; adhesives for use in industry;

putties and other paste fillers; biological preparations for use in industry and science.

5 – Pharmaceuticals; medical preparations; sanitary preparations for medical purposes; dietetic food adapted for medical use; plasters, materials for dressings; dental materials for stopping the teeth; disinfectants; preparations for destroying vermin; fungicides; dietary supplements exclusively for human beings; all the products are for human beings.

9 – Scientific research and laboratory apparatus, educational apparatus and simulators.

10 – Medical and veterinary apparatus and instruments.

44 – Medical services; veterinary services; hygienic and beauty care for humans; hygienic and beauty care for animals; agriculture, aquaculture, horticulture and forestry services.

(260) AM 2026 131693 A

(800) 1832929

(151) 2024 09 29

(891) 2024 09 29

(731) Guangdong Yuxing Technology Industrial Co., Ltd.

Shangkeng Xiangnan Ind'l Zone, Guangyi St, Chenghai Dist, Shantou, 515000 Guangdong, China

(540)



(591) Black, white

(531) 26.04.04; 26.04.05; 26.04.22; 26.04.24; 27.05.15; 27.05.19; 27.05.24

(511)

28 – Apparatus for games; building blocks [toys]; toy robots; toys; smart toys; dolls; balls for playing sports; body-building apparatus; Christmas tree decorations, except confectionery or illumination articles.

(260) AM 2026 131694 A

(800) 1832938

(151) 2024 09 24

(891) 2024 09 24

(731) Guangzhou TAWA Hi Tech Co., Ltd
ROOM 901, 9TH FLOOR, NO.100
JIXIANHOU STREET, YONGTAI,
YONGPING STREET, BAIYUN DISTRICT,
GUANGZHOU, 510000 GUANGDONG,
China

(540)

conpex

(591) Black, white

(531) 27.05.01

(511)

11 – Automobile lights; headlights for automobiles; lighting apparatus for vehicles; lights for vehicles; light bulbs for directional signals for vehicles; anti-dazzle devices for vehicles [lamp fittings]; light-emitting diodes [LED] lighting apparatus; vehicle brake lights; tail lights for vehicles; vehicle headlights.

(260) AM 2026 131695 A

(800) 1832949

(151) 2024 10 14

(891) 2024 10 14

(731) Kelisen Trading (Guangzhou) Co., Ltd.

40, 11F, No. 55, Xidi Second Road, Liwan District, Guangzhou City, 510145 Guangdong Province, China

(540)



(591) Black, white

(531) 26.04.05; 26.04.22; 26.04.24; 27.05.01; 27.05.24; 28.03

(511)

9 – Virtual reality headsets; cabinets for loudspeakers; bluetooth headphone; electronic monitoring equipment; microphones; headsets; headphones; audio- and video-receivers; portable media players; eyeglasses.

(260) AM 2026 131709 A

(800) 1833313

(151) 2024 07 09

(891) 2024 07 09

(731) DIAGRAM S.P.A.

Via Cavicchini 9, I-44037 Jolanda di Savoia (FE), Italy

(540)



(591) Blue and green

(531) 05.03.13; 05.03.15; 20.05.07; 26.11.08; 27.05.01; 27.05.07; 27.05.10; 29.01.12

(511)

9 – Computer software; computer programmes for data processing, in particular in the agriculture, agri-food, aquaculture and forestry fields; computer software for the management, the analysis and the monitoring of data, files and databases, in particular in the agriculture, agri-food, aquaculture and forestry fields;

scientific, surveying, photographic, weighing, measuring, signalling and checking [supervision] apparatus and instruments; sensors and detectors.

42 – Scientific and technological services and research and design services relating thereto; industrial analysis and research services; design and development of computer hardware and software; design, development, updating, maintenance and rental of computer software, in particular in the the agriculture, agri-food, aquaculture and forestry fields; environmental monitoring services in the agriculture, agri-food, aquaculture and forestry fields.

(260) AM 2026 131710 A

(800) 1833347

(151) 2024 10 11

(891) 2024 10 11

(731) CHONGQING AMITY MACHINERY CO., LTD.

NO. 200 ZHONGSHAN 2 ROAD, YUZHONG DISTRICT, 400014 CHONGQING, China

(540)

LAMASTA

(591) Black, white

(511)

6 – Small hardware of metal; safes [strong boxes]; bells for animals; buildings, transportable, of metal; fittings of metal for furniture; fittings of metal for building; padlocks of metal; bands of metal for tying-up purposes; traps for wild animals; buckles of common metal [hardware]; works of art of common metal; unwrought or semi-wrought common metals; tree protectors of metal; identification bracelets of metal; hinges of metal; tool chests of metal, empty; building materials of metal; props of metal; fences of metal; labels of metal; staircases of metal; pulleys of metal, other than for machines; rods of metal for welding; monuments of metal; ropes of metal; scaffolding of metal; wall plugs of metal; vice claws of metal; screws of metal; angle irons of metal; keys of metal; locks of metal, other than electric; door bells of metal, non-electric; weather- or wind-vanes of metal; nails; steel wire; hooks [metal hardware]; iron ores; railway material of metal; anchors.

7 – Rechargeable sweepers; ejectors; whisks, electric, for household purposes; mills for household purposes, other than hand-operated; speed governors for machines, engines and motors; bottle sealing machines; knives, electric; tin openers, electric; electric fruit squeezers; screwdrivers, electric; blade sharpening [stropping] machines; sewing machines; machines for filling brake fluid; elevators; paint spray guns; soldering apparatus, gas-operated; water pumps for automobiles; power drills; power-driven spanners; power-operated saws; powered tire changer machines for land vehicles; power-operated tire mounting machines; wheel balancing machines; tools [parts of machines];

cutting machines; filter presses; dynamos; machines and apparatus for polishing [electric]; trimming machines; stands for machines; aerating pumps for aquaria; pumps [machines]; electric door openers; paper-board making machines; bearings [parts of machines]; metalworking machines; drilling heads [parts of machines]; propulsion mechanisms, other than for land vehicles; machines for making wires and cables; disintegrators; machines for making diaper-pants of paper; forage cutters; valves [parts of machines]; motors, other than for land vehicles; milking machines; belts for machines; electric shoe polishers; compressed air machines; air cylinders [parts of machines]; electric hair clipping machines for animals; sizing machines; optical cold-processing machines; igniting devices for internal combustion engines; agricultural machines; cutters [machines]; enamel making machines; light bulb making machines; brick making machines; cord making machines; tea processing machines; machines for making needles; leather-working machines; electromechanical food preparation machines; lawnmowers [machines]; packaging machines; electromechanical machines for chemical industry; fertilizer manufacturing machines; printing machines; electric kitchen machines; paint spraying machines; machines for making zippers; mixing machines; woodworking machines; saws [machines]; machines for separating gas; pneumatic hammers; washing machines [laundry]; tobacco processing machines; machines for making coal briquettes; glass-working machines; electric machines and apparatus for cleaning; machines for electronic industry; machines for making electric batteries; electric welding machines; electroplating machines; vacuum cleaners; oil-well pumps specially for petroleum; centrifugal mills; glue applying machines; weaving looms; stitching machines; bicycle assembling machines; steam engines; power-operated angle grinders; cranes [lifting and hoisting apparatus]; brewing machines; mine borers; foundry machines; engraving machines; hand-held tools, other than hand-operated; wind-powered installations for generating electricity; high pressure washers.

8 – Sabres; manicure sets; secateurs; agricultural implements, hand-operated; instruments and tools for skinning animals; garden tools, hand-operated; hand-operated lifting jacks; hand-operated hand tools; guns, hand-operated, for the extrusion of mastics; handles for hand-operated hand tools; trowels for mason; abrading instruments [hand instruments]; perforating tools [hand tools]; bits [parts of hand tools]; riveters [hand tools]; graving tools [hand tools]; table cutlery [knives, forks and spoons]; harpoons.

9 – Printers for use with computers; sensors; optical apparatus and instruments; chemistry apparatus and instruments; electronic weighing scales for kitchen use; video phones; photocopiers [photographic, electrostatic, thermic]; interphones; navigational instruments; industrial endoscope cameras; cabinets for lo-

udspeakers; alarms; control panels [electricity]; radio signal tuners; radio receivers and transmitters; wireless routers; levels [instruments for determining the horizontal]; pressure measuring apparatus; surveying apparatus and instruments; measuring apparatus; ear plugs for divers; fire extinguishing apparatus; cameras [photography]; biometric fingerprint door locks; electronic video surveillance apparatus; electric couplings; electronic notice boards; electronic chip cards; electric theft prevention installations; condensers [capacitors]; electric switches; electric contacts; electric plugs; electric sockets; electric batteries; chargers for electric batteries; electric measuring devices; covers for electric outlets; materials for electricity mains [wires, cables]; electric locks; electric door bells; mobile power supply [rechargeable batteries]; air analysis apparatus; internet router; dashboard cameras; weighing apparatus and instruments; video monitor; counters; computer programs, downloadable; computer network switches; computer network bridges; rearview cameras for vehicles; speed checking apparatus for vehicles; lasers, not for medical purposes; counterfeit coin detectors; semi-conductors; heat regulating apparatus; lightning rods; apparatus to check franking; ticket dispensing terminals, electronic; voting machines; video screens; face identification apparatus; remote control apparatus; optical fibres [light conducting filaments]; animated cartoons; radiological apparatus for industrial purposes; electrolyzers.

11 – Extractor hoods for kitchens; humidifiers for household purposes; electric torches; searchlights; fluorescent lighting tube; water purification installations; water purifying apparatus and machines; disinfectant apparatus; light bulbs; heat guns; cooking apparatus and installations; gas stoves; lighting apparatus and installations; electric heating apparatus; electric lamps; electric kettles; air purifier for household purposes; air purifying apparatus and machines; air-conditioning installations; fans [air-conditioning]; electric hair dryers; automatic watering installations; fog machines; lights for vehicles; lava rocks for use in barbecue grills; germicidal lamps for purifying air; curling lamps; electric pocket warmers for warming hands; refrigerating appliances and installations; cooling appliances and installations; electric water purifier for household purposes; gas lighters; oil lamps; electric radiators; electrically heated clothing; polymerisation installations; ice machines and apparatus; heaters for baths; roasting apparatus; bread baking machines; coffee machines, electric; cooking pots, electric; induction cookers; electric cookers; air fryers; fabric steamers; sanitary apparatus and installations; cocks for pipes and pipelines; bath installations; pipes [parts of sanitary installations]; taps.

12 – Mechanics' creepers; carts; air pumps for motorcycles; civilian drones; air pumps [vehicle accessories]; air pumps for automobiles; electric bicycles; electric vehicles; air pumps for bicycles; repair outfits for

inner tubes; trolleys [mobile carts]; luggage carriers for vehicles; tyres for vehicle wheels; engine mounts for land vehicles; motors, electric, for land vehicles.

20 – Furniture; containers, not of metal [storage, transport]; work benches; photograph frames; works of art of bamboo; cork craftwork; display boards; nesting boxes for household pets; furniture fittings, not of metal; door fittings, not of metal; screws, not of metal; pegs [pins], not of metal; locks, other than electric, not of metal; stools; chairs [seats]; chaise longue; armchairs; trays, not of metal; vats, not of metal; transport pallets, not of metal; cushions; tool chests, not of metal, empty; tool boxes, not of metal, empty; boxes of wood or plastic; jerrycans, not of metal; ladders of wood or plastics; vice benches [furniture]; saw benches [furniture]; split rings, not of metal, for keys; boxes of plastic.

21 – Vacuum bottles; brushes; cosmetic utensils; garlic presses; kitchen utensils; watering cans; gardening gloves; dustbins; indoor aquaria; gloves for household purposes; ceramics for household purposes; scoops for household purposes; containers for household or kitchen use; dumpling moulds for household use; bottle openers, electric and non-electric; cleaning instruments, hand-operated; mops; mop wringer buckets; insect traps; enamel ware and plastic ware for household purposes, namely basins, bowls, plates, kettles, and cups; glassware for household purposes, namely cups, plates, kettles, and jars; porcelain ware for household purposes, namely basins, bowls, plates, kettles, tableware, jars, jugs, and pots; glass, unworked or semi-worked, except building glass; combs; sprinklers; drying racks for laundry; steel wool for cleaning; grill supports; cookery moulds; toothbrushes; glass bowls; works of art of porcelain, ceramic, earthenware, terra-cotta or glass; electric toothbrushes; cake moulds; cake plates; ultrasonic pest repellents; egg beaters, non-electric; non-electric cooking utensils; cooking pots, non-electric; thermally insulated containers for food; drinking troughs; drinking vessels.

35 – Sponsorship search; rental of sales stands; provision of an online marketplace for buyers and sellers of goods and services; personnel management consultancy; book-keeping; administrative services for the relocation of businesses; commercial information agency services; business management assistance; marketing; advertising; sales promotion for others; procurement services for others [purchasing goods and services for other businesses]; commercial administration of the licensing of the goods and services of others; organization of exhibitions for commercial or advertising purposes; employment agency; wholesale store services for pharmaceutical, veterinary and sanitary preparations and medical supplies; retail store services for pharmaceutical, veterinary and sanitary preparations and medical supplies; online advertising

on a computer network; import-export agency services.

(260) AM 2026 131713 A

(800) 1833441

(151) 2024 08 06

(891) 2024 08 06

(731) MAISON MINELLI

1 Impasse Saint-Eustache, F-75001 Paris,
France

(540)

minelli

(591) Black, white

(531) 27.05.01

(511)

18 – Leather and imitation leather; handbags; traveling bags; beggar's bags; backpacks; sports bags; beach bags; baby-changing bags; tote bags (fabric bags); briefcases of leather; briefcases (leather goods); wallets; card cases; banknote holders; coin purses not of precious metal; traveling sets (leatherware); satchels; trunks [luggage]; suitcases [carrying cases]; suitcases; luggage; luggage tags (leather goods); key cases (leather goods); cases of leather for driving licenses; business card cases; covers of leather; toiletry bags; makeup bags sold empty; vanity cases, not fitted; garment bags for travel for clothing and shoes; umbrellas; sunshades; walking sticks; collars or clothing for animals; bags for carrying animals; bags or net bags for shopping; bags or small bags (envelopes, pouches) of leather for packaging; whips, harness and saddlery; leashes; purses; hip bags.

25 – Clothing; underwear; socks; stockings; tights; leg warmers; bathing suits; bathing shorts; sarong; dressing gowns; pajamas; housecoats (dressing gowns); nightgowns; neckties, bow ties; scarves; long scarves; stoles; shawls; headbands (clothing); belts (clothing); suspenders; gloves (clothing); fingerless gloves; headwear; visors (headwear); ear muffs; footwear (except orthopedic footwear); sneakers; sandals; boots; ankle boots; running shoes; jogging shoes; dress shoes; slip-on shoes; sports shoes; beach shoes; ski boots; footwear with Velcro; vinyl shoes; leather footwear; flat shoes; high-heeled shoes; slippers ("chaussons"); soles not for orthopedic use; heel pieces for shoes not for orthopedic use; hosiery.

(260) AM 2026 131788 A

(800) 1833881

(151) 2024 11 27

(891) 2024 11 27

(731) Richter Gedeon Nyrt.

Gyömrői út 19-21., H-1103 Budapest, Hungary

(540)

DOTADOLIN

(591) Black, white

(511)

5 – Pharmaceutical preparations.

(260) AM 2026 131789 A

(800) 1833882

(151) 2024 11 27

(891) 2024 11 27

(731) Richter Gedeon Nyrt.

Gyömrői út 19-21., H-1103 Budapest, Hungary

(540)

PELOXARON

(591) Black, white

(511)

5 – Pharmaceutical preparations.

(260) AM 2026 131796 A

(800) 1834081

(151) 2024 09 19

(891) 2024 09 19

(731) FM World Sp. z o.o.

ul. Żmigrodzka 247., PL-51-129 Wrocław,
Poland

(540)

FEDERICO MAHORA

(591) Black, white

(511)

35 – Business consultancy and advisory services; arranging and conducting of business meetings; provision of assistance [business] in the establishment of franchises; provision of assistance [business] in the operation of franchises; commercial or industrial management assistance; assistance in business management within the framework of a franchise contract; mediation of advertising; business assistance relating to franchising; business networking services; business strategy services; commercial management; information about sales methods; advertising agency services; arrangement of advertising; providing marketing information via websites; distribution of advertising, marketing and promotional material; provision of information relating to marketing; market campaigns; compilation of advertisements for use on the internet; trade marketing [other than selling]; internet marketing; development of marketing concepts; search engine optimisation; arranging and conducting of marketing events; assistance in product commercialization, within the framework of a franchise contract; promotion, advertising and marketing of on-line websites; promoting the goods and services of others over the internet; preparation of marketing plans; publication of advertising material on-line; organisation of exhibitions for business or commerce; conducting of commercial events; on-line advertising and marketing services; sales management services; administrative processing and organising of mail order services; busi-

ness intermediary and advisory services in the field of selling products and rendering services; arranging and conducting of demonstrations for advertising purposes; demonstration of goods and services by electronic means, also for the benefit of the so-called teleshopping and homeshopping services; presentation of goods and services; corporate communications services; administration of loyalty programs involving discounts or incentives; organisation of customer loyalty programs for commercial, promotional or advertising purposes; customer club services, for commercial, promotional and/or advertising purposes; customer relationship management; administration of loyalty and incentive schemes; administration of the business affairs of retail stores; compilation of online business directories; online retail store services relating to cosmetic and beauty products; retail services in relation to dietetic preparations; unmanned retail store services relating to food; retail services in relation to dietary supplements; retail services via catalogues related to foodstuffs; commercial information and advice services for consumers in the field of make-up products; wholesale services in relation to beauty implements for humans; advertising services relating to the sale of goods; promotion of goods and services through sponsorship; presentation of companies and their goods and services on the internet; advertising the goods and services of online vendors via a searchable online guide; online ordering services; online advertising; dissemination of advertising matter online; advertising services provided via the internet; advertising services relating to perfumery; advertising services relating to jewelry; wholesale services in relation to kitchen appliances; online retail services relating to cosmetics; retail services in relation to cookware; retail services in relation to sporting articles; online retail services relating to clothing; online retail services relating to jewelry; online community management services being outsourcing services in the field of customer relationship management; online retail services relating to luggage; mail order retail services for cosmetics; retail services relating to candy; retail services relating to delicatessen products; retail services relating to sporting goods; consulting services in the field of internet marketing; providing business information via a web site.

(260) AM 2026 132035 A

(800) 1836255

(151) 2024 11 30

(891) 2024 11 30

(731) Apple Inc.

One Apple Park Way, Cupertino CA 95014,
USA

(540)



(591) White, orange, pink, purple and blue

(531) 24.17.08; 26.04.04; 26.04.16; 26.11.25;
29.01.15

(511)

9 – Computer software; speech to text conversion software; voice-enabled software applications; mobile telephone software; information retrieval software; computer software for enabling hands-free use of consumer electronics through voice recognition; computer software for accessing, browsing and searching online databases; computer software for the redirection of messages, Internet e-mail, and/or other data to one or more electronic handheld devices from a data store on or associated with a personal computer or a server; computer software used to process voice commands, and create audio responses to voice commands; computer software for dictation; computer software for scheduling appointments, reminders, and events on an electronic calendar; computer software for storing, organizing, and accessing phone numbers, addresses, and other personal contact information; computer software for global positioning and for providing travel directions; computer software for making travel arrangements; computer software for making reservations at hotels and restaurants; computer software for personal information management; computer software for travel and tourism, travel planning, navigation, travel route planning, geographic, destination, transportation and traffic information, driving and walking directions, customized mapping of locations, street atlas information, electronic map display, and destination information; computer software for distributing, downloading, transmitting, receiving, playing, editing, displaying, storing and organizing text, data, graphics, images, audio, video, and other multimedia content, electronic publications; computer software for use in recording, organizing, transmitting, manipulating, and reviewing text, data, audio files, video files and electronic games in connection with computers, audio players, video players, media players; computer software for providing consumer resources for searching, locating, rating, evaluating and providing directions for the purchase, consumption and use of a wide range of consumer products, services and information over a global communications network namely, computer software for accessing, browsing and searching online databases; home automation and home device integration software; personal vehicle integration software; computer software used for controlling stand alone devices;

computer software for use in communicating with, monitoring, configuring, adjusting, and controlling residential alarm, security, and surveillance devices and systems, smoke and carbon monoxide detectors and monitors, lighting, electrical and electronic switches and outlets, energy management devices and systems, air conditioning, heating, and ventilation devices and systems, and doors, drapes, curtains, window shades, shutters, blinds, and garage doors; computer software for creating, authoring, distributing, downloading, transmitting, receiving, playing, editing, extracting, encoding, decoding, displaying, storing and organizing text, data, graphics, images, audio, video, and other multimedia content; computer software for use in recording, organizing, transmitting, manipulating, and reviewing text, data, audio files, video files in connection with computers, television set-top boxes, audio players, video players, media players, and handheld digital electronic devices.

(260) AM 2026 132156 A
 (800) 1837421
 (151) 2025 01 08
 (891) 2025 01 08
 (731) Tikkurila Oyj
 Heidehofintie 2, FI-01300 Vantaa,
 Finland
 (540)

HELMI

(591) Black, white
 (511)
 2 – Paints, varnishes, lacquers; preservatives against rust and against deterioration of wood; colorants; mordants; raw natural resins; metals in foil and powder form for painters, decorators, printers and artists; glazing paints and glazes; undercoat paints and primers; red lead oxide; colorants for textiles; bronzing lacquers and gildings; thinners and thickeners for paints; rust prevention and protective preparations for wood, metal, plastic, brick, cement, concrete, glass and ceramic building materials; coverings and coatings (paints); coatings; glazes; lime wash paint; badigeon; siccatives (drying agents) for paints; binding agents for colorants.

(260) AM 2026 132200 A
 (800) 1713946
 (151) 2023 01 13
 (891) 2025 01 16
 (731) Sound Around, Inc.
 1600 63rd Street, Brooklyn NY 11204,
 USA
 (540)

HURTLE

(591) Black, white

(511)
 12 – Motorized, electric-powered, self-propelled, self-balancing, wheeled personal mobility, transportation devices.

28 – Toy scooters; exercise equipment, namely, exercise machines, stationary exercise bikes; exercise equipment in the nature of fitness equipment for yoga, namely, yoga blocks, yoga bolsters in the nature of yoga wedges, yoga boards, yoga cushions, yoga straps, yoga blankets, yoga bolsters, exercise bands in the nature of yoga belts; stretch bands used for yoga and physical fitness purposes; sports gear and exercise equipment, namely, stationary cycles, rowing machines, manually operated jogging machines, chest expanders, chest pulls, inflatable balls, dumbbells, exercise weights, manually operated exercise equipment, exercise balls, training bars in the nature of ballet bars, inversion swings, exercise bands in the nature of stretch bands, dumb-bells, work-out gloves, jump ropes, kettle bells, exercise hand grippers, exercise bands, abdominal wheel exercise rollers, strength training equipment, namely, manually operated exercise equipment.

(260) AM 2026 132418 A
 (800) 1839848
 (151) 2024 11 06
 (891) 2024 11 06
 (731) Egis Gyógyszergyár Zrt.
 Keresztúri út 30-38., H-1106 Budapest,
 Hungary
 (540)

OPVENTI

(591) Black, white
 (511)
 5 – Pharmaceutical preparations for human use; vitamin preparations; food supplements; dietary supplements and dietetic preparations; medicinal ointments; medicated skin creams; antiseptic preparations; disinfectants.

(260) AM 2026 132419 A
 (800) 1839850
 (151) 2024 11 13
 (891) 2024 11 13
 (731) Egis Gyógyszergyár Zrt.
 Keresztúri út 30-38., H-1106 Budapest,
 Hungary
 (540)

REZULYB

(591) Black, white
 (511)
 5 – Pharmaceutical preparations for human use; vitamin preparations; food supplements; dietary supplements and dietetic preparations; medicinal ointments;

medicated skin creams; antiseptic preparations; disinfectants.

(260) AM 2026 132420 A

(800) 1839851

(151) 2024 11 13

(891) 2024 11 13

(731) Egis Gyógyszergyár Zrt.

Keresztúri út 30-38., H-1106 Budapest,
Hungary

(540)

MYBELSA

(591) Black, white

(511)

5 – Pharmaceutical preparations for human use; vitamin preparations; food supplements; dietary supplements and dietetic preparations; medicinal ointments; medicated skin creams; antiseptic preparations; disinfectants.

(260) AM 2026 132421 A

(800) 1839852

(151) 2024 11 12

(891) 2024 11 12

(731) EGIS Gyógyszergyár Zrt.

Keresztúri út 30-38., H-1106 Budapest,
Hungary

(540)

VERANORIB

(591) Black, white

(511)

5 – Pharmaceutical preparations for human use; vitamin preparations; food supplements; dietary supplements and dietetic preparations; medicinal ointments; medicated skin creams.

(260) AM 2026 132422 A

(800) 1839885

(151) 2025 01 15

(891) 2025 01 15

(731) Alexander Bernhardt

Lindenstraße 49, 57627 Hachenburg,
Germany

(540)

Skyjo

(591) Black, white

(511)

28 – Card games.

(260) AM 2026 134161 A

(800) 1819648

(151) 2024 07 25

(891) 2025 05 21

(731) IIC-INTERSPORT International Corporation

GmbH

Wölflistrasse 2, CH-3006 Bern, Switzerland

(540)



(591) Black, white

(531) 26.11.01; 26.11.13; 26.11.25

(511)

9 – Protective helmets for sports; pedometers and other portable electronic indicators for measurements, including for the wrist; individual reflective disks, bands and equipment for the prevention of road accidents, particularly for running, walking and training; signaling whistles; sports whistles; helmets for skiing and snowboarding, hockey helmets; life jackets; life belts; swim floats for safety purposes; flotation vests; suits, gloves and earplugs for divers; spectacles, sunglasses, including sunglasses for skiing, mountain hiking and mountaineering; spectacles worn for sports training; cases for visors, cases for sunglasses, cases for goggles; protective sports vests; snorkels.

18 – All-purpose sport bags, sports and traveling bags, rucksacks, backpacks, in particular backpacks made of waterproof textile materials specially designed for skiing; sling bags for carrying infants, rain covers for bags; beggar's bags, game bags and backpacks for hunting; beach bags; belt bags, namely, fanny packs for running; walking sticks, telescopic poles, hiking poles, trekking poles, Nordic walking sticks; saddlery.

25 – Clothing, footwear, headwear; clothing, footwear and headgear for sports; clothing, footwear, headgear for winter sports; caps, gloves, jackets, vests, shirts, trousers, tights, shorts, headbands, beanies, gloves, socks, running shoes, walking shoes, cross-country shoes, tracksuits, slippers, shoes for ball sports; waist bands (parts of clothing); clothing and shoes adapted for indoor and outdoor team sports and for training; after-ski boots, ski trousers adaptable to boots, gaiters; boots and gloves for skiing; clothing and footwear for indoor and outdoor racket sports; clothing and footwear for tennis; swimwear; swimsuits; bathing caps; water socks; beach clothes; beach shoes; sports underwear.

28 – Sports and gymnastic articles included in this class, including wrist guards, elbow guards, shoulder guards, ankle guards, shin guards and knee guards; elbow guards, protective knee pads for sports; bags for carrying sporting articles; protective padding (parts of sportswear); roller skates, ice skates; skateboards; snowboards, skis, bindings and poles for alpine skiing, cross-country skiing and Nordic skiing, ski

brakes; covers adapted for skis; seal skins (coverings for skis); protective cups for sports; straps for skis; sledges (sports articles); sledges; scooters (toys); balls for sports, balls for handball, volleyball, basketball, beach volleyball, football, rugby, pumps for inflating sports balls, goalkeeper gloves, training balls, floorball sticks, unihockey sticks, field hockey sticks, hockey sticks and pucks; ice skates; belts for sports; games; table tennis, badminton and tennis nets; racketball, table tennis, badminton, squash and tennis rackets; covers and bags for rackets; strings for rackets; racket handles; balls and shuttlecocks, tables for table tennis; protective covers for table tennis tables; buoys and flippers for swimming and diving; belts, vests and straps for swimming; assistance devices in the nature of swimming floats for leisure; fishing tackle, cases and covers for fishing rods; hunting game calls; archery implements.

(260) AM 2026 134218 A

(800) 1859255

(151) 2025 03 13

(891) 2025 03 13

(731) SUBSIDIARY COMPANY

"CONFECTIONERY CORPORATION

"ROSHEN"

1 Nauky Avenue, building 1, Kyiv 03039,
Ukraine

(540)

FLAKSI

(591) Black, white

(511)

30 – Cereal bars; waffles; confectionery; bakery products; oat flakes; chocolate-coated nuts; fruit jellies [confectionery]; caramels [sweets]; crackers; ice cream; muesli; nougat; edible paper wafers; lozenges [confectionery]; biscuits; chips [cereal products]; corn flakes; fondants [confectionery]; popcorn; pralines; sweets; cakes; halvah; candies; chocolate.

(260) AM 2026 134221 A

(800) 1859324

(151) 2025 02 04

(891) 2025 02 04

(731) ORLING s.r.o.

Na Bělisku 1352, CZ-562 01 Ústí nad Orlicí,
Czech Republic

(540)



(591) Black, white

(531) 02.01.08; 02.01.16; 26.01.05; 26.01.19; 28.05

(511)

5 – Pharmaceutical products and preparations; dietetic substances adapted for medical use; foodstuffs for medical purposes for children and adults; dietetic foodstuffs and beverages adapted for medical use, intended for the protection of joints, ligaments, skin, hair or other parts of the musculoskeletal system and the human body; dietetic foods with arthral protein adapted for medical purposes; drinks of dietetic character adapted for medical purposes; preparations for human and animal use for medical purposes; herbal products for medical purposes; medicated beverages; gelatine products for medical purposes; veterinary preparations; medicated nutritional foodstuffs and foodstuff supplements for animals; dietetic substances for medical purposes, for the protection of joints, skin and the musculoskeletal system of animals; preparations for making non-alcoholic medical beverages containing dietetic, nutritional, fortifying and boosting supplements; medicinal preparations to support the health of the immune system and of the respiratory system.

29 – Gelatine food preparations in powder form.

32 – Non-alcoholic gelatine beverages.

(260) AM 2026 134240 A

(800) 1853372

(151) 2025 03 05

(891) 2025 05 26

(731) Individualnyj predprinimatel Kurilkin Pol' Gennad'evich
Sovetskij prospekt, 4, kv. 5, g. Ivanteevka,
Moskovskaya obl. 141280, Russian
Federation

(540)



(591) Black, brown and white

(531) 24.17.04; 26.11.01; 26.11.12; 27.01.12;

27.05.11; 27.05.17; 29.01.12

(511)

1 – Agar-agar for industrial purposes; nitrogen; actinium; alkaloids; alginates for the food industry; alginates for industrial purposes; crotonic aldehyde; ammonium aldehyde; aldehydes; americium; amyl acetate; ammonia; ammonia [volatile alkali] for industrial purposes; anhydrous ammonia; acetic anhydride; anhydrides; anti-knock substances for internal combustion engines; disincrustants; antioxidants for use in the manufacture of cosmetics; antioxidants for use in the manufacture of food supplements; antioxidants for use in the manufacture of pharmaceuticals; antioxidants for use in manufacture; antistatic preparations, other than for household purposes; antifreeze; size for use

in the textile industry; argon; lead arsenate; aspartame for the food industry; aspartame for industrial purposes; astatine; aluminium acetate; lime acetate; lead acetate; acetate of cellulose, unprocessed; acetates [chemicals]; acetylene; acetone; oenological bactericides [chemical preparations for use in wine making]; barium; barytes; albumin [animal or vegetable, raw material]; animal albumen [raw material]; iodised albumen; malt albumen; benzene; benzol; bentonite; berkelium; bicarbonate of soda for chemical purposes; potassium dioxalate; biostimulants for plants; bichromate of potassium; bichromate of soda; bauxite; bromine for chemical purposes; bouillons for bacteriological cultures, other than for medical or veterinary purposes; albumenized paper; baryta paper; diazo paper; blueprint paper; test paper, chemical; litmus paper; reagent paper, other than for medical or veterinary purposes; self-toning paper [photography]; nitrate paper; sensitized paper; photometric paper; borax; agglutinants for concrete; gas purifying preparations; polish removing substances; preparations for the separation of greases; substances for preventing runs in stockings; water-softening preparations; limestone hardening substances; tanning substances; adhesives for industrial purposes; tensio-active agents; fissionable material for nuclear energy; foundry binding substances; concrete-aeration chemicals; leather-dressing chemicals; chemicals for the manufacture of paints; chemicals for the manufacture of pigments; chemical substances for analyses in laboratories, other than for medical or veterinary purposes; starch-liquifying chemicals [ungluing agents]; seed preserving substances; viscose; bismuth; bismuth subnitrate for chemical purposes; vitamins for the food industry; vitamins for use in the manufacture of cosmetics; vitamins for use in the manufacture of food supplements; vitamins for use in the manufacture of pharmaceuticals; witherite; distilled water; seawater for industrial purposes; acidulated water for recharging batteries; heavy water; lye water for the food industry; hydrogen; seaweeds [fertilizers]; grafting wax for trees; gadolinium; getters [chemically active substances]; protective gases for welding; solidified gases for industrial purposes; propellant gases for aerosols; basic gallate of bismuth; gallium; gambier; helium; electrophoresis gels; genes of seeds for agricultural production; hydrazine; aluminium hydrate; hydrates; hyposulfites; hypochlorite of soda; gypsum for use as a fertilizer; ceramic glazings; glycol; expanded clay for hydroponic plant growing [substrate]; kaolin; alumina; glycerides; glycerine for industrial purposes; glucose for the food industry; glucose for industrial purposes; glucosides; gluten for the food industry; gluten for industrial purposes; holmium; hormones for hastening the ripening of fruit; peat pots for horticulture; graphene; graphite for industrial purposes; guano; humus; gurjun balsam for use in the manufacture of varnish; dextrin [size]; dendrimer-based polymers for use in the manufacture of capsules for pharmaceu-

ticals; defoliant; diastase for industrial purposes; manganese dioxide; titanium dioxide for industrial purposes; carbon dioxide for industrial purposes; zirconia; oil dispersants; petroleum dispersants; dispersions of plastics; dysprosium; bichloride of tin; detergent additives to petrol; ceramic compositions for sintering [granules and powders]; additives, chemical, to drilling muds; additives, chemical, to insecticides; chemical additives for oils; additives, chemical, to motor fuel; additives, chemical, to fungicides; dolomite for industrial purposes; tan-wood; yeast for use in biofuel production; yeast for scientific purposes; europium; gelatine for photographic purposes; gelatine for industrial purposes; auxiliary fluids for use with abrasives; dielectric fluids as a chemical preparation for use in metalworking, except oils; fluids for hydraulic circuits; liquids for removing sulfates from batteries; power steering fluid; brake fluid; magnetic fluid for industrial purposes; transmission fluid; tree cavity fillers [forestry]; glaziers' putty; moderating materials for nuclear reactors; diatomaceous earth; fuller's earth for use in the textile industry; lime chloride; isotopes for industrial purposes; active chemical ingredients; ion exchangers [chemicals]; ytterbium; yttrium; iodine for industrial purposes; iodine for chemical purposes; aluminium iodide; alkaline iodides for industrial purposes; casein for the food industry; casein for industrial purposes; kainite; potassium; sorrel salt; californium; calomel [mercurous chloride]; gums [adhesives] for industrial purposes; gum arabic for industrial purposes; tartar, other than for pharmaceutical purposes; camphor, for industrial purposes; calcium carbide; silicon carbide [raw material]; carbide; lime carbonate; magnesium carbonate; carbonates; cement [metallurgy]; cassiopium [lutetium]; catalysts; biochemical catalysts; catechu; caustics for industrial purposes; alum; aluminium alum; ammonia alum; chrome alum; quebracho for industrial purposes; ketones; kieselgur; cinematographic film, sensitized but not exposed; oxygen for industrial purposes; nitric acid; anthranilic acid; benzoic acid; boric acid for industrial purposes; tartaric acid; tungstic acid; gallic acid for the manufacture of ink; gallotannic acid; glutamic acid for industrial purposes; tannic acid; iodic acid; citric acid for industrial purposes; lactic acid; formic acid; persulfuric acid; oleic acid; picric acid; pyrogallic acid; salicylic acid; sebacic acid; sulfuric acid; sulfurous acid; spirits of salt; stearic acid; carbonic acid; spirits of vinegar [dilute acetic acid]; phosphoric acid; hydrofluoric acid; hydrochloric acid; cholic acid; chromic acid; oxalic acid; acids; benzene-based acids; fatty acids; mineral acids; arsenious acid; adhesives for billposting; leather glues; adhesives for wall tiles; adhesives for paperhanging; glue for industrial purposes; conductive adhesives; birdlime; isinglass, other than for stationery, household or alimentary purposes; gluten [glue], other than for stationery or household purposes; starch paste [adhesive], other than for stationery or household purposes; stem cells,

other than for medical or veterinary purposes; collagen for industrial purposes; collodion; compost; masonry preservatives, except paints and oils; beer preserving agents; preservatives for use in the pharmaceutical industry; flower preservatives; mangrove bark for industrial purposes; tan; starch for industrial purposes; silicon; creosote for chemical purposes; krypton; xenon; xylene; xylol; biological tissue cultures, other than for medical or veterinary purposes; cultures of microorganisms, other than for medical and veterinary use; curium; lactose [raw material]; lactose for the food industry; lactose for industrial purposes; lanthanum; dry ice [carbon dioxide]; lecithin [raw material]; lecithin for the food industry; lecithin for industrial purposes; lithium; magnesite; manganate; oils for tanning leather; oils for currying leather; oils for preparing leather in the course of manufacture; oils for the preservation of food; transmission oil; carbolicneum for the protection of plants; paper pulp; wood pulp; grafting mastic for trees; mastic for leather; mastic for tyres; oil cement [putty]; synthetic materials for absorbing oil; brazing preparations; ceramic materials in particulate form, for use as filtering media; filtering materials of unprocessed plastics; filtering materials of mineral substances; filtering materials of vegetable substances; filtering materials of chemical substances; metalloids; alkaline-earth metals; alkaline metals; methane; methyl benzene; methyl benzol; flour for industrial purposes; tapioca flour for industrial purposes; potato flour for industrial purposes; soap [metallic] for industrial purposes; arsenic; emollients for industrial purposes; bate for dressing skins; animal manure; nanopowders for industrial purposes; sodium; naphthalene; sal ammoniac; toxic gas neutralizers; neodymium; neon; neptunium; ammonium nitrate; uranium nitrate; nitrates; combusting preparations [chemical additives to motor fuel]; nitrous oxide; baryta; uranium oxide; oxalates; lithia [lithium oxide]; lead oxide; antimony oxide; chromium oxide; cobalt oxide for industrial purposes; mercuric oxide; olivine [silicate mineral]; gallnuts; clarification preparations; wine finings; beer clarifying agents; textile-brightening chemicals; must-finishing preparations; reducing agents for use in photography; bases [chemical preparations]; wax-bleaching chemicals; fat-bleaching chemicals; organic digestate [fertilizer]; paste fillers for automobile body repair; pectin for the food industry; pectin for industrial purposes; pectin [photography]; perborate of soda; humus top dressing; percarbonates; hydrogen peroxide for industrial purposes; persulfates; perchlorates; foundry sand; plastisols; sensitized plates for offset printing; ferrotype plates [photography]; plasticizers; plastics, unprocessed; X-ray films, sensitized but not exposed; plutonium; artificial sweeteners for the food industry; artificial sweeteners for industrial purposes; chemical coatings for ophthalmic lenses; polonium; diagnostic strips for testing breast milk, other than for medical or veterinary use; potash; potash water; soil for growing;

praseodymium; rubber preservatives; brickwork preservatives, except paints and oils; cement preservatives, except paints and oils; preservatives for tiles, except paints and oils; bacterial preparations, other than for medical and veterinary use; bacteriological preparations for acetification; bacteriological preparations, other than for medical and veterinary use; biological preparations, other than for medical or veterinary purposes; vulcanizing preparations; diagnostic preparations for research laboratory use; diagnostic preparations, other than for medical or veterinary purposes; renovating preparations for phonograph records; currying preparations for leather; currying preparations for skins; metal hardening preparations; fixing baths [photography]; opacifiers for glass; opacifiers for enamel; separating and unsticking [ungluing] preparations; metal annealing preparations; metal tempering preparations; preparations for preventing the tarnishing of lenses; preparations for preventing the tarnishing of glass; cement-waterproofing chemicals, except paints; plant growth regulating preparations; wallpaper removing preparations; anti-boil preparations for engine coolants; fulling preparations for use in the textile industry; descaling preparations, other than for household purposes; fertilizing preparations; flashlight preparations; galvanizing preparations; finishing preparations for use in the manufacture of steel; sizing preparations; animal carbon preparations; preparations of microorganisms, other than for medical and veterinary use; corrosive preparations; cryogenic preparations; dehydrating preparations for industrial purposes; degreasing preparations for use in manufacturing processes; gum solvents; oil-bleaching chemicals; decolorants for industrial purposes; preparations for stimulating cooking for industrial purposes; anti-incrustants; preparations of trace elements for plants; moistening [wetting] preparations for use in the textile industry; moistening [wetting] preparations for use in dyeing; moistening [wetting] preparations for use in bleaching; enzyme preparations for the food industry; enzyme preparations for industrial purposes; filtering preparations for the beverages industry; chemical preparations to prevent mildew; chemical preparations to prevent wheat blight; chemical condensation preparations; chemical preparations for smoking meat; chemical preparations for scientific purposes, other than for medical or veterinary use; chemical preparations for facilitating the alloying of metals; chemical preparations to prevent diseases affecting vine plants; chemical preparations to prevent diseases affecting cereal plants; engine-decarbonising chemicals; fulling preparations; fuel-saving preparations; coal saving preparations; damp-proofing chemicals, except paints, for masonry; anti-sprouting preparations for vegetables; preparations of the distillation of wood alcohol; by-products of the processing of cereals for industrial purposes; chemical substances for preserving foodstuffs; benzene derivatives; cellulose derivatives [chemicals]; promethium; protactini-

um; protein [raw material]; proteins for the food industry; proteins for use in the manufacture of food supplements; proteins for use in manufacture; mordants for metals; radium for scientific purposes; radon; meat tenderizers for industrial purposes; solvents for varnishes; anti-frothing solutions for batteries; drilling muds; solutions for cyanotyping; galvanizing baths; silver salt solutions for silvering; toning baths [photography]; chemical reagents, other than for medical or veterinary purposes; rhenium; mercury; rubidium; carbon black for industrial purposes; soot for industrial or agricultural purposes; lamp black for industrial purposes; samarium; saccharin for the food industry; saccharin for industrial purposes; selenium; saltpeter; sulfur; silver nitrate; carbon disulfide; silicates; aluminium silicate; silicones; scandium; topsoil; foundry moulding preparations; potting soil; acrylic resins, unprocessed; polymer resins, unprocessed; conductive resins, unprocessed; synthetic resins, unprocessed; epoxy resins, unprocessed; soda ash; calcined soda; caustic soda for industrial purposes; barium compounds; fluorspar compounds; salts [fertilizers]; salts [chemical preparations]; ammoniacal salts; ammonium salts; salts of precious metals for industrial purposes; salts for galvanic cells; salt for preserving, other than for foodstuffs; salts for colouring metal; salts for industrial purposes; iron salts; gold salts; iodised salts; calcium salts; sodium salts [chemical compounds]; salts from rare earth metals; mercury salts; toning salts [photography]; chrome salts; chromic salts; salts of alkaline metals; rock salt; salt, raw; mould-release preparations; compositions for the manufacture of phonograph records; compositions for the manufacture of technical ceramics; compositions for repairing inner tubes of tyres; compositions for repairing tyres; acid proof chemical compositions; glutinous tree-grafting preparations; adhesive preparations for surgical bandages; fireproofing preparations; fire extinguishing compositions; compositions for threading; amyl alcohol; vinic alcohol; wood alcohol; sal ammoniac spirits; ethyl alcohol; alcohol for industrial purposes; adjuvants, other than for medical or veterinary purposes; cement for footwear; chimney cleaners, chemical; concrete preservatives, except paints and oils; detergents for use in manufacturing processes; water glass [soluble glass]; strontium; substrates for soil-free growing [agriculture]; loam; barium sulfate; blue vitriol; sulfates; antimony sulfide; sulfides; benzoic sulfimide for industrial purposes; sulfonic acids; sumac for use in tanning; superphosphates [fertilizers]; antimony; thallium; talc [magnesium silicate]; tannin; cream of tartar for the food industry; cream of tartar for industrial purposes; cream of tartar for chemical purposes; tellurium; terbium; thermal paste; tetrachlorides; carbon tetrachloride; acetylene tetrachloride; technetium; thymol for industrial purposes; thiocarbanilide; titanite; sensitized cloth for photography; blueprint cloth; toluol; fuel for nuclear reactors; thorium; peat [fertilizer]; gum tragacanth for industri-

al purposes; thulium; carbonic hydrates; carbon; activated carbon; carbon for filters; animal charcoal; animal carbon; bone charcoal; blood charcoal; fertilizers; nitrogenous fertilizers; fish meal fertilizers; wood vinegar [pyroligneous acid]; uranium; chemical intensifiers for paper; chemical intensifiers for rubber; vulcanization accelerators; phenol for industrial purposes; enzymes for the food industry; enzymes for industrial purposes; ferments for chemical purposes; milk ferments for the food industry; milk ferments for industrial purposes; milk ferments for chemical purposes; fermium; ferrocyanides; fixing solutions [photography]; flavonoids [phenolic compounds] for industrial purposes; flocculants; soldering fluxes; brazing fluxes; formic aldehyde for chemical purposes; phosphatides; phosphates [fertilizers]; phosphorus; photographic paper; photosensitive plates; sensitized photographic plates; sensitized films, unexposed; photographic developers; photographic sensitizers; chemical preparations for use in photography; photographic emulsions; francium; fluorine; chemicals for use in forestry, except fungicides, herbicides, insecticides and parasiticides; glass-frosting chemicals; leather-renovating chemicals; glass-staining chemicals; enamel-staining chemicals; oil-separating chemicals; water-purifying chemicals; oil-purifying chemicals; condensation-preventing chemicals; stain-preventing chemicals for use on fabrics; anti-tarnishing chemicals for windows; leather-waterproofing chemicals; textile-waterproofing chemicals; chemicals, except pigments, for the manufacture of enamel; radiator flushing chemicals; leather-impregnating chemicals; textile-impregnating chemicals; horticultural chemicals, except fungicides, herbicides, insecticides and parasiticides; soldering chemicals; agricultural chemicals, except fungicides, herbicides, insecticides and parasiticides; soil conditioning preparations; industrial chemicals; colour-brightening chemicals for industrial purposes; refrigerants; coolants for vehicle engines; chlorine; chlorates; hydrochlorates; aluminium chloride; magnesium chloride; chlorides; palladium chloride; chromates; flowers of sulfur for chemical purposes; caesium; cellulose; cement for mending broken articles; cerium; calcium cyanamide [fertilizer]; cyanides [prussiates]; cymene; slag [fertilizers]; size for finishing and priming; spinel [oxide mineral]; alkalis; caustic alkali; animal extracts for the food industry; plant extracts, other than essential oils, for the food industry; plant extracts, other than essential oils, for use in the manufacture of cosmetics; plant extracts, other than essential oils, for use in the manufacture of pharmaceuticals; tea extracts for the food industry; tea extracts for use in the manufacture of cosmetics; tea extracts for use in the manufacture of pharmaceuticals; radioactive elements for scientific purposes; rare earths; fissionable chemical elements; emulsifiers; erbium; ethane; methyl ether; sulfuric ether; ethyl ether; glycol ether; ethers; esters; cellulose ethers for industrial purposes; cellulose esters for industrial purposes.

2 – Annotto [dyestuff]; auramine; Canada balsam; white lead; glitter for use in paint; paper for dyeing Easter eggs; dyestuffs; dyes; binding preparations for paints; glazes [paints, lacquers]; orange lead; primers; gamboge for painting; titanium dioxide [pigment]; repositionable paint patches; indigo [colorant]; gum resins; colophony; caramel [food colouring]; carbonyl for wood preservation; cochineal carmine; toner cartridges, filled, for printers and photocopiers; ink cartridges, filled, for printers and photocopiers; edible ink cartridges, filled, for printers; copal; colorants; alizarin dyes; aniline dyes; colorants for the restoration of furniture in the form of markers; ink for leather; colourings for liqueurs; colourings for beverages; shoe dyes; colourings for beer; colourings for butter; dye-wood; malt colorants; food colouring; paints; water-colour paints for use in art; aluminium paints; asbestos paints; bactericidal paints; ceramic paints; marking ink for animals; oil paints for use in art; anti-urine paints; anti-fouling paints; fireproof paints; printing ink; conductive paints; enamels for painting; creosote for wood preservation; turmeric [colorant]; black japan; lacquers; bitumen varnish; bronzing lacquers; wood floor finishes; copal varnish; anti-corrosive bands; anti-rust oils; oils for the preservation of wood; mastic [natural resin]; lime wash; wood stains; cobalt oxide [colorant]; zinc oxide [pigment]; silver paste; printers' pastes [ink]; pigments; coatings [paints]; wood coatings [paints]; coatings for roofing felt [paints]; anti-graffiti coatings [paints]; undercoating for vehicle chassis; varnishes; aluminium powder for painting; bronze powder for painting; silvering powders; metals in powder form for use in painting, decorating, printing and art; anti-corrosive preparations; protective preparations for metals; mordants; wood mordants; stains for leather; thinners for paints; thinners for lacquers; whitewash; soot [colorant]; carbon black [pigment]; lamp black [pigment]; sandarac; thickeners for paints; sienna earth; siccatives [drying agents] for paints; anti-rust greases; natural resins, raw; malt caramel [food colouring]; badigeon; anti-tarnishing preparations for metals; anti-rust preparations; wood preservatives; sumac for varnishes; red lead; distempers; turpentine [thinner for paints]; toner for printers and photocopiers; fixatives [varnishes]; fixatives for watercolours; yellowwood [colorant]; engraving ink; ink for printers and photocopiers; tattooing ink; edible inks; conductive inks; saffron [colorant]; gum-lac; dyewood extracts; enamels [varnishes]; silver emulsions [pigments]; metal foil for use in painting, decorating, printing and art.

16 – Fountain pens; aquarelles; albums; almanacs; document laminators for office use; mimeograph apparatus and machines; atlases; banknotes; souvenir banknotes; banners of paper; paper bows, other than haberdashery or hair decorations; name badges [office requisites]; table linen of paper; tickets; baggage claim check tags of paper; tags for index cards; forms, printed; announcement cards [stationery]; glitter for

stationery purposes; note books; pads [stationery]; drawing pads; wristbands for the retention of writing instruments; pamphlets; booklets; paper; paper sheets [stationery]; waxed paper; baking paper; paper for medical examination tables; origami folding paper; plantable seed paper [stationery]; paper for recording machines; paper for radiograms; papers for painting and calligraphy; electrocardiograph paper; drawer liners of paper, perfumed or not; wood pulp paper; carbon paper; copying paper [stationery]; parchment paper; writing paper; rice paper; luminous paper; toilet paper; wrapping paper; filter paper; wash; blotters; newsletters; rollers for typewriters; house painters' rollers; composing sticks; adhesives [glues] for stationery or household purposes; modelling wax, not for dental purposes; signboards of paper or cardboard; sewing patterns; bunting of paper; newspapers; electrotypes; hectographs; modelling clay; polymer modelling clay; terrestrial globes; drawing sets; engravings; slate pencils; pencil leads; document holders [stationery]; pencil holders; chalk holders; penholders; holders for cheque books; holders for stamps [seals]; page holders; name badge holders [office requisites]; diagrams; adhesive tape dispensers [office requisites]; table runners of paper; engraving plates; writing slates; blackboards; magnetic boards being office requisites; galley racks [printing]; drawing boards; duplicators; punches [office requisites]; cream containers of paper; correcting fluids [office requisites]; magazines [periodicals]; money clips; clips for name badge holders [office requisites]; pen clips; bookmarks; etching needles; tracing needles for drawing purposes; periodicals; printed publications; paper shredders for office use; graphic representations; credit card im printers, non-electric; paper creasers [office requisites]; graining combs; drawing instruments; calendars; tracing paper; tracing cloth; tracing patterns; gums [adhesives] for stationery or household purposes; lithographic stones; ink stones [ink reservoirs]; pencils; pencil lead holders; charcoal pencils; pictures; transfers [decalcomanias]; paintings [pictures], framed or unframed; colouring pictures; cardboard; wood pulp board [stationery]; hat boxes of cardboard; cards; index cards [stationery]; printed geographical maps; trading cards, other than for games; perforated cards for Jacquard looms; catalogues; spools for inking ribbons; flower-pot covers of paper; paintbrushes; painters' brushes; writing brushes; typewriter keys; glue for stationery or household purposes; isinglass for stationery or household purposes; gluten [glue] for stationery or household purposes; starch paste [adhesive] for stationery or household purposes; printing blocks; books; colouring books; manifolds [stationery]; comic books; drawing pins; mats of paper for beer glasses; desk mats; tablemats of paper; envelopes [stationery]; boxes of paper or cardboard; cases for stamps [seals]; paint boxes for use in schools; printed coupons; erasers; French curves; paper ribbons, other than haberdashery or hair decorations; gummed tape

[stationery]; typewriter ribbons; barcode ribbons; adhesive tapes for stationery or household purposes; correcting tapes [office requisites]; inking ribbons; self-adhesive tapes for stationery or household purposes; cigar bands; square rulers for drawing; drawing rulers; absorbent sheets of paper or plastic for foodstuff packaging; humidity control sheets of paper or plastic for foodstuff packaging; viscose sheets for wrapping; sheets of reclaimed cellulose for wrapping; steel letters; type [numerals and letters]; lithographs; letter trays; paint trays; architects' models; postage stamps; plastics for modelling; graphic prints; modelling materials; teaching materials [except apparatus]; sealing compounds for stationery purposes; padding materials of paper or cardboard; bookbinding material; packing [cushioning, stuffing] materials of paper or cardboard; packaging material made of starches; filtering materials of paper; addressing machines; pencil sharpening machines, electric or non-electric; bookbinding apparatus and machines [office equipment]; typewriters, electric or non-electric; franking machines for office use; chalk for lithography; writing chalk; tailors' chalk; marking chalk; spray chalk; bags [envelopes, pouches] of paper or plastics, for packaging; garbage bags of paper or of plastics; plastic bags for pet waste disposal; painters' easels; hand-rests for painters; printing sets, portable [office requisites]; bibs of paper; bibs, sleeved, of paper; floor decals; stickers [stationery]; fingerstalls for office use; writing cases [stationery]; writing cases [sets]; cords for bookbinding; paper knives [letter openers]; printed sheet music; numbering apparatus; bottle envelopes of paper or cardboard; sealing wafers; covers [stationery]; passport holders; protective covers for books; embroidery designs [patterns]; handwriting specimens for copying; oleographs; musical greeting cards; greeting cards; postcards; etchings; paper bags for use in the sterilization of medical instruments; conical paper bags; palettes for painters; ink sticks; pantographs [drawing instruments]; loose-leaf binders; files [office requisites]; folders for papers; papier mâché; pastels [crayons]; modelling paste; pen cases; mezuzah parchments; pen wipers; office perforators; pens [office requisites]; nibs of gold; nibs; steel pens; song books; seals [stamps]; posters; clipboards; address plates for addressing machines; handkerchiefs of paper; plastic bubble film for wrapping; seaweed-based film for wrapping; plastic film for wrapping; plastic cling film, extensible, for palletization; transparencies [stationery]; trays for sorting and counting money; coasters of paper; bookends; stands for pens and pencils; stamp stands; obliterating stamps; inking pads; stamp pads; binding strips [bookbinding]; face towels of paper; towels of paper; inking sheets for document reproducing machines; inking sheets for duplicators; cloth for bookbinding; gummed cloth for stationery purposes; printers' blankets, not of textile; portraits; paperweights; inkstands; office requisites, except furniture; writing materials; writing instruments; drawing

materials; school supplies [stationery]; hand labelling appliances; printed matter; lithographic works of art; prospectuses; printed timetables; ledgers [books]; printers' galleys; indexes; paper cutters [office requisites]; elastic bands for offices; T-squares for drawing; graphic reproductions; retractable reels for name badge holders [office requisites]; pens [writing implements] incorporating tips for operating touchscreen devices; drawing pens; marking pens [stationery]; tissue paper; tissues of paper for removing make-up; paper wipes for cleaning; dental tray covers of paper; place mats of paper; table napkins of paper; tablecloths of paper; paper clasps; document files [stationery]; scrapers [erasers] for offices; paper-clips; clips for offices; erasing products; biological samples for use in microscopy [teaching materials]; histological sections for teaching purposes; steatite [tailor's chalk]; writing board erasers; composing frames [printing]; carrier bags of paper or plastic; sealing wax; arithmetical tables; placards of paper or cardboard; writing or drawing books; fabrics for bookbinding; stationery; pencil sharpeners, electric or non-electric; stencil plates; stencils for decorating food and beverages; cardboard tubes; moisteners [office requisites]; moisteners for gummed surfaces [office requisites]; squares for drawing; chart pointers, non-electronic; plastic blister packs for packaging; bottle wrappers of paper or cardboard; envelope sealing machines for offices; sealing machines for offices; vignetting apparatus; apparatus for mounting photographs; stapling presses [office requisites]; manuals [handbooks]; figurines of papier mâché; paper coffee filters; flags of paper; flyers; flip charts; moulds for modelling clays [artists' materials]; photo-engravings; photographs [printed]; mezuzah cases; stencil cases; canvas for painting; chromolithographs [chromos]; animation cels; compasses for drawing; numbers [type]; artists' watercolour saucers; ink; correcting ink [heliography]; Indian inks; inkwells; blueprints; stencils; stencils [stationery]; erasing shields; balls for ball-point pens; desktop cabinets for stationery [office requisites]; printing type; sealing stamps; address stamps; stamps [seals]; advertisement boards of paper or cardboard; shields [paper seals]; prints [engravings]; labels of paper or cardboard.

25 – Wimples; bandanas [neckerchiefs]; underwear; sweat-absorbent underwear; berets; boas [necklets]; teddies [underclothing]; boxer shorts; ankle boots; ski boots; boots for sports; straps for bras; breeches for wear; trousers; football shoes; brassieres; adhesive bras; valenki [felted boots]; mittens; collars [clothing]; detachable collars; shirt yokes; veils [clothing]; gabardines [clothing]; galoshes; neckties; ascots; gaiters; spats; leggings [leg warmers]; boot uppers; corselets; jerseys [clothing]; waistcoats; sports jerseys; hosiery; heels; heelpieces for footwear; hoods [clothing]; hat frames [skeletons]; pockets for clothing; caps being headwear; kimonos; cap peaks; visors being headwear; tights; slips [underclothing]; combinati-

ons [clothing]; bodices [lingerie]; corsets [underclothing]; suits; bathing suits; masquerade costumes; beach clothes; leotards; jackets [clothing]; stuff jackets [clothing]; fishing vests; leggings [trousers]; liveries; camisoles; sports singlets; cuffs; mantillas; coats; face coverings [clothing], not for medical or sanitary purposes; sleep masks; furs [clothing]; mitres [hats]; muffs [clothing]; footmuffs, not electrically heated; bibs, not of paper; bibs, sleeved, not of paper; fur stoles; hairdressing capes; nipple pasties being underclothing; heel protectors for shoes; ear muffs [clothing]; socks; sweat-absorbent socks; footwear; gymnastic shoes; beach shoes; sports shoes; clothing; paper clothing; outerclothing; embroidered clothing; ready-made clothing; motorists' clothing; cyclists' clothing; clothing for gymnastics; clothing of imitations of leather; latex clothing; clothing of leather; waterproof clothing; clothing incorporating LEDs; sportswear incorporating digital sensors; uniforms; clothing authenticated by non-fungible tokens [NFTs]; clothing containing slimming substances; fittings of metal for footwear; maniples; overcoats; knickers; parkas; pelerines; gloves [clothing]; fingerless gloves; cycling gloves; driving gloves; ski gloves; pyjamas; bathing trunks; shirt fronts; headscarves; pocket squares; dresses; headbands [clothing]; garters; sock suspenders; stocking suspenders; ready-made linings [parts of clothing]; dress shields; soles for footwear; braces [suspenders] for clothing; half-boots; ponchos; girdles; belts [clothing]; money belts [clothing]; sashes for wear; layettes [clothing]; non-slipping devices for footwear; heelpieces for stockings; welts for footwear; chasubles; shirts; short-sleeve shirts; wooden shoes; sandals; bath sandals; boots; jumper dresses; saris; sarongs; sweaters; footwear uppers; inner soles; albs; bath slippers; thermal gloves for touchscreen devices; togas; knitwear [clothing]; underpants; shoes; slippers; skull caps; turbans; headwear; aprons [clothing]; judo uniforms; karate uniforms; tee-shirts; rash guards; dressing gowns; bath robes; overalls; hanbok; top hats; tips for footwear; stockings; sweat-absorbent stockings; shawls; paper hats [clothing]; shower caps; bathing caps; scarves; neck tube scarves; studs for football shoes; hats; babies' pants [underwear]; gaiter straps; pelisses; espadrilles; skirts; petticoats; skorts.

42 – Water analysis; computer system analysis; handwriting analysis [graphology]; chemical analysis; rental of web servers; rental of computer software; computer rental; rental of scientific microscopes; rental of data centre facilities; rental of user-programmable humanoid robots, not configured; rental of meters for the recording of energy consumption; rental of telescopes; energy auditing; blockchain as a service [Baas]; geological test drilling; recovery of computer data; quantum computing; business card design; graphic design of promotional materials; interior design; industrial design; graphic arts design; computer virus protection services; oil-field surveys; surveying [engineering]; geological surveys; geotechnical investiga-

tions; neuromorphic engineering; engineering; installation of computer software; meteorological information; clinical trials; material testing; textile testing; bacteriological research; biological research; geological research; cosmetic research; mechanical research; research in the field of welding; research in the field of building construction; research in the field of telecommunications technology; research in the field of artificial intelligence technology; research in the field of physics; chemical research; research and development of new products for others; medical research; scientific and technological research relating to patent mapping; scientific and technological research in the field of natural disasters; scientific research; scientific research in the field of genetics; scientific research in the field of environmental protection; analysis for oil-field exploitation; pathological testing for forensic purposes; underwater exploration; research in the field of excavation; technological research; calibration [measuring]; website design consultancy; computer security consultancy; artificial intelligence consultancy; computer technology consultancy; consultancy in the design and development of computer hardware; architectural consultancy; internet security consultancy; computer software consultancy; telecommunication network security consultancy; data security consultancy; technological consultancy; oil-well testing; quality control; vehicle roadworthiness testing; culturing of cells for scientific research purposes; mining of crypto assets; land surveying; dress designing; updating of computer software; monitoring of computer systems to detect breakdowns; monitoring of computer systems for detecting unauthorized access or data breach; electronic monitoring of credit card activity to detect fraud via the internet; monitoring of computer system operation by remote access; electronic monitoring of personally identifying information to detect identity theft via the internet; writing of computer code; software as a service [SaaS]; maintenance of computer software; authenticating works of art; design of show scenery; design of interior decor; quality evaluation of standing timber; quality evaluation of wool; digitization of documents [scanning]; digitization of photographs [scanning]; conversion of data or documents from physical to electronic media; urban planning; platform as a service [PaaS]; providing virtual computer systems through cloud computing; providing online geographic maps, not downloadable; providing geographic information; providing information relating to computer technology and programming via a website; providing scientific information, advice and consultancy relating to carbon offsetting; providing scientific information, advice and consultancy relating to net zero emissions; providing online non-downloadable computer software; providing online non-downloadable computer software for minting non-fungible tokens [NFTs]; providing search engines for the internet; conversion of computer programs and data, other than physical con-

version; conducting technical project studies; drug screening for forensic purposes; computer programming of smart contracts on a blockchain; computer system design; golf course design; design of prototypes; unlocking of mobile phones; geological prospecting; oil prospecting; hosting computer websites; development of video and computer games; development of computer platforms; construction drafting; computer software design; software development in the framework of software publishing; archaeological excavation; cloud seeding; digital forensic investigations in the field of computer crimes; user authentication services using blockchain technology; information technology [IT] support services [troubleshooting of software]; consultancy in the field of energy-saving; creating and designing website-based indexes of information for others [information technology services]; creating and maintaining websites for others; computer graphic design for video projection mapping; design of computer-simulated models; design of costumes; computer programming; technical writing; testing and analysis of goods being imported or exported for quarantine clearance purposes; duplication of computer programs; architectural services; chemistry services; packaging design; off-site data backup; computer programming services for data processing; telecommunications technology consultancy; scientific laboratory services; user authentication services using single sign-on technology for online software applications; user authentication services using technology for e-commerce transactions; cartographic or thermographic measurement services by drone; inspection services for new and used vehicles before sale; weather forecasting; logo design services; styling [industrial design]; cartography services; software engineering services for data processing; exploration services in the field of the oil, gas and mining industries; forensic pathology services; technological consultancy services for digital transformation; data encryption services; hosting virtual environments; hosting software platforms for virtual reality-based work collaboration; server hosting; electronic data storage; rental of smartglasses.

(260) AM 2026 134302 A

(800) 1860320

(151) 2025 04 02

(891) 2025 04 02

(731) Tenson AB

Femvägsskälet 2, 421 50 Västra Frölunda,
Sweden

(540)

TENSON

(591) Black, white

(511)

18 – Sport bags; travel bags; duffel bags; toiletry bags; backpacks; hiking rucksacks; waist bags; purses; wallets; walking sticks; umbrellas.

21 – Bottles [sold empty]; glass bottles [sold empty]; plastic bottles [empty]; water bottles [sold empty]; vacuum bottles; insulated bottles [flasks]; sports bottles [empty]; squeeze bottles, empty; reusable bottles; aluminum water bottles.

25 – Clothing, footwear and headgear, hereunder socks; jackets; anoraks; coats; down jackets; rainwear; rainproof clothing; rain jackets; rain trousers; rain coats; shorts; walking shorts; swim shorts; skirts; tights; underwear; base layers; trousers; sweatpants; sweatshirts; sweaters; fleece jackets; shirts; tops; t-shirts; long-sleeved t-shirts; polo shirts; hoodies; vests; belts [clothing]; shoes; sandals; slippers; gloves; mittens; caps; sun visors [headwear]; hiking shoes; hiking boots; trail shoes; beanies; caps being headwear; headbands [clothing]; snowboard jackets; snowboard trousers; snowboard gloves; snowboard mittens; footwear for snowboarding; clothing for skiing; ski wear; ski jackets; ski pants; ski trousers; ski gloves; ski hats; ski balaclavas; ski boots.

35 – Online wholesale and retail store services featuring ski wear, clothing, footwear, headwear, apparel, sports bags, bottles; wholesale and retail store services featuring ski wear, clothing, footwear, headwear, apparel, sports bags, bottles.

(260) AM 2026 134313 A

(800) 1860680

(151) 2025 04 22

(891) 2025 04 22

(731) Limited Liability Company "Assa"

Yuzhnoportovaya St., 9, bldg. 6, premises 4, 5,
RU-115088 Moscow, Russian Federation

(540)

ACCA
ASSA

(591) Black, white

(531) 27.05.11; 28.05

(511)

32 – Aperitifs, non-alcoholic; lithia water; seltzer water; soda water; waters [beverages]; mineral water [beverages]; table waters; cocktails, non-alcoholic; lemonades; non-alcoholic beverages; isotonic beverages; non-alcoholic honey-based beverages; rice-based beverages, other than milk substitutes; soya-based beverages, other than milk substitutes; aloe vera drinks, non-alcoholic; whey beverages; soft drinks; non-alcoholic beverages flavoured with coffee; non-alcoholic beverages flavoured with tea; non-alcoholic fruit juice beverages; fruit nectars, non-alcoholic; orgeat; powders for effervescing beverages; sarsaparilla [non-alcoholic beverage]; syrups for lemonade; sy-

rups for beverages; smoothies; tomato juice [beverage]; vegetable juices [beverages]; fruit juices; must; grape must, unfermented; pastilles for effervescing beverages; non-alcoholic fruit extracts; carbonated water, including aerated mineral water, mineral and aerated waters, vitamin enriched sparkling water [beverages], non-alcoholic flavoured carbonated beverages; kvass; protein-enriched sports beverages; apple juice; preparations for making carbonated water; preparations for making non-alcoholic beverages; non-alcoholic essences for making beverages.

(260) AM 2026 134315 A

(800) 1860721

(151) 2025 04 17

(891) 2025 04 17

(731) Maz Maz Food Productions and Industries
Saveh Central Taraz Nahid Villa, Kaveh
Industrial city, Azadi, 6th street, part 853,
markazi provience, 3914347311 Saveh,
Islamic Republic of Iran

(540)



(591) Blue, black, brown, orange, grey, white

(531) 03.01.24; 03.01.25; 03.01.26; 29.01.15

(511)

29 – Apple puree; potato fritters; fruit-based snack food; potato crisps; potato flakes; corn oil; black pudding; potato-based dumplings; apple purée; sweet corn, processed; fried potatoes; potato chips.

30 – Cereal-based snack food; cereal flour; hominy; corn flour; muesli; maize meal; high-protein cereal bars; hominy grits; processed grains; groats for human food; corn flakes; corn flakes; cereal bars; cereal preparations; corn starch; chips [cereal products]; oatmeal; potato starch for food; bulgur; popcorn.

31 – Cereal seeds, unprocessed; groats for poultry; by-products of the processing of cereals, for animal consumption; potatoes, fresh; grains (seeds); maize.

35 – Radio advertising; direct mail advertising; online advertising in a computer network; import-export agencies; television advertising; pay per click advertising; online advertising on a computer network; publicity; outdoor advertising.

(260) AM 2026 134316 A

(800) 1499642

(151) 2019 10 04

(891) 2025 05 21

(731) IIC-INTERSPORT International Corporation
GmbH

Wölflistrasse 2, CH-3006 Bern, Switzerland

(540)



(591) Black, white

(531) 06.01.02; 06.01.04; 27.05.10

(511)

18 – Sports and travel bags, mountaineering bags, backpacks (rucksacks/backpacks), in particular backpacks made of waterproof textile materials specially designed for skiing; sling bags for carrying infants, rain covers for bags; beggar's bags, game bags and backpacks for hunting; saddlery; canes (walking sticks).

20 – Inflatable or non-inflatable camping mattresses, camping tables and chairs, easy chairs, benches and baskets for fishing, not of metal; cushions and pillows; boxes of wood or plastic; non-metallic pales and stakes for camping tents.

22 – Ropes, string, nets, tents, especially for camping, tarpaulins, sails.

24 – Blankets; sleeping bags for camping; bivouac bags.

25 – Clothing, footwear, gloves and caps, boots for fishing; clothing articles for hiking, for mountain treks, for mountaineering, for hunting, for fishing, for horseback riding, for winter sports and skiing.

28 – Gymnastics and sports articles included in class 28; fishing tackle, cases and covers for fishing rods; hunting game calls; archery implements; skis, bindings and poles for Alpine skiing and Nordic skiing, ski brakes; sledges.

(260) AM 2026 134317 A

(800) 1564134

(151) 2019 12 16

(891) 2025 05 21

(731) IIC-INTERSPORT International Corporation,
GmbH

Wölflistrasse 2, CH-3006 Bern, Switzerland

(540)



(591) Black, white

(531) 27.05.09; 27.05.10

(511)

25 – Clothing, footwear, headwear; trousers; shorts; tee-shirts; polo shirts; shirts; pullovers; jackets; anoraks; tights; bandeaux [clothing]; tracksuits; clothing articles for hiking, for mountain treks, for mountaineering, for hunting, for fishing, for horseback riding, for winter sports and skiing; clothing and footwear for sports; football boots; studs for football boots; running shoes; footwear for walking; cross-country footwear; tennis shoes; cycling footwear; footwear adapted for practicing team sports indoors and outdoors, as well as for training; socks; sports socks; underwear; sports underwear; thermal underwear; ski boots; snowboard boots; after-ski boots; gaiters; skiing and snowboarding jackets; skiing and snowboarding trousers; ski gloves; isothermal gloves; caps; bathing suits; bathing caps; waterproof clothing; hosiery; gloves [clothing]; scarves; belts [clothing]; chasubles; sashes for wear; shower caps; sleep masks; shawls; hairdressing capes; rainproof but breathable clothing for passing and elimination of perspiration; water socks; wet suits for surface water sports; sun-suits; protective vests for water sports; bags especially designed for skiing and snowboarding boots.

28 – Games; toys; gymnastic and sporting articles included in this class; bags for carrying sporting articles; fishing and hunting equipment included in this class; tennis, table tennis, badminton and squash bats and rackets; tables for table tennis; protective cover for table tennis tables; covers and bags adapted for snowshoes; strings for rackets; racket handles; tennis, table tennis, badminton and volleyball nets; snowboards; snowboard bindings; skis; ski bindings; ski brakes; seal skins (coverings for skis); ski poles; covers specially designed for skis and snowboards; skateboards and accessories thereof included in this class; play balls and balloons; football, basketball, handball, handball, volleyball, beach volleyball and rugby balls; pumps especially designed for balls for games; tennis and table tennis balls; badminton shuttlecocks; treadmill for physical exercise; apparatus for physical education; dumb-bells; balls, rings and elastic bands for exercising; treadmill with functions for adjusting platform speed and tilting; rowing machines; stationary exercise bicycles; elliptical bicycles; exercisers (expanders); exercise equipment; balance training equipment; fitness equipment; scooters (toys); sledges (sports articles); windsurf boards; kite-

boards; wakeboards; waterskis; paddleboards; roller skates; ice skates; ice skate blade guards; hockey, floor hockey and field hockey sticks; hockey pucks; golf clubs; bags for golf clubs, with or without wheels; golf bag carts; golf gloves; divot repair tools (golf accessories); flippers for swimming and diving; belts, buoyancy devices, vests and belts for swimming; foam floats for swimming; flotation devices for leisure activities, flotation devices for gymnastics (water aerobics), swimming aids in the form of floats for leisure activities; wrist guards, elbow guards, shoulder pads, ankle pads, shin guards and knee guards (sports articles); elbow and knee pads for sports (sports articles); protective padding (parts of sportswear); weight-lifting belts; vests, elbow and knee pads for sports; ski masks.

(260) AM 2026 134318 A

(800) 1698863

(151) 2022 09 30

(891) 2025 05 15

(731) Novartis AG

CH-4002 Basel, Switzerland

(540)

LOFREMVI

(591) Black, white

(511)

5 – Pharmaceutical preparations.

(260) AM 2026 134319 A

(800) 1712480

(151) 2022 12 16

(891) 2025 04 22

(731) Obshchestvo s ogranichennoy otvetstvennostyu "TEREM"

Nakhimovskij pr-kt, d. 47, et. 15, pom. I, kom. 25, RU-117418 Moskva, Russian Federation

(540)



(591) Red and white

(531) 26.01.04; 26.01.24; 26.04.05; 26.04.10;

26.04.16; 26.04.24; 29.01.12

(511)

1 – Agar-agar for industrial purposes; nitrogen; actinium; alkaloids; alginates for the food industry; alginates for industrial purposes; crotonic aldehyde; ammonium aldehyde; aldehydes; americium; amyl acetate; ammonia [volatile alkali] for industrial purposes; anhydrous ammonia; ammonia; acetic anhydride; an-

hydrides; anti-knock substances for internal combustion engines; disincrustants; antioxidants for use in the manufacture of cosmetics; antioxidants for use in the manufacture of pharmaceuticals; antioxidants for use in manufacture; antistatic preparations, other than for household purposes; antifreeze; size for use in the textile industry; argon; lead arsenate; astatine; aluminium acetate; lime acetate; lead acetate; acetate of cellulose, unprocessed; acetates [chemicals]; acetylene; acetone; oenological bactericides [chemical preparations for use in wine making]; barium; barytes; albumin [animal or vegetable, raw material]; animal albumen [raw material]; iodised albumen; malt albumen; benzene; benzol; bentonite; berkelium; bicarbonate of soda for chemical purposes; potassium dioxalate; biostimulants for plants; bichromate of potassium; bichromate of soda; bauxite; bromine for chemical purposes; albumenized paper; baryta paper; diazo paper; blueprint paper; test paper, chemical; litmus paper; self-toning paper [photography]; nitrate paper; sensitized paper; photometric paper; borax; agglutinants for concrete; gas purifying preparations; polish removing substances; preparations for the separation of greases; substances for preventing runs in stockings; water-softening preparations; limestone hardening substances; tanning substances; adhesives for industrial purposes; tensio-active agents; artificial sweeteners [chemical preparations]; fissionable material for nuclear energy; foundry binding substances; concrete-aeration chemicals; leather-dressing chemicals; chemicals for the manufacture of paints; chemicals for the manufacture of pigments; starch-liquifying chemicals [ungluing agents]; flower preservatives; seed preserving substances; viscose; bismuth; bismuth subnitrate for chemical purposes; vitamins for the food industry; vitamins for use in the manufacture of cosmetics; vitamins for use in the manufacture of pharmaceuticals; witherite; distilled water; seawater for industrial purposes; acidulated water for recharging batteries; heavy water; lye water for the food industry; hydrogen; seaweeds [fertilizers]; grafting wax for trees; gadolinium; getters [chemically active substances]; protective gases for welding; solidified gases for industrial purposes; propellant gases for aerosols; basic gallate of bismuth; gallium; gambier; helium; electrophoresis gels; genes of seeds for agricultural production; hydrazine; aluminium hydrate; hydrates; hyposulfites; hypochlorite of soda; gypsum for use as a fertilizer; ceramic glazings; glycol; expanded clay for hydroponic plant growing [substrate]; kaolin; alumina; glycerides; glycerine for industrial purposes; glucose for the food industry; glucose for industrial purposes; glucosides; gluten for the food industry; gluten for industrial purposes; holmium; hormones for hastening the ripening of fruit; peat pots for horticulture; graphene; graphite for industrial purposes; guano; humus; gurjun balsam for use in the manufacture of varnish; dextrin [size]; detergents for use in manufacturing processes; defoliants; diastase for industrial purposes; manganese dio-

xide; titanium dioxide for industrial purposes; zirconia; oil dispersants; petroleum dispersants; dispersions of plastics; dysprosium; bichloride of tin; detergent additives to petrol; ceramic compositions for sintering [granules and powders]; additives, chemical, to drilling muds; additives, chemical, to insecticides; chemical additives for oils; additives, chemical, to motor fuel; additives, chemical, to fungicides; dolomite for industrial purposes; tan-wood; yeast for use in biofuel production; yeast for scientific purposes; europium; gelatine for photographic purposes; gelatine for industrial purposes; auxiliary fluids for use with abrasives; fluids for hydraulic circuits; liquids for removing sulfates from batteries; power steering fluid; brake fluid; magnetic fluid for industrial purposes; transmission fluid; tree cavity fillers [forestry]; glaziers' putty; moderating materials for nuclear reactors; diatomaceous earth; fuller's earth for use in the textile industry; lime chloride; isotopes for industrial purposes; active chemical ingredients; ion exchangers [chemicals]; ytterbium; yttrium; iodine for industrial purposes; iodine for chemical purposes; aluminium iodide; alkaline iodides for industrial purposes; casein for the food industry; casein for industrial purposes; kainite; potassium; sorrel salt; californium; calomel [mercurous chloride]; gum arabic for industrial purposes; tartar, other than for pharmaceutical purposes; camphor, for industrial purposes; calcium carbide; silicon carbide [raw material]; carbide; lime carbonate; magnesium carbonate; carbonates; cement [metallurgy]; cassiopium [lutetium]; catalysts; biochemical catalysts; catechu; caustics for industrial purposes; alum; ammonia alum; aluminium alum; chrome alum; quebracho for industrial purposes; ketones; kieselgur; cinematographic film, sensitized but not exposed; oxygen for industrial purposes; nitric acid; anthranilic acid; benzoic acid; boric acid for industrial purposes; tartaric acid; tungstic acid; gallic acid for the manufacture of ink; gallotannic acid; glutamic acid for industrial purposes; tannic acid; iodic acid; phenol for industrial purposes; citric acid for industrial purposes; lactic acid; formic acid; persulfuric acid; oleic acid; picric acid; pyrogallic acid; salicylic acid; sebacic acid; sulfuric acid; sulfurous acid; spirits of salt; stearic acid; carbonic acid; spirits of vinegar [dilute acetic acid]; phosphoric acid; hydrofluoric acid; cholic acid; chromic acid; oxalic acid; benzene-based acids; fatty acids; mineral acids; arsenious acid; acids; adhesives for billposting; leather glues; adhesives for wall tiles; adhesives for paperhanging; glue for industrial purposes; gums [adhesives] for industrial purposes; birdlime; conductive adhesives; isinglass, other than for stationery, household or alimentary purposes; gluten [glue], other than for stationery or household purposes; starch paste [adhesive], other than for stationery or household purposes; stem cells, other than for medical or veterinary purposes; collagen for industrial purposes; collodion; compost; beer preserving agents; preservatives for use in the pharmaceutical industry; mangrove bark for in-

dustrial purposes; tan; starch for industrial purposes; silicon; creosote for chemical purposes; krypton; xenon; xylene; xylol; biological tissue cultures, other than for medical or veterinary purposes; cultures of microorganisms, other than for medical and veterinary use; blue vitriol; curium; lactose [raw material]; lactose for the food industry; lactose for industrial purposes; lanthanum; dry ice [carbon dioxide]; lecithin [raw material]; lecithin for the food industry; lecithin for industrial purposes; lithium; magnesite; manganese; oils for tanning leather; oils for currying leather; oils for preparing leather in the course of manufacture; oils for the preservation of food; transmission oil; carbolineum for the protection of plants; paper pulp; wood pulp; grafting mastic for trees; mastic for leather; mastic for tyres; oil cement [putty]; synthetic materials for absorbing oil; brazing preparations; ceramic materials in particulate form, for use as filtering media; filtering materials of unprocessed plastics; filtering materials of mineral substances; filtering materials of vegetable substances; filtering materials of chemical substances; metalloids; alkaline-earth metals; alkaline metals; methane; methyl benzene; methyl benzol; flour for industrial purposes; tapioca flour for industrial purposes; potato flour for industrial purposes; soap [metallic] for industrial purposes; arsenic; bate for dressing skins; emollients for industrial purposes; animal manure; nanopowders for industrial purposes; sodium; naphthalene; sal ammoniac; toxic gas neutralizers; neodymium; neon; neptunium; ammonium nitrate; uranium nitrate; nitrates; combusting preparations [chemical additives to motor fuel]; nitrous oxide; baryta; uranium oxide; oxalates; lithia [lithium oxide]; lead oxide; antimony oxide; chromium oxide; cobalt oxide for industrial purposes; mercuric oxide; olivine [silicate mineral]; gallnuts; clarification preparations; wine finings; textile-brightening chemicals; beer-clarifying and preserving agents; must-finishing preparations; reducing agents for use in photography; bases [chemical preparations]; wax-bleaching chemicals; fat-bleaching chemicals; organic digestate [fertilizer]; paste fillers for automobile body repair; pectin for the food industry; pectin for industrial purposes; pectin [photography]; perborate of soda; humus top dressing; percarbonates; hydrogen peroxide for industrial purposes; persulfates; perchlorates; foundry sand; plastisols; sensitized plates for offset printing; ferrotype plates [photography]; plasticizers; plastics, unprocessed; X-ray films, sensitized but not exposed; plutonium; chemical coatings for ophthalmic lenses; polonium; potash; potash water; soil for growing; praseodymium; rubber preservatives; masonry preservatives, except paints and oils; brickwork preservatives, except paints and oils; cement preservatives, except paints and oils; preservatives for tiles, except paints and oils; bacterial preparations, other than for medical and veterinary use; bacteriological preparations for acetification; bacteriological preparations, other than for medical and veterinary use; biological preparati-

ons, other than for medical or veterinary purposes; vulcanizing preparations; diagnostic preparations, other than for medical or veterinary purposes; renovating preparations for phonograph records; currying preparations for leather; currying preparations for skins; galvanizing preparations; metal hardening preparations; fixing baths [photography]; opacifiers for glass; opacifiers for enamel; separating and unsticking [ungluing] preparations; metal annealing preparations; metal tempering preparations; preparations for preventing the tarnishing of lenses; preparations for preventing the tarnishing of glass; cement-waterproofing chemicals, except paints; plant growth regulating preparations; wallpaper removing preparations; anti-boil preparations for engine coolants; fulling preparations for use in the textile industry; descaling preparations, other than for household purposes; fertilizing preparations; flashlight preparations; finishing preparations for use in the manufacture of steel; sizing preparations; animal carbon preparations; preparations of microorganisms, other than for medical and veterinary use; corrosive preparations; cryogenic preparations; dehydrating preparations for industrial purposes; degreasing preparations for use in manufacturing processes; gum solvents; oil-bleaching chemicals; decolorants for industrial purposes; meat tenderizers for industrial purposes; preparations for stimulating cooking for industrial purposes; anti-incrustants; preparations of trace elements for plants; moistening [wetting] preparations for use in the textile industry; moistening [wetting] preparations for use in dyeing; moistening [wetting] preparations for use in bleaching; enzyme preparations for the food industry; enzyme preparations for industrial purposes; filtering preparations for the beverages industry; chemical preparations to prevent mildew; chemical preparations to prevent wheat blight; chemical condensation preparations; chemical preparations for smoking meat; chemical preparations for scientific purposes, other than for medical or veterinary use; chemical preparations for facilitating the alloying of metals; chemical preparations to prevent diseases affecting vine plants; chemical preparations to prevent diseases affecting cereal plants; engine-decarbonising chemicals; fulling preparations; fuel-saving preparations; coal saving preparations; damp-proofing chemicals, except paints, for masonry; anti-sprouting preparations for vegetables; preparations of the distillation of wood alcohol; by-products of the processing of cereals for industrial purposes; chemical substances for preserving foodstuffs; benzene derivatives; cellulose derivatives [chemicals]; promethium; protactinium; protein [raw material]; proteins for the food industry; proteins for use in the manufacture of food supplements; proteins for use in manufacture; mordants for metals; radium for scientific purposes; radon; solvents for varnishes; anti-frothing solutions for batteries; drilling muds; galvanizing baths; solutions for cyanotyping; silver salt solutions for silvering; toning baths [photography];

chemical reagents, other than for medical or veterinary purposes; rhenium; mercury; rubidium; carbon black for industrial purposes; soot for industrial or agricultural purposes; lamp black for industrial purposes; samarium; saccharin; selenium; saltpeter; sulfur; silver nitrate; carbon disulfide; silicates; aluminium silicate; silicones; scandium; topsoil; foundry moulding preparations; potting soil; acrylic resins, unprocessed; artificial resins, unprocessed; polymer resins, unprocessed; conductive resins, unprocessed; synthetic resins, unprocessed; epoxy resins, unprocessed; soda ash; calcined soda; caustic soda for industrial purposes; barium compounds; fluor spar compounds; salts [fertilizers]; salts [chemical preparations]; ammoniacal salts; ammonium salts; salts of precious metals for industrial purposes; salts for galvanic cells; salt for preserving, other than for foodstuffs; salts for colouring metal; salts for industrial purposes; iron salts; gold salts; iodised salts; calcium salts; sodium salts [chemical compounds]; salt, raw; salts from rare earth metals; mercury salts; toning salts [photography]; chrome salts; chromic salts; salts of alkaline metals; rock salt; mold-release compounds; fire extinguishing compositions; compositions for the manufacture of phonograph records; compositions for the manufacture of technical ceramics; compositions for repairing inner tubes of tyres; compositions for repairing tyres; acid proof chemical compositions; glutinous tree-grafting preparations; adhesive preparations for surgical bandages; fireproofing preparations; compositions for threading; sauce for preparing tobacco; amyl alcohol; vinic alcohol; wood alcohol; sal ammoniac spirits; ethyl alcohol; alcohol; adjuvants, other than for medical or veterinary purposes; cement for footwear; concrete preservatives, except paints and oils; water glass [soluble glass]; strontium; substrates for soil-free growing [agriculture]; barium sulfate; copper sulfate; sulfates; antimony sulfide; sulfides; benzoic sulfimide; sulfonic acids; sumac for use in tanning; superphosphates [fertilizers]; antimony; thallium; talc [magnesium silicate]; tannin; cream of tartar for the food industry; cream of tartar for industrial purposes; cream of tartar for chemical purposes; tellurium; terbium; thermal paste; tetrachlorides; carbon tetrachloride; acetylene tetrachloride; technetium; thymol for industrial purposes; thiocarbonyl; titanite; sensitized cloth for photography; blueprint cloth; toluol; fuel for nuclear reactors; thorium; peat [fertilizer]; gum tragacanth for industrial purposes; thulium; carbonic hydrates; carbon; activated carbon; carbon for filters; animal charcoal; animal carbon; bone charcoal; blood charcoal; fertilizers; nitrogenous fertilizers; fish meal fertilizers; wood vinegar [pyroligneous acid]; uranium; chemical intensifiers for paper; chemical intensifiers for rubber; vulcanization accelerators; enzymes for the food industry; enzymes for industrial purposes; ferments for chemical purposes; milk ferments for the food industry; milk ferments for industrial purposes; milk ferments for chemical pur-

poses; fermium; ferrocyanides; fixing solutions [photography]; flavonoids [phenolic compounds] for industrial purposes; flocculants; soldering fluxes; brazing fluxes; formic aldehyde for chemical purposes; phosphatides; phosphates [fertilizers]; phosphorus; photographic paper; photosensitive plates; sensitized photographic plates; sensitized films, unexposed; photographic developers; photographic sensitizers; chemical preparations for use in photography; photographic emulsions; francium; fluorine; chemicals for use in forestry, except fungicides, herbicides, insecticides and parasiticides; glass-frosting chemicals; leather-renovating chemicals; glass-staining chemicals; enamel-staining chemicals; oil-separating chemicals; water-purifying chemicals; oil-purifying chemicals; soldering chemicals; condensation-preventing chemicals; stain-preventing chemicals for use on fabrics; anti-tarnishing chemicals for windows; leather-waterproofing chemicals; textile-waterproofing chemicals; chemicals, except pigments, for the manufacture of enamel; radiator flushing chemicals; leather-impregnating chemicals; textile-impregnating chemicals; horticultural chemicals, except fungicides, herbicides, insecticides and parasiticides; agricultural chemicals, except fungicides, herbicides, insecticides and parasiticides; soil conditioning preparations; chimney cleaners, chemical; industrial chemicals; colour-brightening chemicals for industrial purposes; refrigerants; coolants for vehicle engines; chlorine; chlorates; hydrochlorates; aluminium chloride; magnesium chloride; chlorides; palladium chloride; chromates; flowers of sulfur for chemical purposes; caesium; cellulose; cement for mending broken articles; cerium; cyanides [prussiates]; calcium cyanamide [fertilizer]; cymene; loam; slag [fertilizers]; size for finishing and priming; spinel [oxide mineral]; alkalies; caustic alkali; plant extracts for use in the manufacture of food; plant extracts for use in the manufacture of cosmetics; plant extracts for use in the manufacture of pharmaceuticals; tea extracts for the food industry; tea extracts for use in the manufacture of cosmetics; tea extracts for use in the manufacture of pharmaceuticals; radioactive elements for scientific purposes; rare earths; fissionable chemical elements; emulsifiers; erbium; ethane; methyl ether; sulfuric ether; ethyl ether; glycol ether; ethers; esters; cellulose ethers for industrial purposes; cellulose esters for industrial purposes; antioxidants for use in the manufacture of food products; reagent paper, other than for medical or veterinary purposes; vitamins for use in the manufacture of food products; dendrimer-based polymers for use in the manufacture of capsules for pharmaceuticals; diagnostic strips for testing breast milk, other than for medical or veterinary use; chemical substances for analyses in laboratories, other than for medical or veterinary purposes.

6 – Aluminium; fittings of metal for compressed air lines; fittings of metal for building; white metal; beacons of metal, non-luminous; recycling bins of metal; vats of metal; beams of metal; joists of metal; bottles

[containers] of metal for compressed gas or liquid air; balustrades of metal; preserve tins; reels of metal, non-mechanical, for flexible hoses; swimming pools [structures] of metal; beryllium [glucinium]; arbours [structures] of metal; sew-on tags of metal for clothing; adhesive tags of metal for bags; blooms [metallurgy]; ingots of common metal; anchors; bolts of metal; eye bolts; casks of metal; mooring buoys of metal; barrels of metal; identification bracelets of metal; bronze; bells; bells for animals; letters and numerals of common metal, except type; silos of metal; busts of common metal; vanadium; bird baths [structures] of metal; valves of metal, other than parts of machines; screws of metal; aviaries [structures] of metal; tungsten; hoppers of metal, non-mechanical; gates of metal; sleeves [metal hardware]; ferrules of metal; ferrules of metal for handles; signboards of metal; diving boards of metal; loading gauge rods of metal for railway wagons; nuts of metal; galena [ore]; celtium [hafnium]; nails; tacks [nails]; horseshoe nails; shoe pegs of metal; germanium; vice claws of metal; armoured doors of metal; doors of metal; folding doors of metal; swing doors of metal; accordion doors of metal; chimney pots of metal; towel dispensers, fixed, of metal; door closers of metal, non-electric; pre-fabricated houses [kits] of metal; memorial plates of metal; chimney shafts of metal; wall plugs of metal; troughs of metal for mixing mortar; packaging containers of metal; containers of metal for storing acids; jealousies of metal; outdoor blinds of metal; iron, unwrought or semi-wrought; iron strip; roof gutters of metal; street gutters of metal; tinplate; plugs of metal; iron slabs; door bolts of metal; window fasteners of metal; bolts, flat; clips of metal for sealing bags; binding screws of metal for cables; cramps of metal [crampons]; wheel clamps [boots]; rivets of metal; box fasteners of metal; locks of metal for bags; locks of metal for vehicles; locks of metal, other than electric; padlocks of metal, other than electronic; spring locks; closures of metal for containers; metal plugs; latches of metal; tension links; couplings of metal for chains; door bells of metal, non-electric; road signs, non-luminous and non-mechanical, of metal; registration plates of metal; signs, non-luminous and non-mechanical, of metal; fences of metal; buckles of common metal [hardware]; bronzes [works of art]; works of art of common metal; ironmongery; indium; cabanas of metal; soundproof booths of metal, transportable; telephone booths of metal; cadmium; paint spraying booths of metal; telfer cables; ropes of metal; jerrycans of metal; horticultural frames of metal; greenhouse frames of metal; framework of metal for building; cornices of metal; skating rinks [structures] of metal; cermets; water-pipe valves of metal; drain traps [valves] of metal; metal cages for wild animals; keys of metal; mooring bollards of metal; cobalt, raw; covers specially made for handling and transport of metal bottles for compressed gas; chill-moulds [foundry]; elbows of metal for pipes; bed

casters of metal; furniture casters of metal; manifolds of metal for pipelines; casings of metal for oilwells; pillars of metal for building; chimney cowls of metal; bottle caps of metal; sealing caps of metal; tent pegs of metal; pegs of metal; copper rings; split rings of common metal for keys; rings of metal; door fittings of metal; fittings of metal for windows; brackets of metal for building; buildings of metal; buildings, transportable, of metal; steel buildings; oil drainage containers of metal; containers of metal [storage, transport]; waste dumpsters of metal, other than for medical use; check rails of metal for railways; baskets of metal; door frames of metal; tool boxes of metal, empty; stringers [parts of staircases] of metal; crampons [climbing irons]; taps of metal for casks; tubing of metal; brackets of metal for furniture; roofing of metal; roofing of metal, incorporating photovoltaic cells; turntables [railways]; screw tops of metal for bottles; manhole covers of metal; hooks [metal hardware]; pitons of metal; pot hooks of metal; hooks of metal for roofing slates; sash fasteners of metal for windows; hooks of metal for clothes rails; bag hangers of metal; clothes hooks of metal; prize cups of common metal; commemorative statuary cups of common metal; chicken-houses of metal; chests of metal; brass, unwrought or semi-wrought; bands of metal for tying-up purposes; scaffolding of metal; staircases of metal; ladders of metal; limonite; steel sheets; cast steel; traps for wild animals; magnesium; manganese; reinforcing materials, of metal, for concrete; reinforcing materials of metal for machine belts; reinforcing materials of metal for pipes; reinforcing materials of metal for building; railway material of metal; materials of metal for funicular railway permanent ways; building materials of metal; refractory construction materials of metal; masts of metal; steel masts; copper, unwrought or semi-wrought; sheets and plates of metal; common metals, unwrought or semi-wrought; pyrophoric metals; metals in powder form; mouldings of metal for building; molybdenum; door knockers of metal; pipe muffs of metal; shoe dowels of metal; porches [structures] of metal; bronzes for tombstones; tombs of metal; flashing of metal for building; roof flashing of metal; fish plates [rails]; anvils; anvils [portable]; beak-irons; rope thimbles of metal; ferrules of metal for walking sticks; handcuffs; jets of metal; duckboards of metal; belt stretchers of metal; stretchers for metal bands [tension links]; wire stretchers [tension links]; stretchers for iron bands [tension links]; nickel silver; nickel; niobium; grease nipples; binding thread of metal for agricultural purposes; thread of metal for tying-up purposes; house numbers of metal, non-luminous; braces of metal for handling loads; wall claddings of metal for building; mouldings of metal for cornices; enclosures of metal for tombs; laths of metal; barrel hoops of metal; wall linings of metal for building; palings of metal; crash barriers of metal for roads; furnace fireguards of metal; tree protectors of metal; latticework of metal; door stops of

metal; stops of metal; window stops of metal; windows of metal; ironwork for doors; ironwork for windows; tin; shuttering of metal for concrete; filings of metal; posts of metal for power lines; props of metal; branching pipes of metal; monuments of metal; monuments of metal for tombs; metal ramps for use with vehicles; acoustic panels of metal; door panels of metal; wainscotting of metal; signalling panels, non-luminous and non-mechanical, of metal; building panels of metal; partitions of metal; lintels of metal; casement windows of metal; strap-hinges of metal; shims; floating floor boards of metal; rocket launching platforms of metal; platforms, prefabricated, of metal; wall tiles of metal; floor tiles of metal; tiles of metal for building; anchor plates; paving slabs of metal; grave slabs of metal; tile floorings of metal; slabs of metal for building; lead seals; loading pallets of metal; handling pallets of metal; transport pallets of metal; trays of metal; stakes of metal for plants or trees; firedogs [andirons]; armour-plating of metal; paving blocks of metal; roof coverings of metal; cladding of metal for building; linings of metal for building; fireplace mantles of metal; steel strip; floors of metal; sills of metal; bathtub grab bars of metal; ceilings of metal; brazing alloys; gold solder; silver solder; collars of metal for fastening pipes; winding spools of metal, non-mechanical, for flexible hoses; floating docks of metal, for mooring boats; stoppers of metal; aluminium wire; iron wire; wire of common metal; wire of common metal alloys, except fuse wire; barbed wire; copper wire, not insulated; soldering wire of metal; steel wire; springs [metal hardware]; rods of metal for welding; rods of metal for brazing and welding; rods of metal for brazing; peeled metal bars; drawn and polished metal bars; bright steel bars; hot-rolled steel bars; dispensers for dog waste bags, fixed, of metal; window frames of metal; frames of metal for building; crucifixes of common metal, other than jewellery; containers of metal for liquid fuel; containers of metal for compressed gas or liquid air; tanks of metal; floating containers of metal; rails of metal; straps of metal for handling loads; fireplace grates of metal; gratings of metal; runners of metal for sliding doors; iron ores; ores of metal; chrome ores; door handles of metal; knobs of metal; sheet piles of metal; pigsties of metal; lead, unwrought or semi-wrought; safes [metal or non-metal]; safes, electronic; insect screens of metal; burial vaults of metal; door scrapers; cable joints of metal, non-electric; junctions of metal for pipes; nozzles of metal; anti-friction metal; silver-plated tin alloys; alloys of common metal; sheaf binders of metal; bindings of metal; bottle closures of metal; shutters of metal; steel alloys; steel, unwrought or semi-wrought; tinfoil; statues of common metal; cask stands of metal; tombstone stelae of metal; bars for metal railings; stables of metal; advertisement columns of metal; posts of metal; telegraph posts of metal; railway points; steps [ladders] of metal; step stools of metal; slings of metal for handling

loads; stair treads [steps] of metal; zip ties of metal; machine belt fasteners of metal; tombstone plaques of metal; nameplates of metal; tantalum [metal]; greenhouses of metal, transportable; titanium; wire cloth; tombac; mobile boarding stairs of metal for passengers; cables of metal, non-electric; wire rope; pipe-work of metal; penstock pipes of metal; water-pipes of metal; gutter pipes of metal; ducts of metal for ventilating and air-conditioning installations; drain pipes of metal; chimneys of metal; pipes of metal; ducts of metal, for central heating installations; steel pipes; turnstiles of metal; angle irons of metal; tinplate packings; door fasteners of metal; bicycle parking installations of metal; window closers of metal, non-electric; door openers of metal, non-electric; window openers of metal, non-electric; wind-driven bird-repelling devices made of metal; tungsten iron; molybdenum iron; silicon iron; titanium iron; chrome iron; figurines of common metal; flagpoles [structures] of metal; hand-held flagpoles of metal; flanges of metal [collars]; weather- or wind-vanes of metal; aluminium foil; metals in foil or powder form for 3D printers; foils of metal for wrapping and packaging; ice moulds of metal; foundry moulds of metal; fittings of metal for coffins; fittings of metal for beds; fittings of metal for furniture; clips of metal for cables and pipes; chromium; cattle chains; chains of metal; safety chains of metal; zinc; zirconium; pantiles of metal; roofing tiles of metal; cast iron, unwrought or semi-wrought; washers of metal; balls of steel; hinges of metal; poles of metal; safety cashboxes; pulleys of metal, other than for machines; window pulleys of metal; railway sleepers of metal; window casement bolts; cotter pins of metal; spurs; pins [hardware]; roller blinds of steel; latch bars of metal; badges of metal for vehicles; labels of metal; lock bolts; cashboxes [metal or non-metal]; tool chests of metal, empty; boxes of common metal; letter boxes of metal.

7 – 3D bioprinters; 3D printers; vending machines; welding machines, electric; soldering apparatus, gas-operated; vulcanization apparatus; acetylene cleaning apparatus; high pressure washers; apparatus for drawing up beer under pressure; apparatus for aerating water; apparatus for aerating beverages; electrical apparatus for sealing plastics [packaging]; electric arc cutting apparatus; electric arc welding apparatus; electric welding apparatus; inking apparatus for printing machines; soldering apparatus, electric; fittings for engine boilers; expansion tanks [parts of machines]; drums [parts of machines]; reels, mechanical, for flexible hoses; brake shoes, other than for vehicles; concrete mixers [machines]; bioreactors for use in manufacturing biopharmaceuticals; reels [parts of machines]; bobbins for weaving looms; harrows; journal boxes [parts of machines]; bulldozers; hoppers [mechanical discharging]; mine borers; railway wagon lifts; rolling mill cylinders; crank shafts; printing rollers for machines; camshafts for vehicle engines; transmission shafts, other than for land vehicles; valves [parts of

machines]; fans for motors and engines; saw benches [parts of machines]; winnowers; vibrators [machines] for industrial use; bearings [parts of machines]; water heaters being parts of machines; bellows [parts of machines]; agitators; drilling rigs, floating or non-floating; lawnmowers [machines]; card clothing [parts of carding machines]; nail extractors, electric; emergency power generators; alternators; dynamos; bicycle dynamos; current generators; electricity generators; hydraulic controls for machines, motors and engines; mufflers for motors and engines; drilling heads [parts of machines]; drilling bits [parts of machines]; cylinder heads for engines; soldering blow pipes, gas-operated; gas-operated blow torches; raking machines; stalk separators [machines]; sieves [machines or parts of machines]; mud catchers and collectors [machines]; tarring machines; rubber tracks being parts of crawlers on mining machines; rubber tracks being parts of crawlers on snow ploughs; rubber tracks being parts of crawlers on loading-unloading machines and apparatus; rubber tracks being parts of crawlers on agricultural machines; rubber tracks being parts of crawlers on construction machines; hydraulic engines and motors; aeronautical engines; aeroplane engines; engines for air cushion vehicles; compressed air engines; jet engines, other than for land vehicles; engines for boats; driving motors, other than for land vehicles; motors, other than for land vehicles; propulsion mechanisms, other than for land vehicles; de-aerators for feedwater; disintegrators; tympan [parts of printing presses]; holding devices for machine tools; turf removing ploughs; pump diaphragms; door closers, hydraulic; door closers, pneumatic; door closers, electric; chisels for machines; jacks [machines]; rack and pinion jacks; moving walkways; electric hand drills; crushers for kitchen use, electric; flues for engine boilers; reapers; reapers and binders; millstones; rakes for raking machines; shredders [machines] for industrial use; kitchen grinders, electric; injectors for engines; incubators for eggs; tools [parts of machines]; ski edge sharpening tools, electric; hand-held tools, other than hand-operated; agricultural implements, other than hand-operated; air condensers; control cables for machines, engines or motors; capstans; calenders; rotary steam presses, portable, for fabrics; ditchers [ploughs]; carburettors; sliders for knitting machines; crankcases for machines, motors and engines; steamrollers; pressure valves [parts of machines]; clack valves [parts of machines]; pressure reducers [parts of machines]; cowlings [parts of machines]; machine wheels; freewheels, other than for land vehicles; scale collectors for machine boilers; lasts for shoes [parts of machines]; brake pads, other than for vehicles; piston segments; grease rings [parts of machines]; reapers and threshers; coal-cutting machines; compressors [machines]; air pumps [garage installations]; compressors for refrigerators; conveyors [machines]; belt conveyors; converters for steelworks; steam condensers [parts of machines]; aerocondensers; diggers [ma-

chines]; rams [machines]; thermic lances [machines]; mechanized livestock feeders; boxes for matrices [printing]; gear boxes, other than for land vehicles; grease boxes [parts of machines]; housings [parts of machines]; harvesting machines; steam engine boilers; coffee grinders, other than hand-operated; taps [parts of machines, engines or motors]; cranes [lifting and hoisting apparatus]; roller bridges; mobile cranes; water separators; spray guns for paint; cranks [parts of machines]; potters' wheels; grindstones [parts of machines]; cultivators [machines]; soldering lamps; winches; blades [parts of machines]; ploughshares; belts for conveyors; lubricators [parts of machines]; igniting magnetos; handling machines, automatic [manipulators]; churns; matrices for use in printing; machine fly-wheels; shearing machines for animals; blowing machines; knitting machines; galvanizing machines; bending machines; ironing machines; mine-working machines; blowing machines for the compression, exhaustion and transport of gases; blowing machines for the compression, sucking and carrying of grain; net hauling machines [fishing]; electroplating machines; bottle sealing machines; sealing machines for industrial purposes; embossing machines; engraving machines; finishing machines; crushing machines; waste disposal units; blade sharpening [stropping] machines; earth moving machines; cord making machines; lace making machines; butter machines; cigarette machines for industrial purposes; sausage making machines; stereotype machines; hosiery looms; dyeing machines; bottle washing machines; dishwashers; machines for the application of sizing; bottle filling machines; cheese slicers, electric; racket stringing machines; leather-working machines; dairy machines; glass-working machines; tobacco processing machines; grain husking machines; painting machines; oil refining machines; peeling machines; machines for processing plastics; ore treating machines; printing machines for use on sheet metal; brewing machines; whitewashing machines; road sweeping machines, self-propelled; leather paring machines; machines for generating gas by electrolysis; bitumen making machines; papermaking machines; pasta making machines, electric; machines for the production of sugar; weeding machines; sifting machines; cinder sifters [machines]; puddling machines; notchers [machine tools]; bread cutting machines; road making machines; railroad constructing machines; machines for the textile industry; rammers [machines]; rail-laying machines; bottle capping machines; bottle stoppering machines; waste compacting machines; vegetable peelers, electric; die-stamping machines; stamping machines; darning machines; milking machines; drainage machines; wrapping machines; grain separators; bookbinding apparatus and machines for industrial purposes; machines and apparatus for cleaning, electric; machines and apparatus for carpet shampooing, electric; machines and apparatus for polishing [electric]; punching machines; riveting machines; kitchen ma-

chines, electric; foundry machines; smoothing presses; fleshing machines; flour mill machines; type-setting machines [printing]; hemming machines; grating machines for vegetables; braiding machines; rinsing machines; wringing machines for laundry; cutting machines; steam engines; printing machines; rotary printing presses; industrial inkjet printing machines; compressed air machines; tilling machines for agricultural purposes; trimming machines; spinning machines; filling machines; friezing machines; cutters [machines]; satinizing machines; agricultural machines; mixing machines; sorting machines for industry; stitching machines; washing machines [laundry]; coin-operated washing machines; laundry washing machines incorporating a drying tumbler; clippers [machines]; spinning frames; looms; kneading machines; typographic machines; type-setting machines [photo-composition]; beating machines; beaters, electric; packing machines; packaging machines; filtering machines; moulding machines; carding machines; sewing machines; typecasting machines; electromechanical machines for chemical industry; labellers [machines]; mills [machines]; mills for household purposes, other than hand-operated; pepper mills, other than hand-operated; centrifugal mills; machine wheelwork; feeders [parts of machines]; transmission mechanisms, other than for land vehicles; forge blowers; mixers [machines]; blenders, electric, for household purposes; vacuum cleaner bags; threshing machines; pneumatic hammers; hammers [parts of machines]; tilt hammers; power hammers; reeling apparatus, mechanical; motorized cultivators; motors for boats; clutches, other than for land vehicles; meat choppers, electric; superchargers; brake linings, other than for vehicles; guides for machines; suction nozzles for vacuum cleaners; vacuum cleaner attachments for disseminating perfumes and disinfectants; pumps [machines]; pumps [parts of machines, engines or motors]; aerating pumps for aquaria; vacuum pumps [machines]; compressed air pumps; pumps for heating installations; beer pumps; pumps for counter-current swimming; lubricating pumps; self-regulating fuel pumps; fuel dispensing pumps for service stations; centrifugal pumps; hydrogen dispensing pumps for service stations; tin openers, electric; knives for mowing machines; chaff cutter blades; knives, electric; knives being parts of machines; shears, electric; scissors, electric; vegetable spiralizers, electric; vegetable slicers, electric; engine mounts, other than for land vehicles; bearing brackets for machines; pulverisers [machines]; axles for machines; steam traps; chucks [parts of machines]; drill chucks [parts of machines]; exhaust manifold for engines; soldering irons, gas-operated; soldering irons, electric; superheaters; gears, other than for land vehicles; reduction gears, other than for land vehicles; drilling machines; saws [machines]; chain saws; guns [tools using explosive cartridges]; glue guns, electric; compressed air guns for the extrusion of mastics; carburettor feeders; feeding apparatus for

engine boilers; loading ramps; ploughs; pneumatic transporters; pneumatic controls for machines, motors and engines; hangers [parts of machines]; anti-friction bearings for machines; roller bearings; self-oiling bearings; bearings for transmission shafts; ball-bearings; elevators [lifts]; hoists; lifts, other than ski-lifts; pulleys; saw blades [parts of machines]; pistons [parts of machines or engines]; shock absorber plungers [parts of machines]; pistons for engines; pistons for cylinders; catalytic converters; torque converters, other than for land vehicles; fuel conversion apparatus for internal combustion engines; presses [machines for industrial purposes]; wine presses; fruit presses, electric, for household purposes; fodder presses; basket presses; printing presses; typographic presses; swaging machines; pneumatic or hydraulic linear actuators, other than for land vehicles; pedal drives for sewing machines; portable laser imprinters; cleaning appliances utilizing steam; food processors, electric; springs [parts of machines]; spinning wheels; punches for punching machines; vacuum cleaners; touchless stationary vacuums; tambours for embroidery machines; radiators [cooling] for motors and engines; sewage pulverizers; air brushes for applying colour; regulators [parts of machines]; pressure regulators [parts of machines]; speed governors for machines, engines and motors; cutting blow pipes, gas-operated; blade holders [parts of machines]; loom shafts; gears for weaving looms; belts for machines; elevator belts; fan belts for motors and engines; dynamo belts; belts for motors and engines; adhesive bands for pulleys; industrial robots; household cleaning and laundry robots with artificial intelligence; 3D printing pens; kick starters for motorcycles; joysticks being parts of machines, other than for game machines; stuffing boxes [parts of machines]; paper feeders [printing]; whisks, electric, for household purposes; sparking plugs for internal combustion engines; glow plugs for Diesel engines; brake segments, other than for vehicles; tending machines; steam/oil separators; cream/milk separators; ball rings for bearings; sowers [machines]; exhausts for motors and engines; pigs for cleaning pipes; snow ploughs; sheaf-binding machines; shaft couplings [machines]; joints [parts of engines]; juice extractors, electric; straw [chaff] cutters; suction cups for milking machines; stands for machines; machine tools; die-cutting and tapping machines; woodworking machines; sharpening machines; bicycle assembling machines; mortising machines; stone-working machines; metalworking machines; size adjustment cutting machines for industrial purposes; threading machines; trueing machines; planing machines; lathes [machine tools]; milling machines; grinding machines; metal drawing machines; rolling mills; starters for motors and engines; stators [parts of machines]; glaziers' diamonds [parts of machines]; tables for machines; derricks; slide rests [parts of machines]; spin dryers [not heated]; couplings, other than for land vehicles; heat exchangers [parts of machines]; transmis-

sions for machines; boiler tubes [parts of machines]; wind turbines; hydraulic turbines; turbines, other than for land vehicles; turbocompressors; central vacuum cleaning installations; suction machines for industrial purposes; machines for the mineralization of drinking water; washing installations for vehicles; degreasers [machines]; dust exhausting installations for cleaning purposes; sifting installations; pneumatic tube conveyors; dust removing installations for cleaning purposes; condensing installations; floating production, storage and offloading [FPSO] units; pneumatic waste oil drainers; lifting apparatus; air suction machines; dividing machines; igniting devices for internal combustion engines; window closers, hydraulic; window closers, pneumatic; window closers, electric; washing apparatus; binding apparatus for hay; haulage apparatus [mining]; door openers, hydraulic; door openers, pneumatic; door openers, electric; window openers, hydraulic; window openers, pneumatic; window openers, electric; curtain drawing devices, electrically operated; adhesive tape dispensers [machines]; anti-pollution devices for motors and engines; beverage preparation machines, electromechanical; food preparation machines, electromechanical; portable ultrasonic washing devices for laundry; elevator operating apparatus; control mechanisms for machines, engines or motors; shoe polishers, electric; machines and apparatus for wax-polishing, electric; air cushion devices for moving loads; handling apparatus for loading and unloading; elevating apparatus; aprons [parts of machines]; filter presses; filters for cleaning cooling air, for engines; filters being parts of machines or engines; moulds [parts of machines]; printing plates; journals [parts of machines]; centrifugal machines; elevator chains [parts of machines]; drive chains, other than for land vehicles; transmission chains, other than for land vehicles; cylinders for motors and engines; cylinders for machines; printing cylinders; pneumatic jacks; shuttles [parts of machines]; universal joints [Cardan joints]; connecting rods for machines, motors and engines; steam mops; pulleys [parts of machines]; vacuum cleaner hoses; screwdrivers, electric; brushes [parts of machines]; dynamo brushes; brushes for vacuum cleaners; brushes, electrically operated [parts of machines]; carbon brushes [electricity]; ejectors; robotic exoskeleton suits, other than for medical purposes; fuel economisers for motors and engines; excavators; shovels, mechanical; grain elevators; agricultural elevators; motors, electric, other than for land vehicles; electrodes for welding machines; electric hammers; parquet wax-polishers, electric; cartridges for filtering machines; moving staircases [escalators]; automatic grappels for marine purposes.

8 – Glaziers' diamonds [parts of hand tools]; apparatus for tattooing; laser hair removal apparatus, other than for medical purposes; razors, electric or non-electric; sharpening steels; scythe stones; gimlets [hand tools]; borers; augers [hand tools]; carpenters' augers; pickhammers; weeding forks [hand tools]; carving

forks; table forks; agricultural forks [hand tools]; lawn clippers [hand instruments]; harpoons; harpoons for fishing; nail extractors, hand-operated; rakes [hand tools]; sand trap rakes; cutter bars [hand tools]; whetstone holders; priming irons [hand tools]; sculptors' chisels; lifting jacks, hand-operated; hand drills, hand-operated; truncheons; clamps for carpenters or coopers; spades [hand tools]; rabbeting planes; chisels; engraving needles; tattoo needles; cutlery; edge tools [hand tools]; choppers being knives; garden tools, hand-operated; abrading instruments [hand instruments]; numbering punches; goffering irons; implements for decanting liquids [hand tools]; depilation appliances, electric and non-electric; sharpening instruments; blade sharpening instruments; livestock marking tools; nail clippers, electric or non-electric; oyster openers; polishing irons [glazing tools]; ear-piercing apparatus; tube cutting instruments; wire strippers [hand tools]; riveters [hand tools]; expanders [hand tools]; cutters; cutting tools [hand tools]; ski edge sharpening tools, hand-operated; hand tools, hand-operated; sterile body piercing instruments; stamping-out tools [hand tools]; picks [hand tools]; sharpening stones; punch rings [knuckle dusters]; trowels; centre punches [hand tools]; daggers; pickaxes; mallets [hand instruments]; pliers; punch pliers [hand tools]; blades [weapons]; annular screw plates; spanners [hand tools]; tap wrenches; ladles [hand tools]; foundry ladles [hand tools]; meat claws; breast drills; lasts [shoemakers' hand tools]; scythe rings; instruments for punching tickets; diggers [hand tools]; rams [hand tools]; scythes; hainault scythes; fire irons; emery grinding wheels; grindstones [hand tools]; sledgehammers; thistle extractors [hand tools]; nail nippers; tree pruners; nail drawers [hand tools]; ice picks; blades [hand tools]; razor blades; blades for planes; plane irons; jig-saws; spoons; table knives, forks and spoons for babies; table knives, forks and spoons of plastic; crow bars; trowels [gardening]; shovels [hand tools]; palette knives; machetes; beard clippers; hair clippers for personal use, electric and non-electric; hair clippers for animals [hand instruments]; taps [hand tools]; fireplace bellows [hand tools]; swords; hammers [hand tools]; emergency hammers; fullers [hand tools]; stone hammers; masons' hammers; riveting hammers [hand tools]; mattocks; ditchers [hand tools]; manicure sets; manicure sets, electric; pedicure sets; needle files; bits [hand tools]; files [tools]; emery files; air pumps, hand-operated; hand pumps; shaving cases; knives; mincing knives; cheese slicers, non-electric; fruit segmenters; egg slicers, non-electric; vegetable knives; pizza cutters, non-electric; scaling knives; hobby knives [scalpels]; fruit corers; moulding irons; ceramic knives; tin openers, non-electric; farriners' knives; multi-tool knives; budding knives; hunting knives; penknives; grafting tools [hand tools]; carving knives; braiders [hand tools]; box cutters; billhooks; paring knives; cleavers; scissors; wick trimmers [scissors]; shears; cattle shearers; border shears;

pruning shears; shearers [hand instruments]; sword scabbards; kitchen mandolines; vegetable slicers, hand-operated; vegetable spiralizers, hand-operated; vegetable peelers, hand-operated; agricultural implements, hand-operated; side arms, other than firearms; stropping instruments; screwdrivers, non-electric; hand-operated corn cob strippers; sabres; stirring sticks for mixing paint; reamer sockets; drill holders [hand tools]; perforating tools [hand tools]; rammers [hand tools]; emery boards; nail files, electric; saws [hand tools]; bow saws; tweezers; hair-removing tweezers; guns [hand tools]; non-electric caulking guns; non-electric caulking guns; guns, hand-operated, for the extrusion of mastics; dies [hand tools]; fruit pickers [hand tools]; saw blades [parts of hand tools]; shear blades; tool belts [holders]; hair braiders, electric; table cutlery [knives, forks and spoons]; crimping irons; hand implements for hair curling; vegetable choppers; money scoops; instruments and tools for skinning animals; fingernail polishers, electric or non-electric; hackles [hand tools]; pin punches; nail punches; fish tapes [hand tools]; food processors, hand-operated; punches [hand tools]; insecticide vaporizers [hand tools]; syringes for spraying insecticides; reamers; frames for handsaws; saw holders; rasps [hand tools]; paring irons [hand tools]; graving tools [hand tools]; milling cutters [hand tools]; razor strops; leather strops; planes; scythe handles; knife handles; handles for hand-operated hand tools; levers; marline spikes; bits [parts of hand tools]; hollowing bits [parts of hand tools]; pruning scissors; silver plate [knives, forks and spoons]; pruning knives; sickles; drawing knives; scrapers [hand tools]; scrapers for skis; mortise chisels; caulking irons; gouges [hand tools]; mortars for pounding [hand tools]; mitre boxes [hand tools]; branding irons; hatchets; adzes [tools]; vices; bench vices [hand implements]; hop cutters [hand tools]; axes; holing axes; fulling tools [hand tools]; earth rammers [hand tools]; tube cutters [hand tools]; hoes [hand tools]; squares [hand tools]; extension pieces for braces for screw taps; embossers [hand tools]; apparatus for destroying plant parasites, hand-operated; metal wire stretchers [hand tools]; metal band stretchers [hand tools]; flat irons; irons [non-electric hand tools]; hand-operated fruit slicers; razor cases; ratchets [hand tools]; scraping tools [hand tools]; awls; spatulas [hand tools]; spatulas for use by artists; wine bottle foil cutters, hand-operated; bayonets; pincers; curling tongs; cuticle tweezers; eyelash curlers.

9 – 3D spectacles; 3D scanners; DVD players; ticket dispensers; juke boxes, musical; fire engines; answering machines; electrical adapters; batteries for electronic cigarettes; accumulators, electric; batteries, electric, for vehicles; accelerometers; actinometers; alidades; breathalyzers; altimeters; ear pads for headphones; ammeters; apparatus for testing breast milk, other than for medical or veterinary use; nanoparticle size analysers; anemometers; anodes; aerials; anticathodes;

apertometers [optics]; high-frequency apparatus; testing apparatus not for medical purposes; electro-dynamic apparatus for the remote control of railway points; electro-dynamic apparatus for the remote control of signals; monitoring apparatus, other than for medical purposes; sound recording apparatus; Global Positioning System [GPS] apparatus; remote control apparatus; distillation apparatus for scientific purposes; diffraction apparatus [microscopy]; air analysis apparatus; apparatus to check franking; sound transmitting apparatus; breathing apparatus for underwater swimming; breathing apparatus, except for artificial respiration; apparatus and installations for the production of X-rays, not for medical purposes; cash registers; electric apparatus for commutation; intercommunication apparatus; stills for laboratory experiments; projection apparatus; fire extinguishing apparatus; radiological apparatus for industrial purposes; X-ray apparatus not for medical purposes; blueprint apparatus; flashing lights [luminous signals]; stereoscopic apparatus; telephone apparatus; facsimile machines; fermentation apparatus for laboratory use; phototelegraphy apparatus; igniting apparatus, electric, for igniting at a distance; acid hydrometers; salinometers; acidimeters for batteries; aerometers; beacons, luminous; battery jars; automated teller machines [ATM]; barometers; anode batteries; galvanic batteries; ignition batteries; solar batteries; solar panels for the production of electricity; batteries, electric; balances [steelyards]; betatrons; binoculars; bioreactors for cell culturing for scientific research; bioreactors for laboratory use; biochips; electronic tags for goods; lens hoods; magnetic tape units for computers; computer memory devices; fire hose nozzles; encoded identification bracelets, magnetic; connected bracelets [measuring instruments]; safety tarpaulins; electronic key fobs being remote control apparatus; bullet-proof clothing; signalling buoys; life buoys; marking buoys; directional compasses; vacuum gauges; variometers; internal cooling fans for computers; verniers; scales; baby scales; bathroom scales; letter scales; weighbridges; precision balances; scales with body mass analysers; levelling staffs [surveying instruments]; camcorders; video baby monitors; video cassettes; video projectors; video telephones; video screens; viewfinders, photographic; electric plugs; micrometer screws for optical instruments; viscosimeters; circuit closers; wavemeters; voltmeters; flash lamps for smartphones; mechanical signs; switchboxes [electricity]; current rectifiers; gas testing instruments; gasometers [measuring instruments]; galvanometers; hands-free kits for telephones; headsets; headsets for playing video games; heliographic apparatus; apparatus for generating gas for calibration purposes; hygrometers; hydrometers; weights; peepholes [magnifying lenses] for doors; hairdressing training heads [teaching apparatus]; holograms; plotters; loudspeakers; sounding leads; plumb bobs; range finders; gauges; parking sensors for vehicles; piezoelectric sensors; densimeters; densitome-

ters; holders adapted for mobile telephones and smartphones; detectors; smoke detectors; infrared detectors; counterfeit coin detectors; joysticks for use with computers, other than for video games; transparencies [photography]; slide projectors; diaphragms [photography]; dictating machines; thin film speakers; wearable speakers; dynamometers; light-emitting diodes [LED]; quantum dot light-emitting diodes [QLED]; organic light-emitting diodes [OLED]; floppy disks; phonograph records; disks, magnetic; optical discs; circular slide rules; disk drives for computers; juke boxes for computers; head-mounted displays; wearable video display monitors; electronic numeric displays; DNA chips; electronic interactive whiteboards; electronic notice boards; electric wire harnesses for automobiles; bullet-proof vests; life jackets; reflective safety vests; identification threads for electric wires; nose clips for divers and swimmers; biometric locks; padlocks, electric; locks, electric; bells [warning devices]; alarm bells, electric; electric door bells; signal bells; acoustic conduits; mirrors for inspecting work; safety signs [luminous]; road signs, luminous or mechanical; warning signs [luminous]; signs, luminous; downloadable emoticons for mobile phones; marine depth finders; probes for scientific purposes; buzzers; needles for surveying compasses; needles for record players; eyewear; reflective articles for wear, for the prevention of accidents; measures; pressure measuring apparatus; simulators for the steering and control of vehicles; inverters [electricity]; pressure indicators; automatic indicators of low pressure in vehicle tyres; temperature indicators; incubators for bacteria culture; measuring instruments; cosmographic instruments; mathematical instruments; levelling instruments; instruments containing eyepieces; surveying instruments; azimuth instruments; interfaces for computers; audio interfaces; ionization apparatus not for the treatment of air or water; satellite finder meters; spark-guards; coaxial cables; fibre optic cables; cables, electric; calipers; slide calipers; screw-tapping gauges; calorimeters; calculating machines; pocket calculators; decompression chambers; rearview cameras for vehicles; cinematographic cameras; thermal imaging cameras; mouth guards for sports; life-saving capsules for natural disasters; electronic pens [visual display units]; holders for electric coils; biometric identity cards; identity cards, magnetic; video game cartridges; toner cartridges, unfilled, for printers and photocopiers; ink cartridges, unfilled, for printers and photocopiers; memory cards for video game machines; encoded magnetic cards; riding helmets; protective helmets; carriers for dark plates [photography]; cathodes; spools [photography]; choking coils [impedance]; coils, electric; electromagnetic coils; cinematographic film, exposed; computer keyboards; solenoid valves [electromagnetic switches]; wire connectors [electricity]; thin client computers; downloadable cryptographic keys for receiving and spending crypto assets; encoded key cards; electronic book readers;

electronic agendas; push buttons for bells; mouse pads; dashboard mats adapted for holding mobile telephones and smartphones; magnetic encoders; visors for helmets; collectors, electric; portable speakers; calibrating rings; smart rings; mobile phone ring holders; mobile phone ring stands; ring sizers; protective suits for aviators; commutators; compact discs [audio-video]; compact discs [read-only memory]; comparators; marine compasses; computers; quantum computers; laptop computers; tablet computers; notebook computers; wearable computers; condensers [capacitors]; contacts, electric; controllers for servo motors; home automation hubs; musical instrument digital interface controllers being audio interfaces; electronic controllers for servo motors; wind socks for indicating wind direction; traffic cones; branch boxes [electricity]; distribution boxes [electricity]; junction boxes [electricity]; battery boxes; cabinets for loudspeakers; diving suits; haptic suits, other than for medical purposes; downloadable e-wallets; evacuation chairs; galena crystals [detectors]; covers for electric outlets; logs [measuring instruments]; lasers, not for medical purposes; lactodensimeters; lactometers; vacuum tubes [radio]; darkroom lamps [photography]; selfie ring lights for smartphones; thermionic valves; amplifying tubes; flashlights [photography]; head cleaning tapes [recording]; magnetic tapes; videotapes; surveying chains; fire escapes; rulers [measuring instruments]; square rulers for measuring; slide-rules; contact lenses; correcting lenses [optics]; optical lenses; optical condensers; sounding lines; electricity conduits; measuring spoons; magnifying glasses [optics]; thread counters; magnets; decorative magnets; close-up lenses; crash test dummies; resuscitation mannequins [teaching apparatus]; mouse [computer peripheral]; trackballs [computer peripherals]; pressure gauges; security tokens [encryption devices]; divers' masks; solderers' helmets; protective masks, not for medical purposes; dust masks incorporating air purification; respiratory masks, other than for artificial respiration; materials for electricity mains [wires, cables]; voting machines; money counting and sorting machines; material testing instruments and machines; furniture especially made for laboratories; megaphones; portable media players; diaphragms [acoustics]; diaphragms for scientific apparatus; metal detectors for industrial or military purposes; digital weather stations; metronomes; rules [measuring instruments]; carpenters' rules; dressmakers' measures; mechanisms for coin-operated apparatus; mechanisms for counter-operated apparatus; coin-operated mechanisms for television sets; shutter releases [photography]; micrometers; microprocessors; microscopes; microtomes; microphones; wireless speaker microphones; audio mixers; modems; lightning conductors; monitors [computer hardware]; monitors [computer programs]; selfie sticks [hand-held monopods]; terminals [electricity]; junction sleeves for electric cables; data sets, recorded or downloadable; teeth protectors; tempera-

ture indicator labels, not for medical purposes; kneepads for workers; headphones; earpieces for remote communication; surveyors' levels; sound recording carriers; magnetic data media; optical data media; electronic sheet music, downloadable; computer game software, recorded; computer software, recorded; downloadable computer software for managing cryptocurrency transactions using blockchain technology; software as a medical device [SaMD], downloadable; sheaths for electric cables; identification sheaths for electric wires; weighing machines; computer hardware; punched card machines for offices; shoes for protection against accidents, irradiation and fire; objectives [lenses] [optics]; lenses for astrophotography; selfie lenses; egg-candlers; fire extinguishers; rescue laser signalling flares; electrified fences; limiters [electricity]; clothing for protection against accidents, irradiation and fire; clothing for protection against fire; asbestos clothing for protection against fire; clothing especially made for laboratories; survival blankets; ozonisers [ozonators]; octants; eyepieces; ohmmeters; wrist rests for use with computers; spectacle frames; oscillographs; plumb lines; mirrors [optics]; spectacles; spectacles for correcting colour blindness; sunglasses; goggles for sports; electronic collars to train animals; finger sizers; signalling panels, luminous or mechanical; biometric passports; wah-wah pedals; effects pedals for guitars; radio pagers; pince-nez; electronic pocket translators; transmitters [telecommunication]; telephone transmitters; transmitters of electronic signals; switches, electric; periscopes; data gloves; gloves for divers; gloves for protection against accidents; gloves for protection against X-rays for industrial purposes; asbestos gloves for protection against accidents; furnaces for laboratory use; droppers for measuring, other than for medical or household purposes; laboratory pipettes; pyrometers; planimeters; plane tables [surveying instruments]; plates for batteries; computer software platforms, recorded or downloadable; wafers for integrated circuits; printed circuit boards; compact disc players; cassette players; protective films adapted for computer screens; protective films adapted for smartphone screens; sound recording strips; mobile phone screen protectors; X-ray films, exposed; films, exposed; life-saving rafts; animal signalling rattles for directing livestock; laboratory trays; digital signs; stands adapted for laptops; in-car telephone handset cradles; cooling pads for laptop computers; airbags for safety purposes for fall protection; semi-conductors; polarimeters; personal digital assistants [PDAs]; fire pumps; measuring glassware; weight belts for divers; life belts; fuses; circuit breakers; converters, electric; telerupters; food analysis apparatus; diagnostic apparatus, not for medical purposes; distance recording apparatus; distance measuring apparatus; speed measuring apparatus [photography]; appliances for measuring the thickness of leather; apparatus for measuring the thickness of skins; speed checking apparatus for vehicles; teaching ap-

paratus; time recording apparatus; apparatus and instruments for astronomy; surveying apparatus and instruments; weighing apparatus and instruments; nautical apparatus and instruments; navigational instruments; optical apparatus and instruments; apparatus and instruments for physics; chemistry apparatus and instruments; measuring apparatus; measuring devices, electric; boiler control instruments; meteorological instruments; naval signalling apparatus; observation instruments; navigation apparatus for vehicles [on-board computers]; satellite navigational apparatus; regulating apparatus, electric; telecommunication apparatus in the form of jewellery; precision measuring apparatus; electric actuators; electric linear actuators; audio- and video-receivers; prisms [optics]; computer software applications, downloadable; wireless portable printers for use with laptops and mobile devices; ticket printers; printers for use with computers; hemline markers; retorts' stands; apparatus for changing record player needles; drainers for use in photography; cleaning apparatus for phonograph records; fire beaters; sighting telescopes for firearms; telescopic sights for artillery; test tubes; pressure indicator plugs for valves; magnetic wires; telegraph wires; telephone wires; wires, electric; conductors, electric; copper wire, insulated; fuse wire; computer programs, recorded; computer game software, downloadable; computer programs, downloadable; computer operating programs, recorded; computer screen saver software, recorded or downloadable; record players; processors [central processing units]; rods for water diviners; electronic publications, downloadable; distribution consoles [electricity]; control panels [electricity]; radar apparatus; masts for wireless aerials; transmitting sets [telecommunication]; radios; vehicle radios; sprinkler systems for fire protection; frames for photographic transparencies; screens for photoengraving; flowmeters; walkie-talkies; voltage surge protectors; voltage regulators for vehicles; stage lighting regulators; light dimmers [regulators], electric; speed regulators for record players; cell switches [electricity]; washing trays [photography]; marking gauges [joinery]; T-squares for measuring; time switches, automatic; relays, electric; safety restraints, other than for vehicle seats and sports equipment; body harnesses for support when lifting loads; X-ray photographs, other than for medical purposes; rheostats; respirators for filtering air; retorts; refractometers; refractors; grids for batteries; security surveillance robots; laboratory robots; teaching robots; telepresence robots; humanoid robots with artificial intelligence for use in scientific research; electric sockets; height measuring instruments; speaking tubes; horns for loudspeakers; subwoofers; saccharometers; optical fibres [light conducting filaments]; traffic-light apparatus [signalling devices]; dog whistles; signalling whistles; sports whistles; sextants; inductors [electricity]; safety nets; nets for protection against accidents; fire alarms; signals, luminous or mechanical; rescue flares, non-explosive and non-pyro-

technic; sirens; electronic access control systems for interlocking doors; scanners [data processing equipment]; scanners [apparatus] for performing automotive diagnostics; hand-held electronic dictionaries; smart speakers; integrated circuit cards [smart cards]; smartglasses; smartphones; foldable smartphones; smartwatches; connections for electric lines; couplings, electric; connectors [electricity]; sonars; sound locating instruments; lighting ballasts; resistances, electric; spectrograph apparatus; spectroscopes; speed indicators; alcoholmeters; satellites for scientific purposes; protection devices for personal use against accidents; audiovisual teaching apparatus; charging stations for electric vehicles; radiotelegraphy sets; radiotelephony sets; spectacle lenses; anti-glare glasses; optical glass; personal stereos; stereoscopes; stands for photographic apparatus; stroboscopes; fire boats; sulfimeters; bags adapted for laptops; drying racks [photography]; spherometers; integrated circuits; printed circuits; counters; parking meters; mileage recorders for vehicles; portable ultrafine dust meters; revolution counters; abacuses; egg timers [sandglasses]; taximeters; ear plugs for divers; tachometers; television apparatus; telegraphs [apparatus]; telescopes; teleprompters; teleprinters; cordless telephones; mobile telephones; theodolites; credit card terminals; interactive touch screen terminals; thermo-hygrometers; thermometers, not for medical purposes; thermostats; thermostats for vehicles; climate control digital thermostats; crucibles [laboratory]; tone arms for record players; totalizers; transistors [electronic]; transponders; protractors [measuring instruments]; transformers [electricity]; step-up transformers; resuscitation training simulators; vehicle breakdown warning triangles; triodes; starter cables for motors; discharge tubes, electric, other than for lighting; capillary tubes for laboratory use; neon signs; Pitot tubes; X-ray tubes not for medical purposes; telephone receivers; headgear being protective helmets; squares for measuring; quantity indicators; petrol gauges; water level indicators; electric loss indicators; light-emitting electronic pointers; slope indicators; levels [instruments for determining the horizontal]; mercury levels; spirit levels; urinometers; amplifiers for servo motors; amplifiers; particle accelerators; electric installations for the remote control of industrial operations; baby monitors; steering apparatus, automatic, for vehicles; balancing apparatus; video recorders; sound reproduction apparatus; invoicing machines; tape recorders; protection devices against X-rays, not for medical purposes; railway traffic safety appliances; data processing apparatus; oxygen transvasing apparatus; theft prevention installations, electric; devices for the projection of virtual keyboards; film cutting apparatus; drying apparatus for photographic prints; optical character readers; centering apparatus for photographic transparencies; dosage dispensers; battery chargers; mobile phone chargers; chargers for electric accumulators; chargers for electronic cigarettes; portable power

chargers; acoustic alarms; sounding apparatus and machines; life-saving apparatus and equipment; apparatus for editing cinematographic film; cathodic anti-corrosion apparatus; couplers [data processing equipment]; wearable activity trackers; anti-theft warning apparatus; computer peripheral devices; anti-interference devices [electricity]; demagnetizing apparatus for magnetic tapes; acoustic couplers; alarms; fog signals, non-explosive; whistle alarms; adding machines; readers [data processing equipment]; heat regulating apparatus; photocopiers [photographic, electrostatic, thermic]; electric and electronic effects units for musical instruments; bar code readers; head-up display apparatus for vehicles; downloadable ring tones for mobile phones; downloadable image files; downloadable music files; animated cartoons; filters for respiratory masks; filters for ultraviolet rays, for photography; filters for use in photography; USB flash drives; magic lanterns; optical lanterns; signal lanterns; cameras [photography]; glazing apparatus for photographic prints; shutters [photography]; darkrooms [photography]; photometers; flash-bulbs [photography]; digital photo frames; enlarging apparatus [photography]; photovoltaic cells; containers for contact lenses; contact lens cases incorporating ultrasonic cleaning functions; spectacle cases; containers for microscope slides; cases for smartphones; cases especially made for photographic apparatus and instruments; chromatography apparatus for laboratory use; chronographs [time recording apparatus]; laboratory centrifuges; spectacle chains; cyclotrons; compasses for measuring; frequency meters; time clocks [time recording devices]; Petri dishes; sleeves for laptops; covers for personal digital assistants [PDAs]; covers for tablet computers; covers for smartphones; fire blankets; chips [integrated circuits]; jigs [measuring instruments]; pedometers; fire-extinguishing balls; meteorological balloons; electrified rails for mounting spot lights; asbestos screens for firemen; fire hose; virtual reality headsets; protective helmets for sports; neural helmets, not for medical purposes; head guards for sports; lifeboats; snorkels; cell phone straps; spectacle cords; tripods for cameras; switchboards; distribution boards [electricity]; equalizers [audio apparatus]; screens [photography]; workmen's protective face-shields; projection screens; radiology screens for industrial purposes; fluorescent screens; exposure meters [light meters]; electrolysis apparatus for laboratory use; ducts [electricity]; galvanic cells; downloadable graphics for mobile phones; epidiascopes; ergometers; armatures [electricity]; black boxes [data recorders]; magnetic resonance imaging [MRI] apparatus, not for medical purposes.

11 – Lampshades; autoclaves, electric, for cooking; steam accumulators; heat accumulators; defrosters for vehicles; adsorption apparatus for generating gas; disinfectant apparatus for medical purposes; distillation apparatus; desiccating apparatus; hydromassage bath apparatus; disinfectant apparatus; air deodorizing ap-

paratus; ionization apparatus for the treatment of air or water; coffee roasters; beverage cooling apparatus; apparatus for fertilizer irrigation; hand drying apparatus for washrooms; fruit roasters; water purifying apparatus and machines; refrigerating apparatus and machines; underfloor heating apparatus and installations; drying apparatus and installations; membrane apparatus for generating gas; freezers; heating and cooling apparatus for dispensing hot and cold beverages; drying apparatus; fermentation apparatus for industrial purposes; coolers for furnaces; expansion tanks for central heating installations; flushing tanks; refining towers for distillation; bidets; bioreactors for use in the treatment of wastewater; bioreactors for use in the treatment of waste; boilers, other than parts of machines; bath tubs; spa baths [vessels]; bath tubs for sitz baths; waffle irons, electric; fans [air-conditioning]; fans [parts of air-conditioning installations]; electric fans for personal use; roasting spits; refrigerating display cabinets; heated display cabinets; dehumidifiers; water heaters; water flushing installations; air reheaters; extractor hoods for kitchens; gas condensers, other than parts of machines; acetylene generators; fog machines; microbubble generators for baths; hydrants; fairy lights for festive decoration; burners; acetylene burners; gas burners; burners for lamps; germicidal burners; incandescent burners; oxyhydrogen burners; laboratory burners; oil burners; alcohol burners; hot water bottles; footwarmers, electric or non-electric; bed warmers; USB-powered hand warmers; pocket warmers; warming pans; roasting apparatus; food dehydrators, electric; lampshade holders; stills; showers; refrigerating containers; gas lighters; friction lighters for igniting gas; chimney blowers; coils [parts of distilling, heating or cooling installations]; furnace ash boxes; evaporators; electric appliances for making yogurt; shower cubicles; Turkish bath cabinets, portable; heating apparatus; cool boxes, electric; refrigerating chambers; fireplaces, domestic; chimney flues; coffee capsules, empty, for electric coffee machines; structural framework for ovens; cooking pots, electric; air valves for steam heating installations; level controlling valves in tanks; thermostatic valves [parts of heating installations]; electrically heated carpets; light bulbs; light bulbs, electric; solar thermal collectors [heating]; distillation columns; furnace grates; ventilation hoods; ventilation hoods for laboratories; lamp globes; air-conditioning apparatus; air conditioners for vehicles; gas boilers; laundry room boilers; heating boilers; coffee machines, electric; coffee machines incorporating water purifiers; taps for pipes and pipelines; taps; mixer taps for water pipes; electrically heated mugs; forges, portable; lava rocks for use in barbecue grills; couscous cookers, electric; lights, electric, for Christmas trees; acetylene flares; safety lamps; gas lamps; curling lamps; nail lamps; curing lamps, not for medical purposes; germicidal lamps for purifying air; light bulbs for directional signals for vehicles; arc lamps; laboratory lamps; oil lamps; ultra-

violet ray lamps, not for medical purposes; miners' lamps; electric lamps; chandeliers; barbecues; bread baking machines; watering machines for agricultural purposes; ice-cream making machines; beer brewing machines, electric, for household purposes; soya milk making machines, electric; pounded rice cake making machines, electric, for household purposes; membranes for reverse osmosis units; filters for water filtering apparatus; multicookers; footmuffs, electrically heated; heaters for baths; heaters for heating irons; immersion heaters; brackets for gas burners; anti-splash tap nozzles; heat pumps; filaments for electric lamps; magnesium filaments for lighting; heating filaments, electric; luminous house numbers; socks, electrically heated; heating apparatus for defrosting vehicle windows; hot air bath fittings; bath fittings; loading apparatus for furnaces; kiln furniture [supports]; sauna bath installations; refrigerating appliances and installations; directional lights for bicycles; running lights for vehicles; electrically heated clothing; blankets, electric, not for medical purposes; fabric steamers; lamp reflectors; vehicle reflectors; hearths; lightsticks, battery-operated; electric cooktops; food steamers, electric; steam boilers, other than parts of machines; pasteurisers; lamp mantles; sockets for electric lights; coffee percolators, electric; stoves [heating apparatus]; bakers' ovens; hot air ovens; kitchen ranges [ovens]; microwave ovens [cooking apparatus]; microwave ovens for industrial purposes; incinerators; kilns; solar furnaces; dental ovens; furnaces, other than for laboratory use; urinals being sanitary fixtures; feeding apparatus for heating boilers; heating plates; cooking stoves; hot plates; wine cellars, electric; heaters, electric, for feeding bottles; aquarium heaters; USB-powered cup heaters; aquarium lights; heating cushions, electric, not for medical purposes; clean chambers [sanitary installations]; electric vessels for making ices and ice cream; tortilla presses, electric; water intake apparatus; apparatus for dehydrating food waste; fumigation apparatus, not for medical purposes; gas scrubbing apparatus; oil-scrubbing apparatus; glue-heating appliances; drying apparatus for fodder and forage; water filtering apparatus; air purifying apparatus and machines; ice machines and apparatus; cooling appliances and installations; cooking apparatus and installations; lighting apparatus and installations; sanitary apparatus and installations; cooking rings; lighting apparatus for vehicles; light-emitting diodes [LED] lighting apparatus; heating apparatus for solid, liquid or gaseous fuels; heating apparatus, electric; hot air apparatus; steam facial apparatus [saunas]; safety accessories for water or gas apparatus and pipes; regulating and safety accessories for gas apparatus; regulating accessories for water or gas apparatus and pipes; regulating and safety accessories for water apparatus; regulating and safety accessories for gas pipes; roasting jacks; plate warmers; anti-glare devices for vehicles [lamp fittings]; rotisseries; radiator caps; searchlights; diving lights; light projectors; washers for wa-

ter taps; snow-making machines; heat guns; radiators [heating]; central heating radiators; radiators, electric; sinks; kitchen sinks incorporating integrated work-tops; drip irrigation emitters [irrigation fittings]; light diffusers; nuclear reactors; heat regenerators; pressure water tanks; roasters; beverage urns, electric; lamps; ceiling lights; toilet seats; hydroponic growing systems; lighting installations for air vehicles; gas scrubbers [parts of gas installations]; tanning beds; lamp glasses; sterilizers; water sterilizers; air sterilizers; air dryers; laundry dryers, electric; hair dryers; malt roasters; tobacco roasters; tajines, electric; heat exchangers, other than parts of machines; thermo-pots, electric; bread toasters; discharge tubes, electric, for lighting; lamp chimneys; luminous tubes for lighting; pipes [parts of sanitary installations]; flues for heating boilers; boiler pipes [tubes] for heating installations; heat-stabilized polypropylene pipes for heating installations; toilets [water-closets]; toilets, portable; humidifiers; humidifiers for central heating radiators; membrane filtration units for water treatment apparatus; wash-hand basins [parts of sanitary installations]; toilet bowls; water conduits installations; air-conditioning installations; desalination plants; installations for processing nuclear fuel and nuclear moderating material; watering installations, automatic; cooling installations for water; cooling installations for liquids; milk cooling installations; cooling installations for tobacco; water purification installations; purification installations for sewage; steam generating installations; water distribution installations; air filtering installations; swimming pool chlorinating apparatus; ventilation [air-conditioning] installations and apparatus; ventilation [air-conditioning] installations for vehicles; water softening apparatus and installations; cooling installations and machines; reverse osmosis units; heating installations; heaters for vehicles; heating installations [water]; polymerisation installations; water supply installations; flare stacks for use in the oil industry; disinfectant apparatus for dispensing solutions into water-pipes for sanitary installations; ash conveyor installations, automatic; deodorizing apparatus, not for personal use; whirlpool-jet apparatus; air cooling apparatus; sous-vide cookers, electric; aquarium filtration apparatus; cooking utensils, electric; flaming torches; headlights for automobiles; vehicle headlights; filters for air conditioning; filters for drinking water; reverse osmosis membrane filters for water treatment; wicks specially for oil stoves; lights for automobiles; bicycle lights; motorcycle lights; lights for vehicles; electric torches; head torches; lanterns for lighting; candle lanterns; street lamps; Chinese lanterns; fountains; ornamental fountains; chocolate fountains, electric; air fryers; deep fryers, electric; fittings, shaped, for furnaces; oven fittings made of fireclay; bread-making machines; refrigerators; refrigerators, cooling apparatus and freezers for medical storage purposes; chromatography apparatus for industrial purposes; kettles, electric; dampers [heating]; book

sterilization apparatus; refrigerating cabinets; carbon for arc lamps; heating elements; standard lamps; bath installations.

17 – Shock-absorbing buffers of rubber; fittings, not of metal, for compressed air lines; asbestos; cellulose acetate, semi-processed; balata; floating anti-pollution barriers; asbestos paper; paper for electrical capacitors; insulating paper; cotton wool for packing [caulking]; mineral wool [insulator]; asbestos felt; insulating felt; asbestos fibres; plastic fibres, other than for textile use; carbon fibres, other than for textile use; vulcanized fibre; gutta-percha; foam supports for flower arrangements [semi-finished products]; dielectrics [insulators]; lute; insulators; insulators for railway tracks; insulators for electric mains; insulators for cables; asbestos millboards; liquid rubber; synthetic rubber; rubber, raw or semi-worked; valves of india-rubber or vulcanized fibre; clack valves of rubber; rings of rubber; water-tight rings; insulating paints; insulating varnish; latex [rubber]; duct tapes; insulating bands; adhesive tapes, other than stationery and not for medical or household purposes; self-adhesive tapes, other than stationery and not for medical or household purposes; asbestos sheets; viscose sheets, other than for wrapping; foil of regenerated cellulose, other than for wrapping; insulating oils; insulating oil for transformers; reinforcing materials, not of metal, for pipes; weatherstripping compositions; caulking materials; brake lining materials, partly processed; sound-proofing materials; insulating materials; insulating refractory materials; padding materials of rubber or plastics; rubber material for recapping tyres; non-conducting materials for retaining heat; boiler composition to prevent the radiation of heat; packing [cushioning, stuffing] materials of rubber or plastics; sealant compounds for joints; filtering materials of semi-processed foams of plastic; filtering materials of semi-processed films of plastic; compositions to prevent the radiation of heat; bags [envelopes, pouches] of rubber, for packaging; pipe muffs, not of metal; rubber sleeves for protecting parts of machines; asbestos packing; clutch linings; threads of plastic for soldering; plastic filaments for 3D printing; threads of plastic materials, other than for textile use; threads of rubber, other than for textile use; elastic yarns, other than for textile use; door stops of rubber; window stops of rubber; stops of rubber; dock bumpers of rubber; insulating gloves; plastic substances, semi-processed; plastic sheeting for agricultural purposes; plastic film, other than for wrapping; anti-glare films for windows [tinted films]; asbestos coverings; bark coverings for sound insulation; asbestos cloth; rubber stoppers; expansion joint fillers; cylinder jointings; washers of rubber or vulcanized fibre; pipe gaskets; draught excluder strips; gaskets; rubber solutions; gum, raw or semi-worked; mica, raw or partly processed; acrylic resins, semi-processed; synthetic resins, semi-processed; junctions, not of metal, for pipes; substances for insulating buildings against moisture; chemical com-

positions for repairing leaks; acrylic glass, semi-processed; organic glass, semi-processed; glass wool for insulation; fibreglass for insulation; asbestos fabrics; fibreglass fabrics for insulation; insulating fabrics; flexible hoses, not of metal; hoses of textile material; connecting hose for vehicle radiators; waterproof packings; rubber seals for jars; fittings, not of metal, for flexible pipes; fittings, not of metal, for rigid pipes; foils of metal for insulating; ebonite moulds; insulating inks; asbestos slate; slag wool [insulator]; watering hose; canvas hose pipes; cords of rubber; asbestos safety curtains; insulating plaster; ebonite.

19 – Aquaria [structures]; alabaster; door frames, not of metal; asbestos cement; asphalt; beams, not of metal; balustrades, not of metal; huts; swimming pools [structures], not of metal; silos, not of metal; harbours [structures], not of metal; concrete; bitumen; plastic landscape edgings; joists, not of metal; telephone booths, not of metal; beacons, not of metal, non-luminous; building paper; busts of stone, concrete or marble; bird baths [structures], not of metal; binding agents for making briquettes; binding material for road repair; stained-glass windows; felt for building; aviaries [structures], not of metal; gates, not of metal; diving boards, not of metal; geotextiles; gypsum [building material]; plaster; potters' clay; earth for bricks; clay; roofing shingles; gravel; aquarium gravel; granite; tar; armoured doors, not of metal; doors, not of metal; swing doors, not of metal; accordion doors, not of metal; folding doors, not of metal; coal tar; chimney pots, not of metal; prefabricated houses [kits], not of metal; parquet floor boards; floating floor boards, not of metal; memorial plaques, not of metal; wood for making household utensils; veneer wood; mouldable wood; chimney shafts, not of metal; jalousies, not of metal; roof gutters, not of metal; street gutters, not of metal; agglomerated bagasses of cane [building material]; road signs, non-luminous and non-mechanical, not of metal; non-luminous and non-mechanical signs, not of metal; limestone; lime; fences, not of metal; works of stonemasonry; works of art of stone, concrete or marble; cabanas, not of metal; soundproof booths, transportable, not of metal; stone; rubble; artificial stone; building stone; paint spraying booths, not of metal; gravestones; reeds for building; horticultural frames, not of metal; framework, not of metal, for building; greenhouse frames, not of metal; cornices, not of metal; bitumen paper for building; wood pulp board for building; paperboard for building; skating rinks [structures], not of metal; quartz; caissons for construction work under water; bricks; firebricks; water-pipe valves, not of metal or plastic; drain traps [valves], not of metal or plastic; cask wood; mooring bollards, not of metal; cement posts; pillars, not of metal, for building; chimney cowls, not of metal; brackets, not of metal, for building; buildings, not of metal; buildings, transportable, not of metal; stringers [parts of staircases], not of metal; silica [quartz]; roofing, not of metal; roofing, not of metal, in-

corporating photovoltaic cells; manhole covers, not of metal; xylolith; chicken-houses, not of metal; manufactured timber; sawn timber; building timber; wood, semi-worked; staircases, not of metal; road marking sheets and strips of synthetic material; reinforcing materials, not of metal, for building; bituminous products for building; road coating materials; materials for making and coating roads; fireclay; pitch; building materials, not of metal; refractory construction materials, not of metal; masts [poles], not of metal; raw chalk; calcareous marl; mosaics for building; mouldings, not of metal, for building; marble; slate powder; porches [structures], not of metal; tombs, not of metal; flashing, not of metal, for building; roof flashing, not of metal; perches; duckboards, not of metal; wall claddings, not of metal, for building; mouldings, not of metal, for cornices; coatings [building materials]; tomb or grave enclosures, not of metal; laths, not of metal; wood panelling; wall linings, not of metal, for building; palings, not of metal; crash barriers, not of metal, for roads; latticework, not of metal; windows, not of metal; olivine for building; shuttering, not of metal, for concrete; posts, not of metal, for power lines; props, not of metal; rubber bearings for seismic isolation of buildings; branching pipes, not of metal; fair huts; tombs [monuments], not of metal; monuments, not of metal; acoustic panels, not of metal; wainscotting, not of metal; signalling panels, non-luminous and non-mechanical, not of metal; building panels, not of metal; parquet flooring; partitions, not of metal; lintels, not of metal; casement windows, not of metal; aquarium sand; play sand; silver sand; sand, except foundry sand; sandstone for building; tarred strips for building; planks of wood for building; rocket launching platforms, not of metal; platforms, prefabricated, not of metal; wall tiles, not of metal; floor tiles, not of metal; tiles, not of metal, for building; paving slabs, not of metal; cement slabs; grave slabs, not of metal; tile floorings, not of metal; slabs, not of metal, for building; scaffolding, not of metal; armour-plating, not of metal; asphalt paving; wood paving; paving blocks, not of metal; luminous paving blocks; macadam; fireproof cement coatings; bituminous coatings for roofing; roof coverings, not of metal; wooden floor boards; cladding, not of metal, for building; linings, not of metal, for building; fireplace mantles, not of metal; door panels, not of metal; floors, not of metal; sills, not of metal; porphyry [stone]; ceilings, not of metal; floating docks, not of metal, for mooring boats; agglomerated cork for building; window frames, not of metal; mortar for building; asbestos mortar; tanks of masonry; scantlings [carpentry]; furrings of wood; vinyl siding; pilings, not of metal; pigsties, not of metal; insect screens, not of metal; burial vaults, not of metal; schists; outdoor blinds, not of metal and not of textile; shutters, not of metal; statues of stone, concrete or marble; alabaster glass; safety glass; glass granules for road marking; window glass for building; window glass, other than vehicle win-

dow glass; building glass; plate glass [windows] for building; insulating glass for building; enamelled glass, for building; tombstone stelae, not of metal; stables, not of metal; advertisement columns, not of metal; posts, not of metal; telegraph posts, not of metal; hips for roofing; stair-treads [steps], not of metal; tombstone plaques, not of metal; greenhouses, transportable, not of metal; terra-cotta [building material]; penstock pipes, not of metal; water-pipes, not of metal; gutter pipes, not of metal; ducts, not of metal, for ventilating and air-conditioning installations; drain pipes, not of metal; chimneys, not of metal; rigid pipes, not of metal, for building; sandstone pipes; turnstiles, not of metal; tufa; angle irons, not of metal; lengthening pieces, not of metal, for chimneys; bicycle parking installations, not of metal; plywood; figurines of stone, concrete or marble; flagpoles [structures], not of metal; foundry moulds, not of metal; rock crystal; cement for blast furnaces; cement for furnaces; magnesia cement; cement; pantiles, not of metal; roofing tiles, not of metal; slate; roofing slates; slag [building material]; slag stone; railway sleepers, not of metal; wood veneers; clinker ballast; concrete building elements; letter boxes of masonry.

20 – Picture frame brackets; recycling bins, not of metal; bottles [containers], not of metal, for compressed gas or liquid air; bamboo, unworked or semi-worked; bumper guards for cots, other than bed linen; reels, not of metal, non-mechanical, for flexible hoses; sew-on tags of plastic or rubber for clothing; pulleys of plastics for blinds; bolts, not of metal; casks of wood for decanting wine; mooring buoys, not of metal; casks, not of metal; barrels, not of metal; identification bracelets, not of metal; sideboards; busts of wood, wax, plaster or plastic; costume stands; bolsters; fans for personal use, non-electric; work benches; vice benches [furniture]; valet stands; coatstands; coat hangers; shoulder poles [yokes]; screws, not of metal; display stands; showcases [furniture]; newspaper display stands; jewellery organizer displays; removable covers for sinks; collars, not of metal, for fastening pipes; comb foundations for beehives; signboards of wood or plastics; loading gauge rods, not of metal, for railway wagons; nuts, not of metal; covers for clothing [wardrobe]; shoe pegs, not of metal; nesting boxes; coffins; doors for furniture; curtain holders, not of textile material; dowels, not of metal; divans; towel dispensers, fixed, not of metal; door closers, not of metal, non-electric; kennels for household pets; bird-houses; keyboards for hanging keys; display boards; plugs [dowels], not of metal; containers, not of metal, for liquid fuel; troughs, not of metal, for mixing mortar; oil drainage containers, not of metal; packaging containers of plastic; indoor window blinds [furniture]; indoor window blinds of paper; indoor window blinds of woven wood; indoor window blinds of textile; flower-stands [furniture]; curtain tie-backs; clips, not of metal, for cables and pipes; binding screws, not of metal, for cables; clips of plastic for sealing bags;

rivets, not of metal; imitation tortoiseshell; locks, not of metal, for vehicles; padlocks, other than electronic, not of metal; locks, other than electric, not of metal; bead curtains for decoration; door bolts, not of metal; bottle closures, not of metal; closures, not of metal, for containers; latches, not of metal; mirrors [looking glasses]; hand-held mirrors [toilet mirrors]; number-plates, not of metal; scratching posts for cats; animal claws; animal hooves; coral; meerscham; whalebone, unworked or semi-worked; stag antlers; tortoiseshell; horn, unworked or semi-worked; animal horns; rattan; corozo; plaited straw, except matting; wickerwork; hampers [baskets] for the transport of items; works of art of wood, wax, plaster or plastic; cabinet work; reeds [plaiting materials]; settees; jerrycans, not of metal; curtain rods; index cabinets [furniture]; reels of wood for yarn, silk, cord; drain traps [valves] of plastic; water-pipe valves of plastic; valves, not of metal, other than parts of machines; staves of wood; plastic keys; plastic key cards, not encoded and not magnetic; mats for infant playpens; reusable baby changing mats; sleeping pads; mats, removable, for sinks; saw horses; bed casters, not of metal; furniture casters, not of metal; brush mountings; chopping blocks [tables]; wind chimes [decoration]; door bells, not of metal, non-electric; bottle caps, not of metal; bassinets; tent pegs, not of metal; curtain rings; split rings, not of metal, for keys; chests of drawers; console tables; waste dumpsters, not of metal, other than for medical use; containers, not of metal [storage, transport]; floating containers, not of metal; lecterns; dog kennels; bakers' bread baskets; baskets, not of metal; Moses baskets; bottle casings of wood; tool boxes, not of metal, empty; taps, not of metal, for casks; armchairs; hairdressers' chairs; deck chairs; hospital beds; waterbeds, not for medical purposes; bedsteads of wood; air beds, not for medical purposes; beds; cots for babies; edgings of plastic for furniture; brackets, not of metal, for furniture; screw tops, not of metal, for bottles; table tops; sash fasteners, not of metal, for windows; coathooks, not of metal; curtain hooks; clothes hooks, not of metal; bag hangers, not of metal; beds for household pets; nesting boxes for household pets; ladders of wood or plastics; playpens for babies; tailors' dummies; air mattresses, not for medical purposes; camping mattresses; mattresses; furniture; furniture of metal; inflatable furniture; office furniture; school furniture; mobiles [decoration]; door knockers, not of metal; shoe dowels, not of metal; curtain rails; runners, not of metal, for sliding doors; legs for furniture; feet for furniture; house numbers, not of metal, non-luminous; cask hoops, not of metal; door stops, not of metal or rubber; window stops, not of metal or rubber; hanging closet organizers; mouldings for picture frames; bed bases; plastic ramps for use with vehicles; furniture partitions of wood; freestanding partitions [furniture]; mother-of-pearl, unworked or semi-worked; ambroid plates; loading pallets, not of metal; handling pallets, not of metal; transport pallets, not of

metal; mirror tiles; head-rests [furniture]; trays, not of metal; stakes, not of metal, for plants or trees; trestles [furniture]; magazine racks; book rests [furniture]; stands for calculating machines; pet cushions; pillows; cushions; cushions for lining pet crates; head support cushions for babies; anti-roll cushions for babies; air cushions, not for medical purposes; air pillows, not for medical purposes; head positioning pillows for babies; racks [furniture]; library shelves; shelves for file cabinets; furniture shelves; plate racks [furniture]; shelves for storage; wood ribbon; straw edgings; towel stands [furniture]; hat stands; bathtub grab bars, not of metal; cask stands, not of metal; inflatable publicity objects; counters [tables]; bedding, except linen; corks for bottles; corks; stoppers, not of glass, metal or rubber; sealing caps, not of metal; stair rods; flower-pot pedestals; standing desks; embroidery frames; dispensers for dog waste bags, fixed, not of metal; drawer organizers; shells; picture frames; sections of wood for beehives; crucifixes of wood, wax, plaster or plastic, other than jewellery; containers, not of metal, for compressed gas or liquid air; reservoirs, not of metal nor of masonry; fodder racks; curtain rollers; door handles, not of metal; knobs, not of metal; fishing baskets; writing desks; bath seats for babies; seats of metal; benches [furniture]; vats, not of metal; honeycombs; sofas; plugs, not of metal; statues of wood, wax, plaster or plastic; oyster shells; silvered glass [mirrors]; shelving units; ambroid bars; umbrella stands; gun racks; trolleys for computers [furniture]; lap desks; dressing tables; washstands [furniture]; typing desks; massage tables; tables of metal; wall-mounted baby changing platforms; saw benches [furniture]; desks; portable desks; tea trolleys; dinner wagons [furniture]; drafting tables; tables; steps [ladders], not of metal; step stools, not of metal; chairs [seats]; high chairs for babies; shower chairs; chests, not of metal; placards of wood or plastics; nameplates, not of metal; stools; bathroom stools; footstools; crates; trolleys [furniture]; straw plait; mobile boarding stairs, not of metal, for passengers; straw mattresses; decorations of plastic for foodstuffs; beehives; bathroom vanities [furniture]; door fasteners, not of metal; window fasteners, not of metal; funerary urns; window closers, not of metal, non-electric; door openers, not of metal, non-electric; window openers, not of metal, non-electric; winding spools, not of metal, non-mechanical, for flexible hoses; figurines of wood, wax, plaster or plastic; hand-held flagpoles, not of metal; door fittings, not of metal; coffin fittings, not of metal; bed fittings, not of metal; furniture fittings, not of metal; window fittings, not of metal; infant walkers; garment covers [storage]; covers specially made for handling and transport of bottles, not of metal, for compressed gas; stuffed animals; stuffed birds; hinges, not of metal; chaise longues; poles, not of metal; screens [furniture]; luggage lockers; filing cabinets; medicine cabinets; lockers [furniture]; meat safes; bookcases; kitchen dressers [furniture]; wardro-

bes; cupboards; window pulleys, not of metal; bamboo curtains; slatted indoor blinds; sneeze guards; screens for fireplaces [furniture]; labels of plastic; yellow amber; drawers for furniture; chests for toys; tool chests, not of metal, empty; boxes of wood or plastic; letter boxes, not of metal or masonry; bottle racks.

(260) AM 2026 134321 A

(800) 1795905

(151) 2023 12 19

(891) 2025 04 20

(731) "DNS KAZAKHSTAN" Limited Liability Company

Saryarka avenue, building 12; Saryarka district, 010000 Astana, Kazakhstan

(540)



(591) Black, white

(531) 26.04.18; 26.04.24; 27.05.17

(511)

9 – 3D spectacles; DVD players; ticket dispensing terminals, electronic; juke boxes, musical; fire engines; answering machines; electrical adapters; batteries for electronic cigarettes; accumulators, electric; batteries, electric, for vehicles; accelerometers; actinometers; alidades; altimeters; ammeters; anemometers; anodes; aerials; anticathodes; apertometers [optics]; high-frequency apparatus; testing apparatus not for medical purposes; electro-dynamic apparatus for the remote control of railway points; electro-dynamic apparatus for the remote control of signals; electro-dynamic apparatus for the remote control of signals; monitoring apparatus, other than for medical purposes; sound recording apparatus; Global Positioning System [GPS] apparatus; distillation apparatus for scientific purposes; diffraction apparatus [microscopy]; air analysis apparatus; apparatus to check franking; sound transmitting apparatus; apparatus for fermentation [laboratory apparatus]; breathing apparatus for underwater swimming; breathing apparatus, except for artificial respiration; apparatus and installations for the production of X-rays, not for medical purposes; cash registers; electric apparatus for commutation; magnetic resonance imaging [MRI] apparatus, not for medical purposes; intercommunication apparatus; stills for laboratory experiments; projection apparatus; fire extinguishing apparatus; radiological apparatus for industrial purposes; X-ray apparatus not for medical purposes; blueprint apparatus; flashing lights [luminous signals]; stereoscopic apparatus; telephone apparatus; facsimile machines; phototelegraphy apparatus; igniting apparatus, electric, for igniting at a distance; acid hydrometers; salinometers; acidimeters for batteries; aerometers; beacons, luminous; battery jars; barometers; anode batteries; galvanic batteries; ignition batteries; solar batteries; solar panels for the production of

electricity; batteries, electric; balances [steelyards]; betatrons; binoculars; biochips; electronic tags for goods; lens hoods; magnetic tape units for computers; computer memory devices; fire hose nozzles; encoded identification bracelets, magnetic; connected bracelets [measuring instruments]; safety tarpaulins; electronic key fobs being remote control apparatus; bullet-proof clothing; signalling buoys; life buoys; marking buoys; directional compasses; vacuum gauges; electrolyzers; variometers; scales; baby scales; bathroom scales; letter scales; weighbridges; precision balances; scales with body mass analysers; levelling staffs [surveying instruments]/rods [surveying instruments]; camcorders; video baby monitors; video cassettes; video telephones; video screens; viewfinders, photographic; electric plugs; micrometer screws for optical instruments; viscosimeters; circuit closers; wavemeters; voltmeters; mechanical signs; signs, luminous; switchboxes [electricity]; current rectifiers; gas testing instruments; gasometers [measuring instruments]; galvanometers; hands-free kits for telephones; heliographic apparatus; hygrometers; hydrometers; weights; pepholes [magnifying lenses] for doors; holograms; plotters; loudspeakers; sounding leads; plumb bobs; range finders; densimeters; densitometers; detectors; smoke detectors; infrared detectors; counterfeit coin detectors; joysticks for use with computers, other than for video games; transparencies [photography]; slide projectors; diaphragms [photography]; dictating machines; dynamometers; light-emitting diodes [LED]; floppy disks; phonograph records; disks, magnetic; optical discs; circular slide rules; disk drives for computers; juke boxes for computers; wearable video display monitors; electronic numeric displays; DNA chips; electronic interactive whiteboards; electronic notice boards; electric wire harnesses for automobiles; bullet-proof vests; life jackets; reflective safety vests; identification threads for electric wires; nose clips for divers and swimmers; locks, electric; bells [warning devices]; alarm bells, electric; electric door bells; signal bells; audio interfaces; acoustic conduits; mirrors for inspecting work; road signs, luminous or mechanical; marine depth finders; probes for scientific purposes; buzzers; needles for surveying compasses; needles for record players; eyewear; reflective articles for wear, for the prevention of accidents; measures; pressure measuring apparatus; simulators for the steering and control of vehicles; inverters [electricity]; pressure indicators; temperature indicators; incubators for bacteria culture; measuring instruments; cosmographic instruments; mathematical instruments; levelling instruments; surveying instruments; azimuth instruments; interfaces for computers; ionization apparatus not for the treatment of air or water; satellite finder meters; spark-guards; coaxial cables; fibre optic cables; cables, electric; calipers; slide calipers; screw-tapping gauges; calorimeters; calculating machines; pocket calculators; decompression chambers; rearview cameras for vehicles; cinematographic cameras; ther-

mal imaging cameras; mouth guards for sports; life-saving capsules for natural disasters; electronic pens [visual display units]; holders for electric coils; identity cards, magnetic; video game cartridges; toner cartridges, unfilled, for printers and photocopiers; memory cards for video game machines; encoded magnetic cards; riding helmets; protective helmets; carriers for dark plates [photography]; automated teller machines [ATM]; cathodes; spools [photography]; choking coils [impedance]; coils, electric; electromagnetic coils; cinematographic film, exposed; computer keyboards; solenoid valves [electromagnetic switches]; wire connectors [electricity]; thin client computers; encoded key cards; electronic book readers; electronic agendas; push buttons for bells; mouse pads; magnetic encoders; visors for helmets; collectors, electric; calibrating rings; smart rings; ring sizers; protective suits for aviators; commutators; compact discs [audio-video]; compact discs [read-only memory]; comparators; marine compasses; computers; laptop computers; tablet computers; notebook computers; wearable computers; condensers [capacitors]; contacts, electric; wind socks for indicating wind direction; traffic cones; branch boxes [electricity]; distribution boxes [electricity]; junction boxes [electricity]; connectors [electricity]; battery boxes; cabinets for loudspeakers; diving suits; galena crystals [detectors]; covers for electric outlets; logs [measuring instruments]; lasers, not for medical purposes; lactodensimeters; lactometers; vacuum tubes [radio]; darkroom lamps [photography]; thermionic valves; amplifying tubes; flashlights [photography]; head cleaning tapes [recording]; magnetic tapes; videotapes; surveying chains; fire escapes; rulers [measuring instruments]; square rulers for measuring; slide-rules; contact lenses; correcting lenses [optics]; close-up lenses; optical lenses; optical condensers; sounding lines; electricity conduits; measuring spoons; magnifying glasses [optics]; thread counters; magnets; decorative magnets; crash test dummies; resuscitation mannequins [teaching apparatus]; mouse [computer peripheral]; pressure gauges; security tokens [encryption devices]; divers' masks; solderers' helmets; protective masks; respiratory masks, other than for artificial respiration; materials for electricity mains [wires, cables]; voting machines; money counting and sorting machines; material testing instruments and machines; furniture especially made for laboratories; megaphones; portable media players; diaphragms [acoustics]; diaphragms for scientific apparatus; metal detectors for industrial or military purposes; digital weather stations; metronomes; rules [measuring instruments]; carpenters' rules; dressmakers' measures; mechanisms for coin-operated apparatus; mechanisms for counter-operated apparatus; coin-operated mechanisms for television sets; shutter releases [photography]; micrometers; microprocessors; microscopes; microtomes; microphones; audio mixers; modems; lightning conductors; monitors [computer hardware]; monitors [computer programs]; selfie sticks [hand-

held monopods]; terminals [electricity]; junction sleeves for electric cables; teeth protectors; temperature indicator labels, not for medical purposes; knee-pads for workers; headphones; surveyors' levels; sound recording carriers; magnetic data media; optical data media; electronic sheet music, downloadable; computer software, recorded; sheaths for electric cables; identification sheaths for electric wires; weighing machines; computer hardware; punched card machines for offices; life saving equipment; shoes for protection against accidents, irradiation and fire; objectives [lenses] [optics]; lenses for astrophotography; selfie lenses; egg-candlers; fire extinguishers; rescue laser signalling flares; electrified fences; limiters [electricity]; clothing for protection against accidents, irradiation and fire; clothing for protection against fire; asbestos clothing for protection against fire; clothing especially made for laboratories; ozonisers [ozonators]; octants; eyepieces; ohmmeters; wrist rests for use with computers; spectacle frames; oscillographs; plumb lines; mirrors [optics]; eyeglasses/spectacles; sunglasses; goggles for sports; electronic collars to train animals; finger sizers; signalling panels, luminous or mechanical; radio pagers; pince-nez; electronic pocket translators; transmitters [telecommunication]; telephone transmitters; transmitters of electronic signals; switches, electric; periscopes; gloves for divers; gloves for protection against accidents; gloves for protection against X-rays for industrial purposes; asbestos gloves for protection against accidents; furnaces for laboratory use; laboratory pipettes; pyrometers; planimeters; plane tables [surveying instruments]; plates for batteries; computer software platforms, recorded or downloadable; wafers for integrated circuits; printed circuit boards; compact disc players; cassette players; protective films adapted for computer screens; protective films adapted for smartphones; sound recording strips; X-ray films, exposed; films, exposed; life-saving rafts; laboratory trays; digital signs; semiconductors; polarimeters; personal digital assistants [PDAs]; fire pumps; measuring glassware; life belts; fuses; circuit breakers; converters, electric; telerupters; food analysis apparatus; diagnostic apparatus, not for medical purposes; distance recording apparatus; distance measuring apparatus; speed measuring apparatus [photography]; appliances for measuring the thickness of leather; apparatus for measuring the thickness of skins; speed checking apparatus for vehicles; teaching apparatus; time recording apparatus; apparatus and instruments for astronomy; surveying apparatus and instruments; weighing apparatus and instruments; nautical apparatus and instruments; navigational instruments; optical apparatus and instruments; apparatus and instruments for physics; chemistry apparatus and instruments; measuring apparatus; measuring devices, electric; boiler control instruments; meteorological instruments; naval signalling apparatus; observation instruments; navigation apparatus for vehicles [on-board computers]; satellite navigational apparatus; regula-

ting apparatus, electric; telecommunication apparatus in the form of jewellery; precision measuring apparatus; audio- and video-receivers; prisms [optics]; computer software applications, downloadable; printers for use with computers; hemline markers; retorts' stands; apparatus for changing record player needles; drainers for use in photography; cleaning apparatus for phonograph records; fire beaters; sighting telescopes for firearms; telescopic sights for artillery; test tubes; pressure indicator plugs for valves; magnetic wires; telegraph wires; telephone wires; wires, electric; conductors, electric; copper wire, insulated; fuse wire; computer programs, recorded; computer game software, recorded; computer programs, downloadable; computer operating programs, recorded; computer screen saver software, recorded or downloadable; record players; processors [central processing units]; rods for water diviners; electronic publications, downloadable; distribution consoles [electricity]; control panels [electricity]; radar apparatus; baby monitors; masts for wireless aerials; transmitting sets [telecommunication]; radios; vehicle radios; sprinkler systems for fire protection; frames for photographic transparencies; screens for photoengraving; flowmeters; walkie-talkies; voltage surge protectors; voltage regulators for vehicles; stage lighting regulators; light dimmers [regulators], electric/light regulators [dimmers], electric; speed regulators for record players; cell switches [electricity]; washing trays [photography]; marking gauges [joinery]; T-squares for measuring; time switches, automatic; relays, electric; safety restraints, other than for vehicle seats and sports equipment; X-ray photographs, other than for medical purposes; rheostats; respirators for filtering air; retorts; refractometers; refractors; grids for batteries; security surveillance robots; laboratory robots; teaching robots; humanoid robots with artificial intelligence; speaking tubes; horns for loudspeakers; subwoofers; saccharometers; optical fibres [light conducting filaments]; traffic-light apparatus [signalling devices]; dog whistles; signalling whistles; sports whistles; sextants; inductors [electricity]; safety nets; nets for protection against accidents; fire alarms; signals, luminous or mechanical; sirens; electronic access control systems for interlocking doors; scanners [data processing equipment]; hand-held electronic dictionaries; integrated circuit cards [smart cards]; smartglasses; smartphones; smartwatches; connections for electric lines; couplings, electric; sonars; sound locating instruments; lighting ballasts; resistances, electric; spectrograph apparatus; spectrosopes; speed indicators; alcoholmeters; satellites for scientific purposes; protection devices for personal use against accidents; audiovisual teaching apparatus; charging stations for electric vehicles; radiotelegraphy sets; radiotelephony sets; spectacle lenses; anti-glare glasses; optical glass; personal stereos; stereoscopes; stands for photographic apparatus; stroboscopes; fire boats; sulfimeters; bags adapted for laptops; drying racks [photography];

spherometers; integrated circuits; printed circuits; counters; parking meters; mileage recorders for vehicles; revolution counters; abacuses; egg timers [sandglasses]; taximeters; ear plugs for divers; tachometers; television apparatus; telegraphs [apparatus]; telescopes; teleprompters; teleprinters; cellular phones/mobile telephones/cell phones; cordless telephones; theodolites; interactive touch screen terminals; thermo-hygrometers; thermometers, not for medical purposes; thermostats; thermostats for vehicles; crucibles [laboratory]; tone arms for record players; totalizers; transistors [electronic]; transponders; protractors [measuring instruments]; transformers [electricity]; step-up transformers; resuscitation training simulators; vehicle breakdown warning triangles; triodes; starter cables for motors; discharge tubes, electric, other than for lighting; capillary tubes; neon signs; Pitot tubes; X-ray tubes not for medical purposes; telephone receivers; squares for measuring; water level indicators; quantity indicators; automatic indicators of low pressure in vehicle tyres; petrol gauges; water level indicators; electric loss indicators; light-emitting electronic pointers; slope indicators; levels [instruments for determining the horizontal]; mercury levels; spirit levels; urinometers; audio amplifiers; particle accelerators; electric installations for the remote control of industrial operations; steering apparatus, automatic, for vehicles; balancing apparatus; video recorders; sound reproduction apparatus; invoicing machines; tape recorders; protection devices against X-rays, not for medical purposes; railway traffic safety appliances; data processing apparatus; oxygen transensing apparatus; theft prevention installations, electric; film cutting apparatus; drying apparatus for photographic prints; optical character readers; centering apparatus for photographic transparencies; dosage dispensers/dosimeters; battery chargers; chargers for electric accumulators; chargers for electronic cigarettes; acoustic alarms; sounding apparatus and machines; apparatus for editing cinematographic film; cathodic anti-corrosion apparatus; couplers [data processing equipment]; wearable activity trackers; anti-theft warning apparatus; computer peripheral devices; anti-interference devices [electricity]; demagnetizing apparatus for magnetic tapes; acoustic couplers; alarms; fog signals, non-explosive; whistle alarms; adding machines; readers [data processing equipment]; heat regulating apparatus; photocopiers [photographic, electrostatic, thermic]; electric and electronic effects units for musical instruments; bar code readers; downloadable ring tones for mobile phones; downloadable image files; downloadable music files; animated cartoons; filters for use in photography; filters for respiratory masks; filters for ultraviolet rays, for photography; USB flash drives; magic lanterns; optical lanterns; signal lanterns; cameras [photography]; glazing apparatus for photographic prints; shutters [photography]; darkrooms [photography]; photometers; flash-bulbs [photography]; digital photo frames; enlarging apparatus

[photography]; photovoltaic cells; containers for contact lenses; spectacle cases; containers for microscope slides; cases for smartphones; cases especially made for photographic apparatus and instruments; chromatography apparatus for laboratory use; chronographs [time recording apparatus]; laboratory centrifuges; spectacle chains; cyclotrons; compasses for measuring; frequency meters; time clocks [time recording devices]; Petri dishes; sleeves for laptops; covers for personal digital assistants [PDAs]; covers for tablet computers; covers for smartphones; fire blankets; chips [integrated circuits]; jigs [measuring instruments]; pedometers; meteorological balloons; electrified rails for mounting spot lights; asbestos screens for firefighters; fire hose; virtual reality headsets; protective helmets for sports; head guards for sports; snorkels; cell phone straps; spectacle cords; tripods for cameras; switchboards; distribution boards [electricity]; equalizers [audio apparatus]; screens [photography]; workmen's protective face-shields; projection screens; radiology screens for industrial purposes; fluorescent screens; exposure meters [light meters]; ducts [electricity]; galvanic cells; downloadable graphics for mobile phones; epidiascopes; ergometers; armatures [electricity]; black boxes [data recorders]; ink cartridges, unfilled, for printers and photocopiers; wah-wah pedals; height measuring instruments; hairdressing training heads [teaching apparatus]; devices for the projection of virtual keyboards; survival blankets; lifeboats; nanoparticle size analysers/nanoparticle size analyzers; ear pads for headphones; data gloves; trackballs [computer peripherals]; downloadable emoticons for mobile phones; telepresence robots; climate control digital thermostats; piezoelectric sensors; organic light-emitting diodes [OLED]; quantum dot light-emitting diodes [QLED]; droppers for measuring, other than for medical or household purposes; electric sockets; computer game software, downloadable; rescue flares, non-explosive and non-pyrotechnic; stands adapted for laptops; headgear being protective helmets; insulating gloves.

16 – Fountain pens; aquarelles; albums; almanacs; document laminators for office use; mimeograph apparatus and machines; atlases; posters; banknotes; banners of paper; paper bows, other than haberdashery or hair decorations; table linen of paper; tickets; forms, printed; announcement cards [stationery]; note books; pads [stationery]; drawing pads; loose-leaf binders; wristbands for the retention of writing instruments; pamphlets; booklets; paper sheets [stationery]; waxed paper; paper for medical examination tables; paper for recording machines; paper for radiograms; papers for painting and calligraphy; electrocardiograph paper; drawer liners of paper, perfumed or not; wood pulp paper; carbon paper; copying paper [stationery]; parchment paper; writing paper; rice paper; luminous paper; toilet paper; wrapping paper; filter paper; washi; paper; blotters; newsletters; rollers for typewriters; house painters' rollers; composing sticks; modelling

wax, not for dental purposes; signboards of paper or cardboard; sewing patterns; bunting of paper; newspapers; electrotypes; hectographs; modelling clay; polymer modelling clay; terrestrial globes; drawing sets; engravings; slate pencils; pencil leads; document holders [stationery]; pencil holders; chalk holders; holders for cheque books; holders for stamps [seals]; page holders; name badge holders [office requisites]; diagrams; table runners of paper; engraving plates; writing slates; blackboards; galley racks [printing]; drawing boards; advertisement boards of paper or cardboard; duplicators; punches [office requisites]; cream containers of paper; magazines [periodicals]; money clips; clips for name badge holders [office requisites]; tags for index cards; pen clips; bookmarks; etching needles; tracing needles for drawing purposes; periodicals; printed publications; paper shredders for office use; graphic representations; credit card imprinters, non-electric; graining combs; drawing instruments; calendars; tracing paper; tracing cloth; tracing patterns; gums [adhesives] for stationery or household purposes; lithographic stones; ink stones [ink reservoirs]; pencils; pencil lead holders; charcoal pencils; pictures; transfers [decalcomanias]; paintings [pictures], framed or unframed; wood pulp board [stationery]; cardboard; hat boxes of cardboard; cards; index cards [stationery]; geographical maps; paper tapes and cards for the recordal of computer programmes; trading cards, other than for games; perforated cards for Jacquard looms; catalogues; spools for inking ribbons; flower-pot covers of paper; paintbrushes; painters' brushes; writing brushes; typewriter keys; glue for stationery or household purposes; isinglass for stationery or household purposes; gluten [glue] for stationery or household purposes; starch paste [adhesive] for stationery or household purposes; printing blocks; books; manifolds [stationery]; comic books; drawing pins; cigar bands; envelopes [stationery]; boxes of paper or cardboard; cases for stamps [seals]; paint boxes for use in schools; correcting fluids [office requisites]; printed coupons; stencils [stationery]; French curves; paper ribbons, other than haberdashery or hair decorations; typewriter ribbons; gummed tape [stationery]; adhesive tapes for stationery or household purposes; correcting tapes [office requisites]; inking ribbons; adhesive tapes for stationery or household purposes; self-adhesive tapes for stationery or household purposes; square rulers for drawing; drawing rulers; flyers; absorbent sheets of paper or plastic for foodstuff packaging; humidity control sheets of paper or plastic for foodstuff packaging; viscose sheets for wrapping; sheets of reclaimed cellulose for wrapping; plastic bubble packs for wrapping or packaging; steel letters; type [numerals and letters]; lithographs; letter trays; paint trays; architects' models; postage stamps; plastics for modelling; graphic prints; modelling materials; teaching materials [except apparatus]; sealing compounds for stationery purposes; adhesives [glues] for stationery or household purposes; padding materials of paper

or cardboard; bookbinding material; packing [cushioning, stuffing] materials of paper or cardboard; packaging material made of starches; filtering materials of paper; tablemats of paper; addressing machines; pencil sharpening machines, electric or non-electric; bookbinding apparatus and machines [office equipment]; typewriters, electric or non-electric; paper creasers [office requisites]; franking machines for office use; chalk for lithography; writing chalk; tailors' chalk; marking chalk; spray chalk; bags [envelopes, pouches] of paper or plastics, for packaging; garbage bags of paper or of plastics; plastic bags for pet waste disposal; painters' easels; hand-rests for painters; printing sets, portable [office requisites]; bibs of paper; bibs, sleeved, of paper; stickers [stationery]; finger-stalls [office requisites]; writing cases [stationery]; cords for bookbinding; paper knives [letter openers]; printed sheet music; numbering apparatus; bottle envelopes of paper or cardboard; sealing wafers; covers [stationery]; passport holders; plastic cling film, extensible, for palletization; embroidery designs [patterns]; handwriting specimens for copying; oleographs; musical greeting cards; greeting cards; postcards; etchings; conical paper bags; paper bags for use in the sterilization of medical instruments; palettes for painters; ink sticks; pantographs [drawing instruments]; files [office requisites]; folders for papers; papier mâché; pastels [crayons]; modelling paste; pen cases; pen wipers; office perforators; pens [office requisites]; nibs of gold; nibs; steel pens; drawing pens; song books; seals [stamps]; sealing stamps; clipboards; address plates for addressing machines; handkerchiefs of paper; plastic film for wrapping; desk mats; trays for sorting and counting money; coasters of paper; bookends; stamp stands; mats for beer glasses; stands for pens and pencils; photograph stands; obliterating stamps; inking pads; stamp pads; binding strips [bookbinding]; towels of paper; inking sheets for document reproducing machines; inking sheets for duplicators; cloth for bookbinding; gummed cloth for stationery purposes; printers' blankets, not of textile; portraits; paperweights; writing cases [sets]; inks-tands; office requisites, except furniture; writing materials; writing instruments; drawing materials; school supplies [stationery]; adhesive tape dispensers [office requisites]; hand labelling appliances; printed matter; lithographic works of art; prospectuses; printed timetables; ledgers [books]; printers' reglets; indexes; paper cutters [office requisites]; rubber erasers; elastic bands for offices; T-squares for drawing; graphic reproductions; retractable reels for name badge holders [office requisites]; penholders; marking pens [stationery]; tissues of paper for removing make-up; dental tray covers of paper; face towels of paper; place mats of paper; table napkins of paper; tablecloths of paper; paper clasps; document files [stationery]; scrapers [erasers] for offices; paper-clips; clips for offices; erasing products; biological samples for use in microscopy [teaching materials]; histological sections for

teaching purposes; steatite [tailor's chalk]; writing board erasers; composing frames [printing]; sealing wax; arithmetical tables; placards of paper or cardboard; writing or drawing books; fabrics for bookbinding; stationery; pencil sharpeners, electric or non-electric; transparencies [stationery]; stencil plates; cardboard tubes; Indian inks; moisteners [office requisites]; moisteners for gummed surfaces [office requisites]; squares for drawing; chart pointers, non-electronic; bottle wrappers of paper or cardboard; envelope sealing machines for offices; sealing machines for offices; vignetting apparatus; apparatus for mounting photographs; stapling presses [office requisites]; manuals [handbooks]; figurines of papier mâché/statuettes of papier mâché; paper coffee filters; flags of paper; silver paper; moulds for modelling clays [artists' materials]; photo-engravings; photographs [printed]; stencil cases; canvas for painting; chromolithographs [chromos]; animation cels; compasses for drawing; numbers [type]; artists' watercolour saucers; correcting ink [heliography]; ink; inkwells; blueprints; stencils; erasing shields; balls for ball-point pens; desktop cabinets for stationery [office requisites]; printing type; address stamps; stamps [seals]; shields [paper seals]; prints [engravings]; labels of paper or cardboard; stencils for decorating food and beverages; name badges [office requisites]; barcode ribbons; glitter for stationery purposes; baggage claim check tags of paper; paper wipes for cleaning.

17 – Shock-absorbing buffers of rubber; fittings, not of metal, for compressed air lines; asbestos; cellulose acetate, semi-processed; balata; floating anti-pollution barriers; asbestos paper; paper for electrical capacitors; insulating paper; cotton wool for packing [caulking]; mineral wool [insulator]; asbestos felt; insulating felt; plastic fibres, other than for textile use; carbon fibres, other than for textile use; asbestos fibres; vulcanized fibre; gutta-percha; foam supports for flower arrangements [semi-finished products]; dielectrics [insulators]; lute; insulators; insulators for railway tracks; insulators for electric mains; insulators for cables; asbestos millboards; liquid rubber; synthetic rubber; rubber, raw or semi-worked; valves of india-rubber or vulcanized fibre; clack valves of rubber; rings of rubber; water-tight rings; insulating paints; insulating varnish; latex [rubber]; duct tapes; insulating tapes; adhesive tapes, other than stationery and not for medical or household purposes; self-adhesive tapes, other than stationery and not for medical or household purposes; asbestos sheets; viscose sheets, other than for wrapping; sheets of regenerated cellulose, other than for wrapping/foil of regenerated cellulose, other than for wrapping; insulating oils; insulating oil for transformers; reinforcing materials, not of metal, for pipes; weatherstripping compositions; caulking materials; brake lining materials, partly processed; soundproofing materials; insulating materials; insulating refractory materials; padding materials of rubber or plastics; rubber material for recapping tyres;

non-conducting materials for retaining heat; boiler composition to prevent the radiation of heat; packing [cushioning, stuffing] materials of rubber or plastics; sealant compounds for joints; filtering materials of semi-processed foams of plastic; compositions to prevent the radiation of heat; bags [envelopes, pouches] of rubber, for packaging; pipe muffers, not of metal; rubber sleeves for protecting parts of machines; asbestos packing; clutch linings; threads of plastic for soldering; threads of plastic materials, other than for textile use; threads of rubber, other than for textile use; elastic yarns, other than for textile use; door stops of rubber; window stops of rubber; stops of rubber; dock bumpers of rubber; plastic substances, semi-processed; insulating plaster; plastic sheeting for agricultural purposes; plastic film, other than for wrapping; anti-dazzle films for windows [tinted films]/anti-glare films for windows [tinted films]; asbestos coverings; bark coverings for sound insulation; asbestos cloth; rubber stoppers; expansion joint fillers; cylinder jointings; washers of rubber or vulcanized fibre; pipe gaskets; draught excluder strips; gaskets; rubber solutions; gum, raw or semi-worked; mica, raw or partly processed; acrylic resins, semi-processed; synthetic resins, semi-processed; junctions, not of metal, for pipes; substances for insulating buildings against moisture; chemical compositions for repairing leaks; glass wool for insulation; fibreglass for insulation; asbestos fabrics; fibreglass fabrics for insulation; insulating fabrics; flexible hoses, not of metal; hoses of textile material; connecting hose for vehicle radiators; waterproof packings; rubber seals for jars; fittings, not of metal, for flexible pipes; fittings, not of metal, for rigid pipes; foils of metal for insulating; ebonite moulds; asbestos slate; slag wool [insulator]; watering hose; canvas hose pipes; cords of rubber; asbestos safety curtains; ebonite; filtering materials of semi-processed films of plastic; plastic filaments for 3D printing.

28 – Arcade video game machines; video game machines; gaming machines for gambling; amusement machines, automatic and coin-operated; toy vehicles; swimming pools [play articles]; trampolines; novelty toys for parties; scratch cards for playing lottery games; starting blocks for sports; bodyboards; skating boots with skates attached; dolls' feeding bottles; tricycles for infants [toys]; stationary exercise bicycles; creels [fishing traps]; shuttlecocks; spinning tops [toys]; dumb-bells; gyroscopes and flight stabilizers for model aircraft; jigsaw puzzles; clay pigeons [targets]; punching bags; bite sensors [fishing tackle]; hang gliders; joysticks for video games; flying discs [toys]; discuses for sports; dolls' houses; dominoes; swimming kickboards; paddleboards; surfboards; spring boards [sports articles]; skateboards; sailboards; chessboards; draughtboards; drones [toys]; darts; Christmas trees of synthetic material; cups for dice; swimming jackets; ascenders [mountaineering equipment]; kites; needles for pumps for inflating balls for

games; toys for pets; stuffed toys; plush toys; toy mobiles; novelty toys for playing jokes; toys; portable games and toys incorporating telecommunication functions; parlor games/parlour games; table-top games; ring games; games; building games; toy imitation cosmetics; swimming pool air floats; kaleidoscopes; bladders of balls for games; rosin used by athletes; edges of skis; bingo cards; playing cards; fairground ride apparatus; reels for fishing; rocking horses; swings; skittles; skittles [games]; billiard cues; golf clubs; hockey sticks; baby gyms; seal skins [coverings for skis]; bells for Christmas trees; dolls' rooms; controllers for game consoles; controllers for toys; confetti; ice skates; roller skates; in-line roller skates; dice; paintball guns [sports apparatus]; ski bindings; dolls' beds; roulette wheels; fish hooks; building blocks [toys]; dolls; flippers for swimming; rhythmic gymnastics ribbons; fishing lines; gut for fishing; bows for archery; skis; waterskis; surf skis; mah-jong; toy models; hunting game calls; puppets; masks [playthings]; carnival masks; theatrical masks; fencing masks; toy putty; matryoshka dolls; masts for sailboards; ball pitching machines; teddy bears; chalk for billiard cues; targets; electronic targets; scale model kits [toys]; scale model vehicles; kite reels; balls for games; artificial fishing bait; billiard table cushions; knee guards [sports articles]; billiard cue tips; elbow guards [sports articles]; backgammon games; pumps specially adapted for use with balls for games; dolls' clothes; fencing weapons; twirling batons; paragliders; pachinkos; baseball gloves; boxing gloves; golf gloves; gloves for games; batting gloves [accessories for games]; fencing gauntlets; piñatas; toy pistols; toy air pistols; percussion caps [toys]; caps for pistols [toys]; toy dough; protective films adapted for screens for portable games; rattles [playthings]; horseshoe games; candle holders for Christmas trees; Christmas tree stands; sole coverings for skis; water wings; floats for fishing; portable games with liquid crystal displays; swimming belts; decoys for hunting or fishing; scent lures for hunting or fishing; archery implements; soap bubbles [toys]; divot repair tools [golf accessories]; billiard markers; protective paddings [parts of sports suits]; rackets; surfboard leashes; harness for sailboards; weight lifting belts [sports articles]; toy robots; sling shots [sports articles]; rollers for stationary exercise bicycles; plush toys with attached comfort blanket; scooters [toys]; sleds [sports articles]; bobsleighs; butterfly nets; landing nets for anglers; nets for sports; tennis nets; bite indicators [fishing tackle]; slot machines [gaming machines]; appliances for gymnastics; quoits; bar-bells; climbers' harness; fishing tackle; artificial snow for Christmas trees; snowshoes; snowboards; remote-controlled toy vehicles; clay pigeon traps; billiard tables; coin-operated billiard tables; tables for table tennis; strings for rackets; gut for rackets; cricket bags; golf bags, with or without wheels; golf bag trolleys; slides [playthings]; body-building apparatus; machines for physical exercises; ath-

letic supporters [sports articles]; rods for fishing; ornaments for Christmas trees, except illumination articles and confectionery; tennis ball throwing apparatus; conjuring apparatus; apparatus for games; bowling apparatus and machinery; toy figures; counters [discs] for games; chips for gambling; foosball tables; party poppers [party novelties]; Christmas crackers [party novelties]; bags especially designed for skis and surfboards; marbles for games; billiard balls; playing balls; play balloons; paintballs [ammunition for paintball guns] [sports apparatus]; snow globes; chess games; draughts [games]; poles for pole vaulting; paper party hats; shin guards [sports articles]; camouflage screens [sports articles]; chest expanders [exercisers]; boomerangs; trading cards for games; waist trimmer exercise belts; flippers for diving; swimming webs/webbed gloves for swimming; inflatable games for swimming pools; roller skis; ski sticks; ski sticks for roller skis; yoga swings; play tents; video game consoles; hand-held consoles for playing video games.

35 – Arranging subscriptions to telecommunication services for others; import-export agencies; commercial information agency services; advertising agency services; cost price analysis; rental of advertising space; business auditing; financial auditing; business intermediary services relating to the matching of potential private investors with entrepreneurs needing funding; employment agency services; computerized file management; book-keeping; invoicing; demonstration of goods; transcription of communications [office functions]; opinion polling; market studies; business information; commercial information and advice for consumers in the choice of products and services; business investigations; business research; marketing research; personnel recruitment; business management and organization consultancy; business organization consultancy; business management consultancy; personnel management consultancy; professional business consultancy; consultancy regarding public relations communication strategies; consultancy regarding advertising communication strategies; layout services for advertising purposes; marketing; marketing in the framework of software publishing; targeted marketing; business management of professional singers; business management of sports people; writing of curriculum vitae for others; scriptwriting for advertising purposes; news clipping services; updating and maintenance of information in registries; updating and maintenance of data in computer databases; updating of advertising material; word processing; online retail services for downloadable and pre-recorded music and movies; online retail services for downloadable ring tones; online retail services for downloadable digital music; organization of exhibitions for commercial or advertising purposes; arranging newspaper subscriptions for others; organization of fashion shows for promotional purposes; organization of trade fairs for commercial or advertising purposes; shop

window dressing; development of advertising concepts; business appraisals; payroll preparation; data search in computer files for others; sponsorship search; administrative assistance in responding to calls for tenders; business management assistance; commercial or industrial management assistance; commercial intermediation services; providing business information via a website; providing commercial and business contact information; provision of an online marketplace for buyers and sellers of goods and services; web indexing for commercial or advertising purposes; presentation of goods on communication media, for retail purposes; economic forecasting; auctioneering; retail services for works of art provided by art galleries; sales promotion for others; promotion of goods and services through sponsorship of sports events; production of teleshopping programmes; production of advertising films; office machines and equipment rental; rental of advertising time on communication media; publicity material rental; rental of billboards [advertising boards]; rental of vending machines; rental of sales stands; rental of photocopying machines; publication of publicity texts; radio advertising; bill-posting; distribution of samples; dissemination of advertising matter; direct mail advertising; registration of written communications and data; editing of publicity texts; advertising; online advertising on a computer network; outdoor advertising; advertising by mail order; television advertising; document reproduction; compilation of statistics; compilation of information into computer databases; business inquiries; systemization of information into computer databases; advisory services for business management; negotiation of business contracts for others; negotiation and conclusion of commercial transactions for third parties; compiling indexes of information for commercial or advertising purposes; tax preparation; drawing up of statements of accounts; telemarketing services; psychological testing for the selection of personnel; wholesale services for pharmaceutical, veterinary and sanitary preparations and medical supplies; retail services for pharmaceutical, veterinary and sanitary preparations and medical supplies; interim business management; outsourced administrative management for companies; business management of hotels; business management for freelance service providers; business project management services for construction projects; commercial administration of the licensing of the goods and services of others; business management of reimbursement programmes for others; administration of consumer loyalty programs; administration of frequent flyer programs; administrative processing of purchase orders; public relations; competitive intelligence services; modelling for advertising or sales promotion; typing; market intelligence services; appointment reminder services [office functions]; website traffic optimization; administrative services for the relocation of businesses; tax filing services; search engine optimization for sales promotion; appoint-

ment scheduling services [office functions]; gift registry services; price comparison services; pay per click advertising; secretarial services; procurement services for others [purchasing goods and services for other businesses]; shorthand; outsourcing services [business assistance]; telephone answering for unavailable subscribers; photocopying services; business efficiency expert services; media relations services; corporate communications services; rental of office equipment in co-working facilities; commercial lobbying services.

37 – Asphaltting; drilling of deep oil or gas wells; drilling of wells; rebuilding engines that have been worn or partially destroyed; rebuilding machines that have been worn or partially destroyed; renovation of clothing; retreading of tyres; vulcanization of tyres [repair]; building sealing; linen ironing; steam pressing of clothing; disinfecting; rat exterminating; mining extraction; refilling of toner cartridges; vehicle battery charging; knife sharpening; building insulating; repair information; construction information; bricklaying; riveting; construction consultancy; varnishing; re-tinning; scaffolding; road paving; window cleaning; vehicle washing; building construction supervision; tuning of musical instruments; upholstering; rustproofing; anti-rust treatment for vehicles; sanding; pumicing; strong-room maintenance and repair; vehicle maintenance; paper hanging; painting or repair of signs; cleaning of buildings [exterior surface]; vehicle polishing; vehicle breakdown repair services; rental of bulldozers; rental of drainage pumps; rental of dish drying machines; rental of road sweeping machines; rental of cleaning machines; rental of cranes [construction equipment]; rental of dishwashing machines; rental of clothes-washing machines; rental of construction equipment; rental of excavators; laying of cable; plumbing; masonry; roofing services; painting services; carpentry services; underwater repair; plastering; quarrying services; repair of security locks; umbrella repair; parasol repair; motor vehicle maintenance and repair; burner maintenance and repair; film projector repair and maintenance; airplane maintenance and repair; safe maintenance and repair; clock and watch repair; repair of power lines; pump repair; upholstery repair; boot repair; clothing repair; photographic apparatus repair; furniture restoration; restoration of musical instruments; restoration of works of art; vehicle greasing; demolition of buildings; warehouse construction and repair; vehicle service stations [refuelling and maintenance]; sterilization of medical instruments; washing; washing of linen; pier breakwater building; pipeline construction and maintenance; underwater construction; harbour construction; factory construction; building of fair stalls and shops; construction; shipbuilding; cleaning of buildings [interior]; street cleaning; vermin exterminating, other than for agriculture, aquaculture, horticulture and forestry; tyre balancing; pest control services, other than for agriculture, aquaculture, horticulture and forestry;

hydraulic fracturing services; artificial snow-making services; laundering; installation of doors and windows; irrigation devices installation and repair; elevator installation and repair/lift installation and repair; heating equipment installation and repair; burglar alarm installation and repair; furnace installation and repair; telephone installation and repair; installation and repair of air-conditioning apparatus; fire alarm installation and repair; freezing equipment installation and repair; electric appliance installation and repair; kitchen equipment installation; installation, maintenance and repair of computer hardware; machinery installation, maintenance and repair; office machines and equipment installation, maintenance and repair; interference suppression in electrical apparatus; swimming-pool maintenance; furniture maintenance; chimney sweeping; boiler cleaning and repair; cleaning of clothing; dry cleaning; vehicle cleaning; diaper cleaning; leather care, cleaning and repair; fur care, cleaning and repair; installation of utilities in construction sites; services of electricians; installation and repair of flood protection equipment; snow removal; refilling of ink cartridges.

(260) AM 2026 134431 A

(800) 1610423

(151) 2021 05 21

(891) 2025 06 11

(731) Laurastar Group SA

Route de Montreux 149, CH-1618 Châtel- St-Denis, Switzerland

(540)

LAURASTAR

(591) Black, white

(511)

5 – Disinfectants; sterilizing products.

7 – Steam cleaners.

8 – Flat irons.

11 – Fabric steamers; steam boilers, other than parts of machines; steam generating apparatus; water filters; disinfectant apparatus; air and water purifying apparatus and machines; air and water purifying systems; sterilizers; air filters for household use.

21 – Ironing boards; steaming boards; flat-iron bases; shaped ironing board covers; flat-iron stands; fabric steaming stands.

37 – Ironing services; rental of ironing apparatus; maintenance and repair of ironing apparatus; smoothing of textile products intended to be reused; disinfecting; installation, maintenance and repair of air and water purifying apparatus; repair of filters and parts thereof.

(260) AM 2026 134432 A

(800) 1682696

(151) 2022 07 22

(891) 2025 06 10

(731) FEVER LABS, INC.

76 Greene St, 4th Fl New York NY 10012, USA

(540)

CANDLELIGHT

(591) Black, white

(511)

41 – Organizing and conducting musical events.

(260) AM 2026 134433 A

(800) 1797202

(151) 2024 03 26

(891) 2025 06 06

(731) Société des Produits Nestlé S.A.

CH-1800 Vevey, Switzerland

(540)



(591) Black, white

(531) 02.05.01; 02.05.06; 27.05.04; 27.05.21

(511)

5 – Dietetic foodstuffs, beverages and substances for medical and clinical use; food and food substances for babies; food preparations for infants; lacteal flour for babies; powdered milk for babies; foodstuffs and food substances for medical use for children and patients; foodstuffs and food substances for medical use for nursing mothers; nutritional supplements for medical use for pregnant women and breastfeeding mothers; nutritional supplements; dietetic supplements for medical use; nutritional and dietetic supplements for medical use; vitamin preparations, mineral-based preparations; dietary fibers; vitamins; vitamin preparations and substances; nutritional and food supplements.

29 – Cooked dishes based on vegetables, potatoes, fruits, meat, poultry, fish and seafood products; Preserved, frozen, dried and cooked fruits and vegetables; milk and dairy products; powdered milk; milk-based beverages and preparations; milk substitutes; milk beverages, milk predominating; milk-based beverages containing cereals and/or chocolate; yogurts; soy milk.

30 – Malt-based preparations for human consumption; Cocoa and cocoa-based beverages and preparations; chocolate, chocolate products, chocolate-based beverages and preparations; cereal-based beverages and

preparations included in this class; cereals, breakfast cereals; cereal bars; ready-to-eat cereals; cereal preparations; cereal-based snacks; food products based on rice, flour, oat meal or cereals, also in the form of cooked dishes.

32 – Still waters, sparkling or aerated waters, treated waters, spring waters, mineral and table waters, flavored waters; Fruit-flavored beverages and beverages based on fruit, fruit juices, fruit concentrates and vegetable juices; nectars, fruit nectars (beverages), lemonades, soda water and other non-alcoholic beverages; syrups, extracts and essences and other preparations for making non-alcoholic beverages (excluding essential oils); water-based beverages with tea extracts; beverages based on milk ferments; soy-based beverages; malt-based beverages; isotonic beverages.

(260) AM 2026 134434 A

(800) 1842241

(151) 2025 01 06

(891) 2025 05 13

(731) BETA GIDA SANAYİ VE TİCARET
ANONİM ŞİRKETİ
ACIDEREOSB MAH. FUZULİ CAD. 1
Sarıçam, Adana, Türkiye

(540)

Airbaby

(591) Black, white

(531) 27.05.01

(511)

3 – Bleaching and cleaning preparations, detergents other than for use in manufacturing operations and for medical purposes, laundry bleach, fabric softeners for laundry use, stain removers, dishwasher detergents; perfumery; nonmedicated cosmetics; fragrances; deodorants for personal use and animals; soaps; dental care preparations: dentifrices, denture polishes, tooth whitening preparations, mouth washes, not for medical purposes; abrasive preparations; emery cloth; sandpaper; pumice stone; abrasive pastes; polishing preparations for leather, vinyl, metal and wood, polishes and creams for leather, vinyl, metal and wood, wax for polishing.

5 – Pharmaceutical and veterinary preparations for medical purposes; chemical preparations for medical and veterinary purposes, chemical reagents for pharmaceutical and veterinary purposes; medicated cosmetics; dietary supplements for pharmaceutical and veterinary purposes; dietary supplements; nutritional supplements; medical preparations for slimming purposes; food for babies; herbs and herbal beverages adapted for medicinal purposes; dental preparations and articles: teeth filling material, dental impression material, dental adhesives and material for repairing teeth; sanitary preparations for medical use; hygienic pads; hygienic tampon plasters; materials for dressings; dia-

pers made of paper and textiles for babies, adults and pets; deodorants, other than for human beings or for animals; air purifying preparations; air deodorising preparations.

16 – Paper and cardboard; paper and cardboard for packaging and wrapping purposes, cardboard boxes; paper towels; toilet paper; paper napkins; plastic materials for packaging and wrapping purposes; printing blocks and types; bookbinding material; printed publications; printed matter; books, magazines, newspapers, bill books, printed dispatch notes, printed vouchers, calendars; posters; photographs [printed]; paintings; stickers [stationery]; postage stamps; stationery, office stationery, instructional and teaching material [except furniture and apparatus]; writing and drawing implements; artists' materials; paper products for stationery purposes; adhesives for stationery purposes, pens, pencils, erasers, adhesive tapes for stationery purposes, cardboard cartons [artists' materials], writing paper, copying paper, paper rolls for cash registers, drawing materials, chalkboards, painting pencils, watercolors [paintings]; office requisites; paint rollers and paintbrushes for painting.

(260) AM 2026 134495 A

(800) 1861967

(151) 2025 05 15

(891) 2025 05 15

(731) OLIMP LABORATORIES Sp. z o.o.

Pustynia 84 F, PL-39-200 Dębica, Poland

(540)

CHELA MAG-B6

(591) Black, white

(511)

5 – Pharmaceutical preparations, including, in particular, medicines for human purposes, dietetic substances adapted for medical use, energising supplements used in prophylaxis and in convalescence, for medical purposes; dietary supplements for medical purposes, preparations for supplementing the body with essential vitamins and microelements, dietetic foods adapted for medical purposes, dietetic foods adapted for medical purposes.

32 – Non-alcoholic drinks enriched with vitamins and mineral salts, carbohydrate drinks, energy drinks, isotonic drinks, fruit juice beverages, fruit nectars.

(260) AM 2026 134501 A

(800) 1862207

(151) 2025 04 10

(891) 2025 04 10

(731) QINGDAO SEA COW AGRITECH CO., LTD.

Unit 101, Building 15, International Industrial Park of Shandong University, No.666 Huadong Road, High-Tech Zone, Qingdao, 266000 Shandong, China

(540)

Hily

(591) Black, white

(531) 27.05.01

(511)

1 – Multi-nutrient fertilisers; fertilizers; compost; soil conditioning preparations; fertilizers for agricultural use; plant fertilizers; chemical fertilizers.

(260) AM 2026 134502 A

(800) 1862208

(151) 2025 05 08

(891) 2025 05 08

(731) Bayer Aktiengesellschaft

Kaiser-Wilhelm-Allee, 51373 Leverkusen,
Germany

(540)



(591) Blue, green and pink

(531) 26.11.12; 26.11.13; 29.01.13

(511)

5 – Pharmaceutical preparations, for use in the following fields: treatment and prevention of cardiovascular diseases; pharmaceutical preparations, for use in the following fields: treatment and prevention of thromboses; pharmaceutical preparations, for use in the following fields: treatment and prevention of inflammatory diseases.

(260) AM 2026 134503 A

(800) 1862237

(151) 2025 05 14

(891) 2025 05 14

(731) Xiamen Olymate Import&Export Co., Ltd.

Unit 2902, No.503 Gaolin Middle Road, Huli
District, Xiamen City, Fujian Province, China

(540)

OlyLife

(591) Black, white

(531) 25.03.03; 27.05.01

(511)

3 – Abrasive pastes; perfumery for cosmetics.

5 – Tonics [medicines]; dietetic foods adapted for medical purposes; medicines for veterinary purposes;

preparations for destroying vermin; sanitary towels; dental abrasives; disposable absorbent pads for lining pet crates; chemical preparations for medical purposes; nutritive substances for microorganisms.

9 – Photocopiers [photographic, electrostatic, thermic]; spectacles; batteries, electric; automated teller machines.

11 – Lamps; roasting apparatus; freezers; fans [parts of air-conditioning installations]; heating installations [water]; solar thermal collectors [heating]; water purification installations; radiators, electric; air-conditioning apparatus.

(260) AM 2026 134504 A

(800) 1862274

(151) 2025 01 27

(891) 2025 01 27

(731) YICHANG TEA GROUP CO., LTD

Chengdong Avenue 168, Wujiagang District,
Yichang, 443003 Hubei Province, China

(540)



(591) Black, white

(531) 01.15.05; 26.04.03; 26.04.13

(511)

30 – Coffee-based beverages; malted milk powder; cocoa beverages with milk; vegetal preparations for use as coffee substitutes; tea; flowers or leaves used as substitutes for tea; black tea; green tea; oolong tea; yellow tea; dark tea; white tea; jasmine tea; tieguanyin tea; iced tea; tea-based beverages; chamomile-based beverages; tea beverages with milk; sugar; cube sugar; honey; confectionery; oil tea powder in the nature of tea-based beverages; ice cream; condiments; yeast; yeast extract; edible aroma agents; flavourings, other than essential oils, for beverages; gluten prepared as foodstuff.

(260) AM 2026 134505 A

(800) 1862391

(151) 2025 03 05

(891) 2025 03 05

(731) BETTER WAY BEAUTY (SINGAPORE)
PTE. LTD.

987 SERANGOON ROAD, SINGAPORE
328147, Singapore

(540)

MISTINE

(591) Black, white

(531) 27.05.01

(511)

25 – Waterproof clothing; pants; underpants; clothing; underclothing; bathing suits; footwear; hats; hosiery; gloves [clothing]; face masks [clothing], not for medical or sanitary purposes; face coverings [clothing], not for medical or sanitary purposes; scarfs; belts [clothing]; girdles; sleep masks; wedding dresses.

(260) AM 2026 134506 A

(800) 1862444

(151) 2025 02 24

(891) 2025 02 24

(731) Ilya Temple

22 Cheniston Gardens, LONDON W8 6TH,
United Kingdom

(540)

Издательство Мысль - Publisher Mysl

(591) Black, white

(531) 28.05

(511)

41 – Publishing; publishing of journals; publishing of books; newspaper publishing; publishing of newspapers; book publishing; magazine publishing; multimedia publishing; publishing of stories; multimedia publishing of journals; publishing of newsletters; multimedia publishing of books; publishing of electronic publications; electronic publishing; publishing of documents; publishing services; multimedia publishing of magazines; publishing of web magazines; publishing services for books; publishing of books, magazines; publishing services for books and magazines; publishing of scientific papers; publishing of books and reviews; multimedia publishing of magazines, journals and newspapers; publishing services, except printing; online digital publishing services; electronic text publishing services; publication of books; publication of journals; publication of texts; arranging of cultural events; organisation of cultural events; organisation of educational events; arranging of educational events; conference services.

(260) AM 2026 134507 A

(800) 1862501

(151) 2025 02 24

(891) 2025 02 24

(731) Euro Games Technology Ltd.

6 Panorama Sofia Str., Richhill Business
Center, ground floor, Vitosha Region,
BG-1766 Sofia, Bulgaria

(540)



(591) Yellow, orange, blue, white and black

(531) 24.17.07; 24.17.25; 27.05.01; 27.05.03;
27.05.17; 27.07.02; 29.01.15

(511)

9 – Operating computer software for main frame computers; monitors (computer hardware); computer hardware; apparatus for recording images; monitors (computer programs); computer game programs; recorded computer game programs; apparatus for recording, transmission or reproduction of sound or images; communications servers (computer hardware); electronic components for gambling machines; computer application software featuring games and gaming; computer software for the administration of on-line games and gaming; computer hardware for games and gaming; computer systems; computer operating system software; computer terminals; interactive terminals; multimedia terminals; electronic terminals for generating lottery tickets; interactive touch screen terminals; computer touchscreens; electronic display panels; liquid crystal display screens; digital signage display panels; multimedia software; multimedia apparatus and instruments; interactive multimedia software for playing games; computer screens; lcd large-screen displays; liquid crystal displays [lcds] for home theatres; media streaming software; computer application software for streaming audio-visual media content via the internet; computer gaming software; software; computer software packages; computer software, recorded; software drivers; virtual reality software; games software; entertainment software for computer games; computer programs for network management; electronic lottery tickets; computer software platforms; operating systems; interactive computer systems; operating system programs; computer game software for use with on-line interactive games; interactive casino games provided through a computer or mobile platform; electronic ticket examination machines; software for slot machines, betting software, software for video slot games, for casino games, for gambling and bingo games, provided online or through computer networks and that can be played on any type of computer device, including arcade games, personal computers, portable devices and mobile phones; computer hardware and software for gambling, gambling machines, gambling games on the internet and via telecommunication network.

28 – Gaming machines for gambling; chips for gambling; mah-jong; arcade games; gambling machines operating with coins, notes and cards; games; electronic games; parlor games; gaming chips; gaming tables; slot machines [gaming machines]; LCD game machines; slot machines and gaming devices; coin-operated amusement machines; roulette chips; poker chips; chips and dice [gaming equipment]; gaming equipment for casinos; roulette tables; gaming roulette wheels; casino games; gambling machines and amusement machines, automatic and coin-operated; coin-operated amusement machines and / or electronic coin-operated amusement machines with or without the possibility of gain; boxes for coin-operated amusement machines, slot machines and gaming machines;

electronic or electrotechnical amusement machines and apparatus, gaming machines, coin-operated entertainment machines; housings for coin-operated amusement machines, gaming equipment, gaming machines, machines for gambling; electropneumatic and electrical gambling machines (slot machines); lottery games; electronic targets for games and sports; parlor game equipment and accessories therefor, included in this class, in particular game tokens, chips and marbles; parlor game apparatus and equipment, and accessories therefor, included in this class, in particular electronic targets, backgammon games, scratch cards, playing cards, lottery cards, dice; lottery tickets; printed lottery tickets; lottery scratch cards; scratch cards for playing lottery games.

41 – Gambling; gaming services for entertainment purposes; casino, gaming and gambling services; training in the development of software systems; provision of gaming equipment for gambling halls; providing casino equipment [gambling]; gaming machine entertainment services; providing casino facilities [gambling]; amusement arcade services; games equipment rental; rental of gaming machines; providing amusement arcade services; rental of gaming machines with images of fruits; editing or recording of sounds and images; sound recording and video entertainment services; hire of sound reproducing apparatus; provision of gaming equipment for casinos; providing of casino facilities; online gambling services; entertainment services related to operation of amusement arcades, on-line casinos and on-line betting services via websites; online interactive entertainment; on-line casino services; online game services through mobile devices; providing online entertainment in the nature of game tournaments; providing on-line information in the field of computer gaming entertainment; sports betting services; online sports betting services; lottery services; organization of lotteries; conducting lotteries; prize draws [lotteries]; conducting lotteries for others; providing slot machine parlors; rental of slot machines [gaming machines]; providing online games and games of chance.

(260) AM 2026 134508 A

(800) 1862503

(151) 2025 02 24

(891) 2025 02 24

(731) Euro Games Technology Ltd.

6 Panorama Sofia Str., Richhill Business Center, ground floor, Vitosha Region,, BG-1766 Sofia, Bulgaria

(540)



(591) Yellow, grey, blue, white and black

(531) 01.01.12; 17.02.04; 27.05.03; 27.05.04; 27.05.11; 27.05.17; 29.01.15

(511)

9 – Operating computer software for main frame computers; monitors (computer hardware); computer hardware; apparatus for recording images; monitors (computer programs); computer game programs; recorded computer game programs; apparatus for recording, transmission or reproduction of sound or images; communications servers (computer hardware); electronic components for gambling machines; computer application software featuring games and gaming; computer software for the administration of on-line games and gaming; computer hardware for games and gaming; computer systems; computer operating system software; computer terminals; interactive terminals; multimedia terminals; electronic terminals for generating lottery tickets; interactive touch screen terminals; computer touchscreens; electronic display panels; liquid crystal display screens; digital signage display panels; multimedia software; multimedia apparatus and instruments; interactive multimedia software for playing games; computer screens; lcd large-screen displays; liquid crystal displays [lcds] for home theatres; media streaming software; computer application software for streaming audio-visual media content via the internet; computer gaming software; software; computer software packages; computer software, recorded; software drivers; virtual reality software; games software; entertainment software for computer games; computer programs for network management; electronic lottery tickets; computer software platforms; operating systems; interactive computer systems; operating system programs; computer game software for use with on-line interactive games; interactive casino games provided through a computer or mobile platform; electronic ticket examination machines; software for slot machines, betting software, software for video slot games, for casino games, for gambling and bingo games, provided online or through computer networks and that can be played on any type of computer device, including arcade games, personal computers, portable devices and mobile phones; computer hardware and software for gambling, gambling machines, gambling games on the internet and via telecommunication network.

28 – Gaming machines for gambling; chips for gambling; mah-jong; arcade games; gambling machines operating with coins, notes and cards; games; electronic games; parlor games; gaming chips; gaming tables; slot machines [gaming machines]; LCD game machines; slot machines and gaming devices; coin-operated amusement machines; roulette chips; poker chips; chips and dice [gaming equipment]; gaming equipment for casinos; roulette tables; gaming roulette wheels; casino games; gambling machines and amusement machines, automatic and coin-operated; coin-operated amusement machines and / or electronic coin-operated amusement machines with or without the possibility of gain; boxes for coin-operated amusement machines, slot machines and gaming machines;

electronic or electrotechnical amusement machines and apparatus, gaming machines, coin-operated entertainment machines; housings for coin-operated amusement machines, gaming equipment, gaming machines, machines for gambling; electropneumatic and electrical gambling machines (slot machines); lottery games; electronic targets for games and sports; parlor game equipment and accessories therefor, included in this class, in particular game tokens, chips and marbles; parlor game apparatus and equipment, and accessories therefor, included in this class, in particular electronic targets, backgammon games, scratch cards, playing cards, lottery cards, dice; lottery tickets; printed lottery tickets; lottery scratch cards; scratch cards for playing lottery games.

41 – Gambling; gaming services for entertainment purposes; casino, gaming and gambling services; training in the development of software systems; provision of gaming equipment for gambling halls; providing casino equipment [gambling]; gaming machine entertainment services; providing casino facilities [gambling]; amusement arcade services; games equipment rental; rental of gaming machines; providing amusement arcade services; rental of gaming machines with images of fruits; editing or recording of sounds and images; sound recording and video entertainment services; hire of sound reproducing apparatus; provision of gaming equipment for casinos; providing of casino facilities; online gambling services; entertainment services related to operation of amusement arcades, on-line casinos and on-line betting services via websites; online interactive entertainment; on-line casino services; online game services through mobile devices; providing online entertainment in the nature of game tournaments; providing on-line information in the field of computer gaming entertainment; sports betting services; online sports betting services; lottery services; organization of lotteries; conducting lotteries; prize draws [lotteries]; conducting lotteries for others; providing slot machine parlors; rental of slot machines [gaming machines]; providing online games and games of chance.

(260) AM 2026 134509 A

(800) 1862546

(151) 2025 04 27

(891) 2025 04 27

(731) Midea Group Co., Ltd.

B26-28F, Midea Headquarter Building, No.6
Midea Avenue, Beijiao, Shunde, Foshan,
Guangdong, China

(540)

Equinox

(591) Black, white

(511)

11 – Air-conditioning apparatus; air purifying apparatus and machines; ventilation [air-conditioning] ins-

tallations and apparatus; dehumidifiers; air cooling apparatus; extractor hoods for kitchens; drying devices; water heaters with air heat pumps; radiators, electric; personal cooling packs, not for medical purposes.

(260) AM 2026 134511 A

(800) 1862568

(151) 2025 01 16

(891) 2025 01 16

(731) BKST Limited Liability Partnership

Auezova street, building 14A, Almay district,
050009 Almaty city, Kazakhstan

(540)

СКРИПТОНИТ

СКРИПТОНИТ

(591) Black, white

(531) 28.05

(511)

9 – 3D spectacles; 3D scanners; DVD players; juke boxes, musical; fire engines; answering machines; electrical adapters; batteries for electronic cigarettes; accumulators, electric; batteries, electric, for vehicles; accelerometers; actinometers; alidades; breathalyzers; altimeters; ear pads for headphones; ammeters; apparatus for testing breast milk, other than for medical or veterinary use; nanoparticle size analysers; anemometers; anodes; aerials; anticathodes; apertometers [optics]; high-frequency apparatus; testing apparatus not for medical purposes; electro-dynamic apparatus for the remote control of railway points; electro-dynamic apparatus for the remote control of signals; monitoring apparatus, other than for medical purposes; sound recording apparatus; Global Positioning System [GPS] apparatus; remote control apparatus; distillation apparatus for scientific purposes; diffraction apparatus [microscopy]; air analysis apparatus; apparatus to check franking; sound transmitting apparatus; breathing apparatus for underwater swimming; breathing apparatus, not for medical purposes; apparatus and installations for the production of X-rays, not for medical purposes; cash registers; electric apparatus for commutation; magnetic resonance imaging [MRI] apparatus, not for medical purposes; intercommunication apparatus; stills for laboratory experiments; projection apparatus; fire extinguishing apparatus; radiological apparatus for industrial purposes; X-ray apparatus not for medical purposes; blueprint apparatus; flashing lights [luminous signals]; stereoscopic apparatus; telephone apparatus; facsimile machines; fermentation apparatus for laboratory use; phototelegraphy apparatus; igniting apparatus, electric, for igniting at a distance; acid hydrometers; salinometers; acidimeters for batteries; aerometers; beacons, luminous; battery jars; automated teller machines [ATM]; barometers; anode

batteries; galvanic batteries; ignition batteries; solar batteries; solar panels for the production of electricity; batteries, electric; balances [steelyards]; betatrons; binoculars; bioreactors for cell culturing for scientific research; bioreactors for laboratory use; biochips; electronic tags for goods; lens hoods; magnetic tape units for computers; computer memory devices; fire hose nozzles; encoded identification bracelets, magnetic; connected bracelets [measuring instruments]; safety tarpaulins; electronic key fobs being remote control apparatus; bullet-proof clothing; signalling buoys; life buoys; marking buoys; directional compasses; vacuum gauges; variometers; internal cooling fans for computers; verniers; scales; baby scales; letter scales; bathroom scales; weighbridges; precision balances; scales with body mass analysers; levelling staffs [surveying instruments]; camcorders; video baby monitors; video cassettes; video mixing desks; video projectors; video telephones; video screens; viewfinders, photographic; electric plugs; micrometer screws for optical instruments; viscosimeters; circuit closers; wavemeters; voltmeters; flash lamps for smartphones; mechanical signs; digital signs; switchboxes [electricity]; current rectifiers; gas testing instruments; gasometers [measuring instruments]; galvanometers; hands-free kits for telephones; headsets; headsets for playing video games; heliographic apparatus; apparatus for generating gas for calibration purposes; hygrometers; wet suits; dry suits; dive skins; hydrometers; weights; peepholes [magnifying lenses] for doors; hairdressing training heads [teaching apparatus]; holograms; plotters; loudspeakers; sounding leads; plumb bobs; range finders; gauges; parking sensors for vehicles; piezoelectric sensors; densimeters; detectors; smoke detectors; infrared detectors; counterfeit coin detectors; joysticks for use with computers, other than for video games; transparencies [photography]; slide projectors; diaphragms [photography]; dictating machines; thin film speakers; wearable speakers; dynamometers; quantum dot light-emitting diodes [QLED]; organic light-emitting diodes [OLED]; light-emitting diodes [LED]; floppy disks; phonograph records; disks, magnetic; optical discs; circular slide rules; disk drives for computers; juke boxes for computers; head-mounted displays; wearable video display monitors; electronic numeric displays; DNA chips; dosimeters; electronic interactive whiteboards; electronic notice boards; electric wire harnesses for automobiles; bullet-proof vests; life jackets; reflective safety vests; identification threads for electric wires; nose clips for divers and swimmers; biometric locks; padlocks, electronic; locks, electric; alarm bells, electric; electric door bells; signal bells; bells [warning devices]; acoustic conduits; mirrors for inspecting work; safety signs [luminous]; road signs, luminous or mechanical; warning signs [luminous]; signs, luminous; marine depth finders; probes for scientific purposes; buzzers; needles for surveying compasses; needles for record players; eyewear; reflective articles

for wear, for the prevention of accidents; measures; pressure measuring apparatus; wheel alignment meters; simulators for the steering and control of vehicles; inverters [electricity]; pressure indicators; automatic indicators of low pressure in vehicle tyres; temperature indicators; inductors [electricity]; incubators for bacteria culture; measuring instruments; cosmographic instruments; mathematical instruments; levelling instruments; surveying instruments; azimuth instruments; interfaces for computers; audio interfaces; ionization apparatus not for the treatment of air or water; satellite finder meters; spark-guards; coaxial cables; fibre optic cables; cables, electric; calipers; slide calipers; screw-tapping gauges; calorimeters; calculating machines; pocket calculators; decompression chambers; rearview cameras for vehicles; cinematographic cameras; thermal imaging cameras; mouth guards for sports; life-saving capsules for natural disasters; holders for electric coils; biometric identity cards; identity cards, magnetic; video game cartridges; ink cartridges, unfilled, for printers and photocopiers; memory cards for video game machines; encoded magnetic cards; riding helmets; protective helmets; carriers for dark plates [photography]; cathodes; choking coils [impedance]; coils, electric; electromagnetic coils; spools [photography]; cinematographic film, exposed; computer keyboards; solenoid valves [electromagnetic switches]; wire connectors [electricity]; thin client computers; encoded key cards; electronic book readers; electronic agendas; push buttons for bells; magnetic encoders; visors for helmets; collectors, electric; portable speakers; calibrating rings; smart rings; ring stands for mobile telephones; ring sizers; protective suits for aviators; commutators; compact discs [audio-video]; compact discs [read-only memory]; comparators; marine compasses; computers; quantum computers; laptop computers; tablet computers; notebook computers; wearable computers; condensers [capacitors]; contacts, electric; controllers for servo motors; musical instrument digital interface controllers being audio interfaces; electronic controllers for servo motors; wind socks for indicating wind direction; traffic cones; branch boxes [electricity]; distribution boxes [electricity]; junction boxes [electricity]; battery boxes; cabinets for loudspeakers; diving suits; haptic suits, other than for medical purposes; downloadable e-wallets; evacuation chairs; galena crystals [detectors]; covers for electric outlets; logs [measuring instruments]; lasers, not for medical purposes; lactodensimeters; lactometers; vacuum tubes [radio]; darkroom lamps [photography]; selfie ring lights for smartphones; thermionic valves; amplifying tubes; flashlights [photography]; lanyards for mobile telephones; head cleaning tapes [recording]; magnetic tapes; videotapes; surveying chains; fire escapes; square rulers for measuring; slide-rules; rulers [measuring instruments]; contact lenses; correcting lenses [optics]; optical lenses; optical condensers; electricity conduits; sounding lines; measuring spoons; thread

counters; magnifying glasses [optics]; magnets; decorative magnets; close-up lenses; crash test dummies; resuscitation mannequins [teaching apparatus]; trackballs [computer peripherals]; pressure gauges; computer network routers; divers' masks; solderers' helmets; protective masks, not for medical purposes; dust masks incorporating air purification; respiratory masks, not for medical purposes; materials for electricity mains [wires, cables]; voting machines; money counting and sorting machines; material testing instruments and machines; furniture especially made for laboratories; megaphones; portable media players; diaphragms for scientific apparatus; diaphragms [acoustics]; metal detectors for industrial or military purposes; digital weather stations; metronomes; carpenters' rules; dressmakers' measures; rules [measuring instruments]; mechanisms for coin-operated apparatus; mechanisms for counter-operated apparatus; coin-operated mechanisms for television sets; shutter releases [photography]; micrometers; microprocessors; microscopes; microtomes; microphones; wireless speaker microphones; audio mixers; modems; lightning conductors; monitors [computer hardware]; monitors [computer programs]; selfie sticks [hand-held monopods]; terminals [electricity]; junction sleeves for electric cables; data sets, recorded or downloadable; teeth protectors; temperature indicator labels, not for medical purposes; knee-pads for workers; headphones; earpieces for remote communication; surveyors' levels; sound recording carriers; magnetic data media; optical data media; electronic sheet music, downloadable; computer game software, recorded; computer software, recorded; software as a medical device [SaMD], downloadable; sheaths for electric cables; identification sheaths for electric wires; weighing machines; computer hardware; punched card machines for offices; lenses for astrophotography; selfie lenses; objectives [lenses] [optics]; egg-candlers; fire extinguishers; rescue laser signalling flares; electrified fences; limiters [electricity]; clothing for protection against accidents, irradiation and fire; clothing for protection against fire; asbestos clothing for protection against fire; clothing especially made for laboratories; survival blankets; ozonizers for calibration purposes; octants; eyepieces; ohmmeters; wrist rests for use with computers; spectacle frames; oscillographs; plumb lines; mirrors [optics]; anti-glare glasses; sunglasses; sunglasses for pets; goggles for sports; finger sizers; signalling panels, luminous or mechanical; biometric passports; effects pedals for guitars; wah-wah pedals; radio pagers; pince-nez; electronic pocket translators; telephone transmitters; transmitters of electronic signals; transmitters [telecommunication]; switches, electric; periscopes; data gloves; gloves for divers; gloves for protection against accidents; gloves for protection against X-rays for industrial purposes; insulating gloves for protection against accidents; asbestos gloves for protection against accidents; furnaces for laboratory use; droppers for

measuring, other than for medical or household purposes; laboratory pipettes; pyrometers; planimeters; plane tables [surveying instruments]; plates for batteries; wafers for integrated circuits; printed circuit boards; compact disc players; cassette players; protective films adapted for computer screens; protective films adapted for smartphones; sound recording strips; screen protectors for mobile telephones; X-ray films, exposed; films, exposed; life-saving rafts; animal signalling rattles for directing livestock; gimbals for smartphones; gimbals for digital cameras; laboratory trays; stands adapted for laptops; in-car telephone handset cradles; cooling pads for laptop computers; airbags for safety purposes for fall protection; semiconductors; polarimeters; personal digital assistants [PDAs]; fire pumps; measuring glassware; weight belts for divers; life belts; fuses; circuit breakers; converters, electric; telerupters; food analysis apparatus; diagnostic apparatus, not for medical purposes; distance recording apparatus; distance measuring apparatus; speed measuring apparatus [photography]; appliances for measuring the thickness of leather; apparatus for measuring the thickness of skins; speed checking apparatus for vehicles; teaching apparatus; time recording apparatus; measuring apparatus; measuring devices, electric; apparatus and instruments for astronomy; surveying apparatus and instruments; weighing apparatus and instruments; nautical apparatus and instruments; optical apparatus and instruments; apparatus and instruments for physics; chemistry apparatus and instruments; boiler control instruments; meteorological instruments; naval signalling apparatus; observation instruments; navigation apparatus for vehicles [on-board computers]; satellite navigational apparatus; regulating apparatus, electric; telecommunication apparatus in the form of jewellery; precision measuring apparatus; electric actuators; electric linear actuators; audio- and video-receivers; prisms [optics]; computer software applications, downloadable; wireless portable printers for use with laptops and mobile devices; ticket printers; printers for use with computers; hemline markers; retorts' stands; apparatus for changing record player needles; drainers for use in photography; cleaning apparatus for phonograph records; fire beaters; sighting telescopes for firearms; telescopic sights for artillery; test tubes; pressure indicator plugs for valves; magnetic wires; telegraph wires; telephone wires; wires, electric; conductors, electric; copper wire, insulated; fuse wire; computer programs, recorded; computer game software, downloadable; computer programs, downloadable; computer operating programs, recorded; computer screen saver software, recorded or downloadable; record players; processors [central processing units]; rods for water diviners; electronic publications, downloadable; distribution consoles [electricity]; control panels [electricity]; radar apparatus; masts for wireless aerials; transmitting sets [telecommunication]; vehicle radios; sprinkler systems for fire protection; frames for photograp-

hic transparencies; screens for photoengraving; flowmeters; frequency extenders; walkie-talkies; voltage surge protectors; voltage regulators for vehicles; stage lighting regulators; speed regulators for record players; cell switches [electricity]; washing trays [photography]; marking gauges [joinery]; T-squares for measuring; time switches, automatic; relays, electric; safety restraints, other than for vehicle seats and sports equipment; body harnesses for support when lifting loads; X-ray photographs, other than for medical purposes; rheostats; respirators for filtering air, not for medical purposes; retorts; refractometers; refractors; grids for batteries; security surveillance robots; laboratory robots; teaching robots; telepresence robots; user-programmable humanoid robots, not configured; humanoid robots with artificial intelligence for use in scientific research; humanoid robots with artificial intelligence for preparing beverages; humanoid robots having communication and learning functions for assisting and entertaining people; electric sockets; height measuring instruments; speaking tubes; horns for loudspeakers; subwoofers; saccharometers; optical fibres [light conducting filaments]; traffic-light apparatus [signalling devices]; dog whistles; signalling whistles; sports whistles; sextants; safety nets; nets for protection against accidents; fire alarms; signals, luminous or mechanical; sirens; electronic access control systems for interlocking doors; autonomous navigation systems for ships; missile warning systems; portable document scanners; scanners [data processing equipment]; scanners [apparatus] for performing automotive diagnostics; hand-held electronic dictionaries; smartphones; foldable smartphones; smart speakers; integrated circuit cards [smart cards]; smartglasses; smartwatches; connections for electric lines; couplings, electric; connectors [electricity]; sonars; sound locating instruments; lighting ballasts; resistances, electric; spectrograph apparatus; spectrometers; speed indicators; alcoholmeters; satellites for scientific purposes; protection devices for personal use against accidents; audiovisual teaching apparatus; charging stations for electric vehicles; radiotelegraphy sets; radiotelephony sets; spectacle lenses; optical glass; personal stereos; stereoscopes; stands for photographic apparatus; stroboscopes; fire boats; sulfitometers; bags adapted for laptops; drying racks [photography]; spherometers; integrated circuits; printed circuits; counters; parking meters; mileage recorders for vehicles; portable ultrafine dust meters; revolution counters; abacuses; egg timers [sandglasses]; taximeters; tachometers; television apparatus; telegraphs [apparatus]; telescopes; teleprompters; teleprinters; mobile telephones; cordless telephones; theodolites; ticket dispensing terminals, electronic; credit card terminals; interactive touchscreen terminals; self-checkout terminals; thermo-hygrometers; thermometers, not for medical purposes; thermostats; thermostats for vehicles; climate control digital thermostats; crucibles [laboratory]; tone arms for record players; totalizers; tran-

sistors [electronic]; transponders; protractors [measuring instruments]; step-up transformers; transformers [electricity]; resuscitation training simulators; vehicle breakdown warning triangles; triodes; starter cables for motors; discharge tubes, electric, other than for lighting; capillary tubes for laboratory use; neon signs; Pitot tubes; X-ray tubes not for medical purposes; telephone receivers; headgear being protective helmets; squares for measuring; quantity indicators; petrol gauges; water level indicators; electric loss indicators; light-emitting electronic pointers; slope indicators; mercury levels; spirit levels; levels [instruments for determining the horizontal]; urinometers; amplifiers; amplifiers for servo motors; particle accelerators; electric installations for the remote control of industrial operations; baby monitors; steering apparatus, automatic, for vehicles; balancing apparatus; video recorders; sound reproduction apparatus; invoicing machines; tape recorders; protection devices against X-rays, not for medical purposes; railway traffic safety appliances; data processing apparatus; oxygen transvasing apparatus; theft prevention installations, electric; devices for the projection of virtual keyboards; film cutting apparatus; drying apparatus for photographic prints; optical character readers; centering apparatus for photographic transparencies; battery chargers; chargers for mobile telephones; chargers for electric accumulators; chargers for electronic cigarettes; portable power chargers; acoustic alarms; sounding apparatus and machines; life-saving apparatus and equipment; apparatus for editing cinematographic film; cathodic anti-corrosion apparatus; couplers [data processing equipment]; wearable activity trackers; anti-theft warning apparatus; computer peripheral devices; anti-interference devices [electricity]; dosage dispensers, not for medical use [measuring apparatus]; demagnetizing apparatus for magnetic tapes; acoustic couplers; alarms; whistle alarms; adding machines; readers [data processing equipment]; heat regulating apparatus; photocopiers [photographic, electrostatic, thermic]; electric and electronic effects units for musical instruments; bar code readers; head-up display apparatus for vehicles; downloadable image files; downloadable music files; animated cartoons; filters for respiratory masks, not for medical purposes; filters for ultraviolet rays, for photography; filters for use in photography; USB flash drives; signal lanterns; optical lanterns; magic lanterns; cameras [photography]; glazing apparatus for photographic prints; shutters [photography]; darkrooms [photography]; photometers; flash-bulbs [photography]; digital photo frames; enlarging apparatus [photography]; photovoltaic cells; containers for contact lenses; contact lens cases incorporating ultrasonic cleaning functions; spectacle cases; containers for microscope slides; cases for smartphones; cases especially made for photographic apparatus and instruments; chromatography apparatus for laboratory use; chronographs [time recording apparatus]; laboratory centrifuges; spectacle chains; cyc-

lotrons; compasses for measuring; frequency meters; time clocks [time recording devices]; Petri dishes; sleeves for laptops; covers for personal digital assistants [PDAs]; covers for tablet computers; covers for smartphones; cases for smartphones incorporating a keyboard; fire blankets; chips [integrated circuits]; jigs [measuring instruments]; pedometers; fire-extinguishing balls; meteorological balloons; electrified rails for mounting spot lights; asbestos screens for fire-fighters; fire hose; virtual reality headsets; protective helmets for sports; neural helmets, not for medical purposes; head guards for sports; lifeboats; snorkels; spectacle cords; tripods for cameras; switchboards; distribution boards [electricity]; equalizers [audio apparatus]; projection screens; radiology screens for industrial purposes; fluorescent screens; screens [photography]; exposure meters [light meters]; electrolysis apparatus for laboratory use; ducts [electricity]; galvanic cells; epidiascopes; ergometers; armatures [electricity]; black boxes [data recorders]; densitometers, not for medical purposes; holders adapted for mobile telephones and smartphones; downloadable emoticons for mobile telephones; toner cartridges, unfilled, for printers and photocopiers; downloadable software for generating cryptographic keys for receiving and spending cryptocurrency; straps for mobile telephones; downloadable graphics for mobile telephones; protective face shields for workers; ear plugs for divers; rescue flares, non-explosive and non-pyrotechnic; light dimmers [regulators], electric; radios; navigational instruments; computer software platforms, recorded or downloadable; electronic collars to train animals; spectacles; spectacles for correcting colour vision deficiency; shoes for protection against accidents, irradiation and fire; downloadable computer software for managing cryptocurrency transactions using blockchain technology; security token hardware for user authentication; mouse [computer peripheral]; home automation hubs; ring holders for mobile telephones; dashboard mats adapted for holding mobile telephones and smartphones; mouse pads; electronic pens for visual display units; downloadable ring tones for mobile telephones; downloadable digital image files authenticated by non-fungible tokens [NFTs]; downloadable digital music files authenticated by non-fungible tokens [NFTs].

18 – Luggage tags; sew-on tags of leather for clothing; adhesive tags of leather for bags; pocket wallets; business card cases; reins; reins for guiding children; sling bags for carrying infants; harness fittings; credit card cases [wallets]; parts of rubber for stirrups; dog waste bag dispensers adapted for use with leashes; chamois leather, other than for cleaning purposes; umbrellas; parasols; saddlery; frames for umbrellas or parasols; frames for bags [structural parts of bags]; card cases [notecases]; cases of leather or leatherboard; valves of leather; whips; vegan leather; imitation leather; mycelium-based imitation leather; leather, unworked or semi-worked; leatherboard; casings, of

leather, for springs; umbrella rings; hat boxes of leather; boxes of vulcanized fibre; boxes of leather or leatherboard; purses; chain mesh purses; fastenings for saddles; butts [parts of hides]; compression cubes adapted for luggage; saddle trees; bags [envelopes, pouches] of leather, for packaging; moleskin [imitation of leather]; travelling sets [leatherware]; knee-pads for horses; muzzles; halters; vanity cases, not fitted; furniture coverings of leather; clothing for pets; covers for animals; suitcase packing organizers; trimmings of leather for furniture; collars for animals; mountaineering sticks; hiking sticks; conference folders; music cases; slings for carrying infants; goldbeaters' skin; cat o' nine tails; leather leashes; pads for horse saddles; horseshoes; girths of leather; leathercloth; horse blankets; garment bags for travel; shoulder belts [straps] of leather; briefcases; traces [harness]; fur; frames for coin purses [structural parts of coin purses]; randsels [Japanese school satchels]; haversacks; leather straps; straps for soldiers' equipment; harness straps; straps for skates; straps of leather [saddlery]; chin straps, of leather; stirrup leathers; umbrella handles; walking stick handles; suitcase handles; grips for holding shopping bags; rucksacks; backpacks for carrying infants; travelling bags; riding saddles; net bags for shopping; umbrella or parasol ribs; stirrups; bags; bags for climbers; toilet bags, not fitted; handbags; beach bags; saddlebags; bags for sports; bags for campers; reusable shopping bags; wheeled shopping bags; school bags; pouch baby carriers; trunks [luggage]; nose bags [feed bags]; bridoons; walking sticks; umbrella sticks; walking stick seats; tefillin [phylacteries]; bits for animals [harness]; bridles [harness]; harness for animals; key cases; horse collars; suitcases; motorized suitcases; suitcases with wheels; valises; attaché cases; umbrella covers; covers for horse saddles; kid; curried skins; animal skins; cattle skins; leather cord; blinkers [harness]; labels of leather; game bags [hunting accessories]; saddlecloths for horses; tool bags, empty.

25 – Wimples; bandanas [neckerchiefs]; underwear; sweat-absorbent underwear; berets; blouses; boas [necklets]; teddies [underclothing]; boxer shorts; ankle boots; ski boots; boots for sports; knickerbockers; trousers; football shoes; brassieres; adhesive bras; valenki [felted boots]; mittens; detachable collars; collars [clothing]; shirt yokes; veils [clothing]; gabardines [clothing]; galoshes; neckties; ascots; gaiters; leggings [leg warmers]; boot uppers; corselets; jerseys [clothing]; waistcoats; sports jerseys; hosiery; heels; heelpieces for footwear; hoods [clothing]; hat frames [skeletons]; pockets for clothing; scarves; caps being headwear; kimonos; cap peaks; visors being headwear; tights; slips [underclothing]; combinations [clothing]; bodices [lingerie]; corsets [underclothing]; suits; bathing suits; masquerade costumes; beach clothes; leotards; stuff jackets [clothing]; fishing vests; jackets [clothing]; leggings [trousers]; liveries; camisoles; sports singlets; cuffs; mantillas; coats; face co-

verings [clothing], not for medical or sanitary purposes; sleep masks; furs [clothing]; fingerless gloves; mitres [hats]; footmuffs, not electrically heated; muffs [clothing]; bibs, not of paper; bibs, sleeved, not of paper; fur stoles; hairdressing capes; heel protectors for shoes; ear muffs [clothing]; socks; sweat-absorbent socks; footwear; gymnastic shoes; beach shoes; sports shoes; clothing; paper clothing; outerclothing; embroidered clothing; ready-made clothing; motorists' clothing; cyclists' clothing; clothing for gymnastics; clothing of imitations of leather; latex clothing; clothing of leather; waterproof clothing; clothing incorporating LEDs; sportswear incorporating digital sensors; uniforms; clothing containing slimming substances; fittings of metal for footwear; maniples; overcoats; drawers [underwear]; parkas; pelerines; cycling gloves; driving gloves; ski gloves; gloves [clothing]; pyjamas; bathing trunks; shirt fronts; headscarves; pocket squares; dresses; headbands [clothing]; garters; sock suspenders; stocking suspenders; ready-made linings [parts of clothing]; dress shields; soles for footwear; braces [suspenders] for clothing; half-boots; lace boots; ponchos; sashes for wear; girdles; belts [clothing]; money belts [clothing]; layettes [clothing]; non-slipping devices for footwear; heelpieces for stockings; welts for footwear; chasubles; shirts; short-sleeve shirts; wooden shoes; sandals; bath sandals; boots; jumper dresses; saris; sarongs; sweaters; footwear uppers; inner soles; albs; bath slippers; thermal gloves for touchscreen devices; togas; knitwear [clothing]; underpants; shoes; slippers; skull caps; turbans; headwear; aprons [clothing]; tee-shirts; rash guards; dressing gowns; bath robes; top hats; tips for footwear; stockings; sweat-absorbent stockings; shawls; paper hats [clothing]; shower caps; bathing caps; neck tube scarves; studs for football shoes; hats; babies' pants [underwear]; gaiter straps; pelisses; skirts; petticoats; skorts; martial arts uniforms; hanbok; espadrilles.

41 – Academies [education]; rental of indoor aquaria; rental of artwork; rental of movie props; rental of sports grounds; rental of tennis courts; lending library services; booking of seats for shows; videotaping; physical education; production of music; animal training; dubbing; publication of books; research in the field of education; escape room [entertainment]; film distribution; health club services [health and fitness training]; layout services, other than for advertising purposes; microfilming; videotape editing; production of radio and television programmes; screenplay writing; music education; religious education; teaching; aikido instruction; boarding school education; gymnastic instruction; correspondence courses; practical training [demonstration]; training services provided via simulators; organization of balls; organization of exhibitions for cultural and educational purposes; providing recreation facilities; arranging and conducting of colloquiums; arranging and conducting of congresses; arranging and conducting of conferences; arran-

ging and conducting of concerts; arranging and conducting of workshops [training]; arranging and conducting of in-person educational forums; arranging and conducting of entertainment events; arranging and conducting of seminars; arranging and conducting of symposiums; arranging and conducting of sports events; arranging of beauty contests; organization of competitions [education or entertainment]; organization of cosplay entertainment events; organization of lotteries; organization of fashion shows for entertainment purposes; organization of electronic sports competitions; organization of shows [impresario services]; organization of sports competitions; vocational guidance [education or training advice]; amusement park services; language interpretation; transfer of business knowledge and know-how [training]; know-how transfer [training]; television entertainment; vocational retraining; scheduling of radio and television programmes; directing of shows; providing online videos, not downloadable; providing online virtual guided tours; providing information in the field of education; providing information relating to recreational activities; providing information in the field of entertainment; providing museum facilities; providing online music, not downloadable; providing facilities for playing Live Action Role Playing [LARP] games; providing training and educational examination for certification purposes; providing online images, not downloadable; providing user reviews for entertainment or cultural purposes; providing golf facilities; providing user rankings for entertainment or cultural purposes; providing sports facilities; providing amusement arcade services; cinema presentations; providing online electronic publications, not downloadable; presentation of circus performances; presentation of variety shows; theatre productions; presenting museum exhibitions; conducting guided climbing tours; conducting fitness classes; educational examination; production of podcasts; film production, other than advertising films; electronic desktop publishing; online publication of electronic books and journals; publication of texts, other than publicity texts; radio entertainment; editing of texts; sado instruction [tea ceremony instruction]; news reporters services; film directing, other than advertising films; party planning [entertainment]; captioning; subtitling; tutoring; entertainer services; holiday camp services [entertainment]; video editing services for events; video imaging services by drone; gambling services; e-sports services; conducting guided tours; disc jockey services; sound engineering services for events; game services provided online from a computer network; games library services; personal trainer services [fitness training]; providing casino facilities [gambling]; calligraphy services; karaoke services; movie studio services; songwriting; cultural, educational or entertainment services provided by art galleries; multimedia library services; modelling for artists; nightclub services [entertainment]; educational services provided by special needs assis-

tants; educational services provided by schools; orchestra services; translation; scriptwriting, other than for advertising purposes; physical fitness assessment services for training purposes; face painting; ticket agency services [entertainment]; music composition services; educational examination for users to qualify to pilot drones; entertainment services; coaching [training]; lighting technician services for events; sport camp services; recording studio services; photographic imaging services by drone; nursery schools; photography; photographic reporting; timing of sports events; production of shows; mobile library services; discotheque services; martial arts instruction; sign language interpretation; providing television programmes, not downloadable, via video-on-demand services; providing films, not downloadable, via video-on-demand services; presentation of live performances; rental of audio equipment; rental of video cameras; rental of video cassette recorders; rental of videotapes; rental of show scenery; rental of sound recordings; toy rental; rental of cinematographic apparatus; rental of motion pictures; games equipment rental; rental of stadium facilities; rental of lighting apparatus for theatrical sets or television studios; rental of radio and television sets; rental of skin diving equipment; rental of sports equipment, except vehicles; rental of stage scenery; rental of electronic book readers; zoological garden services; rental of training simulators.

(260) AM 2026 134512 A

(800) 1862586

(151) 2025 05 16

(891) 2025 05 16

(731) LTD "PANNA"

5th Kabelnaya Str, 3, building 7, RU-111024
Moscow, Russian Federation

(540)

CBETOY

(591) Black, white

(531) 28.05

(511)

16 – Address plates for addressing machines; address stamps; addressing machines; adhesive tapes for stationery or household purposes; animation cels; announcement cards [stationery]; apparatus for mounting photographs; artists' watercolor saucers; baggage claim check tags of paper; bags [envelopes, pouches] of paper or plastics, for packaging; balls for ball-point pens; banknotes; barcode ribbons; bibs of paper; bibs, sleeved, of paper; binding strips [bookbinding]; blotters; bookbinding apparatus and machines [office equipment]; bookbinding material; bookends; book-markers; bottle envelopes of paper or cardboard; bottle wrappers of paper or cardboard; boxes of paper or cardboard; canvas for painting; cardboard tubes; cardboard; cases for stamps [seals]; chalk for lithography; chalk holders; charcoal pencils; clipboards; staples for

offices; cloth for bookbinding; compasses for drawing; composing sticks; cords for bookbinding; correcting ink [heliography]; correcting tapes [office requisites]; wrappers [stationery]; cream containers of paper; dental tray covers of paper; document holders [stationery]; document laminators for office use; drawer liners of paper, perfumed or not; drawing boards; drawing instruments; drawing materials; drawing pads; thumbtacks; drawing rulers; drawing sets; duplicators; elastic bands for offices; electrocardiograph paper; electrotypes; engraving plates; envelope sealing machines for offices; envelopes [stationery]; erasing products; erasing shields; etching needles; fabrics for bookbinding; files [office requisites]; filter paper; filtering materials of paper; flags of paper; flower-pot covers of paper; folders for papers; fountain pens; franking machines for office use; French curves; galleys racks [printing]; garbage bags of paper or of plastics; glitter for stationery purposes; glue for stationery or household purposes; gluten [glue] for stationery or household purposes; gummed cloth for stationery purposes; hand labelling appliances; handkerchiefs of paper; hand-rests for painters; hat boxes of cardboard; hectographs; holders for checkbooks; holders for stamps [seals]; house painters' rollers; humidity control sheets of paper or plastic for foodstuff packaging; index cards [stationery]; ink stones [ink reservoirs]; ink; inking pads; inking ribbons; inking sheets for document reproducing machines; inking sheets for duplicators; inkstands; inkwells; isinglass for stationery or household purposes; letter trays; lithographic stones; ring binders; luminous paper; manifolds [stationery]; marking chalk; marking pens [stationery]; modelling clay; modelling materials; modelling paste; modelling wax, not for dental purposes; moisteners [office requisites]; moisteners for gummed surfaces [office requisites]; money clips; molds for modelling clays [artists' materials]; name badge holders [office requisites]; name badges [office requisites]; nibs; nibs of gold; note books; numbering apparatus; numbers [type]; obliterating stamps; office perforators; office requisites, except furniture; packaging material made of starches; packing [cushioning, stuffing] materials of paper or cardboard; padding materials of paper or cardboard; pads [stationery]; page holders; paint boxes for use in schools; paint trays; paintbrushes; painters' brushes; painters' easels; palettes for painters; pantographs [drawing instruments]; paper bags for use in the sterilization of medical instruments; paper bows, other than haberdashery or hair decorations; paper clasps; paper coffee filters; paper cutters [office requisites]; paper for medical examination tables; paper for radiograms; paper for recording machines; paper knives [letter openers]; paper ribbons, other than haberdashery or hair decorations; paper sheets [stationery]; paper shredders for office use; paper wipes for cleaning; paper; paper-clips; papers for painting and calligraphy; paperweights; papier mâché; parchment paper; passport holders; pastels [crayons]; pen cases;

pen clips; pen wipers; pencil holders; pencil lead holders; pencil leads; pencil sharpeners, electric or non-electric; pencil sharpening machines, electric or non-electric; pencils; pens [office requisites]; perforated cards for Jacquard looms; placards of paper or cardboard; plastic bags for pet waste disposal; plastics for modelling; polymer modelling clay; printed coupons; printers' blankets, not of textile; printers' reglets; printing blocks; printing sets, portable [office requisites]; printing type; punches [office requisites]; retractable reels for name badge holders [office requisites]; rice paper; rollers for typewriters; scrapers [erasers] for offices; sealing compounds for stationery purposes; sealing machines for offices; sealing wafers; sealing wax; self-adhesive tapes for stationery or household purposes; sewing patterns; slate pencils; spools for inking ribbons; spray chalk; square rulers for drawing; squares for drawing; stamp pads; stands for pens and pencils; stapling presses [office requisites]; starch paste [adhesive] for stationery or household purposes; steatite [tailor's chalk]; steel letters; steel pens; stencil cases; stencil plates; stencils; stencils for decorating food and beverages; stickers [stationery]; table linen of paper; table napkins of paper; table runners of paper; tablecloths of paper; tailors' chalk; tissues of paper for removing make-up; toilet paper; towels of paper; tracing cloth; tracing needles for drawing purposes; tracing paper; tracing patterns; trays for sorting and counting money; T-squares for drawing; type [numerals and letters]; typewriter keys; typewriter ribbons; typewriters, electric or non-electric; vignetting apparatus; viscose sheets for wrapping; washi; waxed paper; wood pulp board [stationery]; wood pulp paper; wrapping paper; wristbands for the retention of writing instruments; writing board erasers; writing brushes; writing cases [stationery]; writing chalk; writing instruments; writing materials; writing or drawing books; writing paper; writing slates; stamps [seals]; absorbent sheets of paper or plastic for foodstuff packaging; adhesive tape dispensers [office requisites]; adhesives [glues] for stationery or household purposes; advertisement boards of paper or cardboard; blank punch cards for knitting machines; carbon paper; banners of paper; copying paper [stationery]; correcting fluids [office requisites]; erasers; figurines of papier mâché; fingerstalls for office use; floor decals; gums [adhesives] for stationery or household purposes; origami folding paper; place mats of paper; plastic cling film, extensible, for palletization; plastic film for wrapping; sealing stamps; seals [stamps]; signboards of paper or cardboard; mats of paper for beer glasses; clips for name badge holders [office requisites]; mimeograph apparatus and machines; tablemats of paper; tags for index cards; graining combs; paper creasers [office requisites]; coasters of paper; stamp stands; sheets of reclaimed cellulose for wrapping; gummed tape [stationery]; credit card im printers, non-electric; tissue paper; plastic bubble film for wrapping; flip charts; baking paper; mezuzah par-

chments; plantable seed paper [stationery]; conical paper bags; food bags of paper or plastics; desk mats; cigar bands; document files [stationery]; ink sticks; desktop cabinets for stationery [office requisites]; protective covers for books; stencils [stationery]; Indian inks; face towels of paper; scrapbooks; almanacs; forms, printed; coloring books; greeting cards; postcards; watercolors [paintings]; atlases; souvenir banknotes; tickets; pamphlets; booklets; newsletters; bunting of paper; newspapers; terrestrial globes; engravings; penholders; diagrams; magazines [periodicals]; periodicals; printed publications; graphic representations; calendars; pictures; transfers [decalcomanias]; paintings [pictures], framed or unframed; coloring pictures; cards; printed geographical maps; trading cards, other than for games; catalogues; books; comic books; flyers; lithographs; architects' models; postage stamps; graphic prints; teaching materials [except apparatus]; printed sheet music; embroidery designs [patterns]; oleographs; musical greeting cards; song books; posters; portraits; printed matter; lithographic works of art; prospectuses; printed timetables; ledgers [books]; indexes; calculating tables; stationery; handwriting specimens for copying; manuals [handbooks]; photo-engravings; photographs [printed]; blueprints; chromolithographs [chromos]; shields [paper seals]; prints [engravings]; labels of paper or cardboard; paper party decorations; etchings; graphic reproductions.

(260) AM 2026 134513 A

(800) 1862620

(151) 2025 02 27

(891) 2025 02 27

(731) Messe Frankfurt Exhibition GmbH

Ludwig-Erhard-Anlage 1, 60327 Frankfurt
am Main, Germany

(540)

TEXPERTISE

(591) Black, white

(511)

9 – Magnetic data carriers; recording discs; CDs, DVDs and other digital data recording media or data carriers; downloadable electronic publications, electronic books, electronic brochures, electronic texts, image files, computer programs, electronic games, music files, films, videos; software.

16 – Printed matter, particularly newspapers, periodicals, magazines, cards, catalogues, pamphlets, handbooks, prospectuses, placards and photographs; instructional and teaching materials.

35 – Advertising, marketing and promotional services; business management; business organization; business administration; office functions; marketing research; telemarketing services; personnel management consultancy; employment agency services; arranging, organizing and conducting trade shows, trade fairs and exhibitions for commercial and advertising purpo-

ses; business assistance, management and administrative services, particularly in respect of conducting, arranging and organizing trade shows, trade fairs and exhibitions; organizing and conducting of product presentations; arranging of presentations for advertising purposes; arranging of presentations for business purposes; arranging of presentations for commercial purposes; arranging of presentations for trade purposes; presentation of companies and their goods and services on the internet; sales promotion for others; merchandising; business merchandising display services; arranging commercial transactions, for others, via online shops; demonstration of goods (for publicity purposes); arranging of commercial and business contacts, also via the Internet; rental of advertising space and advertising material; rental of advertising time on communication media; providing and rental of space for trade shows, trade fairs and exhibitions for commercial and advertising purposes; rental of sales stands; business management assistance and consultancy, particularly in respect of conducting, arranging and organizing trade shows, trade fairs and exhibitions; organisation of fashion shows for commercial purposes; organisation of fashion shows for promotional purposes; compilation, updating and maintenance of data in computer databases; compilation of information into computer databases; publication of printed matter (also in electronic form) for advertising purposes; searches about business topics in computer databases and in the Internet; business advice, also in the Internet; commercial information; trade information; providing business information; providing commercial and business contact information; customer loyalty, incentive and bonus program services; organisation and management of customer loyalty programs; loyalty scheme services and supervision of customer loyalty schemes; human resources management and recruitment services; job and personnel placement; information services relating to jobs and career opportunities; production of advertising films; production of video recordings for advertising purposes; production of video recordings for marketing purposes.

38 – Telecommunications; telecommunication services provided via platforms and portals on the Internet and other media, particularly for conducting virtual trade fairs; providing access to telecommunication networks, particularly to the Internet and to Intranets; e-mail data services; electronic data transmission; electronic transmission of messages; electronic transmission of images; transmission of videos, movies, pictures, images, text, photos, games, user-generated content, audio content, and information via the Internet; providing access to databases, particularly interactive databases containing information about consumer goods and industrial products; provision of access to content, websites and portals; providing access to platforms and portals on the internet; providing chatrooms in virtual environments; providing internet chatrooms; providing access to Internet forums or

chatrooms; provision of access to data via the Internet; electronic exchange of messages via chat lines, chatrooms and Internet forums; streaming of data; streaming of audio, visual and audiovisual material via a global computer network; transmission of messages over electronic media; web conferencing services; news agency services; providing access to information on the Internet; providing access to weblogs; rental of access time to global computer networks, particularly for watching events (service relating to telecommunication).

41 – Education; providing of training; entertainment; sporting and cultural activities; educational consultancy services; consultancy services relating to training; vocational guidance; arranging, organizing and conducting of conferences, exhibitions, competitions and shows for cultural or educational purposes; arranging and conducting of educational events; arranging, organizing and conducting of congresses, seminars, conferences, symposia, workshops or colloquiums; production of shows; arranging of entertainment shows; organization and conducting of balls; arranging and conducting of competitions [education or entertainment]; presentation of live performances; presentation of musical performances; party planning [entertainment]; providing online electronic publications, not downloadable; publication and editing of printed matter; publication of printed matter in electronic form; publication of periodicals, catalogs and books in electronic form, also in the Internet; game services provided online from a computer network; booking of seats for shows; ticket agency services [entertainment], also via the Internet; video production; film production, other than advertising films; providing online videos, not downloadable; providing films, not downloadable, via video-on-demand services; providing information in the field of entertainment; providing information in the field of education; providing information in the field of activities for recreational purposes; providing information about sporting activities; providing information about cultural activities; gambling services.

(260) AM 2026 134627 A

(800) 1863782

(151) 2025 04 11

(891) 2025 04 11

(731) LAUNCH TECH CO., LTD.

Launch Industrial Park, No. 4012, North Wuhe Road, Bantian Street, Longgang District, Shenzhen, Guangdong, China

(540)



(591) Black, white
 (531) 16.03.17; 18.01.09; 18.01.23; 27.05.01;
 27.05.02; 27.05.09

(526) AI
 (511)

9 – Computer programs for editing images, sound and video; computer operating programs, recorded; downloadable software applications for mobile phones; computer chatbot software for simulating conversations; computer software for processing digital music files; computer software applications, downloadable; data processing apparatus; compiler software; software for processing images, graphics and text; computer software platforms, recorded or downloadable; user-programmable humanoid robots, not configured; computer software programs for spreadsheet management; downloadable computer software for collecting, analyzing and organizing data in the field of deep learning; computer software for database management; humanoid robots having communication and learning functions for assisting and entertaining people.

42 – Research in the field of deep learning; research in the field of artificial intelligence technology; artificial intelligence consultancy; conversion of computer programs and data, other than physical conversion; design and development of software in the field of mobile applications; development and creation of computer programmes for data processing; development, updating and maintenance of software and database systems; Software as a Service [SaaS]; design and development of computer software; providing virtual computer systems through cloud computing.

(260) AM 2026 134628 A
 (800) 1863870
 (151) 2025 02 25
 (891) 2025 02 25
 (731) INDUSTRIA DE DISEÑO TEXTIL, S.A.
 (INDITEX, S.A.)
 Avenida de la Diputación, "Edificio Inditex",
 E-15142 Arteixo (A Coruña), Spain
 (540)

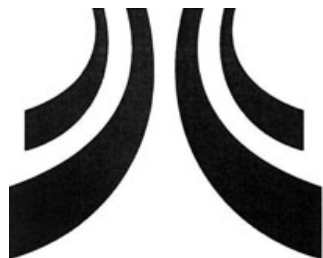

(591) Black, white
 (531) 26.11.03; 26.11.12
 (511)

9 – Spectacles; optical lenses; spectacle chains; contact lenses; spectacle cords; spectacle lenses; spectacle cases; spectacle frames; sunglasses; lens cases; containers for contact lenses; footwear for protection against accidents, irradiation and fire; life jackets; clot-

hing for protection against accidents, irradiation and fire; gloves for protection against accidents; dive skins; divers' masks; nose clips for divers and swimmers; gloves for divers; breathing apparatus for underwater swimming; head protection; chronographs [time recording apparatus]; pedometers; walkie-talkies; teeth protectors; goggles for sports; snorkels; smartwatches; personal stereos; cell phone covers; wearable activity trackers; headphones; diving suits; wet suits; dry suits; helmets for use in sports; shields for protecting the body against injury.

21 – Household or kitchen utensils; containers for household or kitchen use; combs; sponges; brushes; material for brush-making; cleaning articles; steel wool for cleaning; unworked glass [except glass used in building]; semi-worked glass [except glass used in building]; crystal [glassware]; porcelain ware; earthenware; bottle openers, electric and non-electric; cruet sets for oil and vinegar; cocktail stirrers; candle extinguishers; make-up removing appliances; sugar bowls; trays for household purposes; baby baths, portable; dishcloths; tea strainers; candy boxes; bottles; shaving brushes; coffeepots, non-electric; bread bins; heaters for feeding bottles, non-electric; shoe horns; candelabra [candlesticks]; pipettes [wine-tasters]; epergnes; baskets for household purposes; strainers; clothing stretchers; ice buckets; tie presses; comb cases; ironing board covers, shaped; gardening gloves; gloves for household purposes; polishing gloves; shoe trees; non-metal coin banks; soap racks; decanters; birdcages; fitted vanity cases; works of art of porcelain, ceramic, earthenware, terra-cotta or glass; toothpick holders; carpet beaters [hand instruments]; bread baskets for household purposes; cloths for cleaning; pepper pots; clothes-pegs; table plates; feather-dusters; shaving brush stands; sponge holders; toilet paper holders; trouser presses; scent sprays [atomizers]; crumb trays; coasters, not of paper or textile; trivets [table utensils]; boot jacks; salt cellars; clothes drying racks; coffee services [tableware]; tea services [tableware]; table napkin holders; washing boards; ironing boards; cutting boards for the kitchen; cups; teapots; flower pots; tableware, other than knives, forks and spoons; heat-insulated containers; toothbrushes; floss for dental purposes; fruit presses, non-electric, for household purposes; buttonhooks; siphon bottles for carbonated water; nozzles for watering cans; cat litter pans; cages for household pets; cattle hair for brushes; mangers for animals; buckets; dish covers; indoor aquaria; mess-tins; cookware, except forks, knives and spoons; beaters, non-electric; drinking bottles for sports; glass jars [carboys]; isothermic bags; demijohns; glasses [receptacles]; nozzles for watering hose; powder puffs; busts of porcelain, ceramic, earthenware, terracotta or glass; brushes for footwear; stew-pans; pots; closures for pot lids; boxes of glass; coffee grinders; tea caddies; cheese-dish covers; candle drip rings; jugs; lazy susans; earthenware saucepans; dishwashing brushes; traps for rodents; ceramics for house-

hold purposes; beer mugs; fitted picnic baskets, including dishes; cooking utensils, non-electric; cookery moulds; jars; washtubs; fruit cups; corkscrews, electric and non-electric; cosmetic utensils; sieves [household utensils]; painted glassware; cups of paper or plastic; drinking goblets; dustbins for household purposes; flower-pot covers, not of paper; mixing spoons [kitchen utensils]; bowls [basins]; deodorizing apparatus for personal use; soap dispensing bottles; funnels; salad bowls; brooms; mops; brushes for cleaning tanks and containers; enamelled glass; spatulas for kitchen use; spice sets; statues, figurines, plaques and works of art, made of materials such as porcelain, terra-cotta or glass, included in the class; scouring pads; strainers for household purposes; holders for flowers and plants [flower arranging]; flasks; deep fryers, non-electric; frying pans; dishes; chamois leather for cleaning; ice cube moulds; vessels of metal for making ices and iced drinks; egg cups; glass signboards; porcelain signboards; liqueur sets; pie funnels; butter dishes; cooking pots, non-electric; cocktail shakers; mosaics of glass, not for building; portable cool boxes, non-electric; autoclaves, non-electric, for cooking; chamber pots; scoops for household purposes; toothpicks; rolling pins, domestic; perfume burners, electric and non-electric; powder compacts; curry-combs; watering cans; watering devices; cookie [biscuit] cutters; soup tureens; glass stoppers for bottles; mugs; buckets made of woven fabrics; indoor terrariums [vivariums]; towel racks; urns; candle jars [holders]; vases; knife rests for the table; garlic presses [kitchen utensils]; graters for kitchen use; chopsticks.

24 – Textiles and substitutes for textiles; linens; curtains of textile or plastic; bed linen; table linen; bath linen; cloths for removing make-up; labels of textile; linings [textile]; wall hangings of textile; handkerchiefs of textile; bath mitts; shrouds; towels of textile; travelling rugs [lap robes]; curtains; curtain holders of textile material; flags of textile or plastic; duvets; coverings for furniture; covers for cushions; mattress covers; pillowcases; mosquito nets; glass cloths [towels]; billiard cloth; tablecloths, not of paper; traced cloths for embroidery; face towels of textile; sleeping bags [sheeting]; cotton fabrics; haircloth [sackcloth]; brocades; lining fabric for footwear; fabric for footwear; bed covers; bed blankets; trellis [cloth]; zephyr [cloth]; cheviots [cloth]; ticks [mattress covers]; shower curtains of textile or plastic; crepe [fabric]; crepon; damask; elastic woven fabrics; oilcloth for use as tablecloths; gummed cloth, other than for stationery purposes; esparto fabric; chenille fabric; felt; flannel [fabric]; fitted toilet lid covers of fabric; gauze [cloth]; jersey [fabric]; woollen cloth; lingerie fabric; linen cloth; place mats of textile; printers' blankets of textile; marabouts [cloth]; woven fabrics for furniture; fabric of imitation animal skins; knitted fabric; cheese cloth; ramie fabric; rayon fabric; silk [cloth]; taffeta [cloth]; fibreglass fabrics for textile use; adhesive fabric for application by heat; patterned textiles for

use in embroidery; velvet; tulle; table runners of textile; sleeping bags.

27 – Carpets; door mats; mats; beach mats; bathmats; linoleum; wall hangings, not of textile; wallpaper; floor coverings and artificial ground coverings; primary carpet backing; yoga mats.

28 – Gymnastic and sporting articles; decorations for Christmas trees; baseball gloves; boxing gloves; fencing gauntlets; golf gloves; puppets; body-building apparatus; bladders of balls for games; elbow guards [sports articles]; knee guards [sports articles]; flippers for swimming; archery implements; water wings; balls for games; bodyboards; skittles [games]; golf club bags; darts; discuses for sports; skis; sole coverings for skis; surfboard covers; hockey sticks; tabletop games; skateboards; golf clubs; billiard cues; billiard tables; in-line roller skates; ice skates; roller skates; scooters [toys]; punching bags; rackets; surfboards; sailboards; chessboards; spring boards [sports articles]; sleds [sports articles]; shuttlecocks; foosball tables; stationary exercise bicycles; tables for table tennis; yoga blocks; yoga straps; yoga wheels; football gloves; weight lifting gloves; gloves made specifically for use in playing sports; sportballs; dumbbells; protective padding for sports; skipping ropes; basketball baskets; ski sticks; abdominal wheel rollers for fitness purposes.

**INTERNATIONAL TRADEMARKS PROTECTED
IN GEORGIA**

(260) AM 2026 128524 A
(800) 1791632
(151) 2023 11 24
(181) 2033 11 24
(891) 2023 11 24
(511) 5

(260) AM 2026 128525 A
(800) 1791635
(151) 2023 11 29
(181) 2033 11 29
(891) 2023 11 29
(511) 7

(260) AM 2026 128526 A
(800) 1791637
(151) 2024 02 06
(181) 2034 02 06
(891) 2024 02 06
(511) 8

(260) AM 2026 128528 A
(800) 1791688
(151) 2023 11 23
(181) 2033 11 23
(891) 2023 11 23
(511) 5

(260) AM 2026 128529 A
(800) 1791695
(151) 2024 03 11
(181) 2034 03 11
(891) 2024 03 11
(511) 5

(260) AM 2026 128530 A
(800) 1791731
(151) 2024 02 09
(181) 2034 02 09
(891) 2024 02 09
(511) 30

(260) AM 2026 128531 A
(800) 1791781
(151) 2024 01 15
(181) 2034 01 15

(891) 2024 01 15
(511) 33

(260) AM 2026 128537 A
(800) 1791867
(151) 2024 03 22
(181) 2034 03 22
(891) 2024 03 22
(511) 29, 30, 32

(260) AM 2026 128538 A
(800) 1791869
(151) 2024 03 15
(181) 2034 03 15
(891) 2024 03 15
(511) 2

(260) AM 2026 128539 A
(800) 1791909
(151) 2024 01 25
(181) 2034 01 25
(891) 2024 01 25
(511) 3, 11

(260) AM 2026 128541 A
(800) 1791928
(151) 2024 03 27
(181) 2034 03 27
(891) 2024 03 27
(511) 34

(260) AM 2026 128542 A
(800) 1792030
(151) 2024 01 24
(181) 2034 01 24
(891) 2024 01 24
(511) 11, 18, 20, 21, 24, 25

(260) AM 2026 128549 A
(800) 1396813
(151) 2017 12 21
(181) 2027 12 21
(891) 2024 05 09
(511) 5

(260) AM 2026 128550 A
(800) 1433066
(151) 2018 08 16
(181) 2028 08 16
(891) 2024 05 09
(511) 5

(260) AM 2026 129002 A
(800) 1797763
(151) 2024 01 23
(181) 2034 01 23
(891) 2024 01 23
(511) 7, 8, 9, 37, 41

(260) AM 2026 128551 A
(800) 1512395
(151) 2019 11 20
(181) 2029 11 20
(891) 2023 09 20
(511) 5, 9, 11

(260) AM 2026 129017 A
(800) 1798060
(151) 2024 02 06
(181) 2034 02 06
(891) 2024 02 06
(511) 7, 8

(260) AM 2026 128611 A
(800) 1792816
(151) 2024 01 18
(181) 2034 01 18
(891) 2024 01 18
(511) 09, 35, 42

(260) AM 2026 129080 A
(800) 1798421
(151) 2024 05 08
(181) 2034 05 08
(891) 2024 05 08
(511) 28

(260) AM 2026 128612 A
(800) 1792818
(151) 2024 02 28
(181) 2034 02 28
(891) 2024 02 28
(511) 6, 35, 40

(260) AM 2026 129105 A
(800) 1798990
(151) 2024 04 29
(181) 2034 04 29
(891) 2024 04 29
(511) 5, 30, 32

(260) AM 2026 128613 A
(800) 1792866
(151) 2024 05 02
(181) 2034 05 02
(891) 2024 05 02
(511) 4

(260) AM 2026 129106 A
(800) 1799062
(151) 2024 02 09
(181) 2034 02 09
(891) 2024 02 09
(511) 14

(260) AM 2026 128681 A
(800) 1793781
(151) 2023 04 12
(181) 2033 04 12
(891) 2023 04 12
(511) 29, 30, 31, 35, 39

(260) AM 2026 129356 A
(800) 1801961
(151) 2024 02 23
(181) 2034 02 23
(891) 2024 02 23
(511) 9, 28, 41

(260) AM 2026 128881 A
(800) 1796082
(151) 2024 05 08
(181) 2034 05 08
(891) 2024 05 08
(511) 7

(260) AM 2026 129526 A
(800) 1803353
(151) 2024 03 22
(181) 2034 03 22
(891) 2024 03 22
(511) 9, 28, 41

(260) AM 2026 130707 A
(800) 1819570
(151) 2024 07 25
(181) 2034 07 25
(891) 2024 07 25
(511) 3, 21, 29, 30, 32, 33, 35, 43

(260) AM 2026 132186 A
(800) 1002507
(151) 2009 02 16
(181) 2029 02 16
(891) 2024 12 04
(511) 7

(260) AM 2026 131905 A
(800) 667563
(151) 1996 11 14
(181) 2026 11 14
(891) 2024 12 05
(511) 29

(260) AM 2026 132187 A
(800) 1127796
(151) 2012 06 12
(181) 2032 06 12
(891) 2025 01 15
(511) 4

(260) AM 2026 132023 A
(800) 1835856
(151) 2024 08 16
(181) 2034 08 16
(891) 2024 08 16
(511) 8, 21

(260) AM 2026 132205 A
(800) 1827263
(151) 2024 08 16
(181) 2034 08 16
(891) 2025 01 22
(511) 4

(260) AM 2026 132058 A
(800) 1784110
(151) 2024 02 07
(181) 2034 02 07
(891) 2025 01 14
(511) 9

(260) AM 2026 132278 A
(800) 1838381
(151) 2024 09 30
(181) 2034 09 30
(891) 2024 09 30
(511) 9, 28, 41

(260) AM 2026 132060 A
(800) 1814487
(151) 2024 07 17
(181) 2034 07 17
(891) 2024 12 22
(511) 7, 9, 12

(260) AM 2026 132279 A
(800) 1838396
(151) 2024 11 18
(181) 2034 11 18
(891) 2024 11 18
(511) 29

(260) AM 2026 132120 A
(800) 1836661
(151) 2024 12 19
(181) 2034 12 19
(891) 2024 12 19
(511) 1, 2, 3, 4

(260) AM 2026 132280 A
(800) 1838411
(151) 2024 12 13
(181) 2034 12 13
(891) 2024 12 13
(511) 30, 35

(260) AM 2026 132184 A
(800) 523393
(151) 1988 04 14
(181) 2028 04 14
(891) 2025 01 10
(511) 16

(260) AM 2026 132309 A
(800) 1839090
(151) 2024 11 19
(181) 2034 11 19
(891) 2024 11 19
(511) 7, 11

(260) AM 2026 132311 A
(800) 1839134
(151) 2024 10 30
(181) 2034 10 30
(891) 2024 10 30
(511) 33

(260) AM 2026 132529 A
(800) 1840523
(151) 2024 11 22
(181) 2034 11 22
(891) 2024 11 22
(511) 12

(260) AM 2026 132312 A
(800) 1839165
(151) 2024 12 16
(181) 2034 12 16
(891) 2024 12 16
(511) 33

(260) AM 2026 132530 A
(800) 1840524
(151) 2024 11 22
(181) 2034 11 22
(891) 2024 11 22
(511) 12

(260) AM 2026 132388 A
(800) 1839603
(151) 2024 11 13
(181) 2034 11 13
(891) 2024 11 13
(511) 5

(260) AM 2026 132539 A
(800) 1840576
(151) 2024 12 18
(181) 2034 12 18
(891) 2024 12 18
(511) 9, 28, 41

(260) AM 2026 132431 A
(800) 1840176
(151) 2024 07 25
(181) 2034 07 25
(891) 2024 07 25
(511) 9, 36, 41, 42

(260) AM 2026 132555 A
(800) 1840733
(151) 2025 01 26
(181) 2035 01 26
(891) 2025 01 26
(511) 9

(260) AM 2026 132432 A
(800) 1840177
(151) 2024 07 25
(181) 2034 07 25
(891) 2024 07 25
(511) 9, 36, 41, 42

(260) AM 2026 132637 A
(800) 1841998
(151) 2024 10 16
(181) 2034 10 16
(891) 2024 10 16
(511) 9, 42

(260) AM 2026 132527 A
(800) 1840388
(151) 2024 08 23
(181) 2034 08 23
(891) 2024 08 23
(511) 18, 28

(260) AM 2026 132711 A
(800) 1842143
(151) 2025 01 02
(181) 2035 01 02
(891) 2025 01 02
(511) 3

(260) AM 2026 132528 A
(800) 1840422
(151) 2024 09 13
(181) 2034 09 13
(891) 2024 09 13
(511) 9, 28, 41

(260) AM 2026 132712 A
(800) 1842187
(151) 2024 12 17
(181) 2034 12 17
(891) 2024 12 17
(511) 3, 5, 10

(260) AM 2026 132716 A
 (800) 1842256
 (151) 2025 01 30
 (181) 2035 01 30
 (891) 2025 01 30
 (511) 12, 25, 28

(260) AM 2026 132946 A
 (800) 1844460
 (151) 2024 12 23
 (181) 2034 12 23
 (891) 2024 12 23
 (511) 25

(260) AM 2026 132717 A
 (800) 1842274
 (151) 2025 01 08
 (181) 2035 01 08
 (891) 2025 01 08
 (511) 33

(260) AM 2026 132948 A
 (800) 1844498
 (151) 2024 12 13
 (181) 2034 12 13
 (891) 2024 12 13
 (511) 1, 2, 3, 4, 5

(260) AM 2026 132816 A
 (800) 1843248
 (151) 2024 12 19
 (181) 2034 12 19
 (891) 2024 12 19
 (511) 34

(260) AM 2026 132949 A
 (800) 1844500
 (151) 2025 01 16
 (181) 2035 01 16
 (891) 2025 01 16
 (511) 29, 30

(260) AM 2026 132818 A
 (800) 1843293
 (151) 2025 01 13
 (181) 2035 01 13
 (891) 2025 01 13
 (511) 5

(260) AM 2026 132982 A
 (800) 1845550
 (151) 2024 11 25
 (181) 2034 11 25
 (891) 2024 11 25
 (511) 20, 42

(260) AM 2026 132891 A
 (800) 1524297
 (151) 2020 01 30
 (181) 2030 01 30
 (891) 2025 02 21
 (511) 5

(260) AM 2026 132998 A
 (800) 1755617
 (151) 2023 08 02
 (181) 2033 08 02
 (891) 2024 12 24
 (511) 12

(260) AM 2026 132942 A
 (800) 1844414
 (151) 2024 12 19
 (181) 2034 12 19
 (891) 2024 12 19
 (511) 30, 35, 43

(260) AM 2026 132999 A
 (800) 1789110
 (151) 2024 03 28
 (181) 2034 03 28
 (891) 2025 02 24
 (511) 29

(260) AM 2026 132945 A
 (800) 1844433
 (151) 2024 12 04
 (181) 2034 12 04
 (891) 2024 12 04
 (511) 29, 30, 32, 35, 43

(260) AM 2026 133000 A
 (800) 1806206
 (151) 2024 05 16
 (181) 2034 05 16
 (891) 2025 01 06
 (511) 12

(260) AM 2026 133001 A
(800) 1815357
(151) 2024 06 24
(181) 2034 06 24
(891) 2024 12 25
(511) 15

(260) AM 2026 133112 A
(800) 1846816
(151) 2024 11 29
(181) 2034 11 29
(891) 2024 11 29
(511) 31

(260) AM 2026 133002 A
(800) 1832930
(151) 2024 09 25
(181) 2034 09 25
(891) 2025 03 06
(511) 25

(260) AM 2026 133113 A
(800) 1846819
(151) 2024 12 31
(181) 2034 12 31
(891) 2024 12 31
(511) 3

(260) AM 2026 133003 A
(800) 1833972
(151) 2024 11 22
(181) 2034 11 22
(891) 2025 02 14
(511) 12

(260) AM 2026 133120 A
(800) 1767192
(151) 2023 06 28
(181) 2033 06 28
(891) 2025 01 22
(511) 9

(260) AM 2026 133095 A
(800) 1846121
(151) 2024 12 03
(181) 2034 12 03
(891) 2024 12 03
(511) 5

(260) AM 2026 133121 A
(800) 1785532
(151) 2023 12 25
(181) 2033 12 25
(891) 2024 12 27
(511) 3, 9, 11, 12, 18, 28

(260) AM 2026 133096 A
(800) 1846122
(151) 2024 12 03
(181) 2034 12 03
(891) 2024 12 03
(511) 5

(260) AM 2026 133122 A
(800) 1821144
(151) 2024 07 03
(181) 2034 07 03
(891) 2025 03 13
(511) 11, 20

(260) AM 2026 133110 A
(800) 1846778
(151) 2025 02 10
(181) 2035 02 10
(891) 2025 02 10
(511) 3, 21, 35

(260) AM 2026 133123 A
(800) 1832386
(151) 2024 04 15
(181) 2034 04 15
(891) 2025 03 11
(511) 41, 43

(260) AM 2026 133111 A
(800) 1846795
(151) 2025 02 26
(181) 2035 02 26
(891) 2025 02 26
(511) 5

(260) AM 2026 133124 A
(800) 1841044
(151) 2024 12 06
(181) 2034 12 06
(891) 2025 03 07
(511) 3, 5

(260) AM 2026 133183 A
(800) 1846867
(151) 2024 12 03
(181) 2034 12 03
(891) 2024 12 03
(511) 43

(260) AM 2026 133214 A
(800) 1847746
(151) 2025 01 10
(181) 2035 01 10
(891) 2025 01 10
(511) 5

(260) AM 2026 133184 A
(800) 1846891
(151) 2025 02 04
(181) 2035 02 04
(891) 2025 02 04
(511) 5

(260) AM 2026 133215 A
(800) 1847747
(151) 2025 01 10
(181) 2035 01 10
(891) 2025 01 10
(511) 5

(260) AM 2026 133185 A
(800) 1846893
(151) 2024 08 14
(181) 2034 08 14
(891) 2024 08 14
(511) 43

(260) AM 2026 133216 A
(800) 1847774
(151) 2024 05 07
(181) 2034 05 07
(891) 2024 05 07
(511) 9, 14, 16, 18

(260) AM 2026 133186 A
(800) 1846903
(151) 2025 01 08
(181) 2035 01 08
(891) 2025 01 08
(511) 2

(260) AM 2026 133217 A
(800) 1847793
(151) 2024 11 15
(181) 2034 11 15
(891) 2024 11 15
(511) 9, 28

(260) AM 2026 133187 A
(800) 1846972
(151) 2024 11 07
(181) 2034 11 07
(891) 2024 11 07
(511) 35

(260) AM 2026 133219 A
(800) 1847850
(151) 2024 12 27
(181) 2034 12 27
(891) 2024 12 27
(511) 1, 2, 3, 6, 7, 8, 9, 11, 14, 16, 18, 19, 21, 25, 28

(260) AM 2026 133188 A
(800) 1847026
(151) 2024 12 03
(181) 2034 12 03
(891) 2024 12 03
(511) 5

(260) AM 2026 133221 A
(800) 1847939
(151) 2025 02 27
(181) 2035 02 27
(891) 2025 02 27
(511) 33

(260) AM 2026 133213 A
(800) 1847723
(151) 2024 12 30
(181) 2034 12 30
(891) 2024 12 30
(511) 43

(260) AM 2026 133222 A
(800) 1847954
(151) 2025 02 21
(181) 2035 02 21
(891) 2025 02 21
(511) 09, 35

(260) AM 2026 133223 A
(800) 1847958
(151) 2024 12 31
(181) 2034 12 31
(891) 2024 12 31
(511) 31

(260) AM 2026 133294 A
(800) 1848223
(151) 2025 01 21
(181) 2035 01 21
(891) 2025 01 21
(511) 9

(260) AM 2026 133224 A
(800) 1847963
(151) 2024 12 31
(181) 2034 12 31
(891) 2024 12 31
(511) 30

(260) AM 2026 133331 A
(800) 1848971
(151) 2025 02 03
(181) 2035 02 03
(891) 2025 02 03
(511) 5, 16, 44

(260) AM 2026 133289 A
(800) 1848153
(151) 2025 02 11
(181) 2035 02 11
(891) 2025 02 11
(511) 5

(260) AM 2026 133332 A
(800) 1848982
(151) 2024 05 07
(181) 2034 05 07
(891) 2024 05 07
(511) 6, 9, 14, 16, 18

(260) AM 2026 133290 A
(800) 1848158
(151) 2025 01 17
(181) 2035 01 17
(891) 2025 01 17
(511) 5

(260) AM 2026 133333 A
(800) 1848989
(151) 2024 11 13
(181) 2034 11 13
(891) 2024 11 13
(511) 18, 25, 35

(260) AM 2026 133291 A
(800) 1848177
(151) 2024 11 26
(181) 2034 11 26
(891) 2024 11 26
(511) 30

(260) AM 2026 133334 A
(800) 1849023
(151) 2025 01 29
(181) 2035 01 29
(891) 2025 01 29
(511) 30, 32

(260) AM 2026 133292 A
(800) 1848195
(151) 2025 02 17
(181) 2035 02 17
(891) 2025 02 17
(511) 9

(260) AM 2026 133335 A
(800) 1849025
(151) 2025 01 31
(181) 2035 01 31
(891) 2025 01 31
(511) 5, 10, 25

(260) AM 2026 133293 A
(800) 1848208
(151) 2025 01 13
(181) 2035 01 13
(891) 2025 01 13
(511) 9

(260) AM 2026 133336 A
(800) 1849066
(151) 2025 01 31
(181) 2035 01 31
(891) 2025 01 31
(511) 5

(260) AM 2026 133337 A
(800) 1849109
(151) 2025 02 28
(181) 2035 02 28
(891) 2025 02 28
(511) 7

(260) AM 2026 133437 A
(800) 1850120
(151) 2024 11 01
(181) 2034 11 01
(891) 2024 11 01
(511) 20, 21

(260) AM 2026 133438 A
(800) 1850146
(151) 2024 11 08
(181) 2034 11 08
(891) 2024 11 08
(511) 9, 35, 38, 42

(260) AM 2026 133439 A
(800) 1850214
(151) 2024 12 26
(181) 2034 12 26
(891) 2024 12 26
(511) 16

(260) AM 2026 133441 A
(800) 1850233
(151) 2025 02 27
(181) 2035 02 27
(891) 2025 02 27
(511) 10, 44

APPELLATIONS OF ORIGIN OF GOODS
PROTECTED INTERNATIONAL APPELLATIONS OF ORIGIN
OF GOODS

(800) 1430
(151) 2025 03 18
(732) Birjand Chamber of Commerce, Industries, Mines, and Agriculture
Sarbisheh City, Iran;
South Khorasan Mining Engineering Organization
Sarbisheh city, Iran;
South Khorasan Mining House
Sarbisheh City, Iran

(540)

Sang e Bazalt e Manshoori e Talaie e Sarbishe e Iran

(511)
19 – Golden prismatic basalt.

(800) 1428
(151) 2025 03 18
(732) Kansar Khazar Company
Aqqala City, Iran;
Shurabeh Yade Golestan Company
Aqqala City, Iran

(540)

Yod e Aqqala e Iran

(511)
1 – Iodine.
5 – Iodine.

(800) 1429
(151) 2025 03 18
(732) National Company for the Preparation and Production of Refractory Materials.
The cities of Zahedan and Khash, Iran

(540)

Sang e Manyazit e Zahedan va Khash e Iran

(511)
1 – Magnesite stone.
19 – Magnesite stone.

(800) 1438
(151) 2025 03 18
(732) Urmia Gardeners Cooperative Company
Urmia City, Iran

(540)

Sib e Urmia e Iran

(511)
31 – Apple.

(800) 1439

(151) 2025 03 18

(732) Urmia Gardeners Cooperative Company

Urmia City, Iran

(540)

Angor e Urmia e Iran

(511)

31 – Grape.

OFFICIAL NOTIFICATIONS

INVENTIONS

LAPSE OF PATENT WITH THE RIGHT TO RESTORE

(21) AP 2024 16470

(11) P 2025 7726 B

(73) Gigo Jandieri;
Inga Janelidze;
Omar Mikadze;
David Sakhvadze;
Emzar Janelidze

(54) METHOD FOR CASTING OF GRADIENT ALLOYED MOLDS WITH GASIFIABLE MODELS

DATE OF PATENT LAPSE: 2026 03 04

PATENT RESTORATION TERM: 2027 03 04

(21) AP 2024 16473

(11) P 2024 7681 B

(73) LTD "Tekhuri-21";
Grigol Kvaratskhelia

(54) A DAMLESS HYDROELECTRIC POWER STATION AND A COMBINED POWER GENERATION SYSTEM AT ITS BASE

DATE OF PATENT LAPSE: 2026 03 06

PATENT RESTORATION TERM: 2027 03 06

EXPIRATION OF PATENTS RESTORATION TERM

(21) AP 2022 15900

(11) P 2024 7630 B

(73) Ramini Ghvaladze

(54) METHOD OF BAKING DOUGH PRODUCTION WITHOUT YEAST

DATE OF PATENT LAPSE: 2025 03 10

DATE OF EXPIRATION OF PATENT RESTORATION TERM: 2026 03 10

(21) AP 2022 15901

(11) P 2024 7620 B

(73) Ramini Ghvaladze

(54) BAKING MACHINE FOR BAKING BREAD WITHOUT YEAST

DATE OF PATENT LAPSE: 2025 03 10

DATE OF EXPIRATION OF PATENT RESTORATION TERM: 2026 03 10

EXPIRATION OF PATENT

(21) AP 2006 10356
(11) P 2011 5323 B
(73) Interdigital Technology Corporation
(54) METHOD AND SYSTEM FOR IMPROVING RESPONSIVENESS IN EXCHANGING FRAMES
IN A WIRELESS LOCAL AREA NETWORK
DATE OF PATENT RESTORATION TERM: 2026 03 31

TRANSFER OF RIGHTS

(21) AP 2018 15467
(11) P 2022 7354 B
(54) USE OF A GLUTARIMIDE DERIVATIVE TO TREAT DISEASES RELATED TO THE ABERRANT
ACTIVITY OF CYTOKINES
NEW NAME AND/OR ADDRESS OF PATENT OWNER: Vladimir Evgenievich Nebolsin (RU)
General Kovachevich Street, House 8, Building 1,
Ap. 25, 141170, Moscow Region, Shchelkovo,
RP Monino, Georgievskiy m/r, Russian
Federation (RU)
FORMER NAME AND/OR ADDRESS OF PATENT OWNER: Obshchestvo s Ogranichennoy Otvetstven-
nostju "Pharmenterprises"
Skolkovo Innovation Center, Bolshoi Blvd. 42,
Building 1, Office 771, 772, 121205, Moscow,
Russian Federation (RU)
DATE OF REGISTRATION: 2026 03 31

(21) AP 2019 15511
(11) P 2023 7454 B
(54) NOVEL MODULATOR OF METABOTROPIC AND IONOTROPIC TRANSMEMBRANE RECEPTORS
AND USE THEREOF
NEW NAME AND/OR ADDRESS OF PATENT OWNER: Vladimir Evgenievich Nebolsin (RU)
General Kovachevich Street, House 8, Building 1,
Ap. 25, 141170, Moscow Region, Shchelkovo,
RP Monino, Georgievskiy m/r, Russian
Federation (RU)
FORMER NAME AND/OR ADDRESS OF PATENT OWNER: Obshchestvo s Ogranichennoy Otvetstven-
nostju "Pharmenterprises"
Skolkovo Innovation Center, Bolshoi Blvd. 42,
Building 1, Office 771, 772, 121205, Moscow,
Russian Federation (RU)
DATE OF REGISTRATION: 2026 03 31

(21) AP 2019 15712
(11) P 2023 7467 B
(54) GLUTARIMIDE DERIVATIVE FOR OVERCOMING RESISTANCE TO STEROIDS AND TREATMENT
OF DISEASES ASSOCIATED WITH ABERRANT SIGNALING OF INTERFERON PI3K-GAMMA
NEW NAME AND/OR ADDRESS OF PATENT OWNER: Vladimir Evgenievich Nebolsin (RU)
General Kovachevich Street, House 8, Building 1,
Ap. 25, 141170, Moscow Region, Shchelkovo,

RP Monino, Georgievskiy m/r, Russian Federation (RU)
FORMER NAME AND/OR ADDRESS OF PATENT OWNER: Obshchestvo s Ogranichennoy Otvetstvennostju "Pharmenterprises"
Skolkovo Innovation Center, Bolshoi Blvd. 42, Building 1, Office 771, 772, 121205, Moscow, Russian Federation (RU)
DATE OF REGISTRATION: 2026 03 31

(21) AP 2022 16351
(11) P 2025 7791 B
(54) ANTI-CD30L ANTIBODIES AND USES THEREOF
NEW NAME AND/OR ADDRESS OF PATENT OWNER: Prometheus Biosciences Inc. (US)
3050 Science Park Road, San Diego, California 92121, USA (US)
FORMER NAME AND/OR ADDRESS OF PATENT OWNER: DR. Falk Pharma GMBH (DE)
Leinenweberstraße 5, 79108 Freiburg im Breisgau, Germany (DE)
DATE OF REGISTRATION: 25-03-2026

OPEN LICENSING REGIME

(11) P 2024 7671 B
(10) AP 2024 16050 A
(51) F 41 A 21/30
(44) 2024 05 27 №10
(45) 2024 09 25 №18
(21) AP 2022 16050
(22) 2022 09 27
(24) 2022 09 27
(73) Shota Pertia (GE)
Mirotadze St. 14, Tbilisi, Georgia (GE)
(72) Shota Pertia
(74) Vakhtang Torotadze
(54) METHOD FOR GUN BARREL SHOT MUFFLE AND MUFFLER
Open Licensing Regime Announced

(11) P 2024 7698 B
(10) AP 2024 16422 A
(51) F 41 A 21/30
(43) 2024 11 25 №22
(45) 2024 11 25 №22
(21) AP 2023 16422
(22) 2023 12 14
(24) 2023 12 14
(73) Shota Pertia (GE)
Mirotadze St. 14, Tbilisi, Georgia (GE)
(72) Shota Pertia
(74) Vakhtang Torotadze
(54) FIREARMS AND THEIR CARTRIDGE LOADING MECHANISM DRIVE MUFFLER
Open Licensing Regime Announced

- (11) P 2025 7810 B
 - (10) AP 2025 16598 A
 - (51) F 41 A 21/30
 - (43) 2025 10 27 №20
 - (45) 2025 10 27 №20
 - (21) AP 2024 16598
 - (22) 2024 09 14
 - (24) 2024 09 14
 - (73) Shota Pertia (GE)
 Mirotadze St. 14, Tbilisi, Georgia (GE)
 - (72) Shota Pertia
 - (74) Vakhtang Torotadze
 - (54) GUN MUFFLER
- Open Licensing Regime Announced
-

DESIGNS

EXTENSION OF TERM OF DESIGNS REGISTRATION

(11) D 2022 920 S
(73) LLC "Kvareli Cellar" (GE)
Village Chikaani, 4814, Kvareli, Georgia (GE)
(54) BOTTLE
(28) 1
(24) 2021 06 04
(18) 2031 06 04
(58) 2026 03 23

(11) D 2022 921 S
(73) LLC "Kvareli Cellar" (GE)
Village Chikaani, 4814, Kvareli, Georgia (GE)
(54) BOTTLE LABEL
(28) 1
(24) 2021 06 04
(18) 2031 06 04
(58) 2026 03 23

CANCELLATION OF DESIGNS REGISTRATION

(11) D 2020 866 S
(73) LTD "Eshvi" (GE)
Gergeti St. 3, 0105, Mtatsminda District, Tbilisi, Georgia (GE)
(54) 1.-3. EARRING, 4. NECKLACE
(18) 2025 09 10
(58) 2026 03 18

(11) D 2020 872 S
(73) Ketevan Macharashvili (GE)
Shartava St. 35/37, ent. 1, ap. 47b, 0160, Tbilisi, Georgia (GE)
(54) VEIL
(18) 2025 09 17
(58) 2026 03 25

EXTENSION OF TERM OF INTERNATIONAL DESIGNS REGISTRATION

(11) DM/212 541
(73) Forest Well CO., LTD.
2-18-5-2 Higashiterao, Tsurumi-ku, Yokohama-shi, 230-0077 Kanagawa (JP)
(15) 2021 01 25
(24) 2021 01 25
(18) 2031 01 25
(28) 1
(28') 1
(54) 1. AIR PURIFIER

(11) DM/212 575
(73) Bolt Technology OÜ
Vana-Lõuna Tn 15, EE-10134 Tallinn (EE)
(15) 2021 01 26
(24) 2021 01 26
(18) 2031 01 26
(28) 2
(28') 2
(54) 1.-2. MOTOR SCOOTER

(11) DM/212 608
(73) Omega SA (Omega AG) (Omega LTD.)
Jakob-Stämpfli-Strasse 96, 2502 Biel/Bienne (CH)
(15) 2021 02 04
(24) 2021 02 04
(18) 2031 02 04
(28) 1
(28') 1
(54) 1. WATCH

(11) DM/213 727
(73) Shiseido Company Limited
7-5-5 Ginza, Chuo-ku, 104-0061 Tokyo (JP)
(15) 2021 02 15
(24) 2021 02 15
(18) 2031 02 15
(28) 1
(28') 1
(54) 1. PERFUME BOTTLE

(11) DM/214 503
(73) Hopium S.A.S.
54/56 Avenue Hoche, 75008 Paris (FR)
(15) 2020 11 15
(24) 2020 11 15
(18) 2030 11 15
(28) 3
(28') 2
(54) 1. BODYWORK OF A MOTOR-CAR, 2. RIM FOR MOTOR VEHICLES, 3. MOTOR-CAR COCKPIT

(11) DM/215 790
(73) Tomasz Knysak
Wyszyńskiego 75, 42-200 Częstochowa (PL);
Jagoda Knysak
Okrzei 94, 42-300 Myszków (PL);
Marcin Knysak
Pokorna 2/1010, 00-199 Warszawa (PL)
(15) 2021 03 30
(24) 2021 03 30
(18) 2031 03 30
(28) 1
(28') 1
(54) 1. LETTER BOX

(11) DM/215 810
(73) HOPIUM S.A.S.
54/56 Avenue Hoche, 75008 Paris (FR)
(15) 2021 01 15
(24) 2021 01 15
(18) 2031 01 15
(28) 1
(28') 1
(54) 1. MOTORCAR PLATFORM

(11) DM/67472
(73) Braun GMBH
Frankfurter Str. 145, 61476 Kronberg (DE)
(15) 2006 01 09
(24) 2006 01 09
(18) 2031 01 09
(28) 2
(28') 2
(54) ELECTRIC RAZORS

(11) DM/67542
(73) Richemont International SA
Route Des Biches 10 1752 Villars-sur-Glâne (CH)
(15) 2006 03 02
(24) 2006 03 02
(18) 2031 03 02
(28) 6
(28') 6
(54) WATCHES

(11) DM/67587
(73) Léon Hatot SA (Léon Hatot AG) (Léon Hatot LTD.)
Viaduktstrasse 30, CH-2500 Biel/Bienne (CH)
(15) 2006 03 28
(24) 2006 03 28
(18) 2031 03 28
(28) 2
(28') 2
(54) JEWELLERY, INCLUDING NECKLACES

(11) DM/67589
(73) Léon Hatot SA (Léon Hatot AG) (Léon Hatot LTD.)
Viaduktstrasse 30, CH-2500 Biel/Bienne (CH)
(15) 2006 03 28
(24) 2006 03 28
(18) 2031 03 28
(28) 2
(28') 2
(54) WRISTWATCHES

(11) DM/67620
(73) Compagnie Des Montres Longines, Francillon S.A. (Longines Watch Co., Francillon LTD.)
CH-2610 SAINT-IMIER (CH)
(15) 2006 03 28
(24) 2006 03 28
(18) 2031 03 28
(28) 3
(28') 3
(54) WRISTWATCHES

(11) DM/67621
(73) Montres Breguet S.A.
CH-1344 L'abbaye (CH)
(15) 2006 03 28
(24) 2006 03 28
(18) 2031 03 28
(28) 3
(28') 3
(54) JEWELLERY, INCLUDING NECKLACE (1), RING (2), EARRINGS (3)

(11) DM/67622
(73) Blancpain SA
Le Rocher 12, CH-1348 Le Brassus (CH)
(15) 2006 03 28
(24) 2006 03 28
(18) 2031 03 28
(28) 5
(28') 5
(54) WATCH DIALS, WRISTWATCH

(11) DM/67623
(73) Blancpain SA
Le Rocher 12, CH-1348 Le Brassus (CH)
(15) 2006 03 28
(24) 2006 03 28
(18) 2031 03 28
(28) 3
(28') 3
(54) CUFF LINKS

(11) DM/67671
(73) Montres Breguet S.A.
CH-1344 L'abbaye (CH)
(15) 2006 03 29

(24) 2006 03 29
(18) 2031 03 29
(28) 3
(28') 3
(54) CUFF LINKS

(11) DM/67673
(73) Omega SA (Omega AG) (Omega Ltd.)
Jakob-Stämpfli-Strasse 96 2502 Biel/Bienne (CH)
(15) 2006 03 31
(24) 2006 03 31
(18) 2031 03 31
(28) 4
(28') 4
(54) WRISTWATCHES

(11) DM/67678
(73) Omega SA (Omega AG) (Omega LTD.)
Jakob-Stämpfli-Strasse 96, CH-2502 Biel/Bienne (CH)
(15) 2006 03 31
(24) 2006 03 31
(18) 2031 03 31
(28) 9
(28') 9
(54) JEWELRY, IN PARTICULAR NECKLACES (1, 2), BRACELET (3), RINGS (4, 5, 6), EARRINGS (7, 8, 9)

(11) DM/67711
(73) Montres Breguet S.A.
CH-1344 L'abbaye (CH)
(15) 2006 03 29
(24) 2006 03 29
(18) 2031 03 29
(28) 12
(28') 12
(54) JEWELRY, PARTICULARLY NECKLACES (1, 4, 7, 8, 9), EARRINGS (2, 11), RINGS (3, 12),
BRACELETS (5, 10) AND BROOCH (6)

(11) DM/67734
(73) Montres Breguet S.A.
CH-1344 L'abbaye (CH)
(15) 2006 03 30
(24) 2006 03 30
(18) 2031 03 30
(28) 13
(28') 13
(54) 1.-13. JEWELLERY, INCLUDING NECKLACES (1, 4, 5, 9, 11, 12), EARRINGS (2, 7, 13);
RINGS (3,8), BRACELETS (6, 10)

(11) DM/67739
(73) Omega SA (Omega AG) (Omega Ltd.)
Jakob-Stämpfli-Strasse 96 2502 Biel/Bienne (CH)
(15) 2006 03 30
(24) 2006 03 30
(18) 2031 03 30

(28) 1
(28') 1
(54) WRISTWATCH

(11) DM/67741
(73) Léon Hatot SA (Léon Hatot AG) (Léon Hatot LTD.)
Viaduktstrasse 30, CH-2500 Biel/Bienne (CH)
(15) 2006 03 29
(24) 2006 03 29
(18) 2031 03 29
(28) 1
(28') 1
(54) JEWELLERY, SPECIFICALLY NECKLACE

(11) DM/67754
(73) Montres Breguet S.A
CH-1344 L'ABBAYE (CH)
(15) 2006 03 29
(24) 2006 03 29
(18) 2031 03 29
(28) 1
(28') 1
(54) WRISTWATCH

(11) DM/67765
(73) Omega SA (Omega AG) (Omega LTD.)
Jakob-Stämpfli-Strasse 96, CH-2502 Bienne (CH)
(15) 2006 03 28
(24) 2006 03 28
(18) 2031 03 28
(28) 1
(28') 1
(54) KEY RING

(11) DM/67790
(73) Omega SA (Omega AG) (Omega LTD.)
Jakob-Stämpfli-Strasse 96, CH-2502 Bienne (CH)
(15) 2006 03 28
(24) 2006 03 28
(18) 2031 03 28
(28) 28
(28') 8
(54) JEWELRY, NAMELY PENDANTS (1 TO 21), BRACELETS (22, 26, 27), NECKLACE (23),
RINGS (24, 28) EARRINGS (25)

(11) DM/75271
(73) Blancpain SA
Le Rocher 12, CH-1348 LE Brassus (CH)
(15) 2011 02 10
(24) 2011 02 10
(18) 2031 02 10
(28) 1
(28') 1
(54) WATCH

(11) DM/75496
(73) Saverglass
3 rue de la Gare, F-60960 Feuquieres (FR)
(15) 2011 03 07
(24) 2011 03 07
(18) 2031 03 07
(28) 1
(28') 1
(54) BOTTLE

(11) DM/75499
(73) Omega SA (Omega AG) (Omega LTD.)
Jakob-Stämpfli-Strasse 96, CH-2502 Biel/Bienne (CH)
(15) 2011 03 08
(24) 2011 03 08
(18) 2031 03 08
(28) 1
(28') 1
(54) WATCH

(11) DM/75500
(73) Omega SA (Omega AG) (Omega LTD.)
Jakob-Stämpfli-Strasse 96, CH-2502 Biel/Bienne (CH)
(15) 2011 03 08
(24) 2011 03 08
(18) 2031 03 08
(28) 1
(28') 1
(54) WATCH

(11) DM/75501
(73) Blancpain SA
Le Rocher 12, CH-1348 LE Brassus (CH)
(15) 2011 03 08
(24) 2011 03 08
(18) 2031 03 08
(28) 3
(28') 3
(54) WRISTWATCHES

(11) DM/75535
(73) Blancpain SA
Le Rocher 12, CH-1348 LE Brassus (CH)
(15) 2011 03 11
(24) 2011 03 11
(18) 2031 03 11
(28) 2
(28') 2
(54) WATCHES

(11) DM/75537
(73) Montres Breguet S.A.
CH-1344 L'Abbaye (CH)
(15) 2011 03 14

(24) 2011 03 14
(18) 2031 03 14
(28) 8
(28') 8
(54) WATCHES

(11) DM/75559
(73) Checkpoint Systems International GMBH
Ersheimer Strasse 69, 69434 Hirschhorn (EM)
(15) 2011 02 15
(24) 2011 02 15
(18) 2031 02 15
(28) 1
(28') 1
(54) LABELLER

(11) DM/75575
(73) Blancpain SA
Le Rocher 12, CH-1348 LE BRASSUS (CH)
(15) 2011 03 16
(24) 2011 03 16
(18) 2031 03 16
(28) 3
(28') 3
(54) WATCHES

(11) DM/75603
(73) Saverglass
3 rue de la Gare F-60960 Feuquieres (FR)
(15) 2011 03 18
(24) 2011 03 18
(18) 2031 03 18
(28) 1
(28') 1
(54) BOTTLE

(11) DM/75605
(73) Blancpain SA
Le Rocher 12, CH-1348 LE BRASSUS (CH)
(15) 2011 03 18
(24) 2011 03 18
(18) 2031 03 18
(28) 1
(28') 1
(54) WATCH

(11) DM/75658
(73) Montres Breguet S.A.
CH-1344 L'abbaye (CH)
(15) 2011 03 23
(24) 2011 03 23
(18) 2031 03 23
(28) 2
(28') 2

(54) CUFF LINKS

(11) DM/75675

(73) Montres Breguet S.A.

CH-1344 L'ABBAYE (CH)

(15) 2011 03 23

(24) 2011 03 23

(18) 2031 03 23

(28) 1

(28') 1

(54) PENDANT (NECKLACE)

(11) DM/75676

(73) Omega SA (Omega AG) (Omega LTD.)

Jakob-Stämpfli-Strasse 96, CH-2502 Biel/Bienne (CH)

(15) 2011 03 23

(24) 2011 03 23

(18) 2031 03 23

(28) 1

(28') 1

(54) CUFF LINKS

(11) DM/75687

(73) Montres Breguet S.A.

CH-1344 L'ABBAYE (CH)

(15) 2011 03 23

(24) 2011 03 23

(18) 2031 03 23

(28) 1

(28') 1

(54) WRISTWATCH

(11) DM/75874

(73) Omega SA (Omega AG) (Omega LTD.)

Jakob-Stämpfli-Strasse 96, CH-2502 Biel/Bienne (CH)

(15) 2011 03 21

(24) 2011 03 21

(18) 2031 03 21

(28) 14

(28') 14

(54) BRACELET, BRACELETS, EARRINGS, NECKLACE, PENDANT, PENDANTS, RING, RINGS

(11) DM/76107

(73) Tyco International Services GMBH

Freier Platz 10, CH-8200 Schaffhausen (CH)

(15) 2011 05 04

(24) 2011 05 04

(18) 2031 05 04

(28) 1

(28') 1

(54) LOGO

(11) DM/88452
(73) ETA SA Manufacture Horlogère Suisse
Schild-Rust-Strasse 17, CH-2540 Grenchen (CH)
(15) 2015 12 02
(24) 2015 12 02
(18) 2030 12 02
(28) 1
(28') 1
(54) TIMEPIECE MOVEMENT PART

(11) DM/88983
(73) ETI Gıda Sanayi Ve Ticaret Anonim Şirketi
Organize Sanayi Bölgesi 11 Cadde, ESKİSEHIR (TR)
(15) 2016 01 08
(24) 2016 01 08
(18) 2031 01 08
(28) 4
(28') 4
(54) CHOCOLATES

(11) DM/89044
(73) Hamilton International AG (Hamilton International SA) (Hamilton International LTD)
Mattenstrasse 149, CH-2503 Biel/Bienne (CH)
(15) 2015 12 24
(24) 2015 12 24
(18) 2030 12 24
(28) 15
(28') 4
(54) 1.-2. WATCH CASES, 10. DIAL, 11. WATCH CASE, 12. WATCH, 13. DIAL, 14. WATCH, 15. DIAL,
3. DIAL, 4. WATCH CASE, 5. WATCH ELEMENT, 6. BRACELET, 7. WATCH, 8. WATCH CASE,
9. WATCH

(11) DM/89180
(73) Montres Jaquet Droz SA (Montres Jaquet Droz AG) (Montres Jaquet Droz LTD.)
Allée du Tourbillon 2, CH-2300 La Chaux-de-Fonds (CH)
(15) 2016 01 28
(24) 2016 01 28
(18) 2031 01 28
(28) 10
(28') 9
(54) DIALS, OSCILLATING WEIGHT

(11) DM/89203
(73) Montres Breguet S.A.
Place de la Tour 23, CH-1344 L'abbaye (CH)
(15) 2016 02 01
(24) 2016 02 01
(18) 2031 02 01
(28) 4
(28') 4
(54) WATCHES

(11) DM/89249
(73) Omega SA (Omega AG) (Omega LTD.)
Jakob-Stämpfli-Strasse 96, CH-2502 Biel/Bienne (CH)
(15) 2016 02 03
(24) 2016 02 03
(18) 2031 02 03
(28) 4
(28') 4
(54) 1. FINGER RING, 2. PENDANT, 3.-4. FINGER RINGS

(11) DM/89267
(73) Harry Winston SA
Chemin du Tourbillon 8, CH-1228 Plan-les-Ouates (CH)
(15) 2016 02 05
(24) 2016 02 05
(18) 2031 02 05
(28) 1
(28') 1
(54) EARRING

(11) DM/89268
(73) Tissot SA (Tissot AG) (Tissot LTD)
Chemin des Tourelles 17, CH-2400 Le Locle (CH)
(15) 2016 02 05
(24) 2016 02 05
(18) 2031 02 05
(28) 3
(28') 3
(54) WATCH CASE, WATCH DIALS

(11) DM/89411
(73) Harry Winston SA
Chemin du Tourbillon 8, CH-1228 Plan-les-Ouates (CH)
(15) 2016 02 09
(24) 2016 02 09
(18) 2031 02 09
(28) 4
(28') 4
(54) DIALS

(11) DM/89414
(73) Harry Winston SA
Chemin du Tourbillon 8, CH-1228 Plan-les-Ouates (CH)
(15) 2016 02 18
(24) 2016 02 18
(18) 2031 02 18
(28) 3
(28') 3
(54) DIALS, WATCH CASE

(11) DM/89515
(73) Harry Winston SA
Chemin du Tourbillon 8, CH-1228 Plan-les-Ouates (CH)
(15) 2016 02 23

(24) 2016 02 23
(18) 2031 02 23
(28) 1
(28') 1
(54) FINGER RING

(11) DM/89576
(73) Montres Breguet S.A.
Place de la Tour 23, CH-1344 L'abbaye (CH)
(15) 2016 02 29
(24) 2016 02 29
(18) 2031 02 28
(28) 2
(28') 2
(54) EARRINGS, FINGER RING

(11) DM/89627
(73) Soremartec S.A.
Findel Business Center, Complexe B, Rue de Trèves, L-2632 Findel (BX)
(15) 2016 02 15
(24) 2016 02 15
(18) 2031 02 15
(28) 15
(28') 15
(54) 1.-11. PACKAGINGS, 12. SHAPED WRAPPING [PACKAGING], 13. BOTTLE, 14.-15. PACKAGINGS

(11) DM/89630
(73) Swatch AG (Swatch SA) (Swatch LTD.)
Jakob-Stämpfli-Strasse 94, CH-2502 Biel/Bienne (CH)
(15) 2016 03 02
(24) 2016 03 02
(18) 2031 03 02
(28) 1
(28') 1
(54) WATCH CASE

(11) DM/89631
(73) Omega SA (Omega AG) (Omega LTD.)
Jakob-Stämpfli-Strasse 96, CH-2502 Biel/Bienne (CH)
(15) 2016 03 02
(24) 2016 03 02
(18) 2031 03 02
(28) 1
(28') 1
(54) CUFF LINKS

(11) DM/89633
(73) OMEGA SA (Omega AG) (Omega LTD.)
Jakob-Stämpfli-Strasse 96, CH-2502 Biel/Bienne (CH)
(15) 2016 03 02
(24) 2016 03 02
(18) 2031 03 02
(28) 6

(28') 6
(54) 1. BRACELET, 2.-3. JEWELRY PARTS, 4. BRACELET, 5. FINGER RING, 6. EARRINGS

(11) DM/89696
(73) Harry Winston SA
Chemin du Tourbillon 8, CH-1228 Plan-les-Ouates (CH)
(15) 2016 03 04
(24) 2016 03 04
(18) 2031 03 04
(28) 2
(28') 2
(54) BROOCH WATCHES

(11) DM/89704
(73) Harry Winston SA
Chemin du Tourbillon 8, CH-1228 Plan-les-Ouates (CH)
(15) 2016 03 07
(24) 2016 03 07
(18) 2031 03 07
(28) 6
(28') 6
(54) 5. WATCH HOLDER FOR BRACELET, 1.-2. DIALS, 3.-4. WATCH CASES, 6. WATCH HOLDER FOR PENDANT

(11) DM/89747
(73) Harry Winston SA
Chemin du Tourbillon 8, CH-1228 Plan-les-Ouates (CH)
(15) 2016 02 12
(24) 2016 02 12
(18) 2031 02 12
(28) 5
(28') 5
(54) DIALS, WATCH CASE

(11) DM/89748
(73) Montres Breguet S.A
Place de la Tour 23, CH-1344 L'ABBAYE (CH)
(15) 2016 02 29
(24) 2016 02 29
(18) 2031 02 28
(28) 1
(28') 1
(54) WRISTWATCH

(11) DM/89749
(73) Harry Winston SA
Chemin du Tourbillon 8, CH-1228 Plan-les-Ouates (CH)
(15) 2016 03 07
(24) 2016 03 07
(18) 2031 03 07
(28) 6
(28') 6
(54) DIALS, WATCH BRACELET

(11) DM/89847
(73) Omega SA (Omega AG) (Omega LTD.)
 Jakob-Stämpfli-Strasse 96, CH-2502 Biel/Bienne (CH)
(15) 2016 03 10
(24) 2016 03 10
(18) 2031 03 10
(28) 1
(28') 1
(54) FRAME FOR SPECTACLES

(11) DM/89951
(73) Harry Winston SA
 Chemin du Tourbillon 8, CH-1228 Plan-les-Ouates (CH)
(15) 2016 03 21
(24) 2016 03 21
(18) 2031 03 21
(28) 1
(28') 1
(54) FINGER RING

(11) DM/89992
(73) Glashütter Uhrenbetrieb GMBH
 Altenberger Straße 1, 01768 Glashütte (DE)
(15) 2016 03 11
(24) 2016 03 11
(18) 2031 03 11
(28) 4
(28') 4
(54) DIALS

TRADEMARKS**EXTENSION OF TERM OF TRADEMARKS REGISTRATION**

(111) M 1996 1962 R3

(151) 1996 04 19

(186) 2036 04 19

(732) Rockwell Automation Inc.

1201 S Second Street Milwaukee,

WI 53204, USA

(511) 9

(111) M 2006 16531 R2

(151) 2006 03 15

(186) 2036 03 15

(732) Kenvue Inc.

1 Kenvue Way, Summit, New Jersey 07901,

USA

(511) 5

(111) M 1996 1963 R3

(151) 1996 04 19

(186) 2036 04 19

(732) Rockwell Automation Inc.

1201 S Second Street Milwaukee,

WI 53204, USA

(511) 9

(111) M 2005 16230 R2

(151) 2005 09 28

(186) 2035 09 28

(732) Lululemon Athletica Canada Inc.

1818 Cornwall Avenue, Vancouver,

British Columbia, V6J1C7, Canada

(511) 9, 16, 18, 24, 25, 28

(111) M 1996 2159 R3

(151) 1996 05 28

(186) 2036 05 28

(732) Continental Reifen Austria GmbH

Triester. Str. 14, AT-2351 Wiener Neudorf,

Österreich, Austria

(511) 12

(111) M 2006 16463 R2

(151) 2006 02 15

(186) 2036 02 15

(732) Hayat Kimya Sanayi A.Ş.

Mahir Iz Caddesi No: 25 Altunizade

üsküdar, Istanbul, Türkiye

(511) 3, 5, 16

(111) M 1996 2481 R3

(151) 1996 06 25

(186) 2036 06 25

(732) LTWHP LLC

530 Fifth Avenue, 25th Floor, New York,

NY 10036, USA

(511) 18, 25, 28

(111) M 2006 16571 R2

(151) 2006 04 17

(186) 2036 04 17

(732) JSC "Telavi Wine Cellar"

Vill. Kurdghelauri, 2200, Telavi, Georgia

(511) 33, 35

(111) M 1996 2499 R3

(151) 1996 06 25

(186) 2036 06 25

(732) LTWHP LLC

530 Fifth Avenue, 25th Floor, New York,

NY 10036, USA

(511) 18, 25, 28

(111) M 2006 16557 R2

(151) 2006 04 13

(186) 2036 04 13

(732) Berlin-Chemie AG

Gliniker Veg 125, 12489, Berlin, Germany

(511) 5

(111) M 2006 16530 R2

(151) 2006 03 15

(186) 2036 03 15

(732) Kenvue Inc.

1 Kenvue Way, Summit, New Jersey 07901,

USA

(511) 5

(111) M 2006 16558 R2

(151) 2006 04 13

(186) 2036 04 13

(732) Berlin-Chemie AG

Gliniker Veg 125, 12489, Berlin, Germany

(511) 5

(111) M 2006 16559 R2
 (151) 2006 04 13
 (186) 2036 04 13
 (732) Berlin-Chemie AG
 Gliniker Veg 125, 12489, Berlin, Germany
 (511) 5

(111) M 2006 16560 R2
 (151) 2006 04 13
 (186) 2036 04 13
 (732) Berlin-Chemie AG
 Gliniker Veg 125, 12489, Berlin, Germany
 (511) 5

(111) M 2006 16561 R2
 (151) 2006 04 13
 (186) 2036 04 13
 (732) Berlin-Chemie AG
 Gliniker Veg 125, 12489, Berlin, Germany
 (511) 5

(111) M 2006 16562 R2
 (151) 2006 04 13
 (186) 2036 04 13
 (732) Berlin-Chemie AG
 Gliniker Veg 125, 12489, Berlin, Germany
 (511) 5

(111) M 2006 16525 R2
 (151) 2006 03 02
 (186) 2036 03 02
 (732) Kenvue Inc.
 1 Kenvue Way, Summit, New Jersey 07901,
 USA
 (511) 3, 5

(111) M 2006 16574 R2
 (151) 2006 04 17
 (186) 2036 04 17
 (732) JSC "Telavi Wine Cellar"
 Vill. Kurdghelauri, 2200, Telavi, Georgia
 (511) 33, 35

(111) M 2006 16564 R2
 (151) 2006 04 13
 (186) 2036 04 13
 (732) Berlin-Chemie AG
 Gliniker Veg 125, 12489, Berlin, Germany
 (511) 5

(111) M 2006 16841 R2
 (151) 2006 08 31
 (186) 2036 08 31
 (732) Intersun Holding Fzco
 P.O. box: 61051 Jebel Ali Free Zone,
 Dubai, United Arab Emirates
 (511) 16, 29, 30, 31, 35

(111) M 1996 1997 R3
 (151) 1996 04 26
 (186) 2036 04 26
 (732) Henkel AG & Co. KgaA
 Henkelstrasse 67, D-40589 Dusseldorf,
 Germany
 (511) 3

(111) M 1996 1784 R3
 (151) 1996 03 18
 (186) 2036 03 18
 (732) Armaly Sponge Company
 1900 Easy Street, Walled Lake, Michigan
 48390, USA
 (511) 3

(111) M 1996 1788 R3
 (151) 1996 03 18
 (186) 2036 03 18
 (732) Armaly Sponge Company
 1900 Easy Street, Walled Lake, Michigan
 48390, USA
 (511) 5, 21

(111) M 1996 1785 R3
 (151) 1996 03 18
 (186) 2036 03 18
 (732) Armaly Sponge Company
 1900 Easy Street, Walled Lake, Michigan
 48390, USA
 (511) 3, 5, 21

(111) M 1996 2105 R3
 (151) 1996 05 21
 (186) 2036 05 21
 (732) Sumitomo Chemical Company, Limited
 2-7-1, Nihonbashi, Chuo-ku, Tokyo 103-6020,
 Japan
 (511) 1, 5

(111) M 1997 4686 R3
 (151) 1997 03 10
 (186) 2037 03 10
 (732) Sumitomo Chemical Company Limited

2-7-1, Nihonbashi, Chuo-ku, Tokyo 103-6020,
Japan
(511) 1, 2

(111) M 1996 1594 R3
(151) 1996 02 23
(186) 2036 02 23
(732) Jean Patou
24/32 Rue Jean Goujon, Paris, 75008,
France
(511) 3, 18, 25

(111) M 1996 3405 R3
(151) 1996 09 30
(186) 2036 09 30
(732) C F E B Sisley
3 avenue de Friedland, 75008 Paris, France
(511) 3

(111) M 1996 2405 R3
(151) 1996 06 17
(186) 2036 06 17
(732) Functional Products Inc.
8282 Bavaria Road, Macedonia, Ohio 44056,
USA
(511) 1, 4

(111) M 1996 1612 R3
(151) 1996 02 26
(186) 2036 02 26
(732) Sterling Fluid Systems (Germany) GmbH
Lindenstasse 170, D-25524 Itzehoe, Germany
(511) 6, 7, 9, 11

(111) M 1996 2098 R3
(151) 1996 05 17
(186) 2036 05 17
(732) Henkel AG & Co. KgaA
Henkelstrasse 67, 40589 Düsseldorf, Germany
(511) 1, 2, 3, 4, 5, 9, 21

(111) M 1996 2373 R3
(151) 1996 06 14
(186) 2036 06 14
(732) Pernod Ricard
5 Cours Paul Ricard, 75008 Paris, France
(511) 32, 33

(111) M 1996 2673 R3
(151) 1996 07 18
(186) 2036 07 18
(732) Toyota Jidosha Kabushiki Kaisha

(Toyota Motor Corporation)
1, Toyota-Cho, Toyota-Shi, Aichi-Ken,
Japan
(511) 12

(111) M 1996 2674 R3
(151) 1996 07 18
(186) 2036 07 18
(732) Toyota Jidosha Kabushiki Kaisha
(Toyota Motor Corporation)
1, Toyota-Cho, Toyota-Shi, Aichi-Ken, Japan
(511) 7, 12

(111) M 1996 2675 R3
(151) 1996 07 18
(186) 2036 07 18
(732) Toyota Jidosha Kabushiki Kaisha
(Toyota Motor Corporation)
1, Toyota-Cho, Toyota-Shi, Aichi-Ken, Japan
(511) 12

(111) M 1996 1631 R3
(151) 1996 02 27
(186) 2036 02 27
(732) Elopak AS
P.O. Box 24, 3431 Spikkestad, Norway
(511) 6, 7, 9, 16, 20

(111) M 1996 1630 R3
(151) 1996 02 27
(186) 2036 02 27
(732) Elopak a.s.
Spikkestad, Norway
(511) 7, 16, 17, 20

(111) M 1996 3816 R3
(151) 1996 11 01
(186) 2036 11 01
(732) Compagnie Gervais Danone Societe Anonyme
17 Boulevard Haussmann, 75009 Paris, France
(511) 1, 5, 29, 30, 31, 32, 33

(111) M 1996 2250 R3
(151) 1996 06 05
(186) 2036 06 05
(732) HP Hewlett Packard Group LLC
11445 Compaq Center Drive West, Houston,
Texas 77070, USA
(511) 9, 16, 42

(111) M 1996 2717 R3
 (151) 1996 07 22
 (186) 2036 07 22
 (732) Arabesque S.r.l.
 Via Casati, 100, 20862 Arcore (MB), Italy
 (511) 12, 25

(111) M 2015 26253 R1
 (151) 2015 09 08
 (186) 2035 09 08
 (732) LLC Georgian Alliance"
 G. Nadareishvili St. 4, 0144, Tbilisi, Georgia
 (511) 32

(111) M 2016 26795 R1
 (151) 2016 02 29
 (186) 2036 02 28
 (732) LLC "Kvareli Basement"
 Village Chikaani, Kvareli Region, Georgia
 (511) 33

(111) M 1996 1712 R3
 (151) 1996 03 08
 (186) 2036 03 08
 (732) Kabushiki Kaisha Toshiba
 (also trading as Toshiba Corporation)
 72-34, Horikawa-cho, Saiwai-ku, Kawasaki-
 shi, Kanagawa, Japan
 (511) 7, 9, 11, 16

(111) M 2016 26966 R1
 (151) 2016 04 19
 (186) 2036 04 19
 (732) Fisons Limited
 One Onslow Street, Guildford, Surrey
 GU1 4YS, United Kingdom
 (511) 5

(111) M 2015 26570 R1
 (151) 2015 12 07
 (186) 2035 12 07
 (732) BRF Singapore Foods PTE Limited
 8, Marina Boulevard, № 05-02, Marina Bay
 Financial Centre, 018981, Singapore
 200403828K, SG, Singapore
 (511) 30

(111) M 2016 26901 R1
 (151) 2016 03 28
 (186) 2036 03 28
 (732) Johnson & Johnson
 a New Jersey Corporation
 One Johnson & Johnson Plaza,

New Brunswick, New Jersey, 08933-7001,
 USA
 (511) 5

(111) M 2016 26970 R1
 (151) 2016 04 19
 (186) 2036 04 19
 (732) BRF S.A.
 Rua Jorge Tzachel, 475 Fazenda, City
 of Itajaí, State of Santa Catarina, Brazil
 (511) 29, 30

(111) M 2016 26905 R1
 (151) 2016 03 28
 (186) 2036 03 28
 (732) Viacom International Inc.
 1515 Broadway, New York, New York
 10036, USA
 (511) 18, 25, 28, 30, 41

(111) M 2016 26984 R1
 (151) 2016 04 20
 (186) 2036 04 20
 (732) Compagnie Gervais Danone
 (a French corporation)
 17, boulevard Haussmann, 75009 Paris,
 France
 (511) 29, 30, 32

(111) M 2016 26986 R1
 (151) 2016 04 20
 (186) 2036 04 20
 (732) Abbott Laboratories
 100 Abbott Park Road, Abbott Park, Illinois
 60064, USA
 (511) 1, 5, 10, 29, 32, 41, 44, 45

(111) M 2016 27140 R1
 (151) 2016 06 03
 (186) 2036 06 03
 (732) LLC "Georgian Alliance"
 G. Nadareishvili St. 4, 0144, Tbilisi, Georgi
 (511) 35, 43

(111) M 2016 26927 R1
 (151) 2016 03 29
 (186) 2036 03 29
 (732) Intersun Holding FZCO.
 P.O. Box 61051 Jebel Ali Free Zone,
 Dubai, United Arab Emirates
 (511) 29, 30, 31, 32, 35

(111) M 2016 27475 R1
(151) 2016 08 16
(186) 2036 08 16
(732) JSC "Telavi Wine Cellar"
Village Kurdghelauri, 2200, Telavi, Georgia
(511) 33

(111) M 2016 27335 R1
(151) 2016 07 18
(186) 2036 07 18
(732) LTD "Kvlivo"
Razmadze St. 27, Vake District, Tbilisi,
Georgia
(511) 33

(111) M 2016 27085 R1
(151) 2016 05 18
(186) 2036 05 18
(732) Puma SE.
Puma Way 1, 91074 Herzogenaurach,
Germany
(511) 14

(111) M 2016 27154 R1
(151) 2016 06 03
(186) 2036 06 03
(732) Puma SE.
Puma Way 1, 91074 Herzogenaurach,
Germany
(511) 14

(111) M 2016 27337 R1
(151) 2016 07 18
(186) 2036 07 18
(732) JSC "Telavi Wine Cellar"
Village Kurdghelauri, 2200, Telavi, Georgia
(511) 33

(111) M 2016 27497 R1
(151) 2016 08 22
(186) 2036 08 22
(732) JSC "Telavi Wine Cellar"
Village Kurdghelauri, 2200, Telavi, Georgia
(511) 33

(111) M 2016 27275 R1
(151) 2016 06 29
(186) 2036 06 29
(732) LLC "S. Khechinashvili University Clinic"
Ilia Chavchavadze Av. 29-31-33, 0179,
Tbilisi, Georgia
(511) 35, 44

(111) M 2016 27507 R1
(151) 2016 08 22
(186) 2036 08 22
(732) Nobel Ilac Sanayii Ve Ticaret Anonim Sikreti
Representative Office in Georgia
Freedom Square 4, Tbilisi, Georgia
(511) 5, 35

(111) M 2016 27508 R1
(151) 2016 08 22
(186) 2036 08 22
(732) Nobel Ilac Sanayii Ve Ticaret Anonim Sikreti
Representative Office in Georgia
Freedom Square 4, Tbilisi, Georgia
(511) 5, 35

(111) M 2016 27393 R1
(151) 2016 07 19
(186) 2036 07 19
(732) LG Chem LTD
128, Yeoui-doero, Yeongdeungpo-gu,
Seoul, Republic of Korea
(511) 05

(111) M 2016 27602 R1
(151) 2016 09 12
(186) 2036 09 12
(732) Walmark a.s.
Oldřichovice č.44, 739 61 Třinec,
Czech Republic
(511) 5

(111) M 2016 27949 R1
(151) 2016 12 20
(186) 2036 12 20
(732) JSC "Telavi Wine Cellar"
Village Kurdghelauri, 2200, Telavi, Georgia
(511) 33

(111) M 2016 27953 R1
(151) 2016 12 20
(186) 2036 12 20
(732) JSC "Telavi Wine Cellar"
Village Kurdghelauri, 2200, Telavi, Georgia
(511) 33

(111) M 2016 26878 R1
(151) 2016 03 17
(186) 2036 03 17
(732) JSC "Bank of Georgia"
Gagarin St. 29a, 0160, Tbilisi, Georgia
(511) 35, 36

(111) M 2016 26879 R1
(151) 2016 03 17
(186) 2036 03 17
(732) JSC "Bank of Georgia"
Gagarin St. 29a, 0160, Tbilisi, Georgia
(511) 37

(111) M 2016 26950 R1
(151) 2016 04 06
(186) 2036 04 06
(732) LLC "დს გრუპი DS Group"
Pushkin St. 132, Batumi, Georgia
(511) 37

(111) M 2016 27419 R1
(151) 2016 07 28
(186) 2036 07 28
(732) LLC "Zip Credit"
Gamsakhurdia Av. 34/Al. Kazbegi Av. 2,
0160, Tbilisi, Georgia
(511) 36

(111) M 2016 27420 R1
(151) 2016 07 28
(186) 2036 07 28
(732) LLC "Zip Credit"
Gamsakhurdia Av. 34/Al. Kazbegi Av. 2,
0160, Tbilisi, Georgia
(511) 36

(111) M 2016 27704 R1
(151) 2016 10 07
(186) 2036 10 07
(732) LLC "Meama"
Givi Amilakhvari St. 2, Samgori District,
Tbilisi, Georgia
(511) 20, 30

COMPLETE TRANSFER OF RIGHTS

(111) M 2020 32960 R
 (732) LTD "Tineti"
 Shalva Nutsubidze St. 129a, Floor 4, 0186,
 Vake District, Tbilisi, Georgia
 (770) LTD "My.G"
 Shalva Nutsubidze St. 129a, Floor 4, 0186,
 Tbilisi, Georgia
 (580) 2026 03 06

(111) M 2020 32961 R
 (732) LTD "Tineti"
 Shalva Nutsubidze St. 129a, Floor 4, 0186,
 Vake District, Tbilisi, Georgia
 (770) LTD "My.G"
 Shalva Nutsubidze St. 129a, Floor 4, 0186,
 Tbilisi, Georgia

(111) M 2020 33128 R
 (732) LTD "Tineti"
 Shalva Nutsubidze St. 129a, Floor 4, 0186,
 Vake District, Tbilisi, Georgia
 (770) LTD "All Property G"
 Besiki St. 4, Plot 46/10, 0108,
 Tbilisi, Georgia
 (580) 2026 03 11

(111) M 1997 4610 R
 (732) The Absolut Company International AB
 117 97 Stockholm, Sweden
 (770) The Absolut Company Aktiebolag
 Box 83, 296 22 Åhus, Sweden
 (580) 2026 03 24

(111) M 1997 5863 R
 (732) The Absolut Company International AB
 117 97 Stockholm, Sweden
 (770) The Absolut Company Aktiebolag
 Box 83, 296 22 Åhus, Sweden
 (580) 2026 03 24

(111) M 1997 6788 R
 (732) The Absolut Company International AB
 117 97 Stockholm, Sweden
 (770) The Absolut Company Aktiebolag
 Box 83, 296 22 Åhus, Sweden
 (580) 2026 03 24

(111) M 1997 6789 R
 (732) The Absolut Company International AB
 117 97 Stockholm, Sweden
 (770) The Absolut Company Aktiebolag
 Box 83, 296 22 Åhus, Sweden
 (580) 2026 03 24

(111) M 1997 6790 R
 (732) The Absolut Company International AB
 117 97 Stockholm, Sweden
 (770) The Absolut Company Aktiebolag
 Box 83, 296 22 Åhus, Sweden
 (580) 2026 03 24

(111) M 1997 5864 R
 (732) The Absolut Company International AB
 117 97 Stockholm, Sweden
 (770) The Absolut Company Aktiebolag
 Box 83, 296 22 Åhus, Sweden
 (580) 2026 03 24

(111) M 1997 5865 R
 (732) The Absolut Company International AB
 117 97 Stockholm, Sweden
 (770) Ze Absolut Kompani Aktiebolag
 Box 83, 296 22 Åhus, Sweden
 (580) 2026 03 24

(111) M 2022 36192 R
 (732) Syngenta Crop Protection AG
 Rosentalstrasse 67, 4058 Basel, Switzerland
 (770) Syngenta Participations AG
 Rosentalstrasse 67, 4058 Basel, Switzerland
 (580) 2026 03 27

(111) M 1997 5576 R
 (732) The Absolut Company International AB
 117 97 Stockholm, Sweden
 (770) The Absolut Company Aktiebolag
 Box 83, 296 22 Åhus, Sweden
 (580) 2026 03 24

(111) M 2024 38832 R
 (732) Syngenta Crop Protection AG
 Rosentalstrasse 67, 4058 Basel, Switzerland
 (770) Syngenta Participations AG
 Rosentalstrasse 67, 4058 Basel, Switzerland
 (580) 2026 03 27

(111) M 2025 40039 R
 (732) "Baikalskaya" Limited Liability Company
 Ul. Baikalskaya, Stroenie 105A, Pomeshe-
 chenie 1002, Irkutsk, Irkutskaya Oblast,
 664047, Russian Federation
 (770) Limited Liability Company "Baikal"
 Room 8, Build 21, Gornaya Street, Listvyan-
 ka, City of Listvyanskoe, District Irkutskiy,
 Irkutskiy Region, 664520, Russian Federation
 (580) 2026 03 18

(111) M 2025 40497 R
 (732) LLC "IURROLL Georgia"
 Zhiuli Shartava Av. 18, Block B, ap. 694,
 Batumi, Georgia
 (770) Roman Konyayev
 Davit Aghmashenebeli St. 8, Basement,
 Batumi, Georgia
 (580) 2026 02 14

(111) M 2000 13278 R
 (732) The Absolut Company International AB
 117 97 Stockholm, Sweden
 (770) The Absolut Company Aktiebolag
 Box 83, 296 22 Åhus, Sweden
 (580) 2026 03 24

(111) M 1998 8284 R
 (732) The Absolut Company International AB
 117 97 Stockholm, Sweden
 (770) The Absolut Company Aktiebolag
 Box 83, 296 22 Åhus, Sweden
 (580) 2026 03 24

(111) M 2003 14868 R
 (732) Elida beauty US (IP) LLC,
 a Delaware limited liability company
 CCS Global Solutions, 13 West Main
 Street, PO Box 953, Felton, Delaware
 19943, USA
 (770) Alberto-Culver International, Inc.
 a corporation of Daleware
 700 Sylvan Avenue, Englewood Cliffs,
 NJ 07632, USA
 (580) 2026 03 20

(111) M 2003 15103 R
 (732) LLC "PSP Pharma"
 Davit Aghmashenebeli Av. 148, 0112, Tbilisi,
 Georgia
 (770) LLC "PSP"
 Zemo Vedzisi St. 103, 0160, Tbilisi, Georgia
 (580) 2026 03 25

(111) M 1997 5519 R
 (732) Syngenta Crop Protection AG
 Rosentalstrasse 67, 4058 Basel, Switzerland
 (770) Syngenta Participations AG
 Rosentalstrasse 67, 4058 Basel, Switzerland
 (580) 2026 03 27

(111) M 1997 6546 R
 (732) ABG-Dockers Limited
 3rd Floor, 1 Ashley Road, Altrincham,
 Cheshire WA14 2DT, United Kingdom
 (770) Levi Strauss & Co.
 1155 Battery Street, San Francisco,
 California 94111, USA
 (580) 2026 03 19

(111) M 2007 17690 R
 (732) LLC "PSP Pharma"
 Davit Aghmashenebeli Av. 148, 0112, Tbilisi,
 Georgia
 (770) LLC "PSP"
 Zemo Vedzisi St. 103, 0160, Tbilisi, Georgia
 (580) 2026 03 25

(111) M 2008 18831 R
 (732) LLC "PSP Pharma"
 Davit Aghmashenebeli Av. 148, 0112, Tbilisi,
 Georgia
 (770) LLC "PSP"
 Zemo Vedzisi St. 103, 0160, Tbilisi, Georgia
 (580) 2026 03 25

(111) M 1997 6474 R
 (732) The Absolut Company International AB
 117 97 Stockholm, Sweden
 (770) Ze Absolut Kompani Aqtiebolag
 Box 83, 296 22 Åhus, Sweden
 (580) 2026 03 24

(111) M 2011 21862 R
 (732) The Absolut Company International AB
 117 97 Stockholm, Sweden
 (770) The Absolut Company Aktiebolag
 Box 83, 296 22 Åhus, Sweden
 (580) 2026 03 24

(111) M 2012 23193 R
 (732) LTD "Tineti"
 Shalva Nutsubidze St. 129a, Floor 4, 0186,
 Vake District, Tbilisi, Georgia
 (770) LTD "My.G"
 Shalva Nutsubidze St. 129a, Floor 4, 0186,
 Tbilisi, Georgia

(580) 2026 03 11

(111) M 2015 25854 R

(732) LLC "PSP Pharma"

Davit Aghmashenebeli Av. 148, 0112, Tbilisi,
Georgia

(770) LLC "PSP"

Iakob Tsurtaveli St. 54, 1700, Dmanisi,
Georgia

(580) 2026 03 25

(111) M 2014 24932 R

(732) The Absolut Company International AB

117 97 Stockholm, Sweden

(770) The Absolut Company Aktiebolag

Box 83, 296 22 Åhus, Sweden

(580) 2026 03 24

(111) M 2015 26099 R

(732) LLC "PSP Pharma"

Davit Aghmashenebeli Av. 148, 0112, Tbilisi,
Georgia

(770) LLC "PSP"

Iakob Tsurtaveli St. 54, 1700, Dmanisi,
Georgia

(580) 2026 03 25

(111) M 2015 26434 R

(732) Perry Ellis International Europe Limited

Olympic House, Pleasants Street,
Dublin 8, Ireland

(770) Perry Ellis International Group Holdings
Limited

Olympic House, Pleasants Street, Dublin 8,
Ireland

(580) 2026 02 24

(111) M 2015 26435 R

(732) Perry Ellis International Europe Limited

Olympic House, Pleasants Street,
Dublin 8, Ireland

(770) Perry Ellis International Group Holdings
Limited

Olimpik Hauz, Plezents Strit, Dublini 8,
Ireland

(580) 2026 02 24

(111) M 2016 27923 R

(732) Beam Suntory UK Limited

Part Second Floor, UK House, 2,
Great Titchfield Street, London,
United Kingdom, W1D INN, United Kingdom

(770) Morrison Bowmore Distillers Limited
Springburn Bond, Qarlisl Strit, Springburn,
Glazgo G21 1EQ, United Kingdom

(580) 2026 03 25

(111) M 2016 27980 R

(732) Beam Suntory UK Limited

Part Second Floor, UK House, 2, Great
Titchfield Street, London, United Kingdom,
W1D INN, United Kingdom

(770) Morrison Bowmore Distillers Limited
Springburn Bond, Carlisle Street, Springburn,
Glasgow G21 1EQ, United Kingdom

(580) 2026 03 25

(111) M 2016 27864 R

(732) Beam SUntory UK Limited

Part Second Floor, UK House, 2, Great
Titchfield Street, London, United Kingdom,
W1D INN, United Kingdom

(770) Morrison Bowmore Distillers Limited
Springburn Bond, Carlisle Street, Springburn,
Glasgow G21 1EQ, United Kingdom

(580) 2026 03 25

(111) M 2017 28686 R

(732) LLC "PSP Pharma"

Davit Aghmashenebeli Av. 148, 0112, Tbilisi,
Georgia

(770) LLC "PSP"

Iakob Tsurtaveli St. 54, 1700, Dmanisi,
Georgia

(580) 2026 03 25

(111) M 2017 28687 R

(732) LLC "PSP Pharma"

Davit Aghmashenebeli Av. 148, 0112, Tbilisi,
Georgia

(770) LLC "PSP"

Iakob Tsurtaveli St. 54, 1700, Dmanisi,
Georgia

(580) 2026 03 25

(111) M 1998 10493 R

(732) The Absolut Company International AB

117 97 Stockholm, Sweden

(770) The Absolut Company Aktiebolag

Box 83, 296 22 Åhus, Sweden

(580) 2026 03 24

CHANGES OF NAME AND/OR ADDRESS OF TRADEMARKS OWNERS

(111) M 2021 33653 R
(732) LLC "Art Pharma"
Lvovi St. 19, Saburtalo District, Tbilisi,
Georgia
(770) LLC "Art Pharma"
Gamrekeli St. 19 (512), 0160, Tbilisi, Georgia
(580) 2026 03 10

(111) M 2022 34980 R
(732) LLC "Art Pharma"
Lvovi St. 19, Saburtalo District, Tbilisi,
Georgia
(770) LLC "Art Pharma"
Gamrekeli St. 19 (512), 0160, Tbilisi, Georgia
(580) 2026 03 10

(111) M 2022 34979 R
(732) LLC "Art Pharma"
Lvovi St. 19, Saburtalo District, Tbilisi,
Georgia
(770) LLC "Art Pharma"
Gamrekeli St. 19 (512), 0160, Tbilisi, Georgia
(580) 2026 03 10

(111) M 1996 2976 R
(732) Beam Suntory UK Limited
Part Second Floor, UK House 2,
Great Titchfield Street London, United
Kingdom, W1D INN, United Kingdom
(770) Beam Suntory UK Limited
2 Longwalk Road, Stockley Park,
Uxbridge, Middlesex, England UB11 1BA,
United Kingdom
(580) 2026 03 25

(111) M 1997 4610 R
(732) The Absolut Company Aktiebolag
Box 83, 296 22 Åhus, Sweden
(770) The Absolut Company Aktiebolag
11797 Stockholm, Sweden
(580) 2026 02 18

(111) M 1997 5863 R
(732) The Absolut Company Aktiebolag
Box 83, 296 22 Åhus, Sweden
(770) The Absolut Company Aktiebolag
11797 Stockholm, Sweden
(580) 2026 02 18

(111) M 1997 6788 R
(732) The Absolut Company Aktiebolag
Box 83, 296 22 Åhus, Sweden
(770) The Absolut Company Aktiebolag
11797 Stockholm, Sweden
(580) 2026 02 18

(111) M 1997 6789 R
(732) The Absolut Company Aktiebolag
Box 83, 296 22 Åhus, Sweden
(770) The Absolut Company Aktiebolag
11797 Stockholm, Sweden
(580) 2026 02 18

(111) M 1997 6790 R
(732) The Absolut Company Aktiebolag
Box 83, 296 22 Åhus, Sweden
(770) The Absolut Company Aktiebolag
11797 Stockholm, Sweden
(580) 2026 02 18

(111) M 1997 5864 R
(732) The Absolut Company Aktiebolag
Box 83, 296 22 Åhus, Sweden
(770) The Absolut Company Aktiebolag
11797 Stockholm, Sweden
(580) 2026 02 18

(111) M 1997 5865 R
(732) Ze Absolut Kompani Aqtiebolag
Box 83, 296 22 Åhus, Sweden
(770) Ze Absolut Kompani Aqtiebolag
11797 Stockholm, Sweden
(580) 2026 02 18

(111) M 1997 5867 R
(732) Syngenta Participations AG
c/o Syngenta Crop Protection AG,
Rosentalstrasse 67, 4058 Basel,
Switzerland
(770) Syngenta Participations AG
Schwarzwaldallee 215, 4058 Basel,
Switzerland
(580) 2026 03 26

(111) M 1997 5576 R
(732) The Absolut Company Aktiebolag
Box 83, 296 22 Åhus, Sweden
(770) The Absolut Company Aktiebolag
SE-117 97 Stockholm, Sweden

(580) 2026 02 18

(111) M 2026 40918 R
(732) LTD "Bude Ferma"
Vill. Zegaani, Gurjaani Region, Georgia
(770) LTD "Saguleti"
Sukhishvili St. 63, Gori Georgia
(580) 2026 03 17

(111) M 1998 10959 R
(732) CommScope North Carolina LLC
3642 E. US Highway 70, Claremont,
North Carolina, 28610, USA
(770) CommScope Inc. of North Carolina
1100 CommScope Place, SE, Hickory,
North Carolina 28602, USA
(580) 2026 03 24

(111) M 2000 13280 R
(732) Cadbury UK Limited
Bournville Place, Bournville Lane,
Bournville, Birmingham B30 2HP,
United Kingdom
(770) Cadbury UK Limited
P.O. Box 12, Bournville Lane,
Bournville, Birmingham B30 2LU,
United Kingdom
(580) 2026 02 20

(111) M 2000 13278 R
(732) The Absolut Company Aktiebolag
Box 83, 296 22 Åhus, Sweden
(770) The Absolut Company Aktiebolag
11797 Stockholm, Sweden
(580) 2026 02 18

(111) M 1998 8284 R
(732) The Absolut Company Aktiebolag
Box 83, 296 22 Åhus, Sweden
(770) The Absolut Company Aktiebolag
SE-117 97 Stockholm, Sweden
(580) 2026 02 18

(111) M 2000 13484 R
(732) CommScope North Carolina LLC
3642 E. US Highway 70, Claremont,
North Carolina, 28610, USA
(770) CommScope Inc. of North Carolina
1100 CommScope Place, SE, Hickory,
North Carolina 28602, USA
(580) 2026 03 24

(111) M 1996 3769 R
(732) Transamerica Corporation
6400 C Street SW Cedar Rapids,
Iowa 52499, USA
(770) Transamerica Corporation
4333 Edgewood Road NE, Cedar Rapids,
Iowa 52499, USA
(580) 2026 03 24

(111) M 1996 3050 R
(732) Transamerica Corporation
6400 C Street SW Cedar Rapids,
Iowa 52499, USA
(770) Transamerica Corporation
4333 Edgewood Road NE, Cedar Rapids,
Iowa 52499, USA
(580) 2026 03 24

(111) M 1997 5504 R
(732) Syngenta Participations AG
c/o Syngenta Crop Protection AG,
Rosentalstrasse 67, 4058 Basel, Switzerland
(770) Syngenta Participations AG
Schwarzwaldallee 215, 4058 Basel,
Switzerland
(580) 2026 03 25

(111) M 1997 5507 R
(732) Syngenta Participations AG
c/o Syngenta Crop Protection AG,
Rosentalstrasse 67, 4058 Basel, Switzerland
(770) Syngenta Participations AG
Schwarzwaldallee 215, 4058 Basel,
Switzerland
(580) 2026 03 25

(111) M 1997 5508 R
(732) Syngenta Participations AG
c/o Syngenta Crop Protection AG,
Rosentalstrasse 67, 4058 Basel,
Switzerland
(770) Syngenta Participations AG
Schwarzwaldallee 215, 4058 Basel,
Switzerland
(580) 2026 03 25

(111) M 1997 5518 R
(732) Syngenta Participations AG
c/o Syngenta Crop Protection AG,
Rosentalstrasse 67, 4058 Basel,
Switzerland
(770) Syngenta Participations AG
Schwarzwaldallee 215, 4058 Basel,
Switzerland

(580) 2026 03 25

(111) M 1995 885 R
 (732) Syngenta Participations AG
 c/o Syngenta Crop Protection AG,
 Rosentalstrasse 67, 4058 Basel,
 Switzerland
 (770) Syngenta Participations AG
 Schwarzwaldallee 215, 4058 Basel,
 Switzerland
 (580) 2026 03 25

(111) M 1995 883 R
 (732) Syngenta Participations AG
 c/o Syngenta Crop Protection AG,
 Rosentalstrasse 67, 4058 Basel,
 Switzerland
 (770) Syngenta Participations AG
 Schwarzwaldallee 215, 4058 Basel,
 Switzerland
 (580) 2026 03 25

(111) M 1997 5582 R
 (732) Syngenta Participations AG
 c/o Syngenta Crop Protection AG,
 Rosentalstrasse 67, 4058 Basel,
 Switzerland
 (770) Syngenta Participations AG
 Schwarzwaldallee 215, 4058 Basel,
 Switzerland
 (580) 2026 03 26

(111) M 1997 5598 R
 (732) Syngenta Participations AG
 c/o Syngenta Crop Protection AG,
 Rosentalstrasse 67, 4058 Basel,
 Switzerland
 (770) Syngenta participations AG
 Schwarzwaldallee 215, 4058 Basel,
 Switzerland
 (580) 2026 03 25

(111) M 1997 5599 R
 (732) Syngenta Participations AG
 c/o Syngenta Crop Protection AG,
 Rosentalstrasse 67, 4058 Basel,
 Switzerland
 (770) Syngenta Participations AG
 Schwarzwaldallee 215, 4058 Basel,
 Switzerland
 (580) 2026 03 25

(111) M 1997 5602 R
 (732) Syngenta PArTicipations AG
 c/o Syngenta Crop Protection AG,
 Rosentalstrasse 67, 4058 Basel,
 Switzerland
 (770) Syngenta Participations AG
 Schwarzwaldallee 215, 4058 Basel,
 Switzerland
 (580) 2026 03 26

(111) M 1997 5607 R
 (732) Syngenta Participations AG
 c/o Syngenta Crop Protection AG,
 Rosentalstrasse 67, 4058 Basel,
 Switzerland
 (770) Syngenta Participations AG
 Schwarzwaldallee 215, 4058 Basel,
 Switzerland
 (580) 2026 03 25

(111) M 1997 5608 R
 (732) Syngenta Participations AG
 c/o Syngenta Crop Protection AG,
 Rosentalstrasse 67, 4058 Basel,
 Switzerland
 (770) Syngenta Participations AG
 Schwarzwaldallee 215, 4058 Basel,
 Switzerland
 (580) 2026 03 25

(111) M 1995 879 R
 (732) Syngenta Participations AG
 c/o Syngenta Crop Protection AG,
 Rosentalstrasse 67, 4058 Basel,
 Switzerland
 (770) Syngenta Participations AG
 Schwarzwaldallee 215, 4058 Basel,
 Switzerland
 (580) 2026 03 25

(111) M 1997 7600 R
 (732) Syngenta Participations AG
 c/o Syngenta Crop Protection AG,
 Rosentalstrasse 67, 4058 Basel,
 Switzerland
 (770) Syngenta Participations AG
 Schwarzwaldallee 215, 4058 Basel,
 Switzerland
 (580) 2026 03 26

(111) M 2005 16230 R
 (732) Lululemon Athletica Canada Inc.
 1818 Cornwall Avenue, Vancouver,
 British Columbia, V6J1C7, Canada
 (770) Lululemon Athletica Canada Inc.

2113 West Fourth Avenue, Vancouver,
British Columbia, V6K 1N6, Canada
(580) 2026 03 15

(111) M 2005 16346 R
(732) Lululemon Athletica Canada Inc.
1818 Cornwall Avenue, Vancouver,
British Columbia, V6J1C7, Canada
(770) Lululemon Athletica Canada Inc.
2113 West Fourth Avenue, Vancouver,
British Columbia, V6K 1N6, Canada
(580) 2026 03 15

(111) M 1997 5639 R
(732) Syngenta Participations AG
c/o Syngenta Crop Protection AG,
Rosentalstrasse 67, 4058 Basel,
Switzerland
(770) Syngenta Participations AG
Schwarzwaldallee 215, 4058 Basel,
Switzerland
(580) 2026 03 25

(111) M 1995 1015 R
(732) Syngenta Participations AG
c/o Syngenta Crop Protection AG,
Rosentalstrasse 67, 4058 Basel,
Switzerland
(770) Syngenta Participations AG
Schwarzwaldallee 215, 4058 Basel,
Switzerland
(580) 2026 03 25

(111) M 1997 6087 R
(732) Syngenta Participations AG
c/o Syngenta Crop Protection AG,
Rosentalstrasse 67, 4058 Basel,
Switzerland
(770) Syngenta Participations AG
Schwarzwaldallee 215, 4058 Basel,
Switzerland
(580) 2026 03 25

(111) M 1997 5645 R
(732) Syngenta Participations AG
c/o Syngenta Crop Protection AG,
Rosentalstrasse 67, 4058 Basel,
Switzerland
(770) Syngenta Participations AG
Schwarzwaldallee 215, 4058 Basel,
Switzerland
(580) 2026 03 25

(111) M 1995 895 R
(732) Syngenta Participations AG
c/o Syngenta Crop Protection AG,
Rosentalstrasse 67, 4058 Basel,
Switzerland
(770) Syngenta Participations AG
Schwarzwaldallee 215, 4058 Basel,
Switzerland
(580) 2026 03 25

(111) M 1998 10042 R
(732) Syngenta Participations AG
c/o Syngenta Crop Protection AG,
Rosentalstrasse 67, 4058 Basel,
Switzerland
(770) Syngenta Participations AG
Schwarzwaldallee 215, 4058 Basel,
Switzerland
(580) 2026 03 26

(111) M 1996 3373 R
(732) Cadbury UK Limited
Bournville Place, Bournville Lane,
Bournville, Birmingham B30 2HP,
United Kingdom
(770) Cadbury UK Limited
P.O. Box 12, Bournville Lane,
Bournville, Birmingham B30 2LU,
United Kingdom
(580) 2026 02 20

(111) M 1997 6474 R
(732) Ze Absolut Kompani Aktiebolag
Box 83, 296 22 Åhus, Sweden
(770) Ze Absolut Kompani Aktiebolag
11797 Stockholm, Sweden
(580) 2026 02 18

(111) M 2011 21862 R
(732) The Absolut Company Aktiebolag
Box 83, 296 22 Åhus, Sweden
(770) The Absolut Company Aktiebolag
SE-117 97 Stockholm, Sweden
(580) 2026 02 18

(111) M 2012 22289 R
(732) Syngenta Participations AG
c/o Syngenta Crop Protection AG,
Rosentalstrasse 67, 4058 Basel,
Switzerland
(770) Syngenta Participations AG
Schwarzwaldallee 215, 4058 Basel,
Switzerland
(580) 2026 03 25

(111) M 2014 24932 R
 (732) The Absolut Company Aktiebolag
 Box 83, 296 22 Åhus, Sweden
 (770) The Absolut Company Aktiebolag
 SE-117 97 Stockholm, Sweden
 (580) 2026 02 18

(111) M 1998 10029 R
 (732) Syngenta Participations AG
 c/o Syngenta Crop Protection AG,
 Rosentalstrasse 67, 4058 Basel,
 Switzerland
 (770) Syngenta Participations AG
 Schwarzwaldallee 215, 4058 Basel,
 Switzerland
 (580) 2026 03 26

(111) M 2015 25895 R
 (732) Beaute Prestige International
 57 rue de Villiers, 92200 Neuilly-
 sur-Seine, France
 (770) Beaute Prestige International
 56A rue du Faubourg Saint-Honoré,
 75008 Paris, France
 (580) 2026 03 21

(111) M 2016 27073 R
 (732) Magnolia Intellectual Property LLC.
 244 West 54th Street, Suite 501,
 New York, New York 10019, USA
 (770) Magnolia Intellectual Property, LLC.
 1841 Broadway, New York, New York
 10023, USA
 (580) 2026 03 22

(111) M 2016 27615 R
 (732) Tequila Sauza, S. de R.L. de C.V.
 Francisco Javier Sauza 80, Colonia
 Centro, Tequila, Jalisco 46400,
 Mexico
 (770) Tequila Sauza, S. de R.L. de C.V.
 Avenida Avenida Vallarta 6503, Interior 49,
 Colonia Ciudad Granja, C.P. 45010, Zapopan,
 Jalisco, Mexico
 (580) 2026 03 25

(111) M 2017 28200 R
 (732) LLC "Art Pharma"
 Lvovi St. 19, Saburtalo District, Tbilisi,
 Georgia
 (770) LLC "Art Pharma"
 Gamrekeli St. 19 (512), 0160, Tbilisi, Georgia
 (580) 2026 03 10

(111) M 1998 8509 R
 (732) Cadbury UK Limited
 Bournville Place, Bournville Lane,
 Bournville, Birmingham B30 2HP,
 United Kingdom
 (770) Cadbury UK Limited
 P.O. Box 12, Bournville Lane,
 Bournville, Birmingham B30 2LU,
 United Kingdom
 (580) 2026 02 20

(111) M 1998 8510 R
 (732) Cadbury UK Limited
 Bournville Place, Bournville Lane,
 Bournville, Birmingham B30 2HP,
 United Kingdom
 (770) Cadbury UK Limited
 P.O. Box 12, Bournville Lane,
 Bournville, Birmingham B30 2LU,
 United Kingdom
 (580) 2026 02 20

(111) M 1997 7138 R
 (732) Cadbury UK Limited
 Bournville Place, Bournville Lane,
 Bournville, Birmingham B30 2HP,
 United Kingdom
 (770) Cadbury UK Limited
 P.O. Box 12, Bournville Lane,
 Bournville, Birmingham B30 2LU,
 United Kingdom
 (580) 2026 02 20

(111) M 1997 7139 R
 (732) Cadbury UK Limited
 Bournville Place, Bournville Lane,
 Bournville, Birmingham B30 2HP,
 United Kingdom
 (770) cadbury UK Limited
 P.O. Box 12, Bournville Lane,
 Bournville, Birmingham B30 2LU,
 United Kingdom
 (580) 2026 02 20

(111) M 1997 5662 R
 (732) Cadbury UK Limited
 Bournville Place, Bournville Lane,
 Bournville, Birmingham B30 2HP,
 United Kingdom
 (770) Cadbury UK Limited
 P.O. Box 12, Bournville Lane,
 Bournville, Birmingham B30 2LU,
 United Kingdom
 (580) 2026 02 20

(111) M 1997 5663 R
(732) Cadbury UK Limited
Bournville Place, Bournville Lane,
Bournville, Birmingham, B30 2HP,
United Kingdom
(770) Cadbury UK Limited
P.O. Box 12, Bournville Lane,
Bournville, Birmingham B30 2LU,
United Kingdom
(580) 2026 02 20

(111) M 1997 5664 R
(732) Cadbury UK Limited
Bournville Place, Bournville Lane,
Bournville, Birmingham B30 2HP,
United Kingdom
(770) Cadbury UK Limited
P.O. Box 12, Bournville Lane,
Bournville, Birmingham B30 2LU,
United Kingdom
(580) 2026 02 20

(111) M 1997 5666 R
(732) Cadbury UK Limited
Bournville Place, Bournville Lane,
Bournville, Birmingham B30 2HP,
United Kingdom
(770) Cadbury UK Limited
P.O. Box 12, Bournville Lane,
Bournville, Birmingham B30 2LU,
United Kingdom
(580) 2026 02 20

(111) M 1997 5667 R
(732) Cadbury UK Limited
Bournville Place, Bournville Lane,
Bournville, Birmingham B30 2HP,
United Kingdom
(770) Cadbury UK Limited
P.O. Box 12, Bournville Lane,
Bournville, Birmingham B30 2LU,
United Kingdom
(580) 2026 02 20

(111) M 1997 5668 R
(732) Cadbury UK Limited
Bournville Place, Bournville Lane,
Bournville, Birmingham B30 2HP,
United Kingdom
(770) Cadbury UK Limited
P.O. Box 12, Bournville Lane,
Bournville, Birmingham B30 2LU,
United Kingdom
(580) 2026 02 20

(111) M 2018 30062 R
(732) Syngenta Participations AG
c/o Syngenta Crop Protection AG,
Rosentalstrasse 67, 4058 Basel,
Switzerland
(770) Syngenta Participations AG
Schwarzwaldallee 215, Basel 4058,
Switzerland
(580) 2026 03 25

(111) M 1997 6688 R
(732) CommScope North Carolina LLC
3642 E. US Highway 70, Claremont,
North Carolina, 28610, USA
(770) CommScope Inc. of North Carolina
1100 CommScope Place, SE, Hickory,
North Carolina 28602, USA
(580) 2026 03 24

(111) M 1998 10493 R
(732) The Absolut Company Aktiebolag
Box 83, 296 22 Åhus, Sweden
(770) The Absolut Company Aktiebolag
SE-117 97 Stockholm, Sweden
(580) 2026 02 18

CANCELLATION OF TRADEMARKS REGISTRATION

(111) M 1995 1030 R

(151) 1995 09 25

(732) Omega Pharma Innovation &
Development NV
Zuiderpoort Office Park, Atrium B,
Gaston Crommenlaan 6, box 606, 9050
Gent, Belgium

(141) 2026 04 02

(141) 2026 03 27

(111) M 2005 16192 R

(151) 2005 09 19

(732) LTD "Aversi-Pharma"
Davit Aghmashenebeli Av. 148, 0112, Tbilisi,
Georgia

(141) 2026 03 27

(111) M 1995 1029 R

(151) 1995 09 25

(732) Perrigo Pharma International DAC
The Sharp Building, Hogan Place,
Dublin 2, D02 TY74, Ireland

(141) 2026 04 02

(111) M 2005 16199 R

(151) 2005 09 19

(732) Wyeth LLC
66 Hudson Boulevard East, New York,
NY 10001-2192, USA

(141) 2026 03 27

(111) M 2025 39838 R

(151) 2025 06 05

(732) LTD "Refilter"
Charagli St. 79b, 0178, Nadzaladevi District,
Tbilisi, Georgia

(141) 2026 04 03

(111) M 2005 16200 R

(151) 2005 09 19

(732) Wyeth LLC
66 Hudson Boulevard East, New York,
NY 10001-2192, USA

(141) 2026 03 27

(111) M 1995 1054 R

(151) 1995 09 26

(732) Colgate-Palmolive Company
a Delaware corporation
300 Park Avenue, New York, New York
10022, USA

(141) 2026 04 03

(111) M 2005 16210 R

(151) 2005 09 19

(732) Actavis Group PTC EHF
Reykjavikurvegi 76-78, 220 Hafnarfjordur,
Iceland

(141) 2026 03 27

(111) M 1995 960 R

(151) 1995 09 20

(732) Akzo Nobel Chemicals International B.V.
Stationsstraat 77, 3811 LE Amersfoort,
Netherlands

(141) 2026 03 27

(111) M 2005 16216 R

(151) 2005 09 19

(732) Zoetis P LLC
100 Campus Drive, Florham Park, NJ 07932,
USA

(141) 2026 03 27

(111) M 1995 1056 R

(151) 1995 09 26

(732) 3M Company a Delaware Corporation
3M Center, 2501 Hadson Road,
St. Paul, Minnesota 55144, USA

(141) 2026 04 03

(111) M 2005 16217 R

(151) 2005 09 19

(732) GlaxoSmithKline Consumer Healthcare
(UK) IP Limited
980 Great West Road, Brentford,
Middlesex TW8 9GS, United
Kingdom

(141) 2026 03 27

(111) M 2005 16187 R

(151) 2005 09 19

(732) LTD "Aversi-Pharma"
Davit Aghmashenebeli Av. 148, 0112, Tbilisi,
Georgia

(111) M 1995 1001 R

(151) 1995 09 25

(732) Lanxess Deutschland GmbH
51369 Leverkusen, Germany

(141) 2026 04 02

(111) M 1995 995 R
(151) 1995 09 22
(732) Lanxess Deutschland GmbH
51369 Leverkusen, Germany
(141) 2026 04 02

(111) M 1995 1021 R
(151) 1995 09 25
(732) Flexsys Amerika, L.P., a Delaware
Limited Partnership
260 Springside Drive, Akron, Ohio, USA
(141) 2026 04 02

(111) M 1995 1011 R
(151) 1995 09 25
(732) Carreras Limited
Globe House, 4 Temple Place, London
WC2R 2PG, United Kingdom
(141) 2026 04 02

(111) M 1995 1042 R
(151) 1995 09 26
(732) Sumitomo Chemical Co., LTD
27-1, Shinkawa 2-chome, Chuo-ku, Tokyo
104-8260, Japan
(141) 2026 04 03

(111) M 1995 1041 R
(151) 1995 09 26
(732) Sumitomo CHEMical Co., LTD
27-1, Shinkawa 2-chome, Chuo-ku, Tokyo
104-8260, Japan
(141) 2026 04 03

(111) M 1995 1040 R
(151) 1995 09 26
(732) Sumitomo Chemical Company, Limited
2-7-1, Nihonbashi, Chuo-ku, Tokyo 103-6020,
Japan
(141) 2026 04 03

(111) M 1995 1039 R
(151) 1995 09 26
(732) Sumitomo Chemical Co., LTD
27-1, Shinkawa 2-chome, Chuo-ku, Tokyo
104-8260, Japan
(141) 2026 04 03

(111) M 1995 1051 R
(151) 1995 09 26
(732) Sumitomo Chemical Co., LTD
27-1, Shinkawa 2-chome, Chuo-ku, Tokyo
104-8260, Japan
(141) 2026 04 03

(111) M 1995 1049 R
(151) 1995 09 26
(732) Sumitomo Chemical Co., LTD
27-1, Shinkawa 2-chome, Chuo-ku, Tokyo
104-8260, Japan
(141) 2026 04 03

(111) M 1995 1048 R
(151) 1995 09 26
(732) Sumitomo Chemical Company Limited
2-7-1, Nihonbashi, Chuo-ku, Tokyo 103-6020,
Japan
(141) 2026 04 03

(111) M 1995 1012 R
(151) 1995 09 25
(732) Novus International Inc.
17988 Edison Avenue, Chesterfield, Missouri,
63005, USA
(141) 2026 04 02

(111) M 2015 26252 R
(151) 2015 09 08
(732) Nemiroff Intellectual Property Establishment
Staedtle 31, 9490 Vaduz Liechtenstein
(141) 2026 03 20

(111) M 2015 26299 R
(151) 2015 09 23
(732) LTD "Georgian-British Kindergarten Dambo"
Davit Guramishvili Av. 39, ap. 16, 0178,
Tbilisi, Georgia
(141) 2026 04 02

(111) M 2015 26300 R
(151) 2015 09 24
(732) British American Tobacco (Brands) Limited
Globe House, 4 Temple Place, London
WC2R 2PG United Kingdom
(141) 2026 04 02

(111) M 2015 26304 R
(151) 2015 09 24
(732) JSC "Hotel and Restaurant Management
Group – M/Group"

Marshal Gelovani St. 2, 0159, Tbilisi,
Georgia
(141) 2026 04 02

(111) M 2015 26305 R
(151) 2015 09 24
(732) JSC "Bank Republic"
Gr. Abashidze St. 2, 0179, Tbilisi, Georgia
(141) 2026 04 02

(111) M 2015 26306 R
(151) 2015 09 24
(732) JSC "Bank Republic"
Gr. Abashidze St. 2, 0179, Tbilisi, Georgia
(141) 2026 04 02

(111) M 2015 26307 R
(151) 2015 09 24
(732) JSC "Bank Republic"
Gr. Abashidze St. 2, 0179, Tbilisi, Georgia
(141) 2026 04 02

(111) M 2015 26308 R
(151) 2015 09 24
(732) JSC "Bank Republic"
Gr. Abashidze St. 2, 0179, Tbilisi, Georgia
(141) 2026 04 01

(111) M 2015 26309 R
(151) 2015 09 24
(732) JSC "Bank Republic"
Gr. Abashidze St. 2, 0179, Tbilisi, Georgia
(141) 2026 04 01

(111) M 2015 26310 R
(151) 2015 09 24
(732) JSC "Bank Republic"
Gr. Abashidze St. 2, 0179, Tbilisi, Georgia
(141) 2026 04 01

(111) M 2015 26258 R
(151) 2015 09 09
(732) MR. Pardeep Jain and MR. Sudhir Hasija
Trading as P. S. Associates.,
Okhla Industrial Area, Phase - I, New Delhi –
110 020, India
(141) 2026 03 20

(111) M 2015 26311 R
(151) 2015 09 24
(732) LEPL "National Food Agency"
M. Gelovani St. 6, 0160, Tbilisi, Georgia

(141) 2026 04 01

(111) M 2015 26260 R
(151) 2015 09 09
(732) Shantha Biotechnics Private Limited
3rd & 4t Florsi, H.№5-10-173, Fateh Meiden
Roudi, Beshirbagi, Haidarabadi - 500004,
Telangana, India
(141) 2026 03 20

(111) M 2015 26320 R
(151) 2015 09 24
(732) Arven Ilac Sanayi Ve Ticaret Anonim Sirketi
Istinye Mahallesi, Balabandere Caddesi
№14 TR-34460 Sariyer/Istanbul, Türkiye
(141) 2026 04 01

(111) M 2015 26321 R
(151) 2015 09 24
(732) Arven Ilac Sanayi Ve Ticaret Anonim Sirketi
Istinye Mahallesi, Balabandere Caddesi
№14 TR-34460 Sariyer/Istanbul, Türkiye
(141) 2026 04 01

(111) M 2015 26263 R
(151) 2015 09 09
(732) Nissan Jidosha Kabushiki Kaisha
(also trading as Nissan Motor Co., LTD.)
№2, Takara-cho, Kanagawa-ku, Yokohama-
shi, Kanagawa-ken, Japan
(141) 2026 03 20

(111) M 2015 26264 R
(151) 2015 09 09
(732) Shulton Inc.
One Procter & Gamble Plaza, Cincinnati OH,
45202, USA
(141) 2026 03 20

(111) M 2015 26266 R
(151) 2015 09 09
(732) Novartis AG.
4002 Basel, Switzerland
(141) 2026 03 20

(111) M 2015 26267 R
(151) 2015 09 09
(732) Novartis AG.,
4002 Basel, Switzerland
(141) 2026 03 20

(111) M 2015 26269 R
(151) 2015 09 09
(732) Obshchestvo s Ogranichennoy Orvetsvennostuy "Fastgood"
ul. Remizova, house 14, apartment 17, 117186,
Moscow, Russian Federation
(141) 2026 03 20

(111) M 2015 26272 R
(151) 2015 09 09
(732) Swiss Pharma International AG
Waldmannstrasse 8, 8001 Zurich,
Switzerland
(141) 2026 03 20

(111) M 2015 26273 R
(151) 2015 09 09
(732) Swiss Pharma International AG
Waldmannstrasse 8, 8001 Zurich,
Switzerland
(141) 2026 03 20

(111) M 2015 26274 R
(151) 2015 09 09
(732) Société Des Produits Nestlé S.A.,
CH-1800 Vevey, Switzerland
(141) 2026 03 20

(111) M 2015 26324 R
(151) 2015 09 24
(732) Limited Liability Company Industrial
Enterprise "ZIP"
Shirokaya St. 107-a Dneprodzerzhinsk,
Dnepropetrovsk Oblast, 51901, Ukraine
(141) 2026 04 01

(111) M 2015 26325 R
(151) 2015 09 24
(732) Limited Liability Company Industrial
Enterprise "ZIP"
Shirokaya St. 107-a Dneprodzerzhinsk,
Dnepropetrovsk Oblast, 51901, Ukraine
(141) 2026 04 01

(111) M 2015 26251 R
(151) 2015 09 08
(732) Public Joint-stock Company "Arnest"
ul. Kombinatskaya 6, RU-357107
g. Nevinnomyssk, Stavrapolsky Krai,
Russian Federation
(141) 2026 03 20

(111) M 2015 26284 R
(151) 2015 09 16
(732) LTD "Taxi Net"
At the Beginning of Delisi Street, St. 1,
ent. 1, ap. 2, 0177 Tbilisi, Georgia
(141) 2026 03 25

(111) M 2015 26296 R
(151) 2015 09 22
(732) JSC "Kor Standard Bank"
Ketevan Tsamebuli Av. 3, 0103, Tbilisi,
Georgia
(141) 2026 04 01

(111) M 2015 26294 R
(151) 2015 09 22
(732) JSC "Insurance Company Imedi EI"
Kazbegi St. 3-5, 0179, Old Tbilisi District,
Tbilisi, Georgia
(141) 2026 04 01

(111) M 2015 26295 R
(151) 2015 09 22
(732) JSC "Insurance Company Imedi EI"
Kazbegi St. 3-5, 0179, Old Tbilisi District,
Tbilisi, Georgia
(141) 2026 04 01

REGISTRATION OF LICENSE AGREEMENTS

-
- | | |
|---|---|
| <p>(111) M 2013 24375 R
(732) Individual Entrepreneur Dmitry Igorevich
Khitrov
Kutuzov Av., House 26, ap. 113, Russian
Federation
(791) LLC "Jardeli"
Tsagareli St. 67, Saburtalo District, Tbilisi,
Georgia
(793) №1870
19 02 2026-from the term of validity of the
mark
Simple
(511) 33</p> <hr/> | <p>(793) №1874
19 02 2026-from the term of validity of the
mark
Simple
(511) 33</p> <hr/> |
| <p>(111) M 2013 24375 R
(732) Individual Entrepreneur Dmitry Igorevich
Khitrov
Kutuzov Av., House 26, ap. 113, Russian
Federation
(791) LLC "Jardeli"
Tsagareli St. 67, Saburtalo District, Tbilisi,
Georgia
(793) №1875
19 02 2026-from the term of validity of the
mark
Simple
(511) 33</p> <hr/> | <p>(111) M 2019 31549 R
(732) Individual Entrepreneur Dmitry Igorevich
Khitrov
Kutuzov Av., House 26, ap. 113, Russian
Federation
(791) LLC "Jardeli"
Tsagareli St. 67, Saburtalo District, Tbilisi,
Georgia
(793) №1872
19 02 2026-from the term of validity of the
mark
Simple
(511) 33</p> <hr/> |
| <p>(111) M 2018 29563 R
(732) Individual Entrepreneur Dmitry Igorevich
Khitrov
Kutuzov Av., House 26, ap. 113, Russian
Federation
(791) LLC "Jardeli"
Tsagareli St. 67, Saburtalo District, Tbilisi,
Georgia
(793) №1871
19 02 2026-from the term of validity of the
mark
Simple
(511) 33</p> <hr/> | <p>(111) M 2019 31549 R
(732) Individual Entrepreneur Dmitry Igorevich
Khitrov
Kutuzov Av., House 26, ap. 113, Russian
Federation
(791) LLC "Jardeli"
Tsagareli St. 67, Saburtalo District, Tbilisi,
Georgia
(793) №1873
19 02 2026-from the term of validity of the
mark
Simple
(511) 33</p> <hr/> |
| <p>(111) M 2018 29563 R
(732) Individual Entrepreneur Dmitry Igorevich
Khitrov
Kutuzov Av., House 26, ap. 113, Russian
Federation
(791) LLC "Jardeli"
Tsagareli St. 67, Saburtalo District, Tbilisi,
Georgia</p> | |
-

CLASSIFICATION INDEXES

INVENTIONS

CONCORDANCE TABLE OF INTERNATIONAL CLASSIFICATION INDEX AND PUBLICATION NUMBER

INTERNATIONAL CLASSIFICATION INDEXES (51)	NUMBER OF PUBLISHED APPLICATION (10)
A 61 K 39/00; C 07 K 16/26	AP 2026 15688 A

CONCORDANCE TABLE OF PUBLICATION NUMBER AND INTERNATIONAL CLASSIFICATION INDEX

NUMBER OF PUBLISHED APPLICATION (10)	INTERNATIONAL CLASSIFICATION INDEXES (51)
AP 2026 15688 A	A 61 K 39/00; C 07 K 16/26

PATENT

CONCORDANCE TABLE OF INTERNATIONAL CLASSIFICATION INDEX, PATENT NUMBER AND PUBLICATION NUMBER

INTERNATIONAL CLASSIFICATION INDEX (51)	NUMBER OF PATENT (11)	NUMBER OF PUBLISHED APPLICATION (10)
A 61 K 45/06; A 61 K 31/58; A 61 K 9/00; A 61 K 31/167; A 61 K 31/573; A 61 K 31/40; A 61 K 47/02; A 61 M 15/00; A 61 P 11/08; A 61 P 11/06	P 2026 7880 B	AP 2025 16227 A

CONCORDANCE TABLE OF PATENT NUMBER, PUBLICATION NUMBER AND INTERNATIONAL CLASSIFICATION INDEX

NUMBER OF PATENT (11)	NUMBER OF PUBLISHED APPLICATION (10)	INTERNATIONAL CLASSIFICATION INDEX (51)
P 2026 7880 B	AP 2025 16227 A	A 61 K 45/06; A 61 K 31/58; A 61 K 9/00; A 61 K 31/167; A 61 K 31/573; A 61 K 31/40; A 61 K 47/02; A 61 M 15/00; A 61 P 11/08; A 61 P 11/06

CONCORDANCE TABLE OF APPLICATION NUMBER,
PUBLICATION NUMBER AND PATENT

NUMBER OF APPLICATION (21)	NUMBER OF PUBLISHED APPLICATION (10)	NUMBER OF PATENT (11)
AP 2021 16227	AP 2025 16227 A	P 2026 7880 B

APPLICATIONS***

CONCORDANCE TABLE OF INTERNATIONAL CLASSIFICATION INDEX
AND PUBLICATION NUMBER

INTERNATIONAL CLASSIFICATION INDEXES (51)	NUMBER OF PUBLISHED APPLICATION (10)
A 01 D 45/00	AP 2026 16770 A
A 01 G 9/10	AP 2026 16759 A
A 61 B 3/08; A 61 H 5/00	AP 2026 16605 A
B 21 C 5/00	AP 2026 16811 A
F 27 B 3/08; H 05 B 7/148	AP 2026 16695 A
G 06 F 18/24; G 06 F 21/55; G 06 F 21/60; G 06 F 21/62; H 04 L 9/32; H 04 L 9/40	AP 2026 16738 A

CONCORDANCE TABLE OF PUBLICATION NUMBER
AND INTERNATIONAL CLASSIFICATION INDEX

NUMBER OF PUBLISHED APPLICATION (10)	INTERNATIONAL CLASSIFICATION INDEXES (51)
AP 2026 16605 A	A 61 B 3/08; A 61 H 5/00
AP 2026 16695 A	F 27 B 3/08; H 05 B 7/148
AP 2026 16738 A	G 06 F 18/24; G 06 F 21/55; G 06 F 21/60; G 06 F 21/62; H 04 L 9/32; H 04 L 9/40
AP 2026 16759 A	A 01 G 9/10
AP 2026 16770 A	A 01 D 45/00
AP 2026 16811 A	B 21 C 5/00

PATENTS*****CONCORDANCE TABLE OF INTERNATIONAL CLASSIFICATION INDEX,
PATENT NUMBER AND PUBLICATION NUMBER**

INTERNATIONAL CLASSIFICATION INDEX (51)	NUMBER OF PATENT (11)	NUMBER OF PUBLISHED APPLICATION (10)
A 01 D 45/00	P 2026 7879 B	AP 2026 16770 A
A 01 G 9/10	P 2026 7881 B	AP 2026 16759 A
B 21 C 5/00	P 2026 7883 B	AP 2026 16811 A
F 27 B 3/08; H 05 B 7/148	P 2026 7878 B	AP 2026 16695 A
G 06 F 18/24; G 06 F 21/55; G 06 F 21/60; G 06 F 21/62; H 04 L 9/32; H 04 L 9/40	P 2026 7882 B	AP 2026 16738 A
H 01 F 17/06; H 01 F 7/14; H 02 K 7/09	P 2026 7877 B	AP 2024 16570 A

**CONCORDANCE TABLE OF PATENT NUMBER,
PUBLICATION NUMBER AND INTERNATIONAL CLASSIFICATION INDEX**

NUMBER OF PATENT (11)	NUMBER OF PUBLISHED APPLICATION (10)	INTERNATIONAL CLASSIFICATION INDEX (51)
P 2026 7877 B	AP 2024 16570 A	H 01 F 17/06; H 01 F 7/14; H 02 K 7/09
P 2026 7878 B	AP 2026 16695 A	F 27 B 3/08; H 05 B 7/148
P 2026 7879 B	AP 2026 16770 A	A 01 D 45/00
P 2026 7881 B	AP 2026 16759 A	A 01 G 9/10
P 2026 7882 B	AP 2026 16738 A	G 06 F 18/24; G 06 F 21/55; G 06 F 21/60; G 06 F 21/62; H 04 L 9/32; H 04 L 9/40
P 2026 7883 B	AP 2026 16811 A	B 21 C 5/00

**CONCORDANCE TABLE OF APPLICATION NUMBER,
PUBLICATION NUMBER AND PATENT**

NUMBER OF APPLICATION (21)	NUMBER OF PUBLISHED APPLICATION (10)	NUMBER OF PATENT (11)
AP 2022 16570	AP 2024 16570 A	P 2026 7877 B
AP 2025 16695	AP 2026 16695 A	P 2026 7878 B
AP 2025 16738	AP 2026 16738 A	P 2026 7882 B
AP 2025 16759	AP 2026 16759 A	P 2026 7881 B
AP 2025 16770	AP 2026 16770 A	P 2026 7879 B
AP 2025 16811	AP 2026 16811 A	P 2026 7883 B

DESIGNSCONCORDANCE TABLE OF INTERNATIONAL CLASSIFICATION INDEX
AND PUBLICATION NUMBER

INTERNATIONAL CLASSIFICATION INDEX (51)	NUMBER OF PUBLISHED APPLICATION (10)
03-01	AD 2026 1454 S
03-01	AD 2026 1455 S

CONCORDANCE TABLE OF PUBLICATION NUMBER
AND INTERNATIONAL CLASSIFICATION INDEX

NUMBER OF PUBLISHED APPLICATION (10)	INTERNATIONAL CLASSIFICATION INDEX (51)
AD 2026 1454 S	03-01
AD 2026 1455 S	03-01

**DESIGN REGISTERED ACCORDING TO THE ACCELERATED
PROCEDURE**CONCORDANCE TABLE OF INTERNATIONAL CLASSIFICATION INDEX
AND PUBLICATION NUMBERS

INTERNATIONAL CLASSIFICATION INDEXES (51)	NUMBER OF REGISTRATION (11)
02-02	D 2026 1112 S

CONCORDANCE TABLE OF PUBLICATION NUMBERS
AND INTERNATIONAL CLASSIFICATION INDEX

NUMBER OF REGISTRATION (11)	INTERNATIONAL CLASSIFICATION INDEXES (51)
D 2026 1112 S	02-02

CONCORDANCE TABLE OF APPLICATION NUMBERS,
PUBLICATION NUMBERS AND PATENTS

NUMBER OF APPLICATION (21)	NUMBER OF REGISTRATION (11)
AD 2026 1503	D 2026 1112 S

TRADEMARKSCONCORDANCE TABLE OF REGISTRATION NUMBERS, APPLICATION NUMBERS,
PUBLICATION NUMBERS AND BULLETIN NUMBERS

NUMBER OF REGISTRATION (111)	NUMBER OF APPLICATIONS (210)	NUMBER OF PUBLISHED APPLICATIONS (260)	NUMBER OF BULLETIN
1	2	3	4
M 2026 41009 R	AM 132510	AM 2025 132510 A	19(670)2025
M 2026 41010 R	AM 132110	AM 2025 132110 A	18(669)2025
M 2026 41011 R	AM 133267	AM 2025 133267 A	22(673)2025
M 2026 41012 R	AM 132350	AM 2025 132350 A	17(668)2025
M 2026 41013 R	AM 133399	AM 2025 133399 A	22(673)2025
M 2026 41014 R	AM 132246	AM 2025 132246 A	17(668)2025
M 2026 41015 R	AM 133903	AM 2025 133903 A	23(674)2025
M 2026 41016 R	AM 133571	AM 2025 133571 A	23(674)2025
M 2026 41017 R	AM 133653	AM 2025 133653 A	23(674)2025
M 2026 41018 R	AM 133010	AM 2025 133010 A	20(671)2025
M 2026 41019 R	AM 133881	AM 2025 133881 A	23(674)2025
M 2026 41020 R	AM 133559	AM 2025 133559 A	22(673)2025
M 2026 41021 R	AM 133561	AM 2025 133561 A	22(673)2025
M 2026 41022 R	AM 133558	AM 2025 133558 A	22(673)2025
M 2026 41023 R	AM 133560	AM 2025 133560 A	22(673)2025
M 2026 41024 R	AM 133556	AM 2025 133556 A	22(673)2025
M 2026 41025 R	AM 133562	AM 2025 133562 A	22(673)2025
M 2026 41026 R	AM 133963	AM 2025 133963 A	23(674)2025
M 2026 41027 R	AM 133962	AM 2025 133962 A	23(674)2025
M 2026 41028 R	AM 133645	AM 2025 133645 A	23(674)2025
M 2026 41029 R	AM 133648	AM 2025 133648 A	23(674)2025
M 2026 41030 R	AM 133582	AM 2025 133582 A	23(674)2025
M 2026 41031 R	AM 132938	AM 2025 132938 A	23(674)2025
M 2026 41032 R	AM 132488	AM 2025 132488 A	17(668)2025
M 2026 41033 R	AM 132358	AM 2025 132358 A	17(668)2025
M 2026 41034 R	AM 133698	AM 2025 133698 A	23(674)2025
M 2026 41035 R	AM 133040	AM 2025 133040 A	23(674)2025
M 2026 41036 R	AM 133868	AM 2025 133868 A	23(674)2025
M 2026 41037 R	AM 137854	–	7(682)2026
M 2026 41038 R	AM 138018	–	7(682)2026
M 2026 41039 R	AM 138019	–	7(682)2026
M 2026 41040 R	AM 138108	–	7(682)2026
M 2026 41041 R	AM 138031	–	7(682)2026
M 2026 41042 R	AM 138114	–	7(682)2026
M 2026 41043 R	AM 138110	–	7(682)2026
M 2026 41044 R	AM 138115	–	7(682)2026
M 2026 41045 R	AM 138117	–	7(682)2026
M 2026 41046 R	AM 138133	–	7(682)2026
M 2026 41047 R	AM 138267	–	7(682)2026
M 2026 41048 R	AM 138138	–	7(682)2026
M 2026 41049 R	AM 138278	–	7(682)2026
M 2026 41050 R	AM 138279	–	7(682)2026
M 2026 41051 R	AM 138294	–	7(682)2026
M 2026 41052 R	AM 138266	–	7(682)2026
M 2026 41053 R	AM 138022	–	7(682)2026
M 2026 41054 R	AM 138277	–	7(682)2026

1	2	3	4
M 2026 41055 R	AM 138410	–	7(682)2026
M 2026 41056 R	AM 138302	–	7(682)2026
M 2026 41057 R	AM 138423	–	7(682)2026
M 2026 41058 R	AM 138425	–	7(682)2026

CONCORDANCE TABLE OF INDEX OF GOODS AND/OR SERVICES
AND APPLICATION NUMBERS

NUMBER OF PUBLISHED APPLICATIONS (260)	NUMBER OF APPLICATIONS (210)	1	2
		1	2
AM 2026 128298 A	AM 128298	AM 2026 135371 A	AM 135371
AM 2026 132216 A*	AM 132216	AM 2026 135373 A	AM 135373
AM 2026 132664 A*	AM 132664	AM 2026 135375 A	AM 135375
AM 2026 134439 A	AM 134439	AM 2026 135377 A	AM 135377
AM 2026 134739 A	AM 134739	AM 2026 135391 A	AM 135391
AM 2026 134751 A	AM 134751	AM 2026 135395 A	AM 135395
AM 2026 134986 A	AM 134986	AM 2026 135402 A	AM 135402
AM 2026 135089 A	AM 135089	AM 2026 135403 A	AM 135403
AM 2026 135207 A	AM 135207	AM 2026 135404 A	AM 135404
AM 2026 135208 A	AM 135208	AM 2026 135405 A	AM 135405
AM 2026 135209 A	AM 135209	AM 2026 135406 A	AM 135406
AM 2026 135211 A	AM 135211	AM 2026 135407 A	AM 135407
AM 2026 135215 A	AM 135215	AM 2026 135408 A	AM 135408
AM 2026 135216 A	AM 135216	AM 2026 135408 A	AM 135408
AM 2026 135220 A	AM 135220	AM 2026 135463 A	AM 135463
AM 2026 135221 A	AM 135221	AM 2026 135465 A	AM 135465
AM 2026 135280 A	AM 135280	AM 2026 135484 A	AM 135484
AM 2026 135284 A	AM 135284	AM 2026 135485 A	AM 135485
AM 2026 135307 A	AM 135307	AM 2026 135490 A	AM 135490
AM 2026 135308 A	AM 135308	AM 2026 135492 A	AM 135492
AM 2026 135309 A	AM 135309	AM 2026 135494 A	AM 135494
AM 2026 135311 A	AM 135311	AM 2026 135495 A	AM 135495
AM 2026 135313 A	AM 135313	AM 2026 135497 A	AM 135497
AM 2026 135314 A	AM 135314	AM 2026 135505 A	AM 135505
		AM 2026 135554 A	AM 135554
		AM 2026 135555 A	AM 135555
		AM 2026 135619 A	AM 135619
		AM 2026 135624 A	AM 135624

CONCORDANCE TABLE OF PUBLICATION NUMBERS
AND APPLICATION NUMBERS

INDEX OF GOODS AND/OR SERVICES (511)	NUMBER OF PUBLISHED APPLICATIONS (260)	1	2
1	2	19	AM 2026 134986 A
1	AM 2026 135313 A	19	AM 2026 135377 A
1	AM 2026 135314 A	20	AM 2026 134739 A
2	AM 2026 134986 A	21	AM 2026 134739 A
2	AM 2026 135211 A	21	AM 2026 135308 A
3	AM 2026 135308 A	24	AM 2026 134739 A
3	AM 2026 135484 A	25	AM 2026 128298 A
3	AM 2026 135485 A	25	AM 2026 134739 A
3	AM 2026 135490 A	25	AM 2026 135307 A
4	AM 2026 128298 A	25	AM 2026 135484 A
4	AM 2026 134739 A	25	AM 2026 135485 A
4	AM 2026 135211 A	25	AM 2026 135490 A
5	AM 2026 135280 A	26	AM 2026 134739 A
5	AM 2026 135284 A	27	AM 2026 134739 A
5	AM 2026 135494 A	28	AM 2026 128298 A
5	AM 2026 135497 A	28	AM 2026 134739 A
5	AM 2026 135554 A	29	AM 2026 135492 A
7	AM 2026 128298 A	29	AM 2026 135505 A
7	AM 2026 134439 A	30	AM 2026 135492 A
7	AM 2026 135211 A	30	AM 2026 135505 A
9	AM 2026 128298 A	32	AM 2026 132664 A*
9	AM 2026 134739 A	32	AM 2026 135484 A
9	AM 2026 135375 A	32	AM 2026 135485 A
9	AM 2026 135391 A	32	AM 2026 135490 A
9	AM 2026 135465 A	33	AM 2026 134751 A
9	AM 2026 135484 A	33	AM 2026 135220 A
9	AM 2026 135485 A	33	AM 2026 135221 A
9	AM 2026 135490 A	33	AM 2026 135463 A
9	AM 2026 135490 A	33	AM 2026 135484 A
11	AM 2026 135624 A	33	AM 2026 135485 A
12	AM 2026 128298 A	33	AM 2026 135490 A
12	AM 2026 134439 A	33	AM 2026 135495 A
12	AM 2026 135215 A	34	AM 2026 132216 A*
12	AM 2026 135216 A	34	AM 2026 134739 A
12	AM 2026 135555 A	34	AM 2026 135207 A
14	AM 2026 134739 A	34	AM 2026 135208 A
14	AM 2026 135484 A	34	AM 2026 135209 A
14	AM 2026 135485 A	34	AM 2026 135406 A
14	AM 2026 135490 A	34	AM 2026 135407 A
16	AM 2026 134739 A	34	AM 2026 135408 A
16	AM 2026 135484 A	35	AM 2026 134986 A
16	AM 2026 135485 A	35	AM 2026 135309 A
16	AM 2026 135490 A	35	AM 2026 135402 A
17	AM 2026 134986 A	35	AM 2026 135403 A
17	AM 2026 135624 A	35	AM 2026 135404 A
18	AM 2026 134739 A	35	AM 2026 135405 A
18	AM 2026 135307 A	35	AM 2026 135463 A
18	AM 2026 135484 A	35	AM 2026 135484 A
18	AM 2026 135485 A	35	AM 2026 135485 A
18	AM 2026 135490 A	35	AM 2026 135490 A
18	AM 2026 135495 A	35	AM 2026 135495 A
18	AM 2026 135490 A	35	AM 2026 135619 A

1	2	1	2
36	AM 2026 135311 A	42	AM 2026 135391 A
37	AM 2026 1282298 A	43	AM 2026 135484 A
37	AM 2026 134439 A	43	AM 2026 135485 A
37	AM 2026 135089 A	43	AM 2026 135490 A
37	AM 2026 135377 A	43	AM 2026 135492 A
38	AM 2026 135309 A	43	AM 2026 135495 A
41	AM 2026 135371 A	43	AM 2026 135619 A
41	AM 2026 135373 A	37	AM 2026 134439 A
41	AM 2026 135395 A		

CONCORDANCE TABLE OF INDEX OF GOODS AND/OR SERVICES
AND NUMBERS OF TRADEMARKS REGISTERED ACCORDING
TO THE ACCELERATED PROCEDURE

INDEX OF GOODS AND/OR SERVICES (511)	NUMBERS OF REGISTERED ACCORDING TO THE ACCELERATED PROCEDURE (111)
3	M 2026 41052 R
3	M 2026 41057 R
3	M 2026 41058 R
5	M 2026 41057 R
5	M 2026 41058 R
6	M 2026 41052 R
9	M 2026 41038 R
9	M 2026 41039 R
9	M 2026 41054 R
16	M 2026 41052 R
21	M 2026 41052 R
30	M 2026 41049 R
30	M 2026 41050 R
33	M 2026 41037 R
33	M 2026 41040 R
33	M 2026 41042 R
33	M 2026 41046 R
33	M 2026 41047 R
33	M 2026 41051 R
33	M 2026 41056 R
35	M 2026 41048 R
35	M 2026 41055 R
36	M 2026 41044 R
36	M 2026 41045 R
36	M 2026 41048 R
37	M 2026 41055 R
41	M 2026 41044 R
41	M 2026 41045 R
41	M 2026 41046 R
41	M 2026 41053 R
42	M 2026 41038 R
42	M 2026 41039 R
43	M 2026 41041 R
43	M 2026 41043 R
44	M 2026 41044 R
44	M 2026 41045 R
44	M 2026 41053 R
45	M 2026 41048 R

OFFICIAL BULLETIN OF THE INDUSTRIAL PROPERTY

INVENTIONS

VALIDATION OF EUROPEAN PATENTS

DESIGNS

TRADEMARKS

APPELLATIONS OF ORIGIN OF GOODS

7(682)

EDITOR-IN-CHIEF: N. Bebrishvili

EDITOR-TRANSLATOR: E. Gabunia

PROOFREADER: A. Shikhashvili

COMPUTER LAYOUT: M. Ordenidze
K. Svanidze

ISSN 2720-8486

info@sakpatenti.gov.ge
www.sakpatenti.gov.ge

**LIST OF CODES, IN ALPHABETIC SEQUENCE, AND THE CORRESPONDING (SHORT) NAMES OF STATES, OTHER ENTITIES AND INTERGOVERNMENTAL ORGANIZATIONS
(WIPO STANDARD ST.3)**

AD	Andorra				
AE	United Arab Emirates	GD	Grenada	NE	Niger
AF	Afghanistan	GG	Guernsey	NG	Nigeria
AG	Antigua and Barbuda	GH	Ghana	NI	Nicaragua
AI	Anguilla	GI	Gibraltar	NL	Netherlands
AL	Albania	GT	Guatemala	NO	Norway
AM	Armenia	GW	Guinea- Bissau	NP	Nepal
AN	Netherlands Antilles	GY	Guyana	NR	Nauru
AO	Angola	HK	The Hong Kong Special Administrative Region of the People's Republic of China	NZ	New Zealand
AP	African Regional Intellectual Property Organization (ARIPO)	HN	Honduras	OA	African Intellectual Property Organization (OAPI)
AR	Argentina	HR	Croatia	OM	Oman
AT	Austria	HT	Haiti	PA	Panama
AU	Australia	HU	Hungary	PE	Peru
AW	Aruba	IB	International Bureau of the World Intellectual Property Organization (WIPO)	PG	Papua New Guinea
AZ	Azerbaijan	ID	Indonesia	PH	Philippines
BA	Bosnia and Herzegovina	IE	Ireland	PK	Pakistan
BB	Barbados	IL	Israel	PL	Poland
BD	Bangladesh	IM	Isle of Man	PT	Portugal
BE	Belgium	IN	India	PW	Palau
BF	Burkina Faso	IQ	Iraq	PY	Paraguay
BG	Bulgaria	IR	Iran (Islamic Republic of)	QA	Qatar
BH	Bahrain	IS	Iceland	QZ	Community Plant Variety Office (European Community) (CPVO)
BI	Burundi	IT	Italy	RO	Romania
BJ	Benin	JE	Jersey	RS	Serbia
BM	Bermuda	JM	Jamaica	RU	Russian Federation
BN	Brunei Darussalam	JO	Jordan	RW	Rwanda
BO	Bolivia	JP	Japan	SA	Saudi Arabia
BR	Brazil	KE	Kenya	SB	Solomon Islands
BS	Bahamas	KG	Kyrgyzstan	SC	Seychelles
BT	Bhutan	KH	Cambodia	SD	Sudan
BV	Bouvet Island	KI	Kiribati	SG	Singapore
BW	Botswana	KM	Saint Kitts and Nevis	SH	Saint Helena
BX	Benelux Office for Intellectual Property (BOIP)	KP	Democratic People's Republic of Korea	SI	Slovenia
BY	Belarus	KR	Republic of Korea	SK	Slovakia
BZ	Belize	KW	Kuwait	SL	Sierra Leone
CA	Canada	KY	Cayman Islands	SM	San Marino
CD	Democratic Republic of the Congo	KZ	Kazakhstan	SN	Senegal
CF	Central African Republic	LA	Lao People's Democratic Republic	SO	Somalia
CG	Congo	LB	Lebanon	SR	Suriname
CH	Switzerland	LC	Saint Lucia	ST	Sao Tome and Principe
CI	Cote d'Ivoire	LI	Liechtenstein	SV	El Salvador
CK	Cook Islands	LK	Sri Lanka	SY	Syrian Arab Republic
CL	Chile	LR	Liberia	SZ	Swaziland
CM	Cameroon	LS	Lesotho	TC	Turks and Caicos Islands
CN	China	LT	Lithuania	TD	Chad
CO	Colombia	LU	Luxembourg	TG	Togo
CR	Costa Rica	LV	Latvia	TH	Thailand
CU	Cuba	LY	Libyan Arab Jamahiriya	TJ	Tajikistan
CV	Cape Verde	MA	Morocco	TL	Timor-Leste
CY	Cyprus	MC	Monaco	TM	Turkmenistan
CZ	Czech Republic	MD	Republic of Moldova	TN	Tunisia
DE	Germany	ME	Montenegro	TO	Tonga
DJ	Djibouti	MG	Madagascar	TR	Turkey
DM	Dominica	MK	The former Yugoslav Republic of Macedonia	SE	Sweden
DO	Dominican Republic	ML	Mali	TT	Trinidad and Tobago
DZ	Algeria	MM	Myanmar	TV	Tuvalu
EA	Eurasian Patent Organization (EAPO)	MN	Mongolia	TW	Taiwan, Province of China
EC	Ecuador	MO	Macao	TZ	United Republic of Tanzania
EE	Estonia	MP	Northern Mariana Islands	UA	Ukraine
EG	Egypt	MR	Mauritania	UG	Uganda
EH	Western Sahara	MS	Montserrat	US	United States of America
EM	Office for Harmonization in the Internal Market (Trademarks and Designs)(OHIM)	MT	Malta	UY	Uruguay
EP	European Patent Office (EPO)	MU	Mauritius	UZ	Uzbekistan
ER	Eritrea	MV	Maldives	VA	Holy See
ES	Spain	MW	Malawi	VC	Saint Vincent and the Grenadines
ET	Ethiopia	MX	Mexico	VE	Venezuela
FI	Finland	MY	Malaysia	VG	Virgin Islands (British)
FJ	Fiji	MZ	Mozambique	VN	Viet Nam
FK	Falkland Islands (Malvinas)	NA	Namibia	VU	Vanuatu
FO	Faroe Islands			WO	World Intellectual Property Organization (WIPO)
FR	France			WS	Samoa
GA	Gabon			XN	Nordic Patent Institute (NPI)
GB	United Kingdom			YE	Yemen
GC	Patent Office of the Cooperation Council			ZA	South Africa
				ZM	Zambia
				ZW	Zimbabwe