

# Official Bulletin of the Industrial Property

Inventions

Utility Models

Designs

Trademarks



საქართველოს ინტელექტუალური  
საკუთრების ეროვნული ცენტრი

**საქპატენტი**

**SAKPATENTI**

NATIONAL INTELLECTUAL PROPERTY  
CENTER OF GEORGIA

[www.sakpatenti.gov.ge](http://www.sakpatenti.gov.ge)

Date of Publication – 2021 05 13

**8(564)**

# INID CODES FOR IDENTIFICATION OF BIBLIOGRAPHIC DATA

## INVENTIONS, UTILITY MODELS

- (10) Number of publication for application, which has been examined
- (11) Number of patent and kind of document
- (21) Serial number of application
- (22) Date of filing of the application
- (23) Date of exhibition or the date of the earlier filing and the number of application, if any
- (24) Date from which patent may have effect
- (31) Number of priority application
- (32) Date of filing of priority application
- (33) Code of the country or regional organization allotting priority application number
- (44) Date of publication of application not granted, but examined and number of bulletin
- (45) Date of publication of registered document
- (51) International Patent Classification Index

- (54) Title of the invention
- (57) Abstract
- (60) Number of examined patent document granted by foreign patent office, date from which patent has effect and country code
- (62) Number of the earlier application and in case of divided application, date of filing an application
- (71) Name, surname and address of applicant (country code)
- (72) Name, surname of inventor (country code)
- (73) Name, surname and address of patent owner (country code)
- (74) Name, surname of representative or patent attorney
- (85) Date of commencement of the national phase of International Application
- (86) Number and date of filing of international application
- (87) Number and date of publication of international application
- (94) Calculated date of expiry of the SPC or the duration of the SPC

## DESIGNS

- (10) Number of publication for application
- (11) Number of patent and kind of document or number of registration
- (15) Date of registration/Date of patent renewal
- (18) Expected expiration date of patent or registration
- (21) Serial number of application
- (22) Date of filing of the application
- (23) Date of exhibition or the date of the earlier filing and the number of application, if any
- (24) Date from which patent may have effect
- (28) Number of designs included in the application
- (30) Data relating to priority (number of application, date of filing of application, two-letter code identifying the authority with whom the priority application was made)
- (31) Number of priority application
- (32) Date of filing of priority application
- (33) Code of the country or regional organization allotting priority application number
- (34) Two-letter code according to WIPO St.3 identifying the authority with which the priority application was made
- (44) Date of publication of design and number of bulletin (the first publication)
- (45) Date of publication of design registered by WIPO and number of bulletin

- (51) International Classification for designs (class and subclass of the Locarno Classification)
- (54) Title of the invention
- (55) Reproduction of the design
- (57) Description of characteristic features of the design including indication of colors
- (58) Date of recording of any kind of amendment in the Register
- (62) Number of the earlier application, registration and document number and if available the date of filing an application in case of divided application
- (71) Name, surname and address of applicant (country code)
- (72) Name, surname of creator (country code)
- (73) Name, surname and address of patent owner (country code)
- (74) Name, surname of representative or patent attorney
- (81) Contracting states concerned
  - II designated contracting states according to the 1960 Act
  - III designated contracting states according to the 1999 Act
- (85) Owner's permanent address
- (86) Owner's nationality
- (87) Owner's residence
- (88) State in which the owner has a real and effective industrial or commercial establishment

## TRADEMARKS

- (111) - Number of registration
- (151) - Date of registration
- (156) - Date of the renewal
- (181) - Expected expiration date of registration
- (186) - Renewal expiration date of registration
- (141) - Date of cancel of duration of the mark
- (210) - Serial number of application
- (220) - Date of filing of the application
- (230) - Data concerning exhibition
- (260) - Number of application, for which favorable decision of examination about registration has been taken (publication number)
- (310) - Number of the first application
- (320) - Date of filing of the first application
- (330) - Code, identifying national or regional Office where the first application was made
- (511) - International Classification of Goods and Services for the purposes of registration of trade marks and/or list of goods and/or services classified according thereto
- (526) - Disclaimer
- (531) - Description of figurative elements of Trade Marks according to the International Classification of the Figurative Elements of Marks

- (540) - Reproduction of Trade Mark
- (550) - Nature and kind of Trade Mark
- (551) - Indication to the effect that the mark is a collective mark, a certification mark or a guarantee mark
- (554) - Three-dimensional mark
- (580) - Date of recording of any kind changes in respect of applications or registrations
- (591) - Information concerning colors claimed
- (731) - Name and address of the applicant
- (732) - Name and address of the holder of the registration
- (740) - Name and address of the representative
- (750) - Addreses for correspondence
- (770) - Name and address of the previous applicant or holder in case of change in ownership
- (771) - Previous name and address of the applicant or holder in case of change in ownership
- (791) - Name and address of the licensee
- (793) - Indication of conditions and/or restrictions under the license (Type of license, number of license agreement, data of license, data of validity of license)
- (800) - Certain data relating to the international registration of Trade Marks under the Protocol Relating to Madrid Agreement (International registration number
- (852) - Partial cancellation of the list of goods and services
- (891) - Date of subsequent designation

## CODES FOR PUBLICATION IN BULLETIN

- (21) AP 0000 000000 - serial number of application for invention
- (10) AP 0000 0000 A - number of published application for invention (first publication)
- (11) P 0000 0000 B - number of patent for invention (second publication)
- (21) API 0000 000000 - number of application for imported patent
- (11) PI 0000 0000 A - number of imported patent (first publication)
- (21) AU 0000 000000 - serial number of application for utility model
- (10) AU 0000 000 U - number of published application for utility model (first publication)
- (11) U 0000 000 Y - number of patent for utility model (second publication)
- (21) AD 0000 000000 - serial number of application for design
- (10) AD 0000 000 S - number of published application for design (first publication)
- (11) D 0000 000 S - registered design

## INTERNATIONAL PATENT CLASSIFICATION FOR INVENTIONS AND UTILITY MODELS

- SECTION A - HUMAN NECESSITIES
- SECTION B - PERFORMING OPERATIONS; TRANSPORTING
- SECTION C - CHEMISTRY; METALLURGY
- SECTION D - TEXTILES; PAPER
- SECTION E - FIXED CONSTRUCTIONS
- SECTION F - MECHANICAL ENGINEERING; LIGHTING; HEATING; WEAPONS; BLASTING
- SECTION G - PHYSICS
- SECTION H - ELECTRICITY

- 
- M - Trade Mark
  - (210) AM 0000 000000 - Serial number of application;
  - (260) AAM 0000 00000 A - Publication number of application;
  - (111) M 0000 00000 R - Number of registration;
  - (111) MMM0000 00000 Rn - Number of renewals, in which n=1,2,3;
  - (111) M 0000 00000 R(P) - Number of registration under partial assignment of rights
-

# Official Bulletin of the Industrial Property

Inventions

Utility Models

Designs

Trademarks

# CONTENTS

<b>PUBLISHED TITLES OF PROTECTION</b> .....	3
<b>INVENTIONS</b>	
▪ APPLICATIONS APPROVED FOR GRANTING PATENTS .....	4
▪ PATENTED INVENTIONS .....	6
<b>UTILITY MODELS</b>	
▪ APPLICATIONS APPROVED FOR GRANTING PATENT .....	8
<b>DESIGNS</b>	
▪ DESIGNS, WHICH HAVE BEEN REGISTERED WITH THE INTERNATIONAL BUREAU CLAIMING PRIORITY ON THE TERRITORY OF GEORGIA .....	9
<b>TRADEMARKS</b>	
▪ APPLICATIONS FILED UNDER THE NATIONAL PROCEDURE APPROVED FOR REGISTRATION .....	35
▪ REGISTERED TRADEMARKS .....	45
▪ TRADEMARKS REGISTERED ACCORDING TO THE ACCELERATED PROCEDURE .....	50
▪ INTERNATIONAL TRADEMARKS FOR WHICH A DECISION ON GRANTING PROTECTION IS TAKEN .....	53
▪ INTERNATIONAL TRADEMARKS PROTECTED IN GEORGIA .....	116
<b>OFFICIAL NOTIFICATIONS</b>	
<b>INVENTIONS</b>	
▪ EXPIRATION OF PATENT RESTORATION .....	128
▪ ABOLITION OF PATENTS WITH THE RIGHT TO RESTORE .....	128
▪ EXPIRATION OF TERM OF RESTORATION OF PATENT .....	129
▪ EXPIRATION OF PATENTS .....	130
<b>UTILITY MODELS</b>	
▪ EXPIRATION OF TERM OF RESTORATION OF PATENT .....	131
<b>DESIGN</b>	
▪ EXTENSION OF REGISTRATION .....	131
▪ CANCELLATION OF REGISTRATIONS .....	132
▪ EXTENSION OF REGISTRATION OF INTERNATIONAL DESIGNS .....	132
▪ CANCELLATION OF REGISTRATION OF INTERNATIONAL DESIGNS .....	134
<b>TRADEMARKS</b>	
▪ RENEWAL OF REGISTRATIONS .....	136
▪ COMPLETE TRANSFER OF RIGHTS .....	138
▪ CHANGES OF NAMES AND/OR ADDRESSES OF OWNER .....	139
▪ CANCELLATION OF TRADEMARKS REGISTRATION .....	141
<b>CLASSIFICATION INDEXES</b>	
INVENTIONS .....	143
UTILITY MODELS .....	144
TRADEMARKS .....	145

# PUBLISHED TITLES OF PROTECTION

## INVENTIONS

- **APPLICATIONS APPROVED FOR GRANTING PATENT:**  
14666; 14848; 15030; 15178; 14876
- **PATENTED INVENTIONS:**  
7252-7255

## UTILITY MODELS

- **APPLICATIONS APPROVED FOR GRANTING PATENT:**  
15269; 15249

## DESIGNS

- **DESIGNS, WHICH HAVE BEEN REGISTERED WITH THE INTERNATIONAL BUREAU CLAIMING PRIORITY ON THE TERRITORY OF GEORGIA:**  
207295; 212575; 212681; 212704; 210034; 210120; 212750; 210112; 210353; 210110; 212997; 210619; 213245; 213179

## TRADEMARKS

- **APPLICATIONS FILED UNDER THE NATIONAL PROCEDURE APPROVED FOR REGISTRATION:**  
105655; 108696; 109731; 109772; 109825, 109826; 109832; 109840; 109846, 109847; 109911, 109912; 109919; 109922; 109927; 109932, 109933; 109950; 109958; 109961-109964; 110016, 110017; 110021; 110023; 110025; 110027; 110029; 110031-110033; 110035; 110037, 110038; 110040-110043; 110045; 110113-110116; 110118; 110129, 110130; 110135; 110137-110139; 110193; 110197; 110199; 110208; 110212; 110217; 110220, 110221; 110223; 110231
- **REGISTERED TRADEMARKS:**  
33954-34004
- **TRADEMARKS REGISTERED ACCORDING TO THE ACCELERATED PROCEDURE:**  
33943-33953; 34005, 34006
- **INTERNATIONAL TRADEMARKS FOR WHICH A DECISION ON GRANTING PROTECTIONS IS TAKEN:**  
103049\*; 107350\*; 108977; 108986, 108987; 108989; 109005; 109064; 109067-109069; 109071, 109072; 109077, 109078; 109101-109104; 109158-109168; 109177-109181; 109202-109205; 109240-109242; 109245; 109247, 109248; 109260-109264; 109275-109279; 109282; 109307; 109321; 109328-109330; 109341, 109342; 109344; 109350; 109391, 109392; 109404; 109406-109408; 109421; 109424; 109445, 109446; 109526-109530; 109650, 109651; 109802; 109805
- **INTERNATIONAL TRADEMARKS PROTECTED IN GEORGIA:**  
103299; 103919; 105961; 106027; 106487; 106577, 106578; 106872; 107506-107509; 107518- 107522; 107524-107537; 107539-107541; 107605, 107606; 107621, 107622; 107624-107626; 107628-107630; 107632; 107644; 107687-107694; 107700; 107706-107713; 107715-107729; 107732-107734; 107762-107766; 107768-107771; 107773-107775; 107777-107779; 107786- 107791; 107798-107800; 107844-107846; 107848-107850; 107853, 107854; 107856-107859; 107866; 107868, 107869; 107872-107874; 107878-107880; 107882-107884; 107931-107934; 107936-107946; 107958-107967; 107978; 107996, 107997; 108000; 108029-108031; 108039, 108040; 108044; 108046-108050; 108052

---

# INVENTIONS

## APPLICATIONS APPROVED FOR GRANTING PATENTS

The decision can be appealed at the Chamber of Appeal of Sakpatenti within 3 months from the publication or at the Mtskheta District Court Administrative Cases Board (Address: №17, Samkhedro str., Mtskheta), within 1 month following the publication.

### PART A

#### A 61

(10) AP 2021 14666 A (51) Int. Cl. (2006)  
A 61 K 38/16  
A 61 K 38/48  
C 12 N 9/52

(21) AP 2016 14666 (22) 2016 06 08

(31) 62/172,557

(32) 2015 06 08

(33) US

(71) University Of Washington (US)  
4311 11<sup>th</sup> Avenue NE, Suite 500, Seattle,  
WA 98105-4608, USA (US);  
The Regents of the University  
of California (US)  
1111 Franklin St., Twelfth Fl., Oakland,  
CA 94607-5200, USA (US)

(72) PULTZ, Ingrid, Swanson (US);  
WOLF, Clancey (US);  
SIEGEL, Justin, Bloomfield (US);  
TINBERG, Christine, Elaine (US);  
STEWART, Lance (US);  
BAKER, David (US)

(74) Shalva Gvaramadze

(85) 2018 01 05

(86) PCT/US2016/036356, 2016 06 08

(54) COMPOSITIONS AND METHODS

FOR TREATING CELIAC SPRUE DISEASE

(57) Polypeptides, and methods for their use for the treatment of celiac sprue disease or non celiac gluten sensitivity (NCGS) are disclosed, wherein polypeptides with amino acid sequence at least 85% identical to the amino acid sequence of SEQ ID NO: 1, are provided, wherein (a) residue 467 is Ser, residue 267 is Glu, and residue 271 is Asp; and (b) polypeptide comprises amino acid change from SEQ ID NO: 1 at one or more residues selected from the group consisting of 221D/N/Q/H, 262E, 268S/T/A, 269L/T, 270A/T/V, 319A, 354E/Q/R/Y, 358S/Q/T, 368F/Q, 399Q, 402S/Q, 406S, 424K, 449E/N/Q, 461R and 463A/L/M/Q/R/T/V, wherein said polypeptide capable to sprit gliadines.

Claims: 13 independents

27 dependents

Fig.: 8

(10) AP 2021 14848 A (51) Int. Cl. (2006)

A 61 K 45/06

A 61 K 39/395

C 07 K 16/40

(21) AP 2017 14848 (22) 2017 01 05

(31) 62/275,025; 62/407,979

(32) 2016 01 05; 2016 10 13

(33) US; US

(71) University Of Leicester (GB)

University Rd., Leicester, Leicestershire,  
LE1 7RF, United Kingdom (GB);

Omeros Corporation (US)

201 Elliott Ave. West, Seattle,

WA 98119, USA (US)

(72) BRUNSKILL, Nigel, John (GB);

DEMOPULOS, Gregory, A. (US);

DUDLER, Thomas (US);

SCHWAEBLE, Hans-Wilhelm (GB)

(74) Tamar Kochlamazashvili

(85) 2018 08 02

(86) PCT/US2017/012345, 2017 01 05

(54) METHODS FOR INHIBITING FIBROSIS  
IN A SUBJECT IN NEED THEREOF

(57) An invention relates to the usage of monoclonal inhibitory MASP-2 antibody or antigen-binding fragment therefor the prevention or reduction of fibrosis-induced renal damage of kidneys in a subject having steroid-dependent immunoglobulin A nephropathy (IgAN).

Claims: 1 independent

7 dependents

Fig.: 40

**PART C****C 01**

- (10) AP 2021 15030 A (51) Int. Cl. (2006)  
C 01 B 31/08  
C 10 B 53/02
- (21) AP 2019 15030 (22) 2019 03 25
- (71) Iv. Javakhishvili Tbilisi State University  
R.Agladze Institute Of Inorganic Chemistry  
and Electrochemistry (GE)  
E. Mindeli St. 11, 0186, Tbilisi, Georgia (GE)
- (72) Tamaz Marsagishvili (GE);  
Grigol Tatishvili (GE);  
Natela Ananiashvili (GE);  
Manana Gachechiladze (GE);  
Julieta Metreveli (GE);  
Zurab Samkharadze (GE);  
Elizaveta Tskhakaia (GE);  
Nino Giorgadze (GE);  
Marine Machavariani (GE);  
Guram Megreli (GE)
- (54) METHOD FOR RECEIVING SORBENTS  
FROM WASTE OF PLASTICS AND  
CELLULOSE
- (57) Method for receiving sorbents from waste of  
plastics and cellulose provides 1.2-1.5 kg of raw  
material loading into stainless steel reactor without  
pre-treatment and air expulsion with CO<sub>2</sub>, increasing  
the temperature in 12-15 per minute, until reaching  
the final temperature of 850, and supplement  
therewith carbon dioxide with the speed of 400-500  
ml/h during 3 h by using the gases generated at the  
heating process as energy source.  
Claims: 1 independent

**C 02**

- (10) AP 2021 15178 A (51) Int. Cl. (2006)  
C 02 F 1/00  
C 09 K 8/05
- (21) AP 2015 15178 (22) 2015 07 23
- (62) AP 2015 14447 2015 07 23
- (31) 62/036,912; 62/103,668; 62/185,171
- (32) 2014 08 13; 2015 01 15; 2015 06 26
- (33) US; US; US
- (71) Albemarle Corporation (US)  
451 Florida St., Baton Rouge,  
LA 70801-1765, USA (US)
- (72) LAMBETH, Gregory, H. (US);  
GODAVARTHY, Srinivasa, S. (US);  
NALEPA, Christopher, J. (US);  
LIU, Yunqi (US);  
COPPOLA, Kevin (US);  
LOUWEN, Jacobus, N. (NL)
- (74) Tamar Kochlamazashvili
- (85) 2019 08 27

- (86) PCT/US2015/041662, 2015 07 23
- (54) HIGH DENSITY AQUEOUS WELL FLUIDS
- (57) This invention provides zinc-free aqueous  
brine compositions having a density of about 14.3  
ppg or more, and a true crystallization temperature  
of about 20°F or less, and comprise water and one  
or more inorganic bromide salts, with the provisos  
that when calcium bromide is present, one or more  
other water-soluble inorganic salts are also present,  
when lithium bromide is present, calcium bromide  
is absent, when bismuth(III) bromide is present,  
one or more other water-soluble inorganic salts are  
also present, and for a true crystallization  
temperature of about 10°F (-12, 20°C) or less, when  
manganese(II) bromide is present, one or more  
other water-soluble inorganic salts are also present.  
Processes for forming these zinc-free aqueous brine  
compositions are also provided.  
Claims: 12 independents  
12 dependents

**C 07**

- (10) AP 2021 14876 A (51) Int. Cl. (2006)  
C 07 K 16 /24
- (21) AP 2017 14876 (22) 2017 03 16
- (31) 16160907.8
- (32) 2016 03 17
- (33) EP
- (71) Tillotts Pharma Ag (CH)  
Baslerstrasse 15, Rheinfelden 4310,  
Switzerland (CH)
- (72) GUNDE, Tea (CH);  
MEYER, Sebastian (CH);  
FURRER, Esther Maria (CH)
- (74) Khatuna Imnadze
- (85) 2018 09 13
- (86) PCT/EP2017/056237, 2017 03 16
- (54) ANTI-TNF $\alpha$ -ANTIBODIES AND FUNCTIO-  
NAL FRAGMENTS THEREOF
- (57) Present invention relates to antibody molecules  
and functional fragments thereof, capable to be  
bind with tumor necrosis factor alpha (TNF $\alpha$ ), to  
processes for their production, and to their  
therapeutic uses.  
Claims: 7 independents  
10 dependents  
Fig.: 18

## PATENTED INVENTIONS

### PART A

#### A 61

- (11) P 2021 7252 B (51) Int. Cl. (2006)  
A 61 K 47/00  
A 61 K 59/595  
A 61 K 9/08
- (10) AP 2020 15038 A (44) 23(555)/2020  
(21) AP 2017 15038  
(22) 2017 08 30  
(24) 2017 08 30  
(31) 62/382,156  
(32) 2016 08 31  
(33) US  
(86) PCT/US2017/049415, 2017 08 30  
(73) OMEROS CORPORATION (US)  
201 Elliott Ave. West Seattle,  
WA 98119, USA (US)
- (72) WHITAKER, John, Steven (US);  
LAMBERT, William, Joseph (US);  
FERGUSON, Kenneth, M. (US);  
DEMOPULOS, Gregory, A. (US)
- (74) Tamar Kochlamazashvili
- (54) HIGHLY CONCENTRATED LOW  
VISCOSITY MASP-2 INHIBITORY  
ANTIBODY FORMULATIONS, KITS,  
AND METHODS

- (11) P 2021 7254 B (51) Int. Cl. (2006)  
A 61 K 36/00
- (10) AP 2021 15233 A (44) 1(557)/2021  
(21) AP 2019 15233  
(22) 2019 12 09  
(24) 2019 12 09  
(73) Giorgi Aleksidze (GE)  
N. Nikoladze St. 2, 0108, Tbilisi, Georgia (GE)
- (72) Giorgi Aleksidze (GE)
- (74) Davit Dزامukashvili
- (54) HERBAL IMMUNOMODULATORY  
IMMUNOCORRECTIVE INJECTION  
REMEDY AND PREPARATION  
METHOD THEREOF

- (11) P 2021 7253 B (51) Int. Cl. (2006)  
A 61 K 39/00  
C 07 K 16/46  
C 07 K 16/18
- (10) AP 2021 14964 A (44) 1(557)/2021  
(21) AP 2017 14964  
(22) 2017 06 01

- (24) 2017 06 01  
(31) 62/344,746  
(32) 2016 06 02  
(33) US  
(86) PCT/EP2017/063406, 2017 06 01  
(73) MEDIMMUNE LIMITED (GB)  
Milstein Bld. Granta Park, Cambridge CB21  
6GH, GB, UK (GB)
- (72) IRVING, Lorraine (GB);  
THOM, George (GB);  
PERKINTON, Michael (GB);  
SCHOFIELD, Darren (GB)
- (74) Shalva Gvaramadze
- (54) ANTIBODIES TO  $\alpha$ -SYNUCLEIN  
AND USES THEREOF

### PART C

#### C 04

- (11) P 2021 7255 B (51) Int. Cl. (2006)  
C 04 B 21/00
- (10) AP 2020 15125 A (44) 24(556)/2020  
(21) AP 2019 15125  
(22) 2019 07 03  
(24) 2019 07 03  
(73) Razhden Skhvitaridze (GE)  
Ninoshvili St. 3, 0102, Tbilisi, Georgia (GE);  
Elene Shapakidze (GE)  
I. Chavchavadze Av., Lane I, corp. 6, app. 7,  
0179, Tbilisi, Georgia (GE);  
Merab Abazadze (GE)  
Tsinamdzghvrishvili St. 60, Tbilisi,  
Georgia (GE);  
Ioseb Gejadze (GE)  
I. Chavchavadze Av., Lane I, corp. 6, app. 7,  
0179, Tbilisi, Georgia (GE);  
Malkhaz Turdzeladze (GE)  
Ghambashidze St. Lane II, 3, 2000, Zestaponi,  
Georgia (GE);  
Shalva Verulava (GE)  
M. Kostava St. 75, 0160, Tbilisi, Georgia (GE);  
LEPL Levan Samkharauli National Forensics  
Bureau (GE)  
I. Chavchavadze Av. 84, 0162, Tbilisi,  
Georgia (GE);  
Georgian Technical University (GE)  
M. Kostava St. 77, 0171, Tbilisi, Georgia (GE);  
Iv. Javakhishvili Tbilisi State University (GE)  
I. Chavchavadze Av. 1, 0179, Tbilisi,  
Georgia (GE);



LEPL Shota Rustaveli National Science  
Foundation of Georgia (GE)  
M. Aleksidze St. 1, 0193, Tbilisi, Georgia (GE)

(72) Razhden Skhvitardze (GE);

Elene Shapakidze (GE);

Merab Abazadze (GE);

Ioseb Gejadze (GE);

Malkhaz Turdzeladze (GE);

Shalva Verulava (GE)

(54) PREPARATION METHOD FOR  
EXPANDED CLAY WITH SHALE  
BROUGHT BY THE RIVER DURUJI  
AND ACCUMULATED IN THE  
RIVER-BED NEARBY CITY KVARELI

---

---

# UTILITY MODELS

## APPLICATIONS APPROVED FOR GRANTING PATENTS

The decision can be appealed at the Chamber of Appeal of Sakpatenti within 3 months from the publication or at the Mtskheta District Court Administrative Cases Board (Address: №17, Samkhedro str., Mtskheta), within 1 month following the publication.

### PART A

#### A 01

- (10) AU 2021 15269 U (51) Int. Cl. (2006)  
A 01 G 22/00  
A 01 G 31/00
- (21) AU 2020 15269 (22) 2020 02 03  
(71) Iamze Beshkenadze (GE)  
Vazisubani IV/I, corp. 8, app. 99, Tbilisi,  
Georgia (GE)
- (72) Iamze Beshkenadze (GE);  
Maia Gogaladze (GE);  
Nazibrola Klarjeishvili (GE);  
Nikoloz Zazashvili (GE);  
Marina Chikaidze (GE);  
Omar Lomtadze (GE)
- (54) CHELATED CHROME AND ZINC USAGE  
AT VERMICULTIVATION
- (57) Chelated zinc ( $Zn \cdot Cist \cdot H_2O$ ) and chrome  
( $Cr \cdot L \cdot 4H_2O$ ) usage at vermicultivation for rain  
worm substrate, on g/100kg, with the following  
amount:
- Zn·Cist·H<sub>2</sub>O - 32.88-45.52 (I)  
Cr·L·4H<sub>2</sub>O - 52.11-72.12 (II)
- Claims: 1 independent  
Table: 1
- 

#### (54) METHOD FOR SULFUR CEMENT PRODUCTION

(57) A method for sulfur cement production provides the sulfur heating up to 130-140°C temperature, received hydrogen sulfide removal, addition of modifier therein, and mixing, cooling and crushing of received mixture; at that, supplement with compressed air under high-pressure is executed after heating of sulfur. The mixture of sulfur and modifier obtained by mixing is placed in electromagnetic turbine, and is processed with electromagnetic field; at that, refined oil or oil-containing wastes are used as the modifiers. Furthermore, the modifier is added therein, in amount of 0.1-1.5 mass% of sulfur, compressed air is supplied with 1-15 atm., preferably – 6-7 atm. pressure, and mixture treatment is executed with electromagnetic field during 5-30 seconds.

Claims: 1 independent  
3 dependents

---

### PART C

#### C 04

- (10) AU 2021 15249 U (51) Int. Cl. (2006)  
C 04 B 28/36
- (21) AU 2019 15249 (22) 2019 12 24  
(71) Ibragim Zhaksimbetov (KZ)  
15<sup>th</sup> Mkr., H. 80, 130000, Mangystau Region,  
Aktau, Kazakhstan (KZ);  
Oleg Tashkalov (KZ)  
12<sup>th</sup> Mkr., H. 80, app. 73, 130000, Mangystau  
Region, Aktau, Kazakhstan (KZ)
- (72) Ibragim Zhaksimbetov (KZ);  
Oleg Tashkalov (KZ)
- (74) Khatuna Imnadze

## DESIGNS, WHICH HAVE BEEN REGISTERED WITH THE INTERNATIONAL BUREAU CLAIMING PRIORITY ON THE TERRITORY OF GEORGIA

The decision can be appealed at the Chamber of Appeal of Sakpatenti within 3 months from the publication or at the Mtskheta District Court Administrative Cases Board (Address: №17, Samkhedro Str., Mtskheta), within 1 month following the publication.

- (11) DM/207 295 (51) 10-07  
 (15) 2020 03 06 (44) 06/2021 (2021 02 12)  
 (22) 2020 03 06  
 (28) 2  
 (73) Montres Breguet SA (Montres Breguet AG) (Montres Breguet Ltd)  
 Place De La Tour 23, 1344 L'Abbaye (CH)  
 (85) CH  
 (86) CH  
 (87) CH  
 (88) CH  
 (89) CH  
 (81) II. MA III. AM, AL, AZ, BZ, ME, MD, SG, MN, BA, TR, GE, OM, MK, LI, KG, GB, TN, EM, CH  
 (72) Vincenzo Laucella  
 Route De France 38, 1348, Le Brassus (CH)  
 (74) The Swatch Group SA (The Swatch Group AG) (The Swatch Group Ltd.)  
 Faubourg Du Lac 6, 2501 Biel / Bienne (CH)  
 (46) 2021 02 12  
 (54) 1. Watch case, 2. Hand of dial  
 (55)

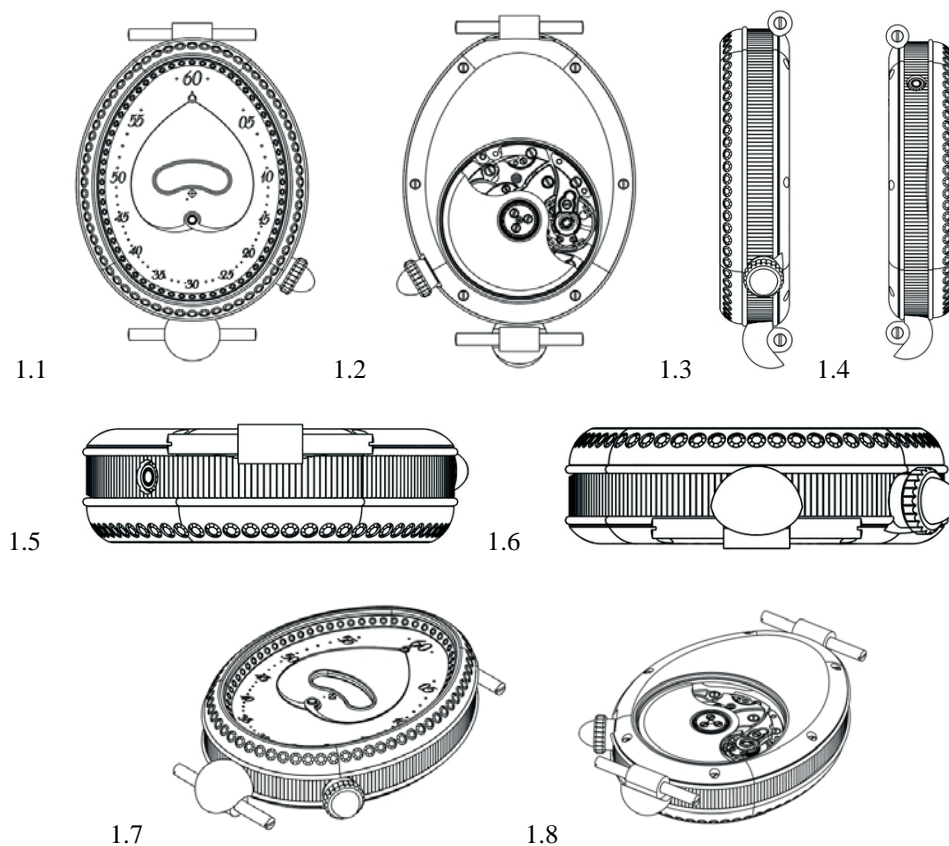



1.9



1.10



1.11



1.12

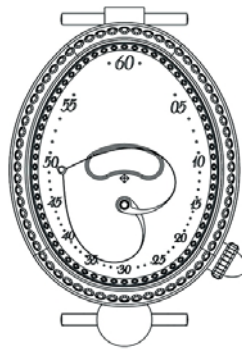

1.13

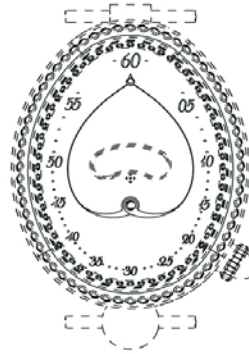

2.1

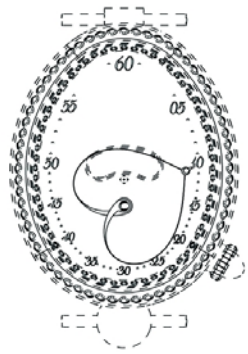

2.2

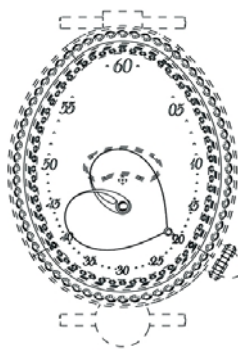

2.3

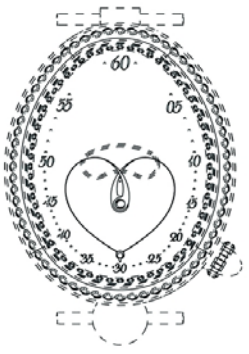

2.4

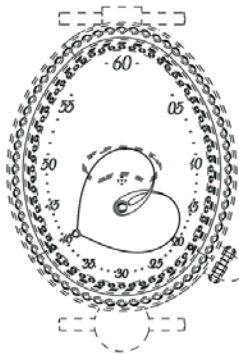

2.5

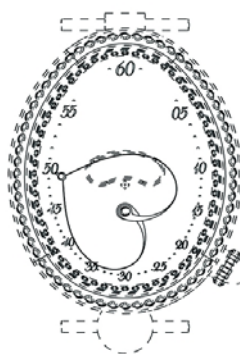

2.6

- (11) DM/212 575 (51) 12-11  
 (15) 2021 01 26 (44) 06/2021 (2021-02-12)  
 (22) 2021 01 26  
 (28) 2  
 (30) No1: 27.07.2020; 008053227-0001; EM; No2: 27.07.2020; 008053227-0002; EM  
 (73) Bolt Technology OÜ  
 Vana-Lõuna Tn 15, EE-10134 Tallinn (EE)  
 (85) –  
 (86) EM  
 (87) EM  
 (88) EM  
 (89) EM  
 (81) III. UA, MX, AZ, SG, OA, NO, RS, GE, CA, KR, JP, CH, RU, IL  
 (72) A. Martin Petrov  
 Vao Küla, Oru Tn 11, Väike-Maarja Vald, 46230, Lääne-Viru Maakond (EE);  
 B. Matti Õunapuu  
 Aia Tn 5b-9, 10111, Tallin (EE);  
 C. Erki Saarik  
 Aaviku Küla, Tamme Tee 4, Rae Vald, 76613, Harju Maakond (EE)  
 (74) AAA Patendibüroo OÜ  
 Tartu Mnt 16, 10117 Tallinn (EE)  
 (54) 1.-2. Motor scooter  
 (55)

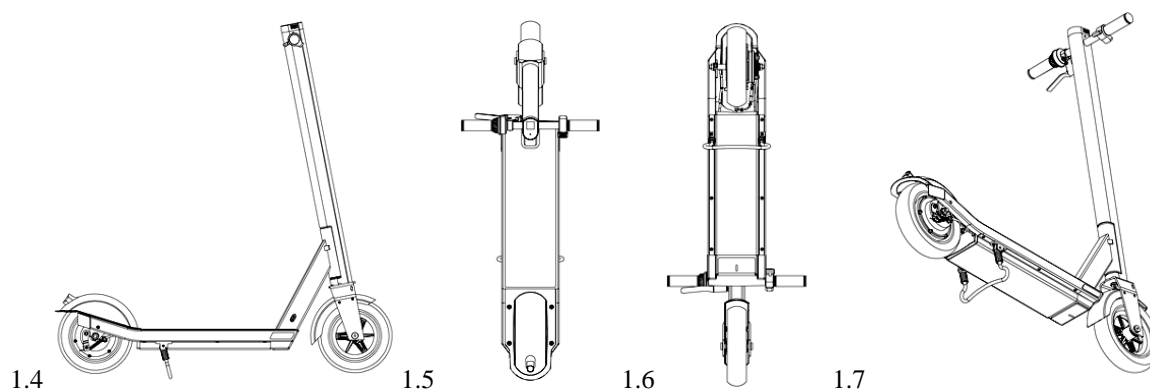
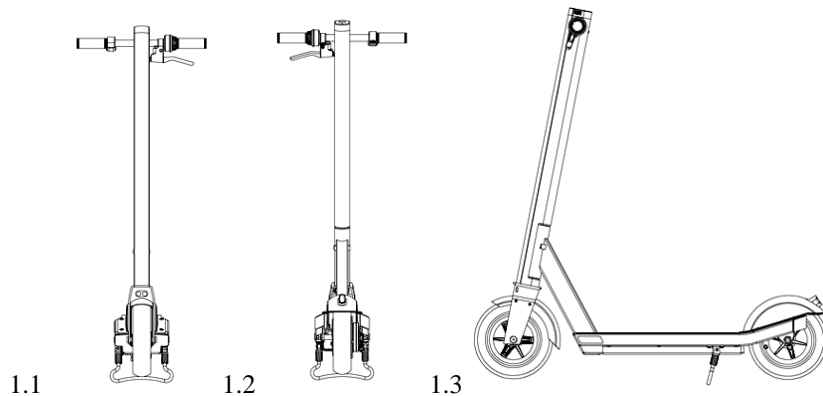

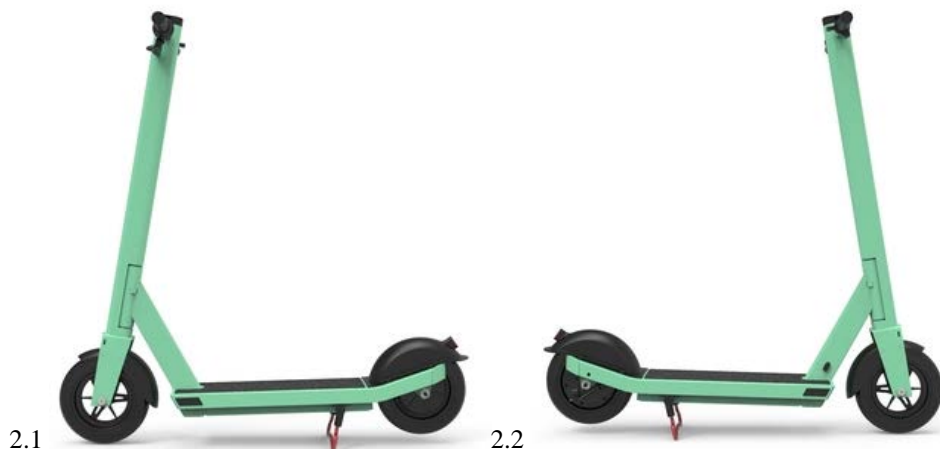

- (11) DM/212 681 (51) 09-01  
(15) 2020 12 14 (44) 07/2021 (2021 02 19)  
(22) 2020 12 14  
(28) 1  
(30) No1: 07.10.2020; 2020504646; RU  
(73) Obshchestvo S Ogranichennoj Otvetstvennost`yu "Konzern BONUS"  
Gogolya 6, 357500 Pyatigorsk (RU)  
(85) RU  
(86) RU  
(87) RU  
(88) RU  
(89) RU  
(81) III. RO, LI, MK, US, GE, BA, EE, RS, DE, NO, EG, FI, BG, DK, EM, IS, AM, HU, ES, MD, GB, PL, TR, IL,  
CH, LT, HR, LV, FR, UA, SG, BX, SI, MC, ME, AZ, SM  
(72) Alan Tedeev  
Millera 2, Apartment 5, 362040, Vladikavkaz (RU)  
(54) 1. Bottle  
(55)

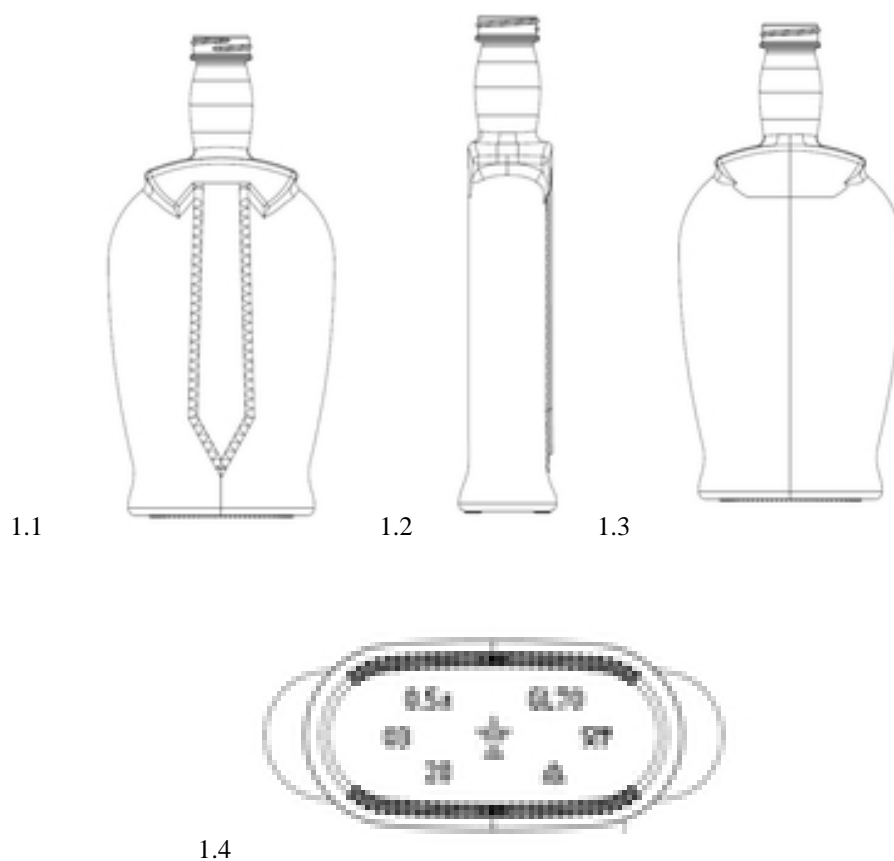

(11) DM/212 704

(51) 09-01

(15) 2020 10 30

(44) 08/2021 (2021 02 26)

(22) 2020 10 30

(28) 2

(73) F.LLI GANCIA & C. S.P.A.

CORSO LIBERTA' 66, 14053 CANELLI (IT)

(85) -

(86) EM, IT

(87) -

(88) EM, IT

(89) EM

(81) II. MA III. WS, KG, LI, OM, MK, CA, GE, US, BA, NO, RS, EG, RU, SY, EM, IS, AM, TJ, MD, VN, TN, GB, TR, SR, ST, MN, IL, KP, CH, JP, KR, MX, AL, UA, SG, MC, ME, BZ, TM, AZ, SM

(72) ALESSANDRO PICCHI

CORSO LIBERTA' 66, 14053, CANELLI (IT)

(54) 1.-2. Bottle

(55)

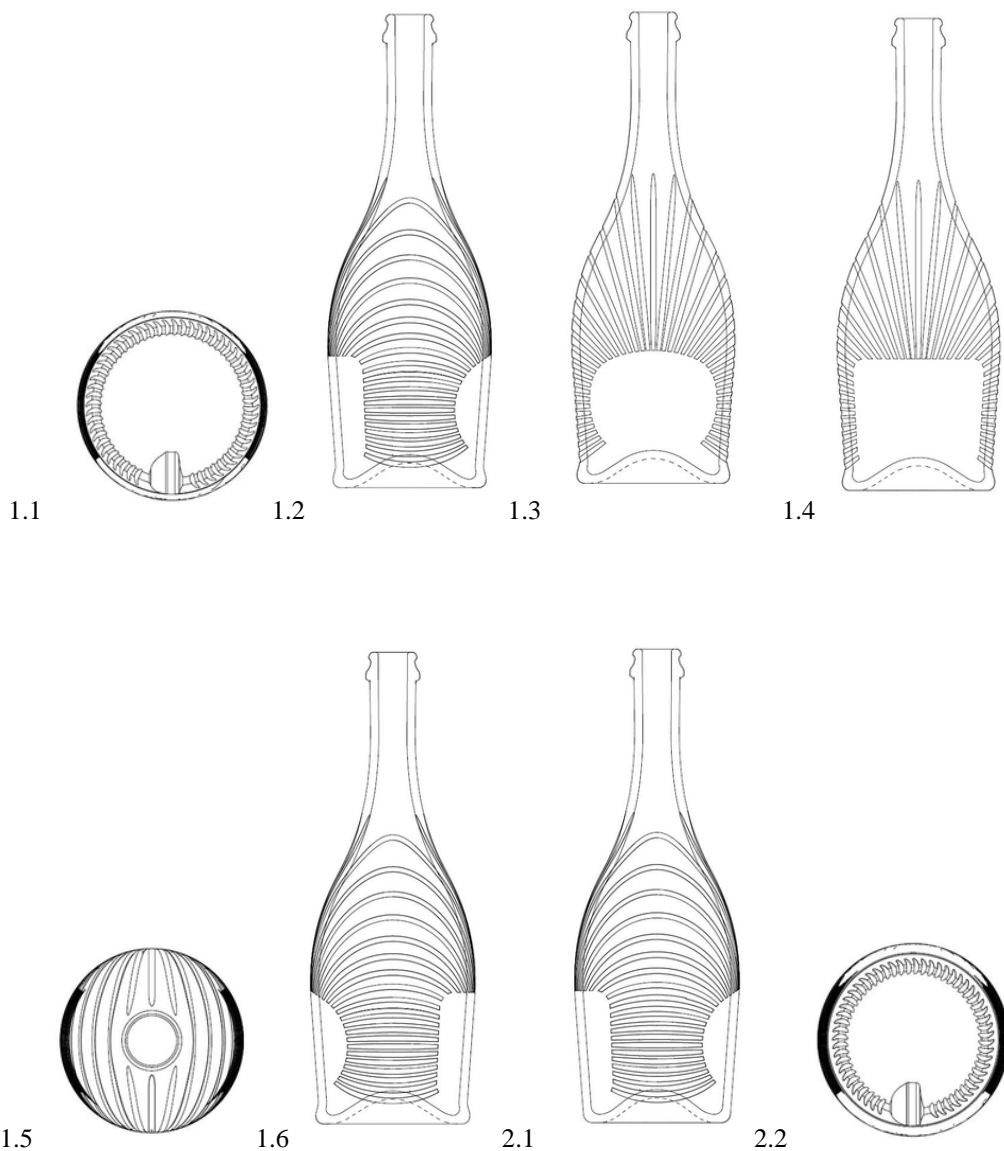



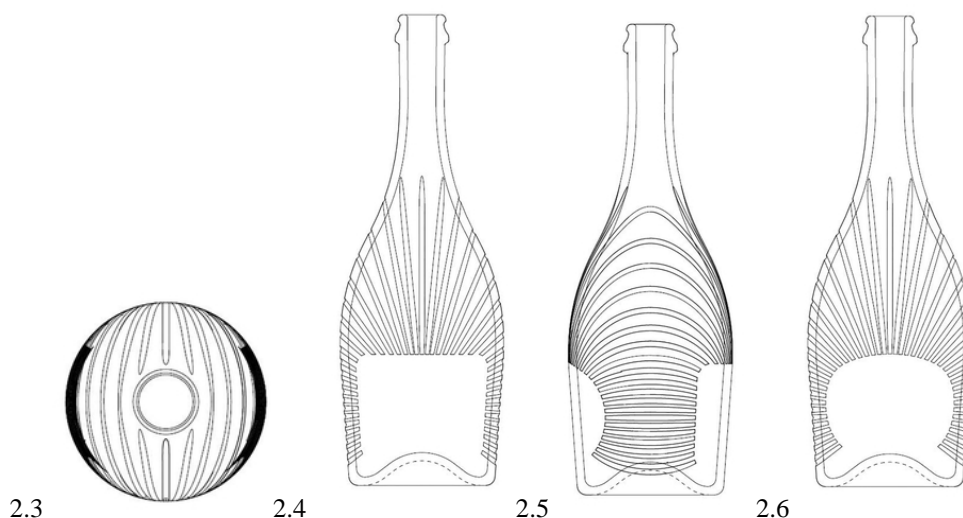

- (11) DM/210 034 (51) 11-01  
 (15) 2020 08 20 (44) 08/2021 (2021 02 26)  
 (22) 2020 08 20  
 (28) 4  
 (73) HARRY WINSTON SA  
 Chemin Du Tourbillon 8, 1228 Plan-les-Ouates (CH)  
 (85) CH  
 (86) CH  
 (87) CH  
 (88) CH  
 (89) CH  
 (81) IL, MA III, KG, LI, TR, OM, GE, MK, CA, BA, MN, NO, CH, EM, AL, AM, UA, SG, MC, MD, ME, BZ,  
 AZ, TN, GB  
 (72) 1-3 Rie Rie YATSUGI-KANG  
 C/o Harry Winston Inc. 718 Fifth Avenue, 10019, New York (US);  
 4 Chaeree KWON  
 C/o Harry Winston Inc. 718 Fifth Avenue, 10019, New York (US)  
 (74) The Swatch Group AG (The Swatch Group SA) (The Swatch Group Ltd.)  
 Faubourg Du Lac 6, 2501 Biel/Bienne (CH)  
 (54) 1.-2. Necklace, 3. Pair of earrings, 4. Necklace  
 (55)

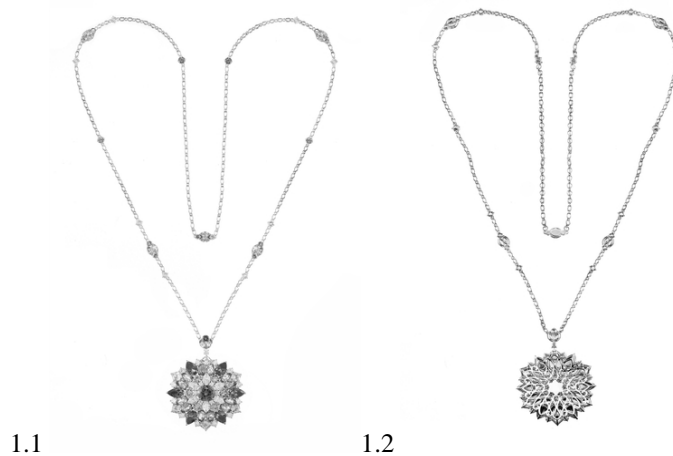



1.3



1.4



1.5



1.6



1.7



1.8



2.1



2.2



2.3



2.4



2.5



2.6



2.7



2.8



3.1



3.2



3.3



3.4



3.5



3.6



3.7



3.8



4.1



4.2



4.3



4.4



4.5



4.6



4.7



4.8

- (11) DM/210 120 (51) 11-01  
 (15) 2020 08 21 (44) 08/2021 (2021 02 26)  
 (22) 2020 08 21  
 (28) 7  
 (73) HARRY WINSTON SA  
 Chemin Du Tourbillon 8, 1228 Plan-les-Ouates (CH)  
 (85) CH  
 (86) CH  
 (87) CH  
 (88) CH  
 (89) CH  
 (81) IL, MA III, KG, LI, MK, CA, TR, OM, GE, BA, NO, MN, CH, EM, AL, AM, UA, SG, MC, MD, BZ, ME, AZ, TN, GB  
 (72) 1; 3-4; 7 Rie YATSUGI-KANG  
 C/o Harry Winston Inc., 718 Fifth Avenue, 10019, New York (US);  
 2 Dominique RIVIERE  
 C/o Harry Winston Inc., 718 Fifth Avenue, 10019, New York (US)  
 (74) The Swatch Group AG (The Swatch Group SA) (The Swatch Group Ltd.)  
 Faubourg Du Lac 6, 2501 Biel/Bienne (CH)  
 (54) 1. Finger ring, 2.-3. Pair of earrings, 4. Finger ring, 5.-7. Necklace  
 (55)



1.1



1.2



1.3



1.4



1.5



1.6



1.7



1.8



2.1



2.2







4.1



4.2



4.3



4.4



4.5



4.6



4.7



4.8



5.1



5.2



5.3



5.4



5.5



5.6



5.7



5.8



6.1



6.2



6.3



6.4



6.5



6.6





6.7



6.8



7.1



7.2



7.3



7.4



7.5



7.6



7.7



7.8

(11) DM/212 750

(51) 19-08

(15) 2021 01 14

(44) 08/2021 (2021 02 26)

(22) 2021 01 14

(28) 5

(73) Private Enterprise "Divotsvit"

St. Vyrobnycha, 10, Urban-village Slobozhanskiy, Dniprovsky District, 52005 Dnipropetrovsk Region (UA)

(85) UA

(86) UA

(87) UA

(88) UA

(89) UA

(81) III. GE, MN, TJ, MD, EM, TM, AZ

(72) Oleg Beloshytskyy

Kharkivska Street, 39, Urban-village Slobozhanskiy, Dniprovski District, 52005, Dnipropetrovsk Region (UA)

(74) Patent Legal Bureau CKT LLC / Tamara Egorova

Lyvarna, 4, Apt 303, 49044 Dnipro (UA)

(54) 1.-5. Label

(55)



1.1



2.1



3.1



4.1



5.1

- (11) DM/210 112 (51) 21-01  
 (15) 2020 08 24 (44) 08/2021 (2021 02 26)  
 (22) 2020 08 24  
 (28) 2  
 (30) No1: 24.02.2020; 29/725,283; US; No2: 24.02.2020; 29/725,283; US  
 (73) Jabberwocky Toys Corporation  
 439 Oakland Ave SE, Suite 100, 30312 Atlanta, GA (US)  
 (85) US  
 (86) US  
 (87) US  
 (88) US  
 (89) US  
 (81) III. KG, LI, GE, CA, MK, BA, NO, EG, RU, EM, IS, BW, MD, VN, GB, KH, TR, GH, MN, IL, CH, JP, KR,  
 MX, UA, OA, NA, SG, MC, BZ, ME, SM  
 (72) Janet Young  
 C/o Jabberwocky Toys Corporation 439 Oakland Ave SE, Suite 100, 30312, Atlanta, GA (US);  
 James Warner  
 C/o Jabberwocky Toys Corporation 439 Oakland Ave SE, Suite 100, 30312, Atlanta, GA (US);  
 Carter Lee  
 C/o Jabberwocky Toys Corporation 439 Oakland Ave SE, Suite 100, 30312, Atlanta, GA (US)  
 (74) Jessica A Keesee  
 Meunier Carlin & Curfman LLC 999 Peachtree St. NE, Suite 1300, 30309 Atlanta, GA (US)  
 (54) 1.-2. Doll  
 (55)

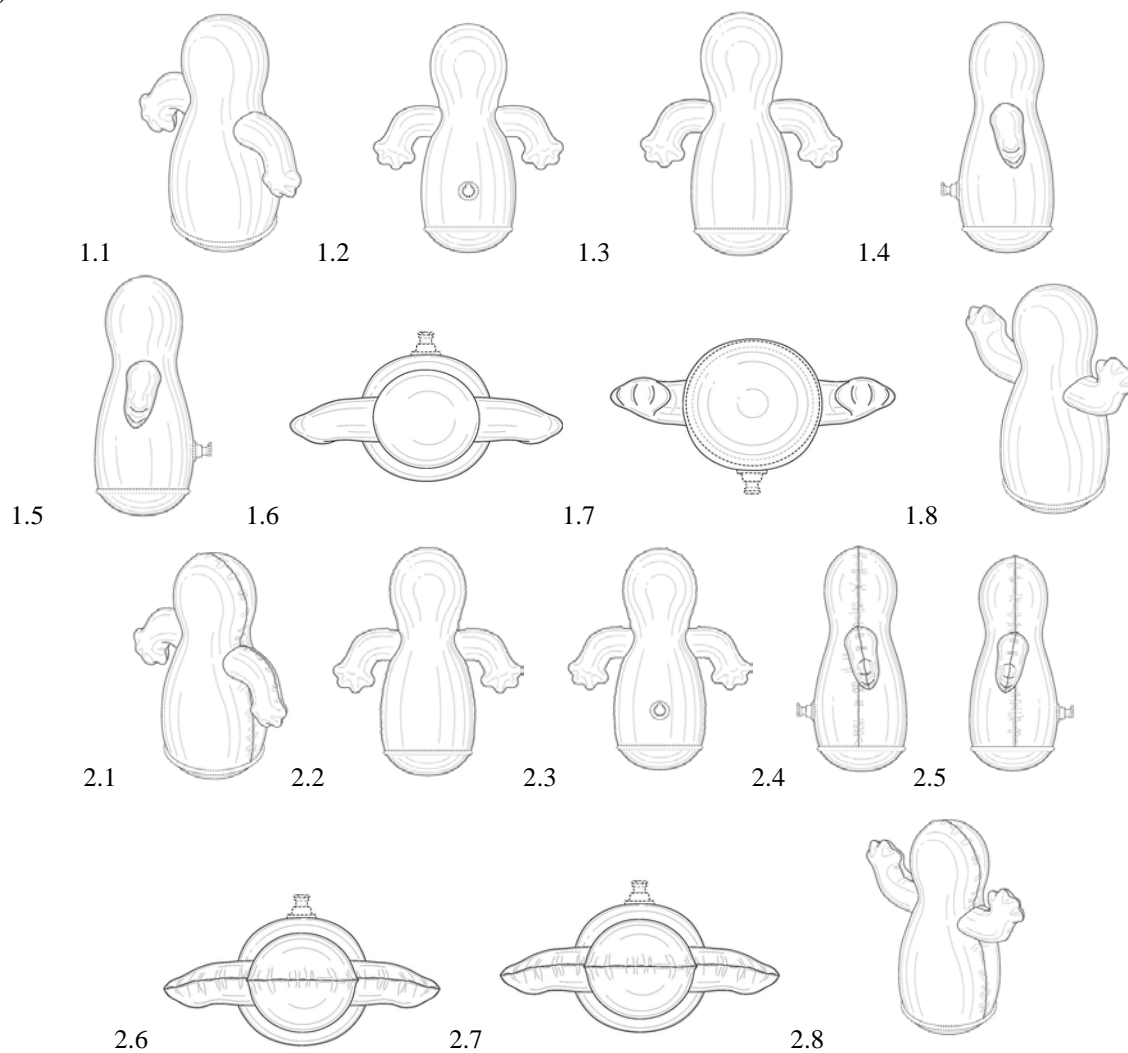

(11) DM/210 353 (51) 09-07  
(15) 2020 09 03 (44) 09/2021 (2021 03 05)  
(22) 2020 09 03

(28) 1  
(30) No1: 21.07.2020; 008048185-001; EM  
(73) CANPACK S.A.

Ul. Jasnogorska 1, 31-358 Krakow (PL)

(85) –

(86) EM, PL

(87) –

(88) –

(89) EM

(81) III. TR, CA, US, GE, NO, GH, RU, IL, CH, KR, MX, UA, OA, MD, VN, TN

(72) Jarosław Piekarz

Ul. Jasnogórska 1, 31-358, Krakow (PL)

(74) Magdalena Krekora

Ul. Górna 95, 32-091 Michałowice (PL)

(54) 1. Beverage can end

(55)



1.1



1.2



1.3



1.4



1.5

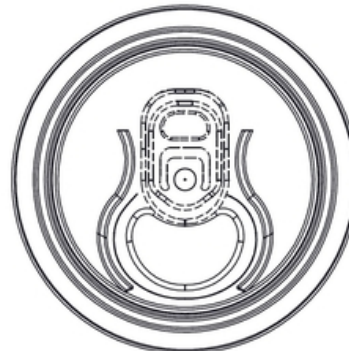

1.6

- (11) DM/210 110 (51) 11-01  
 (15) 2020 08 28 (44) 09/2021 (2021 03 05)  
 (22) 2020 08 28  
 (28) 5  
 (73) HARRY WINSTON SA  
 Chemin Du Tourbillon 8, 1228 Plan-les-Ouates (CH)  
 (85) CH  
 (86) CH  
 (87) CH  
 (88) CH  
 (89) CH  
 (81) IL, MA III, KG, LI, CA, GE, MK, TR, OM, BA, MN, NO, CH, EM, AL, AM, UA, SG, MC, MD, BZ, ME, AZ, TN, GB  
 (72) 1-3 Rie YATSUGI-KANG  
 C/o Harry Winston Inc., 718 Fifth Avenue, 10019, New York (US);  
 4-5 Delphine ABDOURAHIM  
 C/o Harry Winston Inc., 718 Fifth Avenue, 10019, New York (US)  
 (74) The Swatch Group AG (The Swatch Group SA) (The Swatch Group Ltd.)  
 Faubourg Du Lac 6, 2501 Biel/Bienne (CH)  
 (54) 1. Bracelet, 2.-5. Necklace  
 (55)

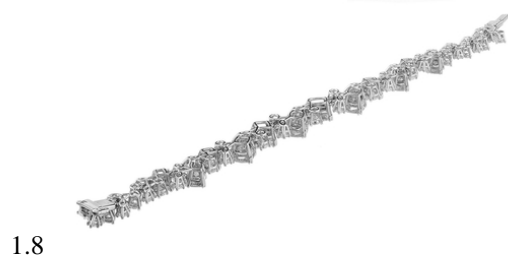
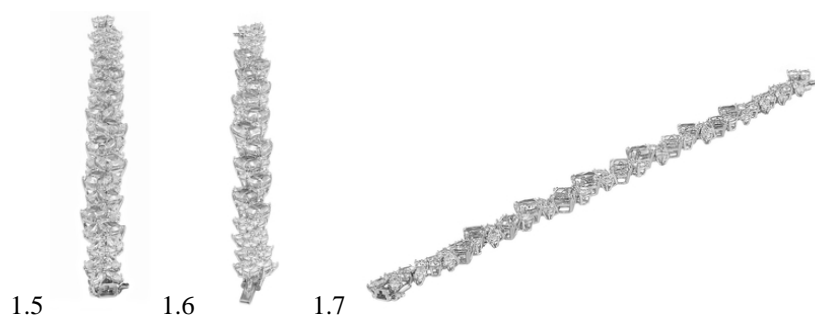





3.5



3.6



3.7



3.8



4.1



4.2



4.3



4.4



4.5



4.6



4.7



4.8



5.1



5.2



5.3



5.4



5.5



5.6



5.7



5.8



(11) DM/212 997 (51) 02-05  
(15) 2021 02 19 (44) 10/2021 (2021 03 12)  
(22) 2021 02 19  
(28) 1  
(30) No1: 27.08.2020; DM/210165; WO  
(73) AH License ApS  
Gøgevænget 12 Gadevang, 3400 Hillerød (DK)  
(85) –  
(86) DK  
(87) DK  
(88) –  
(89) DK  
(81) III. GE, OM, MK, BA, RS, EG, IL, SG, VN, IS  
(72) Henrik Larsen  
Gøgevænget 12 Gadevang, 3400, Hillerød (DK)  
(74) Elmann IPR  
Stockholmsgade 41, 2100 Copenhagen Ø (DK)  
(54) 1. Bib  
(55)

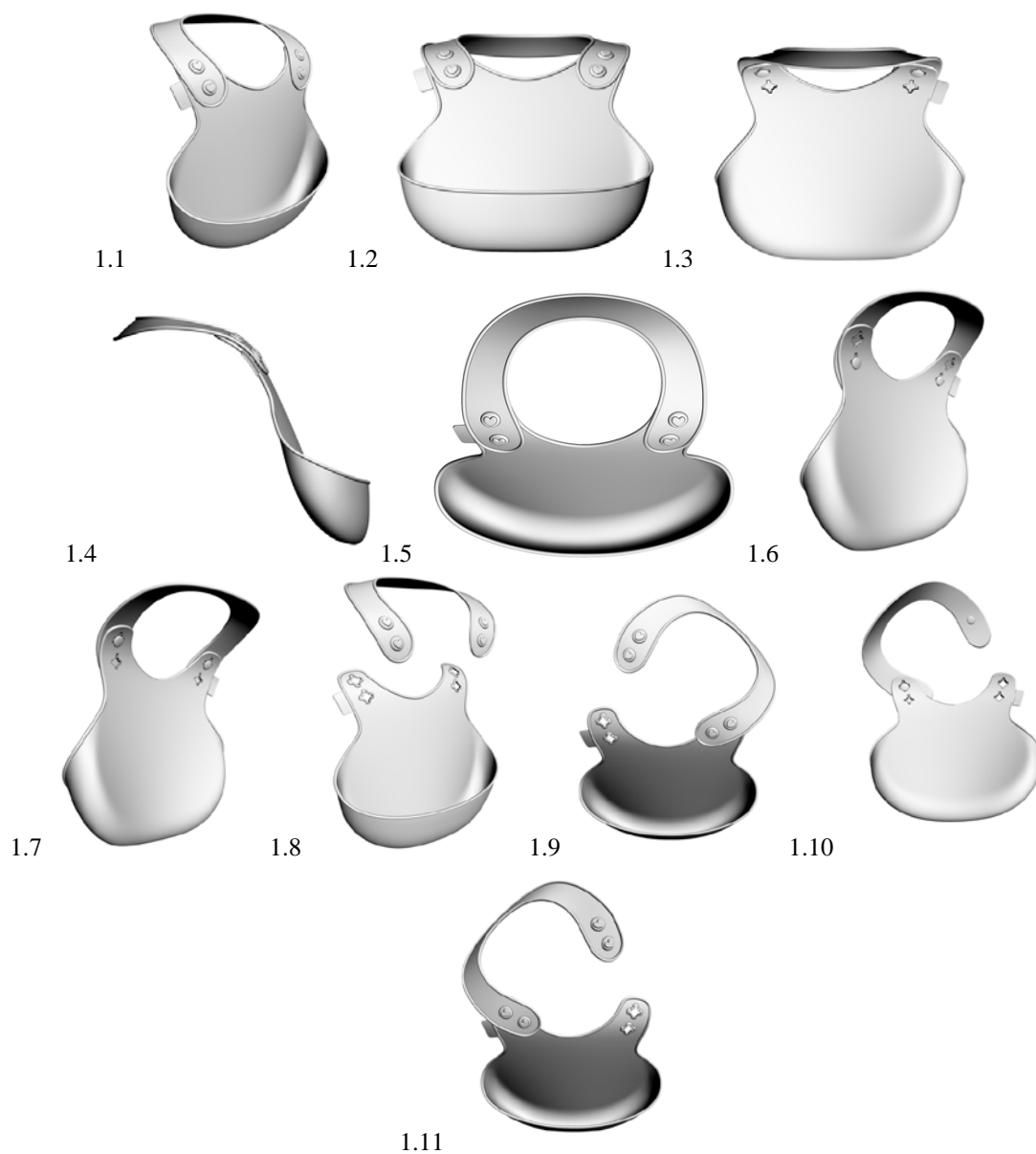

- (11) DM/210 619 (51) 09-01  
 (15) 2020 09 15 (44) 11/2021 (2021 03 19)  
 (22) 2020 09 15  
 (28) 2  
 (73) Nemiroff Intellectual Property Establishment  
 Städtle 31, 9490 Vaduz (LI)  
 (85) LI  
 (86) LI  
 (87) LI  
 (88) LI  
 (89) LI  
 (81) II. MA III. KG, LI, OM, MK, CA, GE, BA, RS, NO, EG, RU, RW, SY, EM, IS, AM, TJ, MD, TN, GB, KH,  
 TR, CH, JP, KR, AL, MX, UA, OA, SG, MC, ME, TM, AZ, SM  
 (72) Anatoliy KIPISH  
 Provulok 2d Myrnyi, Building 20/2, Khmelnytskyi (UA);  
 Iakiv GRIBOV  
 13A Staronavodnytska Street, App. 18, Kyiv (UA)  
 (74) Isler & Pedrazzini AG  
 Giesshübelstrasse 45, 8045 Zürich (CH)  
 (54) 1. Bottle, 2. Bottle  
 (55)

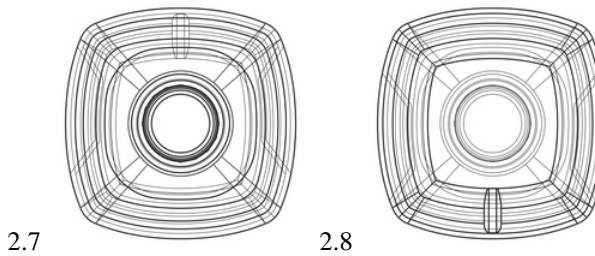
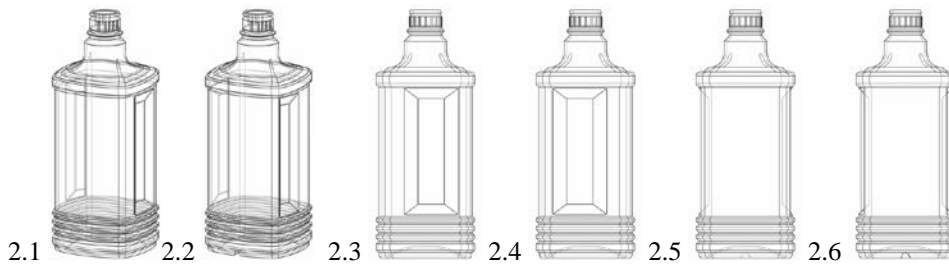
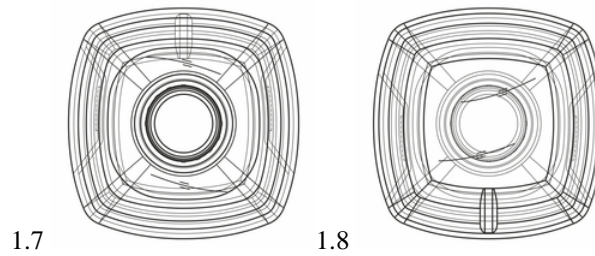
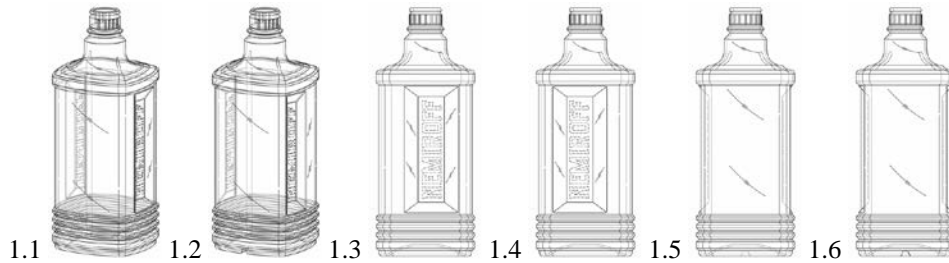

- (11) DM/213 245 (51) 03-01  
(15) 2021 03 10 (44) 12/2021 (2021 03 26)  
(22) 2021 03 10  
(28) 1  
(73) Valentino S.p.A  
Via Turati 16/18, I-20121 Milano (EM)  
(85) –  
(86) EM, IT  
(87) EM, IT  
(88) EM, IT  
(89) EM  
(81) III. KG, UA, TR, US, GE, RU, TJ, EM, AZ, GB  
(72) Jacopo Venturini  
C/o Valentino S.p.A. Via Turati 16/18, I-20121, Milano (IT)  
(74) Matteo Mozzi  
C/o Jacobacci & Partners Via Senato, 8, I-20121 Milano (IT)  
(54) 1. Bag  
(55)

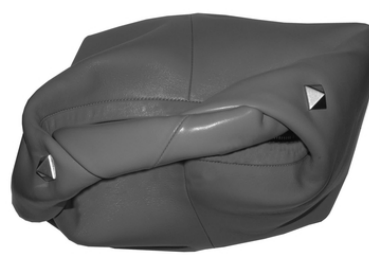

- (11) DM/213 179 (51) 07-01  
 (15) 2021 03 10 (44) 12/2021 (2021 03 26)  
 (22) 2021 03 10  
 (28) 1  
 (73) AH License ApS  
 Høgevej 19, 3400 Hillerød (DK)  
 (85) –  
 (86) DK  
 (87) DK  
 (88) –  
 (89) DK  
 (81) III. MK, CA, TR, GE, OM, US, BA, RS, NO, EG, RU, IL, CH, JP, KR, EM, IS, MX, UA, SG, VN, GB  
 (72) Henrik Larsen  
 Gøgevænget 12 Gadevang, 3400, Hillerød (DK)  
 (74) Elmann IPR  
 Stockholmsgade 41, 2100 Copenhagen Ø (DK)  
 (54) 1. Teat for feeding bottles  
 (55)

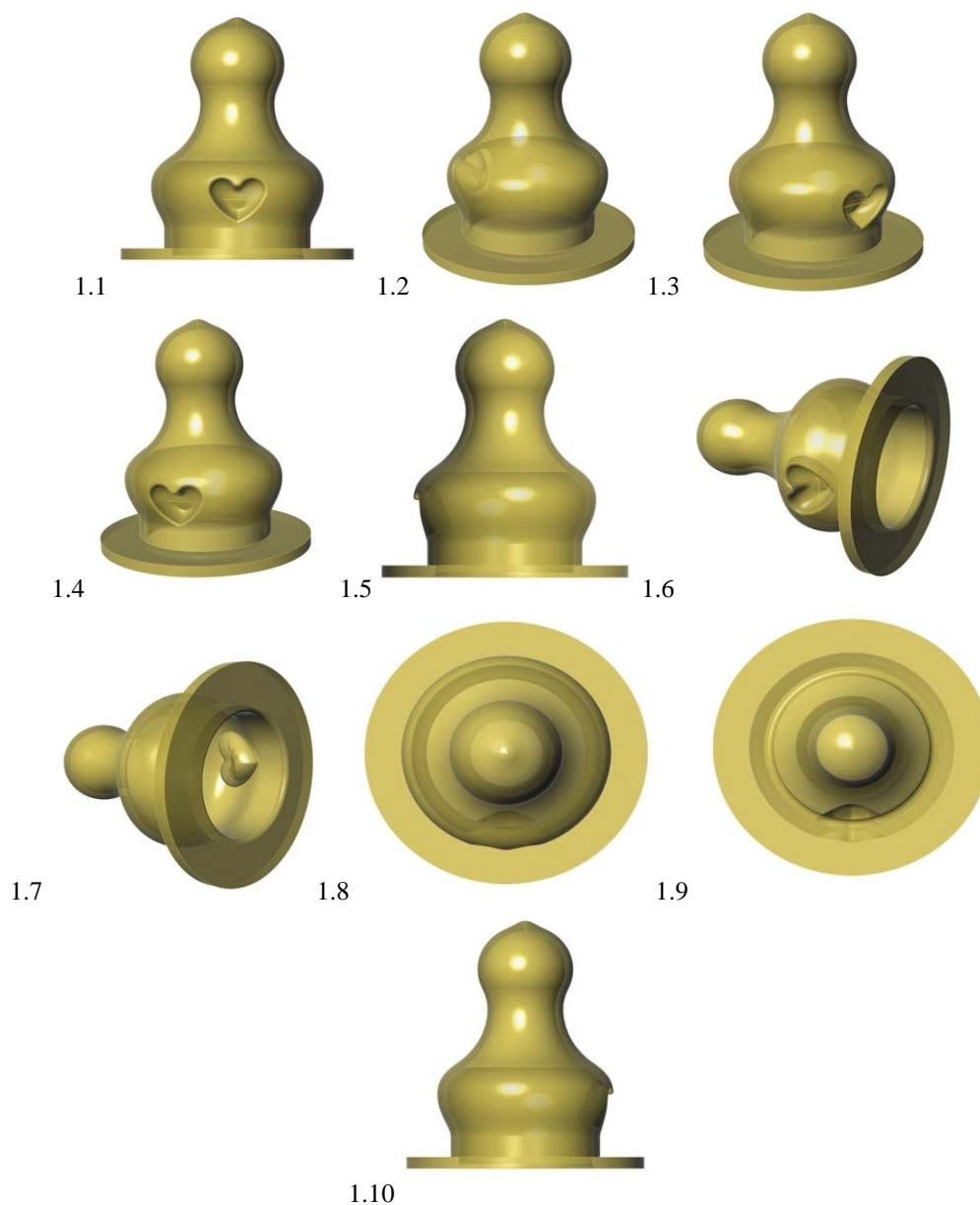

# TRADEMARKS

## APPLICATIONS FILED UNDER THE NATIONAL PROCEDURE APPROVED FOR REGISTRATION

The decision can be appealed at the Chamber of Appeal of Sakpatenti within 3 months from the publication or at the Mtskheta District Court Administrative Cases Board (Address: №17, Samkhedro St., Mtskheta), within 1 month following the publication.

(260) AM 2021 105655 A  
(210) AM 105655  
(220) 2019 11 05  
(731) I/E Alekxander Makeev  
Zhiuli Shartava Av. 8, Fl. 6, app. 23, 6000,  
Batumi, Georgia  
(540)



(591) Beige, white  
(531) 01.03.01; 26.01.01; 26.01.03; 26.01.12;  
26.11.03; 26.11.13; 27.05.01; 29.01.02;  
29.01.12  
(511) 35, 36

(260) AM 2021 108696 A  
(210) AM 108696  
(220) 2020 06 18  
(731) Giorgi Enriko Beridze  
T. Tabidze St. 10, Dead End I, 0108, Tbilisi,  
Georgia  
(740) Salome Jeladze  
(540)

**Berro Brothers**  
**ბერო ბრაზერს**

(591) Black-white  
(511) 25, 42

(260) AM 2021 109731 A  
(210) AM 109731  
(220) 2020 09 11  
(731) LTD "Piel Naturals"  
Budapest St. 3b, app. 51, Tbilisi, Georgia  
(540)



(591) Black-white  
(531) 05.05.16  
(511) 3, 5, 14, 24, 25, 35, 44

(260) AM 2021 109772 A  
(210) AM 109772  
(220) 2020 09 17  
(731) Giorgi Kikabidze  
Il. Chavchavadze Av. 54a, 0179, Tbilisi,  
Georgia  
(740) Giorgi Taktakishvili  
(540)

**OLD  
KOLKHETI**



**ძველი  
კოლხეთი**

(591) Black-white  
(531) 03.04.11; 25.01.09; 25.01.10; 26.01.15  
(526) "KOLKHETI"; "კოლხეთი"  
(511) 32, 33

(260) AM 2021 109825 A  
(210) AM 109825  
(220) 2020 09 21  
(731) Caterpillar Inc.  
(a Delaware Corporation)  
100 NE Adams Street, Peoria, Illinois,  
61629, USA  
(740) Tamar Kochlamazashvili  
(540)



(591) Yellow, black, white  
(531) 26.03.01; 26.03.24; 26.04.02; 26.04.09;  
26.04.11; 26.04.22; 26.04.24; 27.05.23;  
27.05.24  
(511) 7, 12, 35, 37

(260) AM 2021 109826 A  
 (210) AM 109826  
 (220) 2020 09 21  
 (731) Intel Corporation  
 2200 Mission College Blvd, Santa Clara,  
 California 95052, USA  
 (740) Tamaz Shilakadze  
 (540)

**intel**

(591) White, black, grey  
 (531) 27.05.17  
 (511) 9, 42

(260) AM 2021 109832 A  
 (210) AM 109832  
 (220) 2020 09 21  
 (731) Adami Medienpreis GmbH  
 Mediocampus Villa Ida,  
 Menckestraße. N27, 04155, Leipzig, Germany  
 (740) Mariam Ghubianuri  
 (540)

**ADAMI Media Prize**

(591) Black-white  
 (511) 35, 36, 41

(260) AM 2021 109840 A  
 (210) AM 109840  
 (220) 2020 09 23  
 (731) Enriko Beridze  
 T. Tabidze St. 10, Dead End I, 0108,  
 Tbilisi, Georgia  
 (740) Salome Jeladze  
 (540)

**ჩუჩიტა  
 CHURCHTITA**

(591) Black-white  
 (511) 5

(260) AM 2021 109846 A  
 (210) AM 109846  
 (220) 2020 09 24  
 (731) Shalva Khetsuriani  
 Queen Tamara Av. 17, 0112, Tbilisi, Georgia  
 (740) Nestan Mikadze  
 (540)

**ქობორა მუხა  
 Kochora Mukha**

(591) Black-white  
 (511) 33

(260) AM 2021 109847 A  
 (210) AM 109847  
 (220) 2020 09 24  
 (731) Nino Amonashvili  
 Marukhi Heroes St. 15, Tbilisi, Georgia  
 (540)

**ამონაშვილი  
 Amonashvili  
 Амонашвили**

(591) Black-white  
 (511) 16, 25, 41

(260) AM 2021 109911 A  
 (210) AM 109911  
 (220) 2020 09 25  
 (731) LTD "Mill Group"  
 Beliashvili St., Nearby the Institute of  
 Morphology, 0159, Tbilisi, Georgia  
 (740) Giorgi Kutateladze  
 (540)



(591) Yellow, orange, green, blue, white  
 (531) 25.07.17; 29.01.15  
 (511) 29, 30, 31, 32, 33, 43

(260) AM 2021 109912 A  
 (210) AM 109912  
 (220) 2020 09 25  
 (731) LTD "Mill Group"  
 Beliashvili St., Nearby the Institute of  
 Morphology, 0159, Tbilisi, Georgia  
 (740) Giorgi Kutateladze  
 (540)

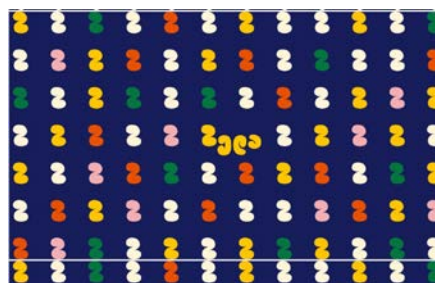

(591) Yellow, orange, green, blue, white  
 (531) 25.07.17; 29.01.15  
 (511) 29, 30, 31, 32, 33, 43

(260) AM 2021 109919 A  
 (210) AM 109919  
 (220) 2020 09 25  
 (731) LTD "Tural Group"  
 D. Guramishvili St., Ozurgeti, Georgia  
 (540)



(591) Red, black  
 (531) 26.04.03; 26.04.12; 26.11.03; 26.11.05;  
 26.11.09; 27.05.01; 27.05.10; 29.01.12  
 (511) 7, 9, 1, 35

(260) AM 2021 109922 A  
 (210) AM 109922  
 (220) 2020 09 25  
 (731) LTD "Wooden Eco House"  
 Vazha-Pshavela Av., II qu., corp. 25,  
 app. 2, 0186, Tbilisi, Georgia  
 (540)



(591) Brown, green, white  
 (531) 07.01.09; 27.05.01; 29.01.12  
 (511) 37

(260) AM 2021 109927 A  
 (210) AM 109927  
 (220) 2020 09 28  
 (731) Villa Godoli  
 Al. Kazbegi Av. 11a, app. 42, 0160, Tbilisi,  
 Georgia  
 (540)



(591) White, dark green  
 (531) 05.03.04; 27.05.01; 27.05.17; 28.19; 29.01.03  
 (511) 43

(260) AM 2021 109932 A  
 (210) AM 109932  
 (220) 2020 09 29  
 (731) Enriko Beridze  
 G. Tsitsishvili St. 18, Tbilisi, Georgia  
 (740) Salome Jeladze  
 (540)

ჩუჩხა  
**CHURCHA**

(591) Black-white  
 (511) 5

(260) AM 2021 109933 A  
 (210) AM 109933  
 (220) 2020 09 29  
 (731) Enriko Beridze  
 G. Tsitsishvili St. 18, Tbilisi, Georgia  
 (740) Salome Jeladze  
 (540)

ჩირა  
**CHIRA**

(591) Black-white  
 (511) 5

(260) AM 2021 109950 A  
 (210) AM 109950  
 (220) 2020 09 30  
 (731) LLC "Meidan Group"  
 Kote Apkhazi St. 44, Tbilisi, Georgia  
 (740) Tamar Lagvilava  
 (540)

შარდენი  
**shardeni**

(591) Black-white  
 (511) 36

(260) AM 2021 109958 A  
 (210) AM 109958  
 (220) 2020 10 01  
 (731) LTD "IDS Borjomi Beverages Co. N.V."  
 Pareraweg 45, Curaçao  
 (740) Giorgi Jokharidze



(540)

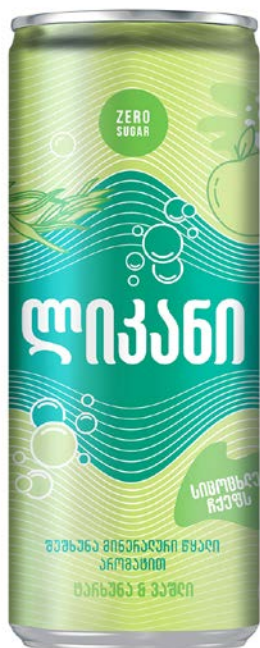

(554) Three Dimensional  
 (591) White, green, blue, sky-blue  
 (531) 01.15.21; 19.03.01; 28.19; 29.01.14  
 (511) 32, 35

(260) AM 2021 109961 A  
 (210) AM 109961  
 (220) 2020 10 01  
 (731) LLC "ONWay"  
 Crimea St. 7, 0101, Tbilisi, Georgia



(591) 373435 black, 8B398F O-lilac, 753884 N-lilac, 65377D W-lilac, 4F3772 A-lilac, 41366C Y-lilac  
 (531) 27.01.06; 27.05.01; 29.01.12  
 (526) "WAY"; "DELIVERY"  
 (511) 39

(260) AM 2021 109962 A  
 (210) AM 109962  
 (220) 2020 10 01  
 (731) Off-White LLC  
 360 Hamilton Ave., N100 White Plains,  
 New York, 10601, USA  
 (740) Nugzar Ksovreli  
 (540)

**OFF**

(591) Black-white  
 (511) 18, 25

(260) AM 2021 109963 A  
 (210) AM 109963  
 (220) 2020 10 01  
 (731) Off-White LLC  
 360 Hamilton Ave., N100 White Plains,  
 New York, 10601, USA  
 (740) Nugzar Ksovreli  
 (540)



(591) Black-white  
 (531) 02.09.15; 27.05.23  
 (511) 9, 18, 21, 24, 25, 27

(260) AM 2021 109964 A  
 (210) AM 109964  
 (220) 2020 10 01  
 (731) Off-White LLC  
 360 Hamilton Ave., N100 White Plains,  
 New York, 10601, USA  
 (740) Nugzar Ksovreli  
 (540)



(591) Black-white  
 (531) 02.01.16; 02.03.16; 02.09.15; 27.05.01  
 (511) 5, 9, 10, 18, 21, 24, 25, 27, 35

(260) AM 2021 110016 A  
 (210) AM 110016  
 (220) 2020 10 02  
 (731) LTD "IDS Borjomi Beverages Co. N.V."  
 Pareraweg 45, Curaçao  
 (740) Giorgi Jokharidze  
 (540)

**ლიკანთან ერთად  
 სიცოცხლე ჩქევს!**

(591) Black-white  
 (511) 32, 35



(260) AM 2021 110017 A  
 (210) AM 110017  
 (220) 2020 10 02  
 (310) 90/112255  
 (320) 2020 08 13  
 (330) US  
 (731) Discovery Communications LLC  
 8403 Colesville Road, Silver Spring, Maryland  
 20910, USA  
 (740) Tamaz Shilakadze  
 (540)



(591) White, red, orange, yellow, green, blue, purple,  
 black  
 (531) 26.02.07; 26.15.01; 29.01.15  
 (511) 9, 38, 41

(260) AM 2021 110021 A  
 (210) AM 110021  
 (220) 2020 10 05  
 (731) LLC "Georgian Wine House"  
 Vill. Zegaani, 1500, Gurjaani, Georgia  
 (740) Sopio Vacheishvili  
 (540)

**GWH**

(591) Black-white  
 (511) 33, 35, 43

(260) AM 2021 110023 A  
 (210) AM 110023  
 (220) 2020 10 05  
 (731) Pfizer Inc.  
 235 East 42nd Street, New York, NY  
 10017, USA  
 (740) Natela Otariidze  
 (540)

**CIBINQO**

(591) Black-white  
 (511) 5

(260) AM 2021 110025 A  
 (210) AM 110025  
 (220) 2020 10 05  
 (731) LTD "Geo-Industry"  
 Il. Chavchavadze St. 36, Vani,  
 Georgia

(540)



(591) Black, green, sky-blue, ivory, brown, white  
 (531) 03.04.02; 03.04.11; 26.01.15; 29.01.15  
 (511) 29

(260) AM 2021 110027 A  
 (210) AM 110027  
 (220) 2020 10 05  
 (731) LTD "Elvisi"  
 Ir. Abashidze St. 3, app. 11, Tbilisi, Georgia  
 (740) Ana Ghambashidze  
 (540)



(591) FF288C crimson, black, white  
 (531) 01.15.03; 27.05.08; 28.19; 29.01.12  
 (511) 39

(260) AM 2021 110029 A  
 (210) AM 110029  
 (220) 2020 10 05  
 (731) Data Bezhuashvili  
 Petre Kavtaradze St. 28, app. 66, 0186, Tbilisi,  
 Georgia  
 (540)



(591) White, sky-blue, grey  
 (531) 02.09.14; 11.03.02; 29.01.13  
 (511) 32, 33

(260) AM 2021 110031 A  
 (210) AM 110031  
 (220) 2020 10 06  
 (731) Aliosha Bakuridze  
 L. Sharashidze St. 2/4, app. 41, 0179, Tbilisi,  
 Georgia;  
 Lasha Bakuridze  
 Janashia St. 30/55, 0179, Tbilisi, Georgia  
 (540)

**ვაზის რძე**

(591) Black-white  
 (511) 5

(260) AM 2021 110032 A  
 (210) AM 110032  
 (220) 2020 10 06  
 (731) LTD "Anaseuli Combine"  
 Vill. Anaseuli, 3500, Ozurgeti Region, Georgia  
 (740) Davit Dzamukashvili  
 (540)

**ანა ბატონიშვილი**

(591) Black-white  
 (511) 30

(260) AM 2021 110033 A  
 (210) AM 110033  
 (220) 2020 10 06  
 (731) Eurodrug Laboratories B.V.  
 Regulusweg 11, 2516 AC The Hague,  
 Netherlands  
 (740) Tamaz Shilakadze  
 (540)

**Eurodrug Brovin**

(591) Black-white  
 (511) 5

(260) AM 2021 110035 A  
 (210) AM 110035  
 (220) 2020 10 07  
 (731) Irakli Kiria  
 G. Dzotsenidze St. 5, app. 29, 0183, Tbilisi,  
 Georgia  
 (740) Giorgi Taktakishvili  
 (540)



(591) Yello, brown  
 (531) 01.03.01; 01.03.17; 02.01.02; 03.04.07;  
 05.01.11; 05.01.16; 05.01.20; 26.01.04;  
 26.01.14; 26.01.15; 26.01.21; 29.01.12  
 (511) 33, 35

(260) AM 2021 110037 A  
 (210) AM 110037  
 (220) 2020 10 07  
 (731) LLC "Vine Products Company Tibaren"  
 Tabidze St. 10, Shindisi, Tbilisi, Georgia  
 (540)

**ტიბარენი**  
**TIBARENI**  
**ТИБАРЕНИ**

(591) Black-white  
 (511) 30, 32, 33, 35

(260) AM 2021 110038 A  
 (210) AM 110038  
 (220) 2020 10 07  
 (731) LLC "Vine Products Company Tibaren"  
 Tabidze St. 10, Shindisi, Tbilisi, Georgia  
 (540)

**წურული**  
**TSURULI**  
**ЦУРУЛИ**

(591) Black-white  
 (511) 30, 32, 33, 35

(260) AM 2021 110040 A  
 (210) AM 110040  
 (220) 2020 10 08  
 (731) Honist Ti Inc.  
 One Coca-Cola Plaza, Atlanta, GA 30313, USA  
 (740) Giorgi Taktakishvili  
 (540)

**HONEST**

(591) Black-white  
 (511) 30, 32

(260) AM 2021 110041 A  
 (210) AM 110041  
 (220) 2020 10 08  
 (731) LLC "Momavlis Megvineoba"  
 (Winemaking of Future)  
 Gldani, V mcr., corp. 5, app. 121, Tbilisi,  
 Georgia

(540)

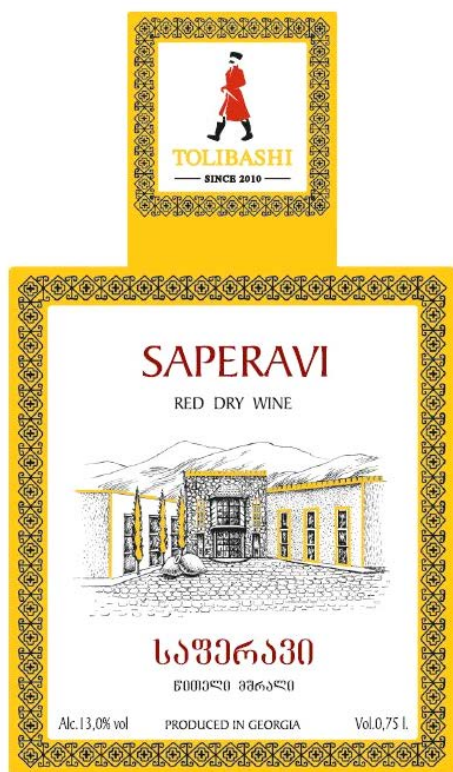

(591) Red, yellow, black, white, golden  
 (531) 02.01.04; 07.01.08; 07.01.12; 25.01.19;  
 27.05.01; 28.19; 29.01.14  
 (511) 33

(260) AM 2021 110042 A  
 (210) AM 110042  
 (220) 2020 10 08  
 (731) SPD Swiss Precision Diagnostics GmbH  
 Route de Saint-Georges 47, Petit-Lancy,  
 Geneva, 1213, Switzerland  
 (740) Tamar Kochlamazashvili  
 (540)



(591) Black-white  
 (531) 01.03.01; 01.03.18; 10.03.07  
 (511) 1, 5, 10

(260) AM 2021 110043 A  
 (210) AM 110043  
 (220) 2020 10 08  
 (731) Irakli Panchulidze  
 Mukhiani II mcr., corp. 3, app. 50, Tbilisi,  
 Georgia

(540)



(591) Blue, white, orange  
 (531) 01.15.11; 11.03.04; 26.01.16; 26.01.24;  
 29.01.13  
 (511) 30, 43

(260) AM 2021 110045 A  
 (210) AM 110045  
 (220) 2020 10 08  
 (731) Colgate-Palmolive Company  
 Delaware Corporation  
 300 Park Avenue, New York, NY  
 10022, USA  
 (740) Tamaz Shilakadze  
 (540)



(591) Red, white, golden, blue  
 (531) 25.01.09; 26.04.02; 26.04.06; 26.04.07;  
 26.04.24; 29.01.14  
 (511) 3

(260) AM 2021 110113 A  
 (210) AM 110113  
 (220) 2020 10 09  
 (731) LTD "Neogas"  
 Gazapkhuli St. 18, Vake-Saburtalo District,  
 Tbilisi, Georgia  
 (540)

**ნეომარკეტი**  
**NEOMARKET**

(591) Black-white  
 (511) 4, 35, 37

(260) AM 2021 110114 A  
 (210) AM 110114  
 (220) 2020 10 12  
 (731) Toyota Jidosha Kabushiki Kaisha  
 (also trading as Toyota Motor Corporation)  
 1, Toiota-cho, Toiota-shi, Aichi-ken, Japan  
 (740) Tamar Kochlamazashvili  
 (540)

**RX350h**

(591) Black-white  
 (531) 27.05.01; 27.07.01; 27.07.11  
 (511) 12

(260) AM 2021 110115 A  
 (210) AM 110115  
 (220) 2020 10 12  
 (731) LTD "Krinti"  
 Madneuli St. 10, Kazreti, Bolnisi, Georgia  
 (540)

**Dettol**

(591) Black-white  
 (511) 1

(260) AM 2021 110116 A  
 (210) AM 110116  
 (220) 2020 10 12  
 (731) LTD "Krinti"  
 Madneuli St. 10, Kazreti, Bolnisi, Georgia  
 (540)

**TOLSEN**

(591) Black-white  
 (531) 27.05.01; 27.05.17  
 (511) 7

(260) AM 2021 110118 A  
 (210) AM 110118  
 (220) 2020 10 12  
 (731) Summit Therapeutics Inc.

14th Fl., One Broadway, Cambridge,  
 Massachusetts, 02142, USA  
 (740) Shalva Gvaramadze  
 (540)

**COQUERDI**

(591) Black-white  
 (511) 5

(260) AM 2021 110129 A  
 (210) AM 110129  
 (220) 2020 10 14  
 (731) JSC "Nikora Trade"  
 Merab Kavtaradze St. 11, 0180, Tbilisi,  
 Georgia  
 (740) Melano Gogisvanidze  
 (540)

**ლიბრე – იაფი**  
**სუპერმარკეტი**

(591) Black-white  
 (511) 35

(260) AM 2021 110130 A  
 (210) AM 110130  
 (220) 2020 10 14  
 (731) PLATINUM WINES Sp. z o.o.  
 Ul. Wolodyjowskiego 70/1, Warszawa, 02-724,  
 Poland  
 (740) Nino Bakhtadze  
 (540)



(591) Red, golden, black, white, beige, sky-blue, blue  
 (531) 01.01.05; 01.01.10; 02.01.02; 02.01.20;  
 02.01.21; 02.03.04; 02.03.20; 02.03.21;  
 24.17.02; 26.01.01; 26.01.06; 27.05.01;  
 29.01.14  
 (511) 33

(260) AM 2021 110135 A  
 (210) AM 110135  
 (220) 2020 10 15  
 (731) Davit Shlamberidze  
 Bagebi, corp. 3, app. 67, Tbilisi, Georgia  
 (540)



(591) 8B6338, EBE49D, FFFFFFFF  
 (531) 19.09.02; 26.01.05; 26.01.18; 27.05.21; 28.19;  
 29.01.12  
 (511) 33, 35

(260) AM 2021 110137 A  
 (210) AM 110137  
 (220) 2020 10 15  
 (731) LTD "Artline Wings"  
 Seaside Square, 6000, Batumi, Georgia  
 (540)

საჯანსაღო  
 CELSIUS

(591) Red  
 (531) 24.17.02; 27.05.01; 28.19; 29.01.01  
 (511) 11, 37

(260) AM 2021 110138 A  
 (210) AM 110138  
 (220) 2020 10 15  
 (731) LTD "Artline Wings"  
 Seaside Square, 6000, Batumi, Georgia  
 (540)



(591) Red, white

(531) 24.17.02; 26.04.02; 26.04.22; 26.04.24;  
 27.05.24; 28.19; 29.01.12  
 (511) 11, 37

(260) AM 2021 110139 A  
 (210) AM 110139  
 (220) 2020 10 15  
 (731) LTD "ARTLINE WINGS"  
 Seaside Square, 6000, Batumi, Georgia  
 (540)



(591) Red, white  
 (531) 24.17.02; 27.05.21; 28.19; 29.01.01  
 (511) 11, 37

(260) AM 2021 110193 A  
 (210) AM 110193  
 (220) 2020 10 16  
 (731) LTD "Karadini"  
 Jansugh Kakhidze St. 9, (Former Krylov St.),  
 Tbilisi, Georgia  
 (540)



(591) Green, grey  
 (531) 05.03.13; 05.03.16; 27.05.08; 28.19; 29.01.12  
 (511) 35, 44

(260) AM 2021 110197 A  
 (210) AM 110197  
 (220) 2020 10 16  
 (731) JSC "Nikora Trade"  
 Merab Kavtaradze St. 11, 0180, Tbilisi,  
 Georgia  
 (740) Melano Gogisvanidze  
 (540)



(591) 820024 bordeaux, e23a6a pink, ffffff white  
 (531) 03.04.01; 03.04.04; 03.04.13; 28.19; 29.01.12  
 (511) 35

(260) AM 2021 110199 A  
 (210) AM 110199  
 (220) 2020 10 19  
 (310) m 2020 07602  
 (320) 2020 04 21  
 (330) UA  
 (731) Kraft Foods Schweiz Holding GmbH  
 Chollerstrasse 4, Zug 6300, Switzerland  
 (740) Giorgi Taktakishvili



(540)

**CARAMILK**(591) Black-white  
(511) 30(260) AM 2021 110208 A  
(210) AM 110208  
(220) 2020 10 20  
(731) Intellect Products  
Sormovlka Exit, House N11, Bld. N2,  
Fl. 9, room 5, Moscow, Russian Federation  
(740) David Abayadze  
(540)**astoria**  
**ასტორია**(591) Black-white  
(511) 33(260) AM 2021 110212 A  
(210) AM 110212  
(220) 2020 10 20  
(731) Varvara Strelkova  
Anna Politkovskaya St. 3, 37, app. 42, 0186,  
Tbilisi, Georgia  
(540)**VariCo**(591) Black-white  
(511) 30, 33(260) AM 2021 110217 A  
(210) AM 110217  
(220) 2020 10 21  
(731) Dow AgroSciences LLC  
9330 Zionsville Road, Indianapolis, Indiana  
46268, USA  
(740) Tamaz Shilakadze  
(540)**UTRISHA**(591) Black-white  
(511) 1(260) AM 2021 110220 A  
(210) AM 110220  
(220) 2020 10 21  
(731) Toyota Jidosha Kabushiki Kaisha  
(also Trading as Toyota Motor Corporation)  
1, Toiota-cho, Toiota-shi, Aichi-ken, Japan  
(740) Tamar Kochlamazashvili  
(540)**LC500**(591) Black-white  
(531) 27.05.01; 27.05.12; 27.07.01; 27.07.11  
(511) 12(260) AM 2021 110221 A  
(210) AM 110221  
(220) 2020 10 21  
(731) Toyota Jidosha Kabushiki Kaisha  
(also Trading as Toyota Motor Corporation)  
1, Toiota-cho, Toiota-shi, Aichi-ken, Japan  
(740) Tamar Kochlamazashvili  
(540)**LC500h**(591) Black-white  
(531) 27.05.12; 27.07.01; 27.07.11  
(511) 12(260) AM 2021 110223 A  
(210) AM 110223  
(220) 2020 10 22  
(731) LTD "Aromaco"  
Ketevan Tsamebuli Av. 41/300 Aragveli 6,  
Ent. 1, Fl. 2, Isani District, Tbilisi,  
Georgia  
(540)

**Aromaco**  
feed your senses

(591) White, black, green  
(531) 05.03.11; 05.03.13; 05.03.15; 26.11.03;  
26.11.05; 26.11.07; 27.05.01; 27.05.10;  
29.01.03  
(526) ლათინური ასოებით  
In Latin letters  
(511) 3, 5, 11, 40, 44(260) AM 2021 110231 A  
(210) AM 110231  
(220) 2020 10 22  
(731) LTD "Kartveli"  
Kakheti Highway 110a, 0151, Tbilisi, Georgia  
(740) Davit Dzamukashvili  
(540)**რეკე****reke**(591) Black-white  
(511) 32, 33

**REGISTERED TRADEMARKS**

(111) M 2021 33954 R  
(151) 2021 04 27  
(181) 2031 04 27  
(260) AM 2020 107159 A  
(220) 2020 02 18  
(732) Georgian University  
Merab Kostava St. 77a, 0171, Tbilisi,  
Georgia

---

(111) M 2021 33955 R  
(151) 2021 04 27  
(181) 2031 04 27  
(260) AM 2020 107266 A  
(220) 2020 02 21  
(732) LLC "Global CBS"  
Stanislavskiy St. 5, Tbilisi, Georgia

---

(111) M 2021 33956 R  
(151) 2021 04 27  
(181) 2031 04 27  
(260) AM 2020 107267 A  
(220) 2020 02 21  
(732) LLC "Global CBS"  
Stanislavskiy St. 5, Tbilisi, Georgia

---

(111) M 2021 33957 R  
(151) 2021 04 27  
(181) 2031 04 27  
(260) AM 2020 107287 A  
(220) 2020 02 24  
(732) LTD "BU"  
Gazapkhuli St. 17, app. 10, Tbilisi, Georgia

---

(111) M 2021 33958 R  
(151) 2021 04 27  
(181) 2031 04 27  
(260) AM 2020 107564 A  
(220) 2020 03 16  
(732) KT & G Corporation  
71, Beotkkot-gil, Daedeok-gu, Daejeon,  
Republic of Korea

---

(111) M 2021 33959 R  
(151) 2021 04 27  
(181) 2031 04 27  
(260) AM 2020 107659 A  
(220) 2020 03 26  
(732) LLC "Eurogeo Chemical"  
Petre Iberi St. 24, 1st floor, 0159, Tbilisi,  
Georgia

---

(111) M 2021 33960 R  
(151) 2021 04 27  
(181) 2031 04 27  
(260) AM 2020 107565 A  
(220) 2020 03 16  
(732) KT & G Corporation  
71, Beotkkot-gil, Daedeok-gu, Daejeon,  
Republic of Korea

---

(111) M 2021 33961 R  
(151) 2021 04 27  
(181) 2031 04 27  
(260) AM 2020 107663 A  
(220) 2020 03 26  
(732) LLC "Eurogeo Chemistry"  
Petre Iberi St. 24, First Fl., 0159, Tbilisi,  
Georgia

---

(111) M 2021 33962 R  
(151) 2021 04 27  
(181) 2031 04 27  
(260) AM 2020 107817 A  
(220) 2020 04 08  
(732) LLC "Baraqa"  
Petre Kavtaradze St., III Lane 4, app. 43,  
Vake District, Tbilisi, Georgia

---

(111) M 2021 33963 R  
(151) 2021 04 27  
(181) 2031 04 27  
(260) AM 2020 107818 A  
(220) 2020 04 08  
(732) LLC "Baraqa"  
Petre Kavtaradze St., III Lane 4, app. 43,  
Vake District, Tbilisi, Georgia

---

(111) M 2021 33964 R  
(151) 2021 04 27  
(181) 2031 04 27  
(260) AM 2020 107819 A  
(220) 2020 04 08  
(732) LLC "Baraqa"  
Petre Kavtaradze St., III Lane 4, app. 43,  
Vake District, Tbilisi, Georgia

---

(111) M 2021 33965 R  
(151) 2021 04 27  
(181) 2031 04 27  
(260) AM 2020 107820 A  
(220) 2020 04 08  
(732) LLC "Baraqa"

---

Petre Kavtaradze St., III Lane 4, app. 43,  
Vake District, Tbilisi, Georgia

---

(111) M 2021 33966 R  
(151) 2021 04 27  
(181) 2031 04 27  
(260) AM 2020 107821 A  
(220) 2020 04 08  
(732) LLC "Baraqa"  
Petre Kavtaradze St., III Lane 4, app. 43,  
Vake District, Tbilisi, Georgia

---

(111) M 2021 33967 R  
(151) 2021 04 27  
(181) 2031 04 27  
(260) AM 2020 107822 A  
(220) 2020 04 08  
(732) LLC "Baraqa"  
Petre Kavtaradze St., III Lane 4, app. 43,  
Vake District, Tbilisi, Georgia

---

(111) M 2021 33968 R  
(151) 2021 04 27  
(181) 2031 04 27  
(260) AM 2020 107826 A  
(220) 2020 04 09  
(732) LLC "Baraqa"  
Petre Kavtaradze St., III Lane 4, app. 43,  
Vake District, Tbilisi, Georgia

---

(111) M 2021 33969 R  
(151) 2021 04 27  
(181) 2031 04 27  
(260) AM 2020 107828 A  
(220) 2020 04 09  
(732) LLC "Baraqa"  
Petre Kavtaradze St., III Lane 4, app. 43,  
Vake District, Tbilisi, Georgia

---

(111) M 2021 33970 R  
(151) 2021 04 27  
(181) 2031 04 27  
(260) AM 2020 107829 A  
(220) 2020 04 09  
(732) LLC "Baraqa"  
Petre Kavtaradze St., III Lane 4, app. 43,  
Vake District, Tbilisi, Georgia

---

(111) M 2021 33971 R  
(151) 2021 04 27  
(181) 2031 04 27  
(260) AM 2020 107830 A  
(220) 2020 04 09

(732) LLC "Baraqa"  
Petre Kavtaradze St., III Lane 4, app. 43,  
Vake District, Tbilisi, Georgia

---

(111) M 2021 33972 R  
(151) 2021 04 27  
(181) 2031 04 27  
(260) AM 2020 107831 A  
(220) 2020 04 09  
(732) LLC "Baraqa"  
Petre Kavtaradze St., III Lane 4, app. 43,  
Vake District, Tbilisi, Georgia

---

(111) M 2021 33973 R  
(151) 2021 04 27  
(181) 2031 04 27  
(260) AM 2020 107832 A  
(220) 2020 04 09  
(732) LLC "Baraqa"  
Petre Kavtaradze St., III Lane 4, app. 43,  
Vake District, Tbilisi, Georgia

---

(111) M 2021 33974 R  
(151) 2021 04 27  
(181) 2031 04 27  
(260) AM 2020 107833 A  
(220) 2020 04 09  
(732) LLC "Baraqa"  
Petre Kavtaradze St., III Lane 4, app. 43,  
Vake District, Tbilisi, Georgia

---

(111) M 2021 33975 R  
(151) 2021 04 27  
(181) 2031 04 27  
(260) AM 2020 107834 A  
(220) 2020 04 09  
(732) LLC "Baraqa"  
Petre Kavtaradze St., III Lane 4, app. 43,  
Vake District, Tbilisi, Georgia

---

(111) M 2021 33976 R  
(151) 2021 04 27  
(181) 2031 04 27  
(260) AM 2020 107835 A  
(220) 2020 04 09  
(732) LLC "Baraqa"  
Petre Kavtaradze St., III Lane 4, app. 43,  
Vake District, Tbilisi, Georgia

---



(111) M 2021 33977 R  
(151) 2021 04 27  
(181) 2031 04 27  
(260) AM 2020 107836 A  
(220) 2020 04 09  
(732) LLC "Baraqa"  
Petre Kavtaradze St., III Lane 4, app. 43,  
Vake District, Tbilisi, Georgia

---

(111) M 2021 33983 R  
(151) 2021 04 27  
(181) 2031 04 27  
(260) AM 2020 107894 A  
(220) 2020 04 12  
(732) LLC "Baraqa"  
Petre Kavtaradze St., III Lane 4, app. 43,  
Vake District, Tbilisi, Georgia

---

(111) M 2021 33978 R  
(151) 2021 04 27  
(181) 2031 04 27  
(260) AM 2020 107837 A  
(220) 2020 04 09  
(732) LLC "Baraqa"  
Petre Kavtaradze St., III Lane 4, app. 43,  
Vake District, Tbilisi, Georgia

---

(111) M 2021 33984 R  
(151) 2021 04 27  
(181) 2031 04 27  
(260) AM 2020 107895 A  
(220) 2020 04 12  
(732) LLC "Baraqa"  
Petre Kavtaradze St., III Lane 4, app. 43,  
Vake District, Tbilisi, Georgia

---

(111) M 2021 33979 R  
(151) 2021 04 27  
(181) 2031 04 27  
(260) AM 2020 107838 A  
(220) 2020 04 09  
(732) LLC "Baraqa"  
Petre Kavtaradze St., III Lane 4, app. 43,  
Vake District, Tbilisi, Georgia

---

(111) M 2021 33985 R  
(151) 2021 04 27  
(181) 2031 04 27  
(260) AM 2020 107896 A  
(220) 2020 04 12  
(732) LLC "Baraqa"  
Petre Kavtaradze St., III Lane 4, app. 43,  
Vake District, Tbilisi, Georgia

---

(111) M 2021 33980 R  
(151) 2021 04 27  
(181) 2031 04 27  
(260) AM 2020 107839 A  
(220) 2020 04 09  
(732) LLC "Baraqa"  
Petre Kavtaradze St., III Lane 4, app. 43,  
Vake District, Tbilisi, Georgia

---

(111) M 2021 33986 R  
(151) 2021 04 27  
(181) 2031 04 27  
(260) AM 2020 107897 A  
(220) 2020 04 12  
(732) LLC "Baraqa"  
Petre Kavtaradze St., III Lane 4, app. 43,  
Vake District, Tbilisi, Georgia

---

(111) M 2021 33981 R  
(151) 2021 04 27  
(181) 2031 04 27  
(260) AM 2020 107892 A  
(220) 2020 04 12  
(732) LLC "Baraqa"  
Petre Kavtaradze St., III Lane 4, app. 43,  
Vake District, Tbilisi, Georgia

---

(111) M 2021 33987 R  
(151) 2021 04 27  
(181) 2031 04 27  
(260) AM 2020 107898 A  
(220) 2020 04 12  
(732) LLC "Baraqa"  
Petre Kavtaradze St., III Lane 4, app. 43,  
Vake District, Tbilisi, Georgia

---

(111) M 2021 33982 R  
(151) 2021 04 27  
(181) 2031 04 27  
(260) AM 2020 107893 A  
(220) 2020 04 12  
(732) LLC "Baraqa"  
Petre Kavtaradze St., III Lane 4, app. 43,  
Vake District, Tbilisi, Georgia

---

(111) M 2021 33988 R  
(151) 2021 04 27  
(181) 2031 04 27  
(260) AM 2020 107899 A  
(220) 2020 04 12  
(732) LLC "Baraqa"  
Petre Kavtaradze St., III Lane 4, app. 43,  
Vake District, Tbilisi, Georgia

---

(111) M 2021 33989 R  
(151) 2021 04 27  
(181) 2031 04 27  
(260) AM 2020 107900 A  
(220) 2020 04 12  
(732) LLC "Baraqa"  
Petre Kavtaradze St., III Lane 4, app. 43,  
Vake District, Tbilisi, Georgia

---

(111) M 2021 33995 R  
(151) 2021 04 27  
(181) 2031 04 27  
(260) AM 2020 107906 A  
(220) 2020 04 12  
(732) LLC "Baraqa"  
Petre Kavtaradze St., III Lane 4, app. 43,  
Vake District, Tbilisi, Georgia

---

(111) M 2021 33990 R  
(151) 2021 04 27  
(181) 2031 04 27  
(260) AM 2020 107901 A  
(220) 2020 04 12  
(732) LLC "Baraqa"  
Petre Kavtaradze St., III Lane 4, app. 43,  
Vake District, Tbilisi, Georgia

---

(111) M 2021 33996 R  
(151) 2021 04 27  
(181) 2031 04 27  
(260) AM 2020 107907 A  
(220) 2020 04 12  
(732) LLC "Baraqa"  
Petre Kavtaradze St., III Lane 4, app. 43,  
Vake District, Tbilisi, Georgia

---

(111) M 2021 33991 R  
(151) 2021 04 27  
(181) 2031 04 27  
(260) AM 2020 107902 A  
(220) 2020 04 12  
(732) LLC "Baraqa"  
Petre Kavtaradze St., III Lane 4, app. 43,  
Vake District, Tbilisi, Georgia

---

(111) M 2021 33997 R  
(151) 2021 04 27  
(181) 2031 04 27  
(260) AM 2020 107908 A  
(220) 2020 04 12  
(732) LLC "Baraqa"  
Petre Kavtaradze St., III Lane 4, app. 43,  
Vake District, Tbilisi, Georgia

---

(111) M 2021 33992 R  
(151) 2021 04 27  
(181) 2031 04 27  
(260) AM 2020 107903 A  
(220) 2020 04 12  
(732) LLC "Baraqa"  
Petre Kavtaradze St., III Lane 4, app. 43,  
Vake District, Tbilisi, Georgia

---

(111) M 2021 33998 R  
(151) 2021 04 27  
(181) 2031 04 27  
(260) AM 2020 107909 A  
(220) 2020 04 12  
(732) LLC "Baraqa"  
Petre Kavtaradze St., III Lane 4, app. 43,  
Vake District, Tbilisi, Georgia

---

(111) M 2021 33993 R  
(151) 2021 04 27  
(181) 2031 04 27  
(260) AM 2020 107904 A  
(220) 2020 04 12  
(732) LLC "Baraqa"  
Petre Kavtaradze St., III Lane 4, app. 43,  
Vake District, Tbilisi, Georgia

---

(111) M 2021 33999 R  
(151) 2021 04 27  
(181) 2031 04 27  
(260) AM 2020 107911 A  
(220) 2020 04 12  
(732) LLC "Eurogeo Chemistry"  
Petre Iberi St. 24, First Fl., 0159, Tbilisi,  
Georgia

---

(111) M 2021 33994 R  
(151) 2021 04 27  
(181) 2031 04 27  
(260) AM 2020 107905 A  
(220) 2020 04 12  
(732) LLC "Baraqa"  
Petre Kavtaradze St., III Lane 4, app. 43,  
Vake District, Tbilisi, Georgia

---

(111) M 2021 34000 R  
(151) 2021 04 27  
(181) 2031 04 27  
(260) AM 2020 108118 A  
(220) 2020 05 04  
(732) İpekyol Giyim Sanayi Pazarlama Ve Ticaret  
Anonim Şirketi  
Merkez Mah. Kazim Orbay Caddesi N35,  
Istanbul, 34381, Turkey

---

---

(111) M 2021 34001 R  
(151) 2021 04 27  
(181) 2031 04 27  
(260) AM 2020 108119 A  
(220) 2020 05 04  
(732) İpekyol Giyim Sanayi Pazarlama Ve Ticaret  
Anonim Şirketi  
Merkez Mah. Kazim Orbay Caddesi N35,  
Istanbul, 34381, Turkey

---

(111) M 2021 34002 R  
(151) 2021 04 27  
(181) 2031 04 27  
(260) AM 2020 108120 A  
(220) 2020 05 04  
(732) İpekyol Giyim Sanayi Pazarlama Ve Ticaret  
Anonim Şirketi  
Merkez Mah. Kazim Orbay Caddesi N35,  
Istanbul, 34381, Turkey

---

(111) M 2021 34003 R  
(151) 2021 04 27  
(181) 2031 04 27  
(260) AM 2020 108133 A  
(220) 2020 05 07  
(732) LTD "Baraqa"  
Petre Kavtaradze St. 4, Lane III, app. 43, Vake  
District, Tbilisi, Georgia

---

(111) M 2021 34004 R  
(151) 2021 04 27  
(181) 2031 04 27  
(260) AM 2020 108595 A  
(220) 2020 06 10  
(732) Irakli Lomidze  
Kachreti St. 44/21, Tbilisi, Georgia

---

**TRADEMARKS REGISTERED ACCORDING TO THE ACCELERATED PROCEDURE**

The decision can be appealed at the Chamber of Appeal of Sakpatenti within 3 months from the publication.

(111) M 2021 33943 R  
 (151) 2021 04 22  
 (181) 2031 04 22  
 (210) AM 112625  
 (220) 2021 04 15  
 (732) NOBEL ILAC SANAYII VE TICARET ANONIM SIRKETI  
 Representative in Georgia  
 Liberty Square 4, 0105, Tbilisi, Georgia  
 (740) Tinatin Tskhvediani  
 (540)

**NBL PROBIOTIC GOLD**  
**ნბლ პრობიოტიკ გოლდი**

(591) Black-white  
 (511) 5, 35

(111) M 2021 33944 R  
 (151) 2021 04 26  
 (181) 2031 04 26  
 (210) AM 112096  
 (220) 2021 03 11  
 (732) LTD "A.T.N.D. Honey"  
 Davati, 1809, Dusheti Region, Georgia  
 (540)



(591) White, brown, green, golden  
 (531) 01.17.11; 03.13.05; 19.03.01; 26.05.01; 29.01.15  
 (554) Three-dimensional  
 (526) "GEORGIA"  
 (511) 30

(111) M 2021 33945 R  
 (151) 2021 04 26  
 (181) 2031 04 26  
 (210) AM 112506  
 (220) 2021 04 08  
 (732) LTD "Alcoholic Beverage Factory"  
 Vaziani Settlement 1320, Vill. Martkopi, Gardabani, Georgia  
 (540)



(591) 000000 Black, white  
 (531) 02.01.21; 22.05.10; 22.05.13; 22.05.17; 25.01.05; 25.01.25; 27.05.10; 28.05  
 (526) "ტიფლისი", "ТИФЛИСЬ"  
 (511) 32, 33

(111) M 2021 33946 R  
 (151) 2021 04 26  
 (181) 2031 04 26  
 (210) AM 112579  
 (220) 2021 04 12  
 (732) JSC "OPPA"  
 A. Kazbegi Av. 15, Tbilisi, Georgia

(540)



(591) White, sky-blue, red, yellow, green  
 (531) 26.04.01; 26.04.04; 26.04.09; 26.04.22;  
 26.04.24; 27.05.01; 27.05.24; 28.19; 29.01.14  
 (511) 36

(111) M 2021 33947 R  
 (151) 2021 04 26  
 (181) 2031 04 26  
 (210) AM 112580  
 (220) 2021 04 12  
 (732) JSC "OPPA"  
 A. Kazbegi Av. 15, Tbilisi, Georgia  
 (540)



(591) White, sky-blue, red, yellow, green  
 (531) 26.04.01; 26.04.04; 26.04.09; 26.04.22;  
 26.04.24; 27.05.01; 27.05.24; 29.01.14  
 (511) 36

(111) M 2021 33948 R  
 (151) 2021 04 27  
 (181) 2031 04 27  
 (210) AM 112673  
 (220) 2021 04 16  
 (732) LLC "BI Residence"  
 H. Abashidze St. 10-12, app. 23, 6100, Batumi,  
 Georgia  
 (540)



(591) A06D00 golden, 302283 blue  
 (531) 24.09.02; 24.09.03; 24.09.09; 26.01.03;  
 26.01.16; 26.11.01; 26.11.01; 27.05.08  
 (511) 36

(111) M 2021 33949 R  
 (151) 2021 04 27  
 (181) 2031 04 27  
 (210) AM 112676  
 (220) 2021 04 17  
 (732) AIBO  
 Shalva Nutsbidze St., III mcr., I qu.,  
 corp. 11, app. 23, 0183, Tbilisi, Georgia  
 (540)

სიბო

(591) Black-white  
 (511) 44

(111) M 2021 33950 R  
 (151) 2021 04 27  
 (181) 2031 04 27  
 (210) AM 112617  
 (220) 2021 04 15  
 (732) Obshchestvo s Ogranichennoy Otvetstvennostyu  
 "Voyager"  
 Leninskaya Sloboda St., House 26, fl. 3,  
 Space XXXV-2, room 10, 115280, Moscow,  
 Russian Federation  
 (740) Giorgi Taktakishvili  
 (540)

PATIVI

პატივი

(591) Black-white  
 (511) 33

(111) M 2021 33951 R  
 (151) 2021 04 27  
 (181) 2031 04 27  
 (210) AM 112618  
 (220) 2021 04 15  
 (732) Obshchestvo s Ogranichennoy Otvetstvennostyu  
 "Voyager"  
 Leninskaya Sloboda St., House 26, fl. 3,  
 Space XXXV-2, room 10, 115280, Moscow,  
 Russian Federation  
 (740) Giorgi Taktakishvili  
 (540)

GARTOBA

გართობა

(591) Black-white  
(511) 33

(111) M 2021 33952 R  
(151) 2021 04 27  
(181) 2031 04 27  
(210) AM 112611  
(220) 2021 04 14  
(732) JSC "TBC Bank"  
K. Majanishvili St. 7, 0102, Tbilisi, Georgia  
(740) Archil Gabatashvili  
(540)



(591) 63666A morengo, 00AEEF azure  
(531) 26.03.03; 26.03.04; 26.03.24; 29.01.13  
(511) 36

(111) M 2021 33953 R  
(151) 2021 04 27  
(181) 2031 04 27  
(210) AM 112681  
(220) 2021 04 19  
(732) JSC "Gefa"  
Akaki Belashvili St. 142, 0159, Tbilisi,  
Georgia  
(740) Salome Jeladze  
(540)

**La Maison du Savon de  
Marseille**

**მარსელის საპნის სახლი**

(591) Black-white  
(511) 3, 35

(111) M 2021 34005 R  
(151) 2021 04 29  
(181) 2031 04 29  
(210) AM 112703  
(220) 2021 04 21  
(732) LTD "Termoindustry"  
Nodar Bokhua St. 1, 0159, Tbilisi,  
Georgia  
(540)



(591) FDAF31 yellow, 00A652 green, 444446 grey  
(531) 07.01.09; 27.05.22; 28.19; 29.01.13  
(511) 11, 17, 35, 37

(111) M 2021 34006 R  
(151) 2021 04 29  
(181) 2031 04 29  
(210) AM 112664  
(220) 2021 04 16  
(732) Inna Blinova  
Abi (bellow of the Lake) Akhaltsikhe Region,  
Georgia  
(540)



(591) Black-white  
(531) 27.05.01; 27.05.19; 27.07.01  
(511) 25, 26

## INTERNATIONAL TRADEMARKS FOR WHICH A DECISION ON GRANTING PROTECTIONS IS TAKEN

The decision can be appealed at the Chamber of Appeal of Sakpatenti within 3 months from the publication or at the Mtskheta District Court Administrative Cases Board (Address: №17, Samkhedro str., Mtskheta), within 1 month following the publication.

(260) AM 2021 103049 A\*  
 (800) 1465333  
 (151) 2019 03 13  
 (891) 2019 03 13  
 (731) Daimler AG  
 Mercedesstrasse 120 70372 Stuttgart, Germany  
 (540)

### ZETROS

(591) Black, white  
 (511)  
 12 – Motor vehicles and parts therefor, included in this class (except tyres for motor vehicles).

(260) AM 2021 107350 A\*  
 (800) 1516945  
 (151) 2019 12 16  
 (891) 2019 12 16  
 (731) "INTERNATIONAL MASIS TABAK" LLC  
 10 Hrant Vardanyan str., 0802 Masis,  
 Ararat Region, Armenia  
 (540)



(591) Light grey, silver, red, black and white  
 (531) 10.01.05; 19.03.24; 25.01.19; 26.03.04;  
 27.05.09; 29.01.15  
 (526) All verbal records except "M TEK" and "MT".  
 (511)  
 34 – Raw and manufactured tobacco; cigarettes; papirosas (cigarettes without filter and with paper mouth-piece); cigarillos; cigars; chewing tobacco; cigarettes containing tobacco substitutes, not for medical purposes; herbs for smoking; snuff; electronic cigarettes; liquid solutions for use in electronic cigarettes; flavourings, other than essential oils, for use in electronic cigarettes; matches; match holders; match boxes; lighters for smokers; gas containers for cigar lighters; firestones; ashtrays for smokers; spittoons for tobacco users; smokers' articles; tips of yellow amber for cigar and cigarette holders; tobacco pouches; cigarette tips;

cigarette filters; tobacco pipes; cigar holders; mouth-pieces for cigarette holders; pipe cleaners for tobacco pipes; books of cigarette papers; absorbent paper for tobacco pipes; cigarette paper; cigar cutters; cigar cases; cigarette cases; pipe racks for tobacco pipes; tobacco jars; snuff boxes; humidors; pocket machines for rolling cigarettes; oral vaporizers for smokers; hookah; accessories and articles for hookahs, molasses for using in tobacco production; smokers' articles, including molasses non-medical; cigarette and molasses' aromatic mixtures for use in hookah.

(260) AM 2021 108977 A  
 (800) 1539382  
 (151) 2020 05 30  
 (891) 2020 05 30  
 (731) PaySend Group Limited  
 Cluny Court, John Smith Business Park,  
 Kirkcaldy, Fife KY2 6QJ, United Kingdom  
 (540)

### PAYSEND

Money for the future

(591) Light-violet and dark blue  
 (531) 27.05.09; 29.01.12  
 (511)  
 9 – Payment terminals, including automatic self-service payment terminals and electronic point-of-sale terminals; automatic teller machines; remote control apparatus for payment terminals network, vending machines and automatic teller machines; identity cards, magnetic; encoded magnetic cards; computer programs for payment terminals network, vending machines, automatic teller machines, conducting financial transactions, crypto- and digital money and crypto-currency; computer software for payment terminals network, vending machines, automatic teller machines; computer programmes [programs], recorded; magnetic data media; chips [integrated circuits]; computer software applications, downloadable, including applications designed for conducting financial transactions, crypto- and digital money and crypto-currency.  
 36 – Insurance; financial affairs, including activity relating to the use of crypto- and digital money and crypto-currency; monetary affairs including operations with the use of crypto- and digital money and crypto-



currency; real estate affairs; issuance of travelers' checks; issuance of credit cards; issuance of tokens of value; debit card services; credit card services; online banking; banking; electronic funds transfer.

(260) AM 2021 108986 A  
 (800) 1539724  
 (151) 2020 03 02  
 (891) 2020 03 02  
 (731) LASSELSBERGER GmbH  
 Wörth 1, A-3380 Pöchlarn, Austria  
 (540)



(591) Blue (CMYK C=100 / M=50 / Y=0 / K=6; sRGB R=0 / G=100 / B=172; Pantone 2384 C; Pantone 3005 U; RAL 5017 Traffic blue), white (CMYK C=0 / M=0 / Y=0 / K=0; sRGB R=255 / G=255 / B=255; RAL 9003 Signal white) and black (CMYK C=0 / M=0 / Y=0 / K=100; sRGB R=0 / G=0 / B=0; RAL 9004 Signal black)

(531) 24.17.04; 26.04.22; 26.04.24; 27.05.10; 27.05.17; 29.01.12

(511)  
 2 – Paints, in particular facade paints, colorants and dyes for industrial use, in particular for use in construction chemistry; paint; colorant; silicate paints; emulsion paints.

17 – Insulating plaster; wall paints for insulation purposes; insulating fills (insulating material); thermal insulations; plastics as semi-finished products.

35 – Advertising.

37 – Construction in the field of opencast mining, masonry, structural engineering, tiling work, maintenance of buildings and their modification or rather removal, in particular with regard to their renovation and additions; information relating to the aforesaid services, not included in other classes.

(260) AM 2021 108987 A  
 (800) 1539782  
 (151) 2019 11 25  
 (891) 2019 11 25  
 (731) Vinpearl Joint Stock Company  
 Hon Tre Island, Vinh Nguyen Ward, Khanh Hoa Province, Nha Trang City, Viet Nam  
 (540)

**Vinpearl Air**

(591) Black, white

(531) 27.05.01  
 (511)  
 39 – Transport of goods and passengers by land, water and air; rental of means of transportation; travel reservation; packaging of goods; storage of goods; airline tickets, bus tickets and train tickets, agency services (term considered too vague by the International Bureau – Rule 13 (2) (b) of the Regulations); providing information on transportation and flight schedule (departure time, arrival time and passenger's name).

(260) AM 2021 108989 A  
 (800) 1539829  
 (151) 2020 04 21  
 (891) 2020 04 21  
 (731) Jinko Solar Co., Ltd.  
 No.1 Jingke Road, Shangrao Economic Development Zone, Shangrao City, 334100 Jiangxi Province, China  
 (540)



(591) Black, white  
 (531) 27.05.09; 27.05.10; 27.05.11

(511)  
 9 – Solar panels for production of electricity; photovoltaic modules; photovoltaic apparatus and installations for generating solar electricity; photovoltaic cells; solar-powered battery chargers; chargers for electric batteries; batteries, electric; solar batteries; power inverters; photovoltaic inverters.

(260) AM 2021 109005 A  
 (800) 1532195  
 (151) 2020 03 27  
 (891) 2020 05 29  
 (731) Dr. Schär AG/SPA  
 Winkelau 9; I-39014 Burgstall (BZ), Italy  
 (540)



(591) Red (Pantone 200) and white  
 (531) 05.07.02; 24.03.09; 26.04.02; 26.04.05; 29.01.12



(511)

5 – Dietetic food adapted for medical use, in particular dietetic pastries and confectionery, bread, bread substitutes, rusks, crispbreads, crackers, biscuits, waffles, pasta and flour adapted for medical purposes.

29 – Dietetic food not adapted for medical use, based on meat products, charcuterie, cheese, fish, poultry, game; prepared soups; meat; fish; poultry; game; fruit; vegetable; fruit or vegetable concentrates; jellies; jams; compotes; eggs; milk and milk products; edible oils and fats.

30 – Dietetic food not adapted for medical use, based on carbohydrates consisting predominantly of cereals, rice, ribbon vermicelli, pastries and confectionery, containing dietary fibre; flour and flour mixes; cereal preparations; bread; bread substitutes; rusks, crispbreads; crackers; pastries and confectionery, biscuits, waffles, flatbread, pasta, ready-to-bake dough, ready meals consisting of pasta, ribbon vermicelli, pizza, cereal-based snack food, chips (cereal products), sponge fingers, cornflakes, muesli, confectionery; desserts, namely tiramisu, chocolate mousse, puddings; chocolate goods; edible ices.

35 – Advertising; business management; business administration; office functions; market research relating to coeliac disease, allergies, intolerances and gluten-free nutrition; consumer consultancy; wholesaling and retailing in relation to dietetic food adapted for medical use, in particular pastries and confectionery, bread, bread substitutes, rusks, crispbreads, crackers, biscuits, waffles, pasta, flour, dietetic food not adapted for medical use, based on meat products, charcuterie, cheese, fish, poultry, game, ready-made soups, meat, fish, poultry, game, fruits, vegetables, fruit and vegetable concentrates, jellies, jams, compotes, eggs, milk and milk products, oils and fats for food, dietetic food not adapted for medical use, based on dietary fibre or carbohydrates, flour, flour mixtures, preparations made from cereals, bread, bread substitutes, rusks, crispbreads, crackers, pastries and confectionery, biscuits, waffles, flatbread, pasta, ready-made dough, ready meals consisting of pasta, ribbon vermicelli, pizzas, cereal-based snack food, chips (cereal products), sponge fingers, cornflakes, muesli, confectionery, desserts, in particular tiramisu, chocolate mousse, puddings, chocolate goods, edible ices, mineral and aerated waters, non-alcoholic beverages, fruit beverages and fruit juices, vegetable juices, syrups and other preparations for making beverages.

(260) AM 2021 109064 A

(800) 1540709

(151) 2020 04 27

(891) 2020 04 27

(731) SF (IP) LIMITED

12/F, San Toi Building, 137-139 Connaught Road Central, Hong Kong, China

(540)



(591) Black, white

(531) 26.01.01; 26.01.18; 26.07.04; 27.03.15; 27.05.01

(511)

9 – Computer programmes [programs], recorded; computer software applications, downloadable; downloadable mobile applications; computer program (downloadable software); data processing apparatus; computer software, recorded; computer operating programs, recorded; electronic publications, downloadable; network communication equipment; remote control apparatus.

16 – Paper; printed matter; paper gift wrap; paper box; stationery; bags [envelopes, pouches] of paper or plastics for packaging; stuffing of paper or cardboard; plastic film for wrapping; glue for stationery or household purposes; writing or drawing books; stamps [seals]; writing materials; cardboard for packaging; printed publications; lithographic works of art; teaching materials [except apparatus].

35 – Presentation of goods on communication media, for retail purposes; advertising; commercial management consulting in the field of transportation and delivery; commercial administration of the licensing of the goods and services of others; business management assistance; market studies; providing business information via a web site; import-export agency services; provision of an on-line marketplace for buyers and sellers of goods and services; marketing; procurement services for others [purchasing goods and services for other businesses]; sales promotion for others; commercial consultant in the field of transportation and delivery; personnel recruitment; administrative services for the relocation of businesses; systemization of information into computer databases; web indexing for commercial or advertising purposes; accounting; rental of vending machines; retail services for pharmaceutical, veterinary and sanitary preparations and medical supplies; sponsorship search; outsourcing services [business assistance].

36 – Insurance underwriting; insurance claims processing; financing and loan services; clearing, financial; organization of monetary collections; financial management; mortgage banking; debt management services; processing of electronic credit card transactions; financial management by the internet; electronic funds transfer; art appraisal; real estate rental service; financial customs brokerage services; financial guarantees [surety services]; charitable fund raising; fiduciary; lending against security.

39 – Freighting; transportation logistics; unloading cargo; traffic information; wrapping of goods; piloting; vehicle breakdown towing services; marine transport; car transport; railway transport; air transport; car parking; storage of goods; rental of warehouses; parcel delivery; delivery of goods; courier services [messages or merchandise]; message delivery; delivery of goods by mail order; car sharing services; rental of storage containers.

42 – Research and development of new products for others; computer software design; design and development of application software for mobile phones; software development for secure network operations; maintenance of computer software; monitoring of computer systems by remote access; development of computer platforms; electronic storage service for electronic data archiving; research in the field of telecommunications technology; developing data processing programs based on third party orders; off-site data backup; software as a service [SaaS]; cloud computing; server hosting; data encryption services.

(260) AM 2021 109067 A

(800) 1540772

(151) 2020 06 16

(891) 2020 06 16

(731) Obshchestvo s ogranichennoy otvetstvennostyu "Danilovka"

10A, Varshavskoye shosse, RU-117105

Moscow, Russian Federation

(540)

SEPTIMA



(591) Sky blue, light-sky blue, blue, red and white

(531) 03.13.20; 24.17.23; 26.01.05; 29.01.13

(511)

3 – Aromatics [essential oils]; air fragrancing preparations; balms, other than for medical purposes; deodorants for human beings or for animals; cosmetic creams; lotions for cosmetic purposes; deodorant soap; cakes of toilet soap; antiperspirant soap; soap for foot perspiration; cosmetic kits; laundry soaking preparations; laundry bleach; cleaning preparations; chemical cleaning preparations for household purposes; scouring solutions; baby wipes impregnated with cleaning preparations; tissues impregnated with cosmetic lotions; cosmetics; douching preparations for personal sanitary or deodorant purposes [toilettries]; detergents, other than for use in manufacturing operations and for medical purposes; degreasers, other than for use in manufacturing processes; antiperspirants [toilettries];

cotton sticks for cosmetic purposes; cloths impregnated with a detergent for cleaning; shampoos; dry shampoos.

5 – Antiseptics; iodides for pharmaceutical purposes; pharmaceutical preparations; chemico-pharmaceutical preparations; chemical preparations for medical purposes; chemical preparations for pharmaceutical purposes; suppositories; germicides; balms for medical purposes; biocides; disinfectants; deodorants for clothing and textiles; air deodorising preparations; lotions for pharmaceutical purposes; ointments for pharmaceutical purposes; antibacterial soap; disinfectant soap; medicated soap; cotton sticks for medical purposes; cotton swabs for medical purposes; preparations for the treatment of burns; anticryptogamic preparations; tissues impregnated with pharmaceutical lotions; antibacterial handwashes; disinfectants for hygiene purposes; detergents for medical purposes; medicated shampoos; medicated dry shampoos.

(260) AM 2021 109068 A

(800) 1540783

(151) 2020 05 27

(891) 2020 05 27

(731) Zielinski and Rozen parfumerie LLC

Ostashkovskaya str., 4, bild. 3, floor 1, of. 1,

room 4, RU-129345 Moscow, Russian

Federation

(540)

PERFUMERIE

ZIELINSKI & ROZEN

(591) Black, white

(531) 27.01.12; 27.05.09

(526) Parfumerie

(511)

3 – Amber [perfume]; aromatics [essential oils]; air fragrancing preparations; sachets for perfuming linen; scented water; javelle water; lavender water; toilet water; massage gels, other than for medical purposes; heliotropine; geraniol; deodorants for human beings or for animals; air fragrance reed diffusers; scented wood; perfumes; perfumery; ionone [perfumery]; hair conditioners; cosmetic creams; incense; hair lotions; lotions for cosmetic purposes; after-shave lotions; beauty masks; oils for perfumes and scents; oils for cosmetic purposes; oils for toilet purposes; essential oils; essential oils of cedarwood; essential oils of lemon; essential oils of citron; oils for cleaning purposes; bergamot oil; gaultheria oil; jasmine oil; lavender oil; almond oil; rose oil; almond milk for cosmetic purposes; cleansing milk for toilet purposes; musk [perfumery]; soap; deodorant soap; shaving soap; cakes of toilet soap; almond soap; mint for perfumery; cosmetic kits; eau de cologne; bases for flower perfumes; joss sticks; cosmetic preparations for baths; bath pre-

parations, not for medical purposes; collagen preparations for cosmetic purposes; aloe vera preparations for cosmetic purposes; tissues impregnated with cosmetic lotions; tissues impregnated with make-up removing preparations; safrol; massage candles for cosmetic purposes; potpourris [fragrances]; bath salts, not for medical purposes; fumigation preparations [perfumes]; cosmetics; cosmetics for children; douching preparations for personal sanitary or deodorant purposes [toiletries]; antiperspirants [toiletries]; toiletry preparations; phytocosmetic preparations; talcum powder, for toilet use; cotton sticks for cosmetic purposes; terpenes [essential oils]; shampoos; dry shampoos; herbal extracts for cosmetic purposes; extracts of flowers [perfumes]; ethereal essences; badian essence; mint essence [essential oil].

(260) AM 2021 109069 A

(800) 1540814

(151) 2020 04 21

(891) 2020 04 21

(731) VENELIN STOYANOV GEORGIEV

apartment 13, floor 5, entrance B, "Asenovska"

street 32, BG-8800 Sliven, Bulgaria

(540)

## VORILYOF ВОРИЛИОФ

(591) Black, white

(531) 28.05

(511)

5 – Absorbent cotton; acai powder dietary supplements; acaricides; acetates for pharmaceutical purposes; acids for pharmaceutical purposes; acne treatment preparations; aconitine; adhesive plasters; adhesive tapes for medical purposes; adhesives for dentures; adjuvants for medical purposes; air purifying preparations; air deodorizing preparations; albumin dietary supplements; albuminous foodstuffs for medical purposes; albuminous preparations for medical purposes; alcohol for pharmaceutical purposes; aldehydes for pharmaceutical purposes; algicides; alginate dietary supplements; alginates for pharmaceutical purposes; alkaline iodides for pharmaceutical purposes; alkaloids for medical purposes; alloys of precious metals for dental purposes; almond milk for pharmaceutical purposes; aloe vera preparations for pharmaceutical purposes; aluminium acetate for pharmaceutical purposes; amino acids for medical purposes; amino acids for veterinary purposes; anaesthetics; analgesics; angostura bark for medical purposes; animal washes [insecticides]; anti-uric preparations; antibacterial soap; antibacterial handwashes; antibiotics; anticryptogamic preparations; antioxidant pills; antiparasitic preparations; antiparasitic collars for animals; antiseptic cotton; antiseptics; appetite suppressants for medical purposes; appetite suppressant pills; aseptic cotton; asthmatic tea; astringents for medical purposes; babies' diapers; babies' diaper-pants; bacterial poisons; bacte-

rial preparations for medical and veterinary use; bacteriological preparations for medical and veterinary use; balms for medical purposes; balsamic preparations for medical purposes; bandages for dressings; barks for pharmaceutical purposes; bath preparations for medical purposes; bath salts for medical purposes; bicarbonate of soda for pharmaceutical purposes; biocides; biological preparations for medical purposes; biological preparations for veterinary purposes; biological tissue cultures for medical purposes; biological tissue cultures for veterinary purposes; bismuth preparations for pharmaceutical purposes; bismuth subnitrate for pharmaceutical purposes; blood plasma; blood for medical purposes; bone cement for surgical and orthopaedic purposes; bouillons for bacteriological cultures; bracelets impregnated with insect repellent; breast-nursing pads; bromine for pharmaceutical purposes; bronchodilating preparations; bunion pads; by-products of the processing of cereals for dietetic or medical purposes; cachets for pharmaceutical purposes; cachou for pharmaceutical purposes; preparations for callouses; calomel [fungicide]; camphor oil for medical purposes; camphor for medical purposes; candy, medicated; candy for medical purposes; capsules for medicines; capsules made of dendrimer-based polymers, for pharmaceuticals; carbolineum [parasiticide]; casein dietary supplements; castor oil for medical purposes; cattle washes [insecticides]; caustic pencils; caustics for pharmaceutical purposes; cedar wood for use as an insect repellent; cellulose esters for pharmaceutical purposes; cellulose ethers for pharmaceutical purposes; cement for animal hooves; charcoal for pharmaceutical purposes; chemical conductors for electrocardiograph electrodes; chemical contraceptives; chemical preparations for the diagnosis of pregnancy; chemical preparations to treat mildew; chemical preparations to treat wheat blight; chemical preparations for treating phylloxera; chemical preparations for treating diseases affecting vine plants; chemical preparations for pharmaceutical purposes; chemical preparations for medical purposes; chemical preparations for veterinary purposes; chemical reagents for medical or veterinary purposes; chemical preparations for treating diseases affecting cereal plants; chemico-pharmaceutical preparations; chewing gum for medical purposes; chilblain preparations; chinoline for medical purposes; chloroform; cocaine; cod liver oil; collagen for medical purposes; collodion for pharmaceutical purposes; collyrium; compresses; condurango bark for medical purposes; solutions for contact lenses; contact lens cleaning preparations; cooling sprays for medical purposes; corn rings for the feet; corn remedies; cotton for medical purposes; cotton swabs for medical purposes; cream of tartar for pharmaceutical purposes; creosote for pharmaceutical purposes; croton bark; cultures of microorganisms for medical or veterinary use; curare; decoctions for pharmaceutical purposes; dental abrasives; dental amalgams; dental cements; dental impre-

ssion materials; dental lacquer; dental mastics; dental amalgams of gold; deodorants, other than for human beings or for animals; deodorants for clothing and textiles; depuratives; preparations for destroying noxious animals; preparations for destroying dry rot fungus; preparations for destroying mice; detergents for medical purposes; diabetic bread adapted for medical use; diagnostic preparations for medical purposes; diagnostic biomarker reagents for medical purposes; diagnostic preparations for veterinary purposes; diapers for incontinence; diapers for pets; diastase for medical purposes; dietary fibre; dietary supplements for animals; dietary supplements with a cosmetic effect; dietetic foods adapted for medical purposes; dietetic beverages adapted for medical purposes; dietetic substances adapted for medical use; digestives for pharmaceutical purposes; digitalin; dill oil for medical purposes; disinfectant soap; disinfectants for hygiene purposes; disinfectants for chemical toilets; disinfectants; dog washes [insecticides]; douching preparations for medical purposes; dressings, medical; drugs for medical purposes; elixirs [pharmaceutical preparations]; enzyme preparations for medical purposes; enzyme preparations for veterinary purposes; enzyme dietary supplements; enzymes for medical purposes; enzymes for veterinary purposes; ergot for pharmaceutical purposes; esters for pharmaceutical purposes; ethers for pharmaceutical purposes; eucalyptol for pharmaceutical purposes; eucalyptus for pharmaceutical purposes; extracts of hops for pharmaceutical purposes; eyepatches for medical purposes; preparations to facilitate teething; febrifuges; fennel for medical purposes; ferments for pharmaceutical purposes; first-aid boxes, filled; fish meal for pharmaceutical purposes; flour for pharmaceutical purposes; flowers of sulfur for pharmaceutical purposes; fly catching paper; fly glue; fly destroying preparations; food for babies; formic aldehyde for pharmaceutical purposes; freeze-dried food adapted for medical purposes; freeze-dried meat adapted for medical purposes; frostbite salve for pharmaceutical purposes; fumigating sticks; fumigation preparations for medical purposes; fungicides; gallic acid for pharmaceutical purposes; gamboge for medical purposes; gases for medical purposes, gauze for dressings; gelatine for medical purposes; gentian for pharmaceutical purposes; germicides; glucose for medical purposes; glucose dietary supplements; glycerine for medical purposes; glycerophosphates; greases for medical purposes; greases for veterinary purposes; guaiacol for pharmaceutical purposes; gum for medical purposes; gurjun balsam for medical purposes; haematogen; haemoglobin; haemorrhoid preparations; haemostatic pencils; herbal teas for medicinal purposes; herbal extracts for medical purposes; preparations for destroying noxious plants; homogenized food adapted for medical purposes; hormones for medical purposes; hydrastine; hydrastinine; hydrated chloral for pharmaceutical purposes; hydrogen peroxide for medical purposes; immunostimulants; infant formula; in-

jectable dermal fillers; insect repellents; insect repellent incense; insecticidal animal shampoo; insecticidal veterinary washes; insecticides; iodides for pharmaceutical purposes; iodine for pharmaceutical purposes; iodoform; Irish moss for medical purposes; isotopes for medical purposes; jalap; jujube, medicated; lacteal flour for babies; larvae exterminating preparations; laxatives; lead water; lecithin for medical purposes; lecithin dietary supplements; leeches for medical purposes; lice treatment preparations [pediculicides]; lime-based pharmaceutical preparations; liniments; linseed for pharmaceutical purposes; linseed meal for pharmaceutical purposes; linseed dietary supplements; linseed oil dietary supplements; lint for medical purposes; liquorice for pharmaceutical purposes; lotions for pharmaceutical purposes; lotions for veterinary purposes; lupulin for pharmaceutical purposes; magnesia for pharmaceutical purposes; malt for pharmaceutical purposes; malted milk beverages for medical purposes; mangrove bark for pharmaceutical purposes; massage candles for therapeutic purposes; medical preparations for slimming purposes; medicated eye-washes; medicated animal feed; medicated dentifrices; medicated after-shave lotions; medicated shampoos; medicated toiletry preparations; medicated hair lotions; medicated dry shampoos; medicated shampoos for pets; medicated soap; medicinal alcohol; medicinal mud; medicinal infusions; medicinal tea; medicinal oils; medicinal herbs; medicinal roots; medicinal drinks; medicinal hair growth preparations; medicine cases, portable, filled; medicines for alleviating constipation; medicines for dental purposes; medicines for human purposes; medicines for veterinary purposes; melissa water for pharmaceutical purposes; menthol; mercurial ointments; preparations of microorganisms for medical or veterinary use; milk ferments for pharmaceutical purposes; milk sugar for pharmaceutical purposes; milking grease; mineral waters for medical purposes; mineral water salts; mineral food supplements; mint for pharmaceutical purposes; moleskin for medical purposes; mothproofing preparations; mothproofing paper; moulding wax for dentists; mouthwashes for medical purposes; mud for baths; mustard oil for medical purposes; mustard for pharmaceutical purposes; mustard plasters; myrobalan bark for pharmaceutical purposes; narcotics; nervines; nicotine gum for use as an aid to stop smoking; nicotine patches for use as aids to stop smoking; nutraceutical preparations for therapeutic or medical purposes; nutritional supplements; nutritive substances for microorganisms; oil of turpentine for pharmaceutical purposes; ointments for pharmaceutical purposes; opiates; opium; opodeldoc; opotherapy preparations; oxygen baths; oxygen for medical purposes; pants, absorbent, for incontinents; panty liners [sanitary]; paper for mustard plasters; parasiticides; pastilles for pharmaceutical purposes; pearl powder for medical purposes; pectin for pharmaceutical purposes; pediculicidal shampoos; pepsins for pharmaceutical purposes; pep-

tones for pharmaceutical purposes; pesticides; petroleum jelly for medical purposes; pharmaceutical preparations; pharmaceutical preparations for treating sunburn; pharmaceutical preparations for skin care; pharmaceutical preparations for treating dandruff; pharmaceuticals; phenol for pharmaceutical purposes; phosphates for pharmaceutical purposes; phytotherapy preparations for medical purposes; plant extracts for pharmaceutical purposes; poisons; pollen dietary supplements; pomades for medical purposes; porcelain for dental prostheses; potassium salts for medical purposes; poultices; powder of cantharides; powdered milk for babies; pre-filled syringes for medical purposes; propolis for pharmaceutical purposes; propolis dietary supplements; protein dietary supplements; protein supplements for animals; purgatives; pyrethrum powder; quassia for medical purposes; quebracho for medical purposes; quinine for medical purposes; quinquina for medical purposes; radioactive substances for medical purposes; radiological contrast substances for medical purposes; radium for medical purposes; reagent paper for veterinary purposes; preparations for reducing sexual activity; remedies for foot perspiration; remedies for perspiration; repellents for dogs; rhubarb roots for pharmaceutical purposes; royal jelly for pharmaceutical purposes; royal jelly dietary supplements; rubber for dental purposes; salts for mineral water baths; salts for medical purposes; sanitary panties; sanitary tampons; sanitary towels; sarsaparilla for medical purposes; scapulars for surgical purposes; sea water for medicinal bathing; sedatives; semen for artificial insemination; serotherapeutic medicines; serums; personal sexual lubricants; sexual stimulant gels; siccatives [drying agents] for medical purposes; slimming pills; slug exterminating preparations; smelling salts; smoking herbs for medical purposes; sodium salts for medical purposes; soil-sterilizing preparations; solvents for removing adhesive plasters; soporifics; starch for dietetic or pharmaceutical purposes; stem cells for medical purposes; stem cells for veterinary purposes; sterilizing preparations; steroids; stick liquorice for pharmaceutical purposes; strychnine; styptic preparations; sugar for medical purposes; sulfonamides [medicines]; sulfur sticks [disinfectants]; sunburn ointments; suppositories; surgical dressings; surgical implants comprised of living tissues; surgical glues; syrups for pharmaceutical purposes; tanning pills; tartar for pharmaceutical purposes; teeth filling material; therapeutic preparations for the bath; thermal water; thymol for pharmaceutical purposes; tincture of iodine; tinctures for medical purposes; tissues impregnated with pharmaceutical lotions; tobacco extracts [insecticides]; tobacco-free cigarettes for medical purposes; tonics [medicines]; preparations of trace elements for human and animal use; transplants [living tissues]; preparations for the treatment of burns; turpentine for pharmaceutical purposes; vaccines; vaginal washes for medical purposes; vermifuges;

vermin destroying preparations; vesicants; veterinary preparations; vitamin preparations; vitamin supplement patches; vulnerary sponges; wadding for medical purposes; wart pencils; wheat germ dietary supplements; yeast for pharmaceutical purposes; yeast dietary supplements.

---

(260) AM 2021 109071 A

(800) 1540931

(151) 2020 04 30

(891) 2020 04 30

(731) Sony Interactive Entertainment Inc.

1-7-1, Konan, Minato-ku, Tokyo 108-0075,  
Japan

(540)

**DUALSENSE**

(591) Black, white

(511)

9 – Video game software; downloadable video game software; recorded video game software; computer game software; computer game software downloadable from a global computer network; recorded computer game software; electronic docking stations; battery chargers for video game machines; battery chargers used for controllers for game consoles.

28 – Controllers for game consoles; game controllers for computer games; computer game consoles for use with an external display screen or monitor; video game consoles; video game consoles for use with an external display screen or monitor; video game interactive hand held remote controls for playing electronic games; video game interactive remote control units.

---

(260) AM 2021 109072 A

(800) 1540953

(151) 2020 05 18

(891) 2020 05 18

(731) VIORICA-COSMETIC S.A.

str. Mesager nr.1, MD-2069 Chişinău,  
Republic of Moldova

(540)



(591) Black, white

(531) 01.03.16; 05.05.20; 25.01.13; 25.01.15;  
27.01.06; 27.05.07

(511)

3 – Non-medicated cosmetics and toiletry preparations; non-medicated dentifrices; perfumery; essential

oils; bleaching preparations and other substances for laundry use; cleaning, polishing, scouring and abrasi-  
ve preparations.

(260) AM 2021 109077 A

(800) 1541077

(151) 2020 01 24

(891) 2020 01 24

(731) Obschestvo s ogranichennoy otvetstvennostyu  
"Upravlyayushchaya kompaniya Miksit"  
22-y km Kievskogo sh., domovl. 4, str. 5,  
fifce 713-E, p. Moskovskiy, RU-125362  
Moscow, Russian Federation

(540)



(591) Black, red, yellow, lilac and blue

(531) 25.05.25; 26.03.04; 26.04.01; 26.04.18;  
27.05.01; 29.01.15

(511)

5 – Drug delivery agents; aconitine; alkaloids for medical purposes; alginates for pharmaceutical purposes; aldehydes for pharmaceutical purposes; amino acids for medical purposes; analgesics; anaesthetics; antibacterial liquid hand soap; antibacterial substances for medical purposes; antibacterial gels; antibiotics; anticoagulants; antimicrobials for dermatologic use; anti-microbial hand wash; antioxidants [dietary supplements]; antiseptics; cotton swabs for medical purposes; corn pads; deodorizing room sprays; aluminium acetate for pharmaceutical purposes; acetates for pharmaceutical purposes; bacteriostats for medical use; germicides; pain relief preparations; medicated lip balms; medicated lip salves; balms for medical purposes; multi-purpose medicated mentholated salves; anesthetic balms in the form of medicinal and cosmetic preparations; anti-inflammatory balms in the form of medicinal and cosmetic preparations; bandages for skin wounds; bandages for dressings; antiseptic spray tape in the form of medicinal and cosmetic preparations; surgical bandages; biocides; biological preparations for medical purposes; petroleum jelly for medical purposes; oxygen baths; medicated bath preparations for therapeutic use; antiseptic cotton; aseptic cotton; absorbent cotton; wadding for medical purposes; medicated shampoos; cotton for medical purposes; disinfectants for medical purposes; dietetic substances adapted for medical use; vitamins and minerals as dietary supplements; vitaminized water as a supplement to medicinal and cosmetic preparations (terms too vague in the opinion of the International Bureau – Rule 13(2)(b) of the Regulations); melissa water for pharmaceutical purposes; sea water for medicinal bathing; enriched water as a medical and dietary supplement; mineral waters for medical purposes; thermal water as a component or supplement to medicinal and

cosmetic preparations (terms too vague in the opinion of the International Bureau – Rule 13(2)(b) of the Regulations); dietary fiber; dental waxes; gases for medical purposes; hamamelis as a component or supplement to medicinal and cosmetic preparations (terms too vague in the opinion of the International Bureau – Rule 13(2)(b) of the Regulations); guaiacol for pharmaceutical purposes; medicated oral care gels; gels, creams and solutions for dermatological use; lubricant gels for personal use; medicated brush-on oral care gels; topical gels for medical and therapeutic purposes; anti-adhesion gels for use with wound drainage devices; anti-inflammatory gels; alcohol-based antibacterial skin sanitizer gels; hydrastinine; hydrocortisone creams; medicinal clay as a component or supplement to medicinal and cosmetic preparations; hydrastine; glycerin for medical use as a component or supplement to medicinal and cosmetic preparations; glycerophosphates as a medical and dietary supplement; glucose for medical purposes; gentian for pharmaceutical purposes; mustard for pharmaceutical purposes; mud for baths; medicinal mud; contraceptive sponges; gamboge for medical purposes; gurjun balsam for medical purposes; all-purpose disinfectants; household deodorizers; air deodorising preparations; deodorants for clothing and textiles; digitalin; sterile cotton pads (terms too vague in the opinion of the International Bureau – Rule 13(2)(b) of the Regulations); biologically active mineral supplements; vitamin supplements; dietary supplements for controlling cholesterol; dietetic substances consisting of vitamins, minerals, amino acids and trace elements; calcium supplements; dietary supplements; dietary and nutritional supplements; dietary supplement drinks; dietetic food supplements; dietary supplements for humans; wheat dietary supplements; soy protein dietary supplements; bactericide skin soaps; bactericide soaps; disinfectant soap; antibacterial scented soaps; zinc dietary supplements; herbal supplements; dietary supplements consisting of amino acids; dietary supplements consisting of amino acids, minerals and trace elements; dietary supplements consisting of vitamins; dietary supplements consisting of trace elements; dietary supplements consisting of minerals; mineral food supplements; nutritional supplements; albumin dietary supplements; vitamin and mineral dietary supplements; dietary supplements for animals; yeast dietary supplements; alginate dietary supplements; glucose dietary supplements; casein dietary supplements; lecithin dietary supplements; linseed oil dietary supplements; propolis dietary supplements; protein dietary supplements; royal jelly dietary supplements; pollen dietary supplements; wheat germ dietary supplements; linseed dietary supplements; powdered fruit-flavored dietary supplement drink mixes; nutritional supplements made of starch adapted for medical purposes; enzyme dietary supplements; yeast for pharmaceutical purposes; gelatine for medical purposes; ginseng for medicinal use; cod liver oil; meal replacement and

dietary supplement drink mixes for medical purposes; pharmaceutical preparations for use in dermatology; calomel; cream of tartar for pharmaceutical purposes; camphor for medical use; cachets for pharmaceutical purposes; hemostatic pencils; wart pencils; caustic pencils; headache pencils (terms too vague in the opinion of the International Bureau – Rule 13(2)(b) of the Regulations); caustics for pharmaceutical purposes; cachou for pharmaceutical purposes; quassia for medical purposes; quebracho for medical purposes; gallic acid for pharmaceutical purposes; acids for pharmaceutical purposes; adhesive tapes for medical purposes; ground flaxseed fiber for use as a dietary supplement; meal replacement shakes for medical purposes; collodion for pharmaceutical purposes; corn rings for the feet; room deodorizing compositions; medicated compresses; candy, medicated; angostura bark for medical purposes; barks for pharmaceutical purposes; cedar wood for use as an insect repellent; condurango bark for medical purposes; croton bark; mangrove bark for pharmaceutical purposes; myrobalan bark for pharmaceutical purposes; quinquina for medical purposes; medicinal roots; rhubarb roots for pharmaceutical purposes; medicinal radix glycyrrhizae; lint for medical purposes; hydrocortisone; cosmetics for therapeutic purposes; starch for dietetic or pharmaceutical purposes; starch for dietetic purposes; starch for pharmaceutical purposes; starch and starch products for pharmaceutical purposes; medicated lip creams; creams for dermatological use; medicinal creams; multi-purpose medicated antibiotic creams; medicated skin creams; medicinal creams for skin care; corn and callus creams; anti-itch creams [antipruritics]; antifungal creams for medical purposes; antibiotic creams; herbal creams for medical purposes; liquorice for pharmaceutical purposes; lactose for pharmaceutical purposes; vitamin drops; candy for medical purposes; adhesive plasters; sticking plasters for medical purposes; non-prescription medicines; dissolvable strips to stop bleeding from minor cuts and grazes; lecithin for medical purposes; antibacterial hand lotions; lotions for treating athlete's foot; medicated face lotions; medicated body lotions; lotions for pharmaceutical purposes; barrier lotions for protection from toxic oils of poisonous plants; medicated lotions; medicated skin lotions; medicated muscle soaks; medicated lotions and creams for the body, skin, face, and hands; medicated diaper rash lotions; calamine lotions; medicated lotions for sunburn; pharmaceutical lotions for the skin; hygienic lubricants; water-based personal lubricants; silicone-based personal lubricants; lupulin for pharmaceutical purposes; liniments; ointments for pharmaceutical purposes; rubbing compounds for medical or therapeutic purposes; medicated diaper rash ointments; sunburn ointments; frostbite salve for pharmaceutical purposes; ointments for treating diaper rash; anti-itch ointments [antipruritics]; anti-inflammatory ointments; herbal ointments for sensitive skin; gauze for medical purposes;

gauze for dressings; herbal mud packs for therapeutic purposes; medicated baby oils; medicinal oils; mustard oil for medical purposes; camphor oil for medical purposes; castor oil for medical purposes; almond oil for pharmaceutical purposes; oil of turpentine for pharmaceutical purposes; dill oil for medical purposes; materials for oral prophylaxis; medical adhesives for binding wounds; dressings, medical; drugs for medical purposes; serotherapeutic medicines; medicines for human purposes; medicines for dental purposes; medicated soap; medicated toothpastes; menthol; medicinal drinks; moleskin for use as a medical bandage; almond milk for pharmaceutical purposes; royal jelly for medical use; royal jelly for pharmaceutical purposes; milk ferments for pharmaceutical purposes; Irish moss for medical purposes; flour for pharmaceutical purposes; linseed meal for pharmaceutical purposes; multivitamin preparations; mint for pharmaceutical purposes; nutritionally fortified beverages for medical purposes; dietary drink mixes for use as meal replacements for medical purposes; dietetic beverages adapted for medical purposes; meal replacement drinks for medical purposes; malted milk beverages for medical purposes; medicated beverages; diabetic fruit juice beverages adapted for medical purposes; vitamin fortified beverages for medical purposes; beverages adapted for medical purposes; medicinal infusions; medicinal herbal infusions; eucalyptol for pharmaceutical purposes; tinctures for medical purposes; diabetic fruit nectars adapted for medical purposes; nematicides; nutraceuticals for use as dietary supplements; nutraceuticals for therapeutic purposes; pain relief medication; opodeldoc; anti-cavity mouth rinses for medical purposes; medicament oral rinses; deodorizers for garbage disposals; decoctions for pharmaceutical purposes; stick liquorice for pharmaceutical purposes; sulfur sticks [disinfectants]; pastilles for pharmaceutical purposes; zinc supplement lozenges; pectin for pharmaceutical purposes; pepsins for pharmaceutical purposes; synthetic peptides for pharmaceutical purposes; peptones for pharmaceutical purposes; nanoparticle-based pharmaceuticals; hydrogen peroxide for medical purposes; pills for pharmaceutical purposes; meal replacement bars for medical purposes; vitamin and mineral bars for medical purposes; plasters, materials for dressings; medical and surgical plasters; corn plasters; anti-inflammatory analgesic plasters; compresses; adhesive bandages; cooling dressing for medical purposes; self-adhesive dressings; ear bandages; eye pads for medical purposes; bunion pads; pomades for medical purposes; powder of cantharides; pyrethrum powder; polynucleotide sequence for medical purposes; antiseptic preparations; bacterial preparations for medical purposes; bacteriological preparations for medical purposes; balsamic preparations for medical purposes; albuminous preparations for medical purposes; biotechnological preparations for medical purposes; biochemical preparations for medical purposes; vitamin pre-



parations; hygienic preparations for medical purposes; diagnostic preparations for medical purposes; dietetic preparations adapted for medical purposes; dietetic food preparations adapted for medical purposes; bath preparations for medical purposes; therapeutic preparations for the bath; fumigation preparations for medical purposes; opotherapy preparations; air purifying preparations; preparations for making dietetic beverages adapted for medical purposes; preparations for making medicated beverages; eye-washes; medicated wart removing preparations; corn remedies; pharmaceutical preparations for treating dandruff; pharmaceutical preparations for skin care; pharmaceutical preparations and substances for the treatment of damaged skin and tissue; pharmaceutical antiallergic preparations and substances; pharmaceutical preparations and substances with analgesic properties; pharmaceutical preparations and substances with anti-inflammatory properties; preparations of lime for pharmaceutical purposes; chilblain preparations; medicinal preparations and substances; pharmaceutical preparations and substances; potassium preparations for pharmaceutical purposes; caffeine preparations for stimulative use; herbal medicines; medicinal preparations; medicated shaving preparations; medicinal hair growth preparations; medicated hair care preparations; nanoparticle-based medical preparations; coca alkaloid preparations for medical purposes; amino acid preparations for medical purposes; ophthalmic preparations; anti-inflammatory preparations; antifungal preparations; anticryptogamic preparations; crude medicines; aloe vera preparations for pharmaceutical purposes; vitamin and mineral preparations for medical purposes; human micronutrient preparations (terms too vague in the opinion of the International Bureau – Rule 13(2)(b) of the Regulations); methionine preparations; caffeine preparations for medical purposes; lysine preparations; tetracycline preparations; thiolutin preparations; threonine preparations; tryptophane preparations; trichomycin preparations; lipotropic factor preparations; chondroitin preparations; odor neutralizing preparations for clothing and textiles; pharmaceuticals for skin care; pharmaceutical preparations; pharmaceutical preparations for activating cellular function; pharmaceutical preparations for wounds; pharmaceutical preparations for treating skin disorders; pharmaceutical preparations for treating and preventing skin and nail diseases; pharmaceutical preparations for treating sports injuries; pharmaceuticals for dry skin treatment; pharmaceutical preparations for the relief of insect bites; pharmaceuticals for prevention of skin blemishes; pharmaceutical preparations for the prevention of stretch marks; pharmaceutical preparations for hydrating the skin during pregnancy; pharmaceutical preparations for human use; pharmaceutical preparations for treating sunburn; enzyme preparations for medical purposes; chemico-pharmaceutical preparations; chemical preparations for medical purposes; chemical preparations for phar-

maceutical purposes; collyrium; lead water; medicated baby powder; albuminous foodstuffs for medical purposes; dietetic foods adapted for medical purposes; food for enteral feeding; by-products of the processing of cereals for dietetic or medical purposes; gluten-free foods adapted for medical purposes; dietary and nutritionally fortified food products adapted for medical purposes; food for infants; food adapted for diabetics; dietetic food and substances adapted for medical or veterinary use, food for babies; propolis for medicinal or therapeutic purposes; propolis for pharmaceutical purposes; pearl powder for medical purposes; processed bee pollen for medicinal or therapeutic purposes; solvents for removing adhesive plasters; hydrated chloral for pharmaceutical purposes; disinfecting hand wash; gargles for medical purposes; rodenticides; gum for medical purposes; rubber for dental purposes; chewing gum for medical purposes; mint-flavored chewing gum for medical purposes; muscle relaxants; mosquito-repellent incense; insect repellents; insect repellent in candle form; insect repellent incense; pre-moistened medicated tissues; sanitizing wipes; tissues and wipes impregnated with pharmaceutical lotions and creams; tissues impregnated with antibacterial preparations; tissues impregnated with pharmaceutical lotions; tissues impregnated with insect repellents; sarsaparilla for medical purposes; dietetic sugar for medical purposes; sugar for medical purposes; sugar substitutes for medicinal or therapeutic purposes; fumigating sticks; suppositories; linseed for pharmaceutical purposes; siccatives [drying agents] for medical purposes; turpentine for pharmaceutical purposes; greases for medical purposes; meal replacement snacks for medical purposes; mineral water salts; bath salts for medical purposes; salts for mineral water baths; bath salts and bath preparations for medical purposes; medicated bath salts; salts for medical purposes; potassium salts for medical purposes; epsom salts for medical purposes; sodium salts for medical purposes; smelling salts; malt for pharmaceutical purposes; alcohol for topical use; alcohol for pharmaceutical purposes; isopropyl alcohol for medical purposes; medicinal alcohol; ergot for pharmaceutical purposes; antibacterial sprays; medicinal sprays for the mouth; medicinal sprays; medicated nasal spray preparations; medicated throat sprays; nasal sprays for medical purposes; nasal and oral spray preparations for use as central nervous system stimulants; decongestant nasal sprays; cooling sprays for medical purposes; anti-inflammatory sprays; herbal sprays for medical purposes; medicated douches; anesthetics for non-surgical use; bactericides; antihistamines; analgesic preparations; adjuvants for medical purposes; styp-tic preparations; sanitary preparations for medical purposes; hypolipidemic agents; homeopathic medicines; disinfectants; disinfectants for hygiene purposes; mouth cavity cleansers for medical purposes; dermatological preparations; nail sanitizing preparations; hand-sanitizing preparations; nail fungus treatment prepara-



tions; acne treatment preparations; burn relief medication; medicated hand wash; antibiotic hand wash; preparations for cleansing the skin for medical purposes; appetite suppressants for medical purposes; medical preparations for slimming purposes; mouthwashes for medical purposes; preparations of trace elements for human use; therapeutic drugs and agents; medicated preparations for skin treatment; medicinal health care preparations; medicated grooming preparations; medicated mouth care and treatment preparations; medicated skin care preparations; allergy relief medication; medicated lip care preparations; menthol bath preparations for medical purposes; menthol vapor bath preparations for babies; topical anesthetics; detergents for medical purposes; articles for headache; skin care preparations for medical purposes; foot care preparations for medical purposes; nail care preparations for medical purposes; anti-inflammatories; anti-fungal medication; liquid antipruritics; microbicides; decongestants; remedies for perspiration; herbal remedies; sanitary preparations for personal hygiene, other than toiletries; hypnotic sedatives; digestives for pharmaceutical purposes; tonics for medical purposes; tonics [medicines]; herbal preparations for medical purposes; nervines; anhidrotics; all-purpose disinfecting and deodorizing preparations; pharmaceutical preparations for health care; pharmaceuticals for ophthalmic use; pharmaceutical drugs; chemical preparations for sanitary purposes; media for bacteriological cultures; steroids; hair growth stimulants for medical purposes; antioxidant pills; tanning pills; appetite suppressant pills; slimming pills; powders for treating athlete's foot; medicated foot powders; tampons for medical purposes; cotton sticks for medical purposes; medicated swabs; thymol for pharmaceutical purposes; thiomersal; fabric deodorizers; smoking herbs for medical purposes; medicinal herbs; medicinal herbs in dried or preserved form; trypsin for medical purposes; charcoal for pharmaceutical purposes; fennel for medical purposes; enzymes for medical purposes; ferments for pharmaceutical purposes; phosphates for pharmaceutical purposes; quinine for medical purposes; chinoline for medical purposes; vitamin enriched bread for therapeutic purposes; diabetic bread adapted for medical use; flowers of sulfur for pharmaceutical purposes; medicinal tea; herbal teas for medicinal purposes; slimming tea for medical purposes; eucalyptus for pharmaceutical purposes; medicinal herbal extracts for medical purposes; herbal extracts for medical purposes; extracts of hops for pharmaceutical purposes; electrolytes for medical purposes; elixirs [pharmaceutical preparations]; ethers for pharmaceutical purposes; esters for pharmaceutical purposes; cellulose esters for pharmaceutical purposes; cellulose ethers for pharmaceutical purposes; non-medicated bactericide detergents; mouth wash elixirs.

16 – Fountain pens; albums; almanacs; paint applicators in the nature of sponges; atlases; posters; banners

of paper; paper bows; decorative paper bows for wrapping; paper bows for gift wrapping; paper badges; cardboard hangtags; paper hangtags; forms, printed; paperboard blanks; order forms; adhesive notepads; score pads; art pads; writing paper pads; note books; illustrated notepads; loose-leaf binders; blank paper notebooks; pamphlets; cosmetic brochures; advertising pamphlets; booklets; paper; waterproof paper; waxed paper; fluting paper [corrugating medium]; notebook paper; business card paper [semi-finished]; découpage paper (paper for decorating surfaces using découpage technique by gluing paper cut images); paper for wrapping and packaging; adhesive notepaper; paper for making bags and sacks; paper stationery; directory paper; envelope paper; postcard paper; gift wrapping paper; cosmetic packaging paper; label paper; drawer liners of paper, perfumed or not; proofing paper; tengujosi [paper made from paper mulberry]; wood pulp paper; imitation leather paper; calendar-finished paper; paper and cardboard; acid-resistant paper; carbon paper; plastic-coated copying paper; kraft paper; crêpe paper; crêpe paper for domestic use; laminated paper; metallic gift wrapping paper; wrapping paper for food and sterile products; parchment paper; recycled paper; recycled bond paper; rice paper; napkin paper; luminous paper; synthetic paper; gummed paper; paper containing mica; honeycomb paper; xuan paper for Chinese painting and calligraphy; heat transfer paper; heat sensitive paper; paper embossers [office requisites]; wrapping paper; environmentally-friendly packaging paper and containers of paper; synthetic bond paper; mildewproof paper; cellophane paper; greaseproof paper; party ornaments of paper; paper name badges; newsletters; printed vouchers; scented drawer liners of paper; printed questionnaires; signboards of paper or cardboard; pennants made of paper; printed news releases; newspapers; ivory paper; corrugated cardboard; engravings; art etchings; art pictures; digests in the field of cosmetology, medical cosmetics and health products; pencil holders; advertisement boards of paper or cardboard; day planners; in-flight magazines; magazines [periodicals]; medical journals; professional journals for cosmetologists and aesthetic medicine professionals; clips for offices; badges of cardboard; identification tags of paper; periodicals; periodical literature in the field of innovations in the field of cosmetics, medical cosmetics, cosmetology and hygiene care; house organs; printed publications; printed publications related to education in the field of cosmetics and cosmetic treatment; calligraphic works; cardboard articles; works of art of paper; graphic representations; printed visuals; illustrations; printed instructions for creating designed and customized cosmetic products; calendars; pocket calendars; wall calendars; desk calendars; tear-off calendars; printed calendars; tracing paper; tracing cloth; tracing patterns; gums [adhesives] for stationery or household purposes; pencils; crayons; pictures; transfers [decalcomanias]; three-dimensional

decalcomanias for use on any surface; paintings [pictures], framed or unframed; cardboard; white paperboard; bristol boards; corrugated paper; mat boards; poster board; illustration boards; wood pulp board [stationery]; pasteboard; millboard; packing cardboard; colorboard [colored paperboard]; cards; business cards; note cards; blank note cards; printed informational cards; catalogues; cosmetics catalogs; paintbrushes; books; memorandum books; birthday books; gift books; books on making designed, customized cosmetics; picture books; collages; envelopes of paper for packaging; envelopes [stationery]; storage containers made of paper; industrial packaging containers of paper; cardboard, corrugated cardboard containers; paper cartons for delivering goods; paper or cardboard boxes for storing cosmetics; paper or cardboard collapsible boxes; cardboard counter display boxes for cosmetics; paper or cardboard boxes; paperboard boxes for industrial packaging; cardboard packaging boxes in made-up form; boxes of paper or cardboard; gift boxes of cardboard or paper; paint boxes and brushes; paper closures for containers; printed coupons; printed courses of lectures and workshops on designing and proper selection of cosmetics; sealing tape for paper cartons; ribbons of paper for gift wrapping; ribbons for hand-held label printers [office requisites]; adhesive bands for stationery or household purposes; gummed tape [stationery]; adhesive tapes for stationery or household purposes; self-adhesive tapes for stationery or household purposes; score sheets; flyers; informational leaflet on cosmetic or medicinal and cosmetic products or its components; leaflets; pharmaceutical information leaflets; leaflets with information on cosmetics, including hand-made cosmetics, customized cosmetics; humidity control sheets of paper or plastic for foodstuff packaging; viscose sheets for wrapping; sheets of reclaimed cellulose for wrapping; informational sheets; transparent celluloid sheets used for hand-drawn animation; plastic bubble packs for wrapping or packaging; graphic prints; graphic art prints; teaching materials [except apparatus]; sealing compounds for stationery purposes; printed material in the nature of color samples; printed correspondence course materials; printing materials on cosmetology and biochemistry for cosmetic purposes; printed teaching materials; printed instructional, educational, and teaching materials; plastic materials for packaging; plastic transparencies; packaging materials made of recycled paper; packaging material made of starches; teaching materials of paper; instructional and teaching materials; printed training materials; filtering materials [paper]; printed assortment sheets (terms too vague in the opinion of the International Bureau – Rule 13(2)(b) of the Regulations); paper bags; shopping bags of paper; bags of paper for packaging; party goodie bags of paper or plastic; Halloween goodie bags of paper or plastic; gift bags of paper; bags [envelopes, pouches] of paper or plastics, for packaging; bags of plastic for packaging; plastic bags for securing valu-

ables; plastic bags for household purposes; bumper stickers; blank plastic stickers; shipping labels of paper; stickers [stationery]; sealing wafers; linerboard for corrugated cardboard; treated paper for wrapping flowers and floral displays; oleographs; questionnaires printed for collection of feedback and suggestions from consumers of designed, customized cosmetics; letter openers of precious metal; musical greeting cards; printed greeting cards with electronic information stored therein; greeting cards; pop-up greeting cards; postcards; blank or partially printed postcards; holiday cards; Christmas cards; occasion cards; picture postcards; cards bearing universal greetings; prints in the nature of photographs; pictorial prints; photographic prints; printed reports; printed consumer reports; printed research reports; etchings; conical paper bags; paper gift bags for cosmetics and health products; shopping bags of plastic; plastic bags for packing; bags [envelopes, pouches] of paper or plastics, for merchandise packaging; gift bags of paper or plastic; grocery bags of paper or plastic; printed informational folders; presentation folders; papier mâché; passe-partouts of paper; picture framing mat boards; pastels [crayons]; artists' pastels; oil pastels; pens [office requisites]; nibs of gold; nibs; steel pens; colored art and craft sand; prints in the nature of pictures; part-work (highly technical periodicals of informative, entertaining, collectible nature, accompanied by disks, separate elements of models, or whole models that are collected during the period of publication) (terms too vague in the opinion of the International Bureau – Rule 13(2)(b) of the Regulations); lithographic prints; informational letters; unmounted posters; mounted posters; plastic adhesives for household or domestic use; handkerchiefs of paper; adhesive plastic film used for mounting images; polypropylene foil for wrapping; plastic flexible packaging film sold in bulk to industrial and commercial manufacturers; plastic films for gift basket wrapping; plastic film for wrapping; letter trays; stands for pens and pencils; photograph stands; photographic or art mounts of paper or cardboard; coasters of cardboard; desktop document racks; towels of paper; hygienic hand towels of paper; portraits; instructional manuals for teaching purposes; study guides; posters made of paper; decorative paper centerpieces; paperweights; writing cases [sets]; printed invitations; magazine supplements to newspapers; artists' materials; office stationery; writing materials; souvenir programs; event programs; printed curricula; printed matter; lithographic works of art; cat box liners in the form of plastic bags; gummed tape for stationery or household purposes; prospectuses; photographic or art mounts; graphic reproductions; recipes printed and sold as a component of packaging for cosmetics sets and its components; printed guides; India ink pens; penholders; pens for writing and highlighting; tissue paper; tissues of paper for cosmetic use; facial tissues of paper; tissues of paper for removing make-up; coarse tissue for cosmetic purposes;

découpage napkins (terms too vague in the opinion of the International Bureau – Rule 13(2)(b) of the Regulations); cellulose wipes; face towels of paper; doilies of paper; book series on cosmetics and cosmetic treatment; printed award certificates; printed certificates; decorative adhesive scotch tapes (decorative tapes for stationery or household purposes); scrapbooks; social note cards; commemorative books; reference books on cosmetics and cosmetology; directories [printed matter]; paper bags for household purposes; pouches of paper for packaging; carrying cases made of paper; placards of paper or cardboard; iron-on transfers of paper; stationery; sharpeners for cosmetic pencils; pencil sharpeners; transparencies [stationery]; three-dimensional models for educational purposes; party decorations of paper; metallic paper party decorations; dangling ornaments of paper; cardboard packaging; plastic wrap; plastic gift wrap; cardboard or paper packaging for bottles, vials, jars; textbooks; figures made of paper; figurines [statuettes] of papier mâché; flags of paper; flags and pennants of paper; felt-tip pens; flash cards [teaching materials]; silver paper; photograph albums; photo-engravings; photographs [printed]; murals; pen and pencil cases; stationery cases; chromolithographs [chromos]; price tags; cardboard or paper name plates; desktop stationery cabinets; printing fonts; printed advertising boards of paper or cardboard; book plates; paper emblems; shields [paper seals]; printed emblems; health and beauty encyclopedias; sketches; prints [engravings]; labels of paper; hand-painted paper labels for bottles, vials, jars; blank or partially printed paper labels; labels, not of textile; reinforced stationery tabs; printed paper labels; adhesive labels of paper; adhesive labels to be printed with an individual's medical and personal information [not of textile]; adhesive labels, not of textile; barcode paper labels; printed paper labels for cosmetics of unusual design; marking tabs; gift tags of paper; cardboard boxes; transparent plastic badge holders (terms too vague in the opinion of the International Bureau – Rule 13(2)(b) of the Regulations).

20 – Non-metal cylinders for compressed gas or liquids, sold empty; nameplates of plastic; storage drums of plastic; casks, not of metal; barrels, not of metal; busts of wood, wax, plaster or plastic; busts of bone or ivory; fans for personal use, non-electric; display stands; display cases for merchandise; floor units of cardboard for displaying merchandise; fitted plastic inserts for use as container liners; upright signboards of wood or plastics; signboards of wood or plastics; low cabinets with a large number of sections (credenza); point-of-purchase displays [furniture]; directory boards; industrial containers for cosmetic, hygienic and medicinal and cosmetic compositions and components (terms too vague in the opinion of the International Bureau – Rule 13(2)(b) of the Regulations); packaging containers of plastic; flower-stands [furniture]; non-metal clips; closures of plastic for contain-

ners; imitation tortoiseshell; bead curtains for decoration; bottle closures, not of metal; closures, not of metal, for containers; closures for containers, not of metal, nor of paper; latches, not of metal; mirrors [looking glasses]; shaving mirrors; bathroom mirrors; locker mirrors; labels of plastic; personal compact mirrors; hand-held mirrors [toilet mirrors]; mirrors enhanced by electric lights; animal teeth; bamboo; animal claws; animal hooves; coral; meerschaum; whalebone, unworked or semi-worked; stag antlers; tortoiseshell; shells; horn, unworked or semi-worked; animal horns; rattan; ivory, unworked or semi-worked; corozo; plaited straw, except matting; wickerwork; hampers [baskets]; wood carvings; works of art made of wax; works of art made of plaster; works of art made of wood; works of art of wood, wax, plaster or plastic; cabinet work; valves, not of metal, for containers; valves of plastic, other than parts of machines; plastic clips for sealing bags; caps of plastic; bottle caps, not of metal; chests of drawers; plastic containers for drugs and medicinal and cosmetic products for commercial use; general purpose storage containers, not of metal; storage containers of plastic for commercial or industrial use; coral, unworked or semi-worked; organizer baskets for cosmetics (terms too vague in the opinion of the International Bureau – Rule 13(2)(b) of the Regulations); baskets, not of metal; boxes of wood; bottle casings of wood; tool boxes, not of metal [furniture]; lockboxes, not of metal; boxes of plastic; shipping and storage boxes of plastic; box springs; bathroom vanities [furniture]; screw tops, not of metal, for bottles; plastic drawer lining material; mobiles [decoration]; plastic handcuff strips; desktop statuary made of bone, ivory, plaster, plastic, wax or wood; tortoiseshell, unworked or semi-worked; meerschaum, unworked or semi-worked; raw mother-of-pearl; mother-of-pearl, unworked or semi-worked; plaques of bone, ivory, plastic, wax or wood; mirror tiles; ambroid plates; registration plates, not of metal; trays, not of metal; pillows; neck support cushions; bath pillows; inflatable pillows; air cushions, not for medical purposes; inflatable neck support cushions; air pillows, not for medical purposes; neck-supporting pillows; showshelves; shelves for filing; cabinets [furniture]; freestanding towel racks [furniture]; shelves for storage; racks [furniture]; wall shelves for cosmetics; folding shelves; wood ribbon; straw edgings; towel stands [furniture]; inflatable publicity objects; presentation boards; counters [tables]; corks for bottles; cork or cork substitute stoppers; corks; sealing caps, not of metal; shims, not of metal; towel dispensers, fixed, not of metal; drawer dividers; sea shells; photograph frames; picture frames; mirror frames; tanks, not of metal nor of masonry; water tanks of plastic; water tanks of plastic for household purposes; water tanks of plastic for industrial purposes; bone carvings; fodder racks; artificial horns; antlers; rattan, unworked or semi-worked; sculptures of bone, ivory, plaster, plastic, wax or wood; sculptures of plastic;

vats, not of metal; bungs, not of metal; statues of wax; statues of plaster; statues of wood; statues of wood, wax, plaster or plastic; statues of bone; statues of bone, ivory, plaster, plastic, wax or wood; statues of plastic; statues of ivory; figurines of wood, wax, plaster or plastic; statuettes of resin; oyster shells; glass for use in framing art; silvered glass [mirrors]; metal shelving; paper racks [furniture]; non-metallic stands (terms too vague in the opinion of the International Bureau – Rule 13(2)(b) of the Regulations); dressing tables; three-mirror dressing tables; washstands [furniture]; tables; display tables; placards of wood or plastics; crates of wood; crates; crates of plastic; straw plaits; articles made of wood, cork, reed, thatch, willow, horn, bone, ivory, whalebone, tortoiseshell, shells, amber, mother-of-pearl, meerschaum, of substitutes of such materials or plastics, included in this class; plastic squeeze tubes, empty; gift package decorations made of plastic; functional plastic decorations for cosmetics; figures of bone, ivory, plaster, plastic, wax or wood; cold cast resin figurines; figurines [statuettes] of bone or ivory; figures made of rattan; plastic molds for making soap; plastic molds for making soap for commercial production purposes; lounge chairs for cosmetic treatments; plastic shields (small plates used to mark products whereon technical, decorative or advertising information is applied); caskets; cabinets for storing cosmetics; mirrored cabinets; display cabinets; cases of wood or plastic; storage boxes for cosmetics, not of metal; plant stand room dividers; shelves for cosmetics.

21 – Atomizers for household purposes; cotton ball jars; storage jars of glass; potpourri dishes; bottles; squeeze bottles; spray bottles; spray bottles, empty; cleaning cotton; buckets made of woven fabrics; household containers fitted for storage of bleaching preparations and other household detergents; household containers fitted for storage of perfumes, cosmetic products, hair lotions, shampoos, toothpastes and powders; household containers fitted for storage of cosmetic and hygienic products; special disposable containers of glass designed exclusively for packaging and storage of pharmaceutical, hygienic and veterinary preparations; household containers for general storage of dietary substances; disposable containers for storing disinfectants, fungicides, herbicides, insecticides, preparations for the destruction of harmful animals (terms too vague in the opinion of the International Bureau – Rule 13(2)(b) of the Regulations); feather brooms; non-electric makeup whips (terms too vague in the opinion of the International Bureau – Rule 13(2)(b) of the Regulations); hair for brushes; cattle hair for brushes; funnels; large-toothed combs for the hair; hair combs, electric; sponges; abrasive sponges for scrubbing the skin; facial sponges for applying make-up; sponges for applying body powder; bath sponges; facial cleansing sponges; microdermabrasion sponges for cosmetic use; mesh spon-

ges for scrubbing the body; mesh sponges made of nylon for cleaning the body; toilet sponges; soap dispensers; glass dispensers for cosmetics, unfilled; household or kitchen utensils and containers; household containers; shaving bowls; lotion containers, empty, for household purposes; glass jars [carboys]; glass flasks [containers]; chamois leather for cleaning; ceramics for household purposes; majolica; glassware, porcelain and earthenware not included in other classes; works of art of porcelain, ceramic, earthenware, terra-cotta or glass; droppers, empty, for cosmetic purposes; brushes for use in hair tinting; shaving brushes; shaving brushes of badger hair; lip brushes; make-up brushes; polishing leather; glass bulbs [receptacles]; fitted vanity cases; fused silica [semi-worked product], other than for building; lids for containers for cosmetics; shaving pots; soap boxes; wall-mounted soap dishes; canister sets; dental care kits comprising toothbrushes and floss; toilet cases; sprinklers; shower caddies; applicator sticks for applying make-up; gloves for hairstyling (dyeing, permanent); exfoliating gloves; exfoliating pads; foot exfoliating pads; painted glassware; cosmetic utensils; toilet utensils; deodorizing apparatus for personal use; make-up removing appliances; appliances for removing make-up, non-electric; appliances for removing make-up, electric; glass stoppers; powder compacts; powder compacts sold empty; sprayers for cleaning gums and teeth; vials, bottles and containers, included in this class (terms too vague in the opinion of the International Bureau – Rule 13(2)(b) of the Regulations); perfume vaporizers; powder puffs; grass sprinklers; dispensers for liquid soap; dispensers for facial tissues; dispensers for cellulose wipes, for household purposes; foam toe separators for use in pedicures; eyelash separators; combs; hairbrushes; combs for back-combing hair; combs and sponges; electric combs; plastic bath racks [caddies]; beaters, non-electric; glasses [receptacles]; statues of porcelain, ceramic, earthenware, terracotta or glass; figurines [statuettes] of porcelain, ceramic, earthenware or glass; exfoliating slippers; aerosol dispensers, not for medical purposes; water apparatus for cleaning teeth and gums; watering devices; hot air hair brushes; flasks; bottles for applying hair color; empty vials for cosmetic formulations; perfume atomizers, empty; comb cases; bowls for use in hair tinting; mixing bowls; back scratchers; neoprene zippered bottle holders; cosmetic spatulas; cosmetic spatulas for use with depilatory preparations; animal bristles [brushware]; pig bristles for brush-making; brushes; electric rotating hair brushes; electrically heated hair brushes; bath brushes; bottle brushes; scrubbing brushes; brushes, except paintbrushes; toothbrushes; toothbrushes, non-electric; toothbrushes, electric; toilet brushes; eyebrow brushes; nail brushes; boxes for dispensing paper towels; boxes of metal, for dispensing paper towels.

39 – Bottling services; temporary storage of personal belongings; temporary storage of deliveries; delivery of newspapers; parcel delivery; delivery of gift baskets with selected items regarding a particular occasion or theme; delivery of messages by courier; delivery of goods; delivery of goods by mail order; delivery of goods and messages accompanied by balloons or novelty presentations; delivery of goods by courier; delivery of packages by courier; delivery of cosmetics, hygienic and medicinal and cosmetic goods; booking of transport; transportation information; storage information; advisory services relating to the delivery of goods; consultancy relating to the transportation, packaging, and storage of goods; vehicle routing by computer on data networks; global transportation of freight for others by all available means; monitoring and tracking of package shipments [transport information]; national transportation; providing information relating to the delivery of documents, letters and packages; providing information relating to the transportation and storage of goods; provision of information regarding the order of delivery of customized or standard goods via the Internet (terms too vague in the opinion of the International Bureau – Rule 13(2)(b) of the Regulations); providing information about temporary storage services; providing on-line information in the field of transport, packaging and storage of goods; express delivery of freight; express delivery of letters; organizing transport services; arranging of transport; arranging for the shipping of cargo; arranging for the transportation and storage of goods; arranging for the transportation of goods by sea; arranging of transport services; arranging for the storage of goods; dispatch of goods; tracking and tracing of shipments [transport information]; tracking and tracing services for letters and packages [transport information]; armored-car transport; shipping of goods; truck hauling; hauling; carting; transport and storage of trash; transporting furniture; transportation, packaging and storage of goods; car transport; boat transport; railway transport; river transport; portage; pick-up and delivery of packages and goods; packaging of goods; reservation of transport for goods; bottling in jars and bottles of cosmetic, hygienic and medicinal and cosmetic products; collection, transportation and delivery of goods, shipping documents, parcels and advertising and marketing correspondence by various means of transport; supply chain logistics and reverse logistics services consisting of the storage, transportation and delivery of freight; goods warehousing; parcel shipping services; messenger services; express delivery of goods by truck; express delivery of goods by air; transport and storage of goods; transport and storage of goods in refrigerated conditions; transportation of cosmetic products and its components; transportation of goods and parcels; transportation of goods by road; transportation, storage and delivery of cosmetic products; packing articles for transportation; packaging articles to the order and specification of others; packaging and

parcelling of goods for transport; packaging and storage of goods; packaging and storage of goods and packages; packaging articles for transportation; wrapping of goods; packing of goods in containers; packing of merchandise; merchandise packaging for others; packaging of goods in transit; packing of goods using sustainable or biodegradable packaging and shipping materials; chauffeur services; delivery services; same day delivery services; courier services [messages or merchandise]; cargo delivery services; logistics services including transportation, packaging, storage and delivery of goods; delivery logistical support services; transportation services provided to individuals; packaging services; gift wrapping; warehouse storage; transport; packing, crating and warehousing services; refrigerated storage of goods; storage of cargo; physical storage of electronically stored data or documents; storage and handling of goods; storage of goods; storage; storage of goods in transit; freight forwarding; express delivery of goods.

42 – Analysis in the field of molecular biology; water analysis; analysis and evaluation of product design; analysis and evaluation of product development; analysis of the compatibility of components of cosmetic and medicinal and cosmetic products selected for the preparation of the final customized product according to user orders; chemical analysis; biological and chemical research; biochemical research; web site design; retail design services; design of Internet pages; design and updating of homepages and web pages; industrial design; design, creation and programming of web pages; product design; graphic arts design; technical measuring and testing laboratory services; clinical trials; material testing; product research and development; biotechnological research; cosmetic research; research in the fields of chemistry and biology; research in the field of gene therapy; research and development of new products for others; research and development services in the field of biochemistry; research and development services in the field of biotechnology; research and development services in the field of diagnostic preparations; scientific research; research services for the development of new products; consulting in the field of cosmetology research; consultancy relating to research and development in the field of therapeutics; consultancy relating to laboratory testing; design consultancy; technical consultancy relating to research services in the field of foods and dietary supplements; consultancy and information services relating to the design, programming and maintenance of computer software; consultancy and research services in the fields of science, engineering and information technology; advisory services relating to gene therapy research; quality control; quality control testing; quality control of goods; quality control of goods and services; laboratory research in the field of bacteriology; laboratory research in the field of cosmetics; laboratory research in the field of che-

mistry; scientific and industrial research; scientific research for medical purposes; scientific research and analysis; scientific research and development; scientific research in the field of hair care preparations; providing information relating to technological research; providing information and data relating to scientific and technological research and development; providing information and data related to research and development in the field of medicine and hygienic-cosmetic care; providing information in the field of product design; providing information in the field of product development; providing online information about industrial analysis and research services; industrial research, development and testing; conducting clinical trials for pharmaceuticals; design and development of technologies in the field of cosmetology; industrial and graphic art design; product development; testing, analysis and evaluation of the goods and services of others for the purpose of certification; testing, analysis and evaluation of the goods of others for the purpose of certification; quality control testing of products; quality control testing of products for certification purposes; quality testing of products for certification purposes; product testing; conducting of quality control tests; conducting of quality control tests on goods and services; analytical laboratory services; chemical research and analysis; biological laboratory services; biomedical research; chemistry services; technological research services; laboratory testing; scientific and technological services and research and design relating thereto; scientific and technological services and research and development relating thereto; scientific laboratory services; computer-aided scientific research, testing and analysis services; research and design services; research and development services in the field of bacteriology; research and development services in the field of gene expression systems; research and development services in the field of immunology; research and development services in the field of chemistry; research and development services in the field of cytology; research, testing and analysis services; scientific research, testing and analysis services; laboratory research and analysis; design services relating to printed matter; industrial analysis; industrial analysis and research services in the field of chemistry; industrial analysis and industrial research services; industrial research, testing and analysis services; drug discovery services; cosmetic and medicinal product development services; styling [industrial design]; testing services for the certification of quality or standards; technical testing and quality control services; quality control services for certification purposes; technical measuring services; technical design; technical testing services; technological services and research and design relating thereto; chemical and biological laboratory services; hosting web portals; hosting an on-line web site for creating and hosting micro web sites for businesses; hosting the web sites of others; hosting and rental of memory

space for web sites; hosting computer databases; hosting computer software applications for others; hosting multimedia entertainment and educational content for others; hosting memory space on the Internet; hosting e-commerce platforms on the Internet; hosting customized web pages; hosting platforms on the Internet; hosting electronic memory space on the Internet for advertising goods and services; electronic data storage; inspection of goods for quality control; maintenance and consultancy services relating to software used in the field of e-commerce.

44 – Analysis of human body composition for medical purposes; public bath services for hygiene purposes; Turkish bath services; depilatory waxing; hair restoration; hygienic and beauty care for human beings; dermatological services for treating skin conditions; dietary advice; health and beauty care; hair weaving; information relating to massage; consultancy in the field of cosmetics; consultations in the field of face, body and hair cosmetic care, conducted through the Internet; medical consultancy; advice relating to allergies; pharmacy advice; nutritional and dietetic consultancy; lifestyle counselling; beauty consultancy; consulting and information services, including via the Internet, related to biopharmaceutical products; consulting and information services, including via the Internet, related to medicinal products; consulting and information services, including via the Internet, related to pharmaceutical products; consultation services in the field of make-up; consultancy in the field of body and beauty care; consultation services relating to beauty care; beauty consultation services; advisory services relating to weight control; advisory services relating to medical apparatus and instruments; advisory services relating to health; advisory services relating to weight loss; advisory services relating to nutrition; advisory services relating to hair care; consultation services relating to skin care; advisory services relating to pharmaceutical products; medical consultations; medical and pharmaceutical consultation; medical assistance consultancy provided by doctors and other specialized medical personnel; beauty therapy services; cosmetic surgery; hair treatment; cosmetic body care services; aromatherapy services; manicuring; massage; medical care; medical care and analysis services relating to patient treatment; medical analysis for the diagnosis and treatment of persons; medical analysis services relating to the treatment of persons; medical analysis services relating to the treatment of patients; medical diagnostic services [testing and analysis]; medical and surgical diagnostic services; medical and surgical services; medical counselling; medical counselling relating to stress; lifestyle counselling and consultancy for medical purposes; medical, medicinal and pharmaceutical consultancy; medical treatment services provided by clinics and hospitals; medical treatment services provided by a health spa; physical examination; geriatric nursing

services; medical testing for diagnostic or treatment purposes; hair styling; providing information in the field of medicine; medical testing services for fitness evaluation; medical testing; hair coloring services; on-line make-up consultation services; teeth whitening services; hairdressing; barbers' services; hairdressing and beauty salon services; pedicure services; hair replacement; weight reduction diet planning and supervision; preparation of prescriptions in pharmacies; medical assistance; provision of health information; providing information about beauty; providing information in the field of hair styling; providing information relating to massage; providing information relating to physical examinations; providing information relating to hairdressing and beauty salon services; providing information relating to medical services; providing information relating to moxibustion; providing information relating to dietary and nutritional supplements; providing information relating to traditional Japanese massage; providing information to patients in the field of administering medication; providing health care information by telephone and the Internet; providing information relating to the preparation and dispensing of medications; provision of medical information; provision of medical information from a web site; nutrition counselling; provision of sauna, beauty salon, hairdressing and massage services; pharmaceutical advice; provision of pharmaceutical information; dispensing of pharmaceuticals; dietary and nutritional guidance; beauty salon services; health spa services for health and wellness of the body and spirit; medical information services provided via the Internet; health counselling; tanning salon and solarium services; hair cutting; tattooing; bodywork therapy; traditional Japanese massage; hair removal by electrolysis; health spa services; visagists' services; hygienic and beauty care for human beings or animals; artificial suntanning services; permanent hair removal and reduction services; hot tub services (terms too vague in the opinion of the International Bureau – Rule 13(2)(b) of the Regulations); services rendered by a dietician; health spa services for health and wellness of the body and spirit incorporating massage, facial and body treatment services, and cosmetic body care services; health and beauty treatment services; individual medical counselling services provided to patients; personal hair removal services; beauty and hair care services; medical and health care clinic services; advisory services relating to health care; cosmetic body care services provided by health spas; cosmetic treatment services for the body, face and hair; cosmetic analysis services for determining the most appropriate cosmetics to be used with a person's face shape and skin tone; cosmetic and plastic surgery; cosmetician services; laser hair removal services; manicure and pedicure services; nail salon services; health and beauty care services provided by saunas, beauty salons, sanatoriums, hairdressing salons and massage parlors; medical services; medical evaluation services; alternative medicine services; bo-

dy piercing services; pharmacy dispensary services; make-up consultation and application services; make-up consultation services provided on-line or in-person; beauty treatment services; nail treatment services; facial treatment services; medical, hygienic and beauty care; providing weight loss program services; hair styling services; home health care services; beauty care services; skin care salon services; solarium services; beauty care services provided by a health spa; health spa services for health and wellness of the body and spirit offered at a health resort; hair care services; pharmacists' services to make up prescriptions; electrolysis and depilatory services; cosmetic electrolysis.

(260) AM 2021 109078 A

(800) 1541082

(151) 2019 12 23

(891) 2019 12 23

(731) SAAT VE SAAT SANAYİ VE TİCARET ANONİM ŞİRKETİ

Maslak Mah, Büyükdere Cad, Noramin İş Merkezi No:237/D Kat B-2, Sarıyer, İstanbul, Turkey

(540)



(591) Black, blue, red, yellow

(531) 26.04.05; 26.04.16; 26.04.24; 26.11.03;

26.11.08; 27.05.01; 29.01.15

(511)

9 – Measurement apparatus and equipment including those for scientific, nautical, topographic, meteorologic, industrial and laboratory purposes, thermometers, not for medical purposes, barometers, ammeters, voltmeters, hygrometers, testing apparatus not for medical purposes, telescopes, periscopes, directional compasses, speed indicators, laboratory apparatus, microscopes, magnifying glasses, stills, binoculars, ovens and furnaces for laboratory experiments, apparatus for recording, transmission or reproduction of sound or images, cameras, photographic cameras, television apparatus, video recorders, CD and DVD players and recorders, MP3 players, computers, desktop computers, tablet computers, wearable technological devices (smart watches, wristbands, head-mounted devices) microphones, loudspeakers, earphones, telecommunications apparatus, apparatus for the reproduction of sound or images, computer peripheral devices, cell phones, covers for cell phones, telephone apparatus, computer printers, scanners [data processing equipment], photocopiers, magnetic and optic data carriers and computer software and programmes recorded thereto, downloadable and recordable electronic publications, encoded magnetic and optic cards, movies, tv

series and video music clips recorded on magnetic, optical and electronic media, antennas, satellite antennas, amplifiers for antennas, parts of the aforementioned goods, ticket dispensers, automatic teller machines (ATM), electronic components used in the electronic parts of machines and apparatus, semi-conductors, electronic circuits, integrated circuits, chips [integrated circuits], diodes, transistors [electronic], magnetic heads for electronic apparatus, electronic locks, photocells, remote control apparatus for opening and closing doors, optical sensors, counters and quantity indicators for measuring the quantity of consumption, automatic time switches, clothing for protection against accidents, irradiation and fire, safety vests and life-saving apparatus and equipment, eyeglasses, sunglasses, optical lenses and cases, containers, parts and components thereof, apparatus and instruments for conducting, transforming, accumulating or controlling electricity, electric plugs, junction boxes [electricity], electric switches, circuit breakers, fuses, lighting ballasts, battery starter cables, electrical circuit boards, electric resistances, electric sockets, transformers [electricity], electrical adapters, battery chargers, electric door bells, electric and electronic cables, batteries, electric accumulators, solar panels for production of electricity, alarms and anti-theft alarms, other than for vehicles, electric bells, signalling apparatus and instruments, luminous or mechanical signs for traffic use, fire extinguishing apparatus, fire engines, fire hose and fire hose nozzles, radar apparatus, sonars, night vision apparatus and instruments, decorative magnets, metronomes.

14 – Jewellery, imitation jewellery, gold, precious stones and jewellery made thereof, tie pins, statuettes and figurines of precious metal, clocks, watches and chronometrical instruments, chronometers and their parts, watch straps, trophies made of precious metal, rosaries.

35 – Advertising, marketing and public relations, organization of exhibitions and trade fairs for commercial or advertising purposes, development of advertising concepts, provision of an online marketplace for buyers and sellers of goods and services, office functions, secretarial services, arranging newspaper subscriptions for others, compilation of statistics, rental of office machines, systemization of information into computer databases, telephone answering for unavailable subscribers, business management, business administration and business consultancy, accounting, commercial consultancy services, personnel recruitment, personnel placement, employment agencies, import-export agencies, temporary personnel placement services, auctioneering, the bringing together, for the benefit of others, of a variety of goods, namely, measurement apparatus and equipment including those for scientific, nautical, topographic, meteorologic, industrial and laboratory purposes, thermometers, not for medical purposes, barometers, ammeters, voltme-

ters, hygrometers, testing apparatus not for medical purposes, telescopes, periscopes, directional compasses, speed indicators, laboratory apparatus, microscopes, magnifying glasses, stills, binoculars, ovens and furnaces for laboratory experiments, apparatus for recording, transmission or reproduction of sound or images, cameras, photographic cameras, television apparatus, video recorders, CD and DVD players and recorders, MP3 players, computers, desktop computers, tablet computers, wearable technological devices, namely, smartwatches, smart wristbands and head-mounted cameras, microphones, loudspeakers, earphones, telecommunications apparatus, apparatus for the reproduction of sound or images, computer peripheral devices, cell phones, covers for cell phones, telephone apparatus, computer printers, scanners [data processing equipment], photocopiers, magnetic and optic data carriers and computer software and programmes recorded thereto, downloadable and recordable electronic publications, encoded magnetic and optic cards, movies, tv series and video music clips recorded on magnetic, optical and electronic media, antennas, satellite antennas, amplifiers for antennas, parts of the aforementioned goods, ticket dispensers, automatic teller machines (ATM), electronic components used in the electronic parts of machines and apparatus, semi-conductors, electronic circuits, integrated circuits, chips [integrated circuits], diodes, transistors [electronic], magnetic heads for electronic apparatus, electronic locks, photocells, remote control apparatus for opening and closing doors, optical sensors, counters and quantity indicators for measuring the quantity of consumption, automatic time switches, clothing for protection against accidents, irradiation and fire, safety vests and life-saving apparatus and equipment, eyeglasses, sunglasses, optical lenses and cases, containers, parts and components thereof, apparatus and instruments for conducting, transforming, accumulating or controlling electricity, electric plugs, junction boxes [electricity], electric switches, circuit breakers, fuses, lighting ballasts, battery starter cables, electrical circuit boards, electric resistances, electric sockets, transformers [electricity], electrical adapters, battery chargers, electric door bells, electric and electronic cables, batteries, electric accumulators, solar panels for production of electricity, alarms and anti-theft alarms, other than for vehicles, electric bells, signalling apparatus and instruments, luminous or mechanical signs for traffic use, fire extinguishing apparatus, fire engines, fire hose and fire hose nozzles, radar apparatus, sonars, night vision apparatus and instruments, decorative magnets, metronomes, jewellery, imitation jewellery, gold, precious stones and jewellery made thereof, tie pins, statuettes and figurines of precious metal, clocks, watches and chronometrical instruments, chronometers and their parts, watch straps, trophies made of precious metal, rosaries enabling customers to conveniently view and purchase those goods, such services may be provided by retail



stores, wholesale outlets, by means of electronic media or through mail order catalogues.

(260) AM 2021 109101 A  
 (800) 1481822  
 (151) 2019 06 06  
 (891) 2020 06 26  
 (731) PEDIATRICA S.r.l.  
 Via A. Nicolodi n. 28/A, I-57121 LIVORNO  
 (LI), Italy  
 (540)

## PediaColin



(591) Black, white  
 (531) 02.09.15; 04.05.02; 12.01.02; 19.08.01;  
 21.01.16; 27.05.01  
 (511)  
 5 – Pharmaceuticals; sanitary preparations for medical purposes; dietetic substances adapted for medical use; infant formula; vitamin supplements; plasters, materials for dressings; disinfectants; sedatives; soporifics; syrups for pharmaceutical purposes; analgesics; anti-pyretics; decongestants; antiseptics; antiparasitic preparations; medicinal drinks; herbal teas for medicinal purposes; cold cream for medical use.

(260) AM 2021 109102 A  
 (800) 1482569  
 (151) 2019 06 03  
 (891) 2020 06 19  
 (731) GUANGDONG OPPO MOBILE  
 TELECOMMUNICATIONS CORP., LTD.  
 No. 18 Haibin Road, Wusha, Chang'an,  
 Dongguan, Guangdong, China  
 (540)

## Reno

(591) Black, white  
 (511)  
 9 – Pedometers; apparatus to check franking; counterfeit coin detectors; mechanisms for coin-operated apparatus; punched card machines for offices; bathroom scales; rules [measuring instruments]; signs, luminous; transmitters of electronic signals; optical fibres [light conducting filaments]; heat regulating apparatus; lightning conductors; electrolyzers; fire extinguishers; radiological apparatus for industrial purposes; protection devices for personal use against accidents; theft prevention installations, electric; eyeglasses; chargers for electronic cigarettes; portable remote

car arrester; optical apparatus and instruments; biometric retinal scanners.

(260) AM 2021 109103 A  
 (800) 1493128  
 (151) 2019 06 14  
 (891) 2020 05 11  
 (731) GUANGDONG OPPO MOBILE  
 TELECOMMUNICATIONS CORP., LTD.  
 No. 18 Haibin Road, Wusha, Chang'an,  
 Dongguan, Guangdong, China  
 (540)

## Find Z

(591) Black, white  
 (511)  
 9 – Computers; computer peripheral devices; computer software, recorded; notebook computers; electronic publications, downloadable; computer programs, downloadable; computer game software, downloadable; USB flash drives; tablet computers; smartglasses; smartwatches; interactive touch screen terminals; humanoid robots with artificial intelligence; smart rings; smartphone software applications, downloadable; personal digital assistants [PDAS]; computer software platforms, recorded or downloadable; wearable computers; virtual reality game software; LCD monitors; light emitting diode displays; USB card readers; pedometers; face recognition devices; transmitters of electronic signals; intercommunication apparatus; telephone apparatus; global positioning system [GPS] apparatus; smartphones; mobile [telephones; cell phones; network communication equipment; wearable activity trackers; cases for smartphones; protective films adapted for smartphones; telecommunication apparatus in the form of jewellery; selfie sticks for use with smartphones; stands adapted for mobile phones; GPS navigation device; in-car telephone handset cradles; sound transmitting apparatus; portable media players; electronic book readers; earphones; virtual reality headsets; wearable video display monitors; HD (high definition) [televisions]; DMB (digital multimedia broadcasting) televisions; selfie sticks [hand-held monopods]; selfie lenses; audiovisual teaching apparatus; wires, electric; USB cables; semi-conductors; electronic chips; electric plugs; video screens; remote control apparatus; optical fibres [light conducting filaments]; heat regulating apparatus; eyeglasses; batteries, electric; rechargeable batteries; wireless chargers; USB chargers; animated cartoons; optical apparatus and instruments; gesture recognition software; biometric retinal scanners; ear pads for headphones.

(260) AM 2021 109104 A

(800) 1527984

(151) 2020 04 01

(891) 2020 06 30

(731) PHARMA MAR, S.A.

Polígono Industrial La Mina Norte, Avda.  
de los Reyes, 1, E-28770 Colmenar Viejo  
(Madrid), Spain

(540)

**ZEPZELCA**

(591) Black, white

(511)

5 – Pharmaceutical products; Veterinary products and substances; hygiene and sanitary products for medical use; dietetic substances for medical use; food for babies; surgical plasters; materials for dressings; teeth filling material; dental impression materials; disinfectants; chemical preparations for destroying vermin; fungicides; herbicides.

(260) AM 2021 109158 A

(800) 1541552

(151) 2020 06 16

(891) 2020 06 16

(731) SOREMARTEC S.A.

16, route de Trèves, L-2633 Senningerberg,  
Luxembourg

(540)



(591) Red, white, brown

(531) 27.05.02; 27.05.03; 27.05.11; 29.01.13

(511)

30 – Pastry and confectionery; biscuits; cakes; chocolate and chocolate-based products; cereal-based snacks; edible ices.

(260) AM 2021 109159 A

(800) 1541561

(151) 2020 06 18

(891) 2020 06 18

(731) Janssen Pharmaceutica NV

Turnhoutseweg 30, B-2340 Beerse, Belgium

(540)

**CARVYKTI**

(591) Black, white

(511)

5 – Human pharmaceutical preparations.

(260) AM 2021 109160 A

(800) 1541605

(151) 2020 05 27

(891) 2020 05 27

(731) PIERRE LANNIER

16 route de Dossenheim, F-67330

ERNOLSHEIM-LES-SAVERNE, France

(540)

**PIERRE LANNIER**

(591) Black, white

(511)

14 – Watches; quartz watches; automatic watches; watches with wireless communication function; wrist-watches; sports watches; watch cases; clock cases; presentation boxes for watches; watch cases; watch bands; watch bands made of metal, leather or plastic; clock dials; watch dials; dials [timepieces]; chronographs [watches]; cases for watches; presentation cases for timepieces; cases for watches and clocks; clocks; timepieces and chronometric instruments; watch movements; wall clocks; small clocks; clock radios; alarm clocks; jewelry articles; fashion jewelry; jewelry of non-precious metals; jewelry of precious metal; fashion jewelry; jewelry boxes; bracelets [jewelry]; charms made of common metals [jewelry]; charms made of precious metals or plated therewith [jewelry]; charms [jewelry]; brooches [jewelry]; chains [jewelry]; ear clips; earrings; jewelry cases [caskets]; pendants [jewelry]; pearls [jewelry].

35 – Retail or wholesale services, mail-order services, retail or wholesale services via the Internet or any remotely controlled electronic means and grouping services on behalf of third parties [with the exception of their transport] enabling consumers to conveniently view, choose and purchase the following products: watches, quartz watches, automatic watches, watches with wireless communication function, wristwatches, sports watches, watch cases, clock cases, presentation cases for watches, cases for watches, watch bands, watch bands of metal, leather or plastic, clock dials, watch dials, dials [timepieces], chronographs [watches], cases for watches, cases for timepieces, cases for watches and clocks, clocks, timepieces and chronometric instruments, watch movements, pendulum clocks [timepieces], small clocks, radio clocks, alarm clocks, jewelry articles, fashion jewelry, jewels of non-precious metals, jewels of precious metals, costume jewelry, jewelry boxes, bracelets [jewelry], charms of common metals [jewelry], charms of precious metals or plated therewith [jewelry], charms [jewelry], brooches [jewelry], chains [jewelry], ear clips, earrings, large jewelry boxes, pendants [jewelry], pearls [jewelry].

(260) AM 2021 109161 A  
 (800) 1541656  
 (151) 2020 05 13  
 (891) 2020 05 13  
 (731) AGRO SELECTIONS FRUITS  
 La Prade de Mousseillous, F-66200 Elne, France  
 (540)



(591) Red, yellow, green, white  
 (531) 05.07.13; 27.03.11; 29.01.13  
 (511)  
 31 – Fresh fruit; unprepared fruit; nectarines; all these goods other than those of the botanical genus Ribes.

(260) AM 2021 109162 A  
 (800) 1541705  
 (151) 2020 03 12  
 (891) 2020 03 12  
 (731) Shandong Meiyong Food Equipment Co., Ltd.  
 Yinjiacun Industrial Zone, Diao Town,  
 Zhangqiu District, Jinan City, Shandong  
 Province, China  
 (540)



(591) Black, white  
 (531) 03.07.01; 03.07.24; 27.03.03; 27.05.01; 28.03  
 (511)  
 7 – Agricultural machines; food preparation machines, electromechanical; wrapping machines; kitchen machines, electric; food or beverage processing machines and apparatus; mixing machines; pumps [machines]; brewing machines; electric motors for refrigerators; swaging machines.

(260) AM 2021 109163 A  
 (800) 1541708  
 (151) 2020 06 03  
 (891) 2020 06 03  
 (731) HYUNDAI MOTOR COMPANY  
 12, Heolleung-ro, Seocho-gu, Seoul,  
 Republic of Korea  
 (540)



(591) Black, white  
 (531) 03.07.17; 24.01.15; 24.01.17; 27.05.02

(511)  
 37 – Motor vehicle maintenance and repair; vehicle maintenance; vehicle breakdown repair services; providing information services relating to vehicle maintenance; vehicle greasing; vulcanization of tyres [repair]; repair of tires; retreading of tyres; provision of coin-operated car washing machines; car washing; vehicle polishing; anti-rust treatment for vehicles; vehicle cleaning; automobile decoration; tuning of motor vehicles; repair services featuring worn or partially damaged vehicle; repair services featuring worn or partially damaged engines for vehicle; custom installation of automobile interiors; replacement of automobile parts; repair or maintenance of motor automobile parts; garage services for the maintenance and repair of motor vehicles; automobile cleaning and car washing; maintenance of automobiles; automobile burglar alarm repair or maintenance; providing information relating to the repair or maintenance of automobiles; automobile reconditioning services; repair or maintenance of heating and cooling systems for motor cars; repair or maintenance of automobile tires; repair or maintenance of wheels for automobiles; automobile supplies repair; motor vehicle maintenance; advisory services relating to vehicle maintenance.

(260) AM 2021 109164 A  
 (800) 1541719  
 (151) 2020 06 19  
 (891) 2020 06 19  
 (731) Captiva MVP Restaurant Partners, LLC  
 Suite 1, 4343 Anchor Plaza Parkway,  
 Tampa FL 33634, USA  
 (540)

## JUST MADE BETTER

(591) Black, white  
 (511)  
 43 – Restaurant services, including sit-down food service, take-out food services and drive-through food services; catering services.

(260) AM 2021 109165 A  
 (800) 1541727  
 (151) 2020 05 15  
 (891) 2020 05 15  
 (731) SOLEPHARM PHARMACEUTICALS, SIA  
 Alkšņu iela 4, Jaunmārupe, LV-2166  
 Mārupes novads, Latvia  
 (540)

## SOLURO

(591) Black, white  
 (511)  
 5 – Pharmaceutical and veterinary preparations.

(260) AM 2021 109166 A  
 (800) 1541728  
 (151) 2019 05 10  
 (891) 2019 05 10  
 (731) Blue Prism Limited  
 2 Cinnamon Park Crab Lane, Fearnhead,  
 Warrington WA2 0XP, United Kingdom  
 (540)

**blueprism**

(591) Blue, white  
 (531) 27.05.01; 27.05.09; 29.01.04  
 (511)

9 – Computer software; computer hardware; parts and fittings for the aforesaid goods; downloadable computer software updates; electronic documentation relating to computer software and computer hardware; computer hardware and computer software in relation to artificial intelligence apparatus; artificial intelligence software.

16 – Printed matter; brochures; computer software operating manuals; computer software reference and instruction manuals; computer hardware reference and instruction manuals.

35 – Business management consultancy; provision of an online marketplace for trading, exchanging, and sale of goods and services, namely, computer software, computer software support services, training materials in connection with the use of computer software and computer systems, with other users; online retail services in respect of computer software, computer software support services, training materials in connection with the use of computer software and computer systems.

38 – Providing an online forum for users to discuss and exchange computer software.

41 – Education and training services in connection with the use of computer software and computer systems; arranging and conducting examinations, conferences, courses, seminars, workshops, and webinars; educational assessment services.

42 – Computer software consultancy; design and development of computer software and hardware; installation, maintenance and updating of computer software; computer system design and consultancy related thereto; computer software technical support services; technical consultancy services relating to information technology; hosting on-line web facilities for others for managing and sharing on-line content in relation to computer software and discussions related thereto; hosting an online forum for users to discuss and exchange computer software; software as a service; software as a service in the field of artificial intelligence; design and development of artificial intelligence computer software and hardware.

(260) AM 2021 109167 A  
 (800) 1541769  
 (151) 2020 06 19  
 (891) 2020 06 19  
 (731) CAPTIVA MVP RESTAURANT PARTNERS,  
 LLC  
 4343 ANCHOR PLAZA PARKWAY,  
 SUITE 1, TAMPA FL 33634, USA  
 (540)

**PEOPLE DEDICATED TO  
 QUALITY**

(591) Black, white  
 (511)  
 43 – Restaurant services, including sit-down food service, take-out food services and drive-through food services; catering services.

(260) AM 2021 109168 A  
 (800) 1541790  
 (151) 2020 06 10  
 (891) 2020 06 10  
 (731) Guangdong Benro Image Technology Industrial Co., Ltd  
 No. 05-A Huo Ju High-Tech Industrial Area,  
 XinQian Jin Village, Tanzhou Town,  
 Zhongshan City, 528467 Guangdong Province,  
 China  
 (540)

**BENRO**

(591) Black, white  
 (531) 27.05.17  
 (511)  
 9 – Tripods for cameras; stands for photographic apparatus; carriers for dark plates [photography]; cases especially made for photographic apparatus and instruments; flashlights [photography]; viewfinders, photographic; projection apparatus.

(260) AM 2021 109177 A  
 (800) 1542145  
 (151) 2020 05 21  
 (891) 2020 05 21  
 (731) Shanghai Hanting Hotel Management Group Co., Ltd.  
 4th Floor, Building 57, No. 461 Hongcao  
 Road, Huhui District, Shanghai, China  
 (540)

**华住**

(591) Black, white

(531) 28.03

(511)

35 – Business management assistance; commercial administration of the licensing of the goods and services of others; marketing; personnel recruitment; administrative services for the relocation of businesses; office machines and equipment rental; accounting; sponsorship search; advertising; presentation of goods on communication media, for retail purposes.

43 – Accommodation bureaux [hotels, boarding houses]; food and drink catering; cafés; bar services; rental of meeting rooms; retirement homes; day-nurseries [crèches]; boarding for animals; rental of chairs, tables, table linen, glassware; rental of cooking apparatus.

(260) AM 2021 109178 A

(800) 1542162

(151) 2020 05 26

(891) 2020 05 26

(731) EuroChem Group AG

Baarerstrasse 37, CH-6300 Zug, Switzerland

(540)

## Avrora

(591) Black, white

(511)

1 – Chemical products used in agriculture, horticulture and forestry; fertilizers; chemical products for fertilizers.

(260) AM 2021 109179 A

(800) 1542171

(151) 2020 05 14

(891) 2020 05 14

(731) GUANGZHOU WANG LAO JI GREAT HEALTH INDUSTRY CO., LTD.

Room 106 (Not using as Factory Building),

No. 3 Shuangshan Road, Nansha District,

Guangzhou City, Guangdong Province, China

(540)



(591) Black, white

(531) 28.03

(511)

32 – Beer; mixed fruit juices; fruit juices; soda pops; waters [beverages]; non-alcoholic beverages; plant-based beverages; non-alcoholic preparations for making beverages; fruit nectars, non-alcoholic; non-alcoholic fruit juice beverages.

(260) AM 2021 109180 A

(800) 1542186

(151) 2020 06 18

(891) 2020 06 18

(731) BOLTON MANITOBA S.p.A.

Via G. B. Pirelli 19, I-20124 Milano, Italy

(540)

## GENIE

(591) Black, white

(511)

3 – Fabric conditioner; fabric softener; fine fabric detergent and heavy duty laundry detergent.

(260) AM 2021 109181 A

(800) 1542188

(151) 2020 06 02

(891) 2020 06 02

(731) KPO MARKETING COMPANY LIMITED

Egypt Street, 12, CY-1097 Nicosia, Cyprus

(540)

## EXPEDITION

(591) Black, white

(511)

33 – Aperitifs; arrack [arak]; brandy; wine; piquette; whisky; vodka; anisette [liqueur]; kirsch; gin; digesters [liqueurs and spirits]; cocktails; curacao; anise [liqueur]; liqueurs; pre-mixed alcoholic beverages, other than beer-based; alcoholic beverages, except beer; alcoholic beverages containing fruit; spirits [beverages]; distilled beverages; mead [hydromel]; peppermint liqueurs; bitters; rum; sake; perry; cider; rice alcohol; alcoholic extracts; fruit extracts, alcoholic; alcoholic essences.

(260) AM 2021 109202 A

(800) 1451137

(151) 2018 09 10

(891) 2020 06 23

(731) MONTEFARMACO OTC S.P.A.

Via IV Novembre, 92, I-20021 Bollate

(MI), Italy

(540)

## MONTEFARMACO

(591) Black, white

(511)

3 – Cosmetics; cosmetics for make-up; detergents; deodorants for the feet; personal deodorants; scented linen sprays; moist wipes for cleaning preparations for sanitary purposes; moist wipes for cosmetic purposes; scented sachets; shower foams; bath foam; bath oil; hand cleansers; soaps; massage oils; perfumed creams; skin cleansers; sun creams; aromatherapy preparations; body oils [for cosmetic use]; cosmetic pads; eye make-up remover; room scenting sprays; beauty



tonics for application to the body and the face; face creams for cosmetic use; body cream; shampoo; hair preparations; hair creams; perfumed tissues; sponges impregnated with cosmetic preparations; sponges impregnated with cleansing preparations; cosmetic creams; cosmetic lotions for the face and the skin; cocoa butter for cosmetic purposes; talcum powder, for toilet use; oral hygiene preparations; dentifrices; foot scrubs; mouthwashes for cosmetic purposes; foot smoothing stones; non-medicated foot lotions; foot care preparations (non-medicated -); beauty serum.

5 – Pharmaceuticals; ophthalmologic preparations; eyewash; eye drops; artificial tears; ferments for pharmaceutical purposes; milk ferments for pharmaceutical purposes; nutritional supplements; nutritional additives comprising of nutritional supplements for non-medical purposes; nutritional supplements; dietary supplements not for medical purposes; dietary supplements for humans not for medical purposes; probiotic supplements; enzyme dietary supplements; protein dietary supplements; dietary supplements for infants; herbal dietary supplements for persons special dietary requirements; absorbent cotton; herbal teas for medicinal purposes; skin care (pharmaceutical preparations for -); deodorants for clothing and textiles; ointments for pharmaceutical purposes; tissues impregnated with pharmaceutical lotions; bath salts for medical purposes; bandages for dressings; sanitary wear; disinfectants for hygiene purposes; antiseptics; medicinal oils; adhesive bands for medical purposes; solutions for contact lenses; cotton for medical use; gauze for dressings; plasters, materials for dressings; sanitizers for household use; sanitizing wipes; disinfectants; antibacterial preparations; antiseptic body care preparations; babies' creams [medicated]; body creams [medicated]; cold cream for medical use; swabs for medical use; disinfectant swabs; impregnated medicated wipes; moisturising body lotion [pharmaceutical]; sterilising solutions; air deodorising preparations; sterilized dressing; vitamin supplements; health food supplements for persons with special dietary requirements; medicinal herb infusions; medicated foot powder; creams (medicated -) for the feet; remedies for foot perspiration; foot care preparations for medical use; corn rings for the feet; corn pads; corn remedies.

9 – Spectacles [optics]; optical apparatus; spectacle cases; sunglasses; sports glasses; spectacle frames; pince-nez chains; covers for glasses; spectacle straps; parts for spectacles; spectacle lenses; contact lenses.

10 – Surgical, medical, dental apparatus and instruments; orthopedic articles; suture materials; dental apparatus; dental protection apparatus; apparatus and instruments for diagnosis or for treatment of bruxism; dental prostheses; foot massagers; orthopaedic devices; orthopaedic supports for feet; insoles for corrective treatment of conditions of the feet; orthotic footwear; orthotic inserts for footwear.

35 – Advertising; business management; business administration; commercial management; clerical services; business advice relating to franchising; business management advice and assistance; organisation of sales promotion; consultancy and support in relation to business organisation and management of shops and sales outlets; organisation of exhibitions of various goods for commercial purposes; retail services and online retail services relating to beauty preparations, perfumery articles, medicines, hygiene and sanitary preparations, nutritional, dietary and food supplements, disinfectants, spectacles, sunglasses, contact lenses, contact lens care preparations, medical apparatus and instruments, orthopaedic articles and devices, dental articles, apparatus and devices, devices for use in orthodontics.

(260) AM 2021 109203 A

(800) 1467880

(151) 2019 02 10

(891) 2020 02 05

(731) Asaldokht shahd Company

No.357, 3rd Nastaran Alley, Professor Hesabi Blvd, Shamsabad Industrial City, Tehran, Islamic Republic of Iran

(540)



**bonmano**

(591) Green and black

(531) 05.05.20; 05.05.21; 26.01.15; 27.05.01; 29.01.13

(511)

30 – Coffee; unroasted coffee; coffee based beverages; tea; coffee powders; chocolate powders; coffee flavouring; tea-based beverages; tea-based beverages with fruit flavouring; white tea; black tea; white chocolate; hot chocolate; mixed coffee; instant coffee; green tea.

(260) AM 2021 109204 A

(800) 1472321

(151) 2019 04 24

(891) 2020 07 09

(731) Neurimmune Holding AG

Wagistrasse 13, CH-8952 Schlieren, Switzerland

(540)

**Neurimmune**

(591) Black, white

(511)

5 – Pharmaceutical preparations for the treatment of nervous system diseases, infectious diseases, neop-

lasms, immune system diseases, endocrine and metabolic diseases, circulatory system diseases, eye diseases; veterinary preparations for the treatment of nervous system diseases, infectious diseases, neoplasms, immune system diseases, endocrine diseases, metabolic diseases, circulatory system diseases, eye diseases; pharmaceutical preparations for immunotherapeutic use, pharmaceutical agents for the elimination of tumors, pharmaceutical preparations for the treatment of neurodegenerative diseases, pharmaceutical preparations, namely, immunogens; pharmaceutical preparations, namely, antibodies used for the testing of the disease; vaccines; diagnostic preparations for medical use in the form of epitopes for detecting protein abnormalities; pharmaceutical preparations, namely, synthetic peptides used for the treatment of central nervous system diseases, metabolic diseases, cardiovascular diseases, cancer, psychiatric diseases, infections; hygiene preparations for medical use; biocides; diagnostic preparations for medical or veterinary use; towels for hygiene purposes; dietetic foods for medical use; dietetic beverages for medical use; biological preparations for medical use in the form of protein antibodies directed against specific protein epitopes for use in the treatment of central nervous system diseases, metabolic diseases, cardiovascular diseases, cancer, psychiatric diseases, infections, immunological diseases, inflammatory diseases, respiratory diseases, psychological diseases; anti-bacterial preparations, namely, antibacterial substances for medical use, anti-bacterial pharmaceutical preparations, bio-pharmaceutical preparations for the treatment of cancer; protein dietary supplements.

42 – Monitoring, inspection and analysis of biologically active chemicals for quality control purposes; research in the field of pharmaceutical products, cosmetics and foodstuffs for others; advisory and information services in the field of monitoring and control for purposes of quality control and analysis of biologically active chemicals; research in the field of medical treatment and medical methods; research in the field of biotechnology and antibodies; medical and scientific research in the field of clinical trial review and research in medical treatment; research in the field of sanitary care; monitoring and inspection of biological synthesis and pharmaceutical production for quality control purposes and for purposes of scientific research and research in the field of biology; software design; computer programming; maintenance of software; design and development of computer hardware; software development; consultancy and providing of information with respect to quality control of pharmaceutical products; scientific research in the field of cancerous diseases; scientific research with respect to chemistry.

44 – Medical services; medical services in the field of immunity; provision of medical information; medical examinations, namely, physical examinations for me-

dical purposes; pharmaceutical consulting in the manufacture of medicines; services provided by consultants in nutrition and dietetics; consultancy and providing of information in the field of sanitary care, namely, providing of health information in connection with health; veterinary services; beauty salon services; animal care services, namely, veterinary care services; medical consulting services for hygiene in the field of care; medical consultancy and providing of medical information with respect to preparation, administration and dosing of pharmaceutical preparations; consulting services with respect to preparation and administration of pharmaceutical products; providing medical information for medical staff and for patients in the form of compiled reports in the field of diagnostic, prophylactic and therapeutic properties of medicines; drug testing, namely, systematic testing of medicinal products for medical use.

(260) AM 2021 109205 A

(800) 1482680

(151) 2019 03 05

(891) 2020 05 06

(731) Pryvatne pidpriemstvo "Delitsiia"

vul. Zavodska, 2-V, m. Bucha, Kyivska obl.  
08292, Ukraine

(540)

(591) Black, white

(531) 02.09.01; 27.05.01; 27.05.11

(511)

30 – Aniseed; peanut confectionery; food flavourings, other than essential oils; high-protein cereal bars; cereals with high protein content; bean meal; nutmegs; tapioca flour; flour; pastries; buns; bread rolls; sandwiches; vanillin (vanilla substitute); vanilla flavourings for culinary purposes; vareniki (stuffed dumplings); waffles; vermicelli [noodles]; cream of tartar for culinary purposes; oatmeal; oat flakes; oat-based food; sausage binding materials; binding agents for ice cream; biscuits; cookies; cloves [spice]; mustard; mustard meal; cake frosting [icing]; glucose for culinary purposes; chocolate-coated nuts; desserts (confectionery); relish [condiment]; gluten additives for culinary purposes; yeast; essences for foodstuffs, except etheric essences and essential oils; fruit jellies [confectionery]; chewing gum; custard; leaven; rice-based snack food; cereal-based snack food, namely cereal bars; artificial coffee; frozen yoghurt [confectionery ices]; flavourings, other than essential oils, for beverages; flavourings, other than essential oils, for cakes; aromatic preparations for food; wheat germ for human consumption; thickening agents for cooking

foodstuffs; cereal preparations; zephyr [confectionery]; chocolate-coated zephyr [confectionery]; ginger [spice]; coffee; unroasted coffee; coffee flavourings; coffee-based beverages; coffee beverages with milk; cocoa; cocoa beverages with milk; cocoa-based beverages; capers; caramels [candy]; lozenges [confectionery]; curry [spice]; potato flour; flowers or leaves for use as tea substitutes; ketchup (sauce); gluten prepared as foodstuff; zephyr [confectionery]; sugar confectionery; tortillas; cinnamon (spice); starch for food; croissants; croissants with jam; hominy grits; groats for human food; corn, milled; corn, roasted; corn meal; popcorn; cornflakes; turmeric; couscous (semolina); cooking salt; confectionery for decorating Christmas trees; ice for refreshment; ice, natural or artificial; liquorice [confectionery]; noodles; candy; linseed for culinary purposes [seasoning]; mayonnaise; macaroni; pasta; maltose; hominy; semolina; chow-chow [condiment]; marinades; marzipan; royal jelly; honey; molasses for food; macaroons [pastry]; almond paste; almond confectionery; pancakes; spring rolls; ice cream; sea water for cooking; seaweed [condiment]; dessert mousses [confectionery]; chocolate mousses; muesli; meat tenderizers for household purposes; meat gravies; mint for confectionery; peppermint sweets; tea-based beverages; star aniseed; infusions, not medicinal; crushed oats; vinegar; husked oats; husked barley; stick liquorice [confectionery]; palm sugar; soy bean paste [condiment]; pelmeni [dumplings stuffed with meat]; pepper; pepper [seasonings]; allspice; pesto (sauce); chocolate cookies; beer vinegar; meat pies; quiches; natural sweeteners; pizzas; chips [cereal products]; pies; fondants [confectionery]; powders for making ice cream; pralines; candy decorations for cakes, pastries; chocolate decorations for cakes; condiments; dressings for salad; seasonings; unleavened bread; propolis (bee glue); gingerbread; spices; puddings; cake powder, cakes; wheat flour; fruit coulis [sauces]; preparations for stiffening whipped cream; rice; rice pudding; rice cakes; baking powder; ferments for pastes; vegetable preparations for use as coffee substitutes; sago; garden herbs, preserved [seasonings]; celery salt; golden syrup; salt for preserving foodstuffs; soya flour; soya sauce; malt for human consumption; malt biscuits; malt extract for food; sauces (condiments); pasta sauce; spaghetti; noodle-based prepared meals; ham glaze; crackers; bread crumbs; petit-beurre biscuits; sushi; eastern delicacies (kozinaki, nougat, sherbet, halva and pakhlava, shaker-churek and rachat-lukum); tabbouleh; tacos; tapioca; cakes; cakes; petits fours [cakes]; dough; cake batter; cake dough; pastry dough; tomato sauce; crackers; tarts; pâté en croûte; sherbets [ices]; halvah; baking soda [bicarbonate of soda for cooking purposes]; edible ices, bread; chicory (coffee substitute); candy; sugar; iced tea; tea; minced garlic [condiment]; chutneys [condiments]; cheeseburgers (sandwiches); puff pastry dough; saffron [seasoning]; chocolate; choco-

late-based beverages; chocolate beverages with milk; chocolate cakes; barley meal; crushed barley.

(260) AM 2021 109240 A  
 (800) 1542608  
 (151) 2020 06 23  
 (891) 2020 06 23  
 (731) Avieta S.A.  
 Rue de Villers No 36, B-4520 Vinalmont,  
 Belgium  
 (540)



(591) Red PMS 192c Black C6  
 (531) 11.01.21; 11.01.25; 26.03.23; 27.05.01;  
 27.05.04; 27.05.08; 27.05.11; 29.01.13

(511)  
 29 – Meat, fish, poultry and game; meat extracts; preserved, frozen, dried and cooked fruits and vegetables; jellies, jams, compotes; eggs; milk and dairy products; edible oils and fats.

30 – Coffee, tea, cocoa and coffee substitutes; rice; tapioca and sago; flour and preparations made from cereals; bread, pastry and confectionery; edible ices; sugar, honey, golden syrup; yeast, baking powder; salt; mustard; vinegar, sauces (condiments); spices; ice for refreshment, Liege Belgian waffle, butter waffle, Brussels Belgian waffle, Liege waffle dough, sugar waffle, sugar-free waffle, rice cake, speculoos, biscuits, cookies, brownies, plain waffle, soft waffle, filled waffle; waffles.

(260) AM 2021 109241 A  
 (800) 1542614  
 (151) 2020 04 20  
 (891) 2020 04 20  
 (731) Obshchestvo s ogranichennoi otvetstvennostyu  
 "Bal'zam"  
 ul. Kominterny, 41B, Nizhniy Novgorod,  
 RU-603157 Nizhegorodskaya obl.  
 Russian Federation

(540)

**Летучий голландец**

(591) Black, white  
 (531) 28.05



(511)

33 – Aperitifs; arrack [arak]; brandy; wine; piquette; whisky; vodka; anisette [liqueur]; kirsch; gin; digesters [liqueurs and spirits]; cocktails; curacao; anise [liqueur]; liqueurs; pre-mixed alcoholic beverages, other than beer-based; alcoholic beverages, except beer; alcoholic beverages containing fruit; spirits [beverages]; distilled beverages; mead [hydromel]; peppermint liqueurs; bitters; rum; sake; perry; cider; rice alcohol; alcoholic extracts; fruit extracts, alcoholic; alcoholic essences.

(260) AM 2021 109242 A

(800) 1542634

(151) 2020 05 29

(891) 2020 05 29

(731) SHEN ZHEN Top-Peak electronics Co. Ltd.  
201-A, Unit 1, Block A, No.2 Tengfeng 5th  
Road, Fenghuang, Fuyong, Baoan District,  
Shenzhen, 518000 Guangdong, China

(540)

# SINOCHIP

(591) Black, white

(531) 27.05.01

(511)

9 – Signal lanterns; anti-interference devices [electricity]; monitoring apparatus, electric; cameras [photography]; materials for electricity mains [wires, cables]; lightning arresters; theft prevention installations, electric.

(260) AM 2021 109245 A

(800) 1542686

(151) 2020 01 10

(891) 2020 01 10

(731) Industria de Diseño Textil, S.A., (Inditex, S.A.)  
Avenida de la Diputación, Edificio Inditex,  
Arteixo, E-15142 La Coruña, Spain

(540)

# dnwr.

(591) Black, white

(531) 24.17.02; 27.05.01; 27.05.17

(511)

18 – Leather and imitation leather; animal skins; luggage and carrier bags; umbrellas and parasols; walking sticks; whips, harness and saddlery items; collars, leashes and clothing for animals; bags for climbers, campers and the beach; handbag frames; frames for umbrellas or parasols; alpenstocks; bags for sports; net bags for shopping; travel bags; bags (envelopes, pouches) of leather, for packaging; bags; bags; travel cases and key cases (leather goods); attaché cases; coin purses, not of precious metal; hat boxes of

leather; leather backpacks for carrying infants; wheeled shopping bags; cases and boxes of leather or leather board; boxes of vulcanized fiber; card cases (note-cases); wallets; school satchels; vanity cases; leather laces; umbrella covers; covers for horse-saddles; haversacks; backpacks; reins for horses; leather laces; suitcase handles; handles for walking sticks and umbrellas; whips; horse blankets; furniture coverings of leather; umbrella rings; blinders (harness); harness for animals; harness fittings; canes incorporating seats; shoulder belts [straps] of leather; empty tool bags of leather; muzzles; bridles [harness]; halters; leather board; bands of leather; traveling trunks; shopping bags; straps for soldiers' equipment; harness straps; leather straps (saddlery); straps for skates; trimmings of leather for furniture; leather straps; leather butt hides; curried skins; blankets for covering animals; stirrups; parts of rubber for stirrups; bits for animals (harness); reins; suitcases; moleskin (imitation of leather); chamois leather other than for cleaning purposes; nose-bags; casings, of leather, for springs; knee-pads for horses; horse riding saddles; fastenings for saddles; straps (harnesses); valves of leather.

25 – Clothing, footwear, headwear; clothing for motorists and cyclists, bibs other than paper; headbands (clothing); bath robes; bathing suits; bathing caps and sandals; boas (clothing); scarves; sports shoes and beach shoes; hoods (clothing); shawls; belts (clothing); money belts (clothing); wet suits for water-skiing; neckties; corsets (girdles); fur stoles; foulards; caps [headwear]; caps, gloves (clothing); raincoats; girdles (underwear); body linen [garments]; mantillas; stockings; socks, neckerchiefs; furs (clothing); pajamas; soles (for footwear); heels; veils (clothing); suspenders; layettes (clothing); shoulder wraps; sports jerseys, fingerless gloves; ear muffs (clothing); inner soles; wristbands (clothing); dress shields, beach clothes; dressing gowns; pockets for clothing; sock suspenders; stocking suspenders; petticoats; tights or leotards; aprons (clothing); fancy-dress costumes; uniforms; cap peaks; wooden shoes; caps; coats; esparto shoes or sandals; non-slip devices for footwear; bath slippers; birettas; blouses; bodysuits (clothing); berets; footmuffs, not electrically heated; lace boots; boots; boot uppers; studs for football boots; ankle boots; fittings of metal for footwear; toe caps for footwear; heelpieces for footwear; shirts; shirt yokes; shirt fronts; T-shirts; short-sleeved tee-shirts; bodices [lingerie]; vests; jackets; fishing vests; stuff jackets; slippers (underwear); ready-made clothing; detachable collars and collars; clothing of leather; clothing of imitation leather; shower caps, slippers; skirts; trousers; ready-made linings (parts of clothing); overcoats (coats); trench coats (clothing); gymnastic shoes; jerseys (clothing), pullovers; sweaters; liveries; muffs (clothing); footwear uppers; pocket squares; parkas; pelerines; pelisses; spats; leggings; knitwear [clothing]; clothing for gymnastics; underwear; sandals; saris; underpants;

hats; wimples (clothing); togas, trouser straps; suits; turbans; clothing; slippers; shoes, sports footwear.

(260) AM 2021 109247 A

(800) 1542717

(151) 2019 12 26

(891) 2020 02 26

(731) Industria de Diseño Textil, S.A, (Inditex, S.A)

Avenida de la Diputación, Edificio Inditex,

E-15142 Arteixo, A Coruña, Spain

(540)

## STWD

(591) Black, white

(511)

3 – Non-medicinal toiletry preparations and cosmetic products; non-medicinal dentifrices; perfumery products, essential oils; bleaching preparations and other substances for laundry use; cleaning, polishing, degreasing and abrasive preparations; non-medicinal soaps; cosmetics; non-medicinal hair lotions; shoe polish, cream and wax; tailors' wax; shoemakers' wax; waxes for leather; depilatory wax; laundry wax; parquet floor wax; shampoos; cosmetic kits; depilatory products; make-up removing preparations; deodorants for human beings or animals [perfumery products]; lipsticks; pencils for cosmetic use; hair sprays; nail varnish; lacquer-removing products; tissues impregnated with cosmetic lotions; cloths impregnated with a detergent for cleaning; after-shave lotions; lotions for cosmetic use; make-up products; pomades for cosmetic use; stain removers; sachets for perfuming linen; nail care products; bleaches for cosmetic use; flower extracts (perfumery products); incense; scented wood; decorative patterns for cosmetic use; false eyelashes and nails; pumice stone; potpourris [fragrances]; cosmetic preparations for slimming; bath preparations for cosmetic use; hair waving preparations; detergents for launderettes; toiletries; oral hygiene products other than for medical use; bath salts other than for medical use; oils for toiletry purposes; sunscreen products; eau de Cologne; deodorant soaps; talcum powder, for toilet use; adhesives for cosmetic use; greases for cosmetic use; abrasives; shaving products; color-brightening chemicals for household use (laundry); cotton sticks for cosmetic use; beauty masks; mustache wax; bleaching products for household use; hair colorants; eyebrow cosmetics; cleaning chalk; shampoos for pets [non-medicinal sanitary preparations]; cosmetics for animals; cosmetic creams; bars of soap; antiperspirant soaps for feet; detergents other than for use in manufacturing operations and for medical use; laundry starch; cleansing milk for toilet purposes; Javelle water; dry-cleaning products; scented water; perfumes; cosmetic preparations for eyelashes; cosmetic products for skin care; make-up powder; adhesives for affixing false hair; fabric softeners for laundry use;

cosmetic dyes; color-removing products; eau de toilette.

9 – Scientific, nautical, surveying, photographic, cinematographic, optical, weighing, measuring, signaling, checking (supervision), life-saving and teaching apparatus and instruments; apparatus and instruments for conducting, switching, transforming, accumulating, regulating or controlling electricity; apparatus for recording, transmission or reproduction of sound or images; compact discs, DVDs and digital recording media; mechanisms for coin-operated apparatus; cash registers, calculating machines, data processing equipment, computers; software; fire extinguishers; computer peripheral devices; anti-glare glasses; pince-nez; optical lenses; chains for pince-nez; contact lenses; cords for pince-nez; spectacles (optics); spectacle glasses; spectacle cases; frames for spectacles and pince-nez; sunglasses; cases for spectacles (pince-nez) and for contact lenses; footwear for protection against accidents, irradiation and fire; bullet-proof vests; life jackets; clothing for protection against accidents, irradiation and fire; gloves for divers; gloves for protection against accidents; diving suits; encoded magnetic cards; protective suits for aviators; electronic agendas; telephone apparatus; weighbridges (weighing apparatus); directional compasses; accounting machines; protective helmets; telescopes; chronographs (time recording apparatus); measuring spoons; pedometers; optical compact disks; mirrors (optics); binoculars (optics); temperature indicators; computer game software; cassette players; bar code readers; signal, magic and optical lanterns; magnifying glasses (optics); dictating machines; mechanisms for counter-operated apparatus; weights; electric, galvanic and solar cells and batteries; recorded computer programs; electronic pocket translators; transistors (electronics); thermometers not for medical use; intercommunication apparatus; video cassettes; animated cartoons; walkie-talkies; downloadable electronic publications; egg timers [sandglasses]; acoustic (sound) alarms; anti-theft alarms; fire alarms; mouse pads; loudspeakers; amplifiers; antennas; anti-glare visors; headphones; answering machines; counterfeit coin detectors; teeth protectors; money counting and sorting machines; apparatus for measuring the thickness of skins and leather; electronic tags for goods; goggles for sports; magnets; light-emitting electronic pointers; mobile telephones; enlarging apparatus (photography); apparatus and instruments for astronomy; thermionic (radio) valves; coin-operated musical automata [juke boxes]; scales; life-saving rafts; magnetic tape recorders; head cleaning tapes; video tapes; magnetic tapes; demagnetizing apparatus for magnetic tapes; barometers; ticket dispensers; thermostats; cameras [photography]; cinematographic apparatus; video cameras; video game cartridges; magnetic encoders; revolution counters; transparencies; slide projectors; dynamometers; ref-

lecting discs for wear, for the prevention of traffic accidents; hemline markers; dosage dispensers; covers for electric outlets; radiotelephony sets; scanners (data processing equipment) (computing); flash-bulbs (photography); photocopiers; holograms; compact disc players; luminous signs; neon signs (advertising); video recorders; megaphones; computer memory devices; microphones; microprocessors; modems; diving snorkels; objectives (lenses) (optics); ozonizers; projection screens; electric switches; dog whistles; push buttons for bells; radios; receivers (audio, video); wrist rests for use with computers; balances (steelyards); television apparatus; record players; word processing equipment; video telephones; carrying cases and holders for portable computers, cases and covers for mobile phones, smartphones, protective cases and covers for digital book readers; smartphones; smart watches; magnetic wires; radiological apparatus for industrial use; personal stereos.

18 – Leather and imitation leather; animal skins; luggage and carrier bags; umbrellas and parasols; walking sticks; whips, harness and saddlery; collars, leashes and clothing for animals; bags for climbers, campers and the beach; handbag frames; frames for umbrellas or parasols; alpenstocks; bags for sports; net bags for shopping; travel bags; bags (envelopes, pouches) of leather, for packaging; bags; bags; travel cases and key cases (leather goods); attaché cases; coin purses, not of precious metal; hat boxes of leather; leather backpacks for carrying infants; wheeled shopping bags; cases and boxes of leather or leather board; boxes of vulcanized fiber; card cases (notecases); wallets; school satchels; vanity cases; leather laces; umbrella covers; covers for horse-saddles; haversacks; backpacks; reins for horses; leather laces; suitcase handles; handles for walking sticks and umbrellas; whips; horse blankets; furniture coverings of leather; umbrella rings; blinders (harness); harness for animals; harness fittings; canes incorporating seats; shoulder belts [straps] of leather; empty tool bags of leather; muzzles; bridles [harness]; halters; leather board; bands of leather; traveling trunks; shopping bags; straps for soldiers' equipment; harness straps; leather straps (saddlery); straps for skates; trimmings of leather for furniture; leather straps; leather butt hides; curried skins; blankets for covering animals; stirrups; parts of rubber for stirrups; bits for animals (harness); reins; suitcases; moleskin (imitation of leather); chamois leather other than for cleaning purposes; nose-bags; casings, of leather, for springs; knee-pads for horses; horse riding saddles; fastenings for saddles; shots (aerial); valves of leather.

25 – Clothing, footwear, headwear; clothing for motorists and cyclists; bibs not of paper; headbands (clothing); bath robes; bathing suits; bathing caps and sandals; boas (clothing); scarves; sports shoes and beach shoes; hoods (clothing); shawls; belts (clothing); money belts (clothing); wet suits for water-skiing; neck-

ties; corsets (girdles); fur stoles; foulards; caps [headwear]; caps; gloves (clothing); raincoats; girdles (underwear); body linen [garments]; mantillas; stockings; socks; neckerchiefs; furs (clothing); pajamas; soles (for footwear); heels; veils (clothing); suspenders; layettes (clothing); shoulder wraps; sports jerseys; mittens; ear muffs (clothing); inner soles; wristbands (clothing); dress shields; beach wear; dressing gowns; pockets for clothing; sock suspenders; stocking suspenders; petticoats; tights or leotards; aprons (clothing); fancy-dress costumes; uniforms; cap peaks; wooden shoes; caps; coats; esparto shoes or sandals; non-slip devices for footwear; bath slippers; birettas; blouses; bodysuits (clothing); berets; footmuffs, not electrically heated; lace boots; boots; boot uppers; studs for football boots; ankle boots; fittings of metal for footwear; toe caps for footwear; heelpieces for footwear; shirts; shirt yokes; shirt fronts; T-shirts; short-sleeved tee-shirts; bodices [lingerie]; vests; jackets; fishing vests; stuff jackets; slips (underwear); ready-made clothing; detachable collars and collars; clothing of leather; clothing of imitation leather; shower caps; slippers; skirts; trousers; ready-made linings (parts of clothing); overcoats (coats); trench coats (clothing); gymnastic shoes; jerseys (clothing); pullovers; sweaters; liveries; muffs (clothing); footwear uppers; pocket squares; parkas; pelerines; pelisses; spats; leggings; knitwear [clothing]; clothing for gymnastics; underwear; sandals; saris; underpants; hats; wimples (clothing); togas; trouser straps; suits; turbans; clothing; slippers; shoes; footwear for sports.

35 – Advertising services; commercial business management; commercial administration; office functions; retail sale and wholesale in stores, via global computer networks, catalog, by mail order, by telephone, via radio and television, and via other electronic media for tanning substances, adhesives (glues) for industry, paints, varnishes, lacquers, colorants, ink for leather, indigo (colorant), ink for skin-dressing, bleaching preparations and other substances for laundry use, cleaning preparations, polishing preparations, scouring and abrasive preparations (abrasive preparations), soaps, perfumery, essential oils, cosmetics, hair lotions, dentifrices, shaving products, waxes, shampoos, cosmetic kits, depilatory products, deodorants for personal use (perfumery), make-up preparations, products for perfuming clothes, incense, eau de cologne, perfumes, lubricants, candles, deodorants other than for human beings or for animals, common metals and their alloys, metal chests, money boxes of metal, poles of metal, knobs not of metal, handles of metal, door handles of metal, cutlery, forks and spoons, razors, manicure sets, cases and razor cases, scientific apparatus and instruments, nautical apparatus and instruments, surveying apparatus and instruments, photographic apparatus and instruments, cinematographic apparatus and instruments, optical apparatus and instruments, weighing apparatus and instruments, measu-

ring apparatus and instruments, signaling apparatus and instruments, control apparatus and instruments (inspection), life-saving apparatus and instruments, teaching apparatus and instruments, apparatus and instruments for conducting electricity, power distribution, transforming electricity, accumulating electricity, regulating electricity, controlling electricity, apparatus for recording sound or images, transmission of sound or images, reproduction of sound or images, recording discs, automatic vending machines and mechanisms for coin-operated apparatus, cash registers, data processing equipment and computers, fire-extinguishing apparatus, computer peripheral devices, contact lenses, pince-nez cords, dressmakers' measures, spectacle cases, cases for eyeglasses and for contact lenses, spectacle frames and lenses (pince-nez), spectacles (optics), sunglasses, magnetic cards, telephone apparatus, protective helmets, chronographs (time recording apparatus), compact discs (audio-video), printers for use with computers, games programs, bar code readers, magnifying glasses (optics), computer software (recorded programs), mice (computer), apparatus for games adapted for use with television receivers only, intercommunication apparatus, electronic publications (downloadable electronically), sand glasses, headphones, mouse pads, protective helmets for sports, goggles for sports, computer memories, lighting apparatus, heating apparatus, steam generating apparatus, cooking apparatus, refrigerating apparatus, drying apparatus, ventilating apparatus, apparatus for water supply and sanitary installations, lanterns, lamp globes, lamps, lanterns, screens, vehicles, safety seats for children (for vehicles), seat covers for vehicles, bicycles, structural parts for bicycles, parts for supporting bicycles, parts and accessories for land vehicles, trolleys for babies with removable media for children, covers for baby carriages, dashboards for baby carriages, covers and hoods for baby carriages, car fasteners for use with baby carriages, pushchairs, covers, hoods, canopies, integrated cradles, all for prams, precious metals and their alloys, jewelery, costume jewelery, precious stones, horological and chronometric instruments, ornamental pins, fancy key rings, badges of precious metal, shoe and hat ornaments of precious metal, cuff links, watches, watch cases, watch bands, jewelry boxes, charms (jewelry), pearls (costume jewelry), earrings, rings, chaplets, headbands, musical instruments, musical boxes, cases for musical instruments, paper, cardboard, printed matter, publications, photographs, stationery, adhesives for stationery or household purposes, artists' materials, paintbrushes, office requisites (except furniture), instructional and teaching material (except apparatus), plastic materials for wrapping, boxes of cardboard or paper, hat boxes, albums, almanacs, calendars, posters, catalogs, wrapping paper, paperweights, mats for beer glasses (discs), bookmarks, book holder, terrestrial globes, leather and imitations of leather, animal skins, trunks and suitcases, umbrellas, parasols and walking sticks,

whips, harness and saddlery, bags for climbers, bags for campers, beach bags, handbag frames, frames for umbrellas or parasols, mountaineering sticks, bags, handbags, traveling bags, travel and key cases (leatherware), attaché cases, purses not of precious metal, school bags, garment covers (for travel, bags of leather (or cloth) for carrying infants, wheeled shopping bags, boxes of leather or leather board, briefcases (folders), pocket wallets, briefcases (leatherware), collars for animals, backpacks, briefcases, moleskin (imitation of leather), furniture, mirrors, frames, fans, pillows, curtain tie-backs, benches (furniture), table tops, chests for toys, screens, boxes of wood or plastic, beds, settees (armchairs), baskets not of metal, cushions, mattresses, cradles, desks, shelves, jewelry cases not of precious metal, tables, umbrella stands, hangers for coats and hats, coatstands, latches not of metal, desks, chairs, armchairs, sofas, stools, corks for bottles, high chairs for babies, utensils and containers for household and kitchen (not of precious metal), combs and sponges, brushes (except paintbrushes), glassware, porcelain and earthenware, bottle openers, oil cruets, candle extinguishers, sugar bowls, dishes, bowls, tea bags, candy boxes, bottles, boxes, shoe horns, candlesticks, epergnes, fitted picnic baskets (including dishes), shakers, ice buckets, coolers, decanters, salad bowls, trays (dishes), shoe trees (molds), piggy banks not of metal, soap holders, jugs, vases, bird cages, butter dishes, plates, knobs of porcelain, bottle holders and coasters not of paper and other than table linen, perfume burners (perfume), crumb scoops, table mats, corkscrews, salt cellars, coffee and tea services, napkin holders, soup bowls, cups, mugs, teapots, tableware, glasses (receptacles), cruets, ropes, strings, nets, tent shops, bags, padding and stuffing materials (except rubber or plastics), eiderdown (feathers), yarns and threads for textile use, textiles and textile goods, bed and table covers, bath linen (except clothing), towels of textile, travel blankets, eiderdowns (down coverlets), covers for cushions, sleeping bags (sheeting), bedspreads, tablecloths (other than of paper), sheets, table napkins (textile), bed covers, pillow cases, bed blankets, ready-made clothing for women, ready-made clothing for men and children, footwear (except orthopedic footwear), headgear, clothing for motorists and cyclists, bibs not of paper, headbands (clothing), bath robes, bathing suits, bathing caps and sandals, boas (necklets), underwear, scarves, hoods (clothing), shawls, belts (clothing), money belts (clothing), water ski suits, neckties, echarpes, stoles, girdles (underwear), scarves, caps, caps, gloves (clothing), underwear, shawls, stockings, socks, neck scarves, fur handkerchiefs (clothing), pyjamas, veils (clothing), suspenders, gymnastic and sports outfits, layettes, jerseys, mittens, ear muffs (clothing), bow ties, sarongs, masquerade costumes, visors (headgear), dressing gowns, petticoats, tights (complete stockings or leotards), aprons (clothing), headwear, wooden shoes, headgear, caps (headwear),

blouses, bodysuits (leotards), berets, heated footmuffs other than electric, boots, shirts, combinations (clothing), collars, pelerines, gaiters (stockings), saris, brassieres, headcloth (clothing), togas, turbans, lace and embroidery, ribbons and braid, buttons, hooks and eyes, pins and needles, artificial flowers, hair ornaments, hat and shoe ornaments (other than of precious metal), hair bands, carpets, rugs, mats, wallpaper, wallpaper, games, toys, gymnastic and sporting articles, decorations for Christmas trees, meat, fish, poultry and game, meat extracts, fruits and vegetables, preserved vegetables, frozen greens and vegetables, dried and cooked vegetables, jellies, jams, compotes, eggs, milk and milk products, edible oils and fats, coffee, tea, cocoa, sugar, rice, tapioca, sago, artificial coffee, flour and preparations made from cereals, bread, pastry and confectionery, ices, honey, treacle, yeast, baking powder, salt, mustard, vinegar, sauces (condiments), spices, ice, agricultural products, horticultural products, forestry products and grains, live animals, fruit and fresh vegetables, natural plants and flowers, foodstuffs for animals, malt, beer, mineral and aerated waters, non-alcoholic beverages, fruit drinks and fruit juices, syrups and other preparations for making beverages; retail sale and wholesale in stores, via global computer networks, catalog, by mail order, by telephone, via radio and television, and via other electronic media for alcoholic beverages (except beers), tobacco, smokers' articles, matches, cigar boxes (with humidifiers), cigarette cases, tobacco pouches, cigarette cases, ashtrays for smokers, lighters for smokers; commercial or industrial company management and operation assistance services; organization of exhibitions for commercial or advertising purposes; promotion of third-party goods and services through loyalty card programs; modeling for advertising or sales promotion; editing of advertising texts; shop-window dressing; services providing assistance with the operation of a franchised business; demonstration of goods; organization of trade fairs for commercial or advertising purposes; sales promotion for others; auctioneering; promotion and management of shopping malls; import-export agencies; online advertising via computer networks; procurement services for others (purchasing of goods and services for other businesses); newspaper subscription services (for others); dissemination of advertising material [leaflets, prospectuses, printed matter, samples]; computer file management; public relations; commercial information agencies; advertising agencies; rental of vending machines; rental of advertising space; dissemination of advertisements; business management assistance; data search in computer files (for others); compilation of data in computer databases; transcription of communications; distribution of advertising matter by mail; business management of performing artists; updating of advertising material; document reproduction; market study; bill posting (ads); opinion polling; systemization of information into computer databases; advertising by mail

order; radio advertising; television advertising; presentation of goods on communication media for retail purposes.

(260) AM 2021 109248 A

(800) 1542831

(151) 2020 07 06

(891) 2020 07 06

(731) Shanghai Baifeng Investment Co., Ltd.

Room 309D, No. 21, Lane 596, Yan'an Middle Road, Jing'an District, Shanghai, China

(540)

# 自然之源

(591) Black, white

(531) 28.03

(511)

3 – Bath foam; toners for cosmetic use; waterproof sunscreen; baby powder [toiletries]; creamy rouge; phytocosmetic preparations; herbal extracts for cosmetic purposes; dishwashing detergents; facial cleansing milk; Javelle water; polishing preparations; grinding preparations; essential oils; hair conditioners; cotton wool for cosmetic purposes; skin whitening creams; sunscreen preparations; make-up powder; cosmetics for animals; beauty creams; air fragrancing preparations; shampoos; cosmetic pencils; hair spray; cosmetic creams for firming skin around eyes; cakes of toilet soap; cleaning preparations; lipsticks; skin exfoliants; non-medicated skin creams; perfumery; beauty masks; cosmetics; cosmetic preparations for skin care; perfumes and toilet water; hand soap; non-medicated skin serums; skin toners; perfumes; lip glosses; sunblock; toothpaste; incense; cosmetic preparations for the face and body; foundation; moisturizing milk.

(260) AM 2021 109260 A

(800) 1543161

(151) 2020 06 04

(891) 2020 06 04

(731) PUBLIC JOINT STOCK COMPANY

GAZPROM NEFT

Pochtamtskaya Ulitsa, Dom 3-5, Liter A,

Ch. Pom. 1N, Kab. 2401, RU-190000

ST PETERSBURG, Russian Federation

(540)



(591) White, orange, grey and black

(531) 25.07.23; 27.05.09; 27.05.10; 27.05.24;  
29.01.14

(511)

1 – Acetate of cellulose, unprocessed; acetates [chemicals]; acetic anhydride; acetone; acetylene; acetylene tetrachloride; acid proof chemical compositions; acids; acidulated water for recharging accumulators; acidulated water for recharging batteries; acrylic resins, unprocessed; actinium; activated carbon; activated charcoal; additives, chemical, to drilling muds; chemical additives to drilling muds; additives, chemical, to fungicides; chemical additives to fungicides; additives, chemical, to insecticides; chemical additives to insecticides; additives, chemical, to motor fuel; chemical additives to motor fuel; adhesive preparations for surgical bandages; adhesives for billposting; adhesives for industrial purposes; adhesives for wallpaper; adhesives for paperhanging; adhesives for wall tiles; adjuvants, other than for medical or veterinary purposes; agar-agar; agglutinants for concrete; agricultural chemicals, except fungicides, herbicides, insecticides and parasiticides; albumenized paper; albumin [animal or vegetable, raw material]; alcohol; aldehydes; alginates for industrial purposes; alginates for the food industry; alkalies; alkaline-earth metals; alkaline iodides for industrial purposes; alkaline metals; alkaloids; alum; alumina; aluminium acetate; aluminium alum; aluminium chloride; aluminium hydrate; aluminium iodide; aluminium silicate; americium; ammonia; ammonia alum; ammoniacal salts; ammonia [volatile alkali] for industrial purposes; volatile alkali [ammonia] for industrial purposes; ammonium aldehyde; ammonium nitrate; ammonium salts; amyl acetate; amyl alcohol; anhydrides; anhydrous ammonia; animal albumen [raw material]; animal carbon; animal carbon preparations; animal charcoal; animal manure; anthranilic acid; anti-boil preparations for engine coolants; anti-frothing solutions for accumulators; anti-frothing solutions for batteries; anti-incrustants; anti-knock substances for internal combustion engines; anti-sprouting preparations for vegetables; anti-tarnishing chemicals for windows; antifreeze; antimony; antimony oxide; antimony sulfide; antioxidants for use in manufacture; antioxidants for use in the manufacture of cosmetics; antioxidants for use in the manufacture of food supplements; antioxidants for use in the manufacture of pharmaceuticals; antistatic preparations, other than for household purposes; argon; arsenic; arsenious acid; artificial sweeteners [chemical preparations]; astatine; auxiliary fluids for use with abrasives; bacterial preparations, other than for medical and veterinary use; bacteriological preparations, other than for medical and veterinary use; bacteriological preparations for acetification; barium; barium compounds; barium sulfate; baryta; baryta paper; barytes; bases [chemical preparations]; basic gallate of bismuth; bate for dressing skins; dressing, except oils, for skins; bauxite; beer-clarifying and pre-

serving agents; beer preserving agents; bentonite; benzene; benzene-based acids; benzene derivatives; benzoic acid; benzoic sulfimide; benzol; berkelium; bicarbonate of soda for chemical purposes; bichloride of tin; bichromate of potassium; bichromate of soda; biochemical catalysts; biological preparations, other than for medical or veterinary purposes; biological tissue cultures, other than for medical or veterinary purposes; birdlime; bismuth; bismuth subnitrate for chemical purposes; bleaching preparations [decolorants] for industrial purposes; decolorants for industrial purposes; blood charcoal; blueprint cloth; blueprint paper; blue vitriol; copper sulfate [blue vitriol]; bone charcoal; borax; boric acid for industrial purposes; brake fluid; brazing fluxes; brazing preparations; brickwork preservatives, except paints and oils; bromine for chemical purposes; by-products of the processing of cereals for industrial purposes; caesium; calcined soda; calcium carbide; calcium cyanamide [fertilizer]; calcium cyanamide [fertiliser]; calcium salts; californium; calomel [mercurous chloride]; camphor, for industrial purposes; carbide; carbolineum for the protection of plants; carbon; carbonates; carbon black for industrial purposes; carbon disulfide; carbon for filters; carbonic acid; carbonic hydrates; carbon tetrachloride; casein for industrial purposes; casein for the food industry; catalysts; catechu; caustic alkali; caustics for industrial purposes; caustic soda for industrial purposes; cellulose; cellulose derivatives [chemicals]; cellulose esters for industrial purposes; cellulose ethers for industrial purposes; cement-waterproofing chemicals, except paints; cement for footwear; cement for mending broken articles; cement preservatives, except paints and oils; cement [metallurgy]; ceramic compositions for sintering [granules and powders]; ceramic glazings; ceramic materials in particulate form, for use as filtering media; cerium; chemical additives for oils; chemical coatings for ophthalmic lenses; chemical condensation preparations; chemical intensifiers for paper; chemical intensifiers for rubber; chemical preparations for facilitating the alloying of metals; chemical preparations for scientific purposes, other than for medical or veterinary use; chemical preparations for smoking meat; chemical preparations for use in photography; chemical preparations to prevent diseases affecting cereal plants; chemical preparations to prevent diseases affecting vine plants; chemical preparations to prevent mildew; chemical preparations to prevent wheat blight; chemical preparations to prevent wheat smut; chemical reagents, other than for medical or veterinary purposes; chemicals, except pigments, for the manufacture of enamel; chemicals for the manufacture of paints; chemicals for the manufacture of pigments; chemicals for use in forestry, except fungicides, herbicides, insecticides and parasiticides; chemical substances for analyses in laboratories, other than for medical or veterinary purposes; chemical preparations for analyses in laboratories, other than for medical or veterinary purposes; chemical substances

for preserving foodstuffs; chimney cleaners, chemical; chlorates; chlorides; chlorine; cholic acid; chromates; chrome alum; chrome salts; chromic acid; chromic salts; chromium oxide; cinematographic films, sensitized but not exposed; cinematographic film, sensitized but not exposed; citric acid for industrial purposes; coal saving preparations; cobalt oxide for industrial purposes; collagen for industrial purposes; collodion; color-brightening chemicals for industrial purposes; colour-brightening chemicals for industrial purposes; combusting preparations [chemical additives to motor fuel]; compositions for repairing inner tubes of tyres; compositions for repairing inner tubes of tires; compositions for repairing tyres; compositions for repairing tires; compositions for the manufacture of phonograph records; compositions for the manufacture of technical ceramics; compositions for threading; compost; concrete-aeration chemicals; concrete preservatives, except paints and oils; condensation-preventing chemicals; coolants for vehicle engines; corrosive preparations; cream of tartar for chemical purposes; cream of tartar for industrial purposes; cream of tartar for the food industry; creosote for chemical purposes; crotonic aldehyde; cryogenic preparations; cultures of microorganisms, other than for medical and veterinary use; curium; currying preparations for leather; currying preparations for skins; cyanides [prussiates]; prussiates; cymene; damp-proofing chemicals, except paints, for masonry; defoliants; degreasing preparations for use in manufacturing processes; grease-removing preparations for use in manufacturing processes; degumming preparations; gum solvents; dehydrating preparations for industrial purposes; dendrimer-based polymers for use in the manufacture of capsules for pharmaceuticals; descaling preparations, other than for household purposes; detergent additives to gasoline; detergent additives to petrol; detergents for use in manufacturing processes; dextrin [size]; diagnostic preparations, other than for medical or veterinary purposes; diastase for industrial purposes; diatomaceous earth; diazo paper; disincrustants; dispersions of plastics; distilled water; dolomite for industrial purposes; drilling muds; dry ice [carbon dioxide]; dysprosium; electrophoresis gels; emollients for industrial purposes; emulsifiers; enamel-staining chemicals; engine-decarbonising chemicals; chemical preparations for decarbonising engines; enzyme preparations for industrial purposes; enzyme preparations for the food industry; enzymes for industrial purposes; enzymes for the food industry; epoxy resins, unprocessed; erbium; esters; ethane; ethers; ethyl alcohol; ethyl ether; europium; expanded clay for hydroponic plant growing [substrate]; fat-bleaching chemicals; fatty acids; ferments for chemical purposes; fermium; ferrocyanides; ferrotype plates [photography]; fertilizers; fertilisers; fertilizing preparations; fertilising preparations; filtering materials of chemical substances; filtering materials of mineral substances; filtering materials of unprocessed plastics; filtering materials of vegetable

substances; filtering preparations for the beverages industry; finishing preparations for use in the manufacture of steel; fire extinguishing compositions; fire-proofing preparations; fish meal fertilizers; fish meal fertilisers; fissionable chemical elements; fissionable material for nuclear energy; fixing baths [photography]; fixing solutions [photography]; flashlight preparations; flavonoids [phenolic compounds] for industrial purposes; flocculants; flour for industrial purposes; flower preservatives; flowers of sulfur for chemical purposes; fluids for hydraulic circuits; liquids for hydraulic circuits; fluorine; fluorspar compounds; formic acid; formic aldehyde for chemical purposes; foundry binding substances; foundry molding preparations; foundry moulding preparations; foundry sand; francium; fuel-saving preparations; fuel for nuclear reactors; fuller's earth for use in the textile industry; fulling preparations; fulling preparations for use in the textile industry; gadolinium; gallic acid for the manufacture of ink; gallium; gallnuts; gallotannic acid; galvanizing baths; baths for galvanizing; galvanizing preparations; gambier; gas purifying preparations; preparations for the purification of gas; gelatine for industrial purposes; gelatine for photographic purposes; genes of seeds for agricultural production; getters [chemically active substances]; glass-frosting chemicals; glass-staining chemicals; glaziers' putty; glucose for industrial purposes; glucose for the food industry; glucosides; glue for industrial purposes; glutamic acid for industrial purposes; gluten for industrial purposes; gluten for the food industry; gluten [glue], other than for stationery or household purposes; glutinous tree-grafting preparations; glutinous tree-banding preparations; glutinous preparations for tree-banding; glutinous preparations for tree-grafting; glycerides; glycerine for industrial purposes; glycol; glycol ether; gold salts; grafting mastic for trees; grafting wax for trees; graphene; graphite for industrial purposes; guano; gum arabic for industrial purposes; gums [adhesives] for industrial purposes; gum tragacanth for industrial purposes; gurjun balsam for use in the manufacture of varnish; gypsum for use as a fertilizer; heavy water; helium; holmium; hormones for hastening the ripening of fruit; horticultural chemicals, except fungicides, herbicides, insecticides and parasiticides; humus; humus top dressing; hydrates; hydrazine; hydrochlorates; hydrochloric acid; hydrofluoric acid; hydrogen; hydrogen peroxide for industrial purposes; hypochlorite of soda; hyposulfites; industrial chemicals; iodic acid; iodine for chemical purposes; iodine for industrial purposes; iodised albumen; iodised salts; ion exchangers [chemicals]; iron salts; isinglass, other than for stationery, household or alimentary purposes; isotopes for industrial purposes; kainite; kaolin; china slip; china clay; ketones; kieselgur; krypton; lactic acid; lactose for industrial purposes; lactose for the food industry; lactose [raw material]; lamp black for industrial purposes; lanthanum; lead acetate; lead arsenate; lead oxide; leather-dressing chemicals; leat-

her-impregnating chemicals; leather-renovating chemicals; leather-waterproofing chemicals; leather glues; lecithin for industrial purposes; lecithin for the food industry; lecithin [raw material]; lime acetate; lime carbonate; lime chloride; limestone hardening substances; liquids for removing sulfates from accumulators; liquids for removing sulfates from batteries; lithia [lithium oxide]; lithium; litmus paper; loam; lutetium [cassiopium]; cassiopium [lutetium]; magnesite; magnesium carbonate; magnesium chloride; magnetic fluid for industrial purposes; malt albumen; manganate; manganese dioxide; mangrove bark for industrial purposes; masonry preservatives, except paints and oils; mastic for leather; mastic for tires; mastic for tyres; meat tenderizers for industrial purposes; mercuric oxide; mercury; mercury salts; metal annealing preparations; metal hardening preparations; metalloids; metal tempering preparations; methane; methyl benzene; methyl benzol; methyl ether; milk ferments for chemical purposes; milk ferments for industrial purposes; milk ferments for the food industry; mineral acids; moderating materials for nuclear reactors; moistening [wetting] preparations for use in bleaching; wetting preparations for use in bleaching; moistening [wetting] preparations for use in dyeing; wetting preparations for use in dyeing; moistening [wetting] preparations for use in the textile industry; wetting preparations for use in the textile industry; mold-release preparations; mould-release preparations; mordants for metals; must-fining preparations; nanopowders for industrial purposes; naphthalene; neodymium; neon; neptunium; nitrate paper; nitrates; nitric acid; nitrogen; nitrogenous fertilisers; nitrogenous fertilizers; nitrous oxide; oenological bactericides [chemical preparations for use in wine making]; oil-bleaching chemicals; oil-purifying chemicals; oil-separating chemicals; oil cement [putty]; oil dispersants; oils for currying leather; oils for preparing leather in the course of manufacture; oils for tanning leather; oils for the preservation of food; oleic acid; olivine [silicate mineral]; opacifiers for enamel; opacifiers for glass; organic digestate [fertilizer]; organic digestate [fertiliser]; oxalates; oxalic acid; oxygen for industrial purposes; palladium chloride; paper pulp; paste fillers for automobile body repair; paste fillers for car body repair; peat pots for horticulture; peat [fertiliser]; peat [fertilizer]; pectin for industrial purposes; pectin for the food industry; pectin [photography]; perborate of soda; percarbonates; perchlorates; persulfates; persulfuric acid; petroleum dispersants; phenol for industrial purposes; phosphates [fertilisers]; phosphates [fertilizers]; phosphatides; phosphoric acid; phosphorus; photographic developers; photographic emulsions; photographic paper; photographic sensitizers; photometric paper; photosensitive plates; picric acid; plant growth regulating preparations; plasticizers; plastics, unprocessed; plastisols; plutonium; polish removing substances; substances for removing polish; polonium; polymer resins, unprocessed; potash; potash water; potassium; potas-

sium dioxalate; potato flour for industrial purposes; potting soil; power steering fluid; praseodymium; preparations for preventing the tarnishing of glass; preparations for preventing the tarnishing of lenses; preparations for stimulating cooking for industrial purposes; preparations for the separation of greases; preparations of microorganisms, other than for medical and veterinary use; preparations of the distillation of wood alcohol; preparations of trace elements for plants; preservatives for tiles, except paints and oils; preservatives for use in the pharmaceutical industry; promethium; propellant gases for aerosols; protactinium; protective gases for welding; proteins for the food industry; proteins for use in manufacture; proteins for use in the manufacture of food supplements; protein [raw material]; purification preparations; clarification preparations; pyrogallic acid; quebracho for industrial purposes; radiator flushing chemicals; radioactive elements for scientific purposes; radium for scientific purposes; radon; rare earths; reagent paper, other than for medical or veterinary purposes; reducing agents for use in photography; refrigerants; renovating preparations for phonograph records; rhenium; rock salt; rubber preservatives; rubidium; saccharin; sal ammoniac; sal ammoniac spirits; salicylic acid; salt, raw; salt for preserving, other than for foodstuffs; saltpeter; salpetre; salts for coloring metal; salts for colouring metal; salts for galvanic cells; salts for galvanic batteries; salts for industrial purposes; salts from rare earth metals; salts of alkaline metals; salts of precious metals for industrial purposes; salts [chemical preparations]; salts [fertilisers]; salts [fertilizers]; samarium; sauce for preparing tobacco; scandium; seawater for industrial purposes; seaweeds [fertilizers]; seaweeds [fertilisers]; sebacic acid; seed preserving substances; selenium; self-toning paper [photography]; sensitized cloth for photography; sensitized films, unexposed; sensitized paper; sensitized photographic plates; sensitized plates for offset printing; separating and unsticking [ungluing] preparations; ungluing preparations; unsticking and separating preparations; silicates; silicon; silicon carbide [raw material]; silicones; silver nitrate; silver salt solutions for silvering; size for finishing and priming; size for use in the textile industry; sizing preparations; slag [fertilisers]; slag [fertilizers]; soap [metallic] for industrial purposes; soda ash; sodium; sodium salts [chemical compounds]; soil conditioning preparations; soil for growing; soldering fluxes; solidified gases for industrial purposes; solutions for cyanotyping; solvents for varnishes; soot for industrial or agricultural purposes; sorrel salt; spinel [oxide mineral]; spirits of salt; spirits of vinegar [dilute acetic acid]; stain-preventing chemicals for use on fabrics; starch-liquifying chemicals [ungluing agents]; ungluing agents [chemical preparations for liquifying starch]; starch for industrial purposes; starch paste [adhesive], other than for stationery or household purposes; stearic acid; stem cells, other than for medical or veterinary purposes; stron-



tium; substances for preventing runs in stockings; substrates for soil-free growing [agriculture]; sulfates; sulfides; sulfonic acids; sulfur; sulfuric acid; sulfuric ether; sulfurous acid; sumac for use in tanning; superphosphates [fertilisers]; superphosphates [fertilizers]; surface-active chemical agents; tensio-active agents; synthetic materials for absorbing oil; synthetic resins, unprocessed; artificial resins, unprocessed; talc [magnesium silicate]; tan; tan-wood; tannic acid; tannin; tanning substances; tapioca flour for industrial purposes; tartar, other than for pharmaceutical purposes; tartaric acid; tea extracts for the food industry; tea extracts for use in the manufacture of cosmetics; tea extracts for use in the manufacture of pharmaceuticals; technetium; tellurium; terbium; test paper, chemical; tetrachlorides; textile-brightening chemicals; textile-impregnating chemicals; textile-waterproofing chemicals; thallium; thiocarbanilide; thorium; thulium; thymol for industrial purposes; titanite; titanium dioxide for industrial purposes; toluene; toluol; toning baths [photography]; toning salts [photography]; topsoil; toxic gas neutralizers; transmission fluid; transmission oil; tree cavity fillers [forestry]; tungstic acid; uranium; uranium nitrate; uranium oxide; vinic alcohol; viscose; vitamins for the food industry; vitamins for use in the manufacture of cosmetics; vitamins for use in the manufacture of food supplements; vitamins for use in the manufacture of pharmaceuticals; vulcanization accelerators; vulcanizing preparations; wallpaper removing preparations; water-purifying chemicals; water-softening preparations; water glass [soluble glass]; wax-bleaching chemicals; welding chemicals; soldering chemicals; wine finings; witherite; wood alcohol; wood pulp; wood vinegar [pyrolygneous acid]; pyrolygneous acid [wood vinegar]; X-ray films, sensitized but not exposed; xenon; xylene; xylol; ytterbium; yttrium; zirconia.

4 – Additives, non-chemical, to motor fuel; alcohol [fuel]; anthracite; beeswax; beeswax for use in the manufacture of cosmetics; belting wax; benzene fuel; benzine; biomass fuel; bone oil for industrial purposes; candles; tapers; carburants; motor fuel; carnauba wax; castor oil for industrial purposes; ceresine; charcoal [fuel]; Christmas tree candles; coal; coal briquettes; coal dust [fuel]; coal naphtha; coal tar oil; coke; combustible briquettes; cutting fluids; diesel oil; gas oil; dust absorbing compositions; dust binding compositions for sweeping; dust laying compositions; dust removing preparations; electrical energy; ethanol [fuel]; firelighters; firewood; fish oil, not edible; fuel; fuel gas; fuel oil; combustible oil; fuel with an alcohol base; gas for lighting; grease for arms [weapons]; grease for belts; grease for footwear; grease for leather; greases for the preservation of leather; oils for lighting; illuminating wax; industrial grease; industrial oil; industrial wax; kerosene; lamp wicks; lanolin; wool grease; lanolin for use in the manufacture of cosmetics; lighting fuel; lignite; ligroin; lubricants;

lubricating graphite; lubricating grease; lubricating oil; mazut; methylated spirit; mineral fuel; moistening oil; motor oil; naphtha; nightlights [candles]; non-slipping preparations for belts; oil-gas; oils for paints; oils for releasing form work [building]; oils for the preservation of leather; oils for the preservation of masonry; oleine; ozokerite; ozocerite; paper spills for lighting; paraffin; peat briquettes [fuel]; peat [fuel]; perfumed candles; petrol; gasoline; petroleum, raw or refined; petroleum ether; petroleum jelly for industrial purposes; producer gas; rape oil for industrial purposes; colza oil for industrial purposes; solidified gases [fuel]; soya bean oil preparations for non-stick treatment of cooking utensils; stearine; sunflower oil for industrial purposes; tallow; textile oil; tinder; vaporized fuel mixtures; wax for skis; wax [raw material]; wicks for candles; wood briquettes; wood spills for lighting; xylene fuel.

35 – Administration of consumer loyalty programs; administration of frequent flyer programs; administrative assistance in responding to calls for tenders; administrative assistance in responding to requests for proposals [RFPs]; administrative processing of purchase orders; advertising; publicity; advertising agency services; publicity agencies; advertising by mail order; advisory services for business management; appointment reminder services [office functions]; appointment scheduling services [office functions]; arranging newspaper subscriptions for others; arranging subscriptions to telecommunication services for others; auctioneering; bill-posting; book-keeping; accounting; business appraisals; business auditing; business efficiency expert services; business information; business inquiries; business intermediary services relating to the matching of potential private investors with entrepreneurs needing funding; business investigations; business management and organization consultancy; business management assistance; business management consultancy; business management for freelance service providers; business management of hotels; business management of performing artists; business management of reimbursement programs for others; business management of reimbursement programmes for others; business management of sports people; business organization consultancy; business project management services for construction projects; business research; commercial administration of the licensing of the goods and services of others; commercial information agency services; commercial information and advice for consumers in the choice of products and services; commercial intermediation services; commercial lobbying services; commercial or industrial management assistance; competitive intelligence services; compilation of information into computer databases; compilation of statistics; compiling indexes of information for commercial or advertising purposes; computerized file management; consultancy regarding advertising communication strate-

gies; consultancy regarding public relations communication strategies; corporate communications services; cost price analysis; data search in computer files for others; demonstration of goods; development of advertising concepts; direct mail advertising; dissemination of advertising matter; distribution of samples; drawing up of statements of accounts; economic forecasting; employment agency services; financial auditing; gift registry services; import-export agency services; interim business management; invoicing; layout services for advertising purposes; marketing; marketing in the framework of software publishing; marketing research; market intelligence services; market studies; media relations services; modelling for advertising or sales promotion; negotiation and conclusion of commercial transactions for third parties; negotiation of business contracts for others; news clipping services; office machines and equipment rental; online advertising on a computer network; online retail services for downloadable and pre-recorded music and movies; online retail services for downloadable digital music; online retail services for downloadable ring tones; opinion polling; organization of exhibitions for commercial or advertising purposes; organization of fashion shows for promotional purposes; organization of trade fairs for commercial or advertising purposes; outdoor advertising; outsourced administrative management for companies; outsourcing services [business assistance]; pay per click advertising; payroll preparation; personnel management consultancy; personnel recruitment; photocopying services; presentation of goods on communication media, for retail purposes; price comparison services; procurement services for others [purchasing goods and services for other businesses]; production of advertising films; production of teleshopping programmes; production of teleshopping programs; professional business consultancy; promotion of goods and services through sponsorship of sports events; providing business information via a web site; provision of an online marketplace for buyers and sellers of goods and services; provision of commercial and business contact information; psychological testing for the selection of personnel; publication of publicity texts; publicity material rental; public relations; radio advertising; registration of written communications and data; administrative services for the relocation of businesses; rental of advertising space; rental of advertising time on communication media; rental of billboards [advertising boards]; rental of office equipment in co-working facilities; rental of photocopying machines; rental of sales stands; rental of vending machines; retail services for pharmaceutical, veterinary and sanitary preparations and medical supplies; retail services for works of art provided by art galleries; sales promotion for others; scriptwriting for advertising purposes; search engine optimization for sales promotion; search engine optimisation for sales promotion; secretarial services; shop window dressing; shorthand; sponsorship search; systemizati-

on of information into computer databases; targeted marketing; tax filing services; tax preparation; telemarketing services; telephone answering for unavailable subscribers; television advertising; transcription of communications [office functions]; typing; updating and maintenance of data in computer databases; updating and maintenance of information in registries; updating of advertising material; web indexing for commercial or advertising purposes; web site traffic optimization; web site traffic optimisation; wholesale services for pharmaceutical, veterinary and sanitary preparations and medical supplies; word processing; writing of publicity texts; writing of résumés for others; writing of curriculum vitae for others.

37 – Airplane maintenance and repair; anti-rust treatment for vehicles; artificial snow-making services; asphaltting; boiler cleaning and repair; bricklaying; building construction supervision; building insulating; building of fair stalls and shops; building sealing; damp-proofing [building]; burglar alarm installation and repair; burner maintenance and repair; carpentry services; chimney sweeping; cleaning of buildings [exterior surface]; cleaning of buildings [interior]; cleaning of clothing; clock and watch repair; clothing repair; construction; construction consultancy; construction information; demolition of buildings; diaper cleaning; disinfecting; drilling of deep oil or gas wells; drilling of wells; dry cleaning; electric appliance installation and repair; elevator installation and repair; lift installation and repair; factory construction; film projector repair and maintenance; fire alarm installation and repair; freezing equipment installation and repair; fur care, cleaning and repair; furnace installation and repair; furniture maintenance; furniture restoration; harbour construction; heating equipment installation and repair; hydraulic fracturing services; fracking services; installation, maintenance and repair of computer hardware; installation and repair of air-conditioning apparatus; installation and repair of flood protection equipment; installation of doors and windows; installation of utilities in construction sites; interference suppression in electrical apparatus; irrigation devices installation and repair; kitchen equipment installation; knife sharpening; laundering; laying of cable; leather care, cleaning and repair; linen ironing; machinery installation, maintenance and repair; masonry; mining extraction; motor vehicle maintenance and repair; office machines and equipment installation, maintenance and repair; painting, interior and exterior; painting or repair of signs; paper hanging; wallpapering; parasol repair; pest control services, other than for agriculture, aquaculture, horticulture and forestry; photographic apparatus repair; pier breakwater building; pipeline construction and maintenance; plastering; plumbing; pressing of clothing; pumicing; pump repair; quarrying services; re-tinning; rebuilding engines that have been worn or partially destroyed; rebuilding machines that have been worn or

partially destroyed; refilling of ink cartridges; refilling of toner cartridges; renovation of clothing; rental of bulldozers; rental of cleaning machines; rental of construction equipment; rental of cranes [construction equipment]; rental of dish drying machines; rental of dishwashing machines; rental of drainage pumps; rental of excavators; rental of laundry washing machines; rental of road sweeping machines; repair information; repair of power lines; repair of security locks; restoration of musical instruments; restoration of works of art; retreading of tires; retreading of tyres; riveting; road paving; roofing services; rustproofing; safe maintenance and repair; sanding; scaffolding; services of electricians; shipbuilding; shoe repair; snow removal; sterilization of medical instruments; sterilisation of medical instruments; street cleaning; strong-room maintenance and repair; swimming-pool maintenance; telephone installation and repair; tire balancing; tyre balancing; tuning of musical instruments; umbrella repair; underwater construction; underwater repair; upholstery; upholstery repair; varnishing; vehicle battery charging; vehicle breakdown repair services; vehicle cleaning; vehicle greasing; vehicle lubrication; vehicle maintenance; vehicle polishing; vehicle service stations [refuelling and maintenance]; vehicle washing; vermin exterminating, other than for agriculture, aquaculture, horticulture and forestry; vulcanization of tires [repair]; vulcanization of tyres [repair]; warehouse construction and repair; washing; washing of linen; window cleaning.

41 – Academies [education]; aikido instruction; amusement park services; animal training; arranging and conducting of colloquiums; arranging and conducting of concerts; arranging and conducting of conferences; arranging and conducting of congresses; arranging and conducting of in-person educational forums; arranging and conducting of seminars; arranging and conducting of symposiums; arranging and conducting of workshops [training]; arranging of beauty contests; boarding school education; booking of seats for shows; calligraphy services; cinema presentations; movie theatre presentations; club services [entertainment or education]; coaching [training]; conducting fitness classes; conducting guided climbing tours; conducting guided tours; correspondence courses; cultural, educational or entertainment services provided by art galleries; disc jockey services; discotheque services; dubbing; educational examination; educational examination for users to qualify to pilot drones; educational services provided by schools; educational services provided by special needs assistants; education information; electronic desktop publishing; entertainer services; entertainment information; entertainment services; film directing, other than advertising films; film distribution; film production, other than advertising films; gambling services; games equipment rental; game services provided online from a computer network; gymnastic instruction; health club services

[health and fitness training]; holiday camp services [entertainment]; judo instruction; karaoke services; know-how transfer [training]; language interpreter services; layout services, other than for advertising purposes; lending library services; lighting technician services for events; microfilming; mobile library services; bookmobile services; modelling for artists; movie studio services; music composition services; news reporters services; nightclub services [entertainment]; nursery schools; online publication of electronic books and journals; orchestra services; organization of balls; organization of competitions [education or entertainment]; organization of cosplay entertainment events; organization of exhibitions for cultural or educational purposes; organization of fashion shows for entertainment purposes; organization of lotteries; organization of shows [impresario services]; organization of sports competitions; party planning [entertainment]; personal trainer services [fitness training]; photographic reporting; photography; physical education; practical training [demonstration]; presentation of circus performances; presentation of live performances; presentation of variety shows; production of music; production of radio and television programmes; production of shows; providing amusement arcade services; providing casino facilities [gambling]; providing films, not downloadable, via video-on-demand services; providing golf facilities; providing museum facilities [presentation, exhibitions]; providing online electronic publications, not downloadable; providing online music, not downloadable; providing online videos, not downloadable; providing recreation facilities; providing sports facilities; providing television programmes, not downloadable, via video-on-demand services; providing television programs, not downloadable, via video-on-demand services; publication of books; publication of texts, other than publicity texts; radio entertainment; recording studio services; recreation information; religious education; rental of artwork; rental of audio equipment; rental of cinematographic apparatus; rental of indoor aquaria; rental of lighting apparatus for theatrical sets or television studios; rental of motion pictures; rental of radio and television sets; rental of show scenery; rental of skin diving equipment; rental of sound recordings; rental of sports equipment, except vehicles; rental of sports grounds; rental of stadium facilities; rental of stage scenery; rental of tennis courts; rental of video cameras; rental of camcorders; rental of video cassette recorders; rental of videotapes; sado instruction [tea ceremony instruction]; screenplay writing; scriptwriting, other than for advertising purposes; sign language interpretation; songwriting; sound engineering services for events; sport camp services; subtitling; teaching; educational services; instruction services; television entertainment; theatre productions; ticket agency services [entertainment]; timing of sports events; toy rental; training services provided via simulators; translation; tutoring; video editing services for events;

videotape editing; videotaping; vocational guidance [education or training advice]; vocational retraining; writing of texts; zoological garden services.

(260) AM 2021 109261 A

(800) 1543177

(151) 2020 06 02

(891) 2020 06 02

(731) QUARTLINK HOLDING LIMITED, private limited liability company  
Pargas, 1, Flat/Office 5, CY-1065 Nicosia, Cyprus

(540)



(591) Green, light green, dark green, olive, blue, white, brown, dark brown, red, light red and pale yellow

(531) 02.09.01; 05.03.11; 05.07.19; 08.03.12; 08.07.17; 25.01.15; 26.01.18; 28.05; 29.01.15

(511)

30 – Ketchup [sauce]; mayonnaise; mayonnaise sauce; sauces [condiments]; pasta sauce; condiments; spices; seasonings; dressings for salad; vegetable oil-based dressings; mustard.

(260) AM 2021 109262 A

(800) 1543202

(151) 2020 06 04

(891) 2020 06 04

(731) PUBLIC JOINT STOCK COMPANY  
GAZPROM NEFT  
Pochtamskaya Ulitsa, Dom 3-5, Liter A,  
Ch. Pom. 1N, Kab. 2401, RU-190000  
ST PETERSBURG, Russian Federation

(540)



15 000 KILOMETRES  
OF CONFIDENCE

(591) Blue, white, orange, orange-brown, brown, yellow and grey

(531) 01.15.05; 19.01.04; 19.07.07; 26.07.25; 29.01.15

(511)

1 – Acetate of cellulose, unprocessed; acetates [chemicals]; acetic anhydride; acetone; acetylene; acetylene tetrachloride; acid proof chemical compositions; acids; acidulated water for recharging accumulators; acidulated water for recharging batteries; acrylic resins, unprocessed; actinium; activated carbon; activated charcoal; additives, chemical, to drilling muds; chemical additives to drilling muds; additives, chemical, to fungicides; chemical additives to fungicides; additives, chemical, to insecticides; chemical additives to insecticides; additives, chemical, to motor fuel; chemical additives to motor fuel; adhesive preparations for surgical bandages; adhesives for billposting; adhesives for industrial purposes; adhesives for wallpaper; adhesives for paperhanging; adhesives for wall tiles; adjuvants, other than for medical or veterinary purposes; agar-agar; agglutinants for concrete; agricultural chemicals, except fungicides, herbicides, insecticides and parasiticides; albumenized paper; albumin [animal or vegetable, raw material]; alcohol; aldehydes; alginates for industrial purposes; alginates for the food industry; alkalies; alkaline-earth metals; alkaline iodides for industrial purposes; alkaline metals; alkaloids; alum; alumina; aluminium acetate; aluminium alum; aluminium chloride; aluminium hydrate; aluminium iodide; aluminium silicate; americium; ammonia; ammonia alum; ammoniacal salts; ammonia [volatile alkali] for industrial purposes; volatile alkali [ammonia] for industrial purposes; ammonium aldehyde; ammonium nitrate; ammonium salts; amyl acetate; amyl alcohol; anhydrides; anhydrous ammonia; animal albumen [raw material]; animal carbon; animal carbon preparations; animal charcoal; animal manure; anthranilic acid; anti-boil preparations for engine coolants; anti-frothing solutions for accumulators; anti-frothing solutions for batteries; anti-incrustants; anti-knock substances for internal combustion engines; anti-sprouting preparations for vegetables; anti-tarnishing chemicals for windows; antifreeze; antimony; antimony oxide; antimony sulfide; antioxidants for use in manufacture; antioxidants for use in the manufacture of cosmetics; antioxidants for use in the manufacture of food supplements; antioxidants for use in the manufacture of pharmaceuticals; antistatic preparations, other than for household purposes; argon; arsenic; arsenious acid; artificial sweeteners [chemical preparations]; astatine; auxiliary fluids for use with abrasives; bacterial preparations, other than for medical and veterinary use; bacteriological preparations, other than for medical and veterinary use; bacteriological preparations for acetification; barium; barium compounds; barium sulfate; baryta; baryta paper; barytes; bases [chemical preparations]; basic gallate of bismuth; bate for dressing skins; dressing,

except oils, for skins; bauxite; beer-clarifying and preserving agents; beer preserving agents; bentonite; benzene; benzene-based acids; benzene derivatives; benzoic acid; benzoic sulfimide; benzol; berkelium; bicarbonate of soda for chemical purposes; bichloride of tin; bichromate of potassium; bichromate of soda; biochemical catalysts; biological preparations, other than for medical or veterinary purposes; biological tissue cultures, other than for medical or veterinary purposes; birdlime; bismuth; bismuth subnitrate for chemical purposes; bleaching preparations [decolorants] for industrial purposes; decolorants for industrial purposes; blood charcoal; blueprint cloth; blueprint paper; blue vitriol; copper sulfate [blue vitriol]; bone charcoal; borax; boric acid for industrial purposes; brake fluid; brazing fluxes; brazing preparations; brickwork preservatives, except paints and oils; bromine for chemical purposes; by-products of the processing of cereals for industrial purposes; caesium; calcined soda; calcium carbide; calcium cyanamide [fertilizer]; calcium cyanamide [fertiliser]; calcium salts; californium; calomel [mercurous chloride]; camphor, for industrial purposes; carbide; carbolineum for the protection of plants; carbon; carbonates; carbon black for industrial purposes; carbon disulfide; carbon for filters; carbonic acid; carbonic hydrates; carbon tetrachloride; casein for industrial purposes; casein for the food industry; catalysts; catechu; caustic alkali; caustics for industrial purposes; caustic soda for industrial purposes; cellulose; cellulose derivatives [chemicals]; cellulose esters for industrial purposes; cellulose ethers for industrial purposes; cement-waterproofing chemicals, except paints; cement for footwear; cement for mending broken articles; cement preservatives, except paints and oils; cement [metallurgy]; ceramic compositions for sintering [granules and powders]; ceramic glazings; ceramic materials in particulate form, for use as filtering media; cerium; chemical additives for oils; chemical coatings for ophthalmic lenses; chemical condensation preparations; chemical intensifiers for paper; chemical intensifiers for rubber; chemical preparations for facilitating the alloying of metals; chemical preparations for scientific purposes, other than for medical or veterinary use; chemical preparations for smoking meat; chemical preparations for use in photography; chemical preparations to prevent diseases affecting cereal plants; chemical preparations to prevent diseases affecting vine plants; chemical preparations to prevent mildew; chemical preparations to prevent wheat blight; chemical preparations to prevent wheat smut; chemical reagents, other than for medical or veterinary purposes; chemicals, except pigments, for the manufacture of enamel; chemicals for the manufacture of paints; chemicals for the manufacture of pigments; chemicals for use in forestry, except fungicides, herbicides, insecticides and parasiticides; chemical substances for analyses in laboratories, other than for medical or veterinary purposes; chemical preparations for analyses in laboratories,

other than for medical or veterinary purposes; chemical substances for preserving foodstuffs; chimney cleaners, chemical; chlorates; chlorides; chlorine; cholic acid; chromates; chrome alum; chrome salts; chromic acid; chromic salts; chromium oxide; cinematographic films, sensitized but not exposed; cinematographic film, sensitized but not exposed; citric acid for industrial purposes; coal saving preparations; cobalt oxide for industrial purposes; collagen for industrial purposes; collodion; color-brightening chemicals for industrial purposes; colour-brightening chemicals for industrial purposes; combusting preparations [chemical additives to motor fuel]; compositions for repairing inner tubes of tyres; compositions for repairing inner tubes of tires; compositions for repairing tyres; compositions for repairing tires; compositions for the manufacture of phonograph records; compositions for the manufacture of technical ceramics; compositions for threading; compost; concrete-aeration chemicals; concrete preservatives, except paints and oils; condensation-preventing chemicals; coolants for vehicle engines; corrosive preparations; cream of tartar for chemical purposes; cream of tartar for industrial purposes; cream of tartar for the food industry; creosote for chemical purposes; crotonic aldehyde; cryogenic preparations; cultures of microorganisms, other than for medical and veterinary use; curium; currying preparations for leather; currying preparations for skins; cyanides [prussiates]; prussiates; cymene; damp-proofing chemicals, except paints, for masonry; defoliants; degreasing preparations for use in manufacturing processes; grease-removing preparations for use in manufacturing processes; degumming preparations; gum solvents; dehydrating preparations for industrial purposes; dendrimer-based polymers for use in the manufacture of capsules for pharmaceuticals; descaling preparations, other than for household purposes; detergent additives to gasoline; detergent additives to petrol; detergents for use in manufacturing processes; dextrin [size]; diagnostic preparations, other than for medical or veterinary purposes; diastase for industrial purposes; diatomaceous earth; diazo paper; disinfectants; dispersions of plastics; distilled water; dolomite for industrial purposes; drilling muds; dry ice [carbon dioxide]; dysprosium; electrophoresis gels; emollients for industrial purposes; emulsifiers; enamel-staining chemicals; engine-decarbonising chemicals; chemical preparations for decarbonising engines; enzyme preparations for industrial purposes; enzyme preparations for the food industry; enzymes for industrial purposes; enzymes for the food industry; epoxy resins, unprocessed; erbium; esters; ethane; ethers; ethyl alcohol; ethyl ether; europium; expanded clay for hydroponic plant growing [substrate]; fat-bleaching chemicals; fatty acids; ferments for chemical purposes; fermium; ferrocyanides; ferrotype plates [photography]; fertilizers; fertilisers; fertilizing preparations; fertilising preparations; filtering materials of chemical substances; filtering materials of mineral substances; filtering

materials of unprocessed plastics; filtering materials of vegetable substances; filtering preparations for the beverages industry; finishing preparations for use in the manufacture of steel; fire extinguishing compositions; fireproofing preparations; fish meal fertilizers; fish meal fertilisers; fissionable chemical elements; fissionable material for nuclear energy; fixing baths [photography]; fixing solutions [photography]; flashlight preparations; flavonoids [phenolic compounds] for industrial purposes; flocculants; flour for industrial purposes; flower preservatives; flowers of sulfur for chemical purposes; fluids for hydraulic circuits; liquids for hydraulic circuits; fluorine; fluorspar compounds; formic acid; formic aldehyde for chemical purposes; foundry binding substances; foundry molding preparations; foundry moulding preparations; foundry sand; francium; fuel-saving preparations; fuel for nuclear reactors; fuller's earth for use in the textile industry; fulling preparations; fulling preparations for use in the textile industry; gadolinium; gallic acid for the manufacture of ink; gallium; gallnuts; gallotannic acid; galvanizing baths; baths for galvanizing; galvanizing preparations; gambier; gas purifying preparations; preparations for the purification of gas; gelatine for industrial purposes; gelatine for photographic purposes; genes of seeds for agricultural production; getters [chemically active substances]; glass-frosting chemicals; glass-staining chemicals; glaziers' putty; glucose for industrial purposes; glucose for the food industry; glucosides; glue for industrial purposes; glutamic acid for industrial purposes; gluten for industrial purposes; gluten for the food industry; gluten [glue], other than for stationery or household purposes; glutinous tree-grafting preparations; glutinous tree-banding preparations; glutinous preparations for tree-banding; glutinous preparations for tree-grafting; glycerides; glycerine for industrial purposes; glycol; glycol ether; gold salts; grafting mastic for trees; grafting wax for trees; graphene; graphite for industrial purposes; guano; gum arabic for industrial purposes; gums [adhesives] for industrial purposes; gum tragacanth for industrial purposes; gurjun balsam for use in the manufacture of varnish; gypsum for use as a fertilizer; heavy water; helium; holmium; hormones for hastening the ripening of fruit; horticultural chemicals, except fungicides, herbicides, insecticides and parasiticides; humus; humus top dressing; hydrates; hydrazine; hydrochlorates; hydrochloric acid; hydrofluoric acid; hydrogen; hydrogen peroxide for industrial purposes; hypochlorite of soda; hyposulfites; industrial chemicals; iodic acid; iodine for chemical purposes; iodine for industrial purposes; iodised albumen; iodised salts; ion exchangers [chemicals]; iron salts; isinglass, other than for stationery, household or alimentary purposes; isotopes for industrial purposes; kainite; kaolin; china slip; china clay; ketones; kieselgur; krypton; lactic acid; lactose for industrial purposes; lactose for the food industry; lactose [raw material]; lamp black for industrial purposes; lanthanum;

lead acetate; lead arsenate; lead oxide; leather-dressing chemicals; leather-impregnating chemicals; leather-renovating chemicals; leather-waterproofing chemicals; leather glues; lecithin for industrial purposes; lecithin for the food industry; lecithin [raw material]; lime acetate; lime carbonate; lime chloride; limestone hardening substances; liquids for removing sulfates from accumulators; liquids for removing sulfates from batteries; lithia [lithium oxide]; lithium; litmus paper; loam; lutetium [cassioptium]; cassioptium [lutetium]; magnesite; magnesium carbonate; magnesium chloride; magnetic fluid for industrial purposes; malt albumen; manganate; manganese dioxide; mangrove bark for industrial purposes; masonry preservatives, except paints and oils; mastic for leather; mastic for tires; mastic for tyres; meat tenderizers for industrial purposes; mercuric oxide; mercury; mercury salts; metal annealing preparations; metal hardening preparations; metalloids; metal tempering preparations; methane; methyl benzene; methyl benzol; methyl ether; milk ferments for chemical purposes; milk ferments for industrial purposes; milk ferments for the food industry; mineral acids; moderating materials for nuclear reactors; moistening [wetting] preparations for use in bleaching; wetting preparations for use in bleaching; moistening [wetting] preparations for use in dyeing; wetting preparations for use in dyeing; moistening [wetting] preparations for use in the textile industry; wetting preparations for use in the textile industry; mold-release preparations; mould-release preparations; mordants for metals; must-finishing preparations; nanopowders for industrial purposes; naphthalene; neodymium; neon; neptunium; nitrate paper; nitrates; nitric acid; nitrogen; nitrogenous fertilisers; nitrogenous fertilizers; nitrous oxide; oenological bactericides [chemical preparations for use in wine making]; oil-bleaching chemicals; oil-purifying chemicals; oil-separating chemicals; oil cement [putty]; oil dispersants; oils for currying leather; oils for preparing leather in the course of manufacture; oils for tanning leather; oils for the preservation of food; oleic acid; olivine [silicate mineral]; opacifiers for enamel; opacifiers for glass; organic digestate [fertilizer]; organic digestate [fertiliser]; oxalates; oxalic acid; oxygen for industrial purposes; palladium chloride; paper pulp; paste fillers for automobile body repair; paste fillers for car body repair; peat pots for horticulture; peat [fertiliser]; peat [fertilizer]; pectin for industrial purposes; pectin for the food industry; pectin [photography]; perborate of soda; percarbonates; perchlorates; persulfates; persulfuric acid; petroleum dispersants; phenol for industrial purposes; phosphates [fertilisers]; phosphates [fertilizers]; phosphatides; phosphoric acid; phosphorus; photographic developers; photographic emulsions; photographic paper; photographic sensitizers; photometric paper; photosensitive plates; picric acid; plant growth regulating preparations; plasticizers; plastics, unprocessed; plastisols; plutonium; polish removing substances; substances for

removing polish; polonium; polymer resins, unprocessed; potash; potash water; potassium; potassium dioxalate; potato flour for industrial purposes; potting soil; power steering fluid; praseodymium; preparations for preventing the tarnishing of glass; preparations for preventing the tarnishing of lenses; preparations for stimulating cooking for industrial purposes; preparations for the separation of greases; preparations of microorganisms, other than for medical and veterinary use; preparations of the distillation of wood alcohol; preparations of trace elements for plants; preservatives for tiles, except paints and oils; preservatives for use in the pharmaceutical industry; promethium; propellant gases for aerosols; protactinium; protective gases for welding; proteins for the food industry; proteins for use in manufacture; proteins for use in the manufacture of food supplements; protein [raw material]; purification preparations; clarification preparations; pyrogallol; pyrogallol acid; pyrogallol for industrial purposes; radiator flushing chemicals; radioactive elements for scientific purposes; radium for scientific purposes; radon; rare earths; reagent paper, other than for medical or veterinary purposes; reducing agents for use in photography; refrigerants; renovating preparations for phonograph records; rhenium; rock salt; rubber preservatives; rubidium; saccharin; sal ammoniac; sal ammoniac spirits; salicylic acid; salt, raw; salt for preserving, other than for foodstuffs; saltpeter; saltpetre; salts for coloring metal; salts for colouring metal; salts for galvanic cells; salts for galvanic batteries; salts for industrial purposes; salts from rare earth metals; salts of alkaline metals; salts of precious metals for industrial purposes; salts [chemical preparations]; salts [fertilisers]; salts [fertilizers]; samarium; sauce for preparing tobacco; scandium; seawater for industrial purposes; seaweeds [fertilizers]; seaweeds [fertilisers]; sebacic acid; seed preserving substances; selenium; self-toning paper [photography]; sensitized cloth for photography; sensitized films, unexposed; sensitized paper; sensitized photographic plates; sensitized plates for offset printing; separating and unsticking [ungluing] preparations; ungluing preparations; unsticking and separating preparations; silicates; silicon; silicon carbide [raw material]; silicones; silver nitrate; silver salt solutions for silvering; size for finishing and priming; size for use in the textile industry; sizing preparations; slag [fertilisers]; slag [fertilizers]; soap [metallic] for industrial purposes; soda ash; sodium; sodium salts [chemical compounds]; soil conditioning preparations; soil for growing; soldering fluxes; solidified gases for industrial purposes; solutions for cyanotyping; solvents for varnishes; soot for industrial or agricultural purposes; sorrel salt; spinel [oxide mineral]; spirits of salt; spirits of vinegar [dilute acetic acid]; stain-preventing chemicals for use on fabrics; starch-liquifying chemicals [ungluing agents]; ungluing agents [chemical preparations for liquifying starch]; starch for industrial purposes; starch paste [adhesive], other than for sta-

tionery or household purposes; stearic acid; stem cells, other than for medical or veterinary purposes; strontium; substances for preventing runs in stockings; substrates for soil-free growing [agriculture]; sulfates; sulfides; sulfonic acids; sulfur; sulfuric acid; sulfuric ether; sulfurous acid; sumac for use in tanning; superphosphates [fertilisers]; superphosphates [fertilizers]; surface-active chemical agents; tensio-active agents; synthetic materials for absorbing oil; synthetic resins, unprocessed; artificial resins, unprocessed; talc [magnesium silicate]; tan; tan-wood; tannic acid; tannin; tanning substances; tapioca flour for industrial purposes; tartar, other than for pharmaceutical purposes; tartaric acid; tea extracts for the food industry; tea extracts for use in the manufacture of cosmetics; tea extracts for use in the manufacture of pharmaceuticals; technetium; tellurium; terbium; test paper, chemical; tetrachlorides; textile-brightening chemicals; textile-impregnating chemicals; textile-waterproofing chemicals; thallium; thiocarbonyl; thorium; thulium; thymol for industrial purposes; titanite; titanium dioxide for industrial purposes; toluene; toluol; toning baths [photography]; toning salts [photography]; topsoil; toxic gas neutralizers; transmission fluid; transmission oil; tree cavity fillers [forestry]; tungstic acid; uranium; uranium nitrate; uranium oxide; vinic alcohol; viscose; vitamins for the food industry; vitamins for use in the manufacture of cosmetics; vitamins for use in the manufacture of food supplements; vitamins for use in the manufacture of pharmaceuticals; vulcanization accelerators; vulcanizing preparations; wallpaper removing preparations; water-purifying chemicals; water-softening preparations; water glass [soluble glass]; wax-bleaching chemicals; welding chemicals; soldering chemicals; wine finings; witherite; wood alcohol; wood pulp; wood vinegar [pyrolygneous acid]; pyrolygneous acid [wood vinegar]; X-ray films, sensitized but not exposed; xenon; xylene; xylol; ytterbium; yttrium; zirconia.

4 – Additives, non-chemical, to motor fuel; alcohol [fuel]; anthracite; beeswax; beeswax for use in the manufacture of cosmetics; belting wax; benzene fuel; benzine; biomass fuel; bone oil for industrial purposes; candles; tapers; carburants; motor fuel; carnauba wax; castor oil for industrial purposes; ceresine; charcoal [fuel]; Christmas tree candles; coal; coal briquettes; coal dust [fuel]; coal naphtha; coal tar oil; coke; combustible briquettes; cutting fluids; diesel oil; gas oil; dust absorbing compositions; dust binding compositions for sweeping; dust laying compositions; dust removing preparations; electrical energy; ethanol [fuel]; firelighters; firewood; fish oil, not edible; fuel; fuel gas; fuel oil; combustible oil; fuel with an alcohol base; gas for lighting; grease for arms [weapons]; grease for belts; grease for footwear; grease for leather; greases for the preservation of leather; oils for lighting; illuminating wax; industrial grease; industrial oil; industrial wax; kerosene; lamp wicks; lanolin;

wool grease; lanolin for use in the manufacture of cosmetics; lighting fuel; lignite; ligroin; lubricants; lubricating graphite; lubricating grease; lubricating oil; mazut; methylated spirit; mineral fuel; moistening oil; motor oil; naphtha; nightlights [candles]; non-slipping preparations for belts; oil-gas; oils for paints; oils for releasing form work [building]; oils for the preservation of leather; oils for the preservation of masonry; oleine; ozokerite; ozocerite; paper spills for lighting; paraffin; peat briquettes [fuel]; peat [fuel]; perfumed candles; petrol; gasoline; petroleum, raw or refined; petroleum ether; petroleum jelly for industrial purposes; producer gas; rape oil for industrial purposes; colza oil for industrial purposes; solidified gases [fuel]; soya bean oil preparations for non-stick treatment of cooking utensils; stearine; sunflower oil for industrial purposes; tallow; textile oil; tinder; vaporized fuel mixtures; wax for skis; wax [raw material]; wicks for candles; wood briquettes; wood spills for lighting; xylene fuel.

35 – Administration of consumer loyalty programs; administration of frequent flyer programs; administrative assistance in responding to calls for tenders; administrative assistance in responding to requests for proposals [RFPs]; administrative processing of purchase orders; advertising; publicity; advertising agency services; publicity agencies; advertising by mail order; advisory services for business management; appointment reminder services [office functions]; appointment scheduling services [office functions]; arranging newspaper subscriptions for others; arranging subscriptions to telecommunication services for others; auctioneering; bill-posting; book-keeping; accounting; business appraisals; business auditing; business efficiency expert services; business information; business inquiries; business intermediary services relating to the matching of potential private investors with entrepreneurs needing funding; business investigations; business management and organization consultancy; business management assistance; business management consultancy; business management for freelance service providers; business management of hotels; business management of performing artists; business management of reimbursement programs for others; business management of reimbursement programmes for others; business management of sports people; business organization consultancy; business project management services for construction projects; business research; commercial administration of the licensing of the goods and services of others; commercial information agency services; commercial information and advice for consumers in the choice of products and services; commercial intermediation services; commercial lobbying services; commercial or industrial management assistance; competitive intelligence services; compilation of information into computer databases; compilation of statistics; compiling indexes of information for commercial or adverti-

sing purposes; computerized file management; consultancy regarding advertising communication strategies; consultancy regarding public relations communication strategies; corporate communications services; cost price analysis; data search in computer files for others; demonstration of goods; development of advertising concepts; direct mail advertising; dissemination of advertising matter; distribution of samples; drawing up of statements of accounts; economic forecasting; employment agency services; financial auditing; gift registry services; import-export agency services; interim business management; invoicing; layout services for advertising purposes; marketing; marketing in the framework of software publishing; marketing research; market intelligence services; market studies; media relations services; modelling for advertising or sales promotion; negotiation and conclusion of commercial transactions for third parties; negotiation of business contracts for others; news clipping services; office machines and equipment rental; online advertising on a computer network; online retail services for downloadable and pre-recorded music and movies; online retail services for downloadable digital music; online retail services for downloadable ring tones; opinion polling; organization of exhibitions for commercial or advertising purposes; organization of fashion shows for promotional purposes; organization of trade fairs for commercial or advertising purposes; outdoor advertising; outsourced administrative management for companies; outsourcing services [business assistance]; pay per click advertising; payroll preparation; personnel management consultancy; personnel recruitment; photocopying services; presentation of goods on communication media, for retail purposes; price comparison services; procurement services for others [purchasing goods and services for other businesses]; production of advertising films; production of teleshopping programmes; production of teleshopping programs; professional business consultancy; promotion of goods and services through sponsorship of sports events; providing business information via a web site; provision of an online marketplace for buyers and sellers of goods and services; provision of commercial and business contact information; psychological testing for the selection of personnel; publication of publicity texts; publicity material rental; public relations; radio advertising; registration of written communications and data; administrative services for the relocation of businesses; rental of advertising space; rental of advertising time on communication media; rental of billboards [advertising boards]; rental of office equipment in co-working facilities; rental of photocopying machines; rental of sales stands; rental of vending machines; retail services for pharmaceutical, veterinary and sanitary preparations and medical supplies; retail services for works of art provided by art galleries; sales promotion for others; scriptwriting for advertising purposes; search engine optimization for sales promotion; search engine opti-



misation for sales promotion; secretarial services; shop window dressing; shorthand; sponsorship search; systemization of information into computer databases; targeted marketing; tax filing services; tax preparation; telemarketing services; telephone answering for unavailable subscribers; television advertising; transcription of communications [office functions]; typing; updating and maintenance of data in computer databases; updating and maintenance of information in registries; updating of advertising material; web indexing for commercial or advertising purposes; web site traffic optimization; web site traffic optimisation; wholesale services for pharmaceutical, veterinary and sanitary preparations and medical supplies; word processing; writing of publicity texts; writing of résumés for others; writing of curriculum vitae for others.

37 – Airplane maintenance and repair; anti-rust treatment for vehicles; artificial snow-making services; asphaltting; boiler cleaning and repair; bricklaying; building construction supervision; building insulating; building of fair stalls and shops; building sealing; damp-proofing [building]; burglar alarm installation and repair; burner maintenance and repair; carpentry services; chimney sweeping; cleaning of buildings [exterior surface]; cleaning of buildings [interior]; cleaning of clothing; clock and watch repair; clothing repair; construction; construction consultancy; construction information; demolition of buildings; diaper cleaning; disinfecting; drilling of deep oil or gas wells; drilling of wells; dry cleaning; electric appliance installation and repair; elevator installation and repair; lift installation and repair; factory construction; film projector repair and maintenance; fire alarm installation and repair; freezing equipment installation and repair; fur care, cleaning and repair; furnace installation and repair; furniture maintenance; furniture restoration; harbour construction; heating equipment installation and repair; hydraulic fracturing services; fracking services; installation, maintenance and repair of computer hardware; installation and repair of air-conditioning apparatus; installation and repair of flood protection equipment; installation of doors and windows; installation of utilities in construction sites; interference suppression in electrical apparatus; irrigation devices installation and repair; kitchen equipment installation; knife sharpening; laundering; laying of cable; leather care, cleaning and repair; linen ironing; machinery installation, maintenance and repair; masonry; mining extraction; motor vehicle maintenance and repair; office machines and equipment installation, maintenance and repair; painting, interior and exterior; painting or repair of signs; paper hanging; wallpapering; parasol repair; pest control services, other than for agriculture, aquaculture, horticulture and forestry; photographic apparatus repair; pier break-water building; pipeline construction and maintenance; plastering; plumbing; pressing of clothing; pumicing; pump repair; quarrying services; re-tinning;

rebuilding engines that have been worn or partially destroyed; rebuilding machines that have been worn or partially destroyed; refilling of ink cartridges; refilling of toner cartridges; renovation of clothing; rental of bulldozers; rental of cleaning machines; rental of construction equipment; rental of cranes [construction equipment]; rental of dish drying machines; rental of dishwashing machines; rental of drainage pumps; rental of excavators; rental of laundry washing machines; rental of road sweeping machines; repair information; repair of power lines; repair of security locks; restoration of musical instruments; restoration of works of art; retreading of tires; retreading of tyres; riveting; road paving; roofing services; rustproofing; safe maintenance and repair; sanding; scaffolding; services of electricians; shipbuilding; shoe repair; snow removal; sterilization of medical instruments; sterilisation of medical instruments; street cleaning; strong-room maintenance and repair; swimming-pool maintenance; telephone installation and repair; tire balancing; tyre balancing; tuning of musical instruments; umbrella repair; underwater construction; underwater repair; upholstery repair; varnishing; vehicle battery charging; vehicle breakdown repair services; vehicle cleaning; vehicle greasing; vehicle lubrication; vehicle maintenance; vehicle polishing; vehicle service stations [refuelling and maintenance]; vehicle washing; vermin exterminating, other than for agriculture, aquaculture, horticulture and forestry; vulcanization of tires [repair]; vulcanization of tyres [repair]; warehouse construction and repair; washing; washing of linen; window cleaning.

41 – Academies [education]; aikido instruction; amusement park services; animal training; arranging and conducting of colloquiums; arranging and conducting of concerts; arranging and conducting of conferences; arranging and conducting of congresses; arranging and conducting of in-person educational forums; arranging and conducting of seminars; arranging and conducting of symposiums; arranging and conducting of workshops [training]; arranging of beauty contests; boarding school education; booking of seats for shows; calligraphy services; cinema presentations; movie theatre presentations; club services [entertainment or education]; coaching [training]; conducting fitness classes; conducting guided climbing tours; conducting guided tours; correspondence courses; cultural, educational or entertainment services provided by art galleries; disc jockey services; discotheque services; dubbing; educational examination; educational examination for users to qualify to pilot drones; educational services provided by schools; educational services provided by special needs assistants; education information; electronic desktop publishing; entertainer services; entertainment information; entertainment services; film directing, other than advertising films; film distribution; film production, other than

advertising films; gambling services; games equipment rental; game services provided online from a computer network; gymnastic instruction; health club services [health and fitness training]; holiday camp services [entertainment]; judo instruction; karaoke services; know-how transfer [training]; language interpreter services; layout services, other than for advertising purposes; lending library services; lighting technician services for events; microfilming; mobile library services; bookmobile services; modelling for artists; movie studio services; music composition services; news reporters services; nightclub services [entertainment]; nursery schools; online publication of electronic books and journals; orchestra services; organization of balls; organization of competitions [education or entertainment]; organization of cosplay entertainment events; organization of exhibitions for cultural or educational purposes; organization of fashion shows for entertainment purposes; organization of lotteries; organization of shows [impresario services]; organization of sports competitions; party planning [entertainment]; personal trainer services [fitness training]; photographic reporting; photography; physical education; practical training [demonstration]; presentation of circus performances; presentation of live performances; presentation of variety shows; production of music; production of radio and television programmes; production of shows; providing amusement arcade services; providing casino facilities [gambling]; providing films, not downloadable, via video-on-demand services; providing golf facilities; providing museum facilities [presentation, exhibitions]; providing online electronic publications, not downloadable; providing online music, not downloadable; providing online videos, not downloadable; providing recreation facilities; providing sports facilities; providing television programmes, not downloadable, via video-on-demand services; providing television programs, not downloadable, via video-on-demand services; publication of books; publication of texts, other than publicity texts; radio entertainment; recording studio services; recreation information; religious education; rental of artwork; rental of audio equipment; rental of cinematographic apparatus; rental of indoor aquaria; rental of lighting apparatus for theatrical sets or television studios; rental of motion pictures; rental of radio and television sets; rental of show scenery; rental of skin diving equipment; rental of sound recordings; rental of sports equipment, except vehicles; rental of sports grounds; rental of stadium facilities; rental of stage scenery; rental of tennis courts; rental of video cameras; rental of camcorders; rental of video cassette recorders; rental of videotapes; sado instruction [tea ceremony instruction]; screenplay writing; scriptwriting, other than for advertising purposes; sign language interpretation; songwriting; sound engineering services for events; sport camp services; subtitling; teaching; educational services; instruction services; television entertainment; theatre productions; ticket agency

services [entertainment]; timing of sports events; toy rental; training services provided via simulators; translation; tutoring; video editing services for events; videotape editing; videotaping; vocational guidance [education or training advice]; vocational retraining; writing of texts; zoological garden services.

(260) AM 2021 109263 A

(800) 1543247

(151) 2019 06 08

(891) 2019 06 08

(731) CTS EVENTIM AG & Co.KgA

Rablstraße 26, 81669 München, Germany

(540)

## Eventim Live

(591) Black, white

(511)

9 – Sound recording, image (included in this class) and data carriers of all kinds, in particular audio and video tapes, audio and video cassettes, compact discs, recording discs, DAT tapes, video tapes, audio-video discs and DVDs, floppy disks, CD-ROMs, all of the aforesaid goods in recorded and blank form; sound recording apparatus; sound or image recordings and publications; minidisks, laser disks, audio cassettes, magnetic tapes; video recordings, films and television films recorded on digital data carriers; computer software and firmware, computer multimedia products; interactive games; game software for video and computer games, video game cartridges and cassettes; computer software for slot machines and arcade games, video game software; computer software provided in electronic form online or via the internet, magnetic and optical program data carriers; digital recordings provided via the internet featuring images, music, sound recordings and other artistic performances; mouse pads for computers; spectacles, spectacle cases, sunglasses.

14 – Key rings, key chains, consisting wholly or predominantly of common metal.

16 – Paper cardboard; printed matter; printed publications; magazines [periodicals]; periodicals; books, promotional literature; schedules and programmes; concert posters, posters, banners; flyers, pamphlets and leaflets; tickets and passes; entry forms; photographs; stickers [stationery], greeting cards and postcards; calendars, note books, diaries; beer mats and coasters; all the aforesaid goods of paper materials or cardboard; temporary [removable] tattoos; stationery, files; plastic materials for packaging, included in this class.

25 – Clothing; footwear; headgear; T-shirts; sweaters; sweat pants; sweater; suits; jerseys (singlets); waistcoats; head scarves; shirts; hats; caps (headwear); baseball caps; gloves (clothing); stockings; slip-

pers; dressing gowns; underwear; capes [clothing]; jeans; pyjamas; clothing for children; sweaters; jogging sets (clothing); bomber jackets; waterproof clothing; windcheaters; overcoats; jackets; socks; rugby shirts; fleece clothes; waist belts; polo shirts; dresses; knitwear [hosiery]; swimwear; shorts; blouses; cardigans; coats; trousers; miniskirts; aprons; stoles; overalls; dance clothes; unitards; leggings; shoes; boots; training shoes; sandals; bandanas; scarves; ties; bow ties.

27 – Wall hangings of paper materials or cardboard.

35 – Advertising; business management; public relations services; business administration; office functions; radio advertising; rental of sales stands; retail and online trading services in relation to nameplates, keys, key blanks, identity plates of metal, locks, other than electric, figurines of metal, statues and statuettes, tin cans, recorded and blank sound recording, image and data carriers of all kinds, in particular audio and video tapes, audio and video cassettes, compact discs, recording discs, DAT tapes, video tapes, audio-video discs and DVDs, floppy disks, CD-ROMs, sound recording apparatus, sound and image recordings and publications, mini discs, laser discs, audio cassettes, magnetic tapes, video recordings as well as feature films and feature films for television broadcasting recorded on digital data carriers, video games for use with television sets, computer software and firmware, multimedia products for computers, interactive games, game software for video and computer games, video game cartridges and cassettes, games equipment for playing computer games, computer software for slot machines and arcade games, video game software, computer software provided in electronic form online or via the internet, magnetic and optical program data carriers, digital recordings provided via the internet featuring images, music, sound recordings and other artistic performances, mouse pads for computers, spectacles, spectacle cases, sunglasses, key rings and key chains made wholly or predominantly from common metal; retail and online trading services in relation to paper, cardboard, printed matter, printed publications, magazines (periodicals), periodicals, books, promotional literature, schedules and programme booklets, concert posters, posters, banners, flyers, pamphlets and leaflets, tickets and passes, entry forms, photographs, stickers [stationery], greeting cards, postcards, note books, calendars, agendas, diaries, mats for beer glasses, coasters, all of the aforesaid goods of paper materials or cardboard; retailing and online trading in relation to temporary tattoos, stationery, files, plastic materials for packaging, leather and imitations of leather, animal skins and hides, travelling trunk, suitcases, umbrellas, parasols, walking sticks, clothing, footwear, headgear, T-shirts, sweatshirts, sweat pants, sweaters, suits, sports jerseys (singlets), waistcoats, head scarves, shirts, hats, caps (headwear), baseball caps, gloves (clothing), stockings, slippers, dressing gowns,

underwear, capes (clothing), jeans, pyjamas, clothing for children, jumpers (pullovers), jogging sets (clothing), bomber jackets, waterproof clothing, windcheaters, overcoats, jackets (clothing), socks, rugby shirts, fleece clothes, waist belts, polo shirts, dresses, knitwear (hosiery), swimwear, shorts, blouses, cardigans, coats, trousers, miniskirts, aprons, stoles, overalls, dance clothes, unitards, leggings, shoes, boots, training shoes, sandals, bandanas, scarves, neckties, bow ties, wall hangings of paper materials or cardboard, fruit beverages, fruit juices, syrups for making beverages, preparations for making beverages, beers, mineral waters and other non-alcoholic beverages; services of an artist's agency (agency of artists) including booking of disc jockeys for others; arranging and concluding of commercial transactions for others, arranging contracts for the purchase and sale of goods and the provision or acceptance of services, including all the aforesaid services also in connection with communications networks; marketing services for cultural, artistic, leisure, social and sports activities and events of all kinds; online and retail services relating to tickets; database services, namely data collection, processing, archiving, analysis, updating and delivery.

38 – Arranging and assigning access authorizations for users to different communication networks; provision of access to communication networks, also for interactive applications, in particular for data distribution; telecommunication services via networks, for the transmission of messages, images, text, speech and data; online services and transmissions, namely transmission of information and messages including e-mail.

39 – Passenger transport, shuttle service, travel arrangement; arranging travels, events and leisure activities for others.

41 – Entertainment and services regarding recreational activities; management and conducting of entertainment and festivals of the performing arts; arranging and conducting of entertainment, educational, cultural and sporting events for charitable purposes; artistic and musical entertainment services; festival services, performance of music, dance, comedy, theater, lyric and circus entertainment, including providing such services online from a computer database or via the internet; entertainment in clubs; operating night clubs and organizing night club events; operation of recording studios; rental of audio and video equipment; arranging and conducting musical events, shows, concerts, festivals, performances and live performances by bands; compilation of radio and television programs, film production [in studios]; video film production; production and presentation of radio and film clips, sound recordings, image recordings, videos, films, concerts, shows; composing of music; music production; providing online electronic, non-downloadable publications containing information

about all the aforesaid services from a computer database or the internet; music and text publications; providing music and visual entertainment online from a computer database or via the internet; providing digital music via the internet; providing electronic games via the internet or other online services; information, education and consultancy relating to all the aforesaid services, including from a computer database or via the internet; advance ticket sales [entertainment]; pre-sales of tickets for concerts, shows and other events; operation of ticket sales offices; reservation of tickets; booking and reservation services for tickets and seat reservations for concerts, shows and other events.

42 – Development of software, in particular in the field of multimedia.

45 – Licensing, sub-licensing or other utilization of computerized billing systems; exploitation of industrial property rights and copyrights through licensing for merchandising purposes.

(260) AM 2021 109264 A

(800) 1543258

(151) 2020 01 31

(891) 2020 01 31

(731) Elten GmbH

Ostwall 7-13, 47589 Uedem, Germany

(540)

## MADDOX

(591) Black, white

(511)

9 – Shoes (protective -); protective shoes [against accident or injury]; shoe soles and insoles for safety and protective footwear; shoes for protection against accidents, irradiation and fire.

(260) AM 2021 109275 A

(800) 1543594

(151) 2020 06 03

(891) 2020 06 03

(731) HYUNDAI MOTOR COMPANY

12, Heolleung-ro, Seocho-gu, Seoul,

Republic of Korea

(540)



(591) Black, white

(531) 03.07.17; 24.01.15; 24.01.17; 27.05.02

(511)

9 – Computer application software for mobile phones for the operation of vehicles and the management assistance of vehicles; computer software; smart phone application (software) for provision of information

relating to trip information history, parking location management, trip information, vehicle health management, driving information, and promotional data; smart phone application (software) for vehicle lease; smart phone application (software) for rental car lease and maintenance; smart phone application (software) for vehicle rental and maintenance; computer software for providing remote diagnosis, information, entertainment, communication, navigation function, and display in vehicles; downloadable smart phone application (software); application software for smart phone; computer application software for vehicles; bluetooth speakers; ear phones; ear buds; headphones; electronic picture frames; batteries for automobiles; car telephone installations; starter cables for motors; vehicle radios attached to cars; satellite receivers attached to cars; media players for automobiles; car speakers; audio/video apparatus for cars; car navigators; GPS used in cars; GPS navigation devices for cars; remote control apparatus attachable to cars; black box for cars; electronic keyless entry system for automobiles; electric audio and visual apparatus and instruments.

(260) AM 2021 109276 A

(800) 1543672

(151) 2020 06 18

(891) 2020 06 18

(731) Audentes Therapeutics, Inc.

600 California Street, 17th Floor, San Francisco  
CA 94108, USA

(540)

## MYOHALYX

(591) Black, white

(511)

5 – Pharmaceutical preparations and substances for treating genetic diseases and disorders and neuromuscular diseases and disorders; therapeutic pharmaceuticals and substances for treating genetic diseases and disorders and neuromuscular diseases and disorders.

(260) AM 2021 109277 A

(800) 1543714

(151) 2020 03 13

(891) 2020 03 13

(731) Open-Type Joint Stock Company "ROT  
FRONT"

2-oy Novokuznetskiy pereulok, d. 13/15,  
RU-115184 Moscow, Russian Federation

(540)

## МИНЬОН

(591) Black, white

(531) 28.05

(511)

30 – Confectionery.

(260) AM 2021 109278 A  
 (800) 281302  
 (151) 1964 03 20  
 (891) 2020 07 10  
 (731) C. Bechstein Pianoforte AG  
 Kantstrasse 17, 10623 Berlin, Germany  
 (540)

**C. BECHSTEIN**

(591) Black, white  
 (531) 27.05.01  
 (511)  
 15 – Grand and upright pianos, harmoniums.

(260) AM 2021 109279 A  
 (800) 928510  
 (151) 2007 05 02  
 (891) 2020 07 10  
 (731) YUSUF TÜVEREKLI  
 Gençtürk Cad. Çukurçesme, K. No.21/23  
 Laleli, EMINÖNÜ/ISTANBUL, Turkey  
 (540)

**TUCİNO**

(591) Black, white  
 (531) 27.05.01  
 (511)  
 25 – Clothing, footwear, headgear.

(260) AM 2021 109282 A  
 (800) 1376971  
 (151) 2017 05 16  
 (891) 2020 06 29  
 (731) Mutalo Group Spółka z ograniczona  
 Odpowiedzialnoscia  
 Zawadzkiego "Zoski" 2a/43, PL-23-204  
 Krasnik, Poland  
 (540)

**KABISA**

(591) Black, white  
 (511)  
 32 – Non-alcoholic beverages; soft drinks; non-alcoholic flavored carbonated beverages; carbonated non-alcoholic drinks; non-carbonated soft drinks; fruit-flavored beverages; fruit flavored non-alcoholic beverages; non-alcoholic beverages containing fruit juices; fruit beverages with a concentrate or syrup with addition of water and sugar; fruit beverages and fruit juices; functional water-based beverages; isotonic beverages; beverages containing vitamins; energy drinks; energy drinks containing caffeine; lemonades; colas [soft drinks]; tonic water [non-medicated beverages]; non-alcoholic beer flavored beverages; beer-based cocktails; beer-based beverages; mineral water [beverages]; aerated water; powders for effervescing beverages; syrups for lemonade; syrups for beverages; sy-

rups for non-alcoholic beverages; syrups for making of lemonade; syrups for making non-alcoholic beverages.

(260) AM 2021 109307 A  
 (800) 1543756  
 (151) 2020 06 26  
 (891) 2020 06 26  
 (731) PEDIATRICA S.r.l.  
 Via A. Nicolodi, 28/A, I-57121 Livorno, Italy  
 (540)

**PediaMag**



(591) Black, white  
 (531) 02.09.15; 04.05.02; 09.03.16; 24.05.01;  
 27.07.21

(511)  
 5 – Pharmaceuticals; sanitary preparations for medical purposes; dietetic substances adapted for medical use; infant formula; vitamin supplements; plasters, materials for dressings; disinfectants; sedatives; soporifics; syrups for pharmaceutical purposes; analgesics; anti-pyretics; decongestants; antiseptics; antiparasitic preparations; medicinal drinks; herbal teas for medicinal purposes; cold cream for medical use.

(260) AM 2021 109321 A  
 (800) 1544272  
 (151) 2020 03 20  
 (891) 2020 03 20  
 (731) adp Gauselmann GmbH  
 Merkur-Allee 1-15, 32339 Espelkamp,  
 Germany  
 (540)



(591) Yellow, black, white  
 (531) 01.03.02; 01.03.20; 27.05.02; 27.05.17;  
 29.01.13

(511)  
 9 – Computer hardware and software, in particular for casino and amusement arcade games, for gaming machines, slot machines or video lottery gaming machines; programs for operating electric and electronic apparatus for games, amusement and/or entertainment purposes; printed electronic circuits; computers; computer software and computer hardware, data recording

apparatus and electronic storage media, computer circuit boards for use with electronic gaming apparatus and gaming machines; apparatus and instruments for conducting, switching, transforming, accumulating, regulating or controlling electricity; data processing equipment; electric, electronic, optical or automatic apparatus, for identifying data carriers, identity cards and credit cards, bank notes and coins; circuit boards, printed circuit boards (electronic components) and combinations thereof, being assemblies and parts for apparatus, included in this class.

28 – Slot machines and/or electronic money-based gaming apparatus with or without prizes; electric and electronic apparatus for games, amusement or entertainment purposes or automatic sports machines; coin-operated gaming machines and entertainment machines; betting machines; housings for slot machines, gaming machines and games machines; electronic or mechanical games apparatus, automatic gaming machines, games machines, slot machines operated by means of coins, tokens, bank notes, tickets or by means of electronic, magnetic or biometric storage media, in particular for commercial use in casinos and amusement arcades, with or without a prize payout; gaming machines, namely video lottery terminals and slot machines.

(260) AM 2021 109328 A  
(800) 1544503  
(151) 2020 03 02  
(891) 2020 03 02  
(731) PUIG FRANCE

65-67 avenue des Champs Elysées,  
F-75008 Paris, France

(540)

## PHANTOM PACO RABANNE

(591) Black, white  
(511)

3 – Non-medicated toiletry preparations and cosmetic products; non-medicated dentifrices; perfumery products, essential oils; bleaching preparations and other substances for laundry use; cleaning, polishing, degreasing and abrasive preparations; fragrances for personal use; eau de Cologne; eau de parfum; eaux de toilette; scented waters; perfumes; extracts of perfumes; non-medicinal products for mouth hygiene; wash and care products for the body not for medical use; lotions, milks and creams for the body not for medical use; deodorants for personal use; antiperspirants for personal use; non-medicinal soaps; non-medicinal soaps for personal use; non-medicinal soaps in liquid, solid or gel form for personal use; bath gels not for medical use; shower gels not for medical use; bathing preparations not for medical use; bath salts not for medical use; skin care preparations other than for medical use; exfoliants; talcum powder for toilet use; perfumed powders; wipes, cottons and towels impreg-

nated with perfuming and non-medicinal cosmetic lotions; cosmetics other than for medical use, non-medicinal toiletries and perfumery products for eyelash, eyebrow, eye, lip and nail care and beauty; non-medicated lip balms; nail polish; nail polish removers; adhesives for cosmetic use; cosmetic slimming preparations other than for medical use; hair treatments and preparations other than for medical use; shampoos other than for medical use; make-up products; make-up removing products; depilatories; non-medicinal shaving products; non-medicinal pre-shave products; non-medicinal after-shave products; beauty products other than for medical use; cosmetic preparations for tanning and self-tanning, other than for medical use; cosmetic kits; household perfumes; incense; potpourris [fragrances]; scented wood; products for perfuming linen; aromatic extracts (terms too vague in the opinion of the International Bureau – Rule 13 (2) (b) of the Regulations); non-medicinal preparations for animal care and cleaning; wax for tailors and shoemakers; cleaning and polishing preparations for leather and footwear.

(260) AM 2021 109329 A  
(800) 1544507  
(151) 2020 05 25  
(891) 2020 05 25

(731) Celotech chemical Co., Ltd  
Room 101, Complex Building North, Second  
Floor, No. 48 Zoumatang Road, Mudu,  
Wuzhongqu, Suzhou, 215000 Jiangsu, China

(540)

## CELOPRE

(591) Black, white  
(531) 27.05.01  
(511)

1 – Cellulose ethers for industrial purposes; starch for industrial purposes; cellulose; cellulose esters for industrial purposes; cellulose derivatives [chemicals]; glucosides; celluloid.

(260) AM 2021 109330 A  
(800) 1544531  
(151) 2020 07 08  
(891) 2020 07 08

(731) China Tobacco Jiangsu Industrial Co., Ltd.  
No. 406-3 Zhongshan North Road,  
Nanjing, 210011 Jiangsu, China

(540)



(591) Black, white  
 (531) 03.01.01; 03.01.04; 03.01.24; 04.03.03;  
 07.01.01; 09.01.10; 26.01.05; 26.01.15;  
 26.01.16

(511)  
 34 – Cigarette paper; lighters for smokers; matches; ashtrays for smokers; tobacco; electronic cigarettes; cigars; cigarettes containing tobacco substitutes, not for medical purposes; cigarettes; cigarette cases; cigarette filters.

(260) AM 2021 109341 A  
 (800) 1544795  
 (151) 2020 03 16  
 (891) 2020 03 16  
 (731) A.D. PADMASINGH ISAAC, TRADING AS  
 AACHI SPICES & FOODS  
 Old No. 4, New No. 181/1, 6th Avenue,  
 Thangam Colony, Anna Nagar West,  
 Chennai – 600040, Tamil Nadu, India

(540)



(591) Red, yellow, white  
 (531) 26.01.02; 26.01.03; 26.01.04; 26.01.22;  
 26.01.24; 27.05.01; 27.05.02; 27.05.17;  
 29.01.13

(511)  
 29 – Meat, fish, poultry and game; meat extracts; preserved, dried and cooked fruits and vegetables; jellies, jams; potato chips; fruit chips; eggs; milk and milk products; all kinds of edible oil and coconut oil; coconut powder; fats including in this class.

30 – Coffee, tea, cocoa and artificial coffee, rice, tapioca and sago, flour and preparations made from cereals, bread, pastry and confectionery, ices, sugar, honey, treacle, yeast; baking-powder, salt, mustard, vinegar, sauces (condiments), spices, ice; fruit sauces.

43 – Services for providing food and drink, temporary accommodation.

(260) AM 2021 109342 A  
 (800) 1544806  
 (151) 2020 03 04  
 (891) 2020 03 04  
 (731) Limited Liability Company "Aquabulco"  
 Pirogova street, 36, office 3, Belgorod city,  
 RU-308027 Belgorod region, Russian  
 Federation

(540)

**АКВАБУЛЬКО**  
**AQUABULCO**

(591) Black, white

(531) 28.05

(511)

35 – Administration of consumer loyalty programs; administration of frequent flyer programs; administrative assistance in responding to calls for tenders; administrative processing of purchase orders; administrative services for the relocation of businesses; advertising; advertising agency services; advertising by mail order; advisory services for business management; appointment reminder services [office functions]; appointment scheduling services [office functions]; arranging newspaper subscriptions for others; arranging subscriptions to telecommunication services for others; auctioneering; bill-posting; book-keeping; business appraisals; business auditing; business efficiency expert services; business inquiries; business intermediary services relating to the matching of potential private investors with entrepreneurs needing funding; business investigations; business management and organization consultancy; business management assistance; business management consultancy; business management for freelance service providers; business management of hotels; business management of performing artists; business management of reimbursement programs for others; business management of sports people; business organization consultancy; business project management services for construction projects; business research; commercial administration of the licensing of the goods and services of others; commercial information agency services; commercial intermediation services; commercial lobbying services; commercial or industrial management assistance; competitive intelligence services; compilation of information into computer databases; compilation of statistics; compiling indexes of information for commercial or advertising purposes; computerized file management; consultancy regarding advertising communication strategies; consultancy regarding public relations communication strategies; cost price analysis; data search in computer files for others; demonstration of goods; development of advertising concepts; direct mail advertising; dissemination of advertising matter; distribution of samples; drawing up of statements of accounts; economic forecasting; employment agency services; financial auditing; gift registry services; import-export agency services; interim business management; invoicing; layout services for advertising purposes; marketing; marketing in the framework of software publishing; marketing research; market intelligence services; market studies; media relations services; modelling for advertising or sales promotion; negotiation and conclusion of commercial transactions for third parties; negotiation of business

contracts for others; news clipping services; office machines and equipment rental; online advertising on a computer network; opinion polling; organization of exhibitions for commercial or advertising purposes; organization of fashion shows for promotional purposes; organization of trade fairs for commercial or advertising purposes; outsourced administrative management for companies; outsourcing services [business assistance]; pay per click advertising; pay per click advertising.; payroll preparation; personnel management consultancy; personnel recruitment; photocopying services; presentation of goods on communication media, for retail purposes; price comparison services; procurement services for others [purchasing goods and services for other businesses]; production of advertising films; production of teleshopping programmes; professional business consultancy; promotion of goods and services through sponsorship of sports events; providing business information; providing business information via a web site; providing commercial and business contact information; providing commercial information and advice for consumers in the choice of products and services; provision of an online marketplace for buyers and sellers of goods and services; psychological testing for the selection of personnel; publication of publicity texts; publicity material rental; public relations; radio advertising; registration of written communications and data; rental of advertising space; rental of advertising time on communication media; rental of billboards [advertising boards]; rental of office equipment in co-working facilities; rental of photocopying machines; rental of sales stands; rental of vending machines; retail services for pharmaceutical, veterinary and sanitary preparations and medical supplies; sales promotion for others; scriptwriting for advertising purposes; search engine optimization for sales promotion; secretarial services; shop window dressing; shorthand; sponsorship search; systemization of information into computer databases; targeted marketing; tax filing services; tax preparation; telemarketing services; telephone answering for unavailable subscribers; television advertising; transcription of communications [office functions]; typing; updating and maintenance of data in computer databases; updating and maintenance of information in registries; updating of advertising material; web indexing for commercial or advertising purposes; web site traffic optimization; wholesale services for pharmaceutical, veterinary and sanitary preparations and medical supplies; word processing; writing of publicity texts; writing of résumés for others.

37 – Airplane maintenance and repair; anti-rust treatment for vehicles; artificial snow-making services; asphaltting; boiler cleaning and repair; bricklaying; building construction supervision; building insulating; building of fair stalls and shops; building sealing; burglar alarm installation and repair; burner maintenance

and repair; carpentry services; chimney sweeping; cleaning of buildings [exterior surface]; cleaning of buildings [interior]; cleaning of clothing; clock and watch repair; clothing repair; construction; construction consultancy; demolition of buildings; diaper cleaning; disinfecting; drilling of deep oil or gas wells; drilling of wells; dry cleaning; electric appliance installation and repair; elevator installation and repair; factory construction; film projector repair and maintenance; fire alarm installation and repair; freezing equipment installation and repair; fur care, cleaning and repair; furnace installation and repair; furniture maintenance; furniture restoration; harbour construction; heating equipment installation and repair; hydraulic fracturing services; installation and repair of air-conditioning apparatus; installation and repair of flood protection equipment; installation, maintenance and repair of computer hardware; installation of doors and windows; interference suppression in electrical apparatus; irrigation devices installation and repair; kitchen equipment installation; knife sharpening; laundering; laying of cable; leather care, cleaning and repair; linen ironing; machinery installation, maintenance and repair; masonry; mining extraction; motor vehicle maintenance and repair; office machines and equipment installation, maintenance and repair; painting, interior and exterior; painting or repair of signs; paper hanging; parasol repair; pest control services, other than for agriculture, aquaculture, horticulture and forestry; photographic apparatus repair; pier breakwater building; pipeline construction and maintenance; plastering; plumbing.; pressing of clothing; providing construction information; providing information relating to repairs; pumicing; pump repair; quarrying services; rebuilding engines that have been worn or partially destroyed; rebuilding machines that have been worn or partially destroyed; refilling of ink cartridges; refilling of toner cartridges; renovation of clothing; rental of bulldozers; rental of cleaning machines; rental of construction equipment; rental of cranes [construction equipment]; rental of dish drying machines; rental of dishwashing machines; rental of drainage pumps; rental of excavators; rental of laundry washing machines; rental of road sweeping machines; repair of power lines; repair of security locks; restoration of musical instruments; restoration of works of art; re-tinning; retreading of tires; riveting; road paving; roofing services; rustproofing; safe maintenance and repair; sanding; scaffolding; shipbuilding; shoe repair; snow removal; sterilization of medical instruments; street cleaning; strong-room maintenance and repair; swimming-pool maintenance; telephone installation and repair; tire balancing; tuning of musical instruments; umbrella repair; underwater construction; underwater repair; upholstery; upholstery repair; varnishing; vehicle battery charging; vehicle breakdown repair services; vehicle cleaning; vehicle greasing; vehicle maintenance; vehicle polishing; vehicle service stations [refuelling and maintenance]; vehicle washing; ver-



min exterminating, other than for agriculture, aquaculture, horticulture and forestry; vulcanization of tires [repair]; warehouse construction and repair; washing of linen; window cleaning.

41 – Academies [education]; aikido instruction; amusement park services; animal training; arranging and conducting of colloquiums; arranging and conducting of concerts; arranging and conducting of conferences; arranging and conducting of congresses; arranging and conducting of in-person educational forums.; arranging and conducting of seminars; arranging and conducting of symposiums; arranging and conducting of workshops [training]; arranging of beauty contests; boarding school education; booking of seats for shows; calligraphy services; cinema presentations; club services [entertainment or education]; coaching [training]; conducting fitness classes; conducting guided climbing tours; conducting guided tours; correspondence courses; disc jockey services; discotheque services; dubbing; educational examination; educational examination for users to qualify to pilot drones; educational services provided by schools; electronic desktop publishing; entertainer services; entertainment services; film directing, other than advertising films; film distribution; film production, other than advertising films; games equipment rental; game services provided online from a computer network; gymnastic instruction; health club services [health and fitness training]; holiday camp services [entertainment]; judo instruction; karaoke services; know-how transfer [training]; language interpreter services; layout services, other than for advertising purposes; lending library services; lighting technician services for events; microfilming; mobile library services; modelling for artists; movie studio services; music composition services; news reporters services; nightclub services [entertainment]; nursery schools; online publication of electronic books and journals; orchestra services; organization of balls; organization of competitions [education or entertainment]; organization of cosplay entertainment events; organization of exhibitions for cultural or educational purposes; organization of fashion shows for entertainment purposes; organization of lotteries; organization of shows [impresario services]; organization of sports competitions; party planning [entertainment]; personal trainer services [fitness training]; photographic reporting; photography; physical education; practical training [demonstration]; presentation of circus performances; presentation of live performances; presentation of variety shows; production of music; production of radio and television programmes; production of shows; providing amusement arcade services; providing films, not downloadable, via video-on-demand services; providing golf facilities; providing information in the field of education; providing information in the field of entertainment; providing information relating to recreational activities; providing museum facilities [presentation, exhibiti-

ons]; providing online electronic publications, not downloadable; providing online music, not downloadable; providing online videos, not downloadable; providing recreation facilities; providing sports facilities; providing television programs, not downloadable, via video-on-demand services; publication of books; publication of texts, other than publicity texts; radio entertainment; recording studio services; religious education; rental of artwork; rental of audio equipment; rental of cinematographic apparatus; rental of indoor aquaria; rental of lighting apparatus for theatrical sets or television studios; rental of motion pictures; rental of radio and television sets; rental of show scenery; rental of skin diving equipment; rental of sound recordings; rental of sports equipment, except vehicles; rental of sports grounds; rental of stadium facilities; rental of stage scenery; rental of tennis courts; rental of video cameras; rental of video cassette recorders; rental of videotapes; sado instruction [tea ceremony instruction]; screenplay writing; scriptwriting, other than for advertising purposes; sign language interpretation; songwriting; sound engineering services for events; sport camp services; subtitling; teaching; television entertainment; theatre productions; ticket agency services [entertainment]; timing of sports events; toy rental; training services provided via simulators; translation; tutoring; video editing services for events; videotape editing; videotaping; vocational guidance [education or training advice]; vocational retraining; writing of texts; zoological garden services.

42 – Analysis for oil-field exploitation; architectural consultancy; architectural services; authenticating works of art; bacteriological research; biological research; business card design; calibration [measuring]; cartography services; chemical analysis; chemical research; chemistry services; clinical trials; cloud computing; cloud seeding; computer programming; computer rental; computer security consultancy; computer software consultancy; computer software design; computer system analysis; computer system design; computer technology consultancy; computer virus protection services; conducting technical project studies; construction drafting; consultancy in the design and development of computer hardware; consultancy in the field of energy-saving; conversion of computer programs and data, other than physical conversion; conversion of data or documents from physical to electronic media; cosmetic research; creating and designing website-based indexes of information for others [information technology services]; creating and maintaining web sites for others; data encryption services; data security consultancy; design of interior decor; development of computer platforms; digitization of documents [scanning]; dress designing; duplication of computer programs; electronic data storage; electronic monitoring of credit card activity to detect fraud via the internet; electronic monitoring of personally identifying information to detect identity theft via the in-

ternet; energy auditing; engineering; exploration services in the field of the oil, gas and mining industries; geological prospecting; geological research; geological surveys; graphic arts design; graphic design of promotional materials; handwriting analysis [graphology]; hosting computer sites [web sites]; industrial design; information technology [it] consultancy; information technology services provided on an outsourcing basis; installation of computer software; interior design; internet security consultancy; land surveying; maintenance of computer software; material testing; mechanical research; medical research; meteorological information; monitoring of computer systems by remote access; monitoring of computer systems for detecting unauthorized access or data breach; monitoring of computer systems to detect breakdowns; off-site data backup; oil-field surveys; oil prospecting; oil-well testing; packaging design; platform as a service [paas]; providing information relating to computer technology and programming via a web site; providing scientific information, advice and consultancy relating to carbon offsetting; providing search engines for the internet; quality control; quality evaluation of standing timber; quality evaluation of wool; recovery of computer data; rental of computer software; rental of web servers; research and development of new products for others; research in the field of building construction; research in the field of environmental protection; research in the field of physics; research in the field of telecommunications technology; research in the field of welding; scientific and technological research in the field of natural disasters; scientific and technological research relating to patent mapping; scientific laboratory services; scientific research; server hosting.; server hosting; software development in the framework of software publishing; styling [industrial design]; surveying; technical writing; technological research; telecommunications technology consultancy; textile testing; underwater exploration; unlocking of mobile phones; updating of computer software; urban planning; vehicle roadworthiness testing; water analysis; weather forecasting; web site design consultancy.

(260) AM 2021 109344 A

(800) 1193500

(151) 2013 07 04

(891) 2020 07 21

(731) OOO "BARNAULKHIMPROM"

Traktoviy Proezd, 9, Barnaul, RU-656016

Altai Territory, Russian Federation

(540)

**SIBOIL**

(591) Black, white

(511)

1 – Acetate of cellulose, unprocessed; acetates [chemicals]; acetic anhydride; acetone; acetylene; acids;

acidulated water for recharging batteries; acrylic resins, unprocessed; actinium; additives, chemical, to drilling muds; additives, chemical, to fungicides; additives, chemical, to insecticides; additives, chemical, to motor fuel; adhesives for billposting; adhesives for industrial purposes; adhesives for paperhanging; adhesives for wall tiles; agar-agar; agglutinants for concrete; agricultural chemicals, except fungicides, weed-killers, herbicides, insecticides and parasiticides; albumin [animal or vegetable, raw material]; albuminized paper; alcohol; aldehydes; alginates for industrial purposes; alkalies; alkaline iodides for industrial purposes; alkaline metals; alkaline-earth metals; alkaloids; alum; alumina; aluminium acetate; aluminium alum; aluminium hydrate; aluminium iodide; aluminium silicate; americium; ammonia [volatile alkali] for industrial purposes; ammonia alum; ammonia; ammonium aldehyde; amyl acetate; anhydrides; anhydrous ammonia; animal albumen [raw material]; animal carbon preparations; anti-boil preparations for engine coolants; antifreeze; anti-frothing solutions for batteries; anti-knock substances for internal combustion engines; antimony oxide; antistatic preparations, other than for household purposes; anti-tarnishing chemicals for windows; antranilic acid; argon; arsenic; arsenious acid; artificial resins, unprocessed; artificial sweeteners [chemical preparations]; astatine; auxiliary fluids for use with abrasives; bacterial preparations other than for medical and veterinary use; bacteriological preparations for acetification; bacteriological preparations other than for medical and veterinary use; balm of gurjun [gurjon, gurjan] for making varnish; barium; baryta paper; baryta; barytes; bases [chemical preparations]; basic gallate of bismuth; baths for galvanizing; bauxite; beer preserving agents; beer-clarifying and preserving agents; bentonite; benzene derivatives; benzene-based acids; benzoic acid; berkelium; bicarbonate of soda for chemical purposes; bichloride of tin; bichromate of potassium; bichromate of soda; biochemical catalysts; biological preparations, other than for medical or veterinary purposes; bird-lime; bismuth nitrite for chemical purposes; bismuth; bleaching preparations [decolorants] for industrial purposes; blueprint paper; borax; boric acid for industrial purposes; brake fluid; brazing preparations; brickwork preservatives, except paints and oils; bromine for chemical purposes; calcined soda; calcium carbide; calcium cyanamide [fertilizer]; californium; camphor, for industrial purposes; carbide; carbolineum for the protection of plants; carbon for filters; carbon sulphide; carbonates; carbonic acid; casein for industrial purposes; cassiopium [lutetium]; catalysts; catechu; caustic soda for industrial purposes; caustics for industrial purposes; cement [metallurgy]; cement for mending broken articles; cement preservatives, except paints and oils; cement-waterproofing preparations, except paints; ceramic compositions for sintering [granules and powders]; ceramic glazings; ceramic materials in particulate form, for use as filtering

media; chemical additives for oils; chemical condensation preparations; chemical preparations for facilitating the alloying of metals; chemical preparations for scientific purposes, other than for medical or veterinary use; chemical preparations for smoking meat; chemical preparations for the manufacture of paints; chemical preparations to prevent mildew; chemical preparations to prevent wheat smut; chemical preparations, except pigments, for the manufacture of enamel; chemical substances for analyses in laboratories, other than for medical or veterinary purposes; chemical substances for preserving foodstuffs; china slip; cholic acid; chrome alum; chromic acid; chromium oxide; cinematographic film, sensitized but not exposed; citric acid for industrial purposes; clarification preparations; coal saving preparations; cobalt oxide for industrial purposes; collodion; color-brightening chemicals for industrial purposes; combusting preparations [chemical additives to motor fuel]; compositions for repairing inner tubes of tires [tyres]; compost; concrete-aeration chemicals; condensation-preventing chemicals; preparations for stimulating cooking for industrial purposes; coolants for vehicle engines; copper sulphate [vitriol]; corrosive preparations; creosote for chemical purposes; crotonic aldehyde; cryogenic preparations; cultures of microorganisms other than for medical and veterinary use; curium; currying preparations for leather; currying preparations for skins; damp proofing preparations, except paints, for masonry; defoliant; degreasing preparations for use in manufacturing processes; degumming preparations; dehydrating preparations for industrial purposes; detergent additives to petrol [gasoline]; detergents for use in manufacturing processes; diagnostic preparations, other than for medical or veterinary purposes; diastase for industrial purposes; diatomaceous earth; diazo paper; dioxide of hydrogen; disincrustants; dispersions of plastics; distilled water; dolomite for industrial purposes; dressing and finishing preparations for textiles; dressing, except oils, for skins; dry ice [carbon dioxide]; dysprosium; earth for growing; electrophoresis gels, other than for medical or veterinary purposes; emollients for industrial purposes; emulsifiers; enamel and glass-staining-chemicals; enamel-staining chemicals; engine-decarbonising chemicals; enzyme preparations for industrial purposes; epoxy resins, unprocessed; ethyl alcohol; europium; expanded-clay for hydroponic plant growing [substrate]; fat-bleaching chemicals; fatty acids; fertilizers; fertilizing preparations; fillers for automobile bodies; filtering materials [chemical preparations]; filtering materials [mineral substances]; filtering materials [unprocessed plastics]; filtering materials [vegetable substances]; filtering preparations for the beverages industry; finishing preparations for use in the manufacture of steel; fire extinguishing compositions; fissionable material for nuclear energy; fixing baths [photography]; fixing solutions [photography]; flashlight preparations; flocculants; flour for industrial purposes; flower preservati-

ves; fluids for hydraulic circuits; formic acid; foundry binding substances; foundry molding [moulding] preparations; foundry sand; fuel-saving preparations; fuller's earth for use in textile industry; fulling preparations for use in textile industry; gadolinium; gallic acid for the manufacture of ink; gallium; gallnuts; gallo-tannic acid; galvanizing preparations; gambier; gas propellents for aerosols; gelatine for industrial purposes; gelatine for photographic purposes; getters [chemically active substances]; glass-frosting chemicals; glass-staining chemicals; glaziers' putty; glucose for industrial purposes; glucosides; glue for industrial purposes; gluten [glue], other than for stationery or household purposes; glycerides; glycerine for industrial purposes; glycol; grafting mastic for trees; grafting wax for trees; graphite for industrial purposes; guano; gum arabic for industrial purposes; gums [adhesives], other than for stationery or household purposes; heavy water; helium; holmium; hormones for hastening the ripening of fruit; horticulture chemicals, except fungicides, herbicides, insecticides and parasiticides; humus top dressing; humus; hydrates; hydrazine; hydrochloric acid; hydrofluoric acid; hydrogen; hypochlorite of soda; hyposulphites; iodic acid; iodine for chemical purposes; iodine for industrial purposes; iodised albumen; ion exchangers [chemical preparations]; isinglass other than for stationery, household or alimentary purposes; isotopes for industrial purposes; kainite; ketones; kieselgur; krypton; lactic acid; lanthanum; lead acetate; lead arsenate; lead oxide; leather glues; leather-dressing chemicals; leather-impregnating chemicals; leather-waterproofing chemicals; lecithin [raw material]; lime acetate; lime carbonate; lime chloride; limestone hardening substances; liquids for removing sulphates from accumulators; lithia [lithium oxide]; lithium; litmus paper; magnesite; magnesium carbonate; magnetic fluid for industrial purposes; malt albumen; manganate; manganese dioxide; mangrove bark for industrial purposes; masonry preservatives, except paints and oils; mastic for leather; mastic for tires [tyres]; meat tenderizers for industrial purposes; mercuric oxide; metal earths; metal hardening preparations; metal tempering preparations; metalloids; methane; methyl benzol; mineral acids; moderating materials for nuclear reactors; moistening [wetting] preparations for use in bleaching; moistening [wetting] preparations for use in dyeing; moistening [wetting] preparations for use in the textile industry; mold-release preparations; mordants for metals; must-fining preparations; naphthalene; neodymium; neon; neptunium; nitrate of uranium; nitrate paper; nitrates; nitric acid; nitric monoxide; nitrogen; nitrogenous fertilizers; oenological bactericides [chemical preparations used in wine making]; oil cement [putty]; oil dispersants; oil-bleaching chemicals; oil-purifying chemicals; oils for currying leather; oils for preparing leather in the course of manufacture; oils for tanning leather; oils for the preservation of food; oil-separating chemicals; oleic acid; olivine [chemical

preparations]; opacifiers for enamel or glass; opacifiers for enamel; opacifiers for glass; organic-bleaching chemicals; oxalates; oxalic acid; oxygen; paper pulp; peat pots for horticulture; pectin [photography]; perborate of soda; percarbonates; perchlorates; persulphates; persulphuric acid; petroleum dispersants; phenol for industrial purposes; phosphoric acid; photometric paper; picric acid; plant growth regulating preparations; plasticizers; plastics, unprocessed; plastisols; plutonium; polish removing substances; polonium; potash water; potash; potassium dioxalate; potassium; potato flour for industrial purposes; power steering fluid; praseodymium; preparations for preventing the tarnishing of glass; preparations for preventing the tarnishing of lenses; preparations for the separation of greases; preparations of the distillation of wood alcohol; preparations of trace elements for plants; preservatives for pharmaceutical preparations; preservatives for tiles, except paints and oils; protective gases for welding; pyrogallol; quebracho for industrial purposes; radiator flushing chemicals; rare earths; reagent paper, other than for medical or veterinary purposes; reducing agents for use in photography; refrigerants; renovating preparations for phonograph records; rubber preservatives; sal ammoniac; salicylic acid; salpêtre; salts for galvanic cells; salts for industrial purposes; salts of precious metals for industrial purposes; scale removing preparations, other than for household purposes; sea water for industrial purposes; seaweeds [fertilizers]; sebacic acid; seed preserving substances; sensitized paper; sensitized plates for offset printing; separating and unsticking [ungluing] preparations; silicates; silicon; silicones; silver nitrate; sizing preparations; soap [metallic] for industrial purposes; soda ash; sodium; soldering chemicals; solidified gases for industrial purposes; solutions for cyanotyping; solvents for varnishes; sorrel salt; spirits of vinegar [dilute acetic acid]; stain-preventing chemicals for use on fabrics; starch for industrial purposes; starch paste [adhesive], other than for stationery or household purposes; starch-liquifying chemicals [ungluing agents]; stearic acid; substances for preventing runs in stockings; substrates for soil-free growing [agriculture]; sulphuric acid; sulphurous acid; surface-active chemical agents; synthetic materials for absorbing oil; synthetic resins, unprocessed; tan; tannic acid; tanning substances; tan-wood; tapioca flour for industrial purposes; tartar other than for pharmaceutical purposes; tartaric acid; test paper, chemical; textile-brightening chemicals; textile-impregnating chemicals; textile-waterproofing chemicals; tire repairing compositions; titanium dioxide for industrial purposes; toxic gas neutralizers; transmission fluid; tree cavity fillers [forestry]; tungstic acid; uranium oxide; wallpaper removing preparations; water glass [soluble glass]; water purifying chemicals; water-softening preparations; wax-bleaching chemicals; vine disease preventing chemicals; wine finings; viscose; witherite; wood pulp; vulcanisation accelerators; vulcanising prepara-

tions; xenon; x-ray films, sensitized but not exposed; ytterbium; yttrium; zirconia.

3 – Abrasive cloth; abrasive paper; abrasives; adhesives for affixing false eyelashes; adhesives for affixing false hair; adhesives for cosmetic purposes; after-shave lotions; almond milk for cosmetic purposes; almond oil; almond soap; alum stones [astringents]; amber [perfume]; ammonia [volatile alkali] [detergent]; antiperspirant soap; antiperspirants [toiletries]; antistatic preparations for household purposes; aromatics [essential oils]; astringents for cosmetic purposes; badian essence; bases for flower perfumes; bath salts, not for medical purposes; beard dyes; beauty masks; bergamot oil; bleaching preparations [decolorants] for cosmetic purposes; bleaching salts; bleaching soda; breath freshening sprays; cake flavourings [essential oils]; cakes of toilet soap; canned pressurized air for cleaning and dusting purposes; carbides of metal [abrasives]; cleaning chalk; cleaning preparations; cleansing milk for toilet purposes; cloths impregnated with a detergent for cleaning; cobblers' wax; colorants for toilet purposes; color-brightening chemicals for household purposes [laundry]; color-removing preparations; corundum [abrasive]; cosmetic creams; cosmetic dyes; cosmetic kits; cosmetic pencils; cosmetic preparations for baths; cosmetic preparations for eyelashes; cosmetic preparations for skin care; cosmetic preparations for slimming purposes; cosmetics; cotton sticks for cosmetic purposes; cotton wool for cosmetic purposes; creams for leather; decorative transfers for use in manufacturing processes; dental bleaching gels; dentifrices; denture polishes; deodorant soap; deodorants for human beings or for animals; depilatories; depilatory wax; detergents other than for use in manufacturing operations and for medical purposes; diamantine [abrasive]; disinfectant soap; dry-cleaning preparations; eau de cologne; emery paper; emery; essential oils of cedarwood; essential oils of lemon; essential oils; ethereal essences; extracts of flowers [perfumes]; eyebrow cosmetics; eyebrow pencils; fabric softeners for laundry use; false eyelashes; false nails; flavorings for beverages [essential oils]; floor wax removers [scouring preparations]; floor wax; fumigation preparations [perfumes]; refurbishing preparations; gaultheria oil; geraniol; glass cloth; glass paper; greases for cosmetic purposes; grinding preparations; hair colorants; hair lotions; hair spray; hair waving preparations; heliotropine; hydrogen peroxide for cosmetic purposes; incense; ionone [perfumery]; jasmine oil; javelle water; joss sticks; lacquer-removing preparations; laundry bleach; laundry blueing; laundry glaze; laundry preparations; laundry soaking preparations; laundry starch; laundry wax; lavender oil; lavender water; leather bleaching preparations; leather preservatives [polishes]; lipsticks; lotions for cosmetic purposes; make-up powder; make-up preparations; make-up removing preparations; make-up; mascara; medicated

soap; mint essence [essential oil]; mint for perfumery; moustache wax; mouth washes, not for medical purposes; musk [perfumery]; nail care preparations; nail varnish; neutralizers for permanent waving; non-slipping liquids for floors; non-slipping wax for floors; oil of turpentine for degreasing; oils for cleaning purposes; oils for cosmetic purposes; oils for perfumes and scents; oils for toilet purposes; paint stripping preparations; pastes for razor strops; perfumery; perfumes; petroleum jelly for cosmetic purposes; polish for furniture and flooring; polishing creams; polishing paper; polishing preparations; polishing rouge; polishing stones; polishing wax; pomades for cosmetic purposes; potpourris [fragrances]; preparations for cleaning dentures; preparations for unblocking drain pipes; preparations to make shiny the leaves of plants; pumice stone; quillaia bark for washing; rose oil; rust removing preparations; sachets for perfuming linen; saffrol; scale removing preparations for household purposes; scented water; scented wood; scouring solutions; shampoos for pets; shampoos; shaving preparations; shaving soap; shaving stones [astringents]; shining preparations [polish]; shoe cream; shoe wax; shoemakers' wax; silicon carbide [abrasive]; skin whitening creams; smoothing preparations [starching]; smoothing stones; soap for brightening textile; soap for foot perspiration; soap; soda lye; stain removers; starch glaze for laundry purposes; sun-tanning preparations [cosmetics]; tailors' wax; talcum powder, for toilet use; terpenes [essential oils]; tissues impregnated with cosmetic lotions; toilet water; toiletries; tripoli stone for polishing; turpentine, for degreasing; varnish-removing preparations; volcanic ash for cleaning; wall-paper cleaning preparations; washing soda, for cleaning; whitening; windscreen cleaning liquids.

4 – Additives, non-chemical, to motor-fuel; alcohol [fuel]; anthracite; beeswax; belting wax; bone oil for industrial purposes; candles; carnauba wax; castor oil for technical purposes; ceresine; charcoal [fuel]; christmas tree candles; coal briquettes; coal dust [fuel]; coal naphtha; coal tar oil; coal; coke; combustible briquettes; combustible oil; cutting fluids; diesel oil; dust binding compositions for sweeping; dust laying compositions; dust removing preparations; electrical energy; firelighters; firewood; fish oil, not edible; fuel with an alcoholic base; grease for arms [weapons]; grease for belts; grease for boots; grease for leather; illuminating grease; illuminating wax; industrial grease; industrial oil; industrial wax; kerosene; lamp wicks; lighting fuel; lignite; ligroin; lubricants; lubricating graphite; lubricating grease; lubricating oil; mazut; methylated spirit; mineral fuel; moistening oil; motor oil; nightlights [candles]; non-slipping preparations for belts; oil for the preservation of leather; oil for the preservation of masonry; oils for paints; oils for releasing form work [building]; oleine; ozocerite [ozokerite]; paper spills for lighting; paraffin; peat [fuel]; peat briquettes [fuel]; perfumed candles; petro-

leum ether; petroleum jelly for industrial purposes; preservatives for leather [oils and greases]; rape oil for industrial purposes; soya bean oil preparations for non-stick treatment of cooking utensils; stearine; sunflower oil for industrial purposes; tallow; textile oil; vaporized fuel mixtures; wax [raw material]; wicks for candles; wood briquettes; wood spills for lighting; wool grease; xylene; xylo.

(260) AM 2021 109350 A

(800) 1537428

(151) 2020 03 04

(891) 2020 07 21

(731) British American Tobacco (Brands) Limited  
British American Tobacco Plc, Globe  
House, 4 Temple Place, London WC2R 2PG,  
United Kingdom

(540)

## RYDE

(591) Black, white

(511)

5 – Dietary and nutritional supplements; CBD oil for medical purposes; dietary preparations containing CBD oil; gum containing nicotine for use as an aid to stop smoking; ouches containing nicotine for use as an aid to stop smoking; patches containing nicotine for use as an aid to stop smoking; food supplements; vitamin, mineral and nutritional supplements; herbal supplements; nutritional supplements in the nature of vitamin and mineral beverages; vitamin and mineral fortified preparations for oral use sold in pouch form for medical purposes; vitamin and mineral fortified lozenges for pharmaceutical purposes; nutritional supplement meal replacement products for boosting energy; tobacco-free cigarettes for medical purposes; tobacco substitutes for medical purposes; herbs for medicinal purposes including dried herbs, liquid herbal extracts and herbal capsules; nicotine preparations for medical purposes, including loose and prepackaged powder tobacco (snus); transdermal patches for medical treatment.

30 – Chewing gums; natural and herbal flavourings (other than essential oils) for chewing gum, lozenges, candy, candy mints and gummy candy; lozenges [confectionery]; candy; candy mints; gummy candy; hemp and derivative based or infused edible products, namely, chewing gums, lozenges [confectionery], candy, candy mints, gummy candy.

32 – Energy drinks.

34 – Cigarettes; tobacco, raw or manufactured; tobacco products; tobacco substitutes (not for medical purposes); cigars; cigarillos; lighters; matches; smokers' articles; cigarette paper; cigarette tubes; cigarette filters; pocket apparatus for rolling cigarettes; hand held machines for injecting tobacco into paper tubes; elec-

tronic cigarettes; accessories for electronic cigarettes; liquids for electronic cigarettes; tobacco products for the purpose of being heated; devices and parts for devices for heating tobacco; accessories for devices for heating tobacco; tobacco substitutes for the purpose of inhalation; cigarettes containing tobacco substitutes; cigarette cases; cigarette boxes; snus with tobacco; snuff with tobacco; snus without tobacco; snuff without tobacco; tobacco free oral nicotine pouches (not for medical use).

(260) AM 2021 109391 A

(800) 1544954

(151) 2020 06 10

(891) 2020 06 10

(731) Dmitry Ganzha

Gentzgasse 21/2/28, A-1180 Wien, Austria

(540)



(591) Red, white

(531) 26.04.02; 26.04.05; 26.04.24; 27.05.01;  
27.05.24; 29.01.12

(511)

9 – Signalling, life-saving apparatus and instruments; warning devices for vehicles, in particular warning triangles for vehicles.

(260) AM 2021 109392 A

(800) 1544970

(151) 2020 06 03

(891) 2020 06 03

(731) HYUNDAI MOTOR COMPANY

12, Heolleung-ro, Seocho-gu, Seoul,  
Republic of Korea

(540)



(591) Black, white

(531) 03.07.17; 24.01.15; 24.01.17; 27.05.02

(511)

38 – Electronic transmission of automobile information and data; transmission of automobile information via communication network; telecommunications; telecommunications services provided wireless networks; transmission of electronic information by national and international networks; transmission of information on optical telecommunication networks; transmission of news; rental of data communications installations; transmission and reception (transmission) of database information via telecommunication

network; emergency alarm services via telecommunication network; communication of data by means of telecommunications; communications by satellite; information about telecommunication; communications by computer terminals; transmission of images; internet access services; providing telecommunications connections to a global computer network; satellite transmission and television broadcasting services; broadcasting and transmission of television programs; providing access to web sites via mobile and internet; transmission of advertising programs and media advertising communications via digital communications network; car telephone communications services; wireless telecommunication services for providing remote diagnosis, traffic information, living information, emergency recovery information, multimedia in vehicles; providing navigation service via the data network; providing application access to via the wireless local area network for vehicles; providing navigation service via the data network for vehicles; providing access to multimedia content on-line for vehicles; providing access to a global computer network via mobile devices for automobiles; wireless communication network service for vehicles; electronic transmission of smart phone application data linked to vehicles; providing long distance telecommunications services for vehicles; providing access to mobile content via cellular telephone for vehicles; data transmission via telematics networks (including those for automobile); information transmission by telematics codes (including those for automobile); information transmission via telematics networks (including those for automobile); telematics communication services (including those for automobile); telematics services (including those for automobile); communication by mobile telephone (including those for automobile); electronic data transmission (including those for automobile); transmission of information via national and international networks (including those for automobile); transmission of news (including those for automobile); transmission of sound, picture and data signals (including those for automobile); transmission of sound, video and information (including those for automobile); provision of access to the internet (including those for automobile); providing access to databases (including those for automobile); text messaging services (including those for automobile).

(260) AM 2021 109404 A

(800) 1545374

(151) 2020 05 18

(891) 2020 05 18

(731) ANKER INNOVATIONS TECHNOLOGY  
CO., LTD.

Room 701, 7F Building 7, 1st Phase Of  
Headquarters Building Of, Changsha  
Zhongdian Software Park, Co., Ltd., No. 39  
Jianshan Road, Changsha National, China

(540)

**NEBULA**

(591) Black, white

(511)

9 – Astronomical projector; profile projectors; selfie sticks [hand-held monopods]; automatic focus projectors; video projectors; slides [photography]; eyeglasses; projection screens; cameras [photography]; remote controller for projector; transparency projection apparatus; slide projectors; projection apparatus.

(260) AM 2021 109406 A

(800) 1545431

(151) 2020 06 08

(891) 2020 06 08

(731) S.C. Johnson &amp; Son, Inc.

1525 Howe Street, Racine, WI 53403-2236,  
USA

(540)

**SPARK ENERGY**

(591) Black, white

(511)

3 – Air-fragrancing preparations or room fragrances; essential oils for perfuming the atmosphere; air fragrances; air perfuming preparations; potpourris [fragrances]; incense.

4 – Candles (lighting); perfumed candles.

(260) AM 2021 109407 A

(800) 1545474

(151) 2019 12 11

(891) 2019 12 11

(731) Henkel AG &amp; Co. KgaA

Henkelstrasse 67, 40589 Düsseldorf, Germany

(540)



(591) Green, blue and white

(531) 01.15.09; 05.03.15; 26.15.01; 27.05.09;  
29.01.13

(511)

3 – Bleaching preparations for laundry use; cleaning substances for laundry use; rinsing agents for laundry use and tableware; dishwashing rinsing agents; stain removing preparations; cleaning, polishing, scouring and abrasive preparations; bleaching preparations for household purposes; cleaning agents for household purposes; spot remover; non-medicated soaps for household use; perfumery; essential oils, essential oils for household use, scented linen sprays, pomanders (aromatic substances) for laundry purposes, scented oils for laundry purposes, scented sachets for laundry purposes; sachets for perfuming linen, fragrance preparations for laundry purposes, laundry blueing; laundry preparations for attracting dyes; color-removing preparations for laundry purposes; grease-removing preparations for laundry purposes; stain removers for laundry purposes; laundry liquids, laundry glaze for laundry purposes; starch glaze for laundry purposes; smoothing preparations (starching) for laundry purposes; hand washes; adhesive removers for laundry purposes; leather bleaching preparations; cloths impregnated with a detergent for cleaning; soap powder; oils for cleaning purposes for laundry purposes, scented soaps for laundry purposes, washing conservation agents; upholstery cleaners; dry-cleaning preparations for laundry purposes; cleansing gels for laundry purposes; cleaning fluids for laundry purposes; foam detergents for laundry purposes; rust removing preparations for laundry purposes; spray cleaners for use on textiles; rinsing agents for laundry, starch for cleaning purposes; synthetic detergents for clothes; detergent strengtheners; agents for removing wax for laundry purposes; laundry soaking preparations; fabric softener for laundry; laundry balls containing laundry detergent; laundry preparations; washing liquids; detergent soap; laundry additives; impregnated treated synthetic cellulose non-woven aperture sheets used in washing; crust preventing and crust resolving agents for pipes and apparatus, namely decalcification agents for household purpose; room fragrancing preparations.

5 – Disinfectants, deodorants and deodorising agents, except for human and animals, air refreshing and air deodorising agents; air deodorizer sprays; insecticides, insect repellents, insect attractants, adhesives and/ or adhesive strips for catching insects; agents for disruption or inhibition of mating of insects; preparations for destroying vermin; fungicides, herbicides; parasiticides and antiparasitic preparations; carpet deodorizers; household deodorizer; odor neutralizing preparations for use on carpets, fabrics, upholstery and in the air; refills for air deodorizers; room deodorants.

11 – Apparatus and installations for sanitary purposes.

21 – Sponges, brushes (except paint brushes), cleaning clothes, articles for cleaning purposes; hand-operated cleaning articles; dispenser for air freshener; treated synthetic cellulose cleaning cloths used in washing; electric and/ or electronic apparatus, instruments and devices for use in destroying, attracting and killing insects; parts and fittings for all the aforesaid goods; devices for trapping, repelling, capturing or killing insects and vermin; vermin and insect traps or catchers, cockroach traps or catchers; cups, jars or



dishes made of paper, plastic or metal for trapping insects.

(260) AM 2021 109408 A

(800) 1545478

(151) 2020 06 25

(891) 2020 06 25

(731) CARIMALI S.p.A.

Via Monte Grappa 7, I-24121 BERGAMO,

Italy

(540)

## HEYLO

(591) Black, white

(511)

7 – Power-operated coffee grinders; electric coffee grinders; dishwashers for plates, glasses and cups; juice extracting machines; automatic dispensers of coffee and other drinks.

11 – Electric coffee brewers; espresso and cappuccino makers; fully automatic coffee machines; electric coffee filters; water softening units; fridges; cup-warming apparatus; hot water heaters; electric chocolate makers; electric apparatus for bars, including small ovens, apparatus for cooking, bread toasters, electric roasting spits.

21 – Coffee percolators, non-electric; coffee filters, non-electric; coffeepots, non-electric; coffee mugs; coffee stirrers; coffee services [tableware].

(260) AM 2021 109421 A

(800) 1545875

(151) 2020 02 06

(891) 2020 02 06

(731) Egis Gyógyszergyár Zrt.

Keresztúri út 30-38, H-1106 Budapest, Hungary

(540)

## PSORIODERM

(591) Black, white

(511)

3 – Bleaching preparations and other substances for laundry use; perfumery, essential oils; cosmetics; shampoos; skin lotion; pomades for cosmetic purposes.

5 – Pharmaceutical preparations; veterinary preparations; sanitary preparations for medical purposes; medicated lotions; dermatological preparations; plasters, materials for dressings; disinfectants.

9 – Apparatus for recording, transmission or reproduction of sound or images; equipment for processing and transmission of data and information; software; computer software for analysing, storing and monitoring physiological data; personal digital assistant; connected bracelets [measuring instruments]; smartwatches; computer software for medical purposes; down-

loadable applications for use with mobile devices; artificial intelligence software; wearable activity trackers; educational mobile applications; tracking devices for medical devices.

10 – Surgical, medical, veterinary and dental apparatus and instruments; medical measuring instruments and apparatus; diagnostic tools for medical purposes; analyzers for medical purposes.

44 – Medical services; diagnostic services; hygienic and beauty care for humans; consultancy in the field of pharmacy, health care and therapy; remote medical examinations; remote medical monitoring of patients.

(260) AM 2021 109424 A

(800) 448210

(151) 1979 09 25

(891) 2020 07 29

(731) BOCKHOLD, naamloze vennootschap

Reppelerweg 1, B-3950 Bocholt, Belgium

(540)

## MARTENS

(591) Black, white

(531) 27.05.01; 27.05.17

(511)

32 – Beer.

(260) AM 2021 109445 A

(800) 1545981

(151) 2020 03 04

(891) 2020 03 04

(731) ÖZMER PASTACILIK VE İÇECEK ÜRÜNLERİ SANAYİ PAZARLAMA TURİZM VE DIŞ TİCARET ANONİM ŞİRKETİ

Şerifali Mahallesi, Beyit Sokak, No:54

Ümraniye, TR-34775 İstanbul, Turkey

(540)



(591) Black and red

(531) 26.04.10; 26.04.18; 26.11.08; 26.11.12;

27.05.19; 29.01.13

(511)

29 – Meat, fish, poultry and game; processed meat products; dried pulses; soups, bouillon; processed olives, olive paste; milk and milk products, butter; edible oils; dried, preserved, frozen, cooked, smoked or salted fruits and vegetables; tomato paste; prepared nuts



and dried fruits as snacks; hazelnut spreads and peanut butter; tahini (sesame seed paste); eggs and powdered eggs; potato chips.

30 – Coffee, cocoa; coffee or cocoa based beverages, chocolate based beverages; pasta, stuffed dumplings, noodles; pastries and bakery products based on flour; desserts based on flour and chocolate; bread, simit [Turkish ring-shaped bagel covered with sesame seeds], pasties, pita, sandwiches, pies, cakes, baklava [Turkish dessert based on dough coated with syrup], desserts based on dough coated with syrup; puddings, custard, rice pudding; honey, bee glue for human consumption, propolis for food purposes; condiments for foodstuff, vanilla (flavoring), spices, sauces (condiments), tomato sauce; yeast, baking powder; flour, semolina, starch for food; sugar, cube sugar, powdered sugar; tea, iced tea; confectionery, chocolate, biscuits, crackers, wafers; chewing gums; ice-cream, edible ices; salt; cereal-based snack food, popcorn, crushed oats, corn chips, breakfast cereals, processed wheat for human consumption, crushed barley for human consumption, processed oats for human consumption, processed rye for human consumption, rice; molasses for food.

32 – Beers; preparations for making beer; mineral water, spring water, table water, soda water; fruit and vegetable juices, fruit and vegetable concentrates and extracts for making beverages, non-alcoholic soft drinks; energy drinks, protein-enriched sports beverages.

(260) AM 2021 109446 A

(800) 1545983

(151) 2020 05 27

(891) 2020 05 27

(731) S.C. Johnson & Son, Inc.

1525 Howe Street, Racine, Wisconsin  
53403-2236, USA

(540)

## **SC JOHNSON A FAMILY COMPANY**

(591) Black, white

(511)

1 – Waterproofing chemicals for footwear, leather or textiles; chemical shoe stretching compositions.

2 – Dyes, colorants, mordants and inks for use in the manufacture of footwear and goods of leather.

3 – Preparations for anti-fouling and stain-preventing pretreatment of textiles including clothing, upholstery and carpets and rugs; stain removers for removing dirt and stains for textiles, including clothing, upholstery, carpets and rugs; soaps other than for body care; detergents other than for personal care; waxes for floors; furniture polish; protective coatings (waxes, sealants,

polishes) for furniture, floors; preparations for unblocking pipe systems; cleaners for hard surfaces; bleaching preparations and other substances for use on textiles; disposable wipes impregnated with cleaning chemicals or chemical compounds for household use; products for scouring and removing varnishes; preparations in the form of waxes for application to finished or unfinished surfaces, namely wax for floors, flooring, footwear, furniture, leather, plastic or vinyl surfaces; preparations for scouring and removing wax; all-purpose household cleaners; toilet bowl detergents; all-purpose cleaners for glass, windows and multi-surfaces; wipes and synthetic cellulose sheets impregnated with preparations for use in washing machines for the absorption of dirt and for anti-fading during a wash; air fragrancing preparations; room or atmosphere perfumes; essential oils for perfuming the atmosphere; potpourris [fragrances]; incense; cleaning, polishing, degreasing and abrasive preparations; polishes, creams and pigmented dressings for footwear and leather goods; products for the preservation of leather, namely, waxes for the preservation of leather, creams for the preservation of leather; dry-cleaning preparations, namely, dry chemical preparations in the form of tablets, of powder for cleaning and other preparations for cleaning leather, suede, vinyl, plastic and products made of these materials; scuff remover from leather and vinyl goods; polish and cream for footwear and leather goods, including for covering scuff marks; products for the preservation of footwear and goods made of leather, namely, polish for footwear and goods of leather; wipes impregnated with cleaning and polishing preparations; oil for the protection of feet against cracks or crevices (not for medical use).

4 – Candles (lighting), liquid or solidified melted scented wax; citronella candles for use as insect repellent, namely, candles containing an insect repellent; perfumed candles.

5 – Liquid and spray disinfectants other than for personal use; air sanitizing products; air room or atmosphere deodorizers; deodorants (not for personal use); air purifying preparations; indoor deodorants for carpets and rugs, deodorants for fabrics and textile materials; insect repellents, insecticides and insect repellents; wipes pre-moistened with an insect repellent preparation for use on the body; anti-mosquito coils; insect baits containing insecticides to control insects and pests and vermin; medicated ointments to soothe and treat itching and redness caused by insect bites; anti-fungal preparation for feet in spray form; shoe deodorizers.

11 – Electric diffusers for air fresheners and perfumes; candle lanterns and lamps for insect repellents.

16 – Plastic bags for all domestic uses; plastic vacuum-closable storage bags for household use; plastic packaging; adhesives for repairing shoes, rain-wear

and other surfaces of leather, rubber, nylon, plastics, canvas, linen or vinyl.

21 – Plastic containers for household use; small utensils and containers for household use (not of precious metals nor coated therewith); shoe horns; shoe trees (stretchers); cloths for cleaning, polishing, waxing, glossing; waxing and polishing sponges; shoe brushes; hand tool for cleaning glass containing cleaning pads; scrubbing brushes for household use.

25 – Non-slipping devices for footwear; anti-skid soles and insoles for footwear; soles, inner soles and pads (soles) for footwear; heels and heelpieces for footwear; heel plates for footwear, heel pads for footwear, heels and stocking protectors (socks) for stockings and tights; socks, stockings and tights.

26 – Shoe laces.

(260) AM 2021 109526 A

(800) 1547016

(151) 2020 02 06

(891) 2020 02 06

(731) Egis Gyógyszergyár Zrt.

Keresztúri út 30-38, H-1106 Budapest,  
Hungary

(540)

**ПСОРИОДЕРМ**

(591) Black, white

(531) 28.05

(511)

3 – Bleaching preparations and other substances for laundry use; perfumery, essential oils; cosmetics; shampoos; skin lotion; pomades for cosmetic purposes.

5 – Pharmaceutical preparations; veterinary preparations; sanitary preparations for medical purposes; medicated lotions; dermatological preparations; plasters, materials for dressings; disinfectants.

9 – Apparatus for recording, transmission or reproduction of sound or images; equipment for processing and transmission of data and information; software; computer software for analysing, storing and monitoring physiological data; personal digital assistant; connected bracelets [measuring instruments]; smartwatches; computer software for medical purposes; downloadable applications for use with mobile devices; artificial intelligence software; wearable activity trackers; educational mobile applications.

10 – Surgical, medical, veterinary and dental apparatus and instruments; medical measuring instruments and apparatus; diagnostic tools for medical purposes; analyzers for medical purposes; monitoring apparatus for medical purposes.

44 – Medical services; diagnostic services; hygienic and beauty care for humans; consultancy in the field

of pharmacy, health care and therapy; medical examinations; remote monitoring of patients via wireless physiological monitoring apparatus.

(260) AM 2021 109527 A

(800) 1547047

(151) 2020 07 21

(891) 2020 07 21

(731) PFD Co., Ltd.

#2F, 627, Ahasan-ro, Gwangjin-gu, Seoul,  
Republic of Korea

(540)

**스떼블랑**

**STEBLANC**

(591) Black, white

(531) 28.03

(511)

3 – Lavender oil; lipsticks; nail polish; make-up; cosmetic preparations for baths; badian essence; shaving stones [astringents]; shampoos; nail art stickers; cosmetic preparations for skin care; eye liner; eye shadow; balms, other than for medical purposes; false eyelashes; dentifrices; perfume; hair gel; cosmetic soaps; cotton wool for cosmetic purposes; cosmetics.

(260) AM 2021 109528 A

(800) 1547070

(151) 2020 06 02

(891) 2020 06 02

(731) Weihai Gaosai Metal Product Co., Ltd.

No. 1, Gaosai Road, Wangtuan Town,  
Lingang, Economic and Technological  
Development, 264200 Zone, Weihai City,  
Shandong Province, China

(540)

**GAOSAI**

(591) Black, white

(531) 27.05.17

(511)

6 – Frames of metal for building; grilles of metal; buildings of metal; girders of metal; stables of metal; palings of metal; fences of metal; pigsties of metal; ropes of metal; straps of metal for handling loads.

(260) AM 2021 109529 A

(800) 1547086

(151) 2020 07 07

(891) 2020 07 07

(731) Kerry Luxembourg S.à.r.l.

17 rue Antoine Jans, L-1820 Luxembourg,  
Luxembourg

(540)



(591) Olive

(531) 05.01.03; 05.01.05; 05.01.11; 26.04.15;  
27.05.10; 29.01.03

(511)

29 – Frozen fruit purees; pasteurised fruit purees; frozen fruits; frozen fruit coulis; prepared, dried, cooked and frozen fruits and vegetables.

(260) AM 2021 109530 A

(800) 1547110

(151) 2020 07 29

(891) 2020 07 29

(731) China Tobacco Jiangsu Industrial Co., Ltd.  
No. 406-3 Zhongshan North Road, Nanjing,  
210011 Jiangsu, China

(540)

(591) Black, white

(531) 27.05.01; 27.05.13

(511)

34 – Cigarette paper; lighters for smokers; matches; ashtrays for smokers; tobacco; electronic cigarettes; cigars; cigarettes containing tobacco substitutes, not for medical purposes; cigarettes; cigarette cases; cigarette filters.

(260) AM 2021 109650 A

(800) 1548893

(151) 2020 05 11

(891) 2020 05 11

(731) Bit Bio Limited

Pioneer House Vision Park, Histon,  
Cambridge, Cambridgeshire CB24 9NL,  
United Kingdom

(540)

**OPERATING SYSTEM OF  
LIFE**

(591) Black, white

(511)

1 – Stem cells for research purposes; stem cells for scientific purposes; stem cells other than for medical or veterinary purposes; skeletal myocytes for research purposes; cortical neurons for research purposes; bio-

logical tissue for research and scientific purposes; biological tissue cultures other than for medical or veterinary purposes; cultures of cell media [other than for medical or veterinary use]; chemical reagents for use in biotechnology, other than for medical or veterinary use; nutritive agents for processing living cells [other than for medical use]; semi-processed natural proteins for manufacturing food; proteins for use in the manufacture of food products; proteins for use in recombinant DNA technology [other than for medical use]; cell growth media, tissue culture media, cytokines, antibodies, and reagents for medical research.

5 – Cell therapeutics; genetically or otherwise modified cells; cells which are propagated, cultivated and expanded in bioreactors; cells for the purpose of tissue regeneration; living cells for medical use; cells for medical use; biological preparations for medical use; diagnostic preparations for medical and/or veterinary purposes; cell preparations for drug screening; cell preparations for genetic testing, screening; stem cells for medical purposes; stem cells for veterinary purposes; cell growth media, tissue culture media, cytokines, antibodies, and reagents for medical or diagnostic use; tissue culture media, growth factors, growth media, serum, and nutritional supplements for in vitro culturing, development, maintenance, expansion, assay or manipulation of cells; cell separation reagents; dietary supplements; protein supplements; nutrition supplements.

9 – Computer software and computer hardware for the separation of biological and non-biological materials; bioreactors; bioreactors for biomanufacturing; bioreactors for research use; bioreactor for cell culturing; bioreactors for laboratory use; manufacturing software; smart manufacturing system controls; electronic control units; magnetic cell separation equipment.

29 – Meat; meat substitutes; tissue engineered meat; synthetic meat; cultured meat; laboratory-grown meat; fish, not live.

40 – Custom manufacture of biopharmaceuticals; processing of biopharmaceutical materials for others; custom manufacture of stem cells for research purposes, stem cells for scientific purposes, stem cells other than for medical or veterinary purposes, skeletal myocytes for research purposes, cortical neurons for research purposes, biological tissue for research and scientific purposes, biological tissue cultures other than for medical or veterinary purposes, cultures of cell media [other than for medical or veterinary use], chemical reagents for use in biotechnology, other than for medical or veterinary use, nutritive agents for processing living cells [other than for medical use], semi-processed natural proteins for manufacturing food, proteins for use in the manufacture of food products, proteins for use in recombinant DNA technology [other than for medical use], cell therapeutics, genetically or otherwise modified cells, cells which are propa-

gated, cultivated and expanded in bioreactors, cells for the purpose of tissue regeneration, living cells for medical use, cells for medical use, biological preparations for medical use, diagnostic preparations for medical and/or veterinary purposes, cell preparations for drug screening, cell preparations for genetic testing, screening, stem cells for medical purposes, stem cells for veterinary purposes, cell growth media, tissue culture media, cytokines, antibodies, and reagents for medical, medical research or diagnostic use, tissue culture media, growth factors, growth media, serum, and nutritional supplements for in vitro culturing, development, maintenance, expansion, assay or manipulation of cells, cell separation reagents, magnetic cell separation equipment, dietary supplements, protein supplements, nutrition supplements, meat, meat substitutes, tissue engineered meat, synthetic meat, cultured meat, laboratory-grown meat and fish, not live.

42 – Biotechnology research; biotechnology testing; Stem cell research; synthetic biology services; Stem cell biology services; scientific services relating to the isolation and cultivation of human tissues and cells; Research and development in the field of microorganisms and cells; Research and development in relation to genetic testing, screening; Research and development in relation to drug screening; cell separation technology services; cell separation research services; consultancy relating to biotechnology; consultancy relating to drug screening; consultancy relating to genetic screening; consultancy relating to cell therapy; laboratory research; research on food; research and development in the field of animal cells cultivated within bioreactors; research in the reduction of carbon emissions.

(260) AM 2021 109651 A

(800) 1548903

(151) 2020 07 09

(891) 2020 07 09

(731) CELLTRION, INC.

23, Academy-ro, Yeonsu-gu, Incheon 22014,  
Republic of Korea

(540)



(591) The colors RED, GREEN and BLUE are claimed as a feature of the mark

(531) 02.01.23; 26.01.03; 26.11.03; 26.11.12;  
29.01.13

(511)

5 – Pharmaceutical preparations for the treatment of autoimmune diseases, none of the foregoing used for the prevention, management and treatment of headaches, head pain, neurological disorders or conditions.

(260) AM 2021 109802 A

(800) 1550972

(151) 2020 05 29

(891) 2020 05 29

(731) Euro Games Technology Ltd.

4, "Maritsa" Str., "Vranya-Lozen-Triugulnika",  
BG-1151 Sofia, Bulgaria

(540)



(591) Blue, gold, orange, yellow, black and white

(531) 01.15.09; 27.05.02; 27.07.02; 28.03; 29.01.15

(511)

9 – Software; computer gaming software; computer software packages; computer operating system software; computer software, recorded; software drivers; virtual reality software; games software; entertainment software for computer games; computer programs for network management; operating computer software for main frame computers; monitors (computer hardware); computer hardware; apparatus for recording images; monitors (computer programs); computer game programs; computer programs for recorded games; apparatus for recording, transmission or reproduction of sound or images; communications servers [computer hardware]; electronic components for gambling machines; computer application software featuring games and gaming; computer software for the administration of on-line games and gaming; computer hardware for games and gaming; electronic components and computer software for gambling, gambling machines, gambling games on the internet and via telecommunication network.

28 – Gaming machines for gambling; chips for gambling; mah-jong; arcade games; gambling machines operating with coins, notes and cards; games; electronic games; parlor games; gaming chips; gaming tables; slot machines [gaming machines]; LCD game machines; slot machines and gaming devices; coin-operated amusement machines; roulette chips; poker chips; chips and dice [gaming equipment]; equipment for casinos; roulette tables; gaming roulette wheels; casino games; gambling machines and amusement machines, automatic and coin-operated; coin-operated amusement machines and/or electronic coin-operated amusement machines with or without the possibility of gain; boxes for coin-operated machines, slot machines and gaming machines; electronic or electrotechnical amusement machines and apparatus, gaming ma-

chines, coin-operated entertainment machines; housings for coin-operated machines, gaming equipment, gaming machines, machines for gambling; electropneumatic and electrical slot machines (gaming machines for gambling).

41 – Gambling; services related to gambling; gaming services for entertainment purposes; casino, gaming and gambling services; training in the development of software systems; provision of equipment for gambling halls; providing casino equipment [gambling]; gaming machine entertainment services; providing casino facilities [gambling]; gaming hall services; amusement arcade services; games equipment rental; rental of gaming machines; providing amusement arcade services; rental of gaming machines with images of fruits; editing or recording of sounds and images; sound recording and video entertainment services; hire of sound reproducing apparatus; provision of gaming equipment for casinos; providing of casino facilities; online gambling services; casino, gaming and gambling services; provision of gaming facilities, gaming halls, Internet casinos, online gaming services.

---

(260) AM 2021 109805 A

(800) 1551046

(151) 2020 02 14

(891) 2020 02 14

(731) Montblanc-Simplo GmbH

Hellgrundweg 100, 22525 Hamburg, Germany

(540)

## **MONTBLANC**

(591) Black, white

(511)

3 – Soaps, perfumery, essential oils, cosmetics; cosmetic preparations for face and body and for beauty care.

9 – Optical apparatus and instruments; eyeglasses, sunglasses; eyeglass frames and cases; magnifying glasses; computer and tablets carrying cases and bags; holders and cases for telephones, portable telephones and smartphones; accessories for portable telephones, smartphones and tablets; data recording and storage media device and instruments; graduated rulers.

14 – Jewellery; cuff links; tie clips; rings, bracelets, earrings, necklaces, brooches; key rings of precious metal; watches, chronometers, clocks, watch movements, watch straps, watch bracelets, boxes of precious metal for watches and jewellery; key holders.

16 – Paper, cardboard and goods made in these materials not included in other classes; printed matter; stationery; articles of paper or cardboard, namely boxes, bags, envelopes and pouches for packaging; wrapping paper; writing instruments; replacement parts for writing instruments, namely, nibs, caps, and clips; pouches for writing instruments; cases for writing ins-

truments; inks and ink refills for writing instruments; writing book; calendars, note books; writing papers, envelopes; business cards; paperweights; diaries, cover for diaries, replacement papers for diaries; inkwells; check-book holders, passport holders; document holders; albums; bookends; money clips; letter trays, writing instrument holders, paper pad refills; desk sets, desk stands for writing instruments and office implements, pen and pencil holders, leather letter trays.

18 – Leather and imitation leather, goods made in these materials and not included in other classes, namely handbags, travelling bags, bags for sports, wheeled bags, wallets, purses, credit card holders, briefcases, attaché-cases, travelling trunks, vanity cases (not fitted), handbags, boxes of leather or leather board, trunks and suitcases, bags for packaging; document cases.

---

---

**INTERNATIONAL TRADEMARKS PROTECTED  
IN GEORGIA**

(260) AM 2021 103299 A  
(800) 1416717  
(151) 2018 01 05  
(181) 2028 01 05  
(891) 2019 04 05  
(511) 25, 35

---

(260) AM 2021 106872 A  
(800) 1510990  
(151) 2019 11 15  
(181) 2029 11 15  
(891) 2019 11 15  
(511) 30

---

(260) AM 2021 103919 A  
(800) 1475429  
(151) 2019 05 24  
(181) 2029 05 24  
(891) 2019 05 24  
(511) 14, 35

---

(260) AM 2021 107506 A  
(800) 1518972  
(151) 2020 01 20  
(181) 2030 01 20  
(891) 2020 01 20  
(511) 33

---

(260) AM 2021 105961 A  
(800) 1364053  
(151) 2017 01 25  
(181) 2027 01 25  
(891) 2019 11 08  
(511) 29, 32

---

(260) AM 2021 107507 A  
(800) 1518977  
(151) 2019 10 23  
(181) 2029 10 23  
(891) 2019 10 23  
(511) 29, 30, 32

---

(260) AM 2021 106027 A  
(800) 1501967  
(151) 2019 09 16  
(181) 2029 09 16  
(891) 2019 09 16  
(511) 43

---

(260) AM 2021 107508 A  
(800) 1519068  
(151) 2020 01 29  
(181) 2030 01 29  
(891) 2020 01 29  
(511) 04

---

(260) AM 2021 106487 A  
(800) 1507644  
(151) 2019 08 02  
(181) 2029 08 02  
(891) 2019 08 02  
(511) 05

---

(260) AM 2021 107509 A  
(800) 1519074  
(151) 2019 12 16  
(181) 2029 12 16  
(891) 2019 12 16  
(511) 18, 25, 28

---

(260) AM 2021 106577 A  
(800) 843462  
(151) 2004 09 13  
(181) 2024 09 13  
(891) 2019 12 24  
(511) 01, 02, 03, 17, 19, 37, 41

---

(260) AM 2021 107518 A  
(800) 1519387  
(151) 2019 12 17  
(181) 2029 12 17  
(891) 2019 12 17  
(511) 03, 05, 10, 32

---

(260) AM 2021 106578 A  
(800) 927823  
(151) 2007 06 07  
(181) 2027 06 07  
(891) 2019 12 24  
(511) 01, 02, 03, 17, 19, 37, 41

---

(260) AM 2021 107519 A  
(800) 1519426  
(151) 2019 12 11  
(181) 2029 12 11  
(891) 2019 12 11  
(511) 29, 30, 32

---

(260) AM 2021 107520 A  
(800) 1519429  
(151) 2020 01 10  
(181) 2030 01 10  
(891) 2020 01 10  
(511) 05

---

(260) AM 2021 107521 A  
(800) 1519443  
(151) 2020 01 18  
(181) 2030 01 18  
(891) 2020 01 18  
(511) 05

---

(260) AM 2021 107522 A  
(800) 1519445  
(151) 2019 12 12  
(181) 2029 12 12  
(891) 2019 12 12  
(511) 34

---

(260) AM 2021 107524 A  
(800) 1519657  
(151) 2020 01 15  
(181) 2030 01 15  
(891) 2020 01 15  
(511) 30

---

(260) AM 2021 107525 A  
(800) 1519775  
(151) 2019 10 25  
(181) 2029 10 25  
(891) 2019 10 25  
(511) 30, 33, 35, 43

---

(260) AM 2021 107526 A  
(800) 1519802  
(151) 2020 01 10  
(181) 2030 01 10  
(891) 2020 01 10  
(511) 10

---

(260) AM 2021 107527 A  
(800) 1519872  
(151) 2020 02 05  
(181) 2030 02 05  
(891) 2020 02 05  
(511) 09

---

(260) AM 2021 107528 A  
(800) 1519879  
(151) 2020 01 29  
(181) 2030 01 29

(891) 2020 01 29  
(511) 41

---

(260) AM 2021 107529 A  
(800) 1519899  
(151) 2019 09 24  
(181) 2029 09 24  
(891) 2019 09 24  
(511) 09

---

(260) AM 2021 107530 A  
(800) 1519917  
(151) 2019 09 24  
(181) 2029 09 24  
(891) 2019 09 24  
(511) 32, 33

---

(260) AM 2021 107531 A  
(800) 1519923  
(151) 2019 12 23  
(181) 2029 12 23  
(891) 2019 12 23  
(511) 12, 37

---

(260) AM 2021 107532 A  
(800) 1519939  
(151) 2019 10 10  
(181) 2029 10 10  
(891) 2019 10 10  
(511) 35

---

(260) AM 2021 107533 A  
(800) 1519947  
(151) 2019 12 12  
(181) 2029 12 12  
(891) 2019 12 12  
(511) 34

---

(260) AM 2021 107534 A  
(800) 1519955  
(151) 2019 12 16  
(181) 2029 12 16  
(891) 2019 12 16  
(511) 07

---

(260) AM 2021 107535 A  
(800) 1520073  
(151) 2020 01 09  
(181) 2030 01 09  
(891) 2020 01 09  
(511) 43

---

(260) AM 2021 107536 A  
(800) 713598  
(151) 1999 04 29  
(181) 2029 04 29  
(891) 2019 10 18  
(511) 25

---

(260) AM 2021 107537 A  
(800) 877211  
(151) 2005 11 07  
(181) 2025 11 07  
(891) 2020 01 27  
(511) 25

---

(260) AM 2021 107539 A  
(800) 1193094  
(151) 2013 11 28  
(181) 2023 11 28  
(891) 2020 02 05  
(511) 03

---

(260) AM 2021 107540 A  
(800) 1221445  
(151) 2014 08 22  
(181) 2024 08 22  
(891) 2020 01 23  
(511) 05

---

(260) AM 2021 107541 A  
(800) 1243741  
(151) 2014 12 05  
(181) 2024 12 05  
(891) 2020 02 27  
(511) 03, 05, 10

---

(260) AM 2021 107605 A  
(800) 1520489  
(151) 2019 12 04  
(181) 2029 12 04  
(891) 2019 12 04  
(511) 09

---

(260) AM 2021 107606 A  
(800) 1520493  
(151) 2020 01 08  
(181) 2030 01 08  
(891) 2020 01 08  
(511) 03

---

(260) AM 2021 107621 A  
(800) 1520903  
(151) 2020 02 17  
(181) 2030 02 17

(891) 2020 02 17  
(511) 07

---

(260) AM 2021 107622 A  
(800) 1520942  
(151) 2020 02 10  
(181) 2030 02 10  
(891) 2020 02 10  
(511) 10

---

(260) AM 2021 107624 A  
(800) 1520966  
(151) 2020 01 30  
(181) 2030 01 30  
(891) 2020 01 30  
(511) 03

---

(260) AM 2021 107625 A  
(800) 1520974  
(151) 2020 02 07  
(181) 2030 02 07  
(891) 2020 02 07  
(511) 05

---

(260) AM 2021 107626 A  
(800) 1521009  
(151) 2020 02 05  
(181) 2030 02 05  
(891) 2020 02 05  
(511) 44

---

(260) AM 2021 107628 A  
(800) 1521089  
(151) 2020 01 02  
(181) 2030 01 02  
(891) 2020 01 02  
(511) 35, 41, 42

---

(260) AM 2021 107629 A  
(800) 1521170  
(151) 2019 09 20  
(181) 2029 09 20  
(891) 2019 09 20  
(511) 01, 35

---

(260) AM 2021 107630 A  
(800) 1521172  
(151) 2020 01 28  
(181) 2030 01 28  
(891) 2020 01 28  
(511) 35

---



(260) AM 2021 107632 A  
(800) 1521243  
(151) 2019 11 27  
(181) 2029 11 27  
(891) 2019 11 27  
(511) 05, 35

---

(260) AM 2021 107644 A  
(800) 1503925  
(151) 2019 10 29  
(181) 2029 10 29  
(891) 2020 03 04  
(511) 05

---

(260) AM 2021 107687 A  
(800) 1521353  
(151) 2019 12 19  
(181) 2029 12 19  
(891) 2019 12 19  
(511) 16, 35

---

(260) AM 2021 107688 A  
(800) 1521354  
(151) 2020 02 12  
(181) 2030 02 12  
(891) 2020 02 12  
(511) 30

---

(260) AM 2021 107689 A  
(800) 1521355  
(151) 2020 02 12  
(181) 2030 02 12  
(891) 2020 02 12  
(511) 30

---

(260) AM 2021 107690 A  
(800) 1521393  
(151) 2019 12 25  
(181) 2029 12 25  
(891) 2019 12 25  
(511) 09

---

(260) AM 2021 107691 A  
(800) 1521422  
(151) 2019 09 20  
(181) 2029 09 20  
(891) 2019 09 20  
(511) 01, 31, 35

---

(260) AM 2021 107692 A  
(800) 1521424  
(151) 2019 11 15  
(181) 2029 11 15

(891) 2019 11 15  
(511) 01, 05, 44

---

(260) AM 2021 107693 A  
(800) 1521431  
(151) 2019 10 23  
(181) 2029 10 23  
(891) 2019 10 23  
(511) 25, 35

---

(260) AM 2021 107694 A  
(800) 1521478  
(151) 2020 02 11  
(181) 2030 02 11  
(891) 2020 02 11  
(511) 03, 05, 10

---

(260) AM 2021 107700 A  
(800) 1521763  
(151) 2019 11 01  
(181) 2029 11 01  
(891) 2019 11 01  
(511) 07, 08, 10, 11, 12, 20, 21, 28

---

(260) AM 2021 107706 A  
(800) 1521932  
(151) 2020 02 27  
(181) 2030 02 27  
(891) 2020 02 27  
(511) 31

---

(260) AM 2021 107707 A  
(800) 1521938  
(151) 2019 12 18  
(181) 2029 12 18  
(891) 2019 12 18  
(511) 07, 09, 12

---

(260) AM 2021 107708 A  
(800) 1521943  
(151) 2020 01 31  
(181) 2030 01 31  
(891) 2020 01 31  
(511) 03

---

(260) AM 2021 107709 A  
(800) 1521949  
(151) 2019 10 03  
(181) 2029 10 03  
(891) 2019 10 03  
(511) 36, 42

---

(260) AM 2021 107710 A  
(800) 1521970  
(151) 2020 01 30  
(181) 2030 01 30  
(891) 2020 01 30  
(511) 05

---

(260) AM 2021 107711 A  
(800) 1522013  
(151) 2019 12 17  
(181) 2029 12 17  
(891) 2019 12 17  
(511) 30

---

(260) AM 2021 107712 A  
(800) 1522056  
(151) 2019 10 09  
(181) 2029 10 09  
(891) 2019 10 09  
(511) 35, 41, 42, 44, 45

---

(260) AM 2021 107713 A  
(800) 1522065  
(151) 2019 12 27  
(181) 2029 12 27  
(891) 2019 12 27  
(511) 01, 17, 19, 20, 40

---

(260) AM 2021 107715 A  
(800) 1522116  
(151) 2019 12 31  
(181) 2029 12 31  
(891) 2019 12 31  
(511) 09, 36, 42

---

(260) AM 2021 107716 A  
(800) 1522130  
(151) 2020 01 15  
(181) 2030 01 15  
(891) 2020 01 15  
(511) 03

---

(260) AM 2021 107717 A  
(800) 1522133  
(151) 2020 01 22  
(181) 2030 01 22  
(891) 2020 01 22  
(511) 30

---

(260) AM 2021 107718 A  
(800) 1522158  
(151) 2020 02 19  
(181) 2030 02 19

(891) 2020 02 19  
(511) 32, 43

---

(260) AM 2021 107719 A  
(800) 1522169  
(151) 2019 10 23  
(181) 2029 10 23  
(891) 2019 10 23  
(511) 07, 09, 11, 14, 35, 38

---

(260) AM 2021 107720 A  
(800) 1522307  
(151) 2020 01 31  
(181) 2030 01 31  
(891) 2020 01 31  
(511) 05, 10, 44

---

(260) AM 2021 107721 A  
(800) 1522378  
(151) 2020 02 19  
(181) 2030 02 19  
(891) 2020 02 19  
(511) 27

---

(260) AM 2021 107722 A  
(800) 1522404  
(151) 2020 01 24  
(181) 2030 01 24  
(891) 2020 01 24  
(511) 05

---

(260) AM 2021 107723 A  
(800) 1522405  
(151) 2020 01 24  
(181) 2030 01 24  
(891) 2020 01 24  
(511) 05

---

(260) AM 2021 107724 A  
(800) 1522413  
(151) 2020 02 07  
(181) 2030 02 07  
(891) 2020 02 07  
(511) 31, 32, 34

---

(260) AM 2021 107725 A  
(800) 1522424  
(151) 2019 12 19  
(181) 2029 12 19  
(891) 2019 12 19  
(511) 03, 09, 14, 18, 25, 35

---

(260) AM 2021 107726 A  
(800) 1522445  
(151) 2020 02 10  
(181) 2030 02 10  
(891) 2020 02 10  
(511) 03, 14, 18, 25, 35

---

(260) AM 2021 107727 A  
(800) 1522457  
(151) 2019 12 23  
(181) 2029 12 23  
(891) 2019 12 23  
(511) 09, 14, 25

---

(260) AM 2021 107728 A  
(800) 1522461  
(151) 2020 01 30  
(181) 2030 01 30  
(891) 2020 01 30  
(511) 30

---

(260) AM 2021 107729 A  
(800) 1522496  
(151) 2020 01 29  
(181) 2030 01 29  
(891) 2020 01 29  
(511) 41

---

(260) AM 2021 107732 A  
(800) 1522517  
(151) 2020 02 14  
(181) 2030 02 14  
(891) 2020 02 14  
(511) 30

---

(260) AM 2021 107733 A  
(800) 1522533  
(151) 2020 02 05  
(181) 2030 02 05  
(891) 2020 02 05  
(511) 39

---

(260) AM 2021 107734 A  
(800) 1522563  
(151) 2020 02 17  
(181) 2030 02 17  
(891) 2020 02 17  
(511) 09

---

(260) AM 2021 107762 A  
(800) 1522994  
(151) 2019 08 26  
(181) 2029 08 26

(891) 2019 08 26  
(511) 05, 32

---

(260) AM 2021 107763 A  
(800) 1523003  
(151) 2020 01 06  
(181) 2030 01 06  
(891) 2020 01 06  
(511) 09, 35

---

(260) AM 2021 107764 A  
(800) 1523072  
(151) 2020 01 27  
(181) 2030 01 27  
(891) 2020 01 27  
(511) 03, 05

---

(260) AM 2021 107765 A  
(800) 1523073  
(151) 2020 01 21  
(181) 2030 01 21  
(891) 2020 01 21  
(511) 29

---

(260) AM 2021 107766 A  
(800) 1523094  
(151) 2020 02 21  
(181) 2030 02 21  
(891) 2020 02 21  
(511) 43

---

(260) AM 2021 107768 A  
(800) 1523122  
(151) 2019 10 17  
(181) 2029 10 17  
(891) 2019 10 17  
(511) 30

---

(260) AM 2021 107769 A  
(800) 1523130  
(151) 2020 02 04  
(181) 2030 02 04  
(891) 2020 02 04  
(511) 03, 05

---

(260) AM 2021 107770 A  
(800) 1523173  
(151) 2019 11 22  
(181) 2029 11 22  
(891) 2019 11 22  
(511) 07, 08, 21, 24

---

(260) AM 2021 107771 A  
(800) 1523189  
(151) 2019 12 26  
(181) 2029 12 26  
(891) 2019 12 26  
(511) 09, 16, 35, 38, 41, 42

---

(260) AM 2021 107773 A  
(800) 1523243  
(151) 2019 12 27  
(181) 2029 12 27  
(891) 2019 12 27  
(511) 05

---

(260) AM 2021 107774 A  
(800) 1523265  
(151) 2019 04 18  
(181) 2029 04 18  
(891) 2019 04 18  
(511) 03, 05, 07, 08, 09, 10, 11, 16, 18, 21, 22, 25, 26

---

(260) AM 2021 107775 A  
(800) 1523277  
(151) 2019 11 14  
(181) 2029 11 14  
(891) 2019 11 14  
(511) 12, 37

---

(260) AM 2021 107777 A  
(800) 1523335  
(151) 2019 10 15  
(181) 2029 10 15  
(891) 2019 10 15  
(511) 03

---

(260) AM 2021 107778 A  
(800) 1523382  
(151) 2020 01 24  
(181) 2030 01 24  
(891) 2020 01 24  
(511) 03, 21

---

(260) AM 2021 107779 A  
(800) 1523501  
(151) 2019 11 21  
(181) 2029 11 21  
(891) 2019 11 21  
(511) 29, 30

---

(260) AM 2021 107786 A  
(800) 1523608  
(151) 2019 10 11  
(181) 2029 10 11

(891) 2019 10 11  
(511) 07

---

(260) AM 2021 107787 A  
(800) 1523658  
(151) 2019 10 18  
(181) 2029 10 18  
(891) 2019 10 18  
(511) 09, 11, 12, 16, 18, 20, 21, 24, 27, 28, 35, 37, 39,  
40, 41, 42

---

(260) AM 2021 107788 A  
(800) 1523669  
(151) 2019 12 18  
(181) 2029 12 18  
(891) 2019 12 18  
(511) 43

---

(260) AM 2021 107789 A  
(800) 820628  
(151) 2004 01 20  
(181) 2024 01 20  
(891) 2020 01 30  
(511) 35, 42, 45

---

(260) AM 2021 107790 A  
(800) 887110A  
(151) 2006 04 04  
(181) 2026 04 04  
(891) 2020 02 18  
(511) 05, 29

---

(260) AM 2021 107791 A  
(800) 926627  
(151) 2007 05 09  
(181) 2027 05 09  
(891) 2020 02 18  
(511) 16, 18

---

(260) AM 2021 107798 A  
(800) 1370914  
(151) 2017 04 04  
(181) 2027 04 04  
(891) 2019 10 31  
(511) 41

---

(260) AM 2021 107799 A  
(800) 1502929  
(151) 2019 10 10  
(181) 2029 10 10  
(891) 2020 03 13  
(511) 35, 36

---

(260) AM 2021 107800 A  
(800) 1503608  
(151) 2019 10 10  
(181) 2029 10 10  
(891) 2020 03 13  
(511) 36

---

(260) AM 2021 107844 A  
(800) 1523796  
(151) 2019 08 26  
(181) 2029 08 26  
(891) 2019 08 26  
(511) 09, 12, 28

---

(260) AM 2021 107845 A  
(800) 1523836  
(151) 2020 01 30  
(181) 2030 01 30  
(891) 2020 01 30  
(511) 03, 05

---

(260) AM 2021 107846 A  
(800) 1523997  
(151) 2020 02 14  
(181) 2030 02 14  
(891) 2020 02 14  
(511) 30

---

(260) AM 2021 107848 A  
(800) 1524016  
(151) 2019 03 11  
(181) 2029 03 11  
(891) 2019 03 11  
(511) 34

---

(260) AM 2021 107849 A  
(800) 1524028  
(151) 2019 12 05  
(181) 2029 12 05  
(891) 2019 12 05  
(511) 08, 24

---

(260) AM 2021 107850 A  
(800) 1524102  
(151) 2020 01 07  
(181) 2030 01 07  
(891) 2020 01 07  
(511) 18, 25, 35

---

(260) AM 2021 107853 A  
(800) 1524187  
(151) 2020 03 12  
(181) 2030 03 12

(891) 2020 03 12  
(511) 33

---

(260) AM 2021 107854 A  
(800) 1524207  
(151) 2020 02 24  
(181) 2030 02 24  
(891) 2020 02 24  
(511) 03, 05, 10

---

(260) AM 2021 107856 A  
(800) 1524260  
(151) 2020 02 14  
(181) 2030 02 14  
(891) 2020 02 14  
(511) 01

---

(260) AM 2021 107857 A  
(800) 1524265  
(151) 2019 09 20  
(181) 2029 09 20  
(891) 2019 09 20  
(511) 01, 31, 35

---

(260) AM 2021 107858 A  
(800) 1524318  
(151) 2020 02 24  
(181) 2030 02 24  
(891) 2020 02 24  
(511) 03, 05

---

(260) AM 2021 107859 A  
(800) 1524325  
(151) 2019 08 26  
(181) 2029 08 26  
(891) 2019 08 26  
(511) 09, 12, 28

---

(260) AM 2021 107866 A  
(800) 1524637  
(151) 2020 02 21  
(181) 2030 02 21  
(891) 2020 02 21  
(511) 05

---

(260) AM 2021 107868 A  
(800) 1524679  
(151) 2020 02 21  
(181) 2030 02 21  
(891) 2020 02 21  
(511) 05

---

(260) AM 2021 107869 A  
(800) 1524729  
(151) 2020 01 15  
(181) 2030 01 15  
(891) 2020 01 15  
(511) 01, 02, 17

---

(260) AM 2021 107872 A  
(800) 1524784  
(151) 2019 06 03  
(181) 2029 06 03  
(891) 2019 06 03  
(511) 09, 42

---

(260) AM 2021 107873 A  
(800) 1524787  
(151) 2019 12 17  
(181) 2029 12 17  
(891) 2019 12 17  
(511) 30

---

(260) AM 2021 107874 A  
(800) 1524957  
(151) 2019 09 30  
(181) 2029 09 30  
(891) 2019 09 30  
(511) 09

---

(260) AM 2021 107878 A  
(800) 1053808  
(151) 2010 09 23  
(181) 2020 09 23  
(891) 2020 03 25  
(511) 35, 36

---

(260) AM 2021 107879 A  
(800) 1059037  
(151) 2010 09 23  
(181) 2020 09 23  
(891) 2020 03 25  
(511) 35, 36

---

(260) AM 2021 107880 A  
(800) 1213515  
(151) 2014 03 28  
(181) 2024 03 28  
(891) 2020 03 25  
(511) 35, 36

---

(260) AM 2021 107882 A  
(800) 1262430  
(151) 2015 02 18  
(181) 2025 02 18

(891) 2020 03 24  
(511) 30, 32

---

(260) AM 2021 107883 A  
(800) 1290993  
(151) 2015 08 11  
(181) 2025 08 11  
(891) 2020 02 28  
(511) 09, 10, 38, 42

---

(260) AM 2021 107884 A  
(800) 1491815  
(151) 2019 08 19  
(181) 2029 08 19  
(891) 2020 03 11  
(511) 41

---

(260) AM 2021 107931 A  
(800) 1525047  
(151) 2019 12 04  
(181) 2029 12 04  
(891) 2019 12 04  
(511) 09, 38, 39, 42

---

(260) AM 2021 107932 A  
(800) 1525143  
(151) 2019 12 27  
(181) 2029 12 27  
(891) 2019 12 27  
(511) 07, 12, 37

---

(260) AM 2021 107933 A  
(800) 1525189  
(151) 2019 11 05  
(181) 2029 11 05  
(891) 2019 11 05  
(511) 21

---

(260) AM 2021 107934 A  
(800) 1525202  
(151) 2020 01 30  
(181) 2030 01 30  
(891) 2020 01 30  
(511) 03, 04, 09, 14, 16, 18, 25, 26, 28, 35

---

(260) AM 2021 107936 A  
(800) 1525219  
(151) 2019 09 20  
(181) 2029 09 20  
(891) 2019 09 20  
(511) 35, 38

---

(260) AM 2021 107937 A  
(800) 1525238  
(151) 2020 03 02  
(181) 2030 03 02  
(891) 2020 03 02  
(511) 05, 09, 10, 42, 44

---

(260) AM 2021 107938 A  
(800) 1525250  
(151) 2020 03 02  
(181) 2030 03 02  
(891) 2020 03 02  
(511) 05, 09, 10, 42, 44

---

(260) AM 2021 107939 A  
(800) 1525254  
(151) 2020 03 02  
(181) 2030 03 02  
(891) 2020 03 02  
(511) 05, 09, 10, 42, 44

---

(260) AM 2021 107940 A  
(800) 1525329  
(151) 2020 03 02  
(181) 2030 03 02  
(891) 2020 03 02  
(511) 05, 09, 10, 42, 44

---

(260) AM 2021 107941 A  
(800) 1525331  
(151) 2019 11 11  
(181) 2029 11 11  
(891) 2019 11 11  
(511) 09, 42

---

(260) AM 2021 107942 A  
(800) 1525352  
(151) 2020 01 20  
(181) 2030 01 20  
(891) 2020 01 20  
(511) 03, 21, 35, 36

---

(260) AM 2021 107943 A  
(800) 1525359  
(151) 2020 03 02  
(181) 2030 03 02  
(891) 2020 03 02  
(511) 05, 09, 10, 42, 44

---

(260) AM 2021 107944 A  
(800) 1525379  
(151) 2019 12 13  
(181) 2029 12 13

(891) 2019 12 13  
(511) 33

---

(260) AM 2021 107945 A  
(800) 1525384  
(151) 2019 12 17  
(181) 2029 12 17  
(891) 2019 12 17  
(511) 01, 05

---

(260) AM 2021 107946 A  
(800) 1525393  
(151) 2019 09 25  
(181) 2029 09 25  
(891) 2019 09 25  
(511) 06, 11

---

(260) AM 2021 107958 A  
(800) 1525592  
(151) 2020 03 04  
(181) 2030 03 04  
(891) 2020 03 04  
(511) 30

---

(260) AM 2021 107959 A  
(800) 1525631  
(151) 2020 03 19  
(181) 2030 03 19  
(891) 2020 03 19  
(511) 05

---

(260) AM 2021 107960 A  
(800) 1525671  
(151) 2020 02 26  
(181) 2030 02 26  
(891) 2020 02 26  
(511) 14

---

(260) AM 2021 107961 A  
(800) 1525692  
(151) 2019 09 12  
(181) 2029 09 12  
(891) 2019 09 12  
(511) 41, 42

---

(260) AM 2021 107962 A  
(800) 1525716  
(151) 2019 11 16  
(181) 2029 11 16  
(891) 2019 11 16  
(511) 33

---

(260) AM 2021 107963 A  
(800) 1525801  
(151) 2019 11 06  
(181) 2029 11 06  
(891) 2019 11 06  
(511) 03, 04

---

(260) AM 2021 107964 A  
(800) 1525862  
(151) 2019 09 20  
(181) 2029 09 20  
(891) 2019 09 20  
(511) 01, 35

---

(260) AM 2021 107965 A  
(800) 1525892  
(151) 2019 09 30  
(181) 2029 09 30  
(891) 2019 09 30  
(511) 35, 39, 41, 43

---

(260) AM 2021 107966 A  
(800) 1525947  
(151) 2020 01 29  
(181) 2030 01 29  
(891) 2020 01 29  
(511) 09, 11

---

(260) AM 2021 107967 A  
(800) 1525948  
(151) 2020 02 20  
(181) 2030 02 20  
(891) 2020 02 20  
(511) 28, 36, 41

---

(260) AM 2021 107978 A  
(800) 1519028  
(151) 2019 03 06  
(181) 2029 03 06  
(891) 2020 03 03  
(511) 09, 38, 42

---

(260) AM 2021 107996 A  
(800) 1526310  
(151) 2020 01 21  
(181) 2030 01 21  
(891) 2020 01 21  
(511) 09

---

(260) AM 2021 107997 A  
(800) 1526331  
(151) 2020 02 13  
(181) 2030 02 13

(891) 2020 02 13  
(511) 33

---

(260) AM 2021 108000 A  
(800) 1526347  
(151) 2020 03 12  
(181) 2030 03 12  
(891) 2020 03 12  
(511) 35

---

(260) AM 2021 108029 A  
(800) 1526980  
(151) 2019 12 23  
(181) 2029 12 23  
(891) 2019 12 23  
(511) 03

---

(260) AM 2021 108030 A  
(800) 1526990  
(151) 2019 12 23  
(181) 2029 12 23  
(891) 2019 12 23  
(511) 03

---

(260) AM 2021 108031 A  
(800) 1527049  
(151) 2020 03 13  
(181) 2030 03 13  
(891) 2020 03 13  
(511) 38

---

(260) AM 2021 108039 A  
(800) 1527208  
(151) 2020 03 13  
(181) 2030 03 13  
(891) 2020 03 13  
(511) 04

---

(260) AM 2021 108040 A  
(800) 1527246  
(151) 2020 01 31  
(181) 2030 01 31  
(891) 2020 01 31  
(511) 11, 20, 35

---

(260) AM 2021 108044 A  
(800) 1527353  
(151) 2020 02 07  
(181) 2030 02 07  
(891) 2020 02 07  
(511) 33

---



(260) AM 2021 108046 A  
(800) 1255257  
(151) 2015 04 03  
(181) 2025 04 03  
(891) 2020 02 21  
(511) 06, 07, 09

---

(260) AM 2021 108047 A  
(800) 1354732  
(151) 2017 04 13  
(181) 2027 04 13  
(891) 2020 03 27  
(511) 03, 05

---

(260) AM 2021 108048 A  
(800) 1394087  
(151) 2018 01 30  
(181) 2028 01 30  
(891) 2020 03 11  
(511) 05

---

(260) AM 2021 108049 A  
(800) 1477450  
(151) 2019 05 08  
(181) 2029 05 08  
(891) 2020 03 11  
(511) 05

---

(260) AM 2021 108050 A  
(800) 1482820  
(151) 2019 06 25  
(181) 2029 06 25  
(891) 2020 03 11  
(511) 05

---

(260) AM 2021 108052 A  
(800) 1514967  
(151) 2019 12 23  
(181) 2029 12 23  
(891) 2020 04 07  
(511) 34

---

---

# OFFICIAL NOTIFICATIONS

## INVENTIONS

### EXPIRATION OF PATENTS RESTORATION

(21) AP 2015 13776  
(11) P 2016 6558 B  
(73) Nugzar Tsereteli;  
Ketevan Tsereteli  
(54) CHARGE FOR OBTAINING SILICOMANGANESE  
DATE OF CANCELLATION OF PATENT: 2021 03 30  
THE TERM OF RESTORATION OF PATENT: 2021 05 10

---

(21) AP 2015 14625  
(11) P 2019 7038 B  
(73) Eurodrug Laboratories B.V.  
(54) COMBINATION OF AT LEAST ONE PROTEASE INHIBITOR AND AT LEAST ONE ACTIVE PRINCIPLE  
FOR USE IN THE PREVENTION AND/OR TREATMENT OF SKIN LESIONS  
DATE OF CANCELLATION OF PATENT: 2021 04 17  
THE TERM OF RESTORATION OF PATENT: 2021 05 10

---

(21) AP 2018 14958  
(11) P 2020 7122 B  
(73) LTD "Shield"  
(54) METHOD FOR AGRICULTURE PROTECTION FROM BROWN MARMORATED STINK BUG  
DATE OF CANCELLATION OF PATENT: 2020 12 11  
THE TERM OF RESTORATION OF PATENT: 2021 05 10

---

### ABOLITION OF PATENTS WITH THE RIGHT TO RESTORE

(21) AP 2012 12672  
(11) P 2013 5916 B  
(73) Dimitri Sanadze  
(54) MACHINE FORMING PASTRY WITH FILLING  
DATE OF CANCELLATION OF PATENT: 2021 04 19  
THE TERM OF RESTORATION OF PATENT: 2022 04 19

---

(21) AP 2011 12890  
(11) P 2014 6203 B  
(73) Pristec AG  
(54) METHOD FOR THE TREATMENT OF LIQUID, IN PARTICULAR MINERAL OIL  
DATE OF CANCELLATION OF PATENT: 2021 04 14  
THE TERM OF RESTORATION OF PATENT: 2022 04 14

---

(21) AP 2013 13632  
(11) P 2017 6716 B  
(73) Cantab Biopharmaceuticals Patents Limited  
(54) OPTIMISED SUBCUTANEOUS THERAPEUTIC AGENTS  
DATE OF CANCELLATION OF PATENT: 2021 04 16  
THE TERM OF RESTORATION OF PATENT: 2022 04 16

---

(21) AP 2014 14012  
(11) P 2019 6996 B  
(73) BIO.LO.GA. S.R.L.  
(54) SHEET FOR CUTANEOUS APPLICATION CONTAINING VITAMIN E OR AN ESTER THEREOF  
DATE OF CANCELLATION OF PATENT: 2021 04 11  
THE TERM OF RESTORATION OF PATENT: 2022 04 11

---

(21) AP 2015 14625  
(11) P 2019 7038 B  
(73) Eurodrug Laboratories B.V.  
(54) COMBINATION OF AT LEAST ONE PROTEASE INHIBITOR AND AT LEAST ONE ACTIVE PRINCIPLE FOR USE IN THE PREVENTION AND/OR TREATMENT OF SKIN LESIONS  
DATE OF CANCELLATION OF PATENT: 2021 04 17  
THE TERM OF RESTORATION OF PATENT: 2022 04 17

---

(21) AP 2018 14757  
(11) P 2019 7027 B  
(73) Georgian Technical University;  
Giorgi Mghebrishvili;  
Grigor Moiseev;  
Nikoloz Mghebrishvili  
(54) SYSTEM FOR INDICATION OF WEAR WEIGHTS OF MOBILE TRAINS AND RAILS  
DATE OF CANCELLATION OF PATENT: 2021 04 13  
THE TERM OF RESTORATION OF PATENT: 2022 04 13

---

## EXPIRATION OF TERM OF RESTORATION OF PATENTS

(21) AP 2006 10338  
(11) P 2011 5226 B  
(73) Pfizer Inc.  
(54) P-CADHERIN ANTIBODIES  
DATE OF CANCELLATION OF PATENT: 2020 04 13  
THE TERM OF RESTORATION OF PATENT VALIDITY HAS EXPIRED: 2021 04 13

---

(21) AP 2011 12921  
(11) P 2015 6409 B  
(73) Maria Clementine Martin Klosterfrau Vertriebsgesellschaft MBH  
(54) DOSAGE FORMS FOR CINEOLE  
DATE OF CANCELLATION OF PATENT: 2020 04 13  
THE TERM OF RESTORATION OF PATENT VALIDITY HAS EXPIRED: 2021 04 13

---

(21) AP 2014 13445  
(11) P 2016 6460 B  
(73) Georgian Technical University  
(54) METHOD FOR SEED MATERIAL BIOACTIVATION  
DATE OF CANCELLATION OF PATENT: 2020 04 16  
THE TERM OF RESTORATION OF PATENT VALIDITY HAS EXPIRED: 2021 04 16

---

(21) AP 2013 13636  
(11) P 2018 6836 B  
(73) Les Laboratoires Servier;  
Armgo Pharma Inc.  
(54) AGENTS FOR TREATING DISORDERS INVOLVING MODULATION OF RYANODINE RECEPTORS  
DATE OF CANCELLATION OF PATENT: 2020 04 17  
THE TERM OF RESTORATION OF PATENT VALIDITY HAS EXPIRED: 2021 04 17

---

(21) AP 2015 13797  
(11) P 2017 6622 B  
(73) LEPL Ferdinand Tavadze Institute of Metallurgy and Materials Science  
(54) METHOD FOR FERROMANGANESE PRODUCTION  
DATE OF CANCELLATION OF PATENT: 2020 04 15  
THE TERM OF RESTORATION OF PATENT VALIDITY HAS EXPIRED: 2021 04 15

---

(21) AP 2015 14314  
(11) P 2018 6879 B  
(73) Pfizer Inc.  
(54) CYCLOALKYL-LINKED DIHETEROCYCLE DERIVATIVES  
DATE OF CANCELLATION OF PATENT: 2020 04 17  
THE TERM OF RESTORATION OF PATENT VALIDITY HAS EXPIRED: 2021 04 17

---

(21) AP 2016 14628  
(11) P 2019 7024 B  
(73) Morfo B. V.  
(54) SECURITY DOCUMENT AND METHOD OF MANUFACTURING  
DATE OF CANCELLATION OF PATENT: 2020 04 20  
THE TERM OF RESTORATION OF PATENT VALIDITY HAS EXPIRED: 2021 04 20

---

(21) AP 2006 9356  
(11) P 2009 4651 B  
(73) Les Laboratoires Servier  
(54) USE OF AGOMELATINE IN OBTAINING MEDICAMENTS INTENDED FOR THE TREATMENT OF  
BIPOLAR DISORDERS  
DATE OF CANCELLATION OF PATENT: 2020 04 19  
THE TERM OF RESTORATION OF PATENT VALIDITY HAS EXPIRED: 2021 04 19

---

## EXPIRATION OF PATENT

(21) AP 2001 6664  
(11) P 2008 4317 B  
(73) Icos Corporation (US)  
(54) INHIBITORS OF HUMAN PHOSPHATIDYL-INOSITOL 3-KINASE DELTA  
EXPIRATION DATE OF PATENT: 24 04 2021

---

## UTILITY MODELS

### EXPIRATION OF TERM OF RESTORATION OF PATENT

(21) AU 2017 14476  
(11) U 2018 1970 Y  
(73) Vasil Chkhikvadze  
(54) MAIN FRAME OF SOIL CULTIVATOR AND SMALL CHASSIS  
DATE OF CANCELLATION OF PATENT: 2020 04 18  
THE TERM OF RESTORATION OF PATENT VALIDITY HAS EXPIRED: 2021 04 18

---

## DESIGNS

### EXTENSION OF REGISTRATION

(11) D 2007 293 S  
(73) Elbi Elektrik Uluslararası Ticaret Ve Sanayi Anonim Şirketi  
Tasoluk-Mehmet Akif Ersoy Mah. Maltepe Cad. N15 Arnavutköy-Gaziosmanpaşa, İstanbul, Turkey (TR)  
(54) ELECTRIC ROSETTE (2 OPTIONS)  
(28) 2  
(24) 2006 05 19  
(18) 2026 05 19  
(58) 2021 04 27

---

(11) D 2007 294 S  
(73) Elbi Elektrik Uluslararası Ticaret Ve Sanayi Anonim Şirketi  
Tasoluk-Mehmet Akif Ersoy Mah. Maltepe Cad. N15 Arnavutköy-Gaziosmanpaşa, İstanbul, Turkey (TR)  
(54) ELECTRICAL CIRCUIT BREAKER (2 OPTIONS)  
(28) 2  
(24) 2006 05 19  
(18) 2026 05 19  
(58) 2021 04 27

---

## CANCELLATION OF REGISTRATIONS

(11) D 2011 482 S  
(73) Tamaz Turmanidze (GE)  
Rustaveli St. 7, b. 11, 6000, Batumi, Georgia (GE)  
(54) WOODEN BOX FOR BOTTLES WITH ALCOHOLIC DRINKS  
(18) 2020 09 17  
(58) 2021 04 19

---

(11) D 2011 475 S  
(73) Joint Stock Company "Elmavalmshebeli" (GE)  
D. Guramishvili Av. 84, 0141, Tbilisi, Georgia (GE)  
(54) CURRENT COLLECTOR  
(18) 2020 10 20  
(58) 2021 04 28

---

## EXTENSION OF REGISTRATION OF INTERNATIONAL DESIGNS

(11) DM/75214  
(73) GLASHÜTTER UHRENBETRIEB GMBH  
Altenberger Straße 1, 01768 Glashütte (DE)  
(15) 2011 01 27  
(24) 2011 01 27  
(18) 2026 01 27  
(28) 2  
(28') 2  
(54) Dial, Wristwatch

---

(11) DM/75718  
(73) SWATCH AG (SWATCH SA) (SWATCH LTD.)  
Jakob-Stämpfli-Strasse 94, CH-2502 BIEL/BIENNE (CH)  
(15) 2011 04 01  
(24) 2011 04 01  
(18) 2026 04 01  
(28) 5  
(28') 2  
(54) Wristwatches

---

(11) DM/75880  
(73) SWATCH AG (SWATCH SA) (SWATCH LTD.)  
Jakob-Stämpfli-Strasse 94, CH-2502 Biel/Bienne (CH)  
(15) 2011 04 15  
(24) 2011 04 15  
(18) 2026 04 15  
(28) 1  
(28') 1  
(54) Set of typographic symbols and characters

---

---

(11) DM/75881  
(73) SWATCH AG (SWATCH SA) (SWATCH LTD.)  
    Jakob-Stämpfli-Strasse 94, CH-2502 Biel/Bienne (CH)  
(15) 2011 04 15  
(24) 2011 04 15  
(18) 2026 04 15  
(28) 8  
(28') 3  
(54) Wristwatches with digital display

---

(11) DM/90166  
(73) ETA SA MANUFACTURE HORLOGÈRE SUISSE  
    Schild-Rust-Strasse 17, CH-2540 Grenchen (CH)  
(15) 2016 04 11  
(24) 2016 04 11  
(18) 2026 04 11  
(28) 6  
(28') 6  
(54) Wristwatches

---

(11) DM/90227  
(73) VALENTINO S.P.A.  
    Via Turati, 16/18, I-20121 Milano (EM)  
(15) 2016 04 05  
(24) 2016 04 05  
(18) 2026 04 05  
(28) 7  
(28') 7  
(54) Shoes

---

(11) DM/90409  
(73) OMEGA SA (OMEGA AG) (OMEGA LTD.)  
    Jakob-Stämpfli-Strasse 96, CH-2502 Biel/Bienne (CH)  
(15) 2016 04 28  
(24) 2016 04 28  
(18) 2026 04 28  
(28) 1  
(28') 1  
(54) Bottom of a watch case comprising a decoration

---

(11) DM/91857  
(73) VALENTINO S.P.A.  
    Via Turati, 16/18, I-20121 Milano (EM)  
(15) 2016 05 19  
(24) 2016 05 19  
(18) 2026 05 19  
(28) 2  
(28') 1  
(54) Shoes

---

## CANCELLATION OF REGISTRATION OF INTERNATIONAL DESIGNS

(11) DM/65958  
(73) SWATCH AG (SWATCH SA) (SWATCH LTD.)  
94, Rue Jakob Stämpfli, CH-2502 BIENNE (CH)  
DATE OF CANCELLATION OF REGISTRATION: 2019 10 18  
(58) 2021 04 21

---

(11) DM/66150  
(73) SOCIÉTÉ DES PRODUITS NESTLÉ S.A.  
Case postale 353, CH-1800 Vevey (CH)  
DATE OF CANCELLATION OF REGISTRATION: 2019 11 26  
(58) 2021 04 21

---

(11) DM/66281  
(73) SWATCH AG (SWATCH SA) (SWATCH LTD.)  
94, Rue Jakob Stämpfli, CH-2502 BIENNE (CH)  
DATE OF CANCELLATION OF REGISTRATION: 2020 01 26  
(58) 2021 04 21

---

(11) DM/66284  
(73) SWATCH AG (SWATCH SA) (SWATCH LTD.)  
94, Rue Jakob Stämpfli, CH-2502 BIENNE (CH)  
DATE OF CANCELLATION OF REGISTRATION: 2020 01 26  
(58) 2021 04 21

---

(11) DM/66324  
(73) SOCIÉTÉ DES PRODUITS NESTLÉ S.A.  
CH-1800 Vevey (CH)  
DATE OF CANCELLATION OF REGISTRATION: 2020 01 28  
(58) 2021 04 21

---

(11) DM/66422  
(73) DAIMLERCHRYSLER AG  
Epplestrasse 225, 70567 Stuttgart (DE)  
DATE OF CANCELLATION OF REGISTRATION: 2020 03 10  
(58) 2021 04 21

---

(11) DM/66481  
(73) DAIMLERCHRYSLER AG  
Epplestrasse 225, 70567 Stuttgart (DE)  
DATE OF CANCELLATION OF REGISTRATION: 2020 03 10  
(58) 2021 04 21

---

(11) DM/66500  
(73) SARA LEE HOUSEHOLD AND BODY CARE NEDERLAND B.V.,  
Traverse 2, NL-3905 NL Veenendaal (NL)  
DATE OF CANCELLATION OF REGISTRATION: 2020 03 22  
(58) 2021 04 21

---



(11) DM/66517  
(73) BRAUN GMBH  
145, Frankfurter Str., 61476 Kronberg (DE)  
DATE OF CANCELLATION OF REGISTRATION: 2020 01 31  
(58) 2021 04 21

---

(11) DM/66558  
(73) SWATCH AG (SWATCH SA) (SWATCH LTD.)  
94, Rue Jakob Stämpfli, CH-2502 BIENNE (CH)  
DATE OF CANCELLATION OF REGISTRATION: 2020 04 25  
(58) 2021 04 21

---

(11) DM/66577  
(73) COMPAGNIE DES CRISTALLERIES DE SAINT-LOUIS  
Saint-Louis Les Bitche, F-57620 LEMBERG (FR)  
DATE OF CANCELLATION OF REGISTRATION: 2020 04 19  
(58) 2021 04 21

---

(11) DM/66578  
(73) COMPAGNIE DES CRISTALLERIES DE SAINT-LOUIS  
Saint-Louis Les Bitche, F-57620 LEMBERG (FR)  
DATE OF CANCELLATION OF REGISTRATION: 2020 04 19  
(58) 2021 04 21

---

(11) DM/66581  
(73) SARA LEE HOUSEHOLD AND BODY CARE NEDERLAND B.V.  
Traverse 2, NL-3905 NL Veenendaal (NL)  
DATE OF CANCELLATION OF REGISTRATION: 2020 04 14  
(58) 2021 04 21

---

(11) DM/66584  
(73) DAIMLERCHRYSLER AG  
Epplestrasse 225, 70567 Stuttgart (DE)  
DATE OF CANCELLATION OF REGISTRATION: 2020 05 06  
(58) 2021 04 21

---

(11) DM/66585  
(73) DAIMLERCHRYSLER AG  
Epplestrasse 225, 70567 Stuttgart (DE)  
DATE OF CANCELLATION OF REGISTRATION: 2020 05 06  
(58) 2021 04 21

---

## TRADEMARKS

### RENEWAL OF REGISTRATIONS

(111) M 2001 14053 R2  
(156) 2001 10 09  
(186) 2031 10 09  
(732) Iridium Satellite LLC  
1750 Tysons Boulevard, Suite 1400,  
McLean, Virginia 22102, USA

---

(111) M 2001 13706 R2  
(156) 2001 01 30  
(186) 2031 01 30  
(732) Valentino S.P.A.  
Via Turati 16/18, Milano, Italy

---

(111) M 2001 13918 R2  
(156) 2001 05 29  
(186) 2031 05 29  
(732) N.E.T. Co. United S.A.  
Vistra Corporate Services Centre, Wickhams  
Cay II, Road Town, Tortola VG1110, Virgin  
Islands (British)

---

(111) M 2001 13919 R2  
(156) 2001 05 29  
(186) 2031 05 29  
(732) N.E.T. Co. United S.A.  
Vistra Corporate Services Centre, Wickhams  
Cay II, Road Town, Tortola VG1110, Virgin  
Islands (British)

---

(111) M 2001 13920 R2  
(156) 2001 05 29  
(186) 2031 05 29  
(732) N.E.T. Co. United S.A.  
Vistra Corporate Services Centre, Wickhams  
Cay II, Road Town, Tortola VG1110, Virgin  
Islands (British)

---

(111) M 2001 13989 R2  
(156) 2001 09 11  
(186) 2031 09 11  
(732) Efes Holland Technical  
Management Consultancy B.V.  
Strawinskylaan 1229, 1077XX Amsterdam,  
Netherlands

---

(111) M 2001 14118 R2  
(156) 2001 10 31  
(186) 2031 10 31  
(732) Efes Holland Technical  
Management Consultancy B.V.  
Strawinskylaan 1229, 1077XX Amsterdam,  
Netherlands

---

(111) M 2001 13990 R2  
(156) 2001 09 11  
(186) 2031 09 11  
(732) Efes Holland Technical  
Management Consultancy B.V.  
Strawinskylaan 1229, 1077XX Amsterdam,  
Netherlands

---

(111) M 2001 14042 R2  
(156) 2001 10 01  
(186) 2031 10 01  
(732) Midea Group CO., Ltd.  
B26-28F, Midea Headquarter Building, No. 6  
Midea Avenue, Beijiao, Shunde, Foshan,  
Guangdong, China

---

(111) M 2001 14209 R2  
(156) 2001 12 17  
(186) 2031 12 17  
(732) Widetech Manufacturing SDN. BHD.  
101A, Hilir Sungei Keluang 5, Bayan Lepas  
Industrial Park IV, 11900 Bayan Lepas,  
Penang, Malaysia

---

(111) M 2011 21361 R1  
(156) 2011 04 13  
(186) 2031 04 13  
(732) Jansport Apanel Corp.  
3411 Silverside Road, Wilmington,  
Delaware, USA

---

(111) M 2011 21379 R1  
(156) 2011 04 15  
(186) 2031 04 15  
(732) Jansport Apanel Corp.  
3411 Silverside Road, Wilmington,  
Delaware, USA

---

(111) M 2011 21380 R1  
(156) 2011 04 15  
(186) 2031 04 15  
(732) Jansport Aparent Corp.  
3411 Silverside Road, Wilmington,  
Delaware, USA

---

(111) M 2011 21549 R1  
(156) 2011 06 14  
(186) 2031 06 14  
(732) Jacobs Douwe Egberts DE GmbH  
Landgemarkstrasse 4-20, 28199 Bremen,  
Germany

---

(111) M 2011 21751 R1  
(156) 2011 09 16  
(186) 2031 09 16  
(732) Jaguar Land Rover Limited  
Abbey Road, Whitley, Coventry CV3 4LF,  
United Kingdom

---

(111) M 2011 21808 R1  
(156) 2011 09 19  
(186) 2031 09 19  
(732) Efes Holland Technical  
Management Consultancy B.V.  
Strawinskylaan 1229, 1077XX Amsterdam,  
Netherlands

---

(111) M 2011 21945 R1  
(156) 2011 10 28  
(186) 2031 10 28  
(732) Sheraton International Ip LLC  
One StarPoint, Stamford, Connecticut 06902,  
USA

---

(111) M 2011 22153 R1  
(156) 2011 12 29  
(186) 2031 12 29  
(732) Efes Holland Technical  
Management Consultancy B.V  
Strawinskylaan 1229, 1077XX Amsterdam,  
Netherlands

---

(111) M 2011 22083 R1  
(156) 2011 12 14  
(186) 2031 12 14  
(732) Grant Thornton international Limited  
Grant thornton House, 22 Melton street,  
London, NW1 2EP, United Kingdom

---

## COMPLETE TRANSFER OF RIGHTS

(111) M 2020 33439 R  
(732) Hamlet Merabishvili  
Batu Kraveishvili Av. 3, Tbilisi, Georgia  
(770) Zaza Rusadze  
Batu Kraveishvili St. 7, 0108, Tbilisi,  
Georgia  
(580) 2021 04 05

---

(111) M 1996 2297 R  
(732) Unilever IP Holdings B.V.  
Weena 455, 3013 AL Rotterdam,  
Netherlands  
(770) UNILEVER N.V.  
Weena 455, NL-3013 AL Rotterdam,  
Netherlands  
(580) 2021 03 24

---

(111) M 2011 21281 R  
(732) Unilever IP Holdings B.V.  
Weena 455, 3013 AL Rotterdam,  
Netherlands  
(770) Unilever N.V.  
Weena 455, 3013 AL Rotterdam,  
Netherlands  
(580) 2021 03 24

---

(111) M 2014 25457 R  
(732) JSC "Miso Euro Credit"  
Giorgi Saakadze II exit 11, Saburtalo district,  
Tbilisi, Georgia  
(770) "Euro Credit +" Ltd  
Giorgi Saakadze 2nd exit 11, 0101, Tbilisi  
Georgia  
(580) 2021 04 06

---

(111) M 2014 25456 R  
(732) JSC "Miso Euro Credit"  
Giorgi Saakadze II exit 11, Saburtalo district,  
Tbilisi, Georgia  
(770) "Euro Credit +" Ltd  
Giorgi Saakadze 2nd exit 11, 0101, Tbilisi  
Georgia  
(580) 2021 04 06

---

## CHANGES OF NAMES AND/OR ADDRESS OF OWNERS

(111) M 2001 14053 R  
(732) Iridium Satellite LLC  
1750 Tysons Boulevard, Suite 1400, McLean,  
Virginia 22102, USA  
(770) Iridium Satellite LLC  
6707 Democracy Blvd. Suite 300, Bethesda,  
MD 20817, USA  
(580) 2021 04 06

---

(111) M 2001 13820 R  
(732) Amazon Europe Core S.à.r.l.  
38 avenue John F. Kennedy, Luxembourg,  
L-1855, Luxembourg  
(770) Amazon Europe Core S.à.r.l.  
5, rue Plaetis, L-2338 Luxembourg,  
Luxembourg  
(580) 2021 03 22

---

(111) M 2001 13918 R  
(732) N.E.T. Co. United S.A.  
Vistra Corporate Services Centre, Wickhams  
Cay II, Road Town, Tortola VG111, Virgin  
Islands (British)  
(770) N.E.T. Co. United S.A.  
P.O. Box 957, Offshore Incorporations Centre,  
Road Town, Tortola, Virgin Islands (British)  
(580) 2021 04 02

---

(111) M 2001 13919 R  
(732) N.E.T. Co. United S.A.  
Vistra Corporate Services Centre, Wickhams  
Cay II, Road Town, Tortola VG1110, Virgin  
Islands (British)  
(770) N.E.T. Co. United S.A.  
P.O. Box 957, Offshore Incorporations Centre,  
Road Town, Tortola, Virgin Islands (British)  
(580) 2021 04 02

---

(111) M 2001 13920 R  
(732) N.E.T. Co. United S.A.  
Vistra Corporate Services Centre, Wickhams  
Cay II, Road Town, Tortola VG1110, Virgin  
Islands (British)  
(770) N.E.T. Co. United S.A.  
P.O. Box 957, Offshore Incorporations Centre,  
Road Town, Tortola, Virgin Islands (British)  
(580) 2021 04 02

---

(111) M 2002 14708 R  
(732) Mitsubishi Jidosha Kogyo Kabushiki Kaisha  
1-21, Shibaura 3-chome, Minato-ku, Tokyo  
108-8410, Japan  
(770) Mitsubishi Jidosha Kogyo Kabushiki Kaisha  
33-8, Shiba 5-chome, Minato-ku, Tokyo, Japan  
(580) 2021 04 07

---

(111) M 2003 15254 R  
(732) Mitsubishi Jidosha Kogyo Kabushiki Kaisha  
1-21, Shibaura 3-chome, Minato-ku, Tokyo  
108-8410, Japan  
(770) Mitsubishi Jidosha Kogyo Kabushiki Kaisha  
33-8, Shiba 5-chome, Minato-ku, Tokyo, Japan  
(580) 2021 04 07

---

(111) M 2003 15293 R  
(732) Mitsubishi Jidosha Kogyo Kabushiki Kaisha  
1-21, Shibaura 3-chome, Minato-ku, Tokyo  
108-8410, Japan  
(770) Mitsubishi Jidosha Kogyo Kabushiki Kaisha  
33-8, Shiba 5-chome, Minato-ku, Tokyo, Japan  
(580) 2021 04 07

---

(111) M 2004 15559 R  
(732) Mitsubishi Jidosha Kogyo Kabushiki Kaisha  
1-21, Shibaura 3-chome, Minato-ku, Tokyo  
108-8410, Japan  
(770) Mitsubishi Jidosha Kogyo Kabushiki Kaisha  
33-8, Shiba 5-chome, Minato-ku, Tokyo, Japan  
(580) 2021 04 07

---

(111) M 2006 17207 R  
(732) Mitsubishi Jidosha Kogyo Kabushiki Kaisha  
1-21, Shibaura 3-chome, Minato-ku, Tokyo  
108-8410, Japan  
(770) Mitsubishi Jidosha Kogyo Kabushiki Kaisha  
33-8, Shiba 5-chome, Minato-ku, Tokyo, Japan  
(580) 2021 04 07

---

(111) M 2006 17208 R  
(732) Mitsubishi Jidosha Kogyo Kabushiki Kaisha  
1-21, Shibaura 3-chome, Minato-ku, Tokyo  
108-8410, Japan  
(770) Mitsubishi Jidosha Kogyo Kabushiki Kaisha  
33-8, Shiba 5-chome, Minato-ku, Tokyo, Japan  
(580) 2021 04 07

---

(111) M 2011 21400 R  
(732) Mitsubishi Jidosha Kogyo Kabushiki Kaisha  
1-21, Shibaura 3-chome, Minato-ku, Tokyo  
108-8410, Japan  
(770) Mitsubishi Jidosha Kogyo Kabushiki Kaisha  
33-8, Shiba 5-chome, Minato-ku, Tokyo, Japan  
(580) 2021 04 07

---

(111) M 2013 24301 R  
(732) Mitsubishi Jidosha Kogyo Kabushiki Kaisha  
1-21, Shibaura 3-chome, Minato-ku, Tokyo  
108-8410, Japan  
(770) Mitsubishi Jidosha Kogyo Kabushiki Kaisha  
33-8, Shiba 5-chome, Minato-ku, Tokyo, Japan  
(580) 2021 04 07

---

(111) M 2013 24302 R  
(732) Mitsubishi Jidosha Kogyo Kabushiki Kaisha  
1-21, Shibaura 3-chome, Minato-ku, Tokyo  
108-8410, Japan  
(770) Mitsubishi Jidosha Kogyo Kabushiki Kaisha  
33-8, Shiba 5-chome, Minato-ku, Tokyo, Japan  
(580) 2021 04 07

---

(111) M 2014 24553 R  
(732) Mitsubishi Jidosha Kogyo Kabushiki Kaisha  
1-21, Shibaura 3-chome, Minato-ku, Tokyo  
108-8410, Japan  
(770) Mitsubishi Jidosha Kogyo Kabushiki Kaisha  
33-8, Shiba 5-chome, Minato-ku, Tokyo, Japan  
(580) 2021 04 07

---

(111) M 2014 24554 R  
(732) Mitsubishi Jidosha Kogyo Kabushiki Kaisha  
1-21, Shibaura 3-chome, Minato-ku, Tokyo  
108-8410, Japan  
(770) Mitsubishi Jidosha Kogyo Kabushiki Kaisha  
33-8, Shiba 5-chome, Minato-ku, Tokyo, Japan  
(580) 2021 04 07

---

(111) M 2014 24556 R  
(732) Mitsubishi Jidosha Kogyo Kabushiki Kaisha  
1-21, Shibaura 3-chome, Minato-ku, Tokyo  
108-8410, Japan  
(770) Mitsubishi Jidosha Kogyo Kabushiki Kaisha  
33-8, Shiba 5-chome, Minato-ku, Tokyo, Japan  
(580) 2021 04 07

---

(111) M 2015 25714 R  
(732) Mitsubishi Jidosha Kogyo Kabushiki Kaisha  
1-21, Shibaura 3-chome, Minato-ku, Tokyo  
108-8410, Japan

(770) Mitsubishi Jidosha Kogyo Kabushiki Kaisha  
33-8, Shiba5-Chome, Minato-ku, Tokyo, Japan  
(580) 2021 04 07

---

(111) M 2016 27907 R  
(732) Mitsubishi Jidosha Kogyo Kabushiki Kaisha  
1-21, Shibaura 3-chome, Minato-ku, Tokyo  
108-8410, Japan  
(770) Mitsubishi Jidosha Kogyo Kabushiki Kaisha  
33-8, Shiba 5-chome, Minato-ku, Tokyo, Japan  
(580) 2021 04 07

---

(111) M 2017 28895 R  
(732) Mitsubishi Jidosha Kogyo Kabushiki Kaisha  
1-21, Shibaura 3-chome, Minato-ku, Tokyo  
108-8410, Japan  
(770) Mitsubishi Jidosha Kogyo Kabushiki Kaisha  
33-8, Shiba 5-chome, Minato-ku, Tokyo, Japan  
(580) 2021 04 07

---

(111) M 2018 29236 R  
(732) Mitsubishi Jidosha Kogyo Kabushiki Kaisha  
1-21, Shibaura 3-chome, Minato-ku, Tokyo  
108-8410, Japan  
(770) Mitsubishi Jidosha Kogyo Kabushiki Kaisha,  
33-8, Shiba 5-chome, Minato-ku, Tokyo Japan  
(580) 2021 04 07

---

## CANCELLATION OF TRADEMARKS REGISTRATION

(111) M 2000 13517 R  
(151) 2000 10 10  
(732) Sanofi  
54, rue La Boétie, 75008 Paris, France  
(141) 2021 04 21

---

(111) M 2000 13537 R  
(151) 2000 10 18  
(732) British American Tobacco (Brands) Inc.  
251 Little Falls Drive, Suite 100, Delaware,  
19808-1674, Wilmington, USA  
(141) 2021 04 29

---

(111) M 2000 13514 R  
(151) 2000 10 10  
(732) Parker Pen Products  
Halifax Avenue, Fradley Park, Lichfield,  
Staffordshire WS13 8SS, United Kingdom  
(141) 2021 04 21

---

(111) M 2000 13513 R  
(151) 2000 10 10  
(732) Meda AB  
Pipers Väg 2A, Box 906 SE-170 09 Solna,  
Sweden  
(141) 2021 04 21

---

(111) M 2000 13534 R  
(151) 2000 10 13  
(732) Intel Corporation  
2200 Mission College Boulevard, Santa Clara,  
California 95052-8119, USA  
(141) 2021 04 26

---

(111) M 2000 13511 R  
(151) 2000 10 10  
(732) Tulip Food Company P/S  
Tulipvei 1, 8940 Ranersi Sv, Denmark  
(141) 2021 04 21

---

(111) M 2000 13525 R  
(151) 2000 10 11  
(732) Colgate-Palmolive Company  
300 Park Avenue, New York, NY 10022, USA  
(141) 2021 04 22

---

(111) M 2000 13522 R  
(151) 2000 10 10  
(732) Unilever N.V.  
Weena 455, NL-3013 AL Rotterdam,  
Netherlands  
(141) 2021 04 21

---

(111) M 2010 20805 R  
(151) 2010 10 13  
(732) LTD "Aqua Geo"  
Vill. Misaktsieli, 3308, Mtskheta district,  
Georgia  
(141) 2021 04 26

---

(111) M 2010 20806 R  
(151) 2010 10 13  
(732) LTD "Aqua Geo"  
Vill. Misaktsieli, 3308, Mtskheta district,  
Georgia  
(141) 2021 04 26

---

(111) M 2010 20822 R  
(151) 2010 10 15  
(732) LTD "Suliko"  
Jincharadze St. 14, b. 2, 6000, Batumi, Georgia  
(141) 2021 04 26

---

(111) M 2010 20825 R  
(151) 2010 10 15  
(732) Harrington Development Inc.  
Arango-Orillac Bldg. East 54 th street,  
Republic of Panama  
(141) 2021 04 26

---

(111) M 2010 20807 R  
(151) 2010 10 13  
(732) Biogen MA Inc., a Massachusetts Corporation  
250 Binney Street, Cambridge, Massachusetts  
02142, USA  
(141) 2021 04 26

---

(111) M 2010 20827 R  
(151) 2010 10 15  
(732) JSC "G P C"  
Marjanishvili St. 26, 0164, Tbilisi, Georgia  
(141) 2021 04 26

---

(111) M 2010 20828 R  
(151) 2010 10 15  
(732) Zurab Shamoyan  
Varketili 3, IIIa mkr., corp. 340, app. 8,  
0163, Tbilisi, Georgia  
(141) 2021 04 26

---

(111) M 2010 20808 R  
(151) 2010 10 13  
(732) JSC "Newpharpromo"  
Davit Aghmashenebeli Av. 148a, 0112, Tbilisi,  
Georgia  
(141) 2021 04 26

---

(111) M 2010 20809 R  
(151) 2010 10 13  
(732) JSC "Newpharpromo"  
Davit Aghmashenebeli Av. 148a, 0112, Tbilisi,  
Georgia  
(141) 2021 04 26

---

(111) M 2010 20810 R  
(151) 2010 10 13  
(732) JSC "Newpharpromo"  
Davit Aghmashenebeli Av. 148a, 0112, Tbilisi,  
Georgia  
(141) 2021 04 26

---

(111) M 2010 20811 R  
(151) 2010 10 13  
(732) JSC "Newpharpromo"  
Davit Aghmashenebeli Av. 148a, 0112, Tbilisi,  
Georgia  
(141) 2021 04 26

---

(111) M 2010 20812 R  
(151) 2010 10 13  
(732) JSC "Newpharpromo"  
Davit Aghmashenebeli Av. 148a, 0112, Tbilisi,  
Georgia  
(141) 2021 04 26

---

(111) M 2010 20813 R  
(151) 2010 10 13  
(732) JSC "Newpharpromo"  
Davit Aghmashenebeli Av. 148a, 0112, Tbilisi,  
Georgia  
(141) 2021 04 26

---

(111) M 2010 20814 R  
(151) 2010 10 13  
(732) JSC "Newpharpromo"  
Davit Aghmashenebeli Av. 148a, 0112, Tbilisi,  
Georgia  
(141) 2021 04 26

---

(111) M 2010 20820 R  
(151) 2010 10 15  
(732) Georgian Football Federation  
Ilia Chavchavadze Av. 76a, 0162, Tbilisi,  
Georgia  
(141) 2021 04 26

---

(111) M 2010 20815 R  
(151) 2010 10 15  
(732) LLC "Standard Tobacco Incorporated"  
Abuseridze-Tbeli St. 13, 0120, Tbilisi, Georgia  
(141) 2021 04 26

---

(111) M 2000 13524 R  
(151) 2000 10 11  
(732) Bayer Intellectual Property GmbH  
Alfred-Nobel-Strasse 10, 40789 Monheim  
am Rhein, Germany  
(141) 2021 04 22

---



# CLASSIFICATION INDEXES

## INVENTIONS

### CONCORDANCE TABLE OF INTERNATIONAL CLASSIFICATION INDEX AND PUBLICATION NUMBERS

INTERNATIONAL CLASSIFICATION INDEXES (51)	NUMBER OF PUBLISHED APPLICATION (10)
A 61 K 38/16; A 61 K 38/48; C 12 N 9/52	AP 2021 14666 A
A 61 K 45/06; A 61 K 39/395; C 07 K 16/40	AP 2021 14848 A
C 01 B 31/08; C 10 B 53/02	AP 2021 15030 A
C 02 F 1/00; C 09 K 8/05	AP 2021 15178 A
C 07 K 16 /24	AP 2021 14876 A

### CONCORDANCE TABLE OF PUBLICATION NUMBERS AND INTERNATIONAL CLASSIFICATION INDEX

NUMBER OF PUBLISHED APPLICATION (10)	INTERNATIONAL CLASSIFICATION INDEXES (51)
AP 2021 14666 A	A 61 K 38/16; A 61 K 38/48; C 12 N 9/52
AP 2021 14848 A	A 61 K 45/06; A 61 K 39/395; C 07 K 16/40
AP 2021 14876 A	C 07 K 16 /24
AP 2021 15030 A	C 01 B 31/08; C 10 B 53/02
AP 2021 15178 A	C 02 F 1/00; C 09 K 8/05

### CONCORDANCE TABLE OF INTERNATIONAL CLASSIFICATION INDEX, PATENT NUMBERS AND PUBLICATION NUMBERS

INTERNATIONAL CLASSIFICATION INDEX (51)	NUMBER OF PATENT (11)	NUMBER OF PUBLISHED APPLICATION (10)
A 61 K 47/00; A 61 K 59/595; A 61 K 9/08	P 2021 7252 B	AP 2020 15038 A
A 61 K 36/00	P 2021 7254 B	AP 2021 15233 A
A 61 K 39/00; C 07 K 16/46; C 07 K 16/18	P 2021 7253 B	AP 2021 14964 A
C 04 B 21/00	P 2021 7255 B	AP 2020 15125 A

### CONCORDANCE TABLE OF PATENT NUMBERS, PUBLICATION NUMBERS AND INTERNATIONAL CLASSIFICATION INDEX

NUMBER OF PATENT (11)	NUMBER OF PUBLISHED APPLICATION (10)	INTERNATIONAL CLASSIFICATION INDEX (51)
P 2021 7252 B	AP 2020 15038 A	A 61 K 47/00; A 61 K 59/595; A 61 K 9/08
P 2021 7253 B	AP 2021 14964 A	A 61 K 39/00; C 07 K 16/46; C 07 K 16/18
P 2021 7254 B	AP 2021 15233 A	A 61 K 36/00
P 2021 7255 B	AP 2020 15125 A	C 04 B 21/00

**CONCORDANCE TABLE OF APPLICATION NUMBERS,  
PUBLICATION NUMBERS AND PATENTS**

NUMBER OF APPLICATION (21)	NUMBER OF PUBLISHED APPLICATION (10)	NUMBER OF PATENT (11)
AP 2017 14964	AP 2021 14964 A	P 2021 7253 B
AP 2017 15038	AP 2020 15038 A	P 2021 7252 B
AP 2019 15125	AP 2020 15125 A	P 2021 7255 B
AP 2019 15233	AP 2021 15233 A	P 2021 7254 B

## UTILITY MODELS

**CONCORDANCE TABLE OF INTERNATIONAL CLASSIFICATION INDEX  
AND PUBLICATION NUMBERS**

INTERNATIONAL CLASSIFICATION INDEXES (51)	NUMBER OF PUBLISHED APPLICATION (10)
A 01 G 22/00; A 01 G 31/00	AU 2021 15269 U
C 04 B 28/36	AU 2021 15249 U

**CONCORDANCE TABLE OF PUBLICATION NUMBERS  
AND INTERNATIONAL CLASSIFICATION INDEX**

NUMBER OF PUBLISHED APPLICATION (10)	INTERNATIONAL CLASSIFICATION INDEXES (51)
AU 2021 15249 U	C 04 B 28/36
AU 2021 15269 U	A 01 G 22/00; A 01 G 31/00

## TRADEMARKS

### CONCORDANCE TABLE OF REGISTRATION NUMBERS, APPLICATION NUMBERS, PUBLICATION NUMBERS AND BULLETIN NUMBERS

NUMBER OF REGISTRATION (111)	NUMBER OF APPLICATIONS (210)	NUMBER OF PUBLISHED APPLICATIONS (260)	NUMBER OF BULLETIN
1	2	3	4
M 2021 33943 R	AM 112625	–	8(564)2021
M 2021 33944 R	AM 112096	–	8(564)2021
M 2021 33945 R	AM 112506	–	8(564)2021
M 2021 33946 R	AM 112579	–	8(564)2021
M 2021 33947 R	AM 112580	–	8(564)2021
M 2021 33948 R	AM 112673	–	8(564)2021
M 2021 33949 R	AM 112676	–	8(564)2021
M 2021 33950 R	AM 112617	–	8(564)2021
M 2021 33951 R	AM 112618	–	8(564)2021
M 2021 33952 R	AM 112611	–	8(564)2021
M 2021 33953 R	AM 112681	–	8(564)2021
M 2021 33954 R	AM 107159	AM 2020 107159 A	19(551)2020
M 2021 33955 R	AM 107266	AM 2020 107266 A	19(551)2020
M 2021 33956 R	AM 107267	AM 2020 107267 A	19(551)2020
M 2021 33957 R	AM 107287	AM 2020 107287 A	19(551)2020
M 2021 33958 R	AM 107564	AM 2020 107564 A	20(552)2020
M 2021 33959 R	AM 107659	AM 2020 107659 A	21(553)2020
M 2021 33960 R	AM 107565	AM 2020 107565 A	20(552)2020
M 2021 33961 R	AM 107663	AM 2020 107663 A	19(551)2020
M 2021 33962 R	AM 107817	AM 2020 107817 A	20(552)2020
M 2021 33963 R	AM 107818	AM 2020 107818 A	21(553)2020
M 2021 33964 R	AM 107819	AM 2020 107819 A	21(553)2020
M 2021 33965 R	AM 107820	AM 2020 107820 A	21(553)2020
M 2021 33966 R	AM 107821	AM 2020 107821 A	21(553)2020
M 2021 33967 R	AM 107822	AM 2020 107822 A	21(553)2020
M 2021 33968 R	AM 107826	AM 2020 107826 A	22(554)2020
M 2021 33969 R	AM 107828	AM 2020 107828 A	22(554)2020
M 2021 33970 R	AM 107829	AM 2020 107829 A	22(554)2020
M 2021 33971 R	AM 107830	AM 2020 107830 A	22(554)2020
M 2021 33972 R	AM 107831	AM 2020 107831 A	22(554)2020
M 2021 33973 R	AM 107832	AM 2020 107832 A	21(553)2020
M 2021 33974 R	AM 107833	AM 2020 107833 A	21(553)2020
M 2021 33975 R	AM 107834	AM 2020 107834 A	22(554)2020
M 2021 33976 R	AM 107835	AM 2020 107835 A	22(554)2020
M 2021 33977 R	AM 107836	AM 2020 107836 A	22(554)2020
M 2021 33978 R	AM 107837	AM 2020 107837 A	22(554)2020
M 2021 33979 R	AM 107838	AM 2020 107838 A	22(554)2020
M 2021 33980 R	AM 107839	AM 2020 107839 A	22(554)2020
M 2021 33981 R	AM 107892	AM 2020 107892 A	21(553)2020
M 2021 33982 R	AM 107893	AM 2020 107893 A	21(553)2020
M 2021 33983 R	AM 107894	AM 2020 107894 A	21(553)2020
M 2021 33984 R	AM 107895	AM 2020 107895 A	21(553)2020
M 2021 33985 R	AM 107896	AM 2020 107896 A	21(553)2020
M 2021 33986 R	AM 107897	AM 2020 107897 A	21(553)2020
M 2021 33987 R	AM 107898	AM 2020 107898 A	21(553)2020
M 2021 33988 R	AM 107899	AM 2020 107899 A	21(553)2020
M 2021 33989 R	AM 107900	AM 2020 107900 A	21(553)2020
M 2021 33990 R	AM 107901	AM 2020 107901 A	21(553)2020

1	2	3	4
M 2021 33991 R	AM 107902	AM 2020 107902 A	21(553)2020
M 2021 33992 R	AM 107903	AM 2020 107903 A	21(553)2020
M 2021 33993 R	AM 107904	AM 2020 107904 A	21(553)2020
M 2021 33994 R	AM 107905	AM 2020 107905 A	21(553)2020
M 2021 33995 R	AM 107906	AM 2020 107906 A	21(553)2020
M 2021 33996 R	AM 107907	AM 2020 107907 A	21(553)2020
M 2021 33997 R	AM 107908	AM 2020 107908 A	21(553)2020
M 2021 33998 R	AM 107909	AM 2020 107909 A	21(553)2020
M 2021 33999 R	AM 107911	AM 2020 107911 A	21(553)2020
M 2021 34000 R	AM 108118	AM 2020 108118 A	23(555)2020
M 2021 34001 R	AM 108119	AM 2020 108119 A	24(556)2020
M 2021 34002 R	AM 108120	AM 2020 108120 A	23(555)2020
M 2021 34003 R	AM 108133	AM 2020 108133 A	23(555)2020
M 2021 34004 R	AM 108595	AM 2020 108595 A	24(556)2020
M 2021 34005 R	AM 112703	–	8(564)2021
M 2021 34006 R	AM 112664	–	8(564)2021

**CONCORDANCE TABLE OF PUBLICATION NUMBERS  
AND APPLICATION NUMBERS**

NUMBER OF PUBLISHED APPLICATION (260)	NUMBER OF APPLICATION (210)	1	2
		1	2
AM 2021 105655 A	AM 105655	AM 2021 110029 A	AM 110029
AM 2021 108696 A	AM 108696	AM 2021 110031 A	AM 110031
AM 2021 109731 A	AM 109731	AM 2021 110032 A	AM 110032
AM 2021 109772 A	AM 109772	AM 2021 110033 A	AM 110033
AM 2021 109825 A	AM 109825	AM 2021 110035 A	AM 110035
AM 2021 109826 A	AM 109826	AM 2021 110037 A	AM 110037
AM 2021 109832 A	AM 109832	AM 2021 110038 A	AM 110038
AM 2021 109840 A	AM 109840	AM 2021 110040 A	AM 110040
AM 2021 109846 A	AM 109846	AM 2021 110041 A	AM 110041
AM 2021 109847 A	AM 109847	AM 2021 110042 A	AM 110042
AM 2021 109911 A	AM 109911	AM 2021 110043 A	AM 110043
AM 2021 109912 A	AM 109912	AM 2021 110045 A	AM 110045
AM 2021 109919 A	AM 109919	AM 2021 110046 A	AM 110046
AM 2021 109922 A	AM 109922	AM 2021 110113 A	AM 110113
AM 2021 109927 A	AM 109927	AM 2021 110114 A	AM 110114
AM 2021 109932 A	AM 109932	AM 2021 110115 A	AM 110115
AM 2021 109933 A	AM 109933	AM 2021 110116 A	AM 110116
AM 2021 109950 A	AM 109950	AM 2021 110118 A	AM 110118
AM 2021 109958 A	AM 109958	AM 2021 110129 A	AM 110129
AM 2021 109961 A	AM 109961	AM 2021 110130 A	AM 110130
AM 2021 109962 A	AM 109962	AM 2021 110135 A	AM 110135
AM 2021 109963 A	AM 109963	AM 2021 110137 A	AM 110137
AM 2021 109964 A	AM 109964	AM 2021 110138 A	AM 110138
AM 2021 110016 A	AM 110016	AM 2021 110139 A	AM 110139
AM 2021 110017 A	AM 110017	AM 2021 110193 A	AM 110193
AM 2021 110021 A	AM 110021	AM 2021 110197 A	AM 110197
AM 2021 110023 A	AM 110023	AM 2021 110199 A	AM 110199
AM 2021 110025 A	AM 110025	AM 2021 110208 A	AM 110208
AM 2021 110027 A	AM 110027	AM 2021 110212 A	AM 110212
		AM 2021 110217 A	AM 110217
		AM 2021 110220 A	AM 110220
		AM 2021 110221 A	AM 110221
		AM 2021 110223 A	AM 110223
		AM 2021 110231 A	AM 110231

CONCORDANCE TABLE OF INDEX OF GOODS AND/OR SERVICES  
AND APPLICATION NUMBERS

INDEX OF GOODS AND/OR SERVICES (511)	NUMBER OF PUBLISHED APPLICATIONS (260)	1	2
1	2		
1	AM 2021 110042 A	25	AM 2021 108696 A
1	AM 2021 110115 A	25	AM 2021 109731 A
1	AM 2021 110217 A	25	AM 2021 109847 A
3	AM 2021 109731 A	25	AM 2021 109962 A
3	AM 2021 110045 A	25	AM 2021 109963 A
3	AM 2021 110223 A	25	AM 2021 109964 A
4	AM 2021 110113 A	27	AM 2021 109963 A
5	AM 2021 109731 A	27	AM 2021 109964 A
5	AM 2021 109840 A	29	AM 2021 109911 A
5	AM 2021 109932 A	29	AM 2021 109912 A
5	AM 2021 109933 A	29	AM 2021 110025 A
5	AM 2021 109964 A	30	AM 2021 109911 A
5	AM 2021 110023 A	30	AM 2021 109912 A
5	AM 2021 110031 A	30	AM 2021 110032 A
5	AM 2021 110033 A	30	AM 2021 110037 A
5	AM 2021 110042 A	30	AM 2021 110038 A
5	AM 2021 110118 A	30	AM 2021 110038 A
5	AM 2021 110223 A	30	AM 2021 110040 A
7	AM 2021 109825 A	30	AM 2021 110040 A
7	AM 2021 109919 A	30	AM 2021 110043 A
7	AM 2021 110116 A	30	AM 2021 110043 A
9	AM 2021 109826 A	30	AM 2021 110199 A
9	AM 2021 109919 A	30	AM 2021 110212 A
9	AM 2021 109963 A	31	AM 2021 109911 A
9	AM 2021 109964 A	31	AM 2021 109912 A
9	AM 2021 110017 A	32	AM 2021 109772 A
10	AM 2021 109964 A	32	AM 2021 109911 A
10	AM 2021 110042 A	32	AM 2021 109912 A
11	AM 2021 109919 A	32	AM 2021 109958 A
11	AM 2021 110137 A	32	AM 2021 110016 A
11	AM 2021 110138 A	32	AM 2021 110029 A
11	AM 2021 110139 A	32	AM 2021 110037 A
11	AM 2021 110223 A	32	AM 2021 110037 A
12	AM 2021 109825 A	32	AM 2021 110038 A
12	AM 2021 110114 A	32	AM 2021 110040 A
12	AM 2021 110220 A	32	AM 2021 110040 A
12	AM 2021 110221 A	32	AM 2021 110231 A
14	AM 2021 109731 A	33	AM 2021 109772 A
16	AM 2021 109847 A	33	AM 2021 109846 A
18	AM 2021 109962 A	33	AM 2021 109911 A
18	AM 2021 109963 A	33	AM 2021 109912 A
18	AM 2021 109964 A	33	AM 2021 110021 A
21	AM 2021 109963 A	33	AM 2021 110029 A
21	AM 2021 109964 A	33	AM 2021 110035 A
24	AM 2021 109731 A	33	AM 2021 110037 A
24	AM 2021 109963 A	33	AM 2021 110038 A
24	AM 2021 109964 A	33	AM 2021 110041 A
		33	AM 2021 110130 A
		33	AM 2021 110135 A
		33	AM 2021 110208 A
		33	AM 2021 110212 A
		33	AM 2021 110231 A
		35	AM 2021 105655 A
		35	AM 2021 109731 A
		35	AM 2021 109825 A
		35	AM 2021 109832 A

1	2
35	AM 2021 109919 A
35	AM 2021 109958 A
35	AM 2021 109964 A
35	AM 2021 110016 A
35	AM 2021 110021 A
35	AM 2021 110035 A
35	AM 2021 110037 A
35	AM 2021 110038 A
35	AM 2021 110113 A
35	AM 2021 110129 A
35	AM 2021 110135 A
35	AM 2021 110193 A
35	AM 2021 110197 A
36	AM 2021 105655 A
36	AM 2021 109832 A
36	AM 2021 109950 A
37	AM 2021 109825 A
37	AM 2021 109922 A
37	AM 2021 110113 A
37	AM 2021 110137 A

1	2
37	AM 2021 110138 A
37	AM 2021 110139 A
38	AM 2021 110017 A
39	AM 2021 109961 A
39	AM 2021 110027 A
40	AM 2021 110223 A
41	AM 2021 109832 A
41	AM 2021 109847 A
41	AM 2021 110017 A
42	AM 2021 108696 A
42	AM 2021 109826 A
43	AM 2021 109911 A
43	AM 2021 109912 A
43	AM 2021 109927 A
43	AM 2021 110021 A
43	AM 2021 110043 A
44	AM 2021 109731 A
44	AM 2021 110193 A
44	AM 2021 110223 A

CONCORDANCE TABLE OF INDEX OF GOODS AND/OR SERVICES  
AND NUMBERS OF TRADEMARKS REGISTERED ACCORDING  
TO THE ACCELERATED PROCEDURE

INDEX OF GOODS AND/OR SERVICES (511)	NUMBERS OF REGISTERED ACCORDING TO THE ACCELERATED PROCEDURE (111)
3	M 2021 33953 R
5	M 2021 33943 R
11	M 2021 34005 R
17	M 2021 34005 R
25	M 2021 34006 R
26	M 2021 34006 R
30	M 2021 33944 R
32	M 2021 33945 R
33	M 2021 33945 R
33	M 2021 33950 R
33	M 2021 33951 R
35	M 2021 33943 R
35	M 2021 33953 R
35	M 2021 34005 R
36	M 2021 33946 R
36	M 2021 33947 R
36	M 2021 33948 R
36	M 2021 33952 R
37	M 2021 34005 R
44	M 2021 33949 R

# OFFICIAL BULLETIN OF THE INDUSTRIAL PROPERTY

**INVENTIONS**  
**UTILITY MODELS**  
**DESIGNS**  
**TRADEMARKS**

## **8(564)**

EDITOR-IN-CHIEF: N. Bebrishvili

EDITOR-TRANSLATOR: E. Gabunia

PROOFREADER: A. Shikhashvili

COMPUTER LAYOUT: M. Ordenidze  
K. Svanidze

[www.sakpatenti.gov.ge](http://www.sakpatenti.gov.ge)

E-mail: [info@sakpatenti.org.ge](mailto:info@sakpatenti.org.ge)