

Official Bulletin of the Industrial Property

Inventions

Utility Models

Designs

Trademarks



საქართველოს ინტელექტუალური
საკუთრების ეროვნული ცენტრი

საქპატენტი

SAKPATENTI

NATIONAL INTELLECTUAL PROPERTY
CENTER OF GEORGIA

www.sakpatenti.gov.ge

Date of Publication – 2022 04 26

8(587)

INID CODES FOR IDENTIFICATION OF BIBLIOGRAPHIC DATA

INVENTIONS, UTILITY MODELS

- (10) Number of publication for application, which has been examined
- (11) Number of patent and kind of document
- (21) Serial number of application
- (22) Date of filing of the application
- (23) Date of exhibition or the date of the earlier filing and the number of application, if any
- (24) Date from which patent may have effect
- (31) Number of priority application
- (32) Date of filing of priority application
- (33) Code of the country or regional organization allotting priority application number
- (44) Date of publication of application not granted, but examined and number of bulletin
- (45) Date of publication of registered document
- (51) International Patent Classification Index

- (54) Title of the invention
- (57) Abstract
- (60) Number of examined patent document granted by foreign patent office, date from which patent has effect and country code
- (62) Number of the earlier application and in case of divided application, date of filing an application
- (71) Name, surname and address of applicant (country code)
- (72) Name, surname of inventor (country code)
- (73) Name, surname and address of patent owner (country code)
- (74) Name, surname of representative or patent attorney
- (85) Date of commencement of the national phase of International Application
- (86) Number and date of filing of international application
- (87) Number and date of publication of international application
- (94) Calculated date of expiry of the SPC or the duration of the SPC

DESIGNS

- (10) Number of publication for application
- (11) Number of patent and kind of document or number of registration
- (15) Date of registration/Date of patent renewal
- (18) Expected expiration date of patent or registration
- (21) Serial number of application
- (22) Date of filing of the application
- (23) Date of exhibition or the date of the earlier filing and the number of application, if any
- (24) Date from which patent may have effect
- (28) Number of designs included in the application
- (30) Data relating to priority (number of application, date of filing of application, two-letter code identifying the authority with whom the priority application was made)
- (31) Number of priority application
- (32) Date of filing of priority application
- (33) Code of the country or regional organization allotting priority application number
- (34) Two-letter code according to WIPO St.3 identifying the authority with which the priority application was made
- (44) Date of publication of design and number of bulletin (the first publication)
- (45) Date of publication of design registered by WIPO and number of bulletin

- (51) International Classification for designs (class and subclass of the Locarno Classification)
- (54) Title of the invention
- (55) Reproduction of the design
- (57) Description of characteristic features of the design including indication of colors
- (58) Date of recording of any kind of amendment in the Register
- (62) Number of the earlier application, registration and document number and if available the date of filing an application in case of divided application
- (71) Name, surname and address of applicant (country code)
- (72) Name, surname of creator (country code)
- (73) Name, surname and address of patent owner (country code)
- (74) Name, surname of representative or patent attorney
- (81) Contracting states concerned
 - II designated contracting states according to the 1960 Act
 - III designated contracting states according to the 1999 Act
- (85) Owner's permanent address
- (86) Owner's nationality
- (87) Owner's residence
- (88) State in which the owner has a real and effective industrial or commercial establishment

TRADEMARKS

- (111) - Number of registration
- (151) - Date of registration
- (156) - Date of the renewal
- (181) - Expected expiration date of registration
- (186) - Renewal expiration date of registration
- (141) - Date of cancel of duration of the mark
- (210) - Serial number of application
- (220) - Date of filing of the application
- (230) - Data concerning exhibition
- (260) - Number of application, for which favorable decision of examination about registration has been taken (publication number)
- (310) - Number of the first application
- (320) - Date of filing of the first application
- (330) - Code, identifying national or regional Office where the first application was made
- (511) - International Classification of Goods and Services for the purposes of registration of trade marks and/or list of goods and/or services classified according thereto
- (526) - Disclaimer
- (531) - Description of figurative elements of Trade Marks according to the International Classification of the Figurative Elements of Marks

- (540) - Reproduction of Trade Mark
- (550) - Nature and kind of Trade Mark
- (551) - Indication to the effect that the mark is a collective mark, a certification mark or a guarantee mark
- (554) - Three-dimensional mark
- (580) - Date of recording of any kind changes in respect of applications or registrations
- (591) - Information concerning colors claimed
- (731) - Name and address of the applicant
- (732) - Name and address of the holder of the registration
- (740) - Name and address of the representative
- (750) - Addreses for correspondence
- (770) - Name and address of the previous applicant or holder in case of change in ownership
- (771) - Previous name and address of the applicant or holder in case of change in ownership
- (791) - Name and address of the licensee
- (793) - Indication of conditions and/or restrictions under the license (Type of license, number of license agreement, data of license, data of validity of license)
- (800) - Certain data relating to the international registration of Trade Marks under the Protocol Relating to Madrid Agreement (International registration number
- (852) - Partial cancellation of the list of goods and services
- (891) - Date of subsequent designation

CODES FOR PUBLICATION IN BULLETIN

- (21) AP 0000 000000 - serial number of application for invention
- (10) AP 0000 0000 A - number of published application for invention (first publication)
- (11) P 0000 0000 B - number of patent for invention (second publication)
- (21) API 0000 000000 - number of application for imported patent
- (11) PI 0000 0000 A - number of imported patent (first publication)
- (21) AU 0000 000000 - serial number of application for utility model
- (10) AU 0000 000 U - number of published application for utility model (first publication)
- (11) U 0000 000 Y - number of patent for utility model (second publication)
- (21) AD 0000 000000 - serial number of application for design
- (10) AD 0000 000 S - number of published application for design (first publication)
- (11) D 0000 000 S - registered design

INTERNATIONAL PATENT CLASSIFICATION FOR INVENTIONS AND UTILITY MODELS

- SECTION A - HUMAN NECESSITIES
- SECTION B - PERFORMING OPERATIONS; TRANSPORTING
- SECTION C - CHEMISTRY; METALLURGY
- SECTION D - TEXTILES; PAPER
- SECTION E - FIXED CONSTRUCTIONS
- SECTION F - MECHANICAL ENGINEERING; LIGHTING; HEATING; WEAPONS; BLASTING
- SECTION G - PHYSICS
- SECTION H - ELECTRICITY

-
- M - Trade Mark
 - (210) AM 0000 000000 - Serial number of application;
 - (260) AAM 0000 00000 A - Publication number of application;
 - (111) M 0000 00000 R - Number of registration;
 - (111) MMM0000 00000 Rn - Number of renewals, in which n=1,2,3;
 - (111) M 0000 00000 R(P) - Number of registration under partial assignment of rights
-

Official Bulletin of the Industrial Property

Inventions

Utility Models

Designs

Trademarks

CONTENT

PUBLISHED TITLES OF PROTECTION	3
INVENTIONS	
▪ APPLICATIONS APPROVED FOR GRANTING PATENT	4
▪ PATENTED INVENTIONS	6
UTILITY MODELS	
APPLICATIONS APPROVED FOR GRANTING PATENT	8
DESIGNS	
▪ APPLICATION APPROVED FOR REGISTRATION	10
▪ REGISTERED DESIGN	11
▪ DESIGNS, WICH HAVE BEEN REGISTERED WITH THE INTERNATIONAL BUREAU CLAIMING PRIORITY ON THE TERRITORY OF GEORGIA	12
TRADEMARKS	
▪ APPLICATIONS FILED UNDER THE NATIONAL PROCEDURE APPROVED FOR REGISTRATION	40
▪ REGISTERED TRADEMARKS	47
▪ TRADEMARKS REGISTERED ACCORDING TO THE ACCELERATED PROCEDURE	54
▪ INTERNATIONAL TRADEMARKS FOR WHICH A DECISION ON GRANTING PROTECTION IS TAKEN	56
▪ INTERNATIONAL TRADEMARKS PROTECTED IN GEORGIA	107
OFFICIAL NOTIFICATIONS	
INVENTIONS	
▪ RESTORATION OF PATENTS	112
▪ ABOLITION OF PATENTS WITH THE RIGHT TO RESTORE	113
▪ EXPIRATION OF TERMS OF RESTORATION OF PATENTS	114
▪ EXPIRATION OF TERMS OF PATENTS	116
UTILITY MODELS	
▪ RESTORATION OF PATENTS	116
▪ ABOLITION OF PATENT WITH THE RIGHT TO RESTORE	117
▪ EXPIRATION OF TERMS OF RESTORATION OF PATENT	117
DESIGNS	
▪ EXTENSION OF TERMS OF DESIGN REGISTRATION	118
▪ EXTENSION OF TERMS OF INTERNATIONAL DESIGNS REGISTRATION	118
▪ CANCELLATION OF INTERNATIONAL DESIGNS REGISTRATION	124
TRADEMARKS	
▪ EXTENSION OF TERMS OF TRADEMARKS REGISTRATION	125
▪ COMPLETE TRANSFER OF RIGHTS	128
▪ CHANGES OF NAMES AND/OR ADDRESSES OF TRADEMARKS OWNER	129
▪ CANCELLATION OF TRADEMARKS REGISTRATION	130
▪ INTERNATIONAL LICENSES AGREEMENTS	132
CLASSIFICATION INDEXES	
INVENTIONS	133
UTILITY MODELS	134
DESIGNS	135
TRADEMARKS	136

PUBLISHED TITLES OF PROTECTION

INVENTIONS

- **APPLICATIONS APPROVED FOR GRANTING PATENT:**
15414; 15262; 15662; 15408
- **PATENTED INVENTIONS:**
7370-7374

UTILITY MODELS

- **APPLICATIONS APPROVED FOR GRANTING PATENT:**
15658; 15684; 15640

DESIGNS

- **APPLICATION APPROVED FOR REGISTRATION:**
1255
- **REGISTERED DESIGN:**
933
- **DESIGNS, WHICH HAVE BEEN REGISTERED WITH THE INTERNATIONAL BUREAU CLAIMING PRIORITY ON THE TERRITORY OF GEORGIA:**
218185; 215847; 218752; 216782; 216049; 215959; 218998; 216037; 219040; 216449

TRADEMARKS

- **APPLICATIONS FILED UNDER THE NATIONAL PROCEDURE APPROVED FOR REGISTRATION:**
112167; 112471; 113393; 113417; 113990; 114463; 114465; 114472; 114532; 114534; 114543; 114590; 114608; 114611; 114615; 114677; 114679; 114686-14690; 114692; 114742, 114743; 114751; 114753; 114757; 114806; 114808-114810; 114900-114902; 114904; 114917; 114920; 114972
- **REGISTERED TRADEMARKS:**
25238-35257; 35264-35320; 35325
- **TRADEMARKS REGISTERED ACCORDING TO THE ACCELERATED PROCEDURE:**
35258-35263; 35321-35324; 35326
- **INTERNATIONAL TRADEMARKS FOR WHICH A DECISION ON GRANTING PROTECTIONS IS TAKEN:**
109396*; 110841*; 112013; 112228; 113534; 113557; 113559; 113562; 113564; 113576; 113578; 113625; 113627; 113633; 113639; 113652; 113664; 113681; 113720; 113722, 113723; 113726; 113745-113747; 113749-113754; 113795; 113804-113813; 113817; 113819-113823; 113829-113832; 113834-113839; 113896; 113898; 113914-113918; 113924-113929; 113931-113934; 113957; 113959-113961; 113965; 114006-114008; 114010, 114011; 114014, 114015; 114026; 114065; 114088; 114093; 114095, 114096; 114117; 114164-114166; 114184-114188; 114210-114213; 114267-114270; 114296-114299; 114356; 114358; 114360; 114386-114390; 114437, 114438, 114440
- **INTERNATIONAL TRADEMARKS PROTECTED IN GEORGIA:**
109456; 109796; 109888; 109973; 110250; 110585; 110596; 110726; 111578; 111634; 112024; 112199; 112207, 112208; 112210; 112236; 112239; 112241, 112242; 112244, 112245; 112321; 112360-112364; 112443; 112459; 112465; 112481; 112526; 112541; 112555; 112637-112641; 112652-112654; 112815; 112847-112852; 112895-112897; 112941, 112942; 112976; 113067, 113068; 113070; 113148, 113149; 113151; 113158; 114554

INVENTIONS

APPLICATIONS APPROVED FOR GRANTING PATENT

The decision can be appealed at the Chamber of Appeal of Sakpatenti within 3 months from the publication or at the Mtskheta District Court Administrative Cases Board (Address: №17, Samkhedro St., Mtskheta), within 1 month following the publication.

PART A

A 61

- (10) AP 2022 15414 A (51) Int. Cl. (2006)
A 61 K 31/565
A 61 P 15/18
- (21) AP 2019 15414 (22) 2019 02 07
(31) 18160586.6; 18155571.5
(32) 2018 03 07; 2018 02 07
(33) EP; EP
(71) Estetra SPRL (BE)
Rue Saint-Georges 5, 4000, Liège, Belgium (BE)
- (72) RAUSIN, Glwadys (BE);
JOST, Maud (BE)
- (74) Larisa Amirkhanyan
(85) 2020 08 21
(86) PCT/EP2019/052980, 2019 02 07
- (54) CONTRACEPTIVE COMPOSITION WITH
REDUCED CARDIOVASCULAR EFFECTS
- (57) Estetrol and drospirenone composition is used in combined oral contraceptive (COC). At that, daily dosage of esetrol is 15 mg, and – of drospirenone is 3 mg.
Claims: 3 independents
10 dependents
Fig.: 8

- (10) AP 2022 15262 A (51) Int. Cl. (2006)
A 61 P 9/10
A 61 P 1/16
A 61 P 25/28
A 61 P 3/06
A 61 K 31/44
- (21) AP 2018 15262 (22) 2018 11 14
(31) 2017143801; 2018137717
(32) 2017 12 14; 2018 10 25
(33) RU; RU
(71) LTD "Valenta-Intellect" (RU)
General Dorokhov St. 18/2, Moscow, 119530,
Russian Federation (RU)
- (72) SKACHILOVA, Sofiya Yakovlevna (RU);
MYASNIKOV, Dmitrij Georgievich (RU);
IVANOV, Andrej Nikolaevich (RU)
- (74) Aleksandre Gegechkori
(85) 2020 01 24
(86) PCT/SK2018/050013, 2018 11 14

(54) L-ENANTIOMER 2-ETHYL-6-METHYL-
-3-HYDROXYPYRIDINIUM L-HYDRO-
XYBUTANDIOATE WITH CEREBRO-
PROTECTIVE, HEPATOPROTECTIVE,
LIPID-REGULATING, ANTI-ISCHEMIC
AND NEUROTROPIC ACTIVITIES

(57) An invention relates to new L-enantiomer 2-ethyl-6-methyl-3-hydroxypyridinium L-hydroxyethane butanedionate of well known chemical compound usage as cerebroprotective, hepatoprotective, lipid-regulating, anti-ischemic and neurotropic remedies.

Claims: 5 independents

PART B

B 01

- (10) AP 2022 15662 A (51) Int. Cl. (2006)
B 01 D 3/30
- (21) AP 2021 15662 (22) 2021 06 16
(71) Daviti Khomasuridze (GE)
Vakhtang Gorgasali St. 103, bld. 3, app. 7a,
0114, Tbilisi, Georgia (GE)
- (72) Daviti Khomasuridze (GE)
- (54) STORMPLATE – DAVIT KHOMASURIDZE
- (57) Stormplate includes flat round body 1, and disposed in the center the vertical inlet pipe 2 having located in its end the hydraulic locker 3; at that, the perforations whereon the nozzles 4 are mounted are executed circle-wisely on flat body. The nozzles 4 are capable to direct running vertically upwards at certain pressure the vertically ascending stream, horizontally, and parallel relative to plate top surface.
- Claims: 1 independent
Fig.: 4

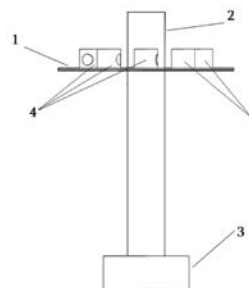

Fig. 1

(10) AP 2022 15408 A (51) Int. Cl. (2006)
B 01 J 20/18
C 02 F 1/28
C 02 F 1/64

(21) AP 2020 15408 (22) 2020 08 14

(71) Jemal Shengelia (GE)

Nutsubidze St. 2, app. 9, 0177, Tbilisi,

Georgia (GE);

Guram Galogre (GE)

Tsinamdghvrishvili St. 91, Tbilisi, Georgia (GE)

(72) Jemal Shengelia (GE);

Guram Galogre (GE)

(54) METHOD OF MAKING ZEOLITE
MODIFIED WITH MANGANESE
DIOXIDE CONTAINING FE³⁺ IONS

(57) A method of making zeolite, modified with manganese dioxide containing Fe³⁺ ions, provides zeolite treatment with Mn(II) salt water solution; and then, the electrolyzes with oxidizer NaClO having concentration of 4-6 g/l obtained by 50-100 g/l NaCl salt water solution. At that, Mn (II) salt water solution is added to Fe (II) salt water solution in molar ratio:

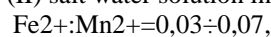

and oxidizing and electrolyzing processes are executed in various apparatuses.

Claims: 1 independent

Table: 1

PATENTED INVENTIONS

PART A

A 01

- (11) P 2022 7370 B (51) Int. Cl. (2006)
 A 01 M 1/026
 A 01 M 99/00
 G 01 N 33/0047
 G 01 N 33/0073
 G 01 N 27/123
 G 01 N 33/00
- (10) AP 2021 15397 A (44) 23(579)/2021
 (21) AP 2019 15397
 (22) 2019 02 01
 (24) 2019 02 01
 (31) 62/625,000
 (32) 2018 02 01
 (33) US
 (86) PCT/US2019/016335, 2019 02 01
 (73) Sensor Development Corporation (US)
 141 Innovation Dr., SM 322, Elyria,
 OH 44035, USA (US)
- (72) SMILANICH, Nicholas Joseph (US);
 REICHERT, Samuel Firestone (US);
 TUDRON, Frank Bernard (US)
- (74) Shalva Gvaramadze
- (54) DEVICE FOR DETECTING INSECT
 LARVAE AND ADULT INSECTS IN
 STORED PRODUCTS BY SENSING
 THEIR VOLATILE PHEROMONES
 AND SEMIOCHEMICALS

A 61

- (11) P 2022 7372 B (51) Int. Cl. (2006)
 A 61 K 31/337
 A 61 K 31/519
 A 61 K 45/06
 A 61 P 35/00
- (10) AP 2021 15157 A (44) 23(579)/2021
 (21) AP 2018 15157
 (22) 2018 01 05
 (24) 2018 01 05
 (31) 62/527,360; 62/443,082; 17157779.4
 (32) 2017 01 06; 2017 02 24; 2017 06 30
 (33) US; US; EP
 (86) PCT/EP2018/050298, 2018 01 05
 (73) Novartis AG (CH)
 Lichtstrasse 35, Basel 4056, Switzerland (CH);
 Les Laboratoires Servier (FR)
 35, rue de Verdun, 92284 Suresnes Cedex,
 France (FR)

- (72) PORTER, Dale (US);
 HALILOVIC, Ensar (US);
 CHANRION, Maïa (FR);
 MARAGNO, Ana Leticia (FR);
 GENESTE, Olivier (FR);
 MERINO, Delphine (AU);
 VAILLANT, François (AU);
 VISVADER, Jane (AU);
 LINDEMAN, Geoffrey (AU);
 LESSENE, Guillaume (AU);
 MARANGONI, Elisabetta (AU)
- (74) Tamaz Shilakadze
- (54) COMBINATION OF A MCL-1 INHIBITOR
 AND A TAXANE COMPOUND, USES AND
 PHARMACEUTICAL COMPOSITIONS
 THEREOF

- (11) P 2022 7373 B (51) Int. Cl. (2006)
 A 61 K 31/437
 A 61 P 31/12
 C 07 D 519/00
 C 07 D 513/04
- (10) AP 2021 15351 A (44) 22(578)/2021
 (21) AP 2018 15351
 (22) 2018 11 02
 (24) 2018 11 02
 (31) 17199687.9
 (32) 2017 11 02
 (33) EP
 (86) PCT/EP2018/000502, 2018 11 02
 (73) Aicuris GMBH & CO. KG (DE)
 Friedrich-Ebert-Straße 475 42117,
 Wuppertal, Germany (DE)
- (72) DONALD, Alastair (DE);
 URBAN, Andreas (DE);
 BONSMANN, Susanne (DE);
 WEGERT, Anita (DE);
 GREMMEN, Christiaan
 SPRINGER, Jasper (NL)
- (74) Tamaz Shilakadze
- (54) NOVEL, HIGHLY ACTIVE AMINO-
 THIAZOLE SUBSTITUTED INDOLE-2-
 CARBOXAMIDES ACTIVE AGAINST
 THE HEPATITIS B VIRUS (HBV)

- (11) P 2022 7374 B (51) Int. Cl. (2006)
 A 61 K 31/437
 A 61 P 31/12
 C 07 D 519/00
 C 07 D 487/04
 C 07 D 471/18
 C 07 D 471/04

-
- (10) AP 2021 15353 A (44) 22(578)/2021
(21) AP 2018 15353
(22) 2018 11 02
(24) 2018 11 02
(31) 17199676.2
(32) 2017 11 02
(33) EP
(86) PCT/EP2018/000503, 2018 11 02
(73) Aicuris GMBH & CO. KG (DE)
Friedrich-Ebert-Straße 475 42117,
Wuppertal, Germany (DE)
(72) DONALD, Alastair (DE);
URBAN, Andreas (DE);
BONSMANN, Susanne (DE);
WEGERT, Anita (DE);
SPRINGER, Jasper (NL)
(74) Tamaz Shilakadze
(54) NOVEL, HIGHLY ACTIVE PYRAZOLO-
PIPERIDINE SUBSTITUTED INDOLE-2-
CARBOXAMIDES ACTIVE AGAINST
THE HEPATITIS B VIRUS (HBV)
-

A 62

- (11) P 2022 7371 B (51) Int. Cl. (2006)
A 62 C 2/06
(10) AP 2021 15411 A (44) 22(578)/2021
(21) AP 2020 15411
(22) 2020 08 18
(24) 2020 08 18
(73) LEPL "Grigol Tsulukidze Mining
Institute" (GE)
Mindeli St. 7, 0186, Tbilisi, Georgia (GE);
LEPL "Shota Rustaveli Georgia
National Scientific Foundation "(GE)
M. Aleksidze Str., II Lane 2, 0183, Tbilisi,
Georgia (GE);
Omar Lanchava (GE)
Panaskerteli St. 15a, app. 22, Tbilisi,
Georgia (GE);
Giorgi Nozadze (GE)
Sea District, IV mcr., bld. 6, app. 37, 0178,
Tbilisi, Georgia (GE);
Maradi Jangidze (GE)
Gldani, IV mcr., bld. 92a, app. 38, Tbilisi,
Georgia (GE)
(72) Omar Lanchava (GE);
Giorgi Nozadze (GE);
Maradi Jangidze (GE)
(54) TRANSFORMABLE LIMIT SYSTEM TO
LOCALIZE FIRES AND MINIMIZE LIFE-
THREATENING CONSEQUENCES IN
VEHICLE TUNNELS
-

UTILITY MODELS

APPLICATIONS APPROVED FOR GRANTING PATENT

The decision can be appealed at the Chamber of Appeal of Sakpatenti within 3 months from the publication or at the Mtskheta District Court Administrative Cases Board (Address: №17, Samkhedro St., Mtskheta), within 1 month following the publication.

PART A

A 61

- (10) AU 2022 15658 U (51) Int. Cl. (2006)
A 61 L 9/00
- (21) AU 2021 15658 (22) 2021 06 10
- (71) Ramaz Gakhokidze (GE)
Barnov St. 82, app. 7, 0179, Tbilisi,
Georgia (GE);
Sopio Burjanadze (GE)
Dighomi Array, VI qu., bld. 5, app. 25, 0159,
Tbilisi, Georgia (GE);
Giorgi Burjanadze (GE)
Dighomi Array, VI qu., bld. 5, app. 25, 0159,
Tbilisi, Georgia (GE);
Jano Burjanadze (GE)
Dighomi Array, VI qu., bld. 5, app. 25, 0159,
Tbilisi, Georgia (GE);
Nikoloz Mekvabishvili (GE)
Barnov St. 67, Tbilisi, Georgia (GE)
- (72) Ramaz Gakhokidze (GE);
Sopio Burjanadze (GE);
Giorgi Burjanadze (GE);
Jano Burjanadze (GE);
Nikoloz Mekvabishvili (GE)
- (74) Tamaz Shilakadze
(54) DEVICE FOR DISINFECTION
AGAINST THE VIRUS COVID 19
- (57) A device for disinfection against the virus Covid 19 includes: a case, wherein ozon creating a tube having ultraviolet rays is placed; the fans to create air flow; and the power supply block. The case is made with inlet and outlet windows, whereon the fans are fixed, and copper grid is fastened to outlet window. The tube having ultraviolet rays is a single discharge electrode; at that, copper wire, that is another electrode, is coiled onto the tube. The electrodes are switched into power supply block.
- Claims: 1 independent
Fig.: 1
-

PART C

C 08

- (10) AU 2022 15684 U (51) Int. Cl. (2006)
C 08 L 101/00
- (21) AU 2021 15684 (22) 2021 07 06
- (71) Iakob Maghalashvili (GE)
Rustaveli St. 63, Gori, Georgia (GE)
- (72) Iakob Maghalashvili (GE)
(54) METHOD FOR MAKING ASPHALT
CONCRETE MIXTURE
- (57) A method provides mineral material heating and mixing therewith the bitumen and filler to create homogeneous mass; at that, pre-crushed plastic fraction of no more than 5 mm size is used as filler, and mineral material is heated up to 160-170°C wholly or partially, whereon the plastic fraction is added later. Part of bitumen or mineral material is mixed with the bitumen until to obtain homogeneous mass. Shredded plastic, obtained as a result of waste disposal, is used as fraction of plastic.
- Claims: 1 independent
2 dependents
-

PART F

F 02

- (10) AU 2022 15640 U (51) Int. Cl. (2006)
F 02 F 7/00
- (21) AU 2021 15640 (22) 2021 05 27
- (71) Pridon Karanadze (GE)
Sherozia St. 5, 5200, Tsalenjikha, Georgia (GE)
- (72) Pridon Karanadze (GE)
- (74) Khatuna Imnadze
- (54) CAR GAS DISTRIBUTION MECHANISM
ACTUATING CHAIN LID
- (57) A lid includes a case 1 executed as a plate and made with metal. The excavations 2 and perforation 3 are made immediately on the periphery of case for fastening bolts placement therein; and an excavation 4 for gas distribution mechanism shaft end placement is executed in case central part or nearby.
- Claims: 1 independent

Fig.: 2

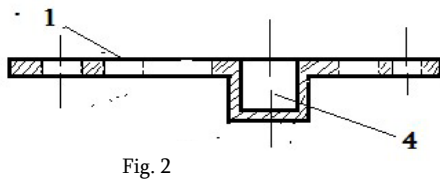
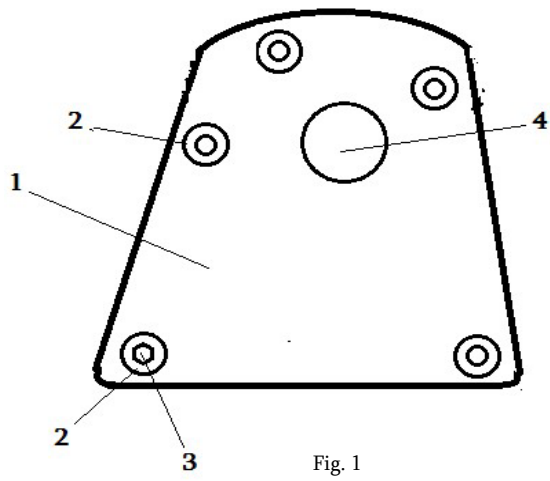

DESIGNS

APPLICATION APPROVED FOR REGISTRATION

The decision can be appealed at the Chamber of Appeal of Sakpatenti within 3 months from the publication or at the Mtskheta District Court Administrative Cases Board (Address: №17, Samkhedro str., Mtskheta), within 1 month following the publication.

- (10) AD 2022 1255 S (51) 09-01
(21) AD 2021 1255 (22) 2021 12 23
(28) 1
(31) 2021503453/49
(32) 2021 07 08
(33) RU
(71) JSC "Academiya Expertov Visshikh Vodok" (Academy of Experts of High Quality Vodka) (RU)
Aviamotornaya St. 50, bld. 2, Basement I, Office 19, 111024, Moscow, Russian Federation (RU)
(72) SERGIENKO, Igor Nikolaevich (RU)
(74) Davit Dzamukashvili (GE)
(54) BOTTLE
(55)



1.1



1.2



1.3



1.4

REGISTERED DESIGN

- (11) D 2022 933 S (51) 09-01
(10) AD 2022 1229 S (44) 2022 01 10 №1
(21) AD 2021 1229
(22) 2021 07 01
(24) 2021 07 01
(28) 4
(18) 2026 07 01
(73) Zviad Tsikolia (GE)
 Ar. Kurdiani St. 6, app. 73, 0112, Tbilisi,
 Georgia (GE)
(72) Zviad Tsikolia (GE)
(74) Shalva Gvaramadze (GE)
(54) 1. COPPER (COLOR) PERFUME FLACONE
 WITH SUPPORT;
 2. GOLDEN PERFUME FLACONE WITH
 SUPPORT;
 3. SILVER (COLOR) PERFUME FLACONE
 WITH SUPPORT;
 4. TRANSPARENT PERFUME FLACONE
 WITH SUPPORT
-

DESIGNS, WHICH HAVE BEEN REGISTERED WITH THE INTERNATIONAL BUREAU CLAIMING PRIORITY ON THE TERRITORY OF GEORGIA

The decision can be appealed at the Chamber of Appeal of Sakpatenti within 3 months from the publication or at the Mtskheta District Court Administrative Cases Board (Address: №17, Samkhedro St., Mtskheta), within 1 month following the publication.

- (11) DM/218 185 (51) 09-03
(15) 2021 11 29 (44) 03/2022 (2022 01 14)
(22) 2021 11 29
(28) 1
(73) ARSAN KİMYA SANAYİ VE TİCARET ANONİM ŞİRKETİ
Cumhuriyet Mah., Gürpınar Yolu Cad., Kaya Millennium İş Merkezi C Blok Kat:6 No:135-136-137-138
Büyükkçekmece İSTANBUL (TR)
(85) TR
(86) TR
(87) TR
(88) TR
(89) TR
(81) III. AL, AM, BA, EM, GE, ME, OA, OM, RS, SG, TJ, TN, UA, US
(72) ORHAN IRMAK
Göksu Evleri Sitesi, Palmiye Caddesi, C/12 Anadolu Hisari, İSTANBUL (TR)
(74) DESTEK PATENT ANONİM ŞİRKETİ
Odunluk Mahallesi, Akademi Caddesi, Zeno İş Merkezi, D Blok, Kat: 4, Nilüfer, 16110 BURSA (TR)
(54) 1. Packaging box
(55)



1.1

- (11) DM/215 847 (51) 09-01
(15) 2021 08 06 (44) 06/2022 (2022 02 04)
(22) 2021 08 06
(28) 1
(73) Logoplaste Innovation Lab, Lda (Portugal)
Edifício Logoplaste, Estrada Da Malveira, Mato Romão, 2750-011 CASCAIS (PT)
(85) –
(86) EM
(87) –
(88) –
(89) EM
(81) III. AM, AZ, BN, CA, EM, GB, GE, IL, JP, KG, KH, KP, KR, MN, MX, OM, RU, SG, SY, TJ, TM, TR,
UA, US, VN
(72) Rudiney Ramos De Souza
Travessa Sargento Joaquin José, 10, 3esq - MURTAL, 2775-105, LISBON (PT);
John Ellis George
89 Foxwood Drive, LL14 4JA., Wrexham, Wales (GB)
(74) Fernando António Ferreira Magno
Av. 5 De Outubro, 146 – 7º, 1050-061 Lisboa (PT)
(54) 1. Bottle base
(55)

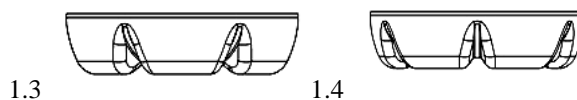
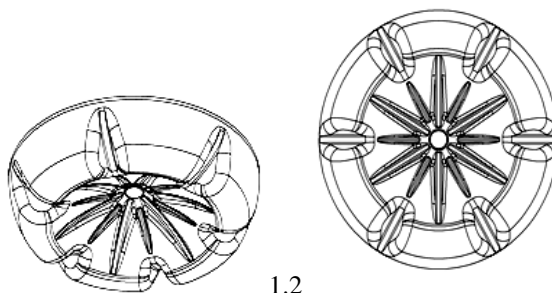

(11) DM/218 752 (51) 09-07
(15) 2021 09 20 (44) 06/2022 (2022 02 11)
(22) 2021 09 20
(28) 1
(73) Yassin Osman Bellaede Weyer
Jüderstrasse 13A, 52134 Herzogenrath (DE)
(85) DE
(86) DE
(87) DE
(88) DE
(89) DE
(81) II. MA III. AZ, EG, GE, RU, TR, US
(72) Bellaede El Boubsi
Jüderstrasse 13A, 52134, Herzogenrath (DE)
(46) 2022 02 11
(54) 1. Spray cap for aerosol container
(55)

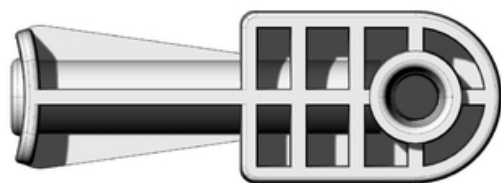

1.1

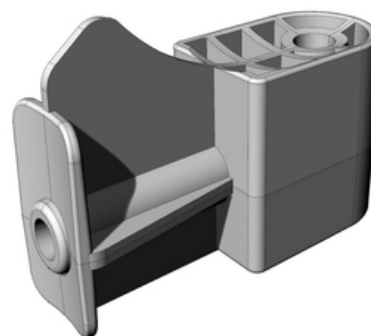

1.2



1.3



1.4



1.5

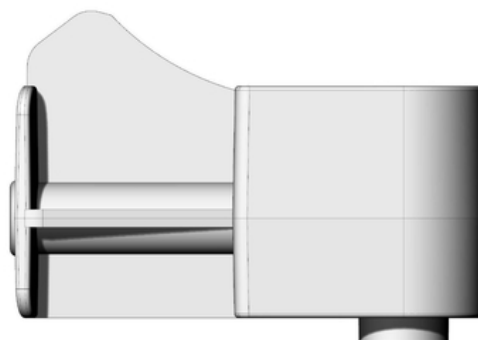

1.6

(11) DM/216 782 (51) 10-07
 (15) 2021 08 05 (44) 06/2022 (2022 02 11)

(22) 2021 08 05

(28) 1

(30) No1: 30.03.2021; 145883; CH

(73) ROLEX SA

Rue François-Dussaud 3-5-7, 1211 Genève 26 (CH)

(85) CH

(86) CH

(87) CH

(88) CH

(89) CH

(81) II. MA III. AL, AM, AZ, BA, BN, BW, BY, BZ, CA, EG, EM, GB, GE, GH, IL, IS, JP, KG, KH, KP, KR, LI, MC, MD, ME, MK, MN, MX, NA, NO, OA, OM, RS, RU, RW, SG, SM, SR, ST, SY, TJ, TM, TN, TR, UA

(72) Davide AIROLDI

16 Rue Du Grand-Bureau, 1227, Genève (CH)

(74) BUGNION S.A.

10, Route De Florissant Case Postale 375, 1211 Genève 12 (CH)

(54) 1. Watch case

(55)

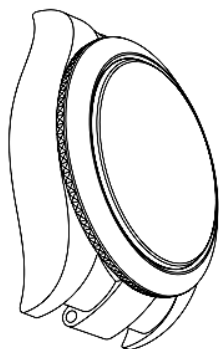

1.1

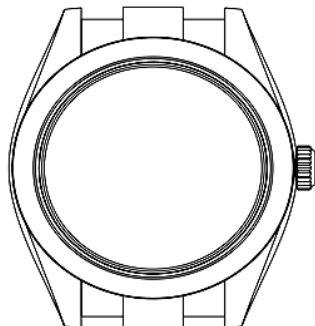

1.2

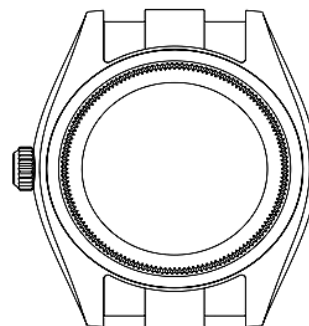

1.3

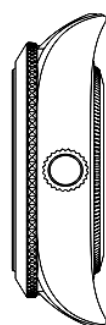

1.4

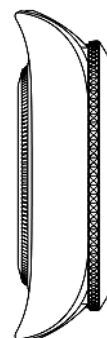

1.5

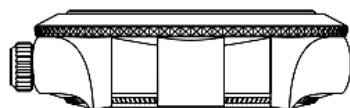

1.6

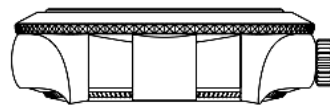

1.7

- (11) DM/216 049 (51) 10-07
 (15) 2021 08 17 (44) 07/2022 (2022 02 18)
 (22) 2021 08 17
 (28) 3
 (73) HARRY WINSTON SA
 Chemin Du Tourbillon 8, 1228 Plan-les-Ouates (CH)
 (85) CH
 (86) CH
 (87) CH
 (88) CH
 (89) CH
 (81) II. MA III. AL, AM, AZ, BA, BZ, CH, EM, GB, GE, KG, LI, MC, MD, ME, MK, MN, NO, OM, SG,
 TN, TR, UA
 (72) Emmanuelle Dominguez
 C/o Harry Winston SA Chemin Du Tourbillon 8, 1228, Plan-les-Ouates (CH)
 (74) The Swatch Group AG (The Swatch Group SA) (The Swatch Group Ltd.)
 Faubourg Du Lac 6, 2501 Biel/Bienne (CH)
 (54) 1. Watch dial, 2. Watch case with bracelet, 3. Watch dial
 (55)

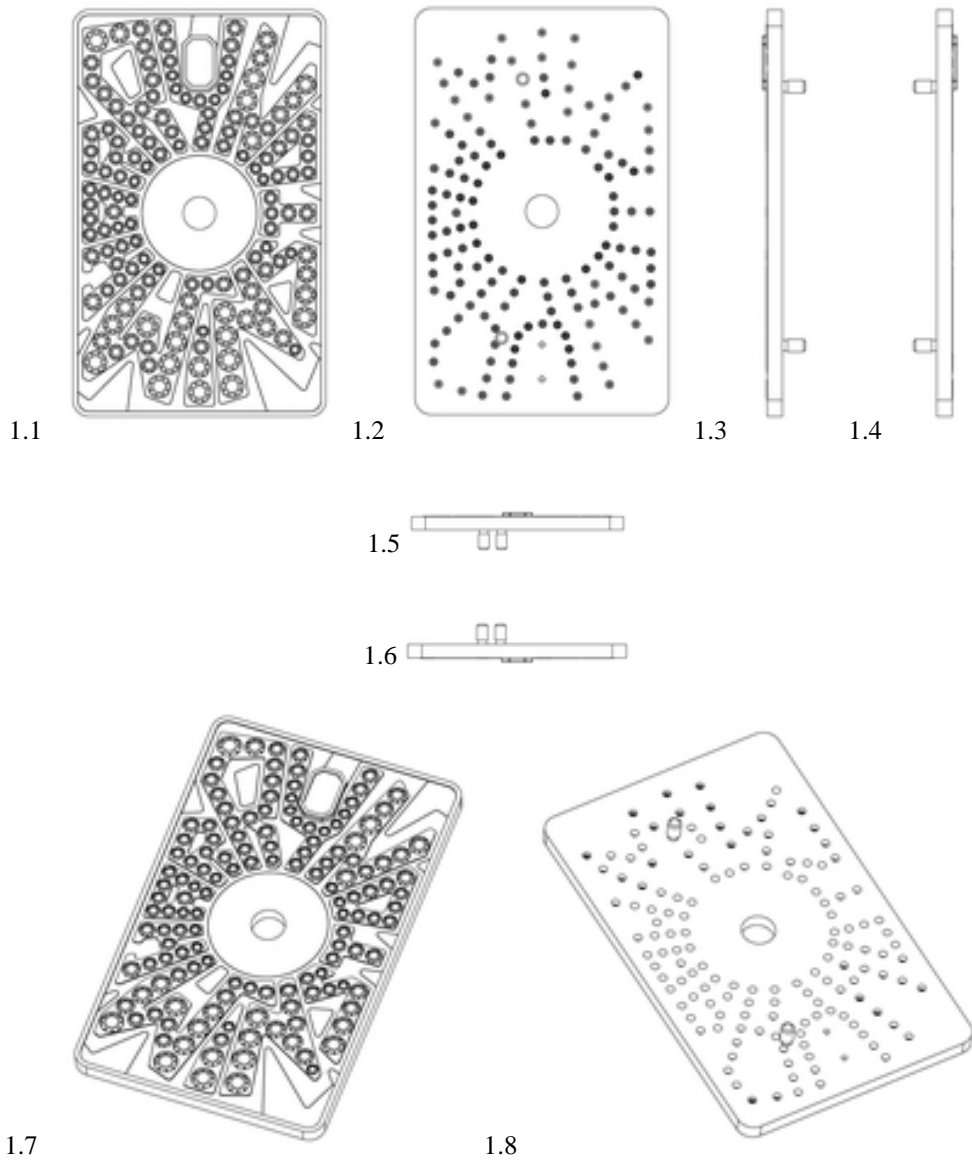

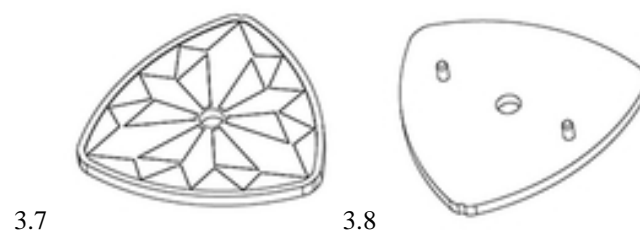
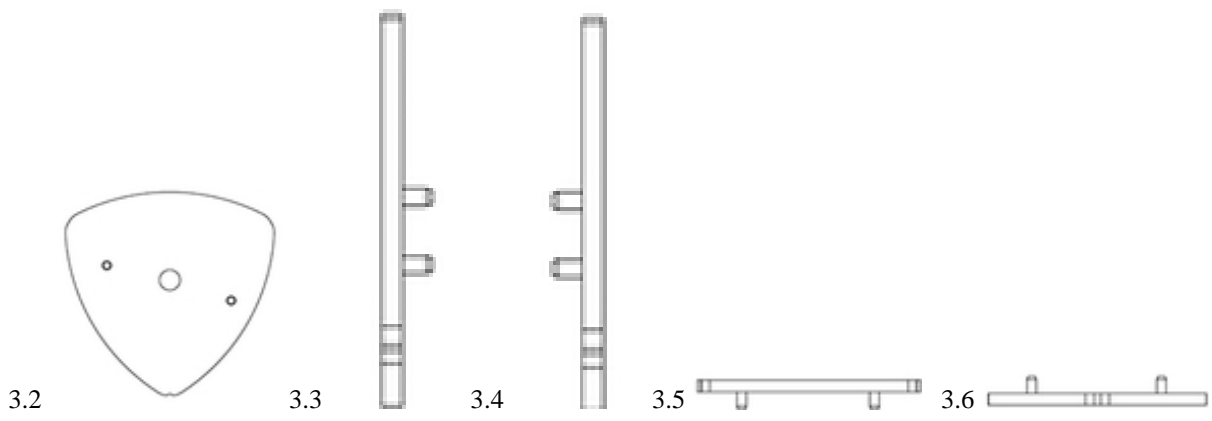
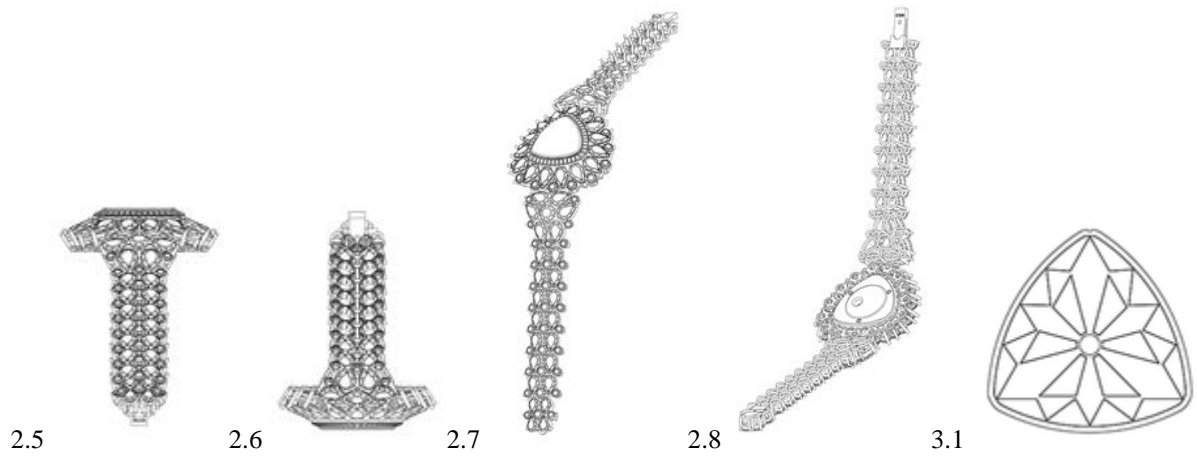
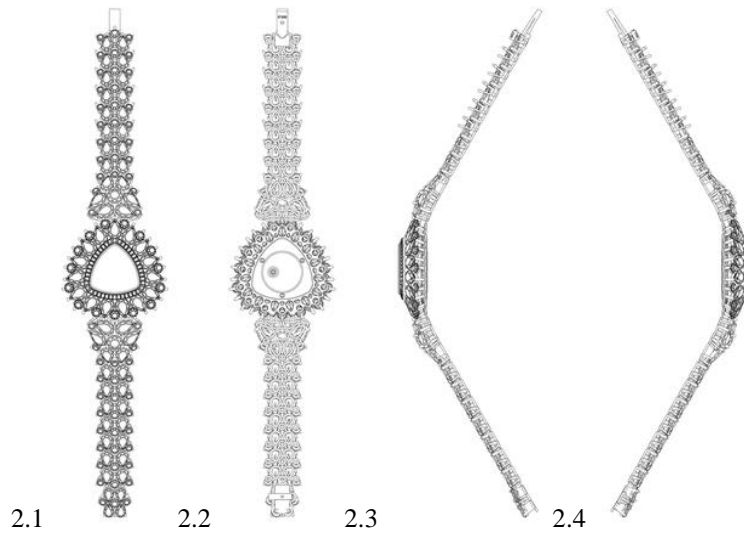

- (11) DM/215 959 (51) 23-03
- (15) 2021 08 18 (44) 07/2022 (2022 02 18)
- (22) 2021 08 18
- (28) 4
- (73) Vaillant GmbH
 Berghauser Str. 40, 42859 Remscheid (DE)
- (85) –
- (86) DE
- (87) –
- (88) –
- (89) DE
- (81) II. GR, IT III. AZ, GE, IL, KG, MD, PL, RU, TJ, TR, UA
- (72) Hagen Fendler
 c/o Vaillant GmbH, Berghauser Strasse 40, 42859, Remscheid (DE)
- (54) 1.-4. Heating equipment
- (55)

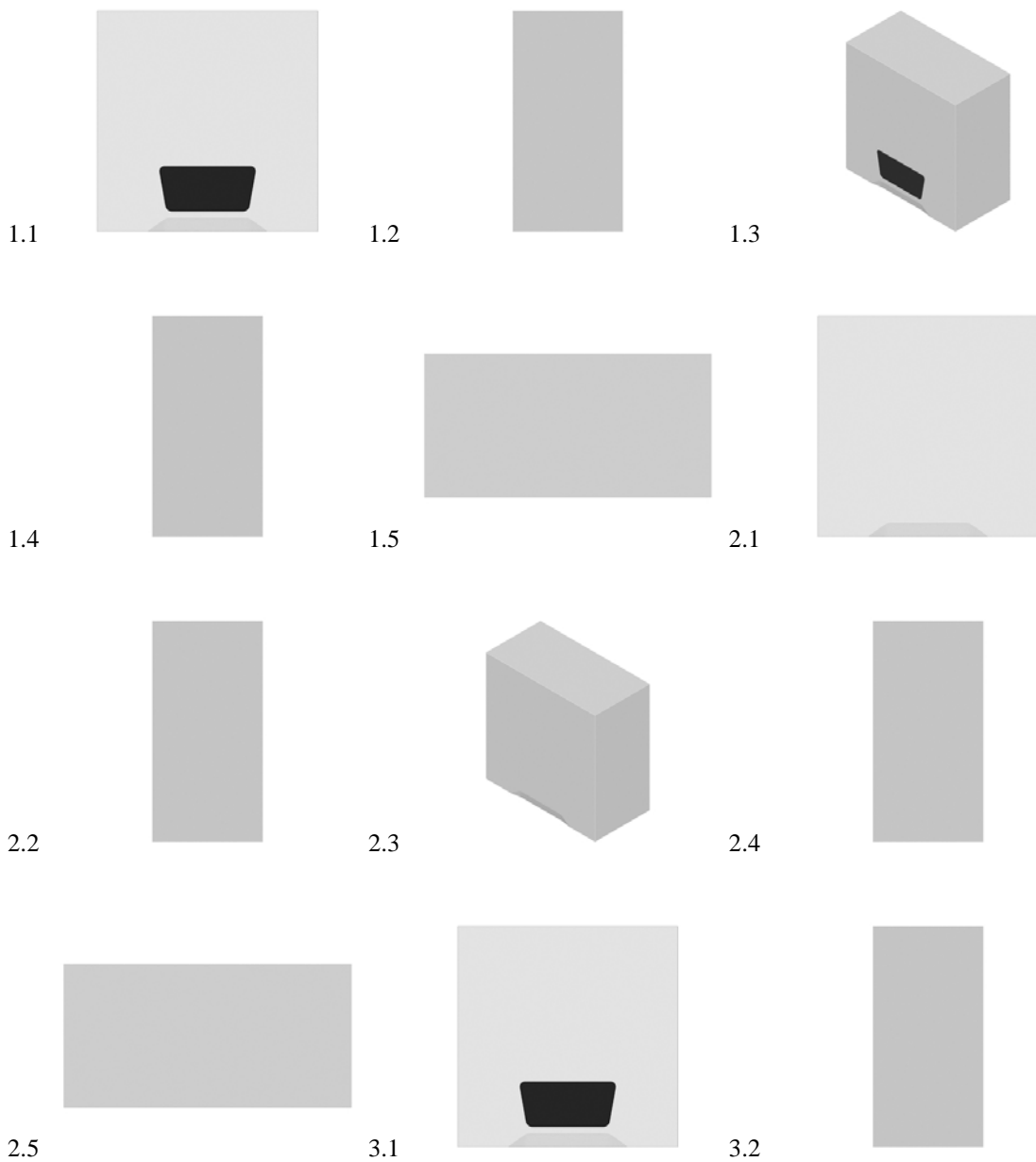

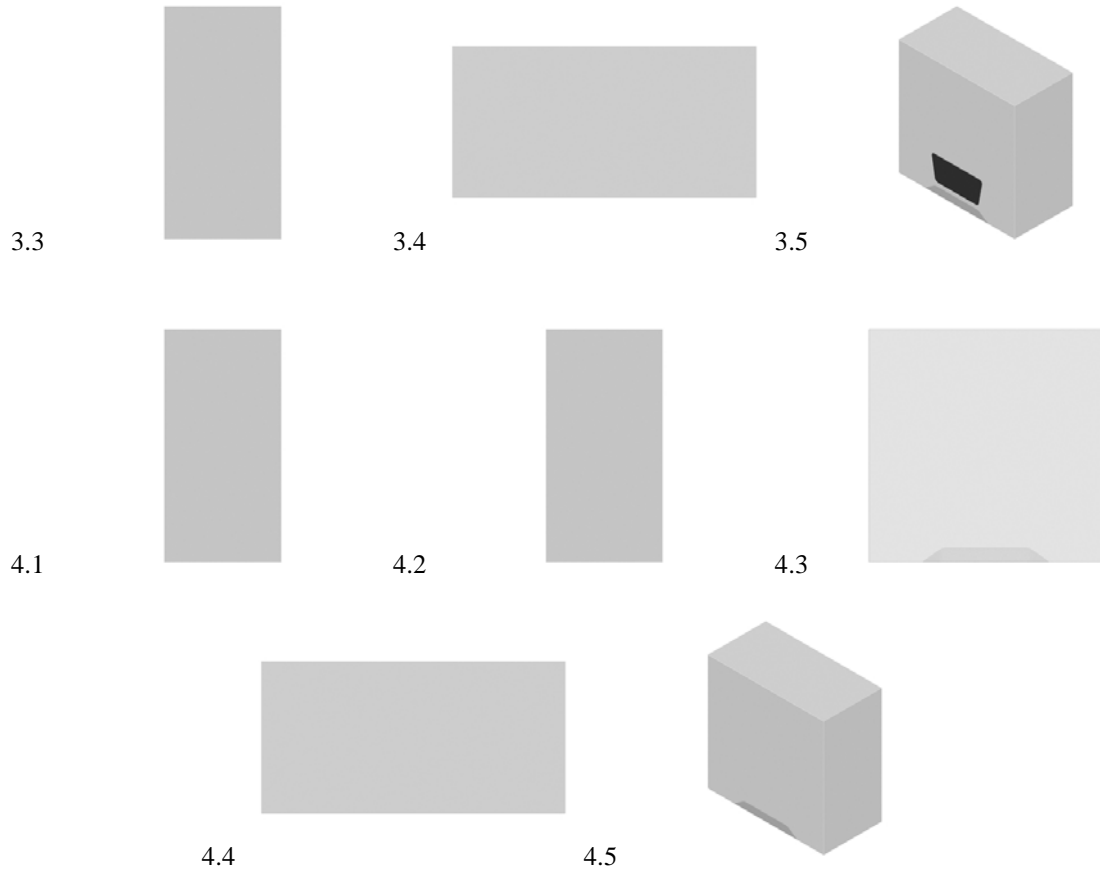

- (11) DM/218 998
- (15) 2021 11 19
- (22) 2021 11 19
- (28) 6
- (30) No1: 19.05.2021; 008545115-0001; EM; No2: 19.05.2021; 008545115-0002; EM;
No3: 19.05.2021; 008545115-0004; EM; No4: 19.05.2021; 008545115-0007; EM;
No5: 19.05.2021; 008545115-0008; EM; No6: 19.05.2021; 008545115-0010; EM
- (73) FERTIBERIA, S.A.
Calle Agustín De Foxá, 27 Plantas 8-11, 28036 Madrid (ES)
- (85) ES
- (86) ES
- (87) ES
- (88) ES
- (89) EM
- (81) III. GE, OA, TN, TR, UA
- (74) Hoffmann Eitle Patent- Und Rechtsanwälte PartmbB
Arabellastraße 30, 81925 Munich (DE)
- (46) 2022 02 25
- (54) 1.-6. Ornamentation for bags [packaging]
- (55)

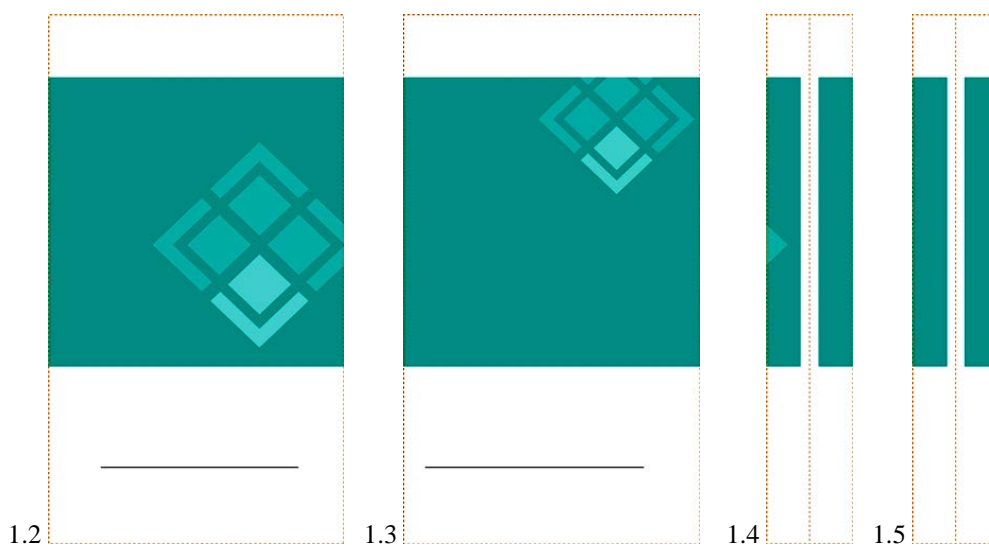
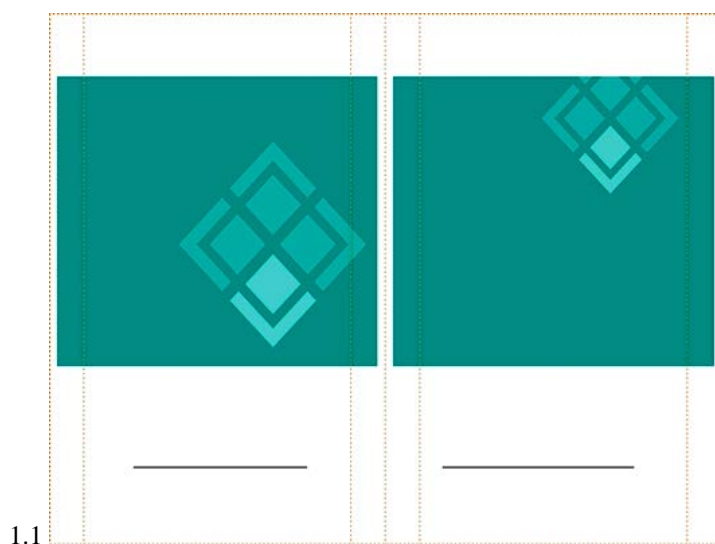



2.1



2.2

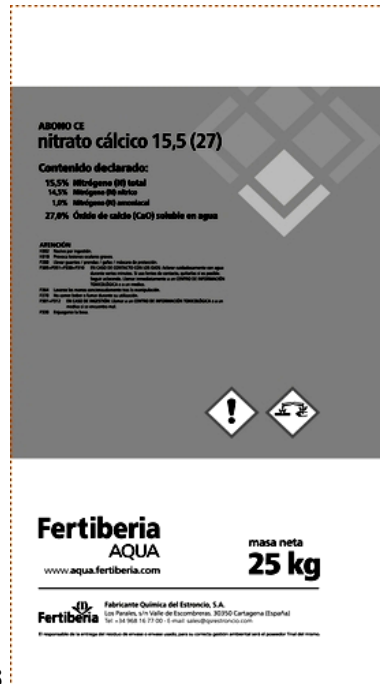

2.3

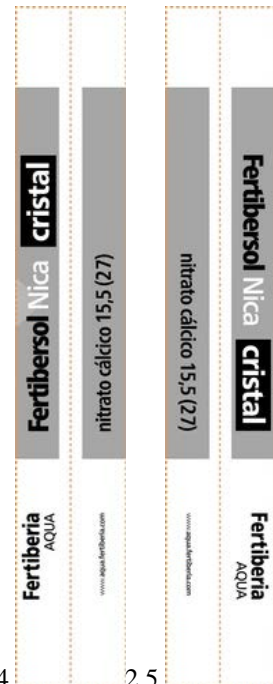

2.4

2.5



3.1

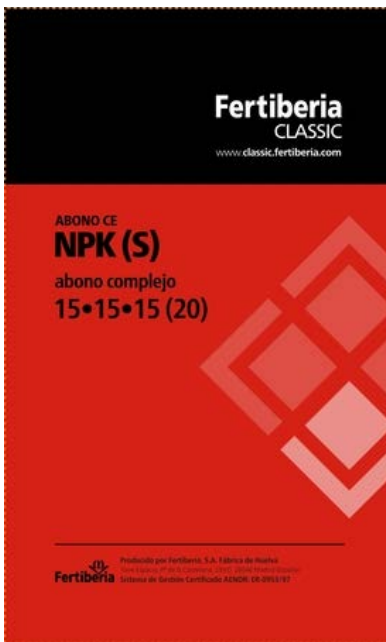

3.2

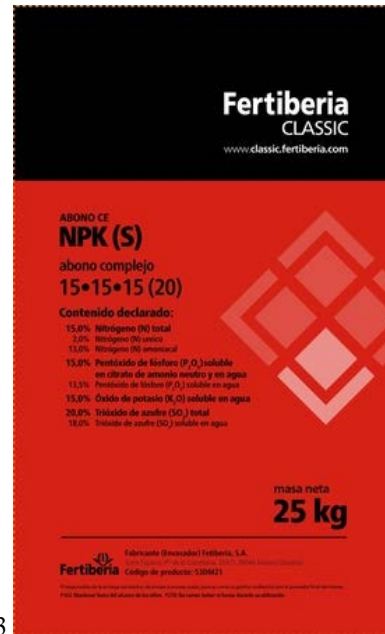

3.3



3.4



3.5

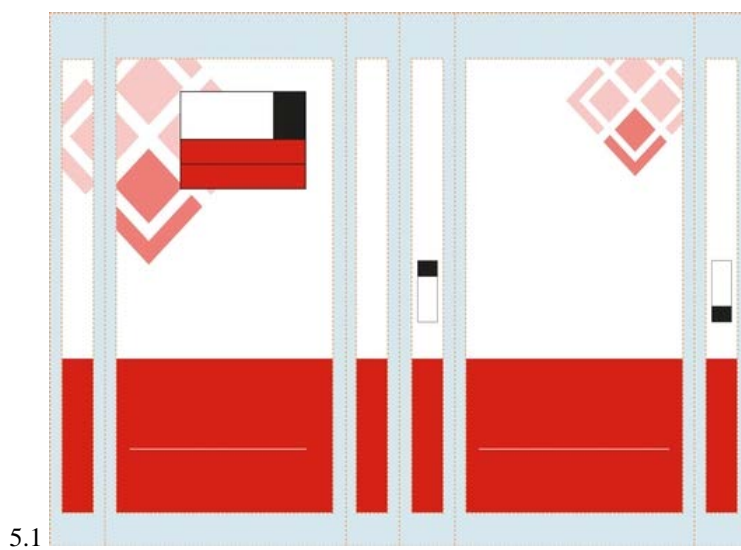
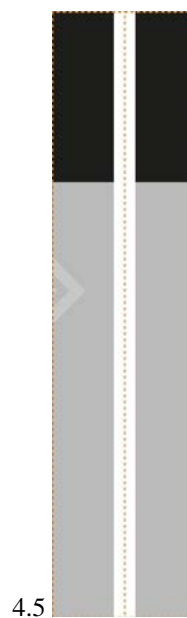
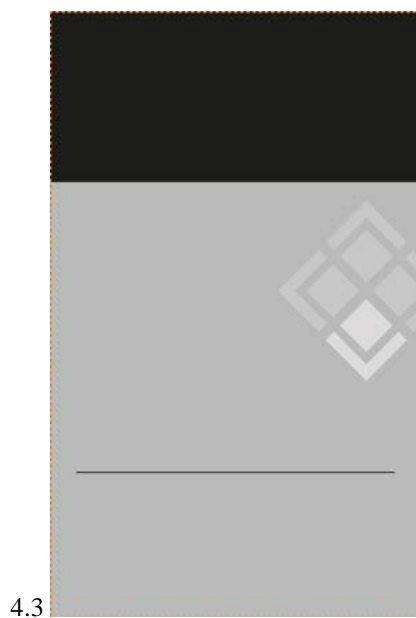
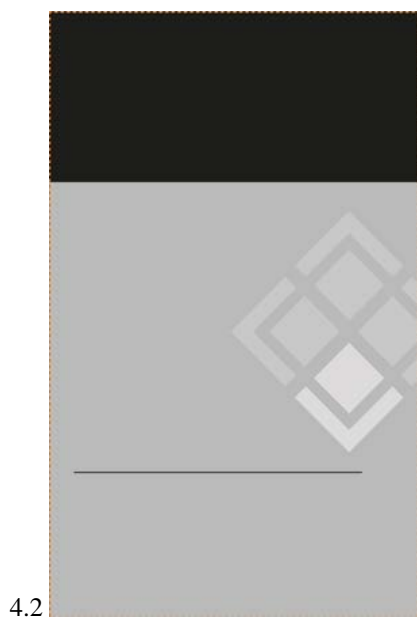
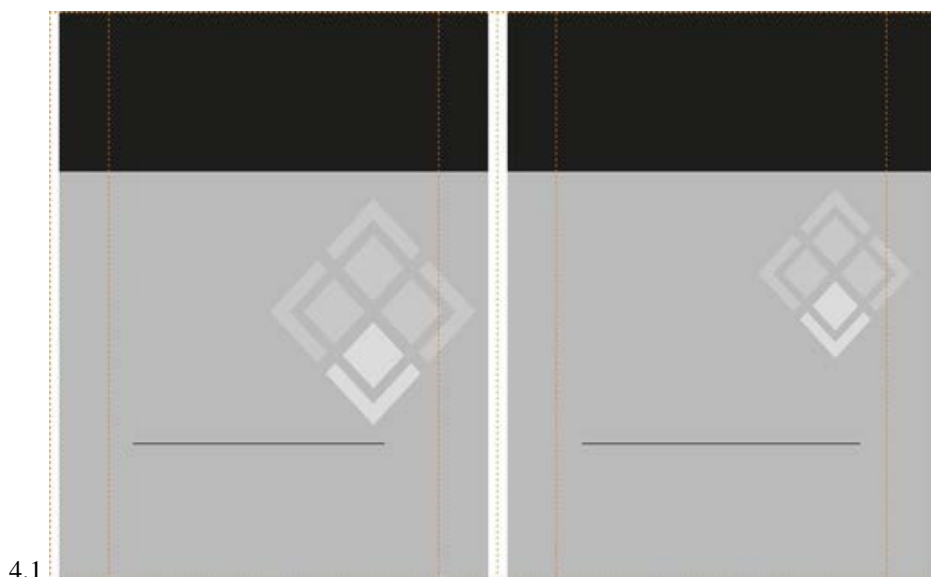

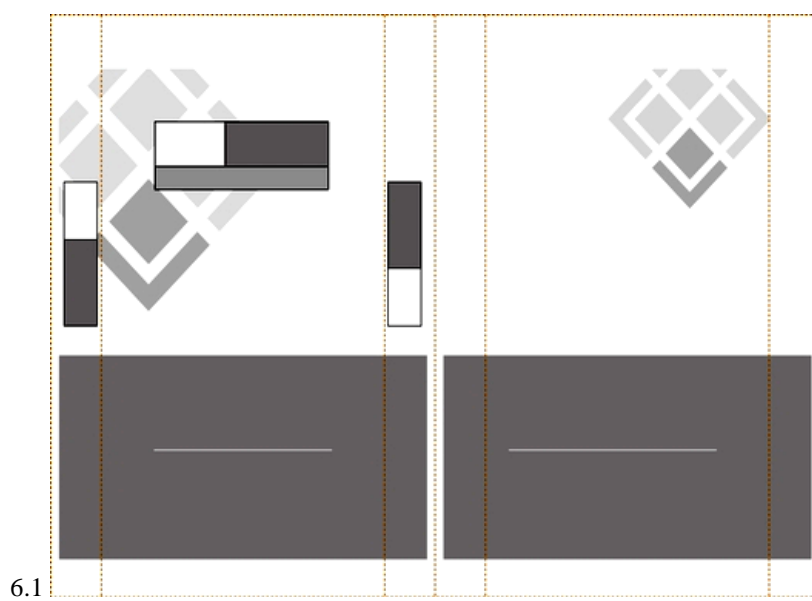
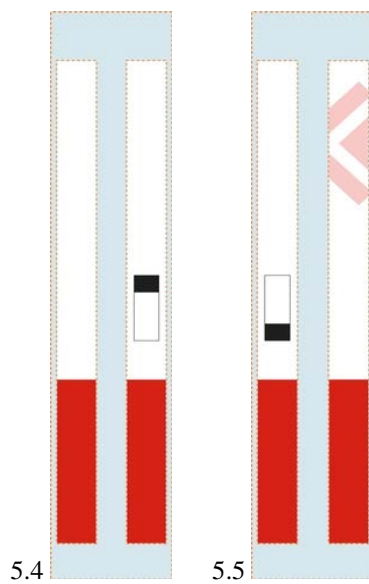
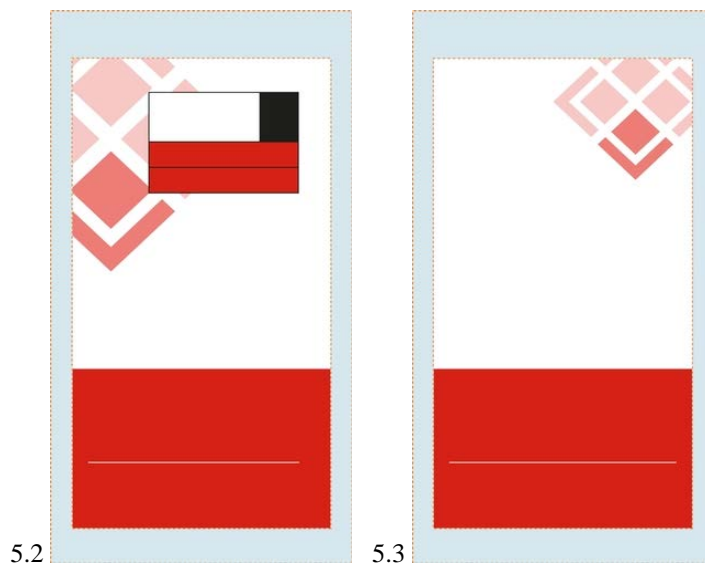



6.2

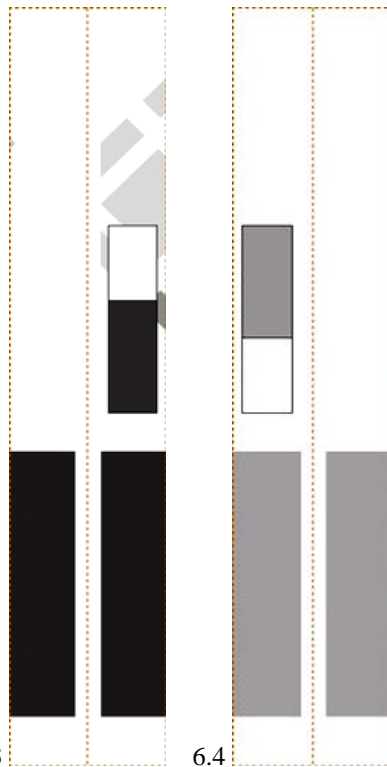

6.3

6.4

- (11) DM/216 037 (51) 11-01
- (15) 2021 08 20 (44) 08/2022 (2022 02 25)
- (22) 2021 08 20
- (28) 7
- (73) HARRY WINSTON SA
Chemin Du Tourbillon 8, 1228 Plan-les-Ouates (CH)
- (85) CH
- (86) CH
- (87) CH
- (88) CH
- (89) CH
- (81) II. MA III. AL, AM, AZ, BA, BZ, CA, CH, EM, GB, GE, KG, LI, MC, MD, ME, MK, MN, NO, OM, SG, TN, TR, UA
- (72) 1-3 Dominique RIVIERE
C/o Harry Winston Inc., 718 Fifth Avenue, 10019, New York, NY (US);
4-5 Rie YATSUGI-KANG
C/o Harry Winston Inc., 718 Fifth Avenue, 10019, New York, NY (US);
6-7 Delphine ABDOURAHIM
C/o Harry Winston Inc., 718 Fifth Avenue, 10019, New York, NY (US)
- (74) The Swatch Group AG (The Swatch Group SA) (The Swatch Group Ltd.)
Faubourg Du Lac 6, 2501 Biel/Bienne (CH)
- (54) 1.-4. Brooch, 5.-6. Necklace, 7. Pendant
- (55)

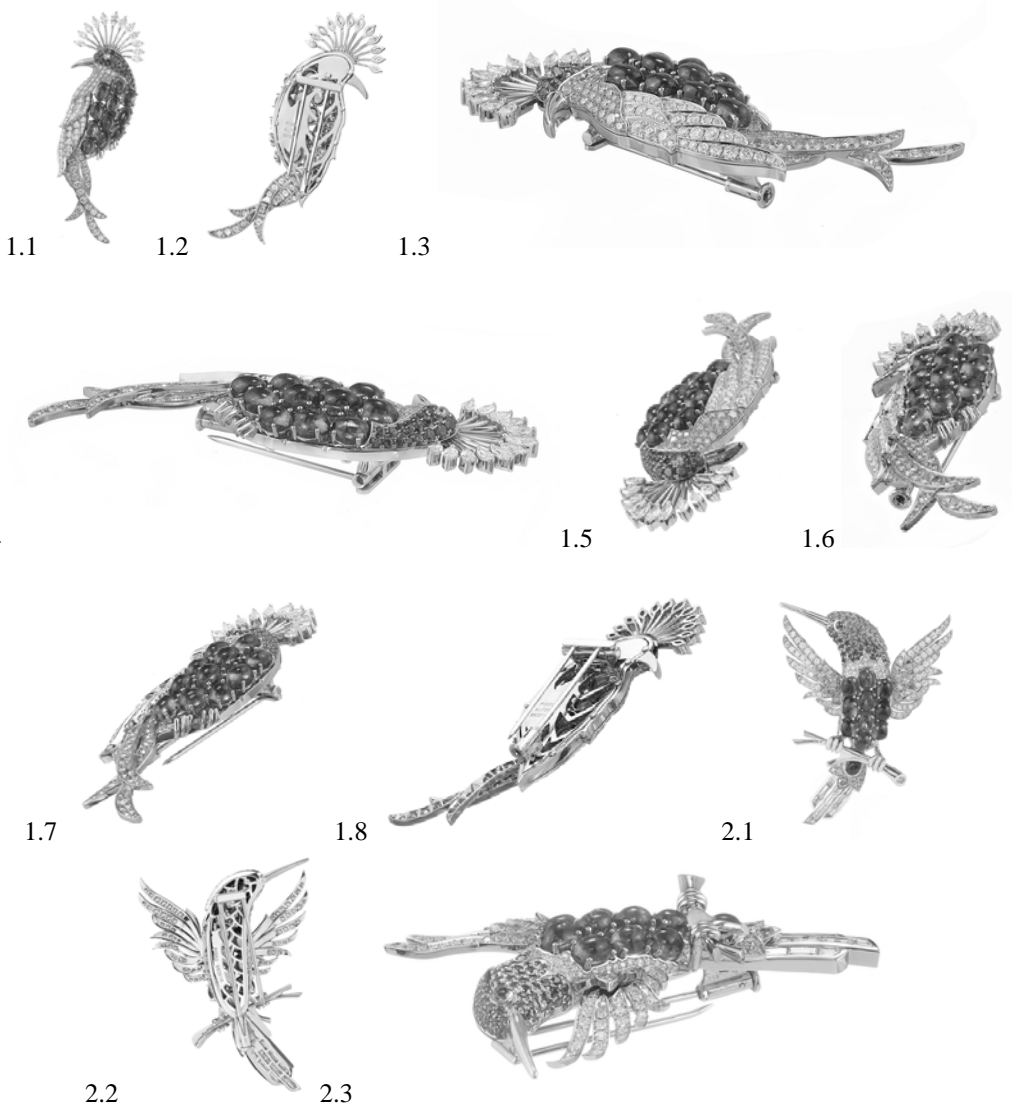

2.4



2.5



2.6



2.7



2.8

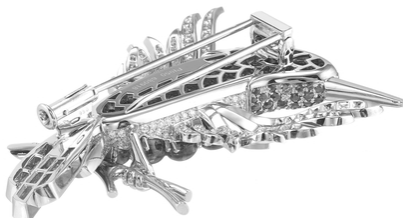

3.1



3.2



3.3



3.4



3.5



3.6



3.7







5.4



5.5



5.6



5.7



5.8



6.1



6.2



6.3



6.4



6.5



6.6



6.7



6.8



7.1



7.2



7.3



7.4



7.5



7.6



7.7



7.8

- (11) DM/219 040 (51) 14-06
(15) 2022 01 08 (44) 08/2022 (2022 02 25)
(22) 2022 01 08
(28) 4
(30) No1: 09.11.2021; 008752109; EM; No2: 09.11.2021; 008752109; EM; No3: 09.11.2021; 008752109; EM;
No4: 09.11.2021; 008752109; EM
(73) CHANGLAI GUO
Unit 1, Building 1, or Unit 2, Building 4, No. 29, Dongfeng Road, 253000 De Zhou (CN)
(85) –
(86) –
(87) –
(88) GB
(89) GB
(81) III. AZ, BA, BY, CA, EG, GE, GH, HR, IL, KG, KH, KR, MX, NO, OA, OM, RS, RU, RW, SG, SY, TJ, TN,
TR, UA, VN
(72) CHANGLAI GUO
Unit 1, Building 1, or Unit 2, Building 4, No. 29, Dongfeng Road, 253000 De Zhou (CN)
(46) 2022 02 25
(54) 1.-4. Stand for mobile telephones
(55)



1.1



1.2



1.3



1.4

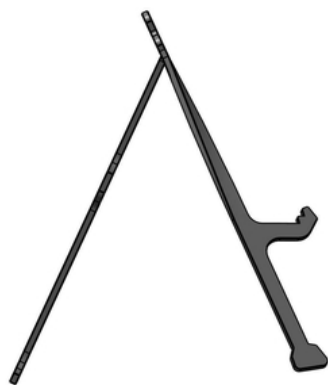

1.5

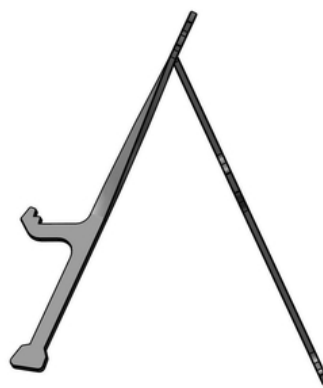

1.6



1.7

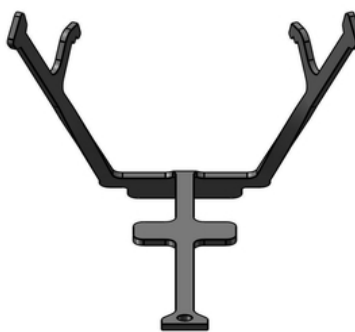

1.8

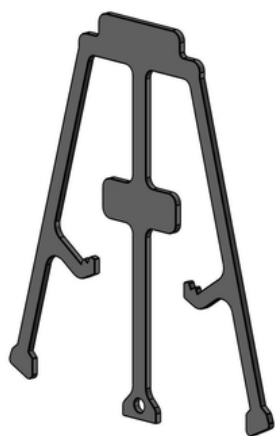

1.9

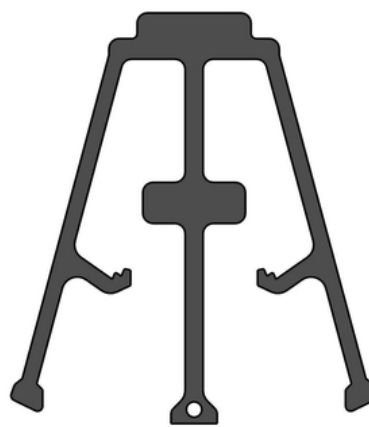

1.10



2.1



2.2



2.3



2.4



2.5



2.6



2.7

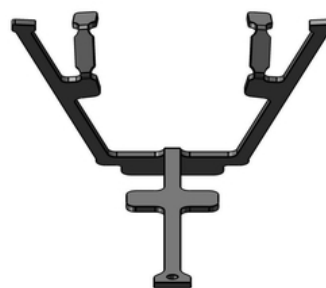

2.8

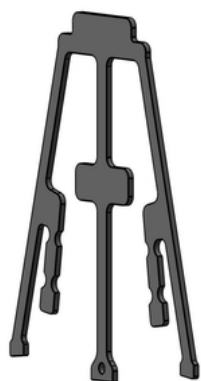

2.9

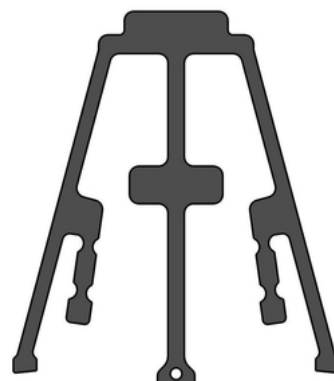

2.10



3.1



3.2

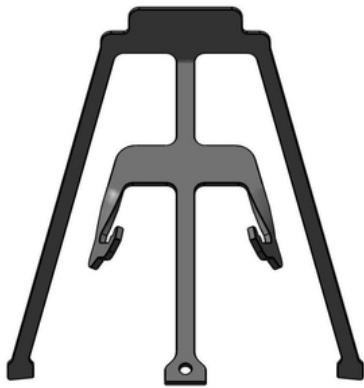

3.3

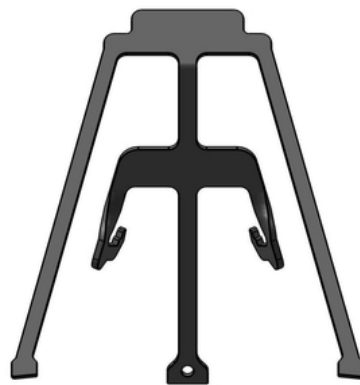

3.4



3.5

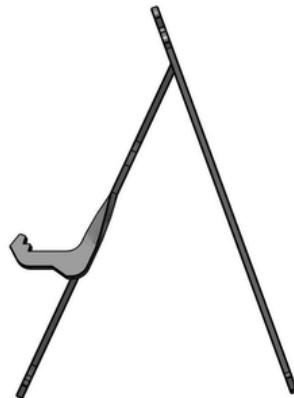

3.6



3.7



3.8

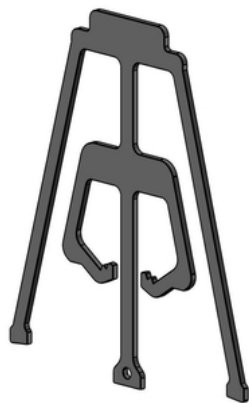

3.9

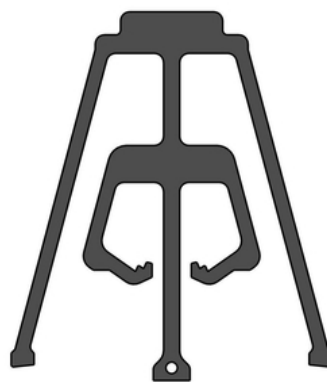

3.10



4.1



4.2



4.3



4.4



4.5



4.6

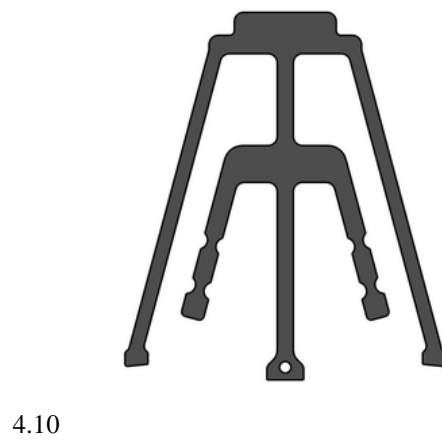

- (11) DM/216 449 (51) 11-01
 (15) 2021 09 02 (44) 09/2022 (2022 03 04)
 (22) 2021 09 02
 (28) 2
 (73) HARRY WINSTON SA
 Chemin Du Tourbillon 8, 1228 Plan-les-Ouates (CH)
 (85) CH
 (86) CH
 (87) CH
 (88) CH
 (89) CH
 (81) II. MA III. AL, AM, AZ, BA, BZ, CA, CH, EM, GB, GE, KG, LI, MC, MD, ME, MK, MN, NO, OM,
 SG, TN, TR, UA
 (72) 1 Rie YATSUGI-KANG
 C/o Harry Winston Inc., 718 Fifth Avenue, 10019, New York, (US);
 Delphine ABDOURAHIM
 C/o Harry Winston Inc., 718 Fifth Avenue, 10019, New York (CH);
 (74) The Swatch Group AG (The Swatch Group SA) (The Swatch Group Ltd.)
 Faubourg Du Lac 6, 2501 Biel/Bienne (CH)
 (54) 1.-2. Necklace
 (55)



1.1

1.2



1.3



1.4



1.5



1.6





2.6



2.7



2.8

TRADEMARKS

APPLICATIONS FILED UNDER THE NATIONAL PROCEDURE APPROVED FOR REGISTRATION

The decision can be appealed at the Chamber of Appeal of Sakpatenti within 3 months from the publication or at the Mtskheta District Court Administrative Cases Board (Address: №17, Samkhedro St., Mtskheta), within 1 month following the publication.

(260) AM 2022 112167 A
(210) AM 112167
(220) 2021 08 11
(731) LLC "NGT RockIT Solutions"
Zhiuli Shartava Str. 40, 0160, Saburtalo
District, Tbilisi, Georgia
(540)



(591) Blue, green
(531) 27.05.01
(511) 42

(260) AM 2022 112471 A
(210) AM 112471
(220) 2021 09 03
(731) LTD "Starlet Group"
R. Tabukashvili Str. 119, app. 49, Kutaisi,
Georgia
(740) Giorgi Taktakishvili
(540)

შარდენი
SHARDEN
ШАРДЕН

(591) Black-white
(511) 30

(260) AM 2022 113393 A
(210) AM 113393
(220) 2021 06 08
(731) LTD "AS Georgia"
Shota Nadirashvili Str. 24, Commercial
Space 1, 0113, Isani District, Tbilisi, Georgia
(540)



(591) Blue, yellow
(531) 26.07.03; 27.05.01; 29.01.12
(526) Georgia
(511) 36

(260) AM 2022 113417 A
(210) AM 113417
(220) 2021 06 09
(731) LTD "Bolero & Company"
Kuchishvili Str. 12-14-16, 0179, Tbilisi,
Georgia
(540)

ატენის ბატონი
Atenis Batoni
Атенис Батони

(591) Black-white
(526) ატენი, Ateni, Атени
(511) 33

(260) AM 2022 113990 A
(210) AM 113990
(220) 2021 07 20
(731) LTD "A-B-F"
Vill. Martkopi, Vaziani Settlement,
Gardabani Region, Georgia
(540)



Врата Кахетии

(591) Black-white
(531) 07.01.01; 24.01.15; 24.01.25; 27.05.01;
27.05.22
(526) Кахетии
(511) 32, 33

(260) AM 2022 114463 A
 (210) AM 114463
 (220) 2021 08 27
 (731) LTD "UAS Pharmaceuticals PTY"
 15 Cansdale Place, Castle Hill NSW, 2154,
 Australia
 (740) Valeri Bendianishvili;
 Lia Tsintsabadze;
 Gvantsa Shvangiradze
 (540)

DERMAVIVE

(591) Black-white
 (511) 5, 44

(260) AM 2022 114465 A
 (210) AM 114465
 (220) 2021 08 27
 (731) LTD "UAS Pharmaceuticals PTY"
 15 Cansdale Place, Castle Hill NSW, 2154,
 Australia
 (740) Valeri Bendianishvili;
 Lia Tsintsabadze;
 Gvantsa Shvangiradze
 (540)

SUNSTOP

(591) Black-white
 (511) 3

(260) AM 2022 114472 A
 (210) AM 114472
 (220) 2021 09 01
 (731) LTD "Sommelier Selection"
 Kuchishvili Str. 20, app. 22, 0179, Mtatsminda
 District, Tbilisi, Georgia
 (540)



(591) Golden, white
 (531) 05.07.10; 11.03.02; 19.01.05; 19.07.01;
 19.09.02; 27.05.01; 27.05.11; 29.01.02
 (511) 33

(260) AM 2022 114532 A
 (210) AM 114532
 (220) 2021 09 03
 (731) Beijing DiDi Infinity Technology
 Development Co., Ltd.

Building 34, No8 Dongbeiwang West Road,
 Haidian District, Beijing, Beijing, Public
 Republic of China
 (740) Pavle Meipariani
 (540)

DiDi

(591) Black-white
 (511) 9, 12, 35, 36, 37, 39, 42, 43

(260) AM 2022 114534 A
 (210) AM 114534
 (220) 2021 09 06
 (731) Toyota Jidosha Kabushiki Kaisha
 (also trading as Toyota Motor Corporation)
 1, Toyota-cho, Toyota-shi, Aichi-ken, Japan
 (740) Tamar Kochlamazashvili
 (540)

GX550

(591) Black-white
 (531) 27.05.01; 27.07.01; 27.07.11
 (511) 12

(260) AM 2022 114543 A
 (210) AM 114543
 (220) 2021 09 09
 (731) LTD "Conus 08"
 Vazisubani Settlement, II mcr., bld. 19,
 app. 2, 0152, Tbilisi, Georgia
 (540)



(591) Green, white, red, brown, beige
 (531) 07.01.01; 07.01.24; 26.01.01; 26.01.06;
 27.05.01; 27.05.09; 27.05.10; 29.01.14
 (511) 43

(260) AM 2022 114590 A
 (210) AM 114590
 (220) 2021 09 10
 (731) Limited Liability Company "Georgian Natural
 Gas Transmission Network Owner"
 Kakheti Highway 21, 0190, Tbilisi, Georgia

(540)



(591) White, black, blue
 (531) 27.05.01; 27.05.17; 27.05.19; 27.05.23;
 29.01.13
 (511) 36

(260) AM 2022 114608 A
 (210) AM 114608
 (220) 2021 09 14
 (731) JSC "Konti-Rus"
 Zolotaya Str. 13, Kursk, Kursky Region,
 305000, Russian Federation
 (740) Nugzar Ksovveli
 (540)

ღღე და ღაბე

(591) Black-white
 (511) 30

(260) AM 2022 114611 A
 (210) AM 114611
 (220) 2021 09 15
 (731) LTD "Anbani"
 Shota Rustaveli Ave. 52a, 0108, Tbilisi,
 Georgia

(540)



(591) Black, golden, white
 (531) 26.01.04; 26.01.05; 26.07.03; 26.13.25;
 27.05.01; 27.05.09; 27.05.10; 27.05.24;
 28.19; 29.01.13
 (511) 33

(260) AM 2022 114615 A
 (210) AM 114615
 (220) 2021 09 15
 (731) LTD "Gurila"
 Shalva Nutsbidze Str. 56/Vazha-Pshavela
 Ave., I qu., bld. 17, app. 82, Tbilisi, Georgia
 (740) Giorgi Meipariani

(540)

GOLDEN PHENOMENON
ოქროს უბნობა
ЗОЛОТОЙ ФЕНОМЕН

(591) Black-white
 (511) 3

(260) AM 2022 114677 A
 (210) AM 114677
 (220) 2021 09 17
 (731) Giorgi Gamsakhurdia
 Davit Aghmashenebeli Str. 32, Kvareli, Georgia
 (540)



(591) Black-white
 (531) 05.03.04; 05.07.10; 26.01.15; 26.01.21
 (511) 33

(260) AM 2022 114679 A
 (210) AM 114679
 (220) 2021 09 20
 (731) IDS Borjomi Beverages Co.N.V.
 Pareraweg 45, Curaçao
 (740) Giorgi Jokharidze
 (540)



(591) C0BCB0 light silver, BFB9AD dark silver,
 008884 dark green (Borjomi Green)
 (531) 03.04.07; 03.04.22; 29.01.13
 (511) 5, 32, 35

(260) AM 2022 114686 A
 (210) AM 114686
 (220) 2021 09 21
 (731) Dmitro Yakovtsev
 Volkova Str. 12, app. 53, Kropivnitzki,
 Ukraine
 (740) Salome Meladze
 (540)



(591) Black-white
 (531) 26.11.03; 26.11.05; 26.11.12; 26.11.13;
 26.13.25; 27.01.01; 27.01.13; 27.05.01
 (511) 32, 35

(260) AM 2022 114689 A
 (210) AM 114689
 (220) 2021 09 21
 (731) Obshchestvo s Ogranichennoy
 Otvetstvennostiu "Parapharm"
 Ul. Sverdlova, Dom 4, 440026, Penza,
 Russian Federation
 (740) Shalva Gvaramadze
 (540)



(591) Yellow, light green, sky-blue, black, white
 (531) 02.09.01; 26.04.06; 26.04.18; 26.04.24;
 28.05; 29.01.15
 (511) 5

(260) AM 2022 114690 A
 (210) AM 114690
 (220) 2021 09 21
 (731) Obshchestvo s Ogranichennoy
 Otvetstvennostiu "Parapharm"
 Ul. Sverdlova, Dom 4, 440026, Penza,
 Russian Federation
 (740) Shalva Gvaramadze

(540)



(591) White, black, beige, grey, yellow, green,
 light brown, dark brown
 (531) 05.05.04; 05.05.23; 05.13.25; 25.01.25;
 25.05.02; 25.12.25; 28.05; 29.01.15
 (511) 5

(260) AM 2022 114692 A
 (210) AM 114692
 (220) 2021 09 22
 (731) STADA Arzneimittel AG
 Stadastraße 2 - 18, 61118 Bad Vilbel,
 Germany
 (740) Shalva Gvaramadze
 (540)

ПРОБИЭЛЬ

(591) Black-white
 (511) 5

(260) AM 2022 114742 A
 (210) AM 114742
 (220) 2021 09 27
 (731) Colgate-Palmolive Company,
 Delaware Corporation
 300 Park Avenue, New York,
 NY 10022, USA
 (740) Tamaz Shilakadze
 (540)

BUBBLES

(591) Black-white
 (511) 21

(260) AM 2022 114743 A
 (210) AM 114743
 (220) 2021 09 27
 (310) 018448458
 (320) 2021 04 07
 (330) EUIPO
 (731) Gilead Sciences Inc.
 a Delaware corporation
 333 Lakeside Drive, Foster City,
 CA 94404, USA
 (740) Natela Otariidze

(540)

Гилеад

(591) Black-white
(511) 5, 44

(260) AM 2022 114751 A

(210) AM 114751

(220) 2021 09 28

(731) Thuraya Telecommunications Company
Etisalat Tower, Sheikh Rashid Bin Saeed
Al Maktoum Road, Abu-Dhabi, United Arab
Emirates, United Arab Emirates

(740) Liliana Darakhvelidze

(540)

THURAYA



(591) Black, grey, white
(531) 03.07.16; 03.07.24; 27.05.01
(511) 9, 16, 38

(260) AM 2022 114753 A

(210) AM 114753

(220) 2021 09 29

(731) LTD "Palavani"
Shindisi Highway 19, Gori, Georgia

(740) Giorgi Taktakishvili

(540)

**სულიერი
СУЛИЕРИ
SULIERI**

(591) Black-white
(511) 33

(260) AM 2022 114757 A

(210) AM 114757

(220) 2021 09 30

(731) LTD "Brand Consulting Group"
Degtarnaya Str. 9, app. 31, 04071, Kyiv,
Ukraine

(740) Ketevan Khutsishvili

(540)

BRJM

(591) Black-white
(511) 33

(260) AM 2022 114806 A

(210) AM 114806

(220) 2021 10 05

(731) Mamuka Baghnashvili
Osip Mandelshtam Str. 8, app. 13, Tbilisi,
Georgia;
Elene Malvenishvili
Kavkasioni Str. 53, Telavi, Georgia

(540)

**კოკროჭინა
Kokrotchina**

(591) Black-white
(511) 29

(260) AM 2022 114808 A

(210) AM 114808

(220) 2021 10 05

(731) Leonardo Beraia
Gumisti Massive, Sokhumi, Georgia

(540)

**ჩორღვანელი
CHORDVANELI
ЧОРДВАНЕЛИ**

(591) Black-white
(511) 32, 33

(260) AM 2022 114809 A

(210) AM 114809

(220) 2021 10 06

(731) LTD "Avaza"
Z. Gorgiladze Str. 2. app. 29, 8010, Batumi,
Georgia

(540)

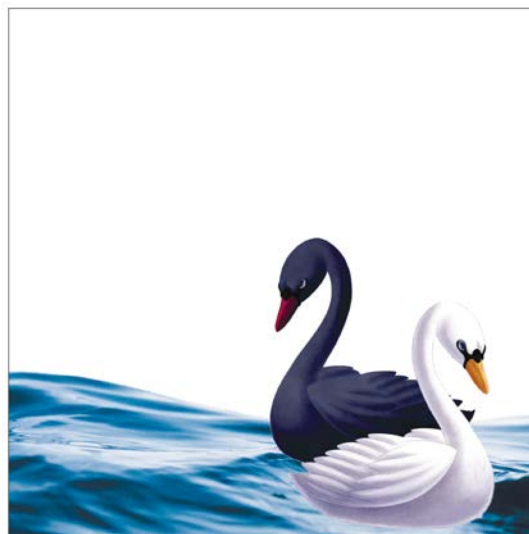

(591) Blue, black, white, orange, yellow

(531) 01.15.24; 03.07.06
(511) 16

(260) AM 2022 114810 A
(210) AM 114810
(220) 2021 10 06
(731) LTD "Avaza"

Z. Gorgiladze Str. 2. app. 29, 8010, Batumi,
Georgia

(540)

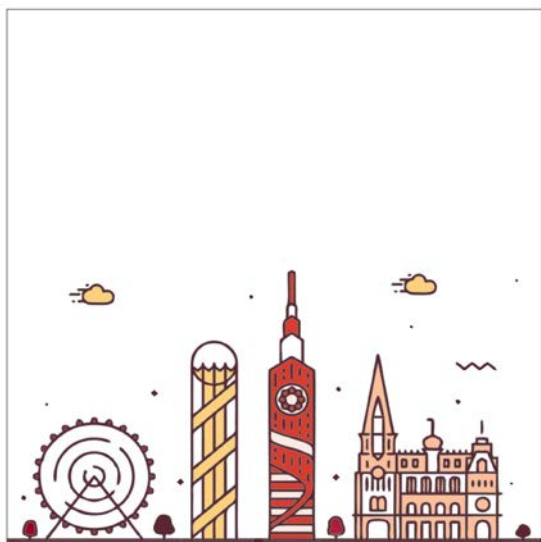

(591) Bordeaux, brown, light brown, white, black
(531) 01.15.11; 07.01.01; 07.01.06; 26.01.05;
29.01.14
(511) 16

(260) AM 2022 114900 A
(210) AM 114900
(220) 2021 10 08
(731) LTD "Palavani"

Shindisi Highway 19, 1400, Gori, Georgia

(740) Giorgi Taktakishvili
(540)

დადი
ДИАДИ
DIADI

(591) Black-white
(511) 33

(260) AM 2022 114901 A
(210) AM 114901
(220) 2021 10 08
(731) LTD "Palavani"

Shindisi Highway 19, 1400, Gori, Georgia

(740) Giorgi Taktakishvili

(540)

აღილი
АДГИЛИ
ADGILI

(591) Black-white
(511) 33

(260) AM 2022 114902 A
(210) AM 114902
(220) 2021 10 08
(731) LTD "Palavani"

Shindisi Highway 19, 1400, Gori, Georgia

(740) Giorgi Taktakishvili
(540)

ლოტიანი
ЛОТИАНИ
LOTIANI

(591) Black-white
(511) 33

(260) AM 2022 114904 A
(210) AM 114904
(220) 2021 10 08
(731) LTD "Rock"

Ketevan Tsamebuli Ave., vis-a-vis to 91,
0144, Tbilisi, Georgia

(540)



(591) 1615C dark brown, 7414C brown,
151C terracotta, 361C green, 368C light green
(531) 01.03.01; 01.03.12; 26.11.12; 28.19;
29.01.13
(511) 35

(260) AM 2022 114917 A
(210) AM 114917
(220) 2021 10 12
(731) LTD "Orovela"

Vill. Chibaani, Akhmeta Region, Georgia

(540)

შავი შავი

(591) Black-white
(511) 32, 33

(260) AM 2022 114920 A
(210) AM 114920
(220) 2021 10 13
(731) Corporacion Habanos, S.A.
Karetera Viekha De Guanabakoa
I Linea Del Ferokaril Final,
Guanabakoa, La Habana, Cuba
(740) Tamaz Shilakadze
(540)



(591) White, black, golden, yellow, light yellow,
dark yellow, blue, sky-blue, brown, light
brown, green
(531) 01.03.01; 01.03.06; 01.03.15; 05.01.12;
06.03.01; 06.03.02; 27.05.02; 29.01.15
(511) 34

(260) AM 2022 114972 A
(210) AM 114972
(220) 2021 10 15
(731) The Coca-Cola Company
One Coca-Cola Plaza, Atlanta,
GA 30313, USA
(740) Giorgi Taktakishvili
(540)

**COCA-COLA ZERO
SUGAR**

(591) Black-white
(511) 32

REGISTERED TRADEMARKS

(111) M 2022 35238 R
(151) 2022 03 29
(181) 2032 03 29
(260) AM 2021 111722 A
(220) 2021 02 16

(732) Robert Okropilashvili
Tabukashvili Str. 203/1, Kutaisi, Georgia

(111) M 2022 35239 R
(151) 2022 03 29
(181) 2032 03 29
(260) AM 2021 111869 A
(220) 2021 02 24

(732) Bosnalijek d.d., Pharmaceutical and Chemical
Industry, Joint Stock Company
71000 Sarajevo, Jukićeva 53, Bosnia and
Herzegovina

(111) M 2022 35240 R
(151) 2022 04 07
(181) 2032 04 07
(260) AM 2021 111870 A
(220) 2021 02 24

(732) Bosnalijek d.d., Pharmaceutical and Chemical
Industry, Joint Stock Company
71000 Sarajevo, Jukićeva 53, Bosnia and
Herzegovina

(111) M 2022 35241 R
(151) 2022 04 07
(181) 2032 04 07
(260) AM 2021 111871 A
(220) 2021 02 25

(732) Bosnalijek d.d., Pharmaceutical and Chemical
Industry, Joint Stock Company
71000 Sarajevo, Jukićeva 53, Bosnia and
Herzegovina

(111) M 2022 35242 R
(151) 2022 04 07
(181) 2032 04 07
(260) AM 2021 111872 A
(220) 2021 02 25

(732) Bosnalijek d.d., Pharmaceutical and Chemical
Industry, Joint Stock Company
71000 Sarajevo, Jukićeva 53, Bosnia and
Herzegovina

(111) M 2022 35243 R
(151) 2022 04 07
(181) 2032 04 07
(260) AM 2021 111873 A
(220) 2021 02 25

(732) Bosnalijek d.d., Pharmaceutical and Chemical
Industry, Joint Stock Company
71000 Sarajevo, Jukićeva 53, Bosnia and
Herzegovina

(111) M 2022 35244 R
(151) 2022 04 07
(181) 2032 04 07
(260) AM 2021 112061 A
(220) 2021 03 08

(732) Bosnalijek d.d., Pharmaceutical and Chemical
Industry, Joint Stock Company
71000 Sarajevo, Jukićeva 53, Bosnia and
Herzegovina

(111) M 2022 35245 R
(151) 2022 04 07
(181) 2032 04 07
(260) AM 2021 112263 A
(220) 2021 03 21

(732) Altunkaya İnşaat Nakliyat Gıda Ticaret
Anonim Şirketi
4. Organize Sanayi Bölgesi, 83409,
Nolu Cadde №8, Gaziantep, Turkey

(111) M 2022 35246 R
(151) 2022 04 07
(181) 2032 04 07
(260) AM 2021 112274 A
(220) 2021 03 22

(732) Compagnie Des Fromages & Richesmonts
5 rue Chantecoq, 92800 Puteaux, France

(111) M 2022 35247 R
(151) 2022 04 07
(181) 2032 04 07
(260) AM 2021 112275 A
(220) 2021 03 22

(732) Compagnie Des Fromages & Richesmonts
5 rue Chantecoq, 92800 Puteaux, France

(111) M 2022 35248 R (151) 2022 04 07 (181) 2032 04 07 (260) AM 2021 112590 A (220) 2021 04 13 (732) Ishihara Sangyo Kaisha LTD 3-15, Edobori, 1-chome, Nishi-ku, Osaka, Japan	71000 Sarajevo, Jukićeva 53, Bosnia and Herzegovina
(111) M 2022 35249 R (151) 2022 04 07 (181) 2032 04 07 (260) AM 2021 112708 A (220) 2021 04 22 (732) Maxeon Solar Pte. LTD. 8 Marina Boulevard N05-02 Marina Bay Financial Centre, 018981, Singapore	(111) M 2022 35254 R (151) 2022 04 07 (181) 2032 04 07 (260) AM 2021 112839 A (220) 2021 05 06 (732) Marriott Worldwide Corporation 10400 Fernwood Road, Bethesda, Maryland, 20817, USA
(111) M 2022 35250 R (151) 2022 03 29 (181) 2032 03 29 (260) AM 2021 112725 A (220) 2021 04 28 (732) Merck Sharp & Dohme Corp. One Merck Drive, Whitehouse Station, New Jersey 08889, USA	(111) M 2022 35255 R (151) 2022 04 07 (181) 2032 04 07 (260) AM 2021 112906 A (220) 2021 05 11 (732) Merck Sharp & Dohme Corp. One Merck Drive, Whitehouse Station, New Jersey 08889, USA
(111) M 2022 35251 R (151) 2022 04 07 (181) 2032 04 07 (260) AM 2021 112730 A (220) 2021 04 29 (732) Colgate-Palmolive Company Delaware Corporation 300 Park Avenue, New York, New York 10022, USA	(111) M 2022 35256 R (151) 2022 04 07 (181) 2032 04 07 (260) AM 2021 113037 A (220) 2021 05 19 (732) LTD "MS Group" Chirnakhuli Str. 4, 0151, Tbilisi, Georgia
(111) M 2022 35252 R (151) 2022 04 07 (181) 2032 04 07 (260) AM 2021 112731 A (220) 2021 04 29 (732) Colgate-Palmolive Company Delaware Corporation 300 Park Avenue, New York, New York 10022, USA	(111) M 2022 35257 R (151) 2022 04 07 (181) 2032 04 07 (260) AM 2021 113048 A (220) 2021 05 20 (732) LLC "TeleImedi" Ak. Tsereteli Ave. 140, Didube District, Tbilisi, Georgia
(111) M 2022 35253 R (151) 2022 04 07 (181) 2032 04 07 (260) AM 2021 112836 A (220) 2021 05 04 (732) Bosnalijek d.d., Pharmaceutical and Chemical Industry, Joint Stock Company	(111) M 2022 35264 R (151) 2022 04 12 (181) 2032 04 12 (260) AM 2021 110188 A (220) 2021 03 11 (732) LTD "Orient" Ak. Tsereteli Ave. 13, app. 1, Tbilisi, Georgia
(111) M 2022 35253 R (151) 2022 04 07 (181) 2032 04 07 (260) AM 2021 112836 A (220) 2021 05 04 (732) Bosnalijek d.d., Pharmaceutical and Chemical Industry, Joint Stock Company	(111) M 2022 35265 R (151) 2022 04 12 (181) 2032 04 12 (260) AM 2021 110191 A (220) 2021 03 18 (732) JSC "Tbilisi Tobacco" Giorgi Nadareishvili Str. 7, Tbilisi, Georgia

(111) M 2022 35266 R
(151) 2022 04 12
(181) 2032 04 12
(260) AM 2021 111322 A
(220) 2021 01 18
(732) LTD "Smart Capital Group"
Gergeti Str. 3, Mtatsminda District, Tbilisi,
Georgia

(111) M 2022 35267 R
(151) 2022 04 12
(181) 2032 04 12
(260) AM 2021 111938 A
(220) 2021 02 27
(732) Doğan Zarf Kağıt Ambalaj Sanayi Ve Ticaret
Limited Şirketi
Litros Yolu, 2. Matbaacılar Sitesi, 1 Bd 16,
Topkapı, Zeytinburnu, Istanbul, Turkey

(111) M 2022 35268 R
(151) 2022 04 12
(181) 2032 04 12
(260) AM 2021 111966 A
(220) 2021 03 04
(732) General Motors LLC
300 Renaissance Center, City of Detroit, State
of Michigan 48265-3000, USA

(111) M 2022 35269 R
(151) 2022 04 12
(181) 2032 04 12
(260) AM 2021 112054 A
(220) 2021 03 05
(732) LTD "Odrex Software"
Tashkenti Str. Lane 4, app. 16, 0160, Tbilisi,
Georgia

(111) M 2022 35270 R
(151) 2022 04 12
(181) 2032 04 12
(260) AM 2021 112066 A
(220) 2021 03 09
(732) Mars Incorporated
6885 Elm Street, Mclean, Virginia 22101, USA

(111) M 2022 35271 R
(151) 2022 04 12
(181) 2032 04 12
(260) AM 2021 112075 A
(220) 2021 03 09
(732) Pediatrica Specialist S.r.L.
Via Nicolodi 28/A, 57121 Livorno (LI), Italy

(111) M 2022 35272 R
(151) 2022 04 12
(181) 2032 04 12
(260) AM 2021 112076 A
(220) 2021 03 09
(732) Pediatrica Specialist S.r.L.
Via Nicolodi 28/A, 57121 Livorno (LI), Italy

(111) M 2022 35273 R
(151) 2022 04 12
(181) 2032 04 12
(260) AM 2021 112281 A
(220) 2021 03 23
(732) Tearsceince Inc.
510 Cottonwood Drive, Milpitas, CA 95035,
USA

(111) M 2022 35274 R
(151) 2022 04 12
(181) 2032 04 12
(260) AM 2021 112282 A
(220) 2021 03 23
(732) Mariam Khanjaliashvili
Vill. Ruispiri, 2200, Telavi, Georgia

(111) M 2022 35275 R
(151) 2022 04 12
(181) 2032 04 12
(260) AM 2021 112289 A
(220) 2021 03 24
(732) Tearsceince Inc.
510 Cottonwood Drive, Milpitas,
CA 95035, USA

(111) M 2022 35276 R
(151) 2022 04 12
(181) 2032 04 12
(260) AM 2021 112290 A
(220) 2021 03 24
(732) Tearsceince Inc.
510 Cottonwood Drive, Milpitas,
CA 95035, USA

(111) M 2022 35277 R
(151) 2022 04 12
(181) 2032 04 12
(260) AM 2021 112369 A
(220) 2021 03 26
(732) LLC "Grand Candy"
31 May Str., 0061, Yerevan, Armenia

(111) M 2022 35278 R
(151) 2022 04 12
(181) 2032 04 12
(260) AM 2021 112370 A
(220) 2021 03 26
31 May St., 0061, Yerevan, Armenia

(111) M 2022 35279 R
(151) 2022 04 12
(181) 2032 04 12
(260) AM 2021 112371 A
(220) 2021 03 26
31 May St., 0061, Yerevan, Armenia

(111) M 2022 35280 R
(151) 2022 04 12
(181) 2032 04 12
(260) AM 2021 112372 A
(220) 2021 03 26
31 May St., 0061, Yerevan, Armenia

(111) M 2022 35281 R
(151) 2022 04 12
(181) 2032 04 12
(260) AM 2021 112373 A
(220) 2021 03 26
31 May St., 0061, Yerevan, Armenia

(111) M 2022 35282 R
(151) 2022 04 12
(181) 2032 04 12
(260) AM 2021 112389 A
(220) 2021 03 29
(732) LTD "Biopolus"
Noneshvili Str. 65, 6000, Batumi, Georgia

(111) M 2022 35283 R
(151) 2022 04 12
(181) 2032 04 12
(260) AM 2021 112392 A
(220) 2021 03 29
(732) LTD "Biopolus"
Noneshvili Str. 65, 6000, Batumi, Georgia

(111) M 2022 35284 R
(151) 2022 04 12
(181) 2032 04 12
(260) AM 2021 112395 A
(220) 2021 03 29
(732) LTD "Biopolus"
Noneshvili Str. 65, 6000, Batumi, Georgia

(111) M 2022 35285 R
(151) 2022 04 12
(181) 2032 04 12
(260) AM 2021 112396 A
(220) 2021 03 29
(732) LTD "Biopolus"
Noneshvili Str. 65, 6000, Batumi, Georgia

(111) M 2022 35286 R
(151) 2022 04 12
(181) 2032 04 12
(260) AM 2021 112400 A
(220) 2021 03 30
(732) Philip Morris Brands Sàrl
Quai Jeanrenaud 3, 2000 Neuchâtel, Switzerland

(111) M 2022 35287 R
(151) 2022 04 12
(181) 2032 04 12
(260) AM 2021 112422 A
(220) 2021 04 01
(732) Philip Morris Brands Sàrl
Quai Jeanrenaud 3, 2000 Neuchâtel, Switzerland

(111) M 2022 35288 R
(151) 2022 04 12
(181) 2032 04 12
(260) AM 2021 112487 A
(220) 2021 04 05
(732) LTD "Lilium"
Shartava Str. 39, 0160, Tbilisi, Georgia

(111) M 2022 35289 R
(151) 2022 04 12
(181) 2032 04 12
(260) AM 2021 112495 A
(220) 2021 04 06
(732) LTD "Biopolus"
Noneshvili Str. 65, 6000, Batumi, Georgia

(111) M 2022 35290 R
(151) 2022 04 12
(181) 2032 04 12
(260) AM 2021 112594 A
(220) 2021 01 18
(732) LTD "Smart Capital Group"
Gergeti Str. 3, Mtatsminda District, Tbilisi,
Georgia

(111) M 2022 35291 R
 (151) 2022 04 12
 (181) 2032 04 12
 (260) AM 2021 112690 A
 (220) 2021 04 20
 (732) LTD "Seven Hills"

Didi Dighomi, Giorgi Brtskinvale Str. 23,
 app. 33, Vake-Saburtalo District, Tbilisi,
 Georgia

(111) M 2022 35292 R
 (151) 2022 04 12
 (181) 2032 04 12
 (260) AM 2021 112697 A
 (220) 2021 04 21

(732) LLC "Elysee Food" (Elyseevskoe)
 Beri Gabriel Salosi Ave. 165, app. 51, Tbilisi,
 Georgia

(111) M 2022 35293 R
 (151) 2022 04 12
 (181) 2032 04 12
 (260) AM 2021 112899 A
 (220) 2021 05 07

(732) LTD "Biopolus"
 Noneshvili Str. 65, 6000, Batumi, Georgia

(111) M 2022 35294 R
 (151) 2022 04 12
 (181) 2032 04 12
 (260) AM 2021 112903 A
 (220) 2021 05 10

(732) LTD "Impexpharm"
 On the right bank of the River Mtkvari, nearby
 the Bacteriophage, 0160, Tbilisi, Georgia

(111) M 2022 35295 R
 (151) 2022 04 12
 (181) 2032 04 12
 (260) AM 2021 112933 A
 (220) 2021 05 13

(732) Reckitt & Colman (Overseas) Health Limited
 103-105 Bath Road, Slough, Berkshire,
 SL1 3UH, United Kingdom

(111) M 2022 35296 R
 (151) 2022 04 12
 (181) 2032 04 12
 (260) AM 2021 112935 A
 (220) 2021 05 13

(732) Maker's Mark Distillery Inc.
 100 Mallard Creek Road, Suite 151, Louisville,
 Kentucky 40207, USA

(111) M 2022 35297 R
 (151) 2022 04 12
 (181) 2032 04 12
 (260) AM 2021 112936 A
 (220) 2021 05 13
 (732) LLC "LTB"

Tornike Eristavi Str. 2, Tbilisi, Georgia

(111) M 2022 35298 R
 (151) 2022 04 12
 (181) 2032 04 12
 (260) AM 2021 113018 A
 (220) 2021 05 14

(732) Unilever IP Holdings B.V.
 Weena 455, Rotterdam 3013 AL, Netherlands

(111) M 2022 35299 R
 (151) 2022 04 12
 (181) 2032 04 12
 (260) AM 2021 113103 A
 (220) 2021 05 21

(732) Turtle Wax Inc.
 2250 West Pinehurst Boulevard, Suite 150,
 Addison, Illinois, 60101, USA

(111) M 2022 35300 R
 (151) 2022 04 12
 (181) 2032 04 12
 (260) AM 2021 113104 A
 (220) 2021 05 21

(732) Turtle Wax Inc.
 2250 West Pinehurst Boulevard, Suite 150,
 Addison, Illinois, 60101, USA

(111) M 2022 35301 R
 (151) 2022 04 12
 (181) 2032 04 12
 (260) AM 2021 113108 A
 (220) 2021 05 24

(732) LLC "Ori Nabiji"
 Navtlughi Str. 39-41, 0113, Isani District,
 Tbilisi, Georgia

(111) M 2022 35302 R
 (151) 2022 04 12
 (181) 2032 04 12
 (260) AM 2021 113143 A
 (220) 2021 05 27

(732) LTD "Pizzaiola"
 Nikoloz Kipshidze Str. 4, app. 74, Tbilisi,
 Georgia

(111) M 2022 35303 R
(151) 2022 04 12
(181) 2032 04 12
(260) AM 2021 113191 A
(220) 2021 05 28
(732) LLP "Ornado Medicine - ორნადო მედიცინა"
Vill. Irganchai, Str. 14, II Lane 1, 1707, Dmanisi
Municipality, Georgia

(111) M 2022 35309 R
(151) 2022 04 12
(181) 2032 04 12
(260) AM 2021 113201 A
(220) 2021 05 28
(732) LTD "Helios Pharma"
Ilia Chavchavadze Ave. 17g, 0179, Tbilisi,
Georgia

(111) M 2022 35304 R
(151) 2022 04 12
(181) 2032 04 12
(260) AM 2021 113193 A
(220) 2021 05 28
(732) LLP "Ornado Medicine - ორნადო მედიცინა"
Vill. Irganchai, Str. 14, II Lane 1, 1707, Dmanisi
Municipality, Georgia

(111) M 2022 35310 R
(151) 2022 04 12
(181) 2032 04 12
(260) AM 2021 113202 A
(220) 2021 05 28
(732) LTD "Helios Pharma"
Ilia Chavchavadze Ave. 17g, 0179, Tbilisi,
Georgia

(111) M 2022 35305 R
(151) 2022 04 12
(181) 2032 04 12
(260) AM 2021 113194 A
(220) 2021 05 28
(732) LLP "Ornado Medicine - ორნადო მედიცინა"
Vill. Irganchai, Str. 14, II Lane 1, 1707, Dmanisi
Municipality, Georgia

(111) M 2022 35311 R
(151) 2022 04 12
(181) 2032 04 12
(260) AM 2021 113203 A
(220) 2021 05 28
(732) LTD "Helios Pharma"
Ilia Chavchavadze Ave. 17g, 0179, Tbilisi,
Georgia

(111) M 2022 35306 R
(151) 2022 04 12
(181) 2032 04 12
(260) AM 2021 113195 A
(220) 2021 05 28
(732) LLP "Ornado Medicine - ორნადო მედიცინა"
Vill. Irganchai, Str. 14, II Lane 1, 1707, Dmanisi
Municipality, Georgia

(111) M 2022 35312 R
(151) 2022 04 12
(181) 2032 04 12
(260) AM 2021 113211 A
(220) 2021 05 30
(732) Reckitt & Colman (Overseas) Hygiene Home
Limited
103-105 Bath Road, Slough, Berkshiri, SL1 3UH,
United Kingdom

(111) M 2022 35307 R
(151) 2022 04 12
(181) 2032 04 12
(260) AM 2021 113199 A
(220) 2021 05 28
(732) LTD "Helios Pharma"
Ilia Chavchavadze Ave. 17g, 0179, Tbilisi,
Georgia

(111) M 2022 35313 R
(151) 2022 04 12
(181) 2032 04 12
(260) AM 2021 113227 A
(220) 2021 05 31
(732) Ruslan Kikava
Vill. Ortabatumi, 6400, Khelvachauri, Georgia

(111) M 2022 35308 R
(151) 2022 04 12
(181) 2032 04 12
(260) AM 2021 113200 A
(220) 2021 05 28
(732) LTD "Helios Pharma"
Ilia Chavchavadze Ave. 17g, 0179, Tbilisi,
Georgia

(111) M 2022 35314 R
(151) 2022 04 12
(181) 2032 04 12
(260) AM 2021 113240 A
(220) 2021 06 01
(732) LTD "Kartuli Tema"
Irakli Gamrekele Str. 35v, 0186, Tbilisi, Georgia

(111) M 2022 35315 R
(151) 2022 04 12
(181) 2032 04 12
(260) AM 2021 113267 A
(220) 2021 06 02
(732) LLP Mikadze, Gegetchkori, Taktakishvili
Kato Mikeladze Str. 3, 0159, Tbilisi, Georgia

(111) M 2022 35325 R
(151) 2022 04 14
(181) 2032 04 14
(260) AM 2021 113228 A
(220) 2021 05 31
(732) LLC "Agritouch"
Tskneti Highway 7, app. 9, Tbilisi, Georgia

(111) M 2022 35316 R
(151) 2022 04 12
(181) 2032 04 12
(260) AM 2021 113286 A
(220) 2021 06 03
(732) Ketevan Vashalomidze
Shalva Nutsubidze Str. 127, app. 85, 0186,
Tbilisi, Georgia

(111) M 2022 35317 R
(151) 2022 04 12
(181) 2032 04 12
(260) AM 2021 113491 A
(220) 2021 06 14
(732) Unilever IP Holdings B.V.
Weena 455, Rotterdam 3013 AL, Netherlands

(111) M 2022 35318 R
(151) 2022 04 12
(181) 2032 04 12
(260) AM 2021 111720 A
(220) 2021 02 16
(732) Sánchez Romero Carvajal Jabugo S.A.
Fernan Caballero, 7, 11.500 Puerto de Santa
María, Cádiz, Spain

(111) M 2022 35319 R
(151) 2022 04 12
(181) 2032 04 12
(260) AM 2021 111834 A
(220) 2021 02 19
(732) Zuffa LLC
6650 South Torrey Pines Drive, Las Vegas,
Nevada 89118, USA

(111) M 2022 35320 R
(151) 2022 04 12
(181) 2032 04 12
(260) AM 2021 112273 A
(220) 2021 03 22
(732) Enriko Beridze
Tsitsishvili Str. 18, Tbilisi, Georgia

TRADEMARKS REGISTERED ACCORDING TO THE ACCELERATED PROCEDURE

The decision can be appealed at the Chamber of Appeal of Sakpatenti within 3 months from the publication.

(111) M 2022 35258 R
(151) 2022 04 07
(181) 2032 04 07
(210) AM 117255
(220) 2022 03 25
(732) Veronika Mchedlishvili
Akaki Tsereteli Ave. 103, app 45, 0119,
Tbilisi, Georgia
(740) Veronika Mchedlishvili
(540)



(591) 080808 black, ED1F24 red, white
(531) 24.09.02; 24.09.05; 24.09.09; 25.01.13;
26.04.22; 29.01.13
(526) CAFE
(511) 43

(111) M 2022 35259 R
(151) 2022 04 07
(181) 2032 04 07
(210) AM 116983
(220) 2022 03 09
(732) Arash GHASSEMLOU
G. Panjikidze Str. 22, Block A, app. 86,
Tbilisi, Georgia
(540)



(591) White, sky-blue, red
(531) 26.01.18; 27.05.01; 29.01.13
(526) Georgia
(511) 39, 41

(111) M 2022 35260 R
(151) 2022 04 07
(181) 2032 04 07
(210) AM 116670
(220) 2022 02 18
(310) 36775
(320) 2021 12 01
(330) AD

(732) Philip Morris Brands Sàrl
Quai Jeanrenaud 3, 2000 Neuchâtel,
Switzerland
(740) Pavle Meipariani
(540)



(591) Black-white
(531) 01.05.01; 01.05.02; 01.05.12; 01.05.15;
01.05.23; 27.05.01; 27.07.01; 27.07.25
(511) 34

(111) M 2022 35261 R
(151) 2022 04 07
(181) 2032 04 07
(210) AM 117106
(220) 2022 03 17
(732) Revaz Tsirekidze
Tamarashvili Ave. 10, app. 43, 0177,
Tbilisi Georgia
(740) Pavle Meipariani
(540)



(591) Black-white
(531) 05.05.20; 28.19
(511) 30

(111) M 2022 35262 R
(151) 2022 04 07
(181) 2032 04 07
(210) AM 117197
(220) 2022 03 24
(732) LTD "Geowest Holding"
Nikoloz Baratashvili Str. 12/Beach Str. 2,
Half-basement 1a, 0114, Krtsanisi District,
Tbilisi, Georgia
(540)



(591) Sky-blue, blue, white

(531) 07.01.24; 29.01.04
(511) 36

(111) M 2022 35263 R
(151) 2022 04 07
(181) 2032 04 07
(210) AM 117262
(220) 2022 03 28
(732) LTD "PSP Pharma"
David Aghmashenebeli Ave. 148, 0112,
Tbilisi Georgia
(740) Nugzar Ksovrelidze
(540)

დოქტორ კვიკ
Доктор Квик
Doctor Quick

(591) Black-white
(511) 3, 5, 21

(111) M 2022 35321 R
(151) 2022 04 12
(181) 2032 04 12
(210) AM 117303
(220) 2022 04 04
(732) Nobel Ilac Sanayii Ve Ticaret-Anonim
Sirketi - Representative in Georgia
Tavisuplebis Moedani 4, 0105, Tbilisi, Georgia
(740) Tinatin Tskhvediani
(540)

Keglad XR
კეგლად იქსარო

(591) Black-white
(511) 5, 35

(111) M 2022 35322 R
(151) 2022 04 13
(181) 2032 04 13
(210) AM 117298
(220) 2022 04 01
(732) Juan De Bagration De Uloa
Vertskhli Str. 52, 0105, Tbilisi, Georgia
(540)



PRINCE OF GEORGIA
საქართველოს უფლისწული

(591) White, golden

(531) 24.09.01; 24.09.13; 27.05.01; 28.19; 29.01.02
(526) GEORGIA, საქართველო
(511) 33

(111) M 2022 35323 R
(151) 2022 04 13
(181) 2032 04 13
(210) AM 117275
(220) 2022 03 29
(732) LTD "First Investment Company Georgia"
Davit Aghmashenebeli Ave. 129a, fl. 4,
Tbilisi, Georgia
(740) Giorgi Kartvelishvili
(540)



MAGNETIC
BEACH RESORT

მაგნეტიკი
ბიჩ რეზორტი

(591) Black-white
(531) 26.01.05; 26.01.06; 27.05.01; 27.05.10
(511) 43

(111) M 2022 35324 R
(151) 2022 04 13
(181) 2032 04 13
(210) AM 117313
(220) 2022 04 05
(732) Egis Gyógyszergyár Zrt.
Keresztúri út 30-38, Budapest, 1106, Hungary
(740) Shalva Gvaramadze
(540)

FLOXET

(591) Black-white
(511) 5

(111) M 2022 35326 R
(151) 2022 04 15
(181) 2032 04 15
(210) AM 117431
(220) 2022 04 11
(732) Novartis AG
4002 Basel, Switzerland
(740) Shalva Gvaramadze
(540)

Золгенсма

(591) Black-white
(511) 5

INTERNATIONAL TRADEMARKS FOR WHICH A DECISION ON GRANTING PROTECTIONS IS TAKEN

The decision can be appealed at the Chamber of Appeal of Sakpatenti within 3 months from the publication or at the Mtskheta District Court Administrative Cases Board (Address: №17, Samkhedro St., Mtskheta), within 1 month following the publication.

(260) AM 2022 109396 A*
 (800) 1545048
 (151) 2020 04 07
 (891) 2020 04 07
 (731) Oriflame Cosmetics AB
 PO Box 1095, SE-101 39 Stockholm,
 Sweden
 (540)

ORIFLAME SWEDISH EXPERIENCE

(591) Black, white
 (511)
 3 – Non-medicated conditioning and care preparations for application to the hair, scalp, skin and nails; shampoos; hair conditioner; soaps; perfumes; perfumery; eau de cologne; toilet waters; essential and herbal oils; cosmetics; make-up; make-up preparations; make-up removers; lipsticks; nail varnishes; nail varnish removers; eyeliner; mascara; non-medicated toilet preparations; hair lotions; hair sprays and hair gels; preparations for use in the bath or shower; bath and shower oils, gels, creams and foams; face and body masks; face and body scrubs; facial washes; skin cleansers and hydrators; skin toners; skin moisturizers; blemish creams and blemish gels; deodorants; antiperspirants; shaving soaps; shaving creams; shaving gels; after-shave preparations; pre-shave preparations; talcum powders; toiletries; dentifrices; toothpastes; mouth washes; foot care preparations (non-medicated); cotton for cosmetic purposes; cotton wool, sticks, buds, swabs, puffs, balls and pads; cotton wool in the form of wipes for cosmetic use; cotton puffs and pads impregnated with make-up removing preparations.

(260) AM 2022 110841 A*
 (800) 1564860
 (151) 2020 09 02
 (891) 2020 09 02
 (731) Belarusian-German Joint Venture "Santa Bremor" Limited Liability Company
 ul. Katin Bor 106, 224025 g. Brest,
 Belarus
 (540)

SOLETTO

(591) Black, white

(511)
 30 – Frozen yogurt [confectionery ices]; ice for refreshment; edible ices; ice pops; ice cream; sorbets [ices].

(260) AM 2022 112013 A
 (800) 1578893
 (151) 2020 12 03
 (891) 2020 12 03
 (731) SLOBOZHANSKY SOAP-BOILER LTD.
 Sumsyki Shliah str., 53, Podvirky,
 Dergachivskyi district, Kharkiv region
 62371, Ukraine

(540)



(591) Black, white
 (531) 25.01.10; 26.04.08; 26.04.18; 26.04.24;
 27.05.24

(511)
 3 – Abrasives; abrasive cloth; glass cloth [abrasive cloth]; abrasive paper; diamantine [abrasive]; ammonia [volatile alkali] [detergent]; antistatic preparations for household purposes; flavourings for beverages [essential oils]; cake flavourings [essential oils]; food flavourings [essential oils]; bleaching soda; laundry bleaching preparations; bleaching preparations [decolorants] for household purposes; bleaching salts; shoe wax; wax for parquet floors; floor wax; volcanic ash for cleaning; cloths impregnated with a detergent for cleaning; gaultheria oil; javelle water; colorants for toilet purposes; preservatives for leather [polishes]; colour-removing preparations; degreasers, other than for use in manufacturing processes; silicon carbide [abrasive]; carbides of metal [abrasives]; quillaia bark for washing; corundum [abrasive]; tailors' wax; shoe cream; creams for leather; polishing creams; starch glaze for laundry purposes; starch for laundry purposes; non-slipping wax for floors; washing soda, for

cleaning; soap for brightening textile; emery; emery cloth; emery paper; oil of turpentine for degreasing; drying agents for dishwashing machines; polishing wax; polishing paper; polishing rouge; polishing stones; polishing preparations; shoe polish; polish for furniture and flooring; fabric softeners for laundry use; laundry blueing; laundry preparations; leather bleaching preparations; floor wax removers [scouring preparations], rust removing preparations; varnish-removing preparations; paint stripping preparations; descaling preparations for household purposes; stain removers; lacquer-removing preparations; laundry soaking preparations; shining preparations [polish]; laundry glaze, preparations to make the leaves of plants shiny; preparations for unblocking drain pipes, smoothing preparations [starching]; dry-cleaning preparations; wallpaper cleaning preparations; windscreen cleaning liquids; non-slipping liquids for floors; safrol; turpentine for degreasing; soda lye; canned pressurized air for cleaning and dusting purposes; tri-poli stone for polishing; colour-brightening chemicals for household purposes [laundry]; cleaning chalk, cleaning preparations; chemical cleaning preparations for household purposes; cobblers' wax; shoemakers' wax; sandpaper; smoothing cloth; smoothing stones; grinding preparations.

(260) AM 2022 112228 A

(800) 1581651

(151) 2020 12 12

(891) 2020 12 12

(731) "DOMINANTA-SERVIS"

Komsomolskaya str., 1, p. 49, pom. 1, room
223, Podolsk, RU-142100 Moscow region,
Russian Federation

(540)

ЗОЛОТАЯ ЗВЕЗДА

(591) Black, white

(531) 28.05

(511)

3 – Bleaching preparations and other substances for laundry use; cleaning, polishing, scouring and abrasive preparations.

(260) AM 2022 113534 A

(800) 1596618

(151) 2021 04 08

(891) 2021 04 08

(731) Smithers-Oasis Company

295 South Water Street, Suite 201, Kent OH
44240, USA

(540)

TerraBrick

(591) Black, white

(511)

1 – Growing media for plants; substances for preserving cut flowers.

(260) AM 2022 113557 A

(800) 1597163

(151) 2021 04 07

(891) 2021 04 07

(731) Shanghai Aowei Technology Development Co., Ltd.

No.188 Guoshoujing Road., China (Shanghai)
Pilot Free Trade Zone, 200120 Shanghai, China

(540)



(591) Black, white

(531) 27.05.01; 27.05.17

(511)

9 – Condensers, namely, capacitors; batteries, electric; charging stations for electric vehicles; battery chargers; telepresence robots; transistors, electronic; security surveillance robots; humanoid robots with artificial intelligence; electronic numeric displays.

11 – Lamps; lights for vehicles; lighting apparatus and installations; street lamps; solar thermal collectors; safety lamps; searchlights; heating apparatus, electric; heating apparatus; light-emitting diodes LED lighting apparatus.

12 – Electric vehicles; tramcars; golf carts, vehicles; rubbish trucks; motor buses; cars; civilian drones; boats.

42 – Consultancy in the field of energy-saving; technological research; quality control; scientific research; conducting technical project studies; material testing; scientific laboratory services; chemical research; computer software design; industrial design.

(260) AM 2022 113559 A

(800) 1597195

(151) 2021 02 09

(891) 2021 02 09

(731) MINISO (Hengqin) Enterprise Management Co., Ltd.

Room 205, Second Floor Office, Nanshanzui
Road No.156, Hengqin District, Zhuhai City,
Guangdong Province, China

(540)



(591) Black, white
(531) 27.05.01; 27.05.17
(511)

9 – Cell phone straps; cell phone cases; hourglasses; decorative fridge magnets; computer mouse pads; USB flash drives; USB cables; USB chargers; cabinets for loudspeakers; headset.

14 – Small accessories (jewelry); key rings; rings (trinkets); plastic bracelet; medals; charms for key rings; wristwatches; clocks; simulated jewellery; jewellery boxes.

16 – Stamps [seals]; photo stands; decal; cards; printed matter; bookmarkers; comic books; art prints; paper bags; stationery.

26 – Badges for wear, not of precious metal; ornamental novelty badges [buttons]; charms, other than for jewellery, key rings or key chains; decorative articles for the hair; clothing brooches; cord-knitted handwork; decorative ribbons; hat trimmings; bobby pins; embroidery.

35 – business management and organization consultancy; commercial administration of the licensing of the goods and services of others; advisory services for business management; import-export agency services; marketing; sales promotion for others; advertising; retail or wholesale services; business management of hotels; sales promotion display services; publicity; rental of vending machines; rental of sales stands; retail or wholesale services for medical supplies.

(260) AM 2022 113562 A

(800) 1597338

(151) 2021 02 17

(891) 2021 02 17

(731) PEGAS TOURISTIK UK LIMITED

16 Upper Woburn Place, London WC1H 0BS,
United Kingdom

(540)



(591) Blue and green

(531) 04.03.05; 26.11.06; 26.11.08; 27.05.10;
27.05.17; 29.01.12

(526) Touristik

(511)

36 – Financial affairs; monetary affairs; real estate affairs; credit bureau services; debt collection agency services; real estate agency services; financial analysis; rental of apartments; rental of real estate; rental of offices [real estate]; rental of farms; lease-purchase financing; savings bank services; accommodation bureau services [apartments]; rent collection; issuance of travelers' checks; issuance of credit cards; issuance of tokens of value; capital investment; insurance infor-

mation; financial information; clearing, financial; insurance consultancy; financial consultancy; stock exchange quotations; lending against security; business liquidation services, financial; brokerage; financial management; exchanging money; online banking; processing of debit card payments; processing of credit card payments; factoring; organization of monetary collections; arranging finance for construction projects; antique appraisal; jewelry appraisal; stamp appraisal; real estate appraisal; numismatic appraisal; art appraisal; financial evaluation [insurance, banking, real estate]; repair costs evaluation [financial appraisal]; electronic funds transfer; surety services; securities brokerage; real estate brokerage; brokerage of carbon credits; insurance brokerage; loans [financing]; pawnbrokerage; providing financial information via a web site; check verification; charitable fund raising; financial sponsorship; mortgage banking; instalment loans; insurance underwriting; life insurance underwriting; health insurance underwriting; accident insurance underwriting; marine insurance underwriting; fire insurance underwriting; apartment house management; real estate management; actuarial services; banking; stock brokerage services; retirement payment services; trusteeship; provident fund services; financial customs brokerage services; mutual funds; financing services; safe deposit services; deposits of valuables; fiscal valuation.

38 – Telecommunications; news agency services; wireless broadcasting; television broadcasting; cable television broadcasting; electronic bulletin board services [telecommunications services]; providing information in the field of telecommunications; communication by electronic mail systems; providing user access to global computer networks; providing access to databases; providing internet chatrooms; providing telecommunications connections to a global computer network; providing telecommunication channels for teleshopping services; transmission of greeting cards online; message sending; computer aided transmission of messages and images; transmission of telegrams; transmission of digital files; e-mail and mailbox services; providing online forums; videoconferencing services; rental of message sending apparatus; rental of access time to global computer networks; rental of modems; rental of telecommunication equipment; rental of telephones; rental of facsimile apparatus; radio broadcasting; communications by fiber optic networks; communications by cellular phones; communications by computer terminals; satellite transmission; communications by telegrams; communications by telephone; facsimile transmission; paging services [radio, telephone or other means of electronic communication]; teleconferencing services; telex services; voice mail services; telecommunications routing and junction services; telegraph services; telephone services.

41 – Rental of sports grounds; rental of tennis courts; lending library services; booking of seats for shows;

videotaping; physical education; discotheque services; dubbing; gambling services; publication of books; providing information relating to recreational activities; providing information in the field of entertainment; movie studio services; health club services [health and fitness training]; nightclub services [entertainment]; layout services, other than for advertising purposes; microfilming; videotape editing; production of radio and television programmes; presentation of variety shows; music composition services; game services provided online from a computer network; providing online electronic publications, not downloadable; organization of balls; providing recreation facilities; arranging and conducting of concerts; organization of competitions [education or entertainment]; arranging of beauty contests; organization of lotteries; organization of fashion shows for entertainment purposes; organization of shows [impresario services]; organization of sports competitions; amusement park services; sign language interpretation; television entertainment; mobile library services; providing online videos, not downloadable; providing online music, not downloadable; karaoke services; providing golf facilities; providing sports facilities; providing amusement arcade services; cinema presentations; presentation of live performances; theatre productions; conducting fitness classes; timing of sports events; videotape film production, other than advertising films; rental of audio equipment; rental of video cameras; rental of video cassette recorders; rental of videotapes; rental of show scenery; rental of sound recordings; toy rental; rental of cinematographic apparatus; rental of motion pictures; games equipment rental; rental of stadium facilities; rental of lighting apparatus for theatrical sets or television studios; rental of radio and television sets; rental of skin diving equipment; rental of sports equipment, except vehicles; rental of stage scenery; electronic desktop publishing; online publication of electronic books and journals; publication of texts, other than publicity texts; radio entertainment; entertainer services; entertainment services; writing and publication of texts, other than publicity texts; zoological garden services; news reporters services; party planning [entertainment]; subtitling; tutoring; holiday camp services [entertainment]; disc jockey services; personal trainer services [fitness training]; providing casino facilities [gambling]; calligraphy services; club services [entertainment or education]; providing museum facilities [presentation, exhibitions]; orchestra services; translation; scriptwriting, other than for advertising purposes; ticket agency services [entertainment]; sports camp services; recording studio services; language interpreter services; photography; photographic reporting; presentation of circus performances; production of shows.

42 – Design and development of computer hardware and software; computer system analysis; recovery of computer data; computer virus protection services; installation of computer software; meteorological in-

formation; web site design consultancy; information technology [IT] consultancy; consultancy in the design and development of computer hardware; architectural consultancy; computer software consultancy; updating of computer software; monitoring of computer systems by remote access; software as a service [SaaS]; maintenance of computer software; conversion of data or documents from physical to electronic media; providing information relating to computer technology and programming via a web site; providing search engines for the internet; conversion of computer programs and data, other than physical conversion; computer system design; rental of web servers; computer rental; rental of computer software; hosting computer sites [web sites]; server hosting; computer software design; creating and maintaining web sites for others; computer programming; copying of computer programs; off-site data backup; cloud computing; cartography services; electronic data storage.

43 – Accommodation bureau services [hotels, boarding houses]; rental of temporary accommodation; rental of meeting rooms; tourist home services; boarding house bookings; hotel services; retirement home services; snack-bar services; café services; cafeteria services; motel services; providing temporary accommodation; boarding for animals; rental of cooking apparatus; rental of chairs, tables, table linen, glassware; rental of lighting apparatus other than for theatrical sets or television studios; rental of tents; rental of transportable buildings; rental of drinking water dispensers; restaurants; self-service restaurant services; food sculpting; canteen services; holiday camp services [lodging]; bar services; providing campground facilities; food and drink catering; day-nursery [crèche] services; providing information about temporary accommodation via the Internet; providing lodging information via the Internet; hotel reservation services provided via the Internet; temporary accommodation reservation services in the nature of making reservations and booking of eco-lodgings via a web site; agency services for booking hotel accommodation; travel agency services for booking hotel accommodation; travel agency services for making hotel reservations; agency services for the reservation of temporary accommodation; travel agency services for reserving temporary accommodation; hotel information services; consultancy provided by telephone call centers and hotlines in the field of temporary accommodation; ice cream parlors; rental of temporary accommodation in the nature of villas and bungalows; rental of temporary accommodation in vacation homes and apartments; rental of vacation homes; rental of vacation cabins; rental of rooms as temporary living accommodation; hotel services for preferred customers; restaurant reservation services; reservation of temporary accommodation in hotels and boarding houses; reservation of hotel accommodation; making hotel reservations for others; reservation of temporary accom-

modation via the Internet; reservation of temporary accommodation in the nature of vacation homes; booking of campground accommodation; rental of beds; rental of function rooms; rental of function rooms for birthday parties; rental of function rooms for wedding receptions; rental of banquet and social function facilities for special occasions; rental of conference rooms; rental of rooms for holding functions, conferences, conventions, exhibitions, seminars and meetings; rental of bar equipment; reception services for temporary accommodation [management of arrivals and departures]; decorating of food; cake decorating; information and advice in relation to the preparation of meals; personal chef services; travel agency services for making restaurant reservations; catering services for hotels; take-away food and drink services; take-away food services; providing temporary accommodation in hotels, motels and boarding houses; providing temporary accommodation in vacation homes; providing temporary accommodation in vacation apartments; providing temporary accommodation as part of hospitality packages; providing temporary accommodation for guests; providing accommodation in hotels and motels; providing conference facilities; providing holiday accommodation; mobile catering services; providing in-flight meal services in an airplane; hotel, restaurant and catering services; hotel, motel, restaurant, bar and catering services; arranging and providing temporary accommodation; arranging temporary housing accommodations; arranging hotel accommodation; serving of alcoholic beverages; serving food and drink for guests; serving food and drink for guests in restaurants; serving food and drink in Internet cafés; providing food and drink in Internet cafés; supplying of meals for immediate consumption; providing food and drink catering services for convention facilities; providing temporary accommodation in serviced apartments; providing exhibition facilities in hotels; providing food and drink catering services for exhibition facilities; providing food and drink catering services for sports events, concerts, conventions and exhibitions; providing temporary lodging at holiday camps; providing information about temporary accommodation services; providing information relating to hotels; providing conference rooms; providing conference, exhibition and meeting facilities; providing on-line information relating to vacation accommodation reservations; providing on-line information relating to hotel reservations; providing food and lodging in health resorts that specialize in promoting patrons' general health and well-being; providing facilities for exhibitions; providing facilities for exhibitions and conferences; providing convention facilities; providing facilities for fairs and exhibitions; providing banquet and social function facilities for special occasions; providing food and drink; providing food and drink for guests in restaurants; providing food and drink as part of hospitality services;

providing food, drink and temporary accommodation for guests; providing hotel accommodation; providing room reservation and hotel reservation services; providing travel lodging information services and travel lodging booking agency services for travelers; providing restaurant services; serving food and beverages in dairy bars; preparation and provision of food and drink for immediate consumption; preparation and provision of food and drink for consumption on and off the premises; services for the preparation of food and drink; preparation of food and drink for immediate consumption; reservation and booking of temporary lodging; business catering services; bartending services; bistro services; catering services; hotel room reservation services; reservation and booking services for hotels, restaurants and holiday accommodation; buffet services for cocktail lounges; delicatessens [restaurants]; temporary accommodation services provided by holiday camps; serving of food and drink; hotel and restaurant services; motel and resort services; boarding house services; bed and breakfast inn services; hotel accommodation services; cafeteria and canteen services; cocktail lounge services; consultancy services in the field of culinary arts; consultancy services in the field of food and drink catering; dairy bar services; catering services for conference centers; catering services for the provision of food and drink; services for the reservation of rooms; hostel services; temporary accommodation services; serving food and drink in restaurants and bars; services for providing food and drink; resort lodging services; food preparation services; hotel and restaurant reservation services; reservation and booking services for restaurants and meals; restaurant, bar and cocktail lounge services; fast food and non-stop restaurant services.

(260) AM 2022 113564 A

(800) 1597374

(151) 2020 10 26

(891) 2020 10 26

(731) AISIN SEIKI KABUSHIKI KAISHA

2-1 Asahi-machi, Kariya-shi, Aichi-ken

448-8650, Japan

(540)

AISIN

(591) Black, white

(531) 27.05.01

(511)

1 – Anti-freezing liquids; formaldehyde absorbing agents; formaldehyde removing agents; oil additives for automobile engines [chemical preparations]; chemical reagents sold as a kit, other than for medical or veterinary purposes; chemicals; brake oil for automobiles; transmission fluids for automobiles; glue and adhesives for industrial purposes; nonmetallic minerals; rea-

gent paper [not for medical purposes]; unprocessed plastics [plastics in primary form]; chemical sealing compounds in liquid form; plant growth regulating preparations; fertilizers; ceramic glazings; priming putty; higher fatty acids; chemical compositions for developing and printing photographs; artificial sweeteners; flour and starch for industrial purposes; pulp.

4 – Mineral oils and greases for industrial purposes [not for fuel]; automotive engine oils; automotive gear oils; additives, non-chemical for motor-fuel; automotive lubricants; fuels; solid lubricants; leather preserving oil and grease; non-mineral oils and greases for industrial purposes [not for fuel]; wax [raw material]; candles; grease for shoes and boots; lamp wicks.

6 – Locks and hinges for automobiles; door locks for automobiles; door hinges for automobiles; trunk locks for automobiles; trunk hinges for automobiles; automobile hood locks; automobile hood hinges; metal hardware; railings of metal; shutters of metal; metal materials for building or construction; metal pulleys, springs and valves [not including machine elements]; containers of metal for transport; loading and unloading pallets of metal; industrial load turntables; traversers for load handling; joinery fittings of metal; metal safes; metal junctions for pipes; metal flanges; iron and steel; prefabricated building assembly kits of metal; metal molds for forming cement products; keys of metal; cotter pins; reservoirs of metal; wire rope; wire nets and gauzes; industrial packaging containers of metal; metal stepladders and ladders; outdoor blinds of metal; nonferrous metals.

7 – Water pumps for automobile engines; water pumps for motors and engines; oil pumps for automobile engines; oil pumps for land vehicle engines; filters for automobile engines; filters for internal combustion engine; oil filters for internal combustion engine; filters for motors and engines; pistons for automobile engines; fan couplings for automobile engines; fans for automobile engines; cylinder heads for automobile engines; cylinder head covers for automobile engines; intake manifolds for automobile engines; crankcases for motors and engines; pistons [parts of machines or engines]; pistons for cylinders of automobile engines; gas engines [not for land vehicles]; gas turbines [not for land vehicles]; non-electric prime movers [not for land vehicles] and parts thereof; machine elements [not for land vehicles]; power generating devices for cogeneration systems; gas engine driven power generators; starters for motors and engines; AC motors and DC motors (excluding those for land vehicles) and parts thereof; AC generators [alternators]; DC generators; pumps; vacuum pumps; pneumatic or hydraulic machines and instruments; sewing machines; parts and fittings for sewing machines; machines and apparatus for the textile industry; metalworking machines and tools using laser beam; laser welding machines; metalworking machines and tools; plastic processing machines and apparatus; sto-

ne working machines and apparatus; glass-working machines and apparatus; ceramic processing machines and apparatus; rubber processing machines; laser beam machines for manufacturing semi-conductors; electrically operated shutter automatic opening and shutting devices; pumps [parts of machines, engines or motors]; fuel pumps for land vehicle engines; chemical processing machines and apparatus; fuel dispensing machines for service stations; vehicle washing installations; waste compacting machines and apparatus for industrial purposes; waste crushing machines for industrial purposes; shafts, axles or spindles [parts of machines]; shaft bearings [parts of machines]; shaft couplings and connectors [parts of machines]; bearings [parts of machines]; power transmissions and gearing [parts of machines]; idling pulleys [parts of machines]; reduction gears [parts of machines]; power transmission belts [parts of machines]; toothed wheels and gears [parts of machines]; speed change gears [parts of machines]; fluid couplings [parts of machines]; hydraulic torque converter [parts of machines]; transmissions for machines; shaft bearings; shaft bearings for land vehicles; shaft couplings and connectors; bearing; bearing for land vehicles.

9 – Measuring and testing machines and instruments for detecting information about the performance of automobiles; measuring and testing machines and instruments; electronic locks; electronic control devices for automobiles; computer programs [recorded or downloadable]; electronic machines, apparatus and their parts, namely barcode readers, smart cards, encoded magnetic cards, interfaces for computers, integrated circuit cards [smart cards], printed circuits and readers [data processing equipment]; navigation apparatus for automobiles; automatic control and remote monitoring apparatus for gas engine heat pumps; telecommunications devices, apparatus and instruments; solar cells; solar panels for the production of electricity; solar panels (solar battery panels); solar battery power generation devices; fuel cells; fuel-cell power generation devices; automotive batteries and battery chargers; electric controlling and regulating machines and apparatus for automobiles; batteries and cells; power distribution and control machines and apparatus; rotary converters; phase modifiers; intruder detecting apparatus for security systems; fire alarms; gas alarms; anti-theft warning apparatus; electronic publications; personal digital assistants; smart phones; navigation apparatus for vehicles [on-board computers]; Global Positioning System [GPS] navigation devices; remote control apparatus; computer software; application software; smart cards [integrated circuit cards]; electronic control apparatus for automobiles and parts thereof; game programs for arcade video game machines; simulators for the steering and control of vehicles; laboratory apparatus and instruments; photographic machines and apparatus; cinematographic machines and apparatus; optical machines and apparatus; electric or magnetic meters and testers; el-

ectric wires and cables; dust masks; gas masks; welding masks; game programs for home video game machines; electronic circuits and CD-ROMs recorded with programs for hand-held games with liquid crystal displays; protective helmets for sports; sports whistles; metronomes; electronic circuits and CD-ROMs recorded with automatic performance programs for electronic musical instruments; electric and electronic effects units for musical instruments; phonographic records; downloadable music files; downloadable image files; recorded video discs and video tapes; exposed cinematographic films; exposed slide films; slide film mounts; power supply control panels and power regulating panels for use in power generating devices for cogeneration systems; power supply control devices and power regulating devices for power generators.

11 – Bathing apparatus for nursing care, not for medical purposes; bath fittings; toilet stool units with a washing water squirter; disinfectant dispensers for toilets; toilet bowls; seating for use with Japanese style toilet bowls; air-conditioning apparatus by gas engine heat pumps for industrial purposes; air conditioners by gas engine heat pumps for industrial purposes; heat pumps; air conditioning apparatus and fittings therefor [for industrial purposes]; space heating and cooling apparatus and fittings therefor [for industrial purposes]; air-conditioning apparatus by gas engine heat pumps for household purposes; air conditioners by gas engine heat pumps for household purposes; air conditioning apparatus and fittings therefor [for household purposes]; household electrothermic appliances; air conditioners with hot water supply by means of cogeneration functions; hot water storage type hot water supplying apparatus using heat from gas engines [for industrial purposes]; gas hot water suppliers for industrial purposes; gas engine heat pumps and their parts; boilers, not for parts for non-electric prime movers, and not for engines; hot water storage type hot water supplying apparatus using heat from gas engines [for household purposes]; gas hot water suppliers for household purposes; gas water heaters for household purposes; hot-air space heating apparatus [for household purposes]; stoves for household purposes [non-electric]; toilet bowls and seats sold as a unit; prefabricated bathrooms sold as a unit; prefabricated shower baths sold as a unit; facial moisturizing equipment using ultrasonic waves for household purposes; nanoparticle water facial spray machines, namely, steam facial apparatus, electronic facial steamers and facial saunas, having fine water particle generating and infiltrating functions for home treatment; household electrothermic appliances for beauty or sanitary purposes; electric refrigerators for household purposes; electric freezers for household purposes; electric cooking ovens for household purposes; air purifiers; facial moisturizing equipment using ultrasonic waves for industrial purposes; nanoparticle water facial spray machines, namely, steam facial apparatus,

electronic facial steamers and facial saunas, having fine water particle generating and infiltrating functions for commercial use; towel steamers for hairdressing purposes; hair drying machines for beauty salon use; hair steamers for beauty salon use; shampoo basins for barber's shop use; hair dryers; hand dryers; steam generating apparatus; fine water particle generating and infiltrating device; sauna apparatus as a unit; sanitary devices; evaporators for chemical processing; distillers for chemical processing; drying apparatus for chemical processing; recuperators for chemical processing; steamers for chemical processing; air conditioners for household purposes; vehicle-mounted air conditioners with installed fine water particle generating and infiltrating devices; air conditioners for automobiles; air conditioners for industrial purposes; ventilation installations; hot water heating installations; freezing machines and apparatus for industrial purposes; laundry dryers, electric, for industrial purposes; cooking apparatus and installations for commercial use; dish drying machines for commercial use; dish disinfectant apparatus for commercial use; kitchen sinks for use with kitchen worktops for commercial use; kitchen sinks for commercial use; cooking apparatus; solar water heaters; water purifying apparatus for industrial purposes; lighting apparatus and installations; non-electric cooking heaters for household purposes; kitchen sinks for use with kitchen worktops for household purposes; kitchen sinks for household purposes; household tap-water filters, non-electric; sauna apparatus; feed water heaters with cogeneration function [for non-electric prime movers and engines]; feed water heaters [for non-electric prime movers and engines]; steam facial treatment machines and/or devices for household purposes; electric steam facial treatment machines and/or devices for industrial purposes.

12 – Non-electric prime movers for land vehicles [other than parts]; automobile engines; vehicles for the physically handicapped and those of reduced mobility; automobiles and their parts and fittings; two-wheeled motor vehicles, bicycles and their parts and fittings; self-propelled electric vehicles; electrically operated personal mobility scooters and automobiles; electric vehicles; wheelchairs for nursing care; electric wheelchairs; wheelchairs and their parts and fittings; rickshaws; sleighs and sleds [vehicles]; hand trucks; horse drawn carriages; carts; bicycle trailers; machine elements for land vehicles; anti-theft alarms for vehicles; anti-theft devices for automobiles; AC motors or DC motors for land vehicles [other than parts]; adhesives rubber patches for repairing tubes or tires; baby carriages [prams]; traction engine; ropeways for cargo or freight handling; parachutes; vessels and their parts and fittings; aircraft and their parts and fittings; railway rolling stock and their parts and fittings; three-wheeled motor vehicle, electric tricycles and their parts and fittings; electric tricycles; shafts, axles and spindles for land vehicles; shafts, axles or spindles for

land vehicles; shaft couplings and connectors for land vehicles; power transmissions and gearing; power transmissions and gearing for land vehicles; idling pulleys; idling pulleys for land vehicles; reduction gears; reduction gears for land vehicles; power transmission belts; power transmission belts for land vehicles; toothed wheels and gears; toothed wheels and gears for land vehicles; speed change gears; speed change gears for land vehicles; fluid couplings; fluid couplings for land vehicles; hydraulic torque converter; hydraulic torque converters for land vehicles; transmissions for land vehicles; transmissions for hybrid cars; drive units for hybrid cars; drive units for electric vehicles.

20 – Furniture; electronic equipment racks; personal computer racks; audio racks; audio equipment racks; storage racks; racks [furniture].

(260) AM 2022 113576 A

(800) 1549986

(151) 2020 07 24

(891) 2021 04 09

(731) Gorilla Drinks Limited

Amathountos, 50E, PEARL BUILDING,
3rd floor, Flat/Office 1, Agios Tychonas,
CY-4532 Limassol, Cyprus

(540)

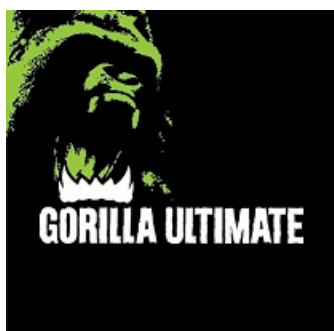

(591) Green white black

(531) 03.05.19; 03.05.20; 27.05.24; 29.01.13

(511)

32 – Isotonic beverages; non-alcoholic beverages; mineral and aerated waters; beverages based on fruit and fruit juices; syrups and other preparations without alcohol for making beverages; waters [beverages]; mineral waters [beverages]; table waters; non-alcoholic cocktails; non-alcoholic honey-based beverages; protein-enriched sports beverages; soft drinks; non-alcoholic fruit juice beverages; energy drinks; fruit nectars; orgeat; powders for effervescing beverages; sarsaparilla [non-alcoholic beverage]; syrups for making lemonades; syrups for beverages; smoothies; tomato juices [beverages]; apple juices; vegetable juices [beverages]; fruit juices; non-alcoholic preparations for making beverages; preparations for making aerated water; pastilles for effervescing beverages; sherbets [beverages]; non-alcoholic fruit extracts.

(260) AM 2022 113578 A

(800) 1574969

(151) 2020 10 29

(891) 2021 06 02

(731) HALO EMBROIDERY MACHINE

(TAIZHOU) CO., LTD.

4-1922-B (office only) (self-declaration),

Wanda Plaza, Development Zone, Taizhou,
Zhejiang, China

(540)

Halò 光环

(591) Black, white

(531) 27.03.01; 27.05.08; 28.03

(511)

7 – Sewing machines; pedal drives for sewing machines; stitching machines; ironing machines.

(260) AM 2022 113625 A

(800) 1597538

(151) 2021 03 23

(891) 2021 03 23

(731) GRIBA VIVAI COOP. SOC. AGRICOLA

Via Niederthorstr. 9, I-39018 Terlan (Terlano),
Italy

(540)

DarkBaron

(591) Black, white

(531) 05.03.13; 05.03.14; 05.07.27; 27.05.01;
27.05.07

(511)

31 – Natural plants; apple trees.

(260) AM 2022 113627 A

(800) 1597586

(151) 2021 04 20

(891) 2021 04 20

(731) PACIFIC PHARMACEUTICALS PTE LTD

101 CECIL STREET, #17-07 TONG ENG
BUILDING, Singapore 069533, Singapore

(540)



(591) Blue, red, and white

(531) 01.01.01; 01.15.15; 24.07.23; 26.11.25;
29.01.13

(511)

5 – Mineral dietary supplements for humans; pharmaceutical drugs.

(260) AM 2022 113633 A

(800) 1597859

(151) 2021 05 25

(891) 2021 05 25

(731) AIRSCREAM UK LIMITED

Ashville Park, Short Way, Bristol BS35 3UU,
United Kingdom;

AIRSCREAM AUSTRALIA PTY LTD

10 Feather Pl, Point Cook VIC 3030, Australia

(540)

AIRSCREAM

(591) Black, white

(511)

34 – Electronic cigarette liquid [e-liquid]; electronic cigarettes; electronic cigarettes, not for medical purposes; flavorings, other than essential oils, for use in electronic cigarettes; flavourings, other than essential oils, for use in electronic cigarettes; liquid solutions for use in electronic cigarettes.

(260) AM 2022 113639 A

(800) 1598145

(151) 2021 04 21

(891) 2021 04 21

(731) HONGBAOLI GROUP CO., LTD.

No. 29 Shuanggao Road, Gaochun District,
Nanjing City, 210000 Jiangsu Province, China

(540)



(591) Black, white

(531) 02.09.01; 05.05.20; 27.05.01; 28.03

(511)

1 – Isopropanol; tensio-active agents; chemical preparations for painting; auxiliary fluids for use with abrasives; getters [chemically active substances]; cement for shoes; glue for industrial purposes; polyurethane; plastisols.

(260) AM 2022 113652 A

(800) 1598407

(151) 2021 03 31

(891) 2021 03 31

(731) Unitron Prom Ltd

Gornaya str., 3A, RU-440000 Penza,
Russian Federation

(540)

È opex Your nut

(591) Black, white

(531) 28.05

(511)

29 – Nuts, prepared.

(260) AM 2022 113664 A

(800) 1598724

(151) 2021 04 23

(891) 2021 04 23

(731) SERBIA BROADBAND – SRPSKE

KABLOVSKE MREŽE d.o.o.

Bulevar Peka Dapčevića 19, 11000 Beograd,
Serbia

(540)

EON

(591) Black, white

(511)

9 – Scientific, research, photographic, cinematographic, audiovisual, optical and teaching apparatus and instruments, all for the needs of telecommunication services and audiovisual production; apparatus and instruments for recording, transmitting, reproducing or processing sound, images or data; downloadable or recorded media, software, blank digital or analog recording and storage media; computers and computer peripherals.

41 – Education; training; entertainment; sporting and cultural activities.

(260) AM 2022 113681 A

(800) 1554438

(151) 2020 08 11

(891) 2021 04 26

(731) SHOKZ HOLDING LIMITED

RM 2603A 26/F TOWER 1 LIPPO CTR,

89 QUEENSWAY ADMIRALTY, Hong Kong,
China

(540)

openswim

(591) Black, white

(511)

9 – Batteries; battery chargers; chargers for batteries; earphones; electronic memories; headphones; horns for loudspeakers; lithium ion batteries; megaphones; memory modules; microphones; smart glasses; spectacles; virtual reality headsets; wireless speakers; MP3 players.

(260) AM 2022 113720 A
 (800) 1599328
 (151) 2021 05 17
 (891) 2021 05 17
 (731) Yiwu Wiseup Hardware Tools Co., Ltd.
 Room 505, Unit 2, No.1 Wuai Road,
 Jiangdong Street, Yiwu City, Zhejiang
 Province, China

(540)

WISEUP

(591) Black, white

(511)

7 – Pumps [machines]; valves [parts of machines]; agricultural machines; hair clipping machines for animals; woodworking machines; kitchen machines, electric; cutters [machines]; jacks [machines]; metal-working machines; igniting devices for internal combustion engines; painting machines; dynamo brushes; welding machines, electric; machines and apparatus for cleaning, electric; hand-held tools, other than hand-operated.

8 – Hand tools, hand-operated; agricultural implements, hand-operated; garden tools, hand-operated; instruments and tools for skinning animals; wrenches [hand tools]; graving tools [hand tools]; scissors; daggers; table cutlery [knives, forks and spoons]; handles for hand-operated hand tools.

9 – Eyeglasses; navigational instruments; switches, electric; weighing machines; measures; signal lanterns; fire extinguishers; USB cables; battery chargers; protection devices for personal use against accidents.

(260) AM 2022 113722 A
 (800) 1599359
 (151) 2021 03 11
 (891) 2021 03 11
 (731) ZHEJIANG TOPYAULD TECHNOLOGY
 CO., LTD.
 East Area Auto Parts & Motorcycle Parts
 Industrial Park, Ruian, Zhejiang, China

(540)

Highfil

(591) Black, white

(531) 27.05.01; 27.05.17

(511)

7 – Air filters for vehicle motors and engines; filters being parts of machines or engines; oil filters for vehicle motors and engines; petrol filters for vehicle motors and engines; nitrogen oxide traps for exhaust systems being parts of internal combustion engines; steam/oil separators; hydraulic oil filter; universal joints

for machines; shock absorbers for machines; connecting rods for machines, motors and engines.

11 – Lighting apparatus for vehicles; refrigerating apparatus and machines; filters for air conditioning; air driers; air-conditioning installations for vehicles; automobile engine preheater; taps; bath fittings; air filtering installations.

(260) AM 2022 113723 A

(800) 1599361

(151) 2021 04 30

(891) 2021 04 30

(731) Cubic Defense Applications, Inc.
 9233 Balboa Avenue, San Diego CA 92123,
 USA

(540)

HALO

(591) Black, white

(511)

9 – Digital beam-forming antennas.

(260) AM 2022 113726 A

(800) 1599484

(151) 2021 03 26

(891) 2021 03 26

(731) Carl-Orff-Stiftung
 Ziegelstadel 1, 86911 Dießen am Ammersee,
 Germany

(540)

Orff-Schulwerk

(591) Black, white

(511)

9 – Apparatus for recording, transmission or reproduction of sound or images; scientific apparatus and instruments, teaching apparatus and instruments; image and sound carriers of all kinds, in particular compact discs, records, magnetic recording media, video cassettes, video tapes, digital recording media; metronomes.

16 – Paper and cardboard; stationery; printed matter; books; music books; music sheet; office requisites (except furniture); instructional and teaching material (except apparatus); decorative objects made of paper; artists' and drawing materials; bags [envelopes, pouches] of paper, cardboard or plastics, for packaging and wrapping; stuffing of paper or cardboard; parts and accessories for all the aforesaid goods, included in this class.

41 – Education; training, also in the form of distance learning; entertainment; cultural activities; providing music schools; providing music academies; education at music schools and music academies; publication of books, publication of music collections, publication of books, publication of music collections, publication of

texts [other than publicity texts]; organization of exhibitions for cultural purposes, in particular for musical purposes; arranging and conducting training workshops; providing boarding schools services; composing music; conducting live events, in particular music festivals, musical performances; organizing and arranging conferences, congresses and symposiums; production of shows; theatrical performances; providing recording studio services; performing sound recordings; museum services.

(260) AM 2022 113745 A

(800) 1600238

(151) 2021 04 28

(891) 2021 04 28

(731) Publichne aktsionerne tovarystvo, "Zakrytyi nedyversyfikovanyi venchurnyi, korporatyvnyi investutsiynyi fond, "HOLDYNH INVEST" Office V704, building 1V, Pavla Tychyny Avenue, Kyiv City 02152, Ukraine

(540)



(591) Black, white

(531) 24.17.01; 25.01.09; 25.03.05; 27.05.01; 27.05.24; 27.07.01; 27.07.24

(511)

29 – Meat, fish, poultry and game; meat extracts; preserved, frozen, dried and cooked fruits and vegetables; jellies, jams, compotes; eggs; milk, cheese, butter, yogurt and other milk products; oils and fats for food; peanuts, prepared; peanut butter; artichokes, preserved; canned vegetables; peeled plum tomatoes, canned; processed eggplants; canned preserved vegetables; eggplants, processed; Greek yoghurt; fruit and vegetable salads; beans, preserved; processed beets; antipasto salads; compotes; potato-based dumplings; cabbage rolls stuffed with meat; flavored nuts; nuts, prepared; peas, preserved; canned peas; mushrooms, preserved; prepared mushrooms; dried edible mushrooms; dried mushrooms; guacamole; potato fritters; jams; jellies for food; cranberries, frozen; cranberry compote; vegetable-based snacks; spicy pickles; meat-based, fish-based, fruit-based or vegetable-based food; prepared legumes; candied nuts; eggplant paste; caviar; vegetable marrow paste; eggplant caviar; bottled vegetables; peppers, prepared; ginger, preserved; crystallized ginger; pickled ginger; ginger jam; canned spinach; edible marine oils for culinary purposes; sauerkraut; stews; pickled gherkin cucumbers; cranberries, dried; canned carrots; cabbage, processed; pota-

toes, preserved; potato flakes; potato chips; baked beans in tomato sauce; beans, canned; canned sliced vegetables; canned beans; edible flowers, dried; onion rings; kimchi; processed fruits and vegetables; fruit compotes; gherkins; vegetable-based concentrate for cooking; fruit-based concentrate for cooking; salted eggs; vegetable-based cream; sweet corn, processed; canned corn; corn oil for food; sesame oil for food; almonds, ground; processed carrots; celery cabbages, frozen; processed sesame seeds; precut vegetables for salads; meat salads; precut vegetable salads; vegetable mousses; vegetable-based spreads; seeds, prepared; sunflower seeds, prepared; vegetables, tinned; vegetable puree; vegetable salads; vegetable-based snack foods; vegetable juices for cooking; canned soups; vegetables, preserved; pickled vegetables; vegetables, processed; vegetables, cooked; vegetables, dried; sea cucumbers, not live; pickled cucumbers; processed tomatoes; hash browns; olives, preserved; olive oil for food; extra virgin olive oil for food; linseed oil for food; sun-dried and salted meats; choucroute garnie [sauerkraut cooked and served with meat]; preserved peppers; pickled peppers; peppers, processed; pollen prepared as foodstuff; pickles; canned olives; marmalade; tinned tomatoes; vegetable soup preparations; stewed fruit; ratatouille; colza oil for food; raisins; satay; grilled meat marinated in soy sauce; soya bean oil for food; soya beans, preserved, for food; sunflower oil for food; lentils, preserved; nut-based spreads; freeze-dried vegetables; preparations for making soup; soups; dried berries; canned tomatoes; peeled tomatoes; preserved cherry tomatoes; pickled fruit and vegetables; cherry tomatoes, preserved; tomato concentrate; tomato paste; tomato purée; tomato juice for cooking; falafel; fruit, preserved; fruit, processed; fruit, stewed; fruit preserved in alcohol; crystallized fruits; fruit peel; pressed fruit paste; fruit pulp; fruit jellies; fruits, tinned; fruit salads; hazelnuts, prepared; oils for food; hummus; onions, preserved; frozen berries; preserved garlic; low-fat potato chips; fruit chips; choucroute garnie; apples, processed; apple purée; berries, preserved.

(260) AM 2022 113746 A

(800) 1600252

(151) 2021 04 26

(891) 2021 04 26

(731) BAUSCH + LOMB IRELAND LIMITED
3013 Lake Drive, Citywest Business Campus,
Dublin 24, Ireland

(540)

OCUCOAT

(591) Black, white

(511)

5 – Ophthalmic preparations and substances; viscoelastic eye lubricants.

(260) AM 2022 113747 A

(800) 1600305

(151) 2021 04 23

(891) 2021 04 23

(731) Cureline, Inc.

150 N. Hill Dr., Suite 24, Brisbane CA 94005,
USA

(540)



(591) Black, white

(531) 26.11.12; 27.05.10

(526) PRECISION BIOPATHOLOGY

(511)

1 – Human biospecimens of tissues, cells and biofluids for use in scientific and medical research.

42 – Biomedical research services, namely, biomarker discovery and validation, molecular analytes isolation (RNA/DNA/Proteins) and analyses, cross-reactivity Ab screening, development of protocols for analyzing biospecimens.

44 – Human biospecimen bank services; medical services, namely, processing, staining and histology analysis of human and animal biospecimens for diagnostic and treatment purposes.

(260) AM 2022 113749 A

(800) 1600368

(151) 2020 12 17

(891) 2020 12 17

(731) Toptikov Kostyantyn Valentynovych

vul. Vronskogo 57, Odesa 65074, Ukraine

(540)



(591) Black, white

(531) 01.15.17; 05.03.13; 05.03.14; 24.17.25;
27.05.09

(511)

37 – Building of fair stalls and shops; rebuilding engines that have been worn or partially destroyed; rebuilding machines that have been worn or partially destroyed; elevator installation and repair, electric appliance installation and repair; installation and repair of air-conditioning apparatus; freezing equipment installation and repair; kitchen equipment installation; installation, maintenance and repair of computer hardware; machinery installation, maintenance and repair; office machines and equipment installation, maintenance and repair; providing information relating to repairs; providing construction information; construction consultancy; services of electricians; construction servi-

ces; artificial snow-making services; installation and repair services; rental of construction equipment; rust-proofing; pump repair; factory construction; warehouse construction and repair; pipeline construction and maintenance; harbour construction; construction; furniture maintenance; plumbing.

42 – Construction drafting; interior design; technological research; research and development of new products for others; mechanical research; research in the field of building construction; energy auditing; engineering; information technology services provided on an outsourcing basis; consultancy in the field of energy-saving; quality control; scientific and technological services and research and design relating thereto; surveying; industrial analysis, industrial research and industrial design services; conducting technical project studies; design of interior decor; design and development of computer hardware and software; freezing equipment design; industrial design; technical writing; technological consultancy.

(260) AM 2022 113750 A

(800) 1600371

(151) 2021 06 07

(891) 2021 06 07

(731) Genki Forest(Beijing) Food Technology Group Co., LTD

Room 501, 5th Floor, Building No.6, East 3rd
Ring North Road, Chaoyang Dist., 100020
Beijing, China

(540)

GENKI FOREST

(591) Black, white

(531) 27.05.01

(511)

29 – Bouillon; fish-based foodstuffs; seaweed extracts for food; vegetable-based snack foods; fruit-based snack food; betel nuts, processed; sliced fruits, canned; vegetables, preserved; eggs; yogurt; milk beverages, milk predominating; milk tea, milk predominating; oils for food; fruit jellies; sausage casings, natural or artificial; tofu-based snacks; nuts, prepared.

30 – Sugar; honey; oatmeal; cereal-based snack food; chamomile-based beverages; rice-based snack food; instant noodles; instant rice; chips [cereal products]; ice cream; condiments; coffee; coffee-based beverages; tea; tea-based beverages; shrimp chips.

32 – Beer; mineral water [beverages]; non-alcoholic fruit juice beverages; non-alcoholic beverages flavoured with tea; soft drinks; non-alcoholic preparations for making beverages; sparkling water; soda water; smoked plum juice beverages; soya-based beverages; sports drinks; energy drinks; grape juice; sports drinks containing electrolytes; mixed fruit juice.

(260) AM 2022 113751 A
 (800) 896258
 (151) 2005 11 18
 (891) 2021 05 18
 (731) MediaRange GmbH
 Zum Quellenpark 29, 65812 Bad Soden,
 Germany

(540)



(591) Grey-blue, blue
 (531) 26.11.13; 27.05.01; 29.01.04
 (511)

9 – Data carriers, particularly recorded and unrecorded sound and image carriers, as well as online and offline data carriers of any format, particularly video compact discs, optical video discs, CDs (CD-R, CD-ROM and CD-RW), DVDs; memory for data processing equipment in the form of network databases; magnetic data carriers (particularly cassettes, videos); ink cartridges (unfilled); toner cartridges (unfilled); refillable cartridges (unfilled); toner cartridges (unfilled) for laser printers; printer refill cartridges (unfilled); printer cartridges (unfilled); printer toner cartridges (unfilled); parts and components of all aforementioned goods (included in this class).

16 – Paper, cardboard and goods made of these materials, included in this class; printed matter; bookbinding material; photographs; stationery; paint brushes; typewriters and office requisites (except furniture); packaging material; transparencies (stationery); ink (included in this class); ink refill bottles (included in this class); paper; penholders and pencils; printed transparencies; parts and components of all aforementioned goods (included in this class); plastic films for CDs or DVDs for the purpose of packaging.

17 – Plastics in extruded form for use in manufacture, included in this class, particularly protective films of plastic for CDs and DVDs (except for the purpose of packaging).

38 – Telecommunications; telecommunication services; videotext and teletext transmission; electronic data transfer; services connected with the transmission and imaging of data via computers or via electronic telecommunications media; interactive telecommunications; e-mail services.

41 – Entertainment, particularly the publication of books and other printed material in the form of recorded image and data carriers of any format, on which any kind of information is stored, particularly of recorded video compact discs, optical video discs, CDs, DVDs, magnetic data carriers (particularly cassettes, videos), video tapes, publication of books and other printed material in electronic form; publication of brochures and newspapers as well as other printed mate-

rial (particularly magazines, books, posters and placards).

(260) AM 2022 113752 A
 (800) 937047
 (151) 2007 05 14
 (891) 2021 06 04
 (731) MarkIT Holding AS
 Jalgpalli tn 1, Tallinn, EE-11312, Estonia

(540)

markit

(591) Black, white
 (511)

35 – Retail and wholesale services, including retail and wholesale services of information technology software and hardware, Internet (online) trade, data search in computer files (for others), computerized file management, systemization of information into computer databases, on-line advertising on a computer network, procurement services for others (purchasing goods and services for other business), compilation of information into computer databases, demonstration of goods, professional business consultancy, office machine and equipment rental, sales promotion for others; publication of publicity texts, advertising, direct mail advertising, modelling for advertising or sales promotion, public relations, dissemination of advertising matter.

(260) AM 2022 113753 A
 (800) 970092
 (151) 2007 12 17
 (891) 2021 04 16
 (731) Limited Liability Company "Scientific and production enterprise, Rogneda"
 Dorozhnaya str., 4B, Staraya Kupavna, the city of Noginsk, RU-142450 Moscow region, Russian Federation

(540)



(591) White, light yellow, yellow, dark yellow, orange, red, dark red, light blue, blue, dark blue, pink, light green, green, dark green, cyan, lilac and light brown

(531) 05.03.15; 27.05.08; 29.01.15

(511)

1 – Additives, chemical, to fungicides; adhesive preparations for surgical bandages; adhesives for billposting; adhesives for paperhanging; adhesives for rubber; birdlime; caustics for industrial purposes; casein for industrial purposes; cement for mending broken articles; cement for pneumatic tires; cement for boots and shoes; copper sulphate (vitriol); chemicals used in industry, science and photography, as well as in agriculture, horticulture and forestry; chemical preparations for the manufacture of paints; chemical substances for preserving foodstuffs; concrete-aeration chemicals; color-brightening chemicals for industrial purposes; enamel and glass-staining chemicals; damp proofing preparations, except paints, for masonry; ferments for chemical purposes; fire extinguishing compositions; fireproofing preparations; fertilizing preparations; glass-frosting chemicals; glutinous tree-banding preparations; getters (chemically active substances); grafting wax for trees; gluten (glue), other than for stationery or household purposes; glue for industrial purposes; gums (adhesives), other than for stationery or household purposes; isinglass other than for stationery, household or alimentary purposes; leather glues; moistening (wetting) preparations for use in dyeing; preparations for preventing the tarnishing of glass; limestone hardening substances; synthetic materials for absorbing oil; solvents for gums (adhesives) and resins; tanning substances; tree cavity fillers (forestry); tempering and soldering preparations; unprocessed artificial resins, unprocessed plastics; welding chemicals; glaziers' putty; oil cement (putty); wallpaper removing preparations.

2 – Anti-corrosive bands; anti-rust oils; anti-rust greases; anti-rust preparations for preservation; anti-corrosive preparations; anti-tarnishing preparations for metals; black japan; badigeon; Canada balsam; carbonyl (wood preservative); coatings for roofing felt (paints) and wood (paints); cobalt oxide (colorant); dyestuffs; enamels (varnishes); enamels for painting; fixatives (varnishes); glazes (paints, lacquers); gildings; indigo (colorant); ink for leather; lacquers including bitumen varnish, bronzing lacquers; mastic (natural resin); marking ink for animals; malt (colorant); metals in powder form for painters, decorators, printers and artists; mordants including mordants for leather and wood; oils for the preservation of wood; paper for dyeing Easter eggs; paints including asbestos paints, bactericidal paints, ceramic paints, fireproof paints; preservatives against deterioration of wood; primers; protective preparations for metals; siccatives (drying agents) for paints; silvering powders; silver emulsions (pigments); shoe dyes; titanium dioxide (pigment); thickeners for paints; thinners for lacquers and paints; undercoating for vehicle chassis; varnishes; white lead; whites (colorants or paints); white-wash; titanium white (pigment); zinc white; wood stains.

(260) AM 2022 113754 A

(800) 1062068

(151) 2010 07 15

(891) 2021 04 08

(731) BETA GIDA SANAYİ VE TİCARET ANONİM ŞİRKETİ

Hacı Sabancı Organize Sanayi Bölgesi, Osb

Fuzuli Cd.no:1 Sarıçam, ADANA, Turkey

(540)

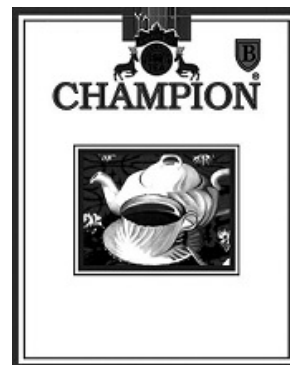

(591) Black, white

(531) 03.04.07; 03.04.13; 11.03.04; 11.03.14; 24.01.05; 24.01.15

(511)

29 – Milk and milk products; nut-based milk, chocolate milk, milk curd, cream cheese, white cheese, all kinds of cheese, yogurt, yogurt drink, clotted cream, whipped cream, milk powder, kefir (milk beverage), milk beverages with high milk content, milk with fruits, yogurt with fruits, koumiss (fermented mare's milk), dairy desserts.

30 – Coffee, cocoa, artificial coffee, mocha, coffee substitutes, coffee or cocoa-based beverages; tea, iced tea.

(260) AM 2022 113795 A

(800) 1600404

(151) 2021 05 03

(891) 2021 05 03

(731) Cubic Defense Applications, Inc.

9233 Balboa Avenue, San Diego CA 92123, USA

(540)



(591) Black, white

(531) 26.01.25; 27.05.01

(511)

9 – Digital beam-forming antennas.

(260) AM 2022 113804 A

(800) 1600637

(151) 2021 04 26

(891) 2021 04 26

(731) TH S.R.L.
Via Cella Raibano 14, I-47843 MISANO
ADRIATICO, Italy

(540)



(591) Black, white
(531) 25.03.03; 27.05.01
(511)

12 – Electric unicycles; electric one wheel scooters; electrically operated scooters; electric motor cycles; electric bicycles; cycle cars; mopeds; motorcycles; motor scooters; go-carts; side cars; quad bikes; bicycles; fittings for bicycles for carrying luggage; bicycle handlebars; bicycle frames; bicycle saddles; motorcycle saddles; panniers adapted for motorcycles; rack trunk bags for bicycles.

(260) AM 2022 113805 A
(800) 1600638
(151) 2021 04 20
(891) 2021 04 20
(731) G. Schneider & Sohn GmbH
Tal 7, 80331 München, Germany
(540)



(591) Black, white
(531) 05.07.02; 26.01.04; 26.01.16; 26.01.18;
26.01.21; 26.01.24; 26.04.03; 27.05.01;
27.05.09; 27.05.10; 27.05.24

(511)
32 – Beers; non-alcoholic beverages; mineral and aerated waters; fruit beverages and fruit juices; syrups and other non-alcoholic preparations for making beverages.

(260) AM 2022 113806 A
(800) 1600699
(151) 2021 04 26
(891) 2021 04 26

(731) BAUSCH + LOMB IRELAND LIMITED
3013 Lake Drive, Citywest Business Campus,
Dublin 24, Ireland

(540)

STELLARIS

(591) Black, white
(511)
10 – Surgical, medical, dental and veterinary apparatus and instruments, artificial limbs, eyes and teeth; orthopedic articles; suture materials; medical and surgical apparatus, equipment and instruments.

(260) AM 2022 113807 A
(800) 1600791
(151) 2021 04 23
(891) 2021 04 23
(731) Cureline, Inc.
150 N. Hill Dr., Suite 24, Brisbane CA
94005, USA
(540)



(591) Black, white
(531) 26.11.03; 26.11.12; 27.05.01; 27.05.10
(526) MOLECULAR SERVICES
(511)

1 – Human biospecimens of tissues, cells and biofluids; and biological substances isolated from biospecimens for use in scientific and medical research.

42 – Biomedical research services, namely, tissue processing, DNA, RNA, protein isolation from biospecimens, molecular and cell biology analyses, biomarker discovery and validation, isolation and separation of cells from biospecimens, antibody characterization and human sample validation studies.

44 – Human biospecimen bank services; medical services, namely, molecular and cell biology analyses of biospecimens for diagnostic and treatment purposes.

(260) AM 2022 113808 A
(800) 1600807
(151) 2021 04 14
(891) 2021 04 14
(731) ROYAL ARMENIA JV LTD
Davtashen 2nd Block 268, 0054 Yerevan,
Armenia

(540)



(591) Red, light red, dark red, black, cream, gray and light pink

(531) 01.15.05; 03.07.05; 05.01.04; 26.01.18; 27.05.01; 29.01.15

(526) 3 IN 1, ARMENIA, CLASSIC

(511)

30 – Coffee; instant coffee.

(260) AM 2022 113809 A

(800) 1600820

(151) 2021 02 23

(891) 2021 02 23

(731) Perkins Holdings Limited

Eastfield; Peterborough PE1 5FQ, United Kingdom

(540)

(591) Blue and white

(531) 26.07.05; 27.05.24; 29.01.12

(511)

7 – Machines, namely machines for use in agriculture, compaction, construction, defence, demolition, earth

conditioning, earth contouring, earth moving, forestry, landscaping, lawn care, lifting, marine propulsion, material handling, mining, mulching, oil and gas distribution, oil and gas exploration, oil and gas production, paving, pipelaying, power generation, road building and repair, sweeping, site preparation and remediation, tunnel boring, vegetation and waste management; machine tools, power operated tools; motors and engines, except for land vehicles; machine coupling and transmission components, except for land vehicles; agricultural implements, other than hand-operated hand tools; incubators for eggs; automatic vending machines; diesel engines; gas engines; electrical engines, other than for land vehicles; internal combustion engines; marine engines; generators of electricity; current generators; alternators; starting devices for engines and motors; exhausts for motors and engines; power transmissions [except for land vehicles]; compressors [superchargers]; ignition devices, fueling injection devices and hydraulic and pneumatic controls for internal combustion engines; lubricating apparatus; radiators [cooling] for engines and motors; filters [parts of machines or engines]; filters for cleaning cooling air, for engines; bearings [parts of machines]; cylinders for motors and engines; cylinder heads for engines; camshafts for vehicle engines; connecting rods for machines, motors and engines; crank shafts; gaskets for internal combustion engines; sealing joints [parts of engines]; gears, other than for land vehicles; gears for machines; automotive engine blocks; exhaust manifold for engines; pistons [parts of machines or engines]; pistons for engines; piston rings; rocker arms for engines; pumps [parts of machines, engines or motors]; timing belt pulleys [parts of engines]; valves [parts of machines]; injectors for engines; control mechanisms for machines, engines or motors; crankcases for machines, motors and engines; fuel economisers for motors and engines; igniting devices for internal combustion engines; silencers for motors and engines; petrol pumps; welding apparatus; control mechanisms for engines; parts and fittings for all the aforesaid goods.

12 – Vehicles; apparatus for locomotion by land, air or water; parts for vehicles; utility vehicles; boats; tractors; engines and motors for land vehicles; power transmissions for land vehicles; transmissions for land vehicles; gear boxes for land vehicles; gears for land vehicles; propulsion mechanisms for land vehicles; axles for land vehicles; brakes for land vehicles; cardan shafts for vehicles; clutches for land vehicles; couplings for land vehicles; drive shafts for land vehicles; shaft couplings for land vehicles; steering units for land vehicles; suspension systems for land vehicles; universal joints for land vehicles; parts and fittings for all the aforesaid goods.

37 – Building construction; repair services relating to vehicles, equipment, machines, engines and motors, generators, machine tools, and parts therefor; installa-

tion services relating to vehicles, equipment, machines, engines and motors, generators, machine tools, and parts therefor; rental of equipment, machines, and machine tools for use in compaction, construction, demolition, earth conditioning, earth contouring, earth moving, lifting, marine propulsion, mining extraction, oil well drilling, oil and gas exploration, oil and gas drilling, paving, pipelaying, road building and repair, sweeping, site preparation and remediation, tunnel boring, waste disposal; repair, installation, maintenance, reconditioning and servicing of vehicles, equipment, machines, engines, motors and generators; repair, installation, maintenance and servicing of parts, fittings or components for vehicles, equipment, machines, engines, motors and generators; rental, maintenance and repair of construction machinery and engines therefor; maintenance and repair of agricultural machinery and engines therefore; reconditioning of industrial machinery and engines; machinery retrofit and conversion services; overhaul of engines; tuning of engines; re-manufacturing of engines; rebuilding engines; maintenance, servicing, tuning and repair of motors; advisory services relating to the installation of engines; rental of equipment, machines, and machine tools for use in oil and gas drilling.

40 – Energy production; generation of power; consultancy services relating to the generation of electrical power; rental of equipment for the treatment and transformation of materials, for energy production and for custom manufacturing; rental of power-generating equipment; rental of generators; rental store services in relation to generators, material handling machines and equipment and parts, fittings and components for the aforesaid; rental of equipment for material treatment, power generation, waste management.

(260) AM 2022 113810 A

(800) 1600840

(151) 2020 12 03

(891) 2020 12 03

(731) Apple Inc.

One Apple Park Way, Cupertino CA
95014, USA

(540)

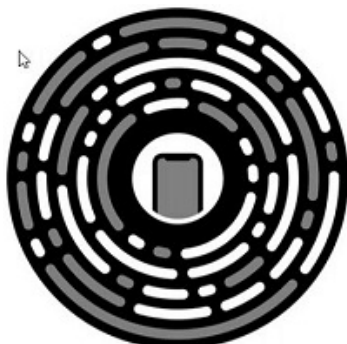

(591) Black, white and gray

(531) 16.01.11; 26.01.05; 26.01.12; 26.01.16;
26.01.24; 26.11.12

(511)

9 – Downloadable and recorded computer software; downloadable and recorded computer software for processing, facilitating, verifying, and authenticating mobile payments and contactless transactions with retailers, merchants, and vendors via wearable and mobile devices; downloadable and recorded computer software for use in searching, transmitting, receiving, storing, accessing, finding, organizing and viewing geographic location information and providing content based on location; downloadable and recorded computer software for application development; downloadable and recorded computer software development tools; downloadable and recorded computer software used in developing other software applications; downloadable and recorded application programming interface (API) software; downloadable and recorded software development kits (SDK); downloadable and recorded computer software to maintain and operate a computer system; downloadable and recorded computer operating software.

(260) AM 2022 113811 A

(800) 1600876

(151) 2021 05 07

(891) 2021 05 07

(731) DHV VALVE & FOUNDRY CO., LTD

No.666 Ganquan West Road, Wujiang
Economic Development Zone, Wujiang,
Suzhou, Jiangsu, China

(540)



(591) Black, white

(531) 26.01.02; 26.01.03; 26.01.18; 26.11.12;
27.05.17; 27.05.23

(511)

7 – Valves [parts of machines]; clack valves [parts of machines]; pressure valves [parts of machines]; air evacuation valves [parts of machines]; hydraulic controls for machines, motors and engines; pneumatic controls for machines, motors and engines; pumps [machines]; compressed air machines; hydraulic valves; pressure regulating valves.

(260) AM 2022 113812 A

(800) 1600901

(151) 2021 04 14

(891) 2021 04 14

(731) ROYAL ARMENIA JV LTD

Davtashen 2nd Block 268, 0054 Yerevan,
Armenia

(540)

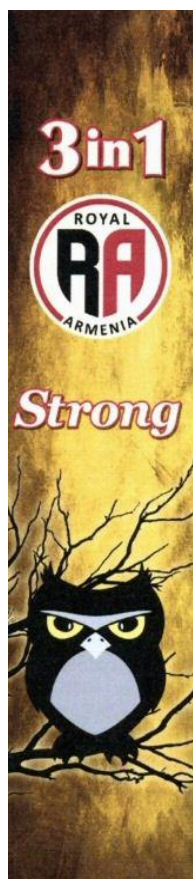

(591) Yellow, light yellow, dark yellow, red, black, cream and gray
 (531) 01.15.05; 03.07.05; 05.01.04; 26.01.18; 27.05.01; 29.01.15
 (526) 3 IN 1", "ARMENIA", "STRONG"
 (511)
 30 – Coffee; instant coffee.

(260) AM 2022 113813 A
 (800) 1600923
 (151) 2021 06 10
 (891) 2021 06 10
 (731) UAB "Narbutas International"
 Odminių g. 3-23, LT-01122 Vilnius,
 Lithuania

(540)

TWIST&SIT

(591) Black, white
 (511)
 20 – Armchairs; seats; sofas; office furniture.

(260) AM 2022 113817 A
 (800) 1601061
 (151) 2021 02 25
 (891) 2021 02 25
 (731) ON FİLTRE OTOMOTİV YEDEK PARÇA

SAN.VE TİC.LTD.ŞTİ.
 Nardüzü Mah. 210 Sokak No:8, Arsuz Hatay,
 Turkey

(540)



(591) Yellow, dark green, light blue
 (531) 01.01.01; 02.09.01; 26.04.22; 26.04.24; 27.05.10; 29.01.13

(511)
 7 – Oil, air and fuel filters for land vehicle engines.

(260) AM 2022 113819 A
 (800) 1601092
 (151) 2021 05 18
 (891) 2021 05 18
 (731) TotalEnergies SE
 2 place Jean Millier, La Défense 6, F-92400
 Courbevoie, France

(540)



(591) Blue, red, orange, yellow, green
 (531) 27.05.01; 27.05.09; 27.05.10; 27.05.19; 27.05.22; 29.01.15

(511)
 1 – Chemicals used in industry, agriculture, horticulture, forestry and aquaculture; manures and fertilisers; unprocessed plastics in all forms; adhesives for use in industry; petrochemicals and their derivatives; polymers and chemical additives to polymers; unprocessed artificial and synthetic resins; drilling muds and chemical additives for drilling muds; chemical solvents; lithium; sodium; hydrocarbons; hydrogen; hydrocarbons and natural gas derivatives; methane; detergents for industrial use; degreasing products for use in manufacturing processes; chemical condensation products; dispersants of petroleum products; chemicals products for the absorption or the removal of all petroleum products; release agents and fluids; chemicals used for petroleum refining; chemicals products for

the treatment, purification and decontamination of gases; urea, products derived from urea and ammonia [chemical products]; products for water treatment; chemical additives for use in industry; chemical additives for carburants, lubricants, fuels, bitumen and other petroleum products; chemical additives for insecticides, herbicides and fungicides; antifreeze and de-frosting products; coolants; hydraulic fluids and transmission fluids; brake liquids; solvents of petroleum origin (chemical products).

2 – Mastic (natural resin); anti-rust products; anti corrosion products, paint for motor vehicles.

3 – Cleaning, polishing, scouring, stripping and abrasive preparations; products for washing and maintenance of vehicles; products for washing and maintenance of machines and buildings; stain removers; windscreen cleaning liquid.

4 – Petroleum (crude or refined); electrical energy in all forms; fuels; biofuels; carburants and biocarburants; fuel oil; natural gas and petroleum gases in all forms; lubricants, industrial oils and greases; base oils; petroleum additives used in industry; non-chemical additives for carburants, lubricants, fuels, bitumen and other petroleum products; non-chemical additives for insecticides, herbicides and fungicides.

5 – Products for destroying noxious animals; insecticides, herbicides, fungicides, pesticides; phytosanitary products; disinfectants; air freshener sprays.

6 – Containers and metal containers for storage or transport; metal plugs; metal cylinders, tanks and vats for gas and petroleum products; pipelines, hoses and metal pipes for the transport of gas and petroleum products.

7 – Apparatus and installations for the production of energies; electricity and gas generators; wind turbines and parts thereof; motor parts; motor filters; oil refining machines; power generators for vehicles; fuel dispensers for service stations; industrial robots; automated robotic apparatus dedicated to energy services, environmental protection or sustainable development.

9 – Scientific, surveying, photographic, optical, weighing, measuring, signalling, checking (inspecting) and teaching apparatus and instruments; apparatus and instruments for conducting, distributing, transforming, accumulating, adjusting, controlling and commanding electricity; electricity conduits and equipment for conducting electricity (wires, cables); electrical collectors; electricity measuring instruments; gasometers (measuring instruments); apparatus and instruments for monitoring and measuring energy; control apparatus and control instruments for energy management; energy regulators; electric cells and batteries, fuel cells and batteries; chargers for batteries and cells; solar apparatus and installations for the production of electricity; photovoltaic cells and modules; solar pa-

nels; accumulators for photovoltaic power; safety and automation apparatus for buildings and private houses; home automation systems; servers for home automation; frequency converters, voltage converters; electric accumulators and apparatus for recharging electric accumulators; protective and safety equipment and clothing; warning triangles for breakdown vehicles; spectacles and spectacle cases; loudspeakers; data processing equipment; software and mobile applications; diagnostic apparatus, not for medical purposes; apparatus and software for testing and analyzing petroleum and chemical products; electronic and magnetic cards; transmitters, cards and badges allowing access to road or motorway networks; radios for vehicles; batteries for vehicles; terminals and stations for recharging and supplying power to batteries and vehicles.

11 – Installations and apparatus for lighting, heating, cooking, steam generating, drying, refrigerating and ventilating; waste incinerators; installations and apparatus for purification, decontamination, depollution of air, water and soil; solar energy sensors and collectors for heating; installations and apparatus for the treatment, distribution and supply of gas; installations and apparatus for the distribution and treatment of water; regulating and safety accessories for water and gas installations; boilers; lamps for lighting.

12 – Vehicles; parts and fittings for vehicles; tyres for the wheels of vehicles, sun visors for automobiles, seat covers for vehicles, tire chains [land vehicle parts], safety belt; drones.

14 – Watches, horological articles and chronometric instruments.

16 – Printed matter; stationery and office requisites (except furniture); brochures, magazines, newspapers, prospectuses, catalogues, guides, books; packaging bags made of paper or cardboard; boxes of cardboard or paper; adhesives for stationery or household purposes; paper advertising and promotional materials and supports; adhesive labels; packaging of plastic materials, namely bags, sachets and sheets.

17 – Semi-finished artificial and synthetic resins; elastomer polymers; polymer films (other than for packaging or wrapping); synthetic rubber; unprocessed and semi-finished gums; semi-finished plastics materials; rubber stoppers; insulating products and materials; insulating oils and greases; seals and sealants.

18 – Luggage, bags; umbrellas; parasols.

19 – Non-metallic building materials; asphalts, bitumen, tars and their derivatives; bituminous coatings and binders for use in construction; non-metallic transportable structures.

20 – Containers and non-metallic containers for storage or transport; packaging containers of plastic; non-metallic plugs.

21 – Brushes, combs and sponges; cleaning articles.

25 – Clothing; footwear; headwear.

28 – Games; toys; gymnastic and sporting articles.

35 – Advertising and sales promotion services; organization and management of commercial operations for customer loyalty schemes; loyalty card services; organization of exhibitions or events for commercial or advertising purposes; advertising and commercial sponsorship and patronage; subscription and subscription management services (for third parties) for publications; administration, billing and accounting services on behalf of third parties; business management relating to the purchase, sale and supply of energies and petroleum, gas and chemical products; procuring of contracts on behalf of third parties for the purchase and sale in the field of energies; utility meter reading for billing purposes; promotion of goods on behalf of third parties powered by all kinds of energies; business advisory services and collection of business information relating to energy consumption (improvement and control of energy consumption); vehicle fleet management services; automatic toll collection subscription services; file, database and hosting platform management services; administrative management of the purchase of products and/or services; wholesale or retail services for petroleum, gas and chemical products; retail services for the following products: automotive products (petroleum and maintenance), vehicle accessories, food products and beverages, newspaper and stationary articles, books and various publications, drugstore products, hygiene and perfumery products, household cleaning products, audio and video products, toys, flowers, clothing and footwear, mobile telephones and accessories thereof, lottery games.

36 – Financial information and affairs; banking services; finance and credit services; insurance services; providing prepayment and payment cards services and other cards for financial purposes and financial services relating thereto; electronic funds transfer; financial advice and information in the field of energy; tax recovery services on behalf of third parties; brokerage of carbon credits; financial sponsorship and patronage; fund investment services; acquisition of holdings in companies or firms of all kinds, financial, commercial, industrial, investment or real estate; venture capital, private equity and development capital activities in the field of energy; consultancy in matters of energy project financing; financial transactions on wholesale markets for energy, gas, electricity and petroleum and chemical products; stock exchange brokerage in the energy field; brokerage of raw materials.

37 – Natural resource extraction services; refuelling and fuelling services; vehicle service stations; maintenance, washing and repair of vehicles and vehicle parts; vehicle oil change services; assistance in case of vehicle breakdown (repair); greasing, lubrication and engine tuning; inflation, repair and fitting of tyres;

road construction, maintenance and upkeep services; commissioning, maintenance, troubleshooting, repair of apparatus and installations of production, distribution and storage of energies; construction, maintenance and upkeep of refineries and structures for the production, distribution and storage of petroleum, gas and chemical products; rental of rigs and drilling equipment; drilling of wells; construction, installation and maintenance of pipelines, oil and gas pipelines; recharging of batteries; recharging of electric vehicles; installation, repair and maintenance of installations for supplying power to and recharging batteries and vehicles; installation of telephone equipment; installation, programming and maintenance of home automation systems in the field of energy.

38 – Telecommunication services; telephone and mobile telephone services; connection services and provision of internet access and access to other global computer networks; broadcasting, transmission and exchange of information and data by the Internet and by any tele-informatic means; electronic messaging services; providing access to platforms, blogs and Internet chat rooms; providing access to databases; information and data teletransmission for the maintenance of storage or distribution facilities of gas and electricity.

39 – Transport, packaging, distribution (delivery), storage, supply of goods, including petroleum, gas and chemical products as well as all products marketed in service stations; transport, distribution (delivery), storage and supply of energy in all forms; information and advice related to the aforesaid services; towing, rental and temporary provisioning of vehicles; traffic and transport information; navigation and geolocation services for vehicles.

40 – Production of all forms of energies; transformation and treatment of all materials for energy production; processing of natural elements (sun, water, wind) into energy; treatment, recycling and disposal of waste and organic matter; refining; purification, decontamination and depollution services for air, water and soil; decontamination, depollution and sanitation services for industrial installations and sites, equipment and apparatus in the field of energy production; technical information and advice to others relating to energy production; rental of apparatus and installations for generating energy in all forms and providing of information relating thereto; rental of chemical treatment apparatus and installations and provision of information relating thereto; mixing lubricants for third parties.

41 – Education; training; entertainment; sporting and cultural activities; publishing of publications (other than advertising) in any form; organization and conducting of competitions, lotteries and sporting competitions; organization and conducting of colloquiums, forums and seminars, conferences, congresses; pro-

duction of shows and films; organization of exhibitions for cultural and educational purposes; organization of information campaigns.

42 – Industrial analysis and research services; engineering services; research, prospecting and exploration services for the oil, gas and mining industries; oil-well testing; commissioning, studies and appraisals of oil, gas and mining deposits; scientific, technological research and technical assistance (engineering) in the field of energies; design and development of energy distribution networks; architectural services and drawing up plans for the construction of installations in energy field and refining; technical consultancy and technical project studies relating to the production and distribution of energies; study, research and development in the field of energy and petroleum, gas and chemical products; research in the field of environmental protection, waste treatment and sustainable development; analysis, diagnostic and testing services in the field of energies; laboratory, analytical, diagnostic and testing services for petroleum, gas and chemical products; audit and expertise services relating to energy and energy consumption; control and audits of safety and quality; technical assistance services with certification and approval; technical inspection and appraisals (engineering services) of installations operating with the aid of energy of all kinds; technical inspections of vehicles; technical services for remote meter reading of energy consumption; design and analysis of computer systems; supply of application service provider [ASP].

43 – Restaurant services (food); restaurants; cafeterias; hotel services, temporary accommodation and booking services thereof.

45 – Security control services for production, storage, transformation and distribution facilities of energy, water, and petroleum, gas or chemical products, and consultations relating thereto; licensing, including licensing of intellectual property rights, technologies, and franchise concepts to third parties; security consulting services in the field of energy; legal and tax advice on energy savings; online social networking services.

(260) AM 2022 113820 A

(800) 1601096

(151) 2020 12 16

(891) 2020 12 16

(731) GUANGDONG BRIGHT DREAM

ROBOTICS CO., LTD.

A2-05, 2nd Floor, Building A1, No. 1 Panpu Road, Country Garden Community, Beijiao Town, Shunde District, Foshan, Guangdong, China

(540)

博智林

BRIGHT DREAM

(591) Black, white

(531) 27.05.01; 28.03

(511)

7 – Agricultural machines; food preparation machines, electromechanical; mixing machines; machines for the ceramic industry (including ceramic machinery for use in construction); kitchen machines, electric; whitewashing machines; electric concrete vibrators; mechanical railed lifting conveyors; elevating or lifting work platforms [including mobile]; mechanical parking systems; metalworking machines; industrial robots; handling machines, automatic [manipulators]; hand-held tools, other than hand-operated; industrial machines for use in electronics industry; optical cold working machines; spray paint machines; starters for motors and engines; alternating current servo motors; hydraulic controls for machines, motors and engines; door openers, electric; control mechanisms for machines, engines or motors; transmissions for machines; soldering apparatus, electric; machines and apparatus for cleaning, electric; washing apparatus; garbage disposal units; curtain drawing devices, electrically operated; robotic exoskeleton suits, other than for medical purposes; spray guns for paint.

9 – Data processing apparatus; humanoid robots with artificial intelligence; telepresence robots; downloadable computer software programs; computer software platforms, recorded or downloadable; quantity indicators; facial recognition devices; automatic measuring instruments; electronic notice boards; wearable activity trackers; navigation apparatus for vehicles [on-board computers]; virtual reality headsets; security surveillance robots; cameras [photography]; lenses for photographic apparatus; surveying apparatus and instruments; laboratory robots; industrial betatrons; optical apparatus and instruments; climate control digital thermostats; remote control apparatus; fire extinguishing apparatus; protection devices for personal use against accidents; theft prevention installations, electric; electronic access control systems for interlocking doors; eyeglasses; charging stations for electric vehicles.

37 – Construction project management services; construction; rental of construction machines and apparatus; building construction; painting of buildings; wall-papering; upholstering; heating equipment installation and repair; repair or maintenance of construction machines and apparatus; repair and maintenance of medical instruments; repair or maintenance of agricultural machines and implements; repair or maintenance

of surveying apparatus and instruments; repair and maintenance of electric vehicles; rustproofing; burglar alarm installation and repair; vehicle battery charging.

42 – Research and development of new products for others; engineering design service; product safety testing services; surveying; testing of hardware of metal for use in construction; product testing; industrial design; construction drafting; architectural design; design of interior decor; platform as a service [PaaS]; computer software design; research in the field of artificial intelligence; development of computer programs recorded on data media (software) designed for use in construction and automated manufacturing (cad/cam); design and development of virtual reality software; design and development of electronic data security systems; cartography services.

(260) AM 2022 113821 A

(800) 1601110

(151) 2021 02 09

(891) 2021 02 09

(731) TotalEnergies SE

2 place Jean Millier, La Défense 6, F-92400
Courbevoie, France

(540)

TotalEnergies

(591) Red

(531) 27.05.01; 29.01.01

(511)

1 – Chemicals used in industry, agriculture, horticulture, forestry and aquaculture; manures and fertilisers; unprocessed plastics in all forms; adhesives for use in industry; petrochemicals and their derivatives; polymers and chemical additives for polymers; unprocessed artificial and synthetic resins; drilling muds and chemical additives for drilling muds; chemical solvents; lithium; sodium; hydrocarbons; hydrogen; hydrocarbon and natural gas derivatives; methane; detergents for industrial use; degreasing preparations for use in manufacturing processes; chemical condensation products; dispersants of petroleum products; chemical products for the absorption or the disposal of all petroleum products; release agents and fluids; chemicals used for petroleum refining; chemical products for the treatment, purification and decontamination of gases; urea, products derived from urea and ammonia [chemical products]; products for water treatment; chemical additives for use in industry; chemical additives for motor fuels, lubricants, fuels, bitumen and other petroleum products; chemical additives for insecticides, herbicides and fungicides; antifreeze and de-icing products; coolants; hydraulic fluids and transmission fluids; brake liquids; petroleum solvents.

4 – Petroleum (crude or refined); electrical energy in all forms; fuels; biofuels; motor fuels and biofuels; fuel oil; natural gas and petroleum gases in all forms;

lubricants, industrial oils and greases; base oils; petroleum additives used in industry; non-chemical additives for motor fuels, lubricants, fuels, bitumen and other petroleum products; non-chemical additives for insecticides, herbicides and fungicides.

7 – Apparatus and installations for the production of energies; electricity and gas generators; wind turbines and parts thereof; motor parts; motor filters; oil refining machines; power generators for vehicles; fuel dispensers for service stations; industrial robots; automated robotic apparatus dedicated to energy services, environmental protection or sustainable development.

9 – Scientific, surveying, photographic, optical, weighing, measuring, signalling, checking (supervision) and teaching apparatus and instruments; apparatus and instruments for conducting, distributing, transforming, accumulating, adjusting, or controlling electricity; electricity conduits and equipment for conducting electricity (wires, cables); electrical collectors; electricity measuring instruments; gasometers (measuring instruments); apparatus and instruments for monitoring and measuring energy; control apparatus and instruments for energy management; energy regulators; electric cells and batteries, fuel cells and batteries; chargers for batteries and cells; solar apparatus and installations for the production of electricity; photovoltaic cells and modules; solar panels; accumulators for photovoltaic power; safety and automation apparatus for buildings and private houses; home automation systems; servers for home automation; frequency changers, voltage converters; electric accumulators and apparatus for recharging electric accumulators; protective and safety equipment and clothing; warning triangles for breakdown vehicles; spectacles and spectacle cases; loudspeakers; data processing equipment; software and mobile applications; diagnostic apparatus, not for medical purposes; apparatus and software for testing and analysing petroleum and chemical products; electronic and magnetic cards; transmitters, cards and badges allowing access to road or motorway networks; radios for vehicles; batteries for vehicles; terminals and stations for recharging and supplying power to batteries and vehicles.

37 – Natural resource extraction services; refuelling and fuelling services; vehicle service stations; maintenance, washing and repair of vehicles and vehicle parts; vehicle oil change services; assistance in case of vehicle breakdown (repair); greasing, lubrication and engine tuning; inflation, repair and fitting of tyres; road construction, maintenance and upkeep services; commissioning, maintenance, troubleshooting, repair of energy production, distribution and storage apparatus and installations; construction, maintenance and upkeep of refineries and structures for the production, distribution and storage of petroleum, gas and chemical products; rental of rigs and drilling equipment; drilling of wells; construction, installation and maintenance of pipelines, oil and gas pipelines; recharging

of batteries; charging of electric vehicles; installation, repair and maintenance of installations for supplying power to and recharging batteries and vehicles; installation of telephone equipment; installation, programming and maintenance of home automation systems in the field of energy.

39 – Transport, packaging, distribution (delivery), storage, supply of goods, including petroleum, gas and chemical products as well as all products marketed in service stations; transport, distribution (delivery), storage and supply of energy, gas and electricity; information and advice related to the aforesaid services; towing, rental and temporary provisioning of vehicles; traffic and transport information; navigation and geo-location services for vehicles.

40 – Production of all forms of energies; transformation and treatment of all materials for energy production; processing of natural elements (sun, water, wind) into energy; treatment, recycling and disposal of waste and organic matter; refining; purification, decontamination and depollution services for air, water and soil; decontamination, depollution and sanitation services for industrial installations and sites, equipment and apparatus in the field of energy production; technical information and advice to others relating to energy production; rental of apparatus and installations for generating energy in all forms and providing of information relating thereto; rental of chemical treatment apparatus and installations and provision of information relating thereto; mixing lubricants for third parties.

(260) AM 2022 113822 A

(800) 1601241

(151) 2021 03 25

(891) 2021 03 25

(731) Sopro Bauchemie GmbH

Biebricher Straße 74, 65203 Wiesbaden,
Germany

(540)

DFX

(591) Black, white

(511)

1 – Chemicals used in industry; impregnating preparations; adhesives used in industry, in particular made of synthetic resins; chemicals used in industry, being additives for building materials; chemicals used in industry, being additives for screed, concrete and mortar; liquid plastics, unprocessed, included in this class; preservatives for building materials (except for organic substances); refining agents for concrete, mortar and screed, included in this class, in particular for preventing the drying out of concrete and mortar, for screeds and finished concrete parts, for enhancing the resistance of cement screeds to impact, wear, frost and chemical stress, for increasing imperviousness against liquids and gases as well as for controlling the working consistency; unprocessed artificial resins; surfa-

ce-active agents (tensides); damp proofing preparations for brickwork, except paints; horticulture chemicals; antifreeze; chemicals as aid for washing out (removing and cleaning) joint compounds; solvents for paints; solvents for varnishes; solvents for lacquers; silicones.

17 – Rubber, gutta-percha, gum, asbestos, mica; goods made of plastics as semi-finished products; artificial and synthetic resins (semi-finished products); resins (semi-finished products) for fabricating adhesives; cast resins (semi-finished products) including silica sand; sealing materials; packing materials; insulating materials; sealing tapes; sealing collars; rubber gloves for insulating purposes, not for household purposes; joint fillers (sealant compounds for joints); insulating coatings (paints) and insulating lacquers; insulating paints; self-adhesive tapes, other than stationery and not for medical or household purposes; insulating coatings; sound proofing materials; filling material as insulating, damping and sealing materials; bituminous sealing and insulating materials for roofs; fiberglass insulation materials for building purposes; fiberglass fabrics for building insulation.

19 – Building materials (non-metallic), in particular with damping and insulating properties; building materials (non-metallic), namely hydraulic binding agents such as cement, lime, gypsum and as additives for binding and hardening concrete, mortar and stony-type building materials; building materials (non-metallic), namely hydraulic binding agents and mixtures composed thereof containing aggregates, pozzolanic materials (concrete admixtures) and/or chemical substances (concrete admixtures); mortar (building material); plaster (building material); screeds (building material); reinforcing fabrics (non-metallic) for building purposes; contact sludges (non-metallic) for building purposes; building materials, non-metallic, in the form of filling materials for building purposes for preparing surfaces made of concrete, mortar and other stony-type building materials; silica sand for building purposes; bitumen; bituminous products for building; pipes, not of metal, for building purposes; concrete; concrete building elements; roof coverings, not of metal; bituminous coatings for roofing (except for sealing and insulating purposes); windows, not of metal; felts for building; gravel; sand for building purposes; prefabricated swimming pools (not of metal); prefabricated chimneys, not of metal; floor tiles, not of metal; tile floorings, not of metal; binding material for road repair; road coating materials.

(260) AM 2022 113823 A

(800) 1601274

(151) 2021 05 11

(891) 2021 05 11

(731) Arla Foods a/s

Sønderhøj 14, DK-8260 Viby J, Denmark

(540)



(591) Red (Pantone 186C) and grey (Pantone Cool Grey 8C)

(531) 26.11.05; 26.11.06; 26.11.12; 29.01.12

(511)

29 – Butter; dairy and vegetable spreads mainly consisting of a mixture of butter and vegetable oil; crème fraîche; oils and fats for food.

(260) AM 2022 113829 A

(800) 1601358

(151) 2021 04 02

(891) 2021 04 02

(731) ROYAL ARMENIA JV LTD

Davtashen 2nd Block 268, 0054 Yerevan, Armenia

(540)

BOOCHINO

(591) Black, white

(511)

30 – Coffee; cold coffee; iced coffee; coffee-based beverages; ground coffee; roasted coffee beans; instant coffee; artificial coffee; vegetal preparations for use as coffee substitutes; unroasted coffee; coffee beverages with milk.

(260) AM 2022 113830 A

(800) 1601382

(151) 2021 06 16

(891) 2021 06 16

(731) UE Furniture Co., Ltd.

NO.1, YongYi West Road, Dipu Town, Anji County, 313300 Zhejiang Province, China

(540)



(591) Blue, orange

(531) 27.05.01; 29.01.12

(511)

20 – Furniture; seats; sofas.

(260) AM 2022 113831 A

(800) 1601422

(151) 2021 03 29

(891) 2021 03 29

(731) Barilla G. e R. Fratelli – Società per Azioni

Via Mantova 166, I-43122 Parma PR, Italy

(540)



(591) Red and white

(531) 26.01.03; 26.01.20; 27.05.24; 29.01.12

(511)

29 – Meat; fish; poultry and game; meat extracts; preserved, frozen, dried and cooked fruits and vegetables; jellies; marmalade; eggs; milk and milk products; edible oils and fats; anchovy, not live; stock; soups; caviar; fruits, tinned (canned (Am.)); vegetables, tinned (canned (Am.)); cheese; milk shakes; fruit chips; frozen fruits; preserved fruits; fruit preserved in alcohol; cooked fruits; crystallized fruits; mushrooms, preserved; gelatine; fruit jellies; vegetable soup preparations; vegetable preserves; vegetables, cooked; dried pulses; lentils, preserved; fruit salads; vegetable salads; margarine; whipped cream; cream (dairy products); potato chips; low-fat potato crisps; fish, preserved; poultry (not live); soup (preparations for making -); fruit-based snack food; vegetable juices for cooking; tomato juice for cooking; yoghurt.

30 – Coffee; tea; cocoa and artificial coffee; rice; tapioca and sago; flour and preparations made from cereals; bread; pastry and confectionery; edible ices; sugar; honey; golden syrup; yeast; baking powder; salt; mustard; vinegar; sauce (condiments); spices; ice; oat-based food; farinaceous foods; starch for food; aniseed; star aniseed; seasonings; coffee flavorings (flavourings); flavourings (other than essential oils); plant-based flavourings, other than essential oils, for beverages; flavourings, other than essential oils, for cakes; oatmeal; high-protein cereal bars; stick liquorice (confectionery); cocoa-based beverages; beverages (coffee-based-); beverages (chocolate-based -); tea-based beverages; baking soda (bicarbonate of soda for cooking purposes); petit-beurre biscuits; sweetmeats (candy); buns; puddings; cocoa; cocoa beverages with milk; coffee beverages with milk; coffee (unroasted -); cinnamon (spice); caramels; condiments; crackers; couscous (semolina); sponge cake; wheat flour; flour; fruit jellies (confectionery); ice; baking powder; macaroni; mayonnaise; rusks; unleavened bread; breadcrumbs; bread rolls; pasta; pesto (sauce); pizza; cereal preparations; ravioli; table salt; tomato sauce; soya sauce; dressings for salad; sandwiches; peppers (seasonings); semolina; hominy grits; cereal-based snack food; rice-based snack food; sorbets (ices); spaghetti; meat gravies (sauces); pasta sauce; noodles; tarts; vermicelli (noodles); saffron (seasoning); ginger (spice); fruit sauce.

35 – Advertising; business management; business administration; office functions; commercial administration;

tion of the licensing of the goods and services of others; dissemination of advertising matter; demonstration of goods; direct mail advertising; marketing; organization of exhibitions for commercial or advertising purposes; organization of trade fairs for commercial or advertising purposes; presentation of goods on communication media, for retail purposes; sales promotion for others; publication of publicity texts; on-line advertising on a computer network; television advertising; retail business services and online retail business services featuring the following goods: coffee, tea, cocoa and artificial coffee, rice, tapioca and sago, flour and preparations made from cereals, bread, pastry and confectionery, ices, sugar, honey, treacle, yeast, baking-powder, salt, mustard, vinegar, sauces (condiments), spices, ice, oat-based food, farinaceous foods, starch for food, aniseed, star aniseed, seasonings, coffee flavorings (flavourings), flavorings, other than essential oils, flavorings (flavourings), other than essential oils, for beverages, flavorings (flavourings), other than essential oils, for cakes, crushed oats, husked oats, high-protein cereal bars, stick liquorice (confectionery), cocoa-based beverages, coffee-based beverages, chocolate-based beverages, tea-based beverages, baking soda (bicarbonate of soda for cooking purposes), biscuits, malt biscuits, petit-beurre biscuits, sweetmeats (candy), buns, puddings, cocoa, cocoa beverages with milk, coffee beverages with milk, unroasted coffee, cinnamon (spice), caramels (candy), condiments, crackers, couscous (semolina), cakes, wheat flour, flour, fruit jellies (confectionery), edible ices, baking powder, macaroni, mayonnaise, rusks, unleavened bread, breadcrumbs, bread rolls, pasta, pesto (sauce), pizzas, cereal preparations, ravioli, cooking salt, tomato sauce, soya sauce, dressings for salad, sandwiches, oatmeal, semolina, hominy grits, cereal-based snack food, rice-based snack food, sorbets (ices), spaghetti, meat gravies, noodles, tarts, vermicelli (noodles), saffron (seasoning), ginger (spice).

41 – Education; providing of training; entertainment; sporting and cultural activities; academies (education); practical training (demonstration); education information; recreation information; gymnastic instruction; correspondence courses; organising cookery courses; organising of competitions; organization of sports competitions; organization of competitions (education or entertainment); organization of exhibitions for cultural or educational purposes; organization of shows (impresario services); arranging and conducting of concerts; arranging and conducting of conferences; arranging and conducting of congresses; arranging and conducting of colloquiums; arranging and conducting of seminars; arranging and conducting of symposiums; arranging and conducting of workshops (training); entertainment party planning; publication of books; publication of texts, other than publicity texts; publication of electronic books and journals online; electronic desktop publishing; presentation of li-

ve performances; game services provided on-line from a computer network.

43 – Services for providing food and drink; temporary accommodation; cafés; cafeterias; rental of temporary accommodation; canteens; hotel reservations; temporary accommodation reservations; boarding house bookings; restaurants; self-service restaurants; hotels; bar services; holiday camp services (lodging); food and drink catering; motels; snack-bars.

(260) AM 2022 113832 A

(800) 1601426

(151) 2020 12 17

(891) 2020 12 17

(731) KOBİ ULUSLARARASI TANITIM VE DAĞITIM HİZMETLERİ SANAYİ TİCARET ANONİM ŞİRKETİ
Musalla Bağları Mahallesi, Kule Caddesi, Kule Plaza, No:2, Kat:18/28, Selçuklu, Konya, Turkey

(540)



(591) Black, white

(531) 16.03.17; 27.03.15; 27.05.01

(511)

35 – Advertising, marketing and public relations; organization of exhibitions and trade fairs for commercial or advertising purposes; development of advertising concepts; provision of an online marketplace for buyers and sellers of goods and services; office functions; secretarial services; arranging newspaper subscriptions for others; compilation of statistics; rental of office machines; systemization of information into computer databases; telephone answering for unavailable subscribers; business management, business administration and business consultancy; accounting; commercial consultancy services; personnel recruitment, personnel placement, employment agencies, import-export agencies; temporary personnel placement services; auctioneering; the bringing together, for the benefit of others, of a variety of goods, namely, chemicals used in industry, science and photography, as well as in agriculture, horticulture and forestry, unprocessed artificial resins, unprocessed plastics, manures, fire extinguishing compositions, tempering and soldering preparations, chemical substances for preserving foodstuffs, tanning substances, adhesives used in industry, paints, varnishes, lacquers, preservatives against rust and against deterioration of wood, colorants, mordants, raw natural resins, metals in foil and powder form for painters, decorators, printers and artists, bleaching preparations and other substances for laundry use, cleaning, polishing, scouring

and abrasive preparations, soaps, perfumery, essential oils, cosmetics, hair lotions, dentifrices, industrial oils and greases, lubricants, dust absorbing, wetting and binding compositions, fuels (including motor spirit) and illuminants, candles and wicks for lighting, pharmaceutical and veterinary preparations, sanitary preparations for medical purposes, dietetic food and substances adapted for medical or veterinary use, food for babies, dietary supplements for humans and animals, plasters, materials for dressings, material for stopping teeth, dental wax, disinfectants, preparations for destroying vermin, fungicides, herbicides, common metals and their alloys, metal building materials, transportable buildings of metal, materials of metal for railway tracks, non-electric cables and wires of common metal, ironmongery, small items of metal hardware, pipes and tubes of metal, safes, goods of common metal, ores, machines and machine tools, motors and engines (except for land vehicles), machine coupling and transmission components (except for land vehicles) agricultural implements other than hand-operated, incubators for eggs, automatic vending machine, hand tools and implements (hand-operated), cutlery, side arms, razors, scientific, nautical, surveying, photographic, cinematographic, optical, weighing, measuring, signalling, checking (supervision), life-saving and teaching apparatus and instruments, apparatus and instruments for conducting, switching, transforming, accumulating, regulating or controlling electricity, apparatus for recording, transmission or reproduction of sound or images, magnetic data carriers, recording discs, compact discs, DVDs and other digital recording media, mechanisms for coin-operated apparatus, cash registers, calculating machines, data processing equipment, computers, computer software, fire-extinguishing apparatus, surgical, medical, dental and veterinary apparatus and instruments, artificial limbs, eyes and teeth, orthopedic articles, suture materials, apparatus for lighting, heating, steam generating, cooking, refrigerating, drying, ventilating, water supply and sanitary purposes, vehicles, apparatus for locomotion by land, air or water, firearms, ammunition and projectiles, explosives, fireworks, precious metals and their alloys and goods in precious metals or coated therewith, jewellery, precious stones, horological and chronometric instruments, musical instruments, paper, cardboard and goods made from these materials, printed matter, bookbinding material, photographs, stationery, adhesives for stationery or household purposes, artists' materials, paint brushes, typewriters and office requisites (except furniture), instructional and teaching material (except apparatus), plastic materials for packaging, printers' type, printing blocks, rubber, gutta-percha, gum, asbestos, mica and goods made from these materials, plastics in extruded form for use in manufacture, packing, stopping and insulating materials, flexible pipes, not of metal, leather and imitations of leather, and goods made of these materials, animal skins, hides, trunks and travelling bags, umb-

rellas and parasols, walking sticks, whips, harness and saddlery, building materials (non-metallic), non-metallic rigid pipes for building, asphalt, pitch and bitumen, non-metallic transportable buildings, monuments, not of metal, shaped building, construction and road construction materials made of concrete, gypsum, earthen, clay, sand, natural stone, artificial stone, wooden, plastic or synthetic materials, building parts, buildings, poles, barriers, concrete panels, concrete pipes, concrete beams, concrete blocks, concrete bollards, concrete walls, concrete fences, concrete roof repair compounds, concrete slabs, concrete roof tiles, barrier of concrete, concrete poles for electric power lines, plaster for building purpose, namely, plaster boards, plaster panels, plaster walls, plasters for prefabricated buildings, bricks, rigid pipes, not of metal, tubes and connection pieces, glass blocks for building, glass bricks, glass tiles, glass panes, glass panels for building construction purposes, furniture, mirrors, picture frames, goods of wood, cork, reed, cane, wicker, horn, bone, ivory, whalebone, shell, amber, mother-of-pearl, meerschaum and substitutes for all these materials, or of plastics, household or kitchen utensils and containers, combs and sponges, brushes (except paint brushes), brush-making materials, articles for cleaning purposes, steelwool, unworked or semi-worked glass (except glass used in building), glassware, porcelain and earthenware, ropes, string, nets, tents, awnings, tarpaulins, sails, sacks and bags, padding and stuffing materials (except of rubber or plastics), raw fibrous textile materials, yarns and threads, for textile use, textiles and textile goods, bed covers, table covers, clothing, footwear, headgear, lace and embroidery, ribbons and braid, buttons, hooks and eyes, pins and needles, artificial flowers, carpets, rugs, mats and matting, linoleum and other materials for covering existing floors, wall hangings (non-textile), games and playthings, gymnastic and sporting articles, decorations for Christmas trees, meat, fish, poultry and game, meat extracts, preserved, frozen, dried and cooked fruits and vegetables, jellies, jams, compotes, eggs, milk and milk products, edible oils and fats, coffee, tea, cocoa and artificial coffee, rice, tapioca and sago, flour and preparations made from cereals, bread, pastry and confectionery, ices, sugar, honey, treacle, yeast, baking-powder, salt, mustard, vinegar, sauces (condiments), spices, ice, grains and agricultural, horticultural and forestry products, live animals, fresh fruits and vegetables, seeds, natural plants and flowers, foodstuffs for animals, malt, beers, mineral and aerated waters and other non-alcoholic beverages, fruit beverages and fruit juices, syrups and other preparations for making beverages, alcoholic beverages (except beers), tobacco, smokers' articles, matches enabling customers to conveniently view and purchase those goods, such services may be provided by retail stores, wholesale outlets, by means of electronic media or through mail order catalogues.

42 – Scientific and industrial analysis and research services; engineering; engineering and architectural design services; testing services for the certification of quality and standards; computer services, namely, computer programming, computer virus protection services, computer system design, creating, maintaining and updating websites for others, computer software design, updating and rental of computer software, providing search engines for the internet, hosting websites, consultancy in the design and development of computer hardware, rental of computer hardware; industrial design services, other than engineering, computer and architectural design; graphic arts designing; authenticating works of art.

(260) AM 2022 113834 A
 (800) 723692
 (151) 1999 07 14
 (891) 2021 06 11
 (731) GAMO OUTDOOR, S.L.
 Ctra. Santa Creu de Calafell km.10, Sant Boi de Llobregat, E-08830 Barcelona, Spain

(540)



(591) Black, white
 (531) 26.01.01; 26.01.10; 26.03.23; 26.07.03;
 27.05.01

(511)
 9 – Telescopic sights for firearms and sunglasses, optical articles, apparatus and instruments for astronomy, spyglasses, binoculars (optical goods), lasers (not for medical use), microscopes, range finders, telescopes, directional compasses, signal lanterns (expressly excluding radio and television apparatus).

13 – Firearms; ammunition and projectiles; explosives; fireworks.

(260) AM 2022 113835 A
 (800) 998943
 (151) 2009 02 13
 (891) 2021 05 26
 (731) DE FONSECA S.P.A.
 Via Caselle 63, I-10040 LEINI (TO), Italy

(540)

DE FONSECA

(591) Black, white

(511)
 25 – Outer and under garments fabric made and knit made, including boots, shoes and slippers.

(260) AM 2022 113836 A
 (800) 1238585
 (151) 2014 12 19
 (891) 2021 05 31
 (731) Luc Belaire International Ltd.
 12 Merrion Square, Dublin 2, Ireland

(540)

LUC BELAIRE

(591) Black, white
 (511)
 33 – Alcoholic beverages (except beers); sparkling wines; wine.

(260) AM 2022 113837 A
 (800) 1461767
 (151) 2019 02 19
 (891) 2021 06 01
 (731) Universal Services of America, LP
 1551 N. Tustin Avenue, Suite 650,
 Santa Ana CA 92705, USA

(540)



(591) The color(s) light blue, dark blue and grey is/are claimed as a feature of the mark
 (531) 26.11.01; 26.11.12; 27.05.09; 27.05.10;
 27.05.11; 29.01.12

(511)
 35 – Payroll administration and management services; payroll preparation and processing; data processing services in the field of payroll, benefits and human resources; business management consultation and services, namely, managing and administering non-core functions, namely, records management, information services, administration, payroll, benefits and accounting; administration of business payroll and benefits for others; human resources consultation and management; serving as a human resources department for others; professional employer organization services in the nature of payroll, benefits and human resources departments; personal career placement services; providing human resource information via a global computer network; advertising, marketing and sales improvement consultancy.

37 – Janitorial services; installation and maintenance of security systems for buildings and premises.

41 – Training services in the field of fire prevention, life-saving techniques, and building safety; educational services, namely, conducting classes, seminars, conferences, workshops, and podcasts in the field of

security guard training and proper surveillance and distributing course materials in connection therewith; providing on-line training classes, courses, seminars, workshops, and podcasts in the field of security guard training and proper surveillance and distributing course materials in connection therewith; training services in the field of security guard and proper surveillance in connection therewith.

42 – Providing non-downloadable software for use in database management, for use as spreadsheet, for word processing, for tracking and reporting documents, information and metrics in the field of security guard services via a website; providing on-line non-downloadable software for use in database management, for use as spreadsheet, for word processing, for tracking and reporting documents, information and metrics in the field of security guard services; computer software consultation.

45 – Security services in the nature of security guard services; evaluating and assessing on-site security programs for others; and property surveillance and security protective services, namely, providing executive protection, civil protection, personal security consultation, home security consultations, personal body guarding, control of building environmental access and security systems; security guard services; security guard services, namely, provision of uniformed, unarmed security professionals; security consulting services in the fields of fire and life safety, and emergency and terrorism response; and design and implementation of security programs, including standing, patrol and console security, fire and life safety, and emergency and terrorism response; consultation in the field of data theft and identity theft; fraud and identity theft protection services; monitoring of credit reports, the Internet, and public records to facilitate the detection and prevention of identity theft and fraud; identity verification, namely, providing authentication of personal identification information; monitoring of security systems for buildings and premises; security consulting services, namely, evaluating and assessing on-site security programs for others; providing property surveillance services, namely, monitoring security systems and security guarding for facilities; security protective services, namely, providing executive protection, personal security consultation, and personal body guarding; concierge services, namely, hotel concierge services, personal concierge services for others comprising making requested personal arrangements and reservations, running errands and providing customer specific information to meet individual needs, all rendered in business establishments, office buildings, hotels, residential complexes and homes.

(260) AM 2022 113838 A
(800) 1479834
(151) 2019 03 26
(891) 2021 06 17
(731) APT Advanced Polymer Technology Corp.
109 Conica Lane, Harmony PA 16037, USA
(540)

LAYKOLD

(591) Black, white
(511)
2 – Paints; primers; clear and pigmented coatings in the nature of paint; decorative coatings in the nature of acrylic paints; coatings in the nature of acrylic finishes for recreational surfaces, sports surfaces, asphalt surfaces, concrete surfaces, wood surfaces, cement surfaces, masonry surfaces; polyurethane coatings for recreational surfaces, sports surfaces, asphalt surfaces, concrete surfaces, wood surfaces, cement surfaces and masonry surfaces.

(260) AM 2022 113839 A
(800) 1486362
(151) 2019 04 26
(891) 2021 05 27
(731) Ajinomoto Co., Inc.
15-1, Kyobashi 1-Chome, Chuo-ku,
Tokyo 104-8315, Japan
(540)

Eat Well, Live Well.



(591) Red
(531) 27.05.09; 27.05.10; 27.05.22; 29.01.01
(511)

1 – Glue and adhesives for industrial purposes; industrial chemicals; sealants for use in the manufacture of semiconductors; dispersing agents; fire retardants; silane coupling agents; activated carbon; chemical preparations for scientific or research use, other than for medical or veterinary use; cell growth media for scientific or research purposes; reagents for scientific or research use; cell culture reagents for scientific or research purposes; higher fatty acids; chemical compositions for developing photographs; reagent paper, not for medical purposes; artificial sweeteners; flour and starch for industrial purposes; unprocessed synthetic resins; unprocessed artificial resins; unprocessed polymer resins; unprocessed plastics; silicones; pulp made of wood, paper, rag or straw; biological preparations, other than for medical or veterinary purposes; by-products of the processing of cereals for industrial purposes; amino acid for industrial purposes; surface-

active chemical agents; plant growth regulating preparations; fertilizers.

5 – Nutritional supplements; dietary supplements; pharmaceuticals; medicines for veterinary purposes; bacteriological culture mediums for medical purposes; cell growth media for medical purposes; chemical reagents for medical purposes; chemical reagents for veterinary purposes; reagent paper for medical purposes; greases for medical purposes; adhesive tapes for medical purposes; sanitary pads; cotton wool for medical purposes; sticking plasters for medical purposes; materials for dressings; babies' diapers; diapers for incontinence; diaper covers; mothproofing paper; lacteal flour for babies; powdered milk for babies; dietetic beverages adapted for medical purposes; dietetic foods adapted for medical purposes; beverages for babies; feed additives for dietary supplemental purposes, not for medical purposes; nutritional supplements for animal foodstuffs, not for medical purposes; feed additives for dietary supplemental purposes, mainly consisting of protein, not for medical purposes; amino acids for medical purposes.

29 – Instant soup; preparations for making soup; soup; bouillon; broth; processed meat; preserved meat; frozen meat products; processed seafood; preserved seafood; frozen processed seafood; processed shrimp; processed shellfish; frozen vegetables; processed vegetables; preserved vegetables; frozen fruits; processed fruits; preserved fruits; croquettes; milk products; milk; powdered milk, not for babies; milk substitutes.

30 – Seasonings, other than spices; cooking salt; sauces [condiments]; premixed sauces; salad dressings; mayonnaise; sugar; natural sweeteners; coffee; instant coffee; coffee-based beverages; coffee-based beverages containing milk; cocoa; tea; tea-based beverages; instant tea; cereal preparations; processed rice products; breadcrumbs; noodles; instant noodles; Chinese stuffed dumplings; sushi; ravioli; spring rolls; stir-fried rice; confectionery; pancakes; bread; sandwiches; hamburgers [sandwiches]; pizzas; hot dogs [sandwiches]; meat pies; instant confectionery mixes.

32 – Non-alcoholic beverages; non-alcoholic beverages in the form of jellies; non-alcoholic beverages flavored with coffee; non-alcoholic beverages flavored with tea; non-alcoholic fruit extracts; preparations for making non-alcoholic beverages; sports beverages; protein-enriched sports beverages; powders for effervescent beverages; fruit juices; non-alcoholic vegetable juice beverages; lemonade; smoothies; mineral water [beverages]; whey beverages; syrups for making non-alcoholic beverages; powders for the preparation of beverages.

(260) AM 2022 113896 A

(800) 1601763

(151) 2021 05 06

(891) 2021 05 06

(731) VARIOBICS

4 avenue du Prince de Galles, F-06400 Cannes, France

(540)

ACTIVLIFE

(591) Black, white

(511)

9 – Scientific apparatus and instruments; measuring apparatus and instruments; teaching apparatus and instruments; data processing equipment; software (recorded programs); diagnostic apparatus not for medical use.

10 – Medical apparatus and instruments; massage apparatus; special furniture for medical use.

16 – Instructional or teaching material (except apparatus).

35 – Advice regarding communication (public relations).

42 – Software design; software development; software development (design); updating of software; computer system analysis; software as a service (SAAS).

(260) AM 2022 113898 A

(800) 1601894

(151) 2021 05 07

(891) 2021 05 07

(731) Edgewell Personal Care Brands, LLC

6 Research Drive, Shelton CT 06484, USA

(540)

SKINTIMATE

(591) Black, white

(511)

8 – Razors.

(260) AM 2022 113914 A

(800) 1602216

(151) 2021 06 14

(891) 2021 06 14

(731) Kia Corporation

12, Heolleung-ro, Seocho-gu, Seoul, Republic of Korea

(540)



(591) Black, white

(531) 27.05.01; 27.05.19; 27.05.22; 27.07.01; 27.07.11

(511)
12 – Vans [vehicles]; motor buses; sports cars; automobiles; electric cars; trucks.

(260) AM 2022 113915 A

(800) 1602218

(151) 2021 06 14

(891) 2021 06 14

(731) Kia Corporation

12, Heolleung-ro, Seocho-gu, Seoul,
Republic of Korea

(540)



(591) Black, white

(531) 27.05.01; 27.05.19; 27.05.22; 27.07.01

(511)

12 – Vans [vehicles]; motor buses; sports cars; automobiles; electric cars; trucks.

(260) AM 2022 113916 A

(800) 1602233

(151) 2021 05 25

(891) 2021 05 25

(731) IVANOVA IRYNA VIKTOROVNA

Leninsky prospekt, d.72, korp. 1, kv. 787,
RU-198332 Saint-Petersburg, Russian
Federation

(540)

FOREVER QUEEN

(591) Black, white

(531) 27.05.01

(511)

18 – Mountaineering sticks; slings for carrying infants; luggage tags; pocket wallets; saddlecloths for horses; business card cases; reins; reins for guiding children; sling bags for carrying infants; harness fittings; credit card cases [wallets]; parts of rubber for stirrups; chamois leather, other than for cleaning purposes; umbrellas; parasols; saddlery; frames for umbrellas or parasols; handbag frames; card cases [note-cases]; cases of leather or leatherboard; valves of leather; whips; imitation leather; leather, unworked or semi-worked; leatherboard; casings, of leather, for springs; umbrella rings; hat boxes of leather; boxes of leather or leatherboard; boxes of vulcanized fibre; purses; chain mesh purses; fastenings for saddles; butts [parts of hides]; saddle trees; bags [envelopes, pouches] of leather, for packaging; moleskin [imitation of leather]; travelling sets [leatherware]; knee-pads for horses; muzzles; halters; vanity cases, not fitted; furniture coverings of leather; clothing for pets; covers for animals; trimmings of leather for furniture; collars for animals; hiking sticks; conference folders; music cases; goldbeaters' skin; cat o' nine tails; leather

leashes; pads for horse saddles; horseshoes; girths of leather; leathercloth; horse blankets; garment bags for travel; shoulder belts [straps] of leather; briefcases; traces [harness]; fur; randrels [Japanese school satchels]; haversacks; leather straps; straps for soldiers' equipment; harness straps; straps for skates; straps of leather [saddlery]; chin straps, of leather; stirrup leathers; umbrella handles; walking stick handles; suitcase handles; grips for holding shopping bags; rucksacks; backpacks for carrying infants; travelling bags; riding saddles; net bags for shopping; umbrella or parasol ribs; stirrups; bags; bags for climbers; tool bags, empty; handbags; beach bags; saddlebags; compression cubes adapted for luggage; bags for sports; bags for campers; shopping bags; wheeled shopping bags; school bags; pouch baby carriers; travelling trunks; trunks [luggage]; nose bags [feed bags]; bridons; walking sticks; umbrella sticks; walking stick seats; tefillin [phylacteries]; bits for animals [harness]; bridles [harness]; harnesses for animals; key cases; horse collars; suitcases; motorized suitcases; suitcases with wheels; valises; attaché cases; covers for horse saddles; umbrella covers; kid; curried skins; animal skins; cattle skins; leather cord; blinkers [harness]; labels of leather; game bags [hunting accessories].

25 – Wimples; bandanas [neckerchiefs]; underwear; sweat-absorbent underwear; berets; overalls; boas [necklets]; teddies [underclothing]; boxer shorts; ankle boots; ski boots; boots for sports; breeches for wear; trousers; football shoes; brassieres; adhesive bras; valenki [felted boots]; mittens; collars [clothing]; detachable collars; shirt yokes; veils [clothing]; gabardines [clothing]; galoshes; neckties; ascots; chaps; spats; leggings [leg warmers]; boot uppers; corselets; jerseys [clothing]; waistcoats; sports jerseys; hosiery; heels; heelpieces for footwear; hoods [clothing]; hat frames [skeletons]; pockets for clothing; scarves; caps being headwear; kimonos; cap peaks; visors being headwear; tights; slippers [underclothing]; combinations [clothing]; wet suits for water-skiing; bodices [lingerie]; corsets [underclothing]; suits; bathing suits; masquerade costumes; beach clothes; headscarves; leotards; jackets [clothing]; stuff jackets [clothing]; fishing vests; leggings [trousers]; liveries; camisoles; sports singlets; cuffs; short-sleeve shirts; mantillas; coats; sleep masks; furs [clothing]; hand warmers [fingerless gloves]; mitres [hats]; muffs [clothing]; footmuffs, not electrically heated; bibs, not of paper; bibs, sleeved, not of paper; fur stoles; hairdressing capes; heel protectors for shoes; ear muffs [clothing]; socks; sweat-absorbent socks; footwear; gymnastic shoes; beach shoes; sports shoes; clothing; paper clothing; outerclothing; embroidered clothing; ready-made clothing; motorists' clothing; cyclists' clothing; clothing for gymnastics; clothing of imitations of leather; latex clothing; clothing of leather; waterproof clothing; clothing incorporating LEDs; uniforms; clothing containing slimming substances; fittings of metal for footwear; maniples; overcoats; knickers; parkas;

pelerines; gloves [clothing]; fingerless gloves; ski gloves; pyjamas; bathing trunks; shirt fronts; pocket squares; dresses; headbands [clothing]; garters; sock suspenders; stocking suspenders; ready-made linings [parts of clothing]; dress shields; soles for footwear; braces for clothing [suspenders]; half-boots; lace boots; ponchos; girdles; belts [clothing]; sashes for wear; money belts [clothing]; layettes [clothing]; non-slipping devices for footwear; heelpieces for stockings; welts for footwear; chasubles; shirts; wooden shoes; sandals; bath sandals; boots; jumper dresses; saris; sarongs; sweaters; footwear uppers; inner soles; albs; bath slippers; togas; knitwear [clothing]; under-pants; shoes; slippers; skull caps; turbans; headwear; aprons [clothing]; judo uniforms; karate uniforms; rash guards; dressing gowns; bath robes; top hats; tips for footwear; stockings; sweat-absorbent stockings; shawls; paper hats [clothing]; shower caps; bathing caps; neck tube scarves; studs for football boots; hats; babies' pants [underwear]; gaiter straps; pelisses; esparto shoes or sandals; skirts; petticoats; skorts.

(260) AM 2022 113917 A
 (800) 1602234
 (151) 2021 06 14
 (891) 2021 06 14
 (731) Kia Corporation
 12, Heolleung-ro, Seocho-gu, Seoul,
 Republic of Korea



(591) Black, white
 (531) 27.05.01; 27.05.19; 27.05.22; 27.07.01;
 27.07.11

(511)
 12 – Vans [vehicles]; motor buses; sports cars; automobiles; electric cars; trucks.

(260) AM 2022 113918 A
 (800) 1602247
 (151) 2021 06 14
 (891) 2021 06 14
 (731) Kia Corporation
 12, Heolleung-ro, Seocho-gu, Seoul,
 Republic of Korea



(591) Black, white
 (531) 27.05.01; 27.05.19; 27.05.22; 27.07.01;
 27.07.11

(511)
 12 – Vans [vehicles]; motor buses; sports cars; automobiles; electric cars; trucks.

(260) AM 2022 113924 A
 (800) 1602351
 (151) 2021 03 11
 (891) 2021 03 11
 (731) Gilbarco Inc.
 7300 West Friendly Avenue, Greensboro
 NC 27410, USA



(591) Black, white
 (531) 14.01.05; 15.09.10; 18.01.09; 18.01.23;
 25.03.01; 27.05.10; 27.07.11

(511)
 9 – Battery charging devices for motor vehicles; charging stations for electric vehicles.

(260) AM 2022 113925 A
 (800) 1602361
 (151) 2021 06 15
 (891) 2021 06 15
 (731) Merck Sharp & Dohme B.V.
 Waarderweg 39; NL-2031 BN Haarlem,
 Netherlands



(591) Black, white
 (511)
 5 – Pharmaceutical preparations and substances.

(260) AM 2022 113926 A
 (800) 1602362
 (151) 2021 06 15
 (891) 2021 06 15
 (731) Merck Sharp & Dohme B.V.
 Waarderweg 39, NL-2031 BN Haarlem,
 Netherlands



(591) Black, white
 (511)
 5 – Pharmaceutical preparations.

(260) AM 2022 113927 A
 (800) 1602391
 (151) 2021 05 12
 (891) 2021 05 12
 (731) Apple Inc.
 One Apple Park Way, Cupertino CA
 95014, USA

(540)



(591) Black, blue, and green

(531) 01.01.02; 01.01.10; 02.09.01; 26.04.04;
26.04.13; 26.04.14; 26.04.18; 26.04.24;
27.05.03; 27.05.21; 29.01.13

(511)

9 – Computer software; downloadable computer software used in developing other software applications; downloadable computer software used in creating, developing, generating, displaying, and printing computer software user interfaces, menus, toolbars, navigation bars, and graphics.

(260) AM 2022 113928 A

(800) 1602394

(151) 2021 05 12

(891) 2021 05 12

(731) Apple Inc.

One Apple Park Way, Cupertino CA
95014, USA

(540)

STOREKIT

(591) Black, white

(511)

9 – Downloadable application development software; downloadable computer software used in developing other software.

(260) AM 2022 113929 A

(800) 1602410

(151) 2021 05 11

(891) 2021 05 11

(731) STADA Arzneimittel AG

Stadastr. 2-18, 61118 Bad Vilbel, Germany

(540)

VIRUSTOP STADA

(591) Black, white

(511)

5 – Pharmaceuticals, medical and veterinary preparations; medicine; nasal rinse, nasal sprays; solutions for inhalation, gargling and nasal rinsing; dietetic food and substances adapted for medical or veterinary use, food for babies; dietary supplements for human be-

ings and animals; plasters, materials for dressings; material for stopping teeth, dental wax; vermin destroying preparations; fungicides, herbicides.

10 – Inhalers; medical devices and apparatus; aerosol dispensers for medical purposes, containers for medicines, nebulisers for medical purposes.

(260) AM 2022 113931 A

(800) 1602430

(151) 2021 06 14

(891) 2021 06 14

(731) Kia Corporation

12, Heolleung-ro, Seocho-gu, Seoul,
Republic of Korea

(540)



(591) Black, white

(531) 27.05.01; 27.05.19; 27.07.01; 27.07.11

(511)

12 – Vans [vehicles]; motor buses; sports cars; automobiles; electric cars; trucks.

(260) AM 2022 113932 A

(800) 1602449

(151) 2021 04 29

(891) 2021 04 29

(731) Apple Inc.

One Apple Park Way, Cupertino CA
95014, USA

(540)

AIRTAG

(591) Black, white

(511)

14 – Key chains; key rings.

(260) AM 2022 113933 A

(800) 1602516

(151) 2021 04 23

(891) 2021 04 23

(731) Yangtze Memory Technologies Co., Ltd.

No.88 Weilai 3rd Road, East Lake High-tech
Development Zone, Wuhan, Hubei, China

(540)

Xtacking

(591) Black, white

(511)

9 – Microchip cards; memory cards; electronic memories; semi-conductor memory units; microprocessors; integrated circuit cards; smart cards [integrated circuit cards]; USB flash drives; electronic semi-conductors; computer chips; transistors; electronic integrated cir-

cuits; multiprocessor chips; microchips [computer hardware]; high definition graphic chipsets; electronic chips for the manufacture of integrated circuits; integrated circuits; semi-conductors; chips [integrated circuits]; wafers for integrated circuits; transistors [electronic].

35 – Distribution of products for advertising purposes; demonstration of products; advertising through all public communication means; advertising; market analysis and research services; organization of fairs and exhibitions for commercial and advertising purposes; provision of information concerning commercial sales; import-export agency services; sales promotion for others; marketing.

42 – Material testing; information technology [IT] consultancy; design of integrated circuits; product development for others; technological research; research and development of new products for others; conducting technical project studies; scientific laboratory services; scientific research; chemical research.

(260) AM 2022 113934 A

(800) 1602528

(151) 2021 05 03

(891) 2021 05 03

(731) RAUCH Fruchtsäfte GmbH

Langgasse 1, A-6830 Rankweil, Austria

(540)



(591) Black, white

(531) 05.03.13; 05.03.14; 27.05.01; 27.05.02;
27.05.07; 27.05.17

(511)

32 – Beer; shandy; non-alcoholic beverages; waters; mineral and aerated waters; fruit drinks; fruit juices; juices; nectars; fruit nectars; fruit nectar beverages; non-alcoholic beverages made from juice concentrates; vegetable juice, vegetable beverages and vegetable juice beverages; vegetable nectar beverages; syrups and other non-alcoholic preparations for making beverages; energy drinks; lemonades; soft drinks, in particular flavoured with fruit.

(260) AM 2022 113957 A

(800) 833696

(151) 2004 04 28

(891) 2021 06 02

(731) MEIJI TECHNO CO., LTD.

322-1, Chikumazawa, Miyoshi-machi,
Iruma-gun, Saitama-ken 354-0043, Japan

(540)



(591) Black, white

(531) 02.01.15; 16.03.15

(511)

9 – Microscopes, electron microscopes, laboratory apparatus and instruments, photographic instruments and apparatus, cinematographic instruments and apparatus, optical apparatus and instruments, measuring or testing apparatus and instruments, electric or magnetic meters and testers, telecommunication instruments and apparatus, electron tubes, computer programs, spectacles (eyeglasses and goggles), exposed cinematographic films, exposed slide films, slide film mounts, recorded video discs and video tapes.

(260) AM 2022 113959 A

(800) 887389

(151) 2006 03 03

(891) 2021 06 24

(731) LABORATOIRES SVR

ZAC de la Tremblaie, Rue de la Mare à Blot,
F-91220 Le Plessis Pate, France

(540)



(591) Black, white

(531) 27.05.01

(511)

3 – Bleaching preparations and other substances for laundry use; cleaning, polishing, scouring and abrasive preparations; soaps; perfumes, essential oils, cosmetics, hair lotions; dentifrices; depilatories; make-up removing products; lipstick; face masks; shaving products; leather preservatives (polishes); creams for leather.

5 – Pharmaceutical and veterinary preparations; sanitary preparations for medical use; dietetic substances adapted for medical use; food for babies; plasters, materials for dressings; material for stopping teeth and dental wax; disinfectants; preparations for destroying vermin; fungicides, herbicides; medicated bath preparations; sanitary pads, pants or towels; chemical preparations for medical or pharmaceutical purposes; medicinal herbs; herb teas; parasiticides; sugar for medical purposes; alloys of precious metals for dental purposes.

(260) AM 2022 113960 A
 (800) 1038695
 (151) 2010 03 22
 (891) 2021 06 15
 (731) Limited Liability Company "RELOUIS BEL"
 office 26, Pobediteley Avenue 104,
 220062 Minsk, Belarus

(540)

(591) Black, white

(531) 27.05.01

(511)

3 – Perfumery, essential oils, cosmetic pencils; eyebrow pencils; cosmetic creams; hair spray; nail varnish; lotions for cosmetic purposes; soap; eau de cologne; lipsticks; pomades for cosmetic purposes; make-up powder; cosmetic preparations for eyelashes and eyebrows; cosmetics.

(260) AM 2022 113961 A

(800) 1217081

(151) 2014 03 20

(891) 2021 06 28

(731) Faith in Nature Limited

Faith House, James Street, Radcliffe,
 Manchester M26 1LN, United Kingdom

(540)

Faith in Nature

(591) Black, white

(511)

3 – Natural cosmetic skin care products; natural cosmetics, non-medicated preparations and substances for the care, conditioning, toning, firming, moisturising, beautifying and cleansing of the skin, face, eyes, body, hands, feet, legs, hair and scalp; wipes for cosmetic use, wipes impregnated with cleansing preparations; wipes for removing make-up, wipes for toilet use; hair preparations and substances, shampoos, conditioners for the hair; soaps, bath and shower preparations and substances; creams and lotions for the skin; deodorants, essential oils, washing, cleaning and scouring preparations; detergents, laundry preparations and substances; fabric conditioners, dishwasher cleaning and rinse aid preparations and substances, toilet cleaners, household cleaning and polishing preparations; washing-up liquids, aromatherapy oils and substances; wipes of paper impregnated with make-up remover; wipes of paper impregnated with cleansing preparations and substances.

5 – Feminine hygiene washes, feminine hygiene pads, sanitary towels and tampons; wipes for hygiene or medical use, wipes impregnated with antiseptic; wipes impregnated with medicated preparations and substances; disinfectants.

16 – Paper, cardboard and goods made from these materials; wipes of paper.

21 – Household fabric cleaning wipes and cleaning brushes and swabs for household use; household or kitchen utensils and containers; combs and sponges; brushes (except paint brushes); brush-making materials; articles for cleaning purposes; steelwool; unworked or semi-worked glass (except glass used in building); glassware, porcelain and earthenware not included in other classes.

(260) AM 2022 113965 A

(800) 1270842

(151) 2015 10 02

(891) 2021 06 24

(731) LABORATOIRES SVR

Zac de la Tremblaie, Rue de la Mare À Blot,
 F-91220 Le Plessis-Pâte, France

(540)

SENSIFINE

(591) Black, white

(511)

3 – Soaps, perfumery, essential oils, cosmetics, hair lotions.

(260) AM 2022 114006 A

(800) 1603067

(151) 2021 05 18

(891) 2021 05 18

(731) Edge Systems LLC

2277 Redondo Avenue, Signal Hill CA 90755,
 USA

(540)

Hydracial

(591) Black, white

(511)

10 – Medical apparatus and instruments for use in skin resurfacing and skin nourishing procedures, namely, devices to perform microdermabrasion and hydrodermabrasion procedures.

(260) AM 2022 114007 A

(800) 1603148

(151) 2021 05 20

(891) 2021 05 20

(731) Zajtsev Dmitrij Petrovich

nab. Obvodnogo kanala, d. 127, kv. 9,
 RU-190013 Sankt-Peterburg, Russian
 Federation

(540)

СТЕНОПАН
STENOPAN

(591) Black, white

(531) 28.05

(511)

16 – Albums; booklets; books; calendars; catalogues; graphic prints; graphic representations; graphic reproductions; newspapers; note books; pamphlets; periodicals; photo-engravings; photographs [printed]; posters; printed matter; printed publications; signboards of paper or cardboard; stationery.

17 – Asbestos fibers; compositions to prevent the radiation of heat; dielectrics [insulators]; insulating materials; insulating paper; non-conducting materials for retaining heat; plastic fibers, other than for textile use; plastic substances, semi-processed; substances for insulating buildings against moisture; synthetic resins, semi-processed; threads of plastic materials, other than for textile use.

19 – Angle irons, not of metal; artificial stone; building materials, not of metal; building panels, not of metal; buildings, not of metal; ceilings, not of metal; cladding, not of metal, for building; door frames, not of metal; duckboards, not of metal; floor tiles, not of metal; floors, not of metal; folding doors, not of metal; gates, not of metal; grog [fired refractory material]; linings, not of metal, for building; manufactured timber; refractory construction materials, not of metal; shuttering, not of metal, for concrete; skating rinks [structures], not of metal; wainscoting, not of metal; wall claddings, not of metal, for building; wall linings, not of metal, for building; wall tiles, not of metal; window frames, not of metal; wood veneers.

20 – Bottle racks; boxes of wood or plastic; counters [tables]; covers for clothing [wardrobe]; cupboards; dinner wagons [furniture]; display stands; doors for furniture; edgings of plastic for furniture; filing cabinets; furniture fittings, not of metal; furniture shelves; house numbers, not of metal, non-luminous; keyboards for hanging keys; labels of plastic; letter boxes, not of metal or masonry; library shelves; meat safes; numberplates, not of metal; office furniture; plate racks; plugs [dowels], not of metal; racks [furniture]; school furniture; shelves for file cabinets; shelves for storage; shelving units; signboards of wood or plastics; stools; tables; tea carts; tool chests, not of metal, empty; wardrobes; window fittings, not of metal.

35 – Administrative processing of purchase orders; advertising; demonstration of goods; import-export agency services; market studies; marketing research; marketing services; organization of exhibitions and trade fairs for commercial or advertising purposes; organization of exhibitions for commercial or advertising purposes; presentation of goods on communication media, for retail purposes; procurement services for others [purchasing goods and services for other businesses]; professional business consultancy; providing business information; sales promotion for others;

updating and maintenance of data in computer databases.

37 – Factory construction; airplane maintenance and repair; building of fair stalls and shops; construction; furniture maintenance; harbour construction; installation of doors and windows; masonry; painting or repair of signs; providing construction information; providing information relating to repairs; rental of construction equipment; repair or maintenance of automobiles; scaffolding; shipbuilding; strong-room maintenance and repair; swimming-pool maintenance; vehicle breakdown repair services; vehicle maintenance; vehicle service stations [refuelling and maintenance]; warehouse construction and repair.

40 – Custom assembling of materials for others; decontamination of hazardous materials; framing of works of art; paper treating; photographic printing; printing; sawing of materials.

(260) AM 2022 114008 A

(800) 1603208

(151) 2021 05 20

(891) 2021 05 20

(731) Obschestvo s ogranitchennoy otvetstvennostyu "KDV Nizhny Tagil"

Frunze str., bld. 83, Nizhny Tagil, RU-622022
Sverdlovskaya oblast, Russian Federation

(540)

BON TIME

(591) Black, white

(511)

30 – Vanilla flavourings for culinary purposes; flavourings, other than essential oils, for cakes; flavourings, other than essential oils, for beverages; coffee flavourings; food flavourings, other than essential oils; star aniseed; baozi; cereal bars; high-protein cereal bars; pancakes; noodle-based prepared meals; freeze-dried dishes with the main ingredient being pasta; freeze-dried dishes with the main ingredient being rice; buns; bulgur; bread rolls; edible rice paper; edible paper; burritos; vanillin [vanilla substitute]; vareniki being stuffed dumplings; waffles; vermicelli; natural sweeteners; binding agents for ice cream; sausage binding materials; seawater for cooking; seaweed [condiment]; malt biscuits; cloves [spice]; mirror icing [mirror glaze]; cake frosting [icing]; glucose for culinary purposes; mustard; croûtons; buckwheat, processed; gluten additives for culinary purposes; yeast; thickening agents for cooking foodstuffs; leaven; rice-based snack food; cereal-based snack food; artificial coffee; vegetal preparations for use as coffee substitutes; dressings for salad; zephyr being confectionery; fruit jellies [confectionery]; candy decorations for cakes; confectionery for decorating Christmas trees; cakes; pastries; peanut confectionery; almond confectionery; pasta; ground ginger; frozen yogurt [confectionery ices]; cocoa; cream of tartar for culinary purposes;

ses; capers; caramels [sweets]; curry [spice]; ketchup [sauce]; quinoa, processed; quiches; gluten prepared as foodstuff; flour-based dumplings; sweets; liquorice [confectionery]; peppermint sweets; mints for breath freshening; dulce de leche; cinnamon [spice]; coffee; unroasted coffee; starch for food; crackers; custard; hominy grits; semolina; oatmeal; crushed barley; groats for human food; ice cubes; corn, milled; corn, roasted; meat pies; turmeric; couscous; noodles; soba noodles; udon noodles; ice for refreshment; ice, natural or artificial; edible ices; rice cakes; potato-based flatbreads; mayonnaise; macarons; macaroni; maltose; hominy; piccalilli; marinades; marzipan; honey; miso; royal jelly; ice cream; bean meal; buckwheat flour; tapioca flour; potato flour; corn flour; nut flours; flour; wheat flour; soya flour; barley meal; dessert mousses [confectionery]; chocolate mousses; muesli; mint for confectionery; cocoa beverages with milk; coffee beverages with milk; coffee-based beverages; cocoa-based beverages; chamomile-based beverages; tea-based beverages; chocolate beverages with milk; chocolate-based beverages; infusions, not medicinal; crushed oats; husked oats; savoury pancakes; onigiri; nutmegs; chocolate-coated nuts; stick liquorice [confectionery]; soya bean paste [seasoning]; lozenges [confectionery]; molasses for food; pâtés en croûte; pelmeni; pepper; allspice; peppers [seasonings]; pesto; biscuits; petit-beurre biscuits; bibimbap [rice mixed with vegetables and beef]; pies; pizzas; meat gravies; fondants [confectionery]; popcorn; powders for making ice cream; baking powder; mustard meal; pralines; condiments; meat tenderizers for household purposes; cereal preparations; oat-based food; propolis; gingerbread; spices; petits fours; rice pudding; puddings; cake powder; fruit coulis [sauces]; ravioli; ramen; chewing gum; chewing gum for breath freshening; relish [condiment]; rice; instant rice; wheat germ for human consumption; spring rolls; sago; sugar; palm sugar; sesame seeds [seasonings]; linseed for culinary purposes [seasoning]; processed seeds for use as a seasoning; aniseed; agave syrup [natural sweetener]; golden syrup; confectionery; savoury pancake mixes; baking soda [bicarbonate of soda for cooking purposes]; malt for human consumption; salt for preserving foodstuffs; cooking salt; celery salt; sorbets [ices]; ham glaze; cranberry sauce [condiment]; soya sauce; tomato sauce; apple sauce [condiment]; sauces [condiments]; pasta sauce; spaghetti; seasonings; chocolate-based spreads; chocolate spreads containing nuts; preparations for stiffening whipped cream; shaved ice with sweetened red beans; rusks; breadcrumbs; sushi; rice crackers; sandwiches; tabbouleh; tacos; tapioca; tarts; dough; pastry dough; almond paste; rice pulp for culinary purposes; cake batter; tortillas; garden herbs, preserved [seasonings]; chocolate decorations for cakes; vinegar; beer vinegar; ferments for pastes; halvah; bread; unleavened bread; chips [cereal products]; corn flakes; oat flakes; hot dog sandwiches; flowers or leaves for use as tea substitutes; jiaozi; chicory [coffee

substitute]; tea; iced tea; chutneys [condiments]; minced garlic [condiment]; cheeseburgers [sandwiches]; chow-chow [condiment]; saffron [seasoning]; chocolate; malt extract for food; essences for foodstuffs, except etheric essences and essential oils; husked barley.

(260) AM 2022 114010 A

(800) 1603291

(151) 2021 05 14

(891) 2021 05 14

(731) Yangtze Memory Technologies Co., Ltd.

No.88 Weilai 3rd Road, East Lake High-tech
Development Zone, Wuhan, Hubei, China

(540)

Yangtze Memory

(591) Black, white

(511)

35 – Advertising; commercial information agency services; marketing; personnel management; rental of office machines and equipment; updating and maintenance of data in computer databases; accounting services; rental of vending machines; sponsorship search; rental of sales stands; retail services for pharmaceutical, veterinary and sanitary preparations and medical supplies.

(260) AM 2022 114011 A

(800) 1603301

(151) 2021 06 16

(891) 2021 06 16

(731) Dongyang Yimei Commodities Co., Ltd

No.676, Beilu West Street, Linjiang

Community, Jiangbei Street, Dongyang City,
Zhejiang Province, China

(540)



(591) Black, white

(531) 27.05.01

(511)

3 – Cosmetics; false nails; varnish-removing preparations; lipsticks; perfumes; eyeshadow cream; nail art stickers; nail care preparations; nail polish; nail varnish removers.

(260) AM 2022 114014 A

(800) 1603330

(151) 2021 06 16

(891) 2021 06 16

(731) China Tobacco Jiangsu Industrial Co., Ltd.

No. 406-3 Zhongshan North Road, Nanjing,
210011 Jiangsu, China

(540)

炫赫门

(591) Black, white

(531) 28.03

(511)

34 – Lighters for smokers; ashtrays for smokers; electronic cigarettes; cigarettes containing tobacco substitutes, not for medical purposes; cigarettes; cigarette filters; matches; cigarette paper; cigarette cases; cigars; tobacco.

(260) AM 2022 114015 A

(800) 1603377

(151) 2021 02 19

(891) 2021 02 19

(731) ŞEYDA YENİGÜN

Zümrütevler Mah. Nil Cad., Seher Sk. No:41/1,
Maltepe, İstanbul, Turkey

(540)

HOMMLIFE

(591) Black, white

(531) 27.05.01

(511)

3 – Non-medicated cosmetics and toiletry preparations; non-medicated dentifrices; perfumery, essential oils; bleaching preparations and other substances for laundry use; cleaning, polishing, scouring and abrasive preparations.

35 – Advertising; business management; business administration; office functions; the bringing together, for the benefit of others, of a variety of goods including non-medicated cosmetics and toiletry preparations, non-medicated dentifrices, perfumery, essential oils, bleaching preparations and other substances for laundry use, cleaning, polishing, scouring and abrasive preparations enabling customers to conveniently view and purchase those goods, such services may be provided by retail stores, wholesale outlets, by means of electronic media or through mail order catalogues.

(260) AM 2022 114026 A

(800) 1587156

(151) 2021 02 04

(891) 2021 06 21

(731) Aktsionernoe obshchestvo "KROKUS
INTERNESHNL"

ul. Mezhdunarodnaya, d. 18, g. Krasnogorsk,
Krasnogorsky raion.; RU-143402 Moskovskaya
obl., Russian Federation

(540)

**CROCUS
FITNESS**
— Sport & Spa —

(591) Red and grey

(531) 26.11.08; 27.05.01; 27.07.01; 29.01.12

(526) Sport & Spa

(511)

9 – Scientific, photographic, cinematographic, optical, weighing, measuring, signalling, checking [supervision], teaching apparatus and instruments; apparatus for recording, transmission or reproduction of sound or images; magnetic data carriers, recording discs; compact discs, DVDs and other digital recording media; data processing equipment; monitoring apparatus, other than for medical purposes; encoded identification bracelets, magnetic; connected bracelets [measuring instruments]; scales; camcorders; video baby monitors; video cassettes; video screens; road signs, luminous or mechanical; weights; detectors; disks, magnetic; optical discs; electronic notice boards; life jackets; nose clips for divers and swimmers; measuring instruments; mouth guards for sports; identity cards, magnetic; video game cartridges; memory cards for video game machines; encoded magnetic cards; riding helmets; protective helmets; protective helmets for sports; electronic book readers; electronic agendas; compact discs [audio-video]; compact discs [read-only memory]; laptop computers; tablet computers; notebook computers; diving suits; surveying chains; decorative magnets; resuscitation mannequins [teaching apparatus]; divers' masks; portable media players; monitors [computer programs]; teeth protectors; temperature indicator labels, not for medical purposes; headphones; sound recording carriers; magnetic data media; optical data media; computer software, recorded; weighing machines; computer hardware; spectacles; sunglasses; goggles for sports; signalling panels, luminous or mechanical; transmitters [telecommunication]; gloves for divers; compact disc players; cassette players; distance recording apparatus; distance measuring apparatus; teaching apparatus; time recording apparatus; measuring apparatus; measuring devices, electric; observation instruments; computer software applications, downloadable; computer programs, recorded; computer game software, downloadable; computer programs, downloadable; electronic publications, downloadable; smartwatches; speed indicators; protection devices for personal use against accidents; audiovisual teaching apparatus; counters; ear plugs for divers; gauges; quantity indicators; tape recorders; video recorders; data processing apparatus; wearable activity trackers; adding machines; readers [data processing equipment]; bar code readers; downloadable ring tones for mobile phones; downloadable image files; downloadable music files; animated cartoons; chronographs [time recording apparatus]; frequency meters; time clocks [time recording devices]; head guards for sports; baby monitors.

16 – Paper and cardboard; printed matter; photographs; stationery and office requisites, except furniture; instructional and teaching material (except apparatus); plastic sheets, films and bags for wrapping

and packaging; fountain pens; aquarelles; albums; almanacs; atlases; posters; note books; banknotes; paper bows, other than haberdashery or hair decorations; table linen of paper; tickets; forms, printed; announcement cards [stationery]; drawing pads; pads [stationery]; wristbands for the retention of writing instruments; pamphlets; booklets; paper sheets [stationery]; waxed paper; paper for recording machines; toilet paper; wrapping paper; filter paper; blotters; newsletters; signboards of paper or cardboard; newspapers; electrotypes; engravings; document holders [stationery]; pencil holders; chalk holders; holders for cheque books; holders for stamps [seals]; page holders; diagrams; writing slates; blackboards; advertisement boards of paper or cardboard; duplicators; punches [office requisites]; magazines [periodicals]; money clips; tags for index cards; pen clips; bookmarks; periodicals; printed publications; graphic representations; calendars; pencils; pencil lead holders; pictures; transfers [decalcomanias]; paintings [pictures], framed or unframed; files [office requisites]; cards; index cards [stationery]; catalogues; glue for stationery or household purposes; books; manifolds [stationery]; comic books; envelopes [stationery]; cases for stamps [seals]; boxes of paper or cardboard; printed coupons; paper ribbons, other than haberdashery or hair decorations; typewriter ribbons; adhesive bands for stationery or household purposes; gummed tape [stationery]; inking ribbons; correcting tapes [office requisites]; adhesive tapes for stationery or household purposes; self-adhesive tapes for stationery or household purposes; flyers; absorbent sheets of paper or plastic for foodstuff packaging; humidity control sheets of paper or plastic for foodstuff packaging; viscose sheets for wrapping; sheets of reclaimed cellulose for wrapping; plastic bubble packs for wrapping or packaging; lithographs; plastics for modelling; graphic prints; modelling materials; sealing compounds for stationery purposes; adhesives [glues] for stationery or household purposes; packing [cushioning, stuffing] materials of paper or cardboard; packaging material made of starches; writing chalk; marking chalk; spray chalk; bags [envelopes, pouches] of paper or plastics, for packaging; stickers [stationery]; writing cases [stationery]; paper knives [letter openers]; numbering apparatus; bottle envelopes of paper or cardboard; passport holders; covers [stationery]; plastic cling film, extensible, for palletization; oleographs; musical greeting cards; greeting cards; postcards; etchings; conical paper bags; folders for papers; papier mâché; pastels [crayons]; modelling paste; pen cases; nibs; steel pens; drawing pens; song books; seals [stamps]; clipboards; handkerchiefs of paper; desk mats; letter trays; trays for sorting and counting money; coasters of paper; bookends; stamp stands; stands for pens and pencils; photograph stands; obliterating stamps; inking pads; stamp pads; towels of paper; inking sheets for document reproducing machines; portraits; paperweights; writing cases [sets]; inkstands; writing mate-

rials; writing instruments; school supplies [stationery]; adhesive tape dispensers [office requisites]; hand labelling appliances; lithographic works of art; prospectuses; printed timetables; ledgers [books]; printers' reglets; indexes; rubber erasers; elastic bands for offices; T-squares for drawing; graphic reproductions; marking pens [stationery]; penholders; tissues of paper for removing make-up; face towels of paper; table napkins of paper; place mats of paper; tablemats of paper; tablecloths of paper; paper clasps; document files [stationery]; paper-clips; staples for offices; erasing products; placards of paper or cardboard; writing or drawing books; pencil sharpeners, electric or non-electric; transparencies [stationery]; cardboard tubes; Indian inks; moisteners [office requisites]; chart pointers, non-electronic; bottle wrappers of paper or cardboard; envelope sealing machines for offices; manuals [handbooks]; paper coffee filters; figurines of papier mâché; flags of paper; silver paper; photo-engravings; stencil cases; canvas for painting; chromolithographs [chromos]; compasses for drawing; numbers [type]; stencils; erasing shields; desktop cabinets for stationery [office requisites]; printing type; address stamps; stamps [seals]; shields [paper seals]; prints [engravings]; labels of paper or cardboard.

18 – Leather and imitations of leather; luggage; umbrellas and parasols; walking sticks; mountaineering sticks; slings for carrying infants; luggage tags; pocket wallets; saddlecloths for horses; business card cases; credit card cases [wallets]; chamois leather, other than for cleaning purposes; umbrellas; parasols; frames for umbrellas or parasols; handbag frames; card cases [notecases]; cases of leather or leatherboard; valves of leather; imitation leather; leather, unworked or semi-worked; leatherboard; casings, of leather, for springs; umbrella rings; hat boxes of leather; boxes of leather or leatherboard; boxes of vulcanized fiber; purses; chain mesh purses; butts [parts of hides]; bags [envelopes, pouches] of leather, for packaging; moleskin [imitation of leather]; travelling sets [leatherware]; vanity cases, not fitted; furniture coverings of leather; trimmings of leather for furniture; music cases; garment bags for travel; shoulder belts [straps] of leather; briefcases; fur; haversacks; leather straps; straps for skates; chin straps, of leather; umbrella handles; walking stick handles; suitcase handles; rucksacks; travelling bags; net bags for shopping; umbrella or parasol ribs; bags; bags for climbers; pouch baby carriers; handbags; beach bags; bags for sports; bags for campers; school satchels; umbrella sticks; walking stick seats; key cases; suitcases; valises; attaché cases; umbrella covers; kid; leather cord.

25 – Clothing, footwear, headgear; sweat-absorbent underwear; boxer shorts; ski boots; boots for sports; football boots; sports jerseys; visors being headwear; wet suits for water-skiing; sports singlets; fingerless gloves; sweat-absorbent socks; sports shoes; motorists' clothing; cyclists' clothing; clothing for gymnas-

tics; ski gloves; bathing trunks; headbands [clothing]; tee-shirts; sweat-absorbent stockings; bathing caps; studs for football shoes; gymnastic shoes.

35 – Advertising; business management; business administration; advertising agency services; rental of advertising space; demonstration of goods; layout services for advertising purposes; business management of sports people; scriptwriting for advertising purposes; updating of advertising material; organization of exhibitions for commercial or advertising purposes; organization of fashion shows for promotional purposes; organization of trade fairs; shop window dressing; provision of an online marketplace for buyers and sellers of goods and services; web indexing for commercial or advertising purposes; presentation of goods on communication media, for retail purposes; sales promotion for others; production of advertising films; rental of advertising time on communication media; publicity material rental; rental of billboards [advertising boards]; rental of vending machines; rental of sales stands; publication of publicity texts; radio advertising; bill-posting; distribution of samples; dissemination of advertising matter; direct mail advertising; writing of publicity texts; online advertising on a computer network; advertising by mail order; television advertising; modelling for advertising or sales promotion; wholesale and retail services; pay per click advertising.

38 – Telecommunications services; wireless broadcasting; television broadcasting; cable television broadcasting; providing access to databases; electronic bulletin board services [telecommunications services]; providing internet chatrooms; providing telecommunication channels for teleshopping services; video-on-demand transmission; transmission of greeting cards online; message sending; computer aided transmission of messages and images; transmission of telegrams; transmission of digital files; providing online forums; videoconferencing services; radio broadcasting; transmission of electronic mail; communications by fiber optic networks; paging services [radio, telephone or other means of electronic communication]; teleconferencing services; telex services; voice mail services; streaming of data.

41 – Education; providing of training; entertainment; sporting and cultural activities; timing of sports events; game services provided online from a computer network; academies [education]; rental of sports grounds; rental of tennis courts; booking of seats for shows; videotaping; physical education; providing information in the field of entertainment; providing information relating to recreational activities; providing information in the field of education; health club services [health and fitness training]; screenplay writing; gymnastic instruction; correspondence courses; practical training [demonstration]; organization of exhibitions for cultural or educational purposes; providing recreation facilities; arranging and conducting of co-

loquiums; arranging and conducting of congresses; arranging and conducting of conferences; arranging and conducting of workshops [training]; arranging and conducting of in-person educational forums; arranging and conducting of seminars; arranging and conducting of symposiums; arranging of beauty contests; organization of competitions [education or entertainment]; organization of lotteries; organization of fashion shows for entertainment purposes; organization of sports competitions; vocational guidance [education or training advice]; television entertainment; vocational retraining; providing online videos, not downloadable; providing online music, not downloadable; providing golf facilities; providing sports facilities; providing amusement arcade services; conducting fitness classes; educational examination; film production, other than advertising films; games equipment rental; rental of stadium facilities; rental of skin diving equipment; rental of sports equipment, except vehicles; electronic desktop publishing; online publication of electronic books and journals; publication of texts, other than publicity texts; radio entertainment; tutoring; holiday camp services [entertainment]; personal trainer services [fitness training]; club services [entertainment or education]; teaching; orchestra services; coaching [training]; sport camp services; photography; photographic reporting; educational services provided by schools; providing online electronic publications, not downloadable.

43 – Services for providing food and drink; temporary accommodation; rental of meeting rooms; tourist home services; hotel services; snack-bar services; café services; cafeteria services; rental of tents; rental of transportable buildings; restaurant services; self-service restaurant services; canteen services; holiday camp services [lodging]; bar services; food and drink catering.

44 – Medical services; hygienic and beauty care for human beings; public bath services for hygiene purposes; manicuring; chiropractic; massage; Turkish bath services; hairdressing; beauty salon services; health counselling; services of a psychologist; sauna services; solarium services; telemedicine services; physical therapy; health center services.

(260) AM 2022 114065 A

(800) 1603833

(151) 2021 06 14

(891) 2021 06 14

(731) Kia Corporation

12, Heolleung-ro, Seocho-gu, Seoul,
Republic of Korea

(540)

KIA EV9

(591) Black, white

(531) 27.05.01; 27.05.19; 27.05.22; 27.07.01;
27.07.11

(511)
12 – Vans [vehicles]; motor buses; sports cars; automobiles; electric cars; trucks.

(260) AM 2022 114088 A

(800) 1604447

(151) 2021 04 28

(891) 2021 04 28

(731) OÜ Anvol

Kaldase tee 4, Maardu linn, Harju maakond,
EE-74114, Estonia

(540)



(591) Red, white

(531) 03.01.14; 03.01.16; 03.01.24; 24.17.02;

26.01.03; 26.01.16; 26.01.18; 26.01.24;

27.05.01; 27.05.24; 29.01.12

(511)

28 – Games, toys and playthings; video game apparatus; gymnastic and sporting articles; decorations for christmas trees; table-top games; building blocks (toys); building constructors (games); electric action toys; electronic toys; electronic games; electronic activity toys; electronic learning toys; electronic games for educational purposes; toys adapted for educational purposes; toy building blocks; scale model kits (toys); constructors (toys); electronic educational game machines for children; children's multiple activity tables (playthings); skill and action games; jigsaw puzzles; toys for educational purposes; games for educational purposes.

(260) AM 2022 114093 A

(800) 1604503

(151) 2021 03 26

(891) 2021 03 26

(731) Ewald Dörken AG

Wetterstrasse 58, 58313 Herdecke, Germany

(540)

DÖRKEN

(591) Black, white

(511)

1 – Chemical products for use in industry; unprocessed epoxy resins; chemical spray and dip solvents for corrosion protection for mass-produced small parts;

galvanizing baths; zinc-galvanizing baths, nickel-free; zinc-flake coatings; cathodic coatings; electrolytic coatings; cathodic coatings; industrial chemicals used in the production of flame-retardant coatings; chemicals for the manufacture of paints; adhesive agents; adhesives used in industry; solvent welding agents for sealing pond films (adhesives); unprocessed plastics; salt hydrates and mixtures containing salt hydrates, included in this class.

2 – Dyes, colorants, pigments and inks; thinners and thickeners for painting and colouring agents; paints and whitewashes; coatings; preparations for coating of surfaces for corrosion- and wear protection; tinting pastes being paints or colorants for colour-mixing installations; tinting pastes being paints or colorants for industrial manufacturing.

6 – Metal materials for building and construction; roof ridge copings, roof hip copings, of metal, in particular with plastic inserts or plastic backfilling; metal sheets for construction; facade sheets of metal; metal films, aluminum compound films; linings of metal for buildings.

17 – Goods of plastics or resins in extruded form for use in manufacturing processes; sealing-, packing- and insulating material for use in construction; hoses (not of metal) for construction purposes; sealing and insulating sheets; underlay sheets of plastic; underlay membranes of plastic; carrier webs; dimpled sheets of plastic for insulation and drainage purposes; underlay sheets with laminated insulating elements; insulating panels for building purposes, not of metal; underlay membranes, underlay nonwovens for building purposes, also for installation under photovoltaic or solar coverings; repair webs of plastic for insulating purposes; plastic nonwovens, including coated plastic nonwovens, included in this class; insulating plastic foils; plastic foils and objects made thereof, namely coverings for storerooms and for horticulture; garden and pond foils; insulating and drainage membranes of plastic; insulating foils; insulating fabrics; spreadable insulating material for buildings; water-impermeable sealings; sealing compounds; sealing preparations; sealing-strips; pipe sleeves, not of metal; elbow joints for hoses, not of metal; pipe couplings and joints, not of metal; waterproof foil membranes for use in manufacture; waterproof insulating membranes; microporous synthetic sheets for use in manufacture; foils (semi-finished products) as plastic material; translucent two-walled foils made of polycarbonates; nonwovens of crude fibres of glass [for insulation purposes]; nonwovens of crude fibres of carbon [for insulation purposes]; nonwovens of crude fibres of stone [for insulation purposes]; carbon fibre reinforced synthetic resins for use in manufacture; fibres for insulating purposes; chemical and synthetic fibres, other than for textile use; adhesive tapes for industrial use; separation-, protection-, sealing- and drainage sheets of metal.

19 – Materials, not of metal, for construction purposes; transportable buildings (not of metal); cladding components for buildings, not of metal; formwork liner sheets, not of metal; heat storage plates for building purposes; plastic composite panels; building materials (not of metal) in the form of reinforced and non-reinforced separating and protective webs, carrier webs, dimpled sheets for building purposes, included in this class; knitted and woven fabrics (not of metal) for building purposes, included in this class; geotextiles; building materials (not of metal) for wall and foundation protection as well as for soil stabilization and drainage, included in this class; high-strength technical woven and knitted fabrics, not of metal, for building purposes; small greenhouses; repair webs for building purposes, namely valleys and reinforcements, not of metal; roof ridge copings, roof hip copings, not of metal, in particular with plastic inserts or plastic backfilling; drainage, storage and filter webs for green roofs; bituminous products for building purposes; drainage pipes, not of metal; run-off channels, not of metal; floor drainage channels, not of metal; downpipes, not of metal, for rain water; run-off drains (channels), not of metal; non-woven fabrics for area protection [building materials]; damp proof membranes of synthetic plastics for building purposes; separating- and filter-nonwovens for building paths and terraces.

20 – Fasteners of plastic for building purposes, included in this class.

22 – Tarpaulins for construction purposes, included in this class; protective and covering tarpaulins; wind-break fabric; textile screens for protection against the wind; scaffolding tarpaulins; scaffolding nets.

24 – Breathable waterproof fabrics; non-woven fabrics in the form of webs for use in manufacture; cut-to-size nonwovens for manufacturing purposes; non-woven fabrics of synthetic fibres; reinforced fabrics of non-woven material.

35 – Wholesale and retail services, including through distribution companies, through independent commercial agents, as well as through mail order (including the internet) in relation to construction materials and chemical preparations, paints, lacquers, coatings as well as in relation to unprocessed artificial resins, unprocessed plastics, adhesives for industrial use, varnishes, corrosion protection preparations, wood preservatives, colouring agents, mordants, unprocessed natural resins, metal in foil and powder form for use in painting, decorating, printing and art, washing and bleaching preparations, cleaning-, polishing-, scouring- and abrasive preparations, industrial oils and greases, lubricants, dust absorbing, wetting and binding compositions, building materials of metal, goods made of plastics (semi-finished), sealing, packing, insulating material, flexible pipes (not of metal), construction materials (not of metal), pipes (not of metal)

for construction purposes, asphalt, pitch, and bitumen, nets, tarpaulins, padding, cushioning or stuffing materials (except rubber or plastics), raw fibrous textile, hooks and eyes; mediation and conclusion of commercial transactions for third parties; arranging of commercial and business contacts; assistance to commercial or industrial enterprises in the conduct of their business; professional business consultancy for franchising concepts; arranging of contracts for providing of craftsmen's services; professional business consultancy; business organization consultancy.

37 – Construction consultancy, in particular for building protection, on tinting paste techniques, building insulation in civil engineering, landscaping and horticulture; all the aforesaid services also online via the internet or other wireless media.

40 – Coating of plastic, metal and ceramic components for wear and corrosion protection; treatment of metal parts for corrosion protection; electroplating; applying of micro corrosion protection layers in dipping-, drawing-, spinning-, injection- and spraying processes, for others; nickel-free zinc galvanizing, for others; anti-corrosion coatings consultancy.

41 – Training, education; arranging and conducting conferences, exhibitions and competitions; arranging and conducting courses, seminars, training courses and workshops; all the aforesaid services in the fields of anticorrosive coatings, tinting paste technology, color technology and building insulation technologies in the fields of civil engineering, landscaping and horticulture; all the aforesaid services also online via the internet or other wireless media.

(260) AM 2022 114095 A

(800) 1604553

(151) 2021 06 30

(891) 2021 06 30

(731) GAS Familia, s.r.o.

Prešovská 8, Stará Ľubovňa, Slovakia

(540)



(591) Darck blue, brown, light brown, white

(531) 24.01.05; 24.01.18; 24.01.19; 25.07.15;
26.11.13; 27.05.01; 27.05.08; 27.05.09;
27.05.10; 27.07.01; 29.01.15

(511)
33 – Brandy.

(260) AM 2022 114096 A
(800) 1604573
(151) 2021 06 30
(891) 2021 06 30
(731) GAS Familia, s.r.o.
Prešovská 8, Stará Ľubovňa, Slovakia
(540)



(591) Black, blue, red, brown, white
(531) 23.05.05; 24.01.05; 24.01.18; 24.01.19;
25.01.06; 26.11.03; 26.11.13; 27.05.01;
27.05.02; 27.05.03; 27.05.09; 27.05.10;
27.05.11; 27.07.01; 29.01.15
(511)
33 – Rum.

(260) AM 2022 114117 A
(800) 1332289
(151) 2016 12 05
(891) 2021 07 15
(731) LO.LI. PHARMA S.R.L.
Via Sabatino Gianni 14, I-00156 Roma,
Italy
(540)

EUMASTOS

(591) Black, white
(511)
5 – Pharmaceutical preparations; dietetic food and substances adapted for medical use; dietary supplements and dietetic preparations for medical use.

(260) AM 2022 114164 A
(800) 1605311
(151) 2020 12 10
(891) 2020 12 10
(731) Zhejiang yifan piping co., LTD
No 3 zhongyang road, diankou town,
zhuji city, shaoxing city, 311835 zhejiang
province, China

(540)

Ifan

(591) Black, white
(531) 27.05.17
(511)
11 – Lamps; water supply installations; cooling appliances and installations; radiators, electric; water purifying installations and apparatus.

17 – Pipe jackets, not of metal; cylinder jointings; plastic substances, semi-processed; plastic sheeting for agricultural purposes; flexible tubes, not of metal; connecting hose for vehicle radiators.

19 – Safety glass; diving boards, not of metal; stone; cement; cement pipe; coatings; silicon-sand (terms too vague in the opinion of the International Bureau – Rule 13 (2) (b) of the Regulations); ointment (terms too vague in the opinion of the International Bureau – Rule 13 (2) (b) of the Regulations).

(260) AM 2022 114165 A
(800) 1605335
(151) 2021 04 12
(891) 2021 04 12
(731) Public Joint Stock Company "Krasnyj Ocyabr"
ul. Malaya Krasnoselskaya, d. 7, str. 24,
RU-107140 Moscow, Russian Federation
(540)

KINOCORN

(591) Black, white
(511)
30 – Star aniseed; pancakes; buns; waffles; sweets; cocoa; coffee; cinnamon [spice]; biscuits; capers; seasonings; caramels [sweets]; cereal preparations; fondants [confectionery]; cake powder; mint for confectionery; gingerbread; chewing gum; ice, natural or artificial; chips [cereal products]; corn flakes; pies; groats for human food; cocoa beverages with milk; pastilles [confectionery]; coffee beverages with milk; chocolate beverages with milk; pralines; sago; molasses for food; chocolate; marzipan; condiments; crackers; halvah; hominy grits; chocolate mousses; chocolate-based spreads; chocolate spreads containing nuts; mints for breath freshening.

(260) AM 2022 114166 A
(800) 1605340
(151) 2021 03 23
(891) 2021 03 23
(731) Egis Gyógyszergyár Zrt.
Kereszturi út 30-38, H-1106 Budapest,
Hungary

(540)



(591) Dark blue and purple

(531) 26.11.09; 26.11.25; 27.05.10; 29.01.12

(511)

3 – Cosmetics and cosmetic preparations.

5 – Pharmaceutical preparations for human use; dietetic substances adapted for medical use; dietary supplements; medicinal ointments; medicated skin creams; plasters, materials for dressings.

(260) AM 2022 114184 A

(800) 1605896

(151) 2021 03 26

(891) 2021 03 26

(731) Obshchestvo s ogranichennoy otvetstvennostyu
"CHEST"
ul. Energetikov, d.24, Ofis 443, RU-140090
g.Dzerzhinsky, obl.Moskovskaya, Russian
Federation

(540)



(591) Black, white

(531) 26.04.04; 26.04.05; 26.04.08; 26.04.12;
27.05.01

(511)

19 – Linings, not of metal, for building; wood for making household utensils; luminous paving blocks; mooring bollards, not of metal; greenhouse frames, not of metal; flashing, not of metal, for building; laths, not of metal; roofing tiles, not of metal; sand, except foundry sand; roofing slates; earth for bricks; potters' clay; drain traps [valves], not of metal or plastic; clay; agglomerated cork for building; cement for furnaces; binding material for road repair; reeds for building; balustrades, not of metal; insect screens, not of metal; wainscotting, not of metal; asphalt; bituminous products for building; reinforcing materials, not of metal, for building; platforms, prefabricated, not of metal; vinyl siding; road marking sheets and strips of synthetic material; mouldings, not of metal, for cornices; pigsties, not of metal; alabaster; posts, not of metal, for power lines; paint spraying booths, not of metal; works of stonemasonry; paving blocks, not of metal; signalling panels, non-luminous and non-mechanical, not of metal; aquarium sand; rigid pipes, not of metal, for building; drain pipes, not of metal; roofing, not of

metal, incorporating photovoltaic cells; casement windows, not of metal; stained-glass windows; xylolith; lengthening pieces, not of metal, for chimneys; framework, not of metal, for building; cornices, not of metal; plywood; gates, not of metal; aquarium gravel; chimney shafts, not of metal; rock crystal; swimming pools [structures], not of metal; prefabricated houses [kits], not of metal; ducts, not of metal, for ventilating and air-conditioning installations; letter boxes of masonry; tombs, not of metal; bicycle parking installations, not of metal; greenhouses, transportable, not of metal; raw chalk; tanks of masonry; door frames, not of metal; limestone; tarred strips for building; window frames, not of metal; hips for roofing; palings, not of metal; coal tar; mortar for building; roof gutters, not of metal; building stone; ceilings, not of metal; plate glass [windows] for building; chimney cowls, not of metal; bitumen paper for building; roof coverings, not of metal; wall linings, not of metal, for building; telephone booths, not of metal; masts [poles], not of metal; road coating materials; buildings, not of metal; cement; refractory construction materials, not of metal; beams, not of metal; tombs [monuments], not of metal; advertisement columns, not of metal; staircases, not of metal; joists, not of metal; concrete; paving slabs, not of metal; windows, not of metal; lattice-work, not of metal; firebricks; coatings [building materials]; porches [structures], not of metal; plaster; busts of stone, concrete or marble; penstock pipes, not of metal; silos, not of metal; materials for making and coating roads; duckboards, not of metal; wood veneers; building panels, not of metal; cement posts; cement for blast furnaces; window glass for building; sills, not of metal; caissons for construction work under water; mouldable wood; manhole covers, not of metal; manufactured timber; cement slabs; props, not of metal; bituminous coatings for roofing; road signs, non-luminous and non-mechanical, not of metal; felt for building; artificial stone; safety glass; silica [quartz]; partitions, not of metal; binding agents for making briquettes; gravestones; alabaster glass; roof flashing, not of metal; fireplace mantles; stone; concrete building elements; mouldings, not of metal, for building; furrings of wood; porphyry [stone]; calcareous marl; paperboard for building; parquet flooring; wood paving; pantiles, not of metal; wood pulp board for building; asbestos mortar; foundry moulds, not of metal; marble; roofing, not of metal; door panels, not of metal; schists; crash barriers, not of metal, for roads; rocket launching platforms, not of metal; cabanas, not of metal; sawn timber; statuettes of stone, concrete or marble; terra-cotta [building material]; doors, not of metal; magnesia cement; quartz; wall claddings, not of metal, for building; tile floorings, not of metal; wooden floor boards; agglomerated bagasses of cane [building material]; mosaics for building; floating docks, not of metal, for mooring boats; rubble; wood, semi-worked; fireproof cement coatings; lime; slate; shuttering, not of metal, for concrete; roofing shing-

les; fences, not of metal; tomb or grave enclosures, not of metal; tombstone stelae, not of metal; burial vaults, not of metal; railway sleepers, not of metal; gravel; monuments, not of metal; pilings, not of metal; wood panelling; bricks; bird baths [structures], not of metal; silver sand; building glass; statues of stone, concrete or marble; olivine for building; beacons, not of metal, non-luminous; turnstiles, not of metal; geotextiles; posts, not of metal; street gutters, not of metal; tufa; insulating glass for building; parquet floor boards; wall tiles, not of metal; shutters, not of metal; gutter pipes, not of metal; works of art of stone, concrete or marble; clinker ballast; gypsum [building material]; stair-treads [steps], not of metal; cask wood; huts; water-pipes, not of metal; lintels, not of metal; tiles, not of metal, for building; building materials, not of metal; building paper; scantlings [carpentry]; veneer wood; skating rinks [structures], not of metal; scaffolding, not of metal; sandstone pipes; slabs, not of metal, for building; memorial plaques, not of metal; non-metal stables; granite; diving boards, not of metal; water-pipe valves, not of metal or plastic; angle irons, not of metal; chimneys, not of metal; asbestos cement; slag [building material]; chimney pots, not of metal; aviaries [structures], not of metal; jalousies, not of metal; arbours [structures], not of metal; outdoor blinds, not of metal and not of textile; stringers [parts of staircases], not of metal; tar; fireclay; tombstone plaques, not of metal; bitumen; macadam; non-luminous and non-mechanical signs, not of metal; telegraph posts, not of metal; asphalt paving; sandstone for building; perches; folding doors, not of metal; branching pipes, not of metal; slate powder; aquaria [structures]; glass granules for road marking; window glass, other than vehicle window glass; grave slabs, not of metal; slag stone; floor tiles, not of metal; fair huts; pitch; planks of wood for building; chicken-houses, not of metal; buildings, transportable, not of metal; floors, not of metal.

35 – Shop window dressing; data search in computer files for others; production of advertising films; commercial intermediation services; advertising; professional business consultancy; updating of advertising material; distribution of samples; negotiation and conclusion of commercial transactions for third parties; word processing; sales promotion for others; advertising agency services; search engine optimization for sales promotion; invoicing; writing of publicity texts; book-keeping; computerized file management; compilation of information into computer databases; providing commercial and business contact information; presentation of goods on communication media, for retail purposes; systemization of information into computer databases; rental of vending machines; cost price analysis; marketing research; organization of exhibitions for commercial or advertising purposes; public relations; rental of sales stands; arranging subscriptions to telecommunication services for others; procurement services for others [purchasing goods and ser-

vices for other businesses]; advertising by mail order; payroll preparation; direct mail advertising; administrative services for the relocation of businesses; business appraisals; business management of hotels; secretarial services; business management and organization consultancy; auctioneering; rental of photocopying machines; commercial or industrial management assistance; opinion polling; website traffic optimization; rental of advertising space; organization of trade fairs; sponsorship search; business auditing; price comparison services; bill-posting; news clipping services; employment agency services; layout services for advertising purposes; business investigations; rental of advertising time on communication media; business efficiency expert services; compilation of statistics; telephone answering for unavailable subscribers; business organization consultancy; personnel management consultancy; providing business information; economic forecasting; television advertising; online advertising on a computer network; organization of fashion shows for promotional purposes; advisory services for business management; business project management services for construction projects; administrative processing of purchase orders; business inquiries; tax preparation; business research; personnel recruitment; business management for freelance service providers; modelling for advertising or sales promotion; shorthand; import-export agency services; pay per click advertising; publication of publicity texts; providing business information via a website; psychological testing for the selection of personnel; providing commercial information and advice for consumers in the choice of products and services; transcription of communications [office functions]; business management consultancy; office machines and equipment rental; updating and maintenance of data in computer databases; commercial administration of the licensing of the goods and services of others; dissemination of advertising matter; outsourcing services [business assistance]; typing; business management of performing artists; commercial information agency services; marketing; radio advertising; business management assistance; telemarketing services; retail services for pharmaceutical, veterinary and sanitary preparations and medical supplies; photocopying services; market studies; business management of sports people; arranging newspaper subscriptions for others; publicity material rental; drawing up of statements of accounts; demonstration of goods.

(260) AM 2022 114185 A

(800) 1605952

(151) 2021 07 05

(891) 2021 07 05

(731) SHANGHAI TOBACCO GROUP CO., LTD.
717 Chang Yang Road, Yangpu District,
Shanghai, China

(540)

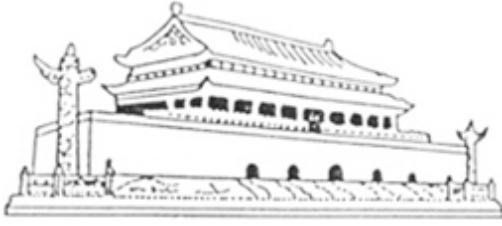

(591) Black, white
(531) 07.01.05; 07.01.06; 07.01.24
(511)
34 – Cigarettes; cigars.

(260) AM 2022 114186 A
(800) 1605970
(151) 2021 01 20
(891) 2021 01 20
(731) FATEKS TERLİK SANAYİ VE TİCARET
LİMİTED ŞİRKETİ
Merkez Efendi Mahallesi, Gümüşsuyu Caddesi,
Işık Sanayi Sitesi, A Blok No:21 Kat:1, Maltepe,
Topkapı Zeytinburnu, İstanbul, Turkey

(540)

FATEX

(591) Black, white
(511)
25 – Footwear, shoes, wellies, boots, slippers, booties,
sports shoes.

(260) AM 2022 114187 A
(800) 1605973
(151) 2021 05 21
(891) 2021 05 21
(731) TUTA LLC
Mtkvari Street, N6, Floor 1, Apartment N1a,
0105 Tbilisi, Krtsanisi District, Georgia

(540)

TUTA

(591) Black, white
(511)
37 – Automobile repair and maintenance; vehicle
washing.

39 – Rental of scooters for transportation purposes;
rental of push scooters (vehicles) for transportation
purposes; provision of hired vehicles; food delivery
services; taxi transport; transport of passengers by car;
car rental; passenger transportation services by land;
providing taxi booking services via mobile applica-
tion.

(260) AM 2022 114188 A
(800) 1605979
(151) 2021 05 21
(891) 2021 05 21

(731) DOC GENERICI S.r.l.
Via Filippo Turati 40, I-20121 MILANO,
Italy

(540)

ARNISTIL

(591) Black, white
(511)
5 – Artificial tears; collyrium; pharmaceuticals.

(260) AM 2022 114210 A
(800) 1039445
(151) 2010 04 14
(891) 2021 07 22
(731) BESIX Group, société anonyme
Avenue des Communautés 100, 1200 Bruxelles,
Belgium

(540)



(591) Red, white and various shades of blue
(531) 26.04.04; 26.07.15; 26.11.12; 29.01.13
(511)

35 – Administrative advice on laws, regulations and
permit requests in matters relating to respect for the
environment, and compliance with security standards;
administrative management of non-compliance follo-
wing site hand-over.

36 – Organization of collections, fund raising, chari-
table fund raising; financial sponsorship (sponsoring)
of charity; financial assistance to development; spon-
sorship services; real estate broking.

37 – Building construction; repair; installation servi-
ces; information on construction matters; supervision
of building work.

40 – Treatment of materials; water treatment.

42 – Scientific and technological services and rese-
arch and design relating thereto; industrial analysis
and research services; services provided by engineers,
advice on civil engineering; architectural consultation;
supervision, monitoring and quality control of site
work and of their compliance with norms, laws, rules,
practices and standards, both national and internatio-
nal, on the environment and building safety.

(260) AM 2022 114211 A
(800) 1122567
(151) 2012 05 16
(891) 2021 07 16
(731) Katjes Fassin GmbH + Co. KG
Dechant-Sprünken-Straße 53-57, 46446
Emmerich, Germany

(540)

Katjes

(591) Black, white

(511)

30 – Sweetmeats (candy); gum and foam confectionery with fruit flavours, including fruit gums and wine gums; fruit jellies (confectionery); liquorice (confectionery); confectionery.

(260) AM 2022 114212 A

(800) 1348656

(151) 2016 03 29

(891) 2021 07 16

(731) Gottfried Stiller GmbH

Bonner Wall 29, 50677 Köln, Germany

(540)

MEGABAD
Der Profi fürs Bad

(591) Blue and white

(531) 27.05.10; 29.01.05; 29.01.12

(511)

11 – Apparatus for lighting, heating, steam generating, cooking, refrigerating, drying, ventilating, water supply and sanitary purposes, kitchen stoves, cooking utensils (electric), cooking stoves, refrigerators, kitchen extraction hoods.

19 – Building materials (non-metallic), structural elements (non-metallic).

20 – Furniture, mirror cabinets, shelves, sideboards, hanging cabinets, high cabinets, wall cupboards, seating furniture, kitchen furniture, mirrors, standing mirrors, wall mirrors.

21 – Household or kitchen utensils and containers, unworked or semi-worked glass (except glass used in building); glassware porcelain and earthenware, insofar as they are not included in other classes.

35 – Advertising, business management, business administration; office functions; arranging and conclusion of commercial transactions, also in context of e-commerce; commercial retailing in the fields apparatus for lighting, heating, steam generating, cooking, refrigerating, drying, ventilating, water supply and sanitary purposes, building materials (non-metallic), structural elements (non-metallic), furniture, mirror cabinets, shelves, sideboards, hanging cabinets, high cabinets, wall cupboards, seating furniture, kitchen furniture, mirrors, standing mirrors, wall mirrors, household or kitchen utensils and containers, kitchen stove, cooking utensils (electric), cooking stoves, refrigerators, dishwashers, kitchen extraction hoods, unworked or semi-worked glass (except glass used in building), glassware, porcelain and earthenware.

37 – Building construction; repair of apparatus for lighting, heating, steam generating, cooking, refrigerating, drying, ventilating, water supply and sanitary purposes, household or kitchen utensils and containers, kitchen ware (electric), kitchen hobs, refrigerators, dishwashers, kitchen extraction hoods; installation services.

(260) AM 2022 114213 A

(800) 1463518A

(151) 2019 03 14

(891) 2021 07 21

(731) Seagen Inc.

21823 30th Drive S.E., Bothell WA 98021,

USA

(540)

TIVDAK

(591) Black, white

(511)

5 – Pharmaceutical preparations for use in humans, namely, chemotherapeutics and biopharmaceuticals; pharmaceutical preparations for the prevention and treatment of disorders of the nervous system, the immune system, the cardio-vascular system, the metabolic system, the respiratory system, the musculo-skeletal system, and the genitourinary system; pharmaceutical preparations for the treatment of cancer, autoimmune diseases, and inflammatory disorders; pharmaceutical preparations for use in dermatology, oncology, hematology, ophthalmology, gastroenterological disorders, and tissue and organ transplantation.

42 – Biotechnology research, namely, research and development of pharmaceutical preparations for use in humans; research and development of pharmaceutical preparations for the diagnosis, prevention and treatment of disorders of the nervous system, the immune system, the cardio-vascular system, the metabolic system, the respiratory system, the musculo-skeletal system, and the genitourinary system; research and development of pharmaceutical preparations for the diagnosis, prevention and treatment of cancer, autoimmune diseases, inflammatory disorders, gastroenterological disorders and for use in dermatology, oncology, hematology, ophthalmology, and tissue and organ transplantation.

(260) AM 2022 114267 A

(800) 1606871

(151) 2021 06 08

(891) 2021 06 08

(731) Bibi Graetz di Dan Graetz

Piazza Mino 37, I-50014 Fiesole, Firenze,

Italy

(540)

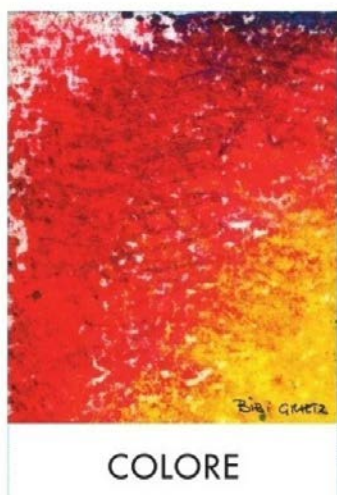

(591) Red, yellow, orange and purple
 (531) 22.05.01; 26.04.05; 26.04.16; 26.15.01;
 27.05.13; 29.01.14

(511)
 33 – Wine.

(260) AM 2022 114268 A
 (800) 1606959
 (151) 2021 03 10
 (891) 2021 03 10
 (731) ZHEJIANG AKKO STAR ELECTRONIC
 TECHNOLOGY CO., LTD
 4th floor, 399 Yin Hai Road, Futian street,
 Yiwu City, Zhejiang Province, China

(540)

(591) Black, white
 (531) 01.15.03; 27.05.01; 27.05.08; 27.05.17
 (511)

9 – Distribution box (electricity); junction box (electricity); rectifier; inverter (electricity); surge protector; starters for electric lights; doorbell; electrical wire; coaxial cable; circuit breaker; automatic time switch; test pen; power plug converter; battery; antenna; signal transponder; measuring apparatus and instruments; complete set of electrical calibration device; electrical switch; electrical plugs, electrical sockets and other electrical contacts (electrical connection); circuit breaker; dimmer (electricity); electrical cables; transformer (electricity); brake box (electricity).

(260) AM 2022 114269 A
 (800) 1606964
 (151) 2021 05 25
 (891) 2021 05 25
 (731) GNOSIS S.p.A.
 Piazza Filippo Meda, 3, I-20121 Milano,
 Italy

(540)

(591) Green (Pantone 5777C) and Black (Pantone 7C)
 (531) 05.03.13; 05.03.14; 27.01.11; 27.05.01;
 27.05.10; 27.07.01; 29.01.12

(511)

1 – Vitamins used as active ingredients in the manufacture of pharmaceutical preparations, food preparations, food supplements.

5 – Vitamins; vitamin supplements; dietetic substances composed of dietetic vitamins for medical and pharmaceutical use; food supplements; nutritional and dietetic supplements; bacteria and bacterial preparations for pharmaceutical or medical use; preparations of probiotics or other nutrients for human consumption; probiotic composition for human food; culture of micro-organisms with a probiotic effect on the human organism, for medical use.

(260) AM 2022 114270 A
 (800) 1606971
 (151) 2021 05 14
 (891) 2021 05 14
 (731) servFaces Holding GmbH & Co. KG
 Breitscheidstraße 78, 01237 Dresden, Germany
 (540)

Servfaces

(591) Black, white
 (511)

1 – Anti-fogging agent [chemical product]; anti-fogging agent for glass [chemical products]; chemicals for coating of fabrics, furs, leather, fleece and textiles; chemicals for the impregnation of fabrics, furs, leather, fleece and textiles; chemicals used for leather treatments; chemical products as additives for concrete; chemical products for the treatment of metals; chemical product for the treatment of metal surfaces; chemical products for the floor treatment; chemical products for the electrical industry; chemical products for the production of flame retardant coatings; chemical products for agriculture; chemical products for commercial and scientific purposes; chemical products for commercial purposes for the production of varnish; chemical products for the production of colorants; chemical products for the production of leather; chemical products for the production of protective coatings; chemical impregnation products for leather; chemical products and preparations for processing leather; chemical products for sealing surfaces; chemical compounds for sealing purposes in the building industry; chemical sealing products; chemical sealing products for closing leaks in oil tanks; chemical sealing products for use in the building industry; chemical sealing products for use in the construction industry;

sealing [chemical products] for bricks; waterproof protective coatings for surfaces [chemical, paints excluded].

2 – Floor sealing compounds [paints and oils]; coatings for the finishing of concrete; surface coating compositions [paints]; protective coatings with sealing qualities for use on concrete [paints]; paint sealers; sealing lacquer for paints; sealants [paints]; water resistant decorative surface coatings.

3 – Vehicle cleaning preparations; leather preservatives [polishes]; leather polishes; preservative creams for leather.

35 – Procurement services for others [purchasing goods and services for other businesses]; export-import agency services; import agency services.

37 – Automobile reconditioning services; surface conditioning of boats.

40 – Glass resurfacing; surfacing of textiles.

(260) AM 2022 114296 A

(800) 1607736

(151) 2021 04 07

(891) 2021 04 07

(731) Astra Energy SA

Helvetique boulevard, 31, CH-1207 Geneva,
Switzerland

(540)



(591) Gold, red and white

(531) 05.03.06; 05.03.13; 26.04.02; 26.04.04;
26.04.07; 26.04.15; 29.01.13

(511)

29 – Oils for food; sunflower oil for food.

(260) AM 2022 114297 A

(800) 1607747

(151) 2021 06 30

(891) 2021 06 30

(731) Saxo Bank A/S

Philip Heymans Allé 15, DK-2900 Hellerup,
Denmark

(540)



(591) Blue and white

(531) 25.05.02; 26.04.02; 26.04.07; 26.04.18;
26.04.24; 27.05.10; 29.01.12

(511)

36 – Finance services; monetary affairs; banking; electronic funds transfer; financial management; financial information; financial consultancy; clearing, financial; financing services; financial evaluations [banking]; trusteeship of money; home banking; debt collection; capital investment; mutual funds; factoring; stocks and bonds brokerage; stock exchange quotations; consulting and information concerning insurance; insurance consultancy; business liquidation services, financial; debit card services; issuance of credit cards; payment card services; credit bureau services; hire-purchase financing; loans [financing]; lending against securities; fiscal valuation; cheque verification; safe deposit services; currency trading and exchange services; deposits of valuables; investment banking services.

(260) AM 2022 114298 A

(800) 1607794

(151) 2021 06 15

(891) 2021 06 15

(731) 1661, Inc.

3433 W. Exposition Place, Los Angeles
CA 90018, USA

(540)

GOAT

(591) Black, white

(511)

25 – Clothing, namely, tops, shirts, blouses, sweaters, sweaters, vests, jackets, coats, hoodies, bottoms, pants, shorts, skirts, leggings, dresses, jumpsuits, sleepwear, underwear, lingerie, robes, swimwear, socks, tights, gloves, scarves, shawls, bandanas, neckwear, rainwear, snow pants, snow suits; footwear; footwear.

(260) AM 2022 114299 A

(800) 826899

(151) 2003 12 31

(891) 2021 05 10

(731) BMC OTOMOTIV SANAYI VE TICARET
ANONIM SIRKETI

Oruc Reis Mahallesi Tekstil Kent Caddesi,

Koza Plaza A Blok K. 4. D. 13-14-15-16,
Esenler, Istanbul, Turkey

(540)

PROCITY

(591) Black, white

(531) 27.05.01

(511)

12 – Apparatus for locomotion by land and parts thereof; motor vehicles, namely automobiles, buses, trucks, tractors, refrigerated vehicles, ambulances, concrete mixing vehicles, dustcarts, street washers, gully emptiers, sports cars, golf carts, forklifts, military vehicles for transport and parts thereof (included in this class); motor car accessories (included in this class); motors and engines for land vehicles and parts thereof (included in this class); vehicle wheels, rims for vehicle wheels, balance weights for vehicle wheels; chassis for vehicles and automobiles; connecting rods (other than parts of motors and engines), couplings, gearboxes, reduction gears, electric motors, cylinder and cylinder liners, clutches, clutch discs, turbines, torsion bars, torque converters, gearings, transmission chains, driving chains for land vehicles; bumpers for vehicles and automobiles; doors, windows, hoods, running boards, mudguards, axles, axle journals for vehicles; hoods for vehicle engines; vehicle bodies, tipping bodies for trucks, trailers for tractors, refrigerated bodies, tipping and lifting apparatus for trucks and wagons (part of vehicles), shock absorbers for automobiles; suspension shock absorbers and shock absorbing springs for vehicles; repair outfits for brakes, breaking devices and parts, brakes, brake linings, brake shoes, brake segments for vehicles; vehicle seats, head-rests for vehicle seats, safety seats for children, direction signals for vehicles; tyres, inner tubes and tubeless tyres for vehicles; repair outfits for inner tubes, patches for repairing inner tubes, valves for vehicle tyres, windscreen wipers, petrol tanks for vehicles, anti-skid chains; luggage, cycle and ski carriers for vehicles; air pumps (vehicle accessories); anti-theft alarms, horns for vehicles; safety belts for vehicle seats, air bags, seat covers for vehicles, vehicle covers, sun shields and visors for automobiles, trailer hitches for vehicles, rearview mirrors, steering knuckles, vehicle suspension springs, steering wheels for vehicles; parts and components of all above goods (included in this class).

(260) AM 2022 114356 A

(800) 1608088

(151) 2021 05 12

(891) 2021 05 12

(731) Obshchestvo s ogranichennoy otvetstvennostju
BUROCRAT
Uglovaya str., vl. 2/1, str. 1, g. Chekhov,
RU-142305 Moskovskaya obl., Russian
Federation

(540)



(591) Red and black

(531) 26.13.25; 27.05.01; 29.01.12

(511)

20 – Coatstands; furniture casters, not of metal; arm-chairs; trestles [furniture]; trolleys for computers [furniture]; tables; tables of metal; desks; chairs [seats].

(260) AM 2022 114358 A

(800) 1608124

(151) 2021 05 25

(891) 2021 05 25

(731) Obshchestvo s ogranichennoy,
otvetstvennost'yu "EVROTORG"
ul. Kazintsya, d. 52a, k. 22, 220099 Minsk,
Belarus

(540)

ЦЕРИТЕЛИ TSERITELI

(591) Black, white

(531) 28.05

(511)

33 – Alcoholic beverages, except beer.

(260) AM 2022 114360 A

(800) 1608153

(151) 2021 05 12

(891) 2021 05 12

(731) Obshchestvo s ogranichennoy otvetstvennostju
BUROCRAT
Uglovaya str., vl. 2/1, str. 1, g. Chekhov,
RU-142305 Moskovskaya obl., Russian
Federation

(540)



(591) Red and white

(531) 26.13.25; 27.05.01; 29.01.12

(511)
20 – Coatstands; furniture casters, not of metal; armchairs; trestles [furniture]; trolleys for computers [furniture]; tables; tables of metal; desks; chairs [seats].

(260) AM 2022 114386 A
(800) 748772
(151) 2000 11 22
(891) 2021 07 30
(731) Société des Produits Nestlé SA
CH-1800 Vevey, Switzerland
(540)

PICNIC

(591) Black, white
(511)
31 – Animal feed.

(260) AM 2022 114387 A
(800) 833796
(151) 2004 08 27
(891) 2021 07 30
(731) Société des Produits Nestlé S.A.
CH-1800 Vevey, Switzerland
(540)

DELI-BON

(591) Black, white
(511)
5 – Veterinary preparations; vitamins and vitamin-enriched preparations for animals; additives for veterinary purposes.
31 – Animal foodstuffs, edible chews for animals, biscuits and snacks for animals.

(260) AM 2022 114388 A
(800) 857488
(151) 2005 04 29
(891) 2021 05 25
(731) Changcheng Electrical Group Zhejiang
Technology Co., Ltd
Hutou Industrial Zone, Liushi Town,
Yueqing Clty, Zhejiang Province, China

(540)

CNC

(591) Black, white
(531) 27.05.01; 27.05.17; 27.05.23
(511)
9 – Converters, electric; capacitors; resistances, electric; relays, electric; fuses; starters; stabilized voltage power supplies; electric switches; high and low voltage switch boards; plugs, sockets and other contacts (electric connections); measuring devices, electric;

power distributing devices for high-low voltage explosion proof; door closers, electric; photocopiers; video recorders; tape recorders; bus ducts.

(260) AM 2022 114389 A
(800) 1248546
(151) 2015 04 01
(891) 2021 07 30
(731) Société des Produits Nestlé S.A.
CH-1800 Vevey, Switzerland
(540)

DENTALIFE

(591) Black, white
(511)
31 – Foodstuffs for animals.

(260) AM 2022 114390 A
(800) 1358566
(151) 2017 05 22
(891) 2021 07 30
(731) Société des Produits Nestlé S.A.
CH-1800 Vevey, Switzerland
(540)

FORTIFLORA

(591) Black, white
(511)
5 – Nutritional supplements for animals.

(260) AM 2022 114437 A
(800) 1609513
(151) 2021 06 02
(891) 2021 06 02
(731) Société Jas Hennessy & Co.
Rue de la Richonne, F-16100 Cognac,
France
(540)



(591) Black, white
(531) 02.09.14; 14.07.02; 24.13.25; 26.11.13
(511)
33 – Alcoholic beverages (with the exception of beers); alcoholic extracts; alcoholic essences; alcoholic fruit extracts.

(260) AM 2022 114438 A
(800) 1609544
(151) 2021 06 29
(891) 2021 06 29
(731) Barilla G. e R. Fratelli – Società per Azioni
Via Mantova 166, I-43122 Parma PR, Italy
(540)



(591) Red and white
(531) 26.01.02; 26.01.20; 26.01.24; 27.05.24;
29.01.12

(511)
31 – Agricultural, horticultural and forestry products and grains, not included in other classes; live animals; fresh fruits and vegetables; seeds; natural plants and flowers; foodstuffs for animals; malt.

32 – Beers; mineral and aerated waters and other non-alcoholic drinks; fruit drinks and fruit juices; syrups and other preparations for making beverages.

33 – Alcoholic drinks (except beers).

42 – Scientific and technological services and related research and design services; industrial analysis and research services; design and development of computer hardware and software.

(260) AM 2022 114440 A
(800) 1609663
(151) 2021 03 26
(891) 2021 03 26
(731) SKSHU PAINT CO., LTD.
518 Liyuan Road North, Licheng District,
Putian, Fujian Province, China
(540)



(591) Red and green
(531) 05.03.13; 05.03.14; 25.03.01; 27.05.01;
27.05.24; 27.07.11; 27.07.24; 29.01.13

(511)
1 – Chemicals for the manufacture of paints; industrial chemicals; oil cement [putty]; synthetic resins, unprocessed; plasticizers; glue for industrial purposes; gluten [glue], other than for stationery or household purposes; neoprene; polyvinyl acetate emulsions; adhesives for industrial purposes.

19 – Plywood; mortar for building; cement; concrete building elements; tiles, not of metal, for building; fireproof cement coatings; non-metallic waterproof building materials in roll form; building materials, not of metal; buildings, not of metal; coatings [building materials].

INTERNATIONAL TRADEMARKS PROTECTED IN GEORGIA

(260) AM 2022 109456 A
(800) 1546158
(151) 2020 03 23
(181) 2030 03 23
(891) 2020 03 23
(511) 06, 22, 35, 37, 39, 43

(260) AM 2022 109796 A
(800) 1550714
(151) 2020 07 03
(181) 2030 07 03
(891) 2020 07 03
(511) 08, 20, 21, 24, 25, 35

(260) AM 2022 109888 A
(800) 1551935
(151) 2020 05 29
(181) 2030 05 29
(891) 2020 05 29
(511) 28, 41

(260) AM 2022 109973 A
(800) 1552722
(151) 2020 07 03
(181) 2030 07 03
(891) 2020 07 03
(511) 08, 20, 21, 24, 25, 35

(260) AM 2022 110250 A
(800) 1556591
(151) 2019 12 27
(181) 2029 12 27
(891) 2019 12 27
(511) 29, 30, 30, 31, 32, 33

(260) AM 2022 110585 A
(800) 1561278
(151) 2020 08 04
(181) 2030 08 04
(891) 2020 08 04
(511) 09, 42

(260) AM 2022 110596 A
(800) 1461566
(151) 2018 12 13
(181) 2028 12 13
(891) 2020 07 03
(511) 09

(260) AM 2022 110726 A
(800) 1563619
(151) 2020 06 30
(181) 2030 06 30
(891) 2020 06 30
(511) 03, 10

(260) AM 2022 111578 A
(800) 1538629
(151) 2020 05 11
(181) 2030 05 11
(891) 2021 01 18
(511) 01, 05

(260) AM 2022 111634 A
(800) 1574671
(151) 2020 07 30
(181) 2030 07 30
(891) 2020 07 30
(511) 10

(260) AM 2022 112024 A
(800) 1579081
(151) 2020 11 30
(181) 2030 11 30
(891) 2020 11 30
(511) 05

(260) AM 2022 112199 A
(800) 1581008
(151) 2020 12 10
(181) 2030 12 10
(891) 2020 12 10
(511) 14

(260) AM 2022 112207 A
(800) 1581220
(151) 2021 01 21
(181) 2031 01 21
(891) 2021 01 21
(511) 36

(260) AM 2022 112208 A
(800) 1581222
(151) 2021 01 19
(181) 2031 01 19
(891) 2021 01 19
(511) 01

(260) AM 2022 112210 A
(800) 1581237
(151) 2020 12 23
(181) 2030 12 23
(891) 2020 12 23
(511) 03, 09, 14, 18, 25, 35

(260) AM 2022 112236 A
(800) 1581781
(151) 2020 09 28
(181) 2030 09 28
(891) 2020 09 28
(511) 19

(260) AM 2022 112239 A
(800) 1581894
(151) 2020 12 03
(181) 2030 12 03
(891) 2020 12 03
(511) 32

(260) AM 2022 112241 A
(800) 1582117
(151) 2021 02 11
(181) 2031 02 11
(891) 2021 02 11
(511) 05

(260) AM 2022 112242 A
(800) 1582144
(151) 2021 02 10
(181) 2031 02 10
(891) 2021 02 10
(511) 09

(260) AM 2022 112244 A
(800) 1582170
(151) 2020 11 20
(181) 2030 11 20
(891) 2020 11 20
(511) 09, 28, 41

(260) AM 2022 112245 A
(800) 857498
(151) 2005 06 28
(181) 2025 06 28
(891) 2021 02 25
(511) 33

(260) AM 2022 112321 A
(800) 1582404
(151) 2021 02 02
(181) 2031 02 02
(891) 2021 02 02
(511) 10

(260) AM 2022 112360 A
(800) 1365951
(151) 2017 04 18
(181) 2027 04 18
(891) 2021 02 03
(511) 18, 20, 22, 25

(260) AM 2022 112361 A
(800) 1426078
(151) 2017 01 25
(181) 2027 01 25
(891) 2020 11 11
(511) 05, 29, 30, 35

(260) AM 2022 112362 A
(800) 1509103
(151) 2019 05 28
(181) 2029 05 28
(891) 2020 11 20
(511) 35, 38, 41

(260) AM 2022 112363 A
(800) 1552489
(151) 2020 06 11
(181) 2030 06 11
(891) 2020 12 30
(511) 05, 10

(260) AM 2022 112364 A
(800) 1581935
(151) 2020 08 24
(181) 2030 08 24
(891) 2021 03 10
(511) 07, 11, 12, 37, 39, 42

(260) AM 2022 112443 A
(800) 1584240
(151) 2020 10 22
(181) 2030 10 22
(891) 2020 10 22
(511) 38, 41

(260) AM 2022 112459 A
(800) 1140495
(151) 2012 10 23
(181) 2022 10 23
(891) 2021 03 15
(511) 33

(260) AM 2022 112638 A
(800) 1586295
(151) 2021 03 03
(181) 2031 03 03
(891) 2021 03 03
(511) 09, 38

(260) AM 2022 112465 A
(800) 1454665
(151) 2018 01 25
(181) 2028 01 25
(891) 2020 12 30
(511) 07, 35

(260) AM 2022 112639 A
(800) 1586324
(151) 2020 10 13
(181) 2030 10 13
(891) 2020 10 13
(511) 04

(260) AM 2022 112481 A
(800) 863480
(151) 2005 03 21
(181) 2025 03 21
(891) 2021 03 10
(511) 21

(260) AM 2022 112640 A
(800) 1586345
(151) 2020 11 19
(181) 2030 11 19
(891) 2020 11 19
(511) 30, 43

(260) AM 2022 112526 A
(800) 1584995
(151) 2021 01 25
(181) 2031 01 25
(891) 2021 01 25
(511) 07, 09, 11, 37, 42

(260) AM 2022 112641 A
(800) 1586401
(151) 2021 01 04
(181) 2031 01 04
(891) 2021 01 04
(511) 03, 05, 31

(260) AM 2022 112541 A
(800) 1585295
(151) 2020 09 11
(181) 2030 09 11
(891) 2020 09 11
(511) 05

(260) AM 2022 112652 A
(800) 1586789
(151) 2020 10 05
(181) 2030 10 05
(891) 2020 10 05
(511) 16

(260) AM 2022 112555 A
(800) 1585593
(151) 2020 08 27
(181) 2030 08 27
(891) 2020 08 27
(511) 01, 02, 35, 37

(260) AM 2022 112653 A
(800) 1586821
(151) 2020 11 23
(181) 2030 11 23
(891) 2020 11 23
(511) 07, 08, 11, 21, 24, 35

(260) AM 2022 112637 A
(800) 1586157
(151) 2020 11 26
(181) 2030 11 26
(891) 2020 11 26
(511) 05

(260) AM 2022 112654 A
(800) 1586854
(151) 2020 08 07
(181) 2030 08 07
(891) 2020 08 07
(511) 35, 36

(260) AM 2022 112815 A
(800) 1588752
(151) 2021 01 25
(181) 2031 01 25
(891) 2021 01 25
(511) 05, 29, 30, 32, 35

(260) AM 2022 112895 A
(800) 1493084
(151) 2019 08 07
(181) 2029 08 07
(891) 2021 04 13
(511) 03

(260) AM 2022 112847 A
(800) 1589051
(151) 2021 03 26
(181) 2031 03 26
(891) 2021 03 26
(511) 09

(260) AM 2022 112896 A
(800) 1495181
(151) 2019 03 29
(181) 2029 03 29
(891) 2021 02 09
(511) 21

(260) AM 2022 112848 A
(800) 1589071
(151) 2021 01 27
(181) 2031 01 27
(891) 2021 01 27
(511) 30

(260) AM 2022 112897 A
(800) 1565611
(151) 2020 10 06
(181) 2030 10 06
(891) 2021 04 02
(511) 20

(260) AM 2022 112849 A
(800) 1589078
(151) 2020 09 03
(181) 2030 09 03
(891) 2020 09 03
(511) 05

(260) AM 2022 112941 A
(800) 1590157
(151) 2021 03 10
(181) 2031 03 10
(891) 2021 03 10
(511) 05

(260) AM 2022 112850 A
(800) 1589083
(151) 2021 02 26
(181) 2031 02 26
(891) 2021 02 26
(511) 09, 11

(260) AM 2022 112942 A
(800) 1590182
(151) 2020 12 12
(181) 2030 12 12
(891) 2020 12 12
(511) 05

(260) AM 2022 112851 A
(800) 1589104
(151) 2020 09 29
(181) 2030 09 29
(891) 2020 09 29
(511) 29, 43

(260) AM 2022 112976 A
(800) 1590910
(151) 2020 11 06
(181) 2030 11 06
(891) 2020 11 06
(511) 29

(260) AM 2022 112852 A
(800) 1589111
(151) 2021 02 04
(181) 2031 02 04
(891) 2021 02 04
(511) 03, 05

(260) AM 2022 113067 A
(800) 1592099
(151) 2021 02 19
(181) 2031 02 19
(891) 2021 02 19
(511) 09, 14, 18, 24, 25, 28, 35

(260) AM 2022 113068 A
(800) 1592117
(151) 2021 04 07
(181) 2031 04 07
(891) 2021 04 07
(511) 18

(260) AM 2022 113070 A
(800) 1592186
(151) 2021 03 01
(181) 2031 03 01
(891) 2021 03 01
(511) 29, 30, 41

(260) AM 2022 113148 A
(800) 1592835
(151) 2021 03 22
(181) 2031 03 22
(891) 2021 03 22
(511) 09

(260) AM 2022 113149 A
(800) 1592843
(151) 2021 03 02
(181) 2031 03 02
(891) 2021 03 02
(511) 01, 05

(260) AM 2022 113151 A
(800) 1592858
(151) 2021 03 01
(181) 2031 03 01
(891) 2021 03 01
(511) 01, 16, 17, 19

(260) AM 2022 113158 A
(800) 1593341
(151) 2020 11 26
(181) 2030 11 26
(891) 2020 11 26
(511) 09, 14, 16, 21, 28, 35

(260) AM 2022 114554 A
(800) 1611636
(151) 2021 03 09
(181) 2031 03 09
(891) 2021 03 09
(511) 05

**OFFICIAL NOTIFICATIONS
INVENTIONS
RESTORATION OF PATENTS**

(21) AP 2012 12581
(11) P 2013 5895 B
(73) Eter Kemertelidze;
Aleksandre Skhirtladze;
Tsisana Sulakvelidze
(54) METHOD OF OBTAINING DIGITONIN
DATE OF CANCELLATION OF PATENT: 2022 02 20
THE TERM OF RESTORATION OF PATENT: 2022 04 25

(21) AP 2014 13542
(11) P 2017 6658 B
(73) Eter Kemertelidze;
Mariam Benidze;
Alexander Skhirtladze
(54) METHOD FOR RECEIVING PLANT GROWTH-PROMOTING FACTOR "ALEXIN"
DATE OF CANCELLATION OF PATENT: 2021 08 05
THE TERM OF RESTORATION OF PATENT: 2022 04 25

(21) AP 2017 14434
(11) P 2019 7014 B
(73) Tengiz Chkhaidze;
Revaz Varsimashvili;
Nino Chkhaidze
(54) DEVICE FOR BREAKING PRODUCTS
DATE OF CANCELLATION OF PATENT: 2022 02 27
THE TERM OF RESTORATION OF PATENT: 2022 04 25

(21) AP 2019 15037
(11) P 2021 7268 B
(73) LTD "Georgian Mineral Group"
(54) COMPOSITE FLOCCULANT
DATE OF CANCELLATION OF PATENT: 2022 03 28
THE TERM OF RESTORATION OF PATENT: 2022 04 25

ABOLITION OF PATENTS WITH THE RIGHT TO RESTORE

(21) AP 2009 11185
(11) P 2011 5342 B
(73) Les Laboratoires Servier
(54) NEW DIOSMETIN DERIVATIVES, PROCESS FOR THEIR PREPARATION AND
PHARMACEUTICAL COMPOSITIONS CONTAINING THEM
DATE OF CANCELLATION OF PATENT: 2022 03 25
THE TERM OF RESTORATION OF PATENT VALIDITY HAS EXPIRED: 2023 03 25

(21) AP 2009 11992
(11) P 2012 5666 B
(73) Merck Sharp & Dohme Corp.
(54) HYDROXYMETHYL PYRROLIDINES AS β 3 ADRENERGIC RECEPTOR AGONISTS
DATE OF CANCELLATION OF PATENT: 2022 04 02
THE TERM OF RESTORATION OF PATENT VALIDITY HAS EXPIRED: 2023 04 02

(21) AP 2012 13272
(11) P 2016 6568 B
(73) Palupa Medical LTD
(54) COMPOSITIONS FOR THE TREATMENT OF NEUROLOGIC DISORDERS
DATE OF CANCELLATION OF PATENT: 2022 03 28
THE TERM OF RESTORATION OF PATENT VALIDITY HAS EXPIRED: 2023 03 28

(21) AP 2013 13609
(11) P 2016 6470 B
(73) Santen Pharmaceutical Co., LTD
(54) DIQUAFOSOL-CONTAINING EYE DROP
DATE OF CANCELLATION OF PATENT: 2022 03 25
THE TERM OF RESTORATION OF PATENT VALIDITY HAS EXPIRED: 2023 03 25

(21) AP 2015 14286
(11) P 2018 6920 B
(73) H. Lundbeck A/S
(54) HALOGENATED QUINAZOLINTHF-AMINES AS PDE1 INHIBITORS
DATE OF CANCELLATION OF PATENT: 2022 03 27
THE TERM OF RESTORATION OF PATENT VALIDITY HAS EXPIRED: 2023 03 27

(21) AP 2016 14591
(11) P 2020 7089 B
(73) Biogaia AB
(54) HISTAMINE-PRODUCING BACTERIAL STRAINS AND THEIR USE IN CANCER
DATE OF CANCELLATION OF PATENT: 2022 03 24
THE TERM OF RESTORATION OF PATENT VALIDITY HAS EXPIRED: 2023 03 24

(21) AP 2018 14743
(11) P 2020 7143 B
(73) Sergo Jorbenadze
(54) GARAGE WITH CATENAS
DATE OF CANCELLATION OF PATENT: 2022 04 02
THE TERM OF RESTORATION OF PATENT VALIDITY HAS EXPIRED: 2023 04 02

(21) AP 2017 14914
(11) P 2022 7339 B
(73) Loxo Oncology Inc.
(54) LIQUID FORMULATIONS OF (S)-N-(5-((R)-2-(2,5-DIFLUOROPHENYL)-PYRROLIDIN-1-YL)-
PYRAZOLO[1,5-A]PYRIMIDIN-3-YL)-3-HYDRO-XYRROLIDINE-1-CARBOXAMIDE
DATE OF CANCELLATION OF PATENT: 2022 04 04
THE TERM OF RESTORATION OF PATENT VALIDITY HAS EXPIRED: 2023 04 04

(21) AP 2019 15037
(11) P 2021 7268 B
(73) LTD "Georgian Mineral Group"
(54) COMPOSITE FLOCCULANT
DATE OF CANCELLATION OF PATENT: 2022 03 28
THE TERM OF RESTORATION OF PATENT VALIDITY HAS EXPIRED: 2024 03 28

(21) AP 2019 15041
(11) P 2020 7132 B
(73) Zviad Bakhutashvili
(54) SYSTEM FOR CARDIOPLEGIA
DATE OF CANCELLATION OF PATENT: 2022 04 03
THE TERM OF RESTORATION OF PATENT VALIDITY HAS EXPIRED: 2023 04 03

EXPIRATION OF TERMS OF RESTORATION OF PATENTS

(21) AP 2009 11190
(11) P 2010 4921 B
(73) Davit Baratashvili;
Neli Khalvashi
(54) METHOD OF CULTIVATION OF SEEDLINGS OF THE ACTINIDIA CHINESE (ACTINIDIA
CHINENSIS)
DATE OF CANCELLATION OF PATENT: 2021 03 30
THE TERM OF RESTORATION OF PATENT VALIDITY HAS EXPIRED: 2022 03 30

(21) AP 2009 11919
(11) P 2013 5781 B
(73) Sunrise R&D Holdings LLC
(54) ACQUIRING ACTUAL REAL-TIME SHOPPER BEHAVIOR DATA DURING SHOPPER'S
PRODUCT SELECTION
DATE OF CANCELLATION OF PATENT: 2021 03 23
THE TERM OF RESTORATION OF PATENT VALIDITY HAS EXPIRED: 2022 03 23

(21) AP 2007 12203
(11) P 2013 5917 B
(73) Biogen MA Inc.
(54) STABILIZED POLYPEPTIDE COMPOSITIONS
DATE OF CANCELLATION OF PATENT: 2021 03 19
THE TERM OF RESTORATION OF PATENT VALIDITY HAS EXPIRED: 2022 03 19

(21) AP 2012 13263
(11) P 2015 6386 B
(73) Les Laboratoires Servier;
Shanghai Institute Of Pharmaceutical Industry
(54) NEW CRYSTAL FORM VII OF AGOMELATINE, PREPARATION METHOD AND USAGE
THEREOF, AND PHARMACEUTICAL COMPOSITIONS CONTAINING THEREOF
DATE OF CANCELLATION OF PATENT: 2021 03 22
THE TERM OF RESTORATION OF PATENT VALIDITY HAS EXPIRED: 2022 03 22

(21) AP 2012 13264
(11) P 2016 6567 B
(73) Les Laboratoires Servier;
Shanghai Institute Of Pharmaceutical Industry
(54) MIXED CRYSTAL AGOMELATINE (FORM-VIII), PREPARATION METHOD AND USE THEREOF
AND PHARMACEUTICAL COMPOSITION CONTAINING SAME
DATE OF CANCELLATION OF PATENT: 2021 03 22
THE TERM OF RESTORATION OF PATENT VALIDITY HAS EXPIRED: 2022 03 22

(21) AP 2013 13608
(11) P 2017 6696 B
(73) Preglem SA
(54) METHOD FOR TREATING GYNECOLOGICAL DISEASES
DATE OF CANCELLATION OF PATENT: 2021 03 22
THE TERM OF RESTORATION OF PATENT VALIDITY HAS EXPIRED: 2022 03 22

(21) AP 2014 13971
(11) P 2017 6742 B
(73) Aziende Chimiche Riunite Angelini Francesco A.C.R.A.F. S.p.A. (IT)
(54) GLYCOGEN-BASED WATER SOLUBILITY ENHANCERS
DATE OF CANCELLATION OF PATENT: 2021 03 31
THE TERM OF RESTORATION OF PATENT VALIDITY HAS EXPIRED: 2022 03 31

(21) AP 2016 14106
(11) P 2018 6819 B
(73) Archil Prangishvili;
Levan Imnaishvili;
Maguli Bedineishvili;
Natia Kirkitadze
(54) BIOMETRICAL ELECTIVE SYSTEM
DATE OF CANCELLATION OF PATENT: 2021 03 31
THE TERM OF RESTORATION OF PATENT VALIDITY HAS EXPIRED: 2022 03 31

(21) AP 2015 14304
(11) P 2018 6932 B
(73) Millennium Pharmaceuticals Inc.
(54) PHARMACEUTICAL FORMULATIONS OF PAN-RAF KINASE INHIBITOR, PROCESSES FOR THEIR
PREPARATION, AND METHODS OF USE
DATE OF CANCELLATION OF PATENT: 2021 03 26
THE TERM OF RESTORATION OF PATENT VALIDITY HAS EXPIRED: 2022 03 26

(21) AP 2017 14457
(11) P 2018 6935 B
(73) Merab Shalamberidze;

Akaki Tsereteli State University;
LEPL "National Science Foundation of Shota Rustaveli"
(54) DEVICE FOR SURGICAL FOOTBED RELIEF DETERMINATION
DATE OF CANCELLATION OF PATENT: 2021 03 24
THE TERM OF RESTORATION OF PATENT VALIDITY HAS EXPIRED: 2022 03 24

(21) AP 2015 14560
(11) P 2019 7025 B
(73) Atricath S.P.A.
(54) ABLATION CATHETER AND ABLATION APPARATUS
DATE OF CANCELLATION OF PATENT: 2021 03 18
THE TERM OF RESTORATION OF PATENT VALIDITY HAS EXPIRED: 2022 03 18

EXPIRATION OF TERMS OF PATENTS

(21) AP 2012 12659
(11) P 2013 1772 B
(73) Otar Chichinadze
(54) DEVICE FOR SYRINGE
EXPIRATION DATE OF PATENT: 2022 04 05

(21) AP 2002 7149
(11) P 2005 3619 B
(73) Pfizer Inc.
(54) Pyrazole Derivatives for Treating HIV
EXPIRATION DATE OF PATENT: 2022 04 04

UTILITY MODELS RESTORATION OF PATENTS

(21) AU 2018 14729
(11) U 2020 2051 Y
(73) Konstantine Maghradze;
Nugzar Joglidze
(54) BAKERY PRODUCT FOR OSTEOPOROSIS PROLIFERATION
DATE OF CANCELLATION OF PATENT: 2022 03 16
THE TERM OF RESTORATION OF PATENT: 2022 04 25

(21) AU 2018 14736
(11) U 2019 2004 Y
(73) Agrarian University of Georgia;
Shota Rustaveli National Science Foundation;
George Adamia;
Gia Khatashvili;
Tamar Varaz;

Giorgi Gigolashvili;
Maritsa Kurashvili;
Marine Pruidze;
Liana Chokheli

(54) METHOD FOR POLLUTED 2,4,6 – TNT (TRINITROTOLUENE) WATER PURIFI-
CATION WITH USAGE

OF SPIRULINA BLUE-GREEN ALGAE

DATE OF CANCELLATION OF PATENT: 2022 03 23

THE TERM OF RESTORATION OF PATENT: 2022 04 25

ABOLITION OF PATENT WITH THE RIGHT TO RESTORE

(21) AU 2018 14736

(11) U 2019 2004 Y

(73) Agrarian University of Georgia;
Shota Rustaveli National Science Foundation;
George Adamia;
Gia Khatashvili;
Tamar Varaz;
Giorgi Gigolashvili;
Maritsa Kurashvili;
Marine Pruidze;
Liana Chokheli

(54) METHOD FOR POLLUTED 2,4,6 – TNT (TRINITROTOLUENE) WATER PURIFI-
CATION WITH USAGE OF SPIRULINA BLUE-GREEN ALGAE

DATE OF CANCELLATION OF PATENT: 2022 03 23

THE TERM OF RESTORATION OF PATENT VALIDITY HAS EXPIRED: 2023 03 23

EXPIRATION OF TERMS OF RESTORATION OF PATENT

(21) AU 2015 13782

(11) U 2016 1888 Y

(73) Zurab Chkhaidze;
Nodar Khodeli;
Otar Shengelia

(54) ARTIFICIAL APPARATUS FOR BLOOD CIRCULATION

DATE OF CANCELLATION OF PATENT: 2021 04 03

THE TERM OF RESTORATION OF PATENT VALIDITY HAS EXPIRED: 2022 04 03

DESIGNS

EXTENSION OF TERMS OF DESIGN REGISTRATION

(11) D 2017 710 S
(73) JSC "Georgian Bank" (GE)
Gagarin Str. 29s, 0160, Tbilisi, Georgia (GE)
(54) FONT
(28) 56
(24) 2017 05 15
(18) 2027 05 15
(58) 2022 04 15

EXTENSION OF TERMS OF INTERNATIONAL DESIGNS REGISTRATION

(11) DM/68628
(73) SWATCH AG (SWATCH SA) (SWATCH LTD.)
94, Rue Jakob Stämpfli, CH-2502 BIENNE (CH)
(15) 2007 03 13
(24) 2007 03 13
(18) 2027 03 13
(28) 1
(28') 1
(54) Watch case

(11) DM/68700
(73) ELDINCO S.A.
6, via Vela, CHIASSO, Tessin (CH)
(15) 2007 03 22
(24) 2007 03 22
(18) 2027 03 22
(28) 1
(28') 1
(54) Watch

(11) DM/68702
(73) BREITLING SA
Schlachthausstrasse, 2 Case postale 1132, CH-2540 Grenchen (CH)
(15) 2007 03 20
(24) 2007 03 20
(18) 2027 03 20
(28) 1
(28') 1
(54) Watch with bracelet

(11) DM/77858
(73) SAVERGLASS
3 rue de la Gare, F-60960 FEUQUIERES (FR)
(15) 2012 03 09
(24) 2012 03 09

(18) 2027 03 09
(28) 1
(28') 1
(54) Bottle

(11) DM/77860
(73) SAVERGLASS
3 rue de la Gare, F-60960 FEUQUIERES (FR)
(15) 2012 02 27
(24) 2012 02 27
(18) 2027 02 27
(28) 1
(28') 1
(54) Bottle

(11) DM/77861
(73) SAVERGLASS
3 rue de la Gare, F-60960 FEUQUIERES (FR)
(15) 2012 02 27
(24) 2012 02 27
(18) 2027 02 27
(28) 1
(28') 1
(54) Bottle

(11) DM/77862
(73) SAVERGLASS
3 rue de la Gare, F-60960 FEUQUIERES (FR)
(15) 2012 02 27
(24) 2012 02 27
(18) 2027 02 27
(28) 1
(28') 1
(54) Bottle

(11) DM/77866
(73) COMPAGNIE DES MONTRES LONGINES, FRANCILLON S.A. (LONGINES WATCH CO.,
FRANCILLON LTD.)
CH-2610 SAINT-IMIER (CH)
(15) 2012 03 06
(24) 2012 03 06
(18) 2027 03 06
(28) 1
(28') 1
(54) Watch

(11) DM/77877
(73) SAVERGLASS
3 rue de la Gare, F-60960 FEUQUIERES (FR)
(15) 2012 02 27
(24) 2012 02 27
(18) 2027 02 27
(28) 1

(28') 1
(54) Bottle

(11) DM/77878
(73) SAVERGLASS
3 rue de la Gare, F-60960 FEUQUIERES (FR)
(15) 2012 02 27
(24) 2012 02 27
(18) 2027 02 27
(28) 1
(28') 1
(54) Bottle

(11) DM/77879
(73) SAVERGLASS
3 rue de la Gare, F-60960 FEUQUIERES (FR)
(15) 2012 02 27
(24) 2012 02 27
(18) 2027 02 27
(28) 1
(28') 1
(54) Bottle

(11) DM/77880
(73) SAVERGLASS
3 rue de la Gare, F-60960 FEUQUIERES (FR)
(15) 2012 02 27
(24) 2012 02 27
(18) 2027 02 27
(28) 1
(28') 1
(54) Bottle

(11) DM/77881
(73) SAVERGLASS
3 rue de la Gare, F-60960 FEUQUIERES (FR)
(15) 2012 02 27
(24) 2012 02 27
(18) 2027 02 27
(28) 1
(28') 1
(54) Bottle

(11) DM/77882
(73) SAVERGLASS
3 rue de la Gare, F-60960 FEUQUIERES (FR)
(15) 2012 02 27
(24) 2012 02 27
(18) 2027 02 27
(28) 1
(28') 1
(54) Bottle

(11) DM/77932
(73) MONTRES BREGUET S.A.
CH-1344 L'ABBAYE (CH)
(15) 2012 03 06
(24) 2012 03 06
(18) 2027 03 06
(28) 1
(28') 1
(54) Cuff links

(11) DM/77934
(73) SAVERGLASS
3 rue de la Gare, F-60960 FEUQUIERES (FR)
(15) 2012 03 06
(24) 2012 03 06
(18) 2027 03 06
(28) 1
(28') 1
(54) Bottle

(11) DM/77979
(73) ALFRED KÄRCHER GMBH & CO. KG
Alfred-Kärcher-Straße 28-40, 71364 Winnenden (DE)
(15) 2012 03 19
(24) 2012 03 19
(18) 2027 03 19
(28) 3
(28') 3
(54) Vacuum cleaners

(11) DM/78312
(73) ALPLA WERKE ALWIN LEHNER GMBH & CO. KG
Allmendstrasse, A-6971 Hard (EM)
(15) 2012 04 18
(24) 2012 04 18
(18) 2027 04 18
(28) 3
(28') 3
(54) Bottles

(11) DM/78387
(73) FERRERO S.P.A.
Piazzale Pietro Ferrero, 1, I-12051 ALBA (CN) (IT)
(15) 2012 02 24
(24) 2012 02 24
(18) 2027 02 24
(28) 2
(28') 2
(54) Bottles

(11) DM/78520
(73) WOLF OIL CORPORATION N.V.
Georges Gilliotstraat 52, B-2620 Hemiksem (BX)
(15) 2012 05 22

(24) 2012 05 22
(18) 2027 05 22
(28) 4
(28') 4
(54) Canisters

(11) DM/78945
(73) ALFRED KÄRCHER GMBH & CO. KG
Alfred-Kärcher-Straße 28-40, 71364 Winnenden (DE)
(15) 2012 03 26
(24) 2012 03 26
(18) 2027 03 26
(28) 2
(28') 2
(54) Window cleaning appliances

(11) DM/79397
(73) KISTLER HOLDING AG
Eulachstrasse 22, CH-8408 Winterthur (CH)
(15) 2012 04 25
(24) 2012 04 25
(18) 2027 04 25
(28) 3
(28') 3
(54) Hollow profiles

(11) DM/79807
(73) WYW BLOCK AG
Landstrasse 140, FL-9494 Schaan (LI)
(15) 2012 03 23
(24) 2012 03 23
(18) 2027 03 23
(28) 2
(28') 2
(54) Blocks for construction

(11) DM/95159
(73) SAVERGLASS
3 rue de la Gare, F-60960 FEUQUIERES (FR)
(15) 2017 02 23
(24) 2017 02 23
(18) 2027 02 23
(28) 6
(28') 6
(54) Bottles

(11) DM/95161
(73) HARRY WINSTON SA
Chemin du Tourbillon 8, CH-1228 Plan-les-Ouates (CH)
(15) 2017 03 03
(24) 2017 03 03
(18) 2027 03 03
(28) 4

(28') 4
(54) 1.-2. Dials, 3. Watch case, 4. Dial

(11) DM/95183
(73) OMEGA SA (OMEGA AG) (OMEGA LTD.)
Jakob-Stämpfli-Strasse 96, CH-2502 Biel/Bienne (CH)
(15) 2017 03 07
(24) 2017 03 07
(18) 2027 03 07
(28) 2
(28') 2
(54) Bracelet, Necklace

(11) DM/95215
(73) HARRY WINSTON SA
Chemin du Tourbillon 8, CH-1228 Plan-les-Ouates (CH)
(15) 2017 03 03
(24) 2017 03 03
(18) 2027 03 03
(28) 1
(28') 1
(54) Table clock

(11) DM/95799
(73) HARRY WINSTON SA
Chemin du Tourbillon 8, CH-1228 Plan-les-Ouates (CH)
(15) 2017 03 15
(24) 2017 03 15
(18) 2027 03 15
(28) 3
(28') 3
(54) 1.-2. Watch cases, 3. Dial

(11) DM/99388
(73) SC BIODOME EUROPE SRL
Str. Florilor 4, sc. A, ap 20, Sighisoara (RO)
(15) 2017 05 24
(24) 2017 05 24
(18) 2027 05 24
(28) 8
(28') 8
(54) 1.-4. Heating boilers, 5. Bowl for pellets for heating boiler, 6. Turbulator for heating boiler,
7.-8. Central heating boilers

CANCELLATION OF INTERNATIONAL DESIGNS REGISTRATION

(11) DM/67913
(73) SARA LEE HOUSEHOLD AND BODY CARE NEDERLAND B.V.
Vleutensevaart 35, NL-3532 AD Utrecht (NL)
CANCELLATION DATE OF REGISTRATION: 2021 06 19
(58) 2022 04 13

(11) DM/76483
(73) ETA SA MANUFACTURE HORLOGÈRE SUISSE
CH-2540 Grenchen (CH)
CANCELLATION DATE OF REGISTRATION: 2021 07 26
(58) 2022 04 13

(11) DM/78038
(73) EUROTRADE S.A.
47-49 Persefonis Str., GR-118 54 ATHENS (GR)
CANCELLATION DATE OF REGISTRATION: 2021 07 06
(58) 2022 04 13

(11) DM/91361
(73) PRATİK İTHALAT İHRACAT GIDA ŞANAYİ VE TİCARET LİMİTED ŞİRKETİ
Topçular Mahallesi Kasımpaşı Sokak No: 2, TR-76000 IĞDIR (TR)
CANCELLATION DATE OF REGISTRATION: 2021 06 22
(58) 2022 04 13

(11) DM/92041
(73) STOKKE AS
Parkgata 6, N-6003 Ålesund (NO)
CANCELLATION DATE OF REGISTRATION: 2021 07 28
(58) 2022 04 13

(11) DM/92167
(73) CHEN NACHUM
101 Weissman st, 4342135 Raanana (IL)
CANCELLATION DATE OF REGISTRATION: 2021 08 05
(58) 2022 04 13

TRADEMARKS**EXTENSION OF TERMS OF TRADEMARKS REGISTRATION**

(111) M 2002 14581 R2

(156) 2002 08 15

(186) 2032 08 15

(732) JSC "Sarajishvili"

Sarajishvili Ave. 4, 0153, Tbilisi, Georgia

(111) M 2002 14405 R2

(156) 2002 04 01

(186) 2032 04 01

(732) AgroFresh Inc.

One Washington Square, 510-530 Walnut
Street 13th Floor – Suite 1350, Philadelphia,
Pennsylvania 19106, USA

(111) M 2002 14280 R2

(156) 2002 02 01

(186) 2032 02 01

(732) Menarini International Operations

Luxembourg S.A.

1, Avenue De La Gare, 1611 Luxembourg,
Luxembourg

(111) M 2002 14363 R2

(156) 2002 03 27

(186) 2032 03 27

(732) Menarini International Operations

Luxembourg S.A.

1, Avenue De La Gare, 1611 Luxembourg,
Luxembourg

(111) M 2002 14370 R2

(156) 2002 03 27

(186) 2032 03 27

(732) Menarini International Operations

Luxembourg S.A.

1, Avenue De La Gare, 1611 Luxembourg,
Luxembourg

(111) M 2002 14371 R2

(156) 2002 03 27

(186) 2032 03 27

(732) Menarini International Operations

Luxembourg S.A.

1, Avenue De La Gare, 1611 Luxembourg,
Luxembourg

(111) M 2002 14372 R2

(156) 2002 03 27

(186) 2032 03 27

(732) Menarini International Operations

Luxembourg S.A.

1, Avenue De La Gare, 1611 Luxembourg,
Luxembourg

(111) M 2002 14373 R2

(156) 2002 03 27

(186) 2032 03 27

(732) Menarini International Operations

Luxembourg S.A.

1, Avenue De La Gare, 1611 Luxembourg,
Luxembourg

(111) M 2002 14705 R2

(156) 2002 09 30

(186) 2032 09 30

(732) Menarini International Operations

Luxembourg S.A.

1, Avenue De La Gare, 1611 Luxembourg,
Luxembourg

(111) M 2002 14376 R2

(156) 2002 03 27

(186) 2032 03 27

(732) Menarini International Operations

Luxembourg S.A.

1, Avenue De La Gare, 1611 Luxembourg,
Luxembourg

(111) M 2002 14706 R2

(156) 2002 09 30

(186) 2032 09 30

(732) Menarini International Operations

Luxembourg S.A.

1, Avenue De La Gare, 1611 Luxembourg,
Luxembourg

(111) M 2002 14377 R2

(156) 2002 03 27

(186) 2032 03 27

(732) Menarini International Operations

Luxembourg S.A.

1, Avenue De La Gare, 1611 Luxembourg,
Luxembourg

(111) M 2002 14394 R2
 (156) 2002 03 27
 (186) 2032 03 27
 (732) Cerveceria Modelo de Mexico, S. De R.L.
 de C.V.
 Javier Barros Sierra No. 555, Piso 3, Colonia
 Zedec Ed Plaza Santa Fe, Delegacion Alvaro
 Obregon, C.P. 01210, Mexico City, Mexico

(111) M 2002 14395 R2
 (156) 2002 03 27
 (186) 2032 03 27
 (732) Cerveceria Modelo de Mexico, S. De R.L.
 de C.V.
 Javier Barros Sierra No. 555, Piso 3, Colonia
 Zedec Ed Plaza Santa Fe, Delegacion Alvaro
 Obregon, C.P. 01210, Mexico City, Mexico

(111) M 2002 14748 R2
 (156) 2002 10 15
 (186) 2032 10 15
 (732) Opus One Winery Llc
 7900 St. Helena Highway, Oakville,
 California 94562, USA

(111) M 2012 22234 R1
 (156) 2012 02 03
 (186) 2032 02 03
 (732) Arcor S.A.I.C.
 Av. Fulvio Pagani 487, Arroyito, Province of
 Cordoba, Argentina

(111) M 2012 22525 R1
 (156) 2012 04 30
 (186) 2032 04 30
 (732) Cummins Inc., an Indiana corporation
 500 Jackson Street, Colimbus, Indiana, US

(111) M 2012 22402 R1
 (156) 2012 03 16
 (186) 2032 03 16
 (732) LTD "Georgian Wine Corporation"
 Simon Chikovani Str. 35, 0171, Tbilisi,
 Georgia

(111) M 2012 22277 R1
 (156) 2012 02 03
 (186) 2032 02 03
 (732) LTD "Georgian Wine Corporation"
 Simon Chikovani Str. 35, 0171, Tbilisi,
 Georgia

(111) M 2012 22508 R1
 (156) 2012 04 25
 (186) 2032 04 25
 (732) LTD "Barambo"
 Vil. Natakhtari, 3308, Mtskheta, Georgia

(111) M 2012 22509 R1
 (156) 2012 04 25
 (186) 2032 04 25
 (732) LTD "Barambo"
 Vil. Natakhtari, 3308, Mtskheta, Georgia

(111) M 2012 22510 R1
 (156) 2012 04 25
 (186) 2032 04 25
 (732) LTD "Barambo"
 Vil. Natakhtari, 3308, Mtskheta, Georgia

(111) M 2012 22511 R1
 (156) 2012 04 25
 (186) 2032 04 25
 (732) LTD "Barambo"
 Vil. Natakhtari, 3308, Mtskheta, Georgia

(111) M 2012 22512 R1
 (156) 2012 04 25
 (186) 2032 04 25
 (732) LTD "Barambo"
 Vil. Natakhtari, 3308, Mtskheta, Georgia

(111) M 2012 22513 R1
 (156) 2012 04 25
 (186) 2032 04 25
 (732) LTD "Barambo"
 Vil. Natakhtari, 3308, Mtskheta, Georgia

(111) M 2012 22541 R1
 (156) 2012 04 30
 (186) 2032 04 30
 (732) LTD "Barambo"
 Vil. Natakhtari, 3308, Mtskheta, Georgia

(111) M 2012 22514 R1
 (156) 2012 04 25
 (186) 2032 04 25
 (732) LTD "Barambo"
 Vil. Natakhtari, 3308, Mtskheta, Georgia

(111) M 2012 22463 R1 (156) 2012 04 05 (186) 2032 04 05 (732) LTD "Georgian Wine Corporation" Simon Chikovani Str. 35, 0171, Tbilisi, Georgia	Omc Chambers, Wickhams Cay 1, Road Town, Tortola, Virgin Islands (British)
(111) M 2012 22471 R1 (156) 2012 04 05 (186) 2032 04 05 (732) Cilag GmbH International Landis & Gyr-Strasse 1, CH-6300 Zug, Switzerland	(111) M 2012 22393 R1 (156) 2012 03 13 (186) 2032 03 13 (732) LTD "Georgian Wine Corporation" Simon Chikovani Str. 35, 0171, Tbilisi, Georgia
(111) M 2012 22472 R1 (156) 2012 04 05 (186) 2032 04 05 (732) Cilag GmbH International Landis & Gyr-Strasse 1, CH-6300 Zug, Switzerland	(111) M 2012 23087 R1 (156) 2012 11 26 (186) 2032 11 26 (732) Karbosan Zimpara Tasi Sanayi Anonim Sirketi Halkali Yolu No. 267, Sefaköy-Istanbul, Turkey
(111) M 2012 22516 R1 (156) 2012 04 25 (186) 2032 04 25 (732) LTD "Barambo" Vil. Natakhtari, 3308, Mtskheta, Georgia	(111) M 2013 23413 R1 (156) 2013 03 11 (186) 2033 03 11 (732) LTD "Mars" Kavtaradze Str. 5, 0186 Tbilisi, Georgia
(111) M 2012 22608 R1 (156) 2012 05 16 (186) 2032 05 16 (732) The Procter & Gamble Company One Procter & Gamble Plaza, Cincinnati, Ohio 45202, USA	(111) M 2013 23477 R1 (156) 2013 03 25 (186) 2033 03 25 (732) LTD "Mars" Kavtaradze Str. 5, 0186 Tbilisi, Georgia
(111) M 2012 22744 R1 (156) 2012 07 02 (186) 2032 07 02 (732) Philip Morris Products S. A. Quai Jeanrenaud 3, CH-2000 Neuchatel, Switzerland	
(111) M 2011 21813 R1 (156) 2011 09 29 (186) 2031 09 29 (732) JSC "Georgian Railway" Tamar Mepe Ave. 15, 0112, Tbilisi, Georgia	
(111) M 2013 23445 R1 (156) 2013 03 13 (186) 2033 03 13 (732) Sin Holding Limited.	

COMPLETE TRANSFER OF RIGHTS

(111) M 2019 30973 R
(732) OOO "JTI Russia"
1 Krasnogvardeyskiy proezd, 15, floors 28-32
123112 Moscow, Russian Federation

(770) Joint Stock Company Donskoy Tabak
1-ya Lugovaia 17, 344002 Rostov-on-don,
Russian Federation
(580) 2022 04 07

(111) M 1996 3429 R
(732) Böllhoff Produktion GmbH
Archimedesstrasse 1-4 33649 Bielefeld,
Germany

(770) Black & Decker Inc.
Drummond Plaza Office Park, 1423
Kirkwood Highway, Newark, Delaware
19711, USA
(580) 2022 04 11

(111) M 2013 23353 R
(732) LTD "Mill-Ari Georgia"
Sulkhan Tsintsadze Str. 12, Non -residential
Space 3-7, Saburtalo district, Tbilisi Georgia

(770) LTD "Georgian Baker"
Beliashvili Str. 2, 0159, Tbilisi, Georgia
(580) 2022 03 24

(111) M 2016 27532 R
(732) Saturn Newco Limited
103-105 Bath Road, Slough, Berkshire,
SL1 3UH, United Kingdom

(770) LRC Products Limited
103-105 Bath Road, Slough,
SL1 3UH, England, United Kingdom
(580) 2022 03 23

(111) M 2016 27598 R
(732) Saturn Newco Limited
103-105 Bath Road, Slough, Berkshire,
SL1 3UH, United Kingdom

(770) LRC Products Limited
103-105 Bath Road, Slough,
SL1 3UH, England, United Kingdom
(580) 2022 03 23

(111) M 2016 27599 R
(732) Saturn Newco Limited
103-105 Bath Road, Slough, Berkshire,
SL1 3UH, United Kingdom

(770) LRC Products Limited

103-105 Bath Road, Slough,
SL1 3UH, England, United Kingdom
(580) 2022 03 23

(111) M 2016 27600 R
(732) Saturn Newco Limited
103-105 Bas Roud, Slau, Berkshiri,
SL1 3UH, United Kingdom

(770) LRC Products Limited
103-105 Bath Road, Slough,
SL1 3UH, England, United Kingdom
(580) 2022 03 23

(111) M 2016 27601 R
(732) Saturn Newco Limited
103-105 Bath Road, Slough, Berkshire,
SL1 3UH, United Kingdom

(770) LRC Products Limited
103-105 Bath Road, Slough,
SL1 3UH, England, United Kingdom
(580) 2022 03 23

(111) M 2016 27690 R
(732) Saturn Newco Limited
103-105 Bath Road, Slough, Berkshire,
SL1 3UH, United Kingdom

(770) LRC Products Limited
103-105 Bath Road, Slough,
SL1 3UH, England, United Kingdom
(580) 2022 03 23

CHANGES OF NAMES AND/OR ADDRESSES OF TRADEMARKS OWNER

(111) M 1997 5299 R
 (732) GlaxoSmithKline Trading Services Limited
 12 Riverwalk, Citywest Business Campus,
 Dublin 24, Ireland
 (770) GlaxoSmithKline Trading Services Limited
 Currabinny, Carrigaline, County Cork, Ireland
 (580) 2022 04 07

(111) M 1997 5300 R
 (732) GlaxoSmithKline Trading Services Limited
 12 Riverwalk, Citywest Business Campus,
 Dublin 24, Ireland
 (770) GlaxoSmithKline Trading Services Limited
 Currabinny, Carrigaline, County Cork, Ireland
 (580) 2022 04 07

(111) M 1997 5303 R
 (732) GlaxoSmithKline Trading Services Limited
 12 Riverwalk, Citywest Business Campus,
 Dublin 24, Ireland
 (770) GlaxoSmithKline Trading Services Limited
 Currabinny, Carrigaline, County Cork, Ireland
 (580) 2022 04 07

(111) M 1997 6226 R
 (732) GlaxoSmithKline Trading Services Limited
 12 Riverwalk, Citywest Business Campus,
 Dublin 24, Ireland
 (770) GlaxoSmithKline Trading Services Limited
 Currabinny, Carrigaline, County Cork, Ireland
 (580) 2022 04 07

(111) M 1997 6227 R
 (732) GlaxoSmithKline Trading Services Limited
 12 Riverwalk, Citywest Business Campus,
 Dublin 24, Ireland
 (770) GlaxoSmithKline Trading Services Limited
 Currabinny, Carrigaline, County Cork, Ireland
 (580) 2022 04 07

(111) M 1997 6210 R
 (732) GlaxoSmithKline Trading Services Limited
 12 Riverwalk, Citywest Business Campus,
 Dublin 24, Ireland
 (770) GlaxoSmithKline Trading Services Limited
 Currabinny, Carrigaline, County Cork, Ireland
 (580) 2022 04 07

(111) M 2002 14405 R
 (732) AgroFresh Inc.
 One Washington Square, 510-530 Walnut
 Street 13th Floor – Suite 1350, Philadelphia,
 Pennsylvania 19106, USA
 (770) AgroFresh Inc.
 100 Independence Mall West, Philadelphia,
 PA 19106-2399, USA
 (580) 2022 03 30

(111) M 2013 23641 R
 (732) Seara Alimentos Ltda
 Av. Marginal Direita do Tietê, 500 - Bloco
 II - Subsolo - Sala 13, Vila Jaguará 05118-100
 São Paulo - SP, Brazil
 (770) Seara Alimentos Ltda
 Av. Chedid Jafet, 222-Bloco A-3º.
 Andar Vila Olimpia-São-Paulu SP 04551-065,
 Brazil
 (580) 2022 03 28

(111) M 2015 25666 R
 (732) Yutong Bus Co., Ltd.
 Yutong Road, Guancheng District,
 Zhengzhou, China
 (770) Zhengzhou Yutong Bus Co., Ltd.
 Yutong Road, Guancheng District,
 Zhengzhou, China
 (580) 2022 02 11

(111) M 1997 7881 R
 (732) Hella GmbH & Co. KGaA
 Rixbecker Strasse 75, 59552 Lippstadt,
 Germany
 (770) Hella KGaA Hueck & Co
 Rixbecker Strasse 75, 59552 Lippstadt,
 Germany
 (580) 2022 04 04

(111) M 2018 30067 R
 (732) Limited Liability Company "Aquant"
 Pokhodny pr. 14, floor/premises/office
 5/II/No.5 RU-125373 Moscow, Russian
 Federation
 (770) "My Republic" LLC
 Pokhodny pr. 14, floor/premises/office
 5/II/No.5 RU-125373 Moscow, Russian
 Federation
 (580) 2022 03 30

(111) M 2018 30068 R
(732) Limited Liability Company "Aquant"
Pokhodny pr. 14, floor/premises/office
5/II/No.5 RU-125373 Moscow, Russian
Federation
(770) "My Republic" LLC
Pokhodny pr. 14, floor/premises/office
5/II/No.5 RU-125373 Moscow, Russian
Federation
(580) 2022 03 30

CANCELLATION OF TRADEMARKS REGISTRATION

(111) M 2001 14019 R
(151) 2001 10 01
(732) Harrington Development Inc.
Elivira Mendez Street, Valerino Bldg,
3rd Floor, Panama, Republic of Panama
(141) 2022 04 11

(111) M 2001 14022 R
(151) 2001 10 01
(732) Preparados Alimenticios, S.A.
Plaza Europa, Número 41, Planta 16
L'hospitalet de Llobregat (Barselona), Spain
(141) 2022 04 11

(111) M 2001 14028 R
(151) 2001 10 01
(732) "actavis" EAD
ul. Athanas Dukov 29, Sofia, Raion Lozenets,
Bulgaria
(141) 2022 04 11

(111) M 2001 14030 R
(151) 2001 10 01
(732) "actavis" EAD
ul. Athanas Dukov 29, Sofia, Raion Lozenets,
Bulgaria
(141) 2022 04 11

(111) M 2011 21829 R
(151) 2011 10 06
(732) Chastnoe aktsionernoe obshchestvo "Kreativ"
Prospeqt Promishlennii 19, Kirovogradi,
25014, Ukraine
(141) 2022 04 14

(111) M 2011 21830 R
(151) 2011 10 06
(732) Chastnoe Aktsionernoe Obshchestvo "Kreativ"
Prospeqt Promishlennii 19, Kirovogradi,
25014, Ukraine
(141) 2022 04 14

(111) M 2011 21816 R
(151) 2011 09 29
(732) LTD "Koka-Tauri"
Vill. Kokotauri, 6100, Keda Region, Georgia
(141) 2022 04 06

(111) M 2011 21817 R
(151) 2011 09 29
(732) Aleksandre KavTaradze
Varketili 3, II mcr., bld. 14, app. 96, 0163,
Tbilisi, Georgia
(141) 2022 04 06

(111) M 2011 21819 R
(151) 2011 09 29
(732) Century 21 Real Estate LLC
175 Park Avenue, Madison,
New Jersey 07940, USA
(141) 2022 04 06

(111) M 2011 21820 R
(151) 2011 09 29
(732) Laboratoire Hra-Pharma
15, Riu Beranje, 75003 Parizi, France
(141) 2022 04 06

(111) M 2011 21821 R
(151) 2011 09 29
(732) Laboratoire Hra-Pharma
15, ru Beranger, 75003 Paris, France
(141) 2022 04 06

(111) M 2011 21822 R
(151) 2011 09 29
(732) Patron Spirits International AG
Quaistrasse 11, 8200 Schaffhausen,
Switzerland
(141) 2022 04 06

(111) M 2011 21825 R
(151) 2011 09 29
(732) Hyundai Motor Company (a Korean limited
liability company incorporated under the laws
of Republic of Korea)
231, Yangjae-Dong, Seocho-Gu, Seoul,
137-938, Republic of Korea
(141) 2022 04 06

(111) M 2011 21811 R
(151) 2011 09 29
(732) Harrington Development Inc.
Elvira Mendez Street, Vallarino bldg.,
3rd Floor, Panama, Republic of Panama
(141) 2022 04 06

(111) M 2011 21812 R
(151) 2011 09 29
(732) Harrington Development Inc.
Elvira Mendez Street, Vallarino bldg.,
3rd Floor, Panama, Republic of Panama
(141) 2022 04 06

(111) M 2011 21827 R
(151) 2011 10 05
(732) LTD "Payment Card Service"
Tsinanauri Str. 19, 0114, Tbilisi, Georgia
(141) 2022 04 14

INTERNATIONAL LICENSES AGREEMENTS

(800) 1079724

(732) Analpa Inc.

8525 Hidden River Pkwy, # 405, Tampa

FL 33637, USA

(791) Grunberg Gmbh

Dradenauer Daikhveg 3-5, 21129, Hamburg,

Germany

(793) №1701

from 08 10 2021 to 01 09 2024

Non-Exclusive

From 20 12 2021-For a period of validity of the
mark

Class – 25

(800) 1182375

(732) Analpa Inc.

8525 Hidden River Pkwy, # 405, Tampa

FL 33637, USA

(791) Grunberg Gmbh

Dradenauer Daikhveg 3-5, 21129, Hamburg,

Germany

(793) №1700

Non-Exclusive

From 20 12 2021-For a period of validity of the
mark

Class – 35

CLASSIFICATION INDEXES

INVENTIONS

CONCORDANCE TABLE OF INTERNATIONAL CLASSIFICATION INDEX AND PUBLICATION NUMBERS

INTERNATIONAL CLASSIFICATION INDEXES (51)	NUMBER OF PUBLISHED APPLICATION (10)
A 61 K 31/565; A 61 P 15/18	AP 2022 15414 A
A 61 P 9/10; A 61 P 1/16; A 61 P 25/28; A 61 P 3/06; A 61 K 31/44	AP 2022 15262 A
B 01 D 3/30	AP 2022 15662 A
B 01 J 20/18; C 02 F 1/28; C 02 F 1/64	AP 2022 15408 A

CONCORDANCE TABLE OF PUBLICATION NUMBERS AND INTERNATIONAL CLASSIFICATION INDEX

NUMBER OF PUBLISHED APPLICATION (10)	INTERNATIONAL CLASSIFICATION INDEXES (51)
AP 2022 15262 A	A 61 P 9/10; A 61 P 1/16; A 61 P 25/28; A 61 P 3/06; A 61 K 31/44
AP 2022 15408 A	B 01 J 20/18; C 02 F 1/28; C 02 F 1/64
AP 2022 15414 A	A 61 K 31/565; A 61 P 15/18
AP 2022 15662 A	B 01 D 3/30

CONCORDANCE TABLE OF INTERNATIONAL CLASSIFICATION INDEX, PATENT NUMBERS AND PUBLICATION NUMBERS

INTERNATIONAL CLASSIFICATION INDEX (51)	NUMBER OF PATENT (11)	NUMBER OF PUBLISHED APPLICATION (10)
A 01 M 1/026; A 01 M 99/00; G 01 N 33/0047; G 01 N 33/0073; G 01 N 27/123; G 01 N 33/00	P 2022 7370 B	AP 2021 15397 A
A 61 K 31/337; A 61 K 31/519; A 61 K 45/06; A 61 P 35/00	P 2022 7372 B	AP 2021 15157 A
A 61 K 31/437; A 61 P 31/12; C 07 D 519/00; C 07 D 513/04	P 2022 7373 B	AP 2021 15351 A
A 61 K 31/437; A 61 P 31/12; C 07 D 519/00; C 07 D 487/04; C 07 D 471/18; C 07 D 471/04	P 2022 7374 B	AP 2021 15353 A
A 62 C 2/06	P 2022 7371 B	AP 2021 15411 A

**CONCORDANCE TABLE OF PATENT NUMBERS,
PUBLICATION NUMBERS AND INTERNATIONAL CLASSIFICATION INDEX**

NUMBER OF PATENT (11)	NUMBER OF PUBLISHED APPLICATION (10)	INTERNATIONAL CLASSIFICATION INDEX (51)
P 2022 7370 B	AP 2021 15397 A	A 01 M 1/026; A 01 M 99/00; G 01 N 33/0047; G 01 N 33/0073; G 01 N 27/123; G 01 N 33/00
P 2022 7371 B	AP 2021 15411 A	A 62 C 2/06
P 2022 7372 B	AP 2021 15157 A	A 61 K 31/337; A 61 K 31/519; A 61 K 45/06; A 61 P 35/00
P 2022 7373 B	AP 2021 15351 A	A 61 K 31/437; A 61 P 31/12; C 07 D 519/00; C 07 D 513/04
P 2022 7374 B	AP 2021 15353 A	A 61 K 31/437; A 61 P 31/12; C 07 D 519/00; C 07 D 487/04; C 07 D 471/18; C 07 D 471/04

**CONCORDANCE TABLE OF APPLICATION NUMBERS,
PUBLICATION NUMBERS AND PATENTS**

NUMBER OF APPLICATION (21)	NUMBER OF PUBLISHED APPLICATION (10)	NUMBER OF PATENT (11)
AP 2018 15157	AP 2021 15157 A	P 2022 7372 B
AP 2018 15351	AP 2021 15351 A	P 2022 7373 B
AP 2018 15353	AP 2021 15353 A	P 2022 7374 B
AP 2019 15397	AP 2021 15397 A	P 2022 7370 B
AP 2020 15411	AP 2021 15411 A	P 2022 7371 B

UTILITY MODELS

**CONCORDANCE TABLE OF INTERNATIONAL CLASSIFICATION INDEX
AND PUBLICATION NUMBERS**

INTERNATIONAL CLASSIFICATION INDEXES (51)	NUMBER OF PUBLISHED APPLICATION (10)
A 61 L 9/00	AU 2022 15658 U
C 08 L 101/00	AU 2022 15684 U
F 02 F 7/00	AU 2022 15640 U

**CONCORDANCE TABLE OF PUBLICATION NUMBERS
AND INTERNATIONAL CLASSIFICATION INDEX**

NUMBER OF PUBLISHED APPLICATION (10)	INTERNATIONAL CLASSIFICATION INDEXES (51)
AU 2022 15640 U	F 02 F 7/00
AU 2022 15658 U	A 61 L 9/00
AU 2022 15684 U	C 08 L 101/00

DESIGNS**CONCORDANCE TABLE OF INTERNATIONAL CLASSIFICATION INDEX
AND PUBLICATION NUMBERS**

INTERNATIONAL CLASSIFICATION INDEXES (51)	NUMBER OF PUBLISHED APPLICATION (10)
09-01	AD 2022 1255 S

**CONCORDANCE TABLE OF PUBLICATION NUMBERS
AND INTERNATIONAL CLASSIFICATION INDEX**

NUMBER OF PUBLISHED APPLICATION (10)	INTERNATIONAL CLASSIFICATION INDEXES (51)
AD 2022 1255 S	09-01

**CONCORDANCE TABLE OF INTERNATIONAL CLASSIFICATION INDEX,
NUMBERS OF REGISTRATION AND PUBLICATION NUMBERS**

INTERNATIONAL CLASSIFICATION INDEX (51)	NUMBER OF REGISTRATION (11)	NUMBER OF PUBLISHED APPLICATION (10)
09-01	D 2022 933 S	AD 2022 1229 S

**CONCORDANCE TABLE OF NUMBERS OF REGISTRATION,
PUBLICATION NUMBERS AND INTERNATIONAL CLASSIFICATION INDEX**

NUMBER OF REGISTRATION (11)	NUMBER OF PUBLISHED APPLICATION (10)	INTERNATIONAL CLASSIFICATION INDEX (51)
D 2022 933 S	AD 2022 1229 S	09-01

**CONCORDANCE TABLE OF APPLICATION NUMBERS,
PUBLICATION NUMBERS AND NUMBERS OF REGISTRATION**

NUMBER OF APPLICATION (21)	NUMBER OF PUBLISHED APPLICATION (10)	NUMBER OF REGISTRATION (11)
AD 2021 1229	AD 2022 1229 S	D 2022 933 S

TRADEMARKS

CONCORDANCE TABLE OF REGISTRATION NUMBERS, APPLICATION NUMBERS, PUBLICATION NUMBERS AND BULLETIN NUMBERS

NUMBER OF REGISTRATION (111)	NUMBER OF APPLICATIONS (210)	NUMBER OF PUBLISHED APPLICATIONS (260)	NUMBER OF BULLETIN
1	2	3	4
M 2022 35238 R	AM 111722	AM 2021 111722 A	17(573)2021
M 2022 35239 R	AM 111869	AM 2021 111869 A	18(574)2021
M 2022 35240 R	AM 111870	AM 2021 111870 A	18(574)2021
M 2022 35241 R	AM 111871	AM 2021 111871 A	18(574)2021
M 2022 35242 R	AM 111872	AM 2021 111872 A	18(574)2021
M 2022 35243 R	AM 111873	AM 2021 111873 A	18(574)2021
M 2022 35244 R	AM 112061	AM 2021 112061 A	19(575)2021
M 2022 35245 R	AM 112263	AM 2021 112263 A	20(576)2021
M 2022 35246 R	AM 112274	AM 2021 112274 A	20(576)2021
M 2022 35247 R	AM 112275	AM 2021 112275 A	20(576)2021
M 2022 35248 R	AM 112590	AM 2021 112590 A	20(576)2021
M 2022 35249 R	AM 112708	AM 2021 112708 A	22(578)2021
M 2022 35250 R	AM 112725	AM 2021 112725 A	21(577)2021
M 2022 35251 R	AM 112730	AM 2021 112730 A	21(577)2021
M 2022 35252 R	AM 112731	AM 2021 112731 A	21(577)2021
M 2022 35253 R	AM 112836	AM 2021 112836 A	22(578)2021
M 2022 35254 R	AM 112839	AM 2021 112839 A	21(577)2021
M 2022 35255 R	AM 112906	AM 2021 112906 A	21(577)2021
M 2022 35256 R	AM 113037	AM 2021 113037 A	22(578)2021
M 2022 35257 R	AM 113048	AM 2021 113048 A	22(578)2021
M 2022 35258 R	AM 117255	-	8(586)2022
M 2022 35259 R	AM 116983	-	8(586)2022
M 2022 35260 R	AM 116670	-	8(586)2022
M 2022 35261 R	AM 117106	-	8(586)2022
M 2022 35262 R	AM 117197	-	8(586)2022
M 2022 35263 R	AM 117262	-	8(586)2022
M 2022 35264 R	AM 110188	AM 2021 110188 A	17(573)2021
M 2022 35265 R	AM 110191	AM 2021 110191 A	18(574)2021
M 2022 35266 R	AM 111322	AM 2021 111322 A	14(570)2021
M 2022 35267 R	AM 111938	AM 2021 111938 A	18(574)2021
M 2022 35268 R	AM 111966	AM 2021 111966 A	18(574)2021
M 2022 35269 R	AM 112054	AM 2021 112054 A	18(574)2021
M 2022 35270 R	AM 112066	AM 2021 112066 A	18(574)2021
M 2022 35271 R	AM 112075	AM 2021 112075 A	19(575)2021
M 2022 35272 R	AM 112076	AM 2021 112076 A	19(575)2021
M 2022 35273 R	AM 112281	AM 2021 112281 A	18(574)2021
M 2022 35274 R	AM 112282	AM 2021 112282 A	20(576)2021
M 2022 35275 R	AM 112289	AM 2021 112289 A	18(574)2021
M 2022 35276 R	AM 112290	AM 2021 112290 A	18(574)2021
M 2022 35277 R	AM 112369	AM 2021 112369 A	18(574)2021
M 2022 35278 R	AM 112370	AM 2021 112370 A	18(574)2021
M 2022 35279 R	AM 112371	AM 2021 112371 A	18(574)2021
M 2022 35280 R	AM 112372	AM 2021 112372 A	18(574)2021
M 2022 35281 R	AM 112373	AM 2021 112373 A	18(574)2021
M 2022 35282 R	AM 112389	AM 2021 112389 A	21(577)2021

1	2	3	4
M 2022 35283 R	AM 112392	AM 2021 112392 A	21(577)2021
M 2022 35284 R	AM 112395	AM 2021 112395 A	21(577)2021
M 2022 35285 R	AM 112396	AM 2021 112396 A	21(577)2021
M 2022 35286 R	AM 112400	AM 2021 112400 A	20(576)2021
M 2022 35287 R	AM 112422	AM 2021 112422 A	20(576)2021
M 2022 35288 R	AM 112487	AM 2021 112487 A	20(576)2021
M 2022 35289 R	AM 112495	AM 2021 112495 A	21(577)2021
M 2022 35290 R	AM 112594	AM 2021 112594 A	14(570)2021
M 2022 35291 R	AM 112690	AM 2021 112690 A	20(576)2021
M 2022 35292 R	AM 112697	AM 2021 112697 A	20(576)2021
M 2022 35293 R	AM 112899	AM 2021 112899 A	23(579)2021
M 2022 35294 R	AM 112903	AM 2021 112903 A	23(579)2021
M 2022 35295 R	AM 112933	AM 2021 112933 A	23(579)2021
M 2022 35296 R	AM 112935	AM 2021 112935 A	23(579)2021
M 2022 35297 R	AM 112936	AM 2021 112936 A	23(579)2021
M 2022 35298 R	AM 113018	AM 2021 113018 A	23(579)2021
M 2022 35299 R	AM 113103	AM 2021 113103 A	23(579)2021
M 2022 35300 R	AM 113104	AM 2021 113104 A	23(579)2021
M 2022 35301 R	AM 113108	AM 2021 113108 A	22(578)2021
M 2022 35302 R	AM 113143	AM 2021 113143 A	23(579)2021
M 2022 35303 R	AM 113191	AM 2021 113191 A	23(579)2021
M 2022 35304 R	AM 113193	AM 2021 113193 A	23(579)2021
M 2022 35305 R	AM 113194	AM 2021 113194 A	23(579)2021
M 2022 35306 R	AM 113195	AM 2021 113195 A	23(579)2021
M 2022 35307 R	AM 113199	AM 2021 113199 A	23(579)2021
M 2022 35308 R	AM 113200	AM 2021 113200 A	23(579)2021
M 2022 35309 R	AM 113201	AM 2021 113201 A	23(579)2021
M 2022 35310 R	AM 113202	AM 2021 113202 A	23(579)2021
M 2022 35311 R	AM 113203	AM 2021 113203 A	23(579)2021
M 2022 35312 R	AM 113211	AM 2021 113211 A	23(579)2021
M 2022 35313 R	AM 113227	AM 2021 113227 A	23(579)2021
M 2022 35314 R	AM 113240	AM 2021 113240 A	23(579)2021
M 2022 35315 R	AM 113267	AM 2021 113267 A	23(579)2021
M 2022 35316 R	AM 113286	AM 2021 113286 A	23(579)2021
M 2022 35317 R	AM 113491	AM 2021 113491 A	23(579)2021
M 2022 35318 R	AM 111720	AM 2021 111720 A	18(574)2021
M 2022 35319 R	AM 111834	AM 2021 111834 A	18(574)2021
M 2022 35320 R	AM 112273	AM 2021 112273 A	20(576)2021
M 2022 35321 R	AM 117303	–	8(586)2022
M 2022 35322 R	AM 117298	–	8(586)2022
M 2022 35323 R	AM 117275	–	8(586)2022
M 2022 35324 R	AM 117313	–	8(586)2022
M 2022 35325 R	AM 113228	AM 2021 113228 A	23(579)2021
M 2022 35326 R	AM 117431	–	8(586)2022

**CONCORDANCE TABLE OF PUBLICATION NUMBERS
AND APPLICATION NUMBERS**

NUMBER OF PUBLISHED APPLICATION (260)	NUMBER OF APPLICATION (210)	1	2
1	2		
AM 2022 112167 A	AM 112167	AM 2022 114679 A	AM 114679
AM 2022 112471 A	AM 112471	AM 2022 114686 A	AM 114686
AM 2022 113393 A	AM 113393	AM 2022 114689 A	AM 114689
AM 2022 113417 A	AM 113417	AM 2022 114690 A	AM 114690
AM 2022 113990 A	AM 113990	AM 2022 114692 A	AM 114692
AM 2022 114463 A	AM 114463	AM 2022 114742 A	AM 114742
AM 2022 114465 A	AM 114465	AM 2022 114743 A	AM 114743
AM 2022 114472 A	AM 114472	AM 2022 114751 A	AM 114751
AM 2022 114532 A	AM 114532	AM 2022 114753 A	AM 114753
AM 2022 114534 A	AM 114534	AM 2022 114757 A	AM 114757
AM 2022 114543 A	AM 114543	AM 2022 114806 A	AM 114806
AM 2022 114590 A	AM 114590	AM 2022 114808 A	AM 114808
AM 2022 114608 A	AM 114608	AM 2022 114809 A	AM 114809
AM 2022 114611 A	AM 114611	AM 2022 114810 A	AM 114810
AM 2022 114615 A	AM 114615	AM 2022 114900 A	AM 114900
AM 2022 114677 A	AM 114677	AM 2022 114901 A	AM 114901
		AM 2022 114902 A	AM 114902
		AM 2022 114904 A	AM 114904
		AM 2022 114917 A	AM 114917
		AM 2022 114920 A	AM 114920
		AM 2022 114972 A	AM 114972

CONCORDANCE TABLE OF INDEX OF GOODS AND/OR SERVICES
AND APPLICATION NUMBERS

INDEX OF GOODS AND/OR SERVICES (511)	NUMBER OF PUBLISHED APPLICATIONS (260)	1	2
1	2	33	AM 2022 113417 A
3	AM 2022 114465 A	33	AM 2022 113990 A
3	AM 2022 114615 A	33	AM 2022 114472 A
5	AM 2022 114463 A	33	AM 2022 114611 A
5	AM 2022 114679 A	33	AM 2022 114677 A
5	AM 2022 114689 A	33	AM 2022 114753 A
5	AM 2022 114690 A	33	AM 2022 114757 A
5	AM 2022 114692 A	33	AM 2022 114808 A
5	AM 2022 114743 A	33	AM 2022 114900 A
9	AM 2022 114532 A	33	AM 2022 114901 A
9	AM 2022 114751 A	33	AM 2022 114902 A
12	AM 2022 114532 A	33	AM 2022 114917 A
12	AM 2022 114534 A	34	AM 2022 114920 A
16	AM 2022 114751 A	35	AM 2022 114532 A
16	AM 2022 114809 A	35	AM 2022 114679 A
16	AM 2022 114810 A	35	AM 2022 114686 A
21	AM 2022 114742 A	35	AM 2022 114904 A
29	AM 2022 114806 A	36	AM 2022 113393 A
30	AM 2022 112471 A	36	AM 2022 114532 A
30	AM 2022 114608 A	36	AM 2022 114590 A
32	AM 2022 113990 A	37	AM 2022 114532 A
32	AM 2022 114679 A	38	AM 2022 114751 A
32	AM 2022 114686 A	39	AM 2022 114532 A
32	AM 2022 114808 A	42	AM 2022 112167 A
32	AM 2022 114917 A	42	AM 2022 114532 A
32	AM 2022 114972 A	43	AM 2022 114532 A
		43	AM 2022 114543 A
		44	AM 2022 114463 A
		44	AM 2022 114743 A

CONCORDANCE TABLE OF INDEX OF GOODS AND/OR SERVICES
AND NUMBERS OF TRADEMARKS REGISTERED ACCORDING
TO THE ACCELERATED PROCEDURE

INDEX OF GOODS AND/OR SERVICES (511)	NUMBERS OF REGISTERED ACCORDING TO THE ACCELERATED PROCEDURE (111)
3	M 2022 35263 R
5	M 2022 35263 R
5	M 2022 35321 R
5	M 2022 35324 R
5	M 2022 35326 R
21	M 2022 35263 R
30	M 2022 35261 R
33	M 2022 35322 R
34	M 2022 35260 R
35	M 2022 35321 R
36	M 2022 35262 R
39	M 2022 35259 R
41	M 2022 35259 R
43	M 2022 35258 R
43	M 2022 35323 R

OFFICIAL BULLETIN OF THE INDUSTRIAL PROPERTY

INVENTIONS
UTILITY MODELS
DESIGNS
TRADEMARKS

8(587)

EDITOR-IN-CHIEF: N. Bebrishvili

EDITOR-TRANSLATOR: E. Gabunia

PROOFREADER: A. Shikhashvili

COMPUTER LAYOUT: M. Ordenidze
K. Svanidze

info@sakpatenti.gov.ge
www.sakpatenti.gov.ge